



ELECTRICAL COMMUNICATION

*Technical Journal of the
International Telephone and Telegraph Corporation
and Associate Companies*

•

PROCESSING INTERNATIONAL TELEGRAPHIC MESSAGES

SEMICONDUCTOR APPLICATIONS TO RECTIFIERS AND TRANSISTORS

RATING OF VALVES UNDER ABNORMAL AMBIENT CONDITIONS

CONDUCTOR HAVING LOW RESISTANCE AT HIGH FREQUENCIES

TELEPHONE STATISTICS OF THE WORLD



Volume 34

DECEMBER, 1957

Number 4

712

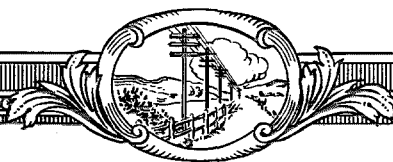

ELECTRICAL COMMUNICATION

*Technical Journal of the
International Telephone and Telegraph Corporation
and Associate Companies*

H. P. WESTMAN, Editor
J. E. SCHLAIKJER, Assistant Editor

EDITORIAL BOARD

G. H. Brodie H. G. Busignies R. S. Caruthers G. Chevigny A. G. Clavier E. M. Deloraine
F. R. Furth G. Goudet J. A. Henderson B. C. Holding J. Kruithof W. P. Maginnis
A. W. Montgomery E. D. Phinney G. Rabuteau P. C. Sandretto C. E. Scholz T. R. Scott
C. E. Strong F. R. Thomas H. B. Wood

Published Quarterly by the
INTERNATIONAL TELEPHONE AND TELEGRAPH CORPORATION
67 BROAD STREET, NEW YORK 4, NEW YORK, U.S.A.

Edmond H. Leavey, President
C. Douglas Webb, Secretary

Subscription, \$2.00 per year; single copies, 50 cents

Copyrighted © 1957 by International Telephone and Telegraph Corporation

Volume 34

DECEMBER, 1957

Number 4

CONTENTS

PROCESSING INTERNATIONAL TELEGRAPHIC MESSAGES	285
SEMICONDUCTORS, THEIR APPLICATIONS TO RECTIFIERS AND TRANSISTORS	309
<i>By Georges Goudet</i>	
RATING OF THERMIONIC VALVES FOR USE UNDER ABNORMAL AMBIENT CONDITIONS	322
<i>By Bernard D. Mills and Walter W. Wright</i>	
MULTILAYER CONDUCTOR HAVING LOW RESISTANCE AT HIGH FREQUENCIES	332
<i>By Masao Sugi and Kaoru Murai</i>	
TELEPHONE STATISTICS OF THE WORLD	337
UNITED STATES PATENTS ISSUED TO INTERNATIONAL TELEPHONE AND TELEGRAPH SYSTEM; MAY-JULY, 1957	342
IN MEMORIAM—FREDERICK GEORGE CREED	345
RECENT TELECOMMUNICATION DEVELOPMENTS— CLOSED CIRCUIT TELEVISION SYSTEM PLANNING	331
ETCHING OF GUSTAV ROBERT KIRCHHOFF	344
CONTRIBUTORS TO THIS ISSUE	346



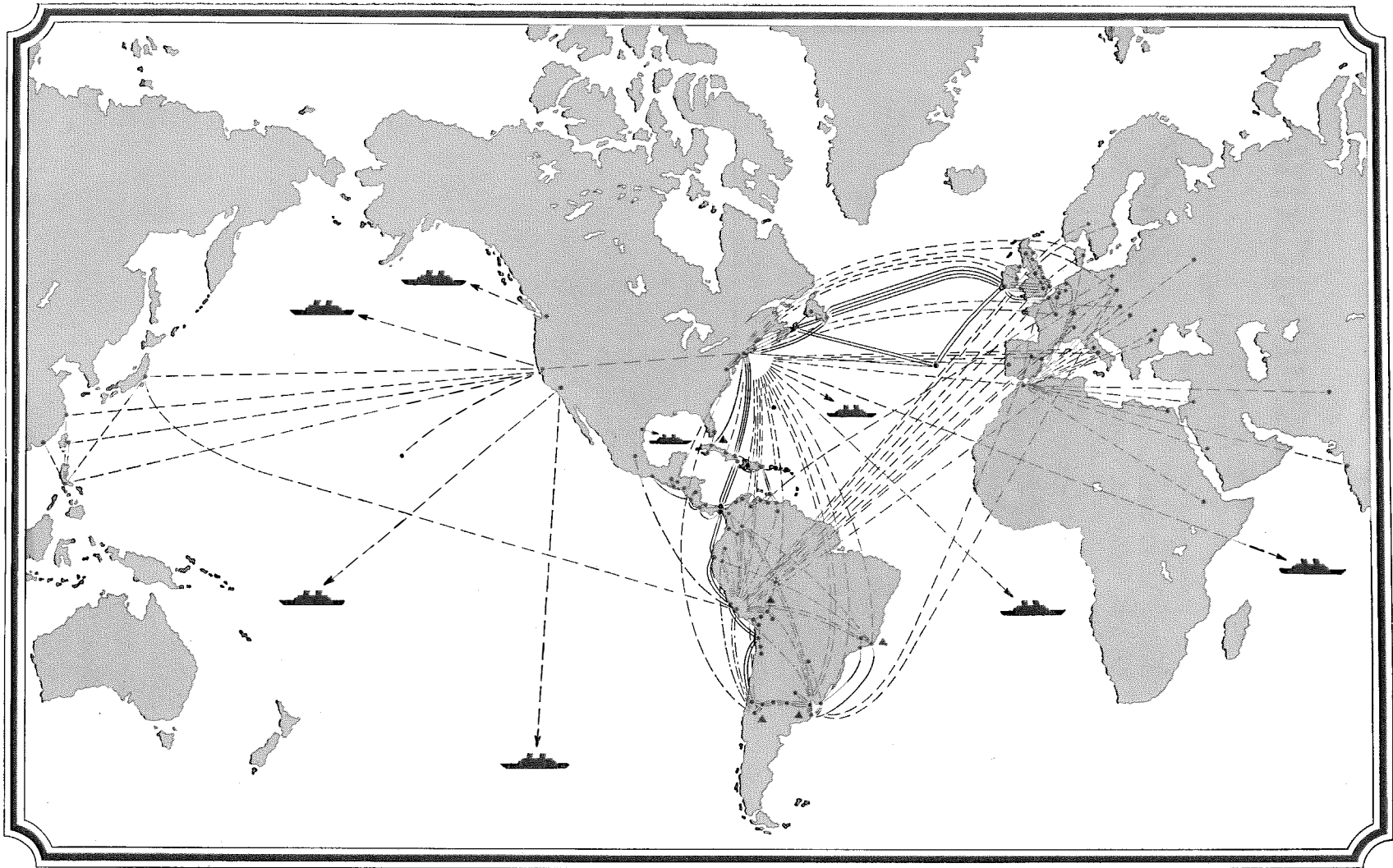

The world-wide telecommunications network of the American Cable & Radio System is shown on the above map. The system is composed of four operating companies: All America Cables and Radio, Inc.; The Commercial Cable Company; Mackay Radio and Telegraph

solid lines on the map represent cables and landlines, the dashed lines are radiotelegraph circuits, the dash-dot lines are radiotelephone circuits, and the ship symbols represent the ship-to-shore radiotelegraph service. Facilities connecting to this network enable service to

Processing International Telegraphic Messages

PERHAPS to many users of the international telegraphic service, the handling of messages within the telegraph company itself is a mystery. A message is placed in the care of the company for transmission and after but a brief interval within the maw of this large and complex organization, it reappears miraculously at its destination. Or, using the telex service, a businessman can sit in his office carrying on a type-

written conversation with another individual in an office on the other side of the world.

As an aid to clarifying the procedures and equipment used to process international telegraphic traffic, there are presented on the following pages a series of photographs that exemplify the major steps. The pictures illustrate the flow of traffic through the headquarters of the American Cable & Radio System in New York City.

1. Messages are received in the operating room through many different routes. Perhaps the most convenient for the customer is the installation, where his traffic is sufficient to make it economical, of a private-wire teleprinter in his office as shown below. This machine is directly connected to the central operating room, permitting almost instantaneous transmission and reception of messages.

The machine shown has a tape perforator and tape transmitter, permitting prerecording of messages before sending, a convenience of particular advantage for multiple-address messages. Incoming messages can also be punched in tape for providing extra copies for internal use. The installation of a private-wire teleprinter gives the customer access to the telex service described in photographs 13-14.



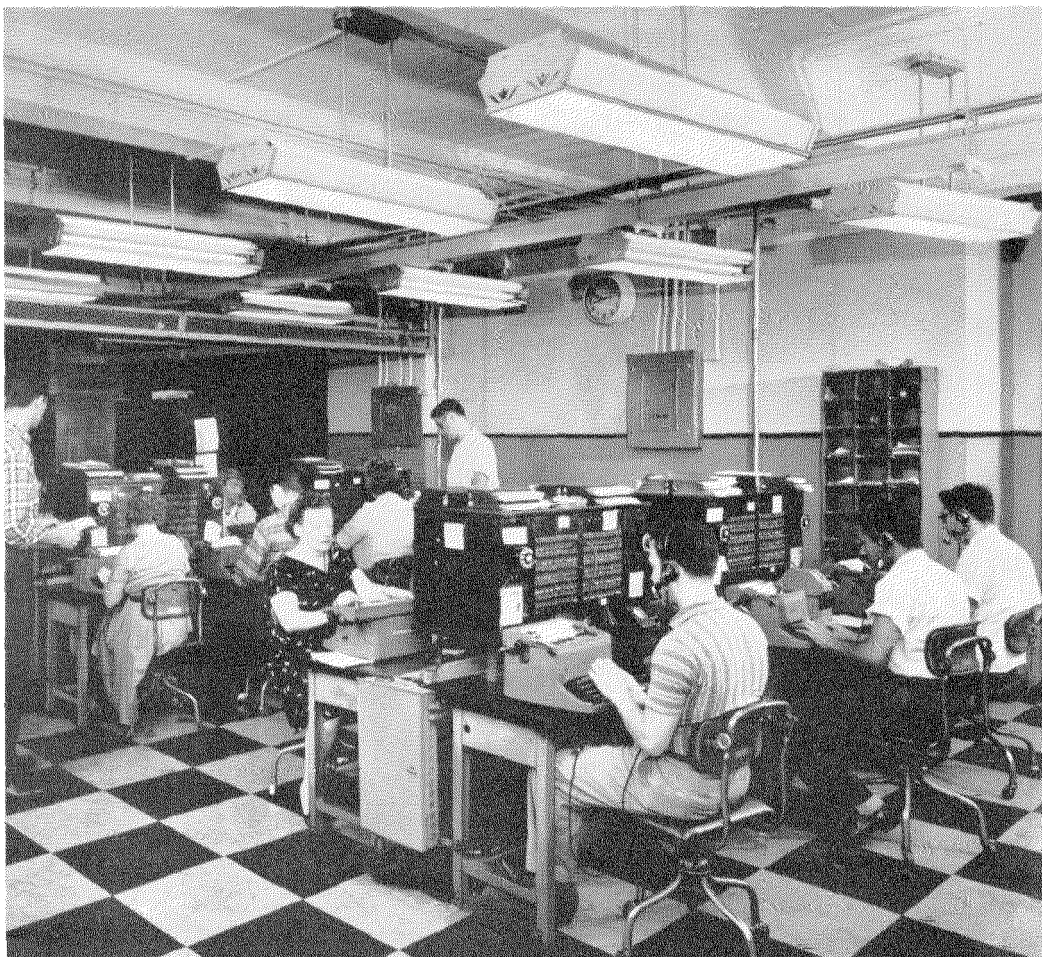

2. Above is shown a portion of the private-wire section in the operating room. Switchboards are used to distribute the customers' incoming and outgoing calls among the various teleprinters. The structure running across the ceiling at the left encloses endless-belt conveyers for dispatching messages to and receiving messages from the check center, the message distributing point for the operating room.

3. At the left is the telephone room, another method of communication with the customer. This facility provides for message handling between customer and operating room by telephone.

4. Another route for accepting messages from and delivering messages to the customer is through the branch offices. Telegrams are delivered to the customer by messenger. To send a message, the customer can telephone the office for a messenger or, if he has a special call box, he can signal to the branch office that a messenger is needed. At the right is a photograph of a typical branch office and below is shown the section of the operating room where teleprinters connect to all branch offices in the area of New York City. These machines provide for the transfer of messages between the branch offices and the operating room.



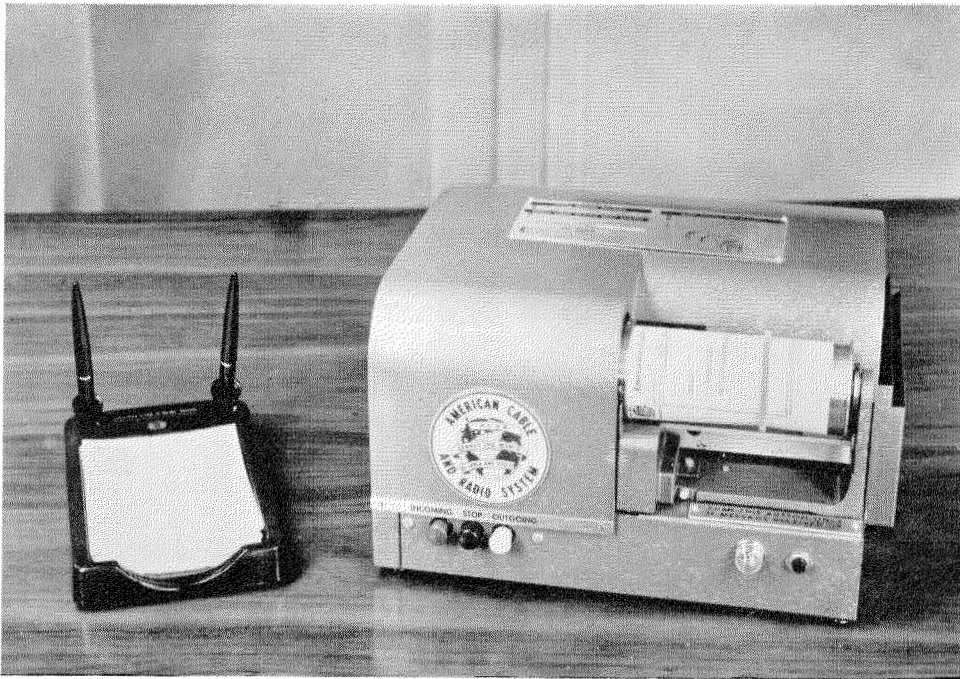

5. Desk-Fax is a relatively new method of communication between customer and operating room. The customer's machine shown at the left enables him to send a message to the operating room by merely wrapping it around the cylinder as shown and pushing a button. At the operating room (below) an exact reproduction is immediately received. The customer receives incoming messages on his desk-top machine. In the operating room, the sending equipment is shown at the right and receiving facilities are at the left. A switchboard is used to distribute the messages to the equipment.

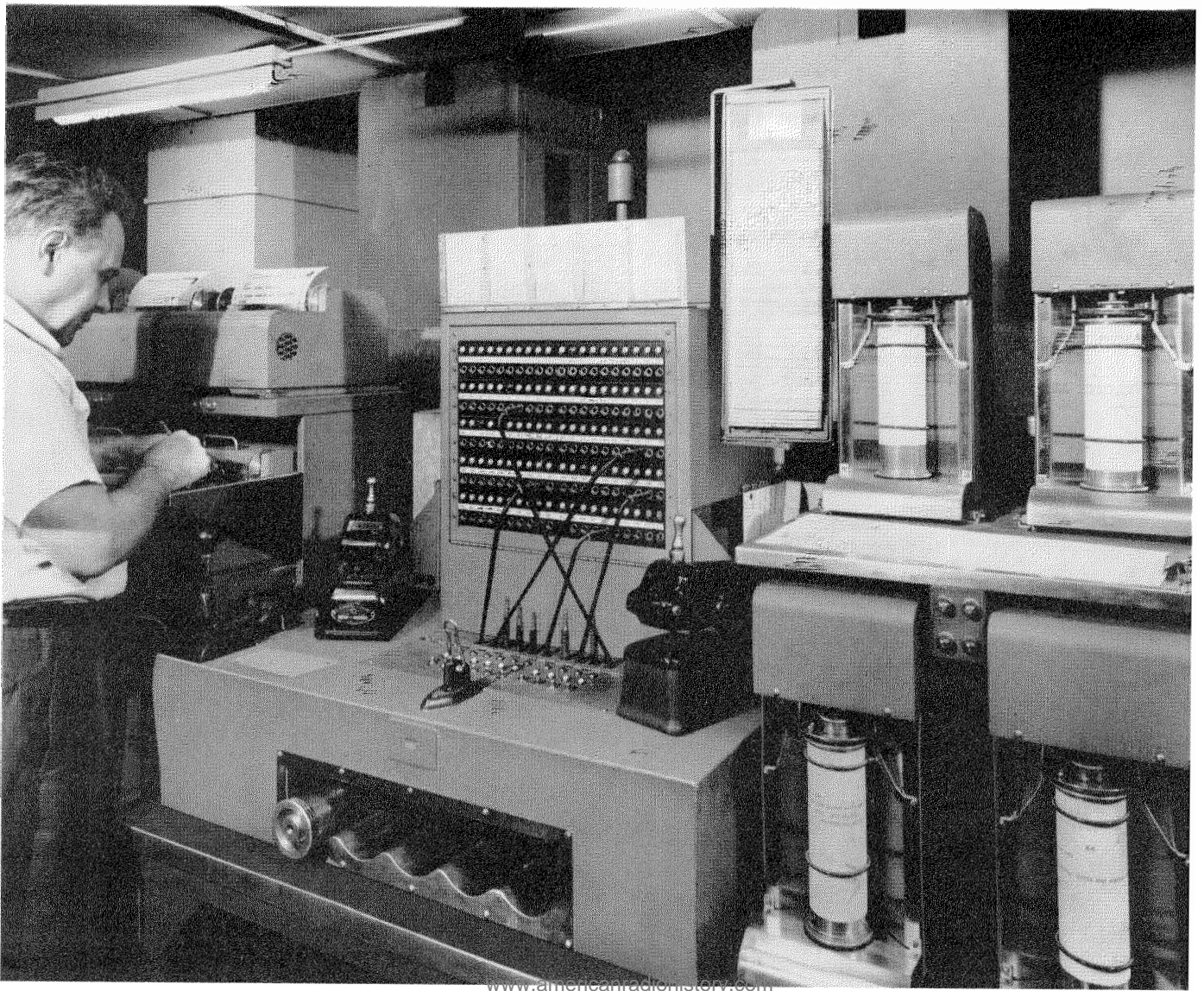



6. The check center, through which messages pass for routing within the operating room, is shown in the view above. Messages incoming to New York come to the check personnel on moving belts. The address of each message is scanned and the proper means of delivery to the customer is determined from the address and from lists of customers' standing orders; code-address directories are also available. Messages are transported by belt conveyer from the check center to the private-wire section, the branch-office section, the telephone room, the Desk-Fax section, or to other delivery means, such as the domestic telegram service.

Messages outgoing from New York are routed by the check personnel to the proper operating-room section for transmission by cable or radio to its overseas destination.

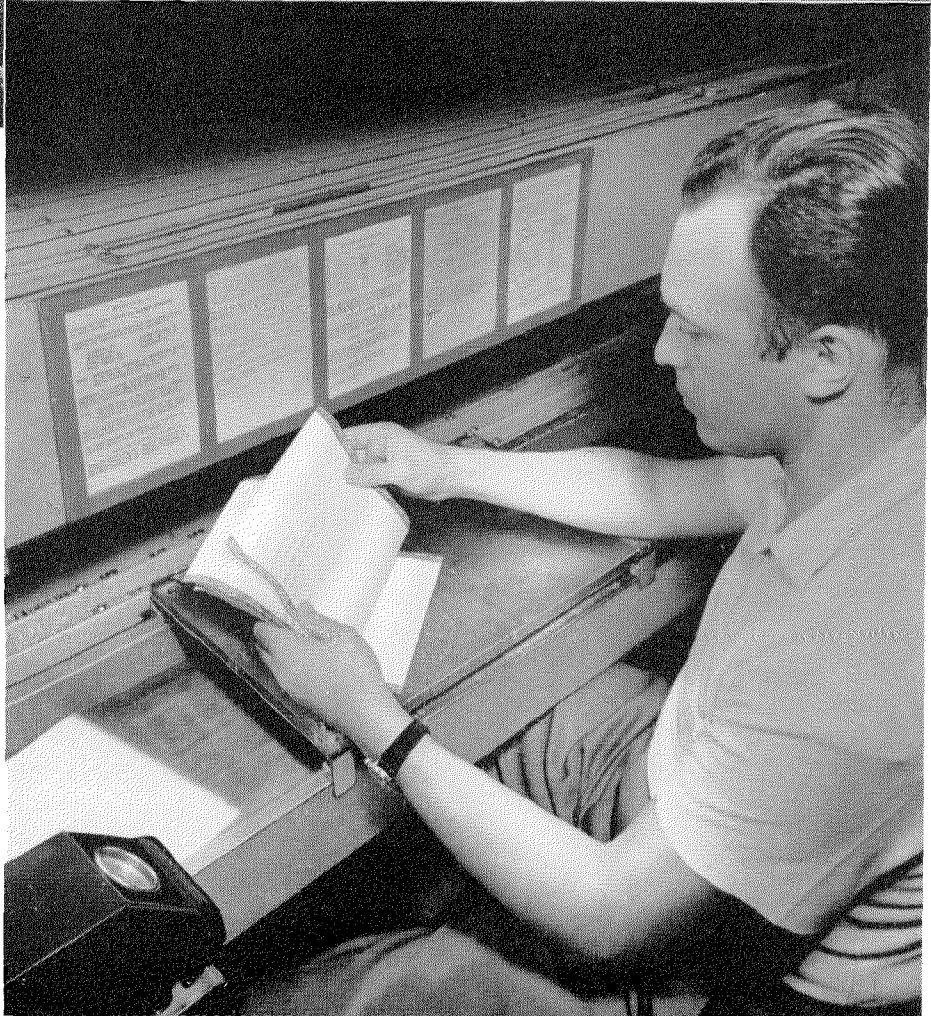

7. The American Cable and Radio System maintains simultaneous cable and radio circuits to many international points, offering the advantage that difficulties with one facility do not cause a breakdown in service. Below is a view of a row of sending positions for international teleprinter traffic. The operator punches the message in teleprinter code in the tape, which, passing through the tape transmitter at the far left, is automatically caused to key a radio transmitter at Brentwood, New York, or to apply signal to a transatlantic telegraph cable terminating at Far Rockaway, New York.





8. A row of international receiving-circuit teleprinters operated by signals received through the radio receiving station at Southampton, New York, or the Far Rockaway cable terminal. The message is simultaneously printed and punched on tape, but tape retransmission is automatically withheld until initiated by the operator after he has inspected the address of the message. By means of a switching unit, messages are routed within the office to the private-wire and branch-office sections. Messages destined to inland areas are switched to the domestic telegraph company for delivery. The remainder of the messages are sent by belt conveyer to the check center for delivery in the New York area.

NY-975-ACLR

American Cable & Radio System

"Via All America" "Via Commercial" "Via Mackay Radio"

TO TELEPHONE A MESSAGE OR CALL
A MESSENGER - Whitehall 4-3100
Teletypewriter Exchanges:
NY 1-405, NY 1-406 and NY 1-407
OR ANY BRANCH OFFICE
SEE OTHER SIDE OF THIS FORM



An IT&T Associate

NO. FULL RATE
TIME LETTER TELEGRAM
CHECK (LT)

SENDER SHOULD INDICATE (MARK "X") CLASS OF SERVICE DESIRED; OTHERWISE FULL RATE AND SERVICE APPLY

SENDER'S NAME AND ADDRESS: Coffee Company New York DATE: August 25, 1957

PLEASE FILL IN ONE ROUTING
VIA ALL AMERICA or VIA COMMERCIAL or VIA MACKAY RADIO

To: CTR 1822
CAFESIG RIODEJANEIRO (9) Via Mackay Radio

PLEASE HIGH SHIPMENT OUR ORDER 5490 51d 7L

COFFEECOY 5-11-52 010 15

UR 450

SEND THIS MESSAGE SUBJECT TO RULES AND REGULATIONS SET FORTH IN THE COMPANIES TARIFF BOOK ON FILE WITH THE FEDERAL COMMUNICATIONS COMMISSION

9. A specimen international teleprinter-circuit message is shown above together with part of the 5-unit tape and the corresponding received answer to this message is shown below. The receiving tape below is produced by a typing reperforator, in which the 5-unit code is punched partially through the tape, and the message is simultaneously printed on the tape.

← RJ ← RIODEJANEIRO ← COFFEECOY ← NEWYORK ← YOUR ORDER WILL BE SHIPPED TODAY ← CA
 698 10 25 1330 5490

All America Commercial Mackay Radio Cables and Radio Cables

STANDARD TIME 1A

1957 AUG 25 AM 11 52 US

RJ698

RIODEJANEIRO 10 25 1330

COFFEECOY

NEWYORK

YOUR ORDER 5490 WILL BE SHIPPED TODAY

CAFESIG

5490

American Cable & Radio System American Cable & Radio
 47 BROAD STREET, N. Y. • BOWLING GREEN 9-5150 47 BROAD STREET, N. Y. • BOWLING GR



10. Manual sending positions for international cable traffic are at the right and the corresponding receiving positions are at the left. These positions are connected with cables to Central and South America that terminate at Manhattan Beach, New

York. The message is transmitted from the tape being punched at the right; received messages are read from an inked line on tape and typewritten on a message form. Sample cable messages are shown on the next page, photographs 11.

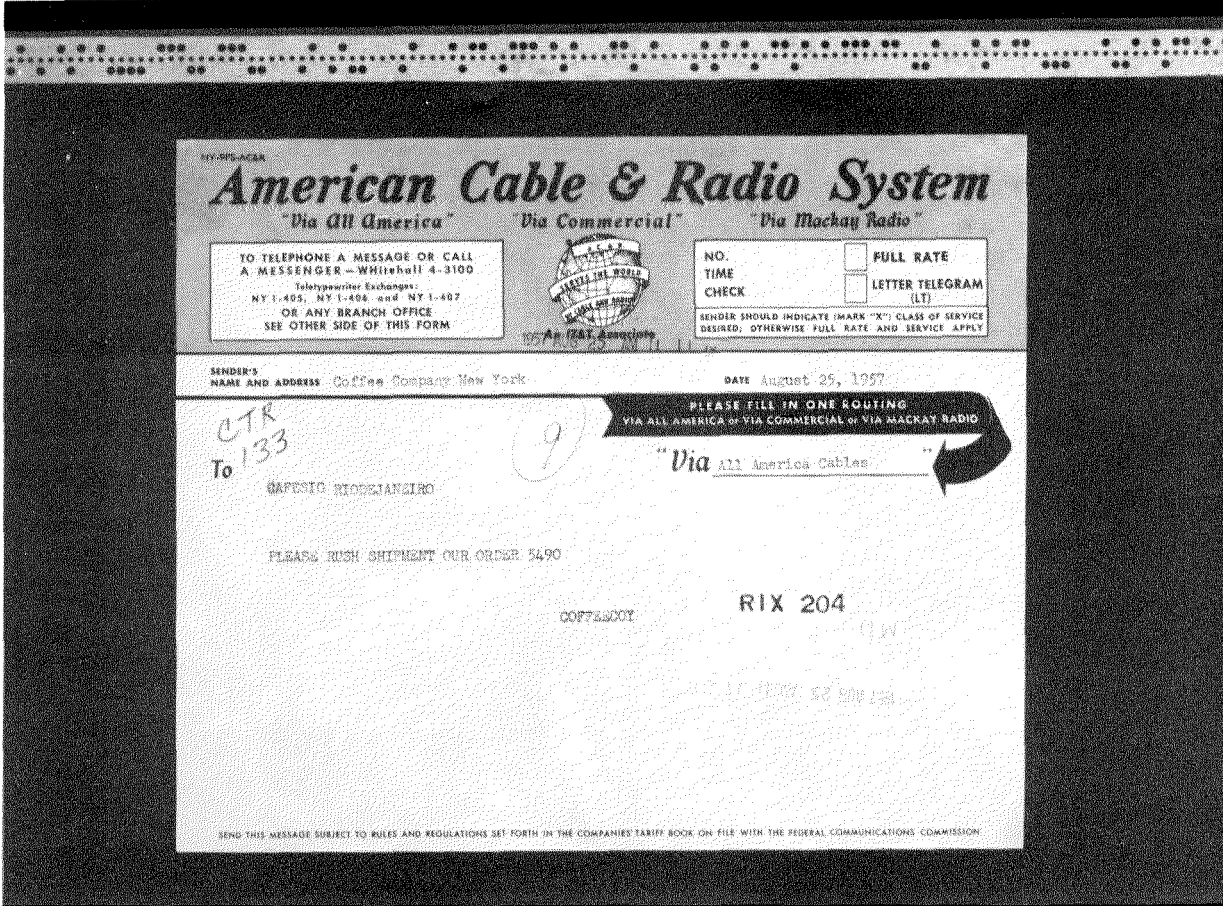

11. Above is a specimen message to be transmitted and a portion of the corresponding punched tape that will control the signals sent over the cable. Below is a portion of a message as it is received on a tape and then typed on a message form. In the

punched transmitting tape, the line of small holes along the middle are used in driving the tape through the equipment and are not part of the code. In both tapes, a hole or line above the middle corresponds to a Morse code dot and below the middle to a dash.

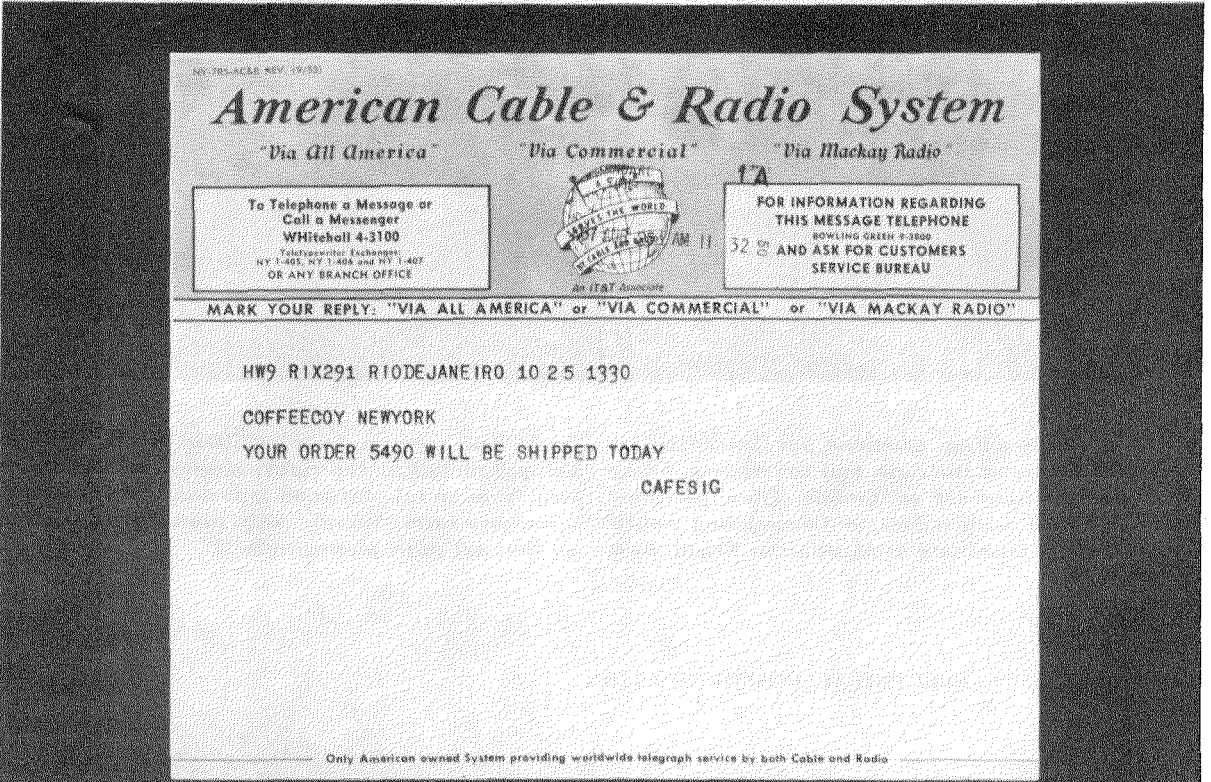



12. On very-lightly loaded radio circuits, where the installation of teleprinter equipment would be uneconomical, transmission by Morse code is used. In

the photograph above, the operator is punching tape for transmission and below, an operator transcribes a received message from inked tape onto a message form.

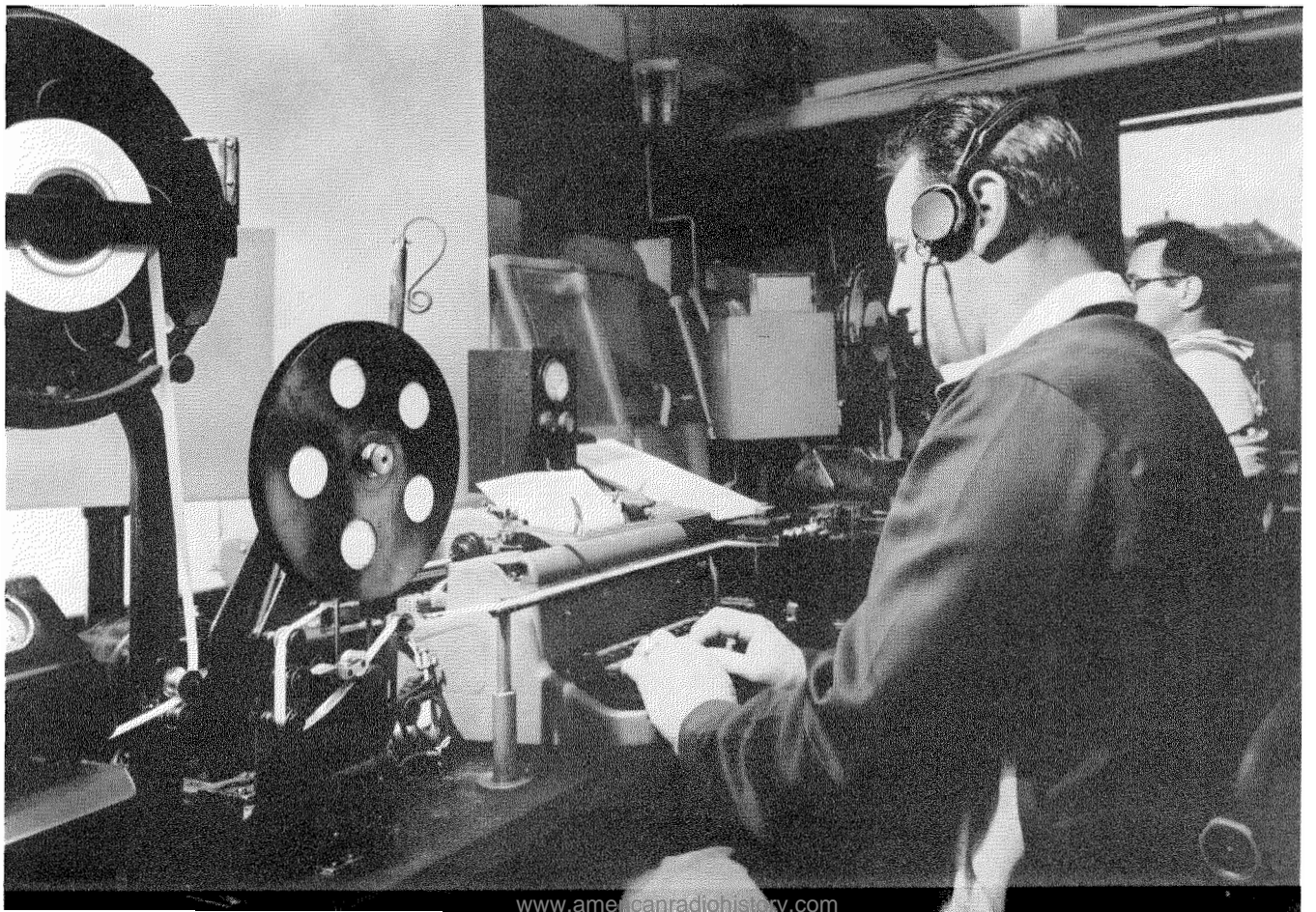





13. International telex service has recently been introduced in the United States. Telex is a means whereby teleprinters in the offices of two businesses, perhaps half a world distant from each other, are connected by a private circuit for intercommunication. In the United States, connection can be made to the teleprinters of customers of the American Cable & Radio System or to those of the telephone company's domestic telex service (TWX). The telex center used to set up these connections is shown on the facing page.

Multiplexing equipment for the international telex service is shown above. This equipment keys the radio transmitter and also handles the signal from

the radio receiver for each two-way telex channel. Each of the three equipments shown handles four 60-word-per-minute telex conversations simultaneously over one radio circuit.

This equipment is unusual in that it provides for automatic error correction. As in all radio transmission, noise or interference can cause the occasional reception of a mutilated code character. The equipment senses all received characters and when it receives one that has been mutilated, it automatically stops printing the message and causes similar equipment at the distant terminal to repeat the character; when it is received correctly, normal printing resumes.

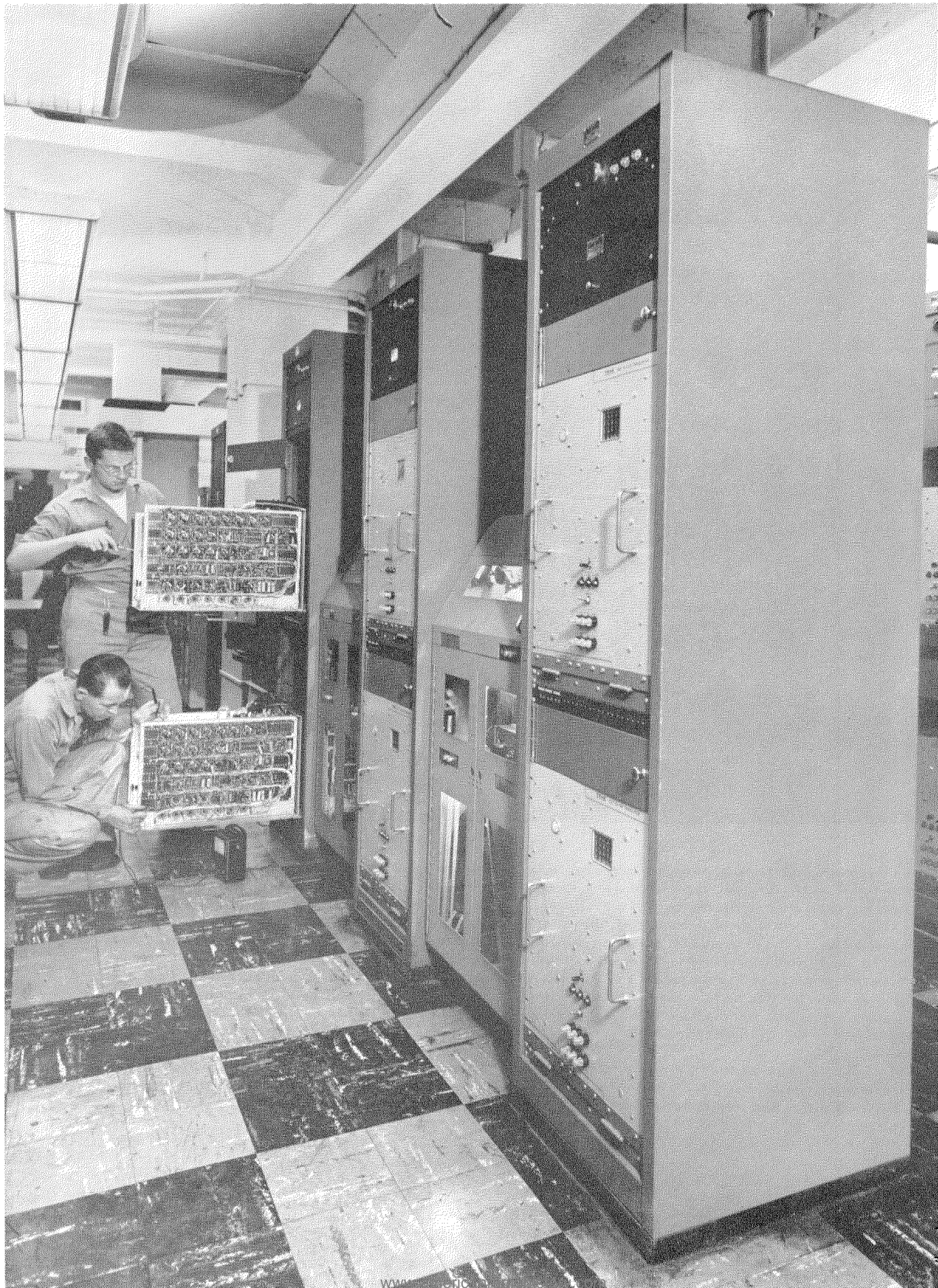

14. Additional equipment in the telex center is pictured on the facing page. Overseas and American teleprinter codes differ for some of the characters. The electronic equipment shown provides the necessary conversion to enable the overseas teleprinters to work with the American telephone company's domestic telex (TWX) network.



15. The service department at headquarters is shown here. Its function is to aid the customer in any required manner.

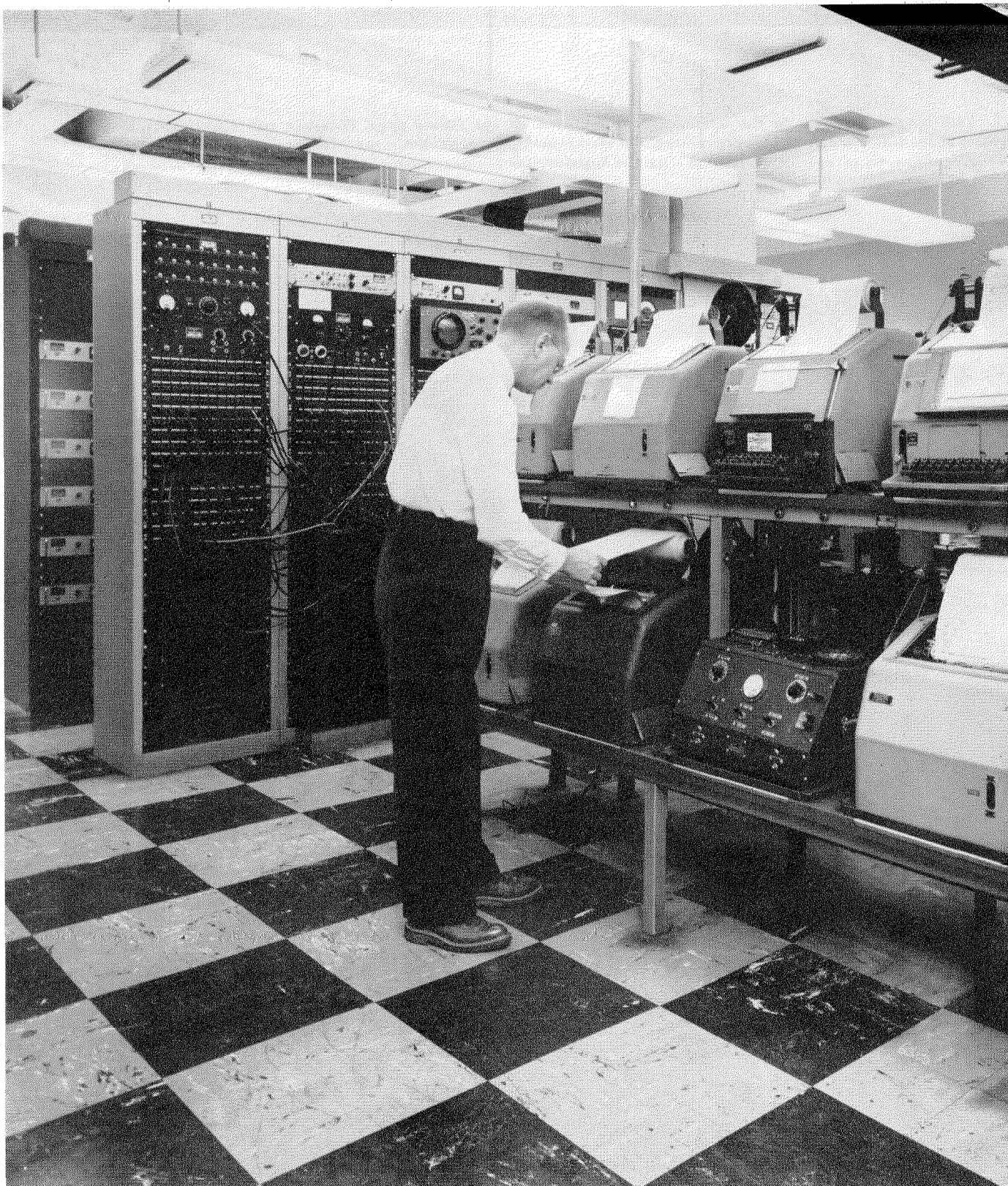

16. Part of the technical operations center for the operating room is shown here. The teleprinters are used for monitoring purposes in assuring proper operation of the cable and radio circuits. Two patchboards, of which one is visible behind the engineer,

enable connection of the operating-room equipment through control lines to the radio transmitting and receiving stations and the cable terminals. By means of multitone equipment, up to 12 messages can be transmitted simultaneously on one control line.

17. The control center at the Brentwood radio transmitting station. Signals from the technical operations center in New York received here operate the transmitters for overseas transmission. The Brentwood control center incorporates, in addition to the receiving equipment for the wire lines, multiplexing equipment to permit simultaneous transmission of several messages over one radio transmitter. Extensive monitoring equipment to assure that the equipment is functioning properly and considerable frequency-checking equipment to assure that all transmitters are operating on their assigned frequencies are also included.

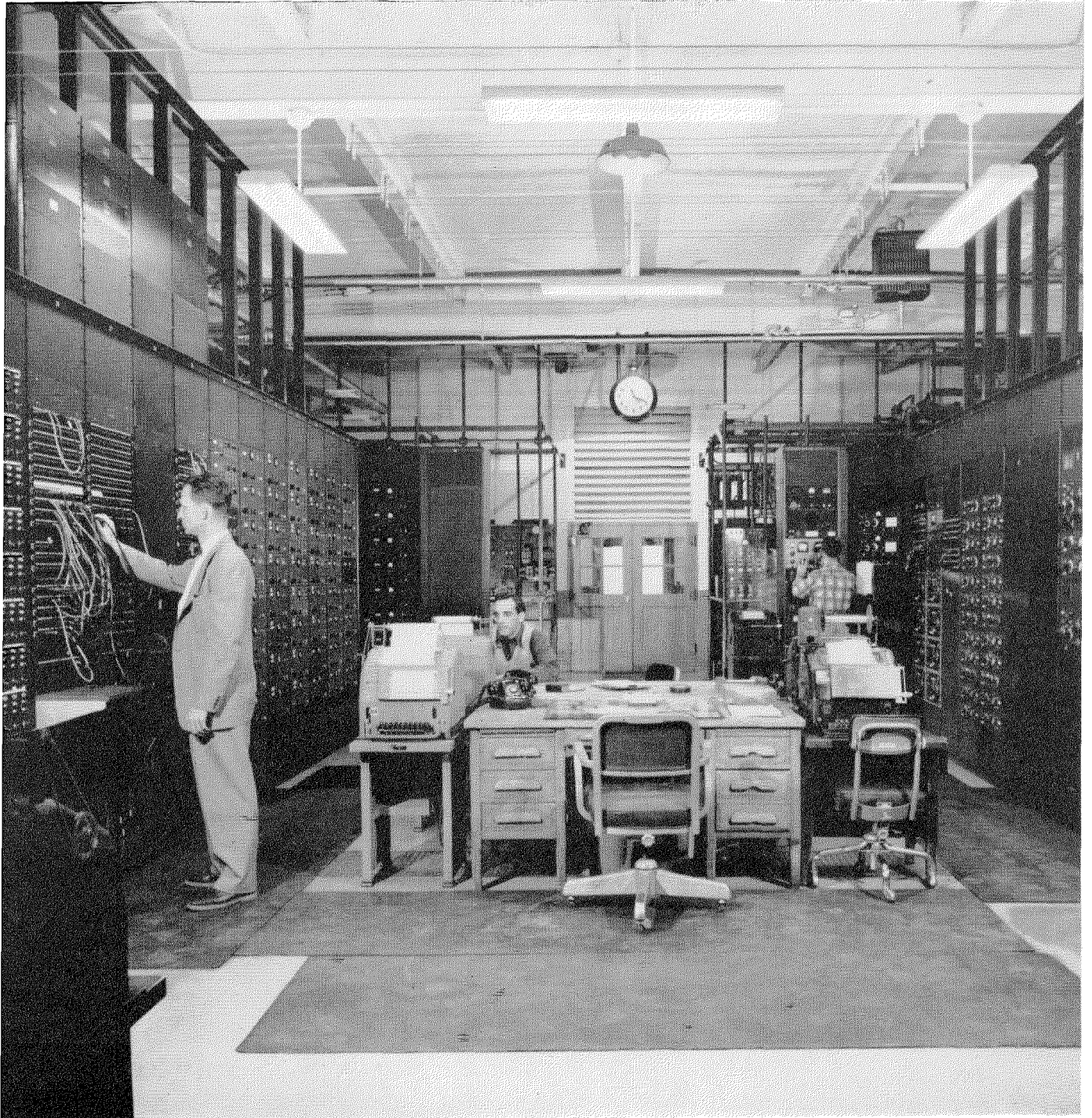

18. Two rows of high-power high-frequency transmitters at Brentwood. The grid of wires on the ceiling permits any of the 50 transmitters at the station to be connected to any of the outside transmission lines leading to the various antennas.



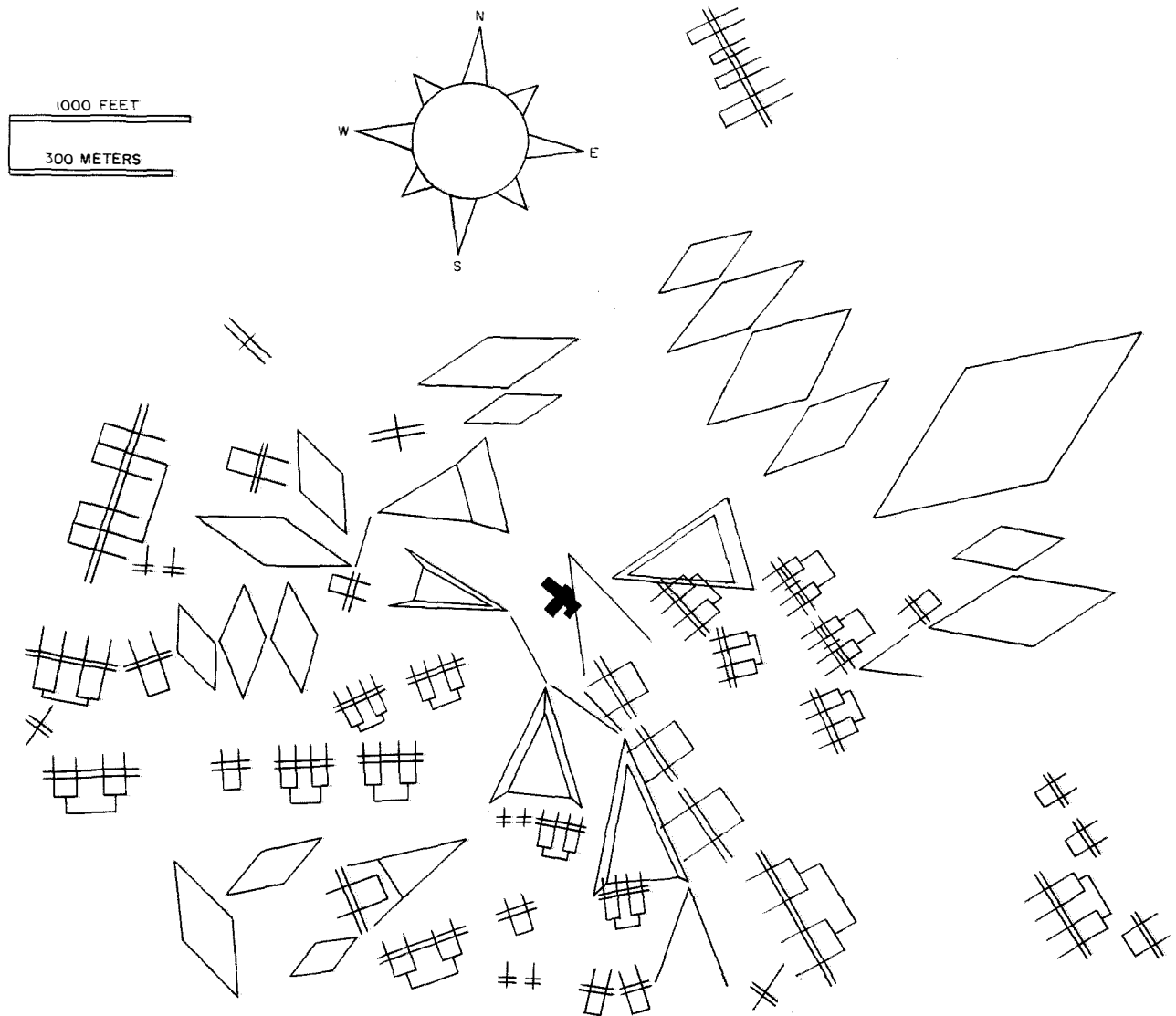
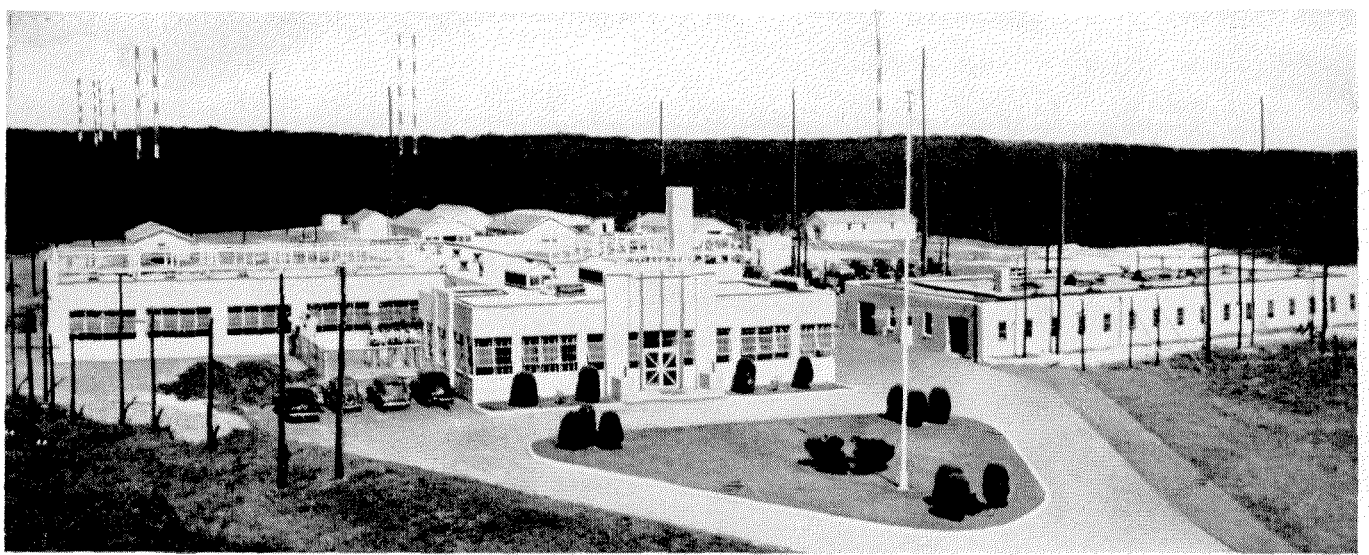

19. The transmitter building at Brentwood, shown above, is in the center of a "farm" of about 30 separate antennas. Wire lines, not shown in the drawing, carry signals from the building to each antenna. The antennas point in almost every direction, each being "aimed" at the appropriate overseas receiving station. Various sizes of antennas are required to accommodate the wide range of frequencies

used, the highest-frequency antennas being the smallest, in general. Radio propagation conditions for a given frequency change hour-by-hour, during the day, over the seasons of the year, and over a cycle of years. Changes often occur within minutes. To prevent interruption of service, provisions are made to change the transmitter frequencies and antennas to operate on optimum frequencies.

20. The international receiving station at Southampton also has a large antenna farm. In the building, below, dozens of receivers pick up the signals incoming to New York from overseas transmitters. These signals are transmitted via control lines to the technical operations center of the operating room in New York City.



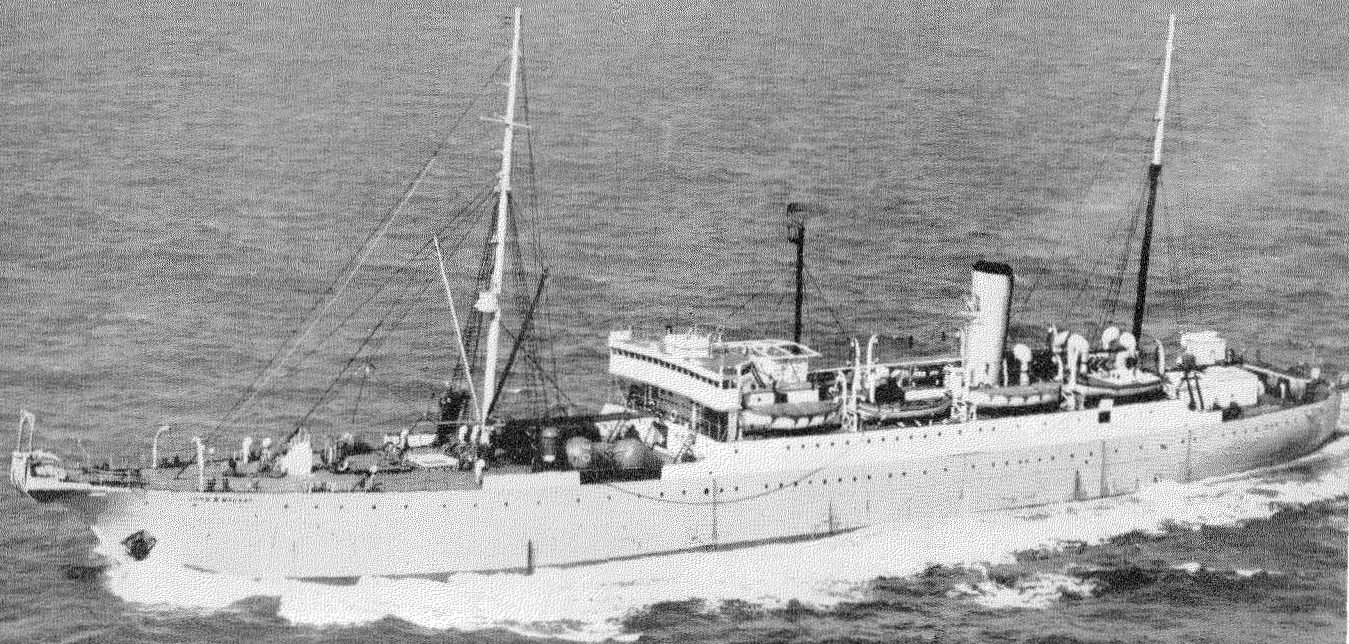

21. A fleet of cableships is maintained for repairing cable and for laying new cable as the communications network expands.

An ordinary cable often has the capacity of carrying several messages simultaneously; the messages are multiplexed just as on radio circuits. However, by splicing repeaters into each end of the cable, usually at the points where the cable just starts to descend to the deepest part of the ocean, the message-carrying capacity of the cable can be multiplied several times. The American Cable & Radio System is in the midst of an extensive program of putting repeaters into its cables. In the photograph at the right, a repeater is just being lowered over the bow sheaves of the cableship to rest on the bed of the ocean.



22. In addition to the point-to-point communications network described previously, the American Cable & Radio System also maintains a marine service for communication with ships at sea. The photograph above was taken at Southampton, New York, in the operating room for Amagansett radio station WSL. The operators communicate with ships using the radio receivers on the desks and, by means of telegraph keys also on the desks, they remotely operate the WSL transmitters at Amagansett, New York. This operating room is connected by direct wire line with the headquarters in New York City and with other important traffic destinations.

The WSF harbor control office and marine routing bureau in New York City is shown at the left. A few operating positions here permit communication with ships close to New York, where the high-powered Amagansett transmitters are not required. Transmitters and antennas atop the headquarters building are used.

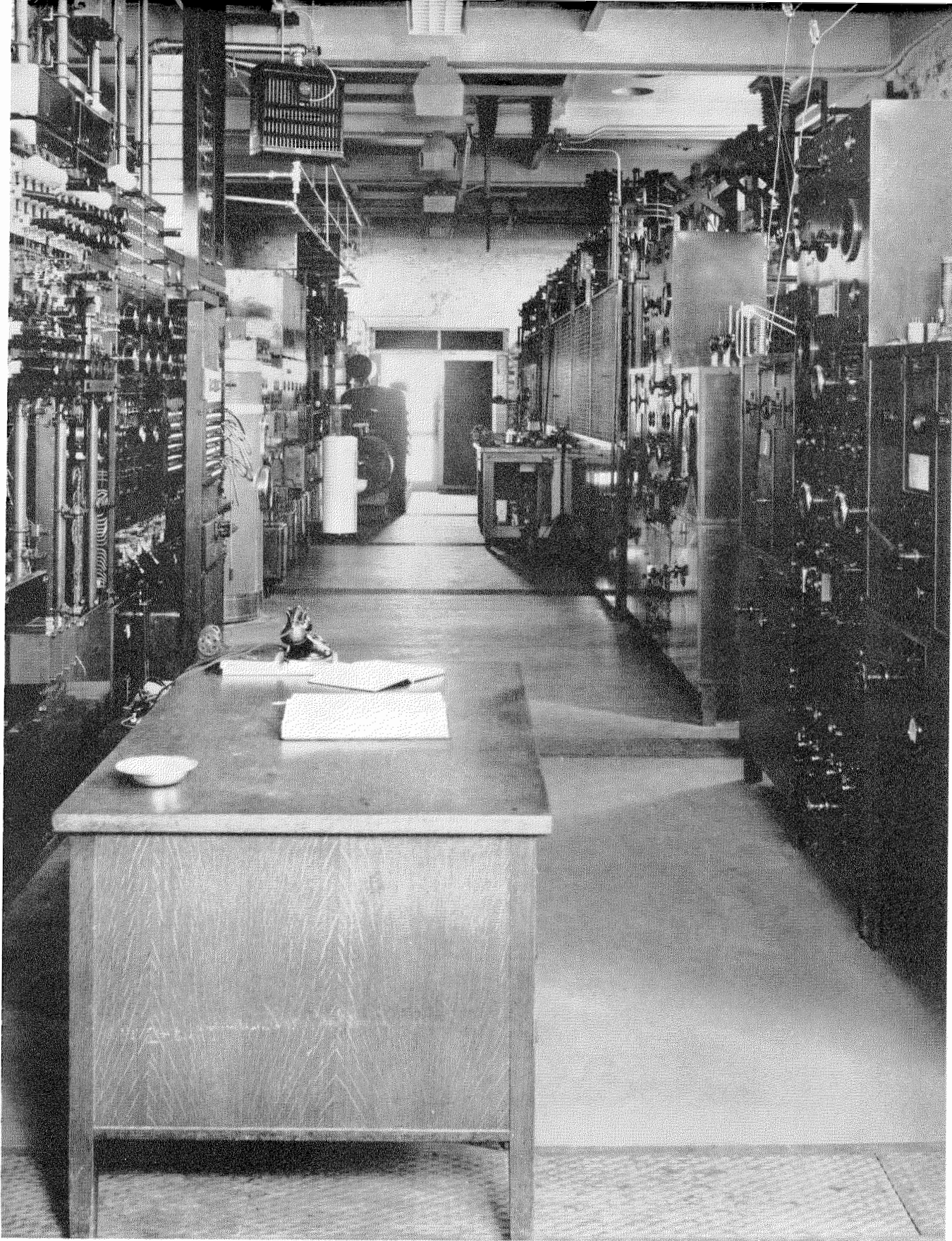

23. Rows of WSL marine transmitters at Amagansett.

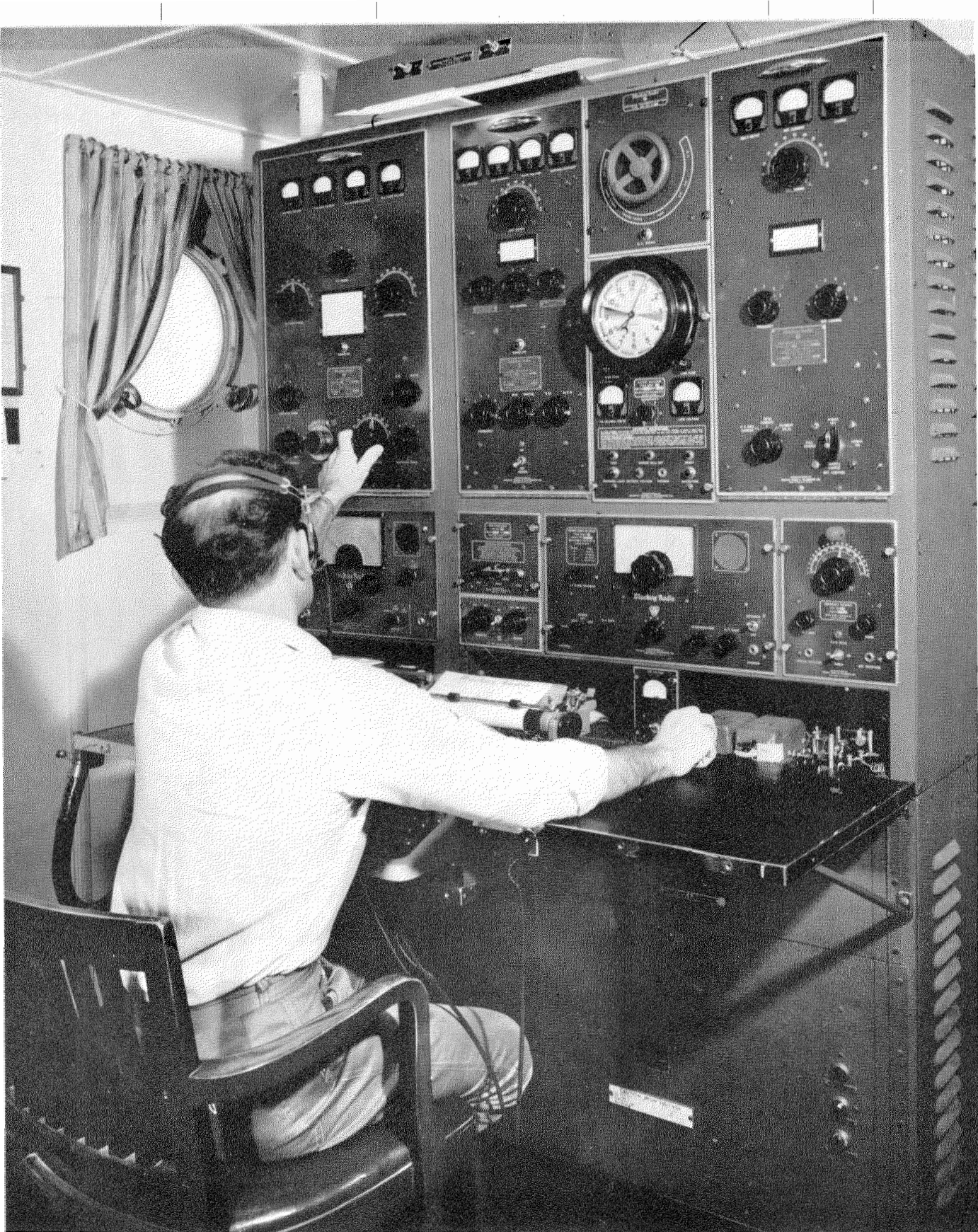

24. A shipboard radio installation is shown here. This all-in-one console includes all the transmitters and receivers required for safety at sea and for the transaction of commercial business; it is a product of the American Cable & Radio System.

Semiconductors, Their Applications to Rectifiers and Transistors*

By GEORGES GOUDET

Laboratoire Central de Télécommunications; Paris, France

TECHNICAL applications of semiconductors are not new. Since 1920, selenium has been used industrially in the manufacture of rectifiers, which have been greatly improved through the years and continue to be much in demand. From 1926, copper oxide has been used in the manufacture of small rectifiers, being particularly useful in measuring instruments. Also, all radio engineers of the period before 1920 will remember the important role played by the natural crystals of lead sulphide, or galena, in the detection of high-frequency signals. Selenium, copper oxide, and galena are three examples of semiconductors.

The present paper, however, concerns two other semiconductors, silicon and germanium, that came into use at a later date and have gained considerable importance in the last few years.

Investigation of their properties and the applications of certain characteristics have produced a revolution in the techniques of rectification and amplification. The present results stem from a long series of researches carried on in the United States, Great Britain, France, Germany, and elsewhere, of which perhaps the first were undertaken by Schottky in 1923.

1. Physical Properties of Semiconductors

1.1 INTRODUCTION

Researches into the physical properties of semiconductors have improved our knowledge of them greatly and have given a much clearer understanding of the flow of an electric current through a solid. As a result, their applications have been substantially increased.

The term "semiconductor" is based on the electrical resistivity of the material, which lies

between that of a good conductor and that of a good insulator.

At ordinary temperatures, the best conductor, silver, has a resistivity of 1.6×10^{-8} ohm-meter. A very-good insulator like quartz has a resistivity of about 10^{16} ohm-meters. Between these two extremes, germanium has a resistivity of 0.6 ohm-meter and silicon, 600 ohm-meters. Taking these figures into account, these substances appear to be more like conductors than insulators. Consequently, they were first considered as being poor conductors, that is, semiconductors. This view, however, has not withstood experimental tests, as will be shown by the phenomena to be described.

1.2 VARIATION OF RESISTIVITY WITH TEMPERATURE

It is usual for the resistivity of a conductor to increase with temperature. However, exactly the

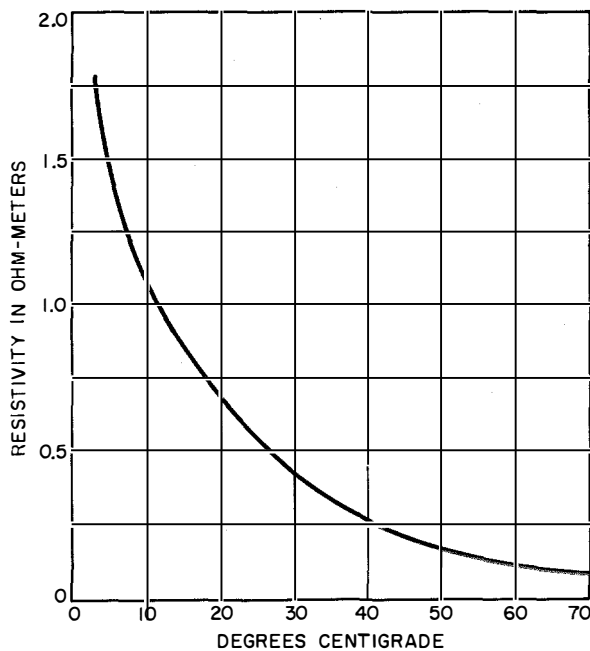

Figure 1—Variation of resistivity of germanium as a function of temperature.

* Presented at a joint meeting of Société des Ingénieurs Civils de France and Société Française des Electriciens on May 11, 1956, in Paris and at a meeting of Asociación de Ingenieros de Telecomunicación on June 11-12, 1956, in Madrid.

opposite occurs in the case of semiconductors. More precisely, there exists a broad temperature range in which the resistivity decreases with increase in temperature. It passes through a minimum and then increases again. Figure 1 shows the variations for germanium between 0 and 70 degrees centigrade. It can be seen that the resistivity at 70 degrees is only about 5 percent of the value at 0 degrees. For copper, the increase in resistivity would be about 25 percent for this rise in temperature.

1.3 EFFECT OF LIGHT

The effect of light is also unusual in that it produces a substantial decrease in resistivity. The curve shown in Figure 2 is an example. It

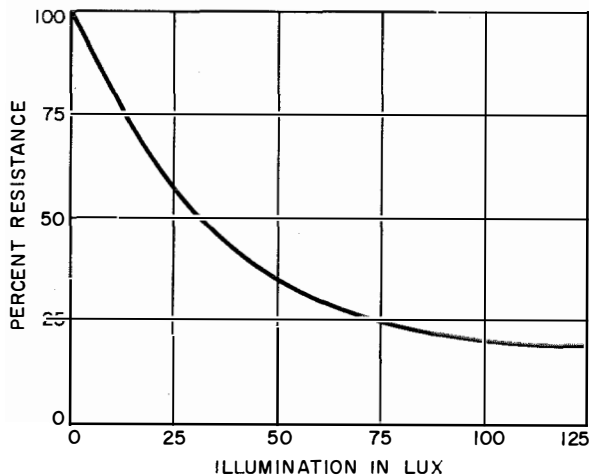

Figure 2—Variation of the resistance of a semiconductor photoconductive cell as a function of illumination in the visible spectrum as a percentage of its value when not illuminated.

applies to selenium, which is one of the metals most frequently used to demonstrate this property.

1.4 EFFECT OF IMPURITIES

Still more surprising is the effect of certain impurities, even in infinitesimal quantities. Germanium and silicon, being tetravalent substances, are affected by trivalent or pentavalent impurities such as aluminum, boron, and indium on the one hand, and phosphorus, arsenic, antimony, and bismuth on the other.

In Figure 3, the curve shows an example of this effect on germanium. For trivalent impurities, it may be seen that the addition of such

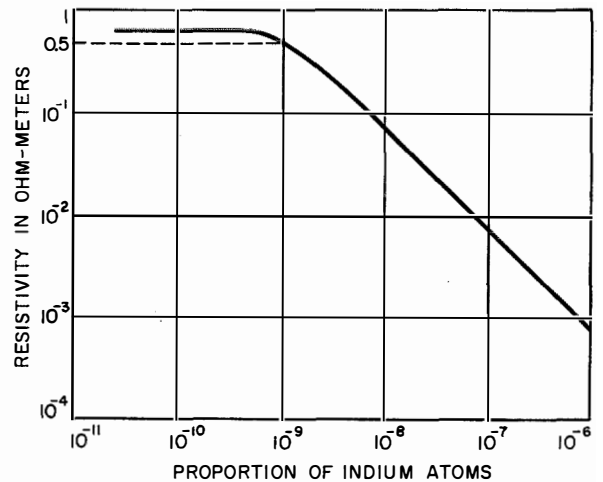

Figure 3—Variation of the resistivity of germanium as a function of the addition of indium.

an insignificant quantity as one atom of indium for 10^9 atoms of germanium causes the resistivity to change from the limit value of 0.6 ohm·meter to 0.5 ohm·meter, that is a reduction of 17 percent. When the resistivity must not differ by more than a few units per 100 from what is considered at present as the limiting value, it is necessary that the proportion of impurities be fewer than one foreign atom for 10^{10} atoms of germanium. This requirement exceeds by far the possibilities of chemical analysis and purification. It raises difficult problems in semiconductor technology.

The reason for such a large decrease in resistivity for so small an impurity content is not immediately evident. A study of the crystal lattice of the doped germanium, that is, germanium that has been solidified after the addition of the above-mentioned impurities, shows that these impurities place themselves in substitution positions, that is, they take the place of a germanium atom in the lattice. This also applies to silicon. Therefore, it may be conceived that, by introducing a pentavalent substance, each atom of which brings in one supplementary electron, the conductivity may be increased.

We are, in fact, tempted to consider the external electrons, being but weakly attached to the atoms, as carrying the electric current

through the solid bodies. But the order of magnitude of the observed effect is very-much larger than the increase in the number of these electrons.

Moreover, an explanation based on this idea might lead to the conclusion that the introduction of trivalent impurities would reduce the conductivity, whereas the contrary occurs.

1.5 HALL EFFECT

Our knowledge would be incomplete to an important extent, if no mention were made of the Hall effect. In Figure 4, there are two ribbons of conducting or semiconducting material in which an electric current is made to flow in the

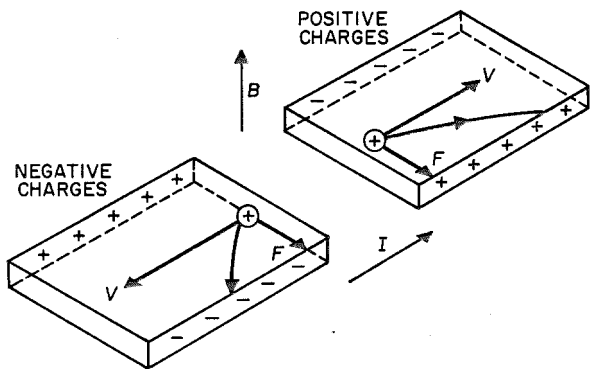

Figure 4—Hall effect.

direction of the arrow labelled I . It is known that this current is not accompanied by matter displacement as in electrolysis but is a movement of electrons. These electrons, being negatively charged, move parallel to the ribbon length in the opposite direction of arrow I with a velocity \mathbf{v} .

Suppose now that the ribbon is placed in a uniform magnetic field, perpendicular to its plane. If \mathbf{B} is the flux density, a charge q will be subjected to a magnetic force.

$$\mathbf{F} = q\mathbf{v} \times \mathbf{B}.$$

In this particular case, the vector $\mathbf{v} \times \mathbf{B}$ is perpendicular to the lines of current and is directed towards the back, but q being negative, \mathbf{F} is directed forward.

The trajectory of the electrons is consequently shifted as indicated, and negative mobile charges

accumulate on the front edge of the ribbon. Simultaneously, an excess of positive charges appears on the rear edge of the ribbon. These charges produce an electric field \mathbf{E} , perpendicular to the lines of current and directed from the front to the rear. It is easy to measure the corresponding electromotive force; it is usually of the order of 1 microvolt.

In the ribbon on the right-hand side of the diagram, the charges are shown as being positive. Consequently, positive charges accumulate on the front edge. Here, the electromotive-force sign is changed, the Hall effect is inverted. This second case would appear to be of no interest, since it is well known that current in solid bodies is due to negative electrons. But the experiment shows that, depending on the ribbon material, the Hall effect may be either positive or negative.

The normal Hall effect, corresponding to negative charges, is obtained with most metals and with tetravalent semiconductors containing pentavalent impurities. Inverted Hall effect is obtained with certain metals, such as zinc, cadmium, iron, and cobalt, and with tetravalent semiconductors containing a trivalent impurity.

This phenomenon was a great embarrassment to physicists because the substances that show an inverted Hall effect have an atomic constitution quite similar to those that do not, and all their other properties, such as their electronic emission, are quite normal. Therefore, it cannot be supposed that current flow in them corresponds to the movement of positive charges, that is, positive electrons.

2. Explanation of Electric Current in Solid Bodies by Means of Wave Mechanics

2.1 SOME INFORMATION ON CRYSTALS

The properties summarized above show how complex is the problem of current flow in solids. To develop a theory for it, a few orders of magnitude concerning crystals must be recalled.

When semiconductors are normally prepared without taking any special precautions, they have a polycrystalline structure. They are made up of an entanglement of small single crystals the linear dimensions of which may vary very widely but may be of, say, 10 microns. Inside each of these microcrystals, the atoms are

regularly arranged following the well-known spatial periodicity of crystal structures. The distance between the nuclei of adjacent atoms is of the order of 1 angstrom (10^{-4} micron). In the space of this periodic structure move the satellite electrons of the nuclei. A certain number of these, being in the vicinity of a nucleus, remain captive to its attraction. On the contrary, those electrons that in the isolated atom belong to the outer layers, and particularly the electrons responsible for the valence, are subject to a strong attraction from the neighboring nuclei. A satisfactory representation is obtained by considering that they are subjected to the periodic electric potential produced by the nuclei and the electrons of the inner layer, the movement of which around each nucleus is of small amplitude and can be neglected.

Taking the existing charges into account and the order of magnitude of distances, it is possible to evaluate the electric field inside a crystal. One finds that potential differences of 1 volt may exist over distances of about 1 angstrom. This corresponds to an electric field of 10^{10} volts per meter. Such high values are never encountered outside the substance. The forces to which an electron is subjected inside a crystal are incomparably larger than those that it may encounter in an electron tube of any type.

This is why classical concepts are generally sufficient for the study of electron tubes, although they are quite inadequate for dealing with solid-state problems. For the latter, the domain of wave mechanics is the only theory that provides explanation of all semiconductor properties.

To avoid excessive detail, only the main results that have been obtained will be outlined and no proofs will be given.

2.2 PERMITTED AND FORBIDDEN BANDS

For a total particle energy W , the application of classical mechanics to the study of the movement of a particle in a medium where a periodic distribution of potential exists gives two types of movement.

For low energies, the particle would remain imprisoned in a potential *pit*, inside which it would oscillate.

For higher energies, it would be able to cross

the regions where the potential energy is maximum and, consequently, it would have a continuously progressive course.

The results obtained by applying wave mechanics are quite different as is evident when it is remembered that wave mechanics derive the motion of particles from the propagation of an associated wave. The study of several physical phenomena, such as the emission of discrete spectrums, black-body radiation, photoemissive effect, et cetera, leads to assignment to this wave of a frequency ν that is proportional to the total energy W of the particle. More precisely, this is

$$W = h\nu,$$

h being Planck's constant, the numerical value of which in meter-kilogram-second units is 6.62×10^{-34} joule-second.

The analysis of the motion in a crystal of an electron having an energy W is then identical with that of the propagation of a wave having a frequency ν in a medium having spatially periodic characteristics.

Radio engineers are fully acquainted with a single-dimensional problem of this kind: that of delay lines. A delay line consists of an unlimited series of identical quadrupoles connected end to end. They will be considered to be nondissipative. The behavior of the line depends entirely on the frequency ν of the electric signal applied at the input. If this frequency lies within one or several frequency bands called pass bands, each quadrupole will merely shift the phase of the signal. Consequently, there is a propagation of the signal along the line, without amplitude attenuation, with a speed depending on the characteristics of the line and on the value of ν .

If however the frequency is chosen outside the pass bands, each section reduces the signal amplitude by a constant ratio, without shifting its phase. It may also be said that there is a transient wave the amplitude of which decreases exponentially starting from the line input.

These results may be readily applied to the movement of electrons in a crystal: the total energy W replacing frequency ν in the case of the delay line.

If this energy is restricted to certain limits that depend on the structure of the material and are called permitted bands, the particle can circulate in the crystal lattice.

On the other hand, a particle thrown into the crystal with an energy not within these bands cannot move about. This case corresponds to the forbidden bands.

In Figure 5, the ordinates on the vertical axis represent the electron energy, and the permitted and forbidden bands are shown.

If the delay line, instead of being unlimited, consists of a finite number of quadripoles and

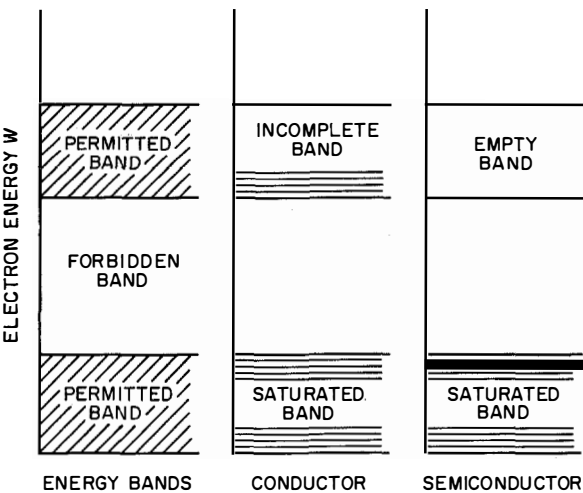

Figure 5—Permitted and forbidden electron energy-level bands.

both its input and output terminals are short-circuited, it will be possible to use it as a resonator. If v is the average speed of propagation of a wave of frequency ν included in the pass band, this wave will have an average wavelength of

$$\lambda = v/\nu,$$

and resonance will be obtained if the length of the line l is a multiple of $\lambda/2$;

$$l = k\lambda/2 = kv/2\nu,$$

k being an integer.

A certain number of resonance frequencies, $\nu = kv/2l$, may thus be obtained inside each pass band. They may be very near to each other if the line consists of a great number of sections. Similar results occur if the line is closed on itself, a classical example being that of the cathode-anode space in a multiple-cavity magnetron. Here, the main resonance mode is surrounded by parasitic modes corresponding in fact to the

other resonant frequencies included in the pass band of the system.

A similar result holds for crystals. From wave mechanics, it is evident that in a finite quantity of material, every permitted band must be subdivided into well-defined permitted *energy levels*, very near to each another. Also, in accordance with a general physical principle called *Pauli's exclusion principle*, it requires that in a given sample of crystal there be no more than four electrons in each energy level. In the permitted bands, there is consequently a limited number of possible positions for the electrons. This explains immediately the meaning of the terms "saturated band" and "incomplete band."

2.3 SPONTANEOUS MOVEMENT OF ELECTRONS

The object of the Fermi-Dirac statistics is the study of the particular allotment of electrons among the various permitted energy levels. The result is simple at absolute zero or very-low temperatures, for then the electrons occupy the lowest energy levels, taking entirely all the free positions available. According to their number, they either completely fill a whole number of bands or the highest-energy-level band is incomplete.

Each of the occupied levels is filled with four electrons. Theory shows that they must be divided into two groups of two electrons each, these two groups having opposing motions. In particular, their average speeds v_m are opposed. The average speed of the combination is zero and their spontaneous movement cannot be detected on a macroscopic scale. They may therefore be considered as motionless.

This is no longer true if an external force is introduced, such as an electric field \mathbf{E} . Then, each electron, having a charge $-e$, is subjected to the force $\mathbf{F} = -e\mathbf{E}$, which modifies its motion.

The wave mechanics show that the fundamental equation of classical dynamics may be used for calculating the new average speed, provided its meaning is altered slightly.

$$\mathbf{F} = m^* (d\mathbf{v}_m/dt).$$

\mathbf{F} represents exclusively the external force; the forces inside the crystalline lattice are excluded. v_m is the average speed of the electron, not its

instantaneous speed. m^* is a coefficient called the effective mass, which has the same meaning as the true mass m but depends on the structure of the crystalline lattice and on the total energy W of the considered particle.

This theory shows that, for particles placed in the lower part of a permitted band, m^* is positive and a particle placed in the upper part of such a band has a negative m^* . *The average speed then varies in the opposite direction to that indicated by classical mechanics.*

2.4 CONDUCTING AND INSULATING MATERIALS —HOLES

This result is very important because it gives a new concept for differentiating between insulating and conducting materials. Consider the action of an electric field \mathbf{E} applied from outside to all the electrons in a saturated band.

The top part of Figure 6 shows schematically the result obtained. For the sake of simplicity, only 7 electronic energy levels have been represented. For each of them, a single charge $q = -4e$ representing the 4 electrons has been indicated by a negative sign in a circle. With no electric field \mathbf{E} , these charges q would have an average speed equal to zero. Suppose that the effective mass m^* is positive for levels 1, 2, and 3, becomes infinite for level 4, and is negative for levels 5, 6, and 7. As a result, the magnitude and direction of the speeds reached after a given time under the action of the field are as shown in the figure; levels 1, 2, and 3 are in the same direction as $\mathbf{F} = -e\mathbf{E}$ and levels 5, 6, and 7 are in the opposite direction.

Theory shows that within the band there is perfect compensation of magnitude and direction of motion and the sum of all these speeds is always zero. This is expressed by saying that *a saturated band does not participate in conductivity.*

A material in which the number of electrons is such that all its bands are either empty or saturated is therefore an insulator. If, however, the material has an incomplete band, this compensation does not occur, and it is a conductor. This characteristic applies only to a single permitted band, which is called a *conduction band*.

Consider the case of a band in which only the highest level, the 7th in the simplified diagram,

is empty. The algebraic sum of the currents carried by all the charges that are present differs from zero by the current that would have been carried by the missing charge. The same result would be obtained by replacing the absent electrons with positive charges $+e$ having the same motion. These positive charges would be driven in the same direction as the applied force. They would thus have a positive effective mass, algebraically opposed to that of the electrons. These fictitious charges play an important role in semiconductor theory. They are called *holes*.

The benefit to be obtained from this substitution is obvious. In the case of almost-saturated bands, only a small number of significant charges need be considered and, above all, the use of negative effective masses may be avoided for they give rise to difficulties in qualitative reasoning and in making approximations of an intuitive character. Depending on the extent to which the

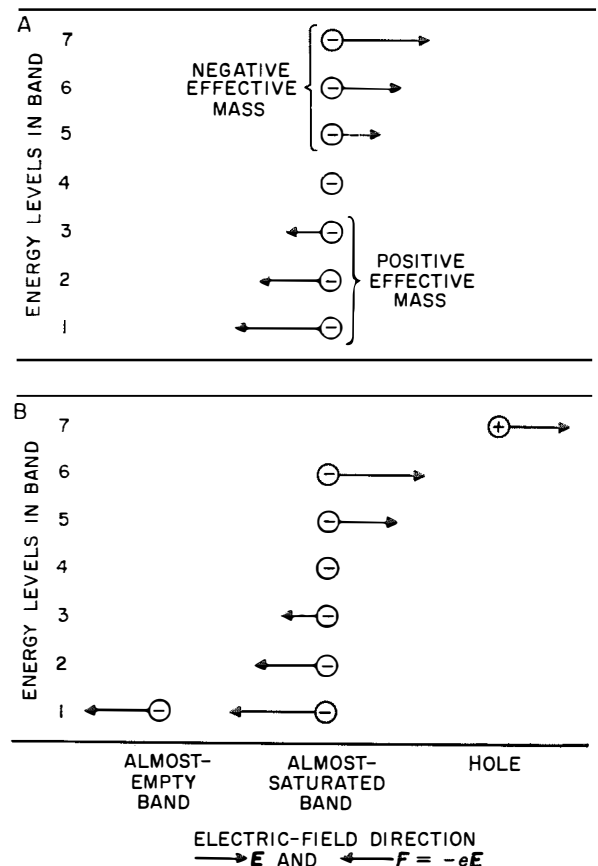

Figure 6—Action of an electric field on a saturated band at *A* and on an incompletely filled band at *B*.

conduction band is filled, it will be possible to consider conductivity as due to holes or to electrons.

The introduction of the hole concept and its extension to magnetic effects provides an explanation of the inverse Hall effect.

2.5 INFLUENCE OF TEMPERATURE

The results indicated above are valid only at low temperature. When the temperature rises, the random motion in the crystalline lattice alters the perfectly periodic character that has been assumed. These distortions hamper the movement of electrons and tend to oppose the external forces.

They also modify the natural motion of the electrons by increasing the energy of a certain number of them, thus enabling them to pass to higher levels. In the case of an insulator, they

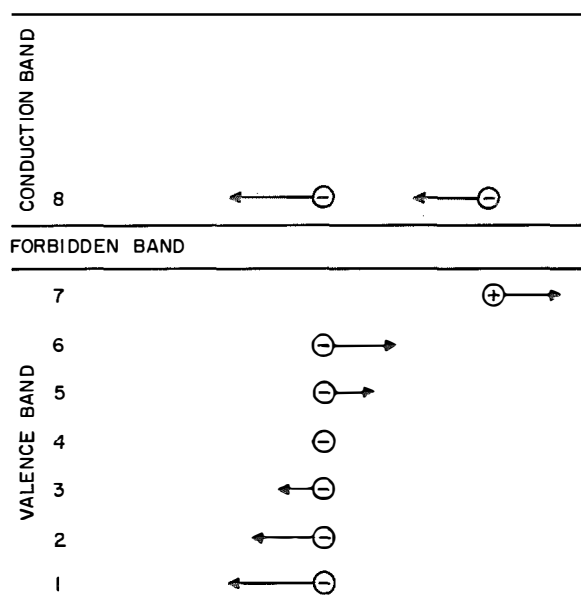

Figure 7—Effect of light on an electron-hole pair.

enable certain electrons filling a saturated or valence band, to pass to the lower part of the empty band just above, called a conduction band. This is shown in Figure 7. Each time this happens, a hole appears in the valence band and one electron goes to the conduction band. Both contribute to give to the material a certain conductivity, since both currents have the same

direction, in the same way as those of positive and negative ions in an electrolyte or an ionized gas. In fact, for a good insulator, this phenomenon is very rare because of the width of the *forbidden gap* separating the two permitted bands.

In substances, where the width δW of this forbidden gap is of the order of 1 electron-volt, the increase in conductivity is substantial at ordinary temperature. Such is the case for germanium in which $\delta W = 0.76$ electron-volt and in silicon where $\delta W = 1.1$ electron-volt. These substances are merely poor insulators; they should not have been called semiconductors.

The preceding analysis explains why the resistivity of a semiconductor decreases at the start when the temperature rises. Afterward, a limitation appears, due to the increase in random motion of molecules that tends to oppose the motion of charges caused by external forces. This accounts for a resistivity minimum, followed by a subsequent increase.

A similar process explains the action of light. The impinging photons give up their energy to certain electrons in the valence band and produce *electron-hole pairs*.

Finally, the action of pentavalent impurities in germanium and silicon can be explained by the fact that they discharge their surplus valence electrons into the conduction band: this is electron conductivity. The doped material is said to be negative or type *N*.

Conversely, trivalent impurities seize an electron to recover the same structure as the other atoms in the lattice. They cause empty places to appear in the upper part of the valence band. This is hole conductivity. The doped material is said to be positive or type *P*.

The importance of the effect produced by infinitesimal quantities of impurities is due to the fact that, in the absence of these impurities, the number of electrons that are able to pass into the conduction band as a result of thermal agitation is very low, about 10^{19} per cubic meter, whereas the number of semiconductor atoms is of the order of 10^{29} per cubic meter. There is, therefore, about one useful electron per 10^{10} atoms of semiconductor material.

On the contrary, each atom of impurity introduces either an electron or a hole, which is why they have a substantial effect although their proportion is only of the order of 10^{-9} .

3. Technology

Semiconductor technology is aimed toward the solution of two chemical problems; the obtaining of material having the required purity and the addition of desirable impurities to this material. Furthermore, this technology must produce

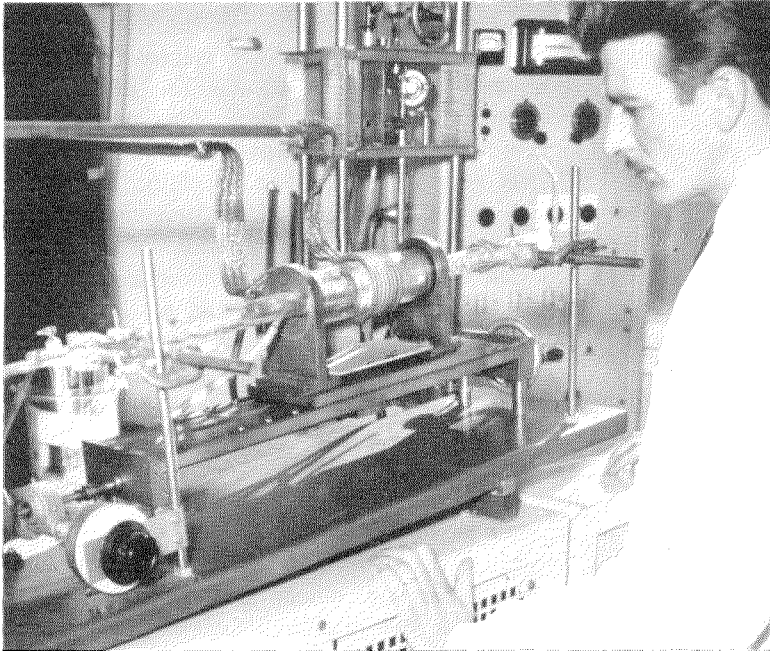

Figure 8—Zone refining of a germanium rod.

single crystals as perfect as possible and of sufficient size for the applications.

It appears that in a polycrystalline structure, the motion of electrons and holes is more complex and that the electrons and holes have a much greater tendency to recombine. This reduces considerably the intensity of certain phenomena, such as the photoresistive effect already mentioned, and is also detrimental in rectifiers and transistors.

Figure 8 shows the refining process. It consists of heating a narrow zone of a germanium rod by radio-frequency current. The impurities divide unequally between the solid and the liquid parts, and concentrate in the liquid. By moving the radio-frequency heating coil progressively along the rod, the impurities are trapped at the end of the rod. This procedure is repeated 5 or 6 times and the extremity in which the impurities have

accumulated is then sawed off. The required high purity is thus obtained.

Figure 9 represents an oven for the pulling of large single crystals. The purified germanium is melted in a crucible placed in the lower part of the framework. It is made to crystallize around a seed attached to the end of a vertical rod. After being brought in contact with the surface of the molten germanium, the seed is lifted progressively to produce the large single crystal of germanium shown in Figure 10.

4. Rectifiers

4.1 PRINCIPLES

Although semiconductors have been used as rectifiers for many years, the mechanism of rectification will be discussed briefly. In Figure 11A, the energy bands of two metallic electrodes 1 and 2 are represented. The electrodes have plane parallel faces and the space between the two faces has been evacuated to allow the free circulation of electrons from one electrode to the other.

If there is no electric field in this intermediate region, it will be in an equipotential condition. The potential energy of an electron placed in this space will be taken as zero energy level. Consider first, the more-remarkable energy levels in electrode 1. Above level A_1 , at the bottom of the conduction band, is level F_1 or the Fermi level, which is the highest level occupied by electrons at low temperature. Since electrons cannot spontaneously leave the electrode at low temperature, A_1 and F_1 are situated below the origin O_1 . There is also the level B_1 , which is the highest level of the conduction band. At a sufficiently high temperature, some electrons can leave the electrode as a result of the thermoelectric effect. B_1 is therefore necessarily above O_1 . At ordinary temperatures, F_1 no longer shows a sharp transition between occupied and empty levels. The thermal agitation drives certain electrons above F_1 . This

has been shown schematically in the diagram by means of greater separation between adjacent horizontal lines to indicate that the electron density decreases with distance above F_1 . In fact, the law of decrease is exponential.

Similar conditions are found in electrode 2. It is assumed that its Fermi level F_2 is nearer to the origin O_2 than is the case for electrode 1. At ordinary temperatures, the thermal agitation is capable of sending some electrons in electrode 2 higher than point O_2 . These electrons have sufficient energy to cross the potential barrier offered by the interval between the two electrodes. This is the reason why the horizontal lines in Figure 11A representing the energy levels of electrode 2 have been extended to the left. As soon as the two electrodes are placed near each other under the conditions mentioned, there is set up a flow of electrons from right to left, whereas the flow

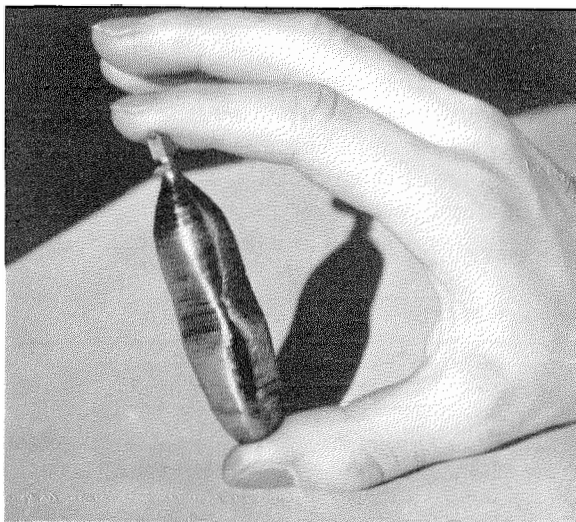

Figure 10—A large single crystal of germanium.

in the opposite direction is considerably smaller. As a result, electrode 1 acquires an excess of negative charges whereas electrode 2 develops a positive charge. At the same time an electric field E , in the direction from right to left, appears in the intermediate space. This means that the potential of electrode 2 rises, or that the corresponding potential energy $W = -eV$ decreases. This is shown in Figure 11B.

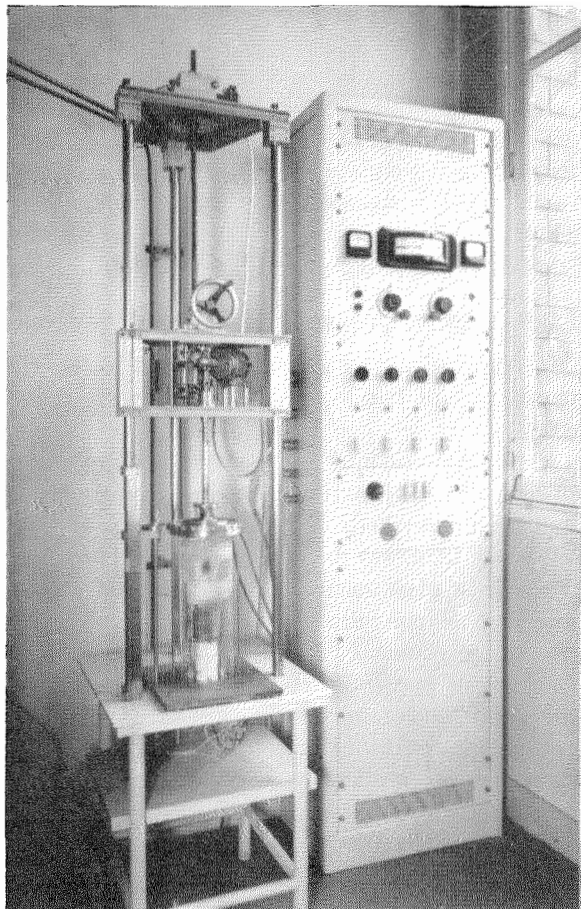

Figure 9—Equipment for producing large single crystals of germanium.

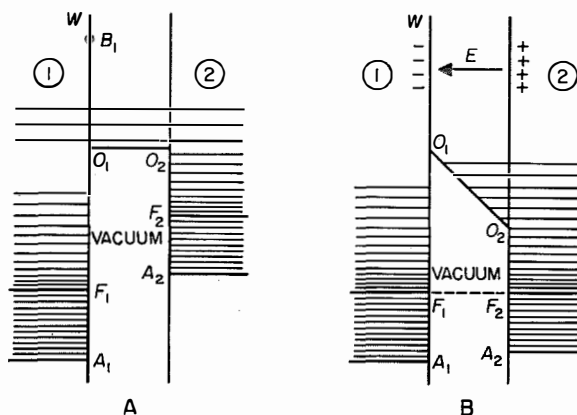

Figure 11—Model for rectification process.

Finally, a state of statistical equilibrium is obtained, when level F_2 has dropped to the same height as F_1 ; then equal and practically negligible electron currents flow in the two directions.

If an external generator adds an alternating component to the preceding potential difference,

the potential energy of electrode 2 decreases and there is practically no current between the two electrodes. The system is said to be blocked. In the opposite case, the situation is similar to that of Figure 11A and electrode 2 sends an electric current toward electrode 1.

Therefore, two different metals separated by vacuum theoretically constitute a rectifier. In

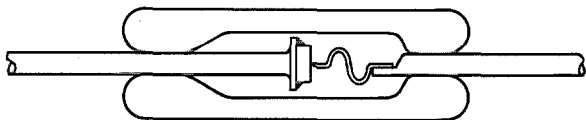

Figure 12—A germanium diode mounted in glass. The diameter of the glass body is 4 millimeters (0.16 inch) and the length is 13 millimeters (0.5 inch).

practice, difficulties would be encountered in the choice of materials and in obtaining satisfactory surface states.

It is much more effective to apply the same principle by using the contact between a metal and a suitably doped semiconductor. When this contact is established, electrons circulate as above in a given direction depending on the nature of the materials in contact.

If the relative positions of the various energy levels are well chosen, this transient process eliminates practically all the carriers of mobile charges, electrons or holes, in the vicinity of the semiconductor surface. The semiconductor coats itself with a superficial layer that is practically

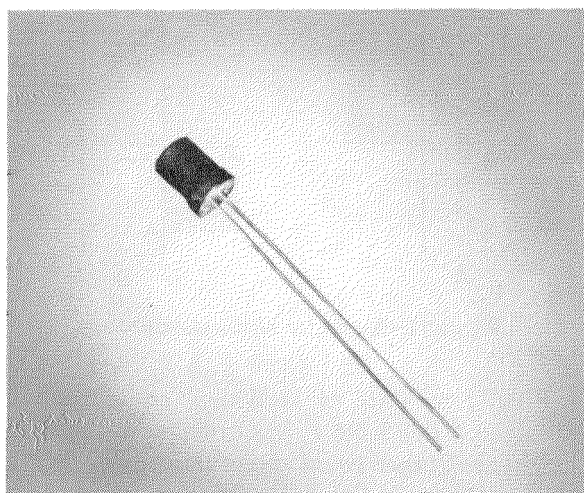

Figure 13—P-N junction silicon diode. The capsule is 6.5 millimeters (0.26 inch) long.

an insulator, like the vacuum in the preceding example. At the time, the semiconductor plays the roles of the vacuum and one of the metals.

A similar result is obtained if two different semiconductors are placed in contact. A reduction can be obtained in the number of carriers of mobile charges in the transition zone. This possibility is used in a particularly clever manner in the P-N junctions. These may be obtained in three principal ways.

If the first method, the pulling equipment shown in Figure 9 is used. First, trivalent impurities, for instance, are added in the crucible, and a certain length of P germanium is pulled out. Then, larger quantities of pentavalent impurities are added to the liquid. They neutralize the preceding ones and their excess produces N germanium. The wanted junction is obtained within a single crystal.

The second method is based on alloying. A suitable substance is deposited on a plate of N germanium, for instance, which substance after local melting produces a zone of type P.

Also, a similar result is obtained by the diffusion process. The most typical method consists of placing a plate of type P, for instance, in a vessel filled with arsenic or phosphorus vapor. These impurities slowly diffuse through the crystal, giving a superficial layer of type N.

4.2 PRACTICAL DESIGNS

The principles discussed above lead to the production of two types of rectifiers: the point-contact rectifier, consisting of the association of a metallic point and a crystal of germanium or silicon, and the junction-type rectifier, which has just been described.

Figure 12 shows the structure of a germanium diode in a glass cartridge. Figure 13 is a P-N junction silicon diode, the characteristics of which are shown in Figure 14. It may be seen that in the passing direction the current is 100 milliamperes for an application of 1 volt. The equivalent resistance is 10 ohms. In the blocking direction, an application of 35 volts results in a current of 2 to 3 microamperes. The resistance is of the order of 100 megohms.

Point-contact rectifiers have very low stray capacitance and can operate in all the radio-frequency range. Junction rectifiers can work up to 50 megacycles per second.

In the power-frequency field, it has been possible to design rectifiers to handle relatively high power. Their excellent characteristics result in very-high efficiencies of the order of 98 per-

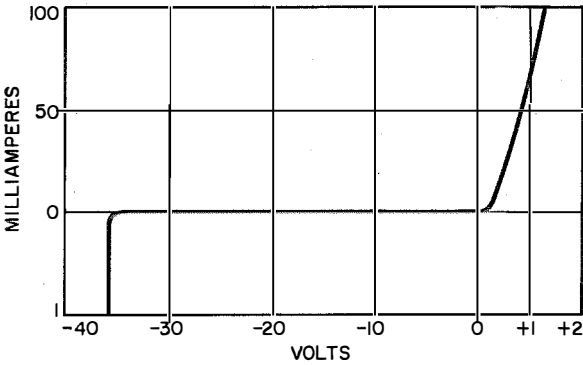

Figure 14—Electrical characteristics of the *P-N* junction diode of Figure 13. Note that both the current and voltage scales are not symmetrical about their zero axes.

cent, thus considerably easing the cooling problem and permitting units to be of small size.

Figure 15 represents a germanium rectifier that will handle 200 amperes at 65 volts. In this type of rectifier, current densities of 75 amperes per square centimeter are used, which is 1000 times greater than with selenium.

5. Transistors

5.1 PRINCIPLES

Semiconductors have permitted the development of rectifiers having properties similar to those of hot-cathode diodes. The parallel has been extended to amplifiers with the design of transistors, which are semiconductor devices similar to triodes. The transistor was announced by Bell Telephone Laboratories in 1948.

To understand their principle, suppose a metallic point is placed in contact with a plate of *N*-type germanium. Following the theory already outlined, at the moment of contact there is a transient process during which the electrons situated in the vicinity of the surface of the germanium migrate toward the metal. This movement eliminates practically all the electrons from the conduction band situated in the zone of the contact. But it may also affect certain electrons situated in the high-energy levels of the

valence band, and holes then take their place. The number of holes thus produced may be greater than the number of electrons initially present in the conduction band. Thus, by removing electrons from a plate of *N*-type germanium, it is possible to create a superficial layer of type *P*, which is more conductive than the original material. This phenomenon stems essentially from the existence of two types of charge carriers and is called *hole injection*. The metallic point producing it is called the *emitter*. If it is made positive with respect to the germanium, the number of electrons that it captures, that is, the number of holes, increases, in the same way as in a triode where the electron stream from the cathode is controlled by the grid potential.

It is readily understood that it is possible to design a crystal triode or transistor by applying to the crystal plate, called the *base*, a second point or *collector* that is negatively biased with respect to the base. In the absence of injected holes, it would constitute with the germanium plate a blocked diode, that is to say, the current to the collector would be negligible. However, as a result of the action of the emitter, a current flows through it since it attracts electrons.

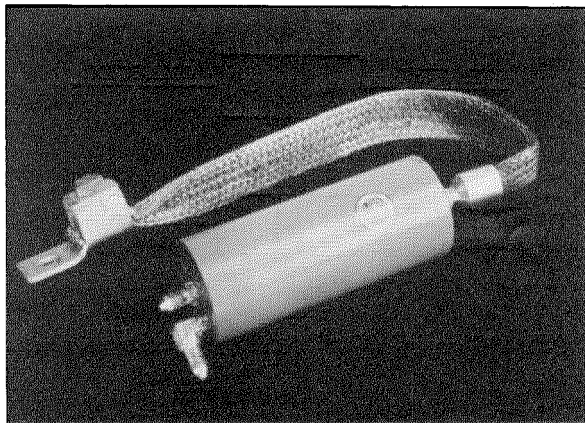

Figure 15—Germanium rectifier with a capacity of 200 amperes at 65 volts.

The energy amplification results from the fact that the collector voltage can be made higher in absolute value than the emitter voltage, being of the order of - 20 to - 30 volts against 1 to 2 volts.

5.2 DESIGN

Figure 16 shows a schematic drawing of a point-contact transistor. Figure 17 shows a variant design in the form of $P-N$ junction diodes.

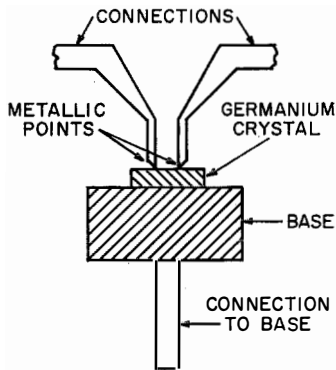

Figure 16—Point-contact transistor.

The base is the central zone, which may be of type N or P . The emitter and the collector are of types opposite to the base type. At the top is an $N-P-N$ -type transistor and below is a $P-N-P$ triode. In the $N-P-N$ type, the electrons play the active role and in the $P-N-P$ transistor, the holes are active. Characteristics are similar, but polarities are inverted.

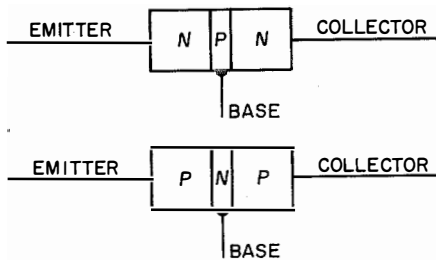

Figure 17— $N-P-N$ and $P-N-P$ junction transistors.

Figure 18 shows the general structure of a junction transistor and Figure 19 is a photograph of some germanium junction transistors of a kind commonly in production.

These transistors produce power gains of the order of 30 decibels. Depending on their design, they have various frequency and power limits. At voice frequencies, a power of several tens of watts has been obtained. With regard to fre-

quency, powers of the order of 150 milliwatts are obtained at about 1000 megacycles per second.

It must be added, however, that all devices employing semiconductors are sensitive to temperature. In the case of germanium, it is hardly possible to work above 75 degrees centigrade and for silicon the limit is about 100 degrees centigrade.

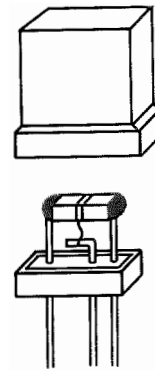

Figure 18—Structural arrangement of a junction transistor.

6. Applications

Despite the temperature limitations, semiconductor diodes and triodes have been applied extensively in the electrical field. The main advantages of these rectifiers are their high efficiency, small space requirements, sturdiness, and practically unlimited life. Transistors also have to their credit, long life, lightness, and small volume. In comparison with conventional elec-

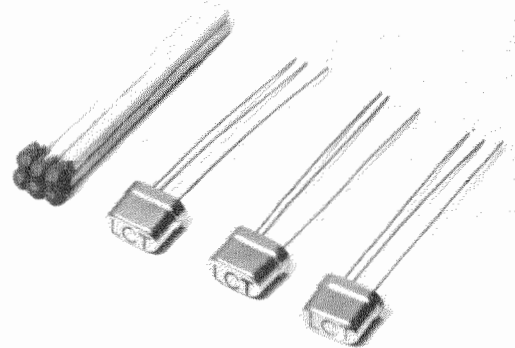

Figure 19—Some germanium junction transistors.

tron tubes, they have the merit of not requiring heating power and of working under very-low voltages, which makes them extremely useful for battery-operated portable equipment. This is why their largest fields of application seem to be at present in hearing aids, pocket radio receivers, and military uses.

Even though this paper has been limited in principle to diodes and triodes, other applications of semiconductors such as photoelectric cells must be mentioned. In particular, attention is called to the silicon solar battery developed by the Bell Telephone Laboratories. This battery

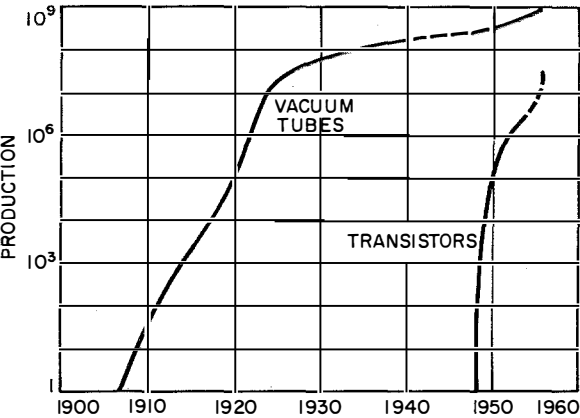

Figure 20—Production of vacuum tubes and transistors.

converts light energy into electric energy with an efficiency of 10 watts per square foot. It has already been used for a complete power supply for portable transmitters, receivers, and telephone repeaters.

The industrial importance of transistors is indicated by Figure 21 which shows the annual production of vacuum tubes since the invention of the triode and of transistors since 1948.

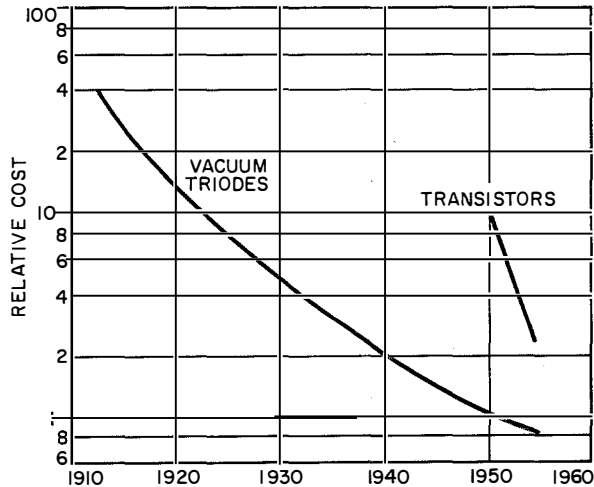

Figure 21—Relative prices of vacuum-tube triodes and transistors.

As shown in Figure 21, a decrease in price accompanies the increase in production. It may be predicted that the transistor will soon outclass the electron tube, even as to price.

It is now certain that in the next few years, germanium and silicon diodes and transistors will be widely used in all applications of electronics to telecommunications, servomechanisms, and more generally for numerous industrial needs.

Rating of Thermionic Valves for Use Under Abnormal Ambient Conditions*

By BERNARD D. MILLS and WALTER W. WRIGHT

Standard Telephones and Cables, Limited; London, England

ELECTRONIC VALVES are now used in a wide variety of ambient conditions such as in sub-arctic temperatures, at very-high altitudes, and at the high temperatures produced by operation in enclosed spaces. Economy and compactness require that valves be used under any such conditions at the maximum possible ratings consistent with reasonable life.

By considering such factors as heater power, cathode sleeve area and configuration, prevalence of surface leakage, and dielectric strength of insulators, the valve manufacturer is able to specify limiting values of cathode-current density and electrode voltages. These are fundamental parameters and if the ambient conditions are such as to raise the bulb and hence the electrode temperatures above the normal conditions, then it may be necessary to consider revised ratings for such abnormal conditions. Such revision of ratings by absolute methods is not at present possible and proof has to be based on the laborious basis of adequate life testing.

As an example of the problems involved, it is interesting to consider the possible effects of high temperatures that may result in:—

- A. Loss of cathode emission or heater burn-out.
- B. Grid emission due to high grid temperature.

* Reprinted from *Journal of Electronics*, volume 1, pages 276-292; November, 1955.

C. Reversal of getter action or liberation of gas from the envelope.

D. Electrolysis of valve base or bulb, especially with rectifiers where high peak voltages may exist between adjacent pins.

E. Accelerated growth of cathode interface.

In the case of low ambient temperatures such as may exist at high altitudes, it would seem possible to uprate the valve, but this must be

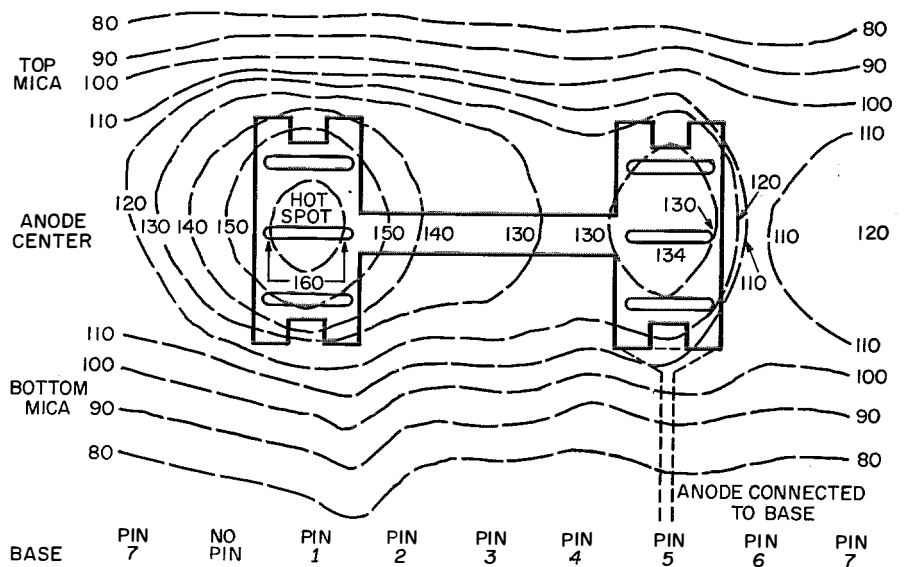

Figure 1—Isothermal map at 10-degree-centigrade intervals of the cylindrical bulb surface of a 6064 7-pin miniature high-transconductance pentode. A diagram of the anode is superimposed in the same scale.

considered on the merits of each type as designed by a particular manufacturer; because, for example, a valve with its cathode operating at a low temperature may become temperature-limited when used in arctic surroundings.

The temperatures of the electrodes inside the valve, especially the anode, are related to the cathode current and electrode voltage and thus

measurement of these temperatures would seem to provide useful information. Such an approach involves the manufacture of special valves with thermocouples welded to the electrodes with their leads sealed through the glass. However, anodes at the temperatures encountered in receiving valves radiate heat at wavelengths longer than those transmitted by the glass envelope; thus the bulb absorbs the radiant energy from the anode and dissipates this energy to the environment by the normal processes of heat transfer. Due to the finite electrical and thermal conductivity of the anode material, a pronounced temperature gradient will exist on the anode with the maximum occurring where the current density is a maximum. This gradient will influence the bulb, on which there will be a hot spot corresponding to the maximum-temperature area of the anode (Figure 1). Therefore, measurement of bulb temperatures, particularly the bulb hot-spot temperature, is a useful way of studying the effect of ambient conditions on valve performance and does not require manufacture of special valves.

Maximum ratings as published by a manufacturer can be taken in any given valve to imply a maximum hot-spot bulb temperature and

a satisfactory life if this temperature is not exceeded.

This question of maximum temperature can be considered in two ways, namely:—

A. A maximum bulb temperature equal to the hot-spot temperature when the valve is operated at maximum ratings in some standard atmosphere, such as air at 25 degrees centigrade and 760 millimetres of mercury pressure, or

B. A maximum hot-spot temperature that allows a satisfactory operational life; for instance, 250 degrees centigrade. Obviously, this temperature will be somewhat greater than that obtained in *A*.

From a detailed comparison of these two criteria, it can be shown that the ratings applied by using *A* above are safe but result in some anomalies, while *B* can be established as a more rational basis for rerating. Extensive life tests are obviously necessary to determine a suitable maximum temperature for each valve type and this work is now in progress.

1. Experimental Investigation

An overall picture of the section of the laboratory devoted to valve rating problems is shown in Figure 2. Besides the major items, a power supply and some associated metering and

Figure 2—Part of a laboratory dealing with valve rating problems.

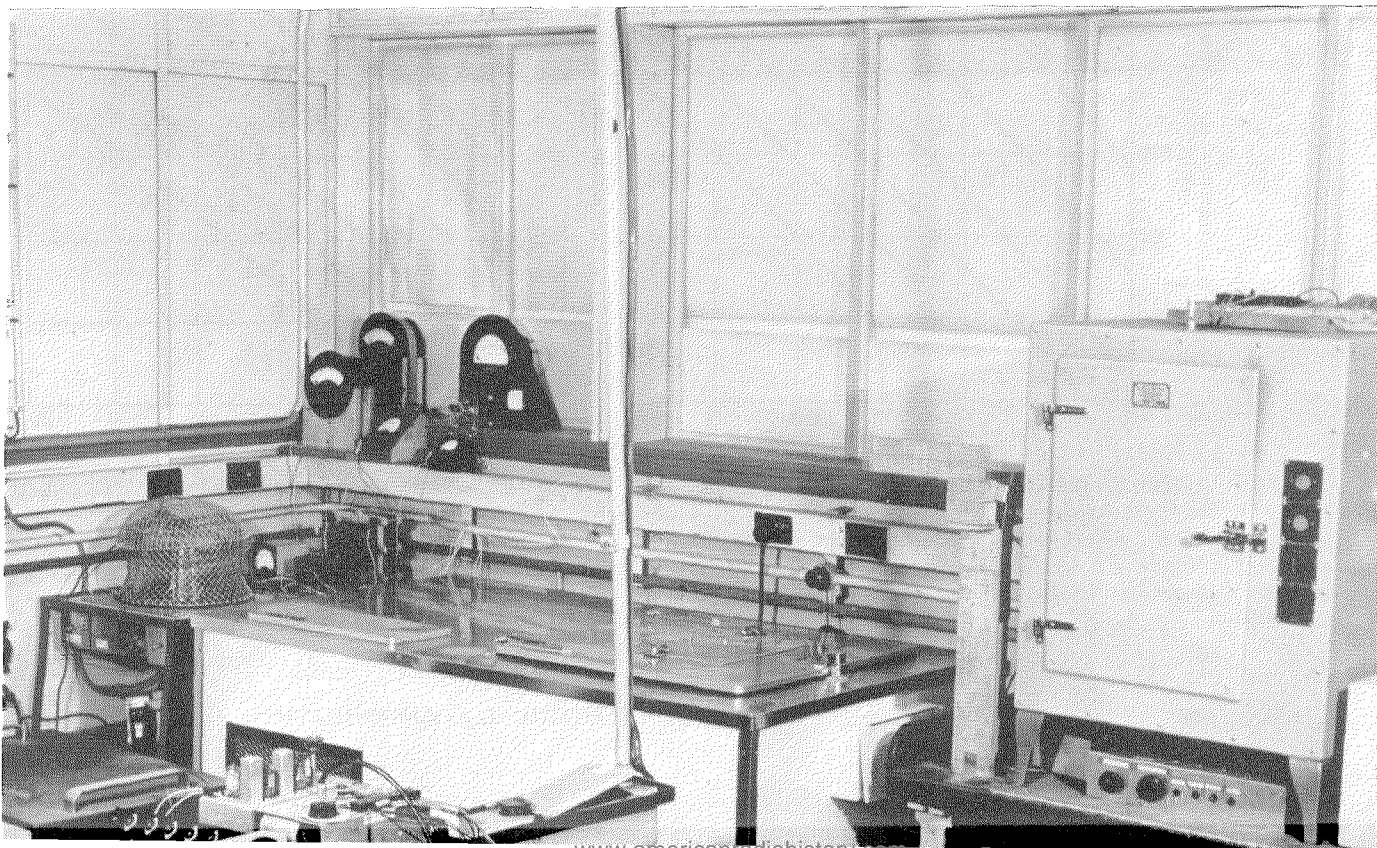

controlling potentiometers are required. By locating the major units contiguously, the incidental equipment can be arranged centrally to service all units.

1.1 HIGH TEMPERATURES

For the determination of satisfactory ratings for valves operated under elevated ambient temperatures, and for the life-expectancy determinations of valves at full ratings, an oven of some 2.5-cubic-foot (0.071-cubic-metre) capacity is used. The oven has a maximum rating of 3200 watts and a mean operating input of 500 to 600 watts. It is thermostatically controlled from room temperature to 300 degrees centigrade. Oven temperature measurements are obtained by a long mercury-in-glass thermometer. The thermal time constant of the oven is approximately 50 minutes, conveniently much greater than the 3 to 4 minutes of an average octal valve.

1.2 LOW TEMPERATURES

To operate valves under arctic conditions, with a consequent uprating of the valve or extended life expectancy, a special refrigerator of 2-cubic-foot (0.057-cubic-metre) capacity has been used. It has facilities for thermostatic control of temperature between + 20 and - 40 degrees centigrade. The equipment is rated to maintain any pre-set temperature with a dynamic load continuously dissipating 300 to 400 watts. Thermostatic control to within 1 degree centigrade is obtained with a specially designed thermistor-actuated switching unit.

Thus the refrigerator and oven allow life tests and other investigations to proceed in ambient conditions from - 40 to + 300 degrees centigrade. Both units have facilities to bring out 12 electrical connections for power supplies and thermocouples. Glass beads and tubing insulation on single-strand copper wire are used in the oven and polyvinyl-chloride insulation is found quite satisfactory in the refrigerator.

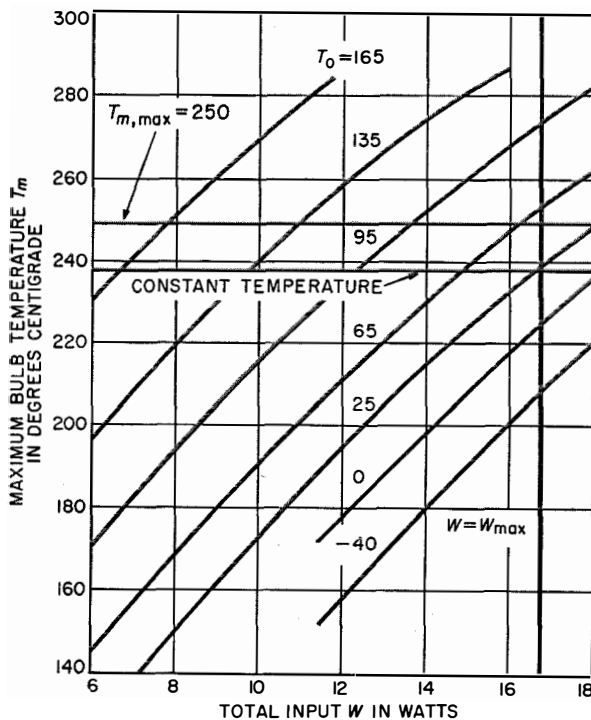

Figure 3—Bulb-temperature curves, $T_m = f(W, T_0)_h$ constant for 6AQ5. Anode voltage = 250, screen-grid voltage = 250, heater voltage = 6.3, heater current = 0.45 ampere, altitude = 0 (sea level). Ambient temperature T_0 is in degrees centigrade.

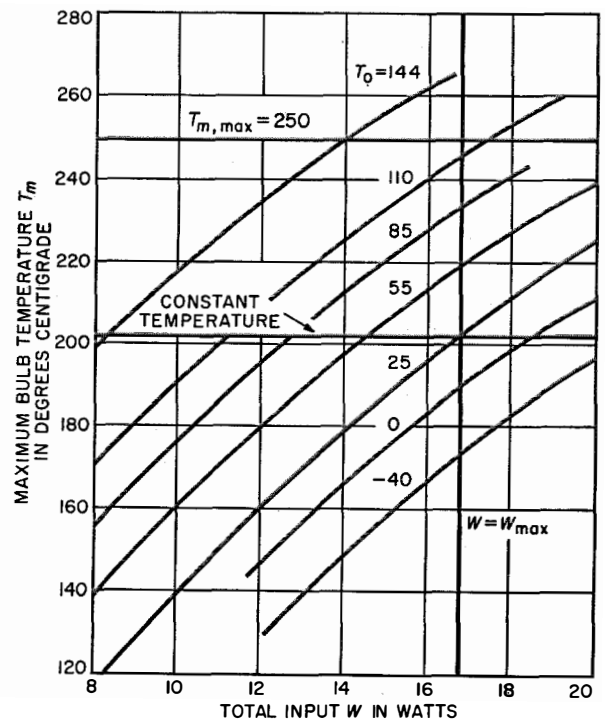

Figure 4—Bulb-temperature curves, $T_m = f(W, T_0)_h$ constant for 6BW6. Anode voltage = 315, screen-grid voltage = 285, heater voltage = 6.3, heater current = 0.45 ampere, altitude $h = 0$ (sea level). Ambient temperature T_0 is in degrees centigrade.

1.3 LOW ATMOSPHERIC PRESSURES

An inverted vacuum-tested desiccator of 10-inch (25.4-centimetre) internal diameter, mounted on an aluminium base plate with a neoprene gasket, forms a working facsimile of pressure conditions at high altitudes when connected to a rough backing pump and controlled-leak valve. Twelve electrical connections are introduced by hermetic seals through the base plate and a closed-tube manometer, calibrated in thousands of feet, gives the equivalent altitude. Adequate precautions are taken to prevent any forced circulation of the residual air in the chamber. By designing the vacuum chamber so that it will fit into the refrigerator, a complete simulation of high-altitude conditions can be made. However, due to the confined spaces in aircraft, it is difficult to assess the valve operating conditions and it is therefore usual to neglect the reduction in ambient temperature, thereby providing some safety margin.

2. Experimental Technique

The anode, screen-grid, and heater voltages and currents are continuously metered to give the total input power. Grid current is measured to indicate any unusual gas evolution, leakage, or grid emission. Bulb temperatures are measured with a calibrated 40-gauge iron-constantan thermocouple that provides reasonable sensitivity and low thermal capacity. The cold junction is maintained at room temperature by immersion in a well-insulated beaker of glycerine. This system is quite accurate (to the order of 1 degree centigrade) and is more convenient than a null-deflection potentiometer method that, however, has been used to check various points.

The thermocouple was initially fixed to the bulb by a mixture of sodium silicate and zinc oxide. However, it has been found that Araldite is quite satisfactory and does not tend to become fluid by hydration at low temperatures.

3. Rerating Procedure

The general method employed is to set the ambient conditions as desired and, when stable, to measure the bulb hot-spot temperature for a

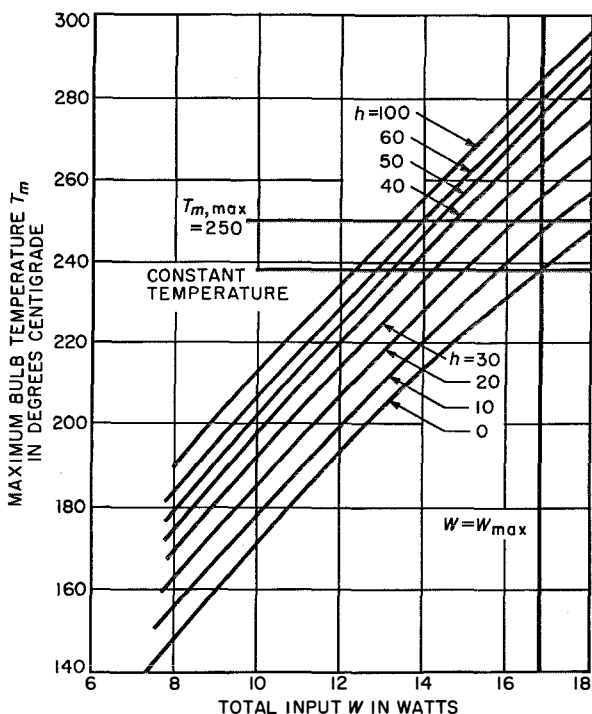

Figure 5—Bulb-temperature curves, $T_m = f(W, h)_{T_0 \text{ constant}}$ for 6AQ5. Electrode-supply data as in Figure 3. Ambient temperature $T_0 = 25$ degrees centigrade. Altitude h is in thousands of feet.

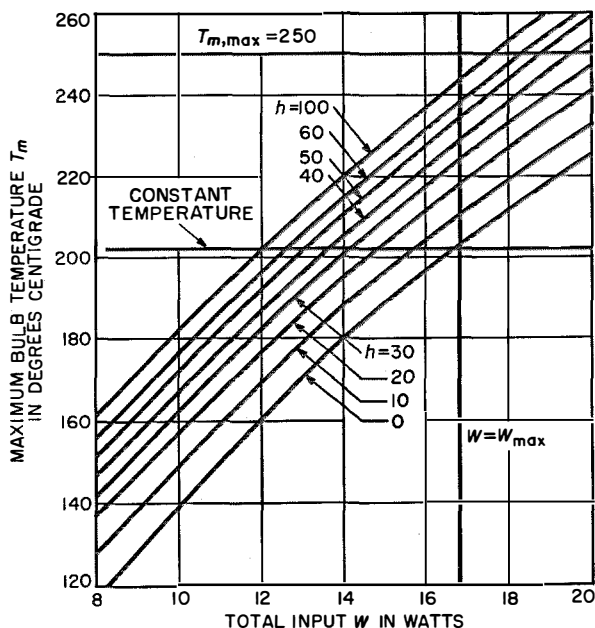

Figure 6—Bulb-temperature curves, $T_m = f(W, h)_{T_0 \text{ constant}}$ for 6BW6. Electrode-supply data as in Figure 4. Ambient temperature $T_0 = 25$ degrees centigrade. Altitude h is in thousands of feet.

range of input anode powers. As screen-grid power varies with anode power if the electrode voltage is held constant, the results are presented graphically using as variables the total input power in watts W , the hot-spot bulb temperature T_m and the ambient temperature T_0 in degrees centigrade, and the altitude h in thousands of feet.

Then, we are interested in the curves:—

$$T_m = f(W, T_0, h). \quad (1)$$

The measurements taken will allow families of the curves:—

$$T_m = f(W, T_0)_{h \text{ constant}} \quad (2)$$

and

$$T_m = f(W, h)_{T_0 \text{ constant}} \quad (3)$$

to be plotted for various values of h and T_0 . The results obtained on valve types $6AQ5$ and $6BW6$ are given in Figures 3–6.

When the choice of rerating criterion has been made, plotting the curve formed by the intercept of $T_m = T_{m, \max}$ gives the rerating required. This has been done for the types $6AQ5$ and $6BW6$ and

is given in Figures 7–10. These show the maximum input power for variation of altitude and ambient temperature—the essential information for the equipment designer.

It is necessary to consider the possibility of inconsistencies if the screen and anode wattage are not equally effective in determining the bulb temperatures. To establish this point, the change in bulb hot-spot temperature T_m for a change of 1 watt in the anode and screen dissipations respectively was measured; for the valve types considered, ΔT_m for 1-watt change in screen dissipation was approximately 90 per cent of ΔT_m for an identical change in anode dissipation. This seems reasonable; screen power and anode power are probably equally effective in determining the average bulb temperature, but the anode determines the final temperature gradient round the bulb. As screen power represents only 10 to 12 per cent of the total, the inconsistencies will be of the order of 1 per cent, which is commensurate with the inaccuracies in the other aspects of the work.

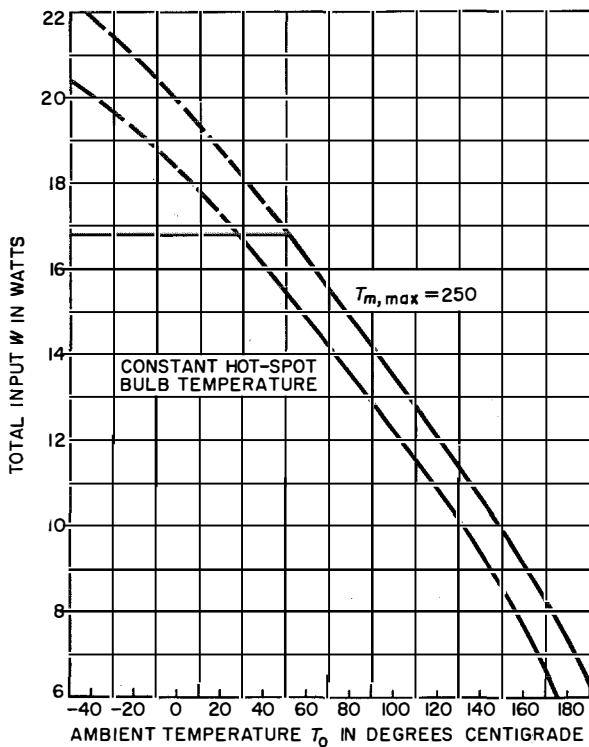

Figure 7—Rerating curve $W = f(T_0)_{T_m, h \text{ constant}}$ for $6AQ5$ at $h = 0$ (sea level).

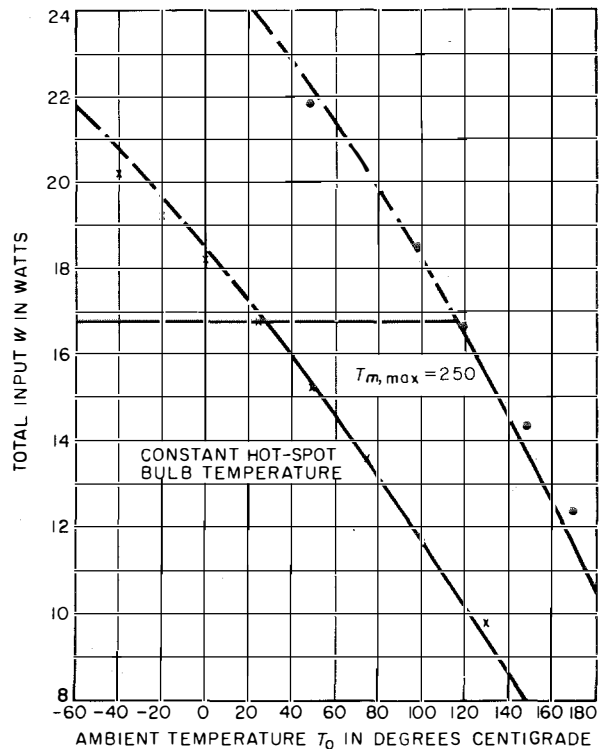

Figure 8—Rerating curve $W = f(T_0)_{T_m, h \text{ constant}}$ for $6BW6$ at $h = 0$ (sea level). The plotted points are those calculated from general rating equations.

There is an important corollary to the above that concerns the use of rerating criteria by the equipment designer; namely, should the screen and anode be rerated proportionally? If the rerating is effected by altering the bias level, this will automatically occur; but there are circuit applications where full screen power may be desirable to ensure satisfactory operation and the rerating may then be effected in the anode circuit only by an increase in load impedance or by a reduction in duty factor.

The designer may distribute his "allowable wattage" between screen and anode at will, provided of course that the maximum rating of neither electrode is exceeded.

The method described above is, nevertheless, one that requires considerable expenditure of time and effort to ensure accuracy of measurement, stability of both the ambient conditions and electrical input, and freedom from drift in the measuring circuits. Indeed, several days are involved in the experimental treatment of one valve type. Rapid methods have therefore been developed to provide reasonably accurate answers that, since the exact conditions of operation are indeterminate, will be of service to designers.

The rapid method is based on the observation that all the curves of the families plotted in

Figures 3-6 are approximately parallel, and therefore, if one complete curve is measured, and the intersection of the family with $W = W_1$ is observed (to determine their distance apart), the complete family may be drawn. From this stage, the rerating curves may be derived by a consideration of the factors affecting heat loss by the valve. Thus there are radiation losses, load conduction, socket losses, and connection losses. Treating these in order, we have:—

3.1 RADIATION LOSSES

The Stefan-Boltzmann law may be expressed:—

$$dW = dAE\sigma(T_a^4 - T_0^4),$$

where dW is the total energy radiated from an area dA at a temperature T_a to an ambient of T_0 degrees kelvin. E is the emissivity of the surface and σ is the Stefan-Boltzmann constant. By integrating W over the whole bulb surface in the case of a valve with $T_m =$ measured hot-spot bulb temperature, $A =$ total area radiating heat; and by introducing a factor n where $0 < n < 1$,

$$\begin{aligned} W &= AE\sigma(nT_m^4 - T_0^4) \\ &= K_1T_m^4 - K_2T_0^4, \end{aligned}$$

where

$$K_1 = nK_2 = nAE\sigma.$$

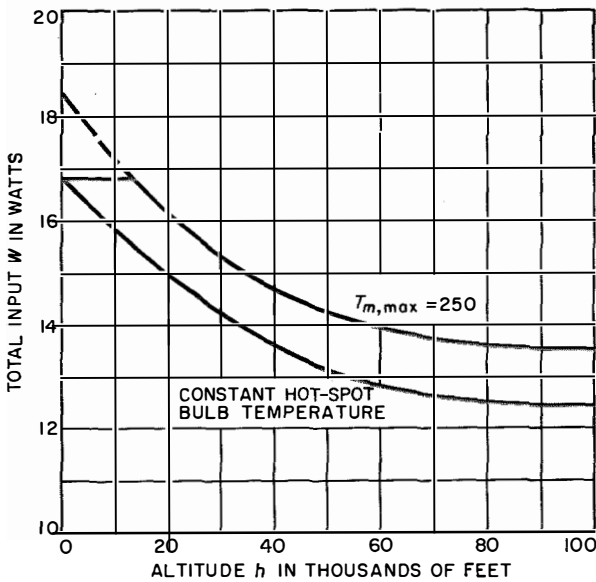

Figure 9—Rerating curve $W = f(h)_{T_m, T_0 \text{ constant}}$ for 6AQ5. Ambient temperature $T_0 = 25$ degrees centigrade.

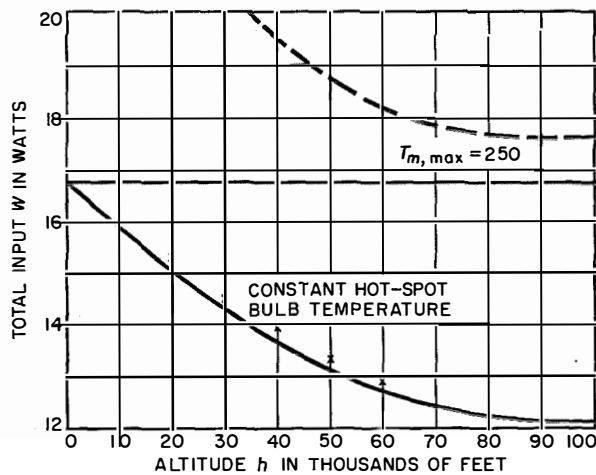

Figure 10—Rerating curve $W = f(h)_{T_m, T_0 \text{ constant}}$ for 6BW6. Ambient temperature $T_0 = 25$ degrees centigrade. The plotted points are those calculated from general rating equations.

The factor n for any given valve can be determined by measuring the bulb temperature along the length of the bulb and then plotting the fourth power of this temperature and graphically integrating the curve: this area divided by T_m^4 and the effective bulb area will give n . This has been done in Figure 11 for valve type 6V6GT and a value of n calculated to be 0.688.

This value will depend on the type of temperature distribution but is of no great importance except that its value varies slightly with T_m .

3.2 SOCKET LOSS—CONDUCTION LOSSES

Employing the same approach:—

$$\Sigma dW = \Sigma A_1 \lambda_1 (\gamma T_m - T_0),$$

where λ_1 is some effective thermal conductivity, A_1 is some effective area, and γT_m some temperature that would cause the same conditions of loss. Thus:—

$$W_2 = K_3 T_m - K_4 T_0,$$

where

$$K_3 = \gamma K_4 = \gamma A_0 \lambda_0.$$

Conduction losses are appreciable at heights greater than 50 000 feet or with wire-ended valves where the mounting uses some form of chassis clip that cools the bulb by conduction to a heat sink. For normal uses, the conduction losses are a very small proportion of the total losses.

3.3 CONVECTION LOSSES

The heat loss by free convection can be written as:—

$$\begin{aligned} dW &= C[(T_e - T_0)/L]^n (P/760)^a dA (T_e - T_0) \\ &= (C/L^n) (P/760)^a dA (T_e - T_0)^{1+n}, \end{aligned}$$

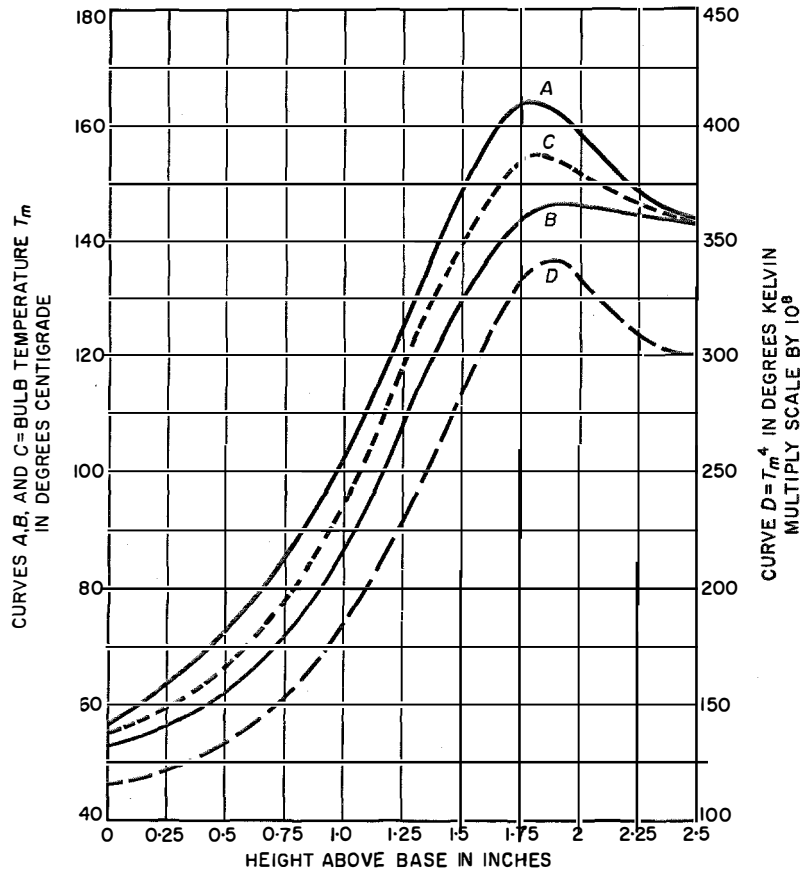

Figure 11—Temperature distribution along bulb of 6V6GT. Curve A = T_m along minor axis. Curve B = T_m along major axis. Curve C = mean bulb temperature. Curve D = $(\text{mean } T_m)^4$. The peak of curve A indicates the bulb hot-spot.

where C is a constant, L depends on dimensions, a is a constant determined by configuration and size of the bulb, and T_e is the average temperature of the elemental area dA losing heat to an ambient of T_0 .

By integration:—

$$\begin{aligned} W_3 &= C(P/760)^a \beta A (T_m - T_0) \\ &= K_5 (T_m - T_0). \end{aligned} \quad \left. \right\} (6)$$

In this equation,

$$\beta A (T_m - T_0)^{1+n} = \oint_A (T_e - T_0)^{1+n} dA,$$

and β may be derived experimentally in a similar way to n .

Summing (4), (5), and (6), a complete equation for energy lost from the valve envelope

is deduced:—

$$W = K_1 T_m^4 - K_2 T_0^4 + K_3 T_m - K_4 T_0 + K_5 T_m - K_6 T_0$$

$$= K_1 T_m^4 + K_6 T_m - K_7, \quad (7)$$

where

$$K_1 = nAE\sigma.$$

$$K_6 = K_3 + K_5$$

$$= \gamma A_0 \lambda_0 + C(P/760)^a \beta A$$

and

$$K_7 = K_2 T_0^4 + (K_4 + K_5) T_0$$

$$= AE\sigma T_0^4 + [A_0 \lambda_0 + C(P/760)^a \beta A] T_0.$$

This equation involves pressure in millimetres of mercury and it is convenient to convert this to altitude using an empirical relation that has

been developed from the figures given in the National Advisory Committee on Aeronautics' "Standard Atmosphere Tables" and covering the range up to 100 000 feet:—

$$P = P_0 \exp -x,$$

where

$$x = 13.4 / [(358/h) - 1]$$

and h is in thousands of feet. Figure 12 gives the points derived from this equation superimposed on the curve given in the Standard Atmosphere Tables. Our general equation (7):—

$$W = K_1 T_m^4 + K_6 T_m - K_7,$$

now takes a form directly applicable to changes in altitude and ambient temperature. As explained previously, it is permissible to ignore the

lead conduction terms, except with flying-lead valves, and thus the equation, by ignoring terms K_3 and K_4 , reduces to:—

$$W = K_1 T_m^4 + K_8 T_m \exp(-xa) - K_9, \quad (8)$$

where

$$K_8 = C\beta A$$

and

$$K_9 = K_2 T_0^4 + K_5 T_0 \exp(-xa).$$

By operating a given valve at several different total dissipations in a given ambient (as, room temperature) and measuring T_m , the coefficients K_1 , K_8 , and K_9 can be determined. K_2 is deduced from the constant term K_9 with a knowledge of K_8 , as the experiment is done at sea level; or, it is better to determine the law for K_9 experimentally by carrying out the measurements at various ambient temperatures. This will give a slightly different value for

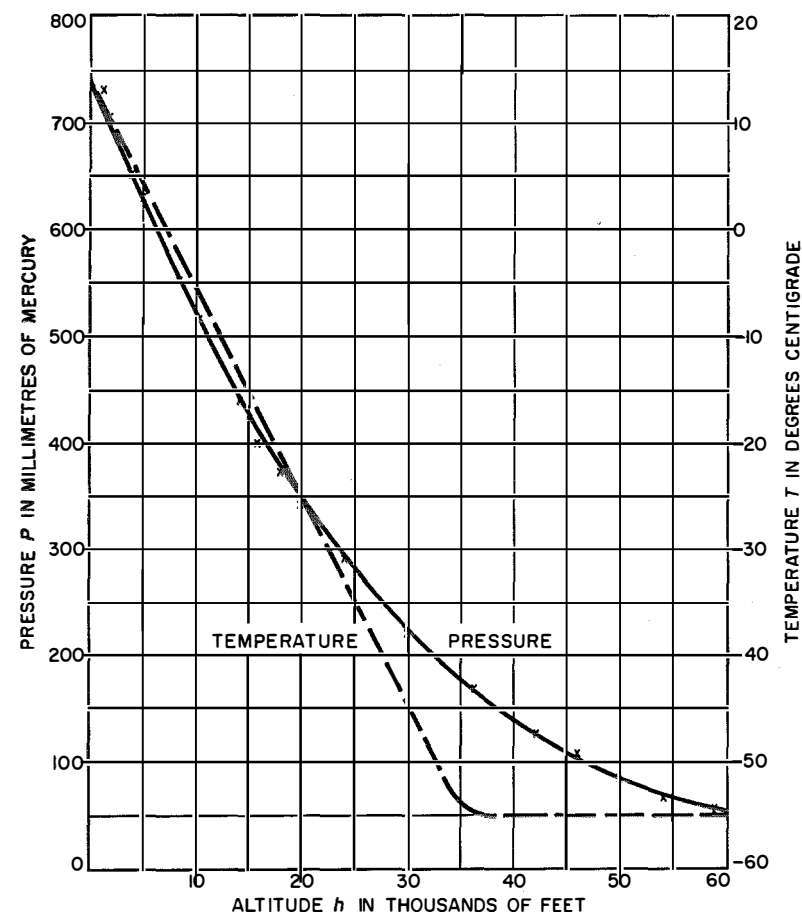

Figure 12—Variation of atmospheric pressure and temperature with altitude: National Advisory Committee for Aeronautics' standard atmosphere. The points X denote values given by the altitude-pressure law assumed in this report, $p = 760 \exp[-13.4 / \{(358/h) - 1\}]$.

K_8 , when

$$K_9 = K_2 T_0^4 + K_8' T_0 \exp(-xa).$$

The general procedure for application of this equation to valves is as follows:—

A curve of maximum hot-spot temperature is drawn against input power at sea level and at room temperature (Figure 3, $T_0 = 25$ -degrees-centigrade curve). Taking three points on this curve, a solution can be obtained for the simultaneous equations derived from:—

$$W = K_1 T_m^4 + K_8 T_m - K_9.$$

This gives for valve type $\delta BW\delta$ the values:—

$$K_1 = 0.0205 \times 10^{-8}$$

$$K_8 = 0.0366$$

$$K_9 = 11 \text{ for } T_0 = 25 \text{ and } h = 0.$$

Now, as Figure 3 gives curves for a number of ambient temperatures, the coefficient K_1 and K_8 can be established in each and will give a curve for K_9 against T_0 as in Figure 13. This can be

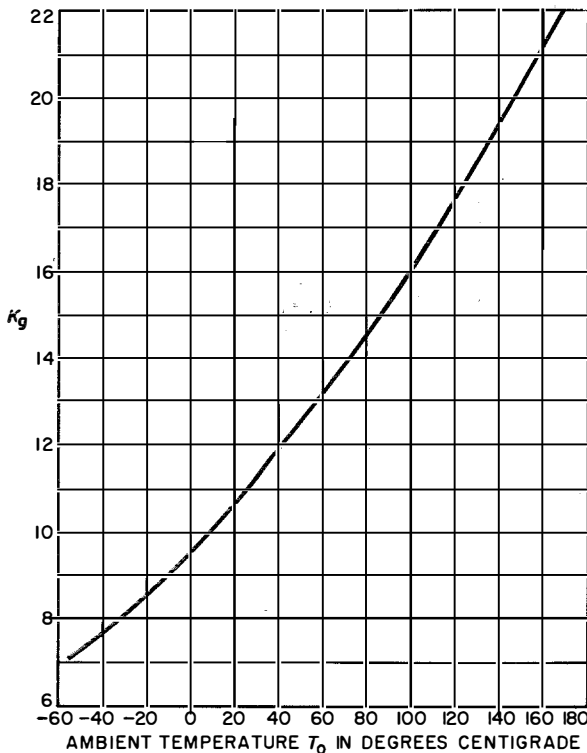

Figure 13—Plot of K_9 versus T_0 for $\delta BW\delta$.
From equation $K_9 = K_2 T_0^4 + K_8' T_0$.

solved to give an equation for K_9 as:—

$$K_9 = 0.0232 \times 10^{-8} T_0^4 + 0.0308. \quad (10)$$

Thus $K_8' = 0.0308$ (compare $K_8 = 0.0366$).

Then a general sea-level-operation equation for valve type $\delta BW\delta$ may be derived as

$$W = 0.0205 \times 10^{-8} T_m^4 + 0.0366 T_m - 0.0232 \times 10^{-8} T_0^4 - 0.0308 T_0. \quad (11)$$

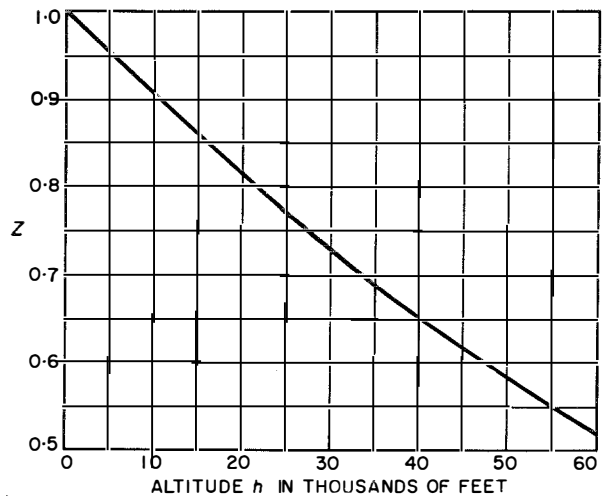

Figure 14—Plot of the factor $Z = \exp[-3.35/\{(358/h) - 1\}]$ for use in (12).

It is more convenient to use the general form (9) and read values of K_9 from the graph Figure 13.

To extend the equation to the general case of altitude variation, it is necessary to determine experimentally a value for the constant a . This should be constant for a given valve and configuration, in this case a long $B\theta A$ -based valve mounted vertically. To determine a , an experimentally determined rerating curve is taken and by substitution in the general equation (8), a value is calculated. This should be repeated for several sets of valves to obtain an average value. For long $B\theta A$ -based valves mounted vertically, a was determined as 0.25.

Thus, the general equation for $\delta BW\delta$ becomes:—

$$W = 0.0205 \times 10^{-8} T_m^4 - 0.0232 \times 10^{-8} T_0^4 + (0.0366 T_m - 0.0308 T_0) \times \exp[-3.35/\{(358/h) - 1\}]. \quad (12)$$

For convenience, $Z = \exp[-3.35/\{(358/h) - 1\}]$ is plotted as Figure 14.

A similar equation for valve type 6AQ5 has been derived as:—

$$W = 0.014 \times 10^{-8} T_m^4 - 0.015 \times 10^{-8} T_0^4 + (0.042 T_m - 0.044 T_0) \times \exp \left[-3.35 / \left\{ (358/h) - 1 \right\} \right]. \quad (13)$$

4. Conclusion

In conclusion it may be remarked that the most-efficient use of valves will result from the wise choice of T_m and the application of the rerating principles outlined here. A wide range of valves are now being measured for their performance under variation of input power and ambient temperature, but the optimum rating will result only after extensive life test. The rerating of valves must proceed with caution

although from the work carried out to date, it appears that there is considerable latitude left to the user to decide how the allowable power is distributed between the various electrodes, always provided the maximum dissipations are not exceeded.

An attempt has been made to formulate a quasi-theoretical approach to this problem and it is shown that simple tests can give information that will enable the whole family of rating curves to be evolved without resort to elaborate testing equipment.

5. Acknowledgement

Acknowledgement is made to the British Admiralty for permission to make use of the information contained in this paper.

Recent Telecommunication Development

Closed Circuit Television System Planning

MR. R. D. CHIPP, manager of systems engineering of Federal Telecommunication Laboratories, in collaboration with Mr. M. A. Mayers of Visual Electronics Corporation, has recently published a book for those who are responsible for evaluating the effectiveness of closed-circuit television as a communication system for their specific purposes.

The book is divided into three parts on the application of these systems, how they work, and the equipment used in them.

The information is presented in nontechnical

language for the executive with emphasis on over-all effectiveness, capabilities and limitations, and advantages and disadvantages.

A glossary of terms is included. There are bibliographies for each part for those who wish to examine more deeply into the subjects.

The book is $8\frac{1}{2}$ by 11 inches (22 by 28 centimeters) and bound in hard covers. It contains 264 pages and 182 illustrations. It may be obtained from John F. Rider, Publisher, Incorporated, 116 West 14th Street, New York 11, New York for \$10.00.

Multilayer Conductor Having Low Resistance at High Frequencies

By MASAO SUGI and KAORU MURAI

Sumitomo Electric Industries, Limited; Opaka, Japan

REMARKABLE progress and improvement have been made over the years in the design of insulators for transmission lines while almost no changes have been made in the conductors, which are usually simple solid or hollow cylindrical copper structures. For high-frequency use, where the skin effect is significant, a revision of design can reduce the effective resistance of the conductor. The theory of the design and some experimental results follow.

1. Principles

In the hollow cylindrical conductor shown in quarter cross section in Figure 1, the lines represent infinitely thin conducting tapes separated from each other by insulation. Each conductor will differ from all others in resistance and inductance, which are functions of the radius r but are not functions of frequency. The current distribution is equivalent to that in a system having as many parallel circuits as there are layers of conductors in the cable and the high-frequency currents tend to flow in the outer layers because of the effects of self-inductance of the individual conductors and of their mutual inductance. This is the cause of skin effect.

The equivalent electrical network of this structure is shown in Figure 2. The impedance seen from the terminals, $R + j\omega L_i$, depends on the effective resistance and the internal inductance of each of the n layers in parallel. If the inductance of each layer can be suitably adjusted with relation to the other layers, the skin effect can be eliminated.

If each layer is made of a tape laid in a helical form with its side edges insulated from each other and if each layer starting from the innermost one is of progressively smaller pitch (distance between turns), the effective inductances of all layers can be equalized result-

ing in each layer carrying an equal proportion of the current as would be the case for direct current, thus reducing the skin effect. Such an arrangement is shown in Figure 3.

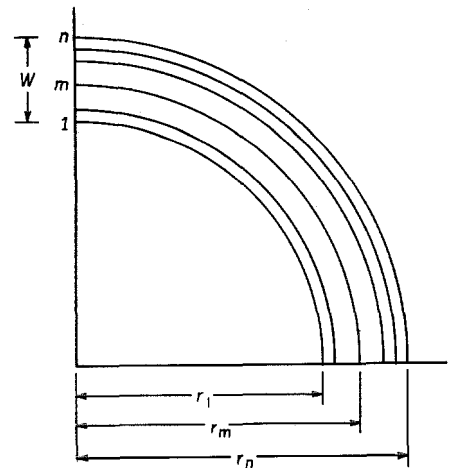

Figure 1—Quarter cross section of a hollow multilayer conductor composed of infinitely thin conducting layers of radius r separated by insulation.

The above theory assumes that the conducting tapes are infinitely thin. Actually, they can be as thick as the penetration of current, which is

$$\vartheta = \frac{5}{\pi} \left(\frac{\rho}{\mu f} \right)^{1/2},$$

where

ϑ = penetration of current in millimeters

ρ = conductor resistivity in microhm-centimeters

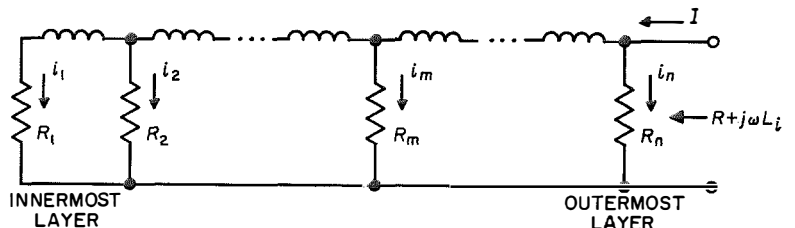

Figure 2—Equivalent circuit of multilayer conductor shown in Figure 1.

f = frequency in kilocycles per second
 μ = magnetic permeability, generally unity.

With tapes of finite thickness, the following condition must be obtained if the effective resistance is to be smaller than for a solid or hollow conductor of the same outer diameter.

$$t \leq \vartheta < nt, \tag{1}$$

where

t = thickness of the elementary layer
 n = number of layers.

The total thickness of all the layers is limited by the effect of the smaller pitch on the resistance of the outer layers.

$$W \ll r \tag{2}$$

where

W = total thickness of the several layers of conductors
 r = mean radius of the group of conductive layers.

For a finite t , eddy currents will be produced in each layer as a result of the mutual effects of the parallel current paths in the tape. This means that an appreciable skin effect will be present within each layer. This complicates the equivalent circuit of Figure 2, requiring the inclusion of resistance with the inductance of the series elements.

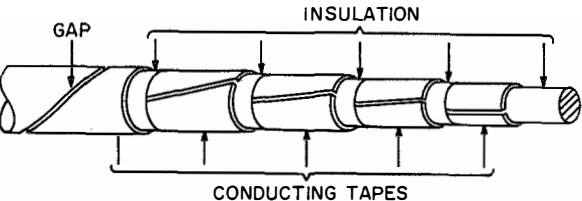

Figure 3—Example of conductor consisting of spiraled tapes insulated from each other and having decreased pitch with position from the center.

The mathematical solution of the problem is quite complicated but with the simplification indicated in Figure 2 and (2), it can be performed successfully. The details of the derivations will be omitted in the following presentation of the essential results.

2. Resistance for Ideal Current Distribution

If the effects of inductance are equalized by varying the pitch of the layers, the currents will

then distribute in accordance with the individual resistances of the layers, when the over-all resistance R of the cable becomes a minimum. This is the ideal distribution. The ratio of R to the resistance R_0 of a solid copper conductor of the same outer diameter is plotted in Figure 4 as a function of the ratio of the thickness of

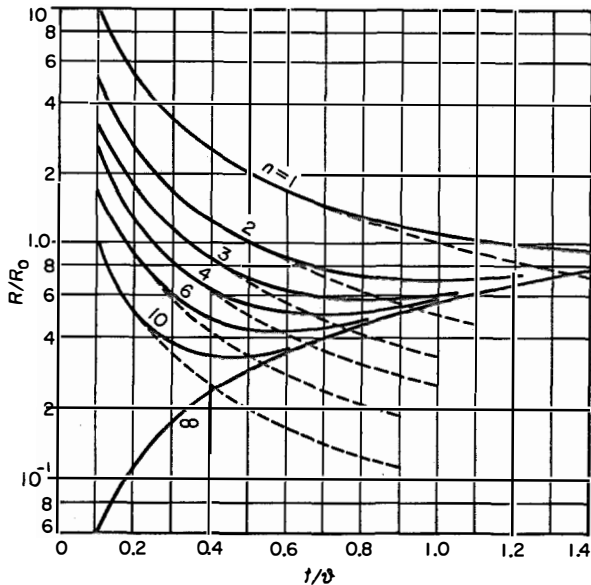

Figure 4—Theoretical reduction in resistance of a multilayer conductor R to a solid or hollow conductor R_0 of the same diameter as a function of the thickness of the layers t to the current penetration ϑ for the number of layers n indicated. The broken lines are for values of R_{DC}/R_0 using the R/R_0 scale.

the layers to the penetration of current. The broken lines show the ratio of the direct-current resistance R_{DC} of the multilayer conductor and R_0 , the high-frequency resistance of a solid conductor of the same outer diameter.

It is evident from Figure 4 that R/R_0 attains a minimum value for a given number of layers over a moderate range of t/ϑ . This minimum becomes smaller as the number of layers is increased and as the value of t/ϑ is reduced.

Figure 4 is developed from exact calculation, for which (3) is an approximation for the condition that $t/\vartheta < 1$.

$$R = \left[R_0 \frac{1}{(3)^{1/2}} \frac{t}{\vartheta} \right] / \left[\tanh \frac{n}{(3)^{1/2}} \left(\frac{t}{\vartheta} \right)^2 \right]. \tag{3}$$

The optimum thickness t_{opt} of the elemental conductor to produce a minimum value of R is

$$t_{opt} = 1.36 \vartheta / n^{1/2} \quad (4)$$

and the value of R for that condition is

$$R_{opt} = 0.98 R_0 / n^{1/2} \approx R_0 / n^{1/2}. \quad (5)$$

The increase of resistance of the elemental layer as a result of its helical form has been neglected above.

It is advantageous to vary the thickness of the layers according to the series 1.4ϑ , 0.75ϑ , 0.55ϑ , 0.45ϑ . . . , with the innermost layer being thickest. This produces R/R_0 of 0.63 for 2 layers, 0.51 for 3 layers, and 0.44 for 4 layers.

3. Pitch of Elemental Conductors

To calculate the pitch of each elemental conductor to produce the ideal current distribution, it was assumed that

$$t < 0.7 \vartheta / n^{1/2} \quad (6A)$$

$$W \ll r \quad (6B)$$

from which, the pitches of the following layers are obtained.

Innermost $\varphi_1 = 0$

m from inside layer

$$\varphi_m = \left(\frac{3W}{r} \right)^{1/2} \frac{m(m-1)}{n(n^2-1)^{1/2}} \quad (7)$$

outermost

$$\varphi_n = \left(\frac{3W}{r} \right)^{1/2} \left(\frac{n-1}{n+1} \right)^{1/2}.$$

If $n \gg 1$,

$$\varphi_n \approx (3W/r)^{1/2},$$

where

$$\varphi_m = (2\pi r)/P_m$$

$$P_m = \text{pitch of } m\text{th layer}$$

$$r = \text{mean radius of conductor layers.}$$

Equation (7) indicates that the pitch decreases quadratically from the innermost layer. Even if condition (6A) is not satisfied, the error will be slight. In designing a cable, the calculation of pitch should take into consideration the actual constructional details of the elemental conductors. This will not be treated here.

The effective increase in resistance R' resulting from the spiralling of the conductor under assumption (6B) is

$$R' = R \left(1 + \frac{3W}{5r} \right). \quad (8)$$

It should be noted that (6B) restricts the number of layers for a given diameter.

4. Resistance Variation with Frequency

The variation of resistance with frequency is given approximately by Figure 4, remembering that t/ϑ increases with frequency. Taking (3) and $t/\vartheta < 0.7$,

$$\frac{R}{R_{DC}} = \left[\frac{n}{(3)^{1/2}} \left(\frac{t}{\vartheta} \right)^2 \right] / \left[\tanh \frac{n}{(3)^{1/2}} \left(\frac{t}{\vartheta} \right)^2 \right]. \quad (9)$$

Figure 5 plots R/R_{DC} as a function of $[n/(3)^{1/2}] \times (t/\vartheta)^2$, which is proportional to frequency. The optimum point is 1.065 because it corresponds to t_{opt} given in (4).

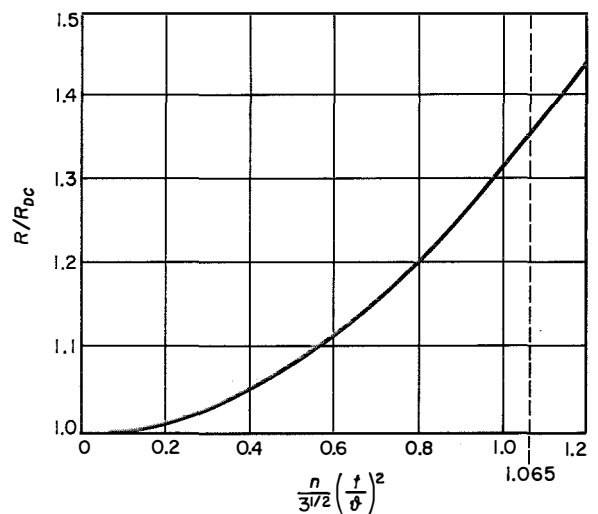

Figure 5—Resistance as a function of frequency, ϑ being dependent on frequency. 1.065 is the optimum design point.

5. Opposed Pitch

A 2-layer conductor based on the same general theoretical considerations but differing slightly in principles has equal but opposite pitches for the inner and outer layers. If the pitch is small enough the currents tend to flow equally in both layers and the axial fields due to the helical current flow will cancel.

With appropriate pitch, the effective resistance can be reduced by 20 to 30 percent over values obtained with solid or hollow conductors of the same diameter.

This design is particularly suited for the outer conductor of coaxial cable in that mechanically it is relatively simple and stable and electrically it has no external axial field.

6. Applications

Multilayer conductors are most effective under the condition that $\delta \ll r$ and practical applications are in the range where $r/\delta > 10$. They would be well suited for use as the inner or outer conductors of coaxial cables for long-distance submarine carrier telephone circuits, for which these conductors must be of large diameter and low resistance.

The maximum operating frequency will be limited by the thinness of the elementary conductors, which could be of copper, aluminum, or other suitable material.

7. Performance Data

Various samples of multilayer cable were manufactured in lengths of about 60 meters (200 feet). Figure 6 shows the design of two of them. In both, the inner solid copper core was included as a manufacturing convenience and was not

used as part of the electrical circuit. The insulation between the layers of tape was a polyester film about 0.0005-inch (0.013-millimeter) thick.

TABLE 1
ELECTRICAL CHARACTERISTICS

Property	Type A	Type B
Maximum Frequency in Kilocycles	300	1500
Direct-Current Resistance		
Ohms per Kilometer	4.36	12.78
Ohms per Statute Mile	7.02	20.56
Distributed Capacitance at 1 Kilocycle		
Microfarads per Kilometer	0.110	0.106
Microfarads per Statute Mile	0.177	0.171
Characteristic Impedance at Maximum Design Frequency in Ohms	46.5	48.0
Attenuation Constant at Maximum Frequency		
Decibels per Kilometer	0.79	2.10
Decibels per Statute Mile	1.27	3.38
Attenuation Ratio to Standard Cable at Maximum Design Frequency	0.68	0.71

Type A had 6 layers with progressive pitch for the inner conductor while the outer conductor was of conventional design suitable for operation up to 300 kilocycles per second.

Type B cable had 4 progressive-pitch layers for the inner conductor and 2 layers having opposed pitches for the outer conductor to permit operation at frequencies as high as 1500 kilocycles.

Table 1 gives the electrical characteristics measured on the experimental lengths of these two cable designs.

Figures 7 and 8 show the attenuation β for both cables as a function of frequency. The broken-line curves give the computed attenuation β_0 for a coaxial cable of conventional design having the same outer-conductor diameter as the experimental cable. The reduction in the

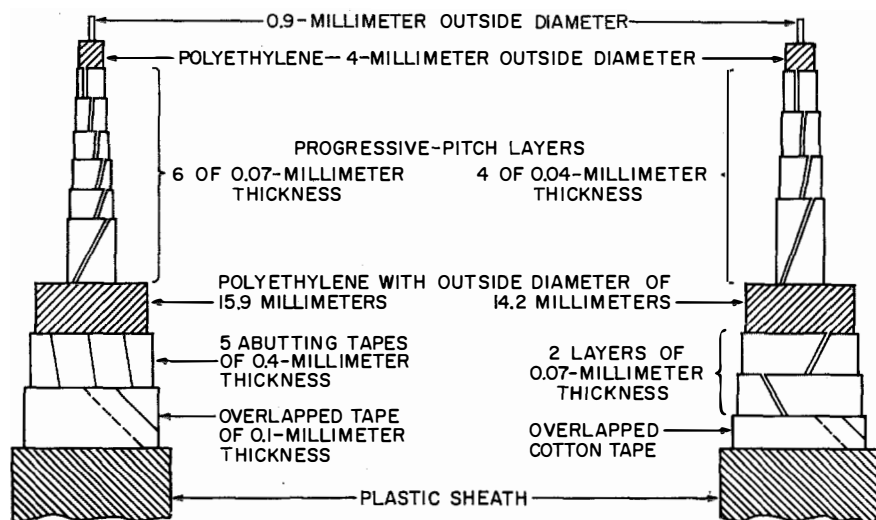

Figure 6—Design details of two experimental cables, type A at left and type B at right. All the conducting tapes and the innermost wire are of copper. Gaps between tape edges are about 1 millimeter.

attenuation β/β_0 of the multi-layer cable over the conventional cable at the maximum design frequency is given in Table 1.

For manufacturing convenience, the two outer opposed-pitch layers of the type-B cable were made considerably thicker than the optimum value of 0.05 millimeter. A further improvement of about 2 percent could be made in attenuation by reducing this dimension.

8. Submarine Telephone Cable

Recent developments in submarine telephone cables for transoceanic service make any substantial reduction in attenuation of great value. The reduction of 30 percent made possible by progressive-pitch multilayer construction will permit either a decrease in the number of repeaters or a reduction in cable diameter.

9. Clogston Cable

In a noteworthy paper¹ concerning the reduction of skin-effect losses by laminating the conductors, a design is presented in which the transmitted wave produces a potential difference between adjacent conductive laminas. Consequently, the quality of the interlayer insulation is important. For short lengths, this interlayer potential difference is shunted by the terminations and becomes less effective. There is, however, no restriction on the total thick-

¹A. M. Clogston, "Reduction of Skin-Effect Losses by the Use of Laminated Conductors," *Proceedings of the IRE*, volume 39, pages 767-782; July, 1951.

ness of the several laminas in this cable and it will produce a lower effective resistance than that obtainable with the design presented by the authors, whose cable has no potential difference between the layers and would be easier and less expensive to manufacture.

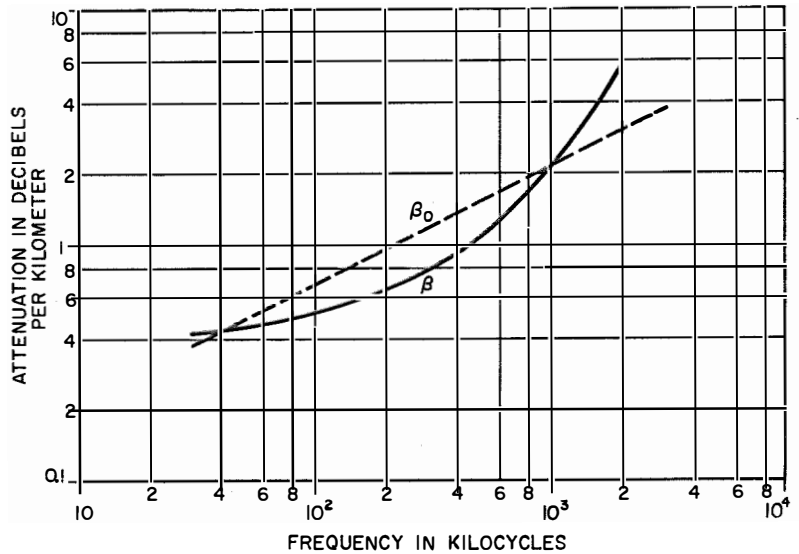

Figure 7—Measured attenuation β of type-A cable as a function of frequency compared with the calculated attenuation β_0 of an equivalent conventional coaxial cable. At the maximum design frequency of 300 kilocycles, $\beta/\beta_0 = 0.68$. Multiply attenuation by 1.6 for decibels per mile.

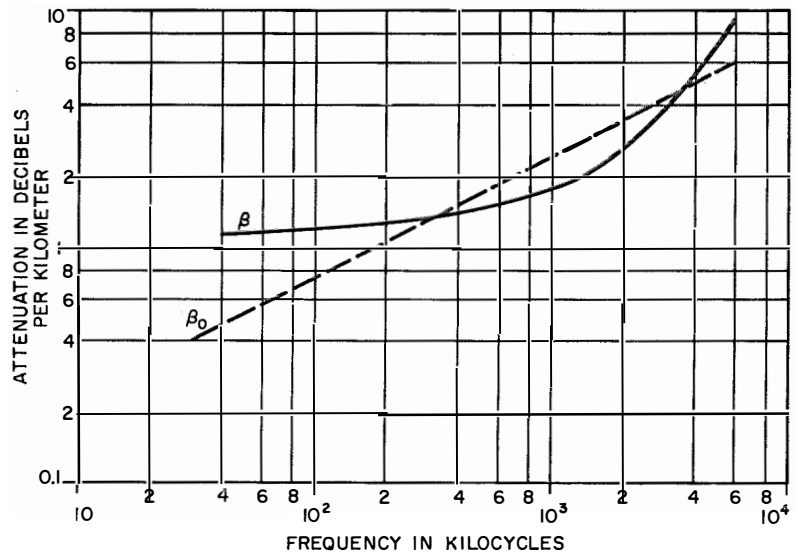

Figure 8—Attenuation β of type-B cable with frequency compared with β_0 of equivalent conventional design, $\beta/\beta_0 = 0.71$ at maximum designed frequency.

Telephone Statistics of the World*

DURING 1955, about 6.5 million telephones were added throughout the world, making a total of 101 million on January 1, 1956. More than half of the world's telephones were in the United States, where some 4700 privately owned and operated systems provided a telephone for one out of every three individuals. In Europe, which had some 29 percent of the world's telephones, mostly under public operation, there was a telephone for roughly one out of every 20 individuals.

For the purpose of this compilation, only those telephones that can be connected to a commercial public system are counted. Fourteen countries reported more than 1 million telephones in service on January 1, 1956: United States, United Kingdom, Canada, Western Germany, Japan, France, Italy, Sweden, Australia, Switzerland, Argentina, The Netherlands, Spain, and Eastern Germany. Of the world's principal countries, 9 had more than 15 telephones per 100 of population: United States (33.7), Sweden (30.4), Canada (26.3), New Zealand (24.6), Switzerland (24.3), Denmark (20.1), Australia (17.8), Norway (17.2), and Iceland (17.1).

New York, with more telephones than any other city, had almost twice as many as Greater London, which ranked second. On a per-capita basis, Washington, District of Columbia, led among the world's large cities with 64.2 telephones per 100 population and Stockholm, Sweden, was first outside the United States with 54.9.

A subdivision in certain of the tables shows the number of telephones operated under private and government ownership. The latter category has reference to municipal and state, as well as national, ownership. Although the American Telephone and Telegraph Company and its subsidiaries operated about 82 percent of the United States' 56 243 206 telephones on January 1, 1956, there were almost 5000 other privately owned companies that furnished service in the United States.

The statistics in this compilation are based on questionnaires sent to the telephone administrations of the various countries throughout the world.

TELEPHONES IN CONTINENTAL AREAS

Partly estimated; statistics reported as of other dates have been adjusted to January 1, 1956

Continental Area	Total Telephones			Privately Owned		Automatic (Dial)	
	Number	Percent of Total World	Per 100 Population	Number	Percent of Total	Number	Percent of Total
North America	60 420 500	59.8	33.1	59 791 900	99.0	50 107 200	82.9
Middle America	733 100	0.7	1.3	655 600	89.4	558 800	76.2
South America	2 568 200	2.6	2.1	1 212 800	47.2	2 116 900	82.4
Europe	29 090 100	28.8	5.2	4 781 300	16.4	22 355 700	76.8
Africa	1 411 200	1.4	0.6	28 700	2.0	986 000	69.9
Asia	4 411 200	4.4	0.3	3 158 900	71.6	2 489 400	56.4
Oceania	2 365 700	2.3	16.0	165 600	7.0	1 656 300	70.0
World	101 000 000	100.0	3.7	69 794 800	69.1	80 270 300	79.5
<i>United States</i>	<i>56 243 206</i>	<i>55.7</i>	<i>33.7</i>	<i>56 243 206</i>	<i>100.0</i>	<i>47 015 867</i>	<i>83.6</i>

* Abridgement from a booklet issued by the American Telephone and Telegraph Company; New York, New York.

TELEPHONES IN COUNTRIES OF THE WORLD AS OF JANUARY 1, 1956

Country	Total Telephones	Per 100 Population	Percent Automatic (Dial)	Ownership	
				Private	Government
NORTH AMERICA					
Alaska	27 762	16.83	78.8	7 265	20 497
Canada	4 149 300	26.28	74	3 541 450	607 850
Greenland	0	—	—	—	—
Saint Pierre and Miquelon	267	5.34	0	0	267
United States	56 243 206	33.73	83.6	56 243 206	0
MIDDLE AMERICA					
Bahamas	6 684	6.82	98.8	0	6 684
Barbados	6 214	2.71	97.5	6 214	0
Bermuda	8 300	19.30	100	8 300	0
British Honduras	961	1.20	0	45	916
Canal Zone (1) (2)	7 384	27.35	100	0	7 384
Costa Rica	11 618	1.20	2	11 503	115
Cuba	142 359	2.32	89.5	142 359	0
Dominican Republic	10 805	0.44	87.6	10 655	150
El Salvador	10 001	0.45	75.6	0	10 001
Guadeloupe and Dependencies	1 759	0.77	0	0	1 759
Guatemala (3)	11 000	0.33	80	0	11 000
Haiti	4 326	0.13	90.2	0	4 326
Honduras (3)	7 400	0.44	60	0	7 400
Jamaica and Dependencies	22 843	1.47	97.6	22 843	0
Leeward Islands:					
Antigua	486	0.93	0	0	486
Montserrat	100	0.77	0	0	100
Saint Christopher-Nevis	325	0.61	0	0	325
Virgin Islands (British)	0	—	—	—	—
Total	911	0.71	0	0	911
Martinique	3 713	1.55	67.7	0	3 713
Mexico (3)	357 426	1.19	72.8	355 626	1 800
Netherlands Antilles	7 600	4.02	96	0	7 600
Nicaragua (3)	3 700	0.29	0	0	3 700
Panama	19 942	2.16	82	19 362	580
Puerto Rico	59 966	2.60	65.7	55 589	4 377
Trinidad and Tobago	23 116	3.21	87.9	23 116	0
Virgin Islands (United States)	2 472	9.16	0	0	2 472
Windward Islands:					
Dominica	351	0.56	0	0	351
Grenada	1 200	1.50	0	0	1 200
Saint Lucia	440	0.50	6.8	0	440
Saint Vincent	426	0.58	0	0	426
Total	2 417	0.80	1.2	0	2 417
SOUTH AMERICA					
Argentina	1 127 933	5.85	82.4	79 019	1 048 914
Bolivia (3)	11 700	0.37	94	11 700	0
Brazil	804 800	1.37	82.8	804 800	0
British Guiana	4 624	0.94	9.7	0	4 624
Chile	149 372	2.20	69.9	148 572	800
Colombia	163 834	1.28	93.7	0	163 834
Ecuador (3)	12 500	0.34	60	1 500	11 000
Falkland Islands and Dependencies	375	17.05	0	0	375
French Guiana	666	2.38	0	0	666
Paraguay (3)	6 200	0.39	86	0	6 200
Peru	63 885	0.68	80.8	63 885	0
Surinam	3 551	1.48	95.3	0	3 551
Uruguay	114 300	4.34	75	0	114 300
Venezuela (3)	104 500	1.78	94	103 250	1 250
EUROPE					
Albania (4)	1 555	0.14	10.6	0	1 555
Andorra (3)	100	1.67	0	0	100
Austria	507 149	7.27	85.4	0	507 149
Belgium	877 702	9.87	80.7	0	877 702
Bulgaria (5)	54 347	0.77	39.4	0	54 347
Channel Islands:					
Guernsey and Dependencies	10 215	22.21	27.1	0	10 215
Jersey	14 013	24.58	0	0	14 013
Total	24 228	23.52	11.4	0	24 228
Czechoslovakia (5)	350 708	2.88	59.4	0	350 708
Denmark	896 755	20.05	44.2	788 908	107 847
Finland	462 015	10.83	65.1	360 830	101 185
France	3 116 697	7.18	68.2	0	3 116 697

- (1) Excluding telephone systems of the military forces. (6) March 31, 1956.
 (2) June 30, 1955. (7) January 1, 1947 (latest official statistics).
 (3) Data partly estimated. (8) Under government operation since 1949.
 (4) January 1, 1943 (latest official statistics). (9) January 1, 1936 (latest official statistics).
 (5) January 1, 1948 (latest official statistics). (10) Includes data for the Isle of Man.

TELEPHONES IN COUNTRIES OF THE WORLD AS OF JANUARY 1, 1956—Continued

Country	Total Telephones	Per 100 Population	Percent Automatic (Dial)	Ownership	
				Private	Government
EUROPE—Continued					
Germany, Democratic Republic	1 042 541	5.67	91.5	0	1 042 541
Germany, Federal Republic	3 985 212	7.59	94.1	0	3 985 212
Gibraltar	1 860	7.44	100	0	1 860
Greece	121 644	1.52	93.2	0	121 644
Hungary (5)	106 768	1.17	72.6	0	106 768
Iceland	27 114	17.05	64.4	0	27 114
Ireland	116 224	4.01	69.1	0	116 224
Italy	2 329 139	4.84	95	2 329 139	0
Liechtenstein	2 726	18.17	100	0	2 726
Luxemburg	32 330	10.43	81.9	0	32 330
Malta and Gozo (6)	8 675	2.76	0	0	8 675
Monaco	6 223	31.12	100	0	6 223
Netherlands	1 117 186	10.32	95.4	0	1 117 186
Norway (2)	588 160	17.17	63.5	54 876	533 284
Poland (5)	192 156	0.80	66.4	0	192 156
Portugal	255 862	2.91	64.9	170 042	85 820
Rumania (7)	127 153	0.77	75.8	126 131 (8)	1 022
Saar	54 606	5.48	100	0	54 606
San Marino (3)	425	3.04	100	0	425
Spain	1 092 857	3.76	79.6	1 076 327	16 530
Sweden	2 219 075	30.44	76.5	0	2 219 075
Switzerland	1 214 640	24.27	98.9	0	1 214 640
Turkey	139 155	0.58	79	0	139 155
Union Soviet Socialist Republics (9)	861 181	0.52	19.9	0	861 181
United Kingdom (6) (10)	6 879 511	13.46	77.3	0	6 879 511
Yugoslavia	162 499	0.92	66.4	0	162 499
AFRICA					
Algeria	134 707	1.40	78	0	134 707
Angola	3 537	0.08	71.3	0	3 537
Ascension Island	40	20.41	75	40	0
Basutoland	672	0.11	4.3	0	672
Bechuanaland	181	0.06	0	0	181
Belgian Congo	15 503	0.13	64.7	0	15 503
Cameroons (French Administration)	3 050	0.10	52.5	0	3 050
Cape Verde Islands	126	0.07	0	0	126
Comoro Islands	0	—	—	—	—
Egypt	151 062	0.65	75.6	0	151 062
Ethiopia and Eritrea	6 322	0.03	81.7	0	6 322
French Equatorial Africa	4 853	0.10	42.3	0	4 853
French West Africa	23 054	0.12	56.9	0	23 054
Gambia	481	0.17	99.2	0	481
Gold Coast (6)	13 423	0.32	41.3	0	13 423
Ifni	115	0.26	0	115	0
Kenya	26 841	0.44	75.8	0	26 841
Liberia	1 067	0.09	100	302	765
Libya	7 000	0.63	76.9	0	7 000
Madagascar and Dependencies	9 556	0.20	45	1 569	7 987
Mauritius and Dependencies	6 875	1.23	8	0	6 875
Morocco:					
Former French Zone	99 550	1.18	80.5	0	99 550
Former Spanish Zone	8 606	0.83	56.1	8 606	0
Tangier	10 761	5.85	97.1	10 452	309
Total	118 917	1.23	80.3	19 058	99 859
Mozambique	7 729	0.13	74	0	7 729
Nigeria, Federation of, and British Cameroons	19 784	0.06	44.1	0	19 784
Portuguese Guinea	332	0.06	0	0	332
Reunion	4 241	1.55	0	0	4 241
Rhodesia and Nyasaland:					
Northern Rhodesia	11 126	0.52	92.5	1 046	10 080
Nyasaland	3 086	0.12	81.5	0	3 086
Southern Rhodesia	47 352	1.94	80.6	0	47 352
Total	61 564	0.86	82.8	1 046	60 518
Ruanda-Urundi	842	0.02	91.9	0	842
Saint Helena	111	2.22	0	0	111
Sao Tome and Principe	306	0.56	0	0	306
Seychelles and Dependencies	150	0.41	100	150	0
Sierra Leone	1 899	0.09	83.1	0	1 899
Somaliland, British Protec.	250	0.04	0	0	250
Somaliland, French	683	1.05	100	0	683
Somaliland (Italian Administration)	1 144	0.09	0	0	1 144
South West Africa	9 126	1.97	46	0	9 126
Spanish Guinea	670	0.32	68.8	670	0
Spanish North Africa	5 682	3.95	100	5 682	0
Spanish Sahara	38	0.07	0	38	0

TELEPHONES IN COUNTRIES OF THE WORLD AS OF JANUARY 1, 1956—Continued

Country	Total Telephones	Per 100 Population	Percent Automatic (Dial)	Ownership	
				Private	Government
AFRICA—Continued					
Sudan	15 179	0.15	77.2	0	15 179
Swaziland	919	0.44	2.7	0	919
Tanganyika	10 572	0.13	54.2	0	10 572
Togoland (British Administration) (6)	460	0.11	0	0	460
Togoland (French Administration)	782	0.07	0	0	782
Tunisia	32 634	0.86	59.1	0	32 634
Uganda	9 509	0.17	75.1	0	9 509
Union of South Africa (6)	712 422	5.14	68.2	0	712 422
Zanzibar and Pemba	1 045	0.38	4.3	0	1 045
ASIA					
Aden Colony	2 564	1.83	100	0	2 564
Aden Protectorate	0	—	—	—	—
Afghanistan (3)	6 050	0.05	30	0	6 050
Bahrain	1 594	1.33	100	1 594	0
Bhutan	0	—	—	—	—
Brunei	145	0.26	0	0	145
Burma (3)	7 300	0.04	0	0	7 300
Cambodia	2 329	0.05	0	0	2 329
Ceylon	26 993	0.31	94.9	0	26 993
China (Less Taiwan) (5)	244 028	0.05	72.9	94 945(7)	149 083
Cyprus	11 187	2.13	87.1	0	11 187
Hong Kong	56 606	2.40	100	56 606	0
India (6)	277 418	0.07	56.4	2 900	274 518
Indonesia	73 918	0.09	11.9	0	73 918
Iran (3)	59 000	0.28	55	0	59 000
Iraq (6)	37 693	0.72	76.1	0	37 693
Israel	65 967	3.69	92.3	0	65 967
Japan (6)	3 123 449	3.48	53.6	3 123 449	0
Jordan	10 057	0.70	69.7	0	10 057
Korea, South	42 648	0.20	39.9	0	42 648
Kuwait	1 538	0.77	78.6	1 538	0
Laos	550	0.04	65.3	0	550
Lebanon	33 745	2.41	85.2	0	33 745
Macao	1 839	0.92	100	0	1 839
Malaya	52 173	0.86	64.4	0	52 173
Maldivé Islands	0	—	—	—	—
Muscat and Oman	151	0.03	100	151	0
Nepal	0	—	—	—	—
Netherlands New Guinea	1 015	0.15	0	0	1 015
North Borneo	1 513	0.41	78.1	0	1 513
Pakistan	42 360	0.05	65.6	0	42 360
Philippine Republic	53 875	0.24	69	47 549	6 326
Portuguese India	254	0.04	0	0	254
Portuguese Timor	386	0.08	0	0	386
Qatar	343	1.14	100	343	0
Ryukyu Islands	10 708	1.34	73.8	0	10 708
Sarawak	1 257	0.20	73.2	0	1 257
Saudi Arabia (3)	8 900	0.13	0	0	8 900
Singapore	36 323	2.94	100	0	36 323
Syria	34 693	0.89	82.5	0	34 693
Taiwan	42 211	0.46	48.6	0	42 211
Thailand	10 519	0.05	100	0	10 519
Trucial Oman	0	—	—	—	—
Viet-Nam	12 017	0.05	83.6	0	12 017
Yemen	0	—	—	—	—
OCEANIA					
Australia	1 653 149	17.75	70	0	1 653 149
British Solomon Islands	0	—	—	—	—
Caroline Islands	196	0.46	0	0	196
Cook Islands	164	1.03	0	77	87
Fiji Islands	4 000	1.16	0	0	4 000
French Oceania	803	1.16	0	0	803
Gilbert and Ellice Islands	109	0.27	73.4	77	32
Guam	9 216	12.13	94.5	0	9 216
Hawaii	165 338	29.01	99.6	165 338	0
Mariana Islands (less Guam)	250	4.17	0	0	250
Marshall Islands	465	3.32	98.9	0	465
Nauru	0	—	—	—	—
New Caledonia and Dependencies	1 998	3.07	66.1	0	1 998
New Hebrides Condominium	213	0.43	0	0	213
New Zealand (6)	534 501	24.61	61.6	0	534 501
Niue Island	59	1.18	0	0	59

TELEPHONES IN COUNTRIES OF THE WORLD AS OF JANUARY 1, 1956—Continued

Country	Total Telephones	Per 100 Population	Percent Automatic (Dial)	Ownership	
				Private	Government
<i>OCEANIA—Continued</i>					
Norfolk	27	2.70	0	0	27
Papua and New Guinea	3 260	0.19	3	97	3 163
Pitcairn Island	0	—	—	—	—
Samoa, American	331	1.66	100	0	331
Samoa, Western	648	0.67	0	0	648
Tokelau Islands	0	—	—	—	—
Tonga (Friendly) Islands	432	0.82	0	0	432

TELEPHONE CONVERSATIONS FOR THE YEAR 1955

Country	Number of Conversations in Thousands			Conversations Per Capita
	Local	Toll	Total	
Alaska	92 600	700	93 300	572.4
Algeria	66 600	25 900*	92 500	9.8
Argentina	3 337 800	39 700	3 377 500	176.7
Australia	1 146 000	94 700	1 240 700	134.8
Bahamas	14 000	100	14 100	151.6
Belgium	488 500	83 700	572 200	64.6
Brazil	3 384 000	47 800	3 431 800	58.7
Canada	6 803 200	153 100	6 956 300	445.9
Ceylon	58 900	4 800	63 700	7.4
Channel Islands	17 200	200	17 400	168.9
Chile	371 600	22 800	394 400	58.1
Colombia	547 800	9 700	557 500	44.0
Costa Rica	39 400	800	40 200	42.3
Cuba	790 000	6 000	796 000	131.4
Denmark	1 058 300	171 800	1 230 100	275.0
Egypt	377 700	14 300	392 000	16.9
El Salvador	19 100	2 100	21 200	9.7
Ethiopia and Eritrea	11 000	500	11 500	0.6
Fiji Islands	6 000	300	6 300	18.8
Finland	561 400	84 900	646 300	152.7
France	1 816 100	531 800	2 347 900	54.2
French West Africa	14 200	1 400	15 600	0.9
Germany, Democratic Republic	770 200	115 400	885 600	49.2
Germany, Federal Republic	2 583 600	558 300	3 141 900	60.1
Greece	299 500	6 200	305 700	38.5
Haiti	18 400	100	18 500	5.6
Hawaii	357 200	3 300	360 500	647.2
Iceland	61 400	1 700	63 100	399.4
Ireland	87 700	14 600	102 300	35.2
Israel	103 500	4 900	108 400	62.0
Italy	3 803 000	233 000*	4 036 000	84.1
Jamaica	51 000	900	51 900	33.6
Japan	10 447 000 (1)	690 500	11 137 500	125.3
Lebanon	49 900	3 800	53 700	38.6
Malaya	140 300	15 500	155 800	25.7
Mexico	789 800	10 800	800 600	27.0
Morocco	86 000	17 200*	103 200	10.9
Mozambique	10 000	300	10 300	1.7
Netherlands	751 400	264 600	1 016 000	94.5
Norway	483 200 (2)	57 700	540 900	158.6
Peru	250 400	3 800	254 200	27.1
Philippine Republic	412 200	500	412 700	18.9
Portugal	233 600	43 300	276 900	31.6
Puerto Rico	123 600	2 500	126 100	54.9
Saar	73 500	1 300	74 800	75.4
Singapore	157 700	700	158 400	130.6
South West Africa	8 900	1 400	10 300	22.5
Spain	2 276 000	82 700	2 358 700	81.4
Sweden	2 842 800 (3)	124 400	2 967 200	407.0
Switzerland	487 300	415 000*	902 300	181.3
Syria	92 800	5 900	98 700	25.5
Trinidad and Tobago	71 700	3 400	75 100	105.8
Tunisia	22 800	7 400	30 200	8.1
Turkey	197 000	7 500	204 500	8.5
Union of South Africa	794 800 (1)	54 300	849 100	62.1
United Kingdom	3 900 800 (1) (4)	335 100	4 235 900	83.1
United States	65 175 000	2 475 000	67 650 000	409.3
Yugoslavia	270 600	20 600	291 200	16.6

(1) Year ended March 31, 1956. (2) Year ended June 30, 1955. (3) Year ended June 30, 1956. (4) Includes conversations for the Isle of Man. *Three-minute units.

United States Patents Issued to International Telephone and Telegraph System; May-July 1957

BETWEEN May 1 and July 31, 1957, the United States Patent Office issued 34 patents to the International System. The names of the inventors, company affiliations, subjects, and patent numbers are listed below.

- R. T. Adams, A. Horvath, and B. Parzen, Federal Telecommunication Laboratories, Standing-Wave-Ratio Monitor, 2 797 387.
- M. Amann, W. Gruger, and R. Scholpp, Mix & Genest (Stuttgart), Sound Damper for Signaling Devices, 2 800 101.
- M. Arditi, G. A. Deschamps, and J. Elefant, Federal Telecommunication Laboratories, Microwave Transmission Systems and Impedance-Matching Devices, 2 794 174.
- A. J. Baracket, Federal Telecommunication Laboratories, Television Synchronizing Generator, 2 794 069.
- A. H. W. Beck and A. D. Brisbane, Standard Telephones and Cables (London), Electron Discharge Tubes, 2 797 356.
- J. H. Bryant, Federal Telecommunication Laboratories, Traveling-Wave Electron Discharge Devices, 2 794 145.
- J. H. Bryant, H. W. Cole, and A. W. McEwan, Federal Telecommunication Laboratories, Traveling-Wave Electron Discharge Devices, 2 798 981.
- J. H. Bryant, A. G. Peifer, and R. W. Wilmarth, Federal Telecommunication Laboratories, Traveling-Wave Electron Discharge Devices, 2 800 603.
- L. A. DeRosa, Federal Telecommunication Laboratories, Radio Location System, 2 800 654.
- E. deFaymoreau and M. Mandel, Federal Telecommunication Laboratories, Pulse-Repetition-Rate Selector, 2 795 775.
- S. H. M. Dodington, Federal Telecommunication Laboratories, Automatic Level Control of Local Oscillation in Superheterodyne Receiver, 2 798 947.
- S. H. M. Dodington, Federal Telecommunication Laboratories, Frequency-Discriminator Circuit, 2 791 690.
- J. S. Foley, Capehart-Farnsworth Company, Unidirectional Signal-Conducting System, 2 796 539.
- E. Ganitta, Mix & Genest (Stuttgart), Arrangement for Coupling Monitoring Devices to Two-Wire Transmission Lines, 2 799 725.
- D. D. Grieg and H. F. Engelmann, Federal Telecommunication Laboratories, Radio-Frequency Transmission Waveguides, 2 800 634.
- H. L. Horwitz and G. L. Hasser, Federal Telephone and Radio Company, Automatic Telephone Systems, 2 797 262.
- J. F. Houdek, Jr., Kellogg Switchboard and Supply Company, Telephone with Push-Button Impulse Sender, 2 791 638.
- R. W. Hughes and N. Weintraub, Federal Telecommunication Laboratories, Power Line Fault Locator, 2 794 071.
- R. V. Judy, Kellogg Switchboard and Supply Company, Combined Telephone and Dictation System, 2 791 632.
- J. A. Kostriza and P. Terranova, Federal Telecommunication Laboratories, Microwave Transmission Lines, 2 797 390.
- A. M. Levine, Federal Telecommunication Laboratories, Compandor Control System, 2 795 650.
- A. Leib, C. Lorenz, A. G. (Stuttgart), Multi-range Voltage-Indicating Valve, 2 799 790.

T. J. Marchese, Federal Telecommunication Laboratories, Traveling-Wave Electron Discharge Devices, 2 800 605.

A. J. Montchause and D. Dautry, Compagnie Générale de Constructions Téléphoniques (Paris), Regulating Device for Electric Switching Equipment, 2 799 754.

S. Nevin, Capehart-Farnsworth Company, Sensitive Electron Discharge Tube, 2 796 547.

M. Peek, Mix & Genest, (Stuttgart), On-Edge Conveyor System, Particularly for Distribution of Flat Objects Such as Letters or Postcards, 2 799 385.

J. Polyzou, Federal Telephone & Radio Company, Carrier Telegraph Receiver, 2 797 261.

W. Reinhard, C. Lorenz, A. G. (Stuttgart), Circuit Arrangement Generating Sawtooth Current Waves, 2 797 316.

D. C. Rogers and C. C. Eaglesfield, Standard Telephones and Cables (London), Traveling-Wave Amplifier, 2 797 360.

T. R. Scott, Standard Telecommunication Laboratories (London), Electric Cables, 2 799 608.

W. Sichak, Federal Telecommunication Laboratories, Antenna Systems, 2 794 185.

W. Sindzinski and R. Goerlich, Mix & Genest (Stuttgart), Pneumatic Dispatching Systems, 2 797 057.

H. E. Thomas and E. Stein, Federal Telecommunication Laboratories, Signal Switching Device, 2 797 341.

R. E. White, Federal Telecommunication Laboratories, Traveling-Wave Electron Discharge Devices, 2 794 144.

Traveling-Wave Amplifier

2 797 360

D. C. Rogers and C. C. Eaglesfield

This invention concerns a magnet assembly for traveling-wave tubes. The focusing magnet for the long electron beam of this tube is com-

posed of magnetic cells in a continuous series along a common axis, each cell consisting of a pair of parallel plates of high magnetic permeability and low reluctance with a permanent magnet between the plates. The magnets of each cell are similarly oriented to provide a rectilinear magnetic field along the axis of the assembly.

Traveling-Wave Electron Discharge Devices

2 800 603

J. H. Bryant, A. G. Peifer, and R. W. Wilmarth

A traveling-wave tube is described in which an improvement in the noise figure is obtained by utilizing a potential-jump electron-gun structure. The various cylindrical elements, which are spaced to provide the potential jump, and the cathode are all in a unitary structure. The input radio-frequency line is also a part of this unitary structure.

Electric Cables

2 799 608

T. R. Scott

A process is disclosed for sheathing a paper-insulated cable with aluminum of as low as 99.5 percent purity. The outer layer of paper is acetylated with up to 20 percent combined acetic acid content. This insulation will not be damaged to an appreciable extent when the aluminum sheath is applied at a temperature of up to 500 degrees centigrade and cooled slowly to a temperature not greater than 120 degrees centigrade after sufficient time to provide proper annealing.

Sensitive Electron Discharge Tube

2 796 547

S. Nevin

To provide a photoelectric tube with high photosensitivity but low noise from heating of the photosensitive cathode, an electron lens is used to focus the cathode image through a small aperture in a mask. The electrons passing

through this aperture may then be amplified by conventional electron multipliers.

Electron Discharge Tubes

2 797 356

A. H. W. Beck and A. D. Brisbane

This patent concerns a tube that will pass signals only when all of a number of different potentials are applied. A number of beams are projected along different axes through electrodes that are normally biased to cut the beams off before they can reach the common anode. If the proper positive potentials are not applied to all of the interacting control electrodes simultaneously, very little energy from the beam will reach the anode, but if all electrodes are supplied with the proper positive pulse potentials, then

energy from all of the beams will reach the anode to provide a strong output signal.

Traveling-Wave Electron Discharge Devices

2 794 145

J. H. Bryant

Radio-frequency input and output coupling means are shown for a traveling-wave tube. A properly dimensioned microstrip conductor is connected to each end of the traveling-wave helix to provide an impedance match between the coaxial input and output leads and the helix. By use of this microstrip coupling, a very-short coupling length is required and the traveling-wave tube may, therefore, be materially shortened.

Recent Telecommunication Development

Etching of Gustav Robert Kirchhoff

GUSTAV ROBERT KIRCHHOFF (1824–1887) is the subject of the latest etching in the series issued by the International Telecommunications Union.

Born and educated in Königsberg, Prussia, Kirchhoff was professor of physics successively at the universities of Breslau, Heidelberg, and Berlin. He made numerous contributions to experimental and mathematical physics. They were on such subjects as electrical measurements, the theorem that bears his name and relates the distribution of electric currents in a network, the equivalent velocity of an electric wave on a wire and light in free space, the nature of crystalline matter, and thermodynamics.

Kirchhoff gave the explanation of the Fraun-

hofer lines, stimulating interest in the powerful tool of spectrum analysis.



Hughes, Kelvin, Kirchhoff, Lorentz, Marconi, Maxwell, Morse, Popov, Pupin, Rayleigh, Siemens, and Tesla.

The etching of Kirchhoff is the 23rd in the series that was started in 1935. On a good grade of paper measuring 9 by 6⁵/₈ inches (23 by 17 centimeters) including margins, these etchings are available at 3 Swiss francs each from Secrétariat général de l'Union internationale des Télécommunications, Palais Wilson, 52, rue des Pâquis, Genève, Suisse. The entire series is comprised of etchings of Ampère, Armstrong, Baudot, Bell, Erlang, Faraday, Ferrié, Fresnel, Gauss and Weber, Heaviside, Hertz,

In Memoriam

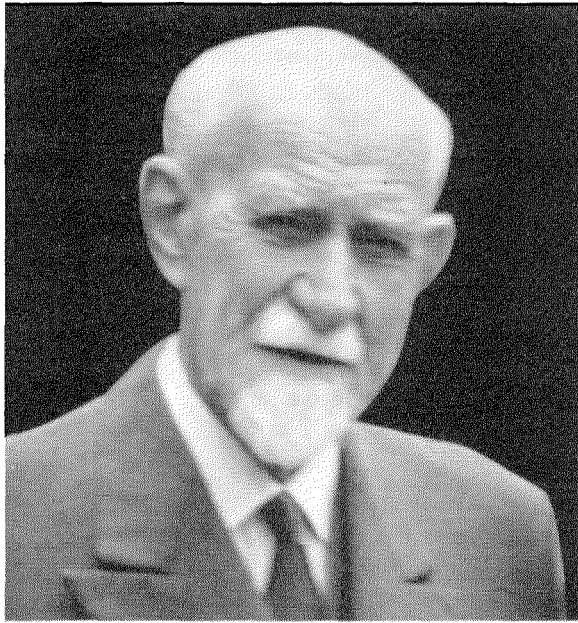

FREDERICK GEORGE CREED

FREDERICK GEORGE CREED was born in Mill Village, Nova Scotia, on October 6, 1871. As a boy, he worked in the Canso, Nova Scotia, cable station of the Western Union Telegraph and Cable Company. After learning both cable and land-line telegraphy, he went to New York in 1890 as a land-line telegrapher and then to South America in 1891 as a cable operator. He returned to Nova Scotia in 1896.

While in South America, he visualized a machine like a typewriter that would punch code characters in paper tape to replace the slow tedious manual methods of punching tape then in use. While accompanying his wife on a visit to her native Scotland in 1897, he obtained financial backing and produced a prototype keyboard perforator. Although the late Lord Kelvin considered the machine method to have no future, Mr. Creed continued and produced an improved model.

In 1902, the British Post Office ordered 12 perforators that proved to be much faster than hand punching. In the following two years, he produced a prototype reperforator receiver and a morse printer. From 1904 to 1909, he operated a factory in Glasgow and then moved to South Croyden in England. In 1915, the plant was moved to its present location in Croyden.

In 1912, Creed high-speed telegraph equipment was installed on a trial basis in the London and Manchester offices of the Daily Mail and shortly thereafter five other newspapers adopted it. This trend was interrupted by the world war but the effectiveness of the teleprinter soon became evident to the newspaper field. Later inventions such as the direct printer in 1923 improved the system.

Mr. Creed retired in 1928 when the company joined the International Telephone and Telegraph Corporation system. He died on December 11, 1957 in his 86th year.

Contributors to This Issue



BERNARD D. MILLS

GEORGES GOUDET. A photograph and biography of Dr. Goudet, author of the paper on semiconductors, appears in the June, 1957, issue of *Electrical Communications*.

• • •

BERNARD DOUGLAS MILLS was born in 1928, at Charters Towers, Queensland, Australia. Educated at All Souls' School and at Queensland University, he received the degree of Bachelor of Engineering with first-class honours in 1950 and the degree of Bachelor of Science in 1951.

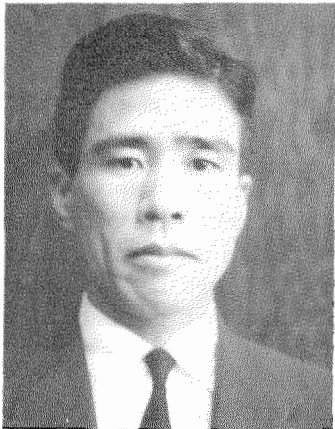

KAORU MURAI

He spent 18 months as a planning engineer with the Southern Electric Authority in Queensland and two years with the Amalgamated Wireless Valve in Sydney. In 1953, he joined Standard Telephones and Cables Limited in England. He is at present a member of the transistor division.

Mr. Mills is coauthor of the paper in this issue dealing with the power rating of thermionic valves.

• • •

KAORU MURAI was born in Uwajima, Japan, in 1921. He graduated in 1942 from Meiji College of Technology, in Tobata, Japan.

Mr. Murai joined the staff of the electrical laboratory of Sumitomo Electric Industries in 1942. He has specialized in communication cables and measuring apparatus for them.

He is coauthor of the paper in this issue on a new design for high-frequency coaxial cables.

• • •

MASAO SUGI was born in 1918 in Kashiwazaki, Japan. He graduated in 1940 from the electrical engineering department of Tokyo Imperial University.

In 1940, he joined the electrical laboratory of Sumitomo Electrical Industries, engaging in research on communication cables and high-frequency transmission lines. Mr. Sugi was made chief of the electrical laboratory of the company in 1956 and in 1957 became chief of the communication cable engineering section.

Mr. Sugi is coauthor of the paper in this issue on a new type of high-frequency coaxial cable.

• • •

WALTER W. WRIGHT was born in London, England, in 1919. He re-

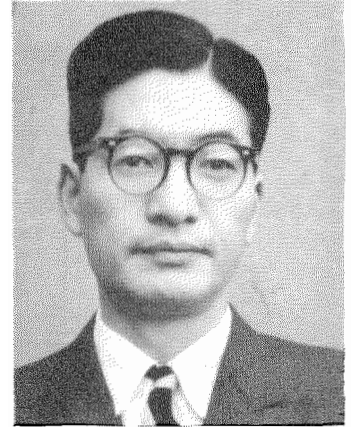

MASAO SUGI

ceived an Honours B.Sc. degree in physics from London University in 1940.

After 6 years with A. C. Cossor, Limited, he joined the staff of Brimar Valve Engineering Division of Standard Telephones and Cables, Limited. Since 1948, he has headed valve development at Footscray and for the past two years has also been responsible for the development of cathode-ray tubes.

Mr. Wright is an associate of the Institute of Physics and a Fellow of the Physical Society of Great Britain.



WALTER W. WRIGHT

INTERNATIONAL TELEPHONE AND TELEGRAPH CORPORATION

Principal U. S. Divisions and Subsidiaries

DIVISIONS	Components Division, Clifton, N. J. Kuthe Laboratories, Inc., Newark, N. J. Farnsworth Electronics Company, Fort Wayne, Ind. Federal Telecommunication Laboratories, Nutley, N. J. Federal Telephone and Radio Company, Clifton, N. J. Industrial Products Division, San Fernando, Calif. Kellogg Switchboard and Supply Company, Chicago, Ill.	SUBSIDIARIES	American Cable & Radio Corporation, New York, N. Y. All America Cables and Radio, Inc., New York, N. Y. Commercial Cable Company, The, New York, N. Y. Mackay Radio and Telegraph Company, New York, N. Y. Federal Electric Corporation, Paramus, N. J. Intelix Systems Incorporated, New York, N. Y. Airmatic Systems Corporation, Rochelle Park, N. J. International Telephone Building Corporation, New York, N. Y. Kellogg Credit Corporation, New York, N. Y. Royal Electric Corporation, Pawtucket, R. I.
------------------	-------------------------------------------------------------------------------------------------------------------------------------------------------------------------------------------------------------------------------------------------------------------------------------------------------------------------------------------------------------------	---------------------	--------------------------------------------------------------------------------------------------------------------------------------------------------------------------------------------------------------------------------------------------------------------------------------------------------------------------------------------------------------------------------------------------------------------------------------------------------------------------------------------------------------------------------------------

and . . . International Standard Electric Corporation, New York, N. Y.,
whose principal research, manufacturing, and sales affiliates are:

ARGENTINA	Capehart Argentina S.A.I.C. (50% owned), Buenos Aires Compañía Standard Electric Argentina, S.A.I.C., Buenos Aires		Mix & Genest (division), Stuttgart and Berlin Standard Central Laboratories (division), Stuttgart Süddeutsche Apparatefabrik (division), Nuremberg
AUSTRALIA	Standard Telephones and Cables Pty. Limited, Sydney Austral Standard Cables Pty. Limited (50% owned), Melbourne Silovac Electrical Products Pty. Limited, Sydney Standard Telephones and Cables (Qld.) Pty. Limited, Brisbane	IRAN	Standard Elektrizitäts-Gesellschaft Iran A.G., Teheran
AUSTRIA	Standard Telephon und Telegraphen Aktiengesellschaft, Czeija, Nissl & Co., Vienna	ITALY	Fabbrica Apparecchiature per Comunicazioni Elettriche Standard S.p.A., Milan
BELGIUM	Bell Telephone Manufacturing Company, Antwerp	MEXICO	Industria de Telecomunicación, S.A. de C.V. (50% owned), Mexico City Standard Eléctrica de México, S.A., Mexico City
BRAZIL	Standard Eléctrica, S.A., Rio de Janeiro	NETHERLANDS	Nederlandsch Standard Electric Maatschappij N.V., The Hague
CANADA	Standard Telephones & Cables Mfg. Co. (Canada), Ltd., Montreal	NEW ZEALAND	New Zealand Electric Totalisators Limited, Wellington
CHILE	Compañía Standard Electric, S.A.C., Santiago	NORWAY	Standard Telefon og Kabelfabrik A/S, Oslo
CUBA	Equipos Telefónicos Standard de Cuba, Havana International Standard Products Corporation, Havana	PORTUGAL	Standard Eléctrica, S.A.R.L., Lisbon
DENMARK	Standard Electric Aktieselskab, Copenhagen	PUERTO RICO	Standard Electric Corporation of Puerto Rico, San Juan
FINLAND	Oy Suomen Standard Electric AB, Helsinki	SPAIN	Standard Eléctrica, S.A., Madrid
FRANCE	Compagnie Générale de Constructions Téléphoniques, Paris Les Téléimprimeurs, Paris Laboratoire Central de Télécommunications, Paris Le Matériel Téléphonique, Paris	SWEDEN	Standard Radio & Telefon AB, Stockholm
GERMANY	C. Lorenz A.G., Stuttgart and Berlin Schaub Apparatebau (division), Pforzheim Standard Elektrik A.G., Stuttgart Informatikwerk (division), Stuttgart Kabelwerk (division), Stuttgart	SWITZERLAND	Standard Téléphone et Radio S.A., Zurich
		TURKEY	Standard Electric Türk Limited Şirketi, Ankara
		UNITED KINGDOM	Creed & Company, Limited, Croydon Standard Telephones and Cables Limited, London Kolster-Brandes Limited, Sidcup Standard Telecommunication Laboratories Limited, London
		VENEZUELA	Standard Telecommunications C.A., Caracas

Overseas Telecommunication Companies

ARGENTINA	Compañía Internacional de Radio, S.A., Buenos Aires Sociedad Anónima Radio Argentina (subsidiary of American Cable & Radio Corporation), Buenos Aires	CUBA	Cuban American Telephone and Telegraph Company, (50% owned), Havana Cuban Telephone Company, Havana Radio Corporation of Cuba, Havana
BOLIVIA	Compañía Internacional de Radio Boliviana, La Paz	PERU	Compañía Peruana de Teléfonos Limitada, Lima
BRAZIL	Companhia Rádio Internacional do Brasil, Rio de Janeiro Companhia Telefônica Nacional, Curitiba and Porto Alegre	PUERTO RICO	Porto Rico Telephone Company, San Juan Radio Corporation of Puerto Rico, San Juan
CHILE	Compañía de Teléfonos de Chile, Santiago Compañía Internacional de Radio, S.A., Santiago	SPAIN	Compañía Radio Aérea Marítima Española, S.A., Madrid
		UNITED KINGDOM	International Marine Radio Company Limited, Croydon

Associate Licensees for Manufacture and Sales

FRANCE	Lignes Télégraphiques et Téléphoniques, Paris	JAPAN	Nippon Electric Company, Limited, Tokyo Sumitomo Electric Industries, Limited, Osaka
ITALY	Società Italiana Reti Telefoniche Interurbane, Milan	SPAIN	Marconi Española, S.A., Madrid