

ELECTRICAL COMMUNICATION

*Technical Journal of the
International Telephone and Telegraph Corporation
and Associate Companies*

ELECTRICAL COMMUNICATION: 1940-1945

MULTIPLEX BROADCASTING

THREE NEW ANTENNA TYPES AND THEIR APPLICATIONS

CONVERSION OF SAN JUAN, PUERTO RICO, TELEPHONE PLANT
TO AUTOMATIC OPERATION

OVEN FOR AIRBORNE PIEZOELECTRIC CRYSTALS

EVALUATION OF NIGHT ERRORS IN AIRCRAFT DIRECTION
FINDING, 150-1500 KILOCYCLES

JACKETING MATERIALS FOR HIGH-FREQUENCY TRANSMISSION LINES

CURRENT RATING OF SINGLE-CORE PAPER-INSULATED POWER CABLES

ELECTRICAL UNITS AND THE MKS SYSTEM

RECENT TELECOMMUNICATION DEVELOPMENTS

MARCH, 1946

VOL. 23

No. 1

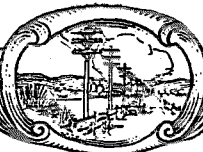

ELECTRICAL COMMUNICATION

Technical Journal of the
INTERNATIONAL TELEPHONE AND TELEGRAPH CORPORATION
and Associate Companies

H. T. KOHLHAAS, Editor

F. J. MANN, Managing Editor

H. P. WESTMAN, Associate Editor

REGIONAL EDITORS

- E. G. PORTS, Federal Telephone & Radio Corporation, Newark, New Jersey
- B. C. HOLDING, Standard Telephones & Cables, Ltd., London, England
- S. VAN MIERLO, Laboratoire Central de Télécommunications, Paris, France

EDITORIAL BOARD

- | | | | | |
|----------------|---------------|-------------|-----------------|------------------|
| H. Busignies | H. H. Buttner | G. Deakin | E. M. Deloraine | W. T. Gibson |
| Sir Frank Gill | W. Hatton | E. Labin | E. S. McLarn | A. W. Montgomery |
| Haraden Pratt | G. Rabuteau | T. R. Scott | C. E. Strong | E. N. Wendell |
| | | | | W. K. Weston |

Published Quarterly by the

INTERNATIONAL TELEPHONE AND TELEGRAPH CORPORATION
67 BROAD STREET, NEW YORK 4, N.Y., U.S.A.

Sosthenes Behn, President

Charles D. Hilles, Jr., Vice President and Secretary

Subscription, \$1.50 per year; single copies, 50 cents

Copyrighted 1946 by International Telephone and Telegraph Corporation

Volume 23

March, 1946

Number 1

CONTENTS

	PAGE
ELECTRICAL COMMUNICATION: 1940-1945—PART I	3
MULTIPLEX BROADCASTING	19
<i>By D. D. Grieg</i>	
THREE NEW ANTENNA TYPES AND THEIR APPLICATIONS	27
<i>By Armig G. Kandoian</i>	
CONVERSION OF SAN JUAN, PUERTO RICO, TELEPHONE PLANT TO AUTOMATIC OPERATION	35
<i>By Jose D. Dominguez</i>	
OVEN FOR AIRBORNE PIEZOELECTRIC CRYSTALS	41
<i>By Stanley Eaton</i>	
EVALUATION OF NIGHT ERRORS IN AIRCRAFT DIRECTION FINDING, 150-1500 KILOCYCLES	42
<i>By H. Busignies</i>	
JACKETING MATERIALS FOR HIGH-FREQUENCY TRANSMISSION LINES	63
<i>By A. J. Warner</i>	
CURRENT RATING OF SINGLE-CORE PAPER-INSULATED POWER CABLES	70
<i>By C. C. Barnes</i>	
ELECTRICAL UNITS AND THE MKS SYSTEM	96
<i>By H. Paul Williams</i>	
RECENT TELECOMMUNICATION DEVELOPMENTS	107
CONTRIBUTORS TO THIS ISSUE	109

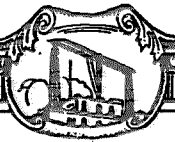

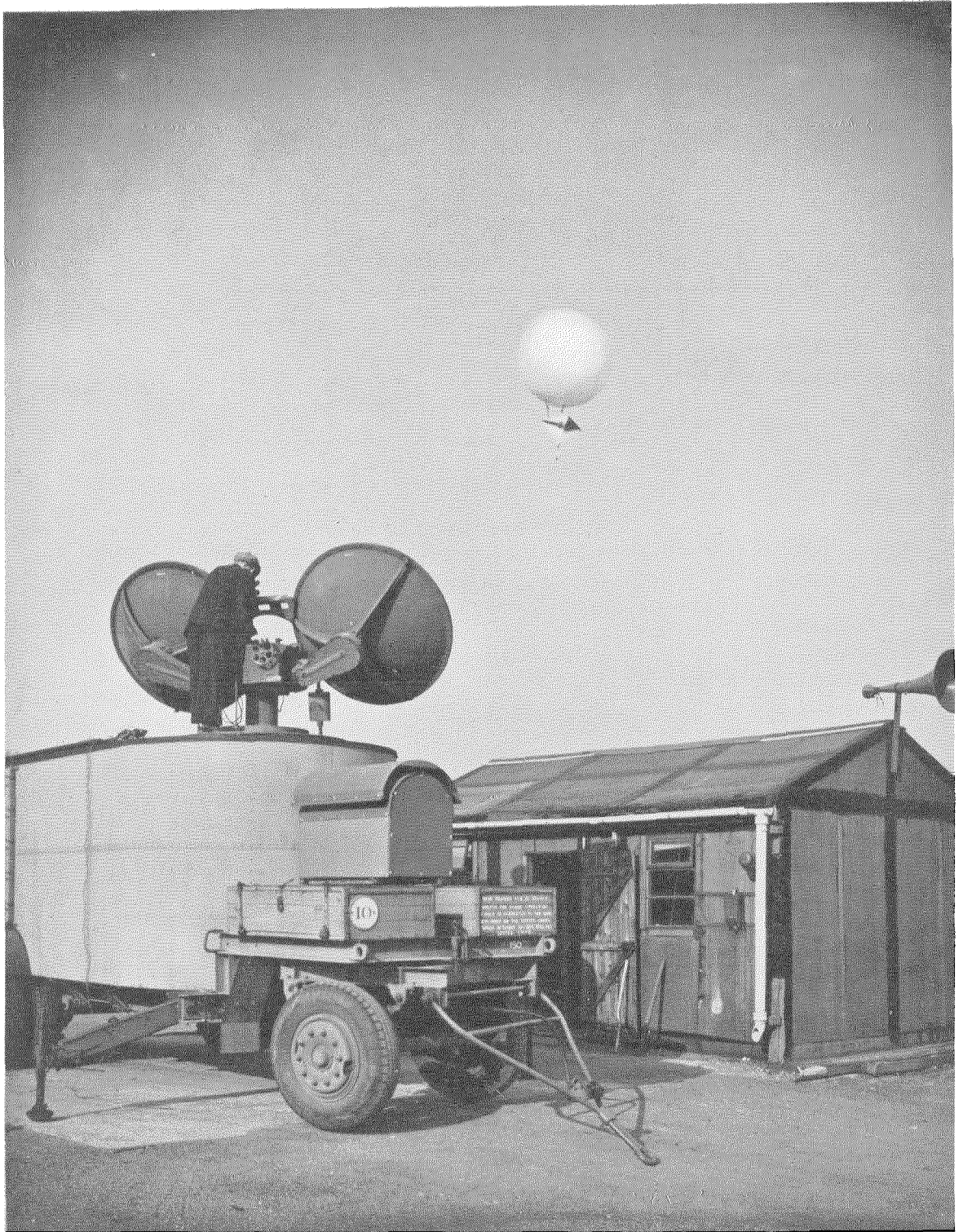

METAL-TAILED BALLOON USED IN TESTING STANDARD TELEPHONES AND CABLES, LTD. (LONDON)
EQUIPMENTS FOR THE ACCURATE DIRECTION OF ANTI-AIRCRAFT GUNFIRE.

Electrical Communication: 1940-1945

War Years' Review—Part I

Editor's Note: This account of war activities of I. T. & T. associate companies, primarily because of its length, will be presented serially. This first installment describes contributions of Standard Telephones & Cables, Ltd., London, and Standard Telephones & Cables Pty. Ltd., Sydney.

STANDARD TELEPHONES AND CABLES, LTD., LONDON, ENGLAND

EVEN at this distance from the conclusion of hostilities, it is impossible to set down the whole story of the war activities of Standard Telephones and Cables, Ltd. These activities in many cases were so intimately interwoven with those of the Fighting Services that anything approaching a detailed review would be precluded for security reasons. For the present, therefore, the picture can only be sketched in the most general terms. It is hoped, nevertheless, that some idea may be gathered of the magnitude of the effort, even though the full technical details remain unpublished.

As telecommunications are perhaps even more necessary to the successful conduct of war than to peacetime economy, and as many of the pre-existing communications systems and much equipment were in regular production for normal purposes, the outbreak of the war did not entail any radical change in the general character of these products, but it did increase enormously the demand for them. As the war progressed, the Company was inevitably concerned with, and played an important part in, many quite spectacular developments which can only be hinted at even now.

The communication needs of the Navy, Army, and Air Force, to say nothing of the merchant navy and the civil defence organizations, created a tremendously increased demand for every type of telecommunication equipment. Thus, an unprecedented expansion of manufacturing facilities was essential, and the position was further complicated by the necessity of dispersing these manufacturing activities to minimize the effects of heavy bombardment from the air. The peak of this effort saw the Company, with more than 25,000 employees in 51 different plants scattered throughout the country, all turning out in vast

quantities the equipment and materials so vitally necessary for the Fighting Services.

Radar Communications Network

A great deal has been and will be written about the spectacular development of radar in its many aspects. Standard Telephones & Cables was prominently associated in many of these applications; but sight must not be lost of the fact that the value of radar would have been very limited if there had not been associated with it a first-class communications network to pass back the radar information and to pass forward the instructions to cope with the rapidly changing operational situations.

From the immediately prewar period, when a nuclear system of coastal radar warning stations was being set up as part of the defence of the British Isles against air attack, the extensive telephone and telegraph network required for its efficient operation was also being planned by the British Post Office and carried out largely by Standard Telephones & Cables. During both the defensive and the offensive phases of the war, this network played a vital role; before the war ended, it was more than four times as big as the entire civil network existing on the outbreak of hostilities.

For the building of this service, not only was an enormous quantity of carrier telegraph equipment required, but the necessary circuits also had to be widely extended by the installation of carrier-on-cable and coaxial-cable telephone circuits. All the cable and the equipment for the carrier telephone and coaxial circuits was supplied from S.T.C. factories in addition to the carrier telegraph equipment for the defence network itself.

Progress of the war revealed the need for

portable carrier telephone equipment of various types and 3-channel open-wire carrier equipment on a vast scale. Then the manufacture of portable carrier and repeater equipment for military line communication work, involving many new techniques mainly developed by S.T.C., placed further heavy loads on the Company's productive resources, which its factories handled to the extent of 75 percent of the entire requirements of the Services.

Submarine Cable

The landing in Normandy and the subsequent operations on the European Continent necessitated the provision of equipment to operate a submarine cable across the English Channel. The cable link between England and France, severed since the Dunkirk evacuation, was replaced by a cable laid by British Post Office engineers between Southbourne and Longues (a distance of approximately 105 nautical miles). The length of the cable necessitated the use of two cable-laying vessels which, despite most unfavourable weather and other conditions, completed the hazardous operation without interference from the enemy. In preparation for this vital link, S.T.C. engineers, in cooperation with the British Post Office, had installed terminal equipment at several probable points

of departure along the south coast of England.

The first cable was in operation on the Normandy beaches by D+4 Day, providing one physical voice circuit and a two-way teleprinter circuit. Three days later, four telephone channels had been established on it.

As the advance proceeded, additional Anglo-Continental circuits were needed, and eight more submarine cables were laid across the Straits of Dover.

Similarly, in the Middle and Far East operations, permanent equipment was installed by S.T.C. engineers in co-operation with Army personnel, a typical example being the establishment of communication over 3-channel carrier telephone systems between Tripoli and Baghdad within eight days of the fall of Tripoli.

Locating Enemy Guns

One of the interesting wartime applications of carrier telephone technique was in locating the positions of enemy guns. When the war began, the basic method used was the same as in 1914-1918. The fundamental problem of detecting and recording the wave form of a sound wave of very low frequency and very small amplitude still existed, but the additional factors of transport and maintenance arose with the change from static to mobile warfare. In the earlier war, the

detecting stations were connected with headquarters, where the oscillograph recorder was installed, by field cables. A cable pair, separate from that used for the microphone pick-up, was required for communication with headquarters and for transmission of the signal which started the oscillograph.

The proposal that carrier telephone technique might be employed, first came from Major F. F. Fulton of the Canadian Military Headquar-

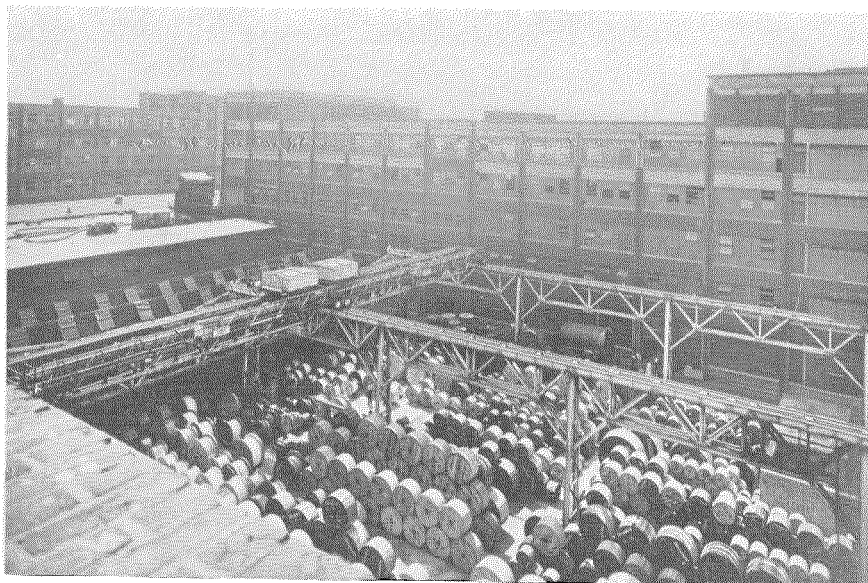

One of the less spectacular S.T.C. war activities was the manufacture of telephone and power cables in unprecedented quantities.

ters in England. He suggested that, if the microphone signals were modulated into a band of frequencies above the audio-frequency telephone range and several such bands employed, it would be possible to use one telephone pair as an omnibus circuit for the observers' telephones and to carry as well several sets of microphone signals. Standard Telephones & Cables designed and made an equipment in which the microphone bridges at the observation posts were supplied with current from a number of oscillators of different carrier frequencies, each post having a special low-pass filter fitted to a field telephone set enabling the user to talk on the line without affecting the sound record. At headquarters, detector circuits with selective filters were connected to the individual observer posts. The carrier system produced important savings, both in installation time and materials, and was used on a considerable scale.

Location of the launching points of the V2 projectiles was another sound-ranging achievement, voice-frequency transmission being used instead of carrier, because of the great length of the base line as compared with sound ranging for ordinary field artillery. This in turn called for the use of communication channels on the ordinary civil network which was generally unsuitable for carrier-frequency transmission. In less than a month the system was designed, supplied, installed, and tested. Within a few days of its completion the first rocket projectile fell in a London suburb, and the equipment correctly showed that it had been fired from Walcheren Island. The successful pin-pointing of the launching sites by means of the single-channel equipment installed in England led to the development of multichannel equipment for operations on the Continent. These also were very effective in countering the attacks.

For the Battle of the Atlantic, large quantities of special coils and filters for various types of submarine-detecting devices were designed and manufactured: they included specially screened coils and filters for use in harbour-defence apparatus, in which the presence of an object in a certain area upsets the balance of an alternating-current bridge. New dust-core coils were designed to replace existing air-core transformers.

To the fight against the magnetic mine, S.T.C.

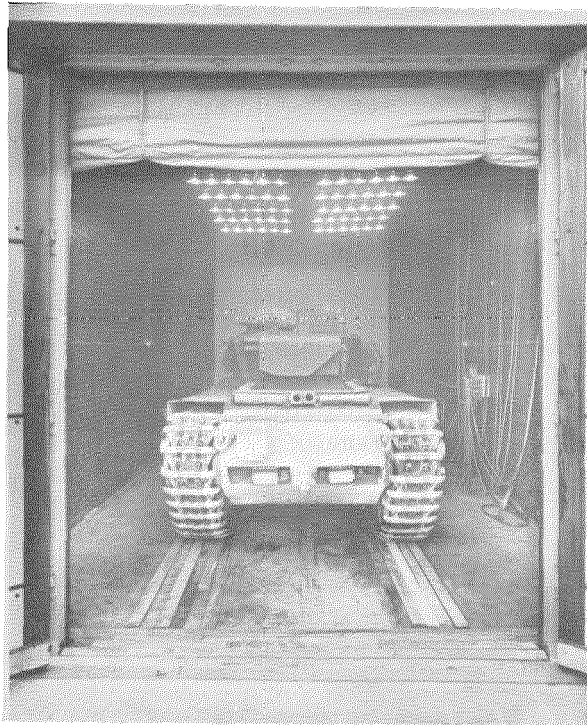

British Army tank in one of the S.T.C. tropical test chambers. In one month, the equivalent of two years service under extreme conditions of heat and humidity such as are encountered in tropical climates may be simulated.

contributed directly by producing cable for the so-called "degaussing" equipment, and indirectly by applying an electronic engine indicator (which it had marketed for many years) to the problem of damping out the high-speed torsional oscillations produced by the Diesel motor-bus engines which were mounted in ships to provide the motive power for the electric generator supplying the demagnetising field.

Radio

With the advent of war, radio broadcasting and communication services, both civil and military, had to be greatly augmented. The expansion of these services necessitated the provision of a great number of high-power transmitters to supplement those existing in 1939. In addition, similar equipments were needed by allied countries and provision had also to be made for transmitters to be rushed to the enemy-occupied countries as soon as they were liberated.

The development, construction, and erection of high-power transmitters for the British Post

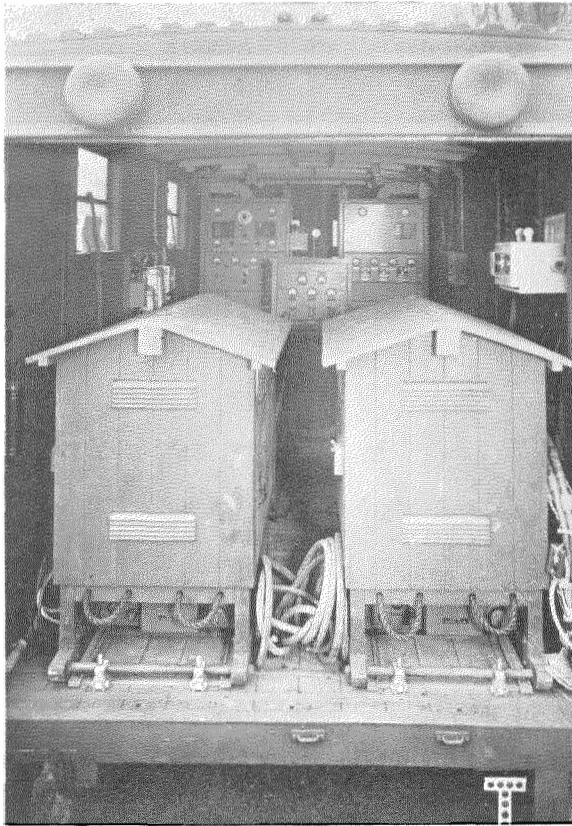

Mobile marker-beacon equipment used with the Standard Beam Approach system showing interior of trailer before removal of marker-beacon huts. The transmitter and control unit are at the back of the trailer.

Office, British Broadcasting Corporation, and Colonial and Foreign Administrations had been the main radio activity in peacetime, and the Company was, therefore, called on to supply a large number of these transmitters during the war. The programme was a formidable one in view of the limited engineering effort available. It was made possible by rationalisation and planning of the engineering work, by the advanced Standard prewar technique which made radical design changes unnecessary; and by the Company's existing unit-construction principle, which made possible the speediest development of new types of equipment by the selection and grouping of standardised units.

Although the task involved was one of solid effort, rather than of major inventions such as were involved in the more spectacular aspects of radio, many of the equipments were new developments to meet special needs; and over all

there was the problem of finding and applying materials and components in place of products no longer obtainable. Distribution of these transmitters was over a wide area; many were used in Great Britain, but considerable numbers were applied to war uses in such places as Malta, India, Angola, Iran, China, and in Belgium and Norway as soon as these countries were freed.

An unusual application of high-power transmitting equipment was that of a 5-kilowatt low-frequency amplifier supplied to the National Physical Laboratory for making accelerated fatigue tests on air frames.

Among new transmitters developed during the war was a 100-kilowatt high-frequency broadcast transmitter having separate radio-frequency channels to permit rapid change of up to four working frequencies. This equipment was operated as a twin-channel transmitter sending out the same programme on two frequencies simultaneously with a total power output for the two channels of 130 kilowatts. Other developments included 5-kilowatt high-frequency continuously tunable telegraph sets, an entirely air-cooled 5-kilowatt medium-frequency broadcast transmitter, and a 10-kilowatt medium-frequency continuous-wave and modulated-continuous-wave telegraph transmitter with high-power Class-B modulator for communication with ships.

The war prevented the shipment of a 125-kilowatt low-frequency broadcast transmitter developed for Kaunas, Lithuania, so the equipment found useful employment in the European propaganda services.

In their wartime applications, S.T.C. transmitters played a prominent part in such services as the exchange of Government and military messages over a wide area of the globe, the dissemination of news and other programmes to many countries to combat enemy propaganda, the stimulation of morale in occupied countries, and the transmission of directions for sabotage and preparations for D-Day. The provision of entertainment to troops and civilians at a time when other forms of relaxation were drastically curtailed, and the linking of people at home with those in the combat zones through "eyewitness" commentaries by war correspondents were other useful activities.

Medium-Power Transmitters

Large numbers of medium-power transmitters were needed for military communications, and, as this type of equipment represented a major peacetime activity, the Services found the Company able to supply a good range of well-trying transmitters from stock or immediate manufacture. As the war progressed, several new types were developed, and adaptive engineering served to modify some existing designs for special requirements. Many equipments were supplied for intercommunication between Royal Air Force stations, between ground and aircraft, ship and shore, and for point-to-point services.

A 3-kilowatt medium-frequency transmitter (similar to that which had been developed specially for the "Queen Mary") designed primarily for continuous-wave and modulated-continuous-wave telegraphy but having emergency telephone facilities, was installed in the "Queen Elizabeth," and its notable operating flexibility and rapid frequency-change facilities led to its adoption as a standard equipment for shore stations throughout the Empire.

A series of transmitters, which found wide application in war service, comprised medium- and high-frequency sets of 400 to 1,500 watts output for telephony, continuous-wave, and modulated-continuous-wave telegraphy. Notable features were: multiple circuits permitting instantaneous change among 6 preselected frequencies; crystal and master-oscillator control; local and short-or-long-distance remote control including starting and stopping, selection of frequency and of service, continuous-wave operation on full or reduced power, check-back, talking and keying, and order

wire circuits—all by means of one twin-pair line.

Another group of transmitters of universal application comprised general-purpose sets which, though simple to operate and economical in space requirements, gave performance and facilities previously associated only with equipment of higher power and grade. These transmitters provided telephone, continuous-wave, and modulated-continuous-wave telegraph services, gave a choice of 4 crystal-controlled spot frequencies, and also had a master-oscillator control with high resetting accuracy; other features included break-in keying, automatic audio-frequency gain control, and built-in alternating-current power-supply gear using selenium rectifiers. Their characteristics made them very suitable for mobile stations, and many were thus used.

Prospects of enemy invasion after the Dunkirk evacuation were such as to necessitate the provision of emergency means for giving instructions to the public in case some of the British Broadcasting Corporation stations fell into enemy hands. To meet this contingency the Company was able to offer some 2.5-kilowatt medium-frequency equipments. The Government



6600-volt power cable manufactured by S.T.C. uncovered in the London "blitz" continued in service. Sewage, gas, and water pipes nearby were all broken.

commandeered a number of motor coaches, which were driven to the S.T.C. factory, and, within an incredibly short time, emerged completely equipped as anti-invasion mobile radio stations. Each station comprised two coaches, one for the transmitter, the other for the power plant. All necessary auxiliaries were carried, including 95-foot masts and erection gear for the antennae, and flexible cables for interconnecting the two vehicles. Sleeping accommodation for the crews was also provided.

Another type of mobile station developed for war use was a compact medium- and medium-low-frequency pulse transmitter with master-oscillator control and high resetting accuracy, rapid frequency-change facilities, and built-in 3-phase alternating-current power-supply apparatus. This was evolved primarily for a special direction-finding system, but a continuous-wave version of 2.5-kilowatt rating formed a useful addition to the range of medium-power communication transmitters. Most of these sets were furnished as complete mobile installations. Some were used in lorries and trailers; others were mounted in twin railroad containers on mobile platforms, the containers having detachable panels at one end so that they could be run together to form a single compartment when the station was set up.

In addition S.T.C. manufactured several types of transmitters of Service design, notably a 500-watt high-frequency telegraph transmitter for ground-to-air stations. Made on a quantity-production-line basis previously employed only for receivers and small apparatus, it was produced rapidly in large quantities.

Transmitters and Receivers

The Company was responsible for several types of complete mobile radio communication stations comprising transmitting and receiving installations with all the necessary auxiliaries to enable them to function as self-contained units. They were arranged in transportable form for ease of carriage and rapid erection in the field, or fitted in vehicles for use on the move or for opening up communication quickly on arrival at a new destination.

An interesting example was a station shipped to Norway in 1940 to provide a high-speed

telegraph service with Great Britain. This station was planned to fit into 4 sectional wooden huts and was despatched, except for bulky elements, in special containers with the British Norwegian Expeditionary Force. When this Force was withdrawn, part of the station, including the transmitter, was brought back to Britain where, despite the adventures and rough handling it had undergone, it was found to work satisfactorily and was reinstalled at a Royal Air Force station.

Another mobile project was the planning and provision of complete radio stations to form telephone links over distances up to 100 miles with one or both stations on the move. A number of these stations were sent to India to provide communication between Army headquarters and mobile columns.

For Royal Air Force-Army co-operation, a type of station was developed for communication between points on the ground and between ground and aircraft. It proved particularly useful where new airfields were under construction as the tenders housing their main and remote-control features could be parked at considerable distances from each other, and at points suited to the ground layout and the working conditions in force.

To meet certain Naval requirements, a number of mobile stations (400-watt telephone/telegraph transmitter and "all-wave" receiver) were provided in the form of 4 small waterproof cabins mounted on two-wheeled chassis for ease in towing on land and stowage in ships. With a trained crew, a complete station could be set up within 10 minutes of arrival on site.

Transmitting and receiving telephone/telegraph equipment for use in tank warfare was an important Army requirement. Simplicity of operation, compactness, and the problems of robustness and mountings to withstand the severe vibration and shocks experienced in a tank under battle conditions were satisfactorily met in a set which was produced in time for use in the Libyan Desert campaigns and in India.

General Communication Receivers

The Company's war effort on radio receivers was mainly devoted to sets forming part of

complete communication equipments for aircraft, tanks, etc., and to those for special systems such as Standard Beam Approach. Among sets supplied for war service were a simple 3-valve high-frequency receiver for trawlers and other small craft, an "all-wave" version for ships and small land stations, and two high-grade superheterodynes operating on high and medium frequencies supplied for large ships.

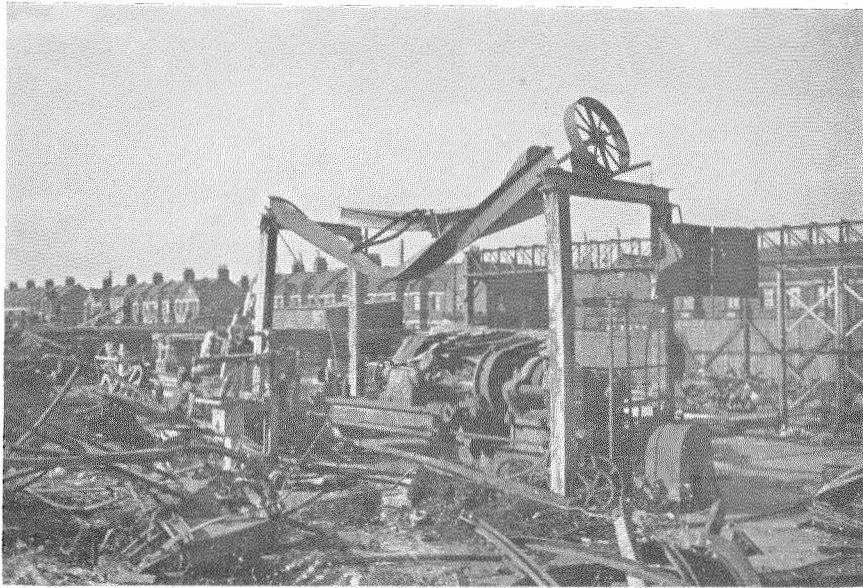

Remains of a building at North Woolwich after an air raid in which valuable machinery was destroyed.

Automatic Distress Signal

A device for automatically recording distress signals from ships under conditions of heavy traffic and interference, was a normal peacetime requirement. The war naturally brought increased demands for the distress-signal receiver (auto alarm) which this Company made for its associate, the International Marine Radio Company. As the mechanisms used in this device were unobtainable during the war, a new equipment was developed which was greatly superior to the original. Some idea of its effectiveness can be gathered from the fact that signals were satisfactorily received under official test conditions with three sets of interfering telegraph signals plus artificial atmospheric signals simultaneously superimposed on the alarm signal.

Ground Direction Finders

Wartime activity in the direction-finding field largely took the form of developing a new technique for automatic direction finders, especially those with cathode-ray indication; this technique was applied to airborne and ground radio compasses and to medium, high and very high frequencies. The results are well exemplified in the automatic radio direction finder which instantaneously and automatically indicates the

bearing of any transmission received. Its first war application was to aircraft carriers, in which it enabled the courses of aircraft to be followed easily, thus facilitating the control of their movements. It was also valuable in guiding aircraft to the carrier, normally a difficult task, especially in conditions of bad visibility. In service the aircraft-carrier type of radio compass is tuned to the channel in use, and each time an aircraft transmits, a spot of light in the centre of the fluorescent screen of the cathode-ray indicator changes to a line. The direction of this line, relative to a scale surrounding the screen, indicates the aircraft's bearing in relation to the fore-and-aft line of the carrier. A second scale, controlled by the ship's gyrocompass, enables bearings to be read relative to true north as well as, or instead of, relative to the ship's head. The equipment is free from "sense ambiguity," i.e., only one reading is shown by the indicator. Other applications of this equipment are for noting the bearing of an airplane in distress so that rescue parties can be directed to the point of descent with improved accuracy, and for keeping track of a number of aircraft around a busy landing field.

Special ground direction finders using Adcock-type antenna systems for long-range bearings and operating over an unusually wide frequency

range were also developed and installed, and proved useful in helping to determine the probable area of attack by enemy aircraft.

Airborne Communication Equipment

One of the most notable advances in technique and new developments was in the field of airborne communication equipment. Included in this category were aircraft transmitting and receiving installations for communication between airplane and airplane, and between airplane and ground, for telephone, telegraph, or both, and working on the medium-, high-, or very-high-frequency bands according to the needs of the services concerned.

Before the war, the Company had evolved a revolutionary solution to the special problems of radio for fast single-seat fighter aircraft, and it was on the basis of this high-frequency set that a very-high-frequency set with the same characteristic features was developed.

An innovation developed for Naval reconnaissance aircraft gave a certainty of communication previously attainable only by crystal control, but more flexible in regard to operating channels. Both transmitter and receiver had a high degree of frequency stability and could be

quickly and accurately set for any frequency within their range without the use of wavemeters. Another feature was all-electric remote control of all operations (including receiver trimming) except change of frequency which normally was made only on the ground. These operating facilities were made possible by temperature-compensated inductance-tuned oscillators; by ganged tuned circuits associated with large dials with spiral scales giving high calibration and resetting accuracies, and marked directly in frequencies; and by the use of the "Miller" effect for remotely trimming the beating oscillator of the receiver.

A special set developed for torpedo-bombers provided virtually "house-phone" contact among the aircraft of a squadron over distances up to 15 miles and among members of the crew in each aircraft. This equipment was exceptionally simple to operate, and its stowage was facilitated by grouping all high-frequency circuits for transmitter and receiver into one unit, accessible in flight, and all intermediate-frequency, low-frequency, and power-supply apparatus into a second unit, access to which was necessary only for maintenance.

Among other interesting sets developed were a combined medium- and high-frequency telephone/telegraph equipment giving long-distance telegraph communication for reconnaissance duties and shorter-distance telephone contact for anti-submarine and other operations; and a high-frequency telephone set for co-operation between aircraft and surface vessels on anti-submarine activities.

New operational requirements led to the development of equipment working on the very-high-frequency band and having additional intercommunication facilities. The new "miniaturisation"

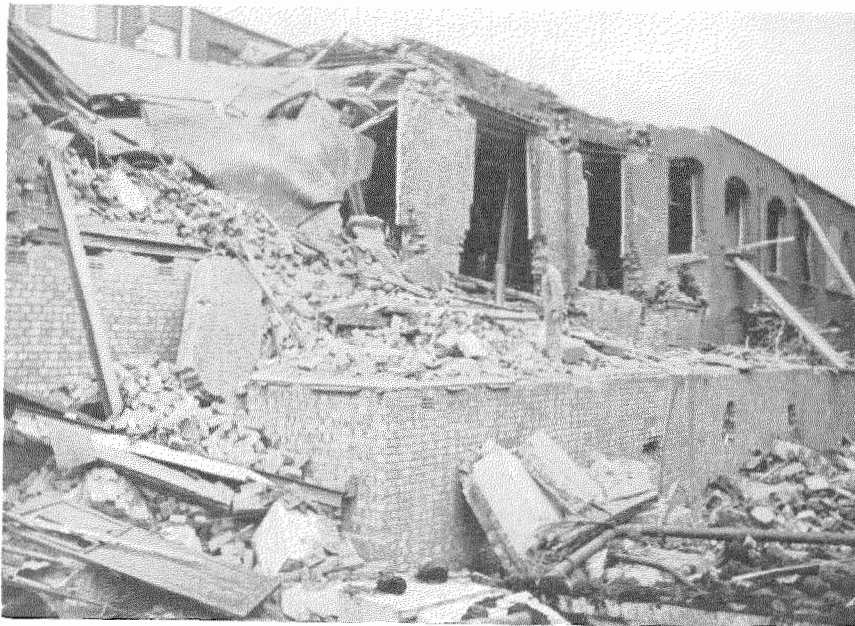

North Woolwich factory after a flying-bomb incident in 1944. The man is standing on a surface shelter which was undamaged except for the blocking of escape exits by debris.

technique, which greatly reduced the size and weight of equipments, was employed in the production of two sets; one for intercommunication, and one for very-high-frequency radiotelephony, having 4 crystal-controlled operating channels with instantaneous selection.

Standard Beam Approach

As is well known, the "Standard" beam approach system was in use by civil and military flying organisations some time before the war, so that on the outbreak of hostilities it continued to perform its normal service, but under far more exacting conditions which led to developments greatly extending its usefulness and reliability. As originally planned, the system was intended to indicate the correct path of descent to an aircraft preparing to land, as well as to guide it in the correct line of approach. In addition to the "left-right" scale and pointer, the visual indicator in the aircraft had a vertical scale and pointer. By noting the reading on the vertical scale at the start of the glide, and by maintaining a constant reading on the indicator, the pilot was able to select a suitable path of descent.

With this glide-path system, the line to be followed by the pilot necessitated a steep descent angle at the beginning of the glide. A straight-line glide path became essential on the introduction of aircraft of high wing loading, so the "Standard" glide-path system, separate from the "Standard" beam approach, was developed to supplement in the vertical plane the guidance given in the horizontal plane by the existing system.

In its normal application "Standard" beam approach is a relatively short-range system, but the development of "Track Guides" enabled it to be applied also to long-distance navigation. On busy traffic routes a chain of course beacons gives the aircraft continuous guidance from one terminal to another, and marker beacons indicate when a pilot should disregard one beacon and pick up another, changing his course accordingly. Collision between aircraft flying in opposite directions is avoided by flying them on opposite edges of the beams.

Very-High-Frequency Homing Unit

Based on the Company's direction-finding technique was the Very-High-Frequency Homing Unit which enabled an aircraft to rendezvous a man on the ground with great accuracy. This apparatus, used with a simple receiver in the aircraft, made it possible for an airplane to identify and fly right over a small portable transmitter at a prearranged rendezvous. The ground transmitter could be "picked-up" at a distance of 50 miles, and supplies could be dropped or a landing made within 200 yards of it.

Among its numerous operational applications may be mentioned guidance for the dropping of weapons and food for the "underground" movement in France, the supplying of Marshal Tito's army, and the evacuation of wounded from the Balkans.

Radar Equipments

In the development and manufacture of radar devices, Standard Telephones and Cables naturally played an important part. Some of these activities can only be indicated in the barest outline at present, but an idea of their importance and effectiveness may be gained from the following brief notes.

Outstanding on the production side was the manufacture of mobile cabin-mounted equipments for the accurate direction of anti-aircraft gunfire. Used in conjunction with the predictor, they indicated the bearing, range, and elevation of aircraft. A high rate of output of this vital defence aid was facilitated by pretesting the various sections before final assembly, a practice common in the mass-production of domestic radio receivers but not previously employed on high-power transmitting gear. Factory tests and calibration of these equipments included the launching of a balloon with a metal "tail," the balloon being "followed" by means of a telescope mounted in the equipment and aligned with its dials; comparison between the visual and radar readings checked the accuracy of the latter.

Other forms of radar equipments included installations around the coast of Britain as long-range wide-scanning devices for giving early warning of the approach and direction of flight

of aircraft, and equipments to give warning of the proximity of low-flying aircraft.

The necessity of verifying whether aircraft flying in a given area were hostile or friendly was met by the development of the Interrogator, pulses transmitted from which triggered response apparatus on our own aircraft, so that the return signal indicated in code whether the aircraft was friendly or not. This return signal was superimposed on the gun-laying equipment mentioned above, thus giving instantaneous indication of the aircraft being "tracked."

The radar installations fitted to all British ships of the line played a vital part in naval affairs, and, early in the war, a new valve was developed by S.T.C. which suggested among other applications the possibility of an amplifier to improve the range of radar equipment. A feature of the new amplifier was that the valve, with its associated circuit elements, was arranged as an integral subunit which in the event of valve failure could be quickly removed from the main unit and replaced.

Blind Bombing

"Blind bombing" of targets which were invisible due to mist, cloud, or successful concealment, was made not only possible but highly accurate by a device developed and produced by the Company. It was a system of radio guidance whereby two equipments on the ground some distance apart, operated jointly to guide aircraft along a pre-determined route passing over the chosen target, watched their movement, and indicated to the crew the precise moment for the release of bombs. Of the many ingenious devices incorporated in the system, mention may be made of the "memory" feature; if due to ether conditions, transmitter failure, or other causes, signals were no longer received from the aircraft, the ground equipment continued to register the airplane's progress on the assumption that it was continuing on its last-known course and its last-known speed; the "release bombs" signal was made at the appropriate time. But if, or when, the aircraft resumed transmission the "memory" reading was automatically wiped out and the equipment continued to register according to the current transmissions from the

aircraft. The mechanisms for determining the correct moment for bomb release took into account the aircraft's speed and direction of travel, the wind, the type of bomb, and all the factors which determine the trajectory of a falling body. Each of the ground equipments was about the size of a high-power broadcast station, and the two equipments could exchange their functions.

Test Equipment

The new techniques involved in the development of radar and centimetre-wave communication equipment necessitated a parallel development of apparatus for its testing and adjustment. For the receiver portions of such installations, signal generators are necessary to provide a source of energy of known and controllable intensity. As a result of work on velocity-modulated valves, S.T.C. was asked to develop a variable-frequency signal generator to work on a band around 10 centimetres (3,000 megacycles). The success of this instrument led to the development of a generator for 6.2 to 6.9 centimetres, and later, of an instrument operating on a wavelength of 6.45 centimetres, and including a calibrator which enabled the performance of the generator itself to be measured and checked.

Another interesting instrument development took the form of a test kit, an assembly of test instruments for use in aircraft carriers in servicing and repairing the various airborne radio equipments. The test kit is virtually a self-contained test laboratory. It comprises a signal generator, output meters, crystal calibrator, and other instruments, all mounted on a framework which includes a work-bench and store-cupboards. Connecting cables, artificial antennae, circuit checkers, and other auxiliaries are included. It is possible with this equipment to carry out even major overhauls and repairs at sea; a receiver can be completely realigned or a transmitter can be completely tested after being practically rebuilt following damage.

Conclusion

Only the briefest glimpse into the wartime activities of Standard Telephones and Cables has been given in the foregoing review. Some of

the high lights have been indicated; others have necessarily been omitted because they cannot be mentioned even now.

It must be remembered, however, that in

its unobtrusive yet indispensable part in the achievement of final victory.

The Company's war work, begun in the preparatory defensive stages before the actual



Fleet Air Arm personnel, undergoing a course of instruction, see equipment being made for their use at a Standard Telephones and Cables plant.

addition to all the spectacular developments of direct and obvious application to the war at sea, on land, in the air, and "on the air," an impressive range of telecommunication equipment that was in normal peacetime production was manufactured in greater quantities than ever before, but under the most arduous conditions, playing

outbreak of hostilities, continued with ever-increasing momentum throughout the war period. Symbolic both of the continuity and widespread nature of this contribution was the presence of an S.T.C. microphone on the table at the historic surrender conference at Field-Marshal Montgomery's headquarters on Luneburg Heath.

STANDARD TELEPHONES AND CABLES PTY. LTD., SYDNEY, AUSTRALIA

STANDARD Telephones and Cables Pty. Ltd. takes pride in its achievements in war production for Australian and Allied Armed Forces. Due to the foresight of the defence authorities, S.T.C. was engaged in the design and manufacture of communication equipment for the Navy, Army, and Air Force for some time prior to the outbreak of war in September, 1939; by 1943 the number of employees had increased fourfold while production for defence purposes accounted for all but 1 percent of the total output.

Embodying major engineering projects comparing favourably with any carried out in other parts of the world, S.T.C.'s war effort was one of the outstanding contributions of the communication industry in Australia, and was largely attributable to the creative and organising abilities and the untiring efforts of the technical and executive personnel.

Equipment supplied in fulfilment of defence contracts may be classified broadly, according to usage, into five groups:

Royal Australian Navy
 Australian Military Forces
 Royal Australian Air Force
 Postmaster General's Department
 Allied Services

Work carried out for the Allies included selenium-rectifier installations for the Royal Navy and for the Royal Netherlands Navy, and the supplying of radio transmitters, radio receivers, selenium rectifiers, and field telephones to the United States Army Signal Corps.

Royal Australian Navy

Many important projects were carried out for the Royal Australian Navy, and included the design and manufacture of radio transmission equipment for the wireless-telegraph transmitting and receiving stations at Belconnen and Harman near Canberra. Most interesting of the radio transmitters for this project was the 200-kilowatt multichannel long-wave transmitter. The primary function of this transmitter was to

send out messages in code to all ships in Australian waters. Its transmissions can be picked up reliably in far-distant parts of the world and also by submarines while submerged off the coast of New Guinea.

Indicative of the importance of the Navy's tasks in wartime is the fact that if the safe arrival of just one merchant ship with its valuable cargo could be attributed to a transmission from the wireless station at Canberra, the total expenditure for the station would be more than recovered.

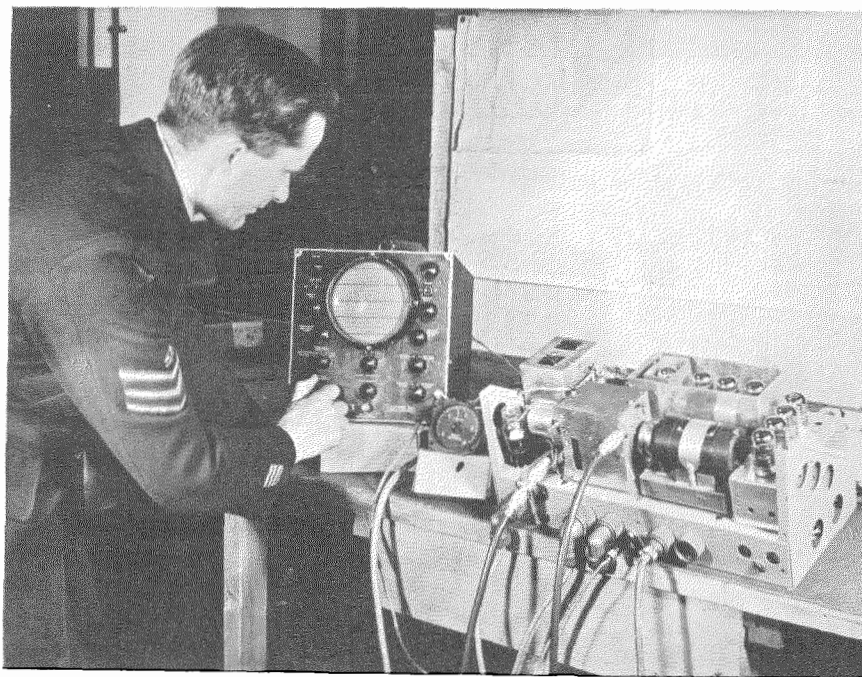

Altitude meter for use in aircraft, developed by S.T.C. for the Royal Australian Air Force.

Other S.T.C. transmitters installed at Belconnen include three 20-kilowatt and three 1-kilowatt multichannel short-wave radio transmitters and a short-wave radio-telephone link used for maintaining emergency communication between Harman and Belconnen. The short-wave radiating systems include a rhombic antenna, providing directional transmissions beamed on England, in addition to numerous omnidirectional vertical and horizontal antennae for the various frequencies in use. A

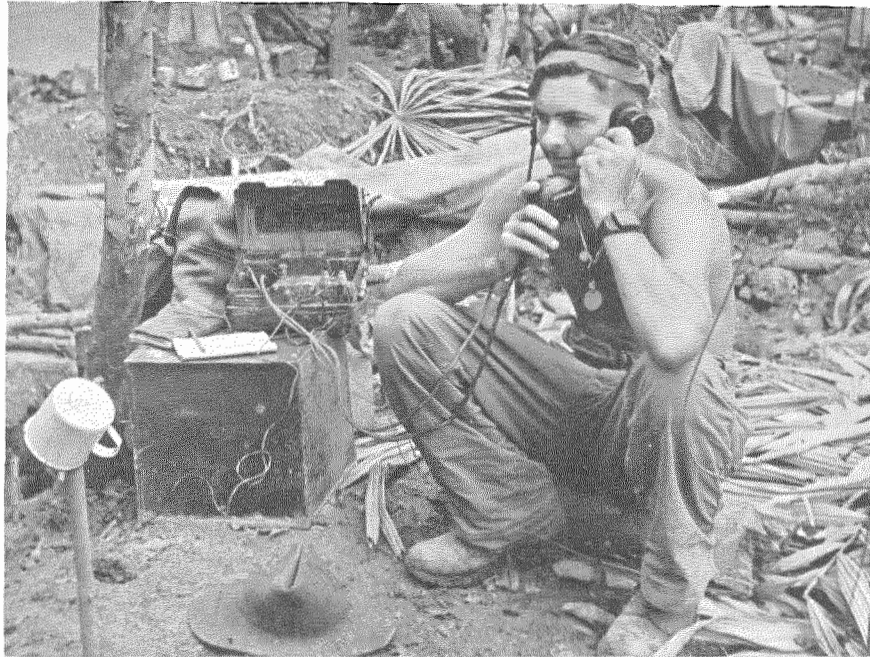

Australian soldier using type-L field telephone at an advanced post during fighting in New Guinea.

feature of the system is the antenna-switching equipment which enables each transmitter to be switched to the appropriate antenna.

Prior to the war, S.T.C. had developed a high-grade radio communication receiver which was used extensively in shore establishments of the Royal Australian Navy. On the outbreak of war further development work was undertaken to render the receiver suitable for operation under active service conditions and, later, for service under tropical conditions. Types were manufactured for the reception of both long- and short-wave signals and these receivers were used for maintaining communication with ships at sea, with other naval shore establishments, for intercepting enemy transmissions, and for direction-finding purposes. The Navy receiving station at Harman is the control centre and all messages are transmitted from as well as received at this point. In addition to a number of receivers, the equipment includes a remote-control system providing full control of the transmitters at Belconnen, and arrangements to permit any of the operators to key one or all of the transmitters simultaneously. The receiving system at Harman comprises a rhombic directional antenna and a number of short- and long-wave antennae similar

in principle to those at Belconnen but on a smaller scale, and a manual switchboard, called an "Antenna Exchange," which is fitted with cords and plugs to connect any antenna to any receiver.

Installed also at Harman and Belconnen are high-speed telegraph equipments on which messages may be transmitted and received automatically at speeds up to 200 words per minute. This equipment, comprising keyboard perforators, automatic transmitter heads, and undulators, was manufactured by Creed and Co., Ltd., London, an associate company.

S.T.C. also supplied equipment for the Royal Australian Navy receiving station at Perth, and completely equipped the receiving stations at Darwin and at Townville, the facilities at which are similar to, though less extensive than, those at Harman.

Australian Military Forces

Late in 1938 the defence authorities of the Commonwealth, fearing the imminent outbreak of hostilities, decided to modernise the communication equipment at its disposal, much of which was a modified version of that available

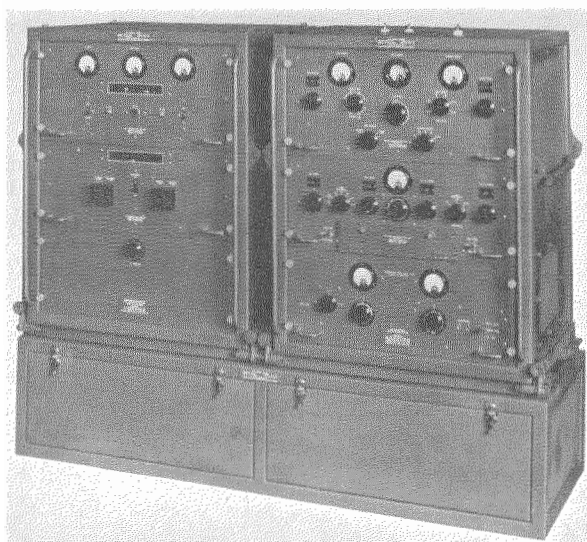

AT-20 500-watt radio transmitter. Thousands of these were supplied to the Royal Australian Air Force and the U. S. Army Signal Corps.

at the end of the first World War. Accordingly the Company was requested by the Ministry of Defence to develop and manufacture a vibrator-type power supply to operate what was known as the No. 1 Army set equipped originally with low- and high-tension batteries. This vibrator power-supply unit was developed, and production continued until all these sets were equipped. Although this was undertaken in 1938, the unit was designed to withstand semitropical conditions.

Following the completion of the vibrator-power-unit project, the military authorities requested the design of a 10-watt radio transmitter and a receiver to be produced on extremely short notice. A number of sets were manufactured by hand and proved so successful that further orders were received but delivery was required so urgently that no time was available for tooling. This radio unit became known as the

S.T.C. 109 Army Set, and was destined to make history, being the first field radio to be taken into battle by the 2nd Australian Imperial Force and, at one critical period during the famous siege of Tobruk, it was the only means the British Forces had for maintaining communication with the outside world.

Although the adoption of improvised production methods was unavoidable to meet the extreme urgency of delivery, the S.T.C. 109 Army Set proved to be one of the best radio units supplied to the Army up to that time. It was a veteran of two campaigns, being extensively used by the 2nd Australian Imperial Force throughout Libya and Syria and later in New Guinea.

Another achievement of the engineering and production personnel in behalf of the Army, was the design and production within six weeks of two sample radio transmitters and receivers for armoured vehicles. The equipment incorporated special features, and the production of samples of first-class finish and performance in so short a time, was truly remarkable. The sample equipments were installed in Army tanks and, under test, communication was established between Sydney and Melbourne, a distance of 600 miles airline.

The Company produced large quantities of various other types of communication equipment for the Army. These included telephone relays, jacks, plugs, keys, transmitter insets, field telephones, field switchboards, selenium-recti-

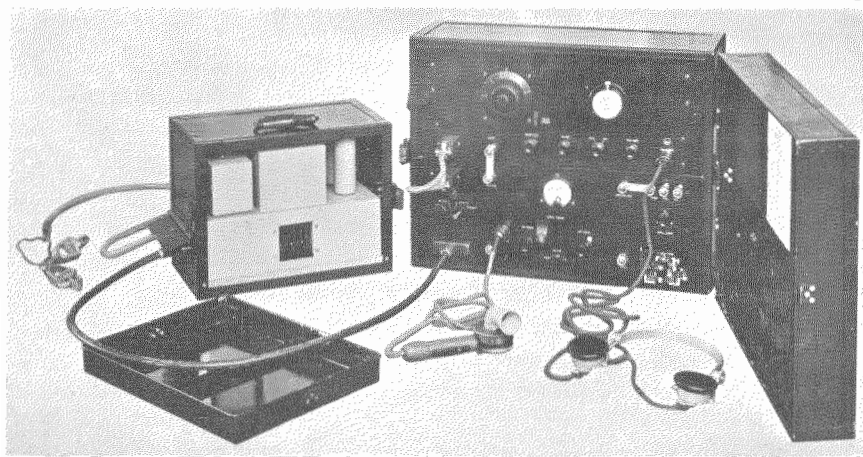

Type 109, the first field radio set taken into battle by the 2nd Australian Imperial Force. It provided the only communication with the British forces during the siege of Tobruk.

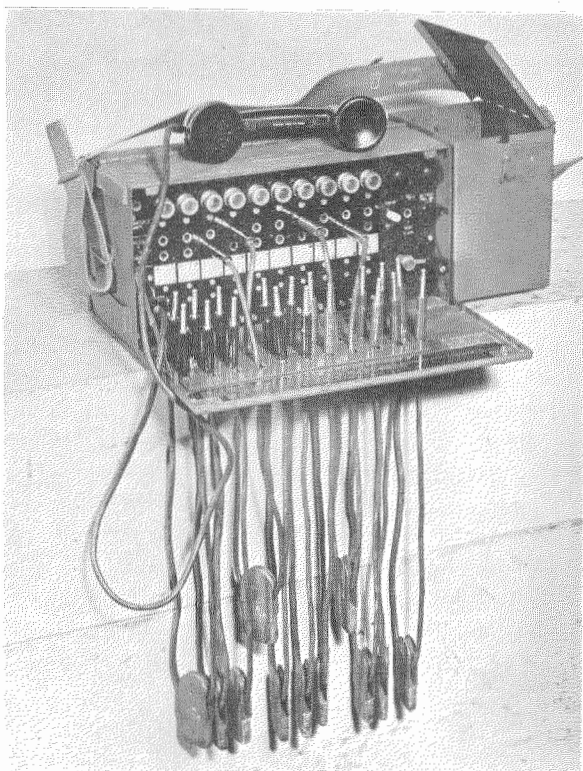

10-line field telephone switchboard. Large quantities were manufactured by S.T.C. for Australia's fighting forces.

fier discs, special types of electronic valves, and specialised apparatus such as voice-frequency telegraph equipment, mobile stations complete with 3-channel carrier-telephone terminals, repeaters, and ringer equipment, and selenium-rectifier equipment for recharging batteries in armoured and other military vehicles. These were items which had not previously been made in Australia and their manufacture was established under the difficulties of wartime control of materials and manpower, and shortage of qualified technical personnel, the deficiency in the latter respect being made up by the administrative staff. After the outbreak of war in the Pacific, special attention was given to the tropic-proofing of equipment for operation in the tropical climates prevailing in the battle areas.

Existing designs were modified to incorporate new processes and finishes, and extensive development work was undertaken. A special form of tropical packing was also introduced to meet the requirements of transportation and storage at extreme conditions of temperature and humidity.

In addition to purely communication apparatus, the Australian Army requested the manufacture of electrical apparatus forming an essential part of anti-aircraft fire-control equipment. This apparatus had previously been made only in Great Britain and manufacture in Australia involved development of new methods and much improvisation as regards raw materials. Nevertheless the extremely exacting tests imposed were satisfactorily met and several thousand of these items were produced.

Royal Australian Air Force

The first equipment supplied to the Royal Australian Air Force was designed some time before the outbreak of war. This consisted of transmitters, types 14-S and AT-8. The 14-S was a 1-kilowatt multichannel transmitter with facilities for 10 short-wave channels or 10 channels combining short and medium wavelengths. The AT-8 was a 500-watt transmitter covering a frequency range of 2 to 20 megacycles. Large numbers of these transmitters were

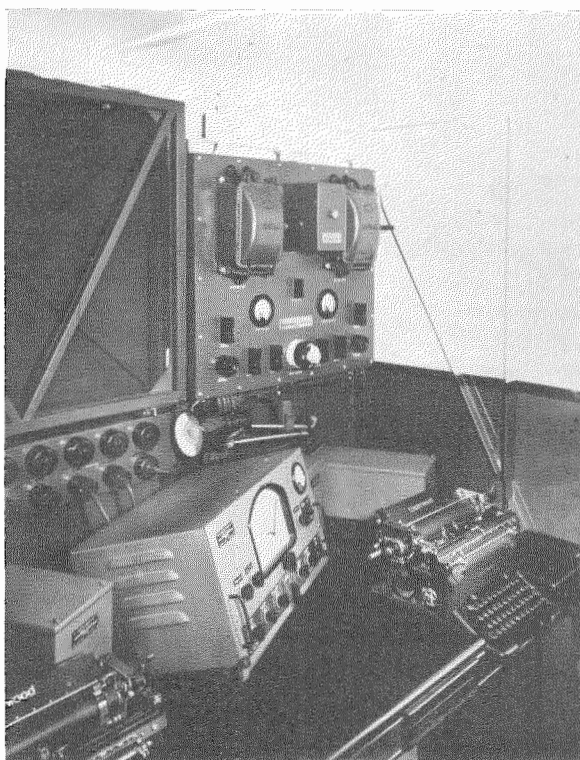

High-frequency radio receiver manufactured by S.T.C. and installed in a U. S. Army Signal Corps truck.

manufactured and the Royal Australian Air Force used them in Australia and in outlying bases. A number of the AT-8 transmitters were in operation in Java when the country was overrun by the Japanese.

On the outbreak of the Pacific War, local manufacture of service equipment became still more urgent, and in 1942 the Company designed to Royal Australian Air Force specifications, the Model AT-20, a 500-watt radio transmitter suitable for installation in vehicles or at fixed stations. A system of forced ventilation by filtered air ensured satisfactory operation in all climates. This transmitter was manufactured by the Company in considerable quantities, and figured prominently in some of the important successes against the Japanese during the fighting in the South West Pacific area.

Other transmission equipment manufactured for the Royal Australian Air Force included a 15-kilowatt continuous-wave transmitter in-

stalled at Laverton and a 25-kilowatt continuous-wave transmitter installed at Ballarat.

The Company manufactured selenium-rectifier direct-current conversion equipment including many 900-ampere units for the Royal Australian Air Force and numerous other units ranging from 250 to 50 amperes. Practically every Royal Australian Air Force servicing depot in Australia doing electroplating has installed S.T.C. selenium-rectifier equipment.

Other important items which the Company manufactured and supplied in considerable quantities to the Royal Australian Air Force included valves for radio-location or radar equipment, field telephones, and head-receivers. The Company also manufactured height-indicating instruments which were installed as standard equipment in Beaufort torpedo bombers. The height indicator is a form of radio altimeter and is a necessary adjunct to the successful operation of this type aircraft.

Multiplex Broadcasting*

By D. D. GRIEG

Federal Telecommunication Laboratories, Inc., New York, New York

WITH the ever-increasing congestion of broadcast stations on the lower frequencies, and the possibilities for technically superior service through the use of wider frequency bands, there has been a natural gravitation toward the higher frequencies. To utilize the higher frequencies effectively, a considerable amount of investigation on special systems of transmission, such as frequency modulation and pulse-position modulation, has been initiated. Steps have been taken in the U. S. A. toward the establishment of an extensive system of broadcasting employing frequency modulation.

Unfortunately these newer and superior methods of modulation have inherited the older concepts of the discrete station or "simplex" system of broadcasting, which unnecessarily limit the advantages offered by transmission at ultra-high frequencies.

1. Simplex Broadcasting

In general, this standard method of broadcasting operates in the following manner: At the larger centers of population, the studios of the several broadcast companies are situated conveniently to the program-originating sources. From these studios, the programs are conveyed by telephone lines to the separate transmitting stations which operate on individual frequencies and are located primarily to provide maximum coverage to the listeners. To make up a broadcast network connecting several cities, an extensive system of wire lines is used to link the stations. Many duplicating networks are utilized by the different broadcast organizations in serving the same centers of population. Several major difficulties arise with this system when applied to the ultra-high frequencies and a few examples follow.

Height of transmitting antennas is of prime importance at these frequencies and since, in general, there can only be a limited number of

optimum transmitting locations, those stations not suitably situated are unable to provide service comparable to that of their competitors. In New York city, for example, there is only one Empire State Building, centrally located, and dominating in height the entire city. The broadcasting company controlling this location enjoys, therefore, a relative monopoly which even a considerably larger amount of power at other locations cannot overcome.

At the ultra-high frequencies, the broadcast coverage area is limited to "line-of-sight" distance which usually restricts the range to approximately 20 or 30 miles. To link areas at greater distances and to extend the networks on a nationwide scale, the use of relay stations has been envisaged. However, with the existing multiplicity of discrete transmitting stations, a consequent duplication of relay networks will be required and would entail considerable economic waste, aside from the georadio problem of optimum relay locations.

There are other disadvantages to the originating stations dealing with the duplication of transmitting apparatus, antenna systems, and the reduced efficiency of such parallel operation.

The listeners' receivers in an area served by several broadcast stations are also at a distinct disadvantage with the existing system. With the various transmitting stations located at different compass points with respect to any one receiving location, it is not possible for a single, simple, receiving antenna to be operated at maximum efficiency because of reflections from nearby structures. This is especially true with facsimile and television transmission, although not much less so with aural broadcasting. The practical elimination of these reflective effects entails the use of a directive antenna; hence, to receive all stations adequately, in addition to the normal receiving tuning, a definitely impracticable rotation of the antenna, or antenna-switching system, is necessary.

Also from the receiver standpoint, which is of paramount importance in a broadcast system, the peculiarities of high-frequency transmission

* Presented, Communication Group, New York Section, American Institute of Electrical Engineers, New York, New York, January 10, 1946.

make the problem of frequency tuning an extremely important one both economically as well as technically. Frequency stability, tunable "plumbing" for separating the various stations, and other factors all add appreciably to the cost of a broadcast receiver.

If these disadvantages are examined critically, it will be seen that there arises a basic need for a planned system of broadcasting at high frequencies which departs from the conventional concept of standard broadcast techniques.

2. Multiplex Broadcasting

Fortunately there exists a rather simple solution to the difficulties exposed. An examination of the underlying causes of the difficulties experienced at the high frequencies narrows down to the peculiar topographical "line-of-sight" requirements of these frequencies. To overcome this peculiarity, maximum use must be made of the unique transmitting location which provides optimum coverage.

Because it is not feasible for space reasons alone, as well as the numerous technical and economical objections, to have a multiplicity of transmitters and antennas at a single location, a logical solution is to use a single antenna and a single transmitter. The use of a common operating radio frequency for all programs follows

naturally. Hence, we arrive at a system known as multiplex broadcasting.

With this system a single transmitter operating at one common carrier frequency is used by all stations. This transmitter is situated with respect to optimum height and location in the broadcast service area. The various studios located within the area convey the several programs to the common transmitting point by wire line or other means. Each of these originating programs serves to modulate the common radio-frequency carrier which is radiated by the common antenna system. Fig. 1 exemplifies such a system as applied to New York city.

It is seen, therefore, that by this method maximum usage may be made of the exceptional transmitting locations. Rather than a single station, many stations enjoy the optimum conditions, resulting in improved and more uniform service.

Furthermore, greater efficiency and lower-cost operation should result from the elimination of duplicate transmitter and antenna installations as well as the centralization of studio-transmitter links.

Important advantages to the broadcast listener result from this multiplex method. At the receiving location, no radio-frequency tuning is required because a common frequency is used for all programs. A fixed-tune receiver may thus be

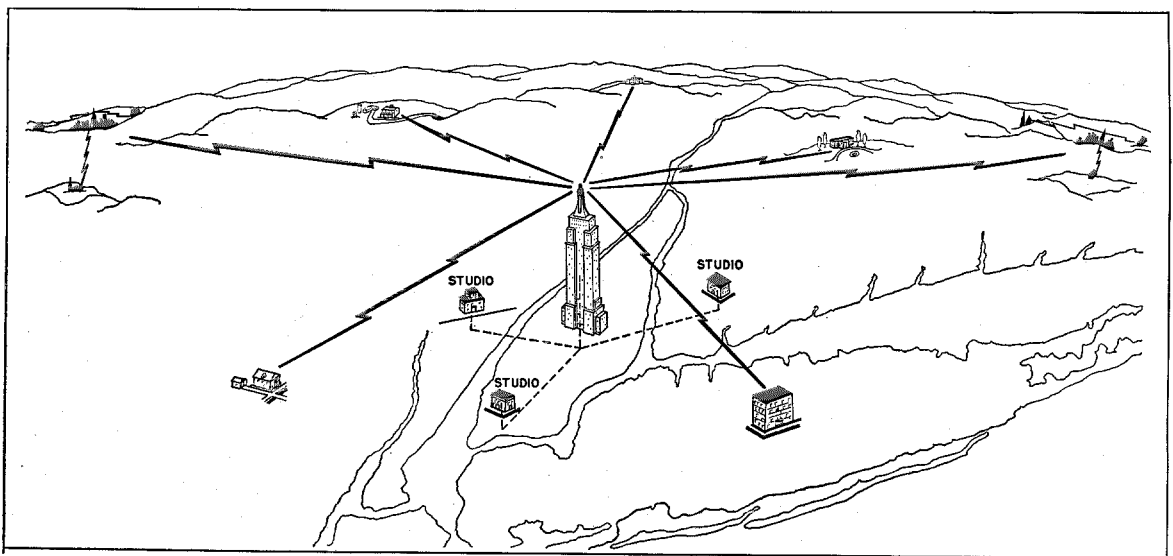

Fig. 1—Multiplex broadcasting applied to New York city and its environs.

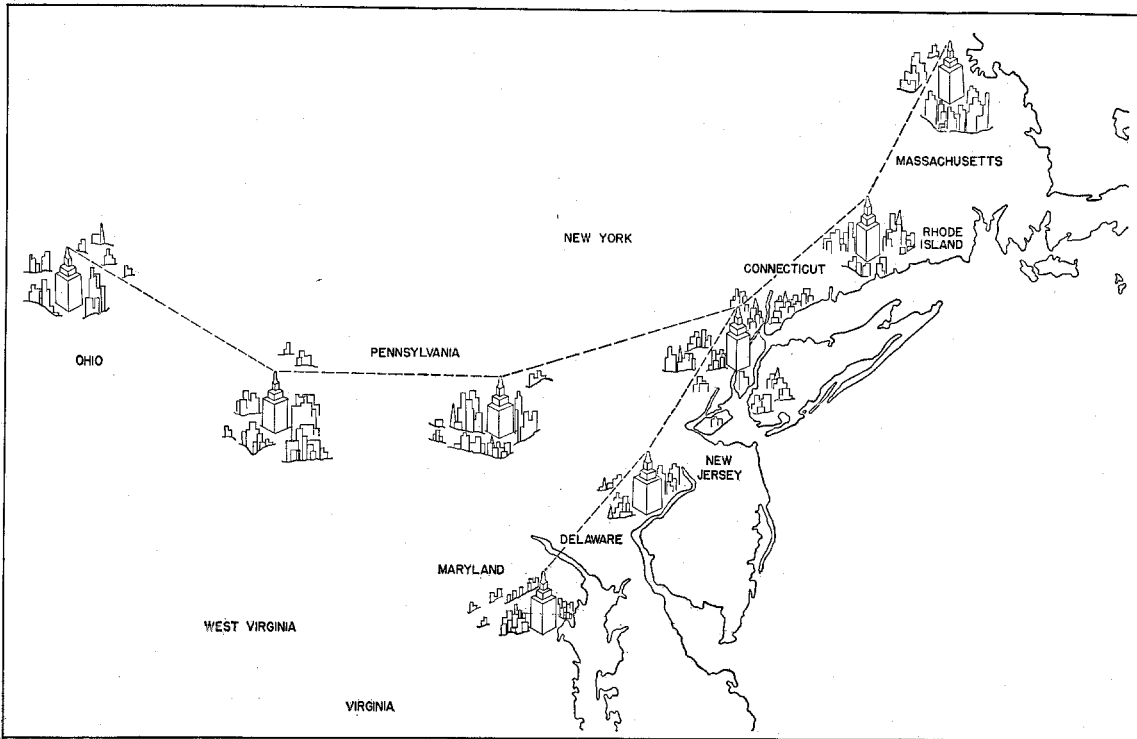

Fig. 2—An example of part of a nationwide multiplex broadcasting system which would use the same transmitting stations for both relay and broadcast services.

used. Furthermore, there is no antenna problem arising from reflections from nearby structures. Thus, a single, efficient, fixed directive antenna can be used for receiving all programs.

An important advantage of the multiplex broadcast method is the simplicity of relaying. A nationwide broadcast relay system can be built up in which one series of relay stations operating on a common carrier frequency provides for the relay and network requirements of the several broadcast companies. These relays would link the various multiplex broadcast centers and therefore offer many economies by eliminating duplication. Fig. 2 shows how such a relay system could be used for linking the important broadcast centers.

3. Type of Multiplexing

Having determined that multiplex broadcasting is advantageous from several points of view, the problem arises as to the type of multiplex which is preferable. It is obvious that any of the three basic modulation methods, viz., amplitude,

frequency, or phase modulation, may be used depending on the specific engineering requirements.

There are two basic types of multiplex possible, the well-known frequency-division multiplex or the more recently introduced time-division multiplex utilizing "time" or "position" modulation of pulses.¹

Frequency-division multiplex is exemplified by the type "K" carrier equipment in which the individual audio-frequency signals are transposed in frequency, with each signal occupying a separate band of frequencies. These bands of frequencies are added together forming a complex signal which modulates the radio-frequency carrier by any suitable method of modulation.

The receiver accomplishes the segregation of the complex modulated signal into the individual bands of frequencies by frequency tuning or frequency-selective filters. The original audio-frequency signals are then obtained by

¹ E. M. Deloraine and E. Labin, "Pulse Time Modulation," *Electrical Communication*, v 22, n 2, p 91, 1944.

demodulation of the separate bands of frequencies. Fig. 3A illustrates the transposition of audio-frequency signals in a system of this type.

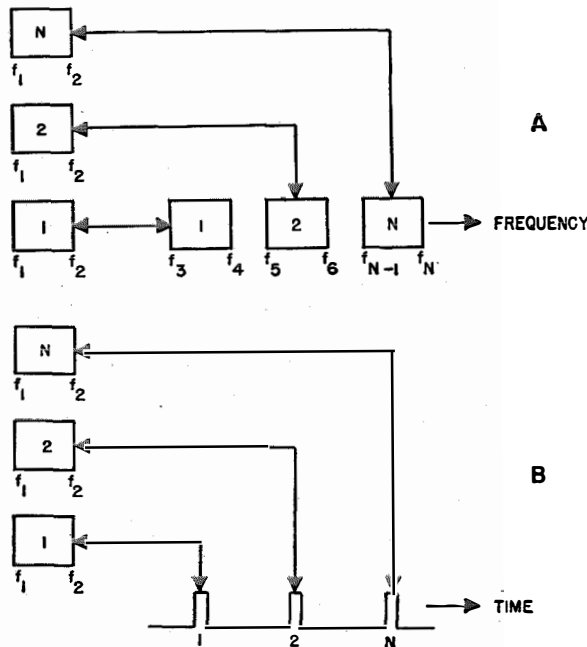

Fig. 3—A, frequency-division and B, time-division multiplex broadcasting.

Time-division multiplex is a discrete method of combining the individual audio-frequency signals as compared with the continuous processing of frequency division. Each audio-frequency signal is divided into small segments in time, and each segment is scanned in sequence. The scanning is performed sufficiently fast so that no appreciable change in the audio-frequency signal occurs during the scan periods and hence the signal is transmitted with full fidelity. A similar rapid sampling of each audio-frequency signal or program takes place in turn and all the segments are added together to yield a sequence of interleaved segments or pulses containing the combined signals.

Although it is possible to utilize this type of waveform directly, the full advantages of time-division multiplex are achieved by utilizing pulses of constant amplitude and translating the amplitude variations into a displacement of the pulse in time with respect to some fixed reference time. This type of signaling has been known as

pulse-time or pulse-position modulation. Fig. 3B shows the transposition of the various audio-frequency channels to a multiplex time-modulated pulse series of this type.

Fig. 4 illustrates the scanning process associated with this method of multiplex operation. In Fig. 4A, the three audio-frequency waveforms, 1, 2, N, represent the complex signals from three studios. These signals are scanned sequentially. Fig. 4B shows the effect of pulse-amplitude modulation. In pulse-time modulation, Fig. 4C, the dynamic amplitude change results in the displacement of the pulse in time, and the rate of change of dynamic amplitude, or frequency, controls the rate of change of pulse displacement.

As in the case of frequency-division multiplex, the radio-frequency carrier may be modulated in amplitude, frequency, or phase. Fig. 5 shows the type of signal which would be radiated with pulse time-division multiplex and either amplitude or frequency modulation.

Thus, each of the originating programs gives rise to a series of pulses which are interleaved in time with the other program-carrying pulse

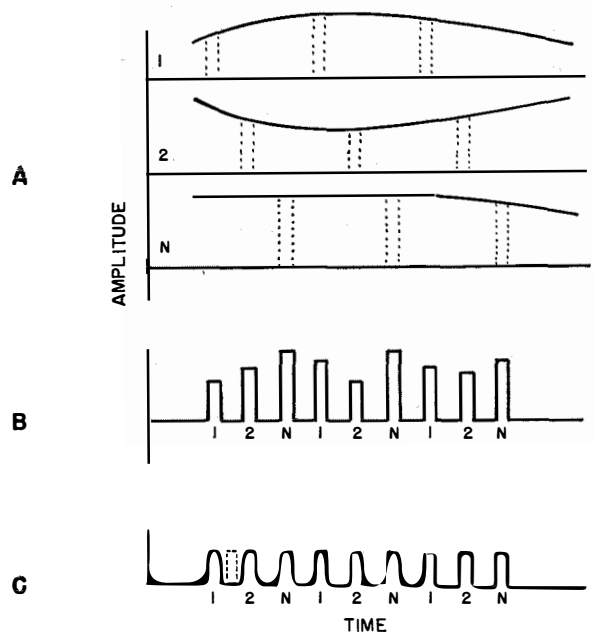

Fig. 4—Scanning process used in time-division multiplex. A represents three audio-frequency wave forms, 1, 2, N, being scanned. B is the result of pulse-amplitude modulation. C is for pulse-time modulation, the dotted pulse indicating on a much-expanded scale the displacement of the pulse as a result of modulation.

trains, and the combined series of pulses modulate the common transmitter. Hence, each station rather than identified by transmitter frequency is uniquely characterized with respect to the other stations by its relative timing position. The listener at the receiving point of course selects the desired program by time channels rather than by frequency tuning.

4. Equipment Required

The type of installation required in frequency-division-multiplex broadcasting is illustrated by Fig. 6A. The transmitter consists of a common high-frequency transmitter, a modulator, and the multiplexing equipment which transposes the several station programs into the required sequence of separate frequency bands. Thus, the programs originating from the various studios are applied to their respective frequency-transposition units and are transposed to separate frequency bands. These transposed, and usually adjacent, bands of frequency form a complex signal which modulates the high-frequency carrier.

The receiver for this type of signal may contain a fixed-tune radio-frequency amplifier and first detector or discriminator, depending on the type of modulation. These circuits separate the entire group of frequency bands from the high-frequency carrier. The individual programs are selected from this complex signal by a tunable intermediate-frequency unit, or tunable second converter-detector unit. The selected band of frequencies can then be transposed to audio-frequencies by the final detector as in a conventional radio system.

Fig. 6B illustrates the equipment requirements for a time-division-multiplex broadcast installation. It can be seen that the type of equipment required is essentially equivalent, with the frequency-transposing and selection units replaced by time-scanning and time-selection apparatus. The transmitter consists of a common high-frequency unit which is modulated in any of the appropriate fashions. The programs from the various studios are transposed into a series of time-modulated pulses which are interleaved to form a pulse series which modulates the high-frequency carrier. The programs of studio 1 are transposed into modulation pulses

by pulse-time modulator 1, the programs of studio 2 are translated into modulation pulses by modulator 2, and so on for the total of individual station programs.

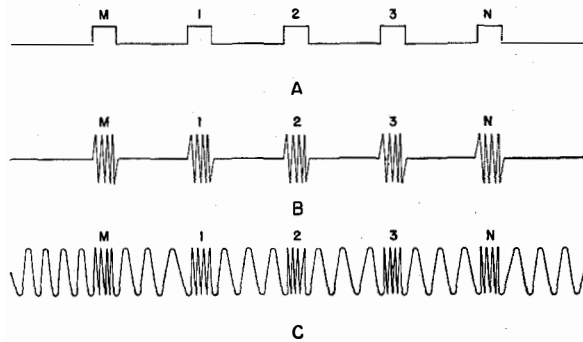

Fig. 5—Transmission of a subcarrier by A, pulse-time modulation; B, amplitude modulation; and C, frequency modulation.

The broadcast receiver for this type of transmission consists of a fixed-tune radio-frequency amplifier and detector unit, a pulse-time station selector, and a pulse-time demodulator which converts the time modulation into the required audio-frequency signal. All programs are received on the same frequency and are selected by the relative timing of the pulses corresponding to the individual programs. Thus, all tuning is done at frequencies above audibility and is totally independent of the carrier frequencies used.

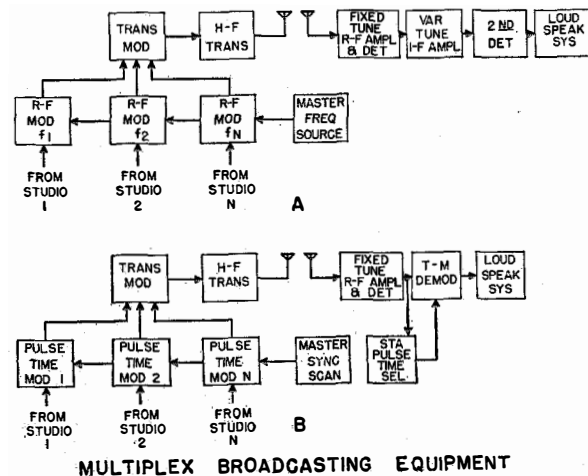
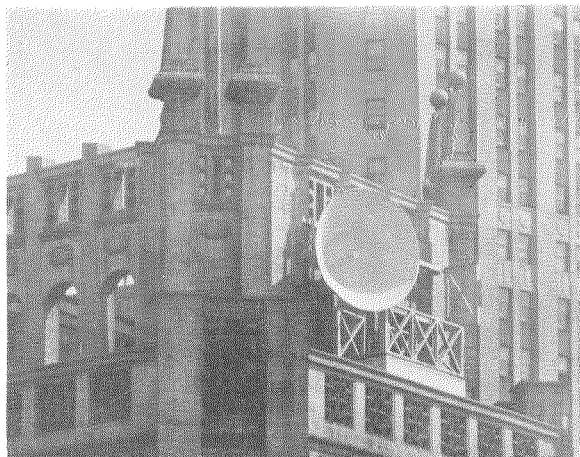

Fig. 6—Comparison of equipment required for frequency division (A) and time-division (B) multiplex broadcasting.



One of the antenna-reflector units mounted on the roof of the International Telephone and Telegraph Building in New York city. Two automatic relay stations in New Jersey provide an 80-mile circuit over which both telephone and high-fidelity transmissions using pulse-time modulation are tested.

The frequency bandwidth and channel considerations for both systems of multiplex are essentially the same. Suppose a multiplex system providing ten high-fidelity broadcast channels with a signal-to-noise transmission improvement over amplitude modulation of 20 decibels is desired. The audio-frequency band can be designated as 15 kilocycles per second.

With the frequency-division-multiplex system, considerations of simplicity at the receiver would dictate the use of amplitude-modulated double-side-band and carrier transmission. In addition, the individual frequency bands or subcarriers must be separated sufficiently so that undue cross-talk is not experienced if simple frequency-tuning networks are used to segregate the various channels.

A reasonable design might start at a lowest subcarrier frequency of 50 kilocycles and with subcarriers corresponding to the different audio-frequency signals separated by 50 kilocycles. A band from 50–500 kilocycles would be required for the entire group of ten channels. To obtain the required signal-to-noise improvement factor, frequency modulation of the high-frequency carrier might be used. A modulation index of the order of 5 would give the required technical performance. Thus, a total bandwidth of ten times the subcarrier bandwidth or 5 megacycles at the operating radio frequency would be utilized.

These computations are approximate only, and can be derived from the usual assumptions made for this type of service. The bandwidth indicated is not necessarily excessive and would represent only a small percentage of the operating carrier frequency.

For the same conditions of channel number, audio-frequency bandwidth, and signal-to-noise improvement, the technical characteristics for a time-division-multiplex system are as follows:

The number of pulses per second used for each channel would be chosen as approximately 2.5 times the highest audio-frequency or 40,000 pulses per second. This allows 25 microseconds for the interleaving of the pulses of all ten channels. Thus, 2.5 microseconds are at the disposal of each channel and must include pulse width, pulse displacement, and guard time between channels. If this available time is divided in the proper proportions among the various factors, a pulse displacement of approximately ± 0.75 microsecond and a pulse build-up time of the order of 0.16 microsecond corresponding to a pulse width of about 0.5 microsecond can be used. For the pulse-time method of modulation, the ratio of the peak displacement to the build-up time would be 4.7 which would yield a signal-to-noise improvement corresponding to the required 20 decibels. The Fourier analysis of the particular pulse shape obtained for the conditions indicated shows that the required bandwidth for the complex pulse multiplex series would be approximately 2.5 megacycles.

If this complex signal is used for double-side-band amplitude modulation of the high-frequency carrier, a total frequency spectrum of 5 megacycles, the same value as indicated for frequency-division-multiplex operation, would be required. Of course, it is possible to use single- or vestigial-side-band transmission at the expense of some complication of the fixed-tune radio-frequency unit in the receiver. There would be a consequent saving of bandwidth.

The technical requirements for both systems are of course a sufficient frequency band to accommodate the total number of stations desired. In addition, for the frequency-division-multiplex method, the proper linearity requirements at both the transmitter and receiver are necessary to avoid undue cross-talk and cross-modulation conditions.

5. Choice of Multiplex

Two methods of achieving the modulation associated with multiplex broadcasting have been set forth. While both are feasible, an examination of their technical requirements tends to indicate that the pulse time-division multiplex is preferable for the type of broadcasting proposed.

The major difficulty associated with the frequency-division method is the requirement for extreme linearity at both the transmitter and receiver to prevent cross-modulation. In addition, there is the necessity for frequency tuning or frequency filtering in both the transmitters and receivers. The expense in achieving the required transmitter performance is not of unusual importance, but the cost of the receiver to meet these requirements is of first consideration.

With a pulse method of modulation, several advantages are attained:

a. Improved cross-talk characteristics without necessitating elaborate circuit precautions at both the receiver and transmitter. The type of multiplexing is such that only one signal is sent at any one instant of time and hence the usual amplitude and phase non-linearities are unimportant. For pulse time-division multiplexing these effects are avoided merely by providing the proper frequency band.

b. Simplification in combining channels at the transmitter and in their separation at the receiver by eliminating the need for relatively complex tuned or untuned filters. With the pulse method, all tuning at the receiver is done at frequencies above audibility and, hence, no elaborate tuning methods are required.

c. By eliminating the necessity for tuning there is a considerable reduction in stability and drift requirements for the receiver.

d. There is an improved signal-to-noise-ratio possibility which is characteristic of pulse modulation. Limiters and other noise-reducing devices may be utilized effectively, independent of the method of radio-frequency transmission. If frequency modulation of the radio-frequency carrier is used, a combination of the noise-reducing properties of both systems can be utilized.

e. Because constant average power is transmitted during modulation, the subcarrier circuits at both the receiver and transmitter may be

considerably simplified and, in addition, operated at maximum efficiency.

f. When repeaters for extending the range of transmission are used, the inherent on-off characteristic of pulse-time modulation allows a simplified repeater system to be utilized.

There are of course additional factors which must be determined for any system of broadcasting. These factors include the number of broadcast channels, service-area considerations of power and signal-to-noise ratio, audio- and radio-frequency bandwidths, and many other

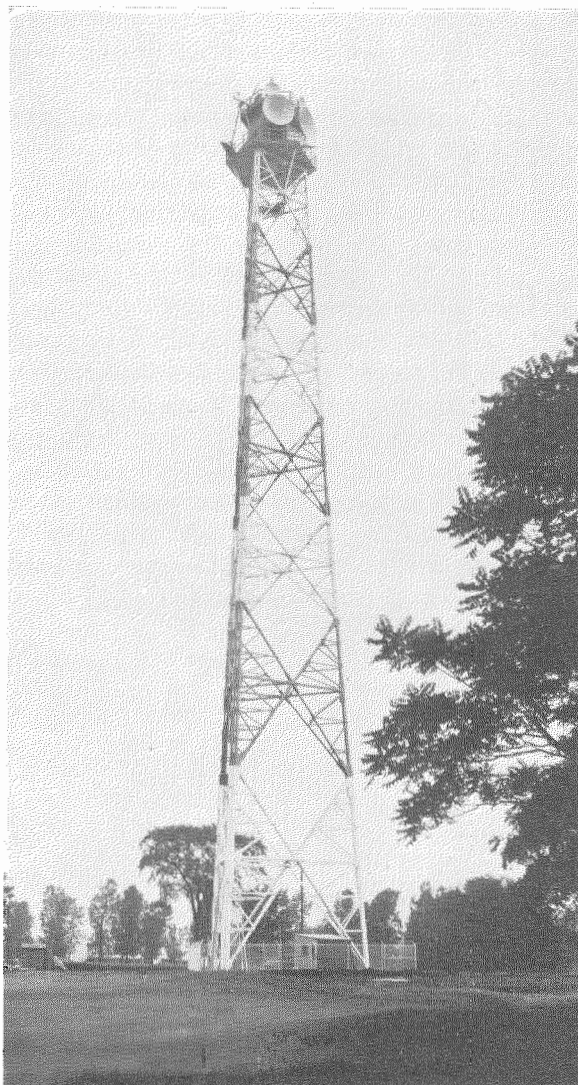

This microwave relay station mounted atop a 200-foot tower at Nutley, New Jersey, is part of the 80-mile triangular circuit over which experimental transmissions are made to test pulse-time modulation.

technical, economic, and aesthetic items. These considerations apply however in the same manner as the corresponding factors in a standard broadcast system and hence need not be discussed in a special light as applied to a multiplex system.

6. Conclusion

It has been shown that multiplex broadcasting, preferably with the pulse time-division multiplex method, would seem to provide an ideal solution to the many problems raised by the migration of broadcast services to the ultra-high-frequency band. Emphasis has been put on the application of this type of operation to aural broadcasting because this operation is of immediate realization. It is obvious that the same advantages would apply to other types of broadcasting as well. Particularly in the case of television, the advantages obtained at the receiving locations by eliminating the necessity for rotatable antennas, and the simplification of the problems of reflection would be of outstanding significance.

The technical details of the systems discussed here have, of course, been only lightly sketched. Considerable experience with these details however has indicated no outstanding technical difficulties. Multiplex broadcasting should, therefore, be seriously considered for application at the shorter wavelengths in the light of a planned, logical system taking full advantage of the characteristics of these wavelengths.

As a recapitulation, the salient features and advantages of high-frequency multiplex broadcasting are set forth:

a. Maximum use is made of the optimum transmitting location, providing more uniform and satisfactory service.

b. Duplication of transmitting and antenna systems is avoided. More efficient operation results from centralization of all transmission means.

c. The problem of reflections at the receiving location are eliminated by the use of a single common transmitting point. Thus, a simplified, single, directive antenna may be utilized for receiving all programs.

d. The creation of an extensive network of repeaters connecting the several service areas is considerably simplified and made more economical by the elimination of duplicating networks.

The combination of high-frequency multiplex broadcasting with pulse-time modulation yields the following additional advantages:

a. It provides a simplified method of combining programs at the transmitter and separating them at the receiver without deleterious cross-talk effects or requiring elaborate circuits to prevent cross-talk.

b. A fixed-tune receiver may be used for all programs.

c. The problems of noise reduction, distortion, and relaying are considerably simplified.

Three New Antenna Types and Their Applications*

By ARMIG G. KANDOIAN

Federal Telecommunication Laboratories, Inc., New York, New York

THREE new types of antennas have been developed for use primarily in the very-high-frequency and ultra-high-frequency spectrums. The radiation pattern of each antenna is essentially equivalent to that of a dipole; that is, it may be represented by a solid of revolution determined by a rotating figure of eight.

Type I, the Discone antenna, is intended primarily for vertical polarization, and, like a vertical dipole, gives an omnidirectional pattern in the horizontal plane. A distinctive feature of this antenna is its simplicity of construction and feeding. Its most important characteristic is satisfactory operation over a very wide band of frequencies (several octaves) without a substantial change of either input impedance or radiation pattern.

This type of antenna has wide applications wherever extremely wide frequency ranges are encountered and simplicity of mechanical design and installation are required.

Type II, a coaxially fed loop antenna, is intended primarily for horizontal polarization. The radiation pattern is omnidirectional in the plane of the loop. The radiators forming the loop are metallicly supported from the mast or other supporting structure. Further, both supports and radiators form part of the coaxial feeding circuit. No balanced lines are used anywhere in the circuit. The bandwidth is controllable, though in general much narrower than with the type I antenna. No stubs are necessary to obtain a match to any common type of coaxial feeder of 50, 70, or 100 ohms.

The most important feature of this antenna is its simplicity of mechanical design and construction, and the ease with which a large number of antennas may be "stacked" for high-degree directivity in the vertical plane while retaining omnidirectional radiation in the horizontal plane.

Typical applications of this type of antenna

are frequency-modulation broadcasting, television, and general communication.

Type III antenna is similar to type II, except that at the center of the loop and perpendicular to it a vertical radiator has been added. The radiation pattern of type III is essentially the same as that of types I or II; the free-space field intensity at all points has both horizontal and vertical components in equal amounts. The type III, being a combination of an "electric" dipole (vertical radiator) and a "magnetic" dipole (horizontal loop), might, therefore, be called an "electric-magnetic" dipole.

Equality of amplitude of the two polarization components is not necessary as any desired ratio of amplitude as well as phase relationship between the horizontally and vertically polarized fields may be obtained.

The most interesting application of this type of radiator is in high-directivity arrays or in illuminating a highly directive parabolic reflector or horn for general communication application. The presence of both vertical and horizontal components, it is felt, will be helpful in reducing fading. There is also a possible application of this type of antenna to very-high-frequency and ultra-high-frequency broadcasting, where the receiving dipole could then be oriented for optimum signal-to-noise ratio.

Type I—The Discone Antenna

The Discone antenna, as the name suggests, consists of a disk and a cone whose apex approaches and becomes common with the outer conductor of the coaxial feeder at its extremity. The center conductor terminates at the center of the disk which is perpendicular to the axis of the cone and the feeding transmission line. Fig. 1 is a schematic of the Discone antenna with a tabulation of typical dimensions. Fig. 2 shows a Discone antenna.

The Discone antenna in its radiation behaves essentially as a vertical dipole. However, its change of impedance versus frequency is very

* Reprinted from *Waves and Electrons*, v 1, n 2; February, 1946.

much less than any ordinary dipole of fixed length. The same is true of its radiation pattern.

From the circuit standpoint the Discone

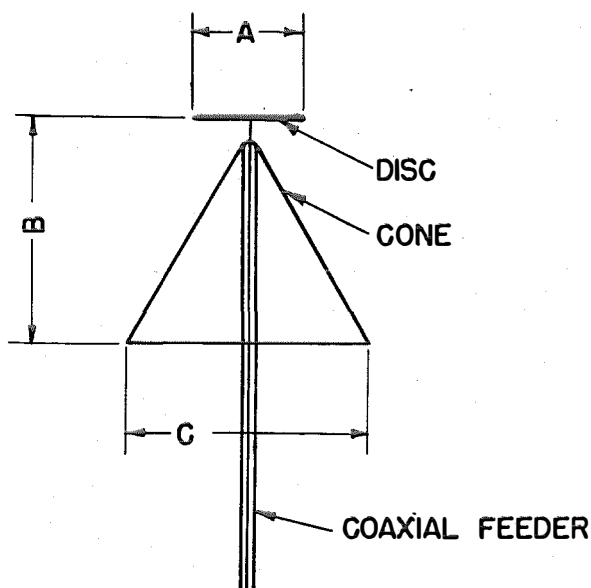

Cutoff frequency	A	B	C
90 megacycles	18 inches	24 inches	20 inches
200 megacycles	9 inches	12½ inches	14 inches

Fig. 1—Schematic diagram of the Discone antenna.

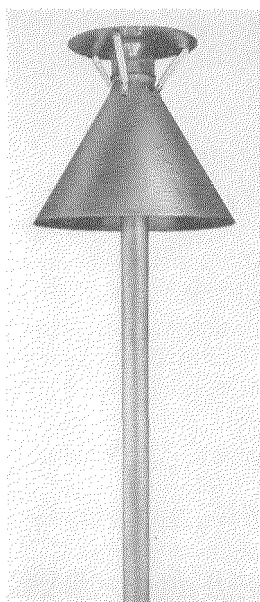

Fig. 2—Discone antenna for cutoff frequency of 200 megacycles.

antenna is essentially a high-pass filter. It has an effective cutoff frequency below which it becomes very inefficient, causing severe standing waves on the feeding coaxial line. Above the cutoff frequency, however, little mismatch exists and the radiation pattern remains substantially the same over a wide range of frequencies. The slant height of the cone is approximately equal to a quarter wavelength at the cutoff frequency.

Fig. 3 illustrates a typical mismatch versus frequency relation of a Discone antenna measured on a 50-ohm coaxial feeder.

Fig. 4 shows a typical, measured radiation pattern of a Discone antenna, cutoff at approximately 200 megacycles, measured every 50 megacycles up to 650. It is evident that, from cutoff (200 megacycles) all the way up to 650 megacycles, no drastic change in the radiation pattern has taken place. At the high-frequency end, however, the pattern does begin to turn upward. Investigation is now in progress to determine its characteristics at much higher frequencies.

The radiation patterns shown in Fig. 4 are measured patterns of the Discone antenna proper. As in most antennas with vertically polarized radiation, the supporting structure, in the present case the coaxial feeder, participates somewhat in the over-all radiation. This is due to currents induced in the supporting structure by the antenna. The amplitude of the induced currents in the present case is of the order of 5 percent of the main antenna current and, hence, cause "scalloping" of the radiation pattern of

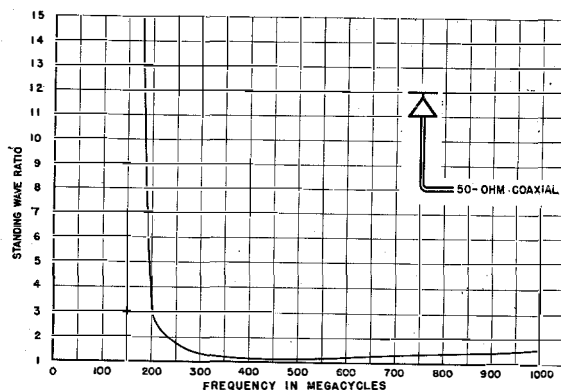

Fig. 3—Mismatch versus frequency of Discone antenna for a cutoff of 200 megacycles.

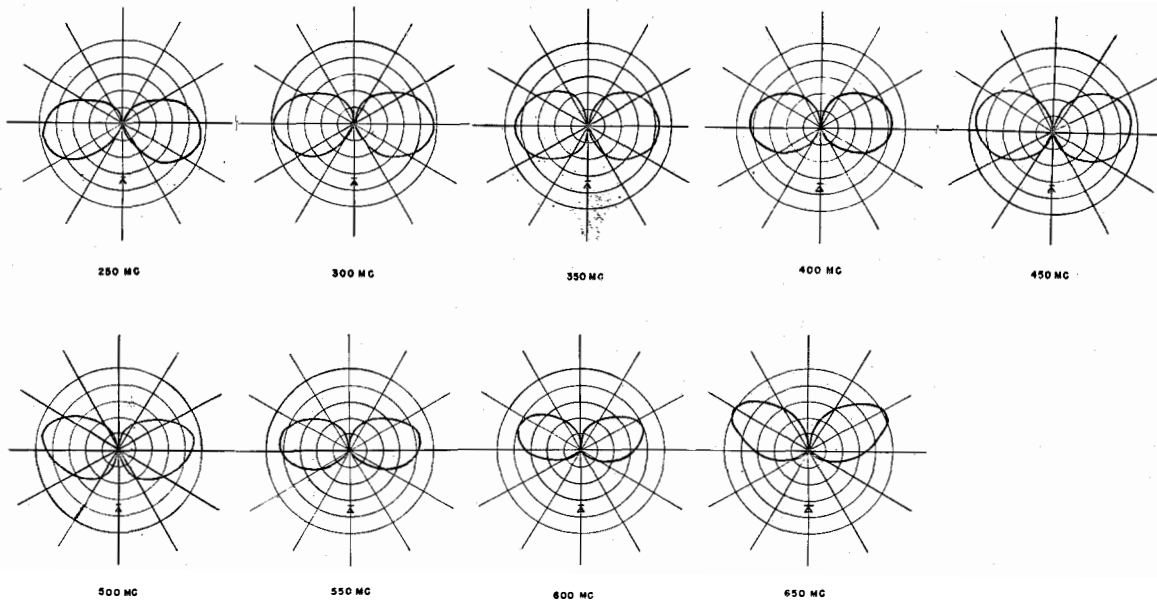

Fig. 4—Vertical radiation patterns of a Discone antenna for a cutoff frequency of 200 megacycles. Radiation patterns measured every 50 megacycles from 250 to 650 megacycles.

approximately ± 5 percent. For applications where it is required, a suppressing means, such as, for example, radial rods clamped on the supporting structure below the open end of the cone, may be used to prevent coupling between the antenna and the supporting structure.

An interesting application of the Discone antenna occurs when the cone of the antenna serves as the complete housing for the transmitting or receiving equipment.

A variation of the Discone antenna which has some useful applications is where the lower end of the cone is "grounded"; that is, made common with a large conducting surface.

Fig. 5 shows another experimental Discone antenna with a cutoff frequency of approximately 90 megacycles. Its performance is in general quite analogous to the small unit just described.

The Discone antenna may be visualized as a radiator intermediate between a conventional dipole and an electromagnetic horn. At the low end of its operating band, it behaves very much as a dipole; at much higher frequencies, it becomes essentially a horn radiator.

For information on antennas related to but



Fig. 5—Discone antenna for cutoff frequency of 90 megacycles.

not entirely equivalent to the Discone, the reader is referred to several investigators.¹⁻³

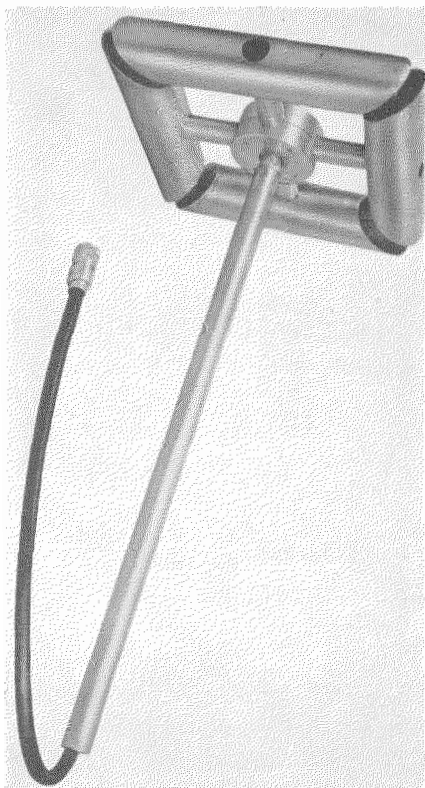

Fig. 6—Coaxially fed loop antenna for 550 megacycles.

Type II—Coaxially Fed Loop

Type II antenna is a loop radiator. This type is sometimes referred to as a "magnetic" dipole. An experimental model of the present type for approximately 550 megacycles is shown in Fig. 6.

Loop antennas for very-high-frequency and ultra-high-frequency application have been described by several investigators.⁴⁻⁷ While the present type of loop has the same radiation characteristic as an equivalent-size loop antenna previously described, its mechanical and elec-

trical design is considerably different and offers some advantages and new possibilities in the application of the loop antennas.

Figs. 7, 8, and 9 show schematic diagrams of the type of loop under consideration. The metallic supporting structure as well as the radiators themselves form part of the coaxial feeding system. By proper choice of surge impedance of these two short lengths of line, in the

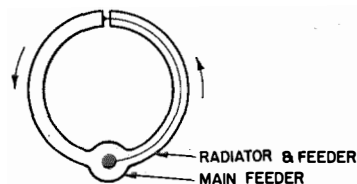

Fig. 7—Schematic diagram of single-element coaxially fed loop. Circumference approximately $\lambda/2$ or less.

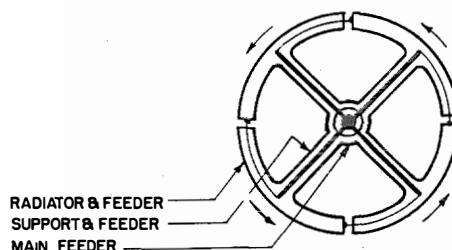

Fig. 8—Schematic diagram of 4-element coaxially fed loop. Circumference approximately 2λ or less.

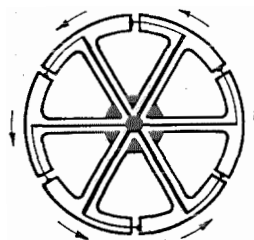

Fig. 9—Schematic diagram of 6-element coaxially fed loop. Circumference approximately 3λ or less.

¹ S. A. Schelkunoff, "Electromagnetic Waves," pp 441-459; D. Van Nostand, New York, 1943.

² G. C. Southworth, United States patents no. 2,231,602 and 2,369,808.

³ W. L. Barrow, L. J. Chu, and J. J. Jansen, "Biconical Electromagnetic Horns," *Proceedings of the I.R.E.*, v 27, pp 769-780; December, 1939.

⁴ Andrew Alford and A. G. Kandoian, "Ultra-High-Frequency Loop Antennas," *Transactions American Insti-*

tute Electrical Engineers, v 59, pp 843-848, 1940; and *Electrical Communication*, v 18, pp 255-265; April, 1940.

⁵ M. W. Scheldorf, "FM Circular Antenna," *General Electric Review*, v 46, pp 163-170; March, 1943.

⁶ Jesse B. Sherman, "Circular Loop Antennas at Ultra-High Frequencies," *Proceedings of the I.R.E.*, v 32, pp 534-537; September, 1944.

⁷ Donald Foster, "Loop Antennas With Uniform Current," *Proceedings of the I.R.E.*, v 32, pp 603-607; October, 1944.

supporting arm and the radiator itself, the desired impedance of 50, 70, or 100 ohms pure resistance may be obtained to match any common type of coaxial transmission line. Fig. 7 shows a single-element design in which the circumference of the loop is in the neighborhood of one-half wavelength or less. Figs. 8 and 9 illustrate multiple-element designs. No limitations, other than practical, exist for the number of elements making up the loop. Thus, a loop antenna of any diameter may be constructed and the current distribution maintained essentially uniform. The limitation of diameter, small compared to a wavelength, need not be observed.

The radiation pattern of a loop with substantially uniform current distribution, and with a diameter small compared to a wavelength, is well known. In the plane of the loop the radiation is nondirective. In the plane perpendicular to the loop the radiation varies approximately as $\cos \beta$, β being the angle measured from the plane of the loop.

For loop antennas of any diameter and uniform current distribution, the radiation in the plane of the loop is still nondirective. In the plane perpendicular to the loop, Foster⁷ has shown that the pattern is of the form $J_1(\pi d/\lambda \cos \beta)$ where d is the loop diameter to wavelength ratio and J_1 represents the Bessel function of the order unity.

An important consideration in any antenna is the input impedance. At very-high frequencies and ultra-high frequencies, the most practical way of expressing this information is in terms of standing waves on the line feeding the antenna. A typical measurement is shown in Fig. 10. The impedance at the center feed point is inductive below and capacitive above the mid

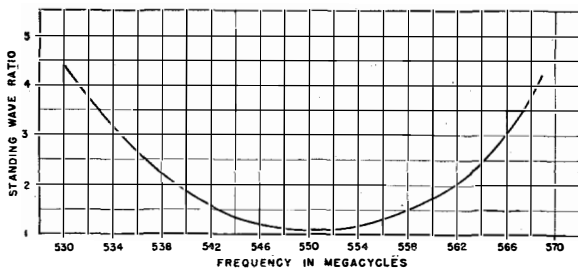

Fig. 10—Characteristic curve of frequency versus standing-wave ratio for a square loop. 4 elements of 2-inch cross section; loop diameter = $3\frac{1}{2}$ inches.

operating frequency of 550 megacycles. The feeding line is a 50-ohm coaxial. Other experimental loops have been constructed giving both

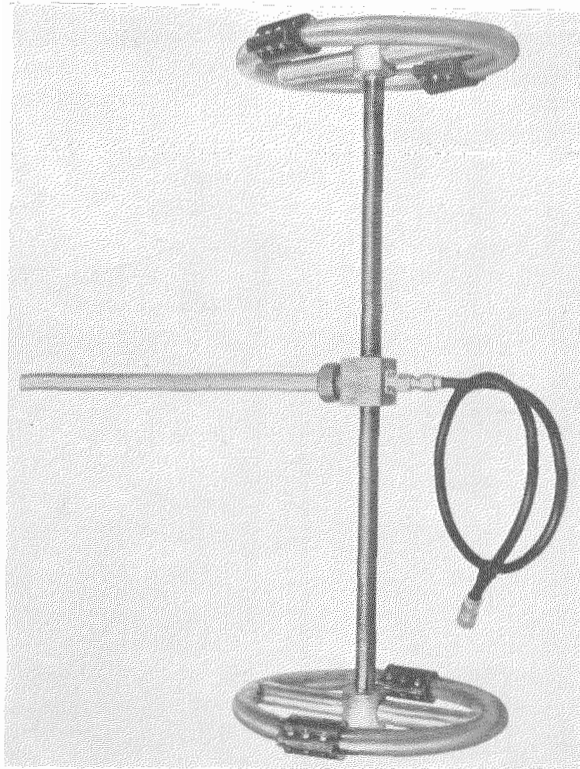

Fig. 11—Vertical stack of two loops with tuning stub.

more and less bandwidth. In general, however, the bandwidth of a loop antenna cannot be made nearly as wide as a Discone type of antenna.

The loop type of antenna is particularly useful when high-degree directivity is desired in the vertical plane while retaining the omnidirectional pattern in the horizontal plane. This is accomplished by vertical stacking of any desired number of loops.

Fig. 11 depicts two experimental loops built as a pair and spaced approximately one wavelength. The input impedance to the pair is 50 ohms.

Any number of such pairs may be stacked to give a desired amount of power gain. At the junction of the transmission line of any two pairs, however, a 2-to-1 impedance-correcting network is required to raise the impedance to the line impedance of 50 ohms (or any other desired

level). A quarter-wave transformer probably is the most convenient network for this purpose. Fig. 12 shows the schematic of a feeding system for a stack of four loops for frequency-modulation broadcasting. Fig. 13 gives the necessary theoretical data to show what spacings to use between loops and what gains may be expected due to vertical stacking when equal currents are fed to successive loops.

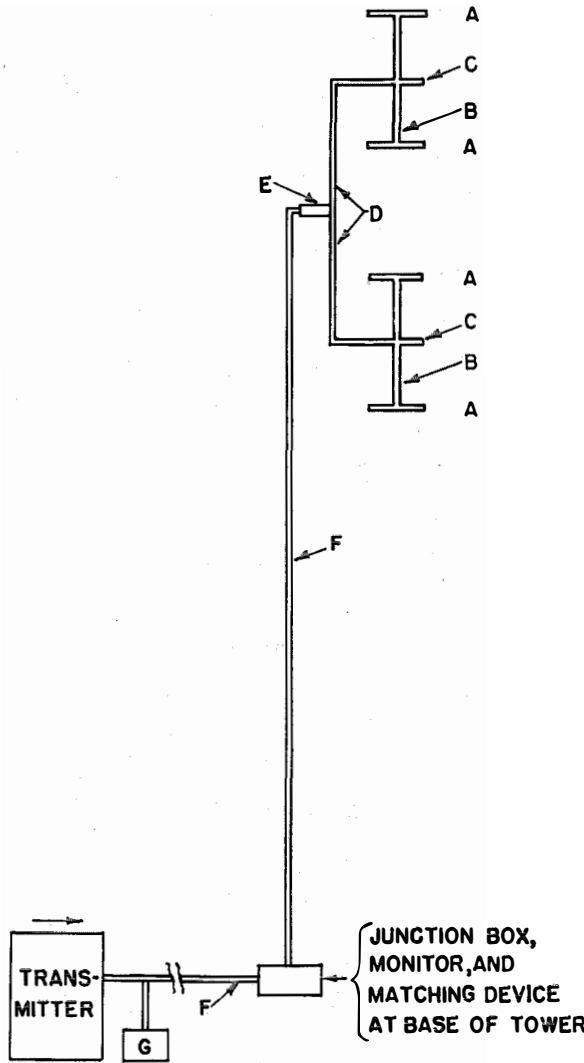

Fig. 12—Transmission line and feeding system for frequency-modulation broadcast antenna.

- A = loop antennas
- B = 100-ohm coaxial line
- C = matching stub to be for operating frequency
- D = 50-ohm line
- E = quarter-wave 35-ohm line
- F = 50-ohm coaxial line
- G = pressurizing and air-drying equipment

A directive vertical pattern essentially free from minor lobes may be obtained by proper distribution of current among successive stacked

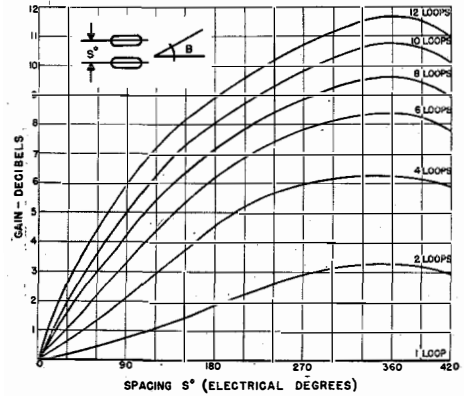

Fig. 13—Gain of linear array of loops vertically stacked.

$$r(\beta) = \frac{\sin\left(\frac{ns^\circ}{2} \sin \beta\right)}{\sin\left(\frac{s^\circ}{2} \sin \beta\right)} \cos \beta$$

$n = \text{number of loops}$

$$\text{gain (db)} = 10 \log_{10} \frac{1}{\frac{1}{n} + \frac{3}{n^2} \sum_{k=1}^{n-1} (n-k) \left[-\frac{2 \cos ks^\circ}{(ks^\circ)^2} + \frac{2 \sin ks^\circ}{(ks^\circ)^3} \right]}$$

loops.⁸ However, under these conditions the overall power gain from a fixed number of loops is reduced.

The characteristics and relative merits of the type of loop under consideration may be summarized as follows:

- a. No balanced feeders are used.
- b. No stubs are needed for matching; hence, the full bandwidth capability of the loop may be realized. A stub may be found desirable, however, to tune the loop, or a group of loops, over a wide frequency range.
- c. No insulating mechanical supports are necessary. Metallic supports are used, rigidly fastened to the mast and radiating members.
- d. Any size loop may be built, with essentially uniform clockwise or counterclockwise current distribution. Loop diameters of several wavelengths are feasible, and for certain applications desirable.

⁸ A. G. Kandoian, "Ultra-High-Frequency Technique; Radiating Systems and Wave Propagation," *Electronics*, v 15, pp 39-44; April, 1942.

Type III—"Electric-Magnetic" Dipole

An experimental model of this type of antenna is illustrated in Fig. 14. This particular unit was built for use in the neighborhood of 1,200 megacycles.

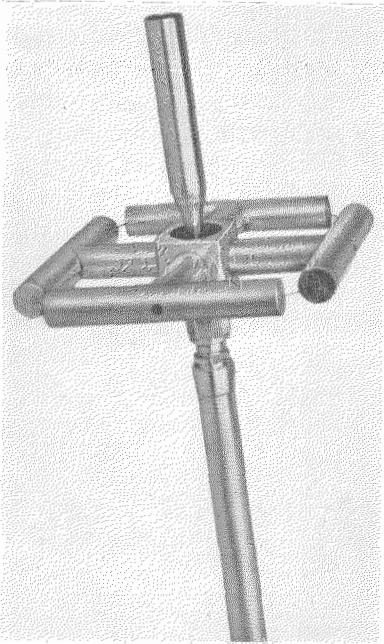

Fig. 14—Type III antenna for an operating frequency of 1,200 megacycles.

The "electric-magnetic" dipole consists essentially of a loop radiator of the type previously described, except that at the transmission-line junction at the center of the loop, and perpendicular to the plane of the loop, a vertical radiator is added. In effect, it is a combination of an "electric" and a "magnetic" dipole.

The radiation pattern of a horizontal loop, with a diameter of the order of $\lambda/2$ or less, is substantially the same as that of a vertical dipole. The only difference in the radiated field is in polarization. Thus, at every point in space equal amounts of horizontal and vertical polarization will be obtained, if the available power is equally divided between the loop and the dipole.

Control of the relative phase and amplitude of currents in the dipole and the loop is, of course, possible; and hence, any type of polarization desired can be produced; i.e., horizontal,

vertical, circular, or the most general case, elliptical.

It is not difficult to demonstrate experimentally that at any point around such a transmitting antenna one can achieve a field strength independent of the orientation of the receiving dipole, provided that the receiving dipole is kept perpendicular to the direction of propagation.

In Fig. 15 is shown the mismatch-versus-frequency characteristic of an antenna of this type for operation in the neighborhood of 1,200

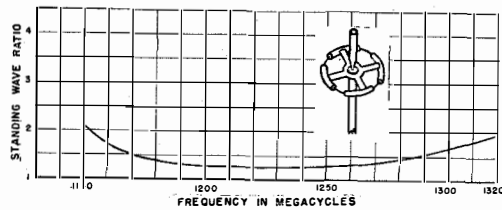

Fig. 15—Curve showing the standing-wave ratio versus frequency for the loop-dipole combination shown.

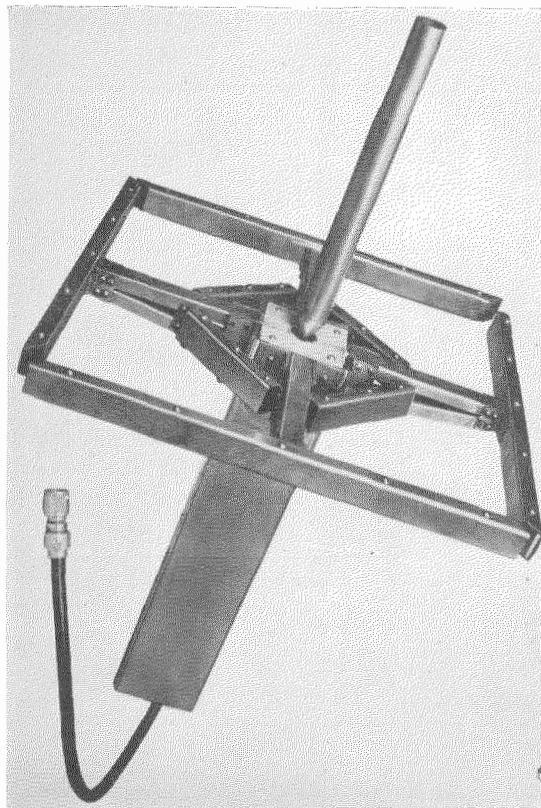

Fig. 16—Type III antenna for an operating frequency of 350 megacycles.

megacycles. Fig. 16 shows another such experimental antenna for use around 350 megacycles.

In ultra-high-frequency communication networks where considerable fading may exist due to changes in the medium of propagation, this type of antenna will probably prove very useful. In cases of severe fading the probabilities are that both horizontal and vertical components of the electric field will not vary at the same rate and at the same time, since they are affected differently by the reflecting medium between the transmitter and receiver. Considerable improvement, therefore, should be experienced in reducing the over-all fading by the use of such a radiator, or a combination of such radiators in an array.

In addition, this type of radiator is particularly well suited for illuminating a large reflecting sur-

face such as a paraboloid in a highly directive antenna system.

A possible important application of the "electric-magnetic" dipole is in the field of very-high-frequency and ultra-high-frequency broadcasting where the relative merits of horizontal as against vertical polarization have been under discussion for some years. If circular polarization were used at the transmitting end, it would permit the use of either a vertical or horizontal dipole at the receiving end, depending on convenience or architectural acceptability. The more particular listener would, of course, tend to orient his dipole to obtain the best signal-to-interference ratio, if there is any interference.

Whether any substantial improvement of performance would result in over-all reception can be determined only after field tests.

Erratum, Vol. 18, No. 3, 1940

METHODS AND APPARATUS FOR MEASURING PHASE DISTORTION, PAGE 228

In item (9) of the bibliography, the French patent application number is given instead of the patent number. The notation should be as follows:

(9) M. Levy: "Devices applicable to phase measurement, the measurements of attenuation or amplification of voltages or electric currents." French Patent No. 832,418.

Conversion of San Juan, Puerto Rico, Telephone Plant to Automatic Operation

By JOSÉ D. DOMINGUEZ

*General Manager and Chief Engineer,
Puerto Rico Telephone Company, San Juan, Puerto Rico*

INTRODUCTION of automatic telephone switching occurred in Puerto Rico at 12:41 A.M. on Sunday, June 3rd, 1945, when the Puerto Rico Telephone Company put into service its first automatic central office. Consisting of 8,000 lines and 10,000 terminals of 7-A-2 rotary equipment manufactured by the Federal Telephone and Radio Corporation, this new office serves San Juan and its suburb, Santurce. This area was served previously by two manual central offices: one in downtown San Juan and the other in Santurce.

San Juan's population increased from 137,000 inhabitants in 1935 to 169,000 in 1940, and is now estimated to be around 200,000, an increase of 46 percent over 1935. During this decade, the number of subscribers' stations increased from 6,700 to 12,000, an expansion of 79 percent. This area now contains 57 percent of the total telephones operated by the Company.

During 1940, plans were made for the conversion on the basis of a single automatic exchange with 5-digit numbers. It was decided to house the automatic equipment in a new building specially designed for the purpose. The center of population of the area served by the new exchange lies within the suburb of Santurce; the wire center presently lies to the west of the new exchange but is moving gradually toward it.

A detailed description of the studies required for this project is outside the scope of this article and we propose to pass over this phase of the undertaking and proceed to a brief description of the construction work.

Building

Land was purchased in 1941 and the building was started in February, 1942. War had been declared, Puerto Rico was being converted into a formidable military and naval base, and the Company was faced with the tremendous problem of providing additional communication

services to the Armed Forces and other agencies. Building materials, like cement and stone, were obtainable often times only with the full cooperation of the Armed Forces and of the War Production Board. The building, Fig. 1, consists of a basement and two floors and was completed in September, 1943. It has a total of 18,000 square feet and was designed for a load of 120 pounds per square foot.

Central Office Equipment

In 1941, 8,000 lines and 10,000 terminals of 7-A-2 rotary equipment were ordered. Priorities for the equipment, station apparatus, telephone cable, and other materials required in the conversion were secured from the War Production Board and by the end of 1942 equipment was being received.

Important shipments of material were lost at sea during this period due to enemy action and it was necessary to re-order them and obtain new priorities. Sufficient equipment and essential parts had been received by September, 1943, to start installation of the equipment.

This being the first installation of automatic equipment in Puerto Rico, considerable thought had to be given to the question of manpower; personnel from various I. T. & T. companies had to be brought in to help in the installation and to instruct the local personnel in both the installation and maintenance of the equipment. At the height of the installation work, there were 146 persons working in three shifts; of these 118 were Puerto Rican, 18 were employees of I. T. & T. affiliated manufacturing companies, and 10 were loaned by other telephone operating companies of the I. T. & T. system in Mexico, Peru, the Argentine, and Brazil.

Part of the manufacture of the equipment was done on the site due to the scarcity of labor in the United States; this was especially so with the

installation of ribbon cable, which was most proficiently performed by local labor.

The automatic equipment is located on the first floor of the new building and is separated from the main frame by a wood-and-glass partition. In the front of the first floor are located the toll terminal room, the toll and local test desks, and a small commercial office. The toll switchboard is located on the second floor together with operators' quarters, service observation room, and the Traffic Department offices. The basement contains the power plant and cable vault.

The switchroom is provided with a dehumidifying plant which automatically maintains the relative humidity between 50 and 60 percent to protect the automatic equipment from high humidity and dust conditions which prevail the year round.

Outside Plant

The first step in the conversion of the San Juan and Santurce exchange areas to automatic operation was the construction of an underground conduit system. The main conduit run is along

Ponce de Leon Avenue, with various secondary leads as shown in the schematic diagram, Fig. 2. Service to downtown San Juan, which used to be by roof-top aerial cable, is now by block cable. Over 276,000 duct feet of conduit were placed in this construction and over 229,000,000 conductor feet of wire in cable were required.

Tie cables were installed between the new exchange and the Santurce manual exchange, thus permitting the termination of cables west of the new exchange in the new main distribution frame; the cables east of the new exchange were extended to the new office with half taps at the old manual office. New underground cables placed to serve downtown San Juan had half taps to the San Juan manual office. This avoided "double" wiring to the stations in downtown San Juan and permitted the block cable plant to be put in service ahead of the actual conversion. This resulted in improved service and a considerable simplification of the actual cutover. Fig. 3 shows, in schematic form, the fundamental idea used in the design of the outside plant.

There was no way of knowing what underground obstacles, such as water pipes, gas pipes, or even old Spanish walls, would be encountered in the construction of the underground system for no reliable plans were available. It was necessary therefore to excavate complete sections and make strategic explorations before actually placing the conduit. In some sections, where obstacles could not be avoided, it was necessary to go down as far as 10 feet. Fortunately, these cases were few.

Underground telephone construction being new in Puerto Rico, it was necessary to train the contractors and supervise their work constantly during the first few

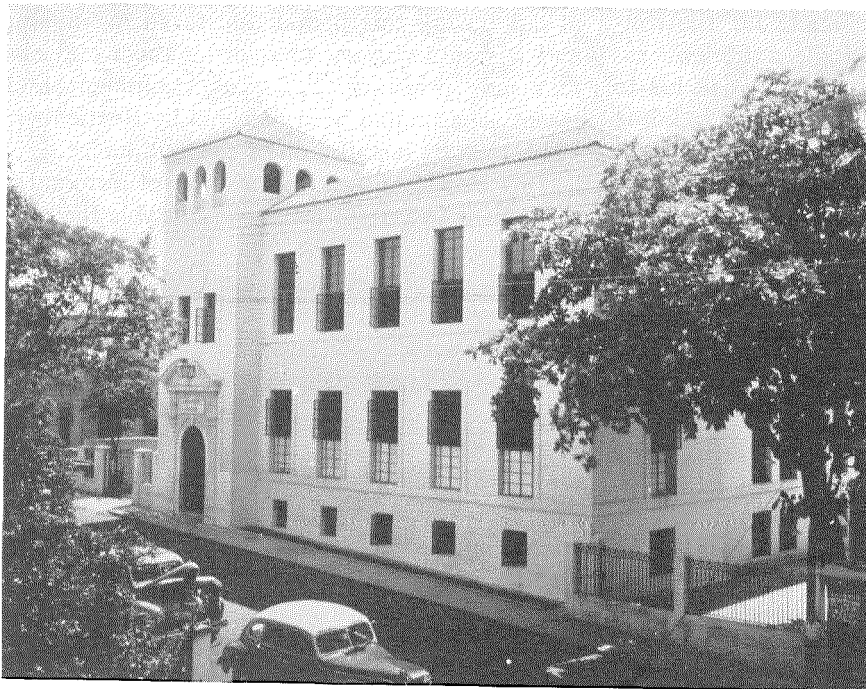

Fig. 1—New automatic central office building on Cerra Street in Santurce.

months of construction. For future reference, detailed plans were prepared of the underground system and all other constructions exposed during the work.

Standard methods of construction were used throughout with very few exceptions as required by the layout of the underground; an interesting case of this nature was what we call the "Z" manhole which was used to permit the rerouting of a lead because of underground obstacles that could not be avoided.

Company Schools

To handle such a large construction program it was necessary to organize schools for splicers, station installers, subscriber instructors, wiremen, and so forth. Many of the candidates were chosen from the rolls of vocational schools and given intensive organized training to fit them for the various jobs.

Main Distribution Frame

The main distribution frame installed in the new automatic exchange is 303 pairs high with the protectors located on the street side.

Cable Vault

Considerable thought was given to the design of the cable vault which provides access of the outside plant cables to the exchange building. A total of 36 ducts are terminated in the central office manhole, which is a continuation of the cable vault into the street and is accessible from the cable vault by a strairway.

Subscribers' Apparatus

Under manual operation, the Company offered mainline as well as 2-party and 4-party harmonic-ringer service. Special ringer keys, associated with each cord circuit of the manual positions, permitted the operator to send out ringing

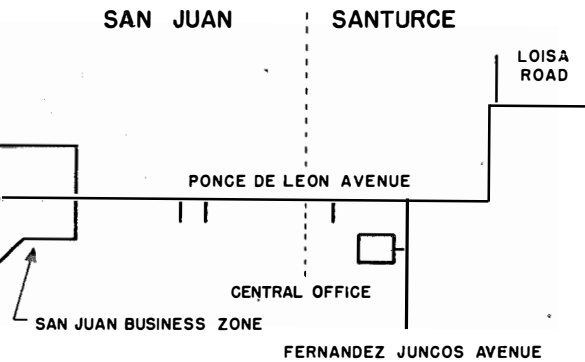

Fig. 2—Main underground conduit routes in San Juan and Santurce. The central office is in Santurce.

During all this construction, it was also necessary to provide cable relief to various aerial leads that would remain in service after the conversion. A new toll cable, approximately 6 kilometers long, was also installed in connection with the conversion. This toll cable permitted the elimination of an open-wire pole line with 7 crossarms carrying important circuits of the Armed Forces and of the Company and enabled us to provide additional circuits required for the war effort.

Coincidentally with the engineering and construction of the outside plant, the problem of electrolysis was given a great deal of thought. It was known that water pipes and underground dips had suffered from stray currents and that the bonding of the rails of the trolley car system in the city was defective. As a result of anticipation of the electrolysis hazard, it was possible to take proper measures as the work progressed to protect the underground plant by means of drainage wires and counter-electromotive-force devices with the result that not a single case of trouble from electrolysis has been encountered since 1940 when relief to a section of Santurce was given by the first underground feeder cables placed in service in Puerto Rico.

Some thought was given to the possibility of using concrete ducts but this was discarded in favor of vitrified clay conduit to avoid the possibility of chemical reactions.

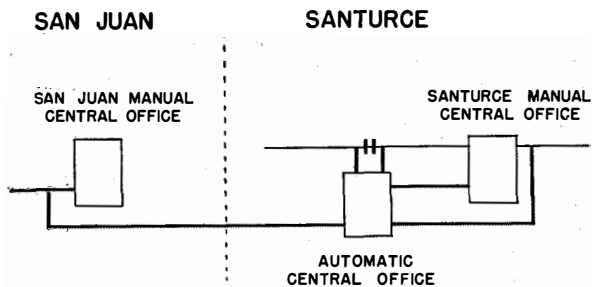

Fig. 3—Fundamental design of outside plant is shown above in schematic form. The existing plant is in light lines and the new plant in heavy.

current of the proper frequency on calls directed to party lines.

Under automatic operation 4-party-line service was discontinued and only mainline and 2-party grounded-ringer service was offered. This change was accomplished by eliminating the 4-party service in this area about 3 months before the conversion and by connecting the 2-party lines as shown in Fig. 4.

About 6,900 new telephones of the McLarn type¹ were introduced and of these 3,200 were used in party-line installations. The balance of the stations had dials added to them on the subscriber's premises or were replaced with telephones to which dials had been fitted. During the last few months before conversion, all new telephone installations, outside moves, or set changes were taken care of with dial-equipped apparatus.

In downtown San Juan about 80 percent of the inside wiring and about 85 percent of the outside wiring had to be replaced because of the new block cable distribution which in most cases required rerouting of the inside wiring.

Instruction of Subscribers

An essential part of the conversion program was the instruction of subscribers. Approximately 9,000 visits were made by a staff which during its maximum period of activity consisted of 35 persons. Arrangements were made for the instructors to obtain dial tone, ringing tone, busy tone, and non-existing line tone over any subscriber's manual telephone.

Demonstration offices were established both in San Juan and in Santurce and subscribers were invited to visit these offices to learn how to use the automatic telephone.

Lectures were given to school children. In schools not equipped with loudspeakers, portable loudspeaker systems were used. As an additional attraction, a large dial made of wood was used at the lectures for demonstration purposes. Over 16,000 children attended these lectures and demonstrations.

Directory

The telephone directory had to be completely remade, for every telephone number in the two

¹E. S. McLarn, "Simplified Subscribers' Telephone Sets," *Electrical Communication*, v. 21, p. 3; 1942.

exchanges affected by the conversion had to be changed to a 5-digit number.

The work of compiling, checking, printing, and distributing the directory had to be timed very carefully with the cutover date in order that all subscribers directly affected by the conversion, as well as those in other parts of the Island, would receive copies at precisely the appropriate moment. It would have defeated the purpose to have delivered the directory too far in advance.

Publicity

A very carefully prepared publicity program was undertaken both before and after the conversion; this included instruction pamphlets, newspaper advertisements, and radio spot announcements.

Co-ordination of the Work

For many months before the actual cutover, a Conversion Committee, with the author as Chairman, met weekly to discuss the work done during the previous week, plan the work for the next week, and co-ordinate the various activities. Each department was represented by its head who would supply all information required for an understanding of the various problems. A Co-ordinator was appointed and all matters were cleared through him.

The Co-ordinator organized a special division responsible for the issuance of "Conversion Orders." These orders stated the work to be done in each subscriber's installation. They were made in quadruplicate in order that the departments affected would be kept informed of the progress of the work.

A history or master card was kept by the Co-ordinator for each subscriber's installation and provided accurate and ready information on the details of the work done and that to be accomplished.

A conversion program was prepared well in advance of the actual cutover date and correlated all the testing work required as well as the duties of every person and department involved in the actual cutover.

Special instructions were issued to each supervisor on the night of the cutover and such important details as the possibility of having to delay the actual cutover by a few minutes, if

necessary, in the event of some emergency in the city, such as a fire, were taken into consideration. Time tables were prepared and included the scheduled time for each operation. Since at the time that the conversion program was prepared the exact day and hour of the cutover were unknown, the terms "D-day" and "H-hour" were used with very good results.

Rehearsals were held to perfect actual procedures. The cutover of a telephone network is a striking example of the necessity for strict discipline and perfect co-ordination; the failure of one cog in the organization at the critical hour could very easily disrupt the careful planning of many months.

Actual Cutover Operations

The actual cutover took 4 minutes and consisted fundamentally of pulling out the heat coils at the main distribution frames of the old manual exchanges in San Juan and Santurce; and the pulling out of dummy plugs in the new main distribution frame.

On the horizontal side of the new frame, each line is provided with 2 small jacks normally used for testing purposes. Until cutover time, each line in the automatic exchange was opened towards the street by the insertion of two dummy plugs in these jacks. These pairs of dummy plugs were mechanically coupled by

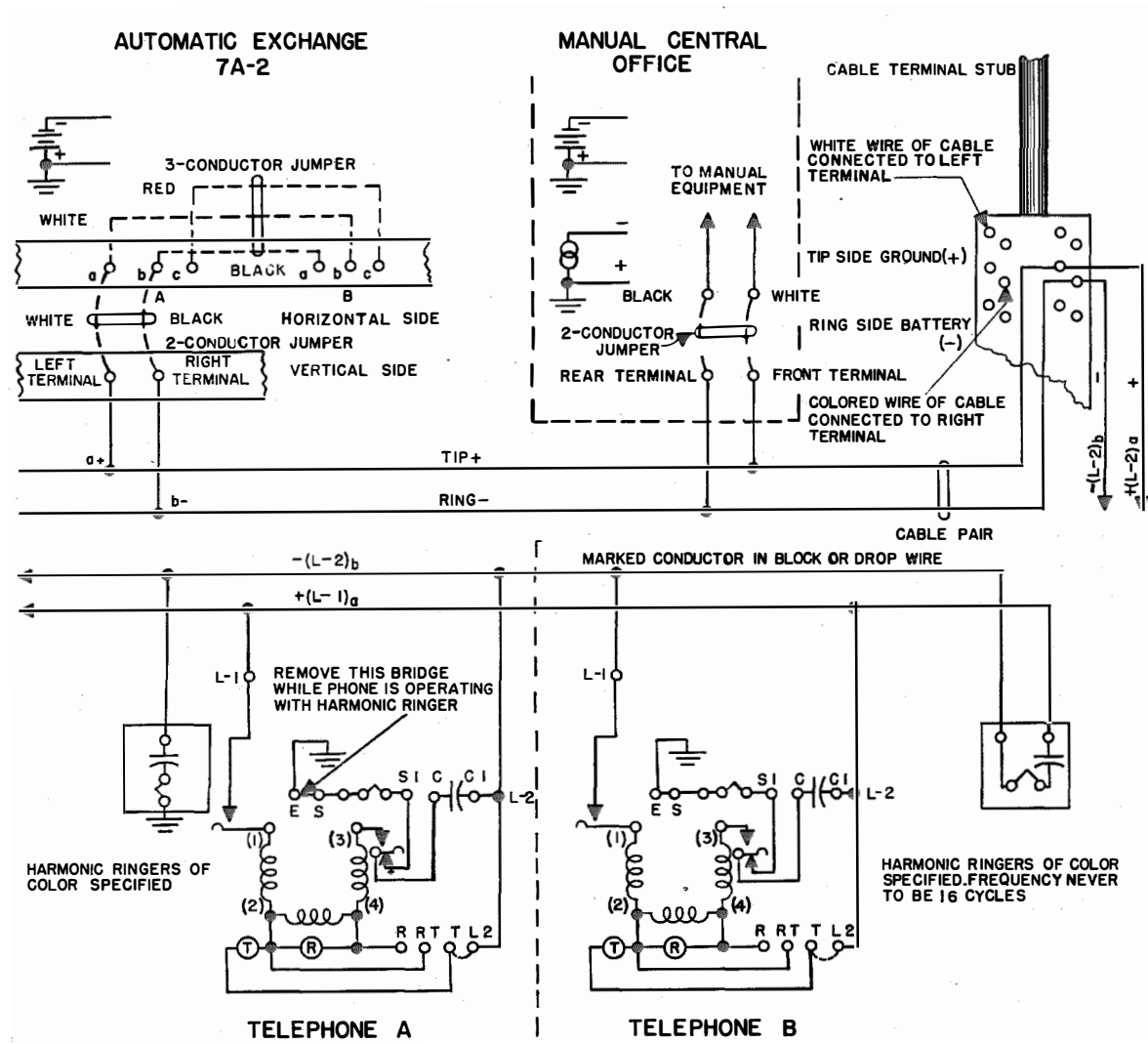

Fig. 4—Mainline and 2-party service is provided in the new automatic system by using the wiring arrangement shown above.

passing nails through very small holes in them. Marlines were placed behind the nails and between the 2 dummy plugs so that when the marlines were pulled both dummy plugs came out with them. Service re-establishments and suspensions required at the time of cutover were readily established by the insertion or removal of individual nails without the necessity of re-stringing the marlines. In this fashion the pulling out of the dummy plugs was accomplished in record time.

Public Reaction

Early Sunday-morning traffic in the old San Juan and Santurce manual exchanges was usually extremely light; however on the Sunday morning of the conversion, traffic was comparatively heavy for the rest of the night. By 7:00 A.M. traffic was heavy and by 8:30 A.M. the exchange was carrying a very heavy traffic load for a Sunday. The next day being a business day, traffic was extremely heavy principally as a

result of curiosity traffic; the delay in obtaining dial tone was very high. Heavy traffic persisted for more than 2 weeks at which time it began to subside and come closer to normal. During that period the San Juan telephone users showed considerable forbearance.

Immediately after the cutover it was necessary to man the registers to help people with their calls. Two of the most common difficulties encountered were incomplete dialing of the 5 digits of the new numbers and delay in dialing after obtaining dial tone. In a number of instances, subscribers who were holding registers for an unnecessarily long time quite frankly said they were waiting for the operator to answer. Occurrences such as these are to be expected even with the greatest precautions especially when, as in our case, this was the first automatic installation in Puerto Rico.

The successful completion of this complex war-time undertaking is the result of the co-operation of all those who have taken part in it, including various I. T. & T. associate companies.

Oven for Airborne Piezoelectric Crystals

By STANLEY EATON

Federal Telephone & Radio Corporation, Newark, N. J.

EXTREME temperatures are encountered in the operation of military aircraft, and present a serious problem in maintaining constant the frequency of the piezoelectric crystals in the radio receivers and transmitters used for intercommunication among the airplanes and for contact with the ground stations.

Over a range of ambient temperature from -40 to $+70$ degrees centigrade, the frequency variation of the crystals should not exceed 0.001 percent, which at 5 megacycles amounts to 50 cycles. A tolerance of about half this may be obtained by using a BT-cut quartz crystal in a new oven, 102-A, manufactured by Federal Telephone and Radio Corporation. This oven will maintain the crystal at a temperature of 75 ± 1 degree centigrade over the ambient range indicated. The variation at the crystal for a constant ambient temperature will not exceed 0.3 degree centigrade.

The oven will hold up to 3 plated-type or 2 pressure-mounted crystals. As shown in Fig. 1, the crystals are mounted in a bakelite chamber A which is surrounded by a casing C of heat-conductive

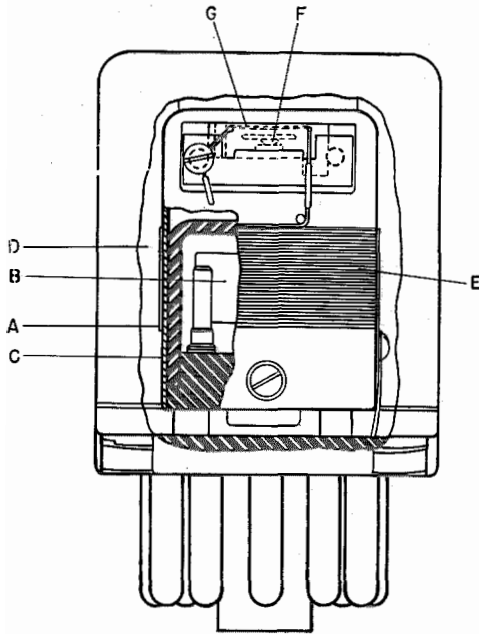

Fig. 1.

heat pulses ranging from 1 second on and 10 off to 10 seconds on and 1 off. This gives rapid response either for a rising or falling ambient temperature. Starting at -40 degrees centigrade, only 5 to 8 minutes are required to reach frequency stability.

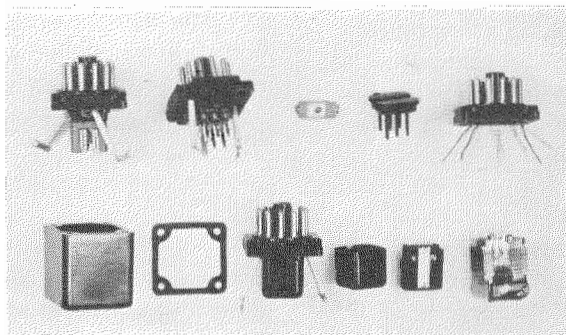

Fig. 2.

material. The temperature of the air in the space D is determined by heater E under control of the bimetallic thermostat F. The unit is $1\frac{3}{8}$ inches square and $2\frac{1}{8}$ inches high, including the standard 11-pin base on which it is mounted. The disassembled parts are shown in Fig. 2.

An important feature is the "trigger" wire G connected in series with the heater and placed close to the thermostat. It causes the thermostat to open early and counteracts "overshooting." The thermostat operates intermittently, producing

The heater is designed to operate on 24 volts, either alternating or direct current. It will operate at lower voltages if the temperature conditions do not require continuous operation of the heater. The power consumption varies approximately from 1 watt at 6 volts to 14 watts at 24 volts.

Evaluation of Night Errors in Aircraft Direction Finding, 150-1500 Kilocycles*

By H. BUSIGNIES

Director, Federal Telecommunication Laboratories, Inc., New York, New York

Summary

THIS paper describes a method enabling pilots to determine the accuracy of night bearings obtained by radio compass in the frequency range of 150–1500 kilocycles per second (200–2000 meters) and the effects when the plane passes through the combination of fields resulting from reflections from the *E* layer or a mountainside. Elementary discussion is presented on the case of the night error on the ground and in altitude, considering the simultaneous presence of (a) the direct wave, (b) the sky wave, and (c) the sky wave reflected from the ground. The night error is smaller at an altitude than on the ground; also there are certain altitudes at which the night error is reduced.

The dynamic aspect of the night error is then studied for a plane moving through the above-mentioned system of waves. How the radio-compass indication changes regularly about a mean value, whether correct or not, is next discussed. All cases of polarization are examined in an elementary manner in an effort to classify the numerous effects with which an experimenter may be confronted.

In conclusion, a number of rules are formulated relative to night direction finding on board airplanes above land or sea, supplemented by maps showing areas where direction finding is safe, unsafe, or dangerous. The maps show that the practical range of night direction finding is increased substantially by the correct interpretation of the radio-compass indications.

1. Introduction

No aircraft direction finder now available is free from night error, and the danger of false bearings is well-recognized particularly in night flying. Knowledge of the degree of accuracy of

night bearings obviously will permit their greater use and thus will enhance safety.

During experimental flights made with the co-operation of the airlines in the United States in 1937, direction finding in mountainous regions was studied. The Rocky Mountains were crossed several times in the laboratory airplane of the United Air Lines, the "Flight Research Plane," equipped with all necessary instruments.¹ This region, from the viewpoint of flying, radio communications, and direction finding, presents substantially the worst conditions that can be encountered simultaneously anywhere.

Observations included several important and dangerous effects, resulting from the simultaneous reception of two or more waves originating from the same transmitter, one directly and the other reflected by the mountain surfaces. The plane, consequently, passed rapidly through a system of stationary waves resulting in rapid variations of indication of direction given by the radio compass. This aspect of the study will be reverted to later.

During these experiments, a definite parallel was established between the case of the mountain error and that of the night error: the first is due to the reflection of waves at the mountain surfaces; the second, to the reflection of waves at the ionosphere. Regular variations of the indication of direction due to the night effect have been ascertained, as follows:¹

Night flight from Salt Lake City to Cheyenne

This flight confirms the variations noted on the way to Salt Lake City. After the difficult passage, good bearings are obtained on Rock Springs, Cheyenne, Walcoot, and on several broadcasting stations where the night effect is shown by variations of ± 5 degrees

The basic differences between the mountain effect and the night effect lie in the direction of

* Presented at the Summer Convention of the Institute of Radio Engineers, Detroit, Michigan, June 23, 1941, and at the New York meeting of the Institute on February 4, 1942. Publication delayed by wartime restrictions.

¹ H. Busignies, "Mountain Effects and the Use of Radio Compasses and Radio Beacons for Piloting Aircraft," *Electrical Communication*, v 19, n 3, pp 44-70; presented Institute of Radio Engineers Pacific Coast Convention, San Francisco, California, June 27, 1939.

propagation of the reflected waves and in the fact that the sky waves are reflected by the ground.

In this paper, only medium waves 150–1500 kilocycles per second (200–2000 meters) are considered. The radio compass used was of the spinning-loop type. No sense antenna was in use during the automatic operation which resulted in an ambiguity of 180 degrees, and also in an indication related only to the plane wave and the stationary magnetic fields exclusive of the stationary electric fields. The conclusions reached apply also to the case of radio compasses involving in their normal operation the use of a sense antenna, as long as the standing-wave ratio in space is smaller than about 1.5. Above this value the proper operation of the radio compass involving a sense antenna begins to be affected by the relative amplitude and phase changes between the electric and magnetic standing waves. These errors, due to operational conditions, are larger and do not follow the laws indicated hereinafter.

The study of these errors is simple, but involves the particular design of the radio compass. This is not part of the present paper which is limited to the loop used alone.

2. Night Errors in Loop Direction Finding, Observed on the Ground and in Altitude—Static Aspect of the Error

2.1 PHYSICAL ASPECT AND ORIGIN OF THE NIGHT ERROR

The night error in a loop direction finder is characterized by a more or less gradual variation of the zero indication, and/or by a transition from the usual sharp zero indication to a blurred minimum.

From experimental data, it seems reasonable to conclude that the night error for medium waves is due to a considerable decrease in the ionic density of the ionospheric layer, the reflections causing several waves to reach the direction finder simultaneously. During the day, the E layer has high ionic density and absorbs these waves while at night, when the ionic density of the layer is lower, much less absorption and more reflection occurs. The case of simultaneous reception of the direct and the reflected wave will be examined. The reception of two reflected

waves seems improbable at the distances generally considered in this study. It occurs frequently at greater distances.

The sky waves reach the direction finder at variable elevation angles, probably between 10 and 75 degrees in the cases that we consider, depending on the height of the ionosphere and the distance.

Night error appears about an hour before sunset and disappears an hour before sunrise.

The transmitting antenna constitutes a most important factor as it can facilitate either zenith radiation toward the ionosphere or horizontal radiation. With an ordinary transmitting antenna, not especially designed to improve the error-free range, the error appears on the earth at distances varying from 45 to 250 kilometers (28 to 155 miles); with antennas minimizing zenith radiation (vertical or antifading type), it is possible to increase these distances appreciably.

Over water, because of horizontal surfaces and higher conductivity, the direct wave is attenuated much less rapidly. The error-free range is thus much greater than over land and reaches 400 kilometers (249 miles) for the longer waves under consideration.

The direct wave, which is the only one present during the day, is polarized vertically on soil of normal conductivity (arable land, for instance), and on the sea, as indicated in Fig. 1.

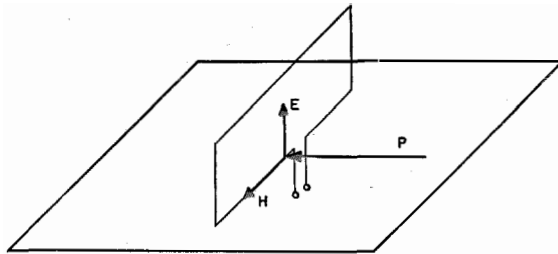

Fig. 1—Vertically polarized direct wave such as is received during the day over soil of normal conductivity and over sea. P = direction of propagation, E = electric field, and H = magnetic field. The magnetic field is parallel to the plane of the loop and, therefore, does not induce any electromotive force in it (null point).

Values commonly adopted for conductivity follow:

Medium	Conductivity in cgs Units
Sea water	1 to 4×10^{-11}
Land (medium conductivity)	10^{-13}
Land (low conductivity)	10^{-15}

At night, the reflected waves appear; their trajectory P is inclined to the horizontal at an angle γ ; their polarization is variable, elliptical, and often horizontal (Fig. 2). The inclined magnetic field H of the reflected wave possesses a parasitic horizontal component which crosses the loop when, under the conditions of Fig. 2, the loop is at zero position for the direct wave.

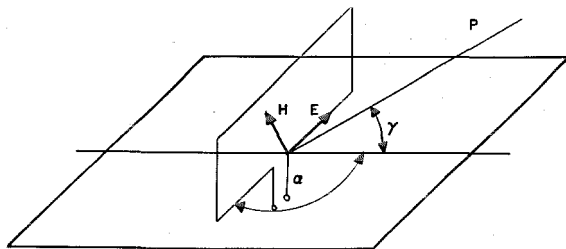

Fig. 2—Reflected wave such as is received at night. P , H , and E are mutually perpendicular. The magnetic field H induces a parasitic electromotive force in the loop. The null point is not at $\alpha = 90$ degrees and error results.

This horizontal component, inducing a parasitic electromotive force, causes the error. In other words, the electric field E , entirely horizontal, results in parasitic reception in the loop. If the polarization becomes progressively vertical, the error produced decreases and becomes zero for vertical polarization. This would be sufficient to explain the night error, provided the earth be neglected. For simplification, the case where the electric vector and direction of propagation are contained in the same vertical plane is called vertical polarization except when the direction of propagation is vertical.

On the basis of this phenomenon, most authors explain the night error by the presence of the horizontal component of the electric field, or the vertical component of the magnetic field.

2.2 POLARIZATION MEASUREMENTS

The existence of an important electric horizontal component near ground of medium conductivity, as well as that of a vertical component of the magnetic field seemed very doubtful. In the belief that these phenomena should be studied more thoroughly, a receiver was developed some years ago for polarization measurement. It utilizes a loop (magnetic field) or a

dipole (electric field) and covers the range of 150–1000 kilocycles (300–2000 meters).

During the day, the vertical polarization of the direct waves is proved by the complete extinction of the signal when the dipole or the loop is placed horizontally. At night, the experiments confirmed the expectations. The results are exactly the same as during the day, even in the presence of errors reaching 20 to 40 degrees while the loop is vertical; a drastic reduction of the received signal is observed (40 to 60 decibels) when the loop or the antenna is placed horizontally.

Thus the conclusion was reached that on ground of medium conductivity, neither an appreciable horizontal component of the electric field, nor an appreciable vertical component of the magnetic field exists in the case of waves following a path inclined to the horizontal, regardless of polarization.

2.3 POLARIZATION OF SKY WAVES

As in the case of reflections from bodies having semiconducting properties without definite boundaries, the wave reflected by the ionosphere has not the same polarization as before reflection. Generally the sky wave is polarized elliptically, but frequently has a large horizontal electric component which renders the polarization almost horizontal. In spite of the extensive literature concerning the theory of ionospheric reflections, there seems to have been no systematic measurements of the polarization of sky waves on the wavelengths under consideration. An attempt will be made to estimate what occurs in the general case of elliptical polarization. In connection with this, it will be pointed out that a wave elliptically polarized can be resolved into two waves of the same direction of propagation, one vertically and the other horizontally polarized, with a given difference of phase between the vectors of the two waves (one wave delayed with respect to the other).

2.4 INCIDENCE OF SKY WAVES

As the E layer is located between 80 and 110 kilometers above the ground, the following approximate angles of elevation occur for the incoming waves.

TABLE II

Distance in Kilometers	γ in Degrees
50	75
100	63
200	45
300	33
400	25
500	19
600	15
700	10

2.5 REFLECTION OF WAVES ON A SEMICONDUCTING SURFACE

The absence of vertical magnetic and horizontal electric components cannot be fully explained by the presence of the reflected plane wave alone. Fig. 3 represents the values of reflection coefficients on the sea for vertical and horizontal polarization.² For the angles of elevation that we generally consider for the sky waves, there must be a difference of 10 to 30 percent between the incident and reflected energy, and therefore very noticeable horizontal electric or vertical magnetic components should appear. Experiments prove the contrary. It is not the purpose of this paper to discuss this in detail. However, to avoid errors of interpretation in the following, the very complex phenomenon of wave reflection from a semiconducting medium should be pointed out roughly.

A plane wave coming down from air to an unlimited surface of such a medium will give rise at the surface of this medium to currents which in turn create:

- a reflected plane wave,
- a plane wave transmitted into the medium which results in conduction currents inside the medium,
- conduction currents can create observable induction fields under certain conditions.

Therefore, close to the boundary, the reflected wave mixed with the induction field has not the aspect of a plane wave. Inside the medium, the transmitted wave is not plane, as it is attenuated at the same time as the conduction currents.

The reflected energy is that of the incident wave less the energy dissipated by the transmitted wave in the medium. The amplitude and

phase of all these waves and fields vary with the incidence and the polarization, which give to this phenomenon its maximum of mathematical complexity.

The amplitude and phase of all these components are such that the horizontal electric or vertical magnetic field vanish at the surface of the medium, provided that the conductivity attains a sufficient value for a given frequency.

Some experiments showing the existence of these components seem opposed to this conclusion. It is possible that these components were present because the medium (the earth) was not homogeneous but increasingly conductive in depth, a further complication. Roughly, the results observed are the same as if the experiments were made at a certain level above the earth.

In altitude the field observed is very complex in the presence of:

- the direct wave,
- the sky wave (elliptically polarized),
- the sky wave reflected by the ground (differently elliptically polarized),

In spite of a desire to be complete, the simplest cases will be considered with the assumption of an infinite conductivity of the earth, but it will be indicated to what extent the physical effect differs from the cases described. An attempt will be made to show what kind of physical effects occur in the most complex cases.

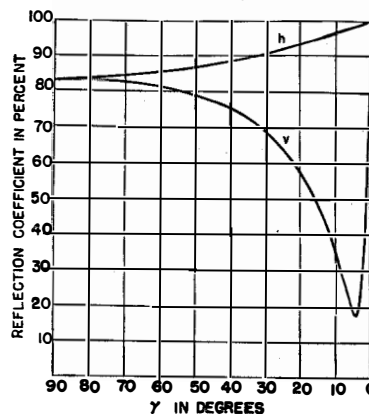

Fig. 3—Reflection coefficient plotted against the angle of incidence of the wave on the surface of the sea. Curves *h* and *v* are for horizontal and vertical polarization, respectively.

² J. A. Stratton, "Electromagnetic Theory," McGraw-Hill Book Company, 1941.

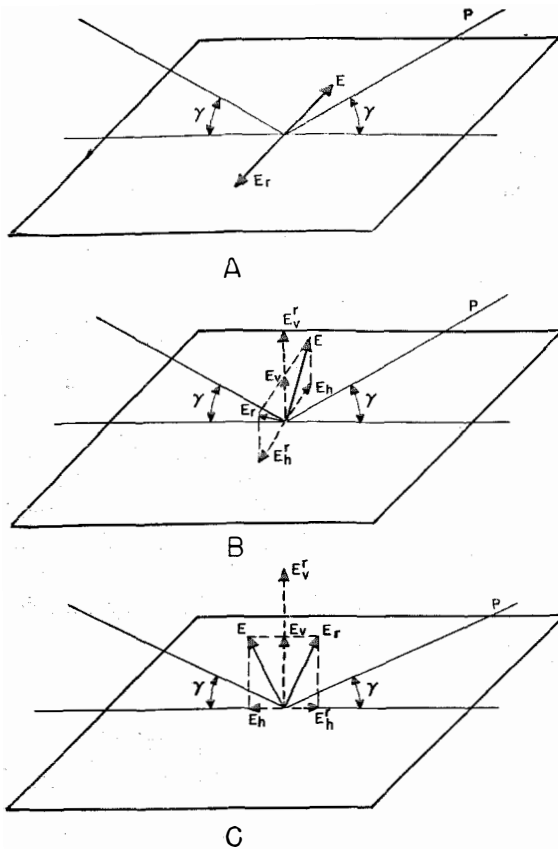

Fig. 4—Effects on the electric field of reflections from ground of good conductivity. A is for horizontal polarization: The reflected wave E_h is opposed to E and they cancel. B is for intermediate polarization in which the reflected horizontal component E_{rh} is opposed to the horizontal component E_h and they cancel. The vertical component is doubled. In C, vertical polarization, the reflected horizontal component E_{rh} is opposed to the horizontal component E_h and they cancel. The vertical component is doubled.

2.6 ELECTRIC FIELD NEAR THE GROUND

The explanation is indicated in Fig. 4 for the electric field. Ground of good conductivity reflects the incident wave; near the ground, the reflected horizontal component, 180 degrees out of phase, cancels the incoming horizontal component. The figure depicts the three elementary cases involved in polarization. In horizontal polarization, no vertical electric component appears. For intermediate or vertical polarization, a vertical electric component is present.

If the polarization is elliptical, the electric vector rotates in a plane perpendicular to the direction of propagation. The vertical component of this vector appears alone as for intermediate

polarization. This is very close to the physical case on moist soil or on the sea.

2.7 MAGNETIC FIELD NEAR THE GROUND

Fig. 5 illustrates the phenomena pertaining to the magnetic field. The reflected vertical component and the incoming vertical component are in opposition.

If the polarization is elliptical, the magnetic vector rotates in a plane perpendicular to the direction of propagation. The horizontal component of this vector appears alone as for intermediate polarization, but it rotates elliptically in the horizontal plane (see Fig. 6). This is very close to the physical case on moist soil or on the sea.

For all polarizations, there exists a horizontal component of the magnetic field which creates the error inasmuch as this component is:

- a. perpendicular to the magnetic field of the direct wave in the case of horizontal polarization,
 - b. neither perpendicular nor parallel to the magnetic field of the direct wave in case of intermediate polarization,
 - c. rotating in the horizontal plane in case of elliptical polarization,
 - d. in the same direction as the magnetic field of the direct wave in vertical polarization.
- No error could result in this case.

2.8 THE NIGHT ERROR IN A RECEIVING LOOP NEAR THE GROUND

In the simplified case of a largely horizontally polarized sky wave (Fig. 2) in phase with a direct wave, the night error in a loop located near the ground will occur as follows:

- Let A = amplitude of the direct field,
- a = amplitude of the indirect field,
- γ = elevation,
- α = angle made by the plane of the loop with the line joining it to the transmitter.

The electromotive force induced in the loop will be:

$$E = A \cos \alpha \dots \quad (\text{direct wave}) \quad (1)$$

$$E = a \sin \alpha \sin \gamma \dots \quad (\text{indirect wave}) \quad (2)$$

For $E=0$ (extinction of signal at the false position)

$$\tan \alpha = \frac{A}{a \sin \gamma}, \tag{3}$$

and the error is:

$$\epsilon = 90^\circ - \alpha. \tag{4}$$

Taking as an example:

$$\frac{A}{a} = 2, \text{ and } \gamma = 30 \text{ degrees,}$$

it follows that:

$$\alpha = -76 \text{ degrees and } \epsilon = 14 \text{ degrees.}$$

If, as is generally the case, the sky wave is not in phase with the direct wave, a sharp minimum

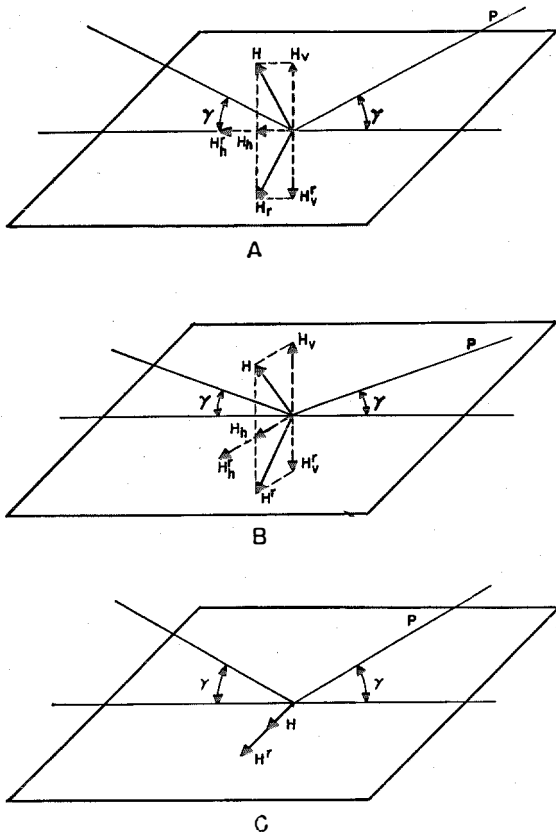

Fig. 5—Effect on the magnetic field of reflections from ground of good conductivity. A is for horizontal (electric field) polarization in which the vertical magnetic components cancel and the horizontal components add. The resulting magnetic field $H_h + H_h'$ is in the direction of the transmitter and 90 degrees from the normal position. B is for intermediate polarization in which the vertical components cancel and the horizontal components add giving an erroneous resulting magnetic field $H_h + H_h'$. In C, vertical polarization, the magnetic fields H and H_r add.

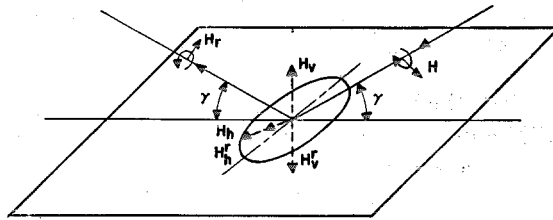

Fig. 6—General case of the reflection of a horizontally polarized sky wave on a conducting surface. H is the magnetic vector of an elliptically polarized sky wave in which the vertical components H_v and H_v' cancel. The horizontal components H_h and H_h' add and rotate in the horizontal plane.

is no longer obtained, but rather a blurred minimum because of the presence of a rotating field. This case was studied in connection with the mountain effect and will be discussed hereinafter. If the sky wave is elliptically polarized, a blurred minimum will evidently also be observed.

2.9 ASPECT OF THE FIELDS IN ALTITUDE

Turning from ground phenomena to consideration of those encountered at greater elevation, the pertinent components of the incident and ground-reflected waves are no longer in phase opposition. It is evident, therefore, that the horizontal electric and vertical magnetic components must appear. Their presence was noted by elevating the receiver 13 meters above the ground for polarization measurements; this, for a wave of 800 meters, represents a phase difference of the order of 5 degrees at an incidence of 30 degrees. In this case, the amplitude of horizontal electric and vertical magnetic components is equal to about 8 percent of the amplitude of the electric and magnetic vectors of the sky wave.

At a certain altitude and for a given wavelength, these two components pass through a maximum corresponding to a horizontal plane S_1 on which the fields are in phase; higher up, as on the ground, they pass through a minimum value, corresponding to a horizontal plane C on which the said components are in phase opposition, and so on. Between these horizontal planes, there are rotating fields.

In the following analysis, the earth is first considered as a perfect conductor. Some cases which approximate this analysis closely will be pointed out.

2.10 ALTITUDES OF THE PLANES $S_1, S_2, \text{ ETC.},$
AND $C, C_1, \text{ ETC.}$

First, the height of the first horizontal plane S_1 will be determined. Here the phenomena are the same as on the ground (classic interference fringes).

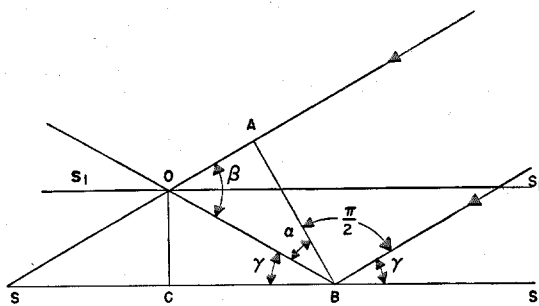

Fig. 7—Development of height of first horizontal plane S_1 .

It is apparent from Fig. 7 that, for an elevation γ , a wave front AB , and ground S , the difference in path traversed by the direct and the reflected waves equals $OB - OA$. Taking into account the 180-degree change of phase occurring on reflection, there is a horizontal plane S_1 on which the horizontal electric and vertical magnetic components cancel when $OB - OA = \lambda$ or $n\lambda$. Thus

$$OB \cos \beta = \lambda \tag{5}$$

and

$$\beta = 2\gamma \tag{6}$$

whence

$$OB = \frac{\lambda}{1 - \cos 2\gamma} \tag{7}$$

and

$$OC = \frac{\lambda \sin \gamma}{1 - \cos 2\gamma} \tag{8}$$

OC is the altitude of the first plane S_1 ; the other planes $S_2, S_3, \text{ etc.},$ are at altitudes 2, 3, and n times greater.

The planes $C, C_1, C_2, \text{ etc.},$ on which components under consideration are in phase, are obtained by substituting $\lambda/2$ for λ .

The table below indicates the altitude of S_1

and C in wavelength as a function of the angle of elevation.

TABLE III

Elevation in Degrees	Altitude of S_1 in λ	Altitude of C in λ
10	2.9	1.45
20	1.46	0.73
30	1	0.5
40	0.78	0.39
45	0.707	0.35
50	0.655	0.33
60	0.578	0.29
70	0.533	0.266
80	0.508	0.254
90	0.5	0.25

2.11 LOOP DIRECTION-FINDING ERRORS ON THE PLANES $S_1, S_2, S_3, \text{ ETC.}$

The direction-finding errors on the ground and on the planes $S_1, S_2, S_3, \text{ etc.},$ are the same as disclosed in Section 2.7. An elliptically polarized sky wave results in a false blurred minimum.

2.12 LOOP DIRECTION-FINDING ERRORS ON THE PLANES $C, C_1, C_2, \text{ ETC.}$

A horizontal component of the magnetic field is no longer present. This is shown in Fig. 8, which illustrates the general case of polarization. Only one vertical component of the magnetic field exists; it does not induce any electromotive force in a truly vertical loop. Thus little or no error occurs. No vertical component of the electric field is present. There is a horizontal electric component but it has no effect on the loop. The same effect occurs with an elliptically polarized sky wave. The resultant rotating magnetic vectors of the sky wave and the sky wave

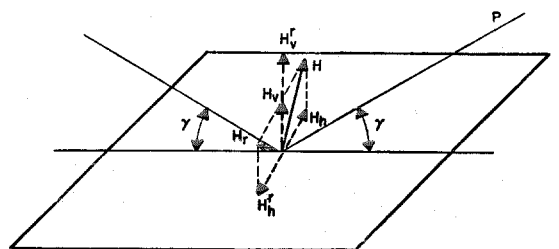

Fig. 8—In the planes C_1, C_2, C_3 for all cases of polarization, the horizontal magnetic components cancel and the vertical magnetic components add. For vertical polarization, the magnetic field is zero.

reflected on the ground rotate in opposite directions, add on the vertical and vanish on the horizontal.

2.13 LOOP DIRECTION-FINDING ERRORS BETWEEN THE PLANES S , S_1 , S_2 , ETC., AND C , C_1 , C_2 , ETC.

Let us examine the effect of the rotating field which occurs between the planes S and C , the direct wave being initially neglected.

The vectors of the sky and reflected fields are unchanged in direction, but are no longer in phase. In the case of horizontal or intermediate polarization, the resultant rotates in the plane which contains the two vectors and this plane is vertical as shown in Fig. 9.

If the polarization is vertical, the resultant $H_h + H_h'$ remains horizontal without rotation in the no-error position.

A rotating vertical loop will always show a position of signal extinction, because:

- a. In intermediate or in horizontal polarization, electromotive force is no longer induced when the vertical plane of the loop is parallel to the vertical plane of rotation of the magnetic vector (see Fig. 9). Error will occur.
- b. In vertical polarization, electromotive force is no longer induced when the plane of the loop is parallel to the horizontal resultant. No error will occur.

Therefore, the combination of the field just considered with the direct field will cause an error for intermediate or horizontal polarization of the sky wave. A definite zero will appear if the electromotive force induced by the rotating field is in phase with the direct field. If not, only a minimum will be observed. Good zero and no error will appear if the sky wave is vertically polarized.

If the sky wave is elliptically polarized, the following reasoning can clear up the case. This wave will be resolved into two waves, one delayed with respect to the other; one vertically, the other horizontally polarized.

The vertically polarized wave will result in a fixed horizontal magnetic vector as seen before, which alone cannot give rise to error.

The horizontally polarized wave will result in a rotating magnetic vector contained in the same vertical plane which contains the direction of propagation.

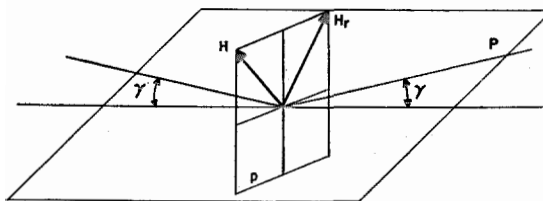

Fig. 9—Between S and C for any polarization, H and H_r are not in phase and the resulting vector rotates in the vertical plane p which contains H and H_r .

The combination of those two vectors will result in a vector rotating in a plane forming with the vertical an angle determined by their respective amplitudes, and positioned by their respective phases.

No zero can be observed in a vertical loop. The blurred minimum will be in a false position.

The combination of this effect with the direct wave will result in erroneous bearings whether blurred or clear.

2.14 PRELIMINARY CONCLUSIONS FOR HIGH-CONDUCTIVITY GROUND

To draw conclusions from the foregoing with reference to the night error in a loop on the ground and in altitude (Fig. 10), the following can be stated:

- a. On the ground and on planes S_1 , S_2 , etc., the error appears in all cases of polarization of the sky wave except in the vertical (zero error). In horizontal polarization, the error possesses the peculiarity of being symmetrical with respect to the position of the zero error as a function of the relative changes of phase between the direct wave and the sky wave. This effect also occurs with elliptical polarization of vertical or horizontal axis.
- b. On planes C , C_1 , C_2 , etc., the error is zero or minute in all cases of polarization if the loop is actually vertical even with elliptically polarized waves.

- c. Between the planes defined above, the errors except for their amplitude are similar to those indicated above in a.
- d. Since the polarization is rarely purely vertical, the error almost always occurs except on the horizontal planes C , C_1 , C_2 , etc., on which, theoretically, the error is always nil.

These preliminary conclusions are roughly valid above sea water and moist soil. The physical effect, of course, is less definite as the amplitudes of the sky wave and reflected sky waves differ by an appreciable amount as well as in their respective phases.

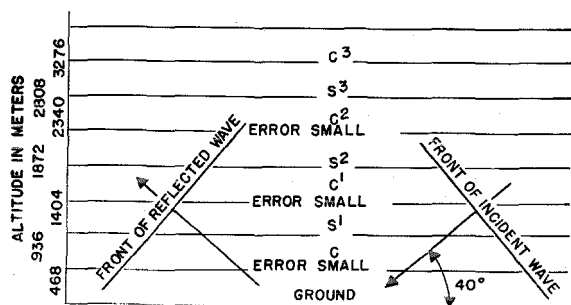

Fig. 10—Example of distribution in altitude of the planes S and C for an incoming wave of 1200 meters at an elevation angle of 40 degrees.

Considering Fig. 3, which indicates the value of reflection coefficients at the surface of the sea, it can be pointed out:

From 90 to 40 degrees, the coefficients do not differ greatly in vertical and horizontal polarization and the above conclusions can be considered as roughly valid (up to 250 kilometers (155 miles) from the transmitter).

From 40 to 0 degrees, the coefficients differ greatly in vertical and horizontal polarizations (250 to 600 kilometers (155 to 373 miles) from the transmitter), but horizontal polarization would be observed more frequently. If so, the above conclusions are still roughly valid; if not, or if the wave is elliptically polarized, a selective effect on the polarization takes place which will modify all the resulting interference. Rotating fields will appear in most of the space. The effects are much too complicated to be treated for all the cases which can

be encountered, but we are now acquainted with the physical aspect of these effects.

2.15 COMPLEMENTARY CONCLUSIONS FOR THE GENERAL CASE OF SOIL OF POOR CONDUCTIVITY

The effects attain a very complicated state in some cases.

The differences of amplitude and phase between the sky wave and the sky wave reflected by the ground increase greatly the selective effect on polarization, and the effect on the reflection of an elliptically polarized wave, in the case of an incident wave of intermediate polarization, will be very marked. The induction field caused by the earth surface currents will be noticeable.

Therefore, rotating fields will be observed in the greater part of the space. However, some simplified cases will be pointed out.

- a. The sky wave is vertically polarized. No error will occur anywhere in the space.
- b. The sky wave is horizontally polarized. The reflected sky wave will also be horizontally polarized, but planes S and C will not be well defined, because the amplitude of both waves is different and their phases changed with respect to the ideal case. The error caused by the combination of these waves with the direct wave will be symmetrical with respect to the exact bearing as a function of any change of phase of 180 degrees either in the sky wave or the direct wave.
- c. The sky wave is elliptically polarized around a principal vertical or horizontal polarization. The reflected sky wave will also be polarized elliptically around a principal vertical or horizontal polarization.

The total resultant will remain polarized around an axis contained in, or perpendicular to, the plane of incidence. The error caused by the combination of these waves with the direct wave will be symmetrical with respect to the exact bearing, as a function of any change of phase of 180 degrees either in the sky wave or the direct wave.

Final conclusions for direction finding at night will be drawn in Section 4 after consideration of the dynamic aspect of the night error.

Part of the night error may be caused by deviation of the sky wave from the vertical plane joining the direction finder and the transmitter. Errors due to this cause actually have been verified (especially on land, almost never on the sea). On medium waves, the proportion of such errors is small and their amplitude is negligible compared with errors caused by the combination of elevation and polarization effects.

3. Dynamic Aspect on Airplanes of Mountain and Night Errors

3.1 GENERAL—FIRST DEMONSTRATION OF THE DYNAMIC ASPECT OF THE ERROR

The dynamic aspect of night and mountain errors was clearly demonstrated by means of an RC5 automatic radio compass³ installed on board the "Flight Research Plane" of United Air Lines.

The receiving loop of this radio compass rotates at five revolutions per second. On its shaft, it carries a 2-phase 10-cycle generator, giving a fixed phase reference. The current at the output of the receiver, as a result of the rotation of the loop, contains an important component of 10-cycle alternating current, the phase of which varies with the direction of the station. A magnetic indicating apparatus measures the phase of this current in relation to that of the 2-phase generator. Indications are obtained with an ambiguity of 180 degrees. The inertia of the indicator is low and its damping adequate, so that variations of course or of wave path are noted on the indicator almost instantaneously, while the amplitude of the variations do not exceed 10 or 20 degrees.

With these characteristics, the automatic radio compass constitutes a device for noting, much more readily than with the ordinary direction-finding loop, variations which may affect the bearings. Prior to 1937, the American air trans-

portation companies used ordinary direction finders exclusively. Thus pilots never had the opportunity of observing the peculiar variations in readings prevalent in mountainous regions.

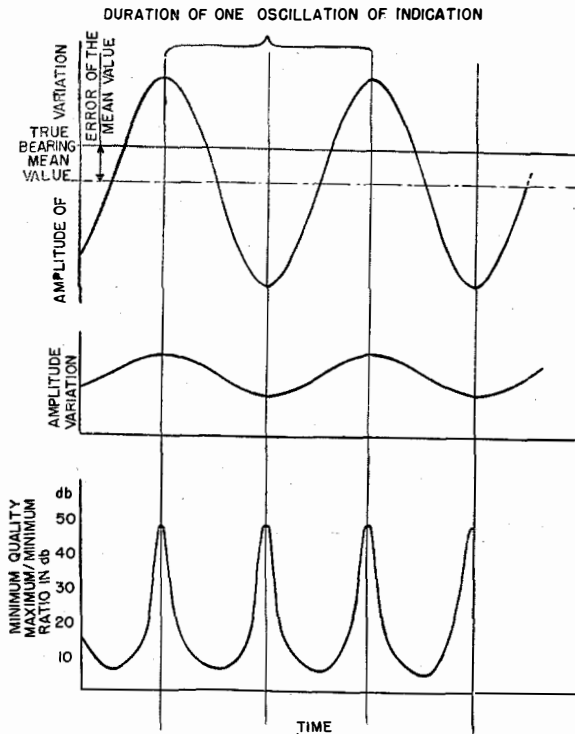

Fig. 11—Relative positions of bearing, amplitude, and direction-finding-minimum variations.

In the first experiments, the observed station was the radio beacon of the landing field toward which the airplane was flying. When reflections from mountains occur, bearing indications vary regularly several degrees about an average position. The true bearing was thus 0 degrees for the correct position of the plane. The actual variations noted, which reached ± 20 degrees at intervals, occurred around a position of average error, generally of the order of a half or a third of the amplitude of variation. The variations of bearings were accompanied by synchronous variations of amplitude. Alternatively, moreover, definite zeros or blurred minima were noted during the rotation of the loop.

The above observations were made in 1937 between Cheyenne and Salt Lake City. Similar observations were made in Switzerland, in 1938

³H. Busignies, "The Automatic Radio Compass and its Applications to Aerial Navigation," *Electrical Communication*, v 15, n 2, October, 1935; and "Principle and Theory of a New Realization of Aircraft Automatic Radio Compass," *L'onde Electrique*, v 16, n 18, January, 1937.

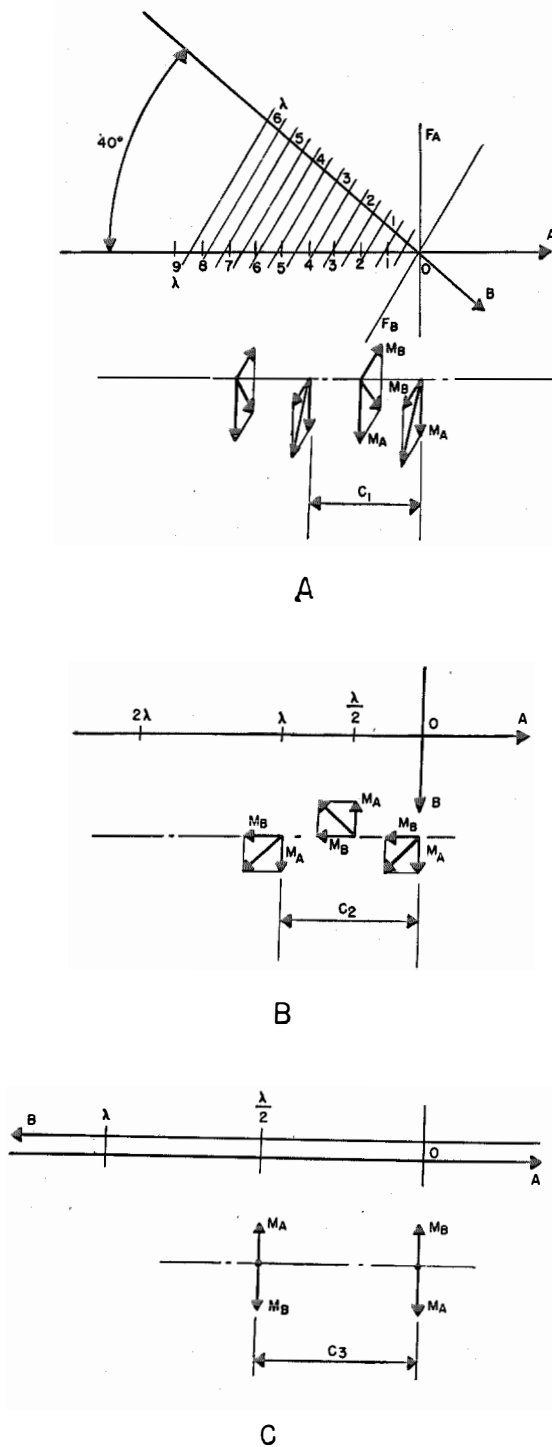

Fig. 12—Successive direction and amplitude of magnetic vector in the direction of flight for two vertically polarized waves.

F_A = wave front in direction A,
 F_B = wave front in direction B,
 A = amplitude of wave A,
 B = amplitude of wave B,

flying over the Jura on the bearings of the Beromunster transmitter. Many similar observations were made since that time under conditions of night effect.

Fig. 11 shows the relation between the variations of bearing, the amplitude of the signal, and the quality of the minimum.

3.2 SUCCESSIVE DIRECTIONS AND AMPLITUDES OF THE RESULTING MAGNETIC FIELD IN SPACE

In general, wherever two or more waves originating from a single source and following different paths are present in space, the envelope of vector amplitudes represents a stationary wave in space. Its amplitude is limited to that of the lowest-amplitude wave, and its form depends essentially on the wave directions and their polarizations.

By way of example, Fig. 12 shows the successive direction and amplitude of the magnetic vector on a given fixed direction, that of flight, in the case of two vertically polarized wave propagations forming angles of 40, 90, and 180 degrees, respectively.

All the configurations corresponding to any particular polarization can readily be traced by compounding independently, at each chosen point in space, the magnetic and electric vectors of the constituent waves. If the amplitude of a given wave is clearly greater than the amplitude of another wave or waves, the dephasing of the resulting vectors and their variations in amplitude will obviously be greatly decreased. It is likewise easy to trace the configurations corresponding to the presence of several waves of different polarizations at a fixed point.

The novelty of the case under examination arises from the fact that the airplane cuts through the zone of interference rapidly and the indication of direction obtained with a loop receiver, for example, varies constantly since the resulting magnetic field changes direction regularly (Fig. 13). The variations noted will be slow

M_A = magnetic vector of A,
 M_B = magnetic vector of B, and

C_1, C_2, C_3 = length of oscillation cycle of bearing indication. In A, $A/B=2$ and the difference in propagation angles = 40 degrees. In B, $A=B$ and the angle = 90 degrees. C, $A=B$ but is opposing (angle = 180 degrees).

or rapid according to the direction in which the airplane flies in relation to the system of interference.

3.3 LENGTH OF ONE COMPLETE CYCLE OF CHANGE IN INDICATION

In the case of greatest interest here, the airplane flies toward the transmitter or toward the radio beacon, and it then cuts through an interference pattern which produces a regular swing in the indication, accompanied by a fixed deviation from the mean value.

In Fig. 12, more specifically referring to mountain effect, if the distance is studied in wavelengths calculated in the direction A, for which the vectors of the two waves are encountered with identical phase, corresponding to a complete cycle of the bearing oscillation, a number *n* may be found as follows:

$$n = \frac{1}{\frac{1}{\cos \gamma} - 1} + 1. \tag{9}$$

For Fig. 12A, *n* = 4.23.

If the airplane speed is 240 kilometers (149 miles) per hour, the following durations will be obtained for a single cycle:

TABLE IV

Frequency in Kilocycles	Wavelength (λ) in Meters	Length of Cycle in Space (Meters)	Duration of Cycle in Seconds
150	2,000	8,460	127
300	1,000	4,230	63.5
3,000	100	423	6.3
30,000	10	42.3	0.6
300,000	1	4.2	0.06

In Fig. 12B, where the propagation directions form an angle of 90 degrees, *n* = 1, and accordingly there is obtained for the same plane speed:

TABLE V

Frequency in Kilocycles	Wavelength (λ) in Meters	Length of Cycle in Space (Meters)	Duration of Cycle in Seconds
150	2,000	2,000	30
300	1,000	1,000	15
3,000	100	100	1.5
30,000	10	10	0.15
300,000	1	1	0.015

In Fig. 12C, where the propagation directions are opposed and the speed is the same, *n* = 0.5, no further oscillations in the bearings are to be noted. Considerable variations, however, occur

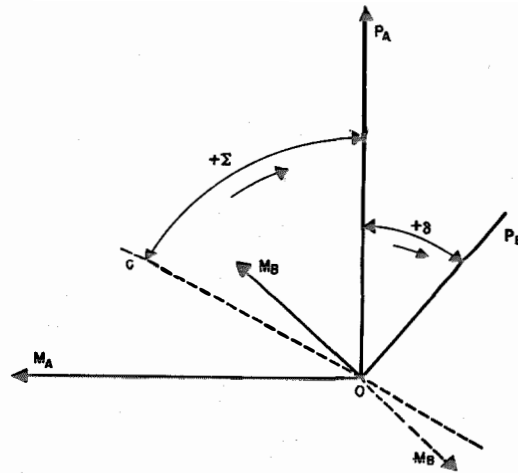

A

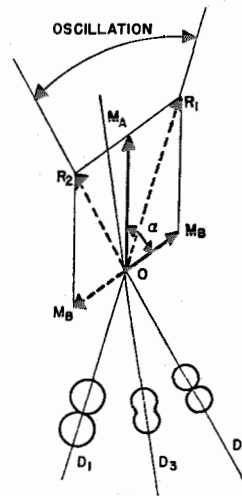

B

Fig. 13—Cycle of oscillation of bearing indications. A gives the wave patterns in which *P_A* and *P_B* are the directions of wave propagation, and *M_A* and *M_B*, the magnetic vectors of the waves A and B, respectively. *O_c* is the plane of the loop. *A/B* = 2 and *S* = 40 degrees. For the same values of *A*, *B*, and *S*, and for an amplitude of oscillation of bearing indications of 180 degrees (variation from 0 to 180 degrees), the limiting resultants, *R₁* and *R₂*, of the magnetic vectors are shown. The reception diagrams *D₁* and *D₂*, corresponding to vectors *R₁* and *R₂*, respectively, have good null points. *D₃* is for a mean position and has a very bad direction-finding minimum because of the presence of a component in phase quadrature.

in signal strength at the rate indicated in the following table:

TABLE VI

Frequency in Kilocycles	Wavelength (λ) in Meters	Length of Cycle in Space (Meters)	Duration of Cycle in Seconds
150	2,000	—	—
300	1,000	500	7.5
3,000	100	50	0.75
30,000	10	5	0.075
300,000	1	0.5	0.0075*

* Equivalent to 135.5 cycles per second.

In the case of mountain effect caused by irregular reflections, the amplitude and duration of oscillation, as a rule, change as a function of displacement of the airplane. In the night effect, the changes due to displacement are generally faster than the changes due to the variations in the layer properties.

In other words, the direct distance to the transmitter and the distance traversed by the reflected waves do not vary equally in terms of the displacement of the airplane. The reflected wave is, therefore, periodically reversed in phase with respect to the direct wave and a variation in bearing indications results.

3.4 DETAILED STUDY OF THE PHENOMENON PERTAINING TO A CYCLE OF OSCILLATING INDICATION

Between the extreme positions corresponding to the points where the magnetic field of the reflected wave is in phase or in phase opposition with the magnetic field of the direct wave, there is interposed the case where the two vectors are 90 degrees out of phase, a condition which, in the loop receiver, represents a very poor minimum for signal direction finding (Fig. 13). A radio compass, working under these conditions in the case of mountain or night errors, therefore, indicates deviations around a mean position, the passage to the mean position being accompanied by a very blurred minimum, while this minimum is transformed into a perfect zero for the two extreme points of deviation.

If several reflected waves are present, the phenomenon may be investigated by the same method but is then more complicated. For the distances and wavelengths considered, one pre-

dominant reflected wave seems to be most often encountered.

It would appear useful to examine the general case of reception on a direction-finding loop of two waves which are out of phase and of differing direction and amplitude.

If A and B are the amplitudes of these two fields (vertical polarization), φ their difference in phase, Σ and $(\Sigma + \delta)$ the angles made by the directions of propagation of the waves A and B , respectively, with respect to the loop, the induced electromotive force E is:

$$E = A \cos \omega t \cos \Sigma + B \cos (\omega t + \varphi) \cos (\Sigma + \delta). \quad (10)$$

In order to find the maxima and minima of this function with respect to Σ , it is necessary to differentiate with respect to ωt , eliminate ωt , differentiate with respect to Σ , and then find the values of Σ for which the resulting expression becomes zero.

From the final expression $d(E)^2/dt$, one obtains

$$\tan 2\Sigma = \frac{B^2 \sin 2\delta + 2AB \cos \varphi \sin \delta}{A^2 + B^2 \cos 2\delta + 2AB \cos \varphi \cos \delta}. \quad (11)$$

The tangents of an angle and of the same angle plus π being identical, two values of Σ are found which satisfy the equation, namely, Σ and $(\Sigma + \pi/2)$. The first corresponds to maximum reception, and the second to minimum reception. There are thus obviously two maxima and two minima, respectively, at 180 degrees from one another.

The value of Σ in the above equation gives directly the angle of error due to the presence of the field B , the field A being considered as the field of exact bearing.

In equation (11) and in Fig. 13, P_A and P_B are the directions of propagation of the fields A and B ; M_A and M_B occupy the relationship shown in the figure.

If $\varphi = \pi$, the vector to be considered with P_B is M_B' .

For $\varphi \pm \epsilon$, the equation yields the same value and the same sign since it does not show the alternating sinusoidal variation of the magnitude of the vector on its direction.

Values of $+\Sigma$ are calculated clockwise as from c ; values of $-\Sigma$ are calculated counter-clockwise as from c .

The direction-finding error in the usual sense is Σ with a changed sign. This is the error which is found in the accompanying tables.

Table VII shows some values of the error for fields in phase and in opposition (Fig. 13), corresponding to the extreme points of the radio-compass variation due to mountain or night effect.

TABLE VII

δ in Degrees	Error Σ
10	3° 20'
10+180 (change of phase)	- 9° 30'
40	13° 5'
40+180 (change of phase)	-27° 28'

$A/B=2$; Σ and δ are calculated in the usual direction-finding sense.

Table VIII gives the successive values of the error for a complete cycle of phase change for the last example in Table VI. These figures correspond to the values of errors noted between the extreme points of variation of the indication.

TABLE VIII

φ in Degrees	Error Σ
0	13° 5'
10 and 350	13° 2'
45 and 315	11° 40'
90 and 270	6° 58'
100 and 260	4° 15'
112° 30' and 257° 30'	0°
135 and 225	11° 15'
170 and 190	26° 37'
180	27° 28'

$A/B=2$, $\delta=40$ degrees, Σ and δ are calculated in the usual direction-finding sense.

To obtain the value of φ corresponding to the zero error, $\Sigma=0$, it will suffice to make:

$$B^2 \sin 2\delta = 2AB \cos \varphi \sin \delta = 0; \quad (12)$$

that is,

$$\cos \varphi = \frac{B^2 \sin 2\delta}{2AB \sin \delta} = -\frac{B}{A} \cos \delta. \quad (13)$$

A particular case must be noted for which $\varphi=90$ degrees, $\delta=90$ degrees, and $A=B$. A perfect rotating field free from maxima or minima is then obtained.

Another particular case occurs when $\varphi=0$ degree; it corresponds to the two limits of variation of bearing in the dynamic aspect of the error. Here the equation yields a result identical with that obtained by another more easily established equation. If, then, the fields are in phase, or in phase opposition, when

extinction is obtained by turning the loop, the following relation obtains:

$$A \cos \Sigma \pm B \cos (\Sigma + \delta) = 0, \quad (14)$$

which gives

$$\tan \Sigma = \frac{A}{B \sin \delta} + \cot \delta. \quad (15)$$

If there is no error, Σ should be found equal to 90 degrees, for extinction must occur when the plane of the loop makes an angle of 90 degrees with the direction of propagation.

The error will, therefore, be given directly with the sign usual in direction finding, by:

$$\cot \epsilon = \frac{A}{B \sin \delta} + \cot \delta. \quad (16)$$

The amplitude and character of the oscillations noted under mountain effects are clear from these quantities which correspond to recognized physical cases. The oscillations are accompanied by synchronous signal-strength variations; these are not, however, observed if the receiver is equipped with automatic volume control.

3.5 WAVES PRODUCING AN ELLIPTICALLY OR CIRCULARLY POLARIZED FIELD TO BE COMPOUNDED WITH THE DIRECT FIELD

The previous study points out the effect occurring when the direct field must be compounded with another field, the latter being assumed to be linearly polarized. It has been shown in Section 2 how complicated the secondary field can be. Its greatest complication results in an elliptical polarization occurring in any plane whatever. In this intricate effect it is encouraging to find that the dynamic aspect of the error is the same as if the secondary field were linearly polarized.

This is the most important statement concerning the dynamic aspect of the night error. Physically this can be explained as follows: On any horizontal plane above the ground (homogeneous), the nature of the fields is the same, except for the phase change occurring between the direct field and the secondary complex field, as a function of the displacement of the airplane.

Therefore, there is an electromotive force of a given amplitude induced in the loop by the direct field and another electromotive force of a

given amplitude induced by the secondary complex field.

When the plane moves, the amplitudes remain constant, but the relative phases change and as a function of the displacement there are points where they are in phase (clear false zero in the loop), in phase opposition (clear false zero in the loop), or out of phase.

The amplitude of oscillation is governed by the relative amplitudes of the two induced electromotive forces. The duration of the oscillation and its aspect are exactly what has been set forth in detail in the preceding section.

3.6 DYNAMIC ASPECT OF THE NIGHT ERROR TAKING THE NATURE OF THE SKY WAVE INTO ACCOUNT

The above calculation, established for the mountain effect, takes into account the following: The airplane flies toward the transmitter and is

- a. in a direct magnetic field M_A ,
- b. in the magnetic field M_B of the sky wave which lies in a direction different from that of M_A .

The conditions under which the night effect appears are similar to those of the mountain effect. The complex field made up of the sky wave and of the sky wave reflected from the ground possesses a horizontal component which is considered as the parasitic vector M_B .

As has been shown in Section 2, this parasitic vector may have a very complex origin and shape, and the dynamic appearance it gives to

the night error will now be examined in two general cases of navigation:

- a. The airplane flies toward the station.
- b. The course of the airplane forms any angle whatsoever with the direction of the station.

Consideration will now be given to the dynamic appearance of the night error in the two following general cases.

3.6.1 Airplane Flies Toward the Station (within the limits of accuracy inherent in the method itself)

3.6.1.1 Duration of the Cycle of Change in Indication

The position and the relative size of vectors M_A and M_B do not affect the duration. They only affect the form and amplitude of the error.

The duration of the cycle is determined by the elevation angle, the wavelength, and the speed of the airplane.

The preceding formulas and tables of calculation are valid. It suffices to consider the angle made by the two directions of propagation as the elevation angle of the sky wave. However, a more complete table (IX) is given below.

The relation between the angle and the distance is very approximate. These figures are valid in a "homing" flight to the transmitter. If the bearing of the station is φ , the above figures must be multiplied by $1/\cos \varphi$. The duration of the cycle will be calculated from the speed of the airplane.

TABLE IX
DYNAMIC ASPECT OF THE NIGHT ERROR
LENGTH IN SPACE OF THE CYCLE OF CHANGE IN INDICATION IN KILOMETERS

Wavelength in Meters	Elevation Angle γ in Degrees							
	10	15	19	25	33	45	63	75
200	10.2	5.2	3.52	2.11	1.25	0.684	0.367	0.269
400	20.4	10.4	7.04	4.22	2.50	1.368	0.734	0.538
600	30.6	15.6	10.56	6.33	3.75	1.99	1.10	0.807
800	40.8	20.8	14.08	8.44	5	2.73	1.46	1.07
1,000	51	26	17.6	10.5	6.27	3.42	1.83	1.34
1,400	71.5	36.4	24.6	14.7	8.75	4.78	2.56	1.87
1,800	92	46.8	31.6	18.9	11.3	6.15	3.3	2.42
2,000	102	52	35.2	21.1	12.5	6.84	3.67	2.69
Distance in Kilometers from the Transmitter	700	600	500	400	300	200	100	50

3.6.1.2 Relative Amplitudes of Direct and Sky Waves

Let us consider now the two principal cases of relative amplitude of the direct and sky waves:

- a. The sky-wave complex field is definitely weaker than the direct-wave field. Under this condition, reliable bearings can be obtained by observing the variations of indication.
- b. The sky-wave complex field equals or exceeds the amplitude of the direct-wave field. Under this condition, bearings are not reliable and must not be used.

Both the above cases will be examined for various field conditions which may occur as shown in Section 2.

a. The sky wave is definitely weaker than the direct wave:

1. The sky wave is polarized vertically: No fluctuation of indication, no error.
2. The sky wave is polarized horizontally: The horizontal, parasitic, magnetic component M_B is perpendicular to the direct magnetic vector M_A and introduces a symmetrical error on each side of the exact reading in the course of the flight. In this case, evidently, the average readings give the exact bearing, but the pilot, not aware of this fact, must consider it as the general case which follows. This case corresponds to Fig. 14A.

3. The sky wave is of intermediate polarization: The error is no longer symmetrical with respect to the true bearing. This case is precisely the one which has been fully analyzed above. The pilot, choosing the average of the extreme readings, will assume an accuracy $\pm\alpha/4$ if the oscillations cover an angle α . If, for example, the extreme indications are 350 degrees to 10 degrees, the pilot will estimate the possible error at ± 5 degrees. In fact, in flying at the mean indication, the only practical method, he will risk an error of 5 degrees, which is not serious in the case of a homing flight. This case corresponds to Fig. 15A. Furthermore, this case will result in an elliptical polarization most of the time, equivalent to that treated below.

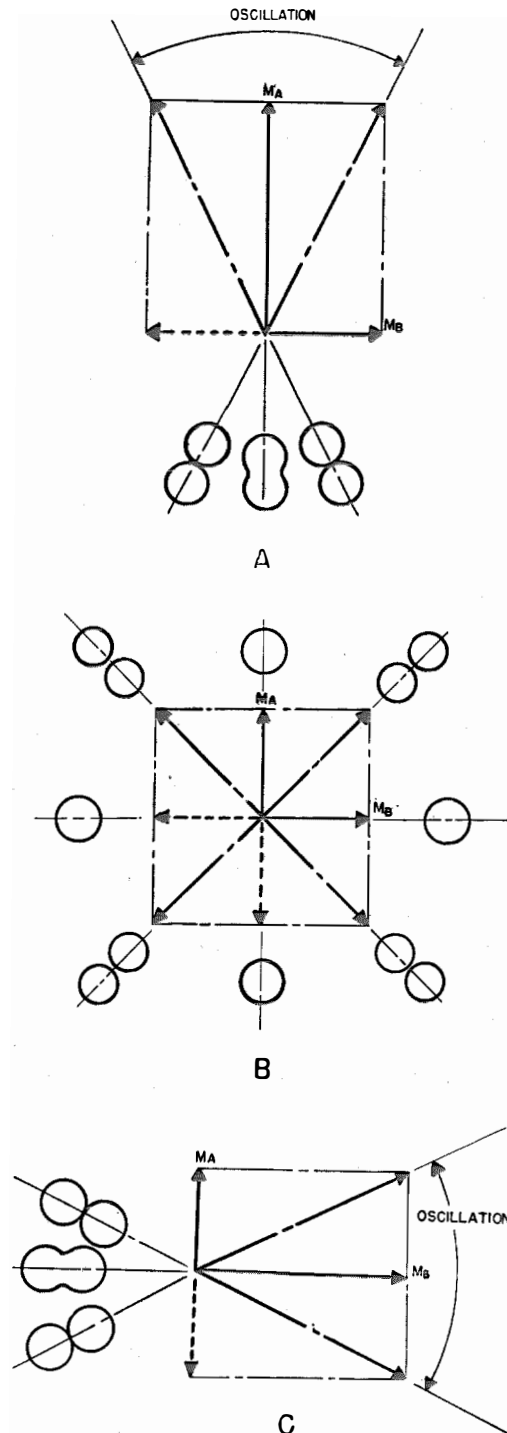
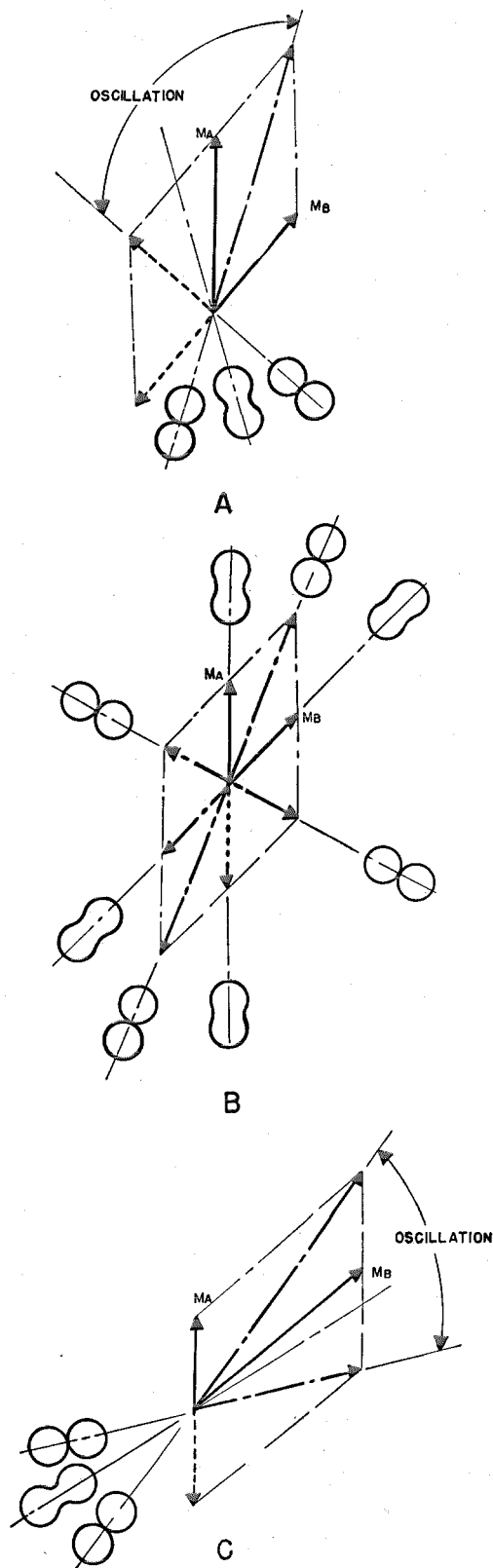

Fig. 14—Reception diagrams for direct waves and horizontally polarized sky waves. A—the amplitude of the sky wave is smaller than that of the direct wave; the oscillation is symmetrical with respect to the exact bearing. B—the amplitude of the sky wave equals that of the direct wave; the indication is indeterminant. C—the amplitude of the sky wave is greater than that of the direct wave; the oscillation is symmetrical with respect to a bearing 90 degrees incorrect.



4. The sky wave is elliptically polarized: If the axis of the ellipse is in any direction, an asymmetrical error will appear with the same aspect as shown in the example of (c) above (Fig. 15A).

If the axis of the ellipse is contained in, or is normal to the plane of incidence, the error will appear as in (2) above (Fig. 14A).

b. The sky wave equals or exceeds the amplitude of the direct wave:

1. The sky wave is polarized vertically: No fluctuation of indication, no error.
2. The sky wave is polarized horizontally: Then the parasitic vector M_B is perpendicular to M_A .

When both vectors are equal, the indications of the radio compass are indeterminate. This effect is shown in Fig. 14B.

When the sky wave is greater than the direct wave (M_B greater than M_A), the oscillation of indication is symmetrical with respect to a bearing 90 degrees incorrect since the oscillation takes place around the vector of greatest amplitude. This effect is shown in Fig. 14C.

3. The sky wave is of intermediate polarization: Then the parasitic vector M_B is not perpendicular to M_A .

When both vectors are equal, the indications of the radio compass are not completely indeterminate but almost worthless. This effect is shown in Fig. 15B.

When the sky wave is greater than the direct wave (M_B greater than M_A), the oscillation of indication occurs around a false bearing. This case corresponds to Fig. 15C. The true bearing, therefore, is no longer to be derived from the limits of the compass indications. The mean of extreme indications is valueless. Furthermore, most of the time, this case will result in an elliptical polarization equivalent to that treated below.

Fig. 15—Reception diagrams for direct waves and for sky waves of intermediate or of elliptical polarization. A—the amplitude of the sky wave is greater than that of the direct wave. This is the case previously examined. B—the amplitude of the sky wave equals that of the direct wave; the bearing is not entirely indeterminate but is almost worthless. C—the amplitude of the sky wave is greater than that of the direct wave; the oscillation of bearing indication occurs around a false bearing.

4. The sky wave is elliptically polarized: The bearings are not reliable, as the oscillation takes place around the axis of polarization of the stronger wave.

Bearings which correspond to case *b* obviously should not be utilized. The following section dealing with aerial navigation by night, shows how they may be discarded.

3.6.2 Course of Airplane Forms Any Angle Whatsoever with the Direction of the Station

3.6.2.1 Duration of the Cycle of Change in Indication

Let us return to the static aspect of the error: an observer in a given, fixed position, will notice a definite error which remains constant and is not affected by physically rotating the radio compass itself. Hence the error is the same for all courses of the plane at a given point.

Now, on board an airplane, let us consider an error ϵ and a bearing angle φ (taken clockwise from the axis of the plane to the direction of the station). For all values of φ , $\varphi + \epsilon$ will be observed.

If the airplane flies toward the station, the length of a cycle of indication has already been defined. This length, calculated in λ will be $n\lambda$:

$$n = \frac{1}{\frac{1}{\cos \gamma} - 1} + 1 \tag{9}$$

where γ is the elevation angle of the sky wave.

If the airplane flies on an exact bearing (see Fig. 16), only the length of the oscillating cycle of indication is increased, the phenomenon remaining identical otherwise (see Section 3.6.1 above for polarization and relative amplitude effects).

The length of the cycle becomes:

$$\frac{n\lambda}{\cos \varphi} \tag{17}$$

where φ is the exact bearing of the transmitter. Fig. 16 shows this in simple form.

The length l_1 of the cycle for a flight toward a station becomes l_2 for a bearing φ and infinity for a bearing of 90 or 270 degrees.

The station is assumed to be at infinity. This is practically justified because night effect is not

noted for short distances at which the proximity of the station would require the introduction of a corrective term.

If a station is on a bearing of about 90 or 270 degrees, the oscillations are too slow to be observed, but the error can be present.

It is always assumed that the airplane is flying at a constant altitude. The effects described are evidently slightly changed when the airplane is going up or down.

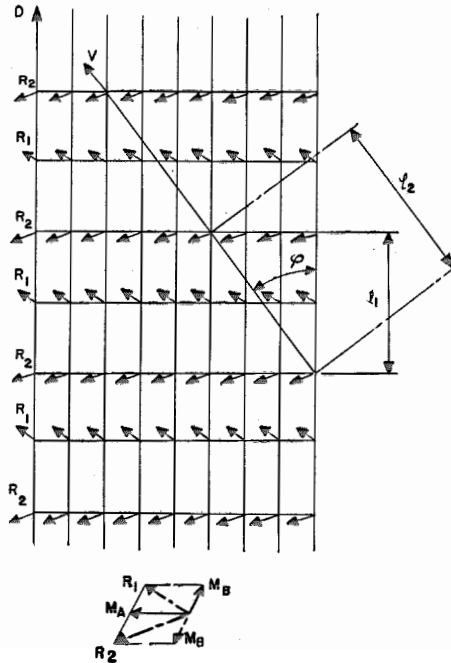

Fig. 16—Duration of the cycle of oscillation of indication for an airplane flying on an exact bearing of the transmitter.

D = direction of an infinitely distant transmitter,

V = flight direction,

*l*₁ = length of oscillation in homing flight to the transmitter,

*l*₂ = length of oscillation cycle for bearing of the transmitter = *l*₁ / cos φ ,

*R*₁ and *R*₂ = extreme positions of resultant magnetic vectors, and

φ = exact bearing.

3.7 DYNAMIC ASPECT OF MOUNTAIN AND NIGHT ERRORS IN DEVICES WHERE A LOOP ANTENNA COMBINATION IS PERMANENTLY UTILIZED

In the foregoing, consideration was given to the aspect of the magnetic field which is solely utilized in the RC5 radio compass or in an ordinary loop, without resolution of the 180-degree ambiguity.

Certain devices permanently employ a directive combination loop antenna (homing radio compasses). They will be more affected than the RC5 radio compass, because the amplitudes of the resulting electric field (acting on the antenna) and the resulting magnetic field (acting on the loop) never remain in the desired phase and amplitude relation for good operation.

These relations vary constantly in the stationary wave, and the more serious difficulty occurs in the change of relative phase of the two vectors. With combination loop antennas, in addition to the effect on the indicating oscillation as explained above, periodic disappearances of indication may be noted, accompanied by internal errors peculiar in the apparatus itself and reversing in the 180-degree indication.

3.8 SIMILAR EFFECTS OBSERVED IN GROUND DIRECTION FINDERS

The effects described occur in a similar manner at fixed direction-finder stations when taking bearings on transmitters moving rapidly. Such effects can be perfectly demonstrated by taking bearings on short-wave airplane transmitters with cathode-ray-oscillograph direction finders on the ground, when the direction finder receives the ground and sky waves, or two sky waves.

4. *Practical Conclusions for Night Flying Over Land and Sea*

4.1 RULES CONCERNING NIGHT DIRECTION FINDING

Phenomena manifested as night errors, and also with their dynamic aspects, have been examined in the three preceding sections. Based on the concepts discussed, the following "rules" are formulated relative to night direction finding on medium waves.

On board the airplane, and on a steady course, the error is revealed by a periodic variation of the direction indication, of given amplitude and duration. In the conditions outlined below, a bearing will be considered as reliable if no oscillation of indication occurs, or reliable within certain limits if a regular oscillation of a moderate amplitude appears.

Consideration will be given to the propagation conditions which result in the presence of direct and sky waves, either over land or sea, as functions of the distance, the wavelength, and the

power of the transmitter. This will determine a first classification of the cases to be expected.

The result will be coordinated with the principal cases of navigation without visibility that the pilot may encounter:

- a. The airplane makes a regular scheduled flight on a known route.
- b. The airplane makes its first trip on a route not yet established.
- c. The airplane is completely lost and the pilot can use only a certain number of identifiable waves in order to resume a normal route.

The three maps of Fig. 17 represent areas within which direction finding is entirely safe S , those safe within certain limits I , and those unsafe U , with respect to the distance and the wavelength, according to known conditions of propagation.

The shorter the wave, the more restricted is the area of safety.

It is advisable to avoid taking bearings on a station in the intermediate area when bearings are close to 90 degrees or 270 degrees within ± 30 degrees. Under these conditions, if a bearing is absolutely necessary, it is advisable to turn the plane in order to take the bearing when flying towards or away from the station. The pilot can be certain of flying towards the station when several regular oscillations of indication occur around the angle 0 degree. He then can take a different exact course with respect to the bearing of the station.

Above all, it is necessary to avoid taking bearings in unsafe areas where only the sky wave is present, or where its value is greater than that of the direct wave.

On waves between 150 and 300 kilocycles (1000 and 2000 meters), the oscillation of indication can be slow, especially on distances greater than 500 kilometers (311 miles) (see Table IX). The complete cycle will take about 3 minutes in homing flight at 360 kilometers (224 miles) per hour. On the other hand, these waves are the most reliable for direction finding.

Let us assume that the pilot in turn is confronted with the three situations indicated above:

- a. The airplane makes a regular schedule flight on a known route:

In this case, the only purpose of the bearings is to permit correction of the course. The pilot can use prepared maps where the safe and unsafe areas are represented, as indicated in Fig. 17, directly on the flight map. Furthermore, he can take advantage of night flights made during clear weather to evaluate readings obtained and mark on the map the amplitudes of the regular variations in bearings and their duration, to control his course still more effectively under conditions of poor visibility. Therefore, he will be able to use waves O_1 , O_2 , or O_3 .

b. The airplane makes its first trip on a route not yet established:

Advance preparation of a radio map is imperative. It should indicate the safe and unsafe areas and take account of the power of the transmitters. The hours of transmission, the call letters, and the signal peculiarities should also be noted.

Transmissions from stations using O_3 waves should not be used except within a radius of 30 kilometers (19 miles) from the desired station.

The power of the broadcasting stations is an

important factor of insecurity in waves between 545 and 1500 kilocycles (200 and 550 meters). Such stations may create strong fields in an unsafe area.

c. The airplane is completely lost and the pilot can use only a certain number of identifiable waves in order to resume a normal route:

As the areas of Fig. 17 show, the pilot for all practical purposes can use O_1 waves at all distances. Furthermore, he can use O_2 waves up to 250 kilometers (155 miles). It is probable that his reckoning of position will be less than this distance. In these two cases, he may note variations of indication reaching 10 or 20 degrees. Except in a desperate case, he should avoid using O_3 waves. If only the latter are available, he should try to direct the plane by "homing" towards the nearest station; he will then generally be flying towards the station despite the errors which may occur in an unsafe zone. At the end of this homing flight, he will be able to check the passing above the known station with the usual accuracy and then will be able to use this accurate "fix" to continue the flight.

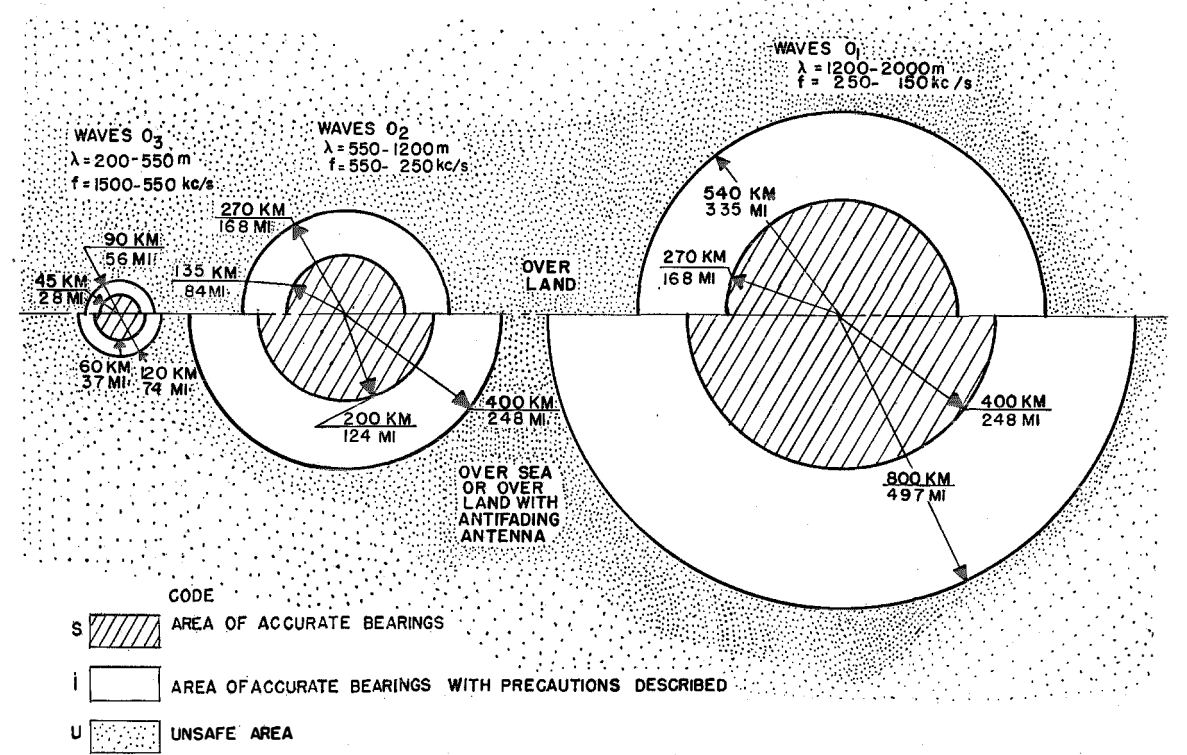

Fig. 17—Regions of safe and unsafe direction finding with respect to terrain and wavelength.

4.2 EFFECT OF THE ALTITUDE OF THE FLIGHT ON THE ABOVE STATEMENTS

In Section 2, it has been shown that above flat ground of normal conductivity, or above the sea, there exists a number of horizontal planes where the errors are reduced. While the opportunity of flying under suitable conditions for verifying these results has not occurred it has been noted that in the air, the errors are always smaller (sometimes much smaller) than on the ground at the same distance from the transmitter.

Actually, on the average, the night error in the atmosphere is lower than the error observed on the ground. This follows from the analysis of Section 2.

The mean values of errors in altitude are probably half those observed on a ground direction finder at the same distance from the transmitter. Especially on the sea, the errors would be found to be small on planes C , C_1 , etc.

In the preparation of Fig. 17, this factor was not taken into account inasmuch as it is possible to fly under conditions where the errors are the same as on the ground. Hence, pilots will sometimes report better results than those indicated in Fig. 17; such reports, in fact, have already been received.

4.3 INFLUENCE OF THE NATURE OF THE EARTH SURFACE

Distances mentioned herein are valid above ground of normal conductivity. Thus, desert and mountains must be excluded. Regarding deserts, information as to the attenuation of the direct field is lacking. Experiments would be necessary in this case to establish a more precise "rule."

Above mountains, sky waves reflected by them can create more serious errors than those discussed.

4.4 COMMON-WAVELENGTH AND SYNCHRONOUS STATIONS

When the airplane is flying in an area where two synchronized waves are present, variations

of indication will occur as in the night effect around the direction of the stronger wave. This evidently may occur by day as well as by night.

When the wavelengths are common but not synchronized, the oscillation of indication occurs even at a fixed station at the beating rate. In case of an airplane, the two effects interfere.

Except in well-recognized cases, such waves must be avoided day and night.

Bibliography

- J. A. STRATTON, "Electromagnetic Theory," McGraw-Hill Book Company, 1941.
- CHARLES R. BURROWS AND MARION C. GRAY, "The Effect of the Earth Curvature on Ground Wave Propagation," *Proceedings of the I.R.E.*, v 29, n 1, January, 1941.
- H. BUSIGNIES, "Mountain Effects and the Use of Radio Compasses and Radio Beacons for Piloting Aircraft," *Electrical Communication*, v 19, n 3, 1941; Institute of Radio Engineers Annual Convention, San Francisco, June 27, 1939.
- H. BUSIGNIES, "Reduction of Night Error in Radio Direction Finding Equipment for Aerodromes," *Electrical Communication*, v 16, n 3, January, 1938.
- Documents du Comité Consultatif International des Radiocommunications, Bucharest, 1937, Quatrième Reunion, Bureau de l'Union Internationale de Telecommunication, Berne.
- CHARLES R. MINGINS, "Electromagnetic Wave Fields Near the Earth's Surface," *Proceedings of the I.R.E.*, v 25, p 1419, November, 1937.
- K. A. NORTON, "The Propagation of Radio Waves Over the Surface of the Earth and in the Upper Atmosphere," *Proceedings of the I.R.E.*, v 24, p 1367, October, 1936, and v 25, p 1203, September, 1937.
- CHARLES R. BURROWS, "The Surface Wave in Radio Propagation Over Plane Earth," *Proceedings of the I.R.E.*, v 25, p 219, February, 1937.
- H. BUSIGNIES, "The Automatic Radio Compass and Its Applications to Aerial Navigation," *Electrical Communication*, v 15, p 157, October, 1936.
- F. R. STANSEL, "A Study of Electromagnetic Field in the Vicinity of a Radiator," *Proceedings of the I.R.E.*, v 24, p 802, May, 1936.
- CHARLES R. BURROWS, "Radio Propagation Over Spherical Earth," *Proceedings of the I.R.E.*, v 23, p 470, May, 1935.
- Documents du Comité Consultatif International des Radiocommunications, Lisbon, 1934, Bureau de l'Union Internationale de Telecommunication, Berne.

Jacketing Materials for High-Frequency Transmission Lines

By A. J. WARNER, B.Sc. (London)

Federal Telecommunication Laboratories, Inc., Newark, New Jersey

1. Introduction

PROBLEMS in the design of high-frequency transmission lines include those of providing an outer protective covering, or jacket, the properties of which are just as important from an over-all standpoint as those of the other components. Such a jacketing material has to be capable of withstanding a great deal of mechanical abuse over a wide temperature range. Much investigational work to develop suitable materials has been, and is being, carried out, not only by raw-material suppliers but also by the cable makers.

The most important characteristics required in a jacketing material for high-frequency transmission lines are:

- a. Flexibility at temperatures as low as -40 degrees centigrade, and at moderate radii of curvature.
- b. Ability to withstand temperatures as high as 120 degrees centigrade without excessive deformation.
- c. Resistance to water.
- d. Resistance to gasoline, particularly aromatic aviation gasoline.
- e. Resistance to hot lubricating oils.
- f. Resistance to hydraulic brake fluids.
- g. Resistance to abrasion.
- h. Long life under service conditions.
- i. Absence of corrosive effects on braid wires.
- j. Flame resistant or at least flame retardant.
- k. Preferably thermoplastic.
- l. Processable on existing equipment or easily modified versions of same.
- m. Available in quantity at a reasonable price.

To these requirements has recently been added another, and a most important one, namely, the material must not cause changes in the power factor of the primary insulation by plasticizer migration, even after prolonged operation at

temperatures in the neighbourhood of 100 degrees centigrade.

The sum of these requirements is no mean one, and for practical considerations, a compromise solution has to be adopted, for no material meets all the stated requirements. The following notes briefly describe the properties of several materials which have been considered in this connection.

2. Materials

2.1 ELASTOMERS OF POLYVINYL CHLORIDE

Vinyl chloride on polymerization gives a white material which on suitable moulding produces hard, tough products. Such polyvinyl chloride resins are known in the trade as Vinylite QYNA or Geon 101 (Koron 101). By adding suitable plasticizers, the hard tough materials can be transformed into flexible elastomers of great commercial importance, whose properties fulfill many of the requirements for a satisfactory jacketing material. They are thermoplastic, flame resistant when suitably compounded, have good abrasion resistance, can be formulated to withstand low-temperature flexing and high-temperature deformation, are relatively cheap to produce, and can be handled with moderate ease on existing plastic-tubing machines. Together with the next class of substances, they form the bulk of current jacketing materials, although they cause undesirable power-factor changes of the primary insulation on ageing, particularly at elevated temperatures. A recent especially formulated noncontaminating jacketing material of this type will be described later.

2.2 ELASTOMERS OF POLYVINYL CHLORACETATE

By copolymerizing vinyl chloride with a small percentage of vinyl acetate, a material is

obtained which possesses somewhat different properties from those of the straight polyvinyl chlorides. A typical commercial product is sold under the trade name of Vinylite VYNW. Like polyvinyl chloride, suitable plasticization provides elastomeric products having widespread commercial application, and the properties of the two types of material are substantially the same.

The ultimate properties of both the straight chloride and chloracetate materials are very dependent on the nature and amount of the plasticizers employed. To achieve the best results it is common practice to have two, three, or sometimes more, plasticizers present in the final product.

Examples of commercial materials that have been produced for use as jackets on high-frequency transmission lines are:

- a. Vinylite VE 5900
- b. Vinylite VE 5904
- c. Vinylite VE 5906
- d. Geon Plastic 2095
- e. Geon Plastic 6281

Vinylite VE 5904 has been discontinued as a jacket on transmission lines. Despite its advantages in having the best low-temperature characteristics, the plasticizer employed, methyl acetyl ricinoleate, attacks the copper wire of the braid very severely, resulting in a useless transmission line.

VE 5906 is the commonest of the existing jacketing materials using polyvinyl chloracetate. It contains as plasticizer a mixture of dioctyl phthalate and tricresyl phosphate. By this combination is achieved low-temperature flexibility without sacrifice in flame-resisting properties, whilst the over-all properties of the material are satisfactory for a large number of applications.

Results obtained on typical vinyl jacketing compounds follows:

	Geon 6281	Geon 2095	Vinylite VE 5906
Shore Hardness	78	64	65
Shore Elasticity	17	32	29
Tensile Strength psi	2300	1850	2400
Elongation %	250	400	325
Deformation at 120°C %	6	23	36
Brittle Point °C	-32	-57.5	-49
Gasoline Penetration, Hours	32-50	15-23	7-8

The moisture-transmission values for these materials are of course dependent on the thickness of the jacket, but average values of 0.2 milligrams/hour/square centimeter have been obtained for VE 5906, 0.17 for VE 5900, and 0.4 for Geon 2095, all in thicknesses of 20 mils. Improvements in these values have been obtained by coating the surface of the jacket with paraffin wax or other similar material.

The values of brittle point given are an indication of the low-temperature flexing performance to be expected on transmission lines, but unfortunately no direct correlation has been obtained. All of the three materials listed have been extruded as jackets and withstood flexing at -40 degrees centigrade without cracking.

The problem of contamination of primary insulation by plasticizer migration will be dealt with later.

2.3 ETHYL CELLULOSE

Ethyl cellulose is relatively new in the plastics field, and its good impact strength at low temperatures has attracted attention to it as a jacketing material. It has the additional merit that, being plasticizable by hydrocarbon materials, the problem of primary-insulation poisoning is lessened, if not removed altogether.

Investigation of special ethyl cellulose formulations shows, however, that the material is unsuitable for use as a jacket. One particular formulation had the following properties:

Shore Hardness	99
Shore Elasticity	6
Tensile Strength psi	2,000
Elongation %	40
Deformation at 120°C %	95.5 standard 500-gram weight 5.7 using 85-gram (3-ounce) weight
Brittle Point °C	-30
Water Absorption in 24 Hours %	1.43
Gasoline Resistance	Poor; penetration after 1 hour, considerable swelling and softening after 24 hours
Plasticizer Sweating	Bad

The properties that rule out ethyl cellulose for use as jacketing material are:

- a. Too low heat-deformation temperature
- b. Too poor gasoline resistance
- c. Too high moisture absorption
- d. The material is inflammable.

2.4 CARDOLITE

Cardolite is a plastic composition containing ethyl cellulose, an unsaturated hydroxy compound derived from cashew-nut oil, an aldehyde, and a chlorinated material. It can be extruded as a thermoplastic, and when properly cured forms a tough, flexible, substantially nonflammable, and insoluble material.

Although considered from time to time as a jacketing material, it has never been used because of (a) the long and complicated cure cycle involved, (b) the toxicity of the chlorinated materials employed, (c) the relatively poor low-temperature characteristics, and (d) the effect on the primary insulation and copper braid during cure.

2.5 NEOPRENE

Neoprene is an extremely good jacketing material. It has very good abrasion resistance, is resistant to oils and gasoline, is flexible over a wide temperature range, and is flame resistant. It requires a curing process, however, which would mean a substantial change in machinery. Furthermore, the corrosive nature of the material in process would prevent the use of bare copper wire as the braid. However, for certain

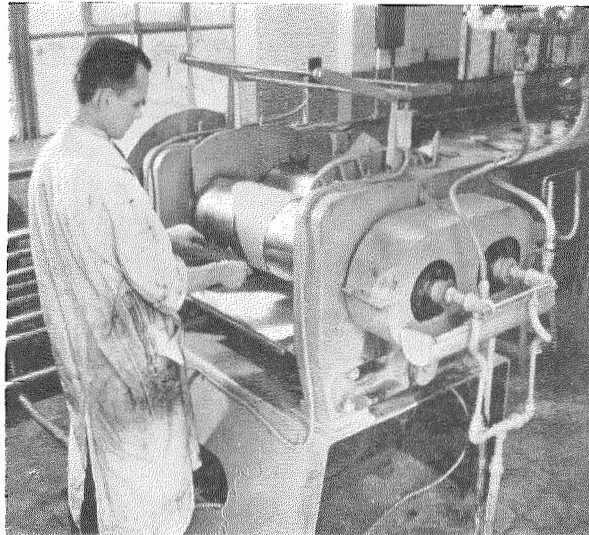

Fig. 2—Laboratory mixing rolls.

cables, notably pulse cables, neoprene jackets are used, the copper being protected by tinning.

2.6 BUNA S, OR SYNTHETIC RUBBER

For certain applications, where formerly natural rubber compounds were used, synthetic rubber, or Buna S, is employed. Such applications are usually restricted to those requiring the greatest flexibility, and in these cases the primary insulation also is Buna S. Among the disadvantages of Buna S are its relatively poor resistance to gasoline and oil, its short life when exposed to ultraviolet light or ozone, and its poor flame resistance.

Like Neoprene, Buna S has to be vulcanized or cured to develop its best properties, and for this reason any proposal to use the material for transmission-line jackets would involve serious equipment difficulties. It would also be necessary to use tinned copper braids to avoid corrosion.

2.7 STYRALOY 22

In an attempt to utilize the inherently good properties of polystyrene, a copolymer has been prepared which exhibits remarkably good low-temperature flexibility and which is reasonably resistant to heat. It has good abrasion resistance at ordinary temperatures, but when hot exhibits "hot-shortness," which gives the material a

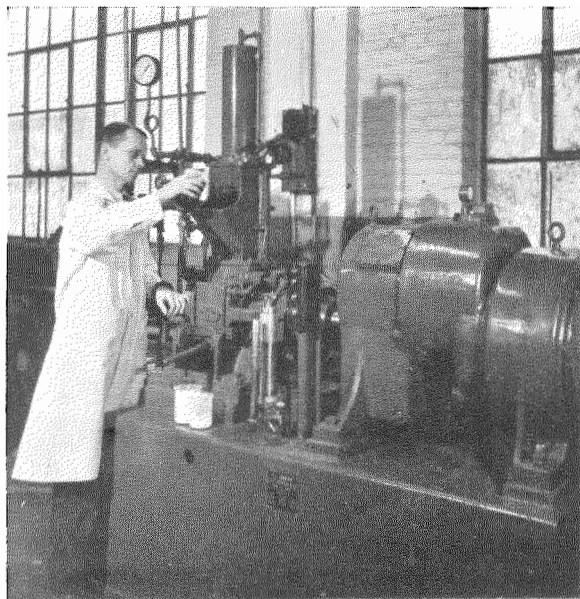

Fig. 1—Experimental Banbury mixer for compounding materials.

“cheesy” texture with poor tear resistance. It has reasonably good resistance to organic solvents and oils. It can be extruded with conventional equipment, and offers no serious processing difficulties. However, it is not flame resistant.

2.8 COTTON BRAID

Transmission lines not subjected to the weather, gasoline and oil, or mechanical abuse, have conventionally used a braided or knitted cotton outer covering, usually impregnated with wax to provide water proofing. In service, however, the operating temperature of the lines is high enough to cause the wax to oxidize and migrate into the primary insulation with resultant deterioration of electrical properties. Furthermore, soldering connectors and fittings to the line melts the wax which dissolves in the polyethylene of the primary insulation giving poor mechanical performance. To overcome these difficulties, nylon and polyethylene thin-walled jackets have been tried.

2.9 NYLON

By use of a suitable die and careful extrusion technique, linear polyamides can be extruded in thin sections over transmission lines. The secret of correct extrusion lies mainly in forming a tube at the die and subsequently drawing down this tube on the extruder to fit the cable snugly. Wall thicknesses as low as 3 to 5 mils can be successfully applied. Nylon, as a noncontaminating jacket, is not suitable mainly from a mechanical standpoint.

When transmission lines jacketed with nylon are maintained at an elevated temperature, some small deterioration in electrical properties occurs because of migration from the nylon to the polyethylene, but the most important effect is embrittlement of the material with a consequent lack of flexibility. At room temperature, the effect of repeated flexings of such a nylon jacket is a “cold-drawing” which results in ridges being formed. Further drawbacks are the relatively high moisture absorption and transmission properties, the ease of attack by hydraulic brake fluids, and its inflammability. For these reasons, nylon has been used only experimentally on transmission lines.

2.10 POLYETHYLENE

Polyethylene can fairly readily be extruded in thin walls as a jacket material, and is currently used where formerly a wax-impregnated cotton braid was employed. Like nylon, the most successful application is to tube it at the die and draw it down on the cable passing through the machine. The drawbacks to the use of polyethylene are: (a) inflammability, (b) lack of resistance to oils and gasoline, (c) rigidity, particularly at low temperatures, and (d) sudden melting point in the vicinity of 110 degrees centigrade. It has also been recorded that polyethylene on exposure to weathering conditions undergoes some change resulting in a rise in brittle point, in some cases actually to above the freezing point of water.

By the addition of carbon black, polybutene, and other materials, attempts have been made to prepare compositions of polyethylene suitable for jacketing but to date no satisfactory compound is available. At the moment, therefore,

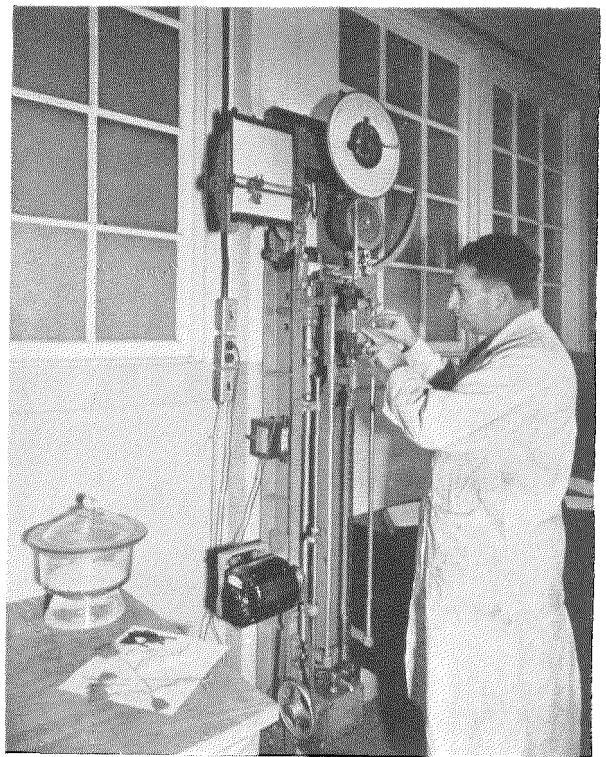

Fig. 3—Tensile testing of jacketing materials.

polyethylene jackets have only very limited application in specialized problems.

3. Noncontaminating Jackets

3.1 NATURE OF PROBLEM

Experience with high-frequency transmission lines revealed instability with age. At elevated temperatures (85 degrees centigrade and above), the electrical properties, especially attenuation, deteriorate.

Original investigations by the Bell Telephone Laboratories revealed that contamination of the polyethylene primary insulation resulted from migration of the plasticizers from the vinyl jackets causing marked rise in the power factor. By using a commercial vinyl-type jacketing material, wrapped around polyethylene and heated for various periods of time, the effect can be measured in terms of increase in power factor of the polyethylene. By immersion of polyethylene in the various plasticizers, it is easy to demonstrate that these materials are the cause of the "poisoning."

3.2 DEVELOPMENT OF NEW MATERIAL

To obtain a noncontaminating jacketing material, several score of plasticizers were investigated. All except one, a resinous plasticizer developed by the Resinous Products Corporation of Philadelphia, were unsatisfactory. After the usual problems of variability and production had been solved, a material was developed having remarkable constancy of physical properties and from which very promising jacketing compounds have been evolved. This material differs from the usual run of plasticizers for vinyl chloride or vinyl chloracetate in that it is not a solvent-type material. It requires very careful handling during the manufacture of the jacketing compound if the best properties are to be developed.

Commercially available jacketing materials containing this new plasticizer have been produced by Federal Telephone and Radio Corporation (IN-102), Bakelite Corporation (VE 3094), B. F. Goodrich Company (8070), and the General Electric Company. Such compounds have average properties as follows:

	IN-102	VE 3094	8070
Shore Hardness	72	80	80
Shore Elasticity	29	19	23
Tensile Strength psi	2400	2700	2400
Elongation %	350	350	330
Deformation at 120°C %	23	10.5	19.1
Brittle Point °C	-50	-40	-28

The effect of these compounds on the electrical properties of polyethylene is negligible, resulting in a transmission line having almost constant attenuation values after repeated heat cycles. At the present moment, the low-temperature flexibility is not as good as could be desired, and despite constant effort it has not yet been improved. However, cables jacketed with this material, when properly manufactured and extruded, can be flexed at -30 to -35 degrees centigrade using the standard Navy test.

Such jacketing materials have been under investigation for some twelve months, and indicate not only vastly superior electrical properties but good promise from an over-all mechanical standpoint.

4. Testing of Jacketing Materials

In preparing slabs for tensile strength, elongation, brittle point, etc., particularly for elastomers such as plasticized polyvinyl chloride or chloracetate, it is very important to determine by trial the best conditions on the mould for the particular compound. Samples prepared under incorrect conditions may show strain or thermal breakdown. Very misleading results are obtained when strains are present in the material, and it is best to check before testing to ensure that the material is substantially strain-free. Thermal breakdown will lead to incorrect deductions on such properties as brittle point, heat deformation, etc.

For most of the physical tests, a moulded sample prepared in the standard rubber mould described in ASTM D15-41 is used. Such a specimen is 0.075±0.010 inch in thickness and 6 inches square. From these test pieces, specimens are cut for tensile strength, elongation, heat deformation, water absorption, plasticizer loss on heating, brittle point, etc.

4.1 TEST PROCEDURES

4.1.1 Tensile Strength

The tensile strength of materials indicates their usefulness for structural applications. In conjunction with the elongation and other tests, it gives also a measure of toughness. The standard method of test, ASTM D412-41, using die C, is employed.

4.1.2 Elongation

This property is important for structural applications and, in conjunction with the tensile strength, gives a measure of toughness. It is also important in conjunction with permanent set in determining flexing properties. It is measured in accordance with ASTM D412-41, using die C.

4.1.3 Shore Hardness and Elasticity

For quick determinations of the properties of elastomers, the Shore hardness and elasticity values have been used for a number of years. To a trained observer, reasonably reproducible values can be obtained and give an indication of what may be expected of more detailed tests. Such hardness and elasticity measurements have been used as a quick, factory, quality-control test.

4.1.4 Heat Deformation

To determine the ability of materials to withstand elevated temperatures without excessive deformation, a heat deformation test is run. The thickness of a standard sample, initially 0.5 inch in diameter and 0.075 ± 0.010 inch thick, is measured before and after subjection to a pre-determined temperature for a stated time.

The Randall-Stickney gauge, having a 0.25-inch foot and a 500-gram load, is heated to the requisite temperature for 1 hour prior to the test. The sample is measured for thickness on an auxiliary gauge, and then placed under the weighted foot of the instrument in the oven. At $\frac{1}{4}$ -hour intervals the thickness of the specimen is measured and the final reading is taken 1 hour after the initial application of the load. The deformation is given in percentage of the original thickness.

The heat-deformation figures are most significant for thermoplastic materials where flow takes place under load. With cross-linked materials, however, the deformation under heat and pressure is not entirely permanent, and the material may recover substantially completely if the load is removed. This occurs with materials like GR-S and neoprene.

4.1.5 Water Absorption and Plasticizer Leaching

Nearly all organic materials, whether natural or synthetic, when immersed in water gain in weight as a result of absorption. This absorption of water may cause deterioration of the material itself, or affect the properties of materials with which it is in contact. Apart from the actual absorption of water, hydrolysis of plasticizers may take place, or the plasticizers may leach out into the water, causing marked alterations in the properties. Materials which have a very low value of water absorption and from which plasticizers cannot be easily leached are desired.

Moulded specimens, 1 by 1.5 inches and 0.075 inch thick are conditioned by heating for 24 hours at 50 degrees centigrade. They are then transferred to a desiccator, cooled, and weighed. The samples are submerged in water for 48 hours, removed, dried by blotting with filter paper, and weighed. After this weighing, the test specimens are conditioned at 50 degrees centigrade for 24 hours, cooled in a desiccator, and reweighed. The increase in weight of the samples after 48 and 96 hours of immersion, corrected for plasticizer loss, gives a measure of the water absorption. The plasticizer loss is determined from the initial and final weights.

This test, whilst admittedly crude, is very simple and serves to eliminate obviously unsuitable materials.

4.1.6 Brittle Point

Most organic materials get progressively stiffer with decreasing temperature, and a knowledge of the low-temperature mechanical properties of jacketing materials is necessary to determine the minimum service operating temperature. It is extremely difficult to find a laboratory test which will correlate with the actual bending of a cable at the low temperature, but the brittle-point test

recently devised is very useful for comparative measurements.

In essence, the test determines the temperature at which a specimen will not fracture when subjected to a certain striking force.

The specimen is $\frac{1}{8}$ inch by $1\frac{1}{2}$ inches by 0.075 ± 0.010 inch thick and is held by a special fixture immersed in a suitable coolant. A striking arm hits the specimen with a relative velocity of 6.5 ± 0.5 feet per second. Starting at a temperature at which the material will fracture

under impact, the temperature of the coolant is gradually raised until five consecutive cases of non-breaking occur. This temperature is the brittle point of the material.

Further work on the testing of jacketing materials at low temperatures is required, and particular emphasis must be given to the testing of the materials in a form similar to the end use, since the process of applying the jacketing material to cables has a marked influence on the final properties.

Current Rating of Single-Core Paper-Insulated Power Cables

By C. C. BARNES

Standard Telephones and Cables, Ltd., North Woolwich, England

METHODS adapted for computing the permissible continuous rating of power cables were outlined in a previous article,¹ but the data provided are not easily applied to single-core cables. The pressing need of recent years for higher system voltages, plus the rapid increase in the bulk transmission of power, has greatly increased the demand for single-core cables; therefore the following notes have been prepared, outlining the method for computing the current rating of single-core cables. To ensure completeness a brief résumé of certain data previously published is included in the notes under the appropriate sections.

1. Fundamental Concepts of Heat Flow in a Single-Core Cable

Current carried by the cable conductors raises the temperature of the cable until equilibrium is established, the heat generated being equal to the heat dissipated through the insulation, lead sheath, cable servings, and finally into the surrounding earth or air (see Fig. 1). Thus if:

I = maximum safe continuous current-carrying capacity in amperes,

R_θ = ohmic resistance/centimetre length of copper conductor at the maximum operating temperature,

θ = maximum permissible temperature drop in degrees centigrade between the conductor and ambient, and

ΣG_T = sum of individual thermal resistance, in thermal ohms per centimetre length, forming the heat-flow path between conductor and ambient. The heat generated = $I^2 R_\theta$, and the heat dissipated = $\theta / \Sigma G_T$. Equating $I^2 R_\theta = \theta / \Sigma G_T$, whence

$$I = \sqrt{\frac{\theta}{R_\theta \Sigma G_T}} \quad (1)$$

In practice, this formula has to be expanded to include the effects arising from the following factors:

- Sheath Losses.* With single-core cables, secondary currents may flow in the lead sheaths. The resulting heat however has only to be dissipated through the cable servings and surrounding earth or air (Section 3).
- Skin Effect.* The tendency is for the current density to become greater toward the surface of a conductor due to the magnetic effect, which causes an effective increase in the value of R_θ (Section 2).
- Proximity Effect.* The interaction of magnetic fields associated with adjacent current-carrying conductors causes a further redistribution of the current which likewise increases R_θ (Section 2).
- Dielectric Loss.* Losses occur in the insulation as a result of the electric field (Section 4).

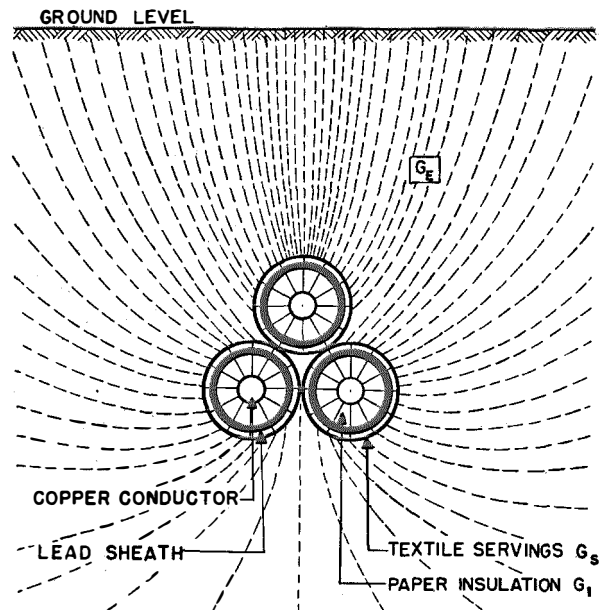

Fig. 1—Heat-flow path for a trefoil group of single-core cables laid direct in the ground. G_E = thermal resistance of soil path, G_s = thermal resistance of serving material, and G_i = thermal resistance of dielectric. The heat due to the lead-sheath losses has only to flow through the thermal path ($G_s + G_E$).

¹ Numbered references will be found on page 95.

If λ = sheath-loss/copper-loss ratio (Section 3),

y = skin-effect increment (Fig. 2),

y_1 = proximity-effect increment (Fig. 3),

Δ = correction factor for dielectric loss (Section 4),

G' = thermal resistance of dielectric (Section 7),

G_s = thermal resistance of serving (Section 7.2), and

G_E = thermal resistance of soil (Section 7.3),

then formula (1) becomes:

$$I = \sqrt{\frac{\theta - \Delta}{R_{\theta}(1 + y + y_1)\{G' + (1 + \lambda)(G_s + G_E)\}}} \quad (2)$$

The permissible current as calculated by this formula is based solely on its heating effect. In some cases, particularly with conductors of very small copper section, the limiting factor may rather be the permissible voltage drop and this must also be checked (see Appendix I).

2. Conductor Resistance, Skin and Proximity Effects;² Correction Factors

The direct-current ohmic resistance for the range of standard copper conductors is given in Table I for various conductor temperatures. (Table I applies to British practice and Table IA to the U.S.A.)

Single-core cables are normally installed in unstranded groups (i.e., the individual single-core lead-covered cables are not twisted together) and therefore no extra lay allowance is necessary.

In the case of large copper sections, the ohmic resistance for alternating current is increased (by the skin-effect factor y , Fig. 2) and when other conductors are present in the immediate vicinity an increase in resistance results from the uneven current distribution (proximity factor y_1 , Fig. 3) caused by the other current-carrying conductors.

A correction for skin effect will not be appreciable for a conductor section smaller than 0.2 square inch. The proximity effect also is usually small. It increases with the conductor diameter and is a maximum when the cables are practically in contact; therefore this correction

is mainly necessary for low-tension cables of very large cross section (0.3 square inch and above).

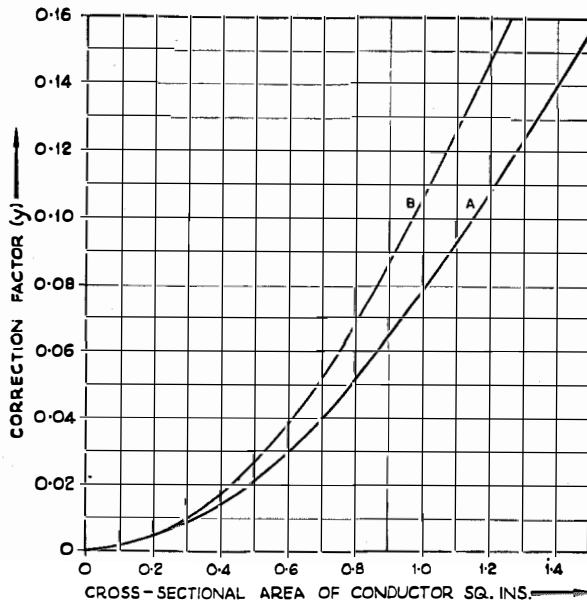

Fig. 2—Skin effect for stranded circular conductors at a frequency of (A) 50 and (B) 60 cycles per second.

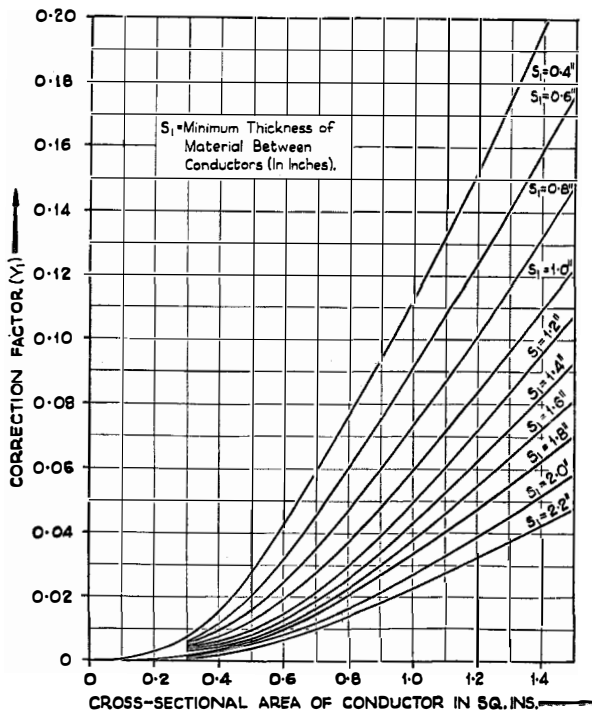

Fig. 3—Proximity effect for stranded circular conductors in trefoil formation for a frequency of 50 cycles per second.

Both these effects can be treated as an apparent increase of conductor resistance, i.e.,

$$R_T = R(1 + y + y_1), \quad (3)$$

where R = uncorrected direct-current resistance,
 y = correction for skin effect,
 y_1 = correction for proximity effect, and
 R_T = corrected ohmic resistance.

The correction for skin y and proximity y_1 effects can be obtained from Figs. 2 and 3.

3. Lead-Sheath Losses,^{3,4,5,6} Correction Factor (S_L)

The heating losses which occur in the lead sheath are of two types: (a) sheath eddy loss and (b) sheath circuit loss.

The former loss, as the name implies, is due to the eddy currents generated in the lead sheath by the alternating magnetic field which surrounds

the conductor; this loss is generally small compared with the sheath circuit loss.

Sheath circuit loss only occurs if two or more sections of the lead sheath are bonded together as, for example, by earthing the sheath at various points.

In this country however it is standard practice, when using single-core cables, to form a single-phase or 3-phase transmission system, to bond and earth the lead sheaths of the single-core cables at both ends of the cable run; published current-rating tables state that the cable run shall be "bonded at both ends."

Referring again to Fig. 1, it should be noted that the copper losses produce a flow of heat through the dielectric, lead sheaths, textile servings, and ground while the heat flow due to the losses generated in the lead sheath have only to traverse the latter two components of the heat-flow path.

TABLE I
 STANDARD RESISTANCE OF STRANDED CONDUCTORS FOR SINGLE-CORE CABLES
 British Practise

Nominal Area in Square Inches	No. and Diameter of Wires in Inches	Diameter (d) of Circular Conductor in Inches	Standard Resistance at Temperature Indicated in Degrees Centigrade									
			15.6	15.6	45	50	55	60	65	70	75	80
			Ohms/1000 yards	Ohms/centimetre $\times 10^{-6}$								
0.007	7/0.036	0.108	3.427	37.48	41.89	42.64	43.39	44.14	44.89	45.64	46.39	47.13
0.01	7/0.044	0.132	2.294	25.09	28.04	28.54	29.04	29.55	30.05	30.55	31.05	31.55
0.0145	7/0.052	0.156	1.643	17.97	20.08	20.44	20.80	21.16	21.52	21.88	22.24	22.60
0.0225	7/0.064	0.192	1.084	11.85	13.24	13.48	13.72	13.95	14.19	14.43	14.67	14.90
0.03	19/0.044	0.220	0.8468	9.261	10.35	10.54	10.72	10.91	11.09	11.28	11.46	11.65
0.04	19/0.052	0.260	0.6063	6.631	7.411	7.543	7.676	7.809	7.941	8.074	8.207	8.339
0.06	19/0.064	0.320	0.4002	4.337	4.892	4.979	5.067	5.154	5.242	5.329	5.417	5.504
0.075	19/0.072	0.360	0.3162	3.458	3.865	3.934	4.003	4.072	4.141	4.210	4.280	4.349
0.1	19/0.083	0.415	0.2380	2.603	2.909	2.961	3.013	3.065	3.117	3.169	3.221	3.273
0.12	37/0.064	0.448	0.2056	2.248	2.512	2.557	2.602	2.647	2.692	2.737	2.782	2.827
0.15	37/0.072	0.504	0.1625	1.777	1.986	2.022	2.057	2.093	2.128	2.164	2.199	2.235
0.2	37/0.083	0.581	0.1223	1.337	1.494	1.521	1.548	1.574	1.601	1.628	1.655	1.681
0.25	37/0.093	0.651	0.09738	1.065	1.190	1.212	1.233	1.254	1.275	1.297	1.318	1.339
0.3	37/0.103	0.721	0.07939	0.8682	0.9703	0.9877	1.005	1.022	1.040	1.057	1.074	1.092
0.4	61/0.093	0.837	0.05908	0.6461	0.7221	0.7350	0.7479	0.7608	0.7738	0.7867	0.7996	0.8125
0.5	61/0.103	0.927	0.04816	0.5267	0.5886	0.5992	0.6097	0.6202	0.6308	0.6413	0.6518	0.6624
0.6	91/0.093	1.023	0.3961	0.4332	0.4841	0.4928	0.5015	0.5101	0.5188	0.5275	0.5361	0.5448
0.75	91/0.103	1.133	0.03229	0.3531	0.3946	0.4017	0.4087	0.4158	0.4229	0.4299	0.4370	0.4440
0.85	127/0.093	1.209	0.02838	0.3104	0.3469	0.3531	0.3593	0.3655	0.3717	0.3779	0.3842	0.3903
1.0	127/0.103	1.339	0.02314	0.2531	0.2829	0.2879	0.2930	0.2981	0.3031	0.3082	0.3132	0.3183
1.25	127/0.112	1.456	0.01957	0.2140	0.2392	0.2434	0.2477	0.2520	0.2563	0.2606	0.2648	0.2691
1.5	169/0.107	1.605	0.01611	0.1762	0.1969	0.2004	0.2040	0.2075	0.2110	0.2145	0.2181	0.2216

Table II summarises data for the three formations of single-conductor cables normally used in practice. Of the three methods, the trefoil (triangular) arrangement is most widely adopted and for that reason is the only method considered in detail in the examples which follow.

The combined sheath losses, eddy current, and sheath current, in a single-core cable, when expressed as a fraction of the copper losses, is given by the following formula:

$$\lambda = R_s \left[\left(\frac{X^2}{R_s^2 + X^2} \right) + \frac{0.0044 (r_L)^2}{R_s S} \right], \quad (4)$$

- where λ = sheath-loss/copper-loss ratio,
- R_s = sheath resistance per 1 000 yards at the operating temperature of the sheath,
- X = sheath reactance in ohms per 1 000 yards
 $= 0.132 \log_{10} (S/r_L)$ (5)
- S = spacing between cable centres, and
- r_L = mean radius of lead sheath.

Using available tables, it is customary to express all values in formula (4) per 1 000 yards,

although the cable dimensions are expressed both in inches or in centimetres.

Formula (4), simplified for practical application, is based on a supply frequency of 50 cycles per second and is only applicable to the case of 3 single-core cables in trefoil formation with the lead sheaths bonded and earthed at both ends.

The first term on the right-hand side of formula (4) refers to the sheath circuit losses, while the second term allows for the sheath eddy loss, which is usually small and can, therefore, be neglected in most cases.

The ohmic resistance R_s of the lead sheath per 1 000 yards at a sheath temperature θ_s above 20 degrees centigrade is obtained from the following formula:

$$R_s = \frac{0.3878(1 + 0.004\theta_s)}{(D_1^2 - D_2^2)}, \quad (6)$$

- where D_1 = diameter over the lead sheath (inches), and
- D_2 = diameter under the lead sheath (inches).

TABLE IA
AMERICAN WIRE GAUGE CONDUCTORS, DIMENSIONS AND RESISTANCES

Copper Size		No. of Wires	Diameter of Wires in Inches	Conductor Diameter in Inches	Area in Square Inches	Skin-Effect Ratio			Effective Resistance per 1 000 Feet in Ohms					
AWG	Circular Mils					25 C/S	50 C/S	60 C/S	DC 25° C	25 C/S 80° C	50 C/S 80° C	60 C/S 85° C	60 C/S 80° C	60 C/S 70° C
12	6,530	7	0.0305	0.092	0.0051	1.00	1.00	1.00	1.680	2.035	2.035	2.065	2.035	1.970
10	10,380	7	0.0385	0.115	0.0082	1.00	1.00	1.00	1.057	1.281	1.281	1.300	1.281	1.240
8	16,510	7	0.0486	0.146	0.0127	1.00	1.00	1.00	0.654	0.793	0.793	0.805	0.793	0.768
6	26,250	7	0.0612	0.184	0.0206	1.00	1.00	1.00	0.410	0.497	0.497	0.504	0.497	0.481
4	41,740	7	0.0772	0.232	0.0328	1.00	1.001	1.00	0.259	0.314	0.315	0.319	0.314	0.304
2	66,370	7	0.0974	0.292	0.0522	1.00	1.001	1.001	0.162	0.196	0.197	0.1995	0.196	0.190
1/0	105,500	19	0.0745	0.373	0.083	1.00	1.001	1.001	0.102	0.124	0.125	0.126	0.124	0.120
2/0	133,100	19	0.0837	0.438	0.1047	1.00	1.002	1.002	0.0811	0.0984	0.099	0.100	0.099	0.0958
3/0	167,800	19	0.0940	0.470	0.1315	1.00	1.003	1.003	0.0642	0.0778	0.0782	0.0790	0.0782	0.0757
4/0	211,600	19	0.1055	0.528	0.166	1.00	1.004	1.004	0.0509	0.0617	0.0620	0.0628	0.0622	0.0602
	250,000	37	0.0822	0.575	0.196	1.001	1.005	1.005	0.0431	0.0522	0.0525	0.0532	0.0525	0.0508
	300,000	37	0.0900	0.630	0.236	1.002	1.006	1.006	0.0360	0.0437	0.0440	0.0446	0.0438	0.0425
	350,000	37	0.0973	0.681	0.275	1.002	1.006	1.008	0.0308	0.0374	0.0377	0.0382	0.0378	0.0366
	400,000	37	0.1040	0.728	0.314	1.003	1.009	1.010	0.0270	0.0327	0.0330	0.0336	0.0331	0.0320
	450,000	37	0.1103	0.772	0.354	1.003	1.011	1.014	0.0240	0.0291	0.0294	0.030	0.0295	0.0286
	500,000	37	0.1162	0.814	0.393	1.004	1.014	1.016	0.0216	0.0272	0.0265	0.0271	0.0266	0.0258
	600,000	61	0.0992	0.893	0.472	1.005	1.018	1.023	0.0180	0.0219	0.0222	0.0227	0.0224	0.0217
	750,000	61	0.1109	0.998	0.589	1.007	1.029	1.036	0.0144	0.0176	0.0179	0.0184	0.0181	0.0175
	800,000	61	0.1145	1.031	0.628	1.008	1.032	1.041	0.0135	0.0165	0.0169	0.0173	0.0171	0.0166
	1,000,000	61	0.1280	1.152	0.787	1.012	1.05	1.065	0.0108	0.0132	0.0137	0.0142	0.0140	0.0136
	1,250,000	91	0.1172	1.289	0.983	1.019	1.076	1.102	0.00863	0.01065	0.0112	0.0117	0.0115	0.0111
	1,500,000	91	0.1284	1.412	1.178	1.027	1.106	1.142	0.00719	0.00895	0.00962	0.0101	0.00995	0.00965
	1,750,000	127	0.1174	1.526	1.374	1.037	1.136	1.185	0.00616	0.00771	0.00846	0.00899	0.00885	0.00857
	2,000,000	127	0.1255	1.632	1.572	1.048	1.167	1.233	0.00539	0.00681	0.00765	0.00820	0.00806	0.00780
	2,500,000	169	0.1216	1.824	1.962	1.071	1.230	1.326	0.00436	0.00565	0.00652	0.00712	0.00700	0.00678

For the purpose of computing the lead-sheath resistance by formula (6), the resistivity of lead (or lead alloy) at 20 degrees centigrade has been taken as 0.215 ohm per square millimetre per

metre, and the temperature coefficient for the normal range of sheath temperatures experienced in practice is 0.004.

An approximate value of the sheath-surface-

TABLE II
INSTALLATION OF SINGLE-CORE CABLES
All Formulae Based on 1,000-Yard Run and a Frequency of 50 Cycles per Second

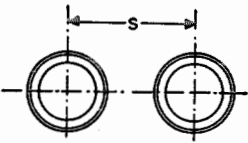
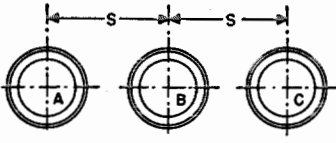
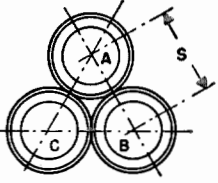
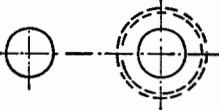
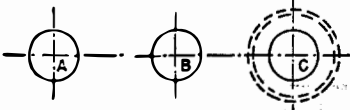
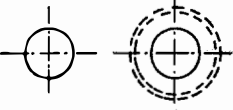
	Single Phase	3-Phase Flat Formation*	3-Phase Trefoil Formation
Installation Formation			
Reactance	Reactance in ohms between two conductors and one lead sheath. $X = 0.132 \log_{10} \left(\frac{S}{r_L} \right)$	Reactance in ohms between the conductors of cables B and A carrying single-phase current and the sheath of cable C, when the conductor of cable C is carrying no current. $X_M = 0.421\omega (\log_{10}^2) \times 10^{-3}$ $= 0.04 \text{ ohm per 1 000 yards at } 50 \text{ c/s.}$	Reactance in ohms between two conductors and one lead sheath. $X = 0.132 \log_{10} \left(\frac{S}{r_L} \right)$
			
Electromotive force in volts between open ends of any two sheaths, far end bonded	$= 2XI$ $= 0.264I \times \log_{10} \left(\frac{S}{r_L} \right)$	$= \sqrt{3}I(X + \frac{1}{3}X_M)$	$= 0.403I \log_{10} \left(\frac{S}{r_L} \right)$
Total sheath circuit and sheath eddy losses in watts for all sheaths, bonded at both ends	$= 2I^2 \left[R_s \left(\frac{X^2}{R_s^2 + X^2} \right) + \frac{0.0029}{R_s} \left(\frac{r_L}{S} \right)^2 \right]$	$= 3I^2 \left[\frac{R_s}{2} \left(\frac{P^2}{R_s^2 + P^2} + \frac{Q^2}{R_s^2 + Q^2} \right) + \frac{0.0044}{R_s} \left(\frac{r_L}{S} \right)^2 \right]$	$= 3I^2 \left[R_s \left(\frac{X^2}{R_s^2 + X^2} \right) + \frac{0.0044}{R_s} \left(\frac{r_L}{S} \right)^2 \right]$

Notes: In Great Britain, lead sheaths are always bonded for the following reasons:

- a. When single-core cables are run together unbonded, the lead sheath is cut by the alternating flux arising from the current flowing in the conductor which in turn induces a voltage (colloquially known as a "standing voltage") in each of the sheaths. Under short-circuit conditions, this induced voltage can reach a dangerous value.
 - b. Where bonding is not used, intermittent contact of the sheaths may occur and cause serious pitting of the lead sheaths.
- * Three-phase flat formation: Transposition of the single-core cable at every joint is standard practice to equalise and minimise sheath losses. If the cables are not transposed, the losses are different in the two outer cables depending on the phase sequences.

Symbols

- I = current in conductor (amperes),
- P = $(X + X_M)$,
- Q = $(X - \frac{1}{3}X_M)$,
- r_L = mean radius of lead sheath,
- R_s = lead-sheath resistance at the operating temperature of the sheath,
- S = axial spacing between cable centres,
- X = lead-sheath reactance,
- X_M = reactance between the conductors of the middle and one outer cable (i.e., B and A) when carrying single-phase current and the sheath of the other outer cable (C) which is carrying no current, and
- ω = $2\pi \times$ frequency in cycles per second (= 314 at 50 cycles per second).

temperature rise (θ_s) can be obtained from the formula:

$$\theta_s = \frac{\theta \times (\text{external thermal resistance})}{\text{total thermal resistance}} \quad (7)$$

The external thermal resistance G_E for cables laid in the ground is obtained from formula (12) (Section 7) or Fig. 6, and for cables in air, Section 10 gives the required data so that the total thermal resistance in the denominator is equal to $G' + G_s + G_E$ (or G_A in place of G_E for cables in air)

After calculating λ , the value may be substituted directly in formula (2), or the current rating can be computed from formula (1) and a correction factor for the effect of the lead-sheath loss may be obtained as follows:

$$S_L = \sqrt{\frac{G' + G_s + G_E}{G' + (1 + \lambda)(G_s + G_E)}} \quad (8)$$

4. Estimation of Dielectric Losses; Correction Factor (Δ)

At 33 kilovolts and lower, the additional heating effect due to the dielectric losses is small and may be neglected, but for higher voltages these losses increase in importance and allowance must be made to ensure that the maximum conductor temperature is not exceeded.

By analogy with an electric circuit, the corresponding fundamental relationship for the thermal circuit is known as "Ohm's law for heat flow" and the temperature drop Δ is given by:

$$\Delta = D_L \times \Sigma G_T \quad (9)$$

where D_L = heating due to dielectric loss in watts /centimetre length, and
 ΣG_T = sum of individual thermal resistances = $G' + G_s + G_E$ (or G_A), assuming for estimating purposes that the total dielectric loss occurs at the conductor surface.

Fig. 4 gives the dielectric loss D_L per phase for 33- and 66-kilovolt single-core cables based on a permittivity (or dielectric constant) of 3.7 and a power factor of 0.005 at the maximum conductor operating temperature of 60 degrees centigrade. For cables in ducts, the maximum conductor temperature is 50 degrees centigrade and the

corresponding value of power factor has been taken as 0.004.

Power-factor values will vary with different manufacturing plants, impregnating compounds, insulating papers, etc., but the above values are

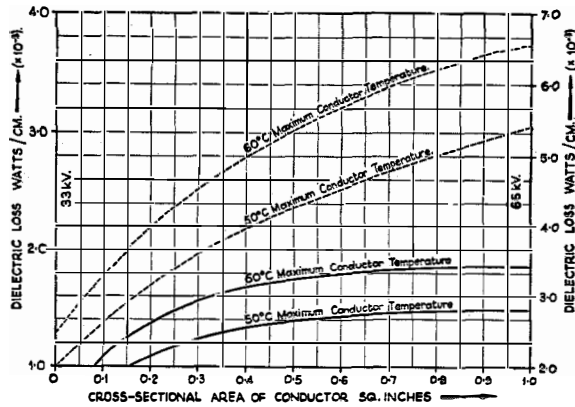

Fig. 4—Dielectric-loss curves (solid) for 33- and (dashed) 66-kilovolt single-core cables based on permittivity or dielectric constant of 3.7 and a power factor of 0.004 at 50 degrees and 0.005 at 60 degrees centigrade. The maximum conductor temperature is noted on each curve. For loss in watts/1 000 yards, multiply curve value by 91.5×10^{-3} and for watts/mile multiply by 161×10^{-3} .

sufficiently accurate for computing the dielectric losses for current-rating calculations. Having calculated the total thermal resistance for a single-core cable and multiplied it by the dielectric loss in watts/centimetre length obtained from Fig. 4, the dielectric temperature drop Δ thus obtained should be deducted from the total permissible temperature drop θ , formula (1), to ensure that the maximum conductor temperature as specified in Table IV is not exceeded.

A correction factor for the additional heating due to dielectric losses is obtained from the expression:

$$\sqrt{\frac{\theta - \Delta}{\theta}} \quad (10)$$

Table III gives correction factors to allow for dielectric losses for the range of 33- and 66-kilovolt single-core solid-type cables. These factors have been computed by the method shown in the detailed examples which follow.

The rating computed by using formula (1) (see Section 8.1 etc.) is to be multiplied by the correction factor. The correction factors given

in Table III are based on cables having the dimensions given in Table V and these factors can be used for cables laid direct, in air, or in ducts, as no practical difference has been found when calculations were made to ascertain correction factors for all three installation conditions.

TABLE III
CORRECTION FACTORS FOR DIELECTRIC LOSSES ON 33- AND 66-KILOVOLT SINGLE-CORE SOLID-TYPE CABLES

Nominal Area of Conductor (Square Inches)	33 Kilovolts	66 Kilovolts
0.06	—	—
0.1	0.997	—
0.15	0.997	—
0.2	0.996	0.985
0.25	0.996	0.984
0.3	0.996	0.984
0.4	0.995	0.983
0.5	0.995	0.982
0.6	0.994	—
0.75	0.993	—

With increasing service voltage, the dielectric losses tend to assume much greater significance, and for operation at 132 kilovolts and higher, special consideration has to be given from both the design and manufacturing angle to minimise this loss.

5. Permissible Temperature Limits and Standard Depths of Laying

Table IV summarises established safe temperature limits for single-conductor cables, the permissible temperature rise θ , and also the depths of laying as standardised in Great Britain.

TABLE IV
PERMISSIBLE TEMPERATURE RISE AND DEPTH OF LAYING, GREAT BRITAIN

System Voltage in Kilovolts	Permissible Temperature Rise θ °C			Maximum Permissible Core Temperature		Depth of Laying in Inches to Top of Cable
	Laid Direct	In Air	In Ducts	Laid Direct or in Air	In Ducts	
1.5 and lower	55	45	35	70	50	18
3.3-11	55	45	35	70	50	36
22	50	40	35	65	50	36
33 and 66, Oval Conductors	50	40	35	65	50	42
33 and 66, Round Conductors	45	35	35	60	50	42

Table IV A gives the copper temperature limits used in the U. S. A. for rating purposes.

TABLE IV A
MAXIMUM PERMISSIBLE COPPER TEMPERATURE, U. S. A.

System Voltage in Kilovolts	Maximum Copper Temperature °C
7	85
12	83
27	74
35	70
46	63
69	60

The standard figure for the soil ambient temperature for cables laid direct is 15 degrees centigrade and, for cables installed in free air, the ambient temperature is taken as 25 degrees centigrade.

6. Cable Dimensions

Table V gives design data for the range of standard single-core paper-insulated cables used in Great Britain. For 22 kilovolts and lower, design data in the table have been extracted from B.S. 480—1942. Table VA gives similar data for the U.S.A.

There is no British Standard specification published for 33 kilovolts and higher, but the data given in Table V are based on sound manufacturing practice and experience, resulting from long-term investigations into high-voltage phenomena.

It is possible that the volume of test data and operational experience now available will tend towards a reduction in the insulation and lead thickness for 33- and 66-kilovolt cables in the near future; any deviation within reasonable limits from the thicknesses quoted in Table V will not introduce serious error in current-rating calculations.

Section 15 explains in detail the reason for not armouring single-core cables with steel tape or steel wire, and the standard serving over the lead sheath is either:

- a. Two bituminous compounded paper tapes, one compounded cotton tape, and one compounded hessian tape (P₂CH), or
- b. Two bituminous compounded paper tapes and two compounded hessian tapes (P₂H), or

c. Two bituminous compounded paper tapes, jute serving, heavily compounded overall (P₂J).

The most widely used serving for single-core cables of the three detailed above is (P₂CH).

D = diameter over paper insulation, and d = conductor diameter (see column 3 of Table I).

The thermal resistance of single-core cables can also be readily obtained from Fig. 5.

7. Thermal Resistances

Fig. 1 illustrates the heat-flow path for single-core cables laid direct in trefoil formation, vertex upward, and the magnitude of the individual thermal resistances which comprise the heat-flow path can be calculated as follows.

Each partial resistance may be split into two components, one being essentially the thermal resistivity of the material K and the other, the geometric factor, which is a function of the shape of the material through which the heat passes.

The internal thermal resistance G' (i.e., between copper conductor and lead sheath) is calculated from the formula:

$$G' = \frac{K}{2\pi} \log_e \frac{D}{d}, \tag{11}$$

where G' = internal thermal resistance in thermal ohms/centimetre length of cable,

7.1 THERMAL RESISTIVITY OF CABLE MATERIALS

The following values are standardized in Great Britain for the thermal resistivity of each part of the cable through which the generated heat flows:

a. Dielectric

(Impregnated Paper) $K = 750^\circ \text{ C/watt/cm}$ for 1.5 kilovolts and lower,

$K = 550^\circ \text{ C/watt/cm}$ for higher voltages.

b. Textile protective coverings

$K_1 = 500^\circ \text{ C/watt/cm}$.

7.2 THERMAL RESISTANCE OF SERVINGS

The thermal resistance of the textile servings G_s , normally applied over the lead sheath, can also be obtained by formula (11), noting of

TABLE V
THICKNESS OF INSULATION AND LEAD SHEATH—BRITISH PRACTISE
Centre Point Earthed Only

Nominal Area of Conductor in Square Inches	Radial Thickness in Inches of Insulation and Lead Sheath (Insulation/Lead Sheath)						
	660 Volts	3.3 Kilovolts	6.6 Kilovolts	11 Kilovolts	22 Kilovolts	33 Kilovolts	66 Kilovolts
0.007	0.055/0.06	—	—	—	—	—	—
0.0145	0.055/0.06	—	—	—	—	—	—
0.0225	0.055/0.06	0.09/0.06	0.12/0.06	0.15/0.06	—	—	—
0.04	0.055/0.06	0.09/0.06	0.12/0.06	0.15/0.06	0.24/0.10	—	—
0.06	0.055/0.06	0.09/0.06	0.12/0.06	0.15/0.06	0.24/0.10	0.40/0.10	—
0.10	0.055/0.06	0.09/0.06	0.12/0.07	0.15/0.07	0.24/0.10	0.40/0.10	—
0.15	0.055/0.06	0.09/0.07	0.12/0.07	0.15/0.07	0.24/0.10	0.40/0.10	0.65/0.14
0.20	0.055/0.07	0.09/0.07	0.12/0.07	0.15/0.07	0.24/0.10	0.40/0.11	0.65/0.14
0.25	0.06/0.07	0.09/0.07	0.12/0.08	0.15/0.08	0.24/0.10	0.40/0.11	0.65/0.14
0.30	0.06/0.07	0.09/0.08	0.12/0.08	0.15/0.08	0.24/0.10	0.40/0.11	0.65/0.15
0.40	0.07/0.08	0.10/0.08	0.13/0.08	0.16/0.09	0.24/0.10	0.40/0.11	0.65/0.15
0.50	0.07/0.08	0.11/0.09	0.14/0.09	0.17/0.09	0.24/0.10	0.45/0.12	0.65/0.15
0.60	0.08/0.09	0.12/0.09	0.15/0.09	0.18/0.09	0.24/0.10	0.47/0.13	—
0.75	0.09/0.09	0.13/0.11	0.16/0.10	0.19/0.10	0.24/0.10	0.50/0.14	—
1.00	0.09/0.10	—	—	—	—	—	—
1.25	0.10/0.11	—	—	—	—	—	—
1.50	0.11/0.11	—	—	—	—	—	—

Note: Dimensions for the range 660 volts to 22 kilovolts (inclusive) are extracted from B.S. 480—1942 and are minimum values at any point of the cable, i.e., the thicknesses specified are subject to the addition of standard works' tolerances.

TABLE VA
THICKNESS OF INSULATION AND LEAD SHEATH—U.S.A. PRACTISE
Centre Point Earthed Only (Grounded Neutral)

Copper Size in Circular Mils	Radial Thickness in Inches of Insulation and Lead Sheath (Insulation/Lead Sheath)						
	1 Kilovolt	3 Kilovolts	7 Kilovolts	12 Kilovolts	27 Kilovolts	35 Kilovolts	69 Kilovolts
16,510	0.060/0.080	0.075/0.080	—	—	—	—	—
26,250	0.060/0.080	0.075/0.080	0.140/0.080	0.195/0.080	—	—	—
41,740	0.060/0.080	0.075/0.080	0.135/0.080	0.190/0.080	—	—	—
66,370	0.060/0.080	0.075/0.080	0.130/0.080	0.180/0.080	—	—	—
105,500	0.060/0.080	0.075/0.080	0.125/0.080	0.170/0.080	0.315/0.090	0.395/0.090	—
133,100	0.060/0.080	0.075/0.080	0.120/0.080	0.165/0.085	0.305/0.090	0.385/0.090	—
167,800	0.060/0.080	0.075/0.080	0.120/0.080	0.165/0.085	0.305/0.090	0.385/0.100	—
211,600	0.060/0.080	0.075/0.080	0.110/0.085	0.155/0.085	0.285/0.090	0.355/0.100	—
250,000	0.060/0.080	0.075/0.080	0.110/0.085	0.150/0.085	0.275/0.090	0.350/0.100	—
300,000	0.060/0.085	0.075/0.085	0.110/0.085	0.150/0.085	0.275/0.090	0.345/0.100	—
350,000	0.060/0.085	0.075/0.085	0.110/0.085	0.150/0.090	0.275/0.100	0.345/0.100	0.650/0.120
400,000	0.060/0.085	0.075/0.085	0.110/0.085	0.150/0.090	0.275/0.100	0.345/0.100	0.650/0.120
450,000	0.060/0.085	0.075/0.085	0.110/0.090	0.150/0.090	0.275/0.100	0.345/0.105	0.650/0.120
500,000	0.060/0.085	0.075/0.085	0.110/0.090	0.150/0.090	0.275/0.100	0.345/0.105	0.650/0.120
600,000	0.060/0.090	0.075/0.090	0.110/0.090	0.150/0.090	0.275/0.100	0.345/0.105	0.650/0.125
750,000	0.060/0.090	0.075/0.090	0.110/0.090	0.150/0.100	0.275/0.105	0.345/0.105	0.650/0.125
800,000	0.060/0.090	0.075/0.090	0.110/0.100	0.150/0.100	0.275/0.105	0.345/0.110	0.650/0.125
1,000,000	0.060/0.100	0.075/0.100	0.110/0.100	0.150/0.100	0.275/0.105	0.345/0.110	0.650/0.135
1,250,000	—	—	0.110/0.105	0.150/0.105	0.275/0.110	0.345/0.110	0.650/0.135
1,500,000	—	—	0.110/0.105	0.150/0.110	0.275/0.110	0.345/0.120	0.650/0.140
1,750,000	—	—	0.110/0.110	0.150/0.110	0.275/0.120	0.345/0.125	0.650/0.140
2,000,000	—	—	0.110/0.110	0.150/0.110	0.275/0.120	0.345/0.125	0.650/0.145
2,500,000	—	—	0.110/0.120	0.150/0.120	0.275/0.125	0.345/0.135	0.650/0.145

Note: Thicknesses are average values and minimum thicknesses must not be less than 90 percent of the values specified.

course that the thermal resistivity of the dielectric K is replaced by thermal resistivity of the textile serving $K_1 = 500^\circ \text{C/watt/cm}$, or the

thermal resistance of the serving can be obtained from Fig. 5, using for the abscissa the ratio of the diameter over the textile serving to the diameter over the lead sheath.

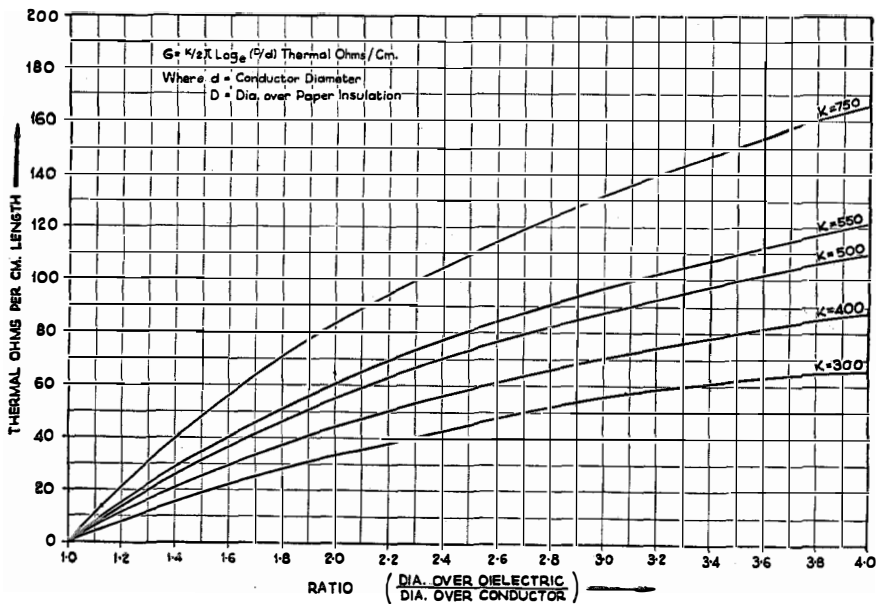

Fig. 5—Thermal resistance of the dielectric of single-core cables.

7.3 THERMAL RESISTIVITY OF SOIL

Soil thermal resistivity $g = 120^\circ \text{C/watt/cm}$ is the accepted standard value, but it may vary widely with the nature of the soil and its moisture content.

It is standard practice to bury single-core cables in trefoil groups and the thermal resistance between the outer covering of a cable forming part of a trefoil group, vertex up-

wards, and the surface of the earth is given by

$$G_E = \frac{g}{2\pi} \log_e \frac{(2h_1 - r_e)^2}{\sqrt{5}r_e^2} + \frac{g}{4\pi} \log_e \frac{(h_1 + h - r_e)^2 + r_e^2}{(h_1 - h - r_e)^2 + r_e^2}, \quad (12)$$

or for 33 kilovolts and higher-voltage cables

$$G_E = 44 \log_{10} \frac{(2h_1 - r_e)^2}{2.24r_e^2} + 22 \log_{10} \frac{(h_1 + h - r_e)^2 + r_e^2}{(h_1 - h - r_e)^2 + r_e^2}, \quad (13)$$

where r_e = over-all radius of cable,
 h = axial depth of the upper cable (= 42 inches + r_e), and
 h_1 = axial depth of the lower cable (= 42 inches + $2.73r_e$).

The above formulas give the external thermal resistance of the lowest and hottest of 3 similar cables touching in trefoil formation, with vertex upwards, plus the increase in thermal resistance which results from mutual heating due to the close proximity of the other 2 cables. To minimize calculations, the soil thermal resistance G_E for cables laid at 42-inch depth can be readily obtained from Fig. 6 if the over-all diameter of one cable in the group is known.

8. Cables Laid Direct

8.1 CALCULATIONS FOR 0.25-SQUARE-INCH CABLE

Table VI gives design data for a 0.25-square-inch single-core paper-insulated lead-covered cable served overall with two compounded paper tapes, one compounded cotton tape, and one compounded hessian tape, for 33-kilovolt working pressure, laid direct in the ground at 42-inch depth in trefoil formation, vertex upward (see Table IV).

8.1.1 Internal Thermal Resistance

$$\text{Ratio} \left(\frac{\text{diameter over insulation}}{\text{diameter over conductor}} \right) = \frac{1.451}{0.651} = 2.23.$$

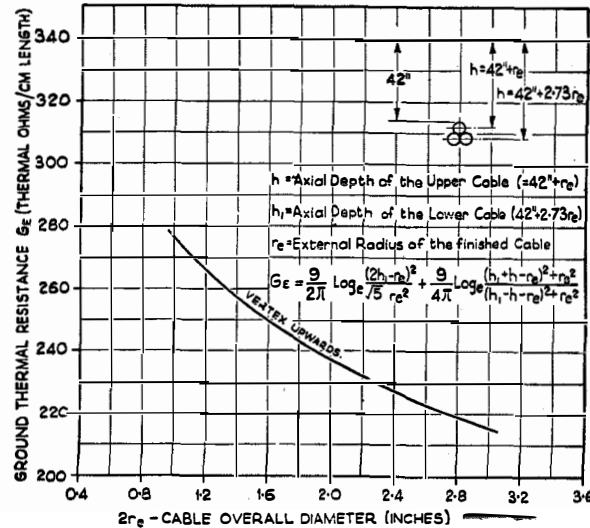

Fig. 6—Thermal resistance of 3 single-core cables in trefoil formation, vertex upward, laid direct in the ground at a depth of 42 inches. Cables are for 33- and 66-kilovolt working pressure.

Referring now to Fig. 5, for $K = 550$ (Section 7), the internal thermal resistance $G' = 70.5$ thermal ohms/centimetre length.

8.1.2 Thermal Resistance of Servings

$$\text{Ratio} \left(\frac{\text{diameter over servings}}{\text{diameter over lead sheath}} \right) = \frac{1.870}{1.69} = 1.11.$$

For $K = 500$, from Fig. 5, the thermal resistance of the textile servings $G_s = 8.5$ thermal ohms/centimetre length.

8.1.3 Ground Thermal Resistance, Trefoil Group, Vertex Upward

Over-all diameter of one single cable = 1.87 inches.

Referring to Fig. 6, $G_E = 241$ thermal ohms/centimetre length, therefore $\Sigma G_T = 70.5 + 8.5 + 241 = 320$ thermal ohms/centimetre length.

TABLE VI
DATA FOR 0.25-SQUARE-INCH CABLE

Design		Diameter (Inches)	Remarks
Conductor	0.25 square inch = 37/093, circular 0.400-inch radial thickness 0.110-inch radial thickness	0.651	Table I, Col. 3 Table V Table V, Tolerance on sheath thickness allowed
Insulation		1.451	
Lead Sheath		1.690	
Servings (P ₂ CH)	Two compounded papers One compounded cotton tape One compounded hessian tape	1.870	Allowance made for protective compounds

8.1.4 Uncorrected Current Rating

Final conductor temperature (Table IV) = 60 degrees centigrade. Ground temperature (Section 5) = 15 degrees centigrade, therefore permissible temperature rise = (60 - 15) = 45 degrees centigrade. Conductor resistance of 60 degrees centigrade (Table I) = 1.254×10^{-6} ohm/centimetre.

Current rating without allowing for sheath losses or skin and proximity effects (formula (1)):

$$I = \sqrt{\frac{\theta}{R_{\theta} \times \Sigma G_T}} = \sqrt{\frac{45}{1.254 \times 10^{-6} \times 320}} = 335 \text{ amperes.}$$

8.1.5 Sheath Circuit Loss (Section 3)

First it is necessary to obtain the approximate value of the surface-temperature rise (formula 7):

$$\theta_s = \frac{\theta \times (\text{external thermal resistance } G_E)}{\text{total thermal resistance } G' + G_s + G_E} = \frac{45 \times 241}{320} = 33.7 \text{ degrees centigrade.}$$

Lead-sheath resistance R_s at 33.7 degrees centigrade is computed by formula (6)

$$R_s = \frac{0.3878[1 + 0.004(33.7 - 20)]}{(1.69^2 - 1.451^2)} = \frac{0.409}{0.75} = 0.545 \text{ ohm/1 000 yards.}$$

Lead-sheath reactance X by formula (5):

$$X = 0.132 \log_{10} \left(\frac{S}{r} \right) = 0.132 \log_{10} \left(\frac{1.87}{0.79} \right) = 0.0495 \text{ ohm/1 000 yards.}$$

Therefore, sheath circuit loss (Section 3)

$$= R_s \left(\frac{X^2}{R^2 + X^2} \right) = 0.545 \left(\frac{0.0495^2}{0.542^2 + 0.0495^2} \right) = 0.0045.$$

8.1.6 Sheath Eddy Loss

Using the latter part of formula (4) in Section 3,

$$\frac{0.0044 \left(\frac{r}{S} \right)^2}{R_s} = \frac{0.0044 \left(\frac{0.79}{1.87} \right)^2}{0.545} = 0.0014.$$

Total sheath loss/1 000 yards of cable = $0.0045 + 0.0014 = 0.0059$.

8.1.7 Sheath/Copper Loss

Referring now to column 9 of Table I, the ohmic resistance/centimetre at 60 degrees centigrade = 1.254×10^{-6} ohm so that

$$\lambda = \text{Ratio} \left(\frac{\text{sheath loss}}{\text{copper loss}} \right) = \frac{0.0059}{1.254 \times 10^{-6} \times 2.54 \times 36 \times 1,760} = 0.029 = 2.9 \text{ percent.}$$

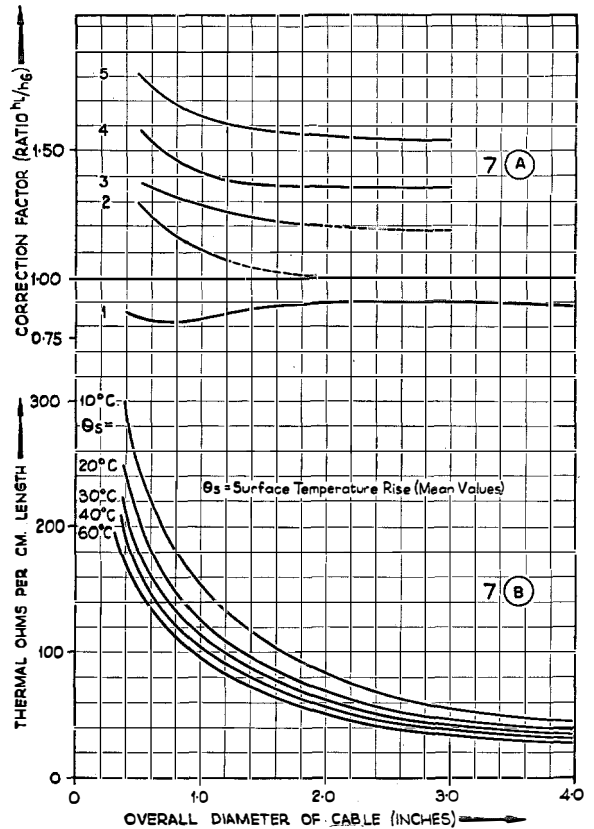

Fig. 7A—Correction factors for the ratio of h_L/h_G plotted against cable diameter (extrapolations dotted) for the following types of cable:

1. Single-core lead-covered and served cable.
2. Two single-core lead-covered and served cables, touching in flat formation, one above the other.
3. Two single-core plain-lead-covered cables, touching in flat formation, one above the other.
4. Three single-core lead-covered and served cables, touching in trefoil formation, vertex upward.
5. Three single-core plain-lead-covered cables, touching in trefoil formation, vertex upward.

Fig. 7B—Thermal resistance of air plotted against diameter for a single-core plain-lead-covered cable. Curves are identified for mean values of surface-temperature rise θ_s .

8.1.8 Correction Factors

Correction factor for sheath loss (formula (8))

$$= \sqrt{\frac{320}{70.5 + (8.5 + 241)1.029}} = 0.99.$$

From Fig. 2, skin effect y for 0.25-square-inch copper section = 0.006, the proximity effect y_1

from Fig. 3, (for $S_1 = 1.87$) = 0.0025, therefore $R_T = 1.0085R$.

Correction factor for skin and proximity effects:

$$\sqrt{\frac{100}{100.85}} = 0.995.$$

TABLE VII
DATA FOR 0.75-SQUARE-INCH CABLE

Design		Diameter (Inches)	Remarks
Conductor	0.75 square inch = 91/103, conductor	1.133	Table I, Col. 3
Insulation	0.500-inch radial thickness	2.133	Table V
Lead Sheath	0.140-inch radial thickness	2.430	Table V, Tolerance on sheath thickness allowed
Servings (P ₂ CH)	Two compounded paper tapes } One compounded cotton tape } One compounded hessian tape }	2.610	Allowances made for protective compounds

TABLE VIII

Thermal Path	Cable Data	Reference	
G'	$= D/d = \frac{2.133}{1.133} = 1.88$ and $K = 550$	Fig. 5	54.5
G_s	$\left(\frac{\text{diameter over textile serving}}{\text{diameter over lead sheath}} \right) = \frac{2.61}{2.43} = 1.074$ and $K = 500$	Fig. 5	6.5
G_E	Overall diameter of one cable = 2.61 inches	Fig. 6	226.0
G_T	$= G' + G_s + G_E$		<u>287</u>
	Maximum permissible conductor temperature	Table IV	60° C
	Ground temperature	Section 5	15° C
	Therefore, permissible temperature rise $\theta = (60 - 15)^\circ \text{C}$	Table IV	45° C
	Conductor resistance at 60° C	Table I	0.4158×10^{-6}
I	Current Rating (not corrected for additional losses) amperes	Formula (1)	615
θ_s	$\frac{45 \times 226}{287}$	Formula (7)	35.4° C
R_s	$0.3878 \frac{[1 + 0.004(35.4 - 20)]}{(2.43^2 - 2.133^2)}$	Formula (6)	0.305 ohm/1 000 yd.
X	$0.132 \log_{10} \left(\frac{2.61}{1.214} \right)$	Formula (5)	0.044 ohm/1 000 yd.
Sheath Loss	$0.305 \left(\frac{0.044^2}{0.305^2 + 0.044^2} \right)$	Section 3	0.0062
Sheath Eddy Loss	$\frac{0.0044 \left(\frac{1.214}{2.61} \right)^2}{0.305}$	Section 3	<u>0.0032</u> 0.009
Ratio (Sheath Loss / Copper Loss) %	$\frac{0.009}{0.4158 \times 10^{-6} \times 161,000} = \frac{0.009}{0.067} = 0.134 = 13.4\%$	Section 3 and Table I	
	Therefore correction factor $\sqrt{\frac{100}{113.4}}$		0.94
Skin Effect y	0.75-square-inch-copper section	Fig. 2	0.046
Proximity Effect y_1	$S = 2.6$	Fig. 3	<u>0.013</u> 0.059
R_T		Section 2	<u>1.059</u>
Correction Factor for R_T	$= \sqrt{\frac{100}{105.9}}$		0.97
Dielectric Loss		Table III	0.993
I	Corrected current rating = $615 \times 0.94 \times 0.97 \times 0.993 = 558$ amperes		

Correction for dielectric loss (Section 4 and Fig. 4):

$G_T = 320$ thermal ohms/centimeter length of cable, therefore

$\Delta = 320 \times 1.49 \times 10^{-3} = 0.48$ degree centigrade, therefore maximum permissible temperature rise

$$= (45 - 0.48) = 44.52 \text{ degrees centigrade}$$

and correction factor

$$= \sqrt{\frac{44.52}{45}} = 0.996$$

(see Table III).

8.1.9 Corrected Current Rating:

$$\begin{aligned} &= 335 \times 0.99 \times 0.995 \times 0.996 \\ &= 328 \text{ amperes.} \end{aligned}$$

It will be noted in the above example that the corrections are very small and for practical purposes, could be ignored; these factors assume greater importance for larger copper sections and higher voltages.

8.2 CALCULATIONS FOR 0.75-SQUARE-INCH CABLE

Table VII contains the only differences between this cable and the one described in Section 8.1.

The following technical information has been calculated by exactly the same method as in example 8.1; therefore, some of the explanatory information has been omitted. (See Table VIII.)

9. Cables in Water (Submarine or Subaqueous)

All types of paper-insulated power cables when laid under water will have an increased permissible loading since the outer surface of the cable assumes approximately the water temperature and the theoretical rise of temperature of the conductor above that of the water is due mainly to the internal thermal resistance of the cable itself.

In practise however, the cable will be lying on the river or sea bed, probably partially or wholly buried in sand or mud, or it may be completely covered to a depth of several feet when laid in a river due to silting up resulting from tidal effects. This means the theoretical assumption of neg-

ligible external thermal resistance is not strictly correct but very little practical data are at present available on this subject.

As an approximation, a value of $g = 30$ may be used for computing the external thermal resistance of a submarine cable.

A number of current-rating calculations for submarine cables have been made which indicate, as a rough estimation, that an increase of 40 percent may be made when the cable is under water above the normal permissible loading for a similar cable buried direct in the ground at the standard depth of laying, and based on $g = 120$ and soil temperature of 15 degrees centigrade.

Single-core cables when laid in water will of course be run in flat formation. The 40-percent increase will not be applicable to shore ends which must be rated according to the method of installation.

10. Cables in Air

When cables are installed in free air, the ambient temperature is taken as 25 degrees centigrade for normal conditions (Section 5). When however the cables are installed in buildings, it is necessary to refer to the "I.E.E. Regulations for the Electrical Equipment of Buildings" for the permissible ratings; these tables are based on carefully defined conditions of installation, ambient temperature, method of grouping, etc.

The thermal resistance of single-core cables in air is obtained as follows. In Fig. 7B, the thermal resistance of a single-core cable, plain lead covered, in free air, is plotted against the cable diameter (inches) for various values of surface-temperature rise θ_s above ambient. These values are calculated from the formula

$$G_A = \frac{1}{\pi d h_c (\theta_s)^{\frac{1}{4}}}, \quad (14)$$

where G_A = thermal resistance of air,

d = diameter of the cable in centimetres,

θ_s = surface-temperature rise above the ambient, and

h_c = constant representing heat flow by convection, i.e., moving air; conduction, i.e., heat flow through the air; and radiation.

The value of h_c is taken as the mean between those applicable to bright and black surfaces for a single cable.

In Fig. 7A, the ratio (h_L/h_G) is plotted against the cable diameter where h_L is the value of h_c for a single cable, plain lead finish, and h_G is the value of h_c applying to other installation conditions.

For 33- and 66-kilovolt single-core cables in air, a mean value for θ_s , the surface-temperature rise is 22 degrees centigrade, based on the assumption that the cables are installed in trefoil formation with outer surfaces touching.

Table IX gives approximate values of θ_s for a very wide range of cables.

To use the curves of Fig. 7 :

From Table IX, find the approximate surface-temperature rise for the applicable conditions.

TABLE IX

APPROXIMATE VALUE OF SURFACE-TEMPERATURE RISE θ_s

Type of Cable	Temperature Rise in Degrees Centigrade			
	Core	Surface θ_s		
		a	b	c
2 Single-Core Low-Voltage Cables, DC	45	36.2	32.3	28.6
2 Single-Core Low-Voltage Cables, AC	45	35.4	31.5	—
3 Single-Core Cables, AC	45	37.1	34.1	—
3 Single-Core Cables, 22 kilovolts	40	29.2	26.9	—
3-Core, Belted, 1 and 3.3 kilovolts	45	34.5	30.5	28.5
3-Core, Belted, 22 kilovolts	30	18.3	16.7	15
3 Single-Core Cables, Trefoil Formation, H Type, 33 kilovolts	40	—	22	—
3 Single-Core Cables, Trefoil Formation, H Type, 66 kilovolts	40	—	22	—

Note: For 22 kilovolts and lower, the values of θ_s are drawn from Table No. 20 of E.R.A. Report F/T 117.

- a = Plain lead covered.
- b = Lead covered and served only.
- c = Lead covered, armoured, and served overall.

From Fig. 7B, find the external thermal resistance for a given cable diameter and value of θ_s .

For installations other than an isolated cable, plain lead covered, correct for different values of h_c by multiplying by the appropriate factor from Fig. 7A.

10.1 CALCULATIONS FOR 0.25-SQUARE-INCH CABLE

This calculation is for a 0.25-square-inch single-core paper-insulated 33-kilovolt lead-covered cable served overall with two compounded paper tapes, one compounded cotton tape, and one compounded hessian tape (P₂CH), laid in trefoil formation, vertex upward, in free air.

10.1.1 Internal Thermal Resistance

(See Section 8) $G' = 70.5$ thermal ohms/centimetre length.

10.1.2 Thermal Resistance of Servings

(See Section 8) $G_s = 8.5$ thermal ohms/centimetre length.

10.1.3 Thermal Resistance of Air Path

Referring to Fig. 7B for a cable 1.87 inches overall and $\theta_s = 22$ degrees centigrade (Table IX) $G_A = 72$ thermal ohms/centimeter length.

Entering Fig. 7A the corresponding factor for 3 single-core cables each paper insulated, lead covered and served, installed in trefoil formation (5 of Fig. 7A) = 1.37.

Thus thermal resistance of air path $G_A = 72 \times 1.37 = 99$ thermal ohms/centimetre length.

Therefore total thermal resistance $G_T = 70.5 + 8.5 + 99 = 178$ thermal ohms/centimetre length.

Final conductor temperature (Table IV) = 60 degrees centigrade, air temperature (Section 5) = 25 degrees centigrade.

Therefore permissible temperature rise (60 - 25) = 35 degrees centigrade.

Conductor resistance at 60 degrees centigrade (Table I) = 1.254×10^{-6} ohm/centimetre.

Current rating without allowing for sheath losses or skin and proximity effects (formula (1))

$$I = \sqrt{\frac{\theta}{R_0 \Sigma R_T}} = \sqrt{\frac{35}{1.25 \times 10^{-6} \times 178}} = 397 \text{ amperes.}$$

Correction factor for sheath loss (Section 3, formula (8)) λ (example 8.1.7) = 2.9 percent.

$$S_L = \sqrt{\frac{70.5 + 8.5 + 99}{70.5 + (8.5 + 99 \times 1.029)}} = 0.99.$$

Correction factor for skin and proximity effect (example 8.1.8) = 0.995.

Correction factor for dielectric loss (Table III) = 0.996.

TABLE X
DATA FOR 0.75-SQUARE-INCH CABLE

Thermal Path	Cable Data	Reference	
G'	$D/d = 1.88$ and $K = 550$	Fig. 5	54.5
G_s	$\left(\frac{\text{diameter over serving}}{\text{diameter over lead sheath}}\right) = 1.075$ and $K = 500$	Fig. 5	6.5
G_A	Over-all diameter of cable 2.61 inches. $\theta_s = 22^\circ \text{ C}$. $G_A = 53$ Correction factor = 1.37 Corrected value of $G_A = 53 \times 1.37$	Fig. 7B and Table IX Fig. 7A	73
G_T	$= G' + G_s + G_A$ Final conductor temperature Ambient air temperature Therefore permissible temperature rise $(60-25)^\circ \text{ C}$	Table IV Section 5 Table IV	134 60° C 25° C 35° C
I	Conductor resistance at 60° C Current rating (not corrected) amperes	Table I Formula (1)	0.4158×10^{-6} 792
Sheath Loss	Correction factor	Example VIII	0.94
Skin and Proximity Effect	Correction factor	Example VIII	0.97
Dielectric Loss		Table III	0.993
I	Corrected current rating = $792 \times 0.94 \times 0.97 \times 0.993$ = 715 amperes		

Therefore corrected current rating = $397 \times 0.99 \times 0.995 \times 0.996 = 388$ amperes.

10.2 CALCULATIONS FOR 0.75-SQUARE-INCH CABLE

This cable differs from that specified in Sec-

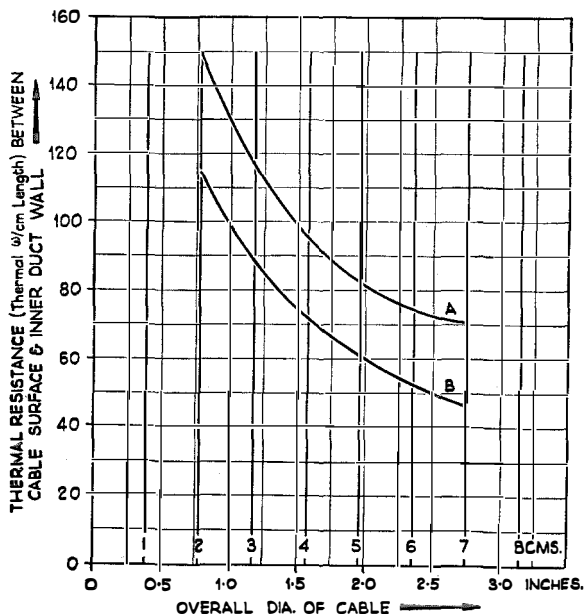

Fig. 8—Thermal resistance between cable surface and inner duct wall for cables in ducts. Curve A is for plain-lead-covered or bare-wire-armoured cable. Curve B is for lead-covered served, or wire-armoured served cable. These curves are applicable only to cables in 4-inch (10.16-centimetre) or 5-inch (12.70-centimetre) internal-diameter ducts.

tion 10.1 only in that its conductor is 0.75 square inch. By the same procedure as detailed for the 0.25-square-inch single-core cable, the results given in Table X were obtained.

11. Cables in Ducts

11.1 HEAT-FLOW CONSIDERATION

When cables are installed in cities and crowded areas, they are often pulled into ducts, since this method of installation permits the addition and withdrawal of cables with the minimum of labour and materials if any modifications in the route are necessary.

The calculation of the thermal characteristics of cables drawn into ducts is a more complex problem than the previous examples, due to the diverse nature of the thermal path which is in effect a combination of those associated with cables in air and cables laid direct.

Single-core cables are generally drawn into trefoil (3-way triangular) ducts and the heat generated in the conductor passes through the impregnated paper insulation (G'), the lead sheath and textile servings (G_s), the air space surrounding the cable in the duct (G_{AS}), the duct wall itself (G_D), and finally through the earth path surrounding the duct (G_{DS}).

The method of computing G' and G_s has already been dealt with and reference must be made to Fig. 8 for the thermal resistance of the

air path (G_{AS}) between the external surface of the served (or lead-covered) cable and the inner duct wall.

For the case of a single-way duct, the thermal resistance of the duct wall itself, i.e., from the inner to the outer surface of the duct, is given by

$$G_d = \frac{g_d}{2\pi} \log_e \frac{r_0}{r_a},$$

thermal ohms/centimetre of duct (15)

where g_d = thermal resistivity of the duct material,

= 120° C/watt/cm² for earthenware ducts, or

= 500° C/watt/cm² for fibre ducts,

r_0 = external radius of duct, and

r_a = internal radius of duct.

According to Beavis,¹¹ the increased temperature rise created by mutual heating for 3 cables in trefoil formation to that of a single cable, expressed in the form of an increased thermal resistance, is given approximately by multiplying the thermal resistance of a single cable by the factor 2.8.

Two types of multiway duct clusters are often used, trefoil type and flat type. In general the thermal resistance to the ground surface for a trefoil duct is about 190 thermal ohms/centimetre length, while the approximate value for a 3-way flat formation is 170 thermal ohms/centimetre length from the outer surface of the duct to the ground surface.

The thermal resistance of the soil path from the outer surface of the duct to the ground surface

$$G_s = \frac{g}{2\pi} \log_e \left(\frac{2h' - r_0}{r_0} \right), \quad (16)$$

thermal ohms/centimetre length

where G_s = thermal resistance of soil path,

h' = depth from ground surface to duct axis,

r_0 = external radius of duct, and

g = soil thermal resistivity.

A depth of laying of 42 inches to the top of the duct is standard for 33-kilovolt and 66-kilovolt cables (30 inches for lower-voltage cables) and all types of ducts.

11.2 CALCULATIONS FOR 0.25-SQUARE-INCH CABLE

This calculation is for a 0.25-square-inch single-core paper-insulated lead-covered cable served overall with two compounded paper tapes, one compounded cotton tape, and one compounded hessian tape (P₂CH) for 33-kilovolt working pressure, pulled into trefoil earthenware ductways having an internal diameter of 4 inches and a wall thickness of 0.6 inch.

11.2.1 Internal Thermal Resistance

(See Section 8.1.1) $G' = 70.5$ thermal ohms/centimetre length.

11.2.2 Thermal Resistance of Servings

(See Section 8.1.2) $G_s = 8.5$ thermal ohms/centimetre length.

11.2.3 Thermal Resistance of Air Space Surrounding Cables

From Fig. 8 for a cable 1.87 inches over-all diameter, $G_{AS} = 63$ thermal ohms/centimetre length.

11.2.4 Thermal Resistance of Duct Wall

(Formula (15))

$$G_D = \frac{120}{2\pi} \log_e \left(\frac{2.6}{2} \right)$$

= 5 thermal ohms/centimetre length.

11.2.5 Thermal Resistance of Soil Path

(Formula (16))

$$G_s = \frac{120}{2\pi} \log_e \left[\frac{2 \times (42 + 2.6) - 2.6}{2.6} \right]$$

= 67 thermal ohms/centimetre length.

As explained in section 11.1, the thermal resistance to ground of a trefoil duct cluster is obtained by multiplying the thermal resistance to ground for one cable in a single-way duct by the factor 2.8, i.e., $G_{DS} = (2.8 \times 67) = 187$ thermal ohms/centimetre length.

11.2.6 Total Thermal Resistance

$G_T = 70.5 + 8.5 + 63 + 5 + 187 = 334$ thermal ohms/centimetre length.

TABLE XI
DATA FOR 0.75-SQUARE-INCH CABLE

Thermal Path	Cable Data	Reference	
G'	$= D/d = 1.88$ and $K = 550$	Fig. 5	54.5
G_s	$\left(\frac{\text{diameter over servings}}{\text{diameter over lead sheath}} \right) = 1.074$ and $K = 550$	Fig. 5	6.5
G_{AS}	Over-all diameter of cable, 2.61 inches	Fig. 8	48.0
G_D	Duct inside diameter, 4 inches; duct wall thickness, 0.6 inch	Formula (15)	5.0
G_{DS}	Section 11.2.5	Formula (16)	$\frac{187.0}{301}$
G_T	$= G' + G_s + G_{AS} + G_D + G_{DS}$	—	—
	Final conductor temperature	Table IV	50° C
	Ground temperature	Section 5	15° C
	Therefore permissible temperature rise (50–15)° C	—	35° C
	Conductor resistance at 50° C	Table I	0.4017×10^{-6}
I	Current rating (not corrected), amperes	Formula (1)	540
Sheath Loss	Sheath circuit loss, 0.0221		
	Sheath eddy loss, 0.0007	Section 3	
	Therefore total loss, 0.0228		
	Correction factor $= \frac{0.0228}{0.4017 \times 0.161} = 35.3 = \sqrt{\frac{100}{135.3}}$		0.86
Skin Effect	Correction factor for skin effect only; no proximity effect	Fig. 2	0.975
Dielectric Loss		Section 4, Table III	0.993
I	Corrected current rating $= 540 \times 0.86 \times 0.975 \times 0.993$ amperes		450

11.2.7 Uncorrected Current Rating

Final conductor temperature (Table IV) = 50 degrees centigrade.

Ground temperature (Section 5) = 15 degrees centigrade. Therefore permissible temperature rise (50–15) = 35 degrees centigrade.

Conductor resistance at 50 degrees centigrade (Table 1) = 1.212×10^{-6} ohm/centimetre.

Current rating without allowing for sheath loss or skin and proximity effects (formula (1))

$$I = \sqrt{\frac{35}{1.212 \times 10^{-6} \times 334}} = 295 \text{ amperes.}$$

11.2.8 Sheath Circuit Loss

Lead-sheath resistance (Section 8.1.4) = 0.545 ohm/1 000 yards.

The lead-sheath reactance must be recalculated as follows, since its magnitude is dependent on the spacing between cable centres which is 5.2 inches; the mean radius of the lead sheath is 0.79 inch. Reactance (by formula (5))

$$\begin{aligned} X &= 0.132 \log_{10} \left(\frac{S}{r} \right) \text{ ohms/1 000 yards} \\ &= 0.132 \log_{10} \left(\frac{5.2}{0.79} \right) = 0.11 \text{ ohm/1 000 yards.} \end{aligned}$$

From Section 3, the sheath circuit loss

$$= R_s \left(\frac{X^2}{R_s^2 + X^2} \right) = 0.545 \left(\frac{0.11^2}{0.545^2 + 0.11^2} \right) = 0.0206.$$

11.2.9 Sheath Eddy Loss

(See Section 3)

$$\frac{0.0025}{R_s} \left(\frac{r}{S} \right)^2 = \frac{0.0044}{0.545} \left(\frac{0.79}{5.2} \right)^2 = 0.0002.$$

Total lead-sheath loss = 0.0206 + 0.0002 = 0.0208. Ohmic resistance/centimetre length of conductor at 50 degrees centigrade (Col. 7, Table I) = 1.212×10^{-6} ohm.

11.2.10 Sheath/Copper Loss

$$\begin{aligned} \text{Ratio} \left(\frac{\text{Sheath loss}}{\text{Copper loss}} \right) &= \frac{0.0208}{1.212 \times 10^{-6} \times 161,000} \\ &= 0.1061 = 10.61 \text{ percent.} \end{aligned}$$

11.2.11 Correction Factors

Correction factor for sheath loss

$$= \sqrt{\frac{100}{110.61}} = 0.95.$$

Correction factor for skin effect (Section 2) only, since the wider spacing of the cables in ducts results in a negligible proximity effect,

$$= \sqrt{\frac{100}{100.6}} = 0.997.$$

Correction factor for dielectric loss in Table III = 0.996.

Corrected current rating = $295 \times 0.95 \times 0.997 \times 0.996 = 278$ amperes.

11.3 CALCULATIONS FOR 0.75-SQUARE-INCH CABLE

This cable differs from that specified in Section 11.2 only in that its conductor is 0.75 square inch. Following the same procedure as detailed for the 0.25-square-inch cable, the following results were obtained. (See Table XI.)

12. Current-Rating Tables for Single-Core Cables

The results obtained so far are summarised in Table XII and ratings for any other copper section, or voltage, can be readily obtained by the methods detailed in earlier sections.

TABLE XII

CALCULATED RATINGS FOR 33-KILOVOLT SINGLE-CORE H-TYPE CABLES IN TREFOIL FORMATION

Nominal Area of Conductor Square Inch	Laid Direct (Amperes)	In Air (Amperes)	In Trefoil Ducts (Amperes)
0.25	328	388	278
0.75	558	715	450

Note: Laid direct, Section 8; in air, Section 10; and in ducts, Section 11.

Section 14 deals with the current rating of H.S.L. type cables which represent, in effect, three single-core paper-insulated lead-covered-and-served cables twisted together.

For a given voltage and conductor size, the rating for an H.S.L. cable is slightly less than the rating for a trefoil group of single-core cables. The calculations in Section 14 give an indication of the small difference in the ratings; a 0.25-square-inch trefoil group laid direct has a rating of 328 amperes whereas the 0.25-square-inch 3-core H.S.L. cable under similar conditions has a rating of 318 amperes.

This difference in rating occurs because the thickness of dielectric and lead on each core of

TABLE XIII

CURRENT-RATING FOR SINGLE-CORE CABLES^{9,10}
Unarmoured, Three Cables Touching in Trefoil Formation

Nominal Area of Conductor in Square Inches	Laid Direct			In Air			In Ducts	
	Up to 1.5 kV, AC 55° C Rise	3, 6 & 10 kV 55° C Rise	20 kV, AC 50° C Rise	Up to 1.5 kV, AC 45° C Rise	3, 6 & 10 kV 45° C Rise	20 kV, AC* 40° C Rise	Up to 1.5 kV, AC 35° C Rise	3, 6, 10 & 22 kV, AC 35° C Rise
0.007	54	—	—	49	—	—	41	—
0.01	63	—	—	60	—	—	57	—
0.0225	101	99	—	97	103	—	77	79
0.04	142	135	128	136	144	141	107	109
0.075	204	194	187	200	208	204	152	160
0.10	239	228	221	241	249	240	178	181
0.15	299	282	274	317	326	310	222	223
0.20	350	331	321	374	387	367	257	260
0.25	397	372	354	430	443	420	287	291
0.30	436	403	382	482	496	466	315	319
0.40	502	464	442	578	595	553	363	362
0.50	564	522	492	665	681	633	401	397
0.75	675	640	601	842	861	801	465	462
1.00	764	735	—	962	—	—	503	—
1.25	814	790	—	1062	—	—	532	—
1.50	880	—	—	1154	—	—	553	—

* For systems with only the centre point earthed.

an H.S.L. cable is less than for the corresponding copper section of a single-core cable and also the conductor resistance of the H.S.L. cable is a little greater because of the extra length of single cable necessary when the lead-covered-and-served cores are twisted together into cable form.

Current ratings for trefoil groups of single-core cables for voltages up to 22 kilovolts, inclusive, are given in B.E.I.R.A. report F/T 128 and Table XIII gives a summary of these ratings. No official tables have yet been published giving ratings for 33- and 66-kilovolt single (or multi-core) H-type cables.*

13. Grouping of Cables

When several cables are laid close together, the normal temperature rise of any cable in the group will be increased by the mutual heating effect.¹¹ This mutual heating may be considered as an increase in the thermal resistance, the magnitude of this increase depending on the actual proximity of the cables to each other.

The thermal resistance of a single cable relative to the thermal resistance when forming one of a group decides the group rating factor which is required to evaluate the permissible rating of all the cables, but it must be clearly understood that the individual cable considered must be the one in the group located at the point where maximum heating occurs.

Also it is essential to note that where 3 single-core cables are run together in trefoil formation, or in a trefoil duct, the mutual heating effect due to the close proximity of the 3 cables forming the group has been allowed for in the ratings computed in preceding examples.

- Cables laid direct—see Fig. 6 and formula (12).
- Cables in air—see Fig. 7B.
- Cables in ducts—mutual heating due to one trefoil group is allowed for by the multiplying factor 2.8 (Section 11.1).

When however more than one trefoil group is installed, the multiplying factors given in Table XIV must be used, the grouping factor selected

* Since this article was prepared, ratings for 33- and 66-kilovolt cables have been published in the *Electrical Review*, p. 673, Nov. 10, 1944, but no details of the cable dimensions are given.

TABLE XIV
GROUPING FACTORS

Type of Cable and Method of Installation	No. of Trefoil Groups Run Together	Rating Factor (Distance in Inches Between Centres of Trefoil Groups)			
		6	12	18	24
Single-core cables in trefoil groups, vertex upward Flat formation	2	0.78	0.83	0.87	0.90
	3	0.66	0.73	0.78	0.82
	4	0.60	0.67	0.73	0.78
	6	0.52	0.60	0.68	0.74

depending on the number of groups and their configuration.

Table XIV provides group rating factors for trefoil groups at various spacings which can be conveniently used for practical problems. For theoretical data on this problem and a mathematical solution, see reference 9.

Above rating factors have been interpolated from E.R.A. report F/T 128 but it must be noted that this report allows for spacing between *external surfaces of cables* while above factors have been corrected to *allow for spacing between centres of trefoil groups* since this is the spacing usually referred to in practice.

14. H.S.L. (Hochstadter Separate Lead) Cable^{12, 13}

For supertension power transmission, cables known as the H.S.L., or separate-lead, types are widely employed and from a current-rating angle they represent, in effect, 3 separate single-core cables twisted together.

The H.S.L. type cable consists of 3 copper conductors, each paper insulated and screened with a 0.5-mil-thick aluminium screen (the screen being applied to a backing paper); each screened paper-insulated core is separately lead sheathed.

Three such cores are usually lapped with a layer of textile tape, twisted together on a core "laying-up" machine, the whole assembly being made into a circular section by filling the interstitial spaces with compounded jute yarns.

The thermal resistance per core for H.S.L. type cables is given by the sum of the thermal resistance between core and sheath (G') and the thermal resistance due to the serving material applied over the individual lead-sheathed cores, and the textile bedding (G_f).

$$G' = 201.7 \log_{10} \left(\frac{r+E}{r} \right), \quad (17)$$

where

r = conductor radius,

and

E = radial thickness of dielectric.

Values of G_f for different values of the ratio F/d_L are given in Fig. 9, based on a value of $K_1 = 500$ for the thermal resistivity of the serving material.

F is the minimum thickness of serving between the lead sheath and armour and d_L is the diameter over the individual lead sheath.

Thus the thermal resistance per core for the H.S.L. cable = $(G' + G_f)$ thermal ohms/centimetre length/loaded core and one third of this value will be used for a 3-core H.S.L. type cable (since the core assembly is equivalent to 3 resistances connected in parallel).

14.1 CALCULATIONS FOR 0.25-SQUARE-INCH H.S.L. CABLE

Table XV gives design details for a 0.25-square-inch 3-core H.S.L. type paper-insulated lead-covered single-wire-armoured and served cable for 33-kilovolt working pressure. The cable is laid direct in the ground at 42-inch depth (see Section 5).

14.1.1 Internal Thermal Resistance

$$G' = 201.7 \log_e \left(\frac{r+E}{r} \right) \quad (\text{Formula (17)})$$

$$= 201.7 \log_e \left(\frac{0.325+0.330}{0.325} \right) = 61.5 \text{ thermal ohms/centimetre length of cable.}$$

To calculate G_f , we obtain the ratio:

$$\left(\frac{\text{thickness of material between lead sheaths and armour}}{\text{diameter over lead sheath}} \right) = \frac{F}{d_L} = \frac{0.135}{1.521} = 0.089.$$

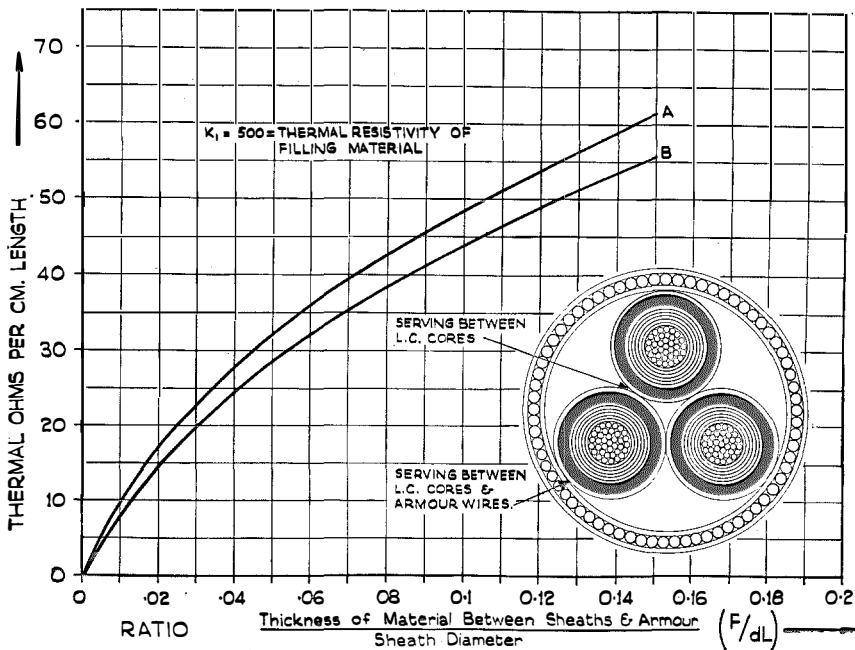

Fig. 9—Thermal resistance per core between sheaths and armour for 3-core separate-lead cable. Curve A is for cables having all material wrapped overall (i.e., sheaths in contact) and curve B is for equal thicknesses of material between sheaths and between sheaths and armour.

Referring now to Fig. 9, Curve B, $G_f = 41$ thermal ohms/centimetre length of core., therefore $(G' + G_f) = 61.5 + 41 = 102.5$ thermal ohms/centimetre length of core.

Since the 3 lead-covered-and-served cores are twisted helically together before the bedding armoring and over-all servings are applied, the individual cores are in effect connected in parallel and therefore the internal thermal

TABLE XV

DATA FOR 0.25-SQUARE-INCH H.S.L. CABLE

Design		Diameter (Inches)	Remarks
Conductor	0.25 square inch = 37/093, circular	0.651	Col. 3, Table I
Insulation	0.325-inch radial thickness	1.301	—
	1 X 5 mil aluminum screen, including backing paper	1.311	
Lead sheath	0.100 inch	1.521	Tolerance on minimum sheath thickness allowed
Servings over individual lead sheath	1 compounded paper tape	1.551	Small allowance made for armoring compounds
	1 compounded cotton tape	1.591	
Lay up	3 cores (1.591 X 2.16 ²)	3.44	—
Bedding	hessian tape 0.1-inch radial thickness	3.64	—
Armouring	single layer of 0.128-inch steel wires	3.896	—
Overall serving	hessian tape 0.1-inch radial thickness	4.096	—

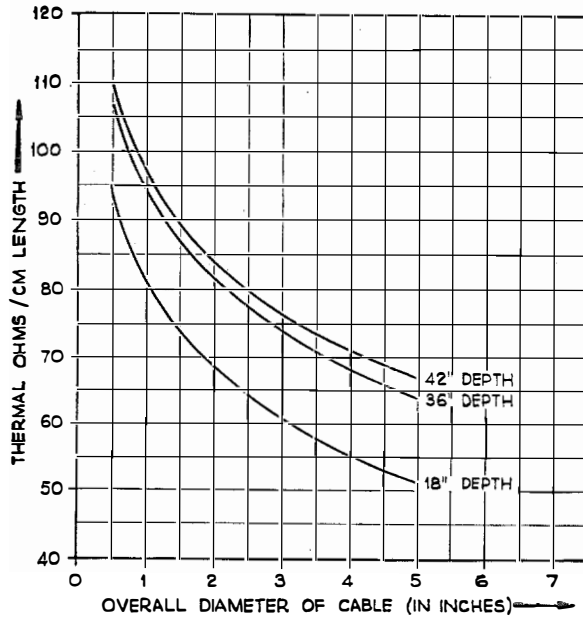

Fig. 10—Thermal resistance of soil for multicore and H.S.L. cables. Soil resistivity $g = 120$ thermal ohms per cubic centimetre.

resistance of cable = $102.5/3 = 34$ thermal ohms/centimetre length of cable.

14.1.2 Thermal Resistance of Over-All Servicing

$$\text{Ratio} \left(\frac{\text{diameter overall}}{\text{diameter over armour}} \right) = \frac{4.096}{3.896} = 1.05.$$

Referring to Fig. 5, for thermal resistivity, $K = 500^\circ \text{C/watt/cm}$. $G_s = 4$ thermal ohms/centimetre length of cable.

14.1.3 Thermal Resistance of Soil Path

Fig. 10 gives the thermal resistance of the soil path and for a cable 4.096 over-all diameter laid at a depth of 42 inches, $G_s = 71$ thermal ohms/centimetre length of cable.

14.1.4 Total Thermal Resistance

$G_T = 34 + 4 + 71 = 109$ thermal ohms/centimetre length of cable.

From Table I, the conductor resistance at 60 degrees centigrade = 1.254×10^{-6} ohm/centimetre length. Since however the 3 cores of an H.S.L. cable are twisted together (unlike a trefoil group of single-core cables where the individual cables are not twisted together) the ohmic resistance of the conductor must be increased by 2 percent to allow for the extra length necessary for the lay-

ing-up operation. Therefore the conductor resistance at 60 degrees centigrade = 1.279×10^{-6} ohm/centimetre length.

Soil temperature = 15 degrees centigrade (Table IV).

Maximum permissible conductor temperature = 60 degrees centigrade (Table IV), therefore permissible temperature rise = $(60 - 15) = 45$ degrees centigrade.

(Formula (I))

$$I = \sqrt{\frac{\theta}{nR_g \Sigma R_T}} = \sqrt{\frac{45}{3 \times 1.279 \times 10^{-6} \times 109}} = 324 \text{ amperes.}$$

(It will be noted that n has been introduced into the denominator of Formula (1), since there are 3 cores twisted together).

14.1.5 Correction Factors

Correction factor for dielectric losses for practical purposes can be taken from Table III, i.e., 0.996.

Sheath losses are practically identical with the factor computed in example 8.1.8, i.e., 0.99.

Skin and proximity effects are similar to 8.1.8 = 0.995.

Thus corrected current rating = $324 \times 0.996 \times 0.99 \times 0.995 = 318$ amperes.

15. Limitations of Single-Core Single-Wire-Armoured Cables

Armoured single-core cables are very seldom used on alternating-current circuits. Each insulated conductor would have a sheath of magnetic material (steel wire armouring) surrounding the current-carrying core and the flux encircling the core would be increased in the zone of the armour wires. The reactance of the cables would thereby be increased, giving rise to heavy additional losses due to the currents induced in the lead sheath and armouring.

There is no alternating magnetic flux in direct-current systems and armoured single-core cables can be used without the above limitations if mechanical protection of the cable is necessary.

Relatively small-copper-section single-core armoured cables may be used on alternating-current systems up to a maximum conductor size of about 0.1 square inch.

Where it is essential that larger conductor sizes used on alternating-current systems be wire armoured (steel tape armouring is not recommended because of its low mechanical strength and high losses), the choice of non-magnetic wire armouring is restricted on the one hand by the mechanical properties of the armouring material and on the other hand by its resistivity.

Two types of nonmagnetic armouring materials are:

- a. Copper silicon manganese alloy (Patent 497,259) having approximately the following characteristics:
 Resistivity = 24.6 microhms/cubic centimetre
 Specific gravity = 8.54
 Tensile strength = 25.6 tons/square inch,
- b. Hard-drawn aluminum alloy (Patent 336,408), having these general characteristics:
 Resistivity = 3.1 microhms/cubic centimetre
 Specific gravity = 2.73
 Tensile strength = 20 to 25 tons/square inch.

The final choice is to a degree dependent on the individual installation conditions obtaining and must consider the differences in resistivity, specific gravity, and basic cost.

In general where nonmagnetic wire-armoured single-core cables are installed not more than 6 inches apart, the lowest loss is obtained with a

relatively high-resistance material, i.e., the copper silicon manganese alloy.

Conversely when the spacing is greater than 6 inches, a low-resistance material is generally more suitable and the hard-drawn aluminum alloy will be recommended.

It must also be strongly emphasized that where single-core armoured cables carrying heavy currents are used, the advice of the cable maker should always be obtained.

16. Single-Core Cables in Parallel

Where very heavy loads have to be carried, it is often more economical to run several trefoil groups of single-core cables in parallel. The following example shows the advantage gained by using two 3-phase circuits in parallel in preference to one circuit of very large copper-section cable, assuming cables have to carry a load of 821 kilovolt-amperes at 660 volts and that single-core paper-insulated lead-covered-and-served cables, laid direct in trefoil formation, will be used.

17. British and U.S.A. Ratings, 33-35-kV, Single-Core Cables in Ducts

Existing tables giving British and U.S.A. current ratings cannot be easily compared because the standard conductor sections and voltage levels differ in the two hemispheres, but in general U.S.A. specifications allow a heavier thickness of insulation and lead sheathing than specified in European standards, and also permit a higher maximum conductor temperature.

TABLE XVI

Load to be Carried	Scheme I 820 kVA at 660 Volts	Scheme II 820 kVA at 660 Volts
Maximum current (Refer to Appendix I) Type of cable	718 amperes One group of single-core cables run in trefoil formation	718 amperes Two groups of single-core cables run in trefoil formation with 18-inch spacing between cable centres
Method of installation (Table IV)	Laid direct in the ground at a depth of 18 inches	Laid direct in the ground at a depth of 18 inches
Nearest standard conductor size (Table XIII)	1.0 square inch carrying 764 amperes	Two circuits, each of 0.3 square inch and carrying 436 amperes
Correction factor for grouping at 18-inch centres (Table XIV)	One group only	0.87
Maximum permissible kilovolt-ampere loading	$\sqrt{3} \times 660 \times 764 = 870 \text{ kVA}$	$2 \times \sqrt{3} \times 660 \times 436 \times 0.87 = 870 \text{ kVA}^*$
Total copper area	$3 \times 1.0 = 3 \text{ square inches}$	$2 \times 3 \times 0.3 = 1.8 \text{ square inches}$
Saving in copper by adopting Scheme II	—	40 percent

* If 12-inch spacing were adopted to reduce the trench work in laying the cables, the maximum loading would be reduced to 828 kVA which is still adequate to meet the specified load of 820 kVA.

Table XVII summarizes the requirements of British and U.S.A. standard specifications for single-core impregnated-paper-insulated lead-covered cables operating at 33–35 kilovolts.

Figure 11 shows the ratings permitted by British and U.S.A. regulations for 33–35-kilovolt single-core paper-insulated lead-covered cables pulled into ducts when the two sets of ratings have been adjusted as far as possible to the same basis.

TABLE XVII
BRITISH AND U.S.A. RATINGS, 33–35 kV,
SINGLE-CORE CABLES IN DUCTS

	British Standards	American Standards
Type of conductor	Circular 33	Circular 35
Service voltage (kV)	a. Laid direct in the ground.	Very seldom laid direct.
Installation conditions	b. In free air. c. Pulled into ducts.	In free air. Normal method, pulled into ducts.
Ground temperature °C (laid direct or in ducts)	15	20
Ambient air temperature °C	25	40
Maximum conductor temperature °C	50	70
Permissible temperature rise °C	Laid direct or in ducts	50
	In air	30
Frequency, cycles per second	50	60
Dielectric thermal resistivity °C/watt/cm.	550	700
Load factor	Standardised ratings are for continuous operation, i.e., 100% load factor.	Ratings standardised at 50, 75 and 100% load factor.
Skin proximity effect	Allowance included at 50 cycles per second.	Skin effect included at 60 cycles per second. Proximity-effect losses are considered negligible.
Lead sheath losses	Standard practice to bond and earth at both ends of the run so these losses are included in published ratings. No standardised figure.	Published ratings based on open-circuit sheath operation, i.e., no sheath loss included.
Specific inductive capacitance (Dielectric constant)	Typical figures are 3.7 for 33kV and above. 3.2 for lower voltages.	3.7

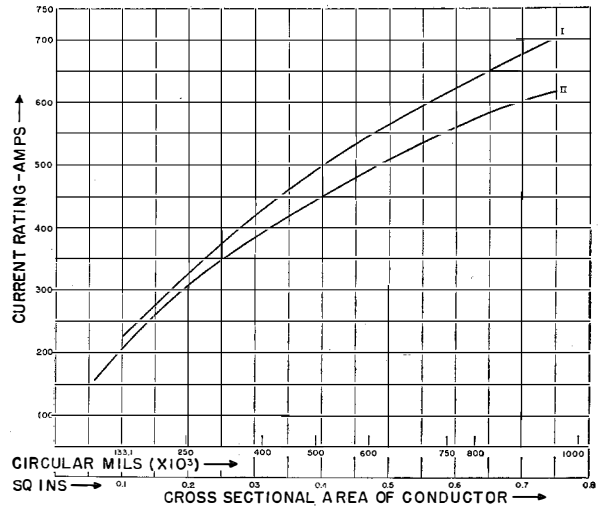

Fig. 11—Comparison of (I) U.S.A. and (II) British ratings on 3 loaded single-core 33–35-kilovolt paper-insulated lead-covered cables in a duct bank.

Basis of Comparison

- a. 3 loaded cables in a duct bank
- b. ground temperature = 15° C
- c. maximum conductor temperature = 70° C
- d. temperature rise = 55° C
- e. open-circuit sheath operation, i.e., sheaths bonded and earthed at one point only so that sheath losses are negligible
- f. load factor = 100%
- g. dielectric thermal resistivity = 700° C/watt/cm
- h. curve I for 60 and curve II for 50 cycles per second, respectively.

No correction has been made however for the small difference in losses which will result from the standardised U.S.A. power frequency of 60 cycles per second; also no correction has been made for dimensional differences resulting from individual standardisation of dimensions in the two countries.

We can see from Fig. 11 that U.S.A. regulations and current-rating formulae result in a current rating, which is a little higher *when compared on the same basis as British ratings, for 33–35-kilovolt single-core cables in ducts*, but the difference only becomes of any importance above sections of (say) 0.4 square inch (500 000 circular mils). It is thus clear the current-rating formulae used in the two countries result in a very small difference only in the computed ratings.

It has been shown in Table XVI that for heavy loads it is often more economical to run several groups of single-core cables in parallel and, providing installation conditions are such that parallel circuits of cables can be pulled into ducts,

the resulting difference between the two sets of ratings is smaller than would appear to be the case when Fig. 11 only is considered.

Reverting now to Fig. 12, which has been plotted on the basis of existing British and U.S.A. regulations, it will be noted the difference between the two sets of ratings is much greater, due mainly to the higher conductor temperature permitted in the U.S.A. for cables pulled into ducts.

Finally it must be emphasized that it is not possible from the comparative data given for a particular case to draw a general comparison between British and U.S.A. rating tables owing to the many variable factors involved, but the method outlined for comparing 33-35-kilovolt single-core cables can be readily applied to other voltage levels.

18. Conclusions

The foregoing detailed calculations outline briefly the method for computing current ratings

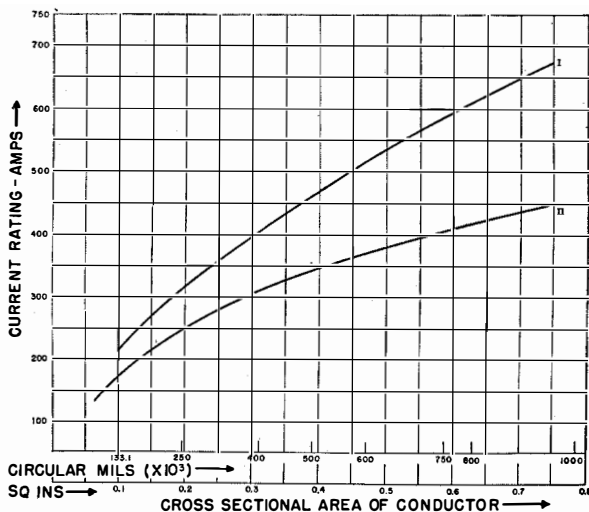

Fig. 12—Comparison of (I) U.S.A. and (II) British ratings on 3 loaded single-core 33-35-kilovolt paper-insulated lead-covered cables in duct bank.

Basis of Comparison		
	I U.S.A. Ratings	II British Ratings
a. 3 loaded cables in duct bank		
b. ground temperature °C	20	15
c. maximum conductor temperature °C	70	50
d. temperature rise °C	50	35
e. sheath losses	excluded	included
f. load factor %	100	100
g. dielectric thermal resistivity °C/watt/cm	700	550
h. frequency, cycles per second	60	50

for single-core cables and reference has been made to some of the limiting conditions governing the permissible rating and installation of these cables.

It will be found after some practise with the method shown that ratings for cables installed under varying conditions can be readily computed.

19. Appendix I

Cable enquiries and orders often state the load in horsepower, watts, or kilovolt-amperes and Fig. 13 gives a summary of standard formulae used to calculate the current and voltage drop in alternating- and direct-current systems.

20. Mathematical Symbols

- d = conductor diameter.
- d_L = diameter over the individual lead sheaths of an H.S.L. (Hochstadter Separate Lead) type cable.
- D = diameter over insulated conductor.
- D_c = over-all diameter of the cable.
- D_L = heating due to dielectric losses.
- D_1 = diameter over lead sheath.
- D_2 = diameter under lead sheath.
- E = radial thickness of dielectric.
- F = thickness of textile material between the lead sheaths and armour of an H.S.L. type cable.
- g = thermal resistivity of the soil.
- g_D = thermal resistivity of the duct material.
- G' = internal thermal resistance per core.
- G_s = thermal resistance of textile servings applied over the lead sheath.
- G_E = thermal resistance of the soil.
- G_A = thermal resistance of the air.
- G_{AS} = thermal resistance of the air space surrounding a cable in a duct.
- G_D = thermal resistance of the duct wall.
- G_{DS} = thermal resistance of the soil surrounding the duct way.
- G_J = thermal resistance due to the serving material applied over the individual lead sheaths and the textile bedding of an H.S.L. type cable.
- ΣG_T = sum of individual thermal resistances (thermal ohms/centimetre length) forming the heat-flow path between the conductor and ambient.

1	2	3	4	5	6	7	8	9
SYSTEM OF SUPPLY	D-C 2 WIRE	D-C 3 WIRE	A-C SINGLE PHASE	A-C 2 PHASE 3 WIRE	A-C 2 PHASE 4 WIRE	A-C 3 PHASE	A-C 3 PHASE 4 WIRE	
GRAPHICAL REPRESENTATION								
CURRENT (I) IN AMPS.	$\frac{HP \times 746}{V \times \eta}$ $\frac{KW \times 1000}{V}$		$\frac{HP \times 746}{V \times \eta \times \cos \theta}$ $\frac{KW \times 1000}{V \times \cos \theta}$ $\frac{kVA \times 1000}{V}$	$\frac{HP \times 746}{2V \times \eta \times \cos \theta}$ $\frac{KW \times 1000}{2V \times \cos \theta}$ $\frac{kVA \times 1000}{2V}$	$\frac{HP \times 746}{\sqrt{3} \times V \times \eta \times \cos \theta}$ $\frac{KW \times 1000}{\sqrt{3} \times V \times \cos \theta}$ $\frac{kVA \times 1000}{\sqrt{3}}$		$\frac{HP \times 746}{3 \times V \times \eta \times \cos \theta}$ $\frac{KW \times 1000}{3 \times V \times \cos \theta}$ $\frac{kVA \times 1000}{3 \times V \times \eta}$	
VOLTAGE DROP	INSULATED CABLE	$\frac{2 \times I \times d \times R \times t}{1000}$		$\frac{2 \times I \times d \times Z \times t}{1000}$		$\frac{1.732 \times I \times d \times Z \times t}{1000}$		
	OVERHEAD LINES	$\frac{2 \times I \times d \times (R_t \cos \theta + X \sin \theta)}{1000}$		$\frac{2 \times I \times d \times (R_t \cos \theta + X \sin \theta)}{1000}$		$\frac{1.732 \times I \times d \times (R_t \cos \theta + X \sin \theta)}{1000}$		

Fig. 13—Calculation of current and voltage drops in alternating- and direct-current systems.

HP = horsepower
 KW = kilowatts
 KVA = kilovolt-amperes
 V = potential difference in volts (see graphical representation)
 V_N = potential difference between one phase and neutral
 η = efficiency of motor (or average efficiency of motors)
 $\cos \theta$ = power factor
 d = distance in yards

R = resistance of one conductor in ohms/1000 yards carrying only current I (both R and Z values are at 60° F (15.6° C))
 Z = impedance of one conductor in ohms/1000 yards carrying only current I
 X = reactance of one conductor in ohms/1000 yards carrying only current I
 I = current in amperes (see graphical representation)
 t = temperature correction factor (Fig. 14) to allow for increase in conductor resistance under load

h = axial depth of the upper cable in a trefoil group.
 h_1 = axial depth of the lower cable in a trefoil group.
 h' = depth from ground surface to duct axis.
 h_c = a constant representing heat flow by convection, conduction, and radiation.
 h_G = value of h_c applying to other installation conditions.
 h_L = value of h_c for a single-core cable, plain lead finish.
 I = maximum safe continuous current-carrying capacity (amperes).
 K = thermal resistivity of the cable dielectric.
 K_1 = thermal resistivity of the textile bedding, servings, etc.
 R = uncorrected direct-current resistance of the copper conductor.

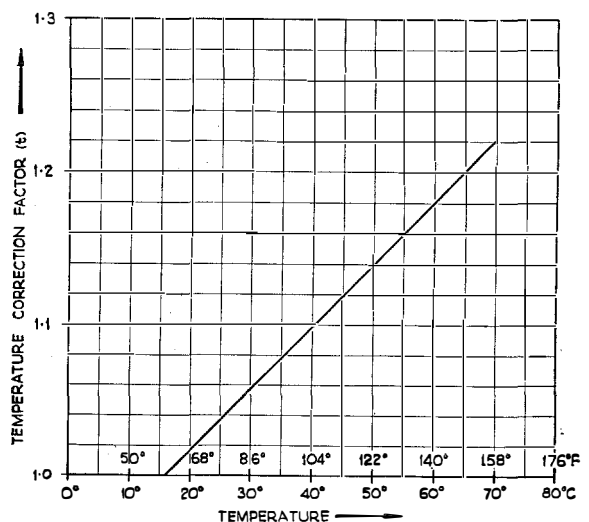

Fig. 14—Temperature correction factor for copper conductors

R_s = lead-sheath resistance at the operating temperature of the sheath.

R_T = corrected ohmic resistance of the copper conductor.

R_θ = ohmic resistance of one centimetre length of copper conductor at the maximum operating temperature.

r = conductor radius.

r_d = internal radius of duct.

r_e = over-all radius of cable.

r_L = mean radius of lead sheath.

r_0 = external radius of duct.

S = axial spacing between cable centres.

S_L = correction factor for lead-sheath losses.

X = lead-sheath reactance.

y = skin-effect increment.

y_1 = proximity-effect increment.

λ = sheath-loss/copper-loss ratio.

Δ = correction factor for dielectric losses.

θ = maximum permissible temperature drop in degrees centigrade between the conductor and its surrounding medium (ambient).

θ_s = temperature rise of the lead sheath (or surface).

21. Acknowledgments

The writer is greatly indebted to Dr. Konstantinowsky and Mr. J. K. Webb, M.Sc., for their very helpful criticism and advice during the preparation of this article.

22. Bibliography

1. C. C. Barnes, "The Current Rating of Paper Insulated Power Cables," *Electrical Communication*, v 21, n 1, p 27, 1942.
2. E. A. Beavis, "Alternating Current Losses in Single Conductor Cables," Engineering Supplement to *Siemens Magazine*, n 159, August, 1938.
3. T. N. Riley, "Sheath Losses in Single Core Cables for Three Phase Transmission," *Journal Institution of Electrical Engineers*, v 65, n 371, November, 1927.
4. Brockbank and Webb, "Sheath and Armour Losses in Single Core Cables for Single Phase or Three Phase Transmission," *Journal Institution of Electrical Engineers*, v 67, p 337, 1928.
5. Arnold, "Theory of Sheath Losses in Single Core Lead Covered Cables," *Journal Institution of Electrical Engineers*, v 67, 1928.
6. W. H. Lythgoe, "Sheath Losses in Paper Cables," *Distribution of Electricity*, v 8, n 85, p 1797, June, 1935.
7. Beavis and Schofield, "Bonding and Earthing of Single Core Three Phase P.I.L.C. Cable Installations," Engineering Supplement to *Siemens Magazine*, n 216, April/May, 1944.
8. British Standard Specification No. 480-1942, "Dimensions of Metal Sheathed Paper Insulated Cables, 660 Volts to 20 kV Inclusive."
9. Whitehead and Hutchings, "Current Rating of Cables for Transmission and Distribution," *Journal Institution of Electrical Engineers*, October, 1938.
10. B.E.I.R.A. Report No. F/T 128.
11. E. A. Beavis, "The Grouping of Power Cables," Engineering Supplement to *Siemens Magazine*, n 179, April, 1940.
12. H. Waddicore, "The Thermal Resistance and Current Carrying Capacity of 3 Core Screened and S. L. Type Cables," *Journal Institution of Electrical Engineers*, v 76, p 195, 1935.
13. P. Dunsheath, "33000 Volt Cables with Metal-Sheathed Cores," *Journal Institution of Electrical Engineers*, v 65, 1927.

Electrical Units and the MKS System

By H. PAUL WILLIAMS, B.Sc., Ph.D.

Standard Telephones and Cables, Ltd., London, England

Editor's Note: Among the references cited, the reader will be particularly interested in a paper by Professor A. E. Kennelly, entitled, "I. E. C. Adopts MKS System of Units," which appeared in the Transactions of the American Institute of Electrical Engineers for 1935 and in the December, 1935, issue of "Electrical Engineering" on page 1373. The following paragraph is quoted from Professor Kennelly's article:

"At its plenary meeting, in June, 1935, at Scheveningen-Bruxelles, the I. E. C. unanimously adopted the Giorgi System of meter-kilogram-second (mks) units, 15 countries being represented by the delegates present. Every electrical engineer should make himself acquainted with the significance of this decision. In effect, it replaces the 3 systems at present in use (namely, the absolute electromagnetic cgs system, the absolute electrostatic cgs system, and the practical series) by one practical system."

IN work involving the fundamental equations of electromagnetic theory, the engineer usually finds himself steering a tricky course through the various systems of units. Furthermore, books on electromagnetic theory seem to exhibit an almost incredible number of ways of expressing the same thing. All this adds considerably to the labour involved in any investigation.

Recently the use of the mks (metre-kilogram-second) system has become popular, especially in American text books. This system, which was suggested by Giorgi in 1901, has the great advantage of wiping out the distinction between electromagnetic units, electrostatic units, and practical units, and substituting in their place one system only, which, moreover, is identical with the present practical units.

The purpose of the present article is to introduce the mks system to those engineers who are not already familiar with it, and also to provide a "dictionary" showing the relationships between the different systems. To emphasize these relationships, the text has been made concise at the expense of literary style.

In discussing the construction of the e.m.u. (electromagnetic unit) and e.s.u. (electrostatic unit) systems and those derived from them, the assumption has been made that ϵ and μ are dimensions in themselves. An alternative outlook is to regard them as dimensionless quantities and introduce into the force equation two factors of proportionality (say α and β), which take upon themselves the onus of being dimensions. However, the argument can be kept more

compact by not introducing this complication. Abraham and Becker¹ carry matters still further by assuming all four quantities, namely ϵ , μ , α , and β , to be dimensionless. Consequently E , H , D , and B all have the same dimensions.

The whole trouble arises out of the fact that electromagnetic quantities cannot be expressed solely in terms of mass, length, and time. A fourth dimension is needed.

In the mks system, the fourth dimension may be either resistance (the metre-kilogram-second-ohm system) or else electric charge (the metre-kilogram-second-coulomb system). The existence of these two variations of the mks system need not worry us for the *units* have the same size in either case. In this article we shall consider the coulomb as the fourth dimension.

1. Systems of Units

1.1 ELECTROMAGNETIC UNITS

The electromagnetic system of units is based on the fundamental law of the force between two poles.

$$F = \frac{m_1 m_2}{\mu r^2},$$

where F = force in dynes,

m_1 = pole strength of pole 1,

m_2 = pole strength of pole 2,

μ = permeability of the medium, and

r = distance between the poles in centimetres.

¹ M. Abraham and R. Becker, "The Classical Theory of Electricity and Magnetism," p. 152, Blackie and Son, London (1932).

By expressing F in dynes and r in centimetres, we keep to cgs units as far as possible. In the case of μ , we find that it cannot be expressed in terms of length, mass, and time. We therefore choose to leave it as a dimension in its own right and give it the value of unity for free space.

In this manner pole strength can be defined and results in

$$[m] = [M^{\frac{1}{2}}L^{\frac{3}{2}}T^{-1}\mu^{\frac{1}{2}}],$$

where M , L , and T stand as usual for mass, length, and time.

We define the magnetic-field intensity H at a point by the force on a unit pole situated at that point. This gives the relationship $F = Hm$, from which it follows:

$$[H] = [M^{\frac{1}{2}}L^{-\frac{1}{2}}T^{-1}\mu^{-\frac{1}{2}}].$$

Furthermore, Ampere's law relating the magnetic field produced by a current I states that $\int H \cdot ds = 4\pi I$ which gives

$$[I] = [M^{\frac{1}{2}}L^{\frac{1}{2}}T^{-1}\mu^{-\frac{1}{2}}].$$

All the other electrical units may be obtained in a similar manner, but it is convenient to stop at this point so as not to confuse the comparison with other systems.

The unit of current obtained in this way was considered to be on the high side for practical purposes, and the practical unit, the ampere, was therefore made equal to 1/10th of the electromagnetic unit.

On the other hand, the unit of potential difference obtained in this way is small, and the practical unit has been made 10^8 times bigger.

1.2 ELECTROSTATIC UNITS

The electrostatic system of units is based on the fundamental law of force between two charges

$$F = \frac{q_1 q_2}{\epsilon r^2},$$

where F = force in dynes,

q_1 = strength of charge 1,

q_2 = strength of charge 2,

ϵ = dielectric constant of the medium, and

r = distance between charges in centimetres.

Again we have cgs units, and also we put ϵ equal to unity for free space. Hence we have

$$[q] = [M^{\frac{1}{2}}L^{\frac{3}{2}}T^{-1}\epsilon^{\frac{1}{2}}].$$

Now current is the rate of flow of charges, so the dimensions of current are those of charge divided by time. Therefore

$$[I] = [M^{\frac{1}{2}}L^{\frac{3}{2}}T^{-2}\epsilon^{\frac{1}{2}}].$$

The unit of current so obtained is small and equals only one part in 3×10^9 of the practical unit. But it will be found that the unit of potential difference in this system is large, actually 300 times as great as the practical unit, the volt.

Without examining the other units further, we already see that an extraordinary situation has arisen. Our two ways of defining current, one by laws involving magnetism and the other via electrostatic force, lead us to units which not only vary greatly in size but also apparently have different dimensions.

Since the same current can be looked upon in two ways, we are at liberty to equate the values obtained by the two methods. Let us suppose we find x electromagnetic units of current are equal to y electrostatic units, then

$$x[M^{\frac{1}{2}}L^{\frac{1}{2}}T^{-1}\mu^{-\frac{1}{2}}] = y[M^{\frac{1}{2}}L^{\frac{3}{2}}T^{-2}\epsilon^{\frac{1}{2}}],$$

$$[\mu^{-\frac{1}{2}}\epsilon^{-\frac{1}{2}}] = \frac{y}{x}[LT^{-1}].$$

From this we deduce that $\mu^{-2}\epsilon^{-\frac{1}{2}}$ has the dimensions of a velocity and also that this velocity is equal to the ratio y/x . Experiments show that the velocity in question is 3×10^{10} centimetres per second for free space or air. This velocity is commonly denoted by c .

This is a celebrated result and it is well known that it led to the prediction of the velocity of propagation of electromagnetic waves. However, for engineering purposes, it is confusing to have two separate systems which, in combination, entail remembering powers of c . Moreover they are related to a practical system by ratios which involve remembering various powers of 10. The mks system entirely avoids these difficulties.

1.3 MIXED SYSTEM OF UNITS

The system referred to here as "mixed" is the one in which current is expressed in electromagnetic units (in contradistinction to the

Gaussian system). In other respects it is like the Gaussian system, i.e., electrical quantities are in electrostatic units and magnetic quantities are in electromagnetic units.

One justification for this choice is that $1/c$ appears wherever there is a differentiation with respect to time—but there are exceptions! All is well if we convert current into change of polarisation with time, but trouble arises when a conversion into the product of conductivity and electric intensity is made.

Maxwell's equations as they are usually given in this system² are as follows:

$$\text{curl } \mathbf{H} = 4\pi \mathbf{i} + \frac{\epsilon}{c} \dot{\mathbf{E}}, \quad (1)$$

$$\text{div } \mathbf{H} = 0, \quad (2)$$

$$\text{curl } \mathbf{E} = -\frac{\dot{\mathbf{H}}}{c}, \quad (3)$$

$$\text{div } \epsilon \mathbf{E} = 4\pi \rho, \quad (4)$$

$$\text{div} \left(\mathbf{i} + \frac{\epsilon}{4\pi c} \dot{\mathbf{E}} \right) = 0. \quad (5)$$

In the above equations μ is taken to be unity.

If the conversion to moving charges is made, then we substitute $\rho \mathbf{u}$ for \mathbf{i} in equation (1) where \mathbf{u} is the average velocity of the charges and ρ is the charge density. Immediately one notices that whereas $\rho \mathbf{u}$ is in electromagnetic units in equation (1), ρ is in electrostatic units in equation (4). This is unsatisfactory for \mathbf{u} is merely a velocity and therefore the same in both systems.

Another substitution that can be made for \mathbf{i} is to express the current density in terms of \mathbf{P} , the polarisation of the medium. \mathbf{P} is the "electric moment per unit volume" and is equal to Nes , where N is the number of charges per unit volume, e the strength of each charge, and s the average distance through which the particles move. Consequently \mathbf{P} (like e) is in electrostatic units and since the current is equal to the time derivative of \mathbf{P} we have

$$\mathbf{i} = \frac{\dot{\mathbf{P}}}{c},$$

$$\therefore \text{curl } \mathbf{H} = \frac{4\pi}{c} \dot{\mathbf{P}} + \frac{\dot{\mathbf{E}}}{c}.$$

Therefore c occurs in the denominator with each differentiation with respect to time.

If, however, we develop the wave equation by taking the double curl of \mathbf{E} , we must substitute $g\mathbf{E}c$ for \mathbf{i} , with the result that $(1/c)$ disappears in one of our time differentiations. In this substitution, g is the conductivity expressed in the same unit as e , namely in electrostatic units. The development is as follows.

$$\begin{aligned} \text{curl curl } \mathbf{E} &= -\frac{1}{c} \frac{\partial}{\partial t} (\text{curl } \mathbf{H}) \\ &= -\frac{1}{c} \frac{\partial}{\partial t} \left(4\pi \mathbf{i} + \frac{\epsilon}{c} \dot{\mathbf{E}} \right), \end{aligned}$$

$$\therefore \text{grad div } \mathbf{E} - \nabla^2 \mathbf{E} = -\frac{1}{c} \frac{\partial}{\partial t} \left(4\pi g \mathbf{E} c + \frac{\epsilon}{c} \dot{\mathbf{E}} \right),$$

$$\therefore \nabla^2 \mathbf{E} = \frac{\epsilon}{c^2} \ddot{\mathbf{E}} + 4\pi g \dot{\mathbf{E}}.$$

Thus $1/c$ is missing from the term involving $\dot{\mathbf{E}}$

In the case of free space, all is well again, for

$$\nabla^2 \mathbf{E} = \frac{\epsilon}{c^2} \ddot{\mathbf{E}},$$

showing $1/(c)^2$ where a double time differentiation appears.

A further peculiarity of these equations, which also applies to the Gaussian system, arises in the case of free space and is dealt with in Section 2.5.

1.4 GAUSSIAN SYSTEM

In this system, the following *magnetic* quantities are all in electromagnetic units: pole strength, intensity, and flux. All the other quantities (including current) are in electrostatic units.

Consequently Maxwell's equations become³

$$\text{curl } \mathbf{H} = \frac{4\pi}{c} \mathbf{i} + \frac{\dot{\mathbf{D}}}{c}, \quad (1)$$

$$\text{div } \mathbf{B} = 0, \quad (2)$$

$$\text{curl } \mathbf{E} = -\frac{\dot{\mathbf{B}}}{c}, \quad (3)$$

$$\text{div } \mathbf{D} = 4\pi \rho, \quad (4)$$

$$\text{div} \left(\mathbf{i} + \frac{\dot{\mathbf{D}}}{4\pi} \right) = 0. \quad (5)$$

Conversion into polarisation \mathbf{P} for equation (1) produces the same result as in the mixed system

² F. W. G. White, "Electromagnetic Waves," p. 25, Methuen Monograph, London (1934).

³ P. 144 of footnote reference 1.

This is because \mathbf{P} is derived from the movement of charges and in both cases charges are in electrostatic units.

A difference occurs, however, when the wave equation is formed. Since we now substitute $g\mathbf{E}$ for \mathbf{i} (not $g\mathbf{E}c$ as in the mixed system), and also, since \mathbf{i} is already divided once by c in the equation for curl \mathbf{H} , the c factors no longer cancel out in the term involving $\dot{\mathbf{E}}$. Instead, this term is now divided by c^2 thereby resembling the term in $\ddot{\mathbf{E}}$. Hence the wave equation becomes

$$\nabla^2 \mathbf{E} = \frac{\epsilon}{c^2} \ddot{\mathbf{E}} + \frac{4\pi g}{c^2} \dot{\mathbf{E}}$$

1.5 RATIONALISED SYSTEM

This system, which was proposed by Heaviside, removes the 4π terms in the fundamental equations of Maxwell. As a result, the force equations must now be written

$$F = \frac{q_1 q_2}{4\pi \epsilon r^2}$$

and

$$F = \frac{m_1 m_2}{4\pi \mu r^2}$$

Therefore the 4π term has been removed in certain equations only to reappear elsewhere. What we have really done is to give the divergence equation a more fundamental role than the inverse-square-law equation.

Rationalism may be used with any of the previously mentioned systems, though it is most commonly applied to the Gaussian system (excluding its application to mks). Applied to the Gaussian system, rationalisation results in the following equations.⁴

$$\text{curl } \mathbf{H} = \frac{1}{c}(\rho \mathbf{V} + \dot{\mathbf{E}}), \tag{1}$$

$$\text{div } \mathbf{B} = 0, \tag{2}$$

$$\text{curl } \mathbf{E} = \frac{-\dot{\mathbf{B}}}{c}, \tag{3}$$

$$\text{div } \mathbf{D} = \rho, \tag{4}$$

$$\text{div } (\mathbf{i} + \epsilon \dot{\mathbf{E}}) = 0. \tag{5}$$

A further consequence of this system is that potential appears with a $1/(4\pi)$ factor, a direct

⁴Leigh Page and N. I. Adams, Jr., "Electrodynamics," D. Van Nostrand Co., New York (1940) and Chapman & Hall, London (1941).

result of the presence of this factor in the force equation. For example, the retarded potentials become

$$\phi = \frac{1}{4\pi} \int_v \frac{[\rho]}{r} dv,$$

$$A = \frac{1}{4\pi c} \int_v \frac{[\rho \mathbf{u}]}{r} dv.$$

Square brackets indicate that the retarded time of $[t - (r/c)]$ is to be used in evaluating the integral. The integration is a volume integral taken over the whole region in which the charges (moving with velocity \mathbf{u}) exist.

With the mks system, rationalisation is usually implied. No definite ruling for or against rationalisation has yet been given by the International Electrotechnical Commission, for at the International Conference at Scheveningen in 1935 this question was left undecided.⁵

1.6 PRACTICAL SYSTEM

Neither the e.m.u. nor the e.s.u. systems provide convenient units for everyday use. The e.m.u. system is characterised by a large unit of current and an exceedingly small unit of potential difference. With the e.s.u. system, the situation is exactly the reverse.

It is convenient, therefore, to take the larger units in the two cases as a starting basis. In actual fact, both these units are somewhat decreased to form the practical units. The relationships are as follows:

1 ampere = 1/10th of 1 electromagnetic unit of current,

1 volt = 1/300th of 1 electrostatic unit of voltage.

The above formulae provide the easiest way of remembering the relationship between practical and cgs units. It may also be helpful to associate the absolute unit of potential difference with 300 volts (the normal high tension on receivers), whilst the absolute unit of current is 10 amperes (the smallest multiple of 10 which will feed the low tension of a large receiver). The fact that the absolute unit of voltage refers

⁵A. E. Kennelly, "The M.K.S. System of Units," *Journal Institution of Electrical Engineers*, v. 78, p. 235, February, 1936; and A. E. Kennelly, "I.E.C. Adopts MKS System of Units," *Electrical Engineering*, v. 54, p. 1373; December, 1935.

to the e.s.u. system is readily brought to mind when one considers the high voltages developed by the friction experiments of electrostatics. Then the other absolute unit, namely that of current, is derived from the e.m.u. system.

One might wonder why the ampere should be a reduction of 1/10th of the biggest absolute unit whilst the volt is 1/300th. The reason is that the two reductions are not independent. Apart from the appearance of the 3 due to the velocity of light, it is necessary to proportion the two so that a logical unit of work results. The unit of work chosen is the joule (10^7 ergs). Hence, if 1 coulomb is moved through a potential difference of 1 volt, the work done is 1 joule. The full scale of relationships is given in Section 3.

1.7 MKS SYSTEM

1.7.1 General

The metre-kilogram-second system has the great advantage that all but one of the absolute units work out to be the same as the present fundamental practical units. The sole exception is the unit for magnetic flux. Of course, secondary units involving the primary ones per unit of length or area are necessarily different (e.g., volts per centimetre becomes volts per metre). There are no powers of 10 and c to be remembered.

On the other hand, the permeability and dielectric constant must be included in all formulae. In the case of free space, these take on the values

$$\begin{aligned}\mu_0 &= 4\pi \times 10^{-7}, \\ \epsilon_0 &= \frac{1}{36\pi} \times 10^{-9}.\end{aligned}$$

If the units of current and charge are to be the same as in the practical system, then the unit of time is necessarily the second since an ampere equals one coulomb per second. Furthermore the mks unit of work must be the joule (equals 1 coulomb moved through 1 volt). By retaining both the joule and the coulomb, it follows automatically that the volt, ohm, henry, and farad are also retained.

Now the joule has the dimensions ML^2T^{-2} and is 10^7 times greater than the cgs unit, the erg. Since the unit of time is unaltered, it follows

that the new units of mass and length must increase the produce of ML^2 by 10^7 . If $M=10^m$ grams and $L=10^l$ centimetres, then

$$2l+m=7.$$

Any combination of l and m fulfilling the above condition will do; in fact, the strange combination $l=0$ and $m=7$ has been used.⁵

In the mks system, $l=2$ and $m=3$, i.e., the unit of length is the metre and that of mass, the kilogram.

These changes give rise to a new unit of force which is equal to 10^{l+m} times the dyne. This new unit of force has been named the *newton* and equals 10^5 dynes.

To determine the value of μ , we note that the dimensions of μ are given by

$$\begin{aligned}[\mu] &= MLQ^{-2}, \\ \mu_{\text{cgs}} &= \frac{\text{gram centimetres}}{(\text{abcoulombs})^2}, \\ &= \frac{10^{-3} \text{ kilogram } 10^{-2} \text{ metres}}{10^2 (\text{coulombs})^2}, \\ &= 10^{-7} \mu_{\text{mks}}.\end{aligned}$$

To preserve the correct relationship between our units in the mks system, it is therefore necessary to give μ_0 (the free-space value for μ) the numerical value 10^{-7} .

When a *rationalised* system is used, the value for μ_0 becomes $4\pi \times 10^{-7}$. At this stage, one arrives at a debatable point regarding the position of μ_0 in the inverse-square law. This feature will receive separate consideration in Section 2.6.

Having determined the value of μ_0 in this way, then the value of ϵ_0 is fixed by the relationship $\mu_0\epsilon_0 = 1/(c)^2$, where $c = 3 \times 10^8$ metres per second. So finally we arrive at the following values for the rationalised mks system:

$$\begin{aligned}\mu_0 &= 4\pi \times 10^{-7} \text{ (henries per metre)}, \\ \epsilon_0 &= \frac{10^{-9}}{36\pi} = 8.85 \times 10^{-12} \text{ (farads per metre)}.\end{aligned}$$

The dimensional equivalents of μ_0 and ϵ_0 are given in parentheses in the above formulae. These equivalents are very easy to remember, for μ_0 and ϵ_0 are associated in this way with inductance and capacitance, respectively. In view of the use of μ_0 and ϵ_0 in all equations, the

factor c completely disappears from the electromagnetic equations.

The figures normally given for permeability and dielectric constant are values *relative* to those for free space. These relative values are usually denoted by μ_r and ϵ_r , respectively, and are of course dimensionless quantities.

1.7.2 Dimensions

No decision was reached at the Scheveningen Conference on the question of the fourth dimension. The ohm has the advantage of being a convenient unit for maintaining a practical standard. The coulomb is theoretically more elegant and results in all the powers of the dimensions of the electromagnetic quantities being in whole numbers.

The choice of charge as a dimension results in the following dimensions for other quantities:

$$\text{Current} = QT^{-1},$$

$$\text{Potential difference} = Q^{-1}ML^2T^{-2},$$

$$\mu_0 = Q^{-2}ML,$$

$$\epsilon_0 = Q^2M^{-1}L^{-3}T^2,$$

$$\text{Capacitance} = Q^2M^{-1}L^{-2}T^2.$$

The last two show that ϵ_0 has the dimensions of capacitance divided by length, i.e., farads per metre.

A fruitful result of the conventions for μ and ϵ is that we can regard free space as a medium with an "intrinsic impedance" of

$$Z_0 = \sqrt{\frac{\mu_0}{\epsilon_0}} = 376.6 \text{ ohms.}$$

The usefulness of the impedance concept is demonstrated in an interesting article by S. A. Schelkunoff.⁶

1.7.3 Unit of Magnetic Flux

This is the only unit which is different from the present practical unit, the maxwell. In the mks system, the unit of magnetic flux is the *weber* and equals 10^8 maxwells.

The discrepancy really results from a fault in the practical system, for the maxwell is equal to 1 unit of electromotive force (e.m.u.)-second,

⁶ S. A. Schelkunoff, "The Impedance Concept and Its Application to Problems of Reflection, Shielding and Power Absorption," *Bell System Technical Journal*, v. 17, p. 17, January, 1938.

whereas a more logical arrangement would have made the practical unit of flux equal to a volt-second. In the mks system, this point has been rectified, for the weber is equal to a volt-second.

The unit of magnetic charge (which is merely a convenient mathematical abstraction) is then also the weber since the flux is simply another way of measuring the "charge."

1.7.4 Conversion of CGS to MKS Units

To find the value of a cgs unit in mks units, we simply substitute 10^{-3} for M and 10^{-2} for L . In addition we must substitute $4\pi \times 10^{-7}$ for μ and $[1/(36\pi)] \times 10^{-9}$ for ϵ .

We must remember also that the force equation in the mks system contains the factor 4π . This actually removes the 4π factors present in μ and ϵ . Had we formed an *unrationalised* mks system, these factors would not have appeared at all in our substitutions.

As an example, we may take the unit of charge. In the cgs system, the electrostatic unit of charge has the dimensions:

$$[e^{\frac{1}{2}}M^{\frac{1}{2}}L^{\frac{3}{2}}T^{-1}],$$

$$\therefore 1 \text{ cgs} = \left(\frac{10^{-9}}{36\pi}\right)^{\frac{1}{2}} (10^{-3})^{\frac{1}{2}} (10^{-2})^{\frac{3}{2}} (4\pi)^{\frac{1}{2}} \text{ mks,}$$

$$\therefore 1 \text{ cgs (electrostatic unit)} = \frac{1}{3 \cdot 10^9} \text{ mks,}$$

$$\therefore 1 \text{ mks unit} = 1 \text{ coulomb.}$$

Care must be taken in making conversions involving units of length, since the mks unit of length is the metre. This caution therefore applies to all conversions concerning E , H , g (conductivity), B , D , i (current density), and ρ (charge density). The first three of these are divided by length, the next three by length squared, and the last by length cubed.

Supposing, for instance, we wish to find the conductivity of sea water in mks units, given that its conductivity in electrostatic units is 3.6×10^{10} . The conductivity is the reciprocal of the resistance of a cube with 1-centimetre-long sides. Our new cube will have sides of 1 metre, so that its resistance will be 1/100 as large. For this reason the unit of conductivity is 100 times greater than it would otherwise be.

The table in Section 3.2 shows that 1 electrostatic unit of resistance equals 9×10^{11} ohms. $1/9 \times 10^{-11}$ mho. Returning to conductivity,

which is conductance per unit length, we find that 1 electrostatic unit equals $1/9 \times 10^{-9}$ mho per metre. Consequently, the conductivity of sea water is 3.6×10^{10} electrostatic units or 4 mks units.

2. Comparison of Formulae

Only the three main systems are given, since other variations can easily be deduced from these.

2.1 MAXWELL'S EQUATIONS

a. MKS System

$$\begin{aligned}\text{curl } \mathbf{H} &= \mathbf{J} + \dot{\mathbf{D}}, \\ \text{div } \mathbf{B} &= 0, \\ \text{curl } \mathbf{E} &= -\dot{\mathbf{B}}, \\ \text{div } \mathbf{D} &= \rho.\end{aligned}$$

(\mathbf{J} is sometimes used to denote current density instead of \mathbf{i} and is amperes per square metre.)

b. Gaussian System

$$\begin{aligned}\text{curl } \mathbf{H} &= \frac{4\pi}{c} \mathbf{i} + \frac{\dot{\mathbf{D}}}{c}, \\ \text{div } \mathbf{B} &= 0, \\ \text{curl } \mathbf{E} &= -\frac{\dot{\mathbf{B}}}{c}, \\ \text{div } \mathbf{D} &= 4\pi\rho.\end{aligned}$$

c. Mixed System

$$\begin{aligned}\text{curl } \mathbf{H} &= 4\pi\mathbf{i} + \frac{\dot{\mathbf{D}}}{c}, \\ \text{div } \mathbf{B} &= 0, \\ \text{curl } \mathbf{E} &= -\frac{\dot{\mathbf{B}}}{c}, \\ \text{div } \mathbf{D} &= 4\pi\rho.\end{aligned}$$

The three supplementary equations are the same in all three systems. Thus for isotropic media:

$$\begin{aligned}\mathbf{i} \text{ (or } \mathbf{J}) &= g\mathbf{E}, \\ \mathbf{D} &= \epsilon\mathbf{E}, \\ \mathbf{B} &= \mu\mathbf{H}.\end{aligned}$$

It is worth noting that in the mks system the magnetic intensity \mathbf{H} has the dimensions of amperes per metre. This is obvious when we remember that the curl \mathbf{H} formula is merely a generalisation of Ampere's law, namely that

$$\oint \mathbf{H} \cdot d\mathbf{s} = I.$$

(Here I is the total current, whereas in the curl formula, \mathbf{J} is the current density, i.e., \mathbf{J} is in amperes per square metre.) Consequently, the unit of magnetic intensity can be defined very simply in the following manner: It is the magnetic intensity which exists between two parallel strips of conductor 1 metre broad, when 1 ampere is flowing through the conductors in opposite directions. In this statement it is assumed that the field is made uniform by the presence of "guard" strips.

Such a conception of \mathbf{H} leads quite simply to the calculation of the characteristic impedance of coaxial lines.⁷

In all other systems, \mathbf{H} also has the dimensions of current per unit length, but if the system is unrationalised, the factor 4π modifies the numerical value. The current may then be either in electrostatic units (Gaussian system) or in electromagnetic units (mixed system); in both cases the unit of length is, of course, the centimetre.

With regard to the remaining quantities \mathbf{E} , \mathbf{B} , \mathbf{D} , and ρ , one should keep in mind the differences arising in the mks system due to the choice of the metre as the unit of length. This point was also made in Section 1.7.4 where a short example was also given.

2.2 POYNTING'S VECTOR

a. MKS System

$$\mathbf{S} = \mathbf{E} \times \mathbf{H},$$

or

$$\mathbf{S} = \frac{1}{2} \mathbf{E} \times \mathbf{H} \text{ (complex Poynting vector).}$$

b. Gaussian System

$$\mathbf{S} = \frac{c}{4\pi} \mathbf{E} \times \mathbf{H}.$$

c. Mixed System

$$\mathbf{S} = \frac{c}{4\pi} \mathbf{E} \times \mathbf{H}.$$

⁷ S. A. Schelkunoff, "Electromagnetic Waves," p. 243, D. Van Nostrand, New York (1943).

The complex Poynting vector is formed in all three cases by taking the conjugate of \mathbf{H} and dividing by 2.

2.3 SCALAR AND VECTOR POTENTIALS

a. MKS System

$$\phi = \frac{1}{4\pi\epsilon_0} \int_v \frac{[\rho]}{r} dv,$$

$$\mathbf{A} = \frac{\mu_0}{4\pi} \int_v \frac{[\rho\mathbf{u}]}{r} dv.$$

b. Gaussian System

$$\phi = \int_v \frac{[\rho]}{r} dv,$$

$$\mathbf{A} = \frac{1}{c} \int_v \frac{[\rho\mathbf{u}]}{r} dv.$$

c. Mixed System

$$\phi = \int_v \frac{[\rho]}{r} dv,$$

$$\mathbf{A} = \int_v \frac{[\rho\mathbf{u}]}{r} dv.$$

The above values refer to free space, the condition under which they are most commonly used. The square brackets indicate that the retarded time of $[t-(r/c)]$ is to be used in evaluating the integral.

2.4 COMPLEX REFRACTIVE INDEX

In all cases, f = frequency in cycles per second, and the time factor is of the form $e^{+j\omega t}$.

a. MKS System

$$\epsilon' = \epsilon_r - j2\frac{g}{f} \cdot 9 \cdot 10^9 \text{ (g in mhos per metre),}$$

$$= \epsilon_r - j60\lambda g \text{ (\lambda in metres)}$$

where

ϵ_r = relative dielectric constant.

b. Gaussian System

$$\epsilon' = \epsilon - j2\frac{g}{f},$$

where

g = conductivity in electrostatic units.

c. Mixed System

$$\epsilon' = \epsilon - j2\frac{g}{f}c^2,$$

where

g = conductivity in electromagnetic units.

2.5 THE "FREE-SPACE ANOMALY"

In the case of zero conductivity, both the mixed and the Gaussian systems give the following equations.

$$\text{curl } \mathbf{H} = \frac{\dot{\mathbf{E}}}{c}, \tag{1}$$

$$\text{curl } \mathbf{E} = \frac{-\dot{\mathbf{H}}}{c}. \tag{2}$$

When we consider the dimensions of the above equations, we are immediately struck by the fact that, although \mathbf{E} and \mathbf{H} are interchanged in the two equations (except for a minus sign), the denominator c remains in the same position.

In order to convert \mathbf{E} from electrostatic to electromagnetic units, we must multiply by c . It would therefore appear that equation (1) was wrong, whilst (2) was right.

The answer lies, of course, in the fact that the dimensions of the dielectric constant and permeability have dropped out, both these factors being unity. To get the dimensions right we should put

$$\text{curl } \mathbf{H} = \epsilon \frac{\dot{\mathbf{E}}}{c}, \tag{1a}$$

$$\text{curl } \mathbf{E} = \frac{-\mu\dot{\mathbf{H}}}{c}, \tag{2a}$$

It is instructive to follow the dimensions through in one case, say in equation (1a).

$$[\mathbf{H}] = [\mu^{-\frac{1}{2}}M^{\frac{1}{2}}L^{-\frac{1}{2}}T^{-1}]. \text{ (See 1.1)}$$

The process of curling divides the dimensions by L (curl being a line integral round a unit area),

$$\therefore [\text{curl } \mathbf{H}] = [\mu^{-\frac{1}{2}}M^{\frac{1}{2}}L^{-\frac{3}{2}}T^{-1}]. \tag{3}$$

Turning now to the right-hand side of the equation, we have

$$[\mathbf{E}] = [\epsilon^{-\frac{1}{2}}M^{\frac{1}{2}}L^{-\frac{1}{2}}T^{-1}],$$

for obviously \mathbf{E} must have the same dimensions as \mathbf{H} except for the substitution of ϵ for μ . To

convert to electromagnetic units, we multiply by c , i.e., by $\mu^{-\frac{1}{2}}\epsilon^{-\frac{1}{2}}$,

$$\begin{aligned}\therefore \mathbf{E}_{\text{esu}} &= [\mu^{-\frac{1}{2}}\epsilon^{-1}M^{\frac{1}{2}}L^{-\frac{1}{2}}T^{-1}], \\ \therefore \mathbf{E}_{\text{emu}} &= [\mu^{-\frac{1}{2}}M^{\frac{1}{2}}L^{-\frac{1}{2}}T^{-1}], \\ \therefore \frac{\dot{\mathbf{E}}}{c} &= [\mu^{-\frac{1}{2}}M^{\frac{1}{2}}L^{-\frac{1}{2}}T^{-1}].\end{aligned}\quad (4)$$

Equations (3) and (4) agree. Note that it was necessary to divide $\dot{\mathbf{E}}$ by c to do this.

A more direct attack on this problem is obtained if we use the fact that $\epsilon\mathbf{E} = \mathbf{D} =$ charge per square centimeter (because $\text{div } \mathbf{D} = 4\pi\rho$). Therefore the unit of charge occurs in the numerator and this is converted to electromagnetic units by *dividing* by c . In a similar manner, the correctness of equation (2a) may be argued from a dimensional point of view.

The moral to be drawn from this case is that μ and ϵ should always be included in the electromagnetic equations. By using the mks system, one is not likely to fall into this error for then μ and ϵ are never equal to unity. We therefore have a further argument in favour of the mks system.

2.6 μ_0 AND THE FORCE EQUATION

It will come as a surprise to many engineers to find the law of force between magnetic poles⁸ written as

$$F = \frac{\mu_0 m_1 m_2}{4\pi r^2}.$$

This formulation however is not incompatible with the usual expression in which μ_0 appears in the denominator. The differences are taken up by the different conception of magnetic pole or "charge" involved in the two cases. Schelkunoff⁹ favours the older formulae because a more symmetrical system of electromagnetic formulae is obtained in this way. Whichever outlook is adopted, *no difference exists in formulae not involving magnetic poles*. For instance, the retarded-vector potential is given in both cases by

$$A = \frac{\mu_0}{4\pi} \int_v \frac{[\rho\mathbf{u}]}{r} dv.$$

⁸ J. A. Stratton, "Electromagnetic Theory," p. 242, McGraw-Hill Book Company, New York (1941).

⁹ P. 70 of footnote reference 7.

Let us consider the two different lines of thought. In both cases, the force on an element of current is given by $\mathbf{J} \times \mathbf{B}$. Hence the torque on an elementary current loop is $I\delta\mathbf{a} \times \mathbf{B}$ (or $\mu I\delta\mathbf{a} \times \mathbf{H}$). At this point we may define the magnetic moment \mathbf{m} of this current loop to be equal to either $I\delta\mathbf{a}$ or $\mu I\delta\mathbf{a}$. In the former case, the force on a pole becomes $\mathbf{F} = m\mathbf{B}$. In the latter case $\mathbf{F} = m'\mathbf{H}$. These lead to the new and old definitions of pole strength, respectively, and show that $m\mu = m'$. Hence when μ_0 is in the numerator (the m case) the pole strengths are defined as $1/\mu$ times the old conception of poles, and since the force equation contains m^2 we have exact equivalence with the older formulae.

The older system shows up to disadvantage when we consider the laws from a physical point of view. Let us consider, for example, the case of a simple solenoid in air inside which is placed a unit "pole" m , or preferably a small current loop. The fictitious pole experiences a force due to the magnetic field set up by the circulating current in the solenoid whereas in the case of a current loop, we have a torque produced and the loop may be considered equivalent to a magnetic dipole.

If now we fill the solenoid with a paramagnetic substance of permeability μ , the force on the pole (or the torque on the loop) is increased by the factor μ . This increase is due to the molecular magnets orientating themselves in such a manner as to produce circulating currents which *augment* the original circulating current in the wire. Obviously, the force on m is given by $\mathbf{F} = m\mu\mathbf{H}$. We can consider that either the pole has increased its strength by a factor μ or, what is more natural, that the field has increased by this factor. In the first place, we are led to a formulation of the inverse-square law with μ in the denominator; in the second place, μ appears in the numerator.

The second viewpoint is preferable and is more in keeping with the fact that whereas like charges *repel* each other, like currents *attract* each other. It is the latter effect which causes paramagnetic substances to augment the impressed field. In engineering practice we are normally only interested in strongly paramagnetic—that is in ferromagnetic—materials. The fact that all substances are also diamagnetic

(i.e., the molecular currents have their orbits modified to act in opposition to the impressed field) can be overlooked for the effect is exceedingly small.

Since $F = qv \times B$, the new definition makes a magnetic charge equal to an electric charge times a velocity. With this definition, the concept of flux density B (arising out of ampere currents) is considered more fundamental than the magnetic intensity H (arising out of the idea of poles). The same school of thought maintains that the related groupings between electric and magnetic quantities should be E and B for one group, whilst D and H form the other group. In support of this, the formula $F = q(E + v \times B)$ is quoted. However the quantities differ by a velocity even in this grouping. So there is something to be said for those who prefer to aim at the maximum symmetry in the electromagnetic equations rather than in physical resemblances.

This difference in the concept of the magnetic poles also shows up in the formulae involving the intensity of magnetisation or "magnetic polarisation." Polarisation being charge per unit area, the dimensions of electric or magnetic charge are necessarily involved. Thus the formula giving μ_0 on top gives¹⁰

$$B = \mu_0 H + \mu_0 M,$$

whereas the old form is

$$B = H + 4\pi I.$$

In the latter case, the old familiar unration-alised form has been quoted in which the μ_0 associated with H is equal to unity. When the mks system is used with μ_0 in the denominator of the force equation, we have

$$B = \mu_0 H + P_m,$$

where P_m has been used instead of I or M to show the relationship with P_e , the electric polarisation.

In conclusion, it will be seen that the choice of position of μ_0 depends on whether symmetry in the formulae or certain physical considerations are put first. Most of us are as yet more familiar with the definition which produces the former result, but the newer conception has much to be said for it and is gaining ground.

3. Tables

3.1 MKS UNITS

TABLE I

Quantity	Unit	Dimensional Equivalent
Length	Metre	
Mass	Kilogram	
Time	Second	
Energy	Joule	Volt-coulomb
Power	Watt	Joule per second
Force	Newton	Joule per meter
Electric charge	Coulomb	Ampere-second
Displacement density	Coulomb per metre ²	
Electric current	Ampere	Coulomb per second
Current density	Ampere per metre ²	
Electromotive force	Volt	Joule per coulomb
Electric intensity	Volt per metre	Newton per coulomb
Impedance	Ohm	Volt per ampere
Admittance	Mho	Ampere per volt
Inductance	Henry	Ohm-second
Permeability	Henry per metre	
Capacitance	Farad	
Dielectric constant	Farad per metre	
Conductivity	Mho per metre	
Magnetomotive force	Ampere	
Magnetic intensity	Ampere per metre	
Magnetic flux	Weber	Volt-second
Magnetic charge	Weber	Volt-second
Magnetic flux density	Weber per metre ²	
Magnetic current	Volt	
Magnetic current density	Volt per metre ²	

¹⁰ P. 11 of footnote reference 8.

3.2 RELATIONSHIP OF UNITS

TABLE II

	Name of Practical Unit	Size in MKS Units	Size in Electromagnetic Units	Size in Electrostatic Units
Energy	Joule	1	10^7 ergs	10^7 ergs
Power	Watt	1	10^7 ergs/sec.	10^7 ergs/sec.
Electric charge	Coulomb	1	10^{-1}	3×10^9
Displacement density	$\frac{\text{Coulombs}}{\text{centimetre}^2}$	$\frac{10^4 \text{ Coulombs}}{4\pi \text{ metre}^2}$	10^{-1}	3×10^9
Electromotive force	Volt	1	10^8	1/300
Electric intensity	Volt/centimetre	10^2 Volt/metre	10^8	1/300
Impedance	Ohm	1	10^9	$1/(9 \times 10^{11})$
Inductance	Henry	1	10^9	$1/(9 \times 10^{11})$
Capacitance	Farad	1	10^{-9}	9×10^{11}
Current	Ampere	1	10^{-1}	3×10^9
Magnetomotive force	Gilbert*	$\frac{10^4}{4\pi}$ amperes	1	3×10^{10}
Magnetic intensity	Oersted†	$\frac{10^3}{4\pi}$ amperes/metre	1	3×10^{10}
Magnetic flux	Maxwell	10^{-8} Webers	1	$1/(3 \times 10^{10})$

* Although the gilbert has the same dimensions as current, it is numerically equal to $1/4\pi$ times the electromagnetic unit of current due to the relationship $\int H \cdot ds = 4\pi I$. In the rationalised mks system, the unit of magnetomotive force is the ampere both dimensionally and numerically. Because of the 4π factor in unrationalized versions, it is safer to refer to the unit of magnetomotive force as the ampere turn or abampere-turn. The addition of the word "turn" has no effect on the dimensions but serves to distinguish the unit from that of current.

The main point to remember in converting from rationalised to unrationalised units is that the rationalised units of H and D are 4π times bigger.

† Formerly called the "gauss." In the cgs system, the name "gauss" is now reserved for use as the unit of magnetic induction (magnetic-flux density). This change was made at the International Electrotechnical Commission Convention held at Oslo in 1930.

4. Conclusion

There is little doubt that the mks system forms a highly satisfactory solution to the problem of the choice of electromagnetic units. The physicist may object to the introduction of the metre or kilogram as fundamental units, and consider that if these are used then the same modification should be made in mechanics and other branches of physics; such a change would not really be

amiss since the resultant units would again be of a more practical nature. In any case, it is quite impossible to satisfy both atomic and macroscopic requirements with a single set of units without at the same time introducing large powers of 10. From an engineering point of view, it is much more desirable that the occurrence of these powers of 10 should be entirely in the atomic scale.

Recent Telecommunication Developments

EMERGENCY COMMUNICATION EQUIPMENT—Federal Telephone and Radio Corporation has announced a new line of emergency communication equipment for 2-way communication between fixed and mobile stations as required by police, fire, forestry, and other services. It is intended for use in the 30- to 44- megacycle band.

As is evident from the illustration of the mobile unit, extreme compactness is attained, yet the plug-in chassis construction allows complete accessibility for servicing.

A serious inconvenience encountered in emergency equipment heretofore available has been that the carrier-operated circuits for rendering the receiver operable often function on noise or on signals from unwanted stations. The new equipment utilizes a sharply tuned vibrating reed in the receiver so that the receiver is turned on only when a particular audio-frequency note is radiated from the calling transmitter.

In addition to the mobile transmitter-receiver pictured, the complete line will include a 50-watt console-type transmitter-receiver, 50- and 250-watt fixed-station cabinet-mounted transmitter-receivers with remote-control consoles, and un-

attended relay stations for handling 2-way communications to points beyond the normal range of a central station.

• • •

HERMETICALLY SEALED SELENIUM RECTIFIERS—A recent addition to Federal Telephone and Radio Corporation products is a half-wave, glass-enclosed hermetically sealed selenium rectifier. The largest of these rectifiers is capable of withstanding an inverse peak potential of 4,000 volts. The current output of this rectifier is 5 milliamperes when connected to a resistive load and operated in an ambient temperature lower than 35 degrees centigrade. For higher ambient temperatures, the current rating must be reduced. The unit is enclosed in a glass tube with metal end ferrules solder sealed to the glass tube. The end ferrules also serve as electrical contacts, the whole unit being mounted in fuse clips. The approximate size of the 4,000-volt unit is $4\frac{1}{2}$ inches long and $\frac{1}{2}$ -inch outside diameter. Rectifiers having lower voltage ratings are proportionally shorter in length.

• • •

QUARTZ-CRYSTAL OVEN—Federal Telephone and Radio Corporation now has available a compact crystal oven capable of holding up to 10 small hermetically sealed crystal units, intended for use in multichannel fixed and mobile point-to-point equipments. The oven dimensions are 3.65 inches by 2.5 inches with a seated height of 1.75 inches. Two thermostats and heaters are employed to maintain the oven temperature within ± 2 degrees centigrade over an ambient range of -15 to $+75$ degrees centigrade. The holder has 24 base pins which plug into a special plastic socket. The weight of the oven loaded with crystals is somewhat less than that of 10 normal small crystals using conventional holders.

• • •

HERMETICALLY SEALED TRANSFORMERS—As soon as the war reached tropical areas, trouble with radio equipment resulted from high humidity, fungus, or both. This caught the Allies

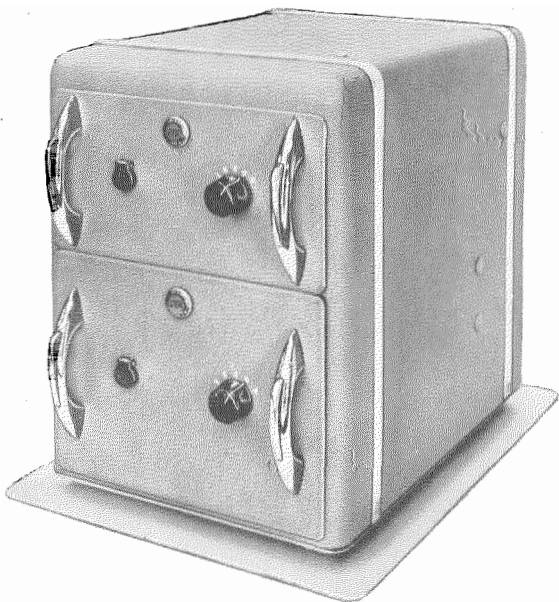

somewhat unprepared, although captured Japanese equipment indicated an awareness on their part of this trouble.

Federal Telephone and Radio Corporation has recently added to its products two lines of hermetically sealed transformers. Both are mounted in metal cases.

One type uses gasketed assembly and the other glass-to-metal seals. The gasketed assemblies, using neoprene or combination neoprene-and-cork gaskets, are assembled without liquid cements. While the art of gasketing is old, glass-to-metal seals as transformer bushings are comparatively new. The production of the glass-to-metal seals has been well mechanized.

These hermetically sealed transformers vary in size from units approximately $\frac{3}{4}$ inch in diameter by 1 inch long to a volume of about 2 cubic feet. Operating voltages range up to 10,000 volts, and power ratings run as high as approximately 3 kilovolt-amperes. Several styles of mountings may be had. The smaller round units may be mounted with a clamp similar to that used on electrolytic capacitors while the larger units are either bracket or stud mounted.

• • •

HIGH-FREQUENCY POWER TRIODE, 7C26—A new high-frequency tube suitable for use in 1-kilowatt and 3-kilowatt frequency-modulation transmitters has been developed by Federal Telephone and Radio Corporation. This tube, designated as type 7C26, is a forced-air-cooled triode rated at full input for frequencies up to 150 megacycles. Maximum ratings and typical operation as a Class-C power amplifier without amplitude modulation are as follows.

Maximum Ratings

Direct Plate Voltage	3,000 volts
Direct Plate Current	1.0 ampere
Plate Input	3,000 watts
Plate Dissipation	1,000 watts

Typical Operation

Direct Plate Voltage	3,000 volts
Direct Plate Current	1.0 ampere
Power Output	2,350 watts
Plate Efficiency	79 percent



Contributors to This Issue

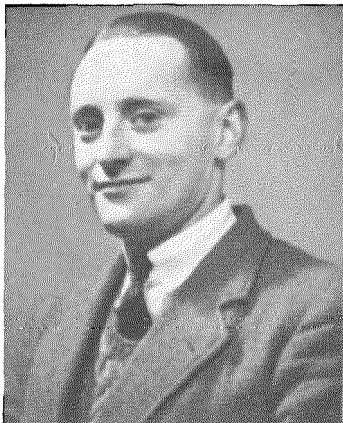

C. C. BARNES

C. C. Barnes holds a Full Technological Certificate (First Class) in Electrical Engineering Practice from the City and Guilds of London Institute.

From 1929 to 1935, he served in the Cable Design and Estimating Departments of W. T. Glover and Company, Ltd., in Manchester. The following three years were spent in the Electrical Department of St. Helens Cable and Rubber Company, Ltd., Slough, Bucks; he then became a member of the staff of the Rubber Cable Department of Scottish Cables, Ltd., Renfrew.

In June, 1939, he joined Standard Telephones and Cables, Ltd., North Woolwich. Mr. Barnes is in charge of the Power Cable Engineering Department and is responsible for the technical and economic problems relating to all types of impregnated paper-insulated power cables.

• • •

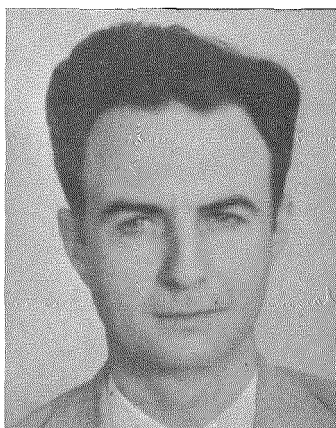

JOSÉ D. DOMINGUEZ

Henri Busignies was born in Sceaux, France, on December 29, 1905. He received the degree of Electrical Engineer from Paris University in 1926.

On completion of his military service, he entered the Paris Laboratories of the International Telephone and Telegraph Corporation in 1928. Until about 1940, Mr. Busignies traveled to Italy, Spain, Switzerland, England, Africa, and the United States in the interests of the company. Since 1940, he has been an executive engineer and is now the Director of Federal Telecommunication Laboratories in New York city.

His first patent was issued in 1926 and has been followed by almost a hundred others. They have been dominantly in the field of automatic direction finding with particular attention to aircraft applications. He received the Lakhovsky award of the Radio Club of France in 1926.

Mr. Busignies is a Fellow of the Institute of Radio Engineers.

• • •

José D. Dominguez received the S.B. degree in electrical engineering from Massachusetts Institute of Technology in 1927. Immediately joining the engineering staff of International Telephone and Telegraph Corporation, he was assigned to the Cuban Telephone Company where he served successively as Traffic Supervisor, Superintendent of Service and Methods, and General Plant Supervisor.

In anticipation of the conversion to automatic operation of the San Juan-Santurce areas, he was transferred to the Porto Rico Telephone Company late in 1939 as Chief Engineer in charge of the Engineering and Plant Departments. He became General Manager and Chief Engineer in 1943 and was responsible for the planning and execution of this first conversion to automatic operation in Porto Rico.

• • •

Stanley Boyd Eaton was born in Belfast, Maine, on March 14, 1908. During 1930, he served as a ship radio operator. He received the B.S. degree in electrical engineering from the University of Maine in 1931.

From 1932 to 1941, he was principal of three high schools in Maine. Becoming a U. S. Army Signal Corps inspector in 1941, he remained in this work until



HENRI BUSIGNIES

1943 when he joined the staff of Federal Telephone and Radio Corporation. After a year as chief inspector for the Crystal Division, he was transferred to Crystal Engineering.

• • •

D. D. Grieg was born on February 26, 1915 in London, England. He received his early schooling in England and the B.S. degree in electrical engineering from the College of the City of New York.

From 1936 to 1940, he was in charge of the television department of the Davega Radio Company. In early 1941 he taught radio communication in the Brooklyn Technical High School. Since 1941, he has been a research engineer for Federal Telecommunication Laboratories. He is now a Division Head and has charge of the Television and Communication Departments.

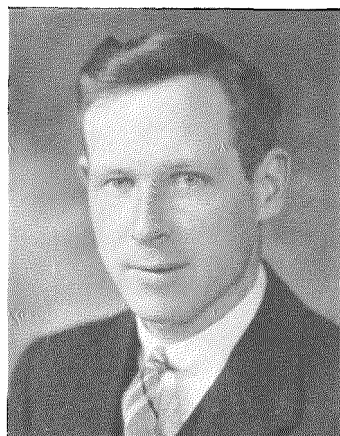

STANLEY B. EATON



D. D. GRIEG

Mr. Grieg is a Senior Member of the Institute of Radio Engineers and a Member of the American Institute of Electrical Engineers. He has served on several technical committees including the Television Committee of the Radio Technical Planning Board and those on Television Relays and Studio-Transmitter Links of the Radio Manufacturers Association. He is the author of several technical papers and holds many patents in the field of radio.

• • •

Armig G. Kandoian was born on November 28, 1911 in Van, Armenia. In 1934, he received the B.S. degree and a year later the M.S. degree in electrical communication from Harvard University.

He joined the engineering staff of International Telephone and Telegraph Corporation in 1935. With its establishment in 1937, he was transferred to



A. J. WARNER

the International Telephone Development Company for work on air navigation and instrument landing systems. Federal Telephone and Radio Corporation took over the activities of that company and was succeeded by Federal Telecommunication Laboratories in 1945. Mr. Kandoian is now a department head responsible for radar, antennas, and multiplex broadcasting.

Mr. Kandoian is a Senior Member of the Institute of Radio Engineers, an Associate of the American Institute of Electrical Engineers, and is a member of the Harvard Engineering Society and of Tau Beta Pi.

• • •

A. J. Warner was born in London, England, on March 25, 1913. He joined the staff of Standard Telephones and Cables, Ltd., in 1930 as a metallurgical chemist and in 1932 was granted a leave of absence. In 1935 he received the B.Sc. degree in chemistry from the University of London. He then returned to S.T.C. as a chemist on raw materials and on research problems related to electrical insulation.

In 1940, Mr. Warner was transferred to the New Insulators Factory at Enfield, Middlesex, England, and in 1941, to the International Telephone and Radio Manufacturing Corporation in Newark, New Jersey, U. S. A. Later this organization became part of Federal Telephone and Radio Corporation. Near the end of 1945, he was named Manager, Dielectrics Laboratories, Federal Telecommunication Laboratories.

Mr. Warner has been designated by the American Society for Testing Materials as one of six members of the Advisory Group which will assist the Armed Forces in technical problems arising in the research program on plastics recently initiated at Princeton University.

He maintains memberships in three professional societies in Great Britain: Chemical Society, Royal Institute of Chemistry, and Society of Chemical Industry. In the U. S. A. he is a member of the American Chemical Society, of Committees D-9 and D-20 of the American Society for Testing Materials, President of the Newark Chapter of the Society of Plastics Engineers, Vice Chairman of the Technical Committee of the Society of the Plastics

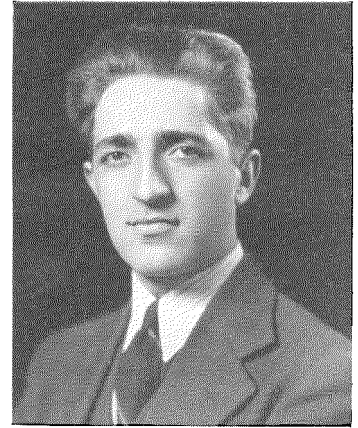

ARMIG G. KANDOIAN

Industry, and a member of the American Institute of Electrical Engineers.

• • •

H. Paul Williams was born on March 16, 1913. He received the B.Sc. and the Ph.D. degrees from London University in 1933 and 1938, respectively.

From 1933 to 1935 he was in the development laboratories of Murphy Radio Ltd. He was engaged in research on the ionosphere from 1935 to 1938 at London and Cambridge.

In 1938, Dr. Williams joined the staff of Standard Telephones and Cables Ltd. and devoted his attention to aircraft landing systems. Later, he specialized in antennas and wave propagation studies.

During the last three years he has given lecture courses in electromagnetic theories and their applications in the Company's out-of-hours courses. He is an Associate Member of the Institution of Electrical Engineers.

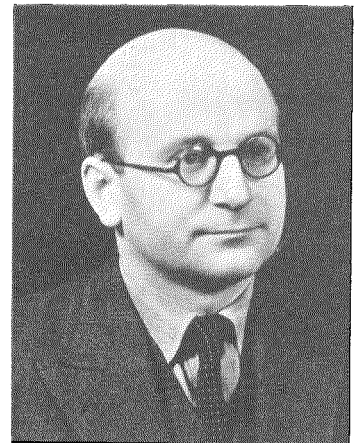

H. PAUL WILLIAMS

INTERNATIONAL TELEPHONE AND TELEGRAPH CORPORATION

Associate Manufacturing and Sales Companies

UNITED STATES OF AMERICA

INTERNATIONAL STANDARD ELECTRIC CORPORATION, New York, New York
FEDERAL TELEPHONE AND RADIO CORPORATION, Newark, New Jersey

BRITISH EMPIRE

STANDARD TELEPHONES AND CABLES, LIMITED, London, England

Branch Offices: Birmingham, Leeds, Manchester, England; Glasgow, Scotland; Dublin, Ireland; Cairo, Egypt; Calcutta, India; Johannesburg, South Africa.

CREDIT AND COMPANY, LIMITED, Croydon, England
INTERNATIONAL MARINE RADIO COMPANY LIMITED, Liverpool, England

KOLSTER-BRANDS LIMITED, Sidney, England
STANDARD TELEPHONES AND CABLES PTY. LIMITED, Sydney, Australia

Branch Offices: Melbourne, Australia; Wellington, New Zealand.
NEW ZEALAND ELECTRIC TOTALISATORS LIMITED, Wellington, New Zealand

SOUTH AMERICA

COMPAÑIA STANDARD ELECTRIC ARGENTINA, SOCIEDAD ANÓNIMA, INDUSTRIAL Y COMERCIAL, Buenos Aires, Argentina

STANDARD ELECTRICA, S.A., Rio de Janeiro, Brazil
COMPAÑIA STANDARD ELECTRIC, S.A.C., Santiago, Chile

EUROPE AND ASIA

VEREINIGTE TELEFON- UND TELEGRAPHEN-WERKE AKTIENGESELLSCHAFT, Vienna, Austria

BELL TELEPHONE MANUFACTURING COMPANY, Antwerp, Belgium

CHINA ELECTRIC COMPANY, LIMITED, Shanghai, China
STANDARD ELECTRIC DOKS A SPOLEKNOSE, Prague, Czechoslovakia

STANDARD ELECTRIC AKTIESELSKAB, Copenhagen, Denmark

COMPAGNIE GÉNÉRALE DE CONSTRUCTIONS TÉLÉPHONIQUES, Paris, France

LE MATÉRIEL TÉLÉPHONIQUE, Paris, France

LES TÉLÉGRAPHISTES, Paris, France

LIGNES TÉLÉGRAPHIQUES ET TÉLÉPHONIQUES, Paris, France
FERDINAND SCHNEIDERFELD BERLINER FERNSPRECH- UND TELEGRAPHENWERK AKTIENGESELLSCHAFT, Berlin, Germany

LORENZ, C. A.G. AND SUBSIDIARIES, Berlin, Germany
MIX & GENEST AKTIENGESELLSCHAFT AND SUBSIDIARIES, Berlin, Germany

SÜDDEUTSCHE APPARATEFABRIK GESELLSCHAFT M.B.H., Nuremberg, Germany

TELEFONFABRIK BERLINER A.G. AND SUBSIDIARIES, Berlin, Germany

NEDERLANDSCHE STANDARD ELECTRIC MAATSCHAPPIJ N.V., Hague, Holland

DIAL TELEFONKERESKEDÉLMŰ RÉSZVÉNY TÁRSASÁG, Budapest, Hungary

STANDARD VILLAMOSSÁGI RÉSZVÉNY TÁRSASÁG, Budapest, Hungary

TELEFONYTÁR R.T., Budapest, Hungary
FABRICA APPARECCHIATURE PER COMUNICAZIONI ELETTRICHE, Milan, Italy

SOCIETA FINANZIARIA ELETTROTELEFONICA, Milan, Italy
SOCIETA ITALIANA RETI TELEFONICHE INTERURBANE, Milan, Italy

NIHON ELECTRIC COMPANY, LIMITED, Tokyo, Japan

SHIMOTO ELECTRIC INDUSTRIES, LIMITED, Osaka, Japan
STANDARD TELEFON- OG KABELFABRIK A/S, Oslo, Norway

STANDARD ELECTRIC COMPANY W. POLSKIE SP. Z.O.O., Wroclaw, Poland

STANDARD ELECTRICA, Lisbon, Portugal

STANDARD FABRICA DE TELEFONE SI RADIO S.A., Bucharest, Rumania

COMPAÑIA RADIO AEREA MARITIMA ESPAÑOLA, Madrid, Spain

STANDARD ELÉCTRICA, S.A., Madrid, Spain

AKTIEBOLAGET STANDARD RADIOFABRIK, Stockholm, Sweden

STANDARD TELEPHONES ET RADIO S.A., Zurich, Switzerland
JUGOSLAVENSKO STANDARD ELECTRIC COMPANY AKCIONARNO DRUŠTVO, Belgrade, Yugoslavia

TELEOPTIK A.D., Belgrade, Yugoslavia

Telephone Operating Systems

UNITED RIVER PLATE TELEPHONE COMPANY, LIMITED, Buenos Aires, Argentina

COMPAÑIA TELEFÓNICA ARGENTINA, Buenos Aires, Argentina

COMPAÑIA TELEGRÁFICO-TELEFÓNICA COMERCIAL, Buenos Aires, Argentina

COMPANHIA TELEFONICA PARANAENSE S.A., Curitiba, Brazil

COMPANHIA TELEFONICA RIO GRANDENSE, Porto Alegre, Brazil

COMPAÑIA DE TELÉFONOS DE CHILE, Santiago, Chile

CUBAN TELEPHONE COMPANY, Havana, Cuba

MEXICAN TELEPHONE AND TELEGRAPH COMPANY, Mexico City, Mexico

COMPANIA PERUANA DE TELÉFONOS LIMITADA, Lima, Peru

PORRTO RICO TELEPHONE COMPANY, San Juan, Puerto Rico

SHANGHAI TELEPHONE COMPANY, FEDERAL, INC., U.S.A., Shanghai, China

Radiotelephone and Radiotelegraph Operating Companies

COMPAÑIA INTERNACIONAL DE RADIO, Buenos Aires, Argentina

COMPAÑIA INTERNACIONAL DE RADIO BOLIVIANA, La Paz, Bolivia

COMPANHIA RADIO INTERNACIONAL DO BRASIL, Rio de Janeiro, Brazil

COMPAÑIA INTERNACIONAL DE RADIO S.A., Santiago, Chile

RADIO CORPORATION OF CUBA, Havana, Cuba

RADIO CORPORATION OF PORTO RICO, San Juan, Puerto Rico

† Radiotelephone and Radio Broadcasting services.

Cable and Radio Telegraph Operating Companies

(Controlled by American Cable & Radio Corporation)

THE COMMERCIAL CABLE COMPANY, New York, New York

MACKAY RADIO AND TELEGRAPH COMPANY, New York, New York

ALL AMERICA CABLES AND RADIO, INC., New York, New York

THE CUBAN ALL AMERICA CABLES, INCORPORATED, Havana, Cuba

SOCIEDAD ANÓNIMA RADIO ARGENTINA, Buenos Aires, Argentina

¹ Cable service. ² International and Marine Radiotelegraph services. ³ Cable and Radiotelegraph services. ⁴ Radiotelegraph service.

Laboratories

INTERNATIONAL TELECOMMUNICATION LABORATORIES, INC., New York, New York

FEDERAL TELECOMMUNICATION LABORATORIES, INC., New York, New York

STANDARD TELECOMMUNICATION LABORATORIES LTD., London, England

LABORATOIRE CENTRAL DE TÉLÉCOMMUNICATIONS, Paris, France