



# ELECTRICAL COMMUNICATION

OCTOBER

No. 2

1932

VOL. 11

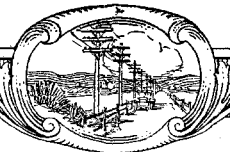

# ELECTRICAL COMMUNICATION

A Journal of Progress in the  
Telephone, Telegraph and Radio Art

H. T. KOHLHAAS, Editor

EDITORIAL BOARD

E. A. Brofos    E. M. Clark    P. K. Condict    G. Deakin    E. M. Deloraine    P. E. Erikson  
John W. Foard    F. Gill    Frank C. Page    H. M. Pease    G. E. Pingree

Published Quarterly by the

**International Standard Electric Corporation**

Head Offices

67 BROAD STREET, NEW YORK, N. Y., U. S. A.

European General Offices

CONNAUGHT HOUSE, ALDWYCH, LONDON, W. C. 2, ENGLAND

G. E. Pingree, President

S. G. Ordway, Secretary

James E. Fullam, Treasurer

Subscription \$3.00 per year; single copies 75 cents

Volume XI

OCTOBER, 1932

Number 2

## CONTENTS

	PAGE
CAPACITY UNBALANCE IN TELEPHONE CABLES AND ITS EFFECT ON NOISE DUE TO EXTERNAL INDUCTION.....	59
<i>By J. Collard, Ph. D.</i>	
THE NEW STANDARD REPEATER EQUIPMENT.....	66
<i>By J. S. Lyall, B. Sc., A. M. I. E. E., A. C. G. I.</i>	
THE NEW QUARTER AMPERE REPEATER TUBE AND ITS APPLICATIONS.....	74
<i>By W. E. Benham, J. S. Lyall and A. R. A. Rendall</i>	
A NEW SLIDE-WIRE POTENTIOMETER.....	80
<i>By J. S. P. Robertson, B. Sc.</i>	
CARRIER CURRENT SYSTEMS FORM IMPORTANT PART OF WORLD COMMUNICATION NETWORK.....	83
<i>By J. S. Jammer</i>	
PROCEEDINGS OF THE INTERNATIONAL CONSULTATIVE COMMITTEE ON LONG DISTANCE TELEPHONY.....	87
2,400 PAIR TELEPHONE CABLE.....	89
<i>By N. A. Allen, Ph. D., M. Sc., A. M. I. E. E.</i>	
A SYNCHRONIZING SYSTEM FOR ELECTRICAL TRANSMISSION OF PICTURES.....	91
<i>By Dr. Yasujiro Niwa</i>	
MOBILE RADIOTELEPHONY.....	97
<i>By Commander F. G. Loring, O. B. E. and H. H. Buttner</i>	



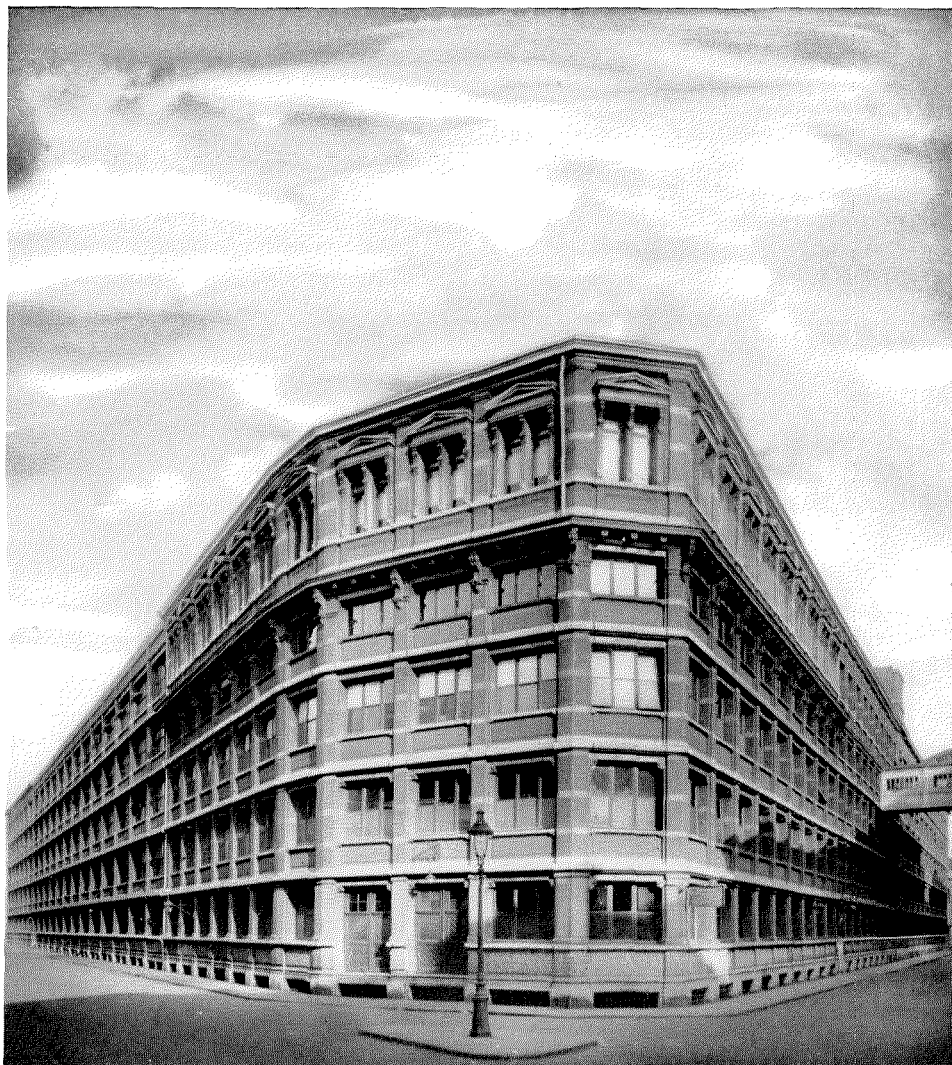

BELL TELEPHONE MANUFACTURING COMPANY

18 Rue Boudewyns

Antwerp, Belgium

# Capacity Unbalance in Telephone Cables and Its Effect on Noise Due to External Induction\*

By J. COLLARD, Ph.D.

*International Telephone and Telegraph Laboratories, Incorporated*

*SYNOPSIS: The paper discusses the question of the noise produced in circuits of telephone cables due to induction from neighbouring electric power circuits. Theoretical formulae are developed, and it is shown that the principal noise is due not, as was previously thought, to the so called "earth" capacity unbalances but to the "direct" or "partial" capacity unbalances of a circuit to the next outer layer or cable sheath and to the next inner layer.*

*Results are given to show that it is usually only the circuits in the outer layer of a cable that are affected by noise due to external induction, and that in the case of these circuits it is the direct capacity unbalance to the sheath that causes the principal noise.*

*Methods of measuring the direct unbalances are discussed, and it is concluded that with modern, high-grade cable the ordinary values of direct capacity obtained are already sufficiently small to prevent noise interference, so that, except in very severe cases of exposure, there is no need to take any steps to reduce these unbalances.*

## Introduction

THE magnitude of the noise which is produced in a telephone cable circuit by induction from the harmonics of neighbouring electric power systems is a function of a very large number of factors. Some of these depend on the inducing system, some on the telephone system and others on the juxtaposition of the two systems. Of those factors depending on the telephone system, one of the most important is the effect of unbalances in the telephone circuit. Owing to the presence of the lead sheath, no voltages due to electric induction can occur in the cable circuits and only magnetic induction need therefore be considered.

A longitudinal E.M.F. is produced by magnetic induction and, since the conductors of a telephone cable are so closely spaced and are twisted up together, the E.M.F. induced to earth may be taken as exactly the same in each conductor. The E.M.F. in each conductor, acting through the admittance to earth of the conductor, will cause currents at noise frequencies to flow through the conductor to earth; and these currents, flowing through the series impedance

of the conductor, will cause a voltage drop in the conductor. The actual voltage to earth of the conductor is therefore equal to the induced E.M.F. minus the voltage drop in the conductor. If, however, all conductors have exactly the same series impedance and shunt admittance to earth, then the voltage drop in each conductor will be exactly the same, so that the voltage to earth of each conductor will be the same. This means that, at the end of the cable, the voltage to earth of the two wires of a pair will be equal, and consequently no difference of voltage occurs between the two wires. A telephone receiver connected across the end of the pair under these conditions will therefore have no noise produced in it although there may be very large E.M.F.'s to earth induced in the cable.

When, however, small differences in the series impedance or admittance to earth of the two wires of a pair occur, the currents flowing to earth and the voltage drops in the two wires will not be exactly the same. There will therefore exist a slight difference in the voltages to earth at the end of the two wires and this difference, after being transmitted to the ends of the circuit, appears as noise in the subscriber's receiver.

The unbalances which produce noise may be either a difference in the series resistance or

\* Paper presented before the International Electrical Congress, Paris, July, 1932.

inductance of the two wires of the circuit or a difference in the capacity or leakance to earth of the two wires. Actually in modern cables the effect of resistance, inductance and leakance unbalance is small compared to that of capacity unbalance. From the practical point of view, therefore, it is only necessary at the present time to consider the question of capacity unbalance.

This fact was realised very early in the history of telephone cables, but unfortunately there was considerable misunderstanding as to what capacity unbalances actually contributed to noise due to external induction. It was thought originally that it was the so-called "earth unbalances," i.e., the total unbalance of a circuit to all other conductors in the cable and to the sheath, which caused noise. Limits for these earth unbalances were therefore fixed, and sometimes special steps were taken to reduce them. In consequence it was not until telephone engineers realised that, as shown in this paper, only the "direct" or "partial" unbalance of a circuit to the next inner and outer layers of the cable could cause noise that any real progress was made in the study.

### Historical

It seems difficult to understand how this important point could have been overlooked, but it was not until a few years ago that investigators in different countries came to a correct understanding of the problem. The first published information to set forth the correct theory of this subject and to suggest means of reducing the trouble was a British Patent<sup>1</sup> taken out by the author in 1928. The next publication to deal with this matter was a paper<sup>2</sup> read in March, 1930, before the Institution of Post Office Electrical Engineers. About this time an American Patent<sup>3</sup> was granted which also dealt with this matter. In February, 1931, the author wrote a short article<sup>4</sup> dealing with the subject from the theoretical and practical points of view. Finally, a similar contribution was published by H. Jordan in E.N.T. of October, 1931.

<sup>1</sup> No. 304,367.

<sup>2</sup> Telephone Cable Circuit Interference by A. Morris.

<sup>3</sup> No. 1,824,829.

<sup>4</sup> "Telephone Cables: Balancing against Induced Noise—Special Methods of Reducing Sheath Unbalances," by John Collard, *The Electrician*, February 27, 1931.

### Theory

Consider first of all the simple case of a single conductor having resistance  $R$ , inductance  $L$ , leakance to earth  $G$  and capacity to earth  $C$ . Let this conductor have a uniform E.M.F.,  $E$  per unit length, induced in it by magnetic induction. Consider a small length  $dx$  of this conductor at a distance  $x$  from one end and let the conductor have a length  $l$  (see Figure 1).

For the voltage  $v$  and current  $i$  in this short section of conductor we have the relations:

$$- \frac{dv}{dx} = i(R + j\omega L) - E$$

$$- \frac{di}{dx} = v(G + j\omega C)$$

From these two equations, by differentiating with respect to  $x$ , we obtain:

$$\frac{d^2v}{dx^2} = v(R + j\omega L)(G + j\omega C)$$

The solution to this differential equation is of the form:

$$v = Ve^{-Px} - Je^{Px}$$

$$\text{where } P = \sqrt{(R + j\omega L)(G + j\omega C)}$$

Similarly we can obtain the following expression for the current:

$$i = \frac{E}{R + j\omega L} - \frac{1}{Z}(We^{Px} - Ue^{-Px})$$

$$\text{where } Z = \sqrt{\frac{R + j\omega L}{G + j\omega C}}$$

If the conductor is insulated from earth at each end, as is usually the case with telephone circuits, we have  $i=0$  at  $x=0$  and  $i=0$  at  $x=l$ . Putting in these limiting conditions and evaluating  $U$  and  $W$  we get:

$$v = \frac{E}{P(e^{Pl} - e^{-Pl})} \left( (1 - e^{Pl}) e^{-Px} - (1 - e^{-Pl}) e^{Px} \right)$$

This expression gives the voltage to earth  $v$  of the conductor at any point distant  $x$  from the end on the assumption of a uniform magnetically induced E.M.F. along the conductor. This

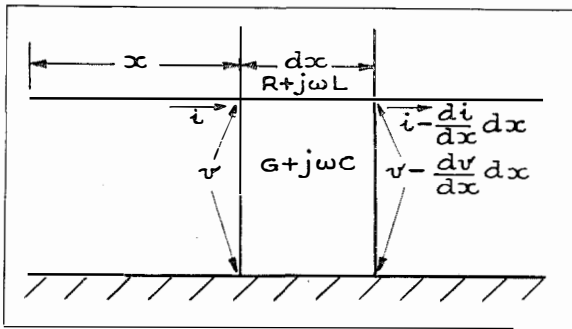

Figure 1

type of exposure is similar to that occurring when a telephone cable is laid along an electrified railway.

Now take the case of a telephone cable consisting of a single layer of quads. Since, as already pointed out, we can consider that, at any given point along the cable, all conductors have the same voltage to earth apart from extremely small differences due to slight, negligible unbalances, there will be no material interchange of current between the conductors of this cable. The formula for the distribution of voltage  $v$  worked out for the case of the single conductor will therefore apply equally well to this single layered cable.

Any given pair in the cable may have capacity unbalance to any other conductor in the case and to the sheath. Since, however, all conductors in the cable are at the same potential due to the external induction, no noise currents can flow from one conductor to another. Hence, even if a given pair in the cable has large unbalances to other conductors in the cable, these unbalances cannot produce noise currents. It is consequently only what is called the "direct" or "partial" capacity unbalance of the given pair to the sheath that can cause noise currents to flow, and the voltage tending to produce these currents is therefore the value  $v$  given by the above expression.

It is now necessary to consider the case of a multilayer cable in which the different layers are not interconnected. A two layer cable is represented in Figure 2. If, as a first approximation, we neglect the effect of currents in the inner layer we can calculate the currents and voltages of the outer layer by means of the expression already obtained. Each layer will have the same

E.M.F.,  $E$  per unit length induced in it. The current  $i_1$  flowing in the small section  $dx$  of the outer layer will cause a voltage drop of  $i_1 (R_1 + j\omega L_1) dx$  in the outer layer. At the same time this current will produce a voltage in the inner layer of  $i_1 j\omega M dx$ , where  $M$  is the mutual inductance between the outer and inner layers.

The expression for  $v$  obtained above gives a value of  $v = 0$  for  $x = \frac{l}{2}$  and this result would be

expected, of course, from the symmetry of the case. The voltage to earth of both the inner and outer layers may therefore be taken as zero at the centre of the length of cable. At any other point at a distance  $x$  from the end we can obtain the voltage to earth by taking the total voltage induced in the length of cable between the centre and the point  $x$  and subtracting from it the total voltage drop between the same two points.

Hence the voltage to earth  $v_1$  of the outer layer at the point  $x$  is given by the expression:

$$v_1 = E\left(\frac{l}{2} - x\right) - (R_1 + j\omega L_1) \int_{\frac{l}{2}}^x i_1 dx$$

In the same way the voltage to earth  $v_2$  of the inner layer is given by the expression:

$$v_2 = E\left(\frac{l}{2} - x\right) - j\omega M \int_{\frac{l}{2}}^x i_1 dx$$

Hence the difference of voltage between the outer and inner layers is:

$$v_2 - v_1 = (R_1 + j\omega L_1 - j\omega M) \int_{\frac{l}{2}}^x i_1 dx$$

Since the mutual inductance  $M$  is equal to the self-inductance  $L_1$  of the outer layer, we get:

$$v_2 - v_1 = R_1 \int_{\frac{l}{2}}^x i_1 dx$$

But, from the expression for  $v_1$  we have:

$$\int_{\frac{l}{2}}^x i_1 dx = \frac{E\left(\frac{l}{2} - x\right) - v_1}{R_1 + j\omega L_1}$$

$$\therefore v_2 - v_1 = \frac{R_1}{R_1 + j\omega L_1} \left( E\left(\frac{l}{2} - x\right) - v_1 \right)$$

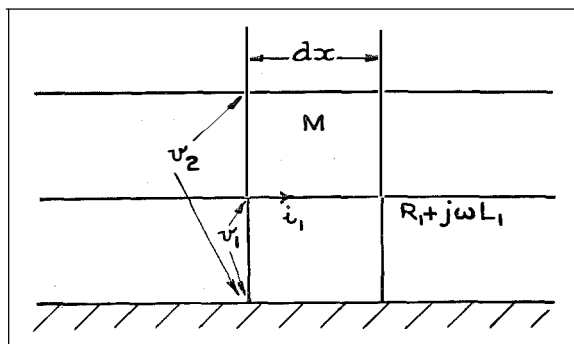

Figure 2

In the case of the two layer cable, all conductors in the outside layer will have a voltage to earth of  $v_1$  and all conductors in the inner layer will have a voltage to the outer layer of  $v_2 - v_1$ . Let us consider first of all a circuit in the outer layer. This will have a voltage to the sheath of  $v_1$  so that any direct capacity unbalance of the circuit to the sheath will have this voltage  $v_1$  acting across it. Since, as in the case of the single layer cable, all other conductors in the outer layer have the same voltage  $v_1$  to earth, the direct unbalances of the given circuit to other conductors in the same layer have no voltage acting across them, and hence these unbalances do not produce noise. The given circuit in the outer layer also has direct unbalances to conductors in the inner layer, and these unbalances have the voltage  $v_2 - v_1$  acting across them. Now consider the case of a circuit in the inner layer. This will have direct unbalance to other conductors in the inner layer but since, as before, all these conductors have the same voltage there is no voltage acting across these unbalances and they do not produce noise. The circuit in the inner layer will also have a direct unbalance to the outer layer and as these unbalances have the voltage  $v_2 - v_1$  acting across them they will produce noise.

In the case of circuits in the outer layer, therefore, the direct unbalances to the sheath produce noise and have a voltage  $v_1$  across them and also the direct unbalances to the inner layer produce noise and have a voltage  $v_2 - v_1$  across them. In the case of circuits in the inner layer only the direct unbalances to the outer layer produce noise and have the voltage  $v_2 - v_1$  across them. In order to determine in the case of the

outer layer the relative effect of the direct unbalance to the sheath and the direct unbalance to the inner layer in producing noise, it is necessary to know the relative values of  $v_1$  and  $v_2 - v_1$ . In the same way, in order to compare the relative amounts of noise in circuits of the inner and outer layers it is necessary to know the relative values of  $v_1$  and  $v_2 - v_1$ .

Relative values of these two voltages have therefore been computed for a typical cable having uniform induction over its length of 50 km. The results, which were obtained from the expressions already calculated, are given below for different distances  $x$  along the cable.

$x$ (Km.)	$v_1$	$v_2 - v_1$
0.....	22.5	7.0
5.....	18.9	6.6
10.....	14.8	5.6
15.....	10.4	4.0
20.....	5.2	2.0
25.....	0	0
30.....	5.2	2.0
35.....	10.4	4.0
40.....	14.8	5.6
45.....	18.9	6.6
50.....	22.5	7.0

It will be seen from this table that the values of the voltage  $v_2 - v_1$  between the inner and outer layer are considerably smaller than the values of  $v_1$ , the voltage between the outer layers and the sheath. In the case of circuits in the outside layer, therefore, it is the direct unbalances to the sheath which have the greatest effect on the noise, since it is these unbalances which have the larger voltage across them. These results also show that the noise in the circuits of the outer layer is several times greater than that in the circuits of the inner layer, since the latter are only affected by the relatively small voltage  $v_2 - v_1$ .

This calculation has been made for one particular type of exposure and for one length of cable. Experience has shown, however, that similar results are obtained for other types of exposure and with other lengths and types of cable.

In the case of cables having more than two separate layers the same reasoning can be applied, and it is clear that the noise in the different

layers gets successively less as the centre of the cable is approached.

### Practical Demonstration

In order to show that the conclusions arrived at from the theoretical study applied to practical cases, it was decided towards the end of 1927 to carry out some tests on the Altdorf-Göschenen cable which is exposed to induction from an electrified section of the Swiss Federal Railways. Measurements were made of the so-called "earth" unbalances and of the direct unbalances to the sheath and next inner layer in the case of circuits in the outer layer, and to the next outer and inner layers in the case of circuits in inner layers. In certain circuits the earth unbalances were reduced, while in other circuits the direct unbalances were reduced. Owing to the change of voltage along the cable, the reduction in unbalances must be made over relatively short sections of cable; in these tests the loading section was therefore taken as the unit within which the balancing was carried out. The reduction in unbalances was obtained by cross-splicing.

The following demonstration, at which Mr. Forrer of the Swiss Administration was present, was then made:

(a) It was shown that circuits for which the earth unbalances had been reduced were not thereby rendered any more free from noise than circuits which had large earth unbalances.

(b) It was shown that for circuits which had the direct unbalances reduced the noise was reduced in corresponding degree.

(c) A condenser of 1,000 micro-microfarads was connected between one wire of a given pair and other wires in the same layer, thus considerably increasing the direct unbalance of that circuit to the conductors of the same layer. It was shown that this had no appreciable effect on the noise in the given circuit.

(d) The same condenser was then connected from one wire of the given pair to the cable sheath, thus considerably increasing the direct unbalance of that circuit to the sheath. It was shown that this materially increased the noise in the given circuit.

(e) By connecting a telephone receiver between quads in the outer layer and the sheath, and between quads in the outer layer and quads in the next inner layer it was shown that the noise voltage between the outer layer and the sheath was considerably greater than between the outer and next inner layer.

This demonstration therefore confirmed the theoretical calculations; it showed very clearly

that the direct capacity unbalances between a given circuit and other circuits of the same layer had no effect in producing noise and hence, that it was the direct unbalances to the next inner and outer layers that produced the noise, and not the so-called earth unbalances.

### Measurement

Suppose that it is desired to measure the direct unbalance of a circuit in the outer layer of a cable to the sheath. Then, in order to prevent the direct unbalance of that circuit to other quads in the same layer or to quads in inner layers from affecting the measurement, it is necessary to arrange so that all the conductors

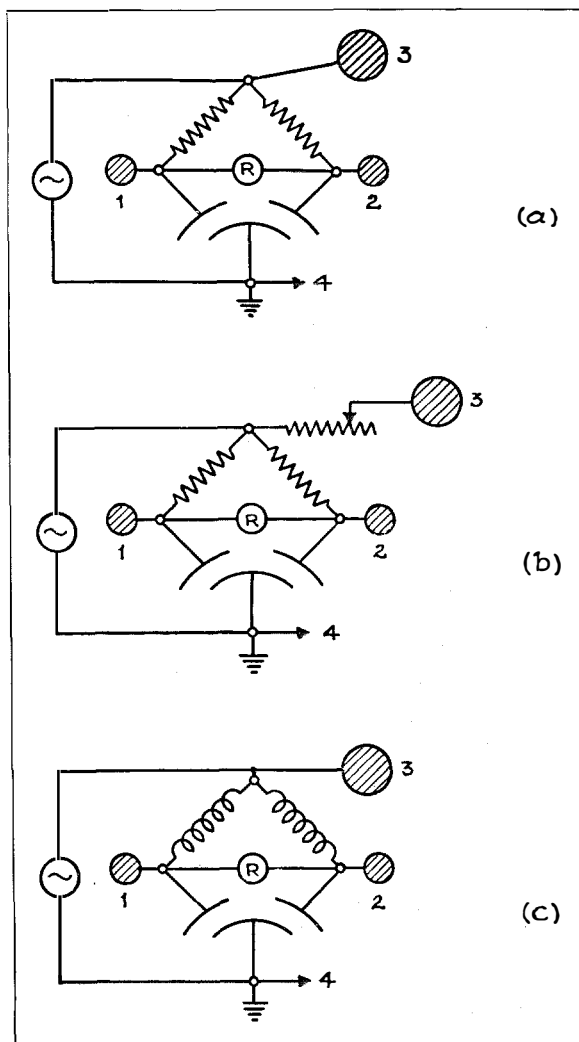

Figure 3



of these quads are at the same potential as the conductors to be tested. Three ways suggested for accomplishing this result are shown in Figure 3. In Figure 3 (a) it will be seen that the remaining wires of the cable are connected to the centre point of the resistance ratio arms while wires 1 and 2 of the circuit, whose direct unbalance to sheath is to be measured, are connected to the lower ends of the two ratio arms. The sheath is connected to the bottom corner of the bridge. With this connection the wires 1 and 2 are at some voltage less than the voltage of the oscillator owing to the voltage drop in the resistance arms. The other wires, however, are at the full voltage of the oscillator. Hence we have not fulfilled the necessary condition of making the voltage of the other wires the same as that of the wires being tested. At first an attempt was made to overcome this difficulty by making the ratio arms of low resistance so as to make the voltage drop small, but this was not found satisfactory.

The arrangement shown in Figure 3 (b) was then used. In this the other wires are supplied through a variable resistance which is adjusted so that its voltage drop is the same as that in the ratio arms. This method is perfectly satisfactory, but its use has now been abandoned in favour of the third arrangement shown in Figure 3 (c). In this case the ratio arms consist of two inductances\* instead of resistances. These are wound on the same core, and are arranged so that while presenting a high and balanced impedance to the out of balance current in the bridge, the inductive effects of the two halves of the winding neutralise each other for currents flowing from the centre point in parallel down the two halves. The current which is supplied through the ratio arms to wires 1 and 2 and which with resistance arms causes a voltage drop in the arms, now produces no voltage drop, except for the negligibly small effect of the resistance of the inductances. The voltage applied to wires 1 and 2 is therefore the full voltage of the oscillator, and the other wires in the cable can thus be connected to the mid-point of the inductance ratio arms. This arrangement therefore avoids altogether the necessity for the

variable resistance through which to supply the other wires of the cable.

When measuring the direct unbalance of a circuit in the outer layer to the next inner layer, the cable sheath and the other conductors of the outer layer are connected to the mid-point of the inductance ratio arms, and the conductors of the inner layers are connected to the point shown earthed in Figure 3.

When these different unbalances have been measured they can, of course, be reduced by either of the two well-known methods, i.e., cross-splicing or condenser balancing but, owing to the phase changes taking place in the cable, this reduction must be made in lengths not exceeding one loading section if the reduction is to be really effective.

### *Conclusions*

It will be clear both from the theoretical work and the practical demonstration, that it is the "direct" or "partial" capacity unbalance of a circuit to the next outer layer or sheath and to the next inner layer, and not the so-called earth unbalances, that produce noise due to external induction. It seems reasonable to suggest therefore that limits for the earth unbalances should no longer be included in cable specifications, especially as an attempt to meet such limits may result in an increase in the direct unbalances which really produce the noise.

A further conclusion to be drawn from these results is that circuits in the inner layers of a cable are much less affected by noise due to external induction, and that, in the case of circuits in the outside layer, the principal noise is due to the direct capacity unbalance to the sheath. Any attempt to reduce the noise in a cable by improving the direct unbalances can therefore be profitably directed to the reduction of the direct unbalances to the sheath of circuits in the outer layer.

It is of interest to determine what values of direct unbalances can be tolerated in practice, and valuable information on this point can be obtained by studying the case of cables which are already working under conditions of interference.

A number of cables, of which the author has had personal experience, have been installed

---

\* British Patent No. 323,037.

during the last twelve years in different countries in Europe and under various interference conditions. All these cables have given satisfactory service, even where the interference conditions were unusually severe as, for example, in the case of the Simplon Tunnel cable and the Stockholm-Gothenburg railway cable. By examining the values of direct unbalance existing in these cables we can obtain an idea of the order of magnitude of unbalance that can be tolerated under all but the most severe cases of induction.

In these older cables no special steps were taken, either in the factory or in the field, to reduce the direct capacity unbalances and, in fact, the steps taken to meet the limits of earth unbalances called for in specifications sometimes resulted in an actual increase of the direct unbalances. It must be realised, therefore, that the values of direct unbalance given for these earlier cables do not represent what would be obtained in modern cables where the designer is unhampered by unnecessary requirements of low earth unbalances.

The values of direct unbalance vary somewhat, of course, according to the type and size of cable, but the following values may be taken as fairly representative of the cables laid between, say, 1920 and 1930. These values are the average direct capacity unbalance to the sheath of side and phantom circuits in the outside layer for a cable length of 230 m.

Circuit	Mean Unbalance (m.m.f.)	Maximum Unbalance (m.m.f.)
Side.....	80	250
Phantom.....	100	300

Actually, of course, it is the unbalance per loading section which is the true criterion of noise; and, from the above figures, it would appear that, since no special steps were taken in the field to reduce direct unbalances to the sheath, average values of direct capacity to the sheath of about 240 m.m.f. for the side circuits and 300 m.m.f. for the phantom circuits were obtained per loading section.

Since the older cables which had these values of direct sheath unbalance were found to be perfectly satisfactory without any special reduction of the direct unbalances in the field, it follows that field balancing with modern cables is even less necessary. It seems reasonable to assume, therefore, that, except in very special cases of exceptionally severe interference conditions, no reduction of the direct unbalances is required. Further, we can conclude from these results that even if the average capacity unbalance to the sheath is as high as 300 m.m.f., a cable will be entirely satisfactory even in cases where quite severe interference conditions occur.

# The New Standard Repeater Equipment

By J. S. LYALL, B.Sc., A.M.I.E.E., A.C.G.I.

*International Telephone and Telegraph Laboratories, Incorporated*

## Introduction

**T**HE new standard repeater equipment, which has been designed to incorporate all the latest improvements in electrical performance and mechanical design, gives improved transmission characteristics, a great economy in space, a much lower current drain and possesses a greatly improved appearance.

As regards electrical performance, a large number of circuit changes have been made but only those affecting the overall characteristics of the system are dealt with in the present paper. These concern improvements in the two wire repeater and the four wire terminating set. The general application of the new quarter ampere vacuum tube also constitutes an important advance.<sup>1</sup>

As regards mechanical construction, the standard telephone repeater equipment has undergone practically no important change since its introduction in Europe about 10 years ago, although minor alterations as regards layout have, of course, been made from time to time, either to effect an improved circuit arrangement or to meet the specific requirements of different telephone administrations.

As the equipment installed in a repeater station is extended to cater for increased traffic needs and begins to approach the ultimate capacity of the building, the general demand is for equipment occupying less space in order that any extension of the building may be postponed. The general trend of component design, involving, for example, the use of Permalloy for transformer cores has resulted in considerable reductions in size; and, if these new small components had been embodied in existing repeater panels, an important saving in space would have resulted. Since, however, the introduction of the new components involved a very considerable outlay in changing manufacturing drawings and in the production of new tools, it was thought

<sup>1</sup> "The New Quarter Ampere Repeater Tube and Its Applications," by W. E. Benham, J. S. Lyall, and A. R. A. Rendall, described elsewhere in this issue of *Electrical Communication*.

worth while to make a thorough study of repeater equipment as a whole in order that, in addition to circuit changes, any other desirable features could be incorporated at the same time, the primary object being to obtain as large a space saving as possible combined with improved appearance and simplification from the point of view of manufacture, operation and maintenance. This study has resulted in the development of a completely new type of equipment bearing little resemblance, as regards mechanical construction, to the equipment which has been in general use for many years.

Apart from an entirely new method of mounting which will be described in detail later, the following new components and features have contributed to the final design of the equipment:

1. A thin mounting plate of 2 mm. (.078") steel, flanges being provided along the horizontal edges to give the necessary rigidity.
2. A new range of vacuum tubes consuming only  $\frac{1}{4}$  ampere in the filament circuit. A lower operating temperature enables these tubes to be located under the dust cover without risk of overheating the other components.
3. A new type of resistance spool, the spool being of moulded Steatite.
4. New small types of transformer and retardation coil having cores of Permalloy C stampings and Permalloy C dust rings.
5. Smaller paper condensers.
6. A vacuum tube socket of moulded Steatite.
7. A new slide-wire potentiometer, elsewhere described in this issue of *Electrical Communication*.
8. The use of aluminium finish.

While the new principles have been worked out primarily in terms of telephone repeater equipment, they are, of course, capable of application to all rack mounted equipment. They have already been incorporated with success in the new V. F. telegraph system.<sup>2</sup>

## Method of Mounting

The new equipment employs the standard type of rack consisting of 77 mm. (3") channel

<sup>2</sup> "A New Voice Frequency Telegraph System," by J. A. H. Lloyd, W. N. Roseway, V. J. Terry and A. W. Montgomery, *Electrical Communication*, April, 1932.

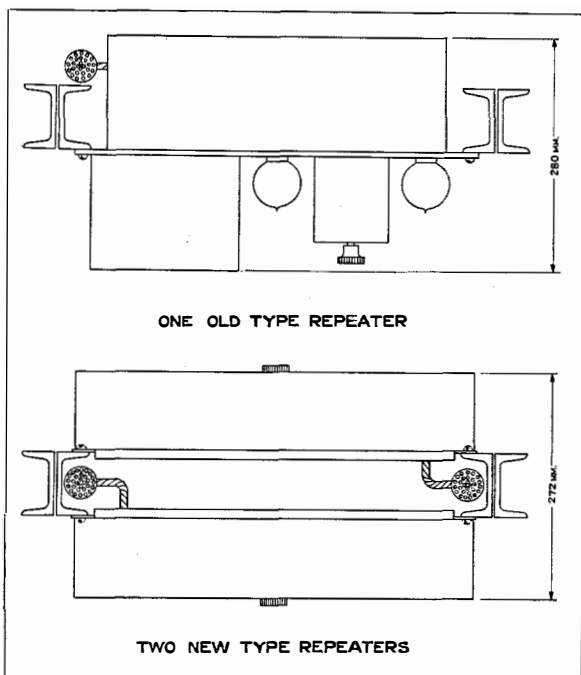

Figure 1—The New Method of Panel Mounting Compared With the Old Method

iron uprights spaced to accommodate 483 mm. (19") mounting plates. This type has been retained in order to facilitate the use of the new equipment as an extension to existing stations. The method of construction adopted for the panels was arrived at after careful consideration of several alternatives, including a universal mounting system similar to that already described in this journal.<sup>3</sup> The universal principle was discarded on account of its lack of flexibility when applied to all the different types of panel constituting a complete repeater equipment.

In the old panels components are mounted on both sides of the mounting plate, but in the new equipment all the components associated with one unit are located on one side of the mounting plate only, and two panels are placed back to back on the framework. The difference between the old and new methods is illustrated in Figure 1. Since the use of the new small components effects a very considerable reduction in the size and weight of any one panel, as seen from the particulars of typical panels in Table I and from the comparison of weights shown in Figure 2,

<sup>3</sup> "The Universal Mounting Plate," by L. H. Webb, *Electrical Communication*, October, 1931.

TABLE I  
Typical Weight and Size Comparison—  
New and Old Panels

PANEL	NEW		OLD	
	Height Single Sided	Weight	Height Double Sided	Weight
	mm. ins.	Kg. lbs.	mm. ins.	Kg. lbs.
2-Wire Repeater	178 7	10 22	178 7	20.4 45
4-Wire Repeater	178 7	10 22	267 10½	25 55
500- $\omega$ Ringer, including 215-FB Relay	178 7	10 22	222 8¾	23.6 52
20- $\omega$ Ringer	89 3½	4.5 10	89 3½	8.2 18
Telephone and Trunk Panel	133 5¼	6.4 14	133 5¼	11.3 25

NOTE: Both old and new panels are 483 mm. (19") wide.

the equipping of panels in this manner on both sides of the rack is accomplished without adding to the weight of the complete bay, while the capacity of the bay is very greatly increased. A dust cover 95 mm. (3¾") high covers all the apparatus on the panel including the vacuum tubes and extends to the edges of the panel, thus concealing the screws holding the panel to the rack. Provision is, of course, made for the projection of essential controls such as key handles, potentiometer knobs, meters, etc. The use of dust covers is also extended to miscellaneous items such as repeating coils, battery supply resistances, and all other apparatus mounted on the bay with the repeaters.

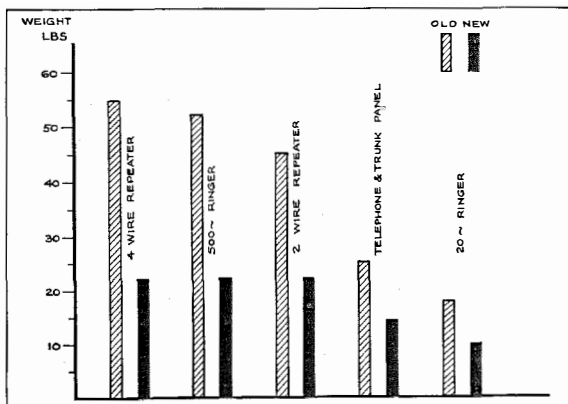

Figure 2—Diagram Illustrating the Difference in Weight of Old and New Panels

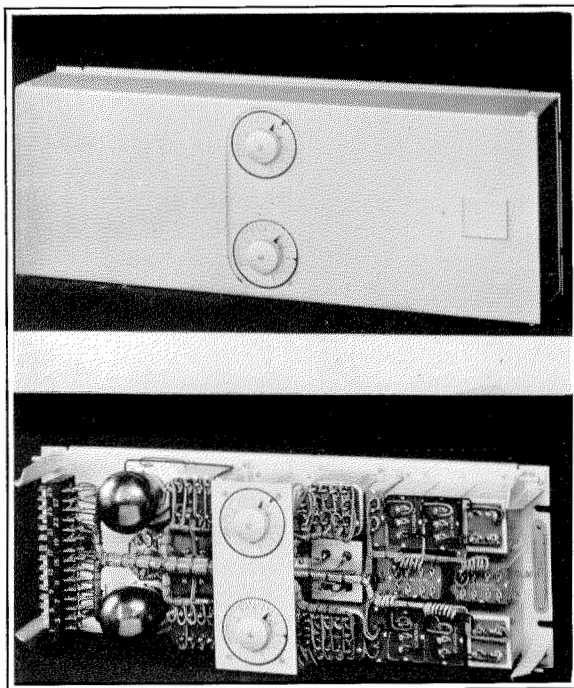

Figure 3—Two-wire Repeater Panel

The local cable forms which have hitherto been exposed at the rear of the rack are now enclosed in the space between the panels and are, therefore, completely hidden. Two cable forms are required for each bay, one running down the channel on each side and serving the apparatus on one side only.

The direct effect of these changes is to give the complete bay on both sides an extremely neat flush appearance and to locate all the apparatus associated with one speech circuit on one side of the rack, this latter feature assisting considerably in the quick location of faults and in making necessary changes in the adjustment of the panel. In addition, the reflecting qualities of the aluminium finish greatly improve the lighting conditions between the racks.

The general appearance of such an equipment may be judged from the photographic reproductions of the new V. F. Telegraph equipment in the April issue of this journal.

### *Circuit Improvements in Apparatus Panels*

Apart from a number of minor changes which have been effected in order to facilitate testing or to simplify maintenance, modifications have been made in the two wire repeater and the four

wire terminating set, as described below. These features result in improved performance on two and four wire circuits. As regards the latter, the design of the four wire repeater itself remains unaltered.

#### *Two Wire Repeater*

This panel has been modified in order to obtain improved gain and impedance characteristics for use with medium-heavy loaded circuits, in order to comply with the recommendations of the Comité Consultatif International. By the inclusion of a new filter and by a slight modification in the input tuning circuit, close impedance matching is obtained between the repeater and the line over the frequency range 300 to 2,400 p : s.

The slope of the gain characteristic may be varied by small steps from a flat characteristic to one which equalises the longest medium-heavy loaded repeater section. Under conditions of maximum rise and maximum gain the nature of the filter cut-off is such that the gain becomes zero at 2,600 p : s and does not again become positive at higher frequencies.

#### *Four Wire Terminating Set*

The performance of the terminating set has been improved by the provision of a filter asso-

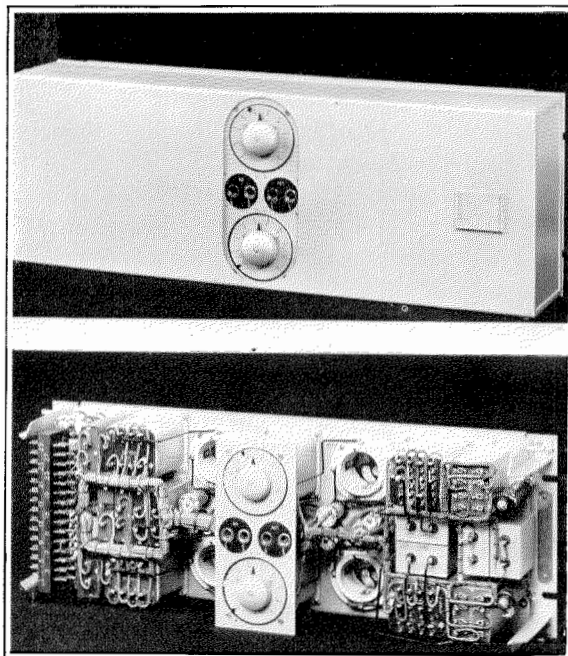

Figure 4—Four-wire Repeater Panel

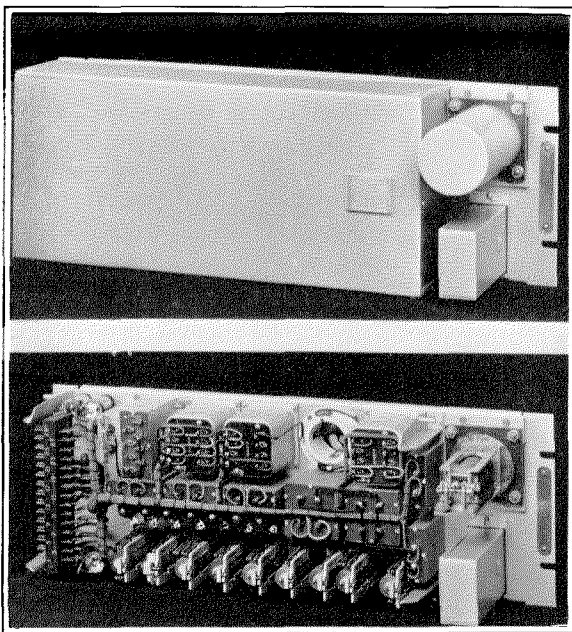

Figure 5—500 Cycle Ringer Panel

ciated with the four wire receive side so that a flat attenuation characteristic is obtained from 300 p : s up to the desired cut-off frequency. The function of this filter is to cause a rapid increase in the attenuation at the higher frequencies from four wire to two wire and from four wire to four wire. Two types of filter having different cut-off frequencies are available and the filter consequently forms a detachable unit of the terminating set. In general a filter having a cut-off frequency of 2,750 p : s will be employed for international circuits, where it is important to suppress frequencies above 3,000 p : s in order to eliminate transient effects on long circuits. For cases where a high grade four wire circuit is extended by means of a two wire medium-heavy circuit, the second type of filter is employed having a cut-off frequency of 2,400 p : s, this lower cut-off being necessary due to the undesirability of incurring additional expense in supplying a balancing network capable of providing a good singing point above 2,400 p : s. This type of filter is also used on medium-heavy four wire circuits.

Transmission through the terminating set at frequencies below the cut-off frequencies of the filters remains unaltered by their inclusion.

### *Constructional Features of Apparatus Panels*

The construction of all panels is similar, the apparatus being arranged on a 483 mm. (19") plate of 2 mm. (.078") steel, a slot being provided in a central position at the left side of the panel to permit the cable form to be brought out to the conveniently located terminal block.

The apparatus components, such as transformers, retardation coils, and condensers are of a uniform height, which fact considerably simplifies the construction of the internal cable form. A further feature which contributes to a small and neat cable form is the location of the components as far as practicable in their logical circuit sequence. This has the additional advantage that the connections can be more easily traced when inspecting the panel for faults. These features may be clearly seen from the illustrations of some typical panels in Figures 3 to 8 inclusive.

A brief description of the most interesting features of the new panels follows:

#### *Dust Covers*

It will be seen from Figures 3, 4, 5, 7 and 8 that the dust covers conceal all the component apparatus except relays of the 215 and 196 types. The height of these in comparison with the remainder of the apparatus is such that it is not economical to increase the height of the cover generally to cater for them. It is also considered advisable to have these relays easily accessible in order to facilitate their adjustment.

Where full length dust covers are provided, they extend to the edges of the panels, thus concealing the rather unsightly screws holding the panel to the rack and incidentally increasing somewhat the actual mounting space available.

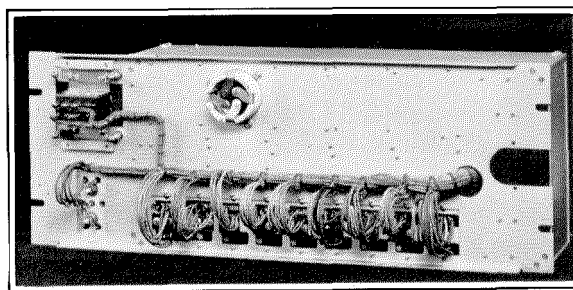

Figure 6—500 Cycle Ringer Panel—Rear View

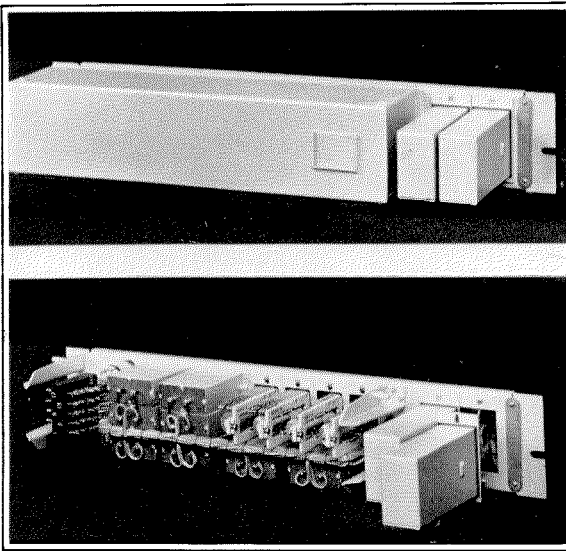

Figure 7—20 Cycle Ringer Panel

Where necessary to expose controls or the dials of meters, the dust cover is provided with an aperture as shown in Figures 3, 4, and 8.

#### Terminal Blocks

It will be noted from the illustrations that in general the construction of the terminal blocks has been changed to make the terminal punchings more accessible for wiring. This has been achieved by increasing the length of the block and decreasing the depth so that in many cases where the block on the old panel consisted of four or five rows of punchings, only two are now required.

#### Relays

Apart from the relays of the 215 and 196 types, which are dealt with as described above, all relays associated with separate panels are located under the common dust cover and are not provided with individual covers. Since the construction of a relay is essentially such that the contact springs and wiring tags occur at opposite ends, provision is made to enable each relay to be withdrawn individually from the panel for inspection of the soldered connections.

Each relay is mounted on a small subsidiary plate with a slot on the lower edge and a keyhole shaped slot on the upper edge so that it can be removed by loosening the holding screws slightly and lifting the relay upwards and outwards. This is well illustrated in Figures 7 and 8, the former

showing a relay in process of removal. As shown in Figure 6, a sufficiently long loop is provided in the skinner from the cable form to the relay to allow the relay to be lifted clear of adjacent apparatus on the front of the panel.

#### Jacks

Each pair of single pole jacks at present used in four-jack circuits, etc., is replaced by one double pole jack, i.e., the tip and ring connections are made in the same jack. Experience has shown that when trouble has been found in jacks, this has been on account of the fact that the springs have been located in a horizontal plane, thus acting as shelves for the collection of dust. In the new equipment all springs of all jacks are located in a vertical plane and the mounting centres of the jacks are increased to allow for the larger pile-ups encountered with double pole jacks, so that 16 jacks are located in a row instead of 24.

The number of jacks appearing on individual panels is extremely small and access to the wiring tags is obtained by removing the escutcheon plate on which they are mounted. Where a large number of jacks is grouped together, as in the case of a repeater jack field, the jack mountings are strapped together and the resulting assembly is hinged as a whole. It should be noted that the jack mountings are now of moulded bakelite and

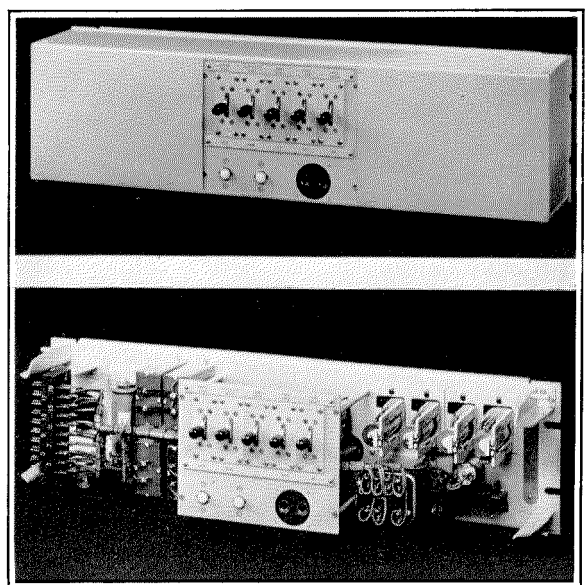

Figure 8—Telephone and Trunk Panel

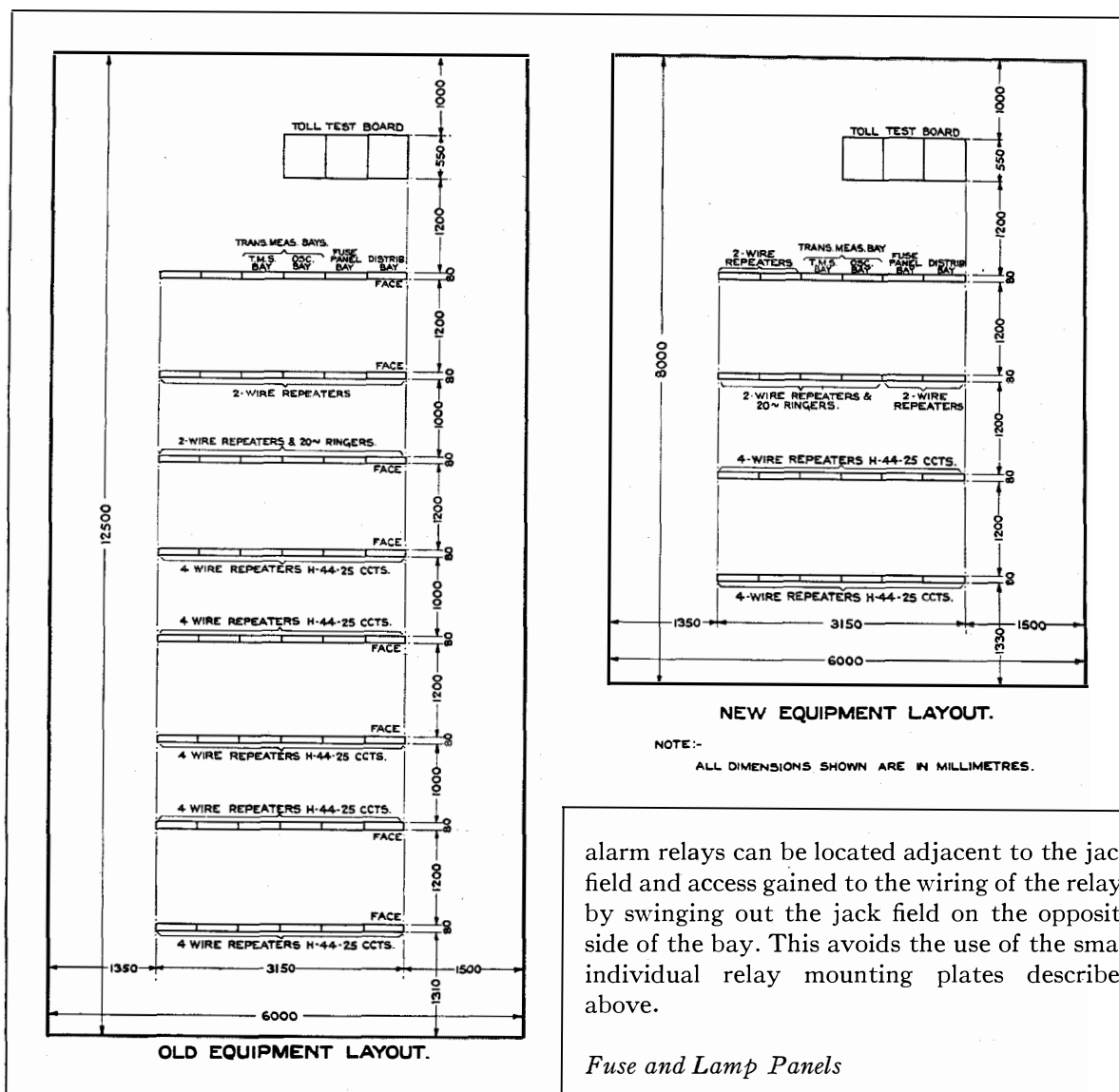

Figure 9—Specimen Floor Plans Comparing Old and New Equipments

therefore are stronger than the ebonite mountings used up to the present.

The hinge referred to occurs at the left side and the plane of the assembly when open is at right angles to the face of the equipment. The front of the jack field when closed is flush with the dust covers on the remainder of the equipment, and a second hinged jack field is, of course, located on the opposite side of the bay. One of the minor advantages of the hinging feature is that strips of relays such as repeater plate circuit

alarm relays can be located adjacent to the jack field and access gained to the wiring of the relays by swinging out the jack field on the opposite side of the bay. This avoids the use of the small individual relay mounting plates described above.

#### *Fuse and Lamp Panels*

The methods which have been found satisfactory in the past for mounting lamps and fuses have, in general, been retained. In place of slate, however, ebony sindanyo has been used, its insulating properties being such that the bushing of the drillings with mica is no longer necessary.

A simpler, more compact type of lamp socket enables 24 lamps to be equipped on a 89 mm. ( $3\frac{1}{2}$ " ) fuse panel instead of 10 as previously.

Since the method of mounting fuses and lamps is necessarily such that all wiring is at the rear of the panels, the present method of mounting is retained, i.e., panels are equipped on one side of the bay only. Fuse and lamp bays constitute such a small percentage of any equipment that



the effect of retaining the single side mounting is negligible from the point of view of the total space occupied. The wiring is now protected, however, by special dust shields covering the rear of the bay. These are supplied in sections convenient for easy handling. The fuses and lamps themselves are not covered in any way, since they form a valuable indicating means for circuit faults.

### Meters

Sector shaped meters have been replaced generally by circular flush type instruments of a smaller pattern. In order to retain the same degree of accuracy with the small scale available on these meters suppressed zero type meters have been employed.

The meters are mounted on pillars which bring the face of the meter level with the front of the dust cover, in which a circular hole is cut to allow the dial to be viewed.

TABLE II  
Bay Capacities

Type of Equipment Layout	Total Capacity per 10'6" Bay	
	New Equipment	Old Equipment
4-Wire Repeaters Phantom Group System H-44-25 Circuits	10 repeaters	4 repeaters
4-Wire Repeaters Phantom Group System H-177-63 Circuits	12 repeaters	6 repeaters
4-Wire Repeaters Flexible System	16 repeaters	6 repeaters
2-Wire Repeaters Phantom Group System H-44-25 Circuits	9 repeaters	6 repeaters
2-Wire Repeaters Phantom Group System H-177-63 Circuits	9 repeaters	6 repeaters
2-Wire Repeaters and 20 $\sim$ Ringers Phantom Group System H-44-25 Circuits	6 repeaters and 6 ringers	4 repeaters and 4 ringers
2-Wire Repeaters and 20 $\sim$ Ringers Phantom Group System H-177-63 Circuits	6 repeaters and 6 ringers	4 repeaters and 4 ringers
2-Wire Repeaters Flexible System	20 repeaters	10 repeaters

TABLE II (Continued)

Type of Equipment Layout	Total Capacity per 10'6" Bay	
	New Equipment	Old Equipment
2-Wire Repeaters Flexible System with cut-off circuits for terminal 500 $\sim$ Ringers	18 repeaters and 18 cut-off circuits	8 repeaters and 8 cut-off circuits
2-Wire Repeaters and 20 $\sim$ Ringers Flexible System	14 repeaters and 14 ringers	6 repeaters and 6 ringers
4-Wire Terminating Sets with 500 $\sim$ Ringers	14 terminating sets and 14 ringers	8 terminating sets and 8 ringers
*4-Wire Terminating Sets	46 terminating sets	48 terminating sets
20 $\sim$ Ringers (terminal) and Filters	30 ringers and 30 filters	12 ringers and 12 filters
500 $\sim$ Ringers and cut-off circuits for 2-Wire Circuits	20 ringers and 20 cut-off circuits	8 ringers and 8 cut-off circuits

\*NOTE: The decrease from 48 on the old to 46 on the new equipment is accounted for by the fact that the old terminating set was mounted on an equipment basis on both sides of the bay. In addition a filter has been added to the new terminating set and the jacks for the four-wire terminations, previously associated with the toll test board, have now been located on the terminating set bay, thus allowing terminating sets with or without associated ringers to be patched as required.

### Apparatus Mounted on an Equipment Basis

In this category are included repeating coils, retardation coils, low frequency correctors, balancing networks and miscellaneous resistances, relays, condensers, etc. These items continue to be mounted on an equipment basis but dust covers are provided for each row or, in some cases, several rows, depending on the layout. In the case of networks and correctors the individual covers previously provided are omitted.

The terminal strips at the top of each bay are also provided with a dust cover which extends over the whole width of the bay.

### Summary of the Outstanding Features of a Complete Equipment

In the case of repeater equipment, the layout of the station depends upon a variety of circumstances such as the types of circuit and whether

the station is intended for intermediate or terminal working or both. Table II gives the bay layouts for various typical combinations and compares them with the corresponding layouts for the old equipment. In determining the total capacities given in this table, all miscellaneous apparatus normally equipped on the bay is allowed for.

Figure 9 shows specimen floor plans for both the old and the new equipments in a through station laid out on a phantom group basis and containing 120 four wire repeaters, 36 two wire repeaters, and 24 two wire repeaters associated with 20 cycle ringers. It will be appreciated that a larger station than that illustrated will show a still more striking space saving.

The advantages of the new equipment over the old type may be summarised as follows:

1. *Improved Appearance*: aluminium finish is employed, the bay cable forms are completely hidden and dust covers of a uniform height are provided for the whole of the apparatus.
2. *Simple Maintenance*: all the apparatus and wiring associated with one speech circuit is conveniently located on one side of the rack.
3. *Reduced Current Drain*: due to the use of the new  $\frac{1}{4}$  ampere vacuum tube.
4. *Reduced Size*: the reduction is such that the capacity of any given floor area is greatly increased.
5. *Reduced Weight*: this is such that with the increased number of units on the bay, the floor loading is not substantially altered.
6. *Adaptability to Existing Equipments*: the same type of rack is employed for mounting, so that the equipment can be installed side by side with equipment of the old type.
7. *Improved Performance*: incorporated where operating experience or the recommendations of the Comité Consultatif International have indicated that it is desirable.

# The New Quarter Ampere Repeater Tube and Its Applications

By W. E. BENHAM, J. S. LYALL and A. R. A. RENDALL

*International Telephone and Telegraph Laboratories, Incorporated*

## *Introduction*

**T**HE costs of power supply in Repeater and similar installations constitute an appreciable part of the annual charges on the equipment and the importance of securing low filament consumption in tubes used in these equipments has long been recognised.

The original Repeater Tubes developed by the Bell Telephone Laboratories ran at 1.3 amperes filament current. It was soon found that this current could be reduced to 1 ampere while maintaining a satisfactory life. The 1 ampere Repeater Tubes (101, 102 and 104 types) and their European equivalents (4101, 4102 and 4104 types) have given excellent service over a number of years.

With a view to reducing operating costs the question of Repeater Tubes operating at a filament current of less than 1 ampere has, among others, engaged the attention of the International Telephone and Telegraph Laboratories, Incorporated, which has developed Repeater Tubes of entirely new design, consuming only  $\frac{1}{4}$  ampere in the filament and having a very satisfactory life. The purpose of the present paper is to describe the new tube and indicate its application.

## *Features of the New Tube*

In addition to the saving in operating costs introduced by a change over to the quarter ampere tube, there are other advantages connected with the entirely new mechanical design. For example, the constructional features of the tube permit of a gain considerably in excess of that given by the tubes of the old repeater group (4101-D, 4102-D and 4104-D). Such an increased gain has been found to be consistent with a uniform product.

The use of a filament which is far more robust than that of the .97 ampere repeater tubes at

the operating temperature enables the tubes to be used in any position or orientation. Another point of interest is the pipless construction of the bulb, whereby the risk of accidental damage is reduced to a minimum. Certain features of the 1 ampere tube, such as the use of a moulded base and contact metal on the valve pins, have been retained.

## *Details of a Range of Quarter Ampere Tubes*

Figures 1a and b and 2a and b show clearly the constructional details of a range of quarter ampere tubes particulars of which are given below.

The 4019-A, 4020-A and 4021-A types correspond to the three types of .97 ampere tubes classed as the "Repeater Group," namely the 4101-D, 4102-D and 4104-D.

The 4019-A type (Figure 1a) replaces the 4101-D in existing equipments and gives a gain some 2 decibels higher.

The 4020-A type (Figure 1b) replaces the 4102-D in existing equipments and gives a gain equal to that of the 4102-D.

The 4021-A type (Figure 2a) replaces the 4104-D type in existing equipments provided minor changes to the grid biasing arrangements are made. Compared with the 4104-D tube the 4021-A type has a gain  $5\frac{1}{2}$  decibels higher which enables it to operate at the same grid and plate voltages as the 4019-A, a power output  $2\frac{1}{2}$  times that delivered by the 4019-A being obtained with the same input. The above constitutes an important advantage in the design of new equipment.

The minor changes necessary to convert the filament circuits of existing equipments to  $\frac{1}{4}$  ampere working are dealt with under the section dealing with application to repeaters.

In addition to the three types quoted above as superseding the .97 ampere Repeater Group, a special high gain 4019-A tube is available, and

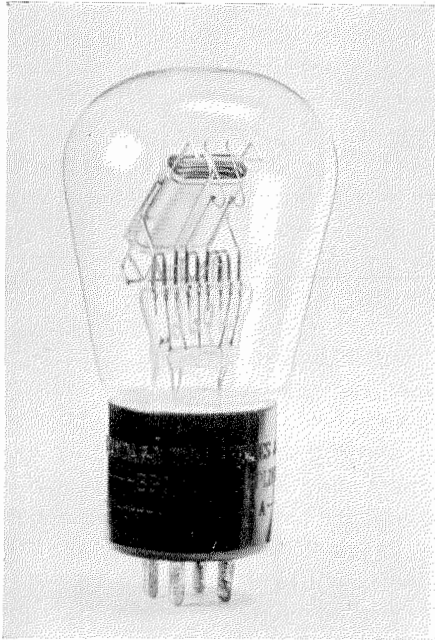

*Figure 1-a—No. 4019-A Type Tube*

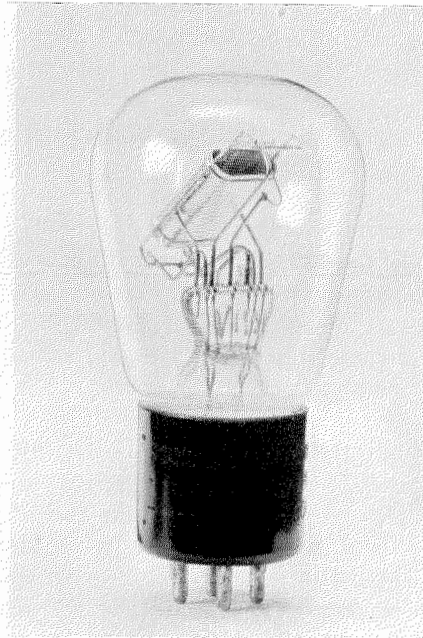

*Figure 1-b—No. 4020-A Type Tube*

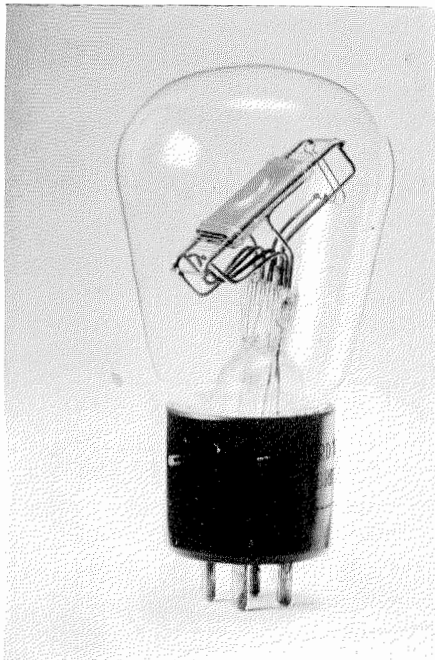

*Figure 2-a—No. 4021-A Type Tube*

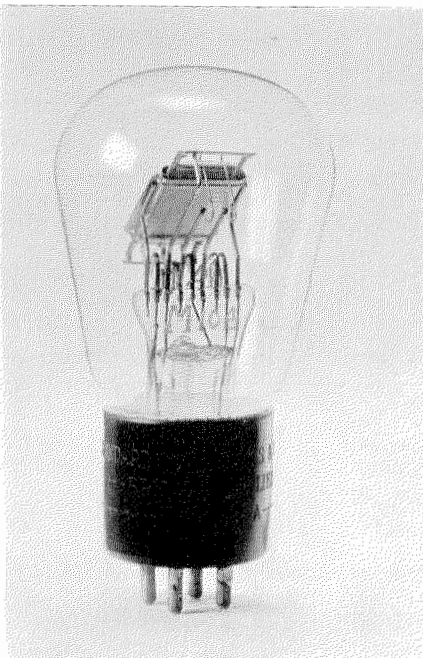

*Figure 2-b—No. 4022-A Type Tube*

is designated 4022-A (Figure 2b). The gain of the 4022-A is some 4 decibels higher than that of the 4019-A, i.e., 6 decibels higher than that of the 4101-D. In general the 4022-A type does not supersede the 4019-A type, but the close clearance construction of the 4022-A type is taken advantage of in the new Voice Frequency Carrier Telegraph System.\*

The 4019-A type is to be preferred in equipments at present employing the 4101-D type, inasmuch as the 4022-A requires grid bias alterations. It is, however, expected that future equipments will be designed round the 4022-A type since the increased gain is a decided advantage in many instances. The power output is substantially the same as that of the 4019-A type.

The characteristic curves of the 4019-A, 4020-A and 4021-A types of ¼ ampere tube are shown in Figures 3—5. Curves for the 4022-A type are shown in Figure 6. Additional data is given in Table I in which bracketed figures, for comparative purposes, refer to the .97 ampere Repeater Group.

**Applications**

The 4019-A and 4020-A types have their major application in equipments in which the 4101-D and 4102-D types are now regularly used. In Repeater field, the saving in operating costs is of especial importance.

\* "A New Voice Frequency Carrier Telegraph System," by J. A. H. Lloyd, W. N. Roseway, V. J. Terry, and A. W. Montgomery, *Electrical Communication*, April, 1932.

The 4021-A tube will be used in Transmission Testing and Public Address Systems and in all cases where a larger output is required than given by the 4019-A tube. The use of the 4104-D tube is restricted because of the inconveniently large operating grid bias. Since the introduction of the 4021-A overcomes this disadvantage, it is expected that 4021-A tubes will find more extensive application than the 4104-D type.

The characteristics of the 4022-A tube have been utilised in the previously referred to voice frequency carrier telegraph system. The amplifier detector in this system is arranged to have a volume limiting feature. When the received signal reaches a predetermined value, grid current begins to flow in the detector tube with the result that the grid bias of the preceding amplifier tube is increased. Thus, the gain of the amplifier is reduced for strong received signals and the volume range of the received signal at the detector is decreased. In order that this arrangement may function efficiently it is essential that the grid current increase rapidly with increase of grid voltage after a certain value of grid voltage is reached. This requirement is satisfactorily met by the 4022-A tube.

The conversion of equipments to use the new tube is in general a simple and straightforward matter involving the application of well-known principles. It is, however, not possible to lay down definite plans applying to all types of panel since each circuit naturally presents its own problems.

TABLE I

TYPE	QAL	QAV	QAM	QAT
London code.....	4019-A (4101-D)	4020-A (4102-D)	4021-A (4104-D)	4022-A
Filament { Current.....	.25 a (.97 a)	.25 a (.97 a)	.25 a (.97 a)	.25 a
{ Voltage.....	4 V (4.5 V)	2 V (2 V)	4 V (4.5 V)	4 V
Working { Plate.....	130 (130)	130 (130)	130 (130)	130
Voltages { Grid.....	-8 (-9)	-1.5 (-1.5)	-8 (-20)	-4.5
At { Average plate current..	7.5 mA (8 mA)	0.75 mA (0.75 mA)	20 mA (20 mA)	7.5 mA
{ Impedance.....	5,500 Ω (6,000 Ω)	55,000 Ω (60,000 Ω)	2,000 Ω (2,000 Ω)	5,500 Ω
Working { Amplification Factor...	7 (5.9)	28 (30)	6 (2.4)	12
Voltages { Gain.....	31 db. (29 db.)	29 db. (29 db.)	34 db. (28½ db.)	35 db.
{ Average Life (hrs.)....	exceeds 10,000 (20,000)	exceeds 10,000 (20,000)	3,000 (5,000)	10,000

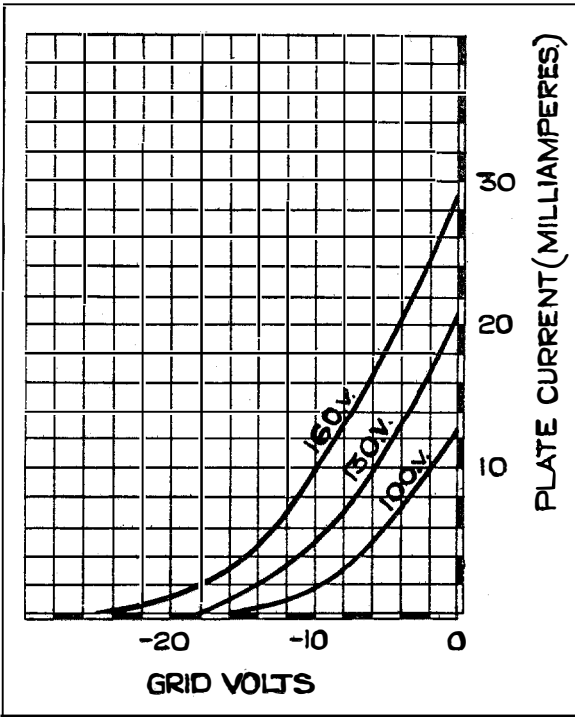

Figure 3—Characteristic Curves of the 4019-A Type Tube

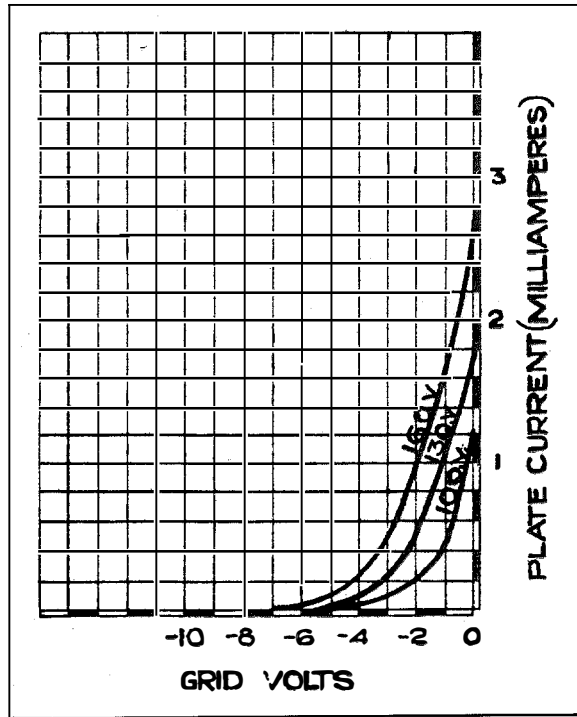

Figure 4—Characteristic Curves of the 4020-A Type Tube

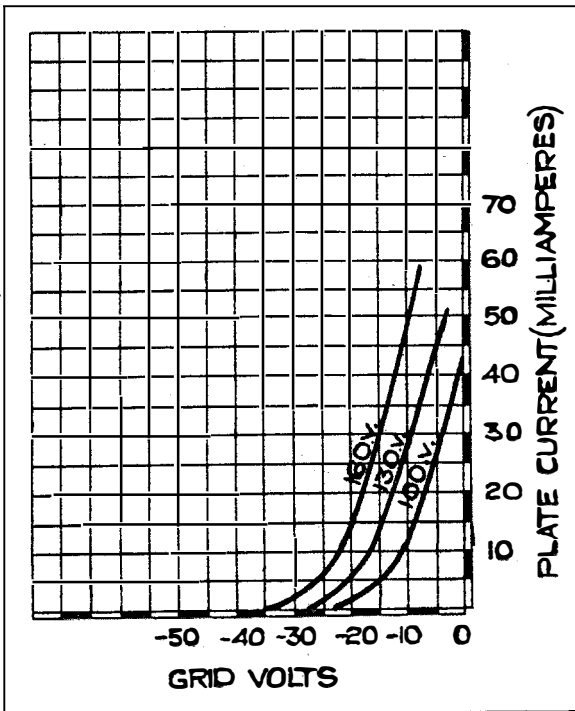

Figure 5—Characteristic Curves of the 4021-A Type Tube

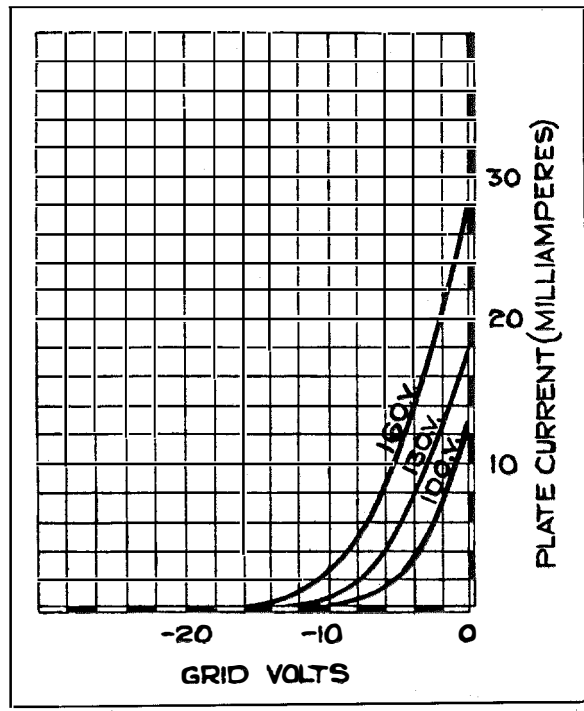

Figure 6—Characteristic Curves of the 4022-A Type Tube

Apart from such obvious steps as modifications in grid biasing resistances, meters, etc., to cater for the lower operating current, there are two fairly general problems which are worthy of mention. These are:

1. The avoidance of any tendency to over-run the filament, since the total plate current of several tubes in series on one filament circuit may be quite a considerable proportion of the lower filament current.

2. The elimination of increased crosstalk and interference due to the necessarily increased impedance of the filament circuit.

### *The Economic Aspect*

Modern telephone technique has a tendency to transfer investment in plant from the line to the repeater office. Before the introduction of vacuum tubes long distances were spanned by the use of heavy gauge (150 and 200 lb. per mile) conductors, but now the same and much greater distances are covered by the use of 20 lb. and 40 lb. conductors and vacuum tube telephone repeaters. In the case of the smallest gauge cables the first cost of repeater equipment is a considerable percentage of the total first cost and the annual cost of repeater equipment is even a higher percentage of the total annual cost.

The same transference of plant expenditure from line to office takes place in a number of other systems, such as voice frequency telegraphy. Here additional line plant is avoided by the use of further office equipment.

In order to reap the full advantage of this change the first cost and annual charges of these offices must be kept as low as is consistent with reliability.

A large item in the office cost is the power plant for supplying the vacuum tubes. This can be realised when it is appreciated that the filament drain of a very large repeater station, using vacuum tubes requiring 1 ampere for the filament current, may be 420 amperes at 24 volts for an average period of 16½ hours a day.

On the charge-discharge routine where a day's reserve is provided, duplicate batteries of 9,200 ampere hour capacity have to be installed. The same station using ¼ ampere vacuum tubes would have a filament load of 120 amperes and filament batteries of only 2,600 ampere hours would be required.

These figures illustrate the large economies effected by the use of ¼ ampere tubes.

The reason why the total current drain and the battery size for ¼ ampere tubes is not a quarter of that for 1 ampere tubes is the existence of certain other power consuming devices, such as relays and ringing machines which do not change their consumption regardless of whether 1 ampere or ¼ ampere vacuum tubes are used.

With a smaller station the reduction in size is not so spectacular but is still important. To demonstrate the quantities involved and the savings effected by the use of ¼ ampere vacuum tubes instead of 1 ampere vacuum tubes, two cases are worked out. The results are shown in Table II for an average station and Table III for a large station.

The quantities are given for stations operating

TABLE II  
AVERAGE STATION CONTAINING ULTIMATE EQUIPMENT OF:

30 2-wire repeaters.

40 4-wire repeaters.

20 Voice frequency ringers.

Assuming 16.5 busy hours per day.

Quantity	Unit in which it is expressed	Charge-discharge routine		Partial floating routine	
		1 amp. tubes	¼ amp. tubes	1 amp. tubes	¼ amp. tubes
Total drain on filament battery 24 volts.	amps.	78	34.5	78	34.5
Size of each of the two filament batteries.	amp./hrs. at 9 hr. rate	1,640	570	700	315
Charging motor generator set (22—33 volts).	output in amps.	280	100	120	60
Floating motor generator set (22—33 volts).	output in amps.			60	25
Plate battery 130 volts.	amp./hrs. at 9 hr. rate.	31	31	31	31
Charging set 130 volts.	output in amps.	6	6	6	6
Reserve engine set 24 and 130 volts.	output B.H.P.	18	9	9.5	6.5
Total power consumption at mains	kW. hrs. per ann.	28,500	14,400	24,800	13,500

TABLE III  
LARGE STATION CONTAINING ULTIMATE  
EQUIPMENT OF:  
400 2-wire repeaters.  
200 4-wire repeaters.

Quantity	Unit in which it is expressed	Charge-discharge routine		Partial floating routine	
		1 amp. tubes	¼ amp. tubes	1 amp. tubes	¼ amp. tubes
Total drain on filament battery 24 volts.	amps.	420	120	420	120
Size of each of the two filament batteries	amp./hrs. at 9 hr. rate	9,200	2,600	3,860	1,100
Charging motor generator set (22—33 volts)	output in amps.	1,000	300	500	150
Floating motor generator set (22—33 volts)	output in amps.			420	120
Plate battery 130 volts.	amp./hrs. at 8 hr. rate	280	280	280	280
Plate motor generator set 130 volts.	output in amps.	50	50	50	50
Reserve engine set (24 and 130 volts).	output B.H.P.	60	30	40	25
Total power consumption at mains.	kW. hrs. per ann.	133,000	52,000	111,000	47,500

on a charge-discharge routine and a partial floating routine since both battery practices are in common use.

In the case of the charge-discharge system, one battery takes the whole load for one day and is charged the next day. It is assumed that the total working period is equivalent to  $16\frac{1}{2}$  full load hours per day. A full day's reserve is, therefore, provided by the batteries.

In the partial floating system the load is

supplied by a generator for part of the day. A battery is floated across the generator to maintain a uniform voltage and to reduce the machine noise. The battery which has been floating during the day is discharged during the night. The system has the advantage over the charge-discharge system that smaller batteries are required. In the battery sizes given it is assumed that the load is supplied by the generator for a period equivalent to  $10\frac{1}{2}$  full load hours per day. Each battery supplies 6 full load hours per day and, therefore, 6 hours reserve is provided.

The plate current drain is the same for all cases, but the sizes of batteries and machines are given for completeness.

It is not possible to express the sizes of the voltage control boards, power boards and cabling in any convenient units, and these by no means negligible items, therefore, have been omitted from the tables.

The cost of the items quoted in the tables have not been given because of the variation from one country to another. From the data provided, however, it would be quite simple to estimate the extent of the saving effected by the introduction of  $\frac{1}{4}$  ampere tubes.

The tables compare new stations, one engineered on the basis of 1 ampere tubes and the other on the basis of  $\frac{1}{4}$  ampere tubes. Where the station has already been constructed the change to  $\frac{1}{4}$  ampere tubes will not give so great a saving immediately, but it may solve some very difficult extension problems. In many cases repeater stations are outgrowing their estimated ultimate capacity and further extensions will require considerable structural alterations. The new small repeater equipment, also described in the present issue of *Electrical Communication*, has solved the problem in the apparatus room and the  $\frac{1}{4}$  ampere tube permits many more repeaters to operate from the batteries than was originally planned.



# A New Slide-Wire Potentiometer

By J. S. P. ROBERTON, B.Sc.

*International Telephone and Telegraph Laboratories, Incorporated*

TELEPHONE Repeaters are required to amplify speech currents in line sections of varying transmission loss; hence it is necessary to have some form of control of the repeater gain, so that it may be suited to the loss encountered in each line section, giving a suitable overall transmission equivalent for the section. In 2-wire repeaters such control is obtained by the use of a potentiometer, which taps off the desired proportion of the voltage at the input to the repeater. In the past it was found that satisfactory control could be obtained with a stud-type potentiometer giving 9 steps of 2 decibels. With the growth of modern long-distance international circuits having many repeater sections, however, it has become necessary to control speech levels at each section more closely, in order to avoid large cumulative errors over the circuits as a whole. Thus there has arisen the need for a potentiometer having a greater number of contact points than is practicable with a stud design, and attention has been turned to slide-wire principles.

The new potentiometer here described was developed primarily to fill this need for a slide-wire potentiometer for the new small type 2-wire repeater, described elsewhere in this issue of *Electrical Communication*. The many advantages of the new design are such, however, that it is likely to have more universal application, and it has already been used in the case of the potentiometers and rheostats required on Voice Frequency and Carrier Frequency Systems.

## *Applications of the New Potentiometer*

Figure 1 illustrates schematically the repeater potentiometer, showing the balanced arrangement, and the feature of constant impedance looking back from the 3-4 terminals, when the terminals 2 and 5 are joined and 1 and 6 terminated in 300 ohms.

Figure 2 shows schematically a 4,000 ohm rheostat capable of dissipating up to 6 watts,

while Figures 3 and 4 illustrate external and internal views of a 600 ohm potentiometer in which special means have been adopted to provide a fairly uniform scale of attenuation over a range

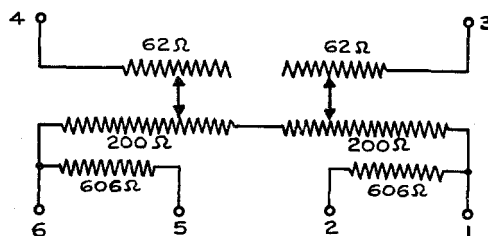

Figure 1

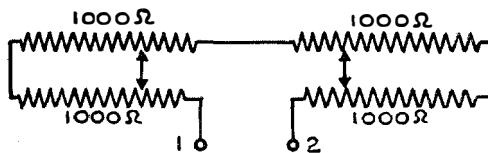

Figure 2

of 30 decibels. Both these applications were made on the New Voice Frequency Telegraph System described in the April, 1932, issue of this journal.

## *The New Slide-Wire Principle*

The principle used to obtain a sliding contact in the new potentiometer has many interesting features, and leads to several advantages in construction, manufacture and operation. It may be understood by reference to the schematic, Figures 5 and 6, and to the photographic reproductions, Figures 3 and 4.

A central cylinder A has a helical groove holding a contact ball B which bridges between the wound resistance rod C and the contact rod D, in such a way that rotation of the grooved cylinder causes the ball to make sliding contact with the resistance element, and the contact rod. While the resistance rod C is fixed to the frame of the device, the contact rod D is mounted on springs E, E, whose tension presses the rod in-

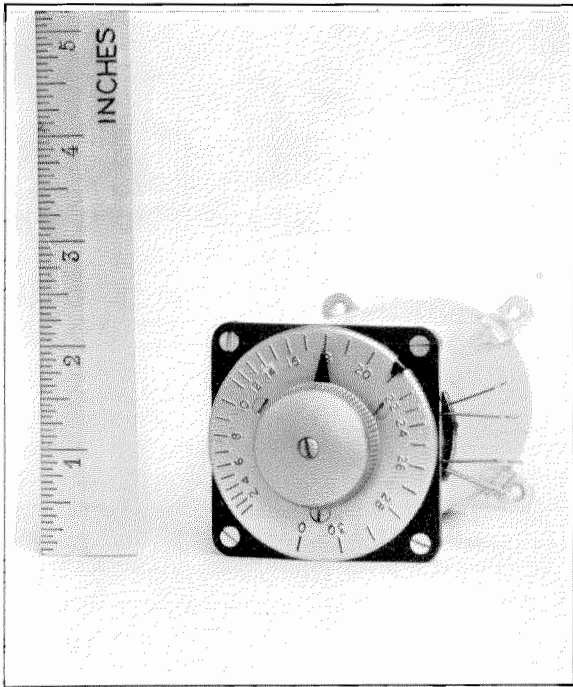

Figure 3

wards against the ball. This tension provides contact pressure between the ball and both the fixed and movable rods, and in addition it provides a pressure registering the ball in the groove. Since the endplay of the cylinder between the ends of the framework is taken up by a thrust washer, back-lash in the movement is entirely eliminated. This feature is important where accuracy of scale setting and of adjustment are required.

Another feature of interest lies in the large helix angle which can be used for the grooved cylinder. In the ordinary worm and pinion drive, helix angles can seldom exceed  $45^\circ$ , but in the form of screw or worm drive described, owing to the small amount of friction between the grooved cylinder and the ball when the surfaces are slightly lubricated, the helix angle can be made as large as  $65^\circ$ , and the resulting movement is still smooth and silky in action. Thus, there is a very high linear movement of the ball or wiper per degree of rotation of the controlling knob, so that the diameter of the grooved cylinder and hence the panel area required by the device are small. This is an important advantage over slide-wire designs which employ annular resistance elements; a further advantage is that manufac-

turing difficulties associated with the winding of such annular resistances are avoided in the new design, in which all the winding is done on straight rods.

The device possesses certain other features of interest, peculiar to the use of a ball contact. In the first place, a ball contact provides the nearest approach to a "point" contact which can be obtained practically; thus the potentiometer setting is precise to a single turn of resistance wire. Secondly, the arrangement is such that the contact is self-cleaning without excessive rubbing action which would lead to speedy wear of the resistance element. The forces of friction at the four supporting points of the ball are such that the ball actually rolls on the two surfaces where electrical contact is made, and slides on the surfaces of the helical groove. However, since the ball rolls simultaneously on the two contacting surfaces, its movement relative to each individual surface must be partly rotational as well. The resulting screwing action at the point of contact is found to give ample cleaning of the contacts. The wear, on the other hand, is found to be very small, as evidenced by a life test on a model wound with 40 S.W.G. Nichrome wire, which was tested for upwards of 250,000 double operations, "go" and "return," without failure. The quality of contact, using phosphor bronze balls, with a contact pressure of 250 grammes minimum, has been found to be excellent even under the usual low voltage conditions of talking circuits.

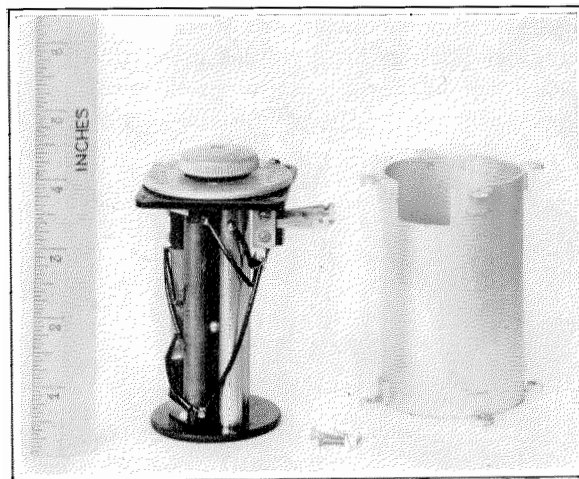

Figure 4

### Mechanical and Constructional Details

In all applications of the new design, moulded bakelite parts have been largely used and machining operations eliminated as far as possible. Most of the applications have been to units required for panel mounting under a common dust cover, and the details of construction, some of which may be seen from the illustrations, Figures 1 and 2, have been carried out to suit this type of mounting. The potentiometer frame consists of moulded front and back plates, bushed to receive the spindle of the grooved cylinder, and supported by some of the resistance rods themselves. To the ends of one of these supporting rods are fixed two T-shaped springs, carrying the resistance elements, which are thus brought

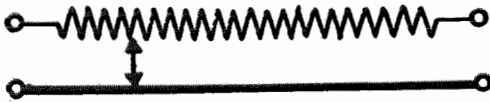

Figure 5

close to the grooved cylinder. So far the latter detail has been machined from bakelite rod, but it is hoped later to obtain it as a moulding. The internal wiring is led up to a terminal block moulded on the front end plate, whence terminals project laterally through the potentiometer cover at a convenient height for making external connections. Though normally protected during service by the panel dust cover, the potentiometer is provided with its own cover which serves to protect the windings, etc., from damage prior to panel assembly. It also serves as the medium for attaching the potentiometer to the panel, giving a mounting much more robust and rigid than if the potentiometer were mounted directly by the rear end plate. The depth of the

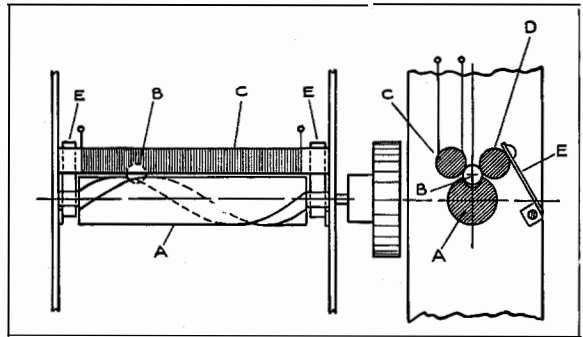

Figure 6

potentiometer is such that the dial plate—another bakelite moulding with raised characters—appears flush with the front of the panel dust cover, and the flush appearance is preserved by having the moulded knob as flat as possible consistent with reasonable control of the movement.

The constructional details may, of course, be varied to suit the particular application, without departing much from the general arrangement outlined. Thus it will be seen, for example, that the balanced arrangement and the constant impedance feature of the 2-wire repeater potentiometer (see Figure 1) require four variable resistance elements with two sliders operating simultaneously. This was easily arranged in the design by having two diametrically opposed helical grooves in the central cylinder, each containing a contact ball, and making each ball bridge between two resistance elements.

In the case of the unbalanced 600 ohm potentiometer shown in Figures 3 and 4, however, only one ball slider is used, which bridges from the resistance rod to a metal rod, the latter providing the termination for the sliding contact, as shown in the simple schematic of Figure 5.

# Carrier Current Systems Form Important Part of World Communication Network

By J. S. JAMMER

*Assistant Vice-President and European General Sales Manager, International Standard Electric Corporation, London*

IF you speak from New York to Brisbane, from Oslo to Madrid, from Bucharest to Buenos Aires, or from London to Angora, some part of the circuit will be a "Standard" carrier channel. The stability, band width, freedom from noise and interference, which are primary features of all "Standard" carrier systems, have made them applicable for international use, and because of the wide range of carrier equipment supplied by the "Standard" group of companies and the economic advantage of this means of communication, there are today as many as forty countries in which carrier comprises a very essential part of the communication network.

In the rapid strides which have been made in recent years towards the establishment of a world-wide communication network, carrier, because of its flexibility and economy, has played an important part. One is struck in reviewing the situation, by the remarkable way in which Bell System and "Standard" engineers in their original development work anticipated and provided for the complex needs of the future.

From the very beginning it was realized that some day world-wide communication would be an accomplished fact and that every unit comprising this network would need to meet the severe requirements of high grade transmission in order that it might play its part in such a comprehensive system. It was for this reason that "Standard" carrier systems were designed to give the very highest grade communication facilities even though in their original application they were used principally for communication within a limited area.

The technical features of carrier systems have been thoroughly described in previous articles, the most comprehensive of these probably being the paper by E. H. Colpitts and O. B. Blackwell.<sup>1</sup>

<sup>1</sup> E. H. Colpitts and O. B. Blackwell, "Carrier Current Telephony and Telegraphy." (Paper presented at the Convention of the A. I. E. E. in New York in February, 1921.)

While the underlying principles of such systems are old in the communication art, the successful development and widespread commercial application of these systems have come about through the concentration of skilled design engineers, the facility of precision manufacture, and a thorough study and understanding of the economics of this means of communication.

The first carrier systems to be used outside of the United States of America were installed in Brazil in 1924 and in Australia in 1925. Australia pioneered in the adoption of the newer types of systems that were produced as the art advanced,<sup>2</sup> and other countries were quick to follow her lead inasmuch as economic analyses showed the justification for the adoption of this type of communication system.<sup>3</sup> By 1929 carrier systems were in use in the four corners of the globe, from Spain to New Zealand<sup>4</sup> and from Japan to South Africa; and, since it was realized that carrier was being universally adopted, the entire art was again reviewed in order that "Standard" carrier systems should incorporate every essential feature of a high grade communication system.<sup>5</sup>

Although "Standard" has developed new and improved types of systems from time to time, it is interesting to note that the original equipments installed in Brazil and in Australia are still in service. As a matter of fact, every carrier system that "Standard" has manufactured is in operation today, although, in many cases, the systems have been moved to new routes when they have served their primary purpose of building up traffic in anticipation of a cable installation. No "Standard" carrier systems have ever been scrapped or worn out. It is interesting also

<sup>2</sup> J. S. Jammer, "Australia First to Use Type C-2-F Carrier System," *Electrical Communication*, July, 1928.

<sup>3</sup> J. S. Jammer, "Why Australia Adopted the Carrier Current System," *International Telephone Review*, July, 1928.

<sup>4</sup> J. S. Jammer, "Carrier in New Zealand," *International Communications Review*, July, 1929.

<sup>5</sup> J. S. Jammer, "Carrier Current Systems and Their World-wide Application," *Electrical Communication*, April, 1929.

# Standard CARRIER



THE TOTAL CHANNEL LENGTH OF STANDARD CARRIER SYSTEMS INSTALLED IS 265000 KILOMETRES SUFFICIENT TO GO NEARLY SEVEN TIMES ROUND THE WORLD

CARRIER SYSTEMS USED IN U.S.A. AND SUPPLIED BY THE WESTERN ELECTRIC COMPANY ARE THE SAME TYPE AS THOSE SUPPLIED IN THE REST OF THE WORLD BY LICENSEE COMPANIES OF INTERNATIONAL STANDARD ELECTRIC CORPORATION.

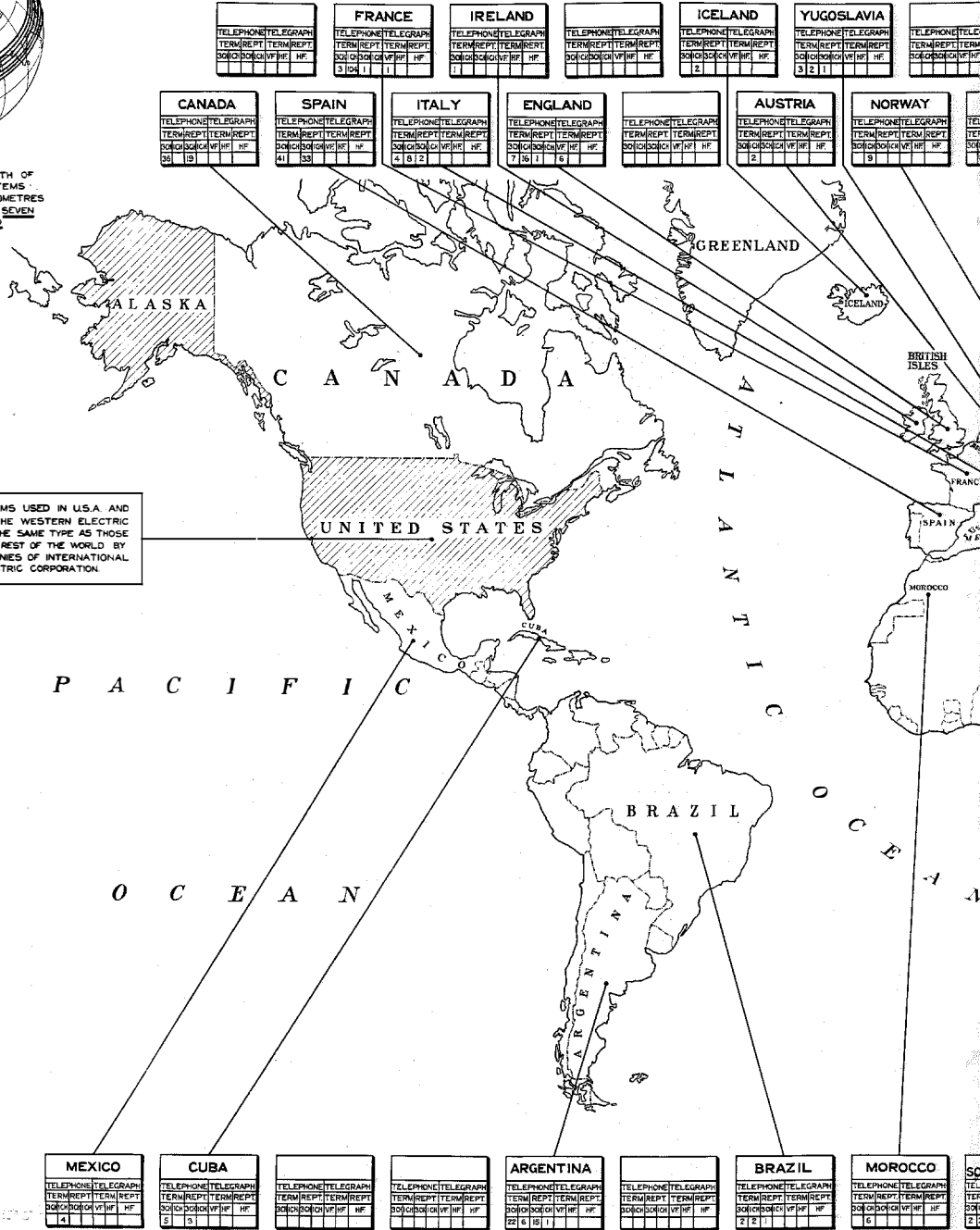

The world-wide application of carrier equipments manufactured and sold by "Standard" licensee comprise a total as at June 1st, 1932, of 750 terminals and 145 repeaters, or 895 equipments. These and these systems, plus those manufactured and sold by licensee companies of the International

# SYSTEMS

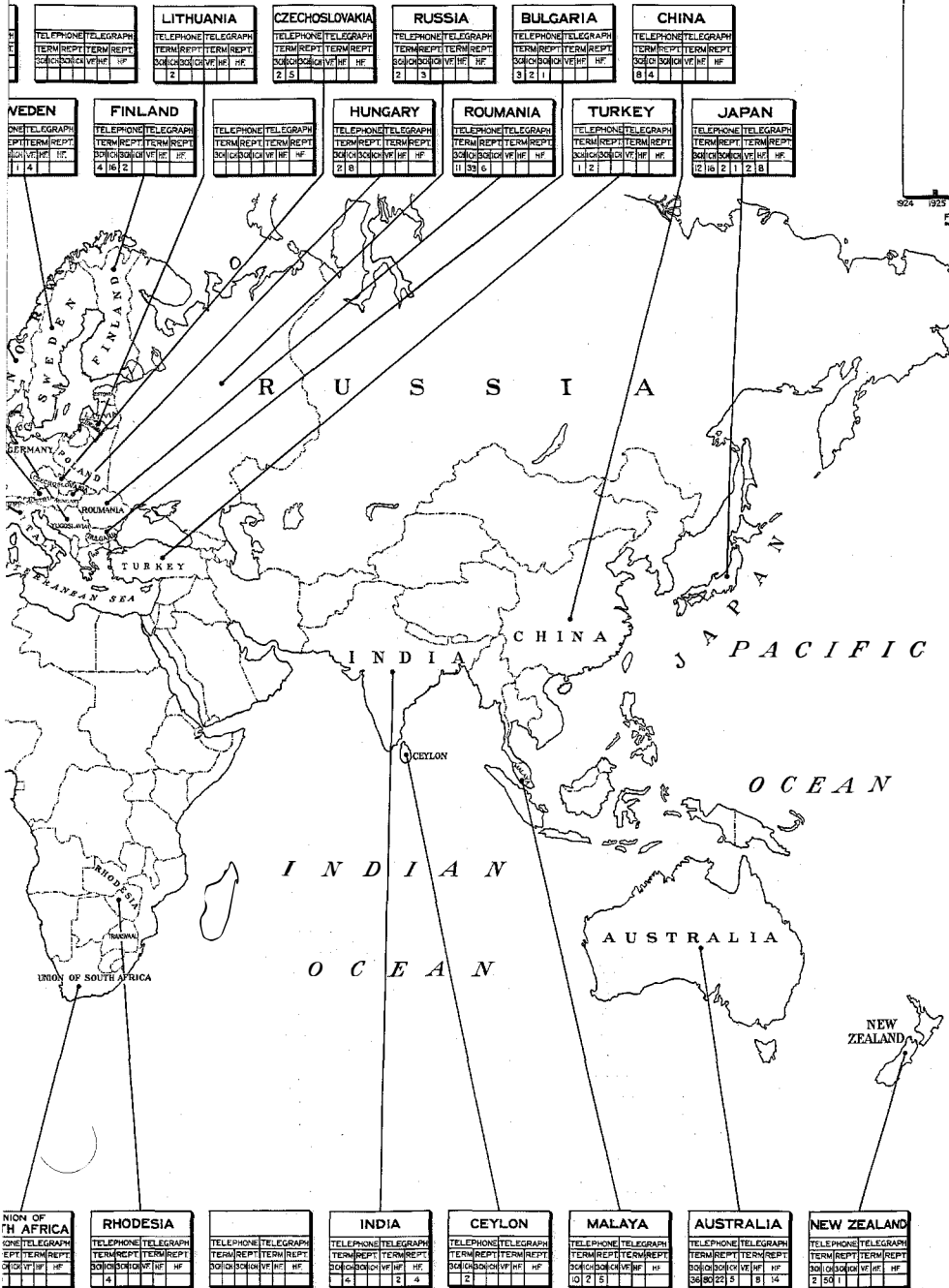
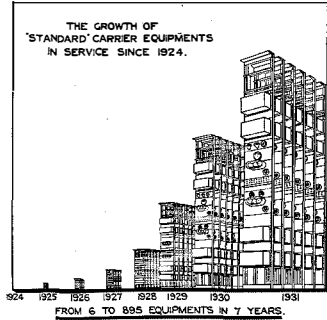

companies is shown individually for each of the 33 countries in which these systems are used. These same type of carrier system is used in the U. S. A. and supplied by the Western Electric Company, Standard Electric Corporation, comprise over 97% of the carrier equipment used in the world

to note that they occupy a unique position in modern communication in that over 97% of the carrier systems in use in the world today are of the type manufactured and sold by the International Standard Electric Corporation or its Licensee Companies.

The number of "Standard" equipments has more than doubled since 1929, and, while there were but six in service in 1924, there are today no fewer than 895 equipments furnished by the International Standard Electric Corporation or its Licensee Companies in use, representing an investment of many millions of dollars. The total channel length of these systems is over 265,000 kilometers, sufficient to go nearly seven times around the world.

The use of carrier equipments has been increasing very rapidly notwithstanding the severe economic depression prevailing in the last two years. As a matter of fact, the world-wide depression has emphasised the economic advantages of carrier, not only for long distance circuits but as feeders to existing cable routes. Telephone and Telegraph Operating Administrations have realised that, by the installation of comparatively inexpensive carrier systems to act as feeders into main routes, potential traffic demands are developed so as to throw a greater load on existing under-loaded facilities. For example, France, a country with a most extensive cable network, is using 109 "Standard" carrier equipments, of which no fewer than 66 are being used to feed traffic into toll cable routes.

The flexibility of carrier systems has prompted many Administrations and companies to adopt carrier equipment as a ready means of furnishing facilities for coping with seasonal traffic and thus providing satisfactory service under conditions which could not be considered if more permanent circuits were used.

The present-day range of "Standard" carrier equipments provides simple, inexpensive systems that prove in on a distance as short as fifty miles, or even twenty miles under favorable economic conditions, and more elaborate systems which work over distances of thousands of miles, ranging from a single additional telephone or tele-

graph channel to a multiplicity of channels, as traffic requirements demand.

In addition to terminal and repeater equipments, considerable attention has been paid to the development of open wire transposition systems and toll entrance cable loading systems for bringing carrier circuits into towns. Because of the skill and technique acquired through an intensive study of carrier and its many applications, "Standard" is able today to assist Operating Administrations and companies in the solution of transmission problems involving carrier. There are many cases in which carrier systems are operating on every pair of a pole line and through specially loaded toll entrance cables for telephony and through greater lengths of ordinary loaded cables for voice frequency telegraph carrier operation. Many refinements for simplifying maintenance are also available; for example, an automatic self regulating repeater which automatically adjusts its gain to compensate for any change in line conditions, without requiring any attention from an attendant, can be furnished as standard equipment.

The accompanying map and table give a picture of the present-day world-wide application of "Standard" carrier systems and some idea of the enormous extent to which these systems play a part in world-wide communication.

CARRIER SYSTEMS FURNISHED BY THE INTERNATIONAL STANDARD ELECTRIC CORPORATION OR ITS LICENSEE COMPANIES

<i>Country</i>	<i>Number</i>	<i>Country</i>	<i>Number</i>
Argentina.....	44	Italy.....	14
Australia.....	165	Japan.....	41
Austria.....	2	Lithuania.....	2
Brazil.....	5	Malaya.....	17
Bulgaria.....	6	Mexico.....	4
Canada.....	55	Morocco.....	6
Ceylon.....	2	New Zealand.....	53
China.....	12	Norway.....	9
Cuba.....	8	Rhodesia.....	4
Czechoslovakia.....	7	Rumania.....	50
Finland.....	22	Russia.....	5
France.....	109	South Africa.....	23
Great Britain.....	30	Spain.....	74
Hungary.....	10	Sweden.....	94
Iceland.....	2	Turkey.....	3
India.....	10	Yugoslavia.....	6
Irish Free State.....	1		

895

# Proceedings of the International Consultative Committee on Long Distance Telephony

THE history and organization of the International Consultative Committee on Long Distance Telephony in Europe (C. C. I.) has already been recorded in this journal.<sup>1</sup> Reference is there made to the recommendations which the C. C. I. formulates in its Commissions of Rapporteurs on Transmission, Protection, Operating and Tariffs. These recommendations are subsequently scrutinized and approved by the Plenary meetings which, so far, have been held yearly since the formation of the C. C. I. In order that the Administrations and Operating Companies belonging to the C. C. I. may have a concise record of these recommendations, the General Secretariat, located at 23 Ave. de Messine in Paris, publishes annually the Proceedings of the Plenary meeting.

In the very nature of things the first Plenary meetings were concerned with relatively few questions; the early Proceedings were therefore, not very extensive, and the Minutes of the first Plenary Meeting (Paris, April 28th—May 3rd, 1924) are recorded in a pamphlet (16 x 24 cm.) of 67 printed pages. As the work of the C. C. I. became more extensive and the questions referred to the Commissions of Rapporteurs increased in number and importance, the Proceedings of the Plenary meetings rapidly became voluminous. In 1926 the format was enlarged to 20 x 25 cm. and the number of pages of that year's Proceedings was 386. Maintaining approximately the same format, the record of the Plenary Meeting in Brussels in 1930 extends to 832 printed pages.

As a means of ready reference the colour on the wrapper of the French original is changed every year: green, blue, white, red, etc., and the various editions are commonly referred to during discussions as "Livre Vert," "Livre Blanc," and so on.

The dimensions of the recent Proceedings are partly accounted for by the fact that contributions in the form of scientific and practical papers

<sup>1</sup> "European Telephony as Affected by the International Telephone Committee—C. C. I." *Electrical Communication*, July, 1927.

by members of the C. C. I. are included for information and reference.

The general scope of the Proceedings has remained practically unaltered since 1925, when work of the C. C. I. was organized in four main groups to deal with:

1. Questions of General Organization.
2. Questions of Transmission.
3. Questions of Traffic, Operating and Tariffs.
4. Questions of Protection.

(NOTE: In the above classification, as set out in the Proceedings, Transmission comprises that by wire and radio; Protection includes measures against high tension interference and electrolytic corrosion.)

The major part of the Proceedings concerns questions of transmission, which are dealt with in accordance with the following outline:

## A. ADVICE OF THE INTERNATIONAL CONSULTATIVE COMMITTEE.

### (a) General.

1. Transmission Standards and Definitions.
2. Recommendations of Principle.

### (b) General Rules concerning the Composition of Transmission Systems.

1. Ordinary Telephony.
2. Carrier Current Telephony.
3. Radio-Broadcast Transmission.
4. Picture Transmission.

### (c) Apparatus.

1. Subscribers' Instruments.
2. Local Exchanges.
3. Toll Exchanges.
4. Telephone Repeater Stations.

### (d) Lines.

1. Overhead Lines.
2. Cables.
  - (a) General.
  - (b) Aerial Cables.
  - (c) Underground Cables.
  - (d) Submarine Cables.
3. Mixed Lines.
  - (e) Maintenance and Supervision of Lines and Installations.
  - (f) Co-existence of Telephone and Telegraph Circuits in the same cable.
  - (g) Co-ordination of Radio Telephony and Telephone Systems.



## B. ESSENTIAL CLAUSES FOR TYPICAL SPECIFICATIONS.

## C. APPENDICES AND BIBLIOGRAPHY.

The advice of the C. C. I. indicated under A above aims primarily at two objects: defining and establishing proper standards of transmission, and recommending the adoption of definite principles in the application of such standards.

The compilation of essential clauses for typical specifications, listed under B above, arose from the need for uniformity of requirements pertaining to lines and transmission equipment. The C. C. I. draws up these specifications on the fundamental principle that they should be confined to essential requirements which can ordinarily be met by telephone manufacturers. For particularly exacting cases Administrations and Operating Companies may add special clauses for a particular purpose.

The Bibliography, under C above, contains a comprehensive list of English, French, and German publications on telecommunication.

Matters concerning Traffic, Operating, and Tariffs appear in the Proceedings in the form of 63 separate recommendations ("avis") to Administrations and Operating Companies on points of common interest on these subjects in international telephony and telegraphy. When a change in operating practices or tariffs is decided upon, the General Secretary of the C. C. I. ascertains from each Administration and Operating Company whether they are prepared to adopt the change (which usually is scheduled to go into effect on a certain date) and accordingly advises all the others.

Questions of protecting telephone lines against high tension interference and electrolytic corrosion are entered into the Proceedings much along the same lines as those pertaining to transmission. That is to say, certain principles of protection are laid down and practical methods of protection outlined.

Apart from the subject matter on protection contained in the Proceedings, the C.C.I. publish

a separate document, entitled: "Directives concernant les mesures à prendre pour protéger les lignes téléphoniques contre les influences perturbatrices des installations d'énergie à courant fort ou à haute tension." Two editions of these "Directives" have already appeared, one in 1926 and the latest and most up-to-date one in 1930. As the title indicates, it contains guiding principles to be adopted concerning measures to be taken in order to protect telephone lines against the disturbing influences of heavy-current or high-tension power lines.

A complete list of the delegates attending each Plenary meeting is given as a preface to each edition of the C. C. I. Proceedings, which also contain verbatim reports of the opening and closing sessions of each meeting.

In view of the valuable information contained in the C. C. I. Proceedings, which are published in the French language, the International Standard Electric Corporation decided to reproduce them in an unofficial English translation for the benefit of English-speaking telephone technicians. This translation has appeared regularly since the first issue of the Proceedings was published, and copies have each year been distributed free to an ever-increasing circle of telephone engineers throughout the world. The translation is done by the writer with the assistance of the technical staff of the International Standard Electric Corporation and the International Telephone and Telegraph Laboratories, Inc. The "Directives" referred to above are also published in English by the International Standard Electric Corporation. Both editions are limited in number, and requests for copies can only be met out of the small remaining stock. Readers of *Electrical Communication* who wish to receive a copy of the English editions of the Proceedings or of the "Directives" should apply to the Editor of *Electrical Communication*, 67 Broad Street, New York; or to the Information Department, International Standard Electric Corporation, Connaught House, Aldwych, London, W. C. 2.

P. E. ERIKSON.

# 2400 Pair Telephone Cable<sup>1</sup>

4848 Conductors in a Single Sheath—Installation in Bucharest by the  
S. A. Romana de Telefoane.

By N. A. ALLEN, Ph.D., M.Sc., A.M.I.E.E.

WE have described in a recent series of articles<sup>2</sup> the progress which has been made during the past few years in developing telephone cables of the type used for connecting groups of subscribers to their local telephone exchange, cables which are colloquially designated as "loop" cables, culminating in the commercial production of twin type (twisted pairs) telephone cables having 1800 pairs of 4 lb. conductors.

Experiments have been continued without cessation in anticipation of still more conductors being required, and this research has embraced both the star quad type of cable and the twin type of cable. In the latter field a further development of a striking nature can now be recorded, as indeed was foreshadowed in an article published in *The Electrician* of November 13, 1931. This is the manufacture and supply on a commercial order of a considerable number of lengths of 2400 pair cable, the customer in this case being the S. A. Romana de Telefoane, Bucharest.

The cable is intended for connection to the new automatic exchange now being constructed in Bucharest to carry circuits from this exchange through one of the principal thoroughfares in the city, where duct space is limited. The fundamental plans of the telephone company showed that circuits in excess of those provided by an 1818 pair cable would be needed and the installation of the 2424 pair cable was required to solve the difficulty.

This cable has the largest number of pairs ever manufactured commercially for a customer in any country in the world. Over 25,000,000 feet of copper wire was required per mile of cable.

The manufacture of this cable presented a number of outstanding features. The "unit principle" was adopted, so that the pairs were first stranded together to form a 101 pair unit (each

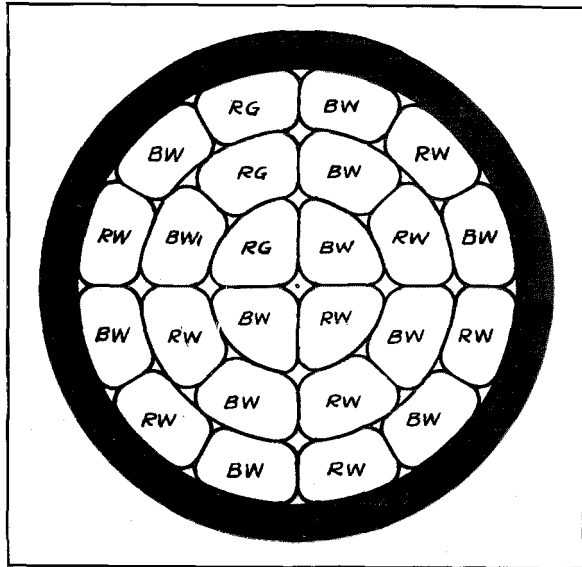

Figure 1--Lay-up of 101 Pair Units in 2424 Pair Telephone Cable

unit contained one spare pair) before laying up the 24 groups together to form a cable. The 101 pair units were then stranded together, there being 24 such units, arranged in the following layer sequence, which is illustrated in the cross-section shown in Figure 1.

Centre layer.....	4	101 pair units
First layer.....	8	101 pair units
Second layer.....	12	101 pair units

The colour scheme was so designed that each layer contained three types of unit in a symmetrical sequence. Thus the centre layer contained one Red-Green unit (containing red and green insulated wires twisted together to form red-green pairs), with two Blue-White units, one on each side of the Red-Green unit, and one Red-White unit, placed diametrically opposite to the Red-Green unit. Similarly the first layer contained one Red-Green unit, four Blue-White units and three Red-White units. The second layer contained one Red-Green unit, six Blue-White units and five Red-White units. The three

<sup>1</sup> Reprinted by permission from *The Electrician*, June 24, 1932.

<sup>2</sup> "Telephone Cables," N. A. Allen, *The Electrician*, March 6 and 13 and November 13, 1931.

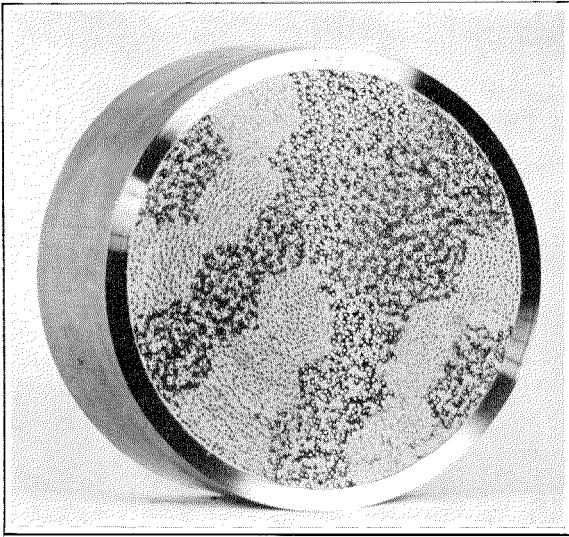

Figure 2—Photograph of Sample of 2400 Pair Cable

Red-Green units, one in each layer, were always radially adjacent throughout the whole length of the cable, and by this means it will be observed that the identification of any pair among the 2424 pairs in the cable would be a matter of extreme simplicity: the method being first to

pick out the unit, and second to pick out the pair within the selected unit.

Figure 2 is a photograph of an actual sample of cable as supplied, the other details of the cable being as follows:

Number of conductors.....	4,848
Weight of conductors.....	4 lb. per mile (nominal)
Diameter of conductors.....	0.0159 in.
Insulation.....	Paper strips
Twisting.....	2 insulated conductors twisted to form pairs No whipping over pairs
Number of pairs.....	2,424
Stranding of pairs to form units... ..	101 pairs stranded by normal methods
Number of units.....	24
Stranding of units to form cable..	Centre 4 units 1st layer 8 units 2nd layer 12 units (See Figure 2)
Lead sheath thickness.....	0.130 (minimum)
Overall diameter.....	3.15 in.
Manufacturing length.....	200 yds. average
Electrical resistance per mile....	230 ohms (maximum)
Insulation resistance per mile....	40,000 megohms actual
Mutual electrostatic capacity per mile.....	0.085 mfd. (maximum) (Actual value well within the limit)

# A Synchronizing System for Electrical Transmission of Pictures\*

By DR. YASUJIRO NIWA

Chief Engineer, Nippon Electric Company, Tokyo

**SUMMARY.**—A synchronizing system for use in the electrical transmission of pictures is described. In this system a tuning fork oscillator similar to that at the sending station is provided at the receiving station, maintaining its frequency approximately equal to the frequency at the sending station. With the picture current from the sending station there is transmitted a very small synchronizing current which, acting on the tuning fork oscillator at the receiving station, brings the frequency of the tuning fork oscillator at the receiving station in exact synchronism with the frequency of the tuning fork at the sending station. A brief account of some preliminary experimental work on the relation between the power required for forced synchronization and the frequency difference is given.

Sample pictures received by a system employing this method of synchronization between Tokyo and Osaka by short wave radio are also shown.

## Introduction

THERE are two kinds of synchronizing methods for electrical transmission of pictures, excluding the so-called start-stop method. In one, synchronizing current is generated at the sending end to drive the synchronous motor there and at the same time, either by wire or radio, a part of the current thus generated is transmitted to the receiving end, where the current received is amplified and used to drive another synchronous motor thereby maintaining the synchronism of the system. In the other, a source of alternating current is provided separately for the sending and receiving stations, respectively, and synchronous operation is attained by carefully regulating the frequency of the alternating current.

Comparing the two methods of synchronous operation, the writer is of the opinion that, at any rate when transmitting by wire, the use of synchronizing current has decided advantages, one of which is that if the apparatus is run synchronously by a synchronizing current, care need be taken only of the operation of the synchronous motors at the sending and receiving stations and as a consequence, the operation at both stations is greatly simplified. In the writer's system<sup>1</sup> of electrical transmission of pictures (Nippon Electric System), therefore, this method

has been adopted for open wire and cable lines and has proved its superiority by the successful operation of the system during the past three years between Tokyo and Osaka by the *Daily News* and the Department of Communications, both of which adopted the N. E. System from the inauguration of the picture transmission service in October, 1928, and August, 1930, respectively.<sup>2</sup>

When the communication channel joining the sending and receiving ends is unstable, it is not easy to transmit the synchronizing current without difficulty; therefore, in order to insure accurate synchronism in such a case, a system in which separate alternating current sources are installed at the sending and receiving ends for driving the respective synchronous motors is considered more suitable.

When the synchronous motors are thus driven by separate sources, the difference in frequencies of the sources requires serious consideration, since an undue frequency difference will cause a slip in the picture received and make it distorted. The extent to which the frequencies should coincide can be determined as follows:

Denote the length and width of the picture by "a" and "b," and the line density by "d" and the permissible slip of the picture by "δ." Then the coincidence of the frequencies of synchronizing currents at the sending and the receiving

\* Paper presented before the International Electrical Congress, Paris, July, 1932.

<sup>1</sup> Y. Niwa, "A System of Electrical Transmission of Pictures," *Electrical Communication*, April, 1930.

<sup>2</sup> S. Inada, "Public Service of Phototelegraphy in Japan," *Electrical Communication*, July, 1931.

ends should be within the value  $\frac{8}{axbxd}$ . When a picture of size 18 x 26 cm. is transmitted using the line density of 50 lines per centimeter with an allowable slip of 2 mm., the difference of frequencies at both ends should not exceed 1 in 117,000.

The maintenance of such a degree of accuracy is accomplished by the use of a tuning fork which is kept at a constant temperature. Thus each fork is kept in a constant-temperature tank and the electrical source for driving the fork is carefully maintained at a constant value. Since the characteristic of a tuning fork oscillator is

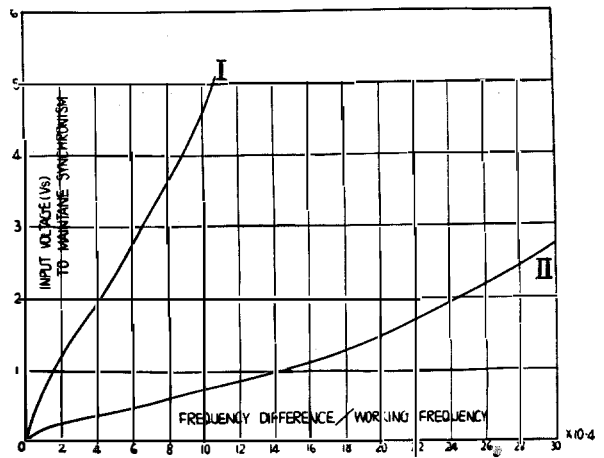

Figure 3

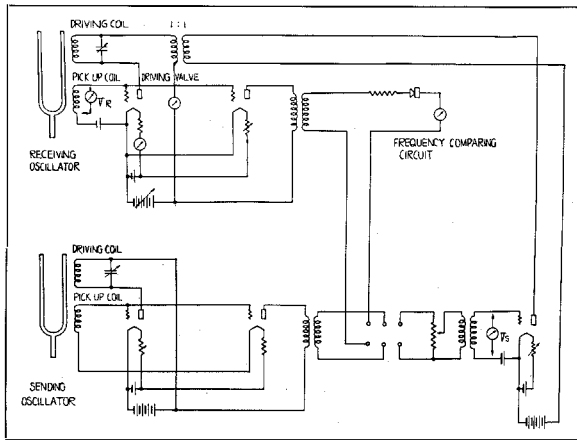

Figure 1

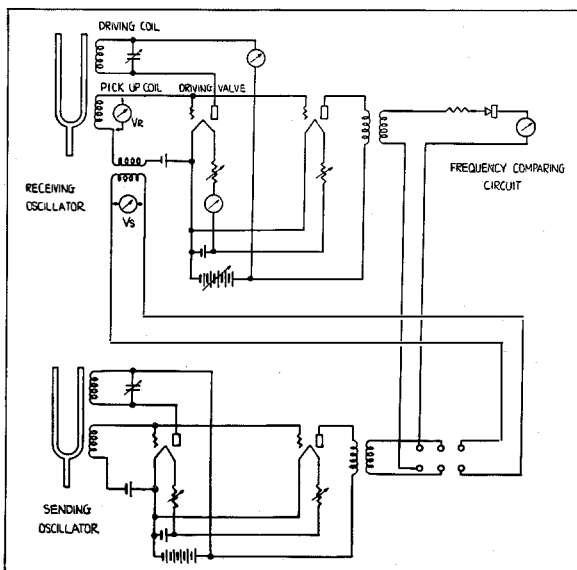

Figure 2

such that it requires considerable time (from one to several hours) before its frequency reaches a constant value, it is necessary that the fork should be kept oscillating constantly. Consequently, some troubles, (such as the temperature of the constant-temperature tank falling, due to poor connection of its heating source, faulty operation of the thermostat regulator, or changes in the power source of the oscillating vacuum tube) will make the transmission of a picture impossible until a constant condition is restored. Thus, if synchronous operation is to be attained by using a separate generator for the sending and receiving stations, respectively, it not only necessitates the use of complex apparatus or mechanisms in order to keep the generators to the required accuracy, but it also requires no small effort to maintain the apparatus properly and to check the two frequencies.

In order to remove this inconvenience, the author, in collaboration with Mr. M. Kobayashi, has devised the hereinafter described synchronizing system which may be termed a forced synchronizing system and which has been used with very good results.

### Forced Synchronizing System

This system may be regarded as a combination of a system which transmits the synchronizing current and one which does not transmit it. In this system, a very small synchronizing current is transmitted with the picture current from

the sending station. At the receiving station a tuning fork oscillator is provided which is similar to that at the sending station and its frequency is maintained approximately equal to the frequency at the sending station. The synchronizing current received at the receiving station is suitably amplified and then supplied to a part of the oscillating circuit of the tuning fork oscillator at this station. The result is that the tuning fork oscillator at the receiving station is brought under the control of the current received due to the so-called pulling effect of the current on the tuning fork oscillator, and its frequency is brought in to exact synchronism with the frequency of the current received, that is, with the frequency of the tuning fork oscillator at the sending station.

Connection for leading the current received to the tuning fork oscillator may be established by inserting a transformer in series in the grid or plate circuit of the vacuum tube which is driving the tuning fork oscillator. Though the smaller the frequency difference, the more satisfactory will be the result, the maximum frequency difference for which the pulling effect of the current received may be utilizable is approximately 1 in 1,000. The system is applicable to either the wire or radio operation, but if it is used in connection with radio, a greater benefit

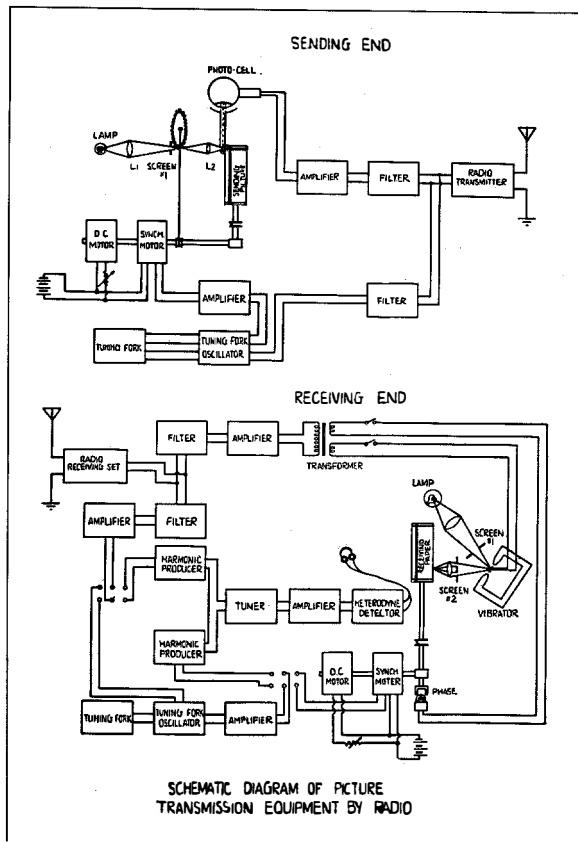

Figure 4—Sending End  
 Figure 5—Receiving End

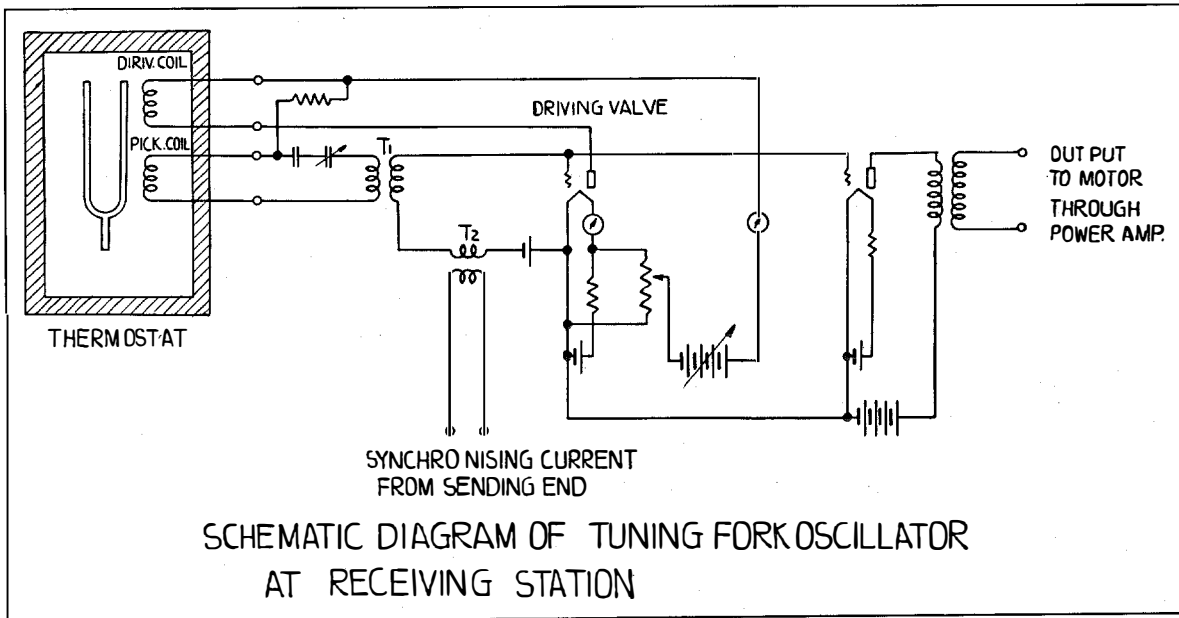

Figure 6

will be obtained. In the latter, the current received decreases occasionally due to fading; at such times the tuning fork at the receiving station is not under the control of the current transmitted, but since it will be restored under the normal control as soon as the current has again increased, synchronism satisfactory as a whole will be maintained.

### *Power Required for Forced Synchronization*

Supposing the frequency of the tuning fork oscillator at the receiving station is pulled into synchronism by the power from the tuning fork oscillator at the sending station, an experiment was first made to determine the relation between the power required for forced synchronization and the difference of frequencies of the two tuning fork oscillators.



Figure 7

In this experiment two methods were used for coupling the power from the sending tuning fork oscillator to the receiving tuning fork oscillator, i.e., (1) through the plate circuit and (2) through the grid circuit, as shown in Figures 1 and 2, respectively. The difference of the frequencies of the two sources was kept constant and the input voltage applied to the grid or plate circuit of the vacuum tube driving the controlled tuning fork oscillator was decreased until the controlled oscillator stepped out of synchronism, which could be detected by the beating of the meter of the frequency comparing circuit. Figure 3 shows the results of the experiments, curve I for case (1) and curve II for case (2). The abscissa indicates the frequency difference and the ordinate, the input voltage to the plate or grid of the tuning fork maintained oscillator, i.e., the reading of the voltmeter  $V_s$  in Figures 1 and 2 below which synchronization ceases. In case (1) the output voltage of the pick-up coil  $V_R$  was about 10 volts, and the necessary synchronizing power was roughly 5% of the controlled power per  $10^{-4}$  difference in frequency. In case (2) the output voltage of the pick-up coil of the tuning fork was about 10 and the synchronizing power was about 0.7% per  $10^{-4}$  difference in frequency.

It was shown experimentally that these relations hold good for a frequency difference up to  $20 \times 10^{-4}$  while stable synchronization becomes impossible above  $30 \times 10^{-4}$ .

### *Schematic Diagrams of the System*

Figures 4 and 5 are schematic diagrams of the writer's picture transmission system with this synchronizing method applied. Figure 4 shows the sending end and Figure 5 the receiving end. Full explanation of the system has been given in previous papers<sup>3</sup> except for the synchronizing method which will only be mentioned below.

At the sending station a synchronizing current of 300 cycles superposed on the picture current is fed into the speech input amplifier of the radio transmitter just as in the system for open wire or cable circuits. At the receiving station, after the currents have been detected, they are separated by filters and the picture current is passed to the translator through the high pass filter.

<sup>3</sup>Loc. cit.

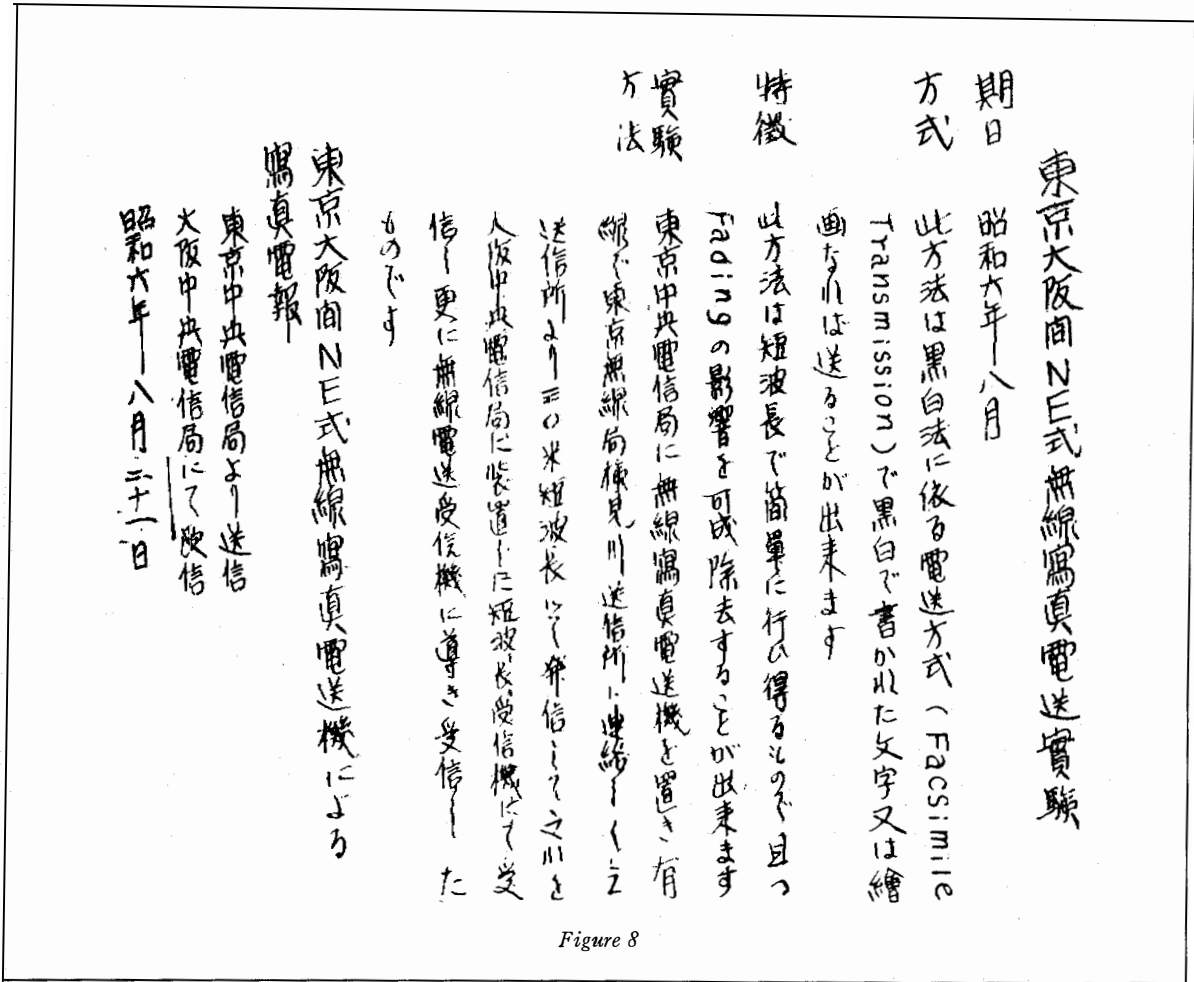

Figure 8

The synchronizing current, after passing through the low pass filter, is fed to the tuning fork driving oscillator. The coupling is effected through the grid circuit of the driving tube, as shown in Figure 6.

The tuning forks at the sending and receiving ends are kept in the constant temperature chambers with thermostat regulator. But the constancy of the two frequencies need not be kept so accurately coincident as is required for independent synchronization, which means easier maintenance, less trouble, and more convenience in the operation.

For checking the coincidence of the frequencies of the tuning fork oscillators at the sending and the receiving ends, the synchronizing current only is sent from the sending station and it, after being received, is mixed with the synchronizing current at the receiving end. The

degree of coincidence can be judged from the period of beat of the two frequencies. However, direct beats of the two frequencies will be too slow to enable quick adjustment; for example, if the difference of the frequencies be 1 in 20,000, with a fundamental wave of 300 cycles, the period of beat will be about one minute. In order to remove this inconvenience, the 30th harmonics of the fundamental frequencies are picked up, by using a special harmonic producer with a neon lamp and allowing them to beat so that a comparison of the frequencies can be made. In this way the period will be reduced to a few seconds. In Figure 5, the arrangements for checking the frequencies are shown.

**Results of Actual Operation**

The new system has been given field trials





Figure 9



Figure 10

with successful results between Tokyo and Osaka, about 450 kilometers apart, by short wave radio. Figures 7 and 8 show some of the transmissions obtained with a 7,890 kilocycle wave. The original picture was cabinet size (13 x 18 cm.) and the time of transmission was about 5 minutes with a line density of 5 per mm.

It was found that the tuning fork at the receiving stations is pulled into synchronism if the difference of the two frequencies is within  $10 \times 10^{-4}$ , provided the synchronizing power to the grid of the driving oscillator of the tuning fork at the receiving end is about the same as the induced voltage from the same fork, i.e., the synchronizing current is about one-fourth of the picture current. If the difference of frequency is below  $6 \times 10^{-4}$  the stepping in or out of the tuning fork oscillators is effected very smoothly while, above this limit, hunting of the synchronous motor is caused as a result of pulling in or out.

An example of a picture, Figure 9, will explain the effect of this forced synchronization. The right portion of the reproduction was made with the forced synchronizing system and the left, with independent synchronization. It is to be seen that during the period of independent synchronization, the picture is slipped due to the frequency difference which is 1 in 1,000 while as soon as forced synchronization is introduced the coincidence of the frequencies can be seen from the accurate framing of the received picture. Figure 10 shows another example of pictures received over a radio circuit suffering from severe fading. Black lines on the picture show the period during which the signals, picture as well as synchronizing, faded out. It may be seen that as soon as the signal intensity recovered, exact synchronism was again established notwithstanding the fact that the difference of the two frequencies were kept exceptionally large for experimental purpose, i.e., 1 in 300.

# Mobile Radiotelephony\*

By COMMANDER F. G. LORING, O.B.E.

*International Marine Radio Company, Ltd.*

and H. H. BUTTNER

*Assistant Vice-President, International Telephone and Telegraph Corporation*

## Introduction

THE organization of mobile radiotelephone service falls into two distinct classes, and in either class it presents difficulties not met with in the case of radiotelegraphy. In the first class we have an elaborate, expensive and highly developed equipment calling for the attention of skilled operators and working in conjunction with the telephone network on land. It is obvious that the establishment of direct telephonic communication between a passenger on board a ship and another person on land, which may (and often does) involve the use of the long distance trunk lines, necessitates a high state of discipline and co-operation combined with apparatus of the highest class for its successful completion. In the second class we go to the other extreme and have to meet the requirements of fishing and coasting vessels involving totally unskilled and often very undisciplined operators, combined with the simplest possible equipment at the lowest possible price. Both problems will come up for examination at Madrid from an international point of view.

The Companies with which we have the honour of being associated are firm believers in the future of radiotelephony in the Maritime Service, not only on board liners such as the British "Majestic" or the Spanish "Cabo Santo Tome" for the purpose of maintaining a subscribers' telephone service with the land network, but more particularly on board vessels below the legal limit of compulsory equipment (i. e., 1,600 tons) as an alternative to radiotelegraph communication with the shore. For these ships the expense of carrying a qualified operator is often prohibitive and in any case must be a serious consideration, and the masters and owners of such vessels have

consequently to forego the financial and administrative advantages arising from a constant touch with the inland telegraph system which is at present only enjoyed by ships carrying radiotelegraph equipment. These vessels are also outside the Safety of Life at Sea wireless organization which has been the means of saving so much life and property in recent years, and we are confident that at the Madrid conference, steps will be taken to bring those ships equipped with radiotelephony only within the confines of that international organization which contributes so materially to the safety and comfort of those whose business or pleasure is upon the seas.

In this connection it seems proper to make some reference to the disabilities which are presented by the language question and how they may affect the use of radiotelephony. They are admittedly serious—we all know the difficulties of conversation in a strange tongue or even in a strange dialect—but we must recollect that, in the first place, the ships we are now considering will usually be in touch with their own countrymen and, secondly, thanks to the ever extending use of the Radio Direction Finder, a ship in distress which continues to send out the code word "MAYDAY" may reasonably hope to be located almost as quickly as if she could give her position by telegraph.

In providing radio communication to mobile units both telephony and telegraphy have natural fields of usefulness. The use of telephony appears to be applicable to those cases in which it is inconvenient to carry special operators on the mobile units or when it is desired to give personal communication between individuals. Telephony also has the advantage that it is thus possible to connect mobile units directly to land telephone systems. Radiotelephony, however, is technically more difficult than radiotelegraphy. Despite this drawback, mobile radiotelephony is

\*Paper, except for small additions, presented before the International Electrical Congress, Paris, July, 1932.

already in world-wide use and, with the continued development of the art, it should occupy an increasingly important place in the field of mobile radio.

This paper will attempt a general review of those instances of two-way radio telephony in which one or both stations are in motion during the communication. Most of the subjects mentioned have already been covered by published papers and for more detailed information the original papers should be consulted. The reference numbers used in the paper refer to the appended bibliography.

### *Radiotelephony on Large Passenger Ships*

#### *Development*

Perhaps the earliest demonstration of two-way radio telephony between ships at sea and a land telephone system was given in 1915 by American Bell Telephone System engineers in connection with the U. S. warship "New Hampshire."<sup>1</sup> Among the trials made after the World War may be mentioned the extensive work of the Bell System and General Electric Company in the United States with the S.S. "Gloucester," S.S. "Ontario," and S.S. "America" in 1920 to 1922, the installations made by the Japanese Department of Communications on boats plying between Japan and Chosen in 1921 and the British Marconi Company demonstration with the cross channel steamers "Lorina" in 1923 and "Princess Ena" in 1925.

Following the development of short wave radio, telephony to and from ships became more practical and in 1929 experiments were begun aboard the British ship "Berengaria" and the American ship "Leviathan." Early in 1930 service was offered to the public aboard the "Leviathan" and the "Majestic." These ships were followed by the "Olympic," "Homer," "Belgenland," "Empress of Britain" and "Monarch of Bermuda."\* All are equipped with elaborate transmitting, receiving and voice frequency equipment. They give duplex service from a telephone booth or a cabin on board the

<sup>1</sup> For numbered references see Bibliography.

\*Since this paper was first prepared, regular radio telephone service has been inaugurated on the German liners "Europa," "Bremen," "Deutschland," "Albert Ballin," "Hamburg," and "New York."

ship through special land stations to the telephone networks of Europe and America.

#### *Technical Features*

The aim of the installations<sup>2</sup> on large passenger ships has been to provide throughout the major part of the transatlantic voyage a connection to both shores resembling from the viewpoint of the subscriber an ordinary telephone connection. The subscriber on board speaks from a telephone booth which is located in the centre of the ship, near the public rooms. For simplicity a four wire system is generally used on the ship, i.e., the transmitter and receiver of the subscriber's telephone set are separately connected to the radio transmitter and receiver, respectively.

The radio equipment is independent of the ship's radiotelegraph facilities and the receivers and transmitters, in general, are similar to but more compact than modern equipment of similar rating used in point-to-point radiotelephony. The transmitter power output ranges from 250 watts on the "Monarch of Bermuda" to about 1 kW on the "Belgenland." Voice frequency equipment consists of a small monitoring board with volume indicators and volume controls.

As the distance between ship and shore stations varies from 75 to 3,000 nautical miles during the transatlantic voyage, it is necessary to use different frequencies, depending on the ship's position, time of day and season of the year. Frequencies now in use are the result of considerable experiment and are shown in Table I.

TABLE I

Transmitting from Ocean Gate, U.S.A., to Ships	Transmitting from Ships to Forked River, U.S.A.	Transmitting from Ships to Baldock, England	Transmitting from Rugby, England to Ships
4,752.5 kc.	4,177.5 kc.	4,430 kc.	4,975 kc.
8,560	8,830	8,860	8,680
12,840	13,210	12,380	12,780
17,120	17,640	16,440	17,080

The chief shore stations now in regular use for this service are Rugby and Baldock, the transmitting and receiving stations of the British General Post Office in England, and Ocean Gate and Forked River, special transmitting and receiving stations for ships maintained by the

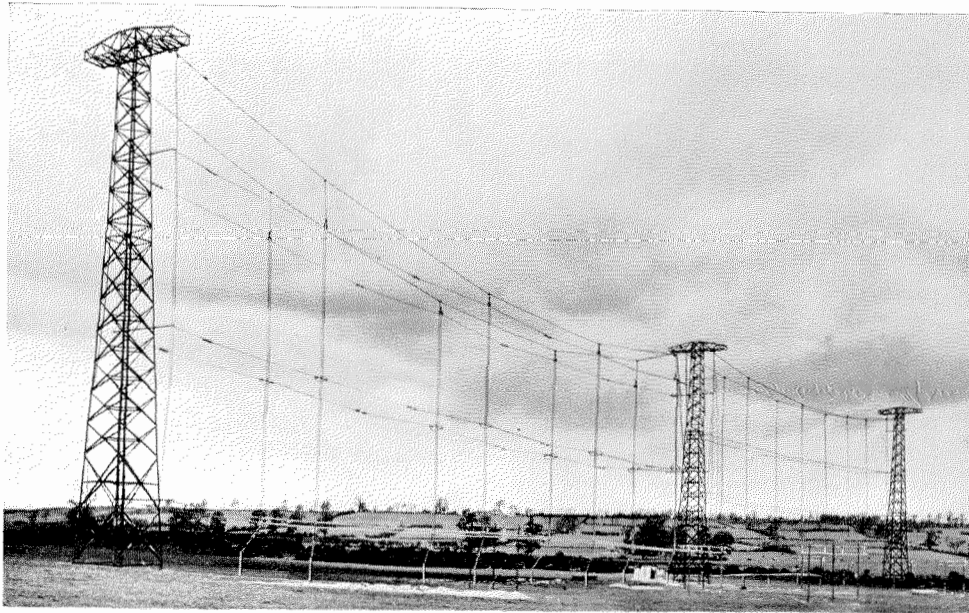

Figure 1—Typical Antenna Array at Rugby, England.

American Telephone and Telegraph Company in the United States. The Marconi radio stations near Montreal work with the Canadian ship "Empress of Britain."

Shore station transmitters and receivers are similar to those used in point-to-point short wave radiotelephone services. The transmitter at Rugby has an output power of about 5 kW and that at Ocean Gate, about 12 kW. Directive antennae (Figure 1) of fairly broad characteristics are employed both for transmitting and receiving and are directed approximately along the North Atlantic steamship lanes (Figure 2). Telephone lines connect the transmitting and receiving stations to the terminal offices at London and New York. Here are located monitoring positions, volume controls, voice operated devices to prevent echoes and retransmission of received noise, and "hybrid" coils to join the four wires from the radio stations to customary two wire telephone lines. From the terminal office the lines go to special positions at the long distance switchboards.

#### Results Obtained

Various factors enter into the overall quality

of the radio circuit. Among them are noise, fading, interference and distortion. All these factors together are considered by the operators in assigning a figure of merit to the individual contacts between ship and shore stations. Actual results obtained during 1931 on the circuit between America and the ships, are shown in Figures 3, 4, 5, and 6. It is to be noted that over 80% of the total contacts for all distances, times and frequencies were "commercial," i.e., suitable for subscribers' conversation. About 95% of all contacts at distances of less than 1,500 nautical miles were "commercial," and about 50% of all contacts for distances less than 500 miles were "excellent," i.e., equivalent to a good wire circuit.

Among the remarkable results which have been obtained with telephony in large passenger ships, may be mentioned contacts over extremely long distances during the world cruise of the "Belgenland" in the winter of 1930-31 and the "Empress of Britain" in 1931-32. For example, successful conversations were held with London when the ships were in the China Sea and with New York, when at Alexandria.

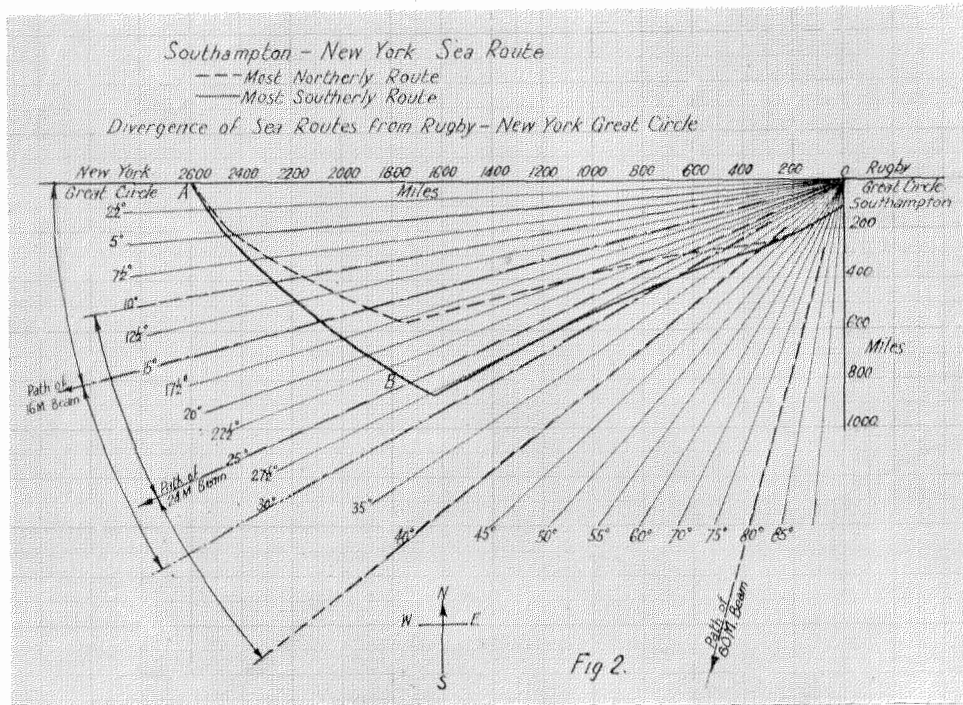

Figure 2—Direction of Beams, Rugby, England.

### *Radiotelephony in Small Ships*

The equipments suitable for installation on board small ships differ materially from those described above. They must be of simple and robust design and must not as a rule consume more than 1 kW from the vessel's mains. In many cases the power is considerably less. Except in the case of whaling fleets, which work on waves of about 400 metres, waves between 150 and 200 metres are usually employed and the ranges obtained under these circumstances are often remarkable.

An equipment delivering 25 watts to the antenna may be relied on to give satisfactory communication at 200 miles, which under favourable conditions will be increased to 300 or 400 miles by day and to 1,000 miles or more at night. With few exceptions simplex working is employed, and messages to and from the ships

are transferred to the land lines by the operator at the coast station.

Very considerable activity may be anticipated in the development of this form of radiotelephony, which dispenses with the services of a skilled operator and thus reduces the cost of operation to a figure compatible with the conditions of service.

During the War, low power radiotelephone sets were employed on a considerable scale on board patrol boats and aircraft, but no substantial progress was made commercially until 1925 and 1926, when small radiotelephone installations were tried out in Belgian and English trawlers and on the Antarctic whaling fleets. In the former case, the preliminary results were of a somewhat negative character but in the latter, the new communication medium was immediately successful and at the present time approximately fifty British and Norwegian whaling

ships operating in the Antarctic have been fitted for radiotelephony.<sup>6</sup> It forms a complete system of communication between the "catchers" (small ships which hunt the whales) and the factory ships and base camps in South Georgia and South Africa. The factory ships and their associated "catchers" usually work on a common frequency providing simplex intercommunication. Whalers operating in the vicinity of South Georgia use several frequencies in the neighbourhood of 750 kc. (400 metres), while South African whalers use 1,500 kc. (200 metres). Transmitters with output powers ranging from 50 to 200 watts are used in the service.

With regard to the general development of low power radiotelephony, which may be said to date from about 1929, it will be convenient to consider it on a geographical basis.

*Northern and Western Coasts of Europe*

The employment of radiotelephony on board fishing vessels is rapidly increasing in this area, and there is a noticeable tendency to replace

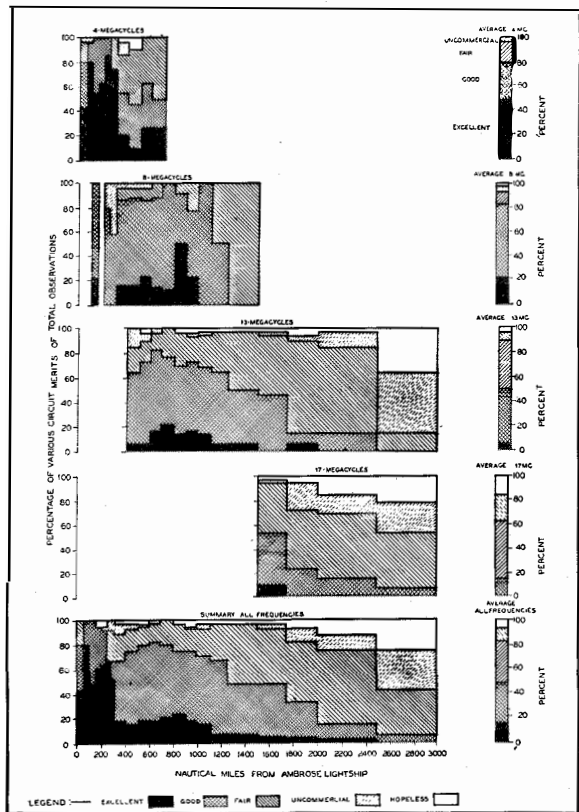

Figure 3—Transmission from Ocean Gate to All Ships, January-June, 1931

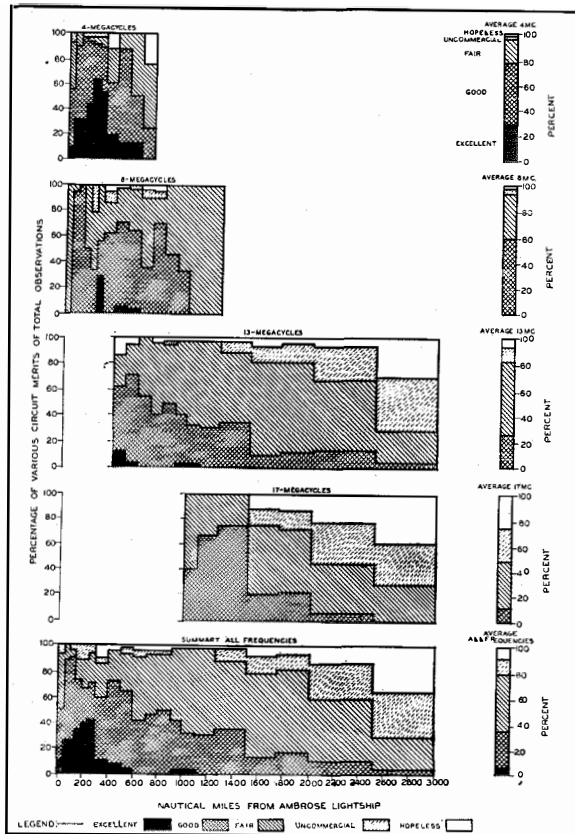

Figure 4—Transmission from All Ships Observed at Forked River, January-June, 1931

the radiotelegraph equipments already fitted on vessels by radiotelephone apparatus. In addition to providing the advantages of telephonic communication the apparatus, being of modern design, is simpler and more economical. A considerable number of vessels are already equipped in this manner, whilst the several Administrations are meeting the demand for land line facilities by the provision of suitable coast stations with which the vessels can communicate. The service is usually simplex and is not connected directly to the inland telephone system, although the German Administration has met with considerable success in duplex working, attained by the use of widely separated wavelengths, in which case the master of the vessel can be placed in direct communication with his owner through the telephone network. The cost of this arrangement is, however, considerably greater than for transmission at the land end by telegraph, and it is considered that this factor will have its

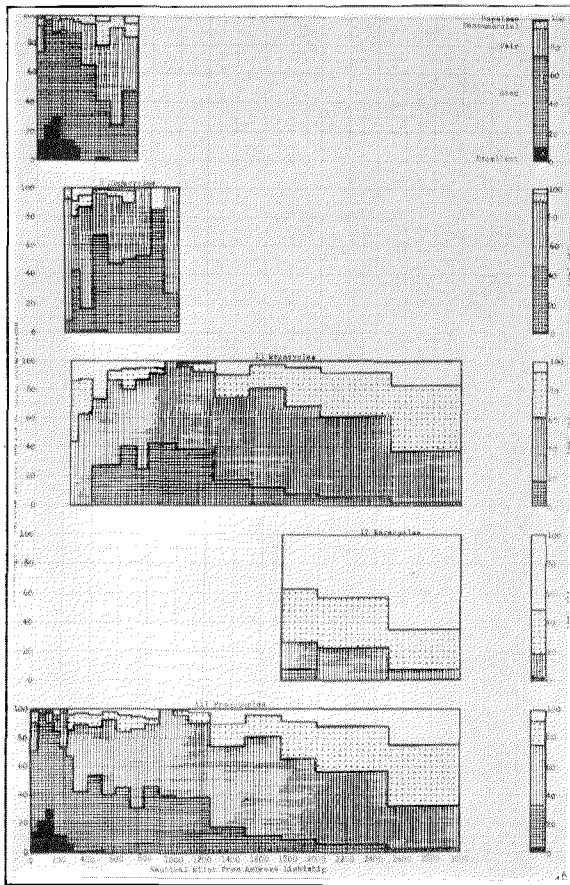

Figure 5—Observations on All Ships at Forked River, July-December, 1931

effect on the final development of trawler radiotelephone service in Europe. It will be realized that owing to the rapidity of the development, it is difficult to estimate the number of vessels actually equipped, but it may be said (June, 1932) that in Great Britain there are some fifty or sixty trawlers equipped with radiotelephony and that coast stations have been provided at Fishguard, Wick and Humber. It is understood that the British Post Office has arranged to equip all British Coast Stations with radiotelephone apparatus designed to work on waves in the 109-200 metres band.

The British Post Office which, of course, has had considerable experience with subscribers' services, in conjunction with the British radio companies, are setting up for trial—and pending any recommendations of the International Radiotelegraph Conference of Madrid in Sep-

tember—a simple organization dealing with fishing and coasting fleets. This organization is based on the assumption that the ships, being voluntarily equipped, will carry no skilled operators.

In this simple form of communication, according to the Post Office plans for the time being at any rate, the speaker on board the ship will not be connected directly with the land line network at the Coast Station, but will dictate his message to the Coast Station operator for subsequent transmission by land line. The ships and Coast Stations will work on a series of wavelengths sufficiently far apart to avoid mutual interference.

Experience to date indicates that it is practically impossible to control the use of radiotelephony between trawlers and, therefore, the Administration is concentrating on maintaining

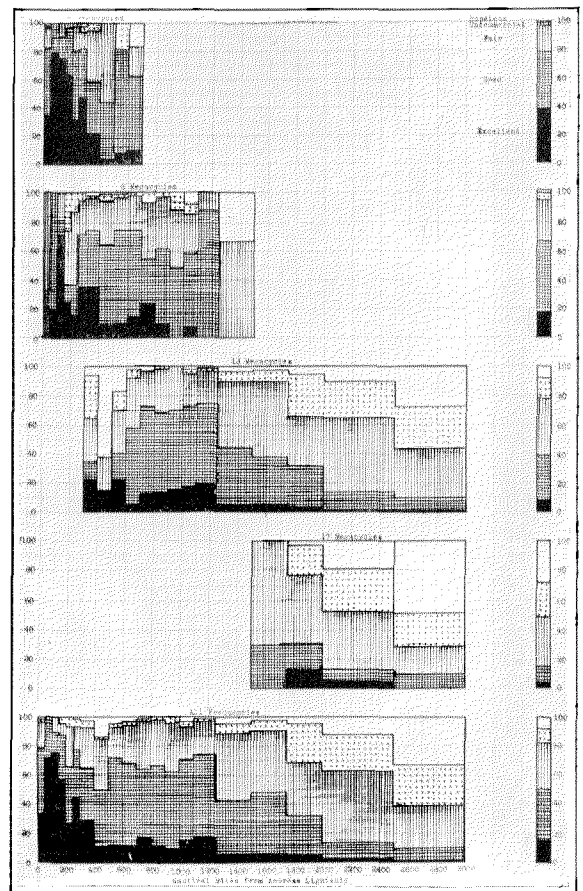

Figure 6—Reception on All Ships from Ocean Gate, July-December, 1931

as good a service as possible between trawlers at sea and the Coast Stations for the handling of bona-fide messages between the vessels and their owners. Intership communication will be carried out on other special waves.

Provisional arrangements have been made also to meet cases of distress. In case the ships lack facilities for the employment of the universal 600 metre wave, they are recommended to employ a wave of 162.6 metres, while the Coast Station in reply will use a wave of 177.5 metres.

In addition to the foregoing, the Royal National Lifeboat Institution has equipped five motor lifeboats with radiotelephony, while the Lightship authorities have adopted the same means of communication for eighteen of the light vessels stationed off the coasts of the United Kingdom.

#### *In France*

La Compagnie Radiomaritime has been engaged for some years in the installation and exploitation of radiotelephone stations of low power on ships of small tonnage, such as trawlers and tugs.<sup>9</sup>

#### *In Belgium*

The above mentioned company has organised two groups of ships. The first comprises forty trawlers of the Port of Ostende which works with the Ostende coast station of the Belgian Administration des P. T. T. on the frequency of 1,666 kc. (180 metres). The second comprises approximately twelve tugs of l'Escaut and Antwerp which work with an S. A. I. T. station at Lille on the frequency of 1,538 kc. (195 metres). Both shore stations are connected to the telephone system.

#### *In Spain*

Several groups of ships equipped with radiotelephony have been established. One consists of fishing patrol boats which work with a series of shore stations near Cadiz; another consists of approximately twelve trawlers of the ports of Vigo and Coruña, while a third group is in the process of formation at San Sebastián.

#### *In the Baltic Sea*

In the Baltic there are a number of German fishing boats and excursion steamers, and a few

Danish, Swedish and Finnish boats which carry on their radio communication with Rugen and Swinemunde shore stations by telephone on wavelengths of 126 and 160 metres. The shore stations use transmitter powers up to 1 kW and the ships use transmitters with various ratings up to 200 watts. With these maximum powers, ranges up to 400 miles are obtained.

#### *United States and Canada*

The United States coastguard service maintains a very large fleet of small patrol boats whose operation is mainly controlled by radio. One hundred and fifty of these boats are equipped with combined telephone and telegraph crystal controlled transmitters of 35 watts output. There are eight coast stations for this service, which is a simplex one and is conducted on waves between 90 and 120 metres.<sup>12</sup> A harbour service for tugs and other small vessels with subscribers on the inland telephone network is in course of establishment at New York, Boston, San Francisco, Los Angeles and Seattle. This system will provide simplex radio communication aboard the vessels, with push button switching from transmitting to receiving conditions, a novel feature being the use of automatic switching between the shore transmitting and receiving stations so that the connection will appear as an ordinary telephone call to the land subscriber. On the northwest coasts of Alaska and Canada provision has been made for sixteen radiotelephone stations for communication with the fifty or sixty fishing vessels and tugs which are already equipped with radiotelephony.

#### *Yellow Sea, Japan*

Radiotelephony has been provided on fifteen passenger boats sailing between Japan, Chosen and Formosa.<sup>8</sup> The ships have transmitters of 30 to 65 watts output and work on a frequency of 410 kc. (732 metres). The shore stations are located in or near the telephone exchange buildings at Kobe and Moji and the radio circuit can be connected to the Japanese telephone system. The land stations employ transmitters of 200 watts power and work on a frequency of 313 kc. (958 metres). This system provides two-way telephone communication when the ships are within 200 km. of the land station.



### *European Packet Boats*

Subscribers' service radiotelephone installations were made on the English Channel steamers "Lavinia" in 1923, "Princess Ena" in 1925 and "Canterbury" in 1930, and on the Dutch Channel steamers "Princess Juliana" and "Colomna" in 1930 and "Orange Nassau" in 1931. The Danish packet "Aalborghus" sailing between Copenhagen and Aalborg has conducted experimental radiotelephone transmissions since 1926 on waves of 870 and 2,150 metres.

Successful results have been obtained on all these ships but the equipments have never been put into regular commercial use for various reasons, the chief one in our opinion being the present world depression.

Ship and shore subscribers' radiotelephone services are relatively expensive to work and maintain, especially on the land line portion of the circuit and in the early stages before they are accepted by the public as a regular means of communication. Consequently both Administrations and shipping companies have been slow to meet an expenditure which is likely to be unremunerative in the initial stages. There is little doubt, however, that a subscribers' radiotelephone service will in due course become a normal feature of the European short voyage passenger vessels.

### *Radiotelephony to Airplanes*

Two-way telephonic communication to aircraft in flight in general, forms only one part of complete airway radio facilities. Limitation of space prevents consideration other than two-way telephony in this paper.

#### *Development*

In Europe, aircraft radiotelephone apparatus developed during the War was applied to the civil airways shortly after the Armistice. One of the first lines so equipped was the British Army postal service between Folkestone and Cologne. This early apparatus was rather crude and it had a two-way range of only 30 to 50 miles. The adoption of the International Convention for Air Navigation in 1919 laid the foundation for international co-operation and standardization in the operation of airways. Based on this Convention, an international radiotelephone com-

munication system for aircraft was rapidly evolved and by 1925 this system had assumed virtually its present form. It is now possible for aircraft flying on any of the regular airways of northwestern or central Europe to obtain telephonic communication at all times with one or more ground stations.

In all the larger European countries except Germany,<sup>14</sup> Italy, and Soviet Russia, the major part of communication between civil aircraft and ground is carried out by telephone rather than telegraph.

In America the application of radiotelephony to aircraft was somewhat slower than in Europe. A number of experimental installations were made in the years 1920 to 1928 but its use on commercial aircraft did not become general until 1929. Encouraged by the United States Department of Commerce, aircraft operators adopted radiotelephony very rapidly after 1929. At the present time, the extensive system of airways which joins all the principal cities of the United States (Figure 7) is served by approximately 120 radiotelephone ground stations, which are spaced, roughly, every 200 miles along all the airways. The chief air lines operating in Central and South America (Pan-American, Aero-Postal and Condor) use radiotelegraphy in preference to telephony because of the long distance between ground stations.

#### *Technical Features—European Airways*

The chief airport ground stations for telephone communication in Europe are Croydon in England, Le Bourget and Marseilles in France, Brussels in Belgium, Rotterdam in Holland, Kastrup in Denmark, Tempelhof, Hanover and Munich in Germany, Wien in Austria and Dubendorf-Kloten in Switzerland. There are in addition many stations of less importance in the various countries.

The continent has been divided into areas<sup>15</sup> and one airport station is responsible for communication to all aircraft flying in its area. Communications are strictly limited to matters dealing with the security and regularity of the air service, and pilots should communicate only with the control station of the area in which they are flying. For direction finding, also, the air routes have been divided into sectors, in each of which is assigned a direction finding control

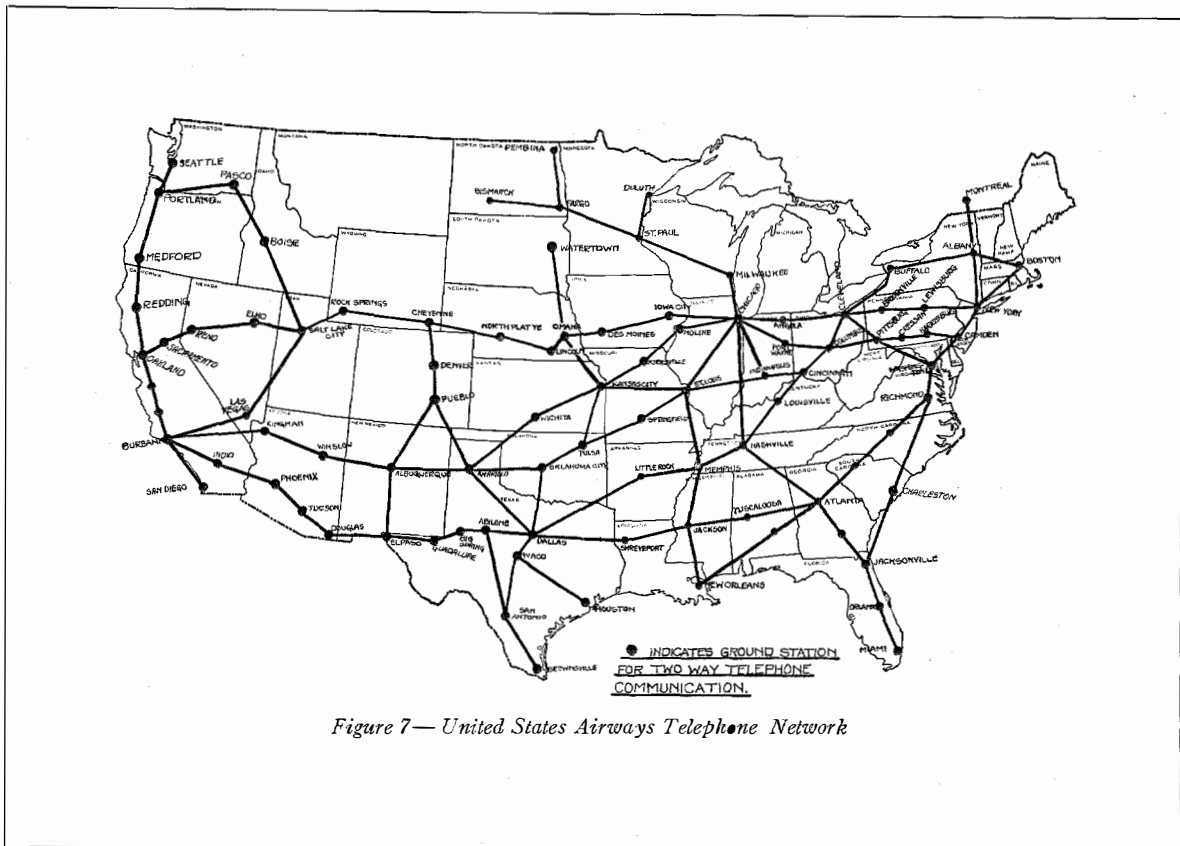

Figure 7—United States Airways Telephone Network

station and one or two collaborating cross bearing stations.

As a result of this organization, it has been possible for nearly all aircraft and ground stations to work on the common frequency 333.3 kc. (900 metres). Occasionally other waves in the 850-950 metre band are used as a supplementary wavelength for telephone communication.

Aircraft using telephony do not normally carry radio operators, in which case the apparatus is mounted in any convenient spot and remotely controlled from the pilot's position. Earphones are sewn into the flying helmets and the microphones are designed to exclude extraneous noise. Provision is made on many of the sets for intercommunication on the airplane itself by use of the radio apparatus.

Croydon may be taken as an example of the ground station facilities provided at the larger European airports. At Croydon,<sup>13</sup> two large receivers are installed in the tower of the main building overlooking the field. One receiver is used for point-to-point communication and the

other is used as required for direction finding or communication with aircraft. Four transmitters are housed two and one-half miles from the airport, and are remotely controlled by the receiver operators. The transmitters are identical units, each requiring a power input of 3 to 4 kW. They work into separate aerials supported on 100 ft. towers grouped about the building. Individual transmitters are used for telephone to aircraft, telegraph, point-to-point communication and standby.

#### *Technical Features—American Airways*

Radiotelephone practice on American airways differs fundamentally from European practice in the use of higher frequencies. Various small bands of frequencies ranging from 1,500 kc. (200 m.) to 16,500 kc. (18.2 m.) have been reserved for this service, and a group of frequencies is assigned to all the aircraft and ground stations operating along a given airway.

United States airways,<sup>16</sup> equipped for two-way radiotelephone service and the location of most

of the ground stations are shown in Figure 7. Many of these ground stations have been equipped by the Western Electric Company and employ a compact crystal controlled 500 watt transmitter,<sup>17</sup> known as the Type 9-A or 9-B.

The equipment commonly used on the aircraft consists of an extremely compact crystal controlled transmitter<sup>17</sup> of 50 watts output, 100 percent modulated, and a small radio receiver.<sup>17</sup> The transmitter and receiver are installed as separate units and are remotely controlled from the pilot's seat.

#### *Results Obtained*

The reliable two-way range of European equipment is approximately 100 miles and under favourable conditions a maximum telephone range in the neighbourhood of 250 miles is often obtained. American short wave equipment has a reliable range of approximately 200 miles. The maximum range depends upon conditions and frequencies, and it may be over 500 miles under certain conditions. The received speech on commercial aircraft is not generally of such quality as would be suitable for general public use, but recent developments have led to much improvement. In the case of the Standard Light Aircraft Receiver (Figure 8), for instance, amateur pilots regularly receive telephone messages from the Heston Aerodrome at distances exceeding 100 miles when in flight using fixed aerials on a wave of 833 metres.

International registrations of aircraft stations show that there are approximately 300 aircraft now using two-way radiotelephony in Europe. These aircraft make roughly 170 separate flights over a total distance of 25,000 miles every day. In the United States, approximately 325 civil aircraft are equipped for two-way telephony, and they fly approximately 100,000 miles daily.

The results secured to date show that it would be impossible to conduct air transport with the safety and regularity of modern air lines without the use of radiotelephony.

### ***Radiotelephony to Trains***

#### *Development*

Radiotelegraphy and later telephony to moving trains has been accomplished a number of

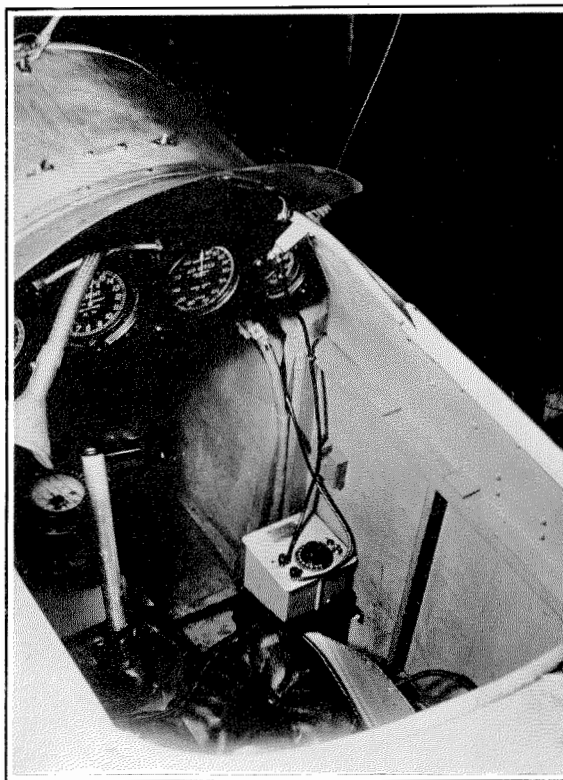

*Figure 8—Light Aircraft Receiver (Weight 5 lbs.)*

times. Among the early experiments may be mentioned those of the Lackawanna Railroad in the United States in 1913, of the Paris-Orleans Railroad in France about 1922, and of the Great Western Railway in Great Britain in 1924.

Perhaps the first really successful two-way telephony to moving trains was inaugurated in 1923 on the Berlin-Hamburg Line. This installation is not strictly a radio transmission, in that it employs auxiliary wires paralleling the railroad track. The transmission across the short gap between the train and the wires and along the wires is accomplished by use of a carrier current frequency of about 60 kc. In 1930 the Canadian National Railroad opened a similar service on trains between Montreal and Toronto.

#### *Technical Features*

In the German installations<sup>18</sup> terminal stations are used at Berlin and Hamburg, 285 km. apart, and at Wittenberge, approximately midway between. These stations are connected to the tele-

phone system. The terminal stations and trains employ apparatus similar to that for low frequency radiotelephony with transmitters of 50 watts maximum output. Terminal stations transmit on 75 kc., and trains on 60 kc.

In addition to the wires along the track an antenna on the roof of the train is employed for transmission. The wires form part of the regular telephone and telegraph circuits which parallel the railway. Special bridging wires are employed where the regular circuits enter cables and stations or deviate from the track.

The subscriber on the train uses a telephone booth located in one of the compartments and speaks just as he would from an ordinary telephone. An operator in an adjacent small room monitors the conversation and adjusts the apparatus.

The Canadian installation is similar in principle to the German.

#### Results Obtained

The results obtained by the two installations mentioned above have shown that it is possible to obtain two-way telephony of satisfactory quality between moving trains and telephone networks.

### Developments in Mobile Radiotelephony

#### Marine

Among developments in the Marine field may be mentioned single wavelength telephony to large liners, improvements in transmitters and receivers and the use of ultra high frequencies.

In experiments conducted by the International Telephone and Telegraph Laboratories, the S.S. "Olympic" transmitted and received on the same frequency by use of voice operated devices instead of the manually operated switch ordinarily used on single wavelength systems. The circuit used is shown schematically in Figure 9. This development appears to be of use in reducing the number of frequencies necessary and in simplifying the apparatus.

For the near future we can look forward to the use of wavelengths considerably below 10 meters for telephonic communication with ships over short distances. Systems of this kind are under development for use between naval ships at sea. The Radio Corporation of America has

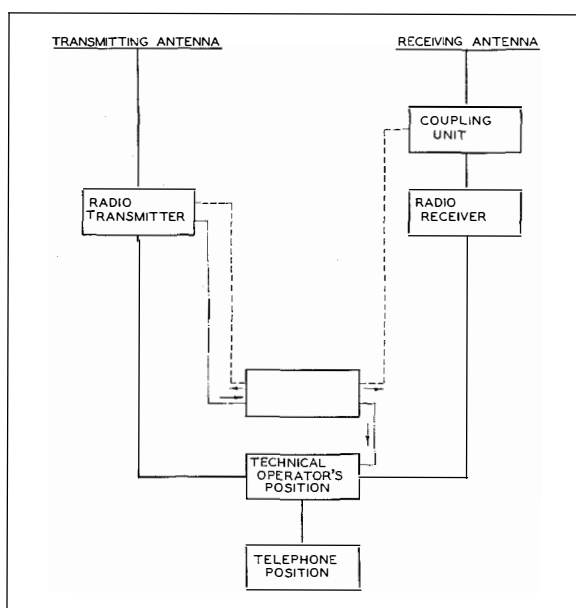

Figure 9—Schematic of Single Wavelength System Used on S.S. "Olympic"

experimented with these waves as a means of guiding and communicating with ferry boats in rivers and harbours. There are doubtless many other uses to which ultra high frequencies will be applied in future marine telephony. Mention should be made in this connection of the possibilities of the Micro-ray apparatus by means of which highly directive radiotelephony was demonstrated in 1931 between Dover and Calais by the International Telephone and Telegraph Laboratories of Hendon, England, in co-operation with the Laboratories of Le Matériel Téléphonique of Paris, France, on a wave of 18 centimetres, using a power of something less than 1 watt in the antenna. This device, immune as it is from interference and completely secret in its operation, under certain circumstances might quite conceivably be applied to communication between ships, and between ships and the shore.

#### Aviation

In aviation the tendency is toward lighter and more robust equipment for use on the planes rather than to higher power. Higher gain receivers are also the tendency. A recent example developed by the Westinghouse Company in the United States is a 20 watt high frequency trans-

mitter weighing 30 lbs. including the dynamotor. In England, Standard Telephones & Cables, Limited, have succeeded in producing a 20 watt equipment which weighs only 15 lbs. including dynamotor, as well as a 4 valve receiver weighing less than 5 lbs. for light aeroplanes (Figure 8).

As in marine services, the ultra high frequencies appear to have possibilities for considerable future use on aircraft. The chief advantages of these frequencies are that efficient antennae are of small size and that the range is limited.

### Conclusion

Although this review has touched on only the major uses of mobile radiotelephony and has omitted many important applications of the art, it has perhaps served to indicate the present world-wide use of this form of communication.

Radiotelephony fulfills a fundamental need in bringing persons on mobile units into direct conversational contact with persons at fixed points. Technical improvements should make possible its application to additional units and we can, therefore, look forward to a constantly increasing expansion of mobile radiotelephony.

### Mobile Radiotelephony Bibliography

1. H. W. Nichols and Lloyd Espenschied, "Radio Extension of the Telephone System to Ships at Sea," *Proceedings I. R. E.*, Vol. 11, No. 6, June, 1923.

2. W. Wilson and L. Espenschied, "Radio Telephone Service to Ships at Sea," *Bell System Technical Journal*, Vol. 9, No. 3, July, 1930; also in abbreviated form *Journal A. I. E. E.*, Vol. 49, No. 7, July, 1930.

3. A. S. Angwin, "Ship-and-Shore Terminal Equipment," *Electrical Communication*, Vol. 9, No. 7, July, 1930.

4. "Telephone Transmitting Equipment on S. S. 'Homeric'," *Marconi Review*, No. 30, May-June, 1931.

5. C. N. Anderson and I. E. Lattimer, "Operation of a Ship-Shore Radio Telephone System," *Proceedings I. R. E.*, Vol. 20, No. 3, March, 1932.

6. E. A. Rattue, "Radio Telephony Applied to Ant-

arctic Whale Hunting," *Electrical Communication*, Vol. 5, No. 4, April, 1927.

7. "Material Submitted by Germany on Radiotelephony with Ships, Including Annexes by Other Administrations," *Documents du C. C. I. R. Deuxieme Reunion*, Document 2 with Annexes 1, 2, 3, 4 and Appendix, pp. 53-81 of Edition published in French by Bureau International de L'Union Télégraphique, 1931.

8. "Material Submitted by Japan on Radiotelephony with Ships," Document 3, pp. 82-84, reference 7 above.

9. "Material Submitted by S. A. I. T. on Assignment of Frequencies (Results of Radiotelephone Use)," Document 62, Annex 6, pp. 388-391, reference 7 above.

10. "Material Submitted by Denmark on Radiotelephony with Ships," *Documents du C. C. I. R. Premiere Reunion*, Document 14, pp. 85-90 of edition published in French by Bureau International de L'Union Télégraphique, 1930.

11. F. B. Woodworth, "A Trial of Radiophone in Alaska," *Bell Laboratories Record*, Vol. 9, No. 8, April, 1931.

12. O. M. Hovgaard, "A Transmitter for the Coast Guard," *Bell Laboratories Record*, Vol. 10, No. 6, February, 1932.

13. E. H. Furnival, "Typical Waveless Apparatus Used on British and European Airways," *Proceedings I. R. E.*, Vol. 17, No. 12, December, 1929.

14. F. Eisner and H. Fassbender, "Radio in Aeronautics—Its Technical Status and the Organization for its Application in Germany," *Proceedings I. R. E.*, Vol. 17, No. 12, December, 1929.

15. G. C. Gross, "European Aviation Radio," *Proceedings I. R. E.*, Vol. 19, No. 12, March, 1931.

16. H. J. Walls, "The Civil Airways and Their Radio Facilities," *Proceedings I. R. E.*, Vol. 17, No. 12, December, 1929.

17. D. K. Martin and S. E. Anderson and R. S. Blair, "Radio Telephone Transmitting and Receiving Equipment for Airplanes," *Bell Laboratories Record*, Vol. 9, No. 10, October, 1930.

18. B. Rosenbaum, "Eisenbahnzug Telephonie," *Jahrbuch der Drahtlosen Telegraphie und Telephonie*, 1925.

19. Second Report of Liaison Committee on Aeronautic Radio Research, *Department of Commerce Radio Bulletin*, October 15, 1931.

20. F. G. Kear and G. H. Wintermute, "A Simultaneous Radiotelephone and Visual Range Beacon for the Airways," *Proceedings I. R. E.*, Vol. 20, No. 3, March, 1932.

21. F. Gerth and W. Sheppman, "Investigations on the Propagation of Ultra Short Waves," *Jahrbuch der Drahtlosen Telegraphie und Telephonie*, Vol. 33, No. 1, 1929.

## INTERNATIONAL TELEPHONE AND TELEGRAPH CORPORATION

### BOARD OF DIRECTORS

<p>FREDERIC W. ALLEN Lee, Higginson &amp; Company</p> <p>ARTHUR M. ANDERSON J. P. Morgan &amp; Co.</p> <p>HERNAND BEHN, President</p> <p>SOSTHENES BEHN, Chairman</p> <p>F. WILDER BELLAMY Dominick &amp; Dominick</p> <p>EDWARD J. BERWIND Chairman, Berwind-White Coal Mining Company</p> <p>JOHN W. CUTLER Edward B. Smith &amp; Co.</p> <p>R. FULTON CUTTING Financier</p> <p>GEORGE H. GARDINER Davis Polk Wardwell Gardiner &amp; Reed</p> <p>ALLEN G. HOYT Vice-President, The National City Bank of New York</p>	<p>RUSSELL C. LEFFINGWELL J. P. Morgan &amp; Co.</p> <p>CLARENCE H. MACKAY Chairman of the Board, Postal Telegraph and Cable Corporation</p> <p>JOHN L. MERRILL President, All America Cables, Incorporated</p> <p>CHARLES E. MITCHELL Chairman, The National City Bank of New York</p> <p>WALTER E. OGLIVIE President, Havana Terminal Railroad Company</p> <p>HENRY B. ORDE, Vice-President</p> <p>BRADLEY W. PALMER Chairman of the Executive Committee, United Fruit Co., Boston</p> <p>GEORGE E. PINGREE President, International Standard Electric Corporation</p> <p>WOLCOTT H. PITKIN Vice-President and General Attorney</p> <p>LANSING P. REED Davis Polk Wardwell Gardiner &amp; Reed</p>
--	--

GEORGE H. GARDINER  
General Counsel

### OFFICERS

<i>Chairman</i> SOSTHENES BEHN	<i>President</i> HERNAND BEHN		
<i>Vice-Presidents</i>			
HENRY B. ORDE	PHILIP K. CONDUCT	WILLIAM F. REPP	A. H. GRISWOLD
LEWIS J. PROCTOR	JOHN L. MERRILL	FRANK GILL	LOGAN N. ROCK
GEORGE E. PINGREE	FRANK W. PHELAN	FRANK C. PAGE	GEORGE S. GIBBS
<i>Vice-President and General Attorney</i> WOLCOTT H. PITKIN		<i>Vice-President and General Technical Director</i> GERALD DEAKIN	
<i>Comptroller</i> EDWIN F. CHINLUND	<i>Secretary</i> S. G. ORDWAY	<i>Treasurer</i> JAMES E. FULLAM	

**T**HE International Telephone and Telegraph Corporation was organized to cooperate and assist technically and financially in the general development of electrical communications in a broad international sense, and, with respect to the organization and development of national communications systems, it is the purpose of the International Telephone and Telegraph Corporation to develop truly national systems operated by the nationals of each country in which the International Corporation is or may become interested. The International Corporation was not organized with the desire of imposing American practices in its foreign activities. There appeared to be a fruitful field of service to be rendered in bringing together under one gen-

eral organization electrical communications systems, and the extension by the International Corporation to the associated companies of the technical and financial facilities and direction that might be needed for their intensive and efficient development. The best American practices have been suggested but never imposed. On the contrary, the International Corporation has always been ready and quick to adjust American practices to local conditions and to adopt such local practices as were conducive to the successful development of the various entities. The combined and co-ordinated effort of the associated companies of the International System is today justifying the plans and purposes of the Corporation.

---

---

## *Licensee Companies*

- BELL TELEPHONE MANUFACTURING COMPANY . . . . . *Antwerp, Belgium*  
*Branches: Brussels.*
- BELL TELEPHONE MANUFACTURING COMPANY . . . . . *Berne, Switzerland*
- BELL TELEPHONE MANUFACTURING COMPANY . . . . . *The Hague, Holland*
- STANDARD ELECTRIC DOMS A SPOLECNOST . . . . . *Prague, Czechoslovakia*  
*Branch: Bratislava.*
- CHINA ELECTRIC COMPANY, LIMITED . . . . . *Shanghai, China*  
*Branches: Canton, Hankow, Harbin, Mukden, Peiping, Tientsin.*
- COMPAÑÍA STANDARD ELECTRIC ARGENTINA . . . . . *Buenos Aires, Argentina*
- INTERNATIONAL STANDARD ELECTRIC CORPORATION, *Branch Office,*  
*Río de Janeiro, Brazil*
- INTERNATIONAL STANDARD ELECTRIC CORPORATION OF MEXICO . . . . *New York, N. Y.*
- LE MATÉRIEL TÉLÉPHONIQUE . . . . . *Paris, France*
- NIPPON DENKI KABUSHIKI KAISHA . . . . . *Tokyo, Japan*  
*Branches: Osaka, Dalny, Seoul, Taihoku.*
- FERDINAND SCHUCHHARDT, BERLINER FERNSPRECH-UND TELEGRAPHENWERK  
AKTIENGESELLSCHAFT . . . . . *Berlin, Germany*
- STANDARD ELECTRIC AKTIESELSKAP . . . . . *Oslo, Norway*
- AKTIESELSKABET SKANDINAVISKE KABEL- OG GUMMIFABRIKER . . . . *Oslo, Norway*
- STANDARD ELECTRIC AKTIESELSKAB . . . . . *Copenhagen, Denmark*
- STANDARD ELECTRICA ROMANA S/A . . . . . *Bucharest, Rumania*
- STANDARD ELÉCTRICA, S. A . . . . . *Madrid, Spain*  
*Branches: Barcelona, Santander.*
- STANDARD ELETTRICA ITALIANA . . . . . *Milan, Italy*  
*Branch: Rome.*
- STANDARD TELEPHONES AND CABLES, LIMITED . . . . . *London, England*  
*Branches: Birmingham, Glasgow, Leeds, Manchester, Dublin, Cairo, Johannes-  
burg, Calcutta, Singapore.*
- STANDARD TELEPHONES AND CABLES (AUSTRALASIA), LIMITED . . . . *Sydney, Australia*  
*Branches: Melbourne, Wellington.*
- STANDARD VILAMOSÁGI RÉSZVÉNY TÁRSASÁG . . . . . *Budapest, Hungary*
- SUMITOMO ELECTRIC WIRE & CABLE WORKS, LIMITED . . . . . *Osaka, Japan*
- ÖSTERREICHISCHE TELEPHON-FABRIK AKTIENGESELLSCHAFT . . . . . *Vienna, Austria*
- VEREINIGTE TELEPHON-UND TELEGRAPHENFABRIKS AKTIENGESELLSCHAFT,  
CZEIJA, NISSEL & CO . . . . . *Vienna, Austria*
- STANDARD ELECTRIC COMPANY W POLSCE SP. Z. O. O . . . . . *Warsaw, Poland*

---

*Sales Offices and Agencies Throughout the World*

---

---