

W. L. Rocco

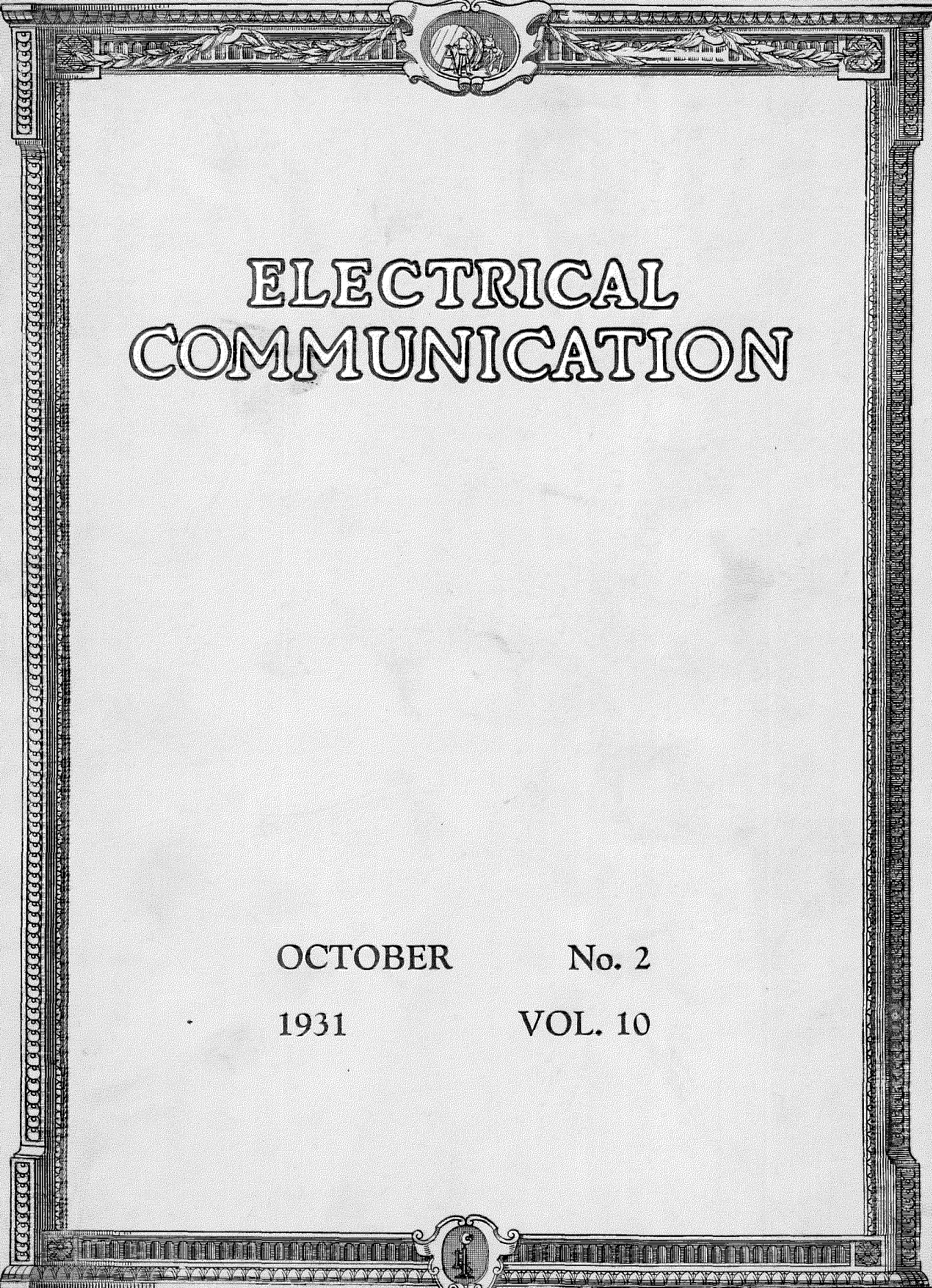

ELECTRICAL COMMUNICATION

OCTOBER

No. 2

1931

VOL. 10

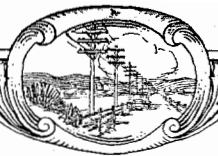

ELECTRICAL COMMUNICATION

A Journal of Progress in the
Telephone, Telegraph and Radio Art

H. T. KOHLHAAS, Editor

EDITORIAL BOARD

J. L. McQuarrie F. Gill G. Deakin P. E. Erikson G. H. Nash M. K. McGrath
G. E. Pingree P. K. Condict E. A. Brofos E. M. Clark Frank C. Page

Published Quarterly by the

International Standard Electric Corporation

Head Offices

67 BROAD STREET, NEW YORK, N. Y., U. S. A.

European General Offices

CONNAUGHT HOUSE, ALDWYCH, LONDON, W. C. 2, ENGLAND

G. E. Pingree, President

S. G. Ordway, Secretary

James E. Fullam, Treasurer

Subscription \$3.00 per year; single copies 75 cents

Volume X

OCTOBER, 1931

Number 2

CONTENTS

	PAGE
A LINK WITH OLIVER HEAVISIDE.....	53
<i>By Rollo Appleyard</i>	
THE SPREAD SIDEBAND SYSTEM ON SHORT WAVE TELEPHONE LINKS.....	60
<i>By L. T. Hinton, A.C.G.I., B.Sc., A.M.I.E.E.</i>	
AN EARTHQUAKE DISASTER AND DAMAGES TO THE LONG DISTANCE TELEPHONE CABLE LINE IN JAPAN, 1930.....	67
<i>By Sannosuke Inada</i>	
A SYSTEM FOR SIMULTANEOUS TELEPHONY AND TELEGRAPHY OVER LONG DISTANCE SMALL-GAUGE CABLES.....	71
<i>By L. A. Braem</i>	
DEVELOPMENTS IN START-STOP TELEGRAPHY—THE NEW CREED PRINTER.....	77
TRANSMISSION TESTING OF SUBSCRIBERS' APPARATUS.....	82
<i>By L. C. Pocock, M.Sc., A.M.I.E.E., A.C.G.I.</i>	
ALTERNATIVE TRUNKING FOR TELEPHONE TRAFFIC IN A MULTI-OFFICE AREA.....	86
THE UNIVERSAL MOUNTING PLATE.....	89
<i>By L. H. Webb, B.Sc.</i>	
IN MEMORIAM—EDUARD OTTO ZWIETUSCH.....	95
STOCKHOLM-MALMÖ RAILWAY CABLE.....	96





INTERNATIONAL TELEPHONE BUILDING
67 Broad Street, New York

A Link with Oliver Heaviside

By ROLLO APLEYARD

SYNOPSIS. The author has confirmed the fact that Oliver Heaviside was a skilled telegraph operator employed by the Great Northern Telegraph Company of Denmark. Particulars have been collected of the apparatus, speeds, and working arrangements contemporary with Heaviside, for comparison with corresponding equipment today. The author gratefully acknowledges his indebtedness to the Great Northern Company for assistance in this investigation. Examples of modern Creed apparatus are illustrated

THE obscurity in which the earlier history of Oliver Heaviside has been lost may be, with the progress of time, to some extent dispersed. Since the memoir* concerning him was published in *Electrical Communication*, an important detail has been supplied by information kindly furnished by Mr. F. C. C. Nielsen, who from 1883 to 1915 was the London Manager of the Great Northern Telegraph Company—the Company which, when Heaviside was a young man, operated a submarine cable between England and Denmark, and another submarine cable in the Far East. The circuit to Denmark began with a land line from Newcastle to Newbiggin-on-Sea, which was the landing place of their submarine cable, laid in 1868, to Søndervig in Denmark, a length of about 347 nautical miles, and thence by another land line to Fredericia. The service was between Newcastle-upon-Tyne and Fredericia direct.

At Newcastle in 1870, there were two telegraph operators. One of these was Oliver Heaviside; the other was Mr. Venndt, who for many years was Superintendent in the Great Northern Company's service. Both were very skilled. Heaviside is remembered as having been lonely and silent, but always ready to explain the construction of the apparatus.

About the year 1872, another member of the staff, F. Kolvig, also met Heaviside at Newcastle. A notebook that belonged to Kolvig contains the entry:

"Heavyside died February, 1925. In Great Northern Company, 1870-1874. The great mathematical genius."

This entry confirms the required dates, and bridges what was a gap in the story. It is to be

* Rollo Appleyard, "Pioneers of Electrical Communication—Oliver Heaviside—VIII," *Electrical Communication*, October, 1928.

observed that Kolvig, who was so closely associated with Oliver, spells the surname in the old form, with a "y."

The possession of these definite particulars encouraged further research; and thanks to the courtesy of the present officials of the Great Northern Telegraph Company, in London and Copenhagen, the records have been searched and the truth is now known. There is only one detail requiring comment: the date of Heaviside's birth appears in the records of the Company as May 18, 1849. The official Register at Somerset House leaves no room for doubt, however, that the actual date was May 18, 1850. From the information now so kindly furnished, it is established that Heaviside was engaged by the Great Northern Telegraph Company at Newcastle-upon-Tyne on February 1, 1870, at a yearly salary of £150, which on February 1, 1871, was increased to £175. As other English operators at the time of their engagement only received about £60 a year, it appears that Heaviside must have possessed special qualifications before his engagement, but of these there is no account.

In the books of the Company his name is spelt "Heavyside," but in his letter asking permission to leave the Company, he signs himself "Heaviside." His service with the Company ceased on May 31, 1874, and the reason given in his letter of resignation is that "I have obtained a situation elsewhere." Here is now available an expression of opinion, dated May 4, 1874, of Heaviside by Mr. H. G. Erichsen, who at that time was the Company's London Manager:

"Heaviside was a clever worker, but somewhat unruly and especially so since he was informed that he was not given an increase in salary. His application to leave the Company is therefore no great disaster, especially as it will mean a saving."

Those who observed him at close quarters

were a little more appreciative of his qualities. In 1873, the Newcastle Superintendent, Mr. Mygind, testified that Heaviside was:

"Very clever and reliable both on Wheatstone and Recorder work. His conduct is exemplary, but in view of his age, high salary, and good qualifications, more interest in the daily work should be expected. His knowledge of the Danish language is fairly good."

One day at Newcastle, he refused to work as a pasting-down clerk, remarking, "I am not a

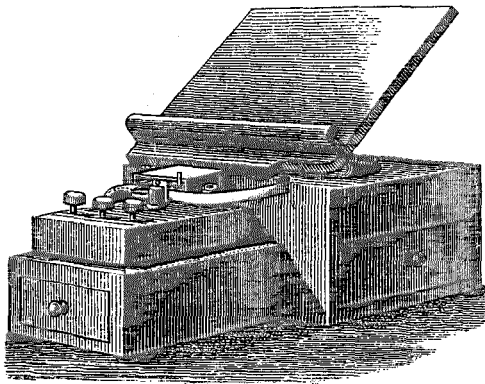

Figure 1—Perforator (Wheatstone's Automatic System).

book-binder." The general impression remaining with the Company is that although he was attracted to the technical side of his work, he probably found it difficult to subordinate himself to the daily drudgery of a telegraph station under the old régime.

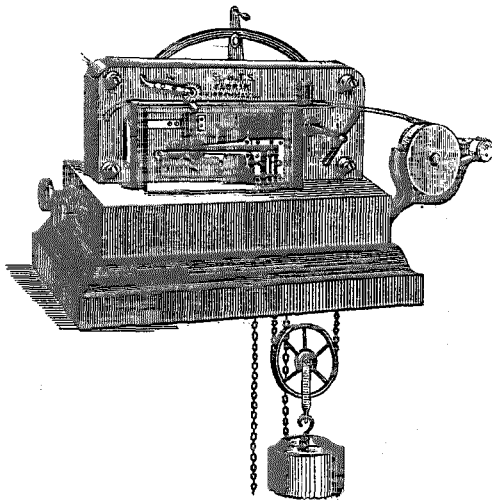

Figure 2—Transmitter (Wheatstone's Automatic System).

Enquiry concerning the account of the apparatus that was operated by Heaviside reveals some instructive particulars.

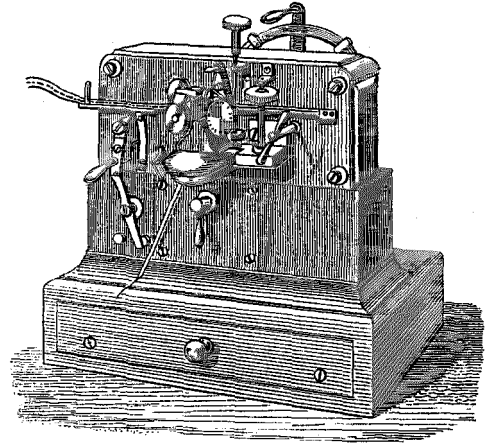

Figure 3—Receiver (Wheatstone's Automatic System).

The Danish cable between the years 1869 and about 1872 or 1873 was worked by a Wheatstone perforator, transmitter, and receiver, (Figures 1, 2, and 3), at twenty-five words a minute. The cable in the Far East was also worked by that system. In early years, the Danish cable, as well as the cable in the Far East, consisted of core insulated with Hooper's Indiarubber, as follows:

	Approximate length in nautical miles	Weight in lbs. per nautical mile	
		Copper	Indiarubber
Newbiggin-Söndervig . .	347	180	180
Woosung-Hong Kong . .	953	300	200

This core was manufactured at Mitcham (Surrey) and was sheathed into cable at Charlton (Kent). The trouble with the Indiarubber was that in a comparatively short time it began to crack at the "wind and water" line. After 1873, gutta-percha cables were used exclusively.

From 1871 to 1873, before Amoy was joined to the cable from Woosung to Hong Kong, the whole length of 953 nautical miles was worked by Wheatstone transmitter and receiver at a speed of from ten to twelve words a minute. In 1873, the Newcastle-Fredericia, and the

Fredericia-Libau cables were worked with Sir William Thomson's (Lord Kelvin's) recorder in connection with a Wheatstone transmitter. The speed thereby was increased to from eighty to ninety words a minute. This was highly satisfactory, except that the royalty to be paid for the use of the instrument was regarded as burdensome. Accordingly, in 1876, Lauritzen's undulator, Figure 4, was adopted. The speed with

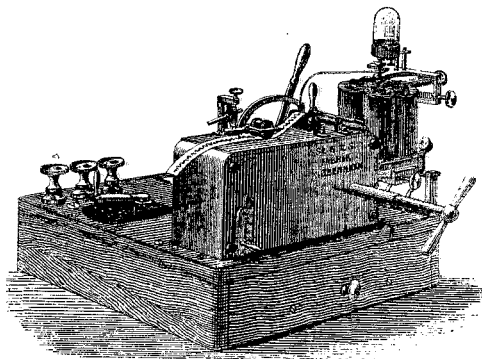

Figure 4—Undulator (Lauritzen's Undulating Inkwriter).

that instrument was at first from fifty to sixty words a minute but, with a later form (Figure 5), a speed of one hundred words a minute was attained. The undulator was also used at Vladivostok, Shanghai, and Hong Kong.

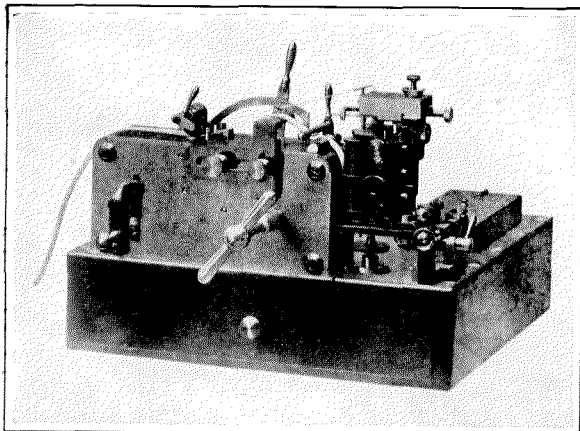

Figure 5—Undulator With Clockwork Driven by Spring.

A Wheatstone transmitter was then constructed to send reversed signals, and was introduced on the cables in the Far East. To produce these reversed signals, a double current key was

used, whereby positive marking currents and negative spacing currents were sent to line.

With speeds of one hundred words a minute, the new difficulty arose that the clerks could not write down the received messages fast enough to keep pace with the instrument. Moreover, at speeds over twenty to thirty words a minute, it was necessary to employ more than one "writer" to keep pace with the receiving instrument. The

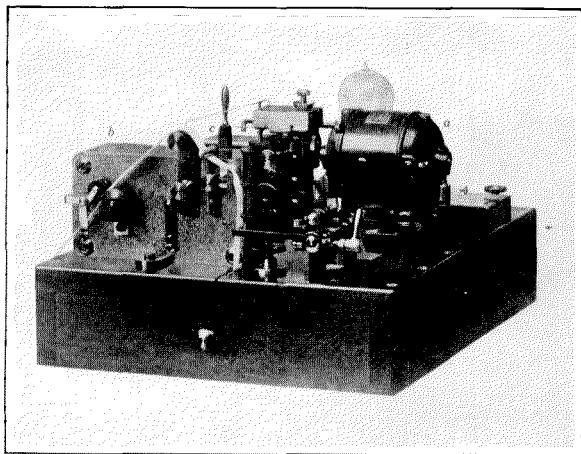

Figure 6—Motor-driven Undulator.

"gummer," Figure 7, was therefore introduced. This enabled the received "slip" to be dealt with in convenient lengths, so that the writing could be done by a division of labour. A further improvement in the undulator was next introduced, Figure 6, whereby the instrument was motor-driven.



Figure 7—Gummer. (Machine for Gumming the Slip.)

It is appropriate to recall a remark made by Mr. F. C. C. Nielsen on the occasion of a dinner given to the staffs of the various cable companies in London, on January 9, 1909—just fifty years after the laying of the first Atlantic cable. Mr. Nielsen alluded to the marvellous development of cable enterprise from its inception to the present day, and reminded them that it was just over fifty years since the laying of the first Atlantic cable, a magnificent performance, although as might have been anticipated, the cable, was not, for some time, in full working order. Mr. Nielsen's recollection did not take him so far back as that—only 39 years, in fact. He said:

"On looking back to those early days of the cable enterprise, I think the Anglo was already a big company; the Eastern did not exist, but only some smaller companies which later on were to become the Eastern. Then came the Great Northern Company. The Danes looked across to England, and the English looked across to Denmark. It would not do to allow all messages to go via Germany, and so the question arose, 'Who should do the work?'"

As it turned out, their Company, the Great Northern, accomplished the task. Mr. Nielsen went on:

"Thirty-nine years ago I had the pleasure of joining the Company, and was initiated in the mysteries of telegraphy."

He then spoke of the marvellous improvements due to the introduction of the Wheatstone instrument, which was worked in those days in Newcastle by Mr. Oliver Heaviside, and their own esteemed Superintendent, Mr. Venndt. He added:

"Of course, fresh developments have taken place since then, and I think the time will come very soon when there will be no telegraph operators left. Thanks to the genius of Mr. Creed, we have got instruments far in advance of those at present in use. We shall come to the time when the instruments will be perfectly automatic. You will be able to send anything you like; in fact, the customer will enter the station and be asked to punch his own messages. He will then take the slip to the counter-clerk, who will measure it out at the price of 11¼ d. per yard—with reduction on quantities and special sale prices."

To complete the story, it may be observed that, from data kindly furnished by the Great Northern Telegraph Company of Denmark, it appears that today the normal Duplex speeds on

the various sections of their London-Shanghai circuits are as follows, in words a minute:

London-Newcastle.....	90
Newcastle-Leningrad.....	90
Leningrad-Irkutsk (on two lines).....	60
Irkutsk-Nagasaki (via Vladivostok).....	60
Nagasaki-Shanghai (on both cables).....	100

Between Irkutsk and Nagasaki there is another circuit which is worked thus:

Irkutsk-Vladivostok.....	50
Vladivostok-Nagasaki.....	50

There are Creed-Receivers at London, Newcastle, Leningrad, Irkutsk, Nagasaki, and Shanghai. The secondary circuit between Irkutsk and Nagasaki is worked with Creed-Receivers at Vladivostok.

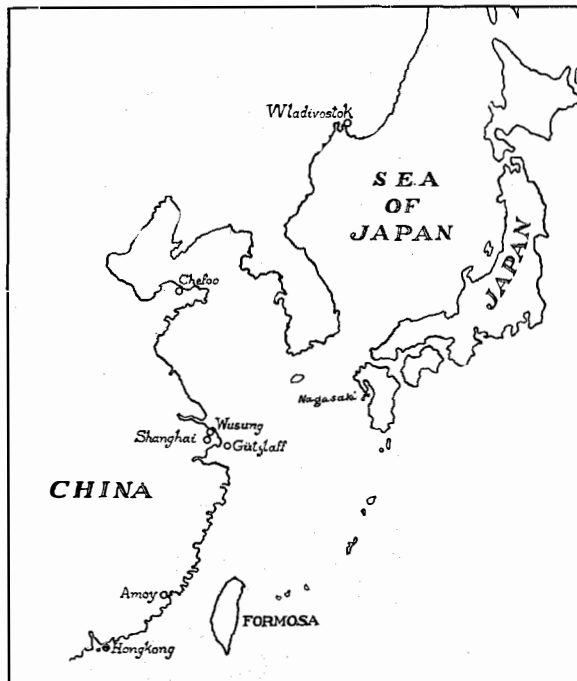

Figure 8—Map of China Seas.

Briefly, the whole system today from London through Nagasaki to Shanghai is operated by Creed perforating receivers, and the messages are printed automatically at the terminal stations by the Creed printer. The average time required for transmission is approximately:

To London from Shanghai.....	27	minutes
" " " Tientsin.....	40	"
" " " Kobe.....	53	"
" Shanghai from London.....	29	"
" " " Hamburg.....	39	"

To show how fully Mr. Nielsen's prophecy has been justified by events, it is helpful to trace the growth of the Creed apparatus since 1909. During the war, instrument makers were in many instances diverted to munition work. In 1918, when peace conditions invited a return to normal productions, it was a difficult task to establish again the required standard of workmanship for the telegraphic equipment, on an economic basis. Undaunted by these adverse circumstances, Mr. Creed met them by redesigning his apparatus. He constructed a keyboard perforator, Figure 9,

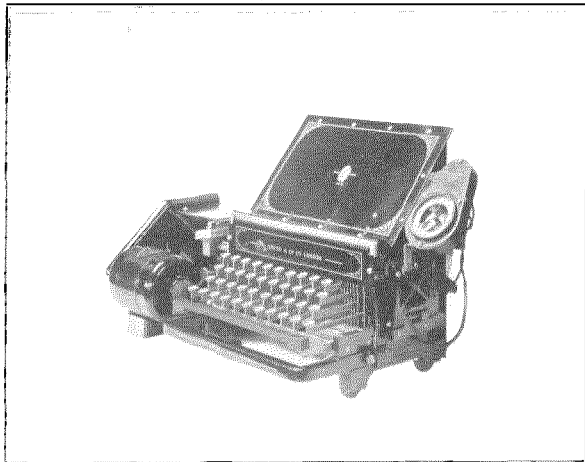

Figure 9—Morse Keyboard Perforator.

for preparing the Wheatstone slip, a Morse transmitter, Figure 10, a receiving perforator, Figure

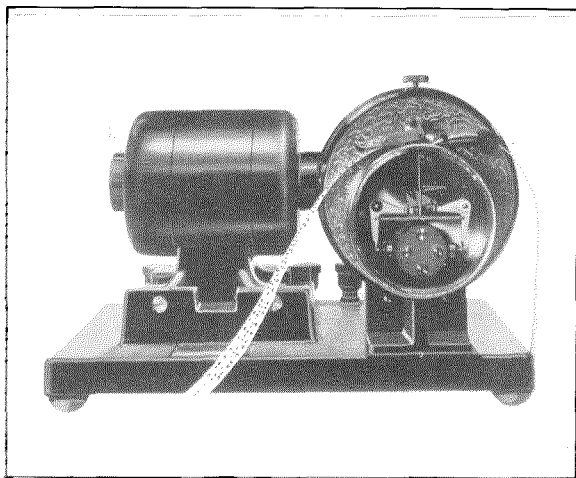

Figure 10—Morse Transmitter.

11, for reproducing it, and a printer, Figure 12, for printing from the reproduced Wheatstone slip. These machines utilised cams for all the

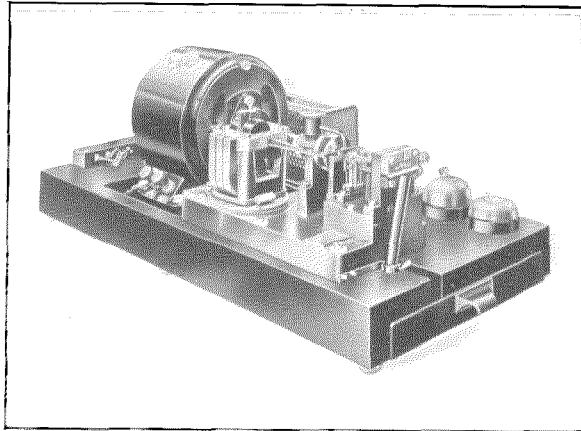

Figure 11—Morse Receiving Reperforator.

relative movements, and they avoided the use of compressed air that characterized his former designs. The new machines were found to be even more efficient, more durable, and simpler than those that preceded them.

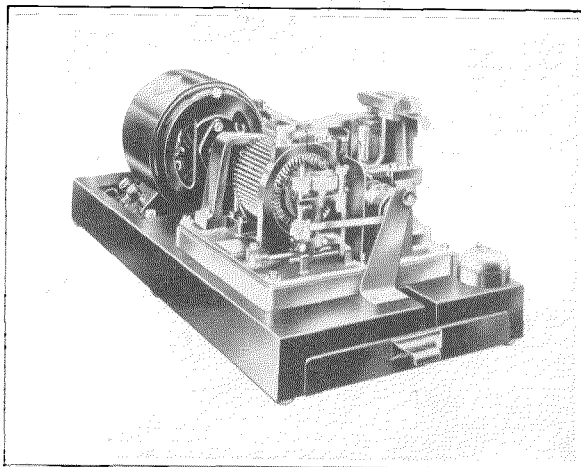

Figure 12—Morse Tape Printer.

The advance, however, did not stop there. About six years ago, Mr. Creed became convinced that the Morse apparatus would fall short of the requirements of commercial telegraphy. He therefore began experiments with 5-unit apparatus, and endeavoured to produce a simpler and more economical machine than

those that then existed. Previous experience with the Morse apparatus was skillfully applied, and the result is the present wonderful equipment.

In 1925, the Creed establishment acquired Mr. Donald Murray's 5-unit keyboard perforator, electro-magnetically actuated, and the whole of the Murray multiplex system machines, including the curved code bar, for England and several European countries. The establishment also had the benefit of Mr. Murray's valuable advice. Among the machines resulting from this combination of effort by those men of genius and skill are the present-day Murray Keyboard Perforator, Figure 13, and Creed Keyboard

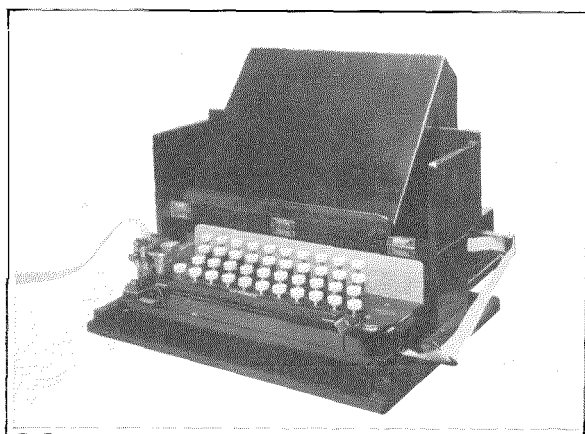

Figure 13—Murray Keyboard Perforator.

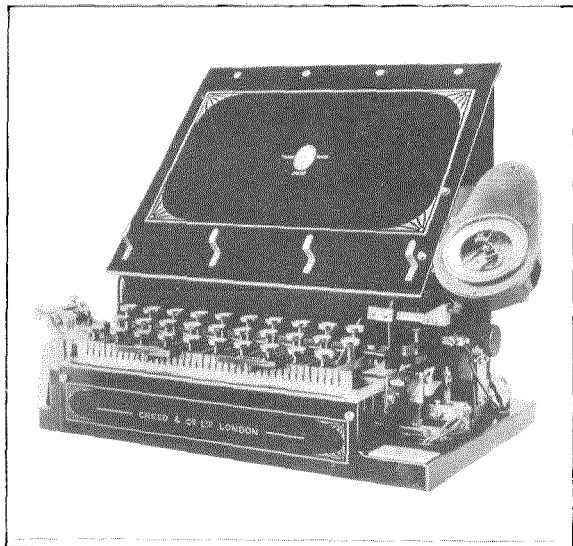

Figure 14—Teleprinter Keyboard Transmitter Perforator.

Perforator Transmitter, Figure 14, the Creed Automatic Transmitter, Figure 15, and the Start-Stop Tape-Printer, Figure 16. These form a complete system suitable for long single-channel circuits working upon an automatic

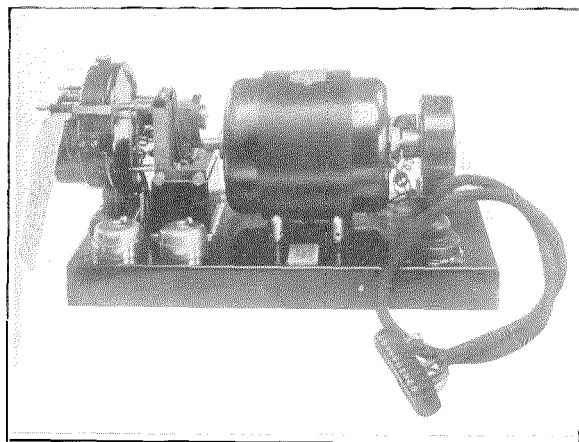

Figure 15—Teleprinter Auto-transmitter.

tape-transmission basis. In the case of long heavy traffic circuits, and some medium traffic circuits, printing on tape is found more advantageous than printing in page, owing to the greater convenience in cutting out errors due to line faults.

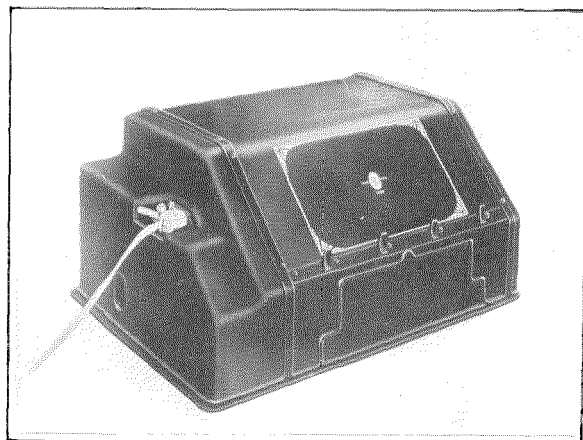

Figure 16—Tape Teleprinter No. 3-R.

For circuits where line-time is of less importance than operator costs, another set of apparatus has been developed consisting of a Keyboard Transmitter and a Printing Receiver,

combined in one instrument, Figure 17. In this case, a similar instrument is used at each end of the line, and is adapted to work either simplex or

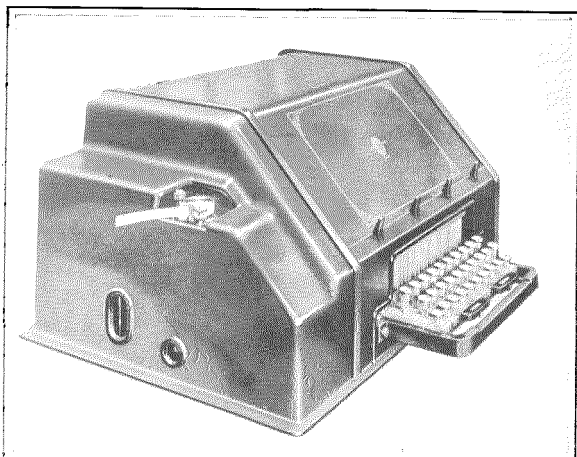

Figure 17—Tape Teleprinter No. 3-A.

duplex. When working simplex, the receiving section of the instrument is automatically connected to the line so as to provide a record of the message sent. When working duplex, no record is kept, and the receiving section of the instrument is used for reception only, and works independently of the transmitter. Both the transmitting and the receiving sections of the combined instrument are actuated by the same motor. The motors at the two ends of the line are, by means of a very simple and trustworthy device, made to work in effective synchronism. The combined instruments are made in two forms, according to requirements, i.e., the tape-printing and the page-printing models, and both are usually worked at about 60 words a minute, but somewhat higher speeds can be attained if desired. It may be observed that in Start-Stop practice, synchronism is not really necessary, i.e., only isochronism is essential.

The Spread Sideband System on Short Wave Telephone Links

By L. T. HINTON, A.C.G.I., B.Sc., A.M.I.E.E.

International Telephone and Telegraph Laboratories, Incorporated

DURING early tests on wavelengths lying below 100 metres several new phenomena were noted which had not been present in work on the longer wavelengths.

In particular, attention was drawn to "fading"* which was a general term adopted to express a change in attenuation of the ether path. Further investigation led to the separation of this term into three distinct parts:—(a) Diurnal variation of field; (b) general fading; and (c) selective fading.

Research in this field has been concentrated on the development of means for overcoming the detrimental effects of these types of fading on the reliability of communication channels. Since it has been found experimentally that the effects of the types of fading on communication efficiency are entirely different, it will be best to consider them separately, and to show methods by which the effect of each source of trouble can be reduced or eliminated.

Diurnal Variation

Diurnal variation is of course present on all frequencies, and is due to the fact that the transmission equivalent or attenuation of the ether path is not a fixed quantity. Approximate values of this attenuation can be calculated for certain distances and wavelengths, but even these are not very reliable for short wave transmission.

The field strength of a given frequency, when measured at a given point, with a constant transmitted power will vary during twenty-four hours from a value so low that no known receiver can detect it, to values as high as 50 db. above one microvolt per metre. In Figure 1 there is shown a typical 24-hour run taken on 19,030 kilocycles (15.75 metres) at Buenos Aires with the transmitter located at Madrid, Spain.

* R. K. Potter, "Transmission Characteristics of Short Wave Telephone Links," I.R.E., April, 1930.

This curve illustrates admirably the very great changes in actual attenuation which take place. The values which are plotted on the curve are averages of the received field taken over about three minutes.

General Fading

This term is used to cover the fluctuation of the whole field from minute to minute during the

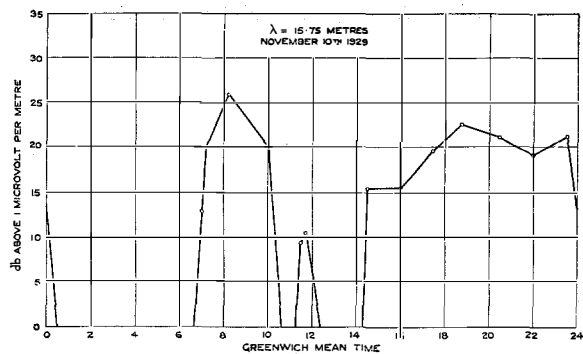

Fig. 1—Field strength of Madrid (E.H.Y.) measured at Buenos Aires.

period when the field is at sufficient strength to be received.

It is characterised by an attenuation change of the carrier and both sidebands simultaneously and to the same extent, and may be considered as a ripple on the smooth curve shown in Figure 1.

It will be apparent that this change in attenuation can be considered together with the diurnal variation, and that both can be compensated by means of corresponding changes in the receiver gain. In commercial receivers this control is partly manual and partly automatic. The receiver operator sets his manual control so that the level of the received signal is approximately correct, and then cuts his automatic gain control system in circuit.

A typical automatic gain control circuit is

illustrated in Figure 2. The direct current output of an auxiliary detector is impressed across a high resistance, which in turn is connected into the grid biasing circuit of the first demodulator tube of the super-heterodyne receiver.

It will be seen that when the signal rises, the current flowing through the high resistance will increase, and thus produce an increased voltage drop across it. This in turn is used to decrease the sensitivity of the first demodulator, and thus to lower the efficiency of the receiver. By this means the output signal level from the receiver remains substantially constant over the period during which a given wavelength can be received.

With the receiver used for commercial telephone traffic on the Buenos Aires to Madrid radio

obscure, but its effect can be understood from a simple assumption of two reflected waves reaching the receiver by means of two independent paths whose relative lengths are changing slightly all the time. The fading is of course due to the changing phase relations of the two paths. Such phase differences can result in a change of equivalent of a single wave from about + 3 db. when two waves are in phase, to an almost total loss when they are 180 degrees out of phase.

The rate at which this fading in and out of phase changes during the period of reception of a given wavelength is somewhat similar to the change of attenuation.

In Figure 3 this fade rate is shown as measured on a volume indicator. The transmitter sends a continuous steady tone, and one fade is counted every time the received volume drops more than about 15 db. below the normal received tone level. It will be seen that this type of fading seems never to be entirely absent, and at times reaches a frequency of some hundreds of fades per minute. In actual practice periods have been noticed when the rate of fading is too rapid for accurate counting.

If a comparison is made between Figures 1 and 3 it can be generally stated that while the field is steady the fading rate is steady, and that when the field is coming in or going out the rate of fade becomes very erratic.

It is now necessary to consider the effect of this type of fading on received speech. It will be apparent that for the very deep fades, when the received field is practically non-existent, the received speech will give the effect of being chopped in much the same way as would occur in a badly adjusted voice-operated echo-suppressing system.

It has been noticed also that before the fading becomes so bad that actual chopping takes place, speech assumes a bad quality which can best be described as sounding like an overloaded amplifier. Experimental curves taken on the New York-London circuit show that of two frequencies lying close to one another, one will fade while the other remains unaffected. Hence, if we consider a carrier and two sidebands which will occupy a total band width of 6,000 cycles, it will be seen that fades can occur: (a) in either or both sidebands simultaneously; (b) in one sideband and the carrier at the same time; or (c) in the

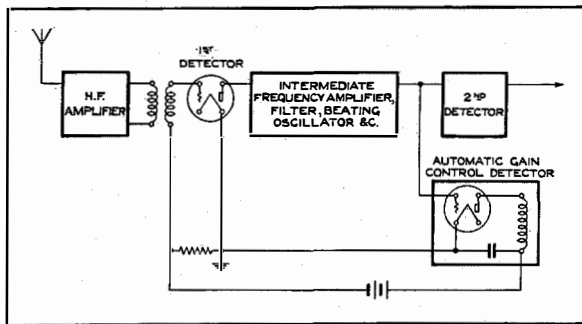

Fig. 2—Schematic of automatic gain control circuit.

link the automatic gain control will hold the total detected signal to a constant level ± 2 db. over a range of received signal variation of 40 db.

A discussion of the factor in the received signal which achieves this result, analysing the total detected signal into its component parts and explaining the function of each part, is presented in a later section of this paper.

Selective Fading

The third type of fading, usually known as selective fading, is rapid and deep in its action. This selective fading is caused by an interference pattern of two or more reflected waves, which reach the receiver after reflection from the ionised strata in the upper atmosphere known as the Heaviside Layer. The exact mechanism which causes the interference pattern is still somewhat

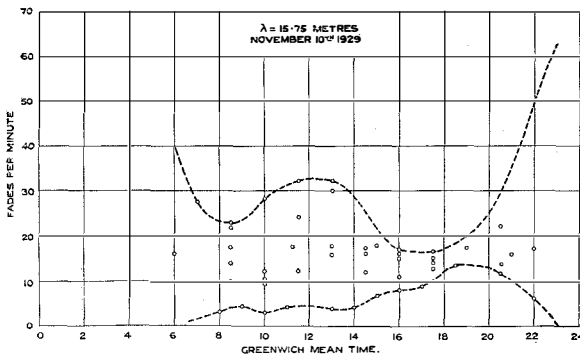

Fig. 3—Fading rate of Madrid (E.H.Y.) measured at Buenos Aires.

carrier alone, leaving the sidebands untouched.

Further it must be emphasized that the width of fade-band is generally so small that only about 100 to 200 cycles are affected at one time. It seems, however, that the movement of the cut-out portions across the spectrum is entirely random, so that there does not appear to be any logical solution in the direction of evening-up the attenuation.

In order fully to appreciate the effect of fading on the quality of received speech it is necessary to investigate mathematically its effect on a signal composed of a carrier modulated with a single frequency. It will be assumed in the discussion that the sideband frequencies lie sufficiently far from the carrier to be affected independently by the fading.

The modulation system used on telephone transmitters produces a carrier frequency and two sidebands. One sideband corresponds in frequency to the carrier frequency plus the voice frequency, and the other to the carrier frequency minus the voice frequency. Let us assume that the carrier is modulated by a single pure tone $\sin wt$, with the result that the modulated wave can be treated on the air as three independent frequencies. Let us call these three frequencies:

$$\text{Carrier} = c \sin rt$$

$$\text{Upper Sideband} = a (\sin (r+w) t) = a \sin pt.$$

$$\text{Lower Sideband} = a \sin (r - w) t = a \sin qt.$$

At the receiving end various systems of detection may be used, but the actual system is immaterial, since at the final detector stage three frequencies appear which have to be detected in order to obtain an intelligible signal. The general formula

for a vacuum tube when used as an anode bend detector is $(A_1e + A_2e^2)$ and if we apply the three frequencies given above to such a device, the operation of detection can be expressed mathematically as follows:

$$\text{Signal} = A_1 (a \sin pt + a \sin qt + c \sin rt) + A_2 (a \sin pt + a \sin qt + c \sin rt)^2 \dots \dots \dots (1).$$

The first term can be neglected for the purposes

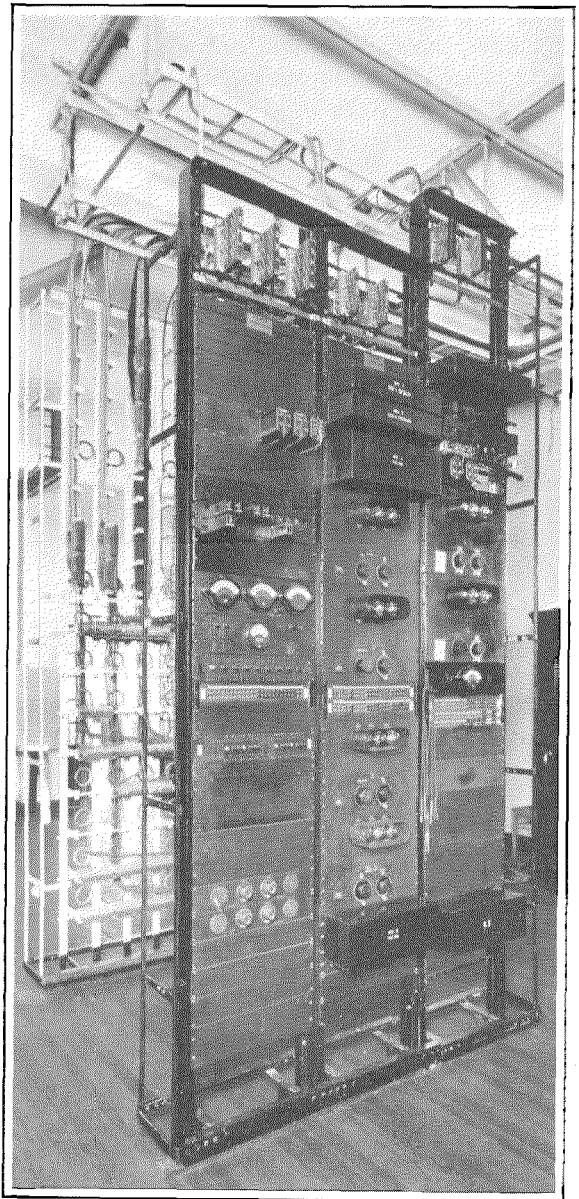

Spread Sideband Equipment installed at Buenos Aires for use on the radio link between Buenos Aires and Madrid.

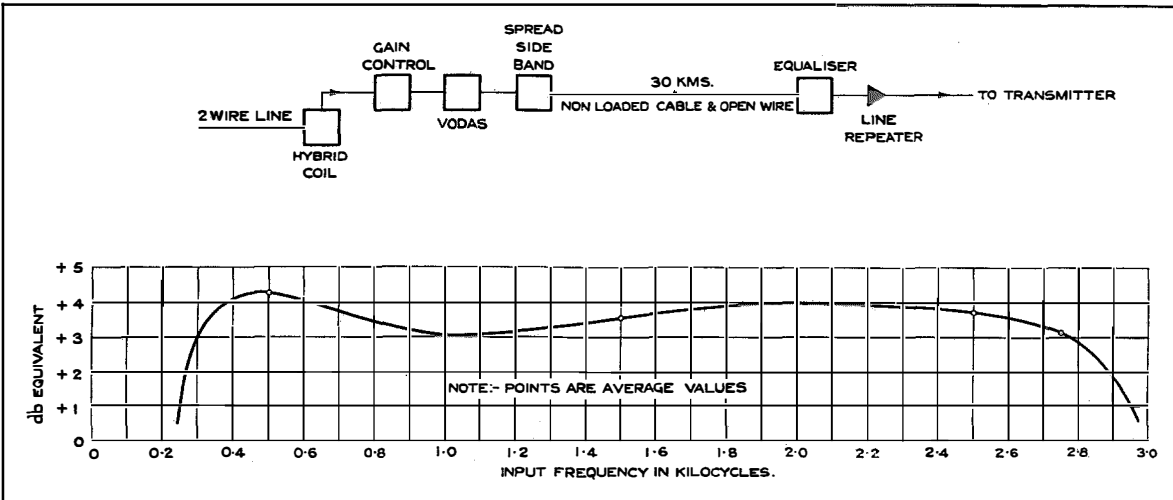

Fig. 4—Attenuation characteristic of transmitting circuit.

of detection since it represents the original three frequencies with a change in amplitude. This term is present due to the fact that the vacuum tube characteristics, as shown above, are not a pure square law. This term is, of course, lost in the filter circuits associated with the output of the detector.

Dealing with the second term, and expanding it, we have:

$$A_2 (a^2 \sin^2 pt + a^2 \sin^2 qt + c^2 \sin^2 rt + 2a^2 \sin pt \sin qt + 2ac \sin pt \sin rt + 2ac \sin qt \sin rt) = A_2 \left(a^2 + \frac{c^2}{2} \right) - A_2 \left(\frac{a^2}{2} \cos 2pt + \frac{a^2}{2} \cos 2qt + \frac{c^2}{2} \cos 2rt \right) - A_2 \left[a^2 \cos (p+q)t + ac \cos (p+r)t + ac \cos (q+r)t \right] + A_2 \left[a^2 \cos (p-q)t + ac \cos (r-p)t + ac \cos (q-r)t \right] \dots \dots \dots (2).$$

The first term represents direct current, and it is by means of variations in this term that the automatic gain control operates as described above.

Now the automatic gain control functions on the total detected signal only, and cannot dis-

criminate between the relative amplitudes of the carrier and sidebands at any instant. On the other hand the subscriber is not interested in the steadiness of the total received signal, but in the steadiness of the detected sidebands which carry the intelligibility. It will be seen, therefore, that the gain control acts only to keep constant a quantity which depends on the sum of the sideband and carrier amplitude, and cannot therefore be affected by a change of relationship between their respective amplitudes.

The second and third terms represent double frequencies and frequency sums of the original frequencies, and therefore lie beyond the audible range.

These terms are likewise removed from the signal by means of the same filters which dealt with the first term of the original equation.

We are, therefore, left with the last term of the equation, which, by means of differences, represents the intelligible signal. Separating this term, therefore, we get:

$$A_2 \left[ac (\cos (r-p)t + \cos (q-r)t) + a^2 \cos (p-q)t \right] \dots \dots \dots (3).$$

The frequency $(r-p)t$ is given by the difference between the carrier and the lower sideband, and is the same as $(q-r)t$ which is given by the difference between the upper sideband and the

carrier. Hence we can write equation (3) in the following form:

$$A_2 \left[2ac \cos (r-p) t + a^2 \cos (p-q) t \right] \dots \dots (4).$$

Referring to our original assumption of the three frequencies involved in the ether wave, it follows that the difference $(r-p) t$ is equal to wt which is the original pure tone in the voice range, and that the difference $(p-q) t$ is equal to $2wt$ which is a second harmonic of the original pure tone. Hence, if the original voice frequency was $\sin wt$, we can write the above expression as:

$$2A_2 ac \cos wt + A_2 a^2 \cos 2wt \dots \dots (5).$$

If the conditions are perfectly stable the amplitude $A_2 a^2$ is small compared to $2A_2 ac$, except when the percentage modulation on peaks of speech approaches 100% when $A_2 a^2$ tends to approach half the value of $2A_2 ac$.

If these two terms are now considered under fading conditions it will be seen that the harmonic term, which is normally small in comparison with the single frequency term, will only become prominent when the carrier fades. This will be apparent, since if the sideband amplitude "a" decreases, the harmonic distortion will become less than normal, both terms being affected by the change. If the carrier amplitude "c" decreases, however, the true signal term only is affected and the harmonic distortion becomes abnormally great, and under extreme circum-

stances has been observed to be greater than the single frequency amplitude.

From the above explanation it will readily be understood that in operation selective fading produces the same type of distortion as an overloaded amplifier, and is sometimes referred to as "harmonic distortion."

It is now necessary to consider this distortion effect on any of the known "privacy systems" such as are used on radio-telephone channels.

We will consider a privacy system in which an original speech frequency, $\sin wt$, is by known means placed in some other position in the speech band before being transmitted. Purely as an example we will assume that a frequency, $\sin xt$, is subtracted from it, so that it goes out on the ether as $\sin (w-x) t$.

Now at the receiving end we shall get a component, $\sin (w-x)t$ and a harmonic component $\sin (2w-2x)t$, to both of which components $\sin xt$ must be added in order to obtain our original speech frequency, $\sin wt$. This addition will, therefore, give us $\sin wt$ and $\sin (2w-x)t$.

To make this clearer let us take a numerical example:

- Let $\sin wt = 1,900$ cycles per sec.
- $\sin xt = 1,000$ cycles per sec.
- $\therefore \sin (w-x)t = 900$ cycles per sec.

Then at the output of the receiver we shall have:

- $\sin (w-x)t = 900$ cycles per sec.
- and $\sin (2w-2x)t = 1,800$ cycles per sec.

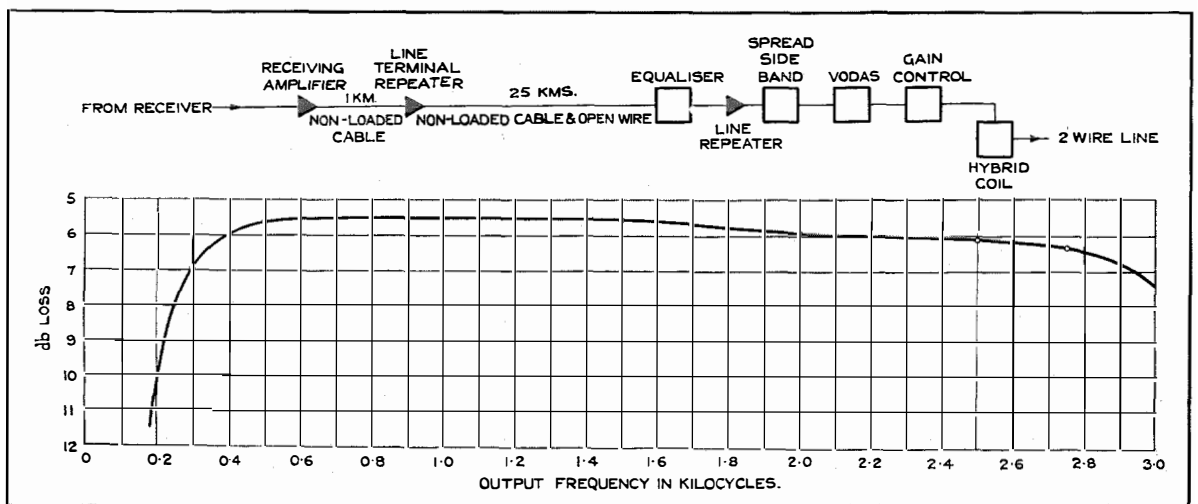

Fig. 5—Attenuation characteristic of receiving circuit.

Now after passing through the receive half of the privacy device, which will add $\sin xt$ to whatever comes to it, we get:

$$\sin (w-x)t + \sin xt = 900 + 1,000 = 1,900 \text{ cycles per sec.}$$

$$\sin (2w-2x)t + \sin xt = 1,800 + 1,000 = 2,800 \text{ cycles per sec.}$$

It will, therefore, be seen that selective fading, when applied to a system using privacy, will result in the production of spurious frequencies bearing no harmonic relation to the true signal. This type of distortion is very much worse than pure harmonic generation, and can very easily render the speech quite unintelligible.

A remedy for this type of distortion would be found if it were possible to separate the spurious frequencies from the true frequencies, and an inspection of equation (5) suggests a line of attack which leads to the Spread Sideband System* which is in successful commercial operation on the Buenos Aires-Madrid radio link.

The operation of this system can easily be understood if we add a fixed frequency, $\sin Wt$, to the original $\sin wt$ which is transmitted. Equation (5) then becomes:

$$2A_2 ac \cos (w+W) t + A_2a^2 \cos (2w+2W) t \dots \dots \dots (6).$$

Now if it is desired to transmit a band of frequencies from zero to wt , and Wt is made equal to the highest value of wt , then by inspection of equation (6) it will be seen that the single frequency term lies between wt and $2wt$ for all values of w , and the harmonic term between $2wt$ and $4wt$. The single frequency term can then be separated from the double frequency term by filters, and the frequency Wt is subtracted from it, thus leaving the band lying between zero and wt as originally required.

A numerical example will probably make the system much clearer. Let us assume that we wish to transmit a band of frequencies for speech from 250 to 2,500 cycles per sec. Then, before we reach the transmitter, we add to this band a fixed frequency of 2,500 cycles with the result that there is an empty space next to the carrier, and the speech lies between 2,750 cycles and 5,000

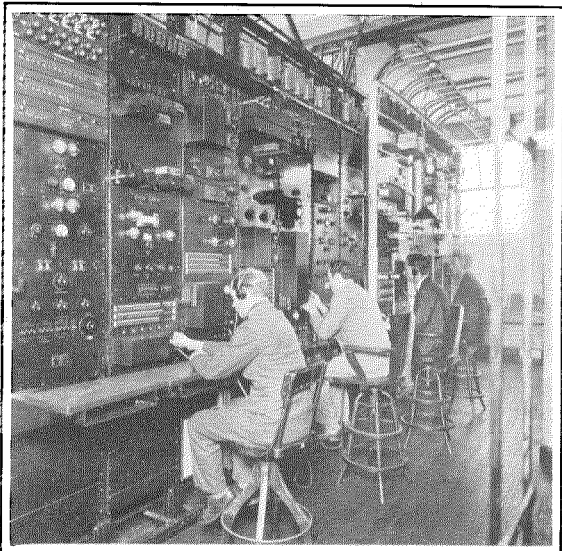

Technical operators' positions at Buenos Aires, showing (left to right) Temporary European, Permanent European, and New York.

cycles per sec. At the output of the receiver, therefore, the results of detection are:

$$\left\{ \begin{array}{l} (2A_2 ac \cos (w+W)t) \\ \left. \begin{array}{l} w = 2,500 \\ = K_1 (2,750 \text{ cycles to} \\ w = 250 \quad 5,000 \text{ cycles)} \end{array} \right\}$$

The spurious frequencies of the second term can, therefore, be separated by a low-pass filter with a cut-off of, say, 5,200 cycles per second, leaving only the first term of the results of detection.

At the receiving end terminal office we will subtract the fixed frequency of 2,500 cycles originally added, and the first term then becomes:

$$K_1 (250 \text{ cycles to } 2,500 \text{ cycles})$$

which is the original speech band which we wished to transmit.

It will be appreciated that speech sounds do not consist of single frequencies, and that intermodulation between component frequencies of a signal is present when the Spread Sideband System is not in use.

When the sidebands are displaced the products of intermodulation between frequencies within either sideband fall outside the displaced band

* British Patent Application 156 of 1930.

after detection, so that this source of distortion, although small, is also removed.

By an extension of the principles enumerated above, a number of sidebands can be placed on one carrier in such relative positions to each other and to the carrier that "harmonic distortion" is eliminated, as well as crosstalk between the various communication channels.

Overall Characteristics

The overall attenuation frequency characteristics of the transmit and receive side are interesting because of the equalisation which is necessary in order to get a flat characteristic. Both legs of the circuit contain delay networks, spread sideband privacy equipment and connecting lines, the latter being made up partially of non-loaded cable and partially of open-wire lines.

Figure 4 shows the overall characteristics taken from the two-wire side of the terminating set at the central office to the input of the transmitter. Figure 5 shows the receive side measured from the output of the second detector in the receiver itself to the two-wire side of the terminating set.

It will be seen from the drawings that the whole of the spread sideband equipment, together with the VODAS equipment* has been so equalised that an essentially flat characteristic is obtained between 300 and 2,800 cycles per second.

The author wishes to thank members of the staffs of the C.T.N.E., the C.I.R.A., and the I. T. & T. Laboratories for their helpful and active co-operation in the tests.

* *Electrical Communication*, Vol. 8, No. 4.

An Earthquake Disaster and Damages to the Long Distance Telephone Cable Line in Japan, 1930

By SANNOSUKE INADA

Director General of Telegraph and Telephone Engineering, Department of Communications, Japan

AT dawn of November 26th, 1930, there occurred a severe earthquake in the northern end of the Izu Peninsula and the Hakone range which are well known for their picturesque scenery and their hot springs.

This quake is reported to have been caused by a chasm slip which took place in the Tanna basin, an extensive valley, and which was the centre of the disturbance. The disaster spread over an area having a radius of 50 to 60 km., extending to Kozu in the east, Shizuoka in the west, Gotemba in the north, and to Shimoda in the south (see Figure 1). The seismic width of the earthquake felt in the Atami district (on the Izu Peninsula) is calculated to have been 100 mm. The severity of the quake, and the time it lasted, are reported to have greatly exceeded the great Kanto Earthquake of 1923.

According to an announcement made by the respective prefectural authorities, the casualties

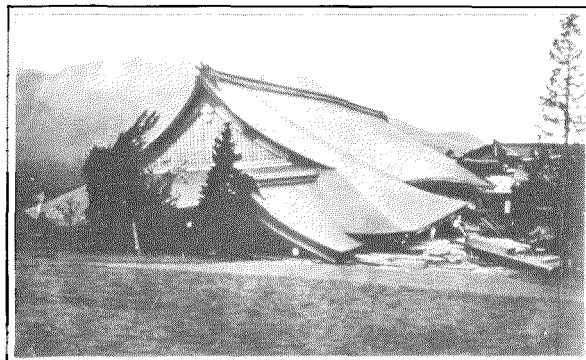

Figure 2—The Collapse of the Hakone Palace.

and the number of houses damaged were as follows:

Towns and villages affected.....	42
Number of people killed.....	250
Number of people injured.....	143
Houses demolished.....	1,530
Houses damaged.....	4,632

Although the zone affected by severe shock was comparatively limited and the damage caused by fire following the earthquake was not very great, the total loss sustained, including that to forests and cultivated fields, amounted to an estimated cost as large as 20,000,000 yen. In Figure 2 is shown the collapse of the Hakone Palace and, in Figure 3, rocks blocking one of the main roads. Damages to the public telephone and telegraph plants affected 37 telegraph circuits, 147 toll telephone circuits, 2,100 telephone subscribers and six post offices, four of which were entirely demolished, one partially destroyed and one flooded. Injury to the telegraph and telephone equipment in these six offices was such that the service was completely interrupted. Among the communication lines which suffered, the 184 pair long distance telephone cable and open wire telegraph lines were the worst affected

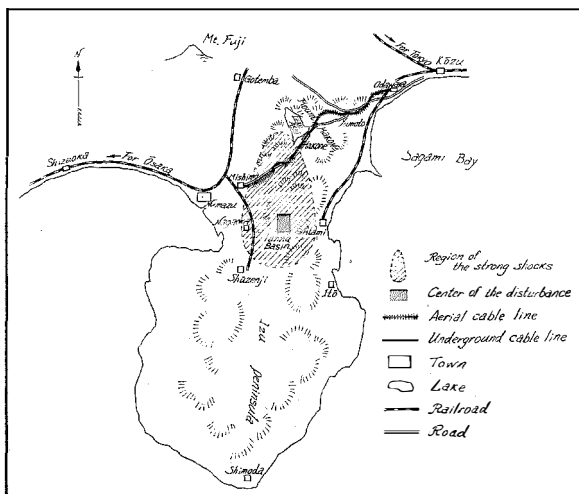

Figure 1—The Region of Shocks and the Route of the Long Distance Telephone Cable Line.

with consequent trouble and confusion in every line of business.

In order to provide relief after such a disaster, rapid restoration of the means of communication is most necessary, especially in the case of long distance communication lines.

Within the zone of the most violent shocks, the long distance Tokyo-Osaka telephone cable and the main open wire telegraph line run through the Hakone Mountains from Odawara on the north-east of the range to Mishima to the south-west for about 32 km. The cable was laid in 1925 soon after the great earthquake of 1923; aerial cable construction was chosen along most of the route except when passing through villages in order to avoid damage such as that inflicted on underground cables in the last disaster. The section between Odawara and Mishima consisted of 24.3 km. of aerial cable, 3.7 km. duct cable, and 3.9 km. of armoured cable. Most of the route followed by this cable is very mountainous, containing many precipitous cliffs and valleys, owing to the fact that the Hakone range was formed by a series of volcanic eruptions

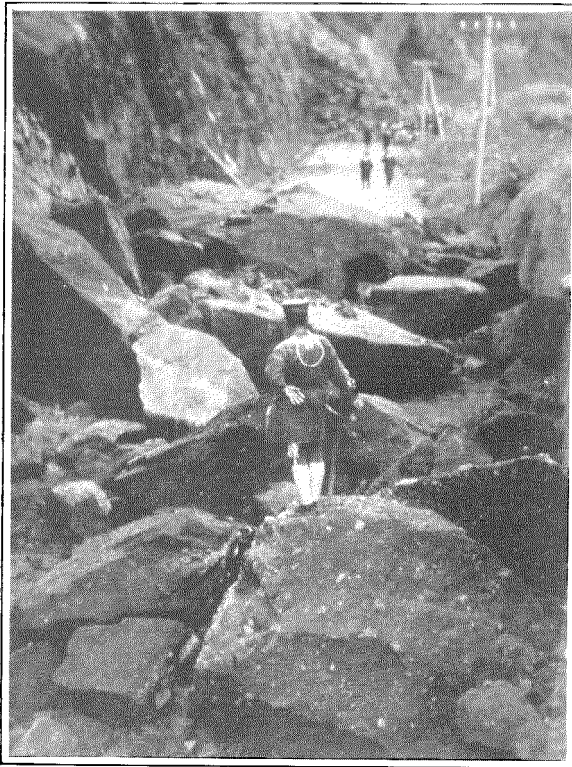

Figure 3—Fragments of Rocks Blocking All Traffic.

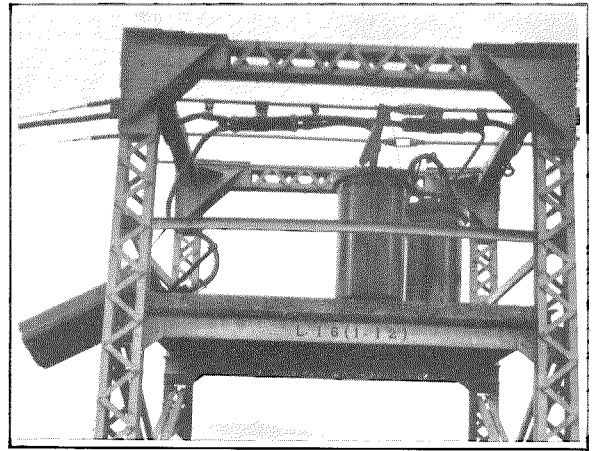

Figure 4—A Loading Coil Case Which Barely Escaped Dropping Down from the Tower.

within what is now a larger and older crater. Since the roads are built along such precipices and are exposed to the destructive effects of landslides, often due to floods or earthquakes, it was decided that the ridges were the most practical and the safest route for the long distance cable. Much effort was expended during the course of construction in the transportation of cable reels and loading cases, as there are no facilities for lifting such heavy loads to the tops of the ridges.

The standards adopted in Japan for aerial cable line construction are as follows: standard span, 30 metres; length of wooden poles, 7.3 metres; tensile strength of messenger wire, 7,300 kgs.

It is of interest to describe the unusual damage sustained by the cable lines and the means taken to remove the troubles. On the cable line the following damage occurred:

Poles inclined	45
Guys cut off or pulled out	700 (approximately)
Loading coil cases moved on platforms	15
Loading coil cases fallen off platforms	5
Cables wound round messenger wires	20 places

In some places a stranded steel head guy, having a breaking strength of about 7,300 kg., was broken by shocks at a point 30 cm. under the ground. This caused the next auxiliary head guy to be broken off also, in consequence of

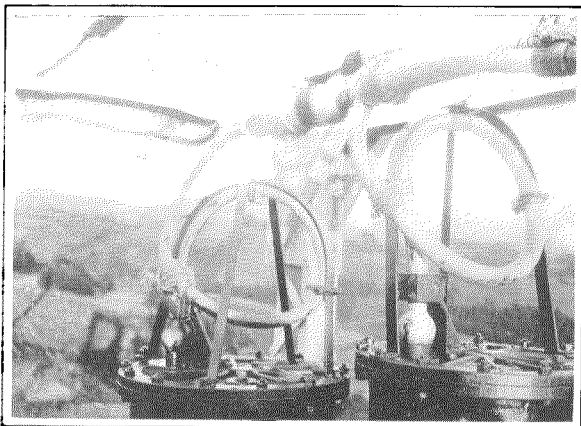

Figure 5—The Stub Cables Were Bent by the Violent Shocks.

which a number of successive poles, extending over 300 metres, were all inclined.

In the aerial part of the cable line, three loading coil cases are mounted on iron towers, which are designed to hold three more cases when another long distance telephone cable is installed. Each loading case contains 27, 30, or 35 loading coils, and weighs about 1,000 kg. Although these cases are so heavy that it was considered sufficient to place them on the tower platforms without fastening, they were jerked out of position by the extraordinary violence of the shocks, so that some of them fell off the platforms, while others hung precariously from the towers, as shown in Figure 4.

The shocks caused a certain amount of damage to the lead sheath cable stubs (Figure 5). Fortunately, the repair work was facilitated by making use of ring-formed slugs.

In the underground cable system, cast iron ducts having a length of 3 meters, an inner diameter of 76 mm., and a thickness of 9.7 mm. were laid at a depth of 1 m. along the road in the town of Hakone. These were so strained by the chasm formations that they were snapped at several points while the cables were crushed and the conductors torn asunder, as indicated in Figures 6, 7, and 8. Loading manhole No. 11 was slightly inclined, and its cover, together with the rim stone, moved 30 cm. out of place. Three loading coil cases set in the above manhole were overturned and two of them had to be replaced by new ones owing to breakage of stub cables with consequent lowering of insulation. The next manhole (a test-joint manhole), approximately 225 m. away in the direction of Odawara, was pushed up together with its foundation, breaking the ducts on both sides. The cables were also severely damaged and submerged in muddy water, with the result that all circuits in the cable were entirely blocked.

At points over 70 metres distance from the nearest test joint, ducts were also destroyed. Such points occurred most frequently where small streams were spanned. In addition, one of the calking joints slipped out, injuring the cables severely and putting them out of service.

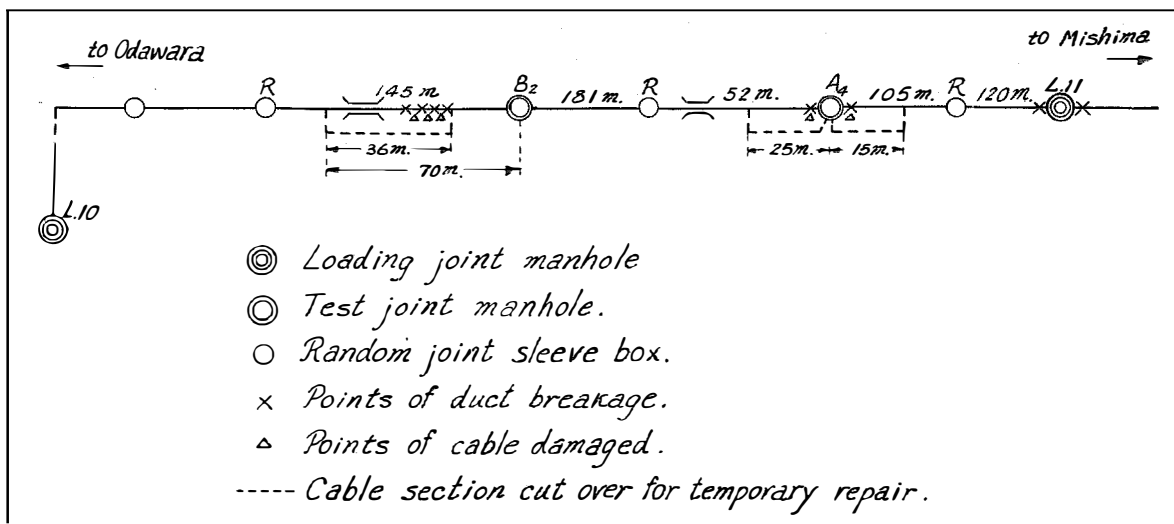

Figure 6—The Section in Which the Underground Telephone Cable Sustained Heavy Damages.

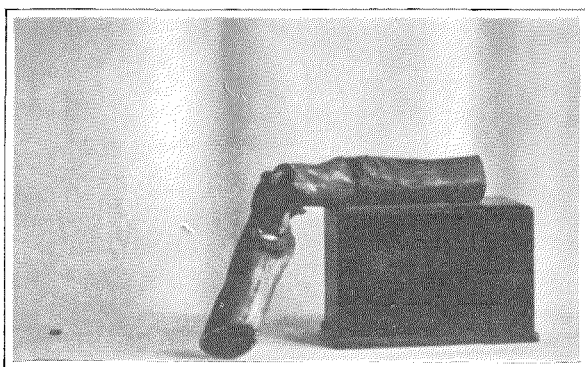

Figure 7—The Cable Crushed by Land Slips.

In view of all these damages there were no means of repairing the section between loading manholes No. 10 and No. 11 and consequently it was necessary to replace the whole section. In consideration of the tremendous difficulties encountered in pulling heavy cable drums up the steep hillsides, a number of these drums had been left for emergencies, and these were promptly made use of in the temporary restoration of communications.

These cables were laid directly on the road along the damaged section and jointed straight to the cable heretofore in use, omitting the loading coils in manhole No. 11. As the armoured cable was injured less than the unarmoured cable, it is expected that the sections between loading manholes Nos. 9, 10, and 11 will be cut over into a new armoured cable before long.

The town of Hakone is situated upon the shore of Lake Ashi, an old crater. At the time of the earthquake a terrific landslide engulfed a part of the town, and all the houses, numbering about

a hundred, collapsed with the exception of a mere handful which were also on the verge of collapse. The underground cables in this district suffered the most serious damage.

As the road was blocked with enormous fragments of rocks and a long succession of minor shocks occurred after the big one, the work of conveying the heavy materials for repairing the cable was both extremely difficult and dangerous. The efforts of the foremen who carried out these difficult tasks, labouring at their complicated job till the evening of the day following the main disaster, is beyond description.

In view of the injury to the duct cables by violent shocks, notwithstanding the fact that they were installed in accordance with specially rigid requirements, we have learned among other things that armoured cable is better fitted for toll telephone construction in volcanic districts. Furthermore, loading coil cases on towers and in manholes should be fastened by proper means to prevent their moving or falling. Head guys and terminal poles should be stronger than those now in use.

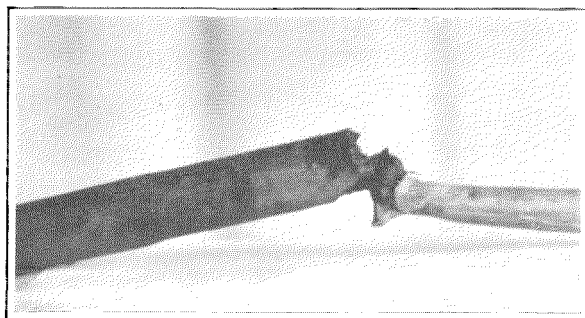

Figure 8—The Cable Broken by Snapping of Ducts.

A System for Simultaneous Telephony and Telegraphy Over Long Distance Small-Gauge Cables

By L. A. BRAEM

Ingénieur civil des mines (Brussels), Ingénieur de l'école supérieur d'électricité (Paris)

DURING the last few years the transmission of telephone and telegraph messages over long distances by means of underground paper-core cables has undergone considerable extension in the densely populated regions of Europe. These cables used to contain a certain number of special non-loaded pairs reserved for telegraphy. The placing of the telegraph and telephone conductors within the same cable led to a considerable economy in cables and duct space. This method, however, calls for certain precautions in order to avoid the disturbing effect of the telegraph currents on the neighbouring telephone circuits, and it might therefore be considered, both from the economical and technical standpoints, as the first stage towards simultaneous telephony and telegraphy. In view of the fact that a metallic circuit possesses certain transmission advantages over a ground return circuit, a second method was frequently applied. This consisted of using for the telegraphic transmission a metallic super-phantom circuit formed out of the available telephone channels, a practice which does away with separate telegraph conductors and leads to an important saving of copper.

The latter tendency of economising conductors has led to the development of two telegraph systems which, so far, have not found a wide application in most of the European countries. Early types of these two telegraph systems have been described in the April, 1925, issue of *Electrical Communication*. One of these systems involves the use of voice frequency currents, and makes practicable the simultaneous transmission of ten to twelve messages in each direction by means of two loaded pairs. The relatively high cost of the terminal installations permits the use of this system only over very great distances.

A second system, which may economically be applied either to short or medium long distances, is based on the well-known composite principles, the application of which on aerial lines dates

back to the early days of the telegraph. However, its adaptation to work in conjunction with modern toll cables has necessitated important modifications and refinements in order to reduce the telegraph currents to values of the same order as the telephone currents and thus decrease interference.

The Bell Telephone Manufacturing Company, Antwerp, recently has undertaken the manufacture of this system which incorporates the latest improvements gained from several years of practical experience in the United States of America, where the system is in operation on a large scale. The equipment, which is known as the Metallic Polar Duplex Telegraph System, is briefly described below.

Advantages of the Composite Method

Figure 1 indicates a composited quad from which can be derived three telephone and two duplex telegraph circuits by using the Metallic Polar Duplex Telegraph System. Comparing the composite operation with the existing metallic super-phantom practice, it will readily be seen that for a given number of cable quads composite operation provides four times more telegraph circuits than metallic super-phantom, and also does away with the difficulties often experienced when it is required to set up and maintain long telegraph super-phantom circuits, due to the great number of conductors per circuit.

The use of separate non-loaded pairs for telegraph purposes does not prove economical except for very short distances. For longer circuits the composite system appears to be more rational and, in the case of existing cables containing telegraph non-loaded pairs, it may often be advantageous, in the event of an increase in the telephone traffic, to delay the installation of a new cable by loading the available telegraph pairs for telephone use, and by superposing on the latter, telegraph channels by means of the composite method.

Principles Underlying Composite Operation

The band of frequencies necessary for good telephonic transmission is situated between 300 and 2500 cycles. The maximum frequency that a given coil-loaded circuit may transmit efficiently will depend upon its cut-off frequency, which is normally slightly higher than the maximum useful telephone frequency. However, currents of frequencies lower than 300 cycles will be transmitted freely through such a circuit, and it is this lower band that is used in the composite telegraph system. The use of the lower band of frequencies for telegraph transmission precludes the use of 20-cycle ringing. It therefore becomes necessary to employ for signalling purposes a frequency higher than the band employed for telegraphy. 135, 500, and 1000 cycle systems have been used for this purpose.

Composite Sets

The telephone and the telegraph bands are separated by means of low-pass and high-pass

filters respectively, connected in parallel at the extremity of the cable, and forming a unit generally known as a Composite Set (See Figure 1).

The low-pass filter of the telegraph branch passes frequencies lying within a band of from 0 to 80 cycles, this band width being such as to permit satisfactory transmission of the third harmonic when the speed of the telegraph transmission does not exceed 50 bauds. This speed corresponds to that of start-stop Teleprinters and Triplex Baudot working at a speed of 200 r.p.m. A further function of this low-pass filter in the telegraph branch is to present at the same time a high impedance and a high attenuation path to telephone frequencies, thus reducing to a minimum the loss introduced in the telephone circuit, and attenuating sufficiently the higher harmonics of the telegraph circuit which would otherwise give rise to an excessive "thump."

The telephone channel of the composite set forms, with the line repeating coil, a high-pass filter, designed to transmit all frequencies above 200 cycles. The high-pass filter also serves to

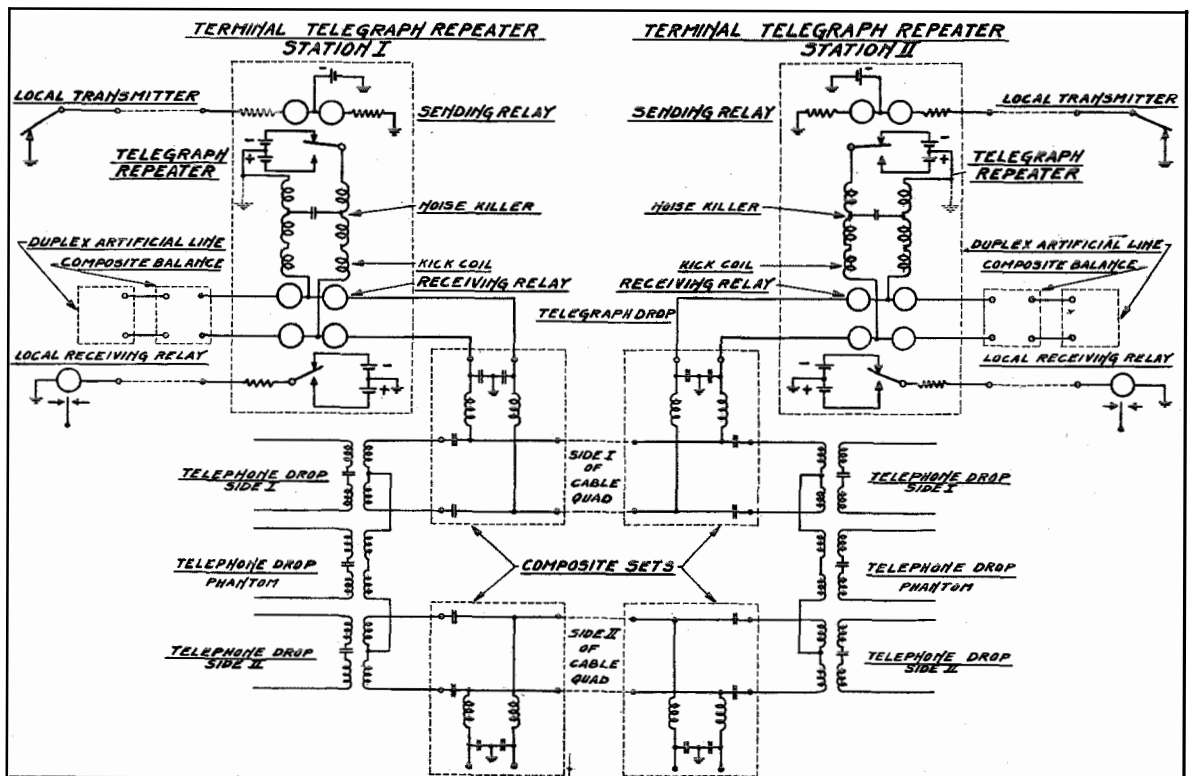

Figure 1—Compositing Quad—Metallic Polar Duplex Telegraph System.

attenuate the telegraph frequencies sufficiently to avoid excessive "thump" in the telephone circuit.

A condenser connected to the mid-point of the repeating coil winding tends to minimize the effect of interference caused by the 20-cycle ringing current used for signalling in the local terminal equipment of the telephone circuit, and in addition gives protection against telephone receiver switchhook clicks, which give rise to transients harmful to telegraph transmission.

Advantage of a Metallic Return System

The modern underground telephone cable makes use of small gauge conductors which are generally loaded and employ intermediate telephone repeaters. Under these conditions it will readily be understood that the disturbing effect produced by the telegraph superposed on the normal telephone transmission would be excessive if the telegraph currents were not reduced considerably below those allowed in telegraph ground-return circuits, superposed on non-loaded open wire lines. On the other hand, the use of small current intensities and voltages on ground return circuits requires special precautions to reduce the detrimental influence of ground potential differences, and of the inductive interference of other telegraph circuits and power lines.

Figure 1 shows schematically the fundamental details of the circuit of the Duplex Telegraph Terminal Equipment associated with one side circuit of a quad. It may clearly be seen—without going into the well-known details of the differential Duplex Operation—that, due to the metallic return, the disturbing currents, described above, are practically eliminated and have no effect on the balance of the receiving relay, since they flow simultaneously in the same geographical direction in the two wires of the pair, and are equal in magnitude due to the close balance maintained between each pair in a telephone cable.

For actual operation involving the working of a number of circuits in a given office from the same set of batteries, it is desirable, although not absolutely necessary, to make a connection to ground at each station, as shown by the dotted line ground connections on Figure 1. These ground connections stabilise the system by pro-

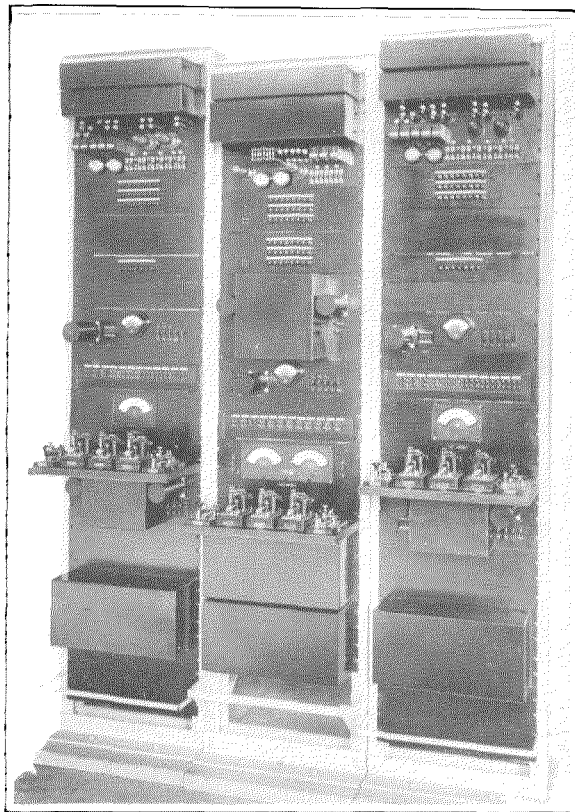

Figure 2—*Demonstration Equipment of Two Terminal and One Intermediate Bays.*

viding it with a definite potential to ground and, moreover, facilitate the clearance of accidental grounds. Although this ground results in unbalancing the currents in the circuits the advantages of the metallic return telegraph still remain, since we may assume that the upper wire is employed for the transmission of signals and the lower one for carrying neutralizing currents only, whose effect will be to offset the influence of the disturbing currents in the other wire.

Single Commutation

One of the principal advantages incorporated in the system manufactured by the Bell Telephone Manufacturing Company is the improved relay design, which enables the equipment to be operated satisfactorily on a single commutation basis, thus effecting considerable economies. It will be noted from Figure 1 that only a single sending relay is used which successively applies to the line two batteries of opposed polarity. The

double commutation method, which requires two relays whose armatures reverse the polarity of one battery, was largely employed in the earlier days in the United States. Double commutation was then preferred, as it was not possible in those days to obtain sufficiently close balance between the four windings of the relay. Due to improvements in manufacturing methods, the main difficulty of exactly balancing these windings as regards their resistance and number of turns has now been overcome, and as a result single commutation working is an assured fact. It is well known that the latter system necessitates more stringent conditions due to the fact that when the normal battery ground is provided, the signals passing over the line energise only one winding of the relay, whereas the others passing through the artificial line energise two windings. The artificial line is adjusted to have an impedance twice as great as that of the single transmitting wire; thus one line winding has to balance the two artificial line windings.

Single commutation requires double the battery voltage, but the same total ampere-hour capacity as that required for double commutation. On the other hand, it reduces the number of relay contacts by half, thus realizing a substantial reduction in cost and promoting ease of maintenance.

“Noise Killer” and “Kick Coil”

Reverting now to the question of telegraph interference in the telephone circuit, it can be said that the receiving-end “thump” is attenuated by the composite set to a point where it will not cause undesirable interference; greater protection than is provided by the composite set alone is necessary, however, to reduce the effect of sending-end “thump.” In order that the additional equipment for this purpose may have the minimum effect on telegraph transmission, an arrangement is inserted in the transmitter branch of the telegraph repeater, where it affects outgoing signals only; this device consists of what is known as a “noise-killer” and a “kick-coil.”

The “noise-killer,” consisting of condensers and inductance coils (see Figure 1), is used to round off the square top of the telegraph signal, which would otherwise give rise to harmonics detrimental to good telephonic transmission. It

constitutes a filter cutting off at about 80 cycles.

The “kick-coil” is required in connection with single commutation working in order to avoid excessive “thump” effect in the phantom circuit. It has its winding connected in parallel-aiding as regards the phantom circuit, and is therefore series opposing or non-inductive for the telegraph currents. The omission of the “kick-coil” would have the result of impressing a voltage in the phantom circuit due to unbalance created by single commutation working. The same effect occurs with a circuit operated on a double commutation basis when the two tongues of the transmitting relays fail to operate in exact synchronism.

Telegraph Relays

The receiving and transmitting relays used in this system are respectively the 209-FA and 215-A types. In order to furnish a good and reliable telegraph service, it is essential that very few relay failures occur during service periods; otherwise, valuable circuit time is lost and the relay maintenance expenses become an excessive factor in the cost of the exploitation of the system. This requirement has been realised in the above telegraph relays which have been designed to render satisfactory service for unusually long periods without any special attention.

The 209-FA is a very sensitive polarised relay which has been specially designed with a view to obtaining a high speed of operation with comparatively feeble current intensities over small-gauge cable circuits. It is provided with four accurately balanced line windings and two auxiliary windings, the latter forming part of the vibrating circuit. The function of the vibrating circuit is to reduce the distortion of telegraph signals and to increase the sensitivity of the relay. It is based on a modification of the well-known Gulstad principle, and although it forms one of the unique features of the system, it cannot be described here in detail, due to lack of space.

The 215-A relay possesses constructional features similar to the 209-FA type but is less sensitive and contains only two balanced line windings and no vibrating circuit windings.

All the contacts of these relays are protected

by means of suitable spark-quenchers, which prevent pitting and corrosion of the contacts and eliminate harmful noises in telephone circuits.

An interesting feature of these relays is an arrangement which permits a ready removal of a relay from the circuit and its replacement when the relay in circuit requires adjustment.

A telegraph relay test circuit is provided by means of which the relays may be quickly and accurately checked or adjusted. Adjustment can be made without disturbing the use of a telegraph repeater, simply by removing the relay from the repeater, and plugging it into the test panel. The repeater is maintained in service by replacing the defective relay by a spare relay which has previously been adjusted in the test panel.

Terminal Telegraph Repeater

The telegraph apparatus shown schematically in Figure 1 constitutes a Terminal Telegraph Repeater for use between a metallic-return cable section and one or two ground-return loops. Two loops are required when the circuit is working duplex, one loop being used for transmission and the other for reception. It will be noted from Figure 1 that the local receiving loop operates on a double current basis, whilst the sending loop works on a single current basis.

Only one local loop is necessary when simultaneous transmission in both directions is not required. This method of working can be used with the same equipment by making a slight modification to the circuit of Figure 1.

Through Telegraph Repeater and By-Pass Set

For lines which are too long for direct transmission of telegraph signals from one terminal repeater to the other, Through Telegraph Repeaters are used. In practice the location of these repeaters is determined by that of the telephone repeaters. They are usually installed in every second telephone repeater station, the intermediate telephone repeater stations being provided with an intermediate composite set and a by-pass set, which provides a path for the telegraph currents to pass round the telephone repeater.

The intermediate telegraph repeater employs

two 209-FA relays and two transmitting branches. Each relay is operated by the line current arriving from one direction, and repeats the signal in the line of the other side, differentially through the winding of the other relay.

The intermediate composite set is made up of two slightly modified terminal composite sets placed in the line on either side of the telephone repeater. The two telegraph branches of the composite set are connected together through the by-pass set.

The by-pass set consists of a retardation coil of high inductance and low mutual inductance between the windings, the object of this coil being to prevent currents feeding back from the output of the telephone repeater to the input through the telegraph branches of the composite set.

Monitoring Set

For both types of telegraph repeaters there has been designed a monitoring circuit which provides convenient means for obtaining a correct duplex balance, monitoring on the circuit, and locating troubles; signals passing through the repeater may be observed, and the attendant may communicate with other stations in both directions. The monitoring set includes differential milliammeters (one for the terminal set, two for the through set), polarised sounders, a telegraph key and a number of switching keys. A monitoring set is provided for several repeaters, and may be connected to any of the repeaters by means of patching cords.

Equipment Features

The apparatus is assembled on panel units mounted on bays 54 cm. wide and 3 m. high, similar in appearance to that of telephone repeater bays.

A complete terminal telegraph equipment unit consists of:

- (1) a terminal repeater panel proper, with the two telegraph relays and the transmitting branch.
- (2) One half of a composite balance panel for balancing the composite set in the telegraph circuit. (A complete panel containing two balance sets ensures the balancing of two terminal repeaters.)

(3) A Duplex Artificial Line intended to balance the cable circuit, and comprising series and shunt capacities and resistances which are inserted in the circuit by means of push button switches.

The following panels are required for a through repeater circuit:

(a) A Through Telegraph Repeater Panel including two 209-FA relays and two transmitting branches.

(b) A Composite Balance Panel.

(c) Two Duplex Artificial Lines.

An additional Duplex balance panel is required if a by-pass set is installed at the next telephone repeater station.

A terminal repeater bay serves either six complete telegraph repeaters without a monitoring panel or five repeaters with one monitoring panel. For a through repeater bay, the corresponding capacity is four panels for the former and three panels for the latter case. Usually, a monitoring panel is placed on every second bay.

Four-Wire Operation

Although this system has been designed for working on Duplex principles, it is equally adaptable for Simplex working. This method does away with the telegraph balances, but requires four wires to permit telegraph transmission in both directions. The repeater panels are so wired that by means of strapping, they can easily be made suitable for this method of operation. The Simplex method of working may in certain circumstances prove more economical, but it must always be borne in mind that it requires twice as many pairs as the Duplex method described above. Where abnormally long telegraph repeater sections are required it becomes necessary to use the four-wire method of operation, since it is possible to operate circuits of practically unlimited length in this way. Duplex operation cannot be considered reliable for distances exceeding 1000 km.

Non-Composite Working

This system may also be applied satisfactorily to non-composited pairs, either non-loaded or loaded, to which the principal advantages of the system, such as the weak line current, the metallic return and the highly sensitive and stable relays, still apply.

When the system is operated on the non-composited basis the location of telegraph repeaters no longer depends on that of the telephone repeaters. The maximum distance between two successive repeaters may then attain 220 km. for 0.9 mm. leads, and 300 km. for the 1.3 mm. circuits.

Figure 2 illustrates an equipment which was used for demonstration purposes, of two terminal and one intermediate bays. Each bay comprises, in addition to a complete telegraph repeater unit, a monitoring panel, a relay test panel and the necessary composite sets.

Noise

From experiments recently made on 1.3 mm. H-177-63 quad 520 km. long, it was found that the telegraph interference was inherently less than the telephone crosstalk on either of the three telephone circuits when full duplex teleprinter was being maintained on one of the side circuits.

Conclusion

Although the fundamental principles of compositing telephone cables are old, it is only quite recently that the art of compositing small-gauge cable circuits has been brought within the bounds of practicability, without impairing existing high grade telephone service.

In view of the reliability of cable circuits and ease of maintenance of the metallic polar duplex telegraph system, it is possible to envisage an extensive network of composited circuits being built up to meet the requirements of Administrations, bankers, and large industrial concerns with offices and plant located in widely separated parts of the country.

Developments in Start-Stop Telegraphy

The New Creed Printer

DEVELOPMENT of the applications of start-stop printing telegraphy naturally calls for progressive advances in the design of operating equipment in order to meet the more stringent demands which are made upon it. Such modifications in the design of teleprinter apparatus must take into account also economy of production, simplicity of operation, and ease of maintenance.

One of the principal reasons for modification in design is necessitated by the application of teleprinters to telegraph exchange service. In this important new role the teleprinter must fulfill all the conditions which are at present met by the telephone, but with the added advantage of giving transmission by telegraphy.

The new Creed teleprinter is designed to give all these facilities, and its construction, which is arranged on a unit basis, is of great advantage in the field for any unit of the machine in the event of trouble can be readily replaced, and the defective part examined and adjusted at some more convenient time. The removal of a particular unit does not in any way affect the adjustment of other units adjacent to it.

In general the principle of operation remains the same as in earlier types, but in the machine that has been developed for teleprinter exchange service a special device has been incorporated for transmitting back to the calling subscriber the exchange and number of the called subscriber, thus verifying the correctness of the connection. This facility is particularly useful in cases where it is desired to leave messages in the absence of the called subscriber.

The design of the machine has been laid out all in one plane, and all the units come within the limits of the travel of the paper carriage. When all the units are in place and screwed to the base plate all connections are made automatically by means of spring clips, the base plate and wiring forming one of the complete units.

The combined transmitting and receiving tele-

printer is shown as a complete unit in Figure 1 and the assembly with the cover removed, in Figure 2. Figure 3 is a rear view of the paper carriage and travelling chariot; Figure 4 illustrates the detailed assembly of all the units of the machine. These units comprise the "answer back" device, cam unit, combination head, ink ribbon unit, keyboard unit, keyboard main base, main shaft, mechanical relay, motor starter unit, operating magnet, paper carriage, printer main base, transmitter unit, typehead, and wiring unit.

In cases where the machine is required for reception only, as in news distribution and ticker services, it is only necessary to undo two screws and remove the keyboard, which is a separate unit connected to the main base.

There is only one high speed shaft in the ma-

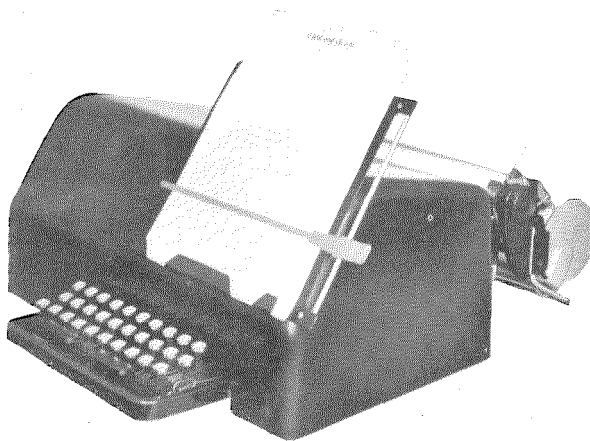

Figure 1—The New Creed Teleprinter—Complete Combined Transmitting and Receiving Unit.

chine. At one end of this shaft is the motor and, at the other end, the automatic motor starter. At right angles to this shaft and driven from it, are the printing head, the receiving cam shaft, the transmitting cam shaft and the "answer back" shaft.

In order to preserve accurate alignment of the

printing, the typehead is provided with an outer bearing, and the typehead stop is fitted with an efficient shock absorber. All the shafts on this instrument are mounted in ball bearings, thus

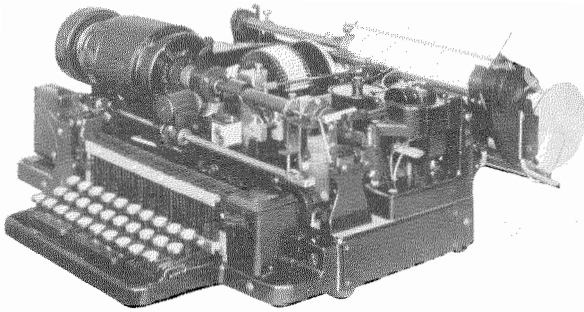

Figure 2—The New Creed Teleprinter With Cover Removed.

making possible the use of a smaller motor. The extensive use of ball bearings has also eliminated the need for frequent lubrication. A detailed view of the keyboard transmitter and receiving units is shown in Figures 5 and 6.

General Details of Units

The power of the motor used has been reduced to 40 watts, but it shows an efficiency of 60% at least. Double brushes are provided and, in addition, there is a special fan which ensures that even when the printer is totally enclosed within a specially designed silencing cover, the temperature is always maintained within safe limits.

Both ends of the motor casting are so constructed that they fit tightly in holes in a pair of plates by which they are supported. Electrical connections between the motor and its associated wiring, which is situated under the base of the machine, are made by means of four pins which come into contact with four springs through a hole in the base. These springs are attached to a block on the under-side of which is moulded a series-parallel switching arrangement, so that the connections may be adapted almost at once for using either A. C. series or D. C. shunt motors.

The governor, which is of the centrifugal type, and is totally enclosed in a bakelite case, is mounted on the free end of the motor spindle, and connection is made by means of a pair of brushes which rub on the slip rings.

A useful improvement over previous models

lies in the incorporation of typewriter ribbon inking in place of ink rollers, the ribbon being so arranged that it automatically reverses when either reel is unwound.

The paper printing attachment unit comprises the platen carriage which moves from right to left as printing along each line proceeds. The main casting carries the feed and control mechanism, and the paper chariot which carries the paper roll.

The platen carriage is mounted on the main casting by means of a running bar along which slides the grooved portion of the frame, and a keyed spindle which passes through the centre of the platen.

Attached to the carriage is a rack which engages for letter feed purposes with a toothed wheel situated in the main casting. The line feed is accomplished by rotating the keyed shaft which passes through the platen, friction between the keyed spindle and the platen being reduced to a minimum by four rollers which serve as a pair of keyways. The principal components of the carriage are a light casting, a pair of end plates which provide bearings for the platen and a pair of rollers which are fitted on a pivoted axis, and are held in contact with the platen by means of a pair of flat springs.

Each of the rollers extends practically half the

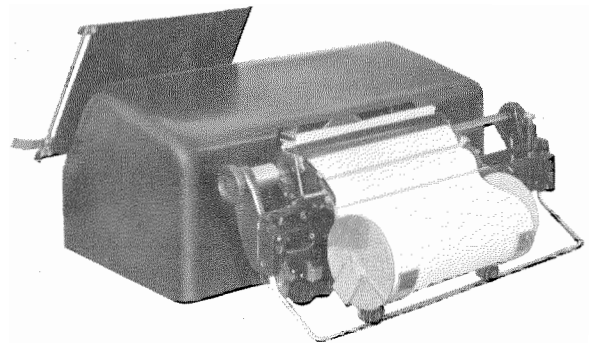

Figure 3—Paper Carriage and Travelling Chariot—Rear View.

length of the platen in order to give an equal application of pressure throughout the width of the paper. Both the platen and the pressure rollers are rubber-covered.

The mechanism controlling the carriage movements is mounted on the main casting. It consists of the letter feed mechanism, the carriage return mechanism, and the line feed mechanism.

In order to warn the operator of the approaching end of each line the mechanism is so arranged that a line feed bell rings automatically at a point ten characters before the end of the line.

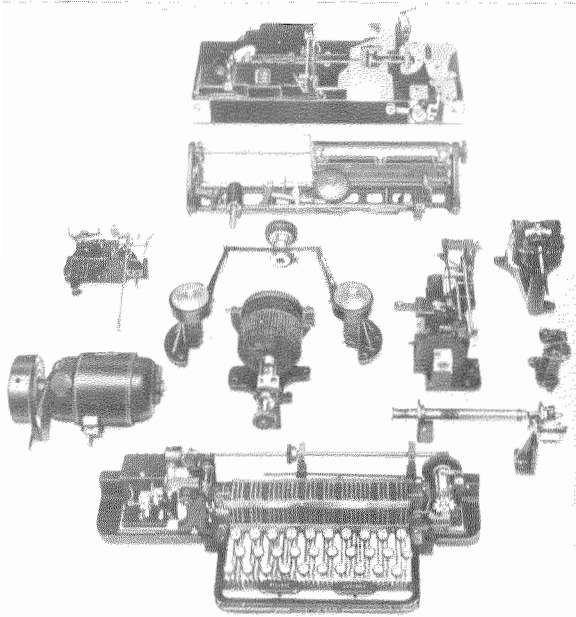

Figure 4—Detailed Assembly of All Units of New Creed Teleprinter.

The bell device is fitted to the page printer attachment.

The teleprinter can be mounted on any table conveniently placed for electricity supply, and requires no special fitting of any kind. The plug socket through which the electrical connections are made may be fastened either to the table or to an adjacent wall.

A special silencing cover, in place of the dust cover normally used, can be fitted on the machine in cases where quiet operation is of considerable importance.

The overall dimensions of the machine with its dust cover in position are: width, $19\frac{1}{2}$ in.; depth, $23\frac{1}{2}$ in.; height $10\frac{1}{2}$ in.

Operating Features

The teleprinter is capable of operation by any typist, at speeds up to 66 words per minute, and it prints on a message roll $8\frac{1}{2}$ in. wide. It utilizes a 5-unit code in which the current permutations

forming each character are all of equal length. Every signal transmitted is preceded by an impulse which starts the receiving printer, and is followed by an impulse which brings the printer to rest again. In this way it will be seen that the difference in speed between two or more machines is not cumulative, as for each letter transmitted the machines start together. The signalling code used by this machine is shown in Figure 7.

Where more than one copy is required, either carbon backed paper in a continuous roll, or manifold books of separate sheets interleaved with carbon paper, may be used. With the former three good copies can be obtained, and with the latter up to ten copies.

For single current operation, the line current necessary is from 17 to 20 milliamperes, but for double current only 12 to 15 milliamperes is required.

A single transmitting armature is used which ensures that all signals have the same characteristics. The contact pressure is about 50 grammes, and oscillograph records show that there is a complete absence of armature rebound.

On the receiving side a high grade polarized electro-magnet is used so that the new teleprinter can be operated over long distances without the use of an additional line relay. This electro-magnet has two windings connected in series, each having a resistance of approximately 100 ohms.

The teleprinter has been so designed that tape and page printing attachments are interchangeable. Only a momentary interval is required to

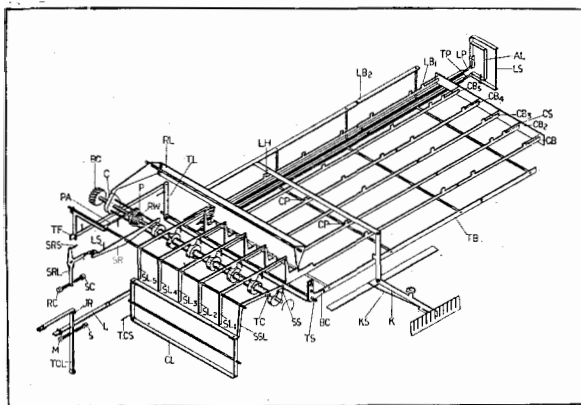

Figure 5—Keyboard Transmitter Unit.

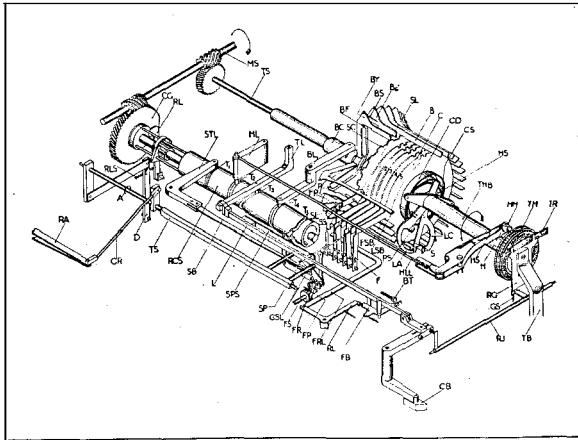

Figure 6—Receiving Unit.

replace one attachment by the other, as a greatly improved form of mounting has been adopted.

Either of the above units can be removed by first operating a latch at one end of the support casting, and then lifting the other end from a vertical stud by which it is supported.

Where telegraph apparatus is operated on a double current simplex basis (transmission in one direction at a time) a send-receive switch is provided for changing over from the sending to the receiving condition, and vice versa. It is impossible for the operator to omit to change back to the receiving condition after the conclusion of transmission, as the switch is incorporated in the transmitter unit, and is entirely automatic in operation.

As the teleprinter may be left unattended for considerable intervals of time, some means must be provided for stopping the machine after transmission has ceased. To effect this it is fitted with an automatic starting switch which closes the motor circuit immediately the printer electromagnet is operated. If no signal is received for a period of two minutes the switch automatically breaks the motor circuit again. The motor is thus kept at rest except during the periods in which signals are actually being received.

To meet the requirements of teleprinter exchange services, the instrument is equipped with the previously referred to "answer back" mechanism which has not hitherto been provided in any other printing telegraph apparatus. On depressing a key on the teleprinter keyboard marked "Who are you?" a special signal combi-

nation is transmitted over the line, causing the "answer back" device on the "called" subscriber's machine to repeat back its exchange and number to the "calling" subscriber.

Principles of Operation

Every character is allotted a combination of five units as shown on the code chart in Figure 7, the black circle representing current intervals and the white circles no current intervals. This combination for each individual letter is passed between the transmitter and the printer.

When a key is depressed it engages a clutch, to which is coupled a series of cams which control the sequence of the transmitting operations. Under the control of these cams the depressed key is locked, and all other keys on the keyboard are prevented from moving until the selected character has been transmitted.

The depression of each key is designed to arrange in a particular manner five bars which are capable of being moved longitudinally, a

START-STOP CODE

A	WHO ARE YOU	●●●●●●	P	O	○○●●○○●●
B	?	○○●●○○●●	Q	I	○○●●○○●●
C	(○○●●○○●●	R	4	○○●●○○●●
D	.	○●○○○○●●	S		○○●●○○●●
E	3	○○●●○○●●	T	5	○○●●○○●●
F		○○●●○○●●	U	7	○○●●○○●●
G		○○●●○○●●	V)	○○●●○○●●
H		○○●●○○●●	W	2	○○●●○○●●
I	8	○○●●○○●●	X	£	○○●●○○●●
J		○○●●○○●●	Y	6	○○●●○○●●
K		○○●●○○●●	Z	.	○○●●○○●●
L	/	○○●●○○●●		CAR.	○○●●○○●●
M	1	○○●●○○●●		FIGS.	○○●●○○●●
N	-	○○●●○○●●		LTRS.	○○●●○○●●
O	9	○○●●○○●●		COL	○○●●○○●●
				SPACE	○○●●○○●●

KEY:- ● = MARK
○ = SPACE

Figure 7—Signalling Code.

displaced bar corresponding to a "marking" signal, and a stationary bar to a "spacing signal." Under the control of the cams, each of these bars determines in correct sequence the characteristic

of one current unit of the combination transmitted.

In addition to the current impulses forming the particular character combination, two additional impulses are automatically transmitted every time a key is depressed. One of these impulses precedes the character combination and serves to engage a clutch through which the printing selector mechanism is driven; the other, which follows the character combination, causes this clutch to be disengaged after the signal has been translated. A graph of line current for the transmission of the letter "Y," plotted against time for both single and double current working is shown in Figure 8.

The line currents at the receiving end of the line pass through the windings of an electro-magnet which turns a shaft into one of two positions for the duration of each signal impulse.

Five small levers are ultimately set backwards or forwards in the same combination as the moving members in the transmitter, this being effected by a synchronised striker which traverses the levers, and is struck forward in front of each lever in succession. The position of the shaft controlled by the electro-magnet determines whether or not the striker will displace the lever, and since the position of this shaft is dependent upon the incoming signal impulse, the character combination selected by the transmitter is accurately reproduced in the printer.

The last stage in the selection of the character to be printed is carried out by an application of the principle of the combination lock, by virtue

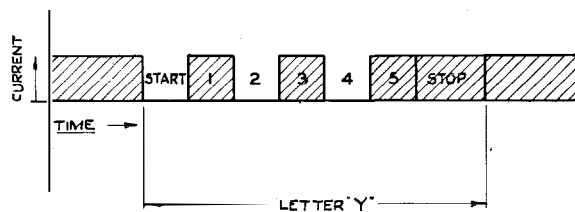

SINGLE CURRENT CLOSED CIRCUIT.

(a)

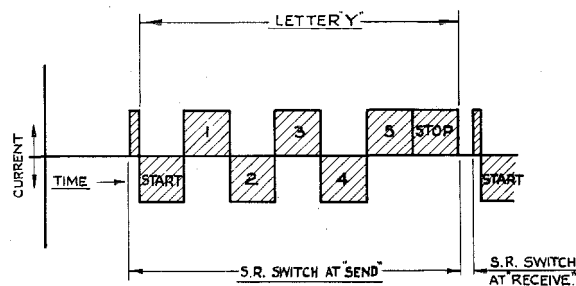

DOUBLE CURRENT

(b)

Figure 8—Graph of Line Current.

of which one of a series of radial latches is caused to drop and entirely stop a rotating typehead in such a position that the required type is interposed between a small hammer and the paper. The hammer is operated during the early part of the selection cycle for the next character, and the impression is thus made on the paper.

Transmission Testing of Subscribers' Apparatus

By L. C. POCOCK, M.Sc., A.M.I.E.E., A.C.G.I.

International Telephone and Telegraph Laboratories, Incorporated, Hendon

AN impartial enquirer into the state of development of the telephone art would find two facts which seem little in keeping with the high scientific standard reached by telephony, and with the wide field of science which has been drawn upon during the last twenty years to aid in the annihilation of distance for the spoken word. "Sound" has shown less amenability to physical and experimental study than other branches of physics; the study of electrical physics has indeed so far surpassed the more ancient science of sound that the older borrows from, and is explained by the newer, whence we have expressions such as "sound field" and "acoustic impedence." When to the difficulty of measuring sound in general is added the necessity of measuring that most complicated combination of sounds called speech, it is no longer surprising that the precision of electrical measurement attained in the balancing of circuits, the adjustment of repeaters, and the forecasting of attenuation, is not duplicated in the data that can be obtained upon the acousto-electric ear (transmitter) and the electro-acoustic mouth (receiver) of the telephone system.

Many laboratories have in the early days of their history dreamed of, and possibly worked for, a scientific and impersonal measurement of what is known as transmitter and receiver efficiency. This is not the place for a discussion of the difficulties and, for the most part, failures which have resulted. It is true that machines capable of measuring the efficiency of particular types of transmitters and receivers have been built, but their performance is empirical rather than scientific, their calibration is most often by voice and ear test, rather than in fundamental units, and their use is in most cases restricted to the laboratory. Doubtless, machines will come into wider use, a more perfect machine will be developed, and then, also, transmitters and receivers will be diligently tested and studied in quarters that at present ignore such means as are available for this work. To the impartial en-

quirer, the second surprising fact is that there are countries in which the telephone system includes skillfully designed and constructed transmission circuits but is lacking in standards of performance for the transmitter and receiver at the end of the line.

Much has been accomplished towards overcoming these deficiencies during the last ten years and the time has now come when the Comité Consultatif International, having established a Transmission Reference System in Paris, is able to approach the problem of recommending the minimum performance to be tolerated in the subscribers' apparatus for long distance calls. This recommendation has far reaching consequences: first, because, to interpret it, each Administration must acquire certain standardised and calibrated apparatus, and second, because when the efficiency of the subscribers' apparatus comes under consideration, and into a field of measurement, large economies result from more scientific planning than was formerly possible.

Looking a little more closely at this question of economy, it will be realised by all telephone engineers that the construction of a long distance communication channel, for example, involves an economic study in which the cost of copper, line construction, loading coils, and repeater stations enter; it will be shown that due consideration must be given to the efficiency of transmitters (and receivers); further, articulation or freedom from speech distortion is now recognised as an important factor to the extent that an improvement in articulation may be brought into the economic study as a negative attenuation, that is, as equivalent to an increase of loudness efficiency. The result of the study determines the most economical construction for a system capable of giving a certain grade of service, that is to say, for example, a grade of service not worse than that afforded, with ordinary transmitters and receivers, on zero loops with interposed attenuation equal to 3.5 népers

TABLE I

Weight of Single Conductor		Relative Efficiency Decibels	Cost of Copper in 10,000 loops		Value of decibel per 10,000 subscribers' loops	
lb./mile	Kg./Km.		Copper per ton*		Copper per ton*	
			£75	£41	£75	£41
20	5.6	0	£13,400	£7,400		
10	2.8	-2.0	6,700	3,770	£3,350	£1,815
6.5	1.8	-3.0	4,360	2,400	2,340	1,370

* Copper priced at £75 and £41 per ton or 18.2c. and 10c. per lb.

(30.4 decibels). In such a case the losses in the two terminal loops, including any loss due to the current supply to the transmitter being less than over a zero loop and any gain expressed in decibels and derived from use of improved quality instruments, must not exceed 1.5 népers (13 decibels) if the equivalent from one local exchange to the other is 2 népers (17.4 decibels). The loss due to reduced current supply may be quite half or more of the allowance for the local loops. Consequently, two propositions may be set up:

1. Any improvement in transmitter efficiency or articulation offered by a new design of transmitter will allow an increased attenuation in the trunk, or a reduction in the efficiency of the local loops without reducing the service below the predetermined grade. Any increase of permissible attenuation in either case has a direct financial capital value.

2. In order that any exchange area may be laid out with maximum economy within the limits of a predetermined grade of transmission, it is necessary to know how the transmitter efficiency varies with the current supply, and what the transmitter and receiver efficiencies and articulation values are in relation to the instruments and circuit used in defining the grade of transmission furnished.

Without precise knowledge regarding the efficiency and articulation of the transmitters and receivers employed, it would be necessary to guess at the gauge of wire to be used for the subscribers' loops, and this would result either in ensuring a margin to the grade of service required by supplying too much copper, or in the contrary case, the grade of service would fall below the intended value.

As an indication of the money values involved in alternative layouts, Table I has been prepared showing the cost of copper and approximate relative transmitting efficiency of loops one mile long, using different weights of copper conductor.

This enables the value of one decibel gain or loss in transmission to be estimated.*

This simple example indicates that the cost of subscribers' lines for a given grade of performance will show appreciable reduction if the average transmitter efficiency is improved by comparatively small amounts. In actual practice, the lines are naturally of varying length and the concentration, or number of lines of a given length is some function of the length, so that the problem is more complex, involving often the joining up in series of two different types of conductor. It must be evident that this work cannot be carried out with satisfactory transmission results and without undue extravagance unless it is based upon some consistent plan, of which the essence is a foreknowledge of the transmission efficiency of the subscribers' apparatus under any given loop conditions.

The necessary data relating to the apparatus employed in any particular country can be obtained by comparison with particular pieces of telephone apparatus, which represent standards of comparison analogous to the physical standards of weight and length preserved in the National Laboratories. These standards of telephone performance, in the shape of groups of

* Similarly, a gain in articulation has a money value according to the number of decibels gain that would produce an equal improvement in the grade of service. The equivalent values have been determined, but cannot be usefully discussed because, as in efficiency testing, the results depend upon the technique adopted. Until a standardised method of test is in vogue, it is undesirable to quote figures unless indeed accompanied by an exact account of the procedure adopted. Such an account may be found in *Speech and Hearing* by Harvey Fletcher, where (p. 272) it is shown that 1 decibel is approximately worth $2\frac{1}{2}\%$ articulation. See also "A Theoretical Study of the Articulation and Intelligibility of a Telephone Circuit," by John Collard, *Electrical Communication*, January, 1929, pp. 168-186.

transmitters and receivers should be as invariable as possible. It is to some extent scepticism of the constancy of the carbon transmitter standard that has been responsible for the rather widespread neglect of systematic investigations by the voice and ear method into the performance of subscribers' apparatus.

Time will show whether scepticism was justified. Evidence accumulates that *well made* transmitter standards do not vary as much as has been supposed, while on the other hand, their human observers vary from one to another in the characteristics of voice and ear, and, what is more important, do not establish sufficiently exactly the technique or method to be adopted in making a test. Put very briefly, a large number of observers and a large number of observations

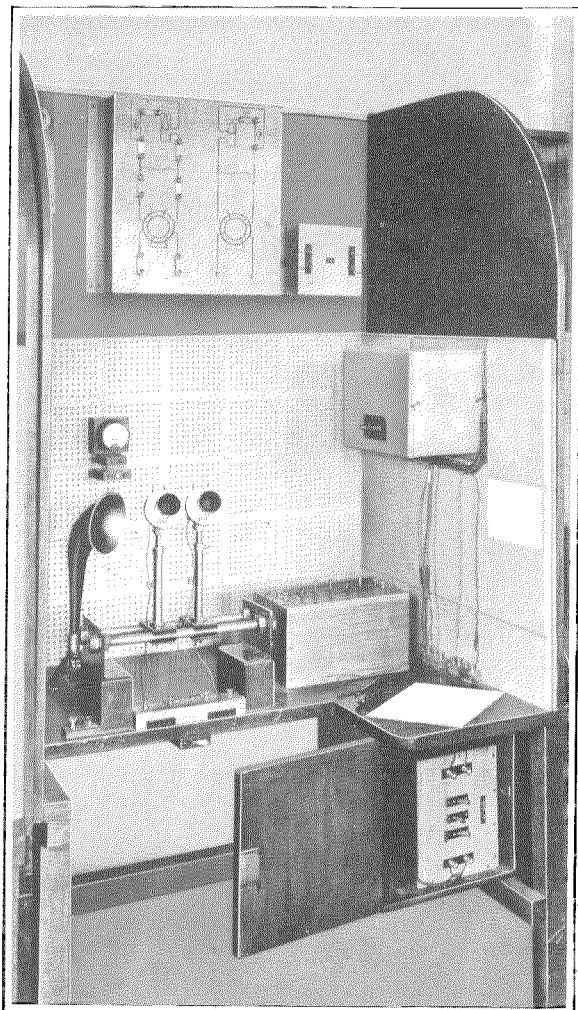

Arrangement of Apparatus at the Talking End

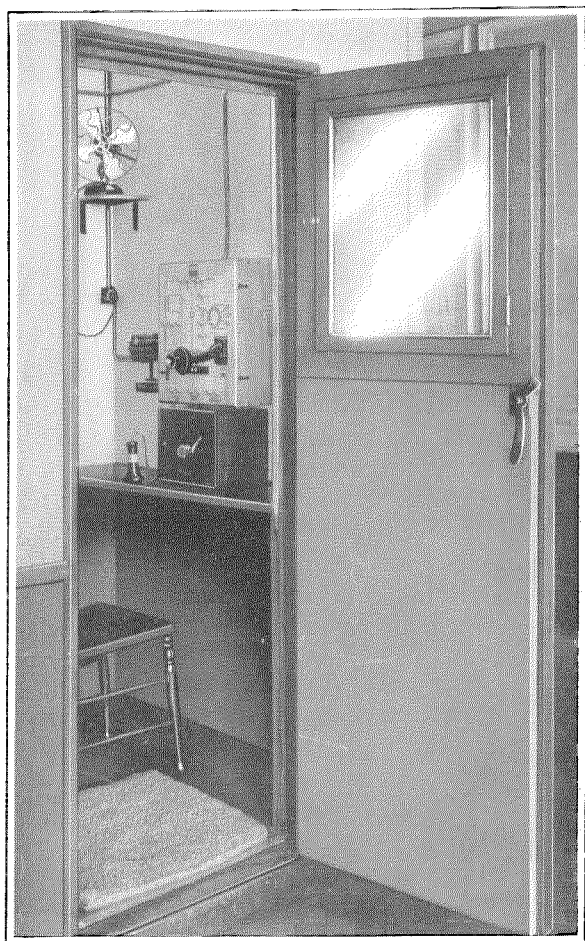

Silence Cabinet.

are required in order to obtain a result by voice and ear measurement that is significant in the sense that it represents the average performance of telephone apparatus in service.

As it is frequently inconvenient or impossible, to employ more than three or four observers, it is in such cases more than ever necessary to define the testing technique with a view to rendering the results of so few observers constant and representative, as well as reproducible by other groups of observers in other laboratories. The same arguments of eliminating unnecessary variables apply to the employment of one standard set-up of carefully defined testing apparatus in all laboratories.

For many years, the laboratories associated with the International Standard Electric Corporation have maintained in London a standard of the type described. Transmitter and receiver

standards have been maintained for the associated manufacturing companies, and in some cases these standards have been supplied to telephone administrations. The standards have been based upon those maintained almost from the birth of telephony by the American Telephone and Telegraph Company, and equality with the parent standards has been maintained by a periodic interchange of standards between London and New York. A precisely defined testing circuit and a defined technique have been in use, and continual attention has been paid to securing methods of testing which represent average service conditions, and at the same time yield results which are reproducible in other similarly equipped laboratories.*

The development of voice-ear measurements has recently taken a step forward. A standard has been established which can be checked by physical measurements, thereby removing the chief objection to the old type of transmitter and receiver standards, namely, the difficulty of detecting whether a drift in the value of the master group of standards occurs over a long period of years. The standards used in telephone laboratories will continue to be, or to resemble, ordinary types of telephone apparatus, but their calibration will rest ultimately either directly or indirectly upon the Transmission Reference Sys-

tem, which can be set up anywhere to a specification, and verified in performance by physical measurements.

The establishment of the Master Transmission Reference System in Paris¹ benefits telephony as a whole. For the first time, there is a standard adopted by common consent, and for the first time two different telephone administrations have a chance of discussing the overall transmission between two telephones in their separate areas in terms of a common basis, and therefore, in mutually intelligible terms.

The Transmission Reference System establishes a standard, but in order to use the standard, equipment and laboratory personnel are needed, as well as the adoption of standardised technique. The Comité Consultatif International has accordingly made recommendations regarding the essential requirements of the testing circuits (or working standards) to be used by telephone administrations.²

Apparatus in accordance with these requirements, and furnished with a number of auxiliary features found to be desirable for facilitating and expediting the testing, is installed in the International Telephone and Telegraph Laboratories, Incorporated, in London. The illustrations show the arrangement of apparatus at the talking end, and one of the silence cabinets in which listening observations are made.

*The method of maintaining standards, the testing circuit and the technique are described in a privately circulated publication entitled *Laboratory Series*. Administrations interested in transmission testing are invited to apply for copies to the Information Department, International Telephone and Telegraph Corporation, Connaught House, Aldwych, London.

¹ "European Telephony as Affected by the International Telephone Committee—'C. C. I.'" *Electrical Communication*, July, 1927.

² A circuit recommended is substantially that used for the past few years by the International Standard Electric Corporation, and its associated Companies.

Alternative Trunking for Telephone Traffic in a Multi-Office Area

THE principle of code translation coupled with the use of tandem centres provides an economical method for handling small groups of outgoing trunks in large areas. For heavy groups, large capacity switches and grading are extensively employed. A new application of alternative trunking has been developed by Standard Telephones and Cables, Ltd., and is described in British Patent Spec. No. 346370, which provides a considerably more efficient method of trunking medium size groups which are too large to be tandemed and too small to take advantage of the large capacity switch.

Hitherto, alternative trunking has been understood to express an arrangement capable of cancelling an unsuccessful set-up, and of admitting connection through other switches. A more efficient method of taking advantage of this principle goes a step further by deliberately providing insufficient direct outgoing trunks, with the knowledge that the overflow traffic may be carried economically by an alternative route through a tandem centre.

The area conditions which will permit the greatest economies to be obtained comprise one or more switching centres with direct circuits to the remaining exchanges in the network. If the junction groups radiating from the switching centres are large, with high busy hour occupancies, the greatest efficiency will be obtained by this new application of Alternative Trunking, as may be seen from the figures given below.

It is a well-established fact that the efficiency of a group of trunks is dependent upon the accessibility between the trunk circuits and the searching switches, e.g., with full availability and the probability of loss of one in 1,000.

A group of 6 trunks carries 1.14 traffic units (34 equated busy hour calls).

A group of 10 trunks carries 3.1 traffic units (93 equated busy hour calls).

A group of 50 trunks carries 32.5 traffic units (975 equated busy hour calls).

This is equivalent to an average trunk occupancy of:

$$6 \text{ trunks: } \frac{1.14}{6} = .19$$

$$10 \text{ trunks: } \frac{3.1}{10} = .31$$

$$50 \text{ trunks: } \frac{32.5}{50} = .64$$

If there is a slip between banks in the multiple, each outlet will carry a volume of traffic equal to the average occupancies shown. If there is no slip the earlier choices will carry a very much greater volume than the later choices although the average remains unaltered.

TOTAL TRAFFIC OFFERED	1.14 T. C.	3.1 T. C.
1st Choice carries.....	.531	.756
2nd " ".....	.354	.670
3rd " ".....	.163	.562
4th " ".....	.066	.437
5th " ".....	.020	.307
6th " ".....	.005	.189
7th " ".....104
8th " ".....047
9th " ".....019
10th " ".....006
Overflow.....	.001	.003

It is a significant fact that out of 1.14 T. C. the first four choices carry 1.113 T. C. or 97.7% of the whole load. Similarly out of 3.1 T. C. the first seven choices carry 3.025 T. C. or 97.6% of the whole.

It follows that if the last choices are removed, a relatively small percentage of the traffic will need to be carried by an alternative route. In order to preserve the occupancies of the early choices it is necessary that the same volume of traffic should be offered to these outlets as before. If all the direct circuits are in use, the call is routed through a tandem exchange—the exchange code being suitably translated.

The number of additional circuits through the

tandem centre required to carry this overflow will depend upon the average occupancy. It has already been shown that the average occupancy for a group of 50 circuits is .64 T. C. and each additional circuit will carry at least this amount of traffic, which is considerably more than the traffic carried by the last five choices of the group of 10.

The number of late choice trunks, which it is wise to save, will depend upon the length, cost and existing plant. A slightly smaller percentage should be removed from the larger groups. Usually the heavier groups cover the shortest distance.

Alternative trunking can be applied with equal advantage to any of the various methods of multiplying between groups of banks now in use. For example if the traffic in a particular route is 3.1 T. C. and the conditions are such that it is most economical to provide only 7 trunks, the overflow traffic to be routed through the tandem

centre will be .075 T. C. If there is no slip the first seven outlets will carry the traffic shown. If there is a complete slip between banks, each of the seven outlets will carry $\frac{3.1 - .075}{7}$ T. C.

Various forms of reversals and slips between shelves will also alter the occupancies of the 7 outlets but the overflow will remain unchanged.

The circuit arrangements to permit alternative trunking have been incorporated in the Translator Bypass System, and equipment for the London area is being manufactured by the Standard Telephones and Cables, Limited for the British Post Office. In one exchange, to which the arrangement has been applied, it was found that 129 out of 413 direct trunks with their terminal apparatus could be dispensed with for an insignificant increase in the number of tandem junctions. The sketch shows the number of junctions saved in each route, calculated on the basis of a loss of 1 in 500.

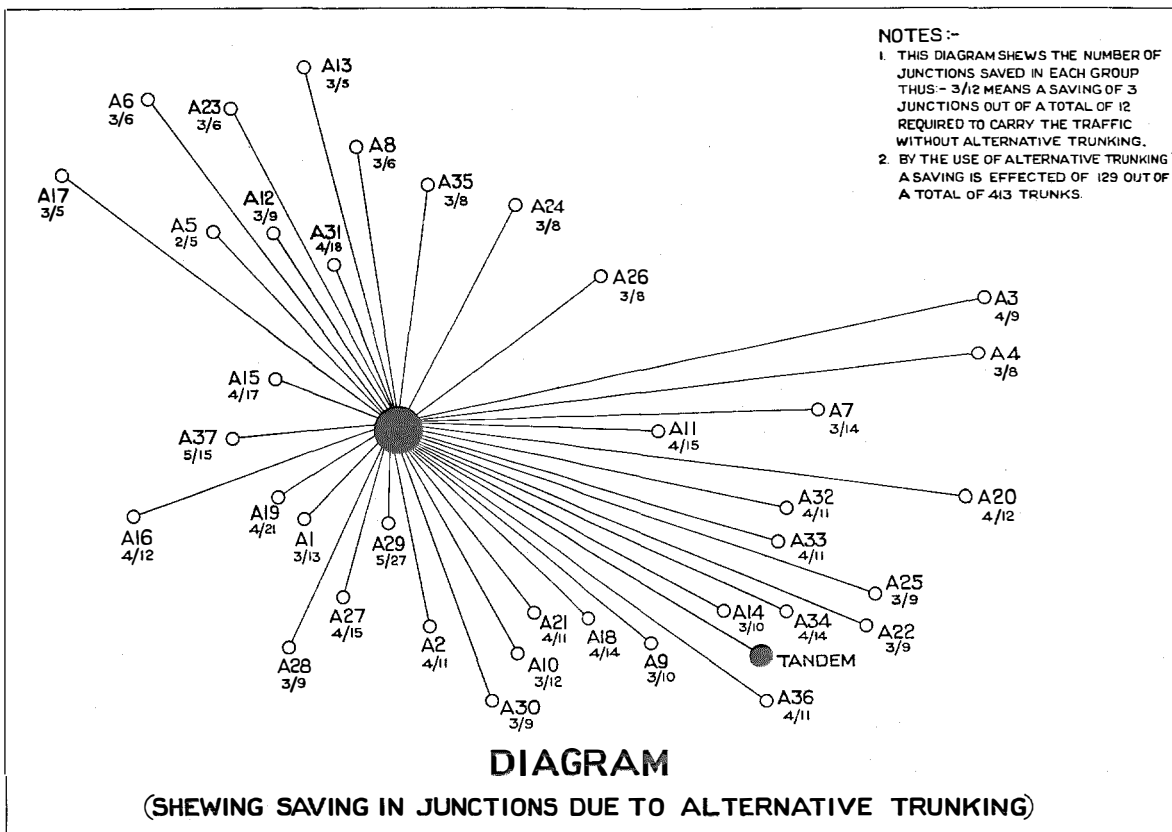

Trunk Route	Number of Trunks required to carry traffic	Trunks Proposed	Traffic Overflowing
A.1	13	10	.10
A.2	11	7	.16
A.3	9	5	.15
A.4	8	5	.11
A.5	5	3	.04
A.6	6	3	.09
A.7	15	11	.13
A.8	6	3	.05
A.9	10	7	.09
A.10	12	9	.14
A.11	15	11	.14
A.12	9	6	.08
A.13	5	2	.07
A.14	10	7	.08
A.15	17	13	.19
A.16	12	8	.15
A.17	5	2	.06
A.18	14	10	.14
A.19	21	17	.19
A.20	12	8	.13
A.21	11	7	.14
A.22	9	6	.10
A.23	6	3	.05
A.24	8	5	.07
A.25	9	6	.11
A.26	8	5	.06
A.27	15	11	.14
A.28	9	6	.07
A.29	27	22	.06
A.30	9	6	.08
A.31	18	14	.17
A.32	11	7	.18
A.33	11	7	.15
A.34	14	10	.14
A.35	8	5	.06
A.36	11	7	.17
A.37	14	10	.21
	413	284	4.25

the tandem centre to the various offices for handling the "Alternative Route" traffic will also be necessary. In no case is the overflow traffic sufficient to demand more than one additional circuit and in fact increase is necessary at all only when the groups of trunks are already fully loaded. The average traffic carried by the trunks outgoing from the tandem centre is slightly over .7 T. C. and on this basis the additional traffic of 4.25 T. C. which it is proposed to pass through the tandem centre will necessitate an additional 6 outgoing circuits.

The following table will enable the total trunk miles saved by the use of alternative trunking to be appreciated:

	Average Miles Length	Without Alternative Trunking		With Alternative Trunking	
		Qty.	Total Miles	Qty.	Total Miles
Direct Circuits.....	4	413	1,652	284	1,136
Outgoing to Tandem Circuits.....	5	24	320	76	380
Additional Outgoing from Tandem Circuits.....	5	6	30

The circuits to and from the tandem centre will be of heavier gauge than the direct circuits and a certain allowance is necessary for the greater cost of these additional circuits.

The principles of alternative trunking can also be used in the reverse sense to permit the direct trunking of a portion of a trunk route which would otherwise be tandemed entirely.

Other advantages from alternative trunking are obtained by the fact that seasonal increase in certain trunk routes can be absorbed by the common group. In a similar way the breakdown of any particular trunk route may be minimised by the automatic use of the alternative route. In very large areas in which there are frequent extensions, the principles of alternative trunking introduce a flexibility which makes it unnecessary to estimate future requirements so accurately, or to provide so much idle capacity of both inside and outside plant for future growth.

To the overflow traffic of 4.25 T. C. should be added the traffic to 110 other exchanges via a tandem centre, totalling 51.7 traffic units. This tandem traffic, while graded in groups of 26, requires 74 trunks. When the overflow traffic is added, the total of 55.95 traffic units could be calculated in graded groups of 40, since in the exchange under consideration the outlets formerly allocated to direct trunks could be used to increase accessibility. The number of trunks now required is 76—an increase of 2 only.

It should be appreciated that the various overflow traffics are of a peaky nature, and could not be added as normal traffic except for the fact that the overflows from the different groups are non-coincident.

Some addition to the trunks outgoing from

The Universal Mounting Plate

By L. H. WEBB, B.Sc.

International Telephone and Telegraph Laboratories, Incorporated

WITH the introduction of the common battery telephone switchboard, originally known as the No. 1 Relay Board, in the early part of the twentieth century, the provision of mounting plates for relays and other associated apparatus assumed considerable importance. Mounting plates required fell generally into two different classes, those mounting from ten to twenty, or even more, pieces of similar apparatus, and those mounting the same quantity of dissimilar apparatus. At first both types followed the same design with all apparatus mounted on cold rolled mild steel plates $\frac{7}{8}$ in. or $\frac{3}{8}$ in. thick. Similar apparatus was grouped together in single rows on strip plates, and mixed apparatus was assembled in rows, either on strip plates or on wider plates accommodating several rows.

The rapid extension of the telephone service and the increasing demand for apparatus necessitated the manufacture of as many components as possible by means of press tools and led to the development of lighter apparatus. When the punched frame relay, usually called the flat type relay, was introduced, a new type of plate was designed to mount twenty of these relays under a common dust cover. It is manufactured entirely by press tools, as may be seen from Figure 1, and provides a satisfactory type of mounting for similar pieces of apparatus since it can be produced economically and the quantities required are sufficient to justify the necessary expenditure on tools. The problem of an improved mounting for dissimilar pieces of apparatus remained unsolved until the International Telephone and Telegraph Laboratories evolved the Universal Mounting Plate. Before describing the Universal Mounting Plate, however, it will be well to review in detail some of the difficulties surrounding the production of the existing type of mounting plate for dissimilar apparatus.

These plates are used to mount a wide variety of apparatus in many different arrangements,

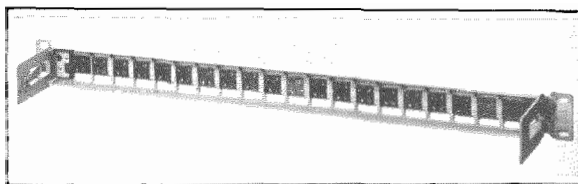

Figure 1—Plate for Mounting Twenty Flat Type Relays Under a Common Dust Cover.

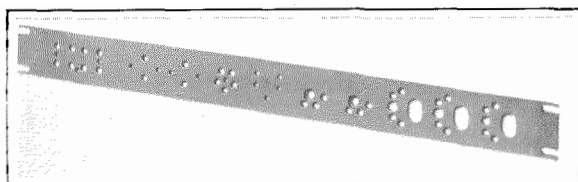

Figure 2—Present Type of Plate for Mounting Mixed Apparatus.

and while their length may be one of a few values, their width may vary between $1\frac{1}{4}$ in. and approximately 10 in. For necessary strength the design utilises flat material $\frac{7}{8}$ in. or $\frac{3}{8}$ in. thick. Plates wider than 2 in. usually carry two rows of apparatus or more. A typical plate is shown in Figure 2, from which it may be seen that the mounting provides for three relays of one type and two of another, an induction coil, a retardation coil, two condensers, and an induction coil of another type. While the demand for any one width of plate is small, that for a particular set of drillings in the plate is very much smaller, so that expensive press tools are not justified. It has not, therefore, been possible to improve the manufacturing processes on this class of plate as rapidly as could have been desired, particularly in view of the fact that some of the apparatus mounted on the plates is itself made on mass-production lines. The operations are both slow and expensive; the positions which the apparatus will occupy on the plate must be marked off from one end, and the various holes and slots required for fixing and wiring put in. Frequently these latter operations are little more than handwork, and where resort is had to tools

of a less expensive kind the wear and tear is always severe; errors are apt to arise during marking out, which do not become apparent until the apparatus is being assembled on the plate, and there is then no option but to discard the whole mounting plate, a procedure resulting in loss of material and of time.

This last objection leads to a consideration of the second set of difficulties surrounding the $\frac{3}{32}$ in. mounting plate for mixed apparatus, viz., delays in production. It often happens that the drillings required are not known until the order has been received and the major portion of the equipment design work has been finished. It is impossible therefore to forecast any exact information which would assist in making quick deliveries. This uncertainty, combined with the small and varied quantities, makes stock keeping a difficult proposition, with the result that delays, both in ordering and in delivering, are involved. Changes in mounting provisions due to modifications made necessary during the production of the equipment or as a result of factory or field tests may lead to further complications

and delays. Similarly, additions or changes during service cannot always be effected; and, if a plate is not fully equipped, the spaces are often left blank.

Attempts have been made in the past to develop a universal mounting plate which would overcome these difficulties, and it has usually been agreed that the plate should consist of one or more crossbars to which can be attached a number of small clips, each clip carrying its own piece of apparatus. The problem, therefore, has resolved itself into one of finding, first, the best shape of crossbar to give sufficient strength to the plate and at the same time involve a minimum loss of mounting space, and second, the simplest means of attaching the clips to the crossbars. Figure 3 illustrates this problem; to the left, there is shown a section of a $\frac{3}{32}$ in. solid mounting plate and, to the right, the problem of the substitution of the equivalent universal mounting plate. The clip (*a*) individual to each piece of apparatus has to be attached to the two crossbars (*b, b*), in such a manner that the stiffness of the plate as a whole is maintained; the

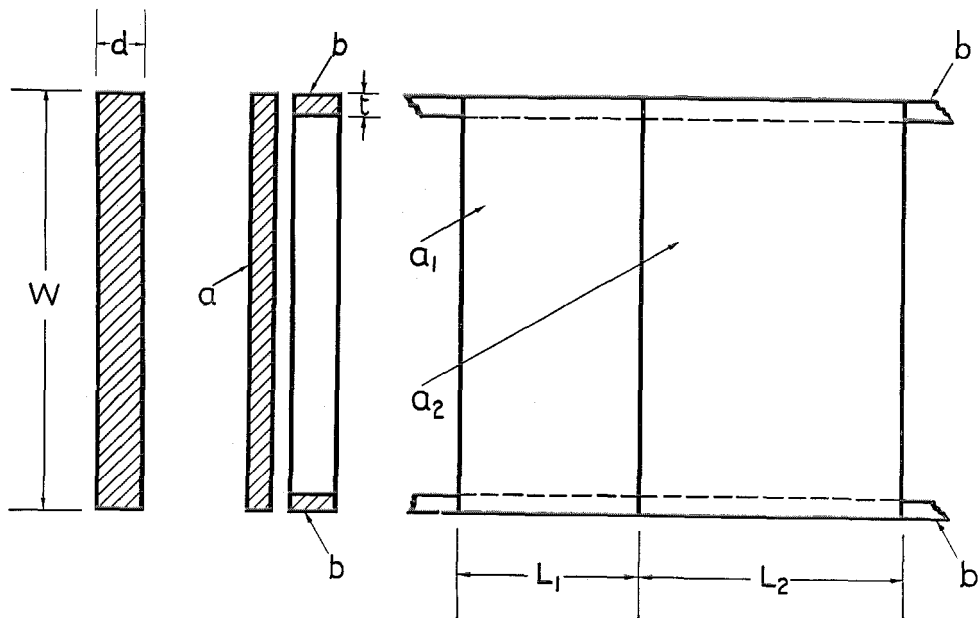

Figure 3—Universal Type of Mounting Plate, Illustrating the Problem Requiring Solution.

loss of mounting space (represented by $2t$, the thickness of the bars), is a minimum, and complete flexibility in the assembly of a number of mounting clips (a_1, a_2), side by side, whose lengths (L) may vary according to the shape of the apparatus they have to carry, is attained. It should be noted that the crossbars (b, b), must

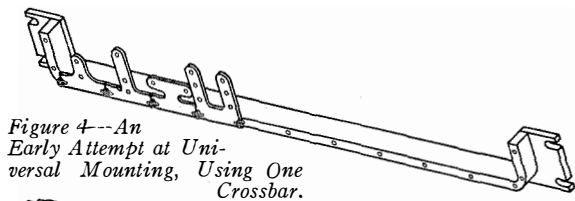

Figure 4—An Early Attempt at Universal Mounting, Using One Crossbar.

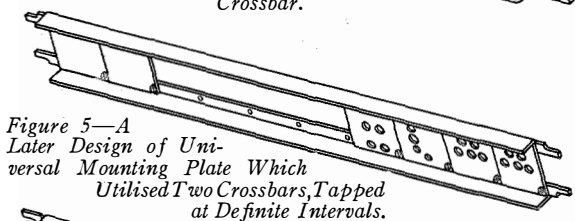

Figure 5—A Later Design of Universal Mounting Plate Which Utilised Two Crossbars, Tapped at Definite Intervals.

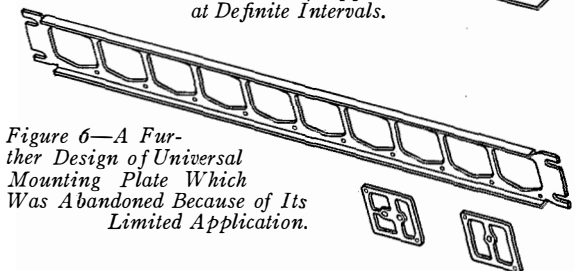

Figure 6—A Further Design of Universal Mounting Plate Which Was Abandoned Because of Its Limited Application.

met. In Figure 4 one crossbar was used, and it was intended to reduce the loss of mounting space by combining into one piece the two crossbars whose thickness (t) was insufficient to allow for tapped holes of the necessary size; the depth (d) was increased above $\frac{7}{8}$ in. to compensate for a relatively small thickness (t). This design was abandoned because the mounting clips were apt to become distorted during shipment of the plate due to the weight of the apparatus, a fact which showed that the use of two crossbars, with provision for supporting the clips at the top and bottom, was to be preferred. Figure 5 represents a later design which utilised two crossbars, tapped at definite intervals for screwing on the mounting clips. Figure 6 illustrates a plate of relatively thin material, stiffened by formed flanges at the top and bottom. From this a series of similar "windows" was punched, the "windows" being so proportioned that they would permit the safe mounting of any piece of apparatus with the aid of a particular mounting clip, and without the risk of the wiring tags which project from the rear of the apparatus touching the plate. As with the previous methods, the mounting clips, shown below the plate, were screwed to the plate by the tapped holes provided, each unit lying directly over a "window."

These schemes were abandoned; in common with the first attempt described above, they suffered from the disadvantage of limited application, which arose from the use of tapped holes along the crossbars, since the length (L) of the mounting clips must necessarily conform to the spacing of these holes. For mounting mixed types of apparatus something more flexible was required, so that any length of clip, depending on the shape of the apparatus to be mounted, could be fixed in any position on the bars adjacent to any other length of clip. The screws and tapped crossbars also resulted in a loss in mounting space.

Another proposal, which marks the first departure from the tapped crossbar, is illustrated in Figure 7, where the crossbars (b, b), are made of U-section and the mounting clips (a) are provided with short flanges which enter between the limbs of the crossbars and are held in position by spinning over the outside edges of the crossbars round the backs of the flanges. There was

be resistant, not only to horizontal and vertical strain, but also to torsional strain set up by the overhang of the apparatus mounted on the plate. This latter condition will not permit the thickness (t) of the crossbars to be too small; but, on the other hand, as t is increased, the available mounting space is reduced, when this is governed by wiring tags on the outer edges of the apparatus projecting through the plate to the rear. At first sight the simplest way of fixing the mounting clips is to drill and tap a number of holes along the crossbars and to assemble the clips in position by screws. If the thickness (t) is small the difficulty of fixing the clip (a) becomes more acute on account of the small space available for a screw hole in the crossbar, and the weakening effect which a number of holes will have on the mounting plate as a whole.

The earliest proposals for a universal mounting plate followed this principle, and Figures 4, 5, and 6 show how the problems of design were

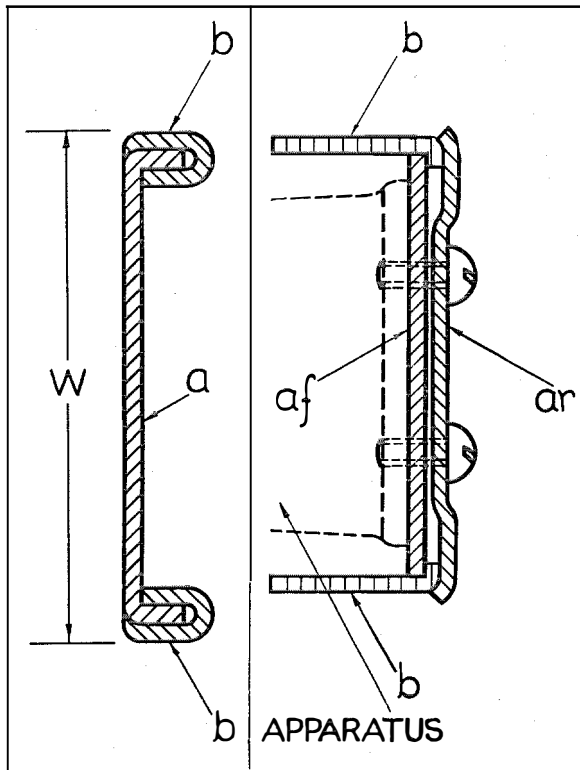

Figure 7—Universal Mounting Plate—The First Departure From the Tapped Crossbar.

Figure 8—Sectional View Illustrating the Principle of the Universal Mounting Plate Developed by the International Telephone and Telegraph Laboratories.

a serious objection to this design since, without damaging the crossbars, it was not possible to remove or add mounting clips after the assembly had once been carried out. The feature of removing or interchanging clips is of course very desirable. The full mounting width (W) was retained in front, but at the back there were three thicknesses of material at the top and bottom, thus reducing the space available for wiring tags and tending to obstruct wiring operations at the back of the plate. However, the design permitted complete flexibility of assembly of different lengths of mounting clips, and to that extent overcame one of the difficulties of the three earlier attempts.

In the Universal Mounting Plate subsequently developed by the International Telephone and Telegraph Laboratories the clamping of the mounting clips to the crossbars has been accomplished in a novel way which overcomes all the difficulties inherent in the earlier designs and

which, as will be shown, meets all the requirements outlined above for the second class of mounting plate already referred to. The principle is shown in Figure 8, where a sectional view of the new plate is given. Instead of a single mounting clip being clamped between two parts of the crossbar by a press tool operation, two mounting clips are clamped against a short abutment from a thin crossbar by the same screws which fix the apparatus to the mounting clips; a principle which, while giving complete flexibility as regards assembly of mixed apparatus, permits the quick removal or addition of any piece of apparatus.

The crossbars (b, b) are constructed from angle iron, having one long flange, which can be made any length to give the necessary stiffness to the plate, and one short flange, whose length is kept as short as possible, and is just sufficient to act as an abutment for the front mounting clip (af). The rear mounting clip (ar) is formed inwards about the central portion of its width and also at its extremities. When the two clips are placed in position on the crossbars there is between them a gap of about 0.008 in., which is gradually reduced to zero as the apparatus fixing screw is tightened. This gives sufficient flexing of the clips within the elastic limit of the material to obtain a firm clamp, and also sets a

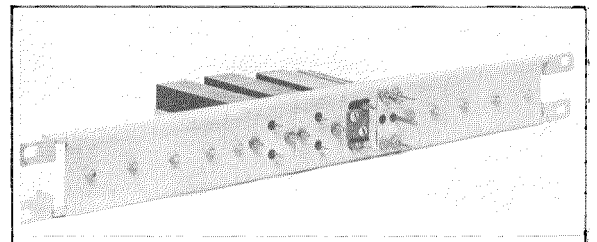
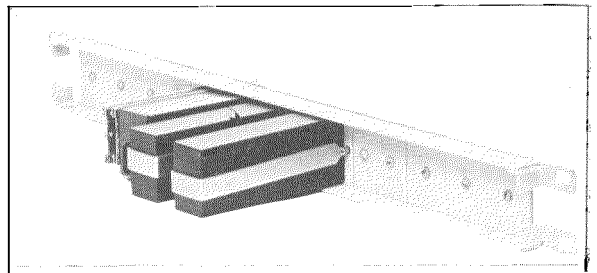

Figure 9—One of the New Universal Mounting Plates Partially Equipped With Mixed Apparatus (Front and Rear Views).

limit to which the fixing screw can be tightened, thus preventing overstraining of the clips. The formed edges of the rear mounting clip bind the two crossbars together on to the front mounting clip which acts as a spacer; and when the assembly is extended along the whole length of the mounting plate it is found that each section of the bars embraced by a pair of clips is maintained in a straight line, so that the whole adequately resists any bending strain which might be set up due to ordinary use. This device is similar to the N-bracing often used in bridge construction.

The apparatus fixing screws perform the dual function of holding the apparatus to the plate, and of clamping the two mounting clips to the crossbars; it is this clamp between mounting clips and crossbars which stiffens the plate as a whole so as very nearly to equal the strength of a solid plate in a vertical direction. Both front and rear mounting clips are pierced with the necessary holes and slots to allow the apparatus to seat on the plate, and, when required, insulating bushes can be pressed into the holes to prevent the wiring tags of the apparatus from touching the frame.

Figure 9 shows a 19 in. Universal Mounting Plate partially equipped with mixed apparatus. It is seen that the unequipped positions are filled with blank mounting clips, the absence of which would reduce the stiffness of the plate, spoil its continuous appearance, and allow free circulation of dust from front to rear. Each crossbar is a separate but similar piece with welded angle pieces at the ends for fixing the plate to the rack

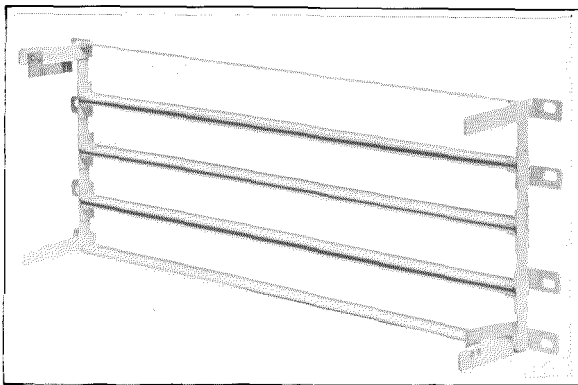

Figure 10—A Multiple Row Universal Mounting Plate Built Up From Unit Crossbars of Three Different Types.

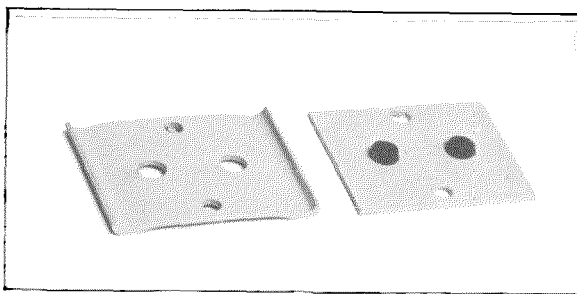

Figure 11—Two Mounting Clips for a Tin-foil Type of Condenser.

in the telephone office. With this arrangement it is necessary to manufacture only one type of crossbar in order to build up any width of single row mounting plate without a dust cover. If a dust cover is required, its supports and spring catches can be made integral with the end angle pieces, as shown in Figure 10, which illustrates a multiple row Universal Mounting Plate built up from unit crossbars of three different types to meet any requirements. Here it is necessary to use means for holding the various crossbars together, in addition to the mounting clips, and a strip of simple section is welded to the various angle pieces at the ends of the crossbars. This spaces the bars correctly and makes the plate sufficiently rigid to mount the full complement of apparatus. The top row is on 2 in. centres; the second, third, and fourth rows are on $1\frac{3}{4}$ in. centres, and provision is made for a common dust cover to fit over the whole plate. The assembly of either a single-row mounting plate or a multiple-row mounting plate is simple, and the arrangement flexible. The advantages of this construction will be readily appreciated by those who realise the large variety of small-quantity mounting plates which are required in telephone practice.

Figure 11 shows two mounting clips for a tin-foil type of condenser, from which it is seen that both pieces are simple products of press tools. No fixing screws, other than those usually provided for fixing the apparatus to the plate, are required for assembling these clips on a Universal Mounting Plate.

It is necessary for all clips assembled in one row to be of the same height, but their widths are entirely independent, and are only limited by the total number to be used and the space available for mounting.

Application

The principal application of the Universal Mounting Plate will be the replacement of $\frac{7}{32}$ in. strip plates which are drilled to mount a variety of apparatus. This is so because it is not economical to set up a number of press tools for piercing the different openings in a one-piece plate intended for this purpose. When, however, the mounting plate can be split up into a number of detachable clips, press tools can be justified for its manufacture, because all of a type can be made at the same time.

It is not possible within the limits of a short article to refer to all the applications to which this new development may be put. Certain of the present types of plates for carrying a row of similar apparatus may be replaced by the new

design where their annual quantities are small, and where the change would be beneficial. In its present state the Universal Mounting Plate is essentially a developed principle intended to be applied in replacing as many existing designs of $\frac{7}{32}$ in. flat mounting plates as an economic study, embracing all factors, will permit. It can be safely stated that it lends itself to mass-production methods in a way which the present designs are never likely to do, and at the same time it provides a wide degree of flexibility in the arrangement of apparatus during equipment design work and during manufacture, and maintains this virtue throughout its life. With justice, therefore, it can be claimed to be a solution of the problem of mounting miscellaneous apparatus.



I N M E M O R I A M

IN the death of Mr. Eduard Otto Zwietusch in an automobile accident, August 8, 1931, the communication industry lost an outstandingly capable and progressive executive, one who served with distinction for over forty-three years. ¶ Born in Milwaukee of German parentage, Mr. Zwietusch retained a fluent command of the German language and an intimate understanding of German life, Americans and Germans both regarding him as one of themselves. ¶ The telephone manufacturing career of Mr. Zwietusch started in 1887, shortly after his graduation from the University of Wisconsin, when he entered the employ of the Western Electric Company, Chicago. He was soon chosen for foreign service and went to Germany as the directing head of E. Zwietusch & Company, Charlottenburg, Salzufer, at that time an associated company of the Western Electric Company. In 1904 he became a German citizen. ¶ Due to his untiring energy and his marked ability in connection with technical and manufacturing problems, he was in a short time able to develop the company into a flourishing concern. In co-operation with the

Reichspost he developed important changes and innovations in the telephone field which were quickly introduced by the German Reichspost. ¶ While essentially a technical man, he was equally at home in the manufacturing and commercial field. One of his hobbies was the design of apparatus using punched parts entirely, and no punching was too intricate or difficult for him to attempt. In the earlier days it must be remembered that telephone apparatus was made up of many small parts riveted together and even of small castings. ¶ Until 1921 Mr. Zwietusch guided the undertaking at Salzufer. Thereafter until 1926 he looked after interests of the International Western Electric Company, now the International Standard Electric Corporation. In January, 1927, he was made Director General of the Vereinigte Telephon-und Telegraphenfabriks Aktien-Gesellschaft, Czeija, Nissl & Co., Vienna, and in 1930 he became Managing Director of the Telephonfabrik Berliner A. G., Berlin-Steglitz. At the time of his death he was Director General of C. Lorenz A. G.

His noble, simple, and kindly manner, his consideration towards everyone and his readiness to help wherever he could, secured for him the love, respect, and confidence of all his colleagues. Both in Europe and in America he leaves a large circle of friends who mourn his premature death.

Stockholm-Malmö Railway Cable

IN *Electrical Communication*,* Vol. IV, No. 4, Mr. Ivar Billing, Byrådirektör in the Swedish Railway Administration, contributed an article on the telephone cable, which had then been installed along the railway between Stockholm and Göteborg, a distance of 458 km. The main reason for placing the telephone circuits in a cable was to protect them against any disturbance from the electric power circuits, used in the operation of the railway.

Electric traction is being used to an increasing extent on the railways in Sweden, as will be seen from the accompanying map. The present length of electrified line is over 900 kilometres, divided almost equally between the northern and southern sections, only the southern section being shown on the map. The rate at which further electrification is planned is that by 1937 or 1940

* "Stockholm-Göteborg Railway Cable," April, 1926.

the total electrified line will be 2,900 kilometres, which represents some 40% of the entire railroad system. In general, a new telephone cable has to be installed as each section of line becomes electrified. A short time ago, the Swedish Parliament sanctioned the electrification of the important section from Stockholm to Malmö, with several tie lines to the Stockholm-Göteborg line and an extension to Trälleborg, which is the railhead for the railway traffic with the continent of Europe. This work is now under way and simultaneously a telephone cable over the same route is being installed. The aggregate length of cable involved is 936.3 km. of various types, particulars of which are given in the table below:

Section	Distance Km.	Type of Cable
Stockholm-Malmö . . .	613.3	3 quads 1.4 mm. conductor 10 quads 0.9 mm. " 2 pairs 1.4 mm. "
Myölby-Orebro	125.0	3 quads 1.4 mm. conductor 16 pairs 0.9 mm. "
Nassjö-Falköping	115.0	3 quads 1.4 mm. conductor 16 pairs 0.9 mm. "
Norrköping-Katrineholm	49.8	3 pairs 1.4 mm. conductor 12 " 0.9 mm. "
Malmö-Trälleborg	33.2	3 pairs 1.4 mm. conductor 12 " 0.9 mm. "
Total	936.3	

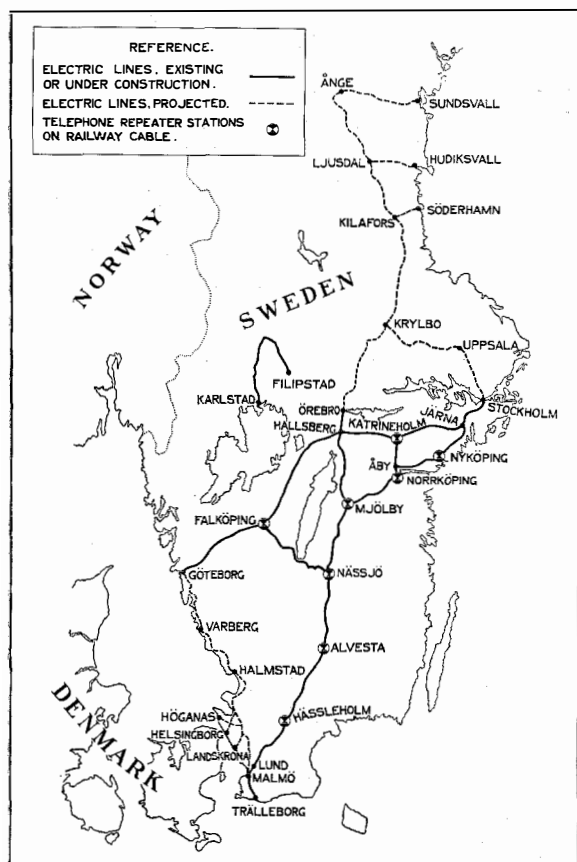

The cable is of the usual telephone type, paper insulated, lead covered and lightly armoured but capable of withstanding a somewhat higher breakdown voltage between conductors and between core and sheath than cable installed in positions free from the danger of interference from electrical power systems. The mutual capacity between wires and pairs is also lower than in normal cables. Loading coils will be installed throughout on a spacing of 2,200 m. to provide the required attenuation and cut-off characteristics. The quadded circuits will be loaded with 160 mH side and 63 mH phantom coils or 177 mH side and 63 mH phantom coils, whilst the

paired circuits will be loaded with 160 mH or 177 mH coils.

Since the cable circuits for certain distances are of such length that loading alone will not give the desired transmission equivalents, the necessary telephone repeaters will be installed in six stations along the route.

The cable is being manufactured by Sieverts Cable Works, Sweden, a company working under a license from the International Standard Electric Corporation in the long-distance cable field. The repeater station equipment is being made by the Standard Telephones and Cables, Limited, of London.



The demand for tickets for the National Disarmament Meeting on July 11, 1931, at Albert Hall, was so great that an overflow meeting had to be held in Kensington Gardens, the speeches being relayed by means of the Public Address system of Standard Telephones and Cables, Limited, London. The photograph shows the crowd gathered around the loud speakers near the Albert Memorial, listening to the speeches.

INTERNATIONAL TELEPHONE AND TELEGRAPH CORPORATION

BOARD OF DIRECTORS

<p>FREDERICK W. ALLEN Lee, Higginson & Company</p> <p>ARTHUR M. ANDERSON J. P. Morgan & Co.</p> <p>HERNAND BEHN, President</p> <p>SOSTHENES BEHN, Chairman</p> <p>F. WILDER BELLAMY Dominick & Dominick</p> <p>EDWARD J. BERWIND Chairman, Berwind-White Coal Mining Company</p> <p>JOHN W. CUTLER Edward B. Smith & Co.</p> <p>R. FULTON CUTTING Financier</p> <p>GEORGE H. GARDINER Davis Polk Wardwell Gardiner & Reed</p> <p>CONDE DE GÜELL President, Compañía Trasatlántica Española, Barcelona</p> <p>ALLEN G. HOYT Vice-President, The National City Bank of New York</p> <p>IVAR KREUGER Chairman, Kreuger & Toll Company, Stockholm</p>	<p>RUSSELL C. LEFFINGWELL J. P. Morgan & Co.</p> <p>CLARENCE H. MACKAY Chairman of the Board, Postal Telegraph and Cable Corporation</p> <p>JOHN L. MERRILL President, All America Cables, Incorporated</p> <p>CHARLES E. MITCHELL Chairman, The National City Bank of New York</p> <p>WALTER E. OGILVIE President, Havana Terminal Railroad Company</p> <p>HENRY B. ORDE, Vice-President</p> <p>BRADLEY W. PALMER Chairman of the Executive Committee, United Fruit Co., Boston</p> <p>GEORGE E. PINGREE President, International Standard Electric Corporation</p> <p>WOLCOTT H. PITKIN Vice-President and General Attorney</p> <p>LANSING P. REED Davis Polk Wardwell Gardiner & Reed</p> <p>MARQUÉS DE URQUIJO President, Banco Urquijo, Madrid</p>
---	---

GEORGE H. GARDINER
General Counsel

OFFICERS

<i>Chairman</i>		<i>President</i>
SOSTHENES BEHN		HERNAND BEHN
	<i>Vice-Presidents</i>	
<p>HENRY B. ORDE</p> <p>LEWIS J. PROCTOR</p> <p>GEORGE E. PINGREE</p>	<p>PHILIP K. CONDUCT</p> <p>JOHN L. MERRILL</p> <p>FRANK W. PHELAN</p>	<p>WILLIAM F. REPP</p> <p>FRANK GILL</p> <p>FRANK C. PAGE</p>
<i>Vice-President and General Attorney</i>		<i>Vice-President and General Technical Director</i>
WOLCOTT H. PITKIN		JAMES L. McQUARRIE
<i>Comptroller</i>	<i>Secretary</i>	<i>Treasurer</i>
EDWIN F. CHINLUND	S. G. ORDWAY	JAMES E. FULLAM

THE International Telephone and Telegraph Corporation was organized to cooperate and assist technically and financially in the general development of electrical communications in a broad international sense, and, with respect to the organization and development of national communications systems, it is the purpose of the International Telephone and Telegraph Corporation to develop truly national systems operated by the nationals of each country in which the International Corporation is or may become interested. The International Corporation was not organized with a single profit-making purpose to itself nor with the desire of imposing American practices in its foreign activities. There appeared to be a fruitful field of service to be ren-

dered in bringing together under one general organization electrical communications systems, and the extension by the International Corporation to the Associated Companies of the technical and financial facilities and direction that might be needed for their intensive and efficient development. The best American practices have been suggested but never imposed. On the contrary, the International Corporation has always been ready and quick to adjust American practices to local conditions and to adopt such local practices as were conducive to the successful development of the various entities. The combined and co-ordinated effort of the Associated Companies of the International System is today justifying the plans and purposes of the Corporation.

Licensee Companies

BELL TELEPHONE MANUFACTURING COMPANY.....	<i>Antwerp, Belgium</i>
<i>Branches: Berne, The Hague, Brussels.</i>	
STANDARD ELECTRIC DOMS A SPOLECNOST.....	<i>Prague, Czechoslovakia</i>
CHINA ELECTRIC COMPANY, LIMITED.....	<i>Shanghai, China</i>
<i>Branches: Canton, Hankow, Harbin, Mukden, Peiping, and Tientsin, China.</i>	
COMPAÑÍA STANDARD ELECTRIC ARGENTINA.....	<i>Buenos Aires, Argentina</i>
INTERNATIONAL STANDARD ELECTRIC CORPORATION, <i>Branch Office,</i>	
	<i>Rio de Janeiro, Brazil</i>
INTERNATIONAL STANDARD ELECTRIC CORPORATION OF MEXICO.....	<i>New York, N. Y.</i>
INTERNATIONAL TELEPHONE AND TELEGRAPH LABORATORIES, INCORPORATED	
	<i>Hendon, England</i>
LE MATÉRIEL TÉLÉPHONIQUE.....	<i>Paris, France</i>
NIPPON DENKI KABUSHIKI KAISHA.....	<i>Tokyo, Japan</i>
<i>Branches: Osaka, Dalny, Seoul, Taihoku.</i>	
FERDINAND SCHUCHHARDT, BERLINER FERNSPRECH-UND TELEGRAPHENWERK	
AKTIENGESELLSCHAFT.....	<i>Berlin, Germany</i>
STANDARD ELECTRIC AKTIESELSKAP.....	<i>Oslo, Norway</i>
AKTIESELSKABET SKANDINAVSKE KABEL- OG GUMMIFABRIKER.....	<i>Oslo, Norway</i>
STANDARD ELECTRIC AKTIESELSKAB.....	<i>Copenhagen, Denmark</i>
STANDARD ELECTRICA ROMANA S/A.....	<i>Bucharest, Rumania</i>
STANDARD ELÉCTRICA, S. A.....	<i>Madrid, Spain</i>
<i>Branches: Barcelona, Bilbao, Sevilla, Santander.</i>	
STANDARD ELETRICA ITALIANA.....	<i>Milan, Italy</i>
<i>Branch: Rome.</i>	
STANDARD TELEPHONES AND CABLES, LIMITED.....	<i>London, England</i>
<i>Branches: Birmingham, Glasgow, Leeds, Manchester, Dublin, Cairo, Johannes-</i>	
<i>burg, Calcutta, Singapore.</i>	
STANDARD TELEPHONES AND CABLES (AUSTRALASIA), LIMITED.....	<i>Sydney, Australia</i>
<i>Branches: Melbourne, Wellington.</i>	
STANDARD VILAMOSSÁGI RÉSZVÉNY TÁRSASÁG.....	<i>Budapest, Hungary</i>
SUMITOMO ELECTRIC WIRE & CABLE WORKS, LIMITED.....	<i>Osaka, Japan</i>
VEREINIGTE TELEPHON-UND TELEGRAPHENFABRIKS AKTIENGESELLSCHAFT,	
CZEIJA, NISSL & CO.....	<i>Vienna, Austria</i>
<i>Branch: Tallinn.</i>	
STANDARD ELECTRIC COMPANY W POLSCE SP. Z O. O.....	<i>Warsaw, Poland</i>

Sales Offices and Agencies Throughout the World
