

Institute of Radio Engineers

(INCORPORATED)

Organized 1912



YEAR BOOK 1930

*Published by Institute of Radio Engineers
33 West 39th Street
New York, N. Y.*

YEAR BOOK

of the

Institute of Radio Engineers

1930

CONTENTS

	Page
Officers and Board of Direction, 1930	4
Past Officers of the Institute	5
Institute Committees for 1930	6
Institute Representatives in Other Technical Bodies	8
General Information	9
History of the Institute	9
Aims of the Institute	9
Publications	10
Awards for Meritorious Achievement	10
Qualifications for Membership	12
Institute Badges	12
Certificates of Membership	14
Meetings	14
Sections of the Institute	14
American Standards Association	16
Report of the Secretary for 1929	18
Comparative Financial Balance Sheet	31
Constitution of the Institute	32
Amendments to the Constitution	39
By-Laws Governing Sections	41
Standards Relating to Radio Engineering	44
Catalog of Membership, Alphabetically Listed	107
Catalog of Membership, Geographically Listed	253

Price \$1.50 per copy

Supplement to the PROCEEDINGS for March, 1930

OFFICERS AND BOARD OF DIRECTION, 1930

(Terms expire January 1, 1931, except as otherwise noted)

President

LEE DE FOREST

Vice-President

A. G. LEE

Treasurer

MELVILLE EASTHAM

Secretary

HAROLD P. WESTMAN

Editor

ALFRED N. GOLDSMITH

Managers

J. H. DELLINGER
R. A. HEISING

L. M. HULL
R. H. MANSON

A. F. VAN DYCK
ARTHUR BATCHELLER
(Serving until Jan. 1, 1932)

C. M. JANSKY, JR.
(Serving until Jan. 1, 1932)

J. V. L. HOGAN
(Serving until Jan. 1, 1933)

R. H. MARRIOTT
(Serving until Jan. 1, 1933)

Junior Past Presidents

ALFRED N. GOLDSMITH
A. HOYT TAYLOR

Board of Editors, 1930

ALFRED N. GOLDSMITH, *Chairman*
STUART BALLANTINE
RALPH BATCHER
J. W. HORTON

G. W. PICKARD
L. E. WHITEMORE
W. WILSON

Assistant Editor
M. I. SANDT

Advertising Manager
M. P. ROY

Past Officers of the Institute

Name	Pres.	Vice Pres.	Sec'y	Assis. Sec'y	Treas.	Editor	Assoc. Editor	Manager
E. F. W. Alexanderson	1921	1920						1917-18
E. H. Armstrong								1918-19; 1921
L. W. Austin	1914							1915-17
Arthur Batcheller								1923-29
Edward M. Bennett	1927	1926						1923-25
Ralph Bown								1916; 21
W. H. G. Bullard						1920		1928
W. G. Cady								
E. L. Chaffee		1922						
G. H. Clark							1914	
John M. Clayton			1923-29	1927-28				
E. H. Colpitta		1927						1921-23
Frank Conrad	1922	1921						
Fulton Cutting								
George S. Davis	1925	1924						1915; 17-19
J. H. Dellinger								1928-29
Melville Eastham								1922-27
Lloyd Esponschied					1927-29			1913; 15-26
L. F. Fuller								1928
Alfred N. Goldsmith	1928		1918-27					1928
A. H. Grebe						1913-28		1924-26; 28
J. H. Hammond, Jr.					1914			
Louis A. Hazeltine								1923-27
R. A. Heising								1927-29
Guy Hill								1914-16; 18-20
J. V. L. Hogan	1920	1916-19						1913-15; 21-29
Warren Hubley						1915-16; 1918-27		
Lewis M. Hull								1920
C. M. Jansky, Jr.	1916							1920
A. E. Kennelly								
L. R. Krumm	1923				1917			1921
Irving Langmuir								
R. H. Langley				1914				
George H. Lewis	1926	1925						1915-19; 26
Donald McNicol								1919-24
R. H. Manson	1912	1913						1927-29
R. H. Marriott								1914-16; 20-22; 26-29
Alexander Meissner		1920						
George R. Metcalfe	1924	1923					1926-27	1922
J. H. Morecroft								1924-25
H. W. Nichols	1913							
G. W. Pickard	1918-19	1915						
G. W. Pierce								
C. J. Porter	1917					1928		
M. I. Pupin								1918-19
A. E. Reoch								1925-27
D. Sarnoff								1918-20
E. J. Simon								1915
G. O. Squier								1918-22
John Stone Stone	1915	1914						1916-19
A. Hoyt Taylor	1929							
Thomas T. Trapnell						1914		
R. A. Weagant								1914-17
H. P. Westman						1929		
L. E. Whittemore		1928						1926-27; 1929

COMMITTEES OF THE INSTITUTE OF RADIO ENGINEERS, 1930

Committee on Meetings and Papers

J. W. HORTON, *Chairman*

Theory, Circuit and General R. F. FIELD	Stations and Operation, Broadcasting R. M. MORRIS
Generating Apparatus and Theory L. P. WHEELER	Television DELBERT E. REPLOGLÉ
Receiving Apparatus and Theory H. A. WHEELER	Picture Transmission R. H. RANGER
Transmission through Space G. W. KENRICK	Miscellaneous Communication Systems H. A. AFFEL
Measurements and Standards C. B. JOLLIFFE	Miscellaneous Technical Papers K. S. VAN DYKE
Vacuum Tubes and Thermionics W. C. WHITE	Historical, Book Reviews, Bibliographies S. S. KIRBY
Aerials and Aerial Systems G. C. SOUTHWORTH	Radio Communication Systems T. A. M. CRAVEN
Acoustics and Audio Frequencies IRVING WOLFF	Radio Manufacturing G. G. THOMAS
Aircraft Radio F. M. RYAN	Members at Large ELLERY W. STONE HARRY SADENWATER

Committee on Admissions

R. A. HEISING, *Chairman*

C. N. ANDERSON	R. H. MARRIOTT
ARTHUR BATCHELLER	E. R. SHUTE
C. M. JANSKY, JR.	J. S. SMITH
A. G. LEE	A. F. VAN DYCK
GEORGE LEWIS	Chairman of each Section, ex officio

Committee on Institute Awards

W. G. CADY, *Chairman*

STUART BALLANTINE	ALFRED N. GOLDSMITH
RALPH BOWN	A. HOYT TAYLOR

Committee on Bibliography

B. E. SHACKELFORD, *Chairman*

M. C. BATSEL	DONALD MCNICOL
W. G. CADY	G. W. PICKARD
J. H. DELLINGER	E. R. SHUTE
MELVILLE EASTHAM	H. M. TURNER
G. W. GIBBS	A. F. VAN DYCK
C. B. JOLLIFFE	H. A. WHEELER
F. H. KROGER	L. P. WHEELER
R. H. LANGLEY	W. C. WHITE
R. H. MANSON	L. E. WHITTEMORE
J. O. MAUBORGNE	W. WILSON

Committee on Broadcasting

L. M. HULL, *Chairman*

ARTHUR BATCHELLER	C. W. HORN
PAUL A. GREENE	R. H. MARRIOTT
RAYMOND GUY	E. L. NELSON
J. V. L. HOGAN	

Committee on Constitution and Laws

R. H. MARRIOTT, *Chairman*

ARTHUR BATCHELLER	R. A. HEISING
MELVILLE EASTHAM	G. W. PICKARD
W. G. H. FINCH	HAROLD A. ZEAMANS
H. E. HALLBORG	

Committee on Membership

I. S. COGGESHALL, *Chairman*

W. H. BELTZ	A. F. MURRAY
F. R. BRICK	M. E. PACKMAN
W. W. BROWN	C. R. ROWE
BEVERLY DUDLEY	J. E. SMITH
H. C. GAWLER	JOHN C. STROEBEL, JR.
F. A. KOLSTER	A. M. TROGNER
S. R. MONTCALM	Secretary of each Section, ex officio

Committee on New York Programs

R. H. RANGER, *Chairman*

AUSTIN BAILEY	F. M. RYAN
H. C. GAWLER	E. R. SKUTE

Committee on Nominations

ALFRED N. GOLDSMITH, *Chairman*

ARTHUR BATCHELLER	R. H. MANSON
W. G. CADY	DONALD MCNICOL
MELVILLE EASTHAM	

Committee on Publicity

W. G. H. FINCH, *Chairman*

H. W. BAUKAT	LLOYD JACQUET
ZEH BOUCK	ARTHUR H. LYNCH
C. E. BUTTERFIELD	J. F. J. MAHER
ORRIN E. DUNLAP	A. H. MORSE
FRED EHLERT	U. B. ROSS
A. H. HALLORAN	J. G. UZMANN
R. D. HEINL	WILLIS K. WING

Committee on Sections

AUSTIN BAILEY, *Chairman*

L. A. BRIGGS	A. F. MURRAY
D. H. GAGE	A. M. PATIENCE
VIRGIL M. GRAHAM	B. E. SHACKELFORD
C. W. HORN	Chairman of each Section, ex officio
R. H. LANGLEY	

Committee on Standardization

J. H. DELLINGER, *Chairman*

WILSON AULL
M. C. BATSEL
W. R. BLAIR
E. L. BOWLES
C. E. BRIGHAM
E. L. CHAFFEE
L. M. CLEMENT
T. A. M. CRAVEN
T. McL. DAVIS
E. T. DICKEY
CARL DREHER
H. W. DREYER
ALLEN DU MONT
C. P. EDWARDS
S. W. EDWARDS
P. H. EVANS
GENERAL FERRIE
H. A. FREDERICK
ALFRED N. GOLDSMITH
W. E. HOLLAND
C. B. JOLLIFFE
GEORGE LEWIS

R. H. MANSON
ALEXANDER MEISSNER
C. B. MIRICK
GINO MONTEFINALE
R. M. MORRIS
E. L. NELSON
L. G. PACENT
HARADEN PRATT
D. E. REPLOGLE
J. L. REYNOLDS
H. B. RICHMOND
C. E. RICKARD
A. F. ROSE
N. H. SLAUGHTER
H. M. TURNER
K. B. WARNER
W. C. WHITE
DONALD WHITING
L. E. WHITTEMORE
C. E. WILLIAMS
HIDETSUGU YAGI

INSTITUTE REPRESENTATIVES IN OTHER TECHNICAL BODIES

Council of the American Association for the Advancement of Science.....
..... J. C. JENSEN
Radio Advisory Committee, Bureau of Standards, Department of Commerce
..... L. M. HULL
Radio Broadcasting Committee, American Engineering Council.....
..... MELVILLE EASTHAM
Committee on Aeronautic Radio Research, Department of Commerce.....
..... F. M. RYAN

AMERICAN STANDARDS ASSOCIATION

Sectional Committee on Radio.....
..... L. E. WHITTEMORE, L. M. HULL, J. V. L. HOGAN
Technical Committees—
Transmitting and Receiving Sets and Installations... MELVILLE EASTHAM
Component Parts and Wiring..... W. P. POWERS
Vacuum Tubes..... M. J. KELLY, JR.
Electro-Acoustic Devices..... A. E. KENNELLY
Power Supply and Outside Plant..... R. H. HORNING
Sectional Committee on Electric Wiring and Apparatus in Relation to Fire
Hazard (National Electric Code)..... DONALD McNICOL
Sectional Committee on Electrical Installations on Shipboard... J. V. L. HOGAN
Sectional Committee on Scientific Symbols and Abbreviations... A. E. KENNELLY
Subcommittee on Electrical Abbreviations—Including Radio.....
..... A. E. KENNELLY, L. E. WHITTEMORE (alternate)
Sectional Committee on Standards for Drawings and Drafting Room Practices
..... L. E. WHITTEMORE
Sectional Committee on Definitions of Technical Terms..... HARADEN PRATT

GENERAL INFORMATION

Institute History

Prior to the formation of the Institute of Radio Engineers, two other organized groups of radio enthusiasts held meetings in New York and Boston. These were the Wireless Institute and the Society of Wireless Telegraph Engineers.

On May 13, 1912, these two organizations were merged, taking the new name of the Institute of Radio Engineers. Headquarters were established in New York.

The Society of Wireless Telegraph Engineers had a membership of eleven on January 1, 1907, and forty-three on January 1, 1912. The Wireless Institute had fourteen members on January 1, 1909, and twenty-seven members on January 1, 1912. The Institute of Radio Engineers, at the time of its foundation, had less than fifty paid-up members.

Prominent in the early work of the Society of Wireless Telegraph Engineers were John Stone Stone, Lee de Forest, and Fritz Lowenstein. Those identified with the initial work of the Wireless Institute included: John S. Murphy, R. A. Somerville, Joseph D. Fountain, R. B. Respress, R. A. Cleva, John Gregg, E. Barnwell, Philip Farnsworth, Sidney L. Williams, R. H. Marriott, G. W. Pickard, Harry Shoemaker, and Eugene Thurston. The consolidation of these two societies and the initial work of organizing the Institute of Radio Engineers were done by J. V. L. Hogan, A. N. Goldsmith, and R. H. Marriott.

Aims of the Institute

The Institute of Radio Engineers functions solely to advance the art and science of radio communication. It numbers among its members nearly all of the men who have been prominent in the development of radio in the United States, as well as many noted radio engineers and scientists in other countries.

The membership of the Institute consists of those persons who are qualified for any of its several grades of membership, either through their interest in radio communication, or by practice of some phase of radio engineering as a profession. The eligibility of an applicant to membership in any grade is finally determined by the Board of Direction of the Institute, in most cases on the recommendation of the Committee on Admissions.

Through the presentation and publication of original papers, by affording its members the opportunity of meeting to discuss radio problems, by awards of honors and prizes, and in other ways, the Institute fosters and encourages the development of this important means of communication, and particularly aids in the exchange of radio information of a technical and engineering nature.

Publications

The papers presented at the meetings of the Sections and of the Institute in New York, together with the discussions and other papers submitted by Institute members, are printed in the PROCEEDINGS of the Institute of Radio Engineers, published monthly. The PROCEEDINGS thus constitutes a continually growing store of information on all phases of radio engineering. Since the first issue in 1913, 678 papers have been printed. The PROCEEDINGS is sent free to all Institute members of all grades. The subscription price to non-members is \$10.00 per year.

Standardization Reports giving definitions of terms and standard graphical symbols used in radio communication were issued in 1913, 1915, 1922, and 1926. The Standardization Report for 1928 was published in the 1929 Year Book. These Standardization Reports have become an important reference authority on terminology and symbols in radio practice.

This Year Book is the seventh one the Institute has published; the first appearing in 1914, the second in 1916, the third in 1926, and subsequent issues each year.

Institute Awards for Meritorious Achievement in Radio

The Institute each year makes two awards to radio investigators in recognition of noteworthy inventions or other developments in radio technique.

One award, the Institute Medal of Honor, is a gold medal suitably engraved. The Medal of Honor is awarded to that person who has made public the greatest advance in the science or art of radio communication, regardless of the time of performance or publication of the work on which the award is based.

The advance may be an unpatented or patented invention which has been completely and adequately described in a scientific or engineering publication of recognized standing, and must be in actual operation. Preference will be given to widely used and widely useful inventions.

The advance may also be a scientific analysis or explanation of hitherto unexplained phenomena of distinct importance to the radio art, though the application thereof need not be immediate. Preference will be given analyses directly applicable in the art. Publication, in this case also, must be in full and approved form.

The advance may further be a new system of traffic regulation or control; a new system of administration of radio companies or of service of steamship, railroad, or other companies; a legislative program beneficial to the radio art, or any portion of the operating or regulating features of the art. It must be publicly described in clear and approved form and must, in general, be actually adopted in practice.

This medal has been awarded to the following:

E. H. Armstrong.....1918	John Stone Stone.....1923
E. F. W. Alexanderson.....1919	M. I. Pupin.....1924
G. Marconi.....1920	G. W. Pickard.....1926
R. A. Fessenden.....1921	L. W. Austin.....1927
Lee de Forest.....1922	Jonathan Zenneck.....1928
G. W. Pierce.....1929	

The other award is known as the Morris Liebmann Memorial Prize. This award was made possible through the generosity of Emil J. Simon, a Fellow of the Institute. It is given to perpetuate the memory of the late Colonel Morris N. Liebmann. The award consists of the sum of five hundred dollars which is the annual income derived from the principal of the gift of ten thousand dollars.

The award is made by a special committee, appointed annually by the Board of Direction, to that member of the Institute who, in the opinion of this committee, shall have made the most important contribution to the radio art during the preceding calendar year.

The Morris Liebmann Memorial Prize has been awarded to the following:

L. F. Fuller.....1919	J. R. Carson.....1924
R. A. Weagant.....1920	Frank Conrad.....1925
R. A. Heising.....1921	Ralph Bown.....1926
C. S. Franklin.....1922	A. Hoyt Taylor.....1927
H. H. Beverage.....1923	Walter G. Cady.....1928
E. V. Appleton.....1929	

All members of the Institute are eligible as candidates for these highly valued prizes. Each year's developments are carefully reviewed and examined by the Committees appointed, and by the Board of

Direction, the awards being made by vote of the Board in the case of the Institute Medal of Honor, and by vote of the committee appointed by the Board in the case of the Liebmann Memorial Prize.

The names of the engineers who have already been granted awards clearly show that the younger men as well as the pioneers, and the design, development and factory engineers as well as research engineers, have been given due recognition in the making of awards.

Grades of and Qualifications for Membership

The several grades of membership in the Institute of Radio Engineers as well as the qualifications required for each, dues, fees, etc., are tabulated on page 13. Full details will be found in the Constitution under Articles II and III. All the benefits of membership are available at once to all new members of any grade, except that Juniors are not eligible to vote. Membership means, also, that one is enrolled with others having a similar interest in radio, and that one is on record as being among those who are interested and active in the development of this new and useful branch of the electrical engineering industry.

The grades of Fellow and Member require a much higher degree of technical training and experience than the grade of Associate. In order to maintain a high standard of membership, the Board of Direction in each case very carefully scrutinizes the applications for Fellow and Member grades.

Before applying for membership in any grade the applicant should carefully read the Constitution of the Institute to ascertain for which of the several grades he is eligible. An extract from the Constitution dealing with admissions, eligibility, fees, etc., is printed on the back of the application form obtainable from Institute Headquarters.

When filling in the application form, the applicant should submit the names of those persons who have knowledge of his professional experience, rather than those who have a high professional standing, but cannot vouch for him. The personal signatures of references are not required.

Institute Badges



The authorized Institute badge is of 14-karat gold, finished in enamel and gold lettering. The Fellow's badge is of blue lettering on a gold background, Member's badge of gold lettering on a blue background, Associate's badge of gold lettering on a maroon background, and Junior's badge

MEMBERSHIP REQUIREMENTS, FEES, ETC.

Grade	Minimum Age	Years Active in Radio Engineering	References Required	Entrance Fee	Transfer Fee to Next Grade	Annual Dues
Fellow	30	7	Five Fellows	\$10	—	\$15
Member	25	4	Five Fellows or Members	\$5	\$5	\$10
Associate	21	A Person Who is Interested in or Connected with the Radio Arts.	†Five Fellows, Members or Associates	\$3	\$4	\$6
Junior	16*	A Person Interested in the study of Radio.	†Five Fellows, Members or Associates	\$1	\$2	\$4

* The maximum age of a Junior member is 20 years. Upon attaining the age of 21, the Junior member is transferred to the grade of Associate.

† In the case of the Junior or Associate applicant who is unable to supply the names of five members of the required grade, it is sufficient, usually, if the names of five business associates or friends are given. These should preferably be persons engaged in engineering or scientific work.

of gold lettering on a white background. The badge is made in three different forms: a screw-back lapel button, a lapel pin, and watch charm. The lapel button is approximately one-half the size of the emblem shown here, and sells for \$2.75 (any grade). The lapel pin and watch charm are approximately of the size of the illustration. The charm is finished on both sides and is provided with a ring for suspending the charm from a watch chain or fob. The lapel pin is priced at \$3.00 (any grade) and the watch charm is supplied at \$5.00 (any grade). Any of these may be ordered through the office of the Secretary.

Members of the Institute of Radio Engineers are authorized to indicate their grade of membership in the Institute only in the following manner:

Fellow I. R. E.
Member I. R. E.
Associate I. R. E.

Certificates of Membership

Upon application to the Secretary's office membership cards are sent to all members each year, and diplomas are supplied to Members and Fellows. The membership cards are signed by the Secretary and the diplomas are signed by the President and the Secretary.

Meetings

New York meetings of the Institute of Radio Engineers are held on the first Wednesday of each month (except during July and August) at the Engineering Societies Building, 33 West 39th Street, New York City. On these occasions engineering papers are presented. These papers describe recent developments in radio, and are the subject of general discussion on the part of those in attendance.

Sections

The following Sections of the Institute, which in most cases meet once a month, have been organized in localities where there is a sufficient number of Institute members:

ATLANTA—H. P. Thornton, chairman; Philip C. Bangs, secretary, 23 Kensington Road, Avondale Estates, Georgia.

BOSTON—George W. Pierce, chairman; Melville Eastham, secretary, General Radio Co., 30 State Street, Cambridge, Mass.

BUFFALO-NIAGARA—L. Grant Hector, chairman; E. C. Waud, secretary, 235 Huntington Ave., Buffalo, N. Y.

CHICAGO—H. E. Kranz, chairman; J. H. Miller, secretary, Jewell Electrical Instrument Co., 1650 Walnut St., Chicago, Ill.

CINCINNATI—R. H. Langley, chairman; W. W. Boes, secretary, 622 Broadway, Cincinnati, Ohio.

CLEVELAND—D. Schregardus, chairman; C. H. Shipman, secretary, 14805 Ardenall Ave., East Cleveland, Ohio.

CONNECTICUT VALLEY—Q. A. Brackett, chairman; F. C. Beekley, secretary, 96 S. Main St., West Hartford, Conn.

DETROIT—A. B. Buchanan, chairman; W. R. Hoffman, secretary, 615 West Lafayette Blvd., Detroit, Mich.

LOS ANGELES—T. C. Bowles, chairman; Charles S. Breeding, secretary, Aero Radio Corp., 5927 Franklin Ave., Hollywood, Calif.

NEW ORLEANS—Pendleton E. Lehde, chairman; Anton A. Schiele, secretary, 1812 Masonic Temple, New Orleans, La.

PHILADELPHIA—J. C. Van Horn, chairman; E. T. Darlington, acting secretary, 2848 Idaho Road, Camden, N. J.

PITTSBURGH—L. A. Terven, chairman; J. G. Allen, secretary, Duquesne Light Co., Pittsburgh, Pa.

ROCHESTER—E. C. Karker, chairman; A. R. Barfield, secretary, Valley Appliances, Inc., Rochester, N. Y.

SAN FRANCISCO—Donald K. Lippincott, chairman; Paul R. Fenner, secretary, Custom House, San Francisco, Calif.

SEATTLE—Austin V. Eastman, chairman; Abner R. Willson, secretary, 8055—14th Ave. N. E., Seattle, Wash.

TORONTO—V. G. Smith, chairman; G. E. Pipe, secretary, Standard Radio Co., 90 Chestnut St., Toronto, Canada.

WASHINGTON—C. B. Jolliffe, chairman; J. B. Brady, secretary, Ouray Bldg., Washington, D. C.

Procedure to be Followed in Forming a Section

In forming a Section of the Institute, the following is the approved procedure:

a. Carefully read the "By-Laws Governing Sections" found on page 41 of this book.

b. Make a tentative canvass of the members residing within the territorial limits of the proposed Section. If at least fifty-five (preferably sixty-five) Associates, Members, or Fellows favor and will support a Section, if established, obtain from Institute Headquarters a petition form. In making this tentative canvass effort should be made to obtain applications from desirable and eligible non-members. Wherever there are less than twenty-five

members of the Institute but it is felt that applications can be obtained from the necessary number of eligible non-members, this tentative canvass may be made and the membership applications forwarded to the Institute's Offices. In making this tentative canvass consideration should be given to the probable permanent Chairman and other officers of the Section, if formed. Much of the success of a Section depends on the calibre of the Chairman and the interest taken by him in the affairs of the Section. Institute Headquarters, therefore, would like information as to the probable candidates at the time the request is made for the petition forms.

c. On receipt of the petition forms and list of members residing within the territorial limits, an organization meeting should be called for the purpose of obtaining signatures to the petition, and to form a temporary organization.

d. The petition form, properly signed by the required number of members and accompanied by the minutes of the temporary organization meeting, should then be forwarded to the Institute Headquarters for presentation to the Board of Direction.

e. Upon receipt of the approval of the Board of Direction of the Institute, a meeting should be called for the purpose of forming the permanent organization. At this meeting the officers of the Section should be elected and the several standing Committees organized.

f. Thereafter not less than five meetings shall be held annually.

g. A full report of each meeting must be made to the Headquarters of the Institute on the form supplied by the Institute.

American Standards Association

The American Standards Association serves as a national clearing house for engineering and industrial standardization and acts as the official channel of cooperation in international standardization. It conducts its work through the activity of Sectional Committees, the responsibility for each of the several hundred standardization projects being in the hands of one or more cooperating agencies known as "sponsors."

The Institute of Radio Engineers and the American Institute of Electrical Engineers are joint sponsors for the Sectional Committee on Radio. The Institute of Radio Engineers is also cooperating in the formulation of standards on five other subjects, its representatives on all of these Sectional Committees being given on page 8.

The Sectional Committee on Radio is composed of representatives from sixteen cooperating organizations. The Executive Committee of the Sectional Committee on Radio consists of the following officers and Chairmen of Technical Committees:

ALFRED N. GOLDSMITH, *Chairman*
C. H. SHARP, *Vice-Chairman*
H. P. WESTMAN, *Secretary*

Chairmen of Technical Committees:

Radio Receivers and Parts	W. A. MACDONALD
Radio Transmitters and Parts	HARADEN PRATT
Vacuum Tubes	J. C. WARNER
Electro-Acoustic Devices	IRVING WOLFF

REPORT OF THE SECRETARY
INSTITUTE OF RADIO ENGINEERS
1929

DURING the past several years it has been the custom for the Secretary to prepare a very brief summary of the major activities of the Institute for the fiscal year for publication in the YEAR BOOK as information to the membership.

The following report is based, in part, upon reports of the various committee chairmen. It is hoped that the report will be of some interest and value to the membership in indicating the progress of the Institute.

General

At the end of 1929 the paid membership of the Institute had reached the gratifying figure of five thousand six hundred, a net increase of seven hundred and fifty members during the year. One new section was organized. All sections held meetings regularly with slightly better attendance, in most cases, than during 1928. The annual three-day convention was held in Washington, D. C., in May with excellent attendance. Two new types of general meetings were instituted; a "district" convention, sponsored by four sections, in Rochester in November, and a sectional meeting with the A. A. S. in Des Moines in December. There was an increase of twenty-two per cent in the number of speakers of national reputation who visited sections on tours. The number of editorial pages published in the PROCEEDINGS for the year was increased from 1,800 to 2,318. Due to the careful selection of the Committee on Meetings and Papers and the Board of Editors it is thought that the quality of papers published has been improved. The report of the 1928 Committee on Standardization was completed and published in the YEAR BOOK. Seven thousand copies of this book and fifteen hundred copies of reprints of the 110-page report were distributed to the Institute membership and others interested in radio standardization. The standardization projects in which the Institute is interested were inaugurated with renewed vigor. An Assistant Secretary of the Institute was secured to devote the major portion of his time to standardization work. The Committee on Broadcasting submitted six reports which were approved by the Board of Direction. The policy of the Institute with respect to Institute activities was modified, in view of the growing interest of engineers

in telegraph and telephone engineering methods as applied to radio problems, to allow the inclusion of papers on telephone and telegraph engineering and to admit engineers working in those fields to the higher grades of membership in the Institute. New committees were appointed to carry out policies established by the Board. The office staff at headquarters was enlarged to carry on the additional duties assigned to it.

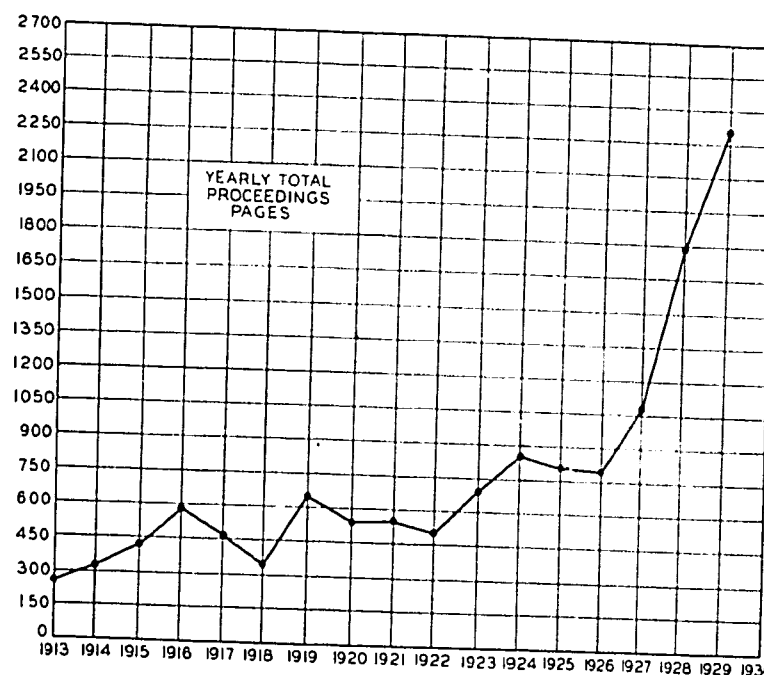

Fig. 1

Directors' Meetings

The affairs of the Institute are managed by the Board of Direction. The Board establishes general policies and supervises the entire operation of the Institute. Nine regular meetings and two special meetings of the Board were held, the average attendance being 8.8 members. President Taylor presided at five meetings of the Board. The two special meetings were held on January 25, 1929, and June 26, 1929, to consider reports of the Committee on Broadcasting which it was not desirable to defer to regular meetings. The business transacted at all meetings of the Board has been duly recorded in the minutes thereof. Matters of special interest to the membership were published in the Institute Notes section of the PROCEEDINGS each month. The

Board elected and transferred 1729 members of all grades during the year upon the favorable recommendations of the Committee on Admissions. To carry out more effectively the activities, new committees were appointed during the year as follows: Bibliography, New York Program, Code for Meetings and Papers, Sectional Meeting with the A. A. A. S., Use of Kilocycle Terminology, 1930 Convention, 1930 Convention Technical Program, Expansion of Institute's Scope and Activities, and Tellers. Most of these are not standing committees.

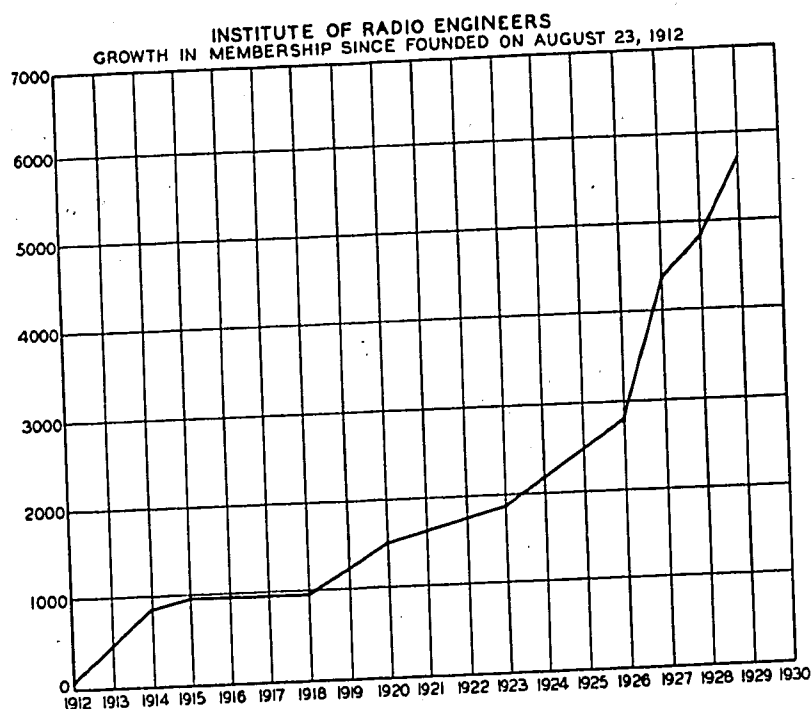

Fig. 2

As representatives of the Institute on the committees of other organizations, or as delegates to special meetings, the Board made the following appointments:

C. W. Latimer and F. B. Jewett, delegates to World Engineering Congress, Tokyo, October, 1929.

C. B. Jolliffe and T. McL. Davis, delegates to 50th Anniversary Celebration, American Society of Mechanical Engineers, Washington, D. C., April, 1930.

Alexander Meissner, delegate to 50th Anniversary Celebration of the Electrotechnical Association, Inc., Berlin, January, 1930.

J. C. Jensen, delegate to Annual Meeting, American Association for the Advancement of Science, Des Moines, December, 1929.

W. Wilson, delegate to International Technical Consulting Committee, The Hague, September, 1929.

J. V. L. Hogan, L. E. Whittemore, and L. M. Hull, representatives on Sectional Committee on Radio, American Standards Association.

Melville Eastham, representative on Radio Broadcasting Committee, American Engineering Council.

Haraden Pratt, representative on Sectional Committee on Definitions of Technical Terms, American Standards Association.

Addresses of the President

In addition to presiding at five New York meetings of the Institute, President Taylor served in his official capacity at two other meetings—at the Eastern Great Lakes Convention in Rochester, where he also presented a technical paper, and at a meeting of the Atlanta Section of the Institute.

Annual Convention

The fourth annual convention of the Institute was held in Washington, D. C., on May 13-16, 1929, under the chairmanship of C. B. Jolliffe. The program included three inspection trips, three special trips for the ladies, four technical sessions (including a joint meeting with the American Section of the International Scientific Radio Union), the presentation of thirty-eight technical papers, and a banquet on the last evening at which the annual Institute awards were made. The Institute was particularly honored in having present Vice-President and Mrs. Meissner of Berlin. Several other members from abroad also attended. The registration was five hundred and fifty-five, the larger portion of which consisted of members outside of the Washington Section. At a concluding session of the convention it was announced that the 1930 convention is to be held in Toronto in August.

Eastern Great Lakes District Convention

On November 18th two hundred and fifty members assembled in Rochester, N. Y., to take part in the first district convention of the Institute. A very interesting two-day program was provided by committees from four sections of the Institute—Rochester, Toronto, Buffalo-Niagara, and Cleveland. The program included two technical sessions at which eight papers were read, three inspection trips, special

trips and theater parties for the ladies, a banquet, and an exhibition of products by manufacturers of radio parts and accessories. V. M. Graham, of the Rochester Section, was the convention chairman.

Meeting with the American Association for the Advancement of Science

A committee composed of J. C. Jensen (chairman), C. A. Culver, H. M. Crothers, John H. Miller, and S. T. Hutchinson was appointed

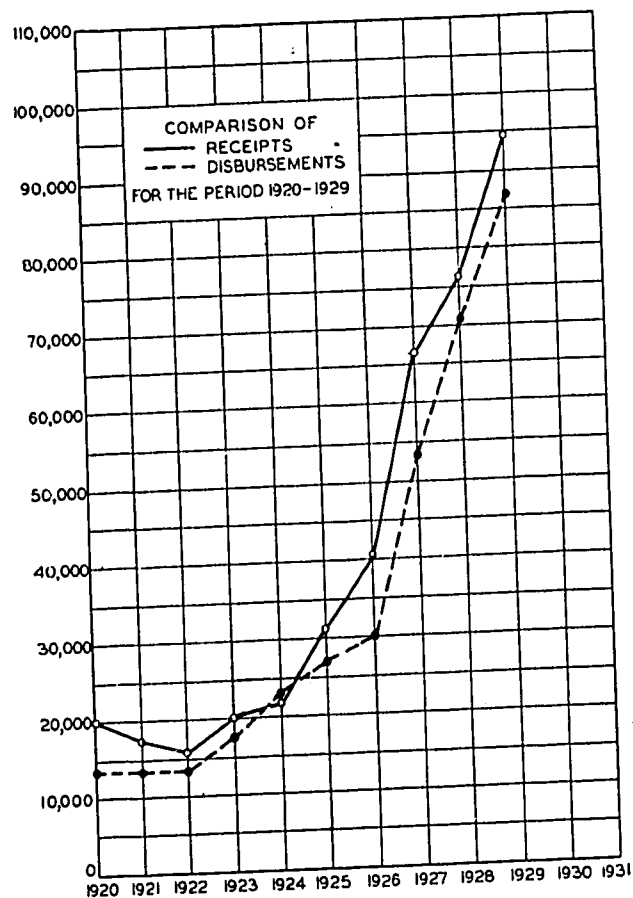

Fig. 3

in October to arrange the program of a sectional meeting of the Institute with the American Association for the Advancement of Science in Des Moines on December 28, 1929. The Institute had two sessions on the program; a noon luncheon and a technical session. At the latter twelve papers were presented.

New York Meetings

Ten technical meetings of the Institute were held in New York City, in the Engineering Societies Building, during the year. All of the papers presented at these meetings have been or will be published in the PROCEEDINGS. The average attendance for each meeting was slightly over three hundred and seventy-five.

Headquarters

During the last three years the headquarters staff has been increased from five to fifteen persons. This increased staff has been required partly through a one hundred per cent increase in the membership of the Institute, a two hundred per cent increase in the pages of PROCEEDINGS published, and an increase of two hundred per cent in the number of standing committees in operation. The staff is so organized now that practically all of the routine and detail work involved in the entire operation of the Institute is carried on at headquarters.

It is appropriate for the Secretary to acknowledge publicly the loyal and unfailing support of all members of the headquarters organization, lacking which the progress of the Institute would have been retarded considerably.

Committees

Under the direction and supervision of the Board of Direction the major activities of the Institute were carried on by twelve committees and eleven subcommittees. It is unfortunate that members of the Institute cannot be afforded an opportunity to acknowledge their debt of appreciation to these important bodies without whose continuous assistance their Institute could not conduct any of its work. These gentlemen, during 1929, have given unsparingly of their time and counsel to the variegated problems, both routine and constructive, which are involved in every phase of the carrying out of policies handed down by the Board of Direction. Members serving on any of the Institute committees are making a very direct and distinct contribution to the radio art.

ADMISSIONS

The Committee on Admissions, R. A. Heising, chairman, met eleven times during the year, the average attendance being 4.5 members. The recommendations of the committee to the Board of Direction were based upon the following number of applications considered and approved:

	<i>Acted Upon</i>	<i>Approved</i>
Transfer to Fellow grade.....	7	4
Recommended by Membership Committee for transfer to Fellow grade.....	12	10
Election to Fellow grade.....	4	3
Transfer to Member grade.....	59	37
Recommended by Membership Committee for transfer to Member grade.....	105	85
Election to Member grade.....	119	63
Election to Associate grade.....	1379	1375
Election to Junior grade.....	151	151
	<hr/>	<hr/>
	1836	1728

The committee undertook the revision of the memorandum originally prepared by the 1928 Committee on Admissions which has been used as a guide to the present committee's endeavor to interpret correctly the various clauses of the Constitution which define the qualifications for advanced grades of membership. This revision was particularly necessary in view of the change in policy, instituted by the Board of Direction, to include general communication activities in the Institute. Because of its effort to assist in the maintenance of a high standard of membership in the Institute, the committee has been called upon to assume much responsibility.

AWARDS

The Committee on Institute Awards, of which Melville Eastham was chairman, conducted its business through correspondence and one meeting. The committee prepared nominations for recipients of the two 1929 awards, the Institute Medal of Honor and the Morris Liebmann Memorial Prize. The awards were presented at the fourth annual convention in Washington in May, G. W. Pierce receiving the Medal of Honor and E. V. Appleton, the Liebmann prize.

BROADCASTING

The Committee on Broadcasting, L. M. Hull, chairman, was established in 1928 to be of assistance to the Federal Radio Commission and the Institute membership in the solution of some of the technical problems involved in radio development. The committee held eight meetings during the year with an average attendance of seven members out of a total membership of eight. In addition, the members of the committee prepared initial drafts and final revisions of all the reports in their own time outside of the regular meetings, and much of the committee's work was handled through correspondence. During

1929 the following reports were prepared by the committee and approved by the Board of Direction:

- No. 3. Synchronization—Preliminary Requirements for the Conduct of Tests.
- No. 4. Permissible Deviation of Carrier Frequency from Licensed Frequency.
- No. 5. Allowable Ratio of Day to Night Power.
- No. 6. Permissible Intensity of Harmonics and other Spurious Radiation.
- No. 7. Modulation Capability.
- No. 9. Effective Methods of Power Rating and Measurement.

These reports, together with two others completed in 1928, were published in the January, 1930, issue of the PROCEEDINGS.

BIBLIOGRAPHY

At the April 5, 1929, meeting of the Board of Direction it was decided that a preliminary committee should be appointed to investigate the desirability and possibility of the Institute's undertaking the compilation and publication of a complete bibliography of the radio literature. In June a committee under the chairmanship of B. E. Shackelford was appointed. At the June 5, 1929, Board meeting it was decided to include within the scope of the activities of the Committee on Bibliography a study of the possibility of the Institute's furnishing a monthly abstract service to its members. A meeting of the committee was held on June 26, 1929. Since that date the committee has gone forward with its work through correspondence and personal contact between certain of its members and engineers in foreign countries. It is thought that the committee's report to the Board of Direction will be available early in 1930.

BOARD OF EDITORS

The Board of Editors of the PROCEEDINGS, W. G. Cady, chairman, has examined one hundred and eighty-five papers submitted for publication. One hundred and twenty-six of these were accepted for publication. The Board is responsible for the technical editing of all papers published and is the final authority in the disposition of manuscripts submitted. Most of the Board's work was done through correspondence. Two meetings, however, were held during the year. The first meeting was held jointly with the Committee on Meetings and Papers. At the second meeting the Board completed its study of certain typographical and "make-up" changes in the PROCEEDINGS, and adopted a number of policies with respect to publication activities.

INSTITUTE SECTIONS

The Committee on Institute Sections, E. R. Shute, chairman, held six meetings during the year. The average attendance per

meeting was eight. Four petitions for the formation of new sections were considered by the committee. The committee was unable to approve three of these, since it was not thought that organization of sections in these territories would be compatible with the interests of the Institute. The petition from members residing in the territory of Cincinnati was approved, and the section was organized. The principal work of the committee during the year was: general supervision of the activities of the sections; revision of the Manual for Section Guidance and Operation; study of monthly reports submitted to the Institute office by sections; arrangements for and conduct of a meeting of section delegates at the annual convention at which eighteen section representatives were present; preparation of a memorandum to the Board of Direction suggesting policies to be followed respecting, (a) new sections, and (b) affiliation of sections with local engineering societies. During the year the Institute office arranged for speakers for thirty-three section meetings, an increase of seven over last year. Approximately twenty-five per cent of the total number of section meetings for the year were arranged in this manner.

The following tabulation indicates the activities and condition of sections of the Institute on December 10, 1929:

Section	Membership Dec. 1929	Number of Meetings			Average Attendance 1929	Percentage of Average Attendance to Total Membership
		1927	1928	1929		
Atlanta	33	6	7	7	23	69
Boston	227	1	3	2	128	56
Buffalo-Niag.	57	7	10	10	30	54
Chicago	360	5	6	6	183	50
Cincinnati	62	—	—	4*	44	70
Cleveland	131	6	10	10	62	47
Conn. Valley	130	5	5	4	33	25
Detroit	126	10	10	9	72	57
Los Angeles	183	6	8	8	120	65
New Orleans	36	—	3	5	39	108
Philadelphia	257	10	8	7	82	32
Pittsburgh	78	—	6	8	141	180
Rochester	65	6	8	7	137	210
San Francisco	138	1	6	10	145	105
Seattle	51	8	8	9	79	154
Toronto	131	9	8	8	90	68
Washington	172	6	8	9	84	48
	2,237	86	114	123	av. 88	av. 82

* The Cincinnati Section was not organized until the middle of the year.

NEW YORK PROGRAM

At the suggestion of the Committee on Meetings and Papers a subcommittee of that committee, known as the New York Program Committee, was created in April, 1929. Since that time the committee, of which W. Wilson was chairman, has arranged the programs of all meetings of the Institute held in New York City. The committee has met monthly.

NOMINATIONS

The Committee on Nominations, Melville Eastham, chairman, conducted its business through correspondence. The committee prepared a list of suggested candidates for the offices of President, Vice-President, and elective Board members for 1930. The recommendations of the committee were used by the Board of Direction as the basis of its choice of candidates for these offices.

MEMBERSHIP

The Committee on Membership held seven meetings in 1929, with an average attendance of five members. The major activity of the committee was a thorough, though not exhaustive, canvass of the larger firms and other employers of radio engineering talent. The committee rewrote the Aims and Activities booklet, prepared an application form suitable for publication each month in the PROCEEDINGS, prepared a bulletin-board membership solicitation form, recommended a list of Associates and Members to the Committee on Admissions for transfer to higher grades, arranged for the solicitation of membership applications from lists supplied by the American Radio Relay League, and prepared an extensive agenda of work to be done in 1930. In a large measure the gain in membership this year has been made possible through the personal interest of members of the Institute in the growth of their society, as was evident by the effective use made of membership material placed in their hands. Through their efforts the Institute enjoyed a fifteen per cent increase in membership.

DISTRIBUTION OF INSTITUTE MEMBERSHIP

Continental United States	4754
Africa	23
Alaska	5
Canal Zone	3
Philippine Islands	9
Australia	30
Belgium	2
Bermuda	2
British West Indies	2

Canada.....	215
Central America.....	1
China.....	30
Colombia.....	1
Costa Rica.....	1
Cuba.....	5
Czechoslovakia.....	4
Denmark.....	13
Dutch East Indies.....	1
Egypt.....	1
England.....	316
Federated Malay States.....	6
France.....	20
Friendly Islands.....	1
Germany.....	15
Gibraltar.....	1
Holland.....	10
Hungary.....	11
India.....	14
Ireland.....	7
Italy.....	6
Japan.....	82
Mexico.....	7
Malta.....	1
New Zealand.....	17
Palestine.....	2
Poland.....	3
Porto Rico.....	4
Portugal.....	1
U. S. S. R. (Russia).....	4
Samoa.....	1
Scotland.....	13
South America.....	25
Spain.....	8
Straits Settlements.....	2
Sweden.....	3
Switzerland.....	1
Wales.....	1
Republic of Panama.....	1
Virgin Islands.....	1
Territory Hawaii.....	9
	<hr/>
	5,695

MEETINGS AND PAPERS

The Meetings and Papers Committee, K. S. Van Dyke, chairman, was responsible for securing papers for publication in the PROCEEDINGS and for making a preliminary examination of all papers submitted with

a view to verifying their technical accuracy. Several committee members undertook extensive editorial work on manuscripts read. One meeting of the committee was held during the year; its activities outside of this organization meeting were confined to correspondence and reading of manuscripts, and to a revision of the "Report of Reader" form upon which the committee indicates its recommendations on papers read. A Subcommittee on Code of Meetings and Papers Committee, W. C. White, chairman, was appointed in April, 1929, to broaden the scope of the material prepared by previous committees on the work of the committee and its relation to the Board of Editors. This subcommittee completed the Code which was adopted by the Board of Direction and which has been of material assistance to the Committee on Meetings and Papers in its work. The table below indicates the extent of the committee's work for the year:

Papers secured for publication.....	185
Papers published in 1929.....	126
Papers rejected by the Committee and Editors.....	20
Papers returned to authors for revision.....	38
Book Reviews prepared and published.....	8
Discussions to papers published.....	11

PUBLICITY

The Committee on Publicity, W. G. H. Finch, chairman, provided publicity for all of the New York meetings as well as an extensive series of releases covering the annual convention. Convention releases were distributed to over two thousand papers in the United States. The monthly releases on New York meetings were sent to one hundred and twenty-five papers and secured national distribution, in addition, through three press associations. The committee cooperated with the Publicity Committee of the Eastern Great Lakes District Convention in securing desirable publicity on that meeting.

STANDARDIZATION

The 1928 Committee on Standardization, L. E. Whittemore, chairman, carried over into 1929 until its report had been completed. This report was published in the 1929 Year Book of the Institute, of which seven thousand copies were printed and distributed to Institute members and others. Fifteen hundred reprints of the 110-page standardization report were printed and were circulated among persons interested in radio standardization.

The 1929 committee, J. H. Dellinger, chairman, inaugurated its activities at a meeting of technical committee chairmen held on September 5, 1929. The set-up of main technical committees for 1929

was: No. 1, Radio Receivers, E. T. Dickey, chairman; No. 2, Radio Transmitters and Antennas, Haraden Pratt, chairman; No. 3, Vacuum Tubes, C. B. Jolliffe, chairman; No. 4, Electro-Acoustic Devices, H. A. Frederick, chairman. Three informal subcommittees of the Technical Committees on Radio Receivers and Radio Transmitters were organized. These were, under Technical Committee on Radio Receivers: marine and direction-finding receivers; aircraft receivers; high-frequency receivers; and, under Technical Committee on Radio Transmitters: nomenclature, symbols and definitions; methods of testing apparatus, equipment, devices, and materials; establishment of provisions for safety of operating and other personnel. The Standardization Committee is making a special point of working in close collaboration with other organizations in similar fields. There are included on the committee's membership officially designated representatives of the A. I. E. E., R. M. A., and N. E. M. A. The latter two associations have representatives on each of the technical committees. Through frequent meetings, and the preparation and circulation of drafts, all of the technical committees were active in reviewing previously published material and in instituting material for standardization in new fields.

SECTIONAL COMMITTEE ON RADIO OF THE AMERICAN STANDARDS ASSOCIATION

The Institute of Radio Engineers and the American Institute of Electrical Engineers are joint sponsors of the Sectional Committee on Radio of the American Standards Association. In July, 1929, the tentative American Standard for specifications for vacuum-tube bases was formally adopted by the A. S. A. This standard was prepared by the 1928 Technical Committee on Vacuum Tubes. During the middle of the year the Sectional Committee was completely reorganized. Officers of the committee were elected as follows: Alfred N. Goldsmith, chairman; C. H. Sharp, vice-chairman, H. P. Westman, secretary. In the reorganization of the technical committees, whose functions roughly correspond to those of the technical committees of the I. R. E. Standardization Committee, the following technical committees were constituted: No. 1, Radio Receivers, W. A. MacDonald, chairman; No. 2, Radio Transmitters, Haraden Pratt, chairman; No. 3, Vacuum Tubes, J. C. Warner, chairman; No. 4, Electro-Acoustic Devices, Irving Wolff, chairman. Although no standards were proposed by the Sectional Committee during 1929, much work was accomplished indicating that several standards should be completed in 1930.

REPORT OF SECRETARY FOR 1929

Institute of Radio Engineers, Inc. COMPARATIVE BALANCE SHEET December 31, 1928 and 1929

	Dec. 31, 1929	Dec. 31, 1928	Increase Decrease
CASH			
General Fund—Corn Exchange Bank	\$15,603.90	14,208.82	1,395.08
General Fund—National State Bank, Newark	7.29	7.29	
Special Fund—Corn Exchange Bank	222.75	417.18	194.43
Savings Account—National State Bank, Newark	5,559.62	5,342.77	216.85
Petty Cash Fund	175.00	175.00	
TOTAL CASH	21,568.56	20,151.06	1,417.50
ACCOUNTS RECEIVABLE			
Juniors			
Associates	73.00	133.00	60.00
Members	1,181.31	1,073.65	107.66
Entrance Fees	25.00	88.00	63.00
Advertising	803.00		803.00
Transfer Fees	2,645.79	1,501.67	1,144.12
	52.20	30.00	22.20
TOTAL ACCOUNTS RECEIVABLE	4,780.30	2,826.32	1,953.98
NOTES RECEIVABLE			
		26.67	26.67
INVENTORY			
Proceedings on Hand	3,688.88	5,141.20	1,452.32
Bound Volumes on Hand	191.36	374.28	179.92
Paper Stock on Hand		1,519.96	1,519.96
Binders on Hand	181.70	36.75	144.95
TOTAL INVENTORY	4,064.94	7,072.19	3,007.25
INVESTMENTS (SCHEDULE "D")			
FURNITURE AND FIXTURES	\$6,760.03		
Less—Reserve for Depreciation	2,279.89		
	4,480.14	3,876.54	603.60
ACCRUED INTEREST ON INVESTMENTS	739.18	618.33	120.85
PREPAID EXPENSES			
Unexpired Insurance Premiums	43.68	54.54	10.86
Stationery Inventory	300.00	300.00	
TOTAL ASSETS	\$73,214.80	66,118.15	7,096.65
LIABILITIES AND SURPLUS			
ACCOUNTS PAYABLE			
SUSPENSE	\$ 3,912.29	4,687.40	775.11
DUES, ETC. PAID IN ADVANCE	120.32	111.28	9.04
Juniors			
Associates	9.70	24.00	14.30
Members	732.73	478.07	254.76
Fellows	75.15	116.70	41.55
	2.00	75.00	73.00
Subscriptions to PROCEEDINGS	2,722.07	2,723.70	1.63
TOTAL LIABILITIES	7,574.26	8,217.05	642.79
MORRIS LIEBMAN MEMORIAL FUND			
Principal			
Unexpended Income	10,000.00	10,000.00	
	77.87	77.87	
TOTAL MORRIS LIEBMAN FUND	10,077.87	10,077.87	
SURPLUS			
Balance, January 1st	47,823.23	40,916.34	6,906.89
Operating Profit for Year (See Exhibit "B")	7,739.44	6,906.89	832.55
SURPLUS, DECEMBER 31st	55,562.67	47,823.23	7,739.44
TOTAL LIABILITIES AND SURPLUS	\$73,214.80	66,118.15	7,096.65

Patterson and Ridgway, Certified Public Accountants,
74 Trinity Place, New York City.

CONSTITUTION

ADOPTED AT THE FIRST MEETING OF THE INSTITUTE OF RADIO ENGINEERS, MAY 13, 1912; AMENDED NOVEMBER 2, 1914, AND DECEMBER 5, 1915

ARTICLE I

NAME AND OBJECT

SEC. 1—The name of this organization shall be the Institute of Radio Engineers.

SEC. 2—Its object shall be the advancement of the theory and practice of radio engineering and of the allied arts and sciences, and the maintenance of a high professional standing among its members. Among the means to this end shall be the holding of meetings for the reading and discussion of professional papers and the publication of such papers, discussions and communications as may seem expedient.

ARTICLE II

MEMBERSHIP

SEC. 1—The membership of the Institute shall consist of:

- a. Honorary Members, who shall be entitled to all rights and privileges of the Institute except the right to nominate, vote and hold office.
- b. Fellows, who shall be entitled to all rights and privileges of the Institute.
- c. Members, who shall be entitled to all rights and privileges of the Institute except the right to hold the office of President and Vice-President.
- d. Associates, who shall be entitled to all rights and privileges of the Institute except the right to hold the office of President, Vice-President, and Editor.
- e. Juniors, who shall be entitled to attend all meetings and to receive copies of all Institute publications.

SEC. 2—Honorary members may be chosen from among those who have rendered acknowledged eminent service to radio science, or the radio arts.

SEC. 3—A Fellow shall be not less than thirty years of age and shall be either:

- a. A radio engineer by profession. As such he shall be qualified to design and take responsible charge of important radio work; he shall have been in the active practice of his profession for at least seven years, and shall have had responsible charge of important radio work for at least three years.

When the applicant holds in a principal national society of an allied branch of engineering, membership in a grade for which the qualifications indicate a standing equal to that required for the grade of Fellow herein, such membership shall be considered equivalent to three of the required seven years of active practice of the radio profession.

CONSTITUTION

- b. A professor of physical science or of electrical engineering. As such he shall have attained special distinction as an expounder of the principles of radio science and of radio engineering; he shall have had at least seven years experience as a teacher of physical or electrical subjects and shall have had responsible charge, for three years, in a radio course of a principal school of science and engineering. Any years of experience as defined in paragraph "a" that the applicant may have had as a radio engineer shall be considered the equivalent of the same number of years of experience as a "teacher of radio subjects."

- c. A person who has done notable original work in radio science of a character to give him a recognized standing at least equivalent to that required for the Fellows under paragraphs "a" and "b."

- d. A person regularly engaged in radio work for at least seven years, who, by inventions or special proficiency in contributions to the radio science or the radio arts or radio literature, has attained a standing at least equivalent to that required for Fellows under paragraphs "a" and "b."

SEC. 4—A Member shall be not less than twenty-five years of age and shall be either:

- a. A radio engineer by profession. As such, under general direction he shall have designed and taken responsibility for important radio engineering work; he shall have been in the active practice of his profession for at least four years.

When the applicant holds in a principal national society of an allied branch of engineering, membership of a grade for which the qualifications indicate a standing equal to that required for the grade of Member herein, such membership shall be considered equivalent to two years of the requisite four years of active practice of the radio profession.

- b. A teacher of physical science or of electrical engineering. He shall have had at least four years experience as a teacher of radio subjects in a school of recognized standing. Any years of experience the applicant may have had as a radio engineer shall be considered the equivalent of the same number of years of experience as a "teacher of radio science or of radio engineering."

- c. A person regularly employed in radio or closely allied work for at least four years, who, by invention or by proficiency in radio science, the radio arts, or radio literature, or as an executive of any radio enterprise of large scope, has attained a standing equivalent to that required for Members under paragraphs "a" and "b." In the case of such an executive the applicant must be qualified to take responsible charge of the broader features of radio engineering involved in the work under his direction.

- d. A commissioned officer of the Army or Navy of the United States Government or of any foreign government, who has been regularly engaged in radio work for a period of at least three years, who shall have had responsible charge of important government radio work for at least one year and who shall have attained the rank of Captain in the Army or Lieutenant in the Navy.

SEC. 5—An Associate shall be not less than twenty-one years of age and shall be:

- a. A radio engineer by profession.
- b. A teacher of radio subjects.
- c. A person who is interested in and connected with the study or application of radio science or the radio arts.

SEC. 6—A Junior shall be not less than sixteen years of age nor over twenty-one years of age, and shall be a person who is interested in the study or application of radio science or the radio arts.

On attaining the age of twenty-one years, Juniors shall be transferred to the grade of Associate.

SEC. 7—In all cases, graduation from the radio course or electrical course of a school of science or of engineering of recognized standing shall be considered the equivalent of one year's radio experience.

SEC. 8—Any person who is a Member at the time this group of amendments is adopted, shall not be barred from eligibility to the grade of Fellow because of the age limitation, provided he shall otherwise be eligible as herein defined.

Any person who is an Associate at the time this group of amendments is adopted, shall not be barred from eligibility to the grade of Member because of age limitations, provided he shall otherwise be eligible as herein defined.

ARTICLE III

ADMISSIONS AND EXPULSIONS

SEC. 1—Honorary Members shall be recommended by at least ten members of the Board of Direction, and upon unanimous vote of the Board shall be proposed to the membership for election. A person elected an Honorary Member shall be promptly notified thereof by letter. The election shall be cancelled if an acceptance is not received within six months after the mailing of notice.

SEC. 2—Applications may be made for admission or transfer to any grade of membership. Applicants shall give references to members of the Institute as follows:

For the grade of Fellow, to five Fellows.

For the grade of Member, to five Fellows, or Members.

For the grade of Associate, to five Fellows, Members or Associates.

For the grade of Junior, to five Fellows, Members or Associates.

Each application for admission or for transfer from one grade to another shall embody a concise statement, with dates, of the candidate's training and experience, and shall be in such form and such detail as may be prescribed by the Board of Direction. It shall be signed by the applicant and shall contain a promise to conform to the requirements of that grade of membership to which he may be elected.

Each of the members referred to by the applicant shall be requested by the Secretary to address a letter to the Board of Direction stating the extent of the writer's personal knowledge of the applicant and his training and experience. If at least a majority of the corporate members named as references do not furnish the requisite endorsement, the Secretary shall call upon the applicant for additional names, and not until written communications have been received from at least three members shall the application be considered by the Board of Direction.

The requirements of the foregoing paragraph may be waived in whole or in part where the applicant is well-known, either personally or by reputation, to the Board of Direction, or where the application is for Junior or Associate grade.

An applicant who is so situated as not to be personally known to the required number of members of any grade may give the names, occupations and addresses of responsible non-members to complete the required number of references.

SEC. 3—A list comprising the names, ages, addresses and occupations of all new applicants for admission or transfer shall be sent by the Secretary to each member of the Board of Direction.

The Board of Direction may consider applications for admission or transfer to the grade of Member at any regular meeting held at least two weeks after the list containing the applicants' names has been sent to each member of the Board of Direction.

The Board of Direction may consider applications for admission or transfer to the grade of Fellow at any regular meeting held at least four weeks after the list containing the applicants' names has been sent to each member of the Board of Direction.

A record affirmative vote, oral or written, of at least two-thirds of the Board members voting at any regular meeting, shall elect or transfer an applicant for any grade. A vote on any application shall stand, unless withdrawn by the Board member voting, until the application is finally acted upon.

SEC. 4—A rejected applicant may renew his application for membership at any time after the expiration of one year from the date of the ballot rejecting his previous application.

SEC. 5—All elected candidates shall be duly notified and shall subscribe to the Constitution and Rules of the Institute. Forms for this purpose shall be prescribed by the Board of Direction. If these provisions are not complied with within six months from the notification of election, such election shall be considered void, unless for special reasons the time shall be extended by the Board of Direction. Membership of any person shall date from the date of his election.

SEC. 6—Fellows, Members, Associates or Juniors, if found delinquent in their duties may be tried by the Board of Direction, and upon decision of the Board their names shall be submitted to the Institute to determine their suspension or expulsion. A three-quarters vote of the Institute shall be necessary to ratify such action of the Board.

SEC. 7—A member may resign his membership by a written communication to the Secretary, who shall present the same to the Board of Direction; when, if all his dues have been paid, his resignation shall be accepted.

ARTICLE IV

DUES

SEC. 1—The entrance fee, payable on admission to the Institute, shall be as follows:

Admission to the grade of Fellow, ten (\$10) dollars.

Admission to the grade of Member, five (\$5) dollars.

Admission to the grade of Associate, three (\$3) dollars.

Admission to the grade of Junior, one (\$1) dollar.

The transfer fee from one grade of membership to another shall be the difference between the corresponding admission fees.

The entrance fees shall be waived until January 1, 1927.

SEC. 2—The annual dues payable by members, whether resident or non-resident, shall be as follows:

- a. By Fellows, ten (\$10) dollars.
By Members, seven dollars and fifty cents (\$7.50).
By Associates, four (\$4) dollars.
By Juniors, three dollars and fifty cents (\$3.50).
- b. Honorary Members shall be exempt from all payments.

SEC. 3—The annual dues shall be payable on the first day of January, in advance of the ensuing year. It shall be the duty of the Secretary to notify each member of the amount due at the time of giving notice of the annual meeting.

SEC. 4—Persons elected after July 1st of any year shall pay only one-half of the dues for that year.

SEC. 5—Any person whose dues are more than three months in arrears shall be notified by the Secretary. Should his dues not be paid when they become six months in arrears, he shall lose the right to vote or to receive the publications of the Institute. Should his dues become nine months in arrears, he shall be again notified in form prescribed by the Board of Direction, and if such dues become one year in arrears, he shall forfeit his connection with the Institute. The Board of Direction may, however, for cause deemed by it sufficient, extend the time for payment and for the application of these penalties.

SEC. 6—The Board of Direction may, for sufficient cause, temporarily excuse from payment of annual dues any member; and the Board may remit the whole or part of dues in arrears, or accept in lieu thereof desirable additions to the library or collections.

SEC. 7—Every person admitted to the Institute shall be considered as belonging thereto and liable for the payment of all dues until he shall have resigned, been expelled, or have been relieved therefrom by the Board of Direction.

ARTICLE V

OFFICERS

SEC. 1—The governing body of the Institute shall be a President, a Vice-President, a Secretary, a Treasurer, and an Editor of Publications, six elected Managers, and three appointed Managers who shall together constitute the Board of Direction.

SEC. 2—The terms of all officers, except the six elected Managers, shall be one year each, and shall begin at the close of the annual meeting at which election is made. The terms of all officers shall continue until successors are duly elected. The President and the Vice-President shall not be eligible for immediate re-nomination to the same office.

CONSTITUTION

SEC. 3—Two Managers shall be elected each year and serve for three years.

For the year 1915 six elected Managers were voted upon as follows: The two candidates receiving the highest number of votes to serve three years; the two candidates receiving the next highest number of votes, two years; the two candidates receiving the next highest number of votes, one year.

SEC. 4—The three appointed Managers shall be chosen by the Board of Direction to serve for terms of one year. These appointed Managers shall have no vote in the election of their successors.

ARTICLE VI

MANAGEMENT

SEC. 1—The President shall have general supervision of the affairs of the Institute. He shall preside at meetings of the Institute and of the Board of Direction at which he may be present and shall be an ex-officio member of all committees. He shall deliver an address at the annual meeting.

SEC. 2—The Board of Direction shall manage the affairs of the Institute in conformity to the laws under which the Institute is organized and the provisions of the Constitution. It shall direct the investment and care of the funds of the Institute; make appropriations for specific purposes; act upon applications for membership as heretofore provided; take measures to advance the interests of the Institute; appoint all its employees, and generally direct its business. The Board of Direction shall make an annual report at the annual meeting, transmitting the report of the Treasurer and of the other officers and of committees. Five members of the Board of Direction shall constitute a quorum.

SEC. 3—The Treasurer shall receive all moneys and deposit same in the name of the Institute. He shall invest all funds not needed for current disbursements, as shall be ordered by the Board of Direction. He shall pay all bills, when certified and audited, as provided by this Constitution and by the rules to be prescribed by the Board of Direction. He shall make an annual report and such other reports as may be prescribed by the Board of Direction.

The Board of Direction shall secure a satisfactory surety for the faithful performance of his duties by the Treasurer, and shall renew the same during the month of January of each year.

SEC. 4—The Secretary will be expected to attend all meetings of the Institute and of the Board of Direction; prepare the business thereof, and duly record the proceedings thereof. He shall see that all moneys due the Institute are carefully collected, and without loss transferred to the custody of the Treasurer. He shall carefully scrutinize all expenditures and use his best endeavor to secure economy in the administration of the Institute. He shall personally certify the accuracy of all bills or vouchers on which money is paid, and shall countersign the checks drawn by the Treasurer against the funds of the Institute when such drafts are known to him to be proper, and duly authorized by the Finance Committee. He shall have charge of the books of account of the Institute, and shall furnish, when required by the Board of Direction, a statement of receipts and expenses under their several headings, and also a statement of monthly

balances. He shall present annually, to the Board of Direction, a balance sheet of his books as of December 31st and shall furnish from time to time such other statements as may be required of him. He shall conduct the correspondence of the Institute and keep full records of the same. He shall perform all other duties which may from time to time be assigned to him by the Board of Direction.

SEC. 5—The Board of Direction may also, if they deem it necessary, appoint an Assistant Secretary, who shall aid the Secretary and be under his immediate direction in all matters.

SEC. 6—The President, as soon as expedient after the annual meeting, shall appoint from the membership, with the advice and consent of the Board of Direction, the following standing committees:

- Committee on Papers.
- Committee on Standardization.
- Committee on Publicity.

Members appointed shall serve until their successors are appointed or the Committees dissolved.

ARTICLE VII

NOMINATION AND ELECTION OF OFFICERS

SEC. 1—Two months before the annual meeting, nominations for the offices of President, Vice-President, Secretary, Treasurer, and two Managers, shall be called for from the membership qualified by this Constitution. Before nominees' names are submitted to the membership for final vote, each nominee shall be consulted and if he so requests, his name shall be withdrawn and the next ranking name substituted.

For the year 1915, nominations for six Managers were called for.

One month before the annual meeting, the Board of Direction shall submit to the entire membership excepting Honorary Members and Juniors, a list of all nominees, which list shall consist of the pairs of names receiving the largest number of nominations for each office. In the event of ties in nominations the Board of Direction shall select the name of the man in its opinion best fitted for that office. The membership shall then submit written ballots in plain sealed envelopes enclosed within mailing envelopes marked "Ballot," and bearing the member's signature, voting for officers from the list of nominees. A majority vote received up to the time of the closing of the polls (twenty-four hours before the opening of the annual meeting) shall elect, and no votes by proxy shall be counted. The method of balloting herein described shall be used for nominating as well as for voting, except the outer envelope shall be marked "Nomination" in the former case. In nominating, as in voting, no proxies or ballots within unsigned outer envelopes shall be opened for counting. Ballots, whether for nomination or voting, shall be checked, opened and counted by a quorum of the Board of Direction, at a regular meeting of the Board. At the time of call for nominations, the Board of Direction shall submit to qualified voters a list of suggested nominations containing at least two names for each office.

SEC. 2—The Editor of Publications shall be elected by vote of the Board of Direction as soon as possible after May 1st.

CONSTITUTION

ARTICLE VIII

MEETINGS

SEC. 1—There shall be an Annual Meeting, at which the annual reports for the year ending December 31st previous shall be presented, and the Ballot for officers reported. At this meeting fifteen (15) members shall constitute a quorum.

SEC. 2—Business meetings shall be held as prescribed by the by-laws.

SEC. 3—In addition to the Annual Meeting, meetings for the reading and discussion of papers shall be held as ordered by the Board of Direction.

SEC. 4—Special meetings may be called by the Board of Direction, and shall be so called upon request of ten members, which request shall state the purpose of such meeting. The call for such meeting shall be issued ten days in advance, and shall state the purpose thereof, and no other business shall be taken up at such meeting. At these meetings ten members shall constitute a quorum.

SEC. 5—The Institute may adopt, from time to time, rules for the order of business at its meetings.

SEC. 6—Meetings of the Board of Direction shall be held at the time of the annual meeting and at such other times as the Board may determine, but only on notice to all members of the Board by the Secretary. Notices of time and place of meeting are to be mailed in New York at least two days in advance.

ARTICLE IX

AMENDMENTS

SEC. 1—Proposed amendments to this Constitution must be reduced to writing and signed by not less than twenty Fellows, Members or Associates, and be submitted to the entire membership, except Honorary Members and Juniors, who shall vote by letter ballot. The amendment shall be adopted if seventy-five per cent of the votes received are in favor of such action, the polls having been open for at least one month after mailing to the qualified membership, notices of the proposed amendments. Votes upon the adoption of proposed amendments shall be checked, opened and counted by a quorum of the Board of Direction at a regular meeting of the Board.

AMENDMENTS

INCREASE OF MEMBERSHIP DUES

In October, 1919, in accordance with the provision of Section 1, above, the membership approved adoption of an amendment to the Constitution authorizing increasing the dues as follows:

	Per Year
Fellows.....	\$15.00
Members.....	10.00
Associates.....	7.50
Juniors.....	5.00

At the Board meeting held in January, 1920, it was decided to defer advancing the dues to the full amount authorized until a later date. The dues adopted were:

	Per Year
Fellows.....	\$12.00
Members.....	9.00
Associates.....	5.00
Juniors.....	4.00

On January 1, 1926, the dues were advanced as follows:

	Per Year
Fellows.....	\$15.00
Members.....	10.00
Associates.....	6.00
Juniors.....	4.00

This leaves the annual dues for Associates and Juniors below the amount authorized by the membership in October, 1919.

On January 1, 1927, the entrance fees were reinstated. These are:

Fellow.....	\$10.00
Member.....	5.00
Associate.....	3.00
Junior.....	1.00

NOMINATION AND ELECTION OF OFFICERS

In January, 1921, the membership by letter vote approved change in Article VII of the Constitution to read as follows:
Article VII, Section 1 of the Constitution to read:

"SEC. 1—Six weeks before the annual meeting, the Board of Direction shall submit to the entire membership, excepting Honorary Members and Juniors, a list of candidates (nominees) for the offices of President, Vice-President, (Secretary, Treasurer) and two Managers. This list shall comprise at least one name and not more than three names for each office, the names being proposed either by Petition as hereinafter provided, or by (a quorum of) the Board of Direction, at one of these stated meetings. The list shall contain no indication as to whether the candidate has been proposed by Petition or by the Board of Direction.

"Nomination by Petition shall be made by letter, addressed to the Board of Direction, setting forth the name of the proposed candidate and the office for which it is desired he be nominated. For acceptance, a letter of Petition must reach the Board of Direction on or before October 15th of any year, and shall be signed by at least thirty-five Fellows, Members or Associates.

"The list of nominees shall contain the names of all candidates proposed by formal Petition or by the Board of Direction, but before this list is submitted to the membership for final vote, each candidate should be consulted and if he so requests, the fact that he has withdrawn from election shall be stated after his name.

"The entire membership, excepting Honorary Members and Juniors, shall vote by written ballots in plain sealed envelopes, enclosed within mailing

envelopes marked "Ballot" and bearing the member's signature, for the officers whose names appear on the list of candidates. A majority vote received up to the time of the closing of the polls (twenty-four hours before the opening of the annual meeting, the date of which shall be stated in the election notice) shall elect, and no votes by proxy shall be counted. No proxies or ballots within unsigned outer envelopes shall be opened for counting. Ballots shall be checked, opened and counted by a quorum of the Board of Direction at a regular meeting of the Board.

"SEC. 2—The Treasurer, Secretary, and Editor of Publications shall be appointed by majority vote of the Board of Direction as soon as practicable after January 15th of each year, for a term of one year or until their successors be appointed."

BY-LAWS GOVERNING SECTIONS

(The purpose of the Institute in furthering the establishment of Sections is to afford opportunity for members situated in various parts of the United States and other countries to meet in organized groups for the discussions of radio engineering topics.)

1—A petition for the formation of a Section shall be signed by not less than twenty-five members (any grade except Juniors) residing within the territorial limits hereinafter prescribed. The Board of Direction may decline to authorize the formation of a Section when, in its judgment, such an organization would not be compatible with the interests of the Institute.

2—A Section shall be known as: The (name of place or geographical district) Section of the Institute of Radio Engineers.

3—The principal activity of a Section shall be the holding of periodical meetings (monthly or bi-monthly, but not less than five regular meetings annually) for the presentation of original papers already presented at New York meetings of the Institute, or at other Sections.

4—The territory of a Section shall be the territory naturally tributary thereto, but shall not include territory so remote or inaccessible that members cannot readily attend meetings. For the purpose of determining the maximum amount of money to which a Section is entitled under these by-laws, points more than sixty miles from the regular meeting place of the Section shall not be considered a part of the Section, except when special conditions warrant such action, territory within a reasonable distance may be authorized by the Board of Direction. If adjacent Sections should be so situated that the sixty-mile limit embraces common territory, the question as to which Section shall claim such members as reside within this common territory shall, if possible, be decided by agreement between the Sections concerned; otherwise by the Board of Direction. (Sections may carry on their mailing list for meeting announcements the names of members located outside of the prescribed Section territory.)

5—The Chairman, Vice-Chairman, Secretary, and any other officers of each Section must be Fellows, Members or Associates of the Institute, and shall be elected for the term of one year beginning January 1, or May 1, and until their successors are elected.

6—The Board of Direction may at any time terminate the existence of any Section when in its judgment the interests of the Institute make such action desirable.

7—Papers and discussions presented before a Section and published in the PROCEEDINGS shall not be republished except with due acknowledgment of the original source.

8—Original papers presented before a Section, suitable for publication in the PROCEEDINGS may be presented to the Meetings and Papers Committee for consideration, which, in judging suitability, will be governed by the same considerations applied to similar matter offered from other sources.

9—The Secretary of the Institute will forward to the Secretary of each Section copies of all printed announcements of the regular meetings in New York, and shall forward also to the Secretary of each Section, three complete sets of proofs, or three pamphlet form copies of each technical paper intended for presentation at New York or for publication in the PROCEEDINGS. This latter is for the purpose of supplying Sections with advance copies for Section discussion.

10—Each Section shall have a Meetings and Papers Committee and a Membership Committee, appointed by the Chairman.

11—Each Section shall conduct its affairs in such manner that no indebtedness shall accrue in excess of the amount due annually as per-member rebate, specified in paragraph 12.

12—The appropriation of Institute funds during any fiscal year for aid in Section maintenance shall be the sum determined as follows: one dollar for each Fellow, Member, and Associate residing within the territory of the Section at the beginning of the administrative year, namely, January 1. Each year, beginning in 1926, the Treasurer will place to the credit of each Section the accrued rebate calculated from members' dues paid in the Section as of March 1 and September 1. Section Treasurers may draw upon this account quarterly; that is, January 1st, April 1st, July 1st and October 1st.

13—Section Secretaries shall forward to the Secretary of the Institute a report of each meeting held by the Section for the presentation or discussion of papers, and on January 1 of each year a statement of the past year's accounts.

STANDARDS RELATING TO RADIO ENGINEERING

The 1929 Year Book of the Institute (pages 144-147) contained a list of standards, closely related to radio engineering, as prepared by other engineering organizations.

Through the courtesy of the organizations responsible for the preparation of these standards, the Institute is permitted to reprint certain numbers from this list. It is thought that the application of the following authoritative and nationally recognized standards to radio engineering and the work of radio engineers is so direct that members of the Institute and others interested in standardization work should be encouraged to make full use of them whenever possible.

MATHEMATICAL SYMBOLS*

(Adopted by the Board of Directors, American Institute of Electrical Engineers, June 23, 1927)

A.S.A. Z 10f 1928

Arithmetic and Algebra

1. $= \neq + - \pm \mp < > \leq \geq () [] \% \infty \approx$ (for approximately equal to)
2. $a \times b = a \cdot b = ab$; $a \div b = a/b = \frac{a}{b}$ (Influence extends to next $+$ or $-$). Thus, $a - b/c - d$ should not be used for $(a - b)/(c - d)$.
Note that $\frac{a}{b}$ is difficult to print in running text.
3. $a/b = c/d$ for proportion. Discourage $a:b::c:d$.
4. Notation by powers of 10 for very large or very small numbers is recommended; as 3.140×10^9 and 3.140×10^{-6} . The notation 0.0^5314 is useful in tables, to indicate that there are five zeros after the decimal point.
5. In writing numbers having a large number of digits, half-spaces may well be used instead of commas to separate groups of digits. In writing decimals, the 0 before the decimal point should not be omitted (except in tables).
6. $|x|$ = absolute value of x . $x! = 1 \cdot 2 \cdot 3 \cdots x$. Discourage $\lfloor x$.
7. $\sqrt{x} = +\sqrt{x}$, not $\pm\sqrt{x}$ (x being real and positive). $a^{1/n} = \sqrt[n]{a}$. $a^{-n} = 1/a^n$. $\exp x = e^x$ is useful when x is a complicated expression. Note that the bar or vinculum after the \sqrt is very expensive to print.
8. When $\log x$ is ambiguous, use $\log_{10} x$ or $\log_e x$. The notation $\ln x$ may be mentioned as an alternative for $\log_e x$.
9. $P(n, r) = n(n-1)(n-2) \cdots (n-r+1)$
 $C(n, r) = [n(n-1)(n-2) \cdots (n-r+1)]/[1 \cdot 2 \cdot 3 \cdots r]$ = binomial coefficients.
A common alternative for $C(n, r)$ is $\binom{n}{r}$; this, however, is difficult to print in running text.
10. $a \propto b$ (meaning a varies directly as b).

* Approved as American Standard by the American Standards Association, January, 1928. Sponsors: American Association for the Advancement of Science, American Institute of Electrical Engineers, American Society of Civil Engineers, The American Society of Mechanical Engineers, and Society for the Promotion of Engineering Education.

Elementary Geometry

11. $\angle \triangle \parallel \perp \odot \square \therefore$

Analytic Geometry

12. $x, y, z; \xi, \eta, \zeta$; rectangular coordinates. Right-handed system preferred.
13. ρ, s =intrinsic coordinates. ρ =radius of curvature, s =length of arc.
14. $l = \cos \alpha, m = \cos \beta, n = \cos \gamma$, direction cosines.
15. r, θ =polar coordinates. ψ =angle from radius vector to tangent.
16. r, θ, ϕ =spherical coordinates. θ =co-latitude, ϕ =longitude. (Usage general in mathematical physics; other notations are used in astronomy.)
17. r, θ, z =cylindrical coordinates. (Usage diverse.)
18. Conics: e =eccentricity. p =semi-latus rectum (usage general in U.S.).
19. Straight line: $y = mx + b$.

Trigonometric and Hyperbolic Functions

20. $^{\circ} \sin x, \cos x, \tan x, \cot x, \sec x, \csc x$.
21. $\sin^{-1}x$ =the principal value of the angle whose sine is x (when x is real). Thus, $-\pi/2 \leq \sin^{-1}x \leq \pi/2, 0 \leq \cos^{-1}x \leq \pi, -\pi/2 \leq \tan^{-1}x \leq \pi/2$. (Discourage arc $\sin x$).
22. $\sin^2 x$ for $(\sin x)^2$ is an exceptional notation, justified by usage. Similarly for $\cos^2 x$, etc.
23. $\sinh x, \cosh x, \tanh x, \coth x, \operatorname{sech} x, \operatorname{csch} x$.
24. $\cosh^{-1}x$ =the principal value (when x is real). (Discourage arc $\sinh x$).
25. $\sinh^2 x$ for $(\sinh x)^2$ is an exceptional notation, justified by usage. Similarly, $\cosh^2 x$, etc.
26. In general f^{-1} means the inverse of the function f ; and f^2 denotes iteration of the functional operation. But in exceptional cases, f^2 may denote the square of the function f (as in $\sin^2 x$ and $\sinh^2 x$). In general, $[f(x)]^{-1} = 1/f(x)$.

Calculus, etc.

27. If $y = f(x)$, derivative $= y' = f'(x) = \frac{dy}{dx} = D_x y$.

Second derivative $= y'' = f''(x) = \frac{d(y')}{dx} = D_x^2 y = \frac{d^2 y}{dx^2}$. Note: $\frac{d^2 y}{dx^2}$

cannot be regarded as a fraction, except when x is the independent variable; in general, $\frac{d^2}{dx^2} = D_x^2$ is a symbol of operation on y .

28. If $u = f(x, y)$, partial derivative $= u_x = f_x(x, y) = D_x u = \frac{\partial u}{\partial x}$.

Similarly, $u_{xy} = f_{xy}(x, y) = D_y(D_x u) = \frac{\partial^2 u}{\partial y \partial x}$. Note: $\frac{\partial^2 u}{\partial y \partial x}$ and $\frac{\partial u}{\partial x}$ are

not fractions; $\frac{\partial}{\partial x} = D_x$ and $\frac{\partial^2}{\partial y \partial x} = D_y D_x$ are symbols of operation.

29. Δy =increment, dy =differential. δy =variation. $\sum_{i=a}^b$ =summation.

30. $\dot{x} = dx/dt = v$; $\ddot{x} = dv/dt$ (used only for differentiation with respect to the time t , and difficult to print).

31. $\lim_{x \rightarrow a}(y) = b$; $y \rightarrow b$ as $x \rightarrow a$. (Discourage \doteq .)

32. $\int_a^b f(x) dx$. $F(x) \Big|_a^b = F(b) - F(a)$. $\iiint f(x, y) dx dy = \int \{ \int f(x, y) dx \} dy$.

33. $\pi = 3.1416 \dots e = 2.718 \dots i$ (or j) $= \sqrt{-1}$.

34. If $z = x + iy$, then $|z|$ =absolute value, or magnitude, $\angle z$ =angle, $R(z)$ and $I(z)$ =real and imaginary parts. \bar{z} =conjugate of z . (Where \bar{z} is difficult to print, use $\operatorname{conj} z$.)

Special Functions

35. Bessel Functions. The notation used in G. N. Watson's Treatise, 1922, as endorsed by E. P. Adams in the Smithsonian Tables, 1922, is recommended.
36. Bernoulli numbers. Of the five or six different notations in use, the notation B_1, B_3, B_5, \dots has historical priority and many practical advantages, but the notation B_1, B_2, B_3, \dots is the one most used in recent years. To indicate what usage is being followed, authors will do well to state explicitly the value of the first few numbers, as $B_1 = 1/6, B_2 = 1/30, B_3 = 1/42, \dots$
37. $\gamma = 0.5772 \dots$ (Euler's constant.)

Vector Analysis¹

38. Vectors to be indicated in printed matter by letters in bold-face type, and in written manuscript by letters modified by a bar above

¹ NOTE: As to further questions of notation in Vector Analysis (including Tensor Analysis), the desirability of a thorough-going attempt to bring uniformity out of the present diversity of usage is recognized, and the appointment of a special committee to take up this subject has been recommended.

(or by the doubling of some part of the character). The magnitude of a vector to be indicated in print by the corresponding italic letter, and in manuscript (when necessary) by the use of the absolute value signs, $| |$.

39. The scalar product, or dot product, = $a \cdot b$, the dot being centered. (Other notations are Sab , or (ab) in round parentheses.)
40. The vector product, or cross product, = $a \times b$, the cross being small. (Other notations are Vab , or $[ab]$ in square brackets.)
41. i, j, k = unit vectors along the axes (right-handed system).

Abbreviations

42. It is desirable to distinguish between (1) a "symbol," that is, a single letter or a single letter affected with subscripts, etc., which is to be used to represent a numerical value in a formula; and (2) an "abbreviation," which may consist of several letters, but is not intended to be substituted for a numerical quantity in a formula.
43. Abbreviations such as ft/sec², ft-lb/min, etc., should not be further condensed, lest clearness be sacrificed to brevity.

NOTE: The recommendations concerning terms and symbols in elementary mathematics contained in Chapter 8 of the report on the Re-organization of Mathematics in Secondary Education, made in 1923 by the National Committee on Mathematical Requirements (under the auspices of the Mathematical Association of America and reprinted by Houghton Mifflin Company in 1927), are, with one or two unimportant exceptions, endorsed.

LETTER SYMBOLS FOR ELECTRICAL QUANTITIES*

(Adopted by the Board of Directors, American Institute of Electrical Engineers, October 18, 1928)

A.S.A. Z 10g1 1929

Name of Quantity	Symbol	Name of Quantity	Symbol
1. Admittance.....	Y, y	23. Frequency.....	f
2. Angular frequency.....	ω	24. Impedance.....	Z, z
3. Angular velocity.....		25. Inductance.....	L
4. Capacitance.....	C	26. Magnetic intensity.....	H
5. Capacity, electrostatic (see capacitance)		27. Magnetic flux.....	Φ
6. Conductance.....	G, g	28. Magnetic flux density..	B
7. Conductivity.....	γ	29. Magnetomotive force...	\mathcal{F}
8. Current.....	I, i	30. Mutual inductance.....	M
9. Difference of potential, electric (see note 4)...	E, e	31. Number of conductors or turns.....	N
10. Dielectric constant.....	K or ϵ	32. Permeability.....	μ
11. Dielectric flux.....	Ψ	33. Permeance.....	\mathcal{P}
12. Dielectric flux density..	D	34. Permittance (see capaci- tance)	
13. Efficiency.....	η	35. Period.....	T
14. Electric potential (see note 4).....	E, e	36. Permittivity (see di- electric constant)	
15. Electrical tension (see voltage)		37. Phase displacement....	θ or ϕ
16. Electromotive force....	E, e	38. Power.....	P, p
17. Electrostatic capacity (see capacitance)		39. Quantity, electric.....	Q, q
18. Electrostatic flux (see dielectric flux)		40. Quantity of electricity..	
19. Electrostatic flux density (see dielectric flux density)		41. Reactance.....	X, x
20. Energy.....	W	42. Resistance.....	R, r
21. Flux density, electro- static (see dielectric flux density)		43. Resistivity.....	ρ
22. Flux density, magnetic (see magnetic flux density)		44. Reluctance.....	\mathcal{R}
		45. Reluctivity.....	ν
		46. Self-inductance.....	L
		47. Susceptance.....	b
		48. Speed of rotation.....	n
		49. Voltage.....	E, e
		50. Work.....	W

* Approved as American Standard by the American Standards Association, February 5, 1929. Sponsors: American Association for the Advancement of Science, American Institute of Electrical Engineers, American Society of Civil Engineers, The American Society of Mechanical Engineers, Society for the Promotion of Engineering Education.

NOTES:

1. Where distinctions between maximum, instantaneous, effective (root-mean-square), and average values are necessary, E_m, I_m, P_m are recommended for maximum values; e, i, p for instantaneous values, E, I for effective (r. m. s.) values, and P for average value.

2. In accordance with the practise in other branches of engineering, it is recommended that quantities per unit volume, area, length, etc., be represented as far as practicable by lower-case letters corresponding to the capitals which represent the total quantities.

3. In print, vector or complex quantities should be represented by bold-face letters. In typing, overscoring may be used to indicate bold-face letters, (vectors).

4. Where a distinction between electromotive force and difference of electric potential is desirable, the symbols E_e , and V_v , respectively, may be used.

Table of Preferred Numbers

Informally approved by the American Standards Association and recommended to industry for a period of trial in practice.

A.S.A.
Z17-1927

.001 to .01				.01 to .1				.1 to 1.0				1 to 10				Values to 5 Figures	Term No.
5 Series	10 Series	20 Series	40 Series	5 Series	10 Series	20 Series	40 Series	5 Series	10 Series	20 Series	40 Series	5 Series	10 Series	20 Series	40 Series		
.0010	.0010	.0010		.010	.010	.010	.010	.10	.10	.10	.10	1	1	1	1		
		.0011				.011	.0105			.11	.105			1.05	1.05	10592	1
	.0012	.0012				.012	.011			.12	.11			1.12	1.12	11220	2
		.0014				.0125	.012			.125	.12			1.18	1.18	11885	3
						.014	.0125			.14	.125		1.25	1.25	1.25	12589	4
	.0016	.0016				.014	.013			.14	.13			1.32	1.32	13335	5
						.015	.014			.15	.14			1.4	1.4	14125	6
						.016	.015			.16	.15			1.5	1.5	14962	7
							.016				.16	1.6	1.6	1.6	1.6	15849	8
		.0018					.017				.17			1.7	1.7	16788	9
		.0020					.018				.18			1.8	1.8	17783	10
							.019				.19			1.9	1.9	18837	11
		.0022					.020				.20		2.0	2.0	2.0	19953	12
							.021				.21			2.1	2.1	21135	13
	.0025	.0025					.022				.22			2.25	2.25	22387	14
							.024				.24			2.35	2.35	23714	15
							.025				.25	2.5	2.5	2.5	2.5	25119	16
		.0028					.026				.26			2.65	2.65	26608	17
							.028				.28			2.8	2.8	28184	18
		.0030					.030				.30			3.0	3.0	29854	19
							.032				.32		3.2	3.2	3.2	31623	20
		.0035					.034				.34			3.4	3.4	33497	21
							.036				.36			3.6	3.6	35482	22
	.0040	.0040					.038				.38			3.8	3.8	37584	23
							.040				.40	4.0	4.0	4.0	4.0	39811	24
		.0045					.042				.42			4.25	4.25	42170	25
							.045				.45			4.5	4.5	44668	26
		.0050					.048				.48			4.75	4.75	47315	27
							.050				.50		5.0	5.0	5.0	50119	28
		.0055					.052				.52			5.3	5.3	53089	29
							.056				.56			5.6	5.6	56234	30
	.0060	.0060					.060				.60			6.0	6.0	59566	31
							.064				.64	6.4	6.4	6.4	6.4	63095	32
		.0070					.068				.68			6.8	6.8	66834	33
							.072				.72			7.2	7.2	70795	34
		.0080					.075				.75			7.6	7.6	74990	35
							.080				.80		8.0	8.0	8.0	79433	36
		.0090					.085				.85			8.5	8.5	84140	37
							.090				.90			9.0	9.0	89125	38
							.095				.95			9.5	9.5	94405	39
	.0100	.0100					.100				1.00	10.0	10.0	10.0	10.0	100000	40

Preferred Numbers are the rounded geometric series with the ratios

$\sqrt[5]{10}$ (5 series)

$\sqrt[10]{10}$ (10 series)

$\sqrt[20]{10}$ (20 series)

$\sqrt[40]{10}$ (40 series)

The exponents thus give the number of terms in one order of magnitude, (that is between 1 and 10, 10 and 100, etc.)

In all length measurements, the numbers apply to the inch as the unit of length. With all other dimensions than lengths, the numbers apply to the unit forming the basis of the standardization.

Preferred Numbers above 10 inches are formed by multiplying the numbers between 1 and 10 in. by 10, 100, etc. Preferred Numbers below .001 in. are formed correspondingly by division of the numbers between .001 in. and .01 in. by 10, 100, etc. Between .001 and .01 in. the 20 series will probably serve as the finest gradation; the 40 series is therefore not given.

So far as possible the numbers of the 5 series are to be used in preference to those of the 10 series, these again in preference to those of the 20 series, and these finally to those of the 40 series. It is permissible to pass over from one series of Preferred Numbers to an adjacent series.

ELECTRICAL MEASURING INSTRUMENTS

(Adopted by the Board of Directors, American Institute of Electrical Engineers, December 10, 1926)
(Effective April 1, 1927)

A.I.E.E.

No. 33; January, 1927

SCOPE

The standards in this section apply to the following kinds of indicating electrical instruments for direct current and for alternating current:

- (1). Ammeters
- (2). Voltmeters
- (3). Wattmeters
- (4). Reactive Volt-Ampere Meters
- (5). Frequency Meters
- (6). Power-Factor, Reactive-Factor and Phase-Angle Meters
- (7). Synchrosopes

These standards are not intended to apply to indicating instruments provided with arrangements for curve drawing, contact making, etc. They do not apply to the following kinds of instruments:

- (a) Small instruments of types and sizes which are used where low cost is essential; for example, small polarized-vane ammeters used on automobiles, battery-charging outfits, etc.
- (b) Instruments constructed for very special requirements.

DEFINITIONS

Definitions given herein apply specifically to the instruments treated in this section. They are included with all other standard definitions in a separate section.

Instruments and Their Parts

33-1 Instrument.—An instrument is a measuring device which measures the present value of the quantity under observation. The term "instrument" is used in two different senses: (a) instrument proper as described below, and (b) to include not only the instrument proper but, in addition, any necessary apparatus, such as shunts, shunt leads, resistors, reactors, condensers, or instrument transformers.

- 33-2 Mechanism.**—The mechanism is the arrangement for producing and controlling the motion of the pointer. It includes all the essential parts necessary to produce this result, but does not include the base, cover, scale, or any parts, such as series resistors or shunts, whose function is to make the indicated value of the measured quantity agree with the actual value.
- 33-3 Moving Element.**—The moving element includes the pointer and the parts which move with it.
- 33-4 Instrument Proper.**—The instrument proper is the mechanism and the scale, built into the case, including all devices (resistors, shunts, etc.) which are built into the case or non-removably attached to it. Examples: An instrument (ammeter) for 500 amperes direct current consists of the instrument proper (which may be thought of as essentially a millivoltmeter) together with a 500-ampere shunt and a pair of shunt leads. Another instrument (wattmeter) consists of the instrument proper (which is essentially a 5-ampere 110-volt wattmeter) together with a current transformer and a potential (voltage) transformer.
- 33-5 Self-Contained Instrument.**—An instrument is said to be self-contained when all the necessary equipment is built into the case or non-removably attached to it.
- 33-6 Current Circuit of an Instrument.**—The current circuit of an instrument is that winding of the instrument proper which carries the current to be measured, or a definite fraction of it, or a current dependent upon it.
- 33-7 Voltage Circuit of an Instrument.**—The voltage circuit of an instrument is that winding of the instrument proper to which is applied the voltage to be measured, or a definite fraction of it, or a voltage dependent upon it.
- 33-8 Series Resistor.**—A series resistor is a resistor in series with a circuit of an instrument. It usually refers to a resistor forming part of the voltage circuit.
- 33-9 Multiplier.**—A multiplier is a particular type of series resistor which is used to extend the voltage range of an instrument beyond some particular value for which the instrument is already complete.
- 33-10 Shunt.**—A shunt is a resistor connected in the circuit to be measured and in parallel with a current circuit of an instrument.

- 33-11 Reactor.**—A reactor is a device used for the purpose of introducing reactance, and usually has a high time-constant.
- 33-12 Shunt Leads.**—Shunt leads are leads which connect the current circuit of an instrument to the shunt.
- 33-13 Crest Voltmeter.**—A crest voltmeter is a voltmeter depending for its indications upon the crest, or maximum value of the voltage of the system to which it is connected. Crest voltmeters should be clearly marked on the instrument proper whether readings are in r. m. s. values or in true crest volts. It is preferred that the marking should be r. m. s. values of the sinusoidal wave having the same crest value.
- 33-14 Synchroscope.**—A synchroscope is a device which indicates synchronism between two machines, and in addition shows whether the incoming machine is fast or slow.
- 33-15 Line-Drop Voltmeter Compensator.**—A line-drop voltmeter compensator is a device used in connection with a voltmeter which causes the latter to indicate the voltage at some distant point of the circuit.

Scales

- 33-16 Indication Range.**—The indication range is the range within which the electrical quantity (current, voltage, power, etc.) is to be indicated without reference to accuracy.
- 33-17 Measurement Range.**—The measurement range is that part of the indication range within which the requirements for accuracy are to be met.
- 33-18 Scale Length.**—The scale length is the length of the arc described by the end of the pointer in moving from the zero position to the end of the scale.

Influences of Operating Conditions

- 33-19 Temperature Influence.***—The temperature influence is defined as the percentage change in the indication which is caused solely by a difference in room temperature of ± 10 deg. cent. from the reference temperature (20 deg. cent.).

* If the influences (referred to in 19, 20, and 21) above and below the normal conditions are not equal the greater value should be given.

33-20 Frequency Influence.*—The frequency influence (in other than frequency meters) is defined as the percentage change in the indication which is caused solely by a change of ± 10 per cent from the rated frequency.

33-21 Voltage Influence.*—The voltage influence (in other than voltmeters and wattmeters) is defined as the percentage change in the indication which is caused solely by a change of ± 10 per cent from the rated voltage.

33-22 External-Field Influence.—The external-field influence is defined as the percentage change in the indication which is caused solely by an external field of an intensity of 5 gauss produced by a current of the same kind and frequency as that on which the instrument operates, with the most unfavorable phase and position of the external field.

33-23 Power-Factor Influence.—The power-factor influence in wattmeters is defined as the percentage change of the indication which is caused solely by the lowering of the power-factor from unity to 0.50, current lagging, at the rated voltage and frequency.

33-24 Position Influence.—The position influence, in other than gravity-controlled instruments, is defined as the maximum displacement of the pointer which is caused solely by an inclination of 30 deg. in any direction under the most unfavorable conditions as to position. It is to be expressed as a percentage of the scale length.

Miscellaneous Definitions

33-25 Period of an Instrument.—The period of an instrument, sometimes called the "periodic time," is the time taken for the pointer to make one complete oscillation (two consecutive swings). A swing is a completed movement in either direction.

33-26 Damping.—This is a term applied to instrument performance to denote the manner in which the pointer settles to its steady indication after a sudden change in the value of the measured quantity. Two general classes of damped motion are distinguished; namely, (a) periodic, in which the pointer oscillates about the final position before coming to rest; (b) aperiodic, in which the pointer comes to rest without overshooting the rest position. The point of change between periodic and aperiodic damping is called critical damping.

* If the influences (referred to in 19, 20, and 21) above and below the normal conditions are not equal the greater value should be given.

33-27 Damping Factor.—Damping factor is the ratio of the angular deviations of the pointer in two successive swings from the position of equilibrium.

33-28 Responsiveness.—This term denotes the rapidity with which the pointer of an instrument comes to rest after a change in the value of the measured quantity. It may be measured by the reciprocal of the time in seconds for the pointer to come to rest after a change in the value of the measured quantity.

33-29 Torque.—The torque of an instrument is the turning moment produced by the electrical quantity to be measured acting through the mechanism. This is better termed the "deflecting torque," and in instruments having control systems is opposed by the controlling torque, which is the turning moment produced by the mechanism of the instrument tending to return the moving element to a fixed position. Torque is expressed in millimeter-grams. The particular value of the torque for the condition of full scale deflection should be designated "full scale torque" and should be accompanied by a statement of the angle corresponding to this deflection.

In instruments where the controlling torque is proportional to the deflection it is also convenient to state the torque in millimeter-grams per degree deflection computed from the torque at full scale. When the controlling torque is not proportional to the deflection it is desirable to state also the torque at points other than full scale.

33-30 Restoring Torque.—The restoring torque is the resultant of the electrical or electrical and mechanical torques tending to restore the moving element to any position of equilibrium when displaced from that position. It should be expressed as the rate of change in resultant turning moment in millimeter-grams per degree at that position.

The principle of restoring torque as here defined applies to any type of instrument and to any method of control such as spring or gravity control, or no mechanical control, as in power factor meters and this term is preferable to the use of the term torque as defined above since it is of universal application which is not the case with torque.

33-31 Weight.—The weight of a moving element includes one-half the weight of the springs, if any. It is to be expressed in grams.

33-32 Error and Correction.—The error of indication is the difference between the indication and the true value of the quantity being measured. It is the quantity which must be algebraically subtracted from the indication to get the true value. A positive error denotes that the indication of the instrument is greater than the true value.

The correction has the same numerical value as the error of indication, but the opposite sign. It is the quantity which must be algebraically added to the indication to get the true value. If T , I , E and C represent respectively the true value, the indicated value, the error, and the correction, the following equations hold:

$$E = I - T$$

$$C = T - I$$

Example: A voltmeter reads 112 volts when the voltage applied to its terminals is actually 110 volts.

Then,

$$\text{Error} = 112 - 110 = +2 \text{ volts}$$

$$\text{Correction} = 110 - 112 = -2 \text{ volts}$$

33-33 Accuracy of Indicating Instruments.—In specifying the accuracy of an indicating instrument the limits of error at any point on the scale shall be expressed as a percentage of the full scale reading.

Classification

33-34 Electrical instruments may be classified as follows:

A. As to Use:

- (a) Portable instruments
- (b) Switchboard instruments

B. As to Principle of Operation

- (a) Electrodynamical (dynamometer)
- (b) Permanent-magnet moving coil*
- (c) Moving-iron
 - (1) Plunger
 - (2) Vane
 - (3) Repulsion
- (d) Induction

* Instead of "permanent-magnet moving coil" the following terms were suggested: "d'Arsonval"; "fixed-field."

- (e) Electrothermic
 - (1) Expansion
 - (2) Thermocouple
- (f) Electrostatic

C. As to Kind of Protection:

- (a) Dust-proof
- (b) Moisture-proof
- (c) Rust-resisting
- (d) Water-tight (submersible).

The terms "portable" and "switchboard" are self-defining. A third classification as to use is suggested, namely, "laboratory-standard."

33-35 In electrodynamic (dynamometer) instruments one or more coils move within the field produced by a fixed coil or coils.

33-36 In permanent-magnet moving-coil instruments a coil moves within the field of a permanent magnet.

33-37 In moving-iron instruments one or several pieces of soft iron are caused to move by the magnetic field of a fixed coil or coil system. Various forms of this instrument (plunger, vane, repulsion) are distinguished chiefly by mechanical features of construction.

33-38 In induction instruments the torque is produced by fixed coils acting upon moving conducting parts (disks, drums, etc.) in which currents are produced by electromagnetic induction.

33-39 Electrothermic instruments depend for their operation on the heating effect of a current. Two distinct types are (a) the expansion type, including the "hot-wire" and "hot-strip" instruments; (b) the thermocouple type, where one or more thermocouples which are heated directly or indirectly by the passage of a current supply a direct current which flows through the coil of a suitable direct-current mechanism, such as one of the permanent-magnet moving-coil type.

33-40 Electrostatic instruments depend for their operation on the forces of attraction and repulsion between bodies charged with electricity.

33-41 A dust-proof instrument is provided with a case which excludes dust from the mechanism.

33-42 A moisture-proof instrument is one in which moisture is excluded from the mechanism, or which is so constructed that moisture will not damage the mechanism.

- 33-43 A rust-resisting instrument** is one whose case and parts are made of rust-resisting materials, or are specially finished to resist the corrosive effects of moist air.
- 33-44 A water-tight (submersible) case** withstands for one hour complete immersion in a tank containing sufficient water to cover all parts to a depth of at least three feet, without any visible trace of penetration of water into the interior.

RATING

- 33-100 Rating of an Instrument.**—The rating of an instrument is a designation assigned by the manufacturer to indicate its operating limitations. The full-scale marking of an instrument does not necessarily correspond to its rating.
- 33-101 Rating of the Circuits of an Instrument.**—The rating of the circuits of an instrument shall be equal to, or less than, the maximum current or voltage to which they may be continuously subjected without exceeding the permissible temperature rises.

HEATING

Temperature Limitations

- 33-150 Limiting Temperature Rise of Instrument Windings.**—The temperature rises of the windings of instruments shall not exceed the values given in the following table for the class of insulation and the method of temperature determination employed.

TABLE I

Method of Temperature Determination to be Employed	Limit of Observable Temperature Rise in Deg. Cent.		
	Class O Insulation See par. 33-152	Class A Insulation See par. 33-153	Class B Insulation See par. 33-154
Thermometer	35	50	70
Resistance	40	55	75

- 33-151 Limiting Temperature Rise of Shunts.***—The temperature rise of shunts shall not exceed 80 deg. cent. determined by the Thermometer Method.

* The temperature rise of a shunt is largely dependent upon the bus bars connected to it and provision should be made to eliminate excessive temperature rise from this source.

Exception: This rule shall not apply to shunts having no soldered joints and made of material which is not permanently changed in resistivity if continuously subjected to a higher temperature.

- 33-152 Class O Insulation Defined.**—Class O insulation consists of cotton, silk, paper and similar organic materials when neither impregnated* nor immersed in oil.
- 33-153 Class A Insulation Defined.**—Class A insulation consists of cotton, silk, paper and similar organic materials when impregnated* or immersed in oil; also enamel as applied to conductors.
- 33-154 Class B Insulation Defined.**—Class B insulation consists of inorganic materials such as mica and asbestos in built-up form combined with binding substances. If Class A material is used in small quantities in conjunction for structural purposes only, the combined material may be considered as Class B, provided the electrical and mechanical properties of the insulated winding are not impaired by the application of the temperature permitted for Class B material. (The word "impair" is here used in the sense of causing any change which could disqualify the insulating material for continuous service.)
- 33-155 Thermometer Method of Temperature Determination Defined.**—This method consists in the determination of the temperature, by mercury or alcohol thermometers, by resistance thermometers or by thermocouples, any of these instruments being applied to the hottest part of the instrument accessible to mercury or alcohol thermometers.
- 33-156 Resistance Method of Temperature Determination Defined.**—This method consists in the determination of temperature by comparison of the resistance of the winding at the temperature to be determined with the resistance at a known temperature.

* Impregnated Cotton, Paper or Silk—An insulation is considered to be "impregnated" when a suitable substance replaces the air between its fibers, even if this substance does not completely fill the spaces between the insulated conductors. The impregnating substance, in order to be considered suitable, must have good insulating properties; must entirely cover the fibers and render them adherent to each other and to the conductor; must not produce interstices within itself as a consequence of evaporation of the solvent or through any other cause; must not flow during the operation of the machine at full working load or at the temperature limit specified; must not deteriorate under prolonged action of heat.

33-157 Determination of the Mean Temperature of a Copper Winding by Measurement of its Electrical Resistance when there is known the Resistance at some Reference Temperature.

Let t be the reference temperature
 r be the resistance at the reference temperature
 R be the observed resistance

Then T (the temperature sought*)

$$= \frac{R}{r}(234.5+t) - 234.5$$

CHARACTERISTICS

33-200 Reference Temperature.—The standard temperature of reference for instrument characteristics shall be 20 deg. cent.

Influences of Operating Conditions

In determining the influences of operating conditions (except position influence), ammeters and voltmeters should be tested with rated current or voltage respectively. Wattmeters should be tested with rated voltage and such a current (not exceeding the rated current) as will give a suitable deflection, preferably not less than that corresponding to one-half of the maximum reading. Frequency meters (except in the test for voltage influence) should be tested at rated voltage. Power-factor meters and reactive-factor meters should be tested with rated voltage and rated current at unity power factor.

33-201 Instrument Calibrations by the Manufacturer and Acceptance Tests by the Purchaser should be based on the legalized international electrical units.

DIELECTRIC TEST

33-250 Standard Test Voltage.—The standard test voltage for instruments having a voltage circuit not exceeding 750 volts without external resistors shall be twice the rated voltage of the combination, plus 1000 volts. The standard test voltage for in-

* This formula is derived from the experimentally determined relation between temperature and resistance of copper:

$$\frac{R}{r} = \frac{234.5+T}{234.5+t}$$

The temperature rise is the difference between the calculated temperature T and the temperature of the cooling medium at time of test.

struments without voltage circuits shall be 1000 volts. Test shall be made with alternating current as described in 33-254.

The test between current circuit and voltage circuit (where both exist) of an instrument shall be taken care of under the test prescribed for insulation resistance. (See paragraph 33-300.)

33-251 Duration of Application of Test Voltage.—The test voltage shall be applied continuously for a period of 60 seconds.

33-252 Condition of Instrument to be Tested.—Dielectric tests shall be made on finished instruments.

33-253 Points of Application of Test Voltage.—The test voltage shall be applied between all electrical circuits connected together and other metal parts grounded.

33-254 Frequency and Wave Shape of Test Voltage.—The frequency of the test voltage shall be not less than 15 cycles nor more than 65 cycles. A sine wave shape is recommended. The voltage wave shall have a crest value equal to $\sqrt{2}$ times the specified test voltage.

INSULATION RESISTANCE

33-300 Insulation Resistance.—The insulation resistance between all the electrical circuits of the instrument connected together and the case shall not be less than 20 megohms. The insulation resistance between the current circuit and the voltage circuit of an instrument (where both exist) shall be not less than 5 megohms. These tests shall be made with 500 volts direct current.

When instruments are specified to have one or more of the circuits internally connected to the case, the necessary exceptions to these requirements are allowed.

CONSTRUCTION

33-350 General.—The construction of electrical instruments shall be mechanically sound, suitable to their class and purpose and shall be such as to give assurance of permanence in the accuracy of the indications. All materials must be suitable for the purpose for which they are used.

33-351 Scale and Pointer.—The preferred value of each scale division should be either 1, 2 or 5 of the units measured or any decimal multiple or submultiple of these numbers. In the case of multiple-range instruments exceptions to this rule may be necessary, but should be avoided where reasonably possible.

The angle subtended by a scale division shall preferably not be less than 0.5 degree in portable instruments, or 1 degree in switch-board instruments. When smaller angles are used the legibility is decreased.

The numbers marked on the scale, except in the lower part of non-uniform scales, shall preferably be by steps of 1, 2 or 5, or a decimal multiple or submultiple of any of these numbers. The figures shall be of such shape as to minimize the risk of different figures being confused with one another and shall be so spaced as to render individual numbers clearly distinguishable from adjacent numbers.

33-352 External Shunts.—The main terminals of the shunt shall be so constructed that slight variations in the manner of connecting it in the circuit (such as might occur in an average workmanlike installation) shall not alter the indication of the instrument by more than 0.25 per cent.

The thermal electromotive force produced by continuous operation of the shunt at rated current shall not exceed the value which would cause a change in the reading (at rated current) of 0.25 per cent. The connections to the circuit should be made so that the opportunity for the escape of heat will be the same at both terminals.

33-353 Marking.—The instrument shall be distinctly marked with the following particulars in such a way that they will be visible from the front of the case: Name (or symbol) of manufacturer; serial number; designation of the quantity measured; the words "direct-current" or "alternating-current" or their abbreviations; the rated current, voltage or frequency (or the ranges of these quantities) or such of these as apply; the maximum current and voltage, in the case of wattmeters, power-factor meters, and reactive-volt-ampere meters. Of these, only the scale marking itself and the designation of the quantity measured shall be conspicuous.

In the case of alternating-current instruments the following additional items are required: Ratio of the appropriate current transformer expressed thus: 1200:5 or 1200/5; ratio of the appropriate potential (voltage) transformer expressed thus: 6600:110 or 6600/110.

Instruments having separate shunts shall also be marked with the millivolt drop of the shunt with which they are to be used, corresponding to full-scale deflection.

Instruments having separate shunts or series resistors should be marked to indicate this fact.

Separate shunts, if not interchangeable, shall be marked as follows: Name (or symbol) of manufacturer; serial number of the instrument with which it was calibrated; the line current corresponding to full-scale deflection of the instrument; the rated current, if this is less than the preceding, and the millivolt drop at rated current. When the shunts are designed to be used with devices taking sufficient current to be an appreciable proportion of the whole, this fact shall be indicated.

Interchangeable separate shunts shall bear the above markings, except that the serial number may be omitted.

If the rating of an instrument differs from the full-scale marking, the rating shall be marked on the instrument proper.

TELEPHONY AND TELEGRAPHY

(Adopted by the Board of Directors, American Institute of Electrical Engineers, June 29, 1922)

A. I. E. E.

No. 34; June, 1922

DEFINITIONS

34-1 General.—Many of the following definitions are tentative and not yet fully established. Some of the definitions are specific to telephony, and differ in detail from similar definitions appearing in other sections of the rules.

Line Circuits

34-2 Ground-Return Circuit.—A ground-return circuit is a circuit consisting of one or more metallic conductors in parallel, with the circuit completed through the earth.

34-3 Metallic Circuit.—A metallic circuit is a circuit of which the earth forms no part.

34-4 Two-Wire Circuit.—A two-wire circuit is a metallic circuit formed by two parallel conductors insulated from each other.

34-5 Superposed Circuit.—A superposed circuit is an additional circuit obtained from a circuit normally required for another service, and in such a manner that the two services can be given simultaneously without mutual interference.

34-6 Phantom Circuit.—A phantom circuit is a superposed circuit, each side of which consists of the two conductors of a two-wire circuit in parallel.

34-7 Side Circuit.—A side circuit is a two-wire circuit forming one side of a phantom circuit.

34-8 Non-Phantom Circuit.—A non-phantomed circuit is a two-wire circuit, which is not arranged for use as the side of a phantom circuit.

34-9 Simplexed Circuit.—A simplexed circuit is a two-wire telephone circuit, arranged for the superposition of a single ground-return signaling circuit operating over the wires in parallel.

34-10 Compositated Circuit.—A compositated circuit is a two-wire telephone circuit, arranged for the superposition on each of its component metallic conductors, of a single independent ground-return signaling circuit.

34-11 Quadded or Phantom Cable.—A quadded or phantom cable is a cable adapted for the use of phantom circuits.

34-12 Simplex Circuit.—A simplex circuit in telegraphy is one arranged for operation in one direction at one time.

34-13 Duplex Circuit.—A duplex circuit in telegraphy is one arranged for simultaneous operation in opposite directions.

34-14 Diplex Circuit.—A diplex circuit in telegraphy is one arranged for the simultaneous transmission of two messages in the same direction.

34-15 Quadruplex Circuit.—A quadruplex circuit in telegraphy is one arranged for the simultaneous transmission of two messages in each direction.

34-16 Multiplex Circuit.—A multiplex circuit in telegraphy is one arranged for the simultaneous transmission of one or more messages in both directions. Both duplex and quadruplex are examples of multiplex whereas diplex is not.

34-17 Linear Electrical Constants.—The linear electrical constants of a line are the electrical constants per unit length of the line, *e.g.* linear resistance, linear inductance, etc.

34-18 Smooth Line.—A smooth line is a line whose electric elements are all continuously and uniformly distributed throughout its length.

34-19* Periodic Line.—A periodic line is a line consisting of successive similar sections in each of which one or more electric elements are not distributed uniformly. As examples of periodic lines are (1) loaded lines and (2) artificial lines consisting of successive similar sections of lumped constants.

34-20 Equivalent Smooth Line.—An equivalent smooth line of a periodic line is a smooth line having the same electrical behavior as the periodic line, at a given single frequency, when measured at terminals or at corresponding section junctions.

34-21 Equivalent Periodic Line.—An equivalent periodic line of a smooth line is a periodic line having the same electrical behavior, for an assumed single frequency, as the smooth line, when measured at terminals or at corresponding section junctions. The terms conjugate smooth line and conjugate periodic line are also sometimes used.

* (19) The term periodic in this definition refers to the line constants and not to time relations.

- 34-22 Composite Line.**—A composite line is a line consisting of a plurality of successive sections having different linear electrical constants, as in the case where an underground cable section is joined to an overhead open-wire section.
- 34-23 Loaded Line.**—A loaded line is one in which the normal reactance of the circuit has been altered for the purpose of increasing its transmission efficiency.
- 34-24 Series Loaded Line.**—A series loaded line is one in which the normal reactance has been altered by reactance serially applied.
- 34-25 Shunt Loaded Line.**—A shunt loaded line is one in which the normal reactance of the circuit has been altered by reactance applied in shunt across the circuit.
- 34-26 Continuous Loading.**—A continuous loading is a series loading in which the added inductance is uniformly distributed along the conductors.
- 34-27* Coil Loading.**—A coil loading is one in which the normal inductance is altered by the insertion of lumped inductance in the circuit at intervals.

Circuit Constants and Characteristics

- 34-28 Damping of a Circuit.**—The damping at a given point in a circuit from which the source of energy has been withdrawn, is the progressive diminution in the effective value of electromotive force and current at that point resulting from the withdrawal of electrical energy.
- 34-29* Damping Constant.**—The damping constant of a circuit is a measure of the ratio of the dissipative to the reactive component of its admittance or impedance.

* (27) This lumped inductance may be applied either in series or in shunt.

As commonly understood, coil loading is a series loading, in which the lumped inductance is applied at uniformly spaced recurring intervals.

* (29) Applied to the admittance of a condenser or other simple circuit having capacity reactance, the damping constant for a harmonic electromotive force of given frequency is the ratio of the conductance G , of the condenser or simple circuit at that frequency to twice the capacitance, C , of the condenser at the same frequency, $(G/2C)$.

Applied to the reactance of a coil or other simple circuit having inductive reactance, the damping constant for a harmonic current of a given frequency is the ratio of the resistance, R , of the coil or circuit at that frequency to twice the inductance, L , at the same frequency, $(R/2L)$.

- 34-30* Mutual Impedance.**—The mutual impedance for single frequency alternating currents, between a pair of terminals and a second pair of terminals of a network, under any given condition, is the negative ratio of the electromotive force produced between either pair of terminals on open circuit to the current flowing between the other pair of terminals.
- 34-31* Self-Impedance.**—The self-impedance between a pair of terminals of a network, under any given condition, is the ratio of the electromotive force applied across the terminals to the entering current.
- 34-32* Characteristic Impedance.**—The characteristic impedance of a line is the ratio of the applied electromotive force to the resulting steady-state current upon a line of infinite length and uniform structure, or of periodic recurrent structure.
- 34-33* Sending-End Impedance.**—The sending-end impedance of a line is the ratio of the applied electromotive force to the resulting steady-state current at the point where the electromotive force is applied.
- 34-34* Propagation Constant.**—The propagation constant of a uniform line, or section of a line of periodic recurrent structure, is the natural logarithm of the ratio of the steady-state currents at various points separated by unit length in a uniform line of infinite length, or at successive corresponding points in a line of recurrent

* (30) A receiving-end impedance is an example of a mutual impedance.

Single frequency voltages and currents are here supposed to be represented by complex numbers. Their ratio is therefore a complex number.

* (31) Single frequency voltages and currents are here supposed to be represented by complex numbers. Their ratio is therefore a complex number.

* (32) In practise, the terms (1) line impedance, (2) surge impedance, (3) iterative impedance, (4) sending-end impedance, (5) initial sending-end impedance, (6) final sending-end impedance, (7) natural impedance and (8) free impedance, have apparently been more or less indefinitely and indiscriminately used as synonyms with what is here defined as "characteristic impedance."

Single frequency voltages and currents are here supposed to be represented by complex numbers. Their ratio is therefore a complex number.

* (33) See note under "Characteristic Impedance." In case the line is of infinite length of uniform structure or of periodic recurrent structure, the sending-end impedance and the characteristic impedance are the same.

Single frequency voltages and currents are here supposed to be represented by complex numbers. Their ratio is therefore a complex number.

* (34) Single frequency voltages and currents are here supposed to be represented by complex numbers. Their ratio is therefore a complex number.

structure of infinite length. The ratio is determined by dividing the value of the current at the point nearer the transmitting end by the value of the current at the point more remote.

34-35 Attenuation Constant.—The attenuation constant for a single frequency is the real part of the propagation constant taken at that frequency.

34-36 Wavelength Constant.—The wavelength constant is the imaginary part of the propagation constant.

34-37 Standard Cable.—A standard cable is an ideal uniform line in terms of which the attenuation of a line or network may be specified. It is characterized by the following constants: Linear resistance, 88 ohms per loop mile (54.7 ohms per loop km.). Linear capacitance between wires 0.054 microfarad per loop mile (0.03355 microfarad per loop km.). Linear inductance and linear leakage, 0.

Equivalent Circuits

34-38* Equivalent Circuit.—An equivalent circuit is a simple network of series and shunt impedances, which, at a given frequency, is the approximate electrical equivalent of a complex network.

34-39* "T" Equivalent Circuit.—A "T" equivalent circuit is a triple-star or "Y" connection of three impedances externally equivalent to a complex network. See Fig. 1 for symbol.

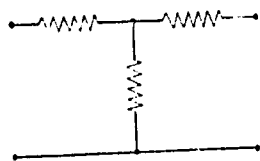

Fig. 1

34-40* "I" Equivalent Circuit.—An "I" equivalent circuit is a connection of five impedances in the form shown in Fig. 2, which is externally equivalent to a complex network. It differs from the

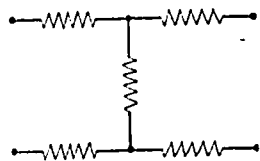

Fig. 2

* (38 to 40) As ordinarily considered, the simple networks as defined are the electrical equivalents of complex networks only with respect to definite pairs of terminals.

"T" equivalent circuit in that the impedances are arranged symmetrically on the two sides of the circuit, which is often desirable in connection with practical problems, as indicating that the circuit is balanced with respect to ground.

34-41* "II" Equivalent Circuit.—A "II" equivalent circuit is a delta connection of three impedances externally equivalent to a complex network. It is also called a "U" equivalent circuit. See Fig. 3 for symbol.

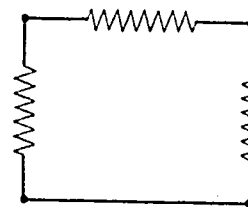

Fig. 3

34-42* "O" Equivalent Circuit.—An "O" equivalent circuit is a connection of four impedances in the form shown in Fig. 4, externally equivalent to a complex network. It differs from the II equivalent circuit in that the impedances are arranged symmetrically on the

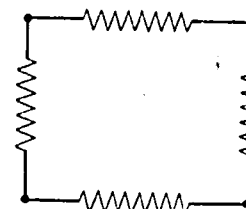

Fig. 4

two sides of the circuit, which is often desirable in connection with practical problems, as indicating that the circuit is balanced with respect to ground.

Telephony

34-43 Manual Telephone System.—A manual telephone system is one in which the calling party gives his order to an operator who completes the call directly by hand, either with or without the assistance of one or more additional operators.

* (41 to 42) As ordinarily considered, the simple networks as defined are the electrical equivalents of complex networks only with respect to definite pairs of terminals.

- 34-44 Automatic or Full Mechanical Telephone System.**—An automatic or full mechanical telephone system is one in which the calling party is enabled to complete a call by remote-control switches without the aid of an operator.
- 34-45 Semi-Automatic or Semi-Mechanical Telephone System.**—A semi-automatic or semi-mechanical telephone system is one in which the calling party gives his order to an operator who completes the call through remote-control switches.
- 34-46 Telephone Exchange.**—A telephone exchange consists of one or more central offices with associated plant, by means of which telephone service is rendered in a specified local community.
- 34-47 Telephone Exchange Area or District.**—A telephone exchange area or district is the area or district served by a telephone exchange.
- 34-48 Central Office (British "Exchange").**—A central office is a switching center for inter-connecting lines terminating therein.
- 34-49 Toll Central Office.**—A toll central office is one in which toll and long distance lines terminate.
- 34-50 Local Central Office.**—A local central office is one in which subscriber's lines terminate.
- 34-51 Private Branch Exchange (Generally Abbreviated "P. B. X.").**
—A private branch exchange is a telephone system generally installed on the premises of a subscriber, including a switchboard and extension sets, and connected to a central office, affording intercommunication between the extension sets and also between these sets and the central office.
- 34-52 Private Exchange.**—A private exchange is one which serves one business organization or individual, and is not connected to a central office.
- 34-53 Private Automatic Exchange.**—A private automatic exchange is an automatic exchange which serves one business organization or individual, and is not connected to a central office.
- 34-54 Subscriber Set (Often Abbreviated to "Subset").** A subscriber set is an assembly of apparatus for sending and receiving telephone calls.
- 34-55 Subscriber Station (Often Abbreviated to "Substation").**—A subscriber station is an installed subscriber set connected to a central office for the purpose of sending and receiving telephone calls.
- 34-56 Pay Station (British "Public Call Office").**—A pay station is a subscriber station available for the use of the public on the pay-

- ment of a fee. The fee may be either deposited in a coin box or paid to an attendant.
- 34-57 Toll Station.**—A toll station is a pay station located outside of a local service area and affording toll and long distance service only.
- 34-58 Subscriber Line or Subscriber Loop.**—A subscriber line or subscriber loop is the wire connection between a subscriber station and the central office.
- 34-59 Subscriber Line Circuit.**—A subscriber line circuit is a subscriber line with its associated individual central office apparatus.
- 34-60 Individual Line (British "Direct Line").**—An individual line is a subscriber line which connects one subscriber station to a central office, though it may have one or more extension sets.
- 34-61 Party Line.**—A party line is a subscriber line which connects two or more subscriber stations to a central office.
- 34-62 Tip Side or Tip Wire, Ring Side or Ring Wire.**—The tip side or wire, or the ring side or wire, is that conductor of a circuit which is associated with the corresponding member of a jack.
- 34-63 Negative Side or Negative Wire, Positive Side or Positive Wire.**
The negative side or wire, or the positive side or wire, is that conductor of a circuit which is normally connected to the corresponding pole of a battery.
- 34-64 Main Distributing Frame.**—A main distributing frame is a structure for terminating the permanent inside and outside wires of a central office and for effecting flexible junctions between them. It generally carries the central office protective devices and functions as a test point between line and office.
- 34-65 Intermediate Distributing Frame.**—An intermediate distributing frame is a structure for terminating permanent inside wires of a central office and for effecting flexible junctions between them.
- 34-66 Switchboard.**—A switchboard is an assemblage of apparatus in a coordinate structure for switching talking and signaling circuits.
- 34-67 Switchboard Section.**—A switchboard section is an element or unit one or more of which constitutes a complete manual switchboard.
- 34-68 Operating Room.**—An operating room is a room which contains a manual switchboard and associated apparatus.
- 34-69 Combination Current.**—A combination current consists of two or more currents of different characteristics in the same circuit. As ordinarily used the term refers to currents whose characteristics are steadily maintained, as for example, a combination of direct current and an alternating current.

- 34-70 Manual Ringing.**—Manual ringing is ringing which is affected by and continues with the operation of a key.
- 34-71 Machine Ringing.**—Machine ringing is intermittent and is caused to act periodically by the apparatus itself.
- 34-72 Superimposed Ringing Current.**—A superimposed ringing current is a combination current for ringing, consisting of a direct and an alternating current.
- 34-73 Pulsating Ringing Current.**—A pulsating ringing current is a current for ringing in which the succeeding impulses are separated by intervals approximately equal to those of the impulses themselves.
- 34-74 Harmonic Selective Signaling.**—Harmonic selective signaling employs devices tuned mechanically or electrically to the frequency of the ringing current, so that each device will not operate when receiving current intended to operate another device.
- 34-75 Multiple Harmonic Signaling.**—Multiple harmonic signaling employs frequencies which are integral multiples of the lowest frequency.
- 34-76 Non-Multiple Harmonic Signaling.**—Non-multiple harmonic signaling employs frequencies which are not integral multiples of the lowest frequency.
- 34-77 "To Call."**—"To call" is to originate a telephone call.
- 34-78 "To Dial."**—"To dial" a number is to use a dial type of calling device in order to control automatic switches.
- 34-79 "To Set Up."**—"To set up" a number is to use a key type or multiple lever type of calling device in order to control automatic switches.
- 34-80 Calling Device.**—A calling device is an apparatus by means of which automatic switches are controlled for the purpose of establishing a connection.
- 34-81 Calling Party.**—A calling party is a person who originates a telephone call.
- 34-82 Called Party.**—A called party is the person who answers when a station is called.
- 34-83 Reverting Call.**—A reverting call is one between two stations on the same subscriber line.

- 34-84 Telephone Traffic.**—Telephone traffic is the aggregate volume of communication handled in a given time.
- 34-85 "Busy."**—"Busy" is the condition of a line or an apparatus when it is in use.
- 34-86 Free.**—Free is the condition of a line or an apparatus when it is not in use. Free is the opposite of busy.
- 34-87 "To Make Busy."**—"To make busy" is to cause a line or an apparatus to appear to be busy.
- 34-88 "To Release" or "To Disconnect."**—"To release" or "to disconnect" is to terminate a telephone connection by disengaging the apparatus.
- 34-89 "To Clear."**—"To clear" is to restore a line or an apparatus to the free condition.
- 34-90 Trunk.**—A trunk is the wire connection between switching devices or central offices.
- 34-91 Trunk Circuit.**—A trunk circuit is a trunk with its associated individual apparatus.
- 34-92 Trunked Call.**—A trunked call is one which employs an inter-office trunk or a trunk between two switchboard positions.
- 34-93 Relay.**—A relay is a device by means of which contacts in one circuit are operated by a change in conditions in the same circuit or in one or more associated circuits.
- 34-94 Polar Relay.**—A polar relay is a relay which operates in response to a change in the direction of the current in the controlling circuit.
- 34-95 Quick Operating Relay.**—A quick operating relay is one which operates its contacts within a specified brief time limit.
- 34-96 Quick Release Relay.**—A quick release relay is one which releases its contacts within a specified brief time limit.
- 34-97 Quick Acting Relay.**—A quick acting relay is one which has the properties of both a quick operating and a quick release relay.
- 34-98 Slow Operating Relay.**—A slow operating relay is one which will not operate until after a specified delay.
- 34-99 Slow Release Relay.**—A slow release relay is one which when operated will not release until after a specified delay.
- 34-100 Slow Acting Relay.**—A slow acting relay is one which has the properties of both a slow operating and a slow release relay.

- 34-101 Line Relay.**—A line relay is one whose coil is normally in the line circuit.
- 34-102 Cut-Off Relay.**—A cut-off relay is one which when operated disconnects from a line apparatus normally connected to it.
- 34-103 Relay Coil Section.**—A relay coil section is one of two or more windings of a coil on one and the same core. The several sections may be concentric or placed side by side on the core.
- 34-104 Tension Spring.**—A tension spring is one which functions to exert mechanical pressure but does not carry an electrical current.
- 34-105 Contact Spring.**—A contact spring is one which takes an electrical part in switching a circuit.
- 34-106 Main Contact Spring.**—A main contact spring is one which may switch a circuit between two or more other contact springs.
- 34-107 Armature Spring.**—An armature spring is the first of a group to be moved by the armature. It may or may not be a main contact spring.
- 34-108 Plunger Spring.**—A plunger spring is the first of a group to be moved by the plunger.
- 34-109 Impulse Springs.**—Impulse springs are those which act to make or break a circuit for the purpose of sending impulses.
- 34-110 Make-Before-Break Contact Springs (Abbreviation "M. B. B.).**—Make-before-break contact springs are those in which the main spring touches the front contact before it breaks away from the back contact. Also called a continuity preserving contact.
- 34-111 Back Contact Spring.**—A back contact spring is one against which the main contact spring rests when in the normal position.
- 34-112 Front Contact Spring.**—A front contact spring is one against which the main contact spring rests when in the operated position.
- 34-113 Automatic Signaling.**—Automatic signaling is effected without the aid of an operator.
- 34-114 Automatic Switch.**—An automatic switch is a remote control device for controlling talking or signaling circuits.
- 34-115 Finder Switch.**—A finder switch is a switch connected to one of a smaller number of circuits and which finds automatically a circuit out of a larger number of circuits from whence the signal comes.

- 34-116 Line Switch.**—A line switch is a switch connected to one of a larger number of circuits from which a signal comes which finds automatically a circuit out of a smaller number of circuits.
- 34-117 Selector Switch.**—A selector switch is a switch whose duty is to select a particular group of trunks and one trunk of the group selected. In particular cases, one of these functions may be omitted.
- 34-118 Connector Switch or Final Selector.**—A connector switch or final selector is a switch whose duty is to establish a connection with the called line. It is usually operated by the last digit or digits of the call number.
- 34-119 Switch Frame.**—A switch frame is a structure for mounting an assembly of switching apparatus which may be integral therewith.
- 34-120 Section of Switches.**—A section of switches, considered from a trunking standpoint, is a group of adjacent switches whose banks are multiplied together.
- 34-121 Switchroom.**—A switchroom is a room which contains an assemblage of automatic switches and associated apparatus.
- 34-122 Bank Wires.**—Bank wires are those wires which multiple adjacent switch banks to each other.
- 34-123 Bank Cable.**—A bank cable is one which connects a switch bank to a terminal rack.
- 34-124 Multiple Cable.**—A multiple cable is one which multiples together two or more sections of switch banks by connecting together their terminals.
- 34-125 Impulse.**—An impulse is any sudden change of brief duration produced in the current of a circuit.
- 34-126 Make Impulse.**—A make impulse is an impulse due to a temporary flow of current.
- 34-127 Break Impulse.**—A break impulse is an impulse due to a temporary interruption of current.
- 34-128 Impulse Frequency.**—The impulse frequency is the number of impulses occurring per second. The reciprocal of this is the impulse period.
- 34-129 Impulse Period.**—The impulse period is the period of time included between the corresponding points in periodically recording impulses. It thus corresponds to the period of alternating current.

- 34-130 Impulse Ratio.**—Impulse ratio is the ratio of duration of an impulse to the impulse period.
- 34-131 Impulse Circuit.**—An impulse circuit is one through which impulses are transmitted.
- 34-132 Telephone Impulse Repeater.**—A telephone impulse repeater is a device for repeating impulses from one line circuit into another and for performing other duties.
- 34-133 Supervisory Signal.**—A supervisory signal is a device for attracting attention of an attendant to a duty in connection with switching apparatus or its accessories. This includes cord supervisory lamps on a manual switchboard and the supervisory lamps in an automatic exchange which indicate that a switch has been occupied but has not completed its function.
- 34-134 Tell-Tale Signal.**—A tell-tale signal is a device for locating the failure of some apparatus; for example, the blowing of a fuse, the continued drawing of heavy current by apparatus intended to receive only momentary current, etc.
- 34-135 Alarm Signal.**—An alarm signal is a sound producing device for attracting attention to either a supervisory or a tell-tale signal.
- 34-136 Telephone Repeater.**—A telephone repeater is a device for amplifying a voice current from one line circuit into another line circuit.
- 34-137 Telephone Receiver.**—A telephone receiver is an electrically operated device designed to produce sound waves or vibrations which correspond to the electromagnetic waves or vibrations actuating it.
- 34-138 Microphone.**—A contact device designed to have its electrical resistance directly and materially altered by slight differences in mechanical pressure.
- 34-139 Telephone Transmitter.**—A telephone transmitter is a sound-wave-operated or vibration-operated device designed to produce electromagnetic waves or vibrations which correspond to the sound waves or vibrations actuating it.
- 34-140* Coefficient of Coupling of a Transformer.**—The coefficient of coupling of a transformer at a given frequency is the ratio of the mutual impedance between the primary and secondary of the

* (140) Single frequency voltages and currents are here supposed to be represented by complex numbers. Their ratio is therefore a complex number.

- transformer, to the square root of the product of the self-impedances of the primary and of the secondary.
- 34-141 Repeating Coil.**—A term used in telephone practise meaning the same as transformer, and ordinarily a transformer of unity ratio.
- 34-142* Retardation Coil.**—A retardation coil is a reactor (reactance coil) used in a circuit for the purpose of selectively reacting on currents which vary at different rates.
- 34-143 Manual Switchboard.**—A manual switchboard is one in which the switching operations are performed by hand.
- 34-144 Multi Office Exchange (British "Multi Exchange System").**—A multi office exchange is one which is composed of more than one office.
- 34-145 Trunk Hunting.**—Trunk hunting is the operation of an automatic switch in moving its wipers or brushes to an idle set of terminals or contacts in a chosen group of terminals or contacts.
- 34-146 Wiper.**—A wiper is that portion of the moving member of a selector which engages with a bank contact.
- 34-147 Bank.**—A bank is an assembly of fixed contacts with which the moving members of a selector engage: Banks are usually multiplied.

Telegraphy

- 34-148 Relay.**—A relay is a device by means of which contacts in one circuit are operated by a change in conditions in the same circuit or in one or more associated circuits.
- 34-149 Polar Relay.**—A polar relay is a relay which operates in response to a change in the direction of the current in the controlling circuit.
- 34-150 Non-Polar Relay, or Neutral Relay.**—A non-polar relay is a relay which operates in response to a change in the strength of the current in the controlling circuit, irrespective of the direction of the current.
- 34-151 Neutral Relay.**—See non-polar relay.

* (142) In telephone and telegraph usage, the terms "impedance coil," "inductance coil," "choke coil" and "reactance coil" are sometimes used in place of the term "retardation coil."

- 34-152 Selector.**—A selector is a device which performs certain functions such as causing an electric lamp to light, or an electric bell to sound, in response to a definite signal or group of successive signals received over a controlling circuit.
- 34-153 Direct-Point Repeater.**—A direct-point repeater is a repeater in which the receiving relay controlled by the signals received over a line repeats these signals into another line or lines without the interposition of any other repeating or transmitting apparatus.
- 34-154 Concentrator.**—A concentrator is a traffic distributing device by means of which a number of telegraph or telephone lines, and connections to operating instruments are brought together at one point to facilitate their interconnection at such times as signals or messages are to be transmitted from one to the other.
- 34-155 Transmitter.**—A transmitter is a device for effecting electrical changes in a controlled circuit. The term transmitter is commonly applied principally to devices which in response to a controlling means effects in a main line telegraph circuit electrical changes necessary to send signals over the line.
- 34-156 Synchronous System.**—A synchronous system of telegraphy is one in which the proper transmission and reception of signals is dependent upon the synchronous operation of similar commutators or other devices located at the sending and receiving stations of a circuit.
- 34-157 Differential Duplex.**—A differential duplex is a duplex system in which at each station one of two portions of the receiving instrument are connected in series with the line wire and the other in series with an artificial line of such electrical characteristics that the effects upon the receiver of currents passing through the main and artificial lines, as a result of outgoing signals, are neutralized.
- 34-158 Bridge Duplex.**—A bridge duplex is a duplex system in which the receiving instruments at each station are connected across two impedances, one in series with the line wire and the other in series with the artificial line in such manner that no electrical change in the receiver circuit is effected by outgoing signals.
- 34-159 Half-Set Repeater.**—A half-set repeater is a repeater used for connecting together a simplex circuit and a duplexed circuit converting them into the equivalent of a single simplex circuit.

- 34-160 Intermediate Current Supply.**—An intermediate current supply is an ungrounded source of current connected in series with a line wire at a station other than a terminal on a ground return telegraph circuit.
- 34-161 Phantoplex Circuit.**—A phantoplex circuit is a superposed circuit operated by alternating current over a simplex, duplex or quadruplex circuit operated from direct-current sources.
- 34-162 Spark Condenser.**—A spark condenser is a condenser, with or without associated non-inductive resistance, connected with a pair of instrument contact points for the purpose of diminishing sparking at these points.
- 34-163 Current Margin.**—In a non-polar simplex system, the difference between the current flowing through a receiving instrument when operated to that flowing when not operated.
- 34-164 Margin Ratio.**—In a non-polar simplex system, the ratio of the current flowing through a receiving instrument when operated to that flowing when not operated.
- 34-165 Percentage Margin.**—In a non-polar simplex, the current margin expressed as a percentage of the current flowing through the relay when operated.
- 34-166 Main Circuit.**—A main circuit is a major electrical circuit of a telegraph system and includes both transmitting and receiving devices.
- 34-167 Local Circuit.**—A local circuit is a circuit, within the limits of the station, usually controlled by a receiving instrument in a main circuit or controlling a transmitter effecting changes in a main line circuit.

STORAGE BATTERIES*

(Revised Edition Adopted by the Board of Directors, American Institute of Electrical Engineers,
February 16, 1928)

A.S.A. C 40 1928

SCOPE

- 36-1** The standards in this section apply to storage batteries of the lead-acid type and of the nickel-iron alkaline type. They are suitable for large and small batteries in either stationary or portable service.
- 36-2** These standards conform to accepted usage.

CLASSIFICATION OF STORAGE BATTERIES

- 36-51** Storage batteries are classified as stationary or portable batteries on the basis of construction.
- 36-52 Stationary Batteries.**—Are those designed for service in a permanent location.
- 36-53 Portable Batteries.**—Are those designed for convenient transportation during service. Portable batteries may be used for service in a permanent location.

CONSTRUCTION

- 36-100 Storage Battery.**—A connected group of two or more electrochemical cells for the generation of electrical energy in which the cells after being discharged may be restored to a charged condition by an electric current flowing in a direction opposite to the flow of current when the battery discharges. Common usage permits this designation to be applied to a single cell used independently.
- 36-101 Storage Cell.**—The unit of the battery, consisting of positive and negative plates, separators, electrolyte and container, for the generation of electrical energy and capable of being recharged by an electric current.
- 36-102 Active Materials.**—Materials of plates reacting chemically to produce electrical energy during the discharge. The active materials of storage cells are restored to their original composition, in the charged condition, by oxidation or reduction processes

* Approved as American Standard by American Standards Association October 19, 1928. Sponsor: American Institute of Electrical Engineers.

STORAGE BATTERIES

produced by the charging current. In the charged condition the active materials are as follows:

<u>Plate</u>	<u>Lead-acid cells</u>	<u>Nickel-iron alkaline cells</u>
Positive	Lead peroxide	Oxides of nickel
Negative	Sponge lead	Iron

- 36-103 Grid.**—A metallic framework for conducting the electric current and supporting the active material.¹
- 36-104 Positive Plate.**—The grid and active material from which the current flows to the external circuit when the battery is discharging.
- 36-105 Negative Plate.**—The grid and active material to which the current flows from the external circuit when the battery is discharging.
- 36-106 Electrolyte.**—An aqueous solution of sulphuric acid used in lead cells and of certain hydroxides used in nickel-iron alkaline cells. The concentration of the solutions varies somewhat with the type of cell, its use and condition. The electrolyte of charged cells at 70 deg. Fahr. (21 deg. cent.) will ordinarily fall within the following limits of specific gravity.

	<u>Lead-acid cells</u>	<u>Nickel-iron alkaline cells</u>
Maximum.....	1.300	1.230
Minimum.....	1.200	1.160

- 36-107 Separator.**—A device for preventing metallic contact between the plates of opposite polarity within the cell.
- 36-108 Group.**—Assembly of a set of plates of the same polarity for one cell.
- 36-109 Element.**—The positive and negative groups with separators assembled for a cell.
- 36-110 Couple.**—The element of a cell containing two plates, one positive and one negative. This term is also applied to a positive and negative plate connected together as one unit for installation in adjacent cells.
- 36-111 Jar.**—The container for the element and electrolyte of a cell. Specifically a jar for lead-acid cells is usually of hard rubber composition or glass; but for nickel-iron alkaline cells is a nickel plated steel container frequently referred to as a "can."

¹ In certain types of batteries the active material is enclosed in containers which are held in place by the grid.

- 36-112 Tank.**—A lead container, supported by wood, for the element and electrolyte of a cell. This is restricted to some relatively large types of cells.
- 36-113 Case.**—A container for several cells. Specifically wood cases are containers for cells in individual jars; rubber or composition cases are provided with compartments for the cells.
- 36-114 Tray.**—A support or container for one or more cells.
- 36-115 Terminal Posts.**—The points of the cell or battery to which the external circuit is connected.
- 36-116 Cell Connector.**—A conductor used for carrying current between adjacent cells.
- 36-117 Counter Electromotive Force Cells.**—Cells of practically no capacity used to oppose the line voltage. Frequently called "Counter cells."
- 36-118 End Cells.**—The cells of a battery which may be cut in or out of the circuit for the purpose of adjusting the battery voltage.
- 36-119 Pilot Cell.**—A selected cell whose temperature, voltage and specific gravity of electrolyte are assumed to indicate the condition of the entire battery.

CAPACITY

- 36-150 Ampere-Hour Capacity.**—The number of ampere-hours which can be delivered by a cell or battery under specified conditions as to temperature, rate of discharge and final voltage.
- 36-151 Watt-Hour Capacity.**—The number of watt-hours which can be delivered by a cell or battery under specified conditions as to temperature, rate of discharge and final voltage.
- 36-152 Time-Rate.**—The rate in amperes at which a battery will be fully discharged in a specified time, under specified conditions of temperature and final voltage. Example, the eight-hour rate or the twenty-minute rate.

VOLTAGE

- 36-200 Open-Circuit Voltage.**—The voltage of a cell or battery at its terminals when no current is flowing. For the purpose of measurement, the small current required for the operation of a voltmeter is usually negligible.
- 36-201 Closed-Circuit Voltage.**—The voltage at the terminals of a cell or battery when current is flowing.

- 36-202 Average Voltage.**—The average value of the voltage during the period of charge or discharge. It is conveniently obtained from the time integral of the voltage curve.
- 36-203 Initial Voltage.**—The voltage of a cell or battery at the beginning of a charge or discharge. It is usually taken after the current has been flowing for a sufficient period of time for the rate of change of voltage to become practically constant.
- 36-204 Final Voltage.**—The prescribed voltage upon reaching which the discharge is considered complete. The final voltage is usually chosen so that the useful capacity of the cell is realized. Final voltages vary with the type of battery, the rate of the discharge, temperature, and the service in which the battery is used.
- 36-205 Polarity.**—An electrical condition determining the direction in which current tends to flow. By common usage the discharge current is said to flow from the positive or peroxide plate through the external circuit. In a nickel-iron alkaline battery the positive plate is that containing nickel peroxide.
- 36-206. Polarization.**—The change in voltage at the terminals of a storage cell, when a specified current is flowing, equal to the difference between the actual and the equilibrium (constant open-circuit condition) potentials of the plates, exclusive of the IR drop.

CHARGING AND DISCHARGING

- 36-250 Charge.**—The conversion of electrical energy into chemical energy within the cell or battery. This consists of the restoration of the active materials by passing a uni-directional current through the cell or battery in the opposite direction to that of the discharge. A cell or battery which is said to be "charged" is understood to be fully charged.
- 36-251 Charging Rate.**—The current expressed in amperes at which a battery is charged.
- 36-252 Constant-Current Charge.**—A charge in which the current is maintained at constant value. For some types of lead batteries this may involve two rates called the starting and the finishing rates.
- 36-253 Constant Voltage Charge.**—A charge in which the voltage at the terminals of the battery is held at a constant value. A modified constant voltage system is usually one in which the voltage of the charging circuit is held substantially constant, but a fixed

resistance is inserted in the battery circuit producing a rising voltage characteristic at the battery terminals as the charge progresses. This term is also applied to other methods for producing automatically a similar characteristic.

36-254 Boost Charge.—A partial charge, usually at a high rate for a short period.

36-255 Equalizing Charge.—An extended charge given to a battery to insure the complete restoration of the active materials in all the plates of all the cells.

36-256 Trickle Charge.—A continuous charge at low rate approximately equal to the internal losses and suitable to maintain the battery in a fully charged condition. This term is also applied to very low rates of charge suitable not only for compensating for internal losses but to restore intermittent discharges of small amount delivered from time to time to the load circuit.

36-257 Finishing Rate.—The rate of charge expressed in amperes to which the charging current for some types of lead batteries is reduced near the end of charge to prevent excessive gassing and temperature rise.

36-258 Discharge.—The conversion of the chemical energy of the battery into electrical energy.

36-259 Reversal.—Change in normal polarity of a storage cell.

36-260 Local Action or Self Discharge.—The internal loss of charge which goes on continuously within a cell regardless of connections to an external circuit.

36-261 Floating.—A method of operation in which a constant voltage is applied to the battery terminals sufficient to maintain an approximately constant state of charge.

36-262 Specific Gravity of Electrolyte.—The electrolyte of lead-acid batteries increases in concentration to a fixed maximum value during charge and decreases during discharge. The concentration is usually expressed as the specific gravity of the solution. This variation of specific gravity of the solution affords an approximate indication of the state of charge.

The specific gravity of the electrolyte in nickel-iron alkaline batteries does not change appreciably during charge or discharge and therefore does not indicate the state of charge. The specific gravities, however, are indication of the electrochemical usefulness of the electrolyte.

36-263 Gassing.—The evolution of oxygen or hydrogen, or both.

EFFICIENCY

36-300 Efficiency.—The ratio of the output of a cell or battery to the input required to restore the initial state of charge under specified conditions of temperature, current rate, and final voltage.

36-301 Ampere-Hour Efficiency.—(Electrochemical Efficiency.)—The ratio of the ampere-hours output to the ampere-hours of the recharge.

36-302 Volt Efficiency.—The ratio of the average voltage during the discharge to the average voltage during the recharge.

36-303 Watt-Hour Efficiency.—(Energy efficiency.)—The ratio of the watt-hours output to the watt-hours of the recharge.

TEMPERATURE

36-350 Reference Temperature.—The capacity obtained from a storage battery on discharge varies with the temperature of the electrolyte. The following standard reference temperatures are established.

(1) The temperature of electrolyte at beginning of discharge shall be 25 deg. cent. (77 deg. fahr.). No limit is placed on the temperature attained by the electrolyte during discharge.

(2) The ambient temperature on discharge shall be from 5 deg. cent. to 8 deg. cent. lower than the temperature of the electrolyte, on the beginning of discharge. The ambient temperature shall be kept constant throughout the discharge.

36-351 Temperature Coefficient of Voltage.—The change in open-circuit voltage per degree (cent.) change in temperature.²

36-352 Temperature Coefficient of Capacity.—The change in delivered capacity expressed as a percentage of the ampere-hour or watt-hour capacity per degree (cent.) change in temperature between specified limits.

36-353 Critical Temperature.—The temperature of the electrolyte at which an abrupt change in capacity occurs.

² This is but a few tenths of a millivolt and must not be confused with the effect of temperature on changes in voltages resulting from polarization and IR drop when charging or discharging.

RATING OF BATTERIES

36-400 General.—Batteries are usually rated in terms of the number of ampere-hours which they are capable of delivering when fully charged and under specified conditions as to temperature, rate of discharge and final voltage (See 36-150, 36-204 and 36-250). For different classes of service, different time-rates (See definition of time-rate, 36-152) are frequently used. For comparing the capacities of batteries of different size but of the same general design, it is customary to use the same time-rate, and a comparison based on the different lengths of time they will discharge at the same rate is not recommended as it is misleading.

36-401 Misrating.—A battery which fails to deliver its rated capacity on the third successive measured cycle of charge and discharge under specified current rates, temperature of electrolyte, specific gravity, and final voltage, shall be considered to be improperly rated.

NATIONAL ELECTRICAL CODE
 Regulations of the
 National Board of Fire Underwriters for
 Electrical Wiring and Apparatus
 as recommended by the
 National Fire Protection Association

A.S.A. CI 1930

ARTICLE 37. RADIO EQUIPMENT*

3701. General.

(a) The requirements of this article shall neither apply to equipment installed on shipboard, nor to antennas used for coupling carrier current to line conductors; but shall be deemed to be additional to, or amendatory of, those prescribed in Articles 1 to 19, inclusive, of this code.

(b) Transformers, voltage reducers, keys and other devices employed shall be of types expressly approved for radio reception or transmission.

(c) Methods of wiring from the source of power to and between devices, related to apparatus connected to interior wiring systems, shall be in accordance with the rules covering permanent or portable fixtures, devices and appliances.

It is recommended that the authority enforcing this code be freely consulted as to the specific methods to be followed in any case of doubt relative to installation of antenna and counter-poise conductors and that the National Electrical Safety Code, Part 5, be followed.

3702. For Receiving Stations Only.

(a) Antenna and counterpoise conductor sizes shall be not less than No. 14 if of copper or No. 17 if of bronze or copper-clad steel. Antenna and counterpoise conductors outside buildings shall be kept well away from all electric light or power wires of any circuit of more than 600 volts, and from railway, trolley or feeder wires, so as to avoid the possibility of contact between the antenna or counterpoise and such wires under accidental conditions.

* Approved as American Standard by the American Standards Association, July 19, 1929.

(b) Antenna and counterpoise where placed in proximity to electric light or power wires of less than 600 volts, or signal wires, shall be constructed and installed in a strong and durable manner, and shall be so located and provided with suitable clearances as to prevent accidental contact with such wires by sagging or swinging.

(c) Splices and joints in the antenna span shall be soldered unless made with approved splicing devices.

(d) The preceding paragraphs, (a), (b), and (c), shall not apply to light and power circuits used as receiving antenna, but the devices used to connect the light and power wires to radio receiving sets shall be of approved type.

(e) Lead-in conductors, that is, conductors from antennas to sets, shall be of copper, approved copper-clad steel or other metal which will not corrode excessively, and in no case shall they be smaller than No. 14, except that bronze or copper-clad steel not less than No. 17 may be used.

(f) Lead-in conductors from the antenna to the first building attachment shall conform to the requirements for antennas similarly located. Lead-in conductors from the first building attachment to the building entrance shall, except as specified in the following paragraph, be installed and maintained so that they cannot swing closer to open supply conductors than the following distances:

Supply wires 0 to 600 volts	2 feet
Supply wires exceeding 600 volts	10 feet

Where all conductors involved are supported so as to insure a permanent separation and the supply wires do not exceed 150 volts to ground, the clearance may be reduced to not less than 4 inches. Lead-in conductors on the outside of buildings shall not come nearer than the clearances specified above to electric light and power wires unless separated therefrom by a continuous and firmly fixed non-conductor which will maintain permanent separation. The non-conductor shall be in addition to any insulating covering on the wire.

(g) Each lead-in conductor shall enter the building through a non-combustible, non-absorptive, insulating bushing slanting upward toward the inside or by means of an approved device designed to give adequate insulation and protection. The lead-in conductor from the building entrance to the set shall have rubber insulation approved for voltages 0-600 (Type R).

(h) Each lead-in conductor shall be provided with an approved protective device (lightning arrester) which will operate at a voltage of 500 volts or less, properly connected and located either inside the building at some point between the entrance and the set which is convenient to a ground, or outside the building as near as practicable to the point of entrance. The protector shall not be placed in the immediate vicinity of easily ignitable stuff, or where exposed to inflammable gases or dust or flyings of combustible materials.

(i) If an antenna grounding switch is employed, it shall in its closed position form a shunt around the protective device. The switch should be placed in the most direct line between the lead-in conductor and the point where the grounding connection is made. Such a switch shall not be used as a substitute for the protective device.

(j) If fuses are used, they shall not be placed in the circuit from the antenna through the protective device to ground.

(k) The protective grounding conductor may be bare and shall be of copper, bronze or approved copper-clad steel. The protective grounding conductor shall be not smaller nor have less conductance per unit of length, than the lead-in conductor, and in no case shall be smaller than No. 14 if of copper nor smaller than No. 17 if of bronze or copper-clad steel. The protective grounding conductor shall be run in as straight a line as possible from the protective device to a good permanent ground. The ground connections shall be made to a cold-water pipe where such pipe is available and is in service and connected to the street mains. An outlet pipe from a water tank fed from a street main or a well may be used, provided such outlet pipe is adequately bonded to the inlet pipe connected to the street water main or well. If water pipes are not available, ground connections may be made to a grounded steel frame of a building or to an artificial ground such as a galvanized iron pipe or a rod driven into permanently damp earth or to a metal plate or other body of metal buried similarly. Gas piping shall not be used for the ground.

(l) The protective grounding conductor shall be guarded where exposed to mechanical injury. An approved ground clamp shall be used where the protective grounding conductor is connected to pipes or piping.

(m) The protective grounding conductor may be run either inside or outside the building. The protective grounding conductor and ground, installed as prescribed in the preceding paragraphs (k) and (l), may be used as the operating ground.

It is recommended that in this case the operating grounding conductor be connected to the ground terminal of the protective device.

If desired, a separate operating grounding connection and ground may be used, this operating grounding conductor being either bare or provided with an insulated covering.

(n) Wires inside buildings shall be securely fastened in a workmanlike manner and shall not come nearer than 2 inches to any electric light or power wire not in conduit unless separated therefrom by some continuous and firmly fixed non-conductor, such as porcelain tubes or approved flexible tubing, making a permanent separation. This non-conductor shall be in addition to any regular insulating covering on the wire.

(o) Storage-battery leads shall consist of conductors having approved rubber insulation. The circuit from a filament, "A," storage battery of more than 20 ampere-hours capacity, NEMA rating, shall be properly protected by a fuse or circuit-breaker rated at not more than 15 amperes. The circuit from a plate, "B," storage battery shall be properly protected by a fuse or circuit-breaker rated at not more than 1 ampere in the negative lead. Fuses or circuit-breakers shall be located not more than 18 inches along the wire from a battery terminal.

3703. For Transmitting Stations Only.

(a) Antenna and counterpoise conductors outside buildings shall be kept well away from all electric light or power wires of any circuit of more than 600 volts, and from railway trolley or feeder wires, so as to avoid the possibility of contact between the antenna or counterpoise and such wires under accidental conditions. Antenna and counterpoise conductors where placed in proximity to electric light or power wires of less than 600 volts, or signal wires, shall be constructed and installed in a strong and durable manner, and shall be so located and provided with suitable clearances as to prevent accidental contact with such wires by sagging or swinging.

(b) Antenna conductor sizes shall be not less than given in the following table:

Material	Stations to which power supplied is less than 100 watts and where voltage of power is less than 400 volts	Stations to which power supplied is more than 100 watts or voltage of power is more than 400 volts
Soft copper.....	14	7
Medium-drawn copper.....	14	8
Hard-drawn copper.....	14	10
Bronze or copper-clad steel.....	14	12

(c) Splices and joints in the antenna and counterpoise span shall be soldered unless made with approved splicing devices.

(d) Lead-in conductors shall be of copper, bronze, approved copper-clad steel or other metal which will not corrode excessively and in no case shall be smaller than No. 14.

(e) Antenna and counterpoise conductors and wires leading therefrom to ground switch, where attached to buildings, shall be firmly mounted 5 inches clear of the surface of the building, on non-absorptive insulating supports such as treated pins or brackets, equipped with insulators having not less than 5 inches creepage and air-gap distance to inflammable or conducting material, except that the creepage and air-gap distance for continuous-wave sets of 1000 watts and less input to the transmitter, shall be not less than 3 inches.

(f) In passing the antenna or counterpoise lead-in into the building a tube or bushing of non-absorptive, insulating material, slanting upward toward the inside, shall be used and shall be so insulated as to have a creepage and air-gap distance in the case of continuous-wave sets of 1000 watts and less input to the transmitter, not less than 3 inches, and in all other cases not less than 5 inches. If porcelain or other fragile material is used it shall be protected where exposed to mechanical injury. A drilled window pane may be used in place of a bushing provided creepage and air-gap distances as specified above are maintained.

(g) A double-throw knife switch having a break distance of at least 4 inches and a blade not less than 1/8 inch by 1/2 inch, or a flexible grounding lead and clamp in place of this switch, shall be used to join the antenna lead-in to the grounding conductor. The switch or flexible grounding lead may be located inside or outside the building. The base of the switch shall be of non-absorptive insulating material. The switch or flexible grounding lead shall be so mounted that its current-carrying parts will be at least 3 inches clear of the building wall or other conductors in the case of continuous-wave sets of 1000 watts and less, and in all other cases at least 5 inches. The conductor from grounding switch or flexible grounding lead to ground shall be securely supported. These provisions shall also apply to the connection of the counter poise lead-in to its grounding conductor.

It is recommended that the switch be located in the most direct line between the lead-in conductors and the point where grounding connection is made.

(h) Antenna and counterpoise conductors shall be effectively and permanently grounded at all times when station is not in actual operation and unattended, by a conductor at least as large as the lead-in and in no case smaller than No. 14 copper, bronze or approved copper-clad steel. This protective grounding conductor need not have an insulated covering or be mounted on insulating supports. The protective grounding conductor shall be run in as straight a line as possible to a good permanent ground. The ground connections shall be made to a cold-water pipe where such pipe is available and is in service and connected to the street mains. An outlet pipe from a water tank fed from a street main, or a well may be used, provided such outlet pipe is adequately bonded to the inlet pipe connected to the street water main or well. If water pipes are not available, ground connections may be made to a grounded steel frame of a building or to an artificial ground such as a galvanized iron pipe or a rod driven into permanently damp earth or to a metal plate or other body of metal buried similarly. The protective grounding conductor shall be protected where exposed to mechanical injury. A suitable approved ground clamp shall be used where the protective grounding conductor is connected to pipes or piping. Gas pipes shall not be used for the ground.

It is recommended that the protective grounding conductor be run outside the building.

(i) The operating grounding conductor shall be of copper strip not less than $3/8$ inch wide by $1/32$ inch thick, or of copper, bronze, or approved copper-clad steel having a periphery, or girth, of at least $3/4$ inch, such as a No. 2 wire, and shall be firmly secured in place throughout its length.

(j) The operating grounding conductor shall be connected to a good permanent ground. Preference shall be given to water piping. Other permissible grounds are grounded steel frames of buildings or other grounded metal work in the building, and artificial grounding devices such as driven pipes, rods, plates, cones, etc. Gas piping shall not be used for the ground.

(k) Where the current supply is obtained directly from lighting or power circuits, the conductors whether or not lead-covered shall be installed in approved metal conduit, armored cable or metal raceways.

(l) When necessary to protect the supply system from high-potential surges and kick-backs there shall be installed in the supply

line as near as possible to each radio transformer, rotary spark gap, motor and generator in motor-generator sets and other auxiliary apparatus one of the following:

(1) Two condensers (each of not less than $1/10$ microfarad capacity and capable of withstanding 600 volt test) in series across the line with mid-point between condensers grounded; across (in parallel with) each of these condensers shall be connected a shunting fixed spark-gap capable of not more than $1/32$ inch separation.

(2) Two vacuum-tube-type protectors in series across the line with the mid-point grounded.

(3) Lightning arresters, such as the aluminum-cell type.

NATIONAL ELECTRICAL SAFETY CODE*
Bureau of Standards

Fourth Edition, December 31, 1926

A.S.A. C2 1927

SECTION 50. SCOPE

500. Scope.

The rules of part 5 apply to radio transmitting and receiving installations, including antennas, counterpoise wires, lead-in conductors, grounding conductors, grounding connections, protective devices, and batteries. The rules do not apply to antennas used for coupling carrier-current equipment to line conductors.

In case the installation is covered by more than one rule, the superior requirement shall apply.

SECTION 51. CLASSIFICATION OF RADIO STATIONS

510. Classification of Radio Stations.

For the purpose of these rules radio stations are classified as follows:

A. Receiving stations.

B. Transmitting stations.

1. *Low-power*.—Transmitting stations to which the power supplied is less than 100 watts and where the voltage of the power supplied is less than 400 volts.

2. *Medium-power*.—Transmitting stations not classified as low-power or high-power.

3. *High-power*.—Transmitting stations to which the power supplied is greater than 1,000 watts or where the voltage of the power supplied is greater than 2,000 volts.

SECTION 52. ANTENNA AND COUNTERPOISE INSTALLATION

520. Application of Rules.

These rules apply to the following:

A. **Outdoor antennas of all classes of receiving and transmitting stations.** (There are no requirements for indoor antennas.)

B. **Counterpoise wires.**

* Approved as American Standard by the American Standards Association, November 15, 1927. The complete handbook can be purchased from the Government Printing Office, Washington, D. C. Price \$1.00.

521. General Requirements.

A. **Counterpoise wires.**—Counterpoise wires shall conform to the requirements for antennas similarly located.

B. **Antennas of receiving and low-power transmitting stations.**—Such antennas shall, in general, comply with the requirements for the construction of communication lines for public use in similar situations.

C. **Antennas of medium- and high-power transmitting stations.**—Such antennas shall, in general, comply with the requirements for the construction of supply lines in similar situations.

522. Locations to be Avoided.

The following situations should be avoided in erecting antennas and guy wires:

A. Attachments to supply or communication poles.

B. Crossings over railroad tracks or public highways.

C. Crossings over supply or communication conductors.

D. Crossings under supply or communication conductors.

E. Antenna conflicts with supply or communication conductors.

(See definition of "Antenna conflict.")

523. Ordinary Construction of Antennas.

Antennas shall be constructed according to the requirements of rule 523 when they do not cross over railroad tracks, supply conductors, or communication conductors and do not conflict with supply or communication conductors.

A. **Antenna conductors.**

1. *Material.*

(a) RECEIVING ANTENNAS.

No requirements.

(b) TRANSMITTING ANTENNAS.

Antennas shall be of copper, bronze, copper-covered steel, or other metal which will not corrode excessively under the prevailing conditions.

2. *Size.*—Antenna conductor sizes shall be not less than given in Table I.

3. *Strength.*

(a) ANTENNAS OF RECEIVING AND LOW-POWER TRANSMITTING STATIONS.

No requirements.

(b) ANTENNAS OF MEDIUM- AND HIGH-POWER TRANSMITTING STATIONS.

TABLE I
ANTENNA CONDUCTOR SIZES—ORDINARY CONSTRUCTION

Material	Receiving antennas		Transmitting antennas			
			Low-power		Medium- and high-power	
	Size A.W.G.	Diameter	Size A.W.G.	Diameter	Size A.W.G.	Diameter
Copper:						
Soft-drawn.....	14	<i>Inch</i> 0.064	14	<i>Inch</i> 0.064	7	<i>Inch</i> 0.143
Medium-drawn.....	14	0.064	14	0.064	8	0.128
Hard-drawn.....	14	0.064	14	0.064	10	0.102
Bronze or copper-covered steel....	17	0.045	14	0.064	12	0.081

The strength of the antenna conductor shall be not less than that of No. 10 A. W. G. (diameter 0.102 inch) hard-drawn copper.

B. Antenna insulators.

1. *Antennas of receiving and low-power transmitting stations.*—No requirements.

2. *Antennas of medium- and high-power transmitting stations.*—Insulators shall be of non-combustible material and shall have a creepage distance of not less than 10 inches.

C. Antenna supports.

1. *Strength of supports.*—Supports shall be of such initial size as to carry the vertical load and where necessary shall be guyed or braced so as to withstand the transverse and longitudinal loads to which they may be subjected.

2. *Roof supports.*—Antenna supports erected on roofs shall be of rigid construction, and where necessary shall be arranged to distribute the load over the roof. Such supports shall be erected so that they are not dependent in any way on the antenna for stability.

3. *Chimneys.*—The attachment of antennas to chimneys should be avoided.

4. *Grounding metal supports on roofs.*—Metal poles or masts extending more than 10 feet above the supporting building shall be permanently and effectively grounded.

5. *Trees.*—Where a tree is used as an antenna support, sufficient sag (or other means) shall be provided to keep the tension in the antenna safely below the breaking strength when the tree sways in the wind.

D. Attaching antennas to supports.

1. *Strength of attachment.*—The means used for attaching the antenna to the support shall be such as to withstand a greater load than that which will break the conductor itself.

2. *Attachment on small poles.*—If the pole is not strong enough to support a person, some arrangement shall be provided to draw up the antenna from the ground.

E. Minimum clearance above ground.

1. *Spans 150 feet or less in length.*—Antenna conductors shall have clearances above ground as given in Table II.

TABLE II
MINIMUM ANTENNA CLEARANCES ABOVE GROUND

Location	Receiving and low-power antennas	Medium- and high-power antennas
Above streets and other traveled roadways.....	<i>Feet</i> 18	<i>Feet</i> 28
Along road in rural districts.....	15	28
Above roadways to residence garages.....	10	—
Above spaces or ways accessible only to pedestrians.....	10	—

2. *Spans exceeding 150 feet in length.*—For such spans the above clearances shall be increased by 0.1 foot for each 10 feet in excess of 150 feet.

F. *Minimum clearances below supply and communication conductors.*—Antennas shall have the following clearances from conductors under which they cross:

TABLE III
MINIMUM ANTENNA CLEARANCES BELOW OTHER CONDUCTORS

Crossing under—	Receiving and low-power antennas	Medium- and high-power antennas
Communication conductors.....	<i>Feet</i> 2	<i>Feet</i> 10
Supply conductors, 0 to 750 volts.....	4	10
Supply conductors exceeding 750 volts.....	6	10

G. *Clearances from combustible material.*—Antennas of medium- and high-power transmitting stations shall be placed so that an air gap of at least 10 inches exists between the antenna and the nearest combustible material.

524. Special Construction of Antennas.

Antennas shall be specially constructed according to the following requirements when they cross over railroad tracks, supply conductors, or communication conductors, or are in conflict with supply or communication conductors.

A. *Recommendation against locating antennas in situations where special construction is required.*—It is strongly recommended

that the installation of antennas in these special situations be avoided. If such locations are employed, it must be recognized that special hazards are introduced and that great care is necessary in the construction and maintenance of antennas to avoid contact with supply or communication conductors or to avoid the reduction of clearance over railroad tracks.

B. Construction of antennas crossing over or conflicting with service loops 0 to 150 volts to ground.—Antennas constructed in these situations shall conform to the requirements for the ordinary construction of antennas (rule 523) and, in addition, with the requirements set forth below for splices (rule 524, C, 2) and for minimum clearances above communication and supply line conductors (rule 524, C, 4).

C. Construction of antennas crossing over or conflicting with communication conductors or supply conductors 0 to 750 volts.

1. *Antenna conductor strength.*—The strength of the antenna conductor shall be not less than that of hard-drawn copper to the following sizes:

Span length	Size of hard-drawn copper	
	Size A.W.G.	Diameter
0 to 150 feet.....	8	<i>Inch</i> 0.128
Exceeding 150 feet.....	6	0.162

2. *Splices.*—Splices in antenna spans shall be made with a suitable twisted-sleeve connector which will provide a strong unsoldered joint.

3. *Antenna supports.*

(a) MATERIAL.

The poles for supporting antennas shall be of steel, concrete, or wood. Wood poles shall be free from observable defects that would decrease their strength or durability.

(b) SIZE.

Wood poles shall have a top diameter of not less than 6 inches.

(c) SETTING.

Poles shall be set to such a depth and in such a manner that any applied load will break the pole before the butt is pulled loose from its setting.

4. *Minimum clearances above communication and supply conductors, 0 to 750 volts.*—Antennas crossing over such conductors shall have the following clearances:

Antennas of receiving and low-power transmitting stations.....	6
Antennas of medium- and high-power transmitting stations.....	10

D. Antennas crossing over railroads or crossing over or conflicting with supply lines exceeding 750 volts.

1. *Antennas of receiving and low-power transmitting stations.*—Such antennas shall conform to the requirements for communication lines for public use in similar situations as far as grades of construction and clearances from all other wires and from ground are concerned. (See part 2.)

2. *Antennas of medium- and high-power transmitting stations.*—Such antennas shall conform to the requirements for supply lines in similar situations as far as grades of construction and clearances from all other wires and from ground are concerned. (See part 2.)

525. Guarding of Antennas.

Antennas for transmitting stations shall be installed or protected so as to be inaccessible to unauthorized persons.

SECTION 53. LEAD-IN CONDUCTORS

530. Application of Rules.

The requirements of this section apply to lead-in conductors of receiving stations and transmitting stations of low and medium power. Lead-in conductors of high-power transmitting stations shall meet such requirements of part 1, "Supply stations," as apply.

531. Material.

Lead-in conductors shall be of copper, bronze, copper-covered steel, or other metal which will not corrode excessively under the prevailing conditions.

532. Size.

A. *Receiving stations.*—For receiving stations the size of lead-in conductor shall be not less than No. 14 A. W. G. (0.064 inch) if of copper, or less than No. 17 A. W. G. (0.045 inch) if of bronze or copper-covered steel.

B. *Low- and medium-power transmitting stations.*—For such transmitting stations the lead-in conductor shall be not less than No. 14 A. W. G. (0.064 inch).

533. Installation of Lead-in Conductor.

A. *From antenna to first building attachment.*—This section of the lead-in wire shall conform to the requirements for antennas similarly located.

B. From first building attachment to building entrance.—This section of the lead-in conductor shall be installed and maintained so that it cannot swing closer to open supply conductors than the following distances:

	Feet
Supply lines 0 to 750 volts.....	2
Supply lines exceeding 750 volts.....	10

Exception.—The 2-foot clearance may be reduced if the lead-in conductor is separated from supply conductors by a continuous and firmly fixed non-conductor which will maintain permanent separation. This non-conductor shall be in addition to any insulating covering on the wires.

C. From building entrance to set.

1. Receiving stations.

(a) Lead-in conductors shall be securely fastened in a workman-like manner.

(b) Clearance between lead-in conductor and any supply conductor not in conduit shall not be less than 2 inches.

Exception.—This 2-inch clearance does not apply if a firmly fixed non-conductor such as porcelain tube affords a permanent separation. This non-conductor shall be in addition to any insulating covering on the wires.

2. Low- and medium-power transmitting stations.

(a) Lead-in conductors shall be securely fastened to suitable insulators.

(b) Clearance between lead-in conductor and any supply wire shall be at least 5 inches.

(c) Lead-in conductors shall be installed and protected to prevent persons from readily coming into accidental contact with them.

SECTION 54. CONSTRUCTION AT BUILDING ENTRANCE

540. Application of Rules.

The requirements of this section apply to construction at receiving stations and transmitting stations of low and medium power. Construction at building entrances at high-power transmitting stations shall meet such requirements of part 1, "Supply stations," as apply.

541. Entrance Bushing.

Lead-in conductors shall enter the building through a rigid, non-combustible, non-absorptive, insulating tube or bushing, or through a drilled windowpane.

542. Creepage and Air-Gap Distance.

The entrance bushing or windowpane mentioned in rule 541 above shall afford the following creepage and air-gap distance from extraneous bodies:

Receiving stations.....	No requirement.
Low- and medium-power transmitting stations using damped waves.....	5 inches.
Low- and medium-power transmitting stations using undamped waves.....	3 inches.

543. Mechanical Protection of Bushings.

Entrance bushings of porcelain or other fragile material at transmitting stations shall be protected where exposed to mechanical injury.

SECTION 55. PROTECTIVE AND OPERATING GROUNDING CONDUCTORS

550. Application of Rules.

The requirements of this section apply to grounding conductors of receiving stations and transmitting stations of low and medium power. Grounding conductors of high-power transmitting stations shall meet such requirements of part 1, "Supply stations," as apply.

551. General.

The protective grounding conductor may be used also as the operating grounding conductor.

552. Material and Size.

A. Receiving stations.

1. *Material.*—No requirements.

2. *Size.*—

(a) OPERATING GROUNDING CONDUCTOR.

No requirements.

(b) PROTECTIVE GROUNDING CONDUCTOR.

This conductor shall not be smaller than the lead-in conductor.

B. Transmitting stations.—The operating and grounding conductors shall have strength and conductance per unit length not less than No. 14 A. W. G. (0.064 inch) hard-drawn copper.

553. Installation of Grounding Conductors.

A. Method of running.

1. Grounding conductors shall be run in as straight a line as possible from the set or the protective device to a good permanent ground.

2. Grounding conductors may be run either inside or outside of the building.

Recommendation.—It is recommended that the protective grounding wire for low- and medium-power transmitting stations be run outside of the building.

B. Mechanical protection.—Grounding conductors shall be guarded where exposed to mechanical injury.

C. Insulation.—Grounding conductors may be of insulated or bare wire and need not be run on insulating supports.

SECTION 56. GROUND CONNECTIONS

560. Application of Rules.

The requirements of this section apply to ground connections for all classes of transmitting stations and to protective ground connections of receiving stations.

561. General.

Grounding shall be done in accordance with the following methods. (See section 9 for complete rules for grounding.)

562. Gas Pipe Not to be Used.

Gas pipe should not be used for grounding purposes.

563. Water-pipe Grounds.

The ground connections shall be made to a cold-water pipe where such pipe is available and is in service and connected to the street mains. An outlet pipe from a water tank fed by a street main or a well may be used, provided such outlet pipe is adequately bonded to the inlet pipe connected to the street water main or well.

564. Attachment to Pipes.

Grounding conductors shall be attached to pipes by means of suitable ground clamps. The entire surface of the pipe to be covered by the clamp shall be thoroughly cleaned.

565. Driven or Buried Grounds.

If cold-water pipes are not available, ground connections may be made to a galvanized-iron pipe or to a rod driven into permanently damp earth or to a metal plate or other body of metal buried similarly.

566. Attachment to Ground Rod or Plate.

The grounding conductor shall be attached to the rod, buried plate, or other body of metal so as to give reliable connection both mechanically and electrically. This connection shall be made so that it

will not fail through corrosion, even when the joint is buried in the earth.

SECTION 57. PROTECTIVE DEVICES

570. Application of Rules.

The requirements of this section apply to protective devices for receiving stations and transmitting stations of low and medium power. Protective devices for high-power transmitting stations shall meet such requirements of part 1, "Supply stations," as apply.

571. Lightning Arrester.

A. Where required.—Each lead-in conductor of a receiving station shall be provided with a lightning arrester, whether or not an antenna grounding switch is used.

B. Operating voltage.—The lightning arrester shall be such as to operate at a potential of 500 volts or less.

C. Location.—The arrester may be located outside the building as near as practicable to the point of entrance, or inside the building between the point of entrance and the receiving set and convenient to a ground. The arrester shall not be placed in the immediate vicinity of easily ignitable material or in a location exposed to dust, inflammable gases, or flyings of combustible materials.

572. Antenna Grounding Switch.

A. Where required.—An antenna grounding switch shall be used at low- and medium-power transmitting stations. An antenna grounding switch is not required at receiving stations, but may be used in addition to the lightning arrester.

B. Type of switch.

1. *Receiving stations.*—The switch should be of the single-pole double-throw type.

2. *Low- and medium-power transmitting stations.*—The switch shall be of the double-throw type and shall meet the following requirements:

Minimum break distance 4 inches.

Minimum cross-section of switch blade $\frac{1}{4}$ inch \times $\frac{1}{2}$ inch

Switch base: Non-absorptive insulating material.

C. Location.—The switch may be located either outside or inside the building. The switch should be placed in the most direct line between the lead-in conductor and the point where the grounding connection is made.

D. Clearance for live switch parts.—The switch shall be mounted so that its current-carrying parts will clear the building wall or conductors not connected to the switch by the following distances:

Switches for receiving stations: No clearance required.

Switches for low- and medium-power transmitting stations:

Damped-wave sets.....	5 inches.
Undamped-wave sets.....	3 inches.

E. Method of connection.

1. *Receiving stations.*—The switch shall be wired so that the antenna lead-in conductor can be disconnected from the set and connected to the grounding conductor. When in the grounding position the switch shall short-circuit the lightning arrester.

2. *Low- and medium-power transmitting stations.*—No requirements.

F. Operation of switch.

1. *Receiving stations.*—No requirements.

2. *Low- and medium-power transmitting stations.*—Antenna and counterpoise lead-in conductors of low- and medium-power transmitting stations shall be connected to the grounding conductor whenever the station is not in use.

573. Protection Against Kick-back.

A. Where required.—Protection should be provided at low- and medium-power transmitting stations where necessary to protect the supply system against high-potential surges and "kick-backs."

Any of the following methods may be used:

1. Two condensers, usually of 0.1 to 0.5 microfarad capacity and capable of withstanding five times the normal voltage to which they are subjected, placed in series with one another across the supply line with mid-point between condensers grounded. Across (in parallel with) each of these condensers shall be connected a shunting fixed spark gap capable of not more than $\frac{1}{32}$ -inch separation.

2. Two vacuum-tube-type protectors in series with one another across the line with the mid-point grounded (if the line voltage does not exceed 110 volts).

3. Electrolytic lightning arresters, such as the aluminum-cell type.

C. Location.—Apparatus for protection against "kick-back" should be installed across the supply conductors as near as possible to each radio transformer, rotary spark gap, motor, and generator (in motor-generator sets), or other auxiliary apparatus.

SECTION 58. CONNECTION TO POWER SUPPLY LINES

580. Connection to Power Supply Lines.

Devices used in connection with power supply lines and methods of wiring shall be in accordance with the rules covering permanent or portable fixtures, devices, and appliances. (See section 37.)

SECTION 59. BATTERIES

590. Application of Rules.

The requirements of this section apply to batteries for receiving stations and transmitting stations of low and medium power. Battery installations for high-power transmitting stations shall meet such requirements of part 1, "Supply stations," as apply.

591. Care in Handling.

Care shall be used in handling batteries in order to avoid contacts with terminals having a high enough difference of potential to cause shock.

592. Storage Battery.

A. Wiring.—The wiring of storage batteries used with radio receiving equipment shall be subject to the rules covering the wiring of permanent or portable fixtures, devices, and appliances. (See section 37.)

B. Ventilation.—Storage batteries shall be located where there is adequate ventilation.

C. Precautions.

1. Open flames shall be kept away from storage batteries.

2. Storage batteries should be placed on trays or mats of lead, rubber, or other material which will not be affected by the electrolyte.

D. Large battery installations.—Installations of non-portable storage batteries of more than 50-kilowatt-hour capacity at the 8-hour rate of discharge, if used for radio, shall comply with section 13 and rule 353.

CATALOG *of* MEMBERSHIP

ARRANGED ALPHABETICALLY

and

GEOGRAPHICALLY

NOTE

The following list of membership is divided into two sections; the first contains an alphabetical list of members of the Institute of all grades and the second comprises a geographical list of members. In the alphabetical portion, the letter and date immediately following the member's name indicate the grade of membership and date of election. Where more than one letter and date group follow the member's name, the subsequent notations refer to the grade and date of transfer to a higher grade. (F) denotes the grade of Fellow; (M) Member; (A) Associate; (J) Junior.

Where only one address is shown in the alphabetical list it is the mailing address.
The geographical list contains the state and town in which the member is located and his present grade of membership in the Institute.

CATALOG OF MEMBERSHIP

(This list is corrected only to December 31, 1929)

LIST OF MEMBERS OF ALL GRADES

Arranged Alphabetically

(See note on page 108)

A

- ABBITT, WILLIAM H. (A'28), Professor of Physics, Texas Technological College, Lubbock, Tex.
- ABBOTT, WALTER (A'27), Radio Corporation of America, Rocky Point, L.I., N.Y.
- ABERCROMBIE, JULIUS B. (A'27), Radio Operator, Station KGBX, 1221 Frederick Ave., St. Joseph, Mo. For mail: 1810 Crescent Dr., St. Joseph, Mo.
- ABEY, ROBERT E. (A'27), Proprietor, Radio Shop, 905 W. Magnolia Ave., Ft. Worth, Tex. For mail: 1601 Enderly Place, Ft. Worth, Tex.
- ABRAHAM, F. X. J. (A'27), Radio Engineer, The British Broadcasting Corporation, Research Dept., Marconi's Wireless Telegraph Company, Ltd., Chelmsford, England. For mail: Chesterton, Baddow Rd., Chelmsford, Essex, England.
- ABRAHAM, IRVING (A'28), Manager, Radio Service Dept., Kreye Battery Service, 626 Kings Highway, Brooklyn, N.Y. For mail: 1536 E. 54th St., Brooklyn, N.Y.
- ABRAHAMS, SAMUEL L. (A'21), Electrical Engineer, General Electric Company, River Works, Lynn, Mass.
- ABSHERE, LILBURN O. (A'28), Air Inspector, A. T. and S. F. Ry. Shops, Raton, N.M. For mail: 845 S. 5th St., Raton, N.M.
- ACHATZ, RAYMOND V. (A'20), Secretary and General Manager, Southern Indiana Telephone Co., Aurora, Ind.
- ACHESON, MARCUS A. (A'29), Design Engineer, General Electric Company, Building 37, Schenectady, N.Y. For mail: 1132 Baker Ave., Schenectady, N.Y.
- ACKERMAN, E. K. (A'27), Designing and Service Radio Receivers, Radio Test Laboratories, 7113 Euclid Ave., Room 209, Cleveland, Ohio.
- ACKERMAN, F. R. (A'29), Director of Apprentices, The Morgan Engineering Company, Alliance, Ohio. For mail: 43 S. Linden Ave., Alliance, Ohio.
- ACKERMAN, MILTON J. (A'25), Quality Control Division, Radio-Victor Corporation of America, Camden, N.J.
- ACKERMAN, RUDOLPH W. (M'28), Chief Engineer, Gold Seal Electrical Company, Radio Tube Division, 129 S. 15th St., Newark, N.J. For mail: 30 N. Arlington Ave., East Orange, N.J.
- ACTON, EDWARD H. (A'26), Superintendent, Aluminum Company of Canada, Ltd., Box 100, Shawingan Falls, P.Q., Canada.
- ADACHI, WILLIAM Y. (A'26), Estimator, Brooklyn Edison Company, Pearl and Willoughby Sts., Brooklyn, N.Y. For mail: 1569 Ocean Ave., Brooklyn, N.Y.
- ADAIR, SAMUEL E. (A'19-M'19), Treasurer and Director, Engineering Dept., Jenkins and Adair, Inc., 3333 Belmont Ave., Chicago, Ill.
- ADAMS, FRANK S. (A'26), Radio Engineer, 110 Ivor Rd., Sparkhill, Birmingham, England.
- ADAMS, GEORGE G. (A'27), Communication Dept., Pan-American Airways, Inc., Miami, Fla.
- ADAMS, IRA J. (A'20-M'28), Patent Lawyer, 41 Park Row, New York, N.Y.
- ADAMS, QUINTON (M'28), Manager, Engineering Products Division, Radio Corporation of America, 233 Broadway, New York, N.Y.
- ADAMS, STUART (A'27), 217 Dewey St., Worcester, Mass.
- ADAMS, WILLIAM E. (A'27), Service Engineer, Elliott Engineering Company, 215 Washington St., Binghamton, N.Y.
- ADCOCK, STUART E. (A'28), Engineer, Sterchi Bros., Station WNOX, P.O. Box 531, Knoxville, Tenn.
- ADDEY, FREDERICK (M'20), Assistant Inspector Wireless Telegraphs, Wireless Branch, Secretary's Office, G.P.O., North London, E.C. 1, England.
- ADELBERGER, PAUL J. (A'29), Manager, Radio Dept., Lynam Electric Company, 114 Wayne Ave, Wayne, Pa. For mail: 225 W. Wayne Ave, Wayne, Pa.
- ADENDORFF, GERALD V. (M'28), Consulting Engineer, Hilliards Chambers, Church Square, Cape Town, South Africa.
- ADLER, BENJAMIN (A'28), Engineer, Radio Corporation of America, 70 Van Cortlandt Park South and Saxon Ave., New York, N.Y. For mail: 14th Ave. and 166th St., White-stone, L.I., N.Y.
- ADLER, LEONARD E. (A'29), Technical Employee, American Telephone and Telegraph Company, 820 Poydras St., New Orleans, La. For mail: 1833 Robert St., New Orleans, La.
- APFEL, HERMAN A. (A'14), Engineer, American Telephone and Telegraph Company, Dept. of Development and Research, 195 Broadway, New York, N.Y. For mail: 827 Morningside Rd., Ridgewood, N.J.
- AGATE, CARLTON S. (A'19-M'29), Chief Engineer, Marconiphone Company, Ltd., 210 Tottenham Court Rd., London W. 1, England. For mail: 33 Dornton Road, South Croydon, England.
- AGUSTY, JOAQUIN (A'26), Radio Corporation of Porto Rico, Station WAQ, San Juan, Porto Rico. For mail: P.O. Box 868, San Juan, Porto Rico.

- AIKEN, CHARLES B. P.** (A'25), Radio Engineer, Bell Telephone Laboratories, Inc., 463 West St., New York, N.Y.
- AIKENS, ANDREW J.** (A'27), Engineer, Dev. and Res. Dept., American Telephone and Telegraph Company, 195 Broadway, New York, N.Y.
- AINSWORTH, A. L.** (A'22), Vice-President, DeForest Radio Corporation, 245 Carlaw Ave., Toronto, Ont. Canada.
- AITKENHEAD, JOHN, JR.** (A'26), Radio Operator, Allen Theater Broadcasting Station, Akron, O. For mail: 162 N. Portage Path, Akron, O.
- AKASAKA, TOSHI** (A'19), 19 Kasumicho, Azabuku, Tokyo, Japan.
- AKERS, DALLAS C.** (A'26), Salesman, Henderson Electric Co., Ampere, N.J. For mail: 181 Greenwood Ave., East Orange, N.J.
- AKIN, ROBERT M., JR.** (A'26), Director, Westchester Radio Laboratories, 62 Water St., Ossining, N.Y. For mail: Ossining, N.Y.
- AKUTSU, SHIJI** (A'27), Radio Engineer, The Japan Wireless Telegraph Company, Jiji Bldg., Marunouchi, Tokyo, Japan. For mail: c/o Nippon Musen Denshin, Kabushiki Kaisha, Marunouchi, Tokyo, Japan.
- ALBEE, NORMAN E.** (A'16), Manager, Electrical Appliances, Dept. 620, Sears Roebuck and Company, Chicago, Ill. For mail: 5501 Washington Blvd., Apt. 409, Chicago, Ill.
- ALBERT, J. H.** (A'29), Long Lines Transmission Supervisor, Pacific Telephone and Telegraph Company, 801 Dexter-Horton Bldg., Seattle, Wash.
- ALBERT, WILLIAM H.** (A'26), Laboratory Assistant, Radio Frequency Laboratories, Boonton, N.J. For mail: 151 Mandeville Ave., Boonton, N.J.
- ALBERT, WILLIAM V.** (A'15), General Delivery, Reading, Pa.
- ALBIN, FREDERICK G.** (A'26), Vice-President, Radio Sales and Service, Inc., 1264 S. Lake St., Los Angeles, Calif. For mail: 2276 Shattuck Ave., Berkeley, Calif.
- ALBISTON, WILLIAM A.** (A'25), Radio and Electrical Engineer, W. A. Albiston Company, 87 Bossanska St., Belgrade, Yugoslavia. For mail: BM-BRD4, London, W. C. 1, England.
- ALCUS, ISAAC** (A'26), 7445 Maple St., New Orleans, La.
- ALDERMAN, LAWRENCE T.** (A'27), Manager, Park Row Radio Company, 29 Park Row, New York, N.Y. For mail: 1340 Nelson Ave., New York, N.Y.
- ALEXANDER, DAVID C.** (A'27), Manager, Radio Dept., Alexander-Seewald Company, 414 W. Peachtree St. N.W., Atlanta, Ga.
- ALEXANDER, DONALD W. H.** (A'28), Student, Dodge Inst. of Telegraphy, Valparaiso, Ind. For mail: 2027 Lawrence Ave., Chicago, Ill.
- ALEXANDER, LOUIS** (A'26), Sales Engineer, Aerovox Wireless Corporation, 70 Washington St., Brooklyn, N.Y.
- ALEXANDER, WAYNE** (A'29), Manager, Retail Dept., A. L. Owen Music Company, 4736 N. Racine Ave., Chicago, Ill.
- ALEXANDERSON, E. F. W.** (A'13-A'13-F'15), Consulting Engineer, General Electric Company, 1 River Rd., Schenectady, N.Y.
- ALKER, CHARLES** (A'28), Woodworking and Radio Experimenting, California Art Wood Company, 607 E. Newmark Ave., Monterey Park, Calif.
- ALLAIN, JOSEPH A.** (J'29), Radio Maintenance Department, Grigsby-Grunow Company, 2020 N. Austin Blvd., Chicago, Ill. For mail: 1758 Sunnyside Ave., Chicago, Ill.
- ALLAN, ERNEST J.** (A'24), Radio Engineer, E. J. Allan and Company, Nethergate, Dundee, Scotland. For mail: 8 Westfield Pl., Dundee, Scotland.
- ALLAN, J. T.** (A'26), The General Electric Company, Ltd., Magnet House, Kingsway, London, W. C. 2, England. For mail: Abington, Hockley, Essex, England.
- ALLAWAY, GEORGE N.** (A'28), Engineer-in-Charge, Durban Broadcasting Station, Municipal Bldgs., Durban, South Africa.
- ALLEN, ALBERT** (A'27), Research Engineer, Atlantic Precision Company, 80 Federal St., Boston, Mass. For mail: 16 Wildwood St., Winchester, Mass.
- ALLEN, ALBERT B.** (A'26), Assistant Radio Engineer, The Detroit News Radio Station, 615 W. Lafayette St., Detroit, Mich. For mail: 14908 Northlawn Ave., Detroit, Mich.
- ALLEN, CHARLES G.** (A'25), Sales Manager, Leslie McMichael, Ltd., 205 Strand, W.C.2, England. For mail: Home Lea, 3 Nightingale Lane, Bromley, Kent, England.
- ALLEN, HUGH E.** (A'23), Radio Engineer, General Electric Co., Schenectady, N.Y. For mail: 311-5th St., Scotia, N.Y.
- ALLEN, JAMES G.** (A'28), Radio Engineer, Duquesne Light Co., 800 Duquesne Bldg., Pittsburgh, Pa. For mail: 123 Harrison Ave., Avalon, Pa.
- ALLEN, JOHN E.** (A'23), Chief of Tech. Pennsylvania Water and Power Company, 1611 Lexington Bldg., Baltimore, Md.
- ALLEN, JUSTUS** (A'27), Radio Operator, Great Lakes Radio Broadcasting Co., 22 Strauss Bldg., Chicago, Ill. For mail: 50 Main St., Downer's Grove, Ill.
- ALLEN, OTIS T.** (A'25), P.O. Box 29, Oakland City Station, Atlanta, Ga.
- ALLEN, PRESTON D.** (A'27), Director, Broadcasting Station KIX, Tribune Publishing Company, Hotel Oakland, Oakland, Cal. For mail: Hotel Oakland, Oakland, Cal.
- ALLEN, ROY** (A'28), Service Manager, T. E. Swann Company, 706 West 2nd St., Oklahoma City, Okla.
- ALLEY, KENNETH G.** (J'27-A'28), Mechanic, Central Illinois Public Service Company, West Frankfort, Ill.
- ALLINSON, CYRIL P.** (A'26), Radio Journalist and Engineer, Radio Press, Bush House, London W. C. 2, England. For mail: 2 Barrow Hill Rd., St. John's Wood, N. W. 3, England.
- ALLNER, FREDERICK A.** (A'22), General Superintendent, Pennsylvania Water and Power Co., Lexington Bldg., Baltimore, Md.

- ALLSTON, WILLIAM F.** (A'29), Radio Engineer, Tropical Radio Telegraph Company, 321 St. Charles Street, New Orleans, La.
- ALLYN, R. S.** (A'27), Patent Lawyer and Consulting Engineer, 41 Park Row, New York, N.Y.
- ALMAS, STAN L.** (A'28), Radio Service Manager, Grier-Sutherland Company, 563 E. Larned St., Detroit, Mich. For mail: 5046 S. Charendon, Detroit, Mich.
- ALMES, WILLIAM E.** (A'25), District Manager, Silver-Marshall, Incorporated, 6401 W. 65th St., Chicago, Ill. For mail: 3024 Wells St., Milwaukee, Wis.
- ALMQUIST, MILTON L.** (A'22), Engineer, American Telephone and Telegraph Company, 195 Broadway, New York, N.Y.
- ALONSO, JULIO** (A'24), Engineer, Marques Del Puerto 7, Bilbao, Spain.
- ALPERN, DWIGHT K.** (J'21-A'24), Assistant Professor of Electrical Engineering, Swarthmore College, Swarthmore, Pa.
- ALSTON, VERNON C.** (A'27), Radio Engineer, "Detroit News," Detroit, Mich. For mail: 1122 Coplin Ave., Detroit, Mich.
- ALTHOFF, FREDERICK E.** (A'29), 3328 Louisiana Ave., St. Louis, Mo.
- ALVERSON, GEORGE S.** (A'29), Sales Engineer, Graybar Electric Company, Lexington Avenue and 43rd Street, New York, N.Y.
- ALVERSON, JAMES G.** (A'26), Geophysical Engineering, P.O. Box 2392, Los Angeles, Calif.
- AMATO, PETER** (A'28), Proprietor and Manager, New England Radio Company, 1617 Blue Hill Ave., Boston, Mass. For mail: 31 Suffolk St., Lynn, Mass.
- AMBROZICH, JOHN L.** (J'26-A'28) Electric Inspector and Superintendent of Fire Alarms, Village of Chisholm, Minn. For mail: 417 1/2 W. Spruce St., Chisholm, Minn.
- AMICK, WILLIAM M.** (A'28), Assistant Engineer, Western Electric Company, Inc., Kearny, N.J. For mail: 60 N. 7th St., Newark, N.J.
- AMIS, FREDERICK H.** (M'28), Electrical Engineer, International Standards Electric Corporation, Connaught House, Aldwych, London W. C. 2, England. For mail: 115 Onslow Gardens, Wallington, Surrey, England.
- AMMEN, CHARLES E.** (A'25), General Manager, Radio Shoppe, Inc., New Orleans, La. For mail: 350 Lowerline St., New Orleans, La.
- AMSDEN, FRANK POWER** (A'29), Technician, 116 South Second Street, Harrisburg, Pa. For mail: 2845 Canby Street, Penbrook, Pa.
- AMY, ERNEST V.** (A'20-M'27), Engineer, Radio Corporation of America, 66 Broad St., New York, N.Y. For mail: 235 West 76th St., New York, N. Y.
- ANAZAWA CHUHEI** (A'25), Radio Engineering Section, Dept. of Communications, Tokyo, Japan. For mail: 502 Tsunohazu, Yodobasimachi, Tokyo, Japan.
- ANDERSEN, H. W.** (A'28), Technician, 912 S. Broadway, Los Angeles, Calif. For mail: 4503 Paulhan St., Los Angeles, Calif.
- ANDERSON, ADRIEN L.** (A'17), Engineer, Standard Oil Company of Calif., Monterey, Calif. For mail: 265 Pine Ave., Pacific Grove, Calif.
- ANDERSON, CHESTER H.** (A'26), Assistant Production Manager, Diamond Iron Works, Minneapolis, Minn. For mail: 2018 Emerson Ave., Minneapolis, Minn.
- ANDERSON, CLIFFORD N.** (A'19), Radio Telephone Engineer, American Telephone and Telegraph Company, 195 Broadway, New York, N.Y.
- ANDERSON, DONALD T.** (A'29), Branch Manager, United Reproducers Corporation, 410 South Harwood Ave., Dallas, Tex.
- ANDERSON, EDWARD R.** (A'26), Radio Salesman, Eastern Outfitting Co., 628 S. Main St., Los Angeles, Calif. For mail: 217 N. Wilcox Ave., Bell, Calif.
- ANDERSON, EDWIN C.** (A'20), Radio Test Engineer, Radio Corporation of America, Van Cortlandt Park South and Saxon Ave., New York, N.Y. For mail: 45 East 55th St., New York, N.Y.
- ANDERSON, GILBERT J. C.** (J'27-A'28), Anderson Radio Repair Service, 103 Madison St., Port Clinton, Ohio. For mail: 120 Maple St., Port Clinton, Ohio.
- ANDERSON, GORDON A.** (A'26), Chief Operator, Radio Station KOIL, Council Bluffs, Iowa. For mail: 24 Charles St., Council Bluffs, Ia.
- ANDERSON, HAROLD W.** (A'26), Assistant Professor of Electrical Engineering, University of Kansas, Lawrence, Kan.
- ANDERSON, JOHN F.** (A'28), Chief Load Dispatcher, Hydro Electric Power Commission, Belleville, Ont., Canada. For mail: P.O. Box 46, Belleville, Ont., Canada.
- ANDERSON, J. E.** (A'26), Technical Editor, "Radio World," 145 W. 45th St., New York, N.Y. For mail: 24-15-27th St., Astoria, L.I., N.Y.
- ANDERSON, J. E.** (A'29), Laboratory Assistant, Day Fan Electric Co., Dayton, Ohio. For mail: 1601 Monroe Ave., Dayton, Ohio.
- ANDERSON, PAUL E.** (J'29), Broadcast Operator, Radio Station WTAG, 22 Franklin St., Worcester, Mass. For mail: Room 319, Worcester Y.M.C.A., Worcester, Mass.
- ANDERSON, PIERSON A.** (A'26-M'27), Commercial Engineer, Radio Corporation of America, 233 Broadway, New York, N.Y.
- ANDERSON, RAYMOND T.** (A'26), Chief Engineer, The V. D. Anderson Co., 1935 W. 96th St., Cleveland, Ohio. For mail: 223 W. Bridge Dr., Berea, Ohio.
- ANDERSON, SIDNEY E.** (A'23), Electrical and Radio Engineer, Bell Telephone Laboratories, Inc., 463 West St., New York, N.Y.
- ANDERSON, THURE C.** (A'27), Proprietor, T. C. Anderson Radio Service, 145 Main St., Ridgway, Pa. For mail: 416 N. Broad St., Ridgway, Pa.
- ANDRAE, ROBERT T.** (A'22), Statistic Engineer, Power Corporation of Canada, 330 Coristine Bldg., Montreal, Canada. For mail: 1483 Atwater Ave., Apt. 6, Montreal, P.Q., Canada.
- ANDRES, CHAS., JR.** (A'27), Manager, Maintenance Dept., Radio Specialty Co., 841 Carondelet St., New Orleans, La.

- ANDRES, LLOYD J. (A'27), Chief Engineer, Dramaphone Corporation, 3701 Cortland St., Chicago, Ill.
- ANDRES, PAUL G. (A'27), Chief Engineer, Temple Corporation, 5253 W. 65th St., Chicago, Ill.
- ANDREW, VICTOR J. (A'25), Radio Engineer, Westinghouse Electric and Manufacturing Company, Chicopee Falls, Mass. For mail: 35 Arlington St., Chicopee Falls, Mass.
- ANDREWARTHA, H. C. (A'29), Representative and Service Engineer, C. E. Needham & Brother, Change Alley, Sheffield, Yorks, England. For mail: "Tresco," 33 Wayland Road, Sharrow, Sheffield, Yorks, England.
- ANDREWS, EDWARD F. (A'26), The Andrews-Hammond Corporation, 614 Davis St., Evanston, Ill. For mail: St. Clair Hotel, St. Clair and Ohio Sts., Chicago, Ill.
- ANDREWS, HOWARD L. (A'29), Student, Brown University, Providence, R.I.
- ANDREWS, JOSEPH F. (A'18-M'26), American Telephone and Telegraph Company, 15 Dey St., New York, N.Y.
- ANDREWS, PAUL D. (A'23-M'29), Radio Engineer, Radio Eng. Dept., General Electric Co., 1 River Road, Schenectady, N.Y. For mail: 9 N. Ferry Street, Schenectady, N.Y.
- ANDREWS, W. A. (M'20), Lecturer, University of Bristol, Superintendent, Merchant Venturers' Technical College, Bristol, England.
- ANDRUS, ROY E. (A'29), Proprietor and Owner, Roy's Radio Shop, Austinburg, Ohio. For mail: R. D. No. 2, Ashtabula, Ohio.
- ANGLE, G. B. (A'29), Tropical Telegraph Company, P.O. Box 488, Hialeah, Fla.
- ANKERSEN, G. W. (J'27-A'28), 927 Montana St., Chicago Ill.
- ANNETT, EARL (A'26), Chief Installation Engineer, General Sound Equipment Company, 21 Wilton Square, Toronto, Ont., Canada. For mail: 91-A Balmoral Ave., Toronto, Ont., Canada.
- ANNUCCI, LOUIS M. (A'27), Building Estimator, Acampora Bros., 14 Spencer Place, Mamaroneck, N.Y. For mail: 66 Stephenson Ave., New Rochelle, N.Y.
- ANSELM, S. C. (A'15), Engineer-in-Chief, "Radio-Suisse" S. A., Munchenbuchsee, Cton Berne, Switzerland.
- ANSON, C. T. (A'29), Student Engineer, General Electric Company, Schenectady, N.Y. For mail: 2334 Turner Avenue, Schenectady, N.Y.
- ANTHONY, A. W., JR. (A'29), President-Treasurer, Pease-Anthony Equipment Company, 30 Charles River Rd., Cambridge, Mass. For mail: 31 Horne Rd., Belmont, Mass.
- APKER, CHARLES L. (A'26), Engineer, 4932 N. Mervine St., Philadelphia, Pa.
- APPEL, HENRY W. (A'29), Assistant Radio Engineer, RCA-Victor Company, Inc., Bldg. 15, Floor 5, Camden, N.J. For mail: 145 E. 82nd St., New York, N.Y.
- APPEL, JOSEPH H., JR. (A'26), Buyer, Radio and Phonograph Depts., John Wanamaker Company, 9th St. and Broadway, New York, N.Y. For mail: 13 Circle Rd., Scarsdale, N.Y.
- APPICH, WILLIAM H. (A'29), Cashier and Office Manager, Potomac Butter Company, 308-10th St., N.W., Washington, D.C. For mail: 621 G. Street, S.W., Washington, D.C.
- APPLERY, BERTIE (A'28), Foreman of Toolroom, Whittelsey Avian Manufacturing Company, Howard Ave., Bridgeport, Conn. For mail: 1355 Fairfield Ave., Bridgeport, Conn.
- APPLETON, EDWARD V. (A'26), Professor, Wheatstone Laboratory, King's College, London, England. For mail: St. John's Darke's Lane, Potters Bar, Middlesex, England.
- APPLETON, HARRY (A'27), Radio Technician, 1100 S. Grand Ave., Los Angeles, Calif. For mail: 3013 S. Hobart Bldg., Los Angeles, Calif.
- APPLETON, SAMUEL (A'20), "U.S.S. Nokomis," c/o Postmaster, New York, N.Y. For mail: 35 Hull St., Beverly, Mass.
- APPLETON, WILLIAM A. (M'20), Radio and Electric Engineer, Gloucester House, 19 Charing Cross Rd., London, England. For mail: 189 Wembley Hill Rd., Wembley, London, England.
- ARAKAWA, DAITARO (A'19), Radio Engineer, Komukioku, Teishinsho, Tokyo, Japan. For mail: No. 7, 1-Chome, Nishihara-Machi, Koishikawa, Tokyo, Japan.
- ARCHER, C. (A'29), Chief Sound Film Engineer, Kinemas Limited, Exploration Bldgs., Commissioner Street, Johannesburg, South Africa.
- ARMER, AUSTIN A. (A'28), Radio Engineer, Magnavox Company, 4250 Horton St., Oakland, Calif. For mail: 1115 High Court, Berkeley, Calif.
- ARMOR, JAMES C. (A'15), Electrical Engineer, Allis-Chalmers Manufacturing Company, Pittsburgh Works, Pittsburgh, Pa. For mail: 75 N. Fremont St., Bellevue, Pa.
- ARMSTRONG, EDWIN H. (A'14-F'27), Marcellus Hartley Research Laboratory, Columbia University, New York, N.Y. For mail: 451 West End Ave., New York, N.Y.
- ARMSTRONG, H. M. (A'25), Radio Engineer, Kellogg Switchboard and Supply Company, 1066 W. Adams St., Chicago, Ill. For mail: 532 N. Lombard Ave., Oak Park, Ill.
- ARMSTRONG, HAROLD W. (J'27), 7327 Phillips Ave., Chicago, Ill.
- ARMSTRONG, L. J. HEATON (A'28), Radio Engineer, International Standard Electric Corporation, Connaught House, Aldwich, London, W. C. 2, England.
- ARMSTRONG, RALPH W. (A'29), Radio Engineer, Radio Engineering Dept., Westinghouse Electric and Manufacturing Company, Pittsburgh, Pa. For mail: 901 South Ave., Wilkingsburg Branch, Pittsburgh, Pa.
- ARMSTRONG, REECE M. (A'26), Radio Laboratory, West Penn Power Co., Connelville, Pa. For mail: P.O. Box 62, Springdale, Pa.
- ARNOLD, ELMER J. (A'28), Hummers Furniture Company, Lasalle, Ill.
- ARNOLD, JOHN W. (A'29), Member, Engineering Department, Western Union Telegraph Company, 195 Broadway, New York, N.Y.

- ARNOLD, LOWELL GEORGE (A'29), Sales and Service Engineer, Newark Electric Supply Company, 152 Mulberry St., Newark, N.J. For mail: 28 Park St., Roseland, N.J.
- ARNOLD, PRESCOTT N. (A'29), Research Associate, Bureau of Standards, Radio Section, Washington, D.C.
- ARNOLD, THOMAS E. (A'27), Communication Section, A. C. T. S. Chanute Field, Rantoul, Ill.
- ARPS, MERVIN W. (A'14-M'19), Lieutenant, U.S. Navy, "U.S.S. Florida," c/o Postmaster, New York, N.Y.
- ARRIGONI, ARTHUR (A'29), Serviceman, General Radio Company, 274 Brannan Street, San Francisco, Calif. For mail: 242A Hartford Street, San Francisco, Calif.
- ARTHUR, GUY B., JR. (J'28-A'28), 3222 S. Michigan Ave., Chicago, Ill.
- ARTHUR, RALPH L. (A'28), Machine Shop Foreman, Howard Radio Company, South Haven, Mich.
- ARTZT, MAURICE (A'26), Radio Test, General Electrical Company, Schenectady, N.Y. For mail: 12 Riverside Ave., Scotia, N.Y.
- ASCH, MARCUS (A'29), Recording Engineer, Metropolitan Studios, Lewis Street, Fort Lee, N.J. For mail: 50-65 40th Street, Long Island City, L.I., N.Y.
- ASCH, MOE (A'27), Radio Engineer, Walthal Electric Company, 233 Spring St., New York, N.Y. For mail: 2738 E. 19th St., Sheepshead Bay, N.Y.
- ASHBAUGH, EDWIN C. (A'27), Chief Operator, Radio Corporation of America, 326 Broadway, New York, N.Y.
- ASHBROOK, ROY B. (A'26), Communication Engineer, Southern California Edison Company, 3rd and Broadway, Los Angeles, Calif. For mail: 601 N. Mission Dr., San Gabriel, Calif.
- ASHLOCK, H. D. (A'27), Radio Engineer, Indiana Electric Corporation, Indianapolis, Ind. For mail: 611 W. Taylor St., Kokomo, Ind.
- ASHMORE, J. W. (A'20), Radio Corporation of America, Belfast, Me. For mail: 66 Union St., Belfast, Me.
- ASHTON, JOHN E. (J'28), Repairman, Ed's Radio Shop, 3 West St., Englewood, N.J. For mail: 163 Waldo Pl., Englewood, N. J.
- ASHWIN, CECIL W. H. (A'26), Radio Operator and Engineer, Marconi Comm. Co., Ltd., Marconi House, London, England. For mail: 26 Thorncliff Rd., Barrow-in-Furness, England.
- ASSERSON, RAYMOND (M'27), Radio Frequency Laboratories, Inc., Boonton, N.J. For mail: 2 Tower Hill Road, Mountain Lakes, N.J.
- ASTEN, OLIVER B. (A'29), Service Engineer, Electrical Research Products, Inc., 250 W. 57th St., New York, N.Y. For mail: 17 High Haith Road, Arlington, Mass.
- ASTER, ALVIN K. (J'15-A'18), Engineer, Bell Telephone Laboratories, Inc., 463 West St., New York, N.Y.
- ATHERTON, MALCOLM J. V. (A'26), P.O. Box 87, Fullerton, Calif.
- ATKIN, ROBERT (A'29), Studio Engineer, National Broadcasting Company, 711-5th Ave., New York, N.Y. For mail: 1160 Bryant Ave., New York, N.Y.
- ATKINS, CARL EDWARD (J'29), Laboratory Assistant, J. W. Myers, 5 Germania Bldg., Jackson, Mich. For mail: 302 E. Biddle St., Jackson, Mich.
- ATKINSON, CYRIL T. (A'23), Manager, Test Dept., Messrs. Gent and Company, Ltd., Faraday Works, Leicester, England. For mail: La Casa Rosa, Greenland Ave., Humberstone, Leicester, England.
- ATTMORE, WILLIAM B. (A'28), Sales Engineer, Victor Talking Machine Company, Camden, N.J. For mail: Clementon, N.J.
- ATWOOD, WARREN S. (J'25-A'28), Switchman, New York Telephone Company, 140 West St., New York, N.Y. For mail: 75-17 41st St., Jackson Heights, L.I., N.Y.
- AUBRY, PIERCE J. (A'25), Radio Buyer, Associated Buyers Corporation, 1440 Broadway, New York, N.Y. For mail: P.O. Box 294, Malverne, L.I., N.Y.
- AUCKERMAN, U. H. (A'29), Signal Apprentice, Chesapeake and Ohio Railway, c/o C. A. Taylor, Supt. of Signals, Richmond, Va.
- AUGENBAUGH, WILLIAM K. (A'27), Control Room Operator, Radio Station WLW, Crosley Radio Corporation, Cincinnati, Ohio. For mail: Apt. 6, Ripley A., 6650 Chestnut St., Mariemont, Cincinnati, Ohio.
- AUGUSTINE, ROY W. (A'23-M'26), Secretary and Engineer, Joy Kelsey Corporation, Chicago, Ill. For mail: 249 Thomas St., Oak Park, Ill.
- AUGUSTUS, LEE M. (A'29), Student, University of Michigan, Ann Arbor, Mich. For mail: 45 Florence St., Ypsilanti, Mich.
- AULL, WILSON, JR. (A'17-M'27), Radio Engineer, Room 707, 41 Park Row, New York, N.Y.
- AULT, ARTHUR K. (A'29), Machinist, Baltimore and Ohio Railroad, Mt. Clare, Baltimore, Md. For mail: 333 S. Gilmor St., Baltimore, Md.
- AUSTIN, EDWARD (A'23), Test and Inspection Engineer, Crosley Radio Corporation, Colerain and Sassafras Sts., Cincinnati, Ohio.
- AUSTIN, FRANCIS M. (A'26), Power Sales Dept., Houston Lighting and Power Company, Electric Bldg., Houston, Tex.
- AUSTIN, KIRBY B. (A'25), Radio Engineering Dept., General Electric Company, Schenectady, N.Y.
- AUSTIN, LESLIE C. (A'28), Manager, Radio Dept., Woolley and Company, Inc., 1113-3rd Ave., Seattle, Wash. For mail: 540 N. 82nd St., Seattle, Wash.
- AUSTIN, LOUIS W. (A'13-M'13-F'15), Bureau of Standards, Washington, D.C.
- AUSTIN, OTTO C. (A'27), Distribution Engineer, Madison Gas and Electric Company, Madison, Wis. For mail: 430 W. Wilson St., Madison, Wis.
- AVERY, ALFRED L. (A'28), Supervisor, Pacific Telephone and Telegraph Company, 800 Fairview, N., Seattle, Wash. For mail: 6809-17th St., N.E., Seattle, Wash.

- AVERY, ROBERT D.** (J'29), Assistant Broadcast Engineer, Richardson Wayland Electric Corporation, 106 Church Ave., Roanoke, Va. For mail: 206 Virginia Ave., Virginia Heights, Roanoke, Va.
- AXTEN, BERNARD J.** (A'26), Technical Assistant, Kodak Ltd., The Works, Harrow, Middlesex, England. For mail: King's Leigh, 49 Ealing Rd., Wembley, Middlesex, England.
- AYER, OLIVER G.** (A'27), District Manager, F.A.D. Andrea, Inc., 1370 West Blvd., Cleveland, Ohio.
- AYER, RAYMOND B.** (A'26), Vacuum Tube Development, General Electric Company, 1 River Road, Schenectady, N.Y. For mail: 211 Hugh St., Schenectady, N.Y.
- AYMAR, ERWIN** (A'26), Engineer, Engineering Dept., Western Union, 195 Broadway, New York, N.Y. For mail: 8 Garden Place, Brooklyn, N.Y.
- B**
- BAART, JOHN C.** (A'24), Radio Inspector, Radio Material Office, Navy Yard, Norfolk, Va. For mail: 844 N. Park Ave., Portsmouth, Va.
- BABCOCK, WALLACE C.** (A'25), Communication Engineer, American Telephone and Telegraph Company, Rm. 1537, 195 Broadway, New York, N.Y. For mail: 213-05 Waverly Ave., Bayside, L.I., N.Y.
- BACH, ROY O.** (A'19), Engineer, The Pacific Telephone and Telegraph Company, Dexter Horton Bldg., Seattle, Wash.
- BACHMAN, EDWIN J.** (A'28), Radio Serviceman, Bee Automobile Company, 622 Linden St., Allentown, Pa. For mail: 1064 Catasauqua St., Fullerton, Pa.
- BACHOFER, C. L.** (A'27), Radio Experimenter, Stromberg-Carlson Telephone Manufacturing Company, 1060 University Ave., Rochester, N.Y. For mail: 33 Loomis St., Rochester, N.Y.
- BACKLUND, LOUIS R.** (J'27), 39 Central Ave., Naugatuck, Conn.
- BACKUS, CYRUS D.** (A'19-M'26), Examiner, U. S. Patent Office, Washington, D.C.
- BADGEROW, BERT E.** (J'26), Commercial Operator and Engineer, 419 S. 16th St., Omaha, Neb. For mail: 9901 Florence Heights Blvd., Omaha, Neb.
- BAECKLER, WALTER** (A'29), Electrical Engineer, National Carbon Company, Inc., Edgewater Works, Cleveland, Ohio.
- BAGSHAW, GEORGE W.** (A'27), Engineer and Manager, Messrs. J. G. Graves, Ltd., Wireless Manufacturing, Sheffield, England. For mail: 148 Sandygate Rd., Sheffield, England.
- BAIER, ARTHUR H.** (A'27), Manager and Treasurer, Cedar Lee Radio Company, 2134 Lee Rd., Cleveland Heights, Ohio.
- BAIER, HENRY J.** (A'27), Manager and President, Cedar Lee Radio Company, 2134 Lee Rd., Cleveland Heights, Ohio.
- BAILEY, AMBROSE L.** (J'28), Radio Expert, Wood, Alexander and James, Ltd., Hamilton, Ont., Canada. For mail: 15 Huxley Ave., N. Hamilton, Ont., Canada.
- BAILEY, ARNOLD B.** (A'27), Radio Engineer, Bell Telephone Laboratories, Inc., 463 West St., New York, N.Y.

- BAILEY, AUSTIN** (A'22-M'25), Telephone Engineer, American Telephone and Telegraph Company, 195 Broadway, Rm. 1607, New York, N.Y.
- BAILEY, RALPH G.** (A'27), Service Manager, William A. Friemel, Radio Dealer, 236 Rock Rd., Glen Rock, N.J. For mail: 142 Glen Ave., Glen Rock, N.J.
- BAILEY, STUART L.** (A'28), Assistant Radio Engineer, Dept. of Commerce, Bureau of Lighthouses, Office of the Supt. of Lighthouses, 11th District, Detroit, Mich.
- BAILEY, WALTER H.** (M'27), Radio Superintendent, Thomas and John Brocklebank, Ltd., Cunard Bldgs., Liverpool, England.
- BAILEY, W. M.** (M'23), Wireless Specialty Apparatus Company, 76 Atherton St., Jamaica Plain, Boston, Mass. For mail: 31 Tudor St., Lynn, Mass.
- BAIN, J. R.** (A'29), Student, Canadian Westinghouse Company, Hamilton, Ont., Canada. For mail: 65 Garfield Ave., S., Hamilton, Ont., Canada.
- BAIN, JOHN L.** (M'27), Managing Editor, "Popular Radio Weekly," Atlas Press Pty., Ltd., Tattersall's Lane, Melbourne, Australia. For mail: 48 Lincoln Rd., Essendon, Melbourne, Australia.
- BAINBRIDGE-BELL, L. H.** (A'26), Radio Engineer, Radio Research Station, Ditton Park, Langley, Bucks, England. For mail: Norfolk Villa, Montagu Rd., Datchet, Windsor, England.
- BAIR, RALPH S.** (A'21), Radio Engineer, Bell Telephone Laboratories, Inc., 463 West St., New York, N.Y.
- BAIRD, FREDERICK** (A'23), Secretary, Wardle Engineering Company, Ltd., Elsinore Rd., Old Trafford, Manchester, England. For mail: "Lewaigue," 13 Hornby Rd., Stratford, Manchester, England.
- BAIRD, HOLLIS S.** (A'28), Chief Engineer, Short-wave and Television Laboratory, 70 Brookline Ave., Boston, Mass.
- BAKER, BROTHWELL H.** (A'28), Advertising Manager, A. H. Grebe and Company, 113 W. 57th St., New York, N.Y. For mail: 133-01 Sanford Ave., Flushing, L.I., N.Y.
- BAKER, DEAN R.** (A'28), Radio Engineer, Slagle Radio Company, 1232 Maumee Ave., Ft. Wayne, Ind. For mail: 2131 Curde Ave., Ft. Wayne, Ind.
- BAKER, JAMES M.** (J'29-A'29), Radio Laboratory Assistant, Metro Electric Company, 2161 N. California Ave., Chicago, Ill. For mail: 1199 Edgewood Rd., Lake Forest, Ill.
- BAKER, JUDD O.** (A'28), Engineer-in-Charge, Theatre Equipment Dept., R.C.A. Photophone, Inc., 411-5th Ave., New York, N.Y. For mail: 286 Old Broadway, Shadow Lawn, Hastings-on-Hudson, N.Y.
- BAKER, LEWIS C.** (A'27), 721 Geary St., San Francisco, Calif.
- BAKER, NEIL D.** (A'28), Custom Set Builder, 28 E. Salem St., Hackensack, N.J. For mail: 216 Jefferson Ave., Hasbrouck Heights, N.J.
- BAKER, NORMAN G.** (A'25), Proprietor, Station KTNT, Muscatine, Iowa. For mail: Box 297, Muscatine, Iowa.

- BAKER, THOMAS S.** (A'29), Shift Engineer, Radio Corporation of America, Bolinas, Calif.
- BAKER, THOMAS T.** (M'26), Tactecaster, Hatch End, Middlesex, England.
- BAKER, W. R. G.** (A'19-F'28), Managing Engineer Radio Dept., General Electric Company, Schenectady, N.Y.
- BALCH, J. A.** (M'17), President, Mutual Telephone Company, P. O. Box 2200, Honolulu, T.H.
- BALDWIN, ARTHUR V.** (A'27), Radio Engineer, Johnsonburg Radio Company, Johnsonburg, Pa. For mail: 516 High St., Johnsonburg, Pa.
- BALDWIN, GEORGE** (A'27), Radio Service Engineer, Canadian Westinghouse Company, Ltd., Service Dept., Hamilton, Ont., Canada.
- BALDWIN, JOHN M.** (A'26), Chief Engineer, Radio Station KDYL, Ezra Thompson Bldg., Salt Lake City, Utah.
- BALDWIN, NATHANIEL** (M'28), President, Nathaniel Baldwin, Inc., 3477 S. 23rd St. E., Salt Lake City, Utah.
- BALDWIN, PRESTON DE GRAUW** (J'27-A'29), Radiomarine Corporation of America, Tuckerton, N.J.
- BALL, GEORGE F.** (A'26), Wireless Telephone Engineer, Govt. Radio Station, Mombasa, Kenya Protectorate, East Africa.
- BALL, I. DALE** (A'19), Assistant Radio Inspector, Office of Supervisor of Radio, 29th Floor, David Stott Bldg., Detroit, Mich.
- BALLANTINE, STUART** (A'16-F'28), Radio Frequency Laboratories, Boonton, N.J.
- BALLARD, WILLIAM C.** (A'16-M'27), Instructor, Engineering Dept., Cornell University, Ithaca, N.Y.
- BALLENTINE, EDWIN C.** (A'25-M'29), Radio Engineering Dept., General Electric Company, 1 River Rd., Schenectady, N.Y. For mail: 2024 Euclid Ave., Schenectady, N.Y.
- BALLING, ALFRED W.** (A'26), 1625 Clinton Ave., Rochester, N.Y.
- BALSBAUGH, CLAIR L.** (A'28), Serviceman, The Radio Shop, Main St., Palmyra, Pa. For mail: 113 E. Cherry St., Palmyra, Pa.
- BALSLEY, JAMES R.** (A'26), Chief Engineer, Movietone Dept., Wm. Fox Studios, Hollywood, Calif. For mail: 1620 Benedict Canon, Beverly Hills, Calif.
- BANDITSON, HARRY** (A'29), Manager, Modern Radio and Equipment Company, 191 Franklin St., Buffalo, N.Y.
- BANFI, ALESSANDRO** (A'29), Chief Engineer, Italian Broadcasting Company, Corso Italia 1, Milano, Italy.
- BANGS, PHILIP C.** (A'18), Heating and Ventilating Engineer, Warren Webster and Company, 152 Nassau St., Atlanta, Ga. For mail: 23 Kensington Rd., Avondale Estates, Ga.
- BANK, MAURICE** (A'29), Engineer, 1247 S. Kedvale Ave., Chicago, Ill.
- BANKS, ADRIAN C.** (A'28), Radio Serviceman, Blackman District Co., 28 W. 23rd St., New York, N.Y. For mail: 3714-92nd St., Elmhurst, L.I., N.Y.
- BANKS, J. VERNON** (A'29), Manager, Alhambra Radio Company, 1309 E. 15th St., Tulsa, Okla.
- BANNISTER, M. W.** (J'26-A'28), Student, University of Arizona, Tucson, Ariz. For mail: Box 172, University Station, Tucson, Ariz.
- BARBER, D. G.** (A'28), Marine Operator, Inter-City Radio Telegraph Co., Cleveland, Ohio. For mail: Green Camp, Ohio.
- BARBER, WALTER G.** (A'26), Baldwin Int. Radio of Canada, Ltd., 445 King St., W., Toronto, Ont., Canada.
- BARBER, WILLIAM E.** (M'27), Chief Designer, Royal Aircraft Establishment, Farnborough, Hampshire, England. For mail: Risboro, Salisbury Rd., Farnborough, Hants, England.
- BARBULESCO, CONSTANTIN D.** (M'27), Radio Engineer, Wright Field, Dayton, Ohio. For mail: 333 Cambridge Ave., Dayton, Ohio.
- BARCLAY, HUGH N.** (A'26), Radio Dept., Kent Piano Company, 339 Hastings St., W., Vancouver, B.C., Canada. For mail: 227-6th St., W., North Vancouver, B.C., Canada.
- BARDIN, WILLIAM F.** (A'25), Radio Engineer, Broadcasting Station 4 QG, Brisbane, Australia. For mail: Archibald St., Fairfield, Brisbane, Australia.
- BARFIELD, A. R.** (A'29), Radio Engineer, Valley Appliances, 634 Lexington Ave., Rochester, N.Y.
- BARGAMIAN, JOHN** (A'29), Radio Service Engineer, Electric, Ltd., 1844 William St., Montreal, P.Q., Canada. For mail: 161 Woodbine St., Cranston, R.I.
- BARKER, HOWARD T.** (A'27), Assistant Repeater Chief, Western Union Telegraph Company, Rm. 200, 44 Church St., Buffalo, N.Y. For mail: 144 Dundee St., Buffalo, N.Y.
- BARKER, L. T.** (A'29), Telegraph Operator, C.B. and Q. Railroad Co., Waldron, Mo. For mail: Waldron, Mo.
- BARKER, PERCY L.** (A'28), Assistant Engineer, Radio Section, P. O. Research Station, Dullis Hill Lane, London, W. C. 2, England.
- BARKHAUSEN, H.** (A'26), Professor, Technische Hochschule Institute, Helmholtzstrasse 9, Dresden, Germany.
- BARKLEY, HOWARD F.** (A'25), P. O. Box 148, Great Barrington, Mass.
- BARKLEY, WILLIAM J.** (M'29), Assistant to President, DeForest Radio Company, 139 Franklin St., Jersey City, N.J. For mail: 21 Clinton Ave., Maplewood, N.J.
- BARLOW, ROY G.** (A'28), Engineer, General Petroleum Corporation, Higgins Bldg., Los Angeles, Calif. For mail: 7530 S. Hobart Blvd., Los Angeles, Calif.
- BARLOW, WILLIAM H.** (A'28), Albert Pick and Company, 1200 W. 35th St., Chicago, Ill. For mail: 1430 Hyde Park Blvd., Chicago, Ill.
- BARNES, JAMES C.** (J'28-A'28), Bell Telephone Laboratories, Inc., 463 West St., New York, N.Y.
- BARNES, JOHN L.** (A'27), Graduate Student in Mathematics, Princeton University, Princeton, N.J. For mail: 113 Warwick Rd., Had-donfield, N.J.

- BARNES, T. DANA (A'27), Meter Engineer, Westinghouse Electric and Manufacturing Company, Newark Works, Newark, N.J. For mail: 296 Roseville Ave., Newark, N.J.
- BARNETT, ERIC E. (A'24), Director, Chenik and Barnett (Wireless) Ltd., Steytlers Bldgs., 42 Loveday St., Johannesburg, Transvaal, South Africa. For mail: P. O. Box 745, Johannesburg, Transvaal, South Africa.
- BARNETT, M. A. F. (A'26), Physicist, Dominion Laboratory, Wellington, New Zealand.
- BARNETT, LOUIS W. (J'28), Assistant Radio Engineer, Radio Station, WDJ, Tuscola Radio Supply Company, 105 S. Main St., Tuscola, Ill. For mail: 215 E. Sale St., Tuscola, Ill.
- BARNUEBA, RICHARD (A'29), 408 E. 15th St., New York, N.Y.
- BARONE, SALVATORE A. (J'16-A'19), Radio Engineer, Wired Radio, Inc., 4th Ave. and 13th St., Newark, N.J. For mail: 37 Peck Ave., Newark, N.J.
- BAROUDI, KAMEL S. (A'26), Zamalik, Gezira, Cairo, Egypt.
- BARREGARYE, LAURENCE H. (J'28), Radioman, Von Fossen Music Company, Beardstown, Ill. For mail: 312 E. 2nd St., Beardstown, Ill.
- BARRETO, M. DE BAROS (F'24), Radio Service, Commercial and Technical Dept., M. Barros and Cia, Rue S. Jose 66, Rio de Janeiro, Brazil, South America. For mail: Rue Vicente de Souza, 25 Botafogo, Rio de Janeiro, Brazil, South America.
- BARRETT, HERMAN R. (A'28), Coyne Electrical School, 500 S. Paulina St., Chicago, Ill. For mail: 1020 N. Winchester Ave., Chicago, Ill.
- BARRINGTON, R. N. (M'21), Engineer-in-Charge, Marconi's Wireless Telegraph Company, Marconi House, Strand, London, England.
- BARRON, J. H., JR. (M'29), U. S. Radio Inspector, Dept. of Commerce, Radio Division, Washington, D.C.
- BARROW, FREDERICK A. (A'23), Radio Engineer, Marconi Wireless Telegraph Company, Ltd., 173 William St., Montreal, P.Q., Canada. For mail: 705 Wilson Ave., Montreal, P.Q., Canada.
- BARROW, LEMUEL T. (A'27), Proprietor and Manager, Bastrop Radio Shop, Bastrop, Tex. For mail: P. O. Box 35, Bastrop, Tex.
- BARROW, W. L. (A'28), Instructor, Massachusetts Institute of Technology, Communications Division, Cambridge, Mass.
- BARRY, FRANCIS J. (J'28), Radio Serviceman, Dow Radio, Inc., 239 Harvard St., Brookline, Mass. For mail: 18 Longfellow St., Dorchester, Mass.
- BARRY, JAMES A. (J'23-A'28), Proprietor, Gray and Barry, 923 S. 24th St., Fort Smith, Ark.
- BARSDORF, HARRY OLIVER (J'29), Radio Service Work, 171 N. Summer St., Adams, Mass.
- BARTAL, OTTO (A'28), Aide in Engineering Dept., Interstate Broadcasting Corporation, 350 Stone Ave., Brooklyn, N.Y. For mail: 9124 Avenue L, Brooklyn, N.Y.
- BARTELINK, E. H. B. (A'29), 2 Delestraat, Den Haag, Holland.
- BARTHOLOMEW, FRANCIS J. (A'27), Electrical Engineer, Bartholomew-Montgomery and Company, Ltd., 712 Standard Bank Bldg., Vancouver, B.C., Canada.
- BARTHOLOMEW, ROBERT G. (A'29), Radio Technician, 526 Broad St., Quakertown, Pa.
- BARTLETT, A. C. (A'29), Research Laboratories, General Electric Company, Ltd., Wembley, England. For mail: 31 Malden Rd., Watford, Herts, England.
- BARTLETT, MILLARD C. (A'26), Manager, Service Dept., Trilling and Montague, 218 Chestnut St., Sunbury, Pa.
- BARTLETT, WALLACE A. (A'22), Executive, Brandes, Ltd., Cray Works, Sidcup, Kent, England.
- BARTNOFSKY, HARRY (A'26), Service Manager, Freed-Eisemann Radio Corporation, 36 Flatbush Ave., Brooklyn, N.Y. For mail: 720 Alabama Ave., Brooklyn, N.Y.
- BARTON, LOY E. (M'29), Engineer, RCA-Victor Company, Inc., Camden, N.J. For mail: 228 Burrwood Ave., Collingswood, N.J.
- BARTON, R. W., JR. (A'29), Supervisor, RCA-Victor Company, Inc., Camden, N.J. For mail: 3421 A Street, Philadelphia, Pa.
- BASAURE, ALIRO (A'28), Wireless Operator, S.S. "Aconagua," South American Steamship Company, 1 Broadway, New York, N.Y. For mail: 98th Tubildad St., Valparaiso, Chile, South America.
- BASHENOFF, VALERIAN I. (M'27), Electrical Institute of U.S.S.R., Gorochovskeja 23, Moscow 66, U.S.S.R. For mail: Maschkoff Perenlok 1, Lodg 31, Moscow Centre, U.S.S.R.
- BASSLER, SHERMAN G. (J'27-A'29), Radio Operator, Intercity Radio and Telegraph Company of Cleveland, Cleveland, Ohio. For mail: 302 E. New Castle St., Zelenople, Pa.
- BATCHELDER, LAURENCE (A'29), Electrical Engineer, Submarine Signal Corporation, 160 State St., Boston, Mass. For mail: 22 Chauncy St., Cambridge, Mass.
- BATCHELDER, S. P. (A'25), Engineer, Radio Station WBZ, Westinghouse Electric and Manufacturing Company, East Springfield, Mass. For mail: 25 Windemere St., East Springfield, Mass.
- BATCHELLER, ARTHUR (A'14-M'20), U. S. Supervisor of Radio, Subtreasury Bldg., Nassau and Wall Sts., New York, N.Y.
- BATCHER, RALPH R. (A'18-M'22), Vice-President, Decatur Manufacturing Company, 45 Harmon St., New York, N.Y. For mail: 113-35—198th St., Hollis, L.I., N.Y.
- BATES, CLIFFORD W. (A'29), Development Dept., Leeds and Northrup Company, 4901 Stenton Ave., Philadelphia, Pa. For mail: 403 N. Narberth Ave., Narberth, Pa.
- BATES, CYRIL R. (A'26), Messrs. L. McMichael, Ltd., Descham Rd., Slough, Bucks, England. For mail: 49 Woodbridge Rd., Knowle, Bristol, England.
- BATES, LEE A. (A'28), President, The Lee A. Bates Radio Company, 274 Main St., Worcester, Mass.
- BATHE, CHARLES E. (A'29), Superintendent of Standardization and Radio, Oklahoma Gas and Electric Company, 20 W. Noble St., Oklahoma City, Okla.

- BATSEL, MAX C. (A'21-F'27), Chief Engineer, R.C.A. Photophone, Inc., 411-5th Ave., New York, N.Y.
- BAUDINO, JOSEPH E. (A'28), Audio Engineer, Westinghouse Electric and Manufacturing Co., Radio Operations Dept., East Pittsburgh, Pa. For mail: Westinghouse Club, Wilkensburg, Pa.
- BAUER, BRUNTON (A'29), Radio Engineer, Bell Telephone Laboratories, Inc., 463 West St., New York, N.Y.
- BAUER, FRITZ (A'28), Engineer, Station KGBX, Foster Hall Tire Company, 1221 Frederick Ave., St. Joseph, Mo. For mail: 304 S. 17th St., St. Joseph, Mo.
- BAUER, PAUL S. (J'20-A'26), Student, Cruft High Tension Laboratory, Harvard University, Cambridge, Mass.
- BAUGHMAN, RAYMOND C. (A'29), Radio Operator, Radio Corporation of America, Chicago, Ill. For mail: Blairsburg, Iowa.
- BAUKAT, HENRY W. (A'27-M'29), Technical Editor, "Radio Retailing," McGraw-Hill Publishing Company, 10th Ave. and 36th St., New York, N.Y. For mail: 519 Alden Ave., Westfield, N.J.
- BAUM, SYDNEY H. (A'24), Radio Engineer, Freed-Eisemann Radio Corporation, 49 Junius St., Brooklyn, N.Y. For mail: 384 Essex St., Brooklyn, N.Y.
- BAUMGARTEN, FRANK A. (A'26), Vice-President, Wireless Electric Company, 206 Stanwix St., Pittsburgh, Pa. For mail: 5559 Beacon St., Pittsburgh, Pa.
- BAUNACH, EDWARD L. (J'26-A'29), Photo Engraver, Moss Photo Engraving Company, 438-448 W. 37th St., New York, N.Y. For mail: 7823-10th Ave., Brooklyn, N.Y.
- BAXTER, CHARLES E. (A'27), Telephone and Telegraph Engineer, New York Central Lines, 466 Lexington Ave., New York, N.Y.
- BAYLES, JOSEPH (A'26), Service Manager, A. H. Mayers, Inc., 781-9th Ave., New York City. For mail: 1074 Summit Ave., New York, N.Y.
- BAYNE, R. R. (A'28), Radio Repairs and Service, Canadian Westinghouse Company, 355 King St., W., Toronto, Ontario, Canada. For mail: 374 Jane St., Toronto, Ont., Canada.
- BAZLEY, PAUL B. (A'26), Electrical Drafting, Western Electric Company, Irvington, N.J. For mail: 278 Orange Ave., Irvington, N.J.
- BEACH, CHESTER L. (A'20), Radio Corporation of America, 233 Broadway, New York, N.Y. For mail: 310 La Salle Ave., Hasbrouck Heights, N.J.
- BEACHLEY, VANCE E. (A'27), Service Manager, The Fromar Company, 25 S. 3rd St., Harrisburg, Pa. For mail: 1926 Park St., Harrisburg, Pa.
- BEAKES, WILLIAM E. (A'14-M'14), Manager, Tropical Radio Telegraph Company, 1 Federal St., Boston, Mass.
- BEAL, RALPH R. (A'15), Electrical Engineer, Federal Telegraph Company, Palo Alto, Calif. For mail: 755 Hamilton Ave., Palo Alto, Calif.
- BEANE, E. A. (M'27), U. S. Supervisor of Radio, Dept. of Commerce, 549 W. Washington St., Chicago, Ill.
- BEANS, FLOYD L. (A'29), Radio Sales and Service, 801 Cattell St., Easton, Pa.
- BEAR, WILLIAM P. (A'23), Power Sales Engineer, Pacific Gas and Electric Company, San Francisco, Calif. For mail: Ambassador Hotel, 53 Mason St., San Francisco, Calif.
- BEARD, J. GREGSON (A'29), Radio Engineer, Westinghouse Electric and Manufacturing Company, Chicopee Falls, Mass. For mail: 27 Bowdoin Terrace, Springfield, Mass.
- BEARDSLEY, FRANKLIN (A'29), 63 Michanic St., Oxford, Mich.
- BEARUP, T. W. (M'27), Broadcasting Company of Australia Pty, Ltd., Melbourne, Australia.
- BEASLEY, IRA E. (A'19), Assistant, Physics Dept., Cleveland Clinic, Euclid Ave. and 93rd St., Cleveland, Ohio. For mail: 870 E. 130th St., East Cleveland, Ohio.
- BEATTY, RUE THOMPSON (A'29), Service Manager, Service Department, Bender Radio Store, Kane, Pa. For mail: 805 Welsh St., Kane, Pa.
- BEATTY, W. E. (A'29), Kolster Radio Company, Station WAH, 39 Broadway, New York, N.Y.
- BEAUMONT, WILLIAM FREDERICK (A'29), Radio Sales and Service, Holmes and Holtz, 303 Lafayette St., Jamestown, N.Y.
- BECHLER, W. C., JR. (A'28), Senior Radio Inspector, U. S. Navy Yard, Philadelphia, Pa.
- BECKWITH-EWELL, STARR L. (A'26), Surgeon, 750 Main St., Hartford, Conn.
- BEDFORD, DONALD D. (A'29), Radio Inspector, Stromberg-Carlson Telephone Company, 1060 University Ave., Rochester, N.Y. For mail: 6 Nothingham Circle, Rochester, N.Y.
- BEDFORD, GEORGE W. (A'28), Lighthouse Service, U. S. Dept. of Commerce, U. S. Lighthouse Depot, 3rd District, Staten Island, N.Y. For mail: 61 Burnside Ave., West New Brighton, S.I., N.Y.
- BEEKLEY, F. CHEYNEY (A'26-M'27), General Manager, Maxim Silencer Company, Hartford, Conn. For mail: 96 S. Main St., West Hartford, Conn.
- BEEB, ARTHUR W. (A'29), Radio Operator, Radio Station KGH, Room 850, Marion Hotel, Little Rock, Ark.
- BEEB, RAYMOND M. (A'25), Proprietor, "The Radio Shop," 403 W. 3rd St., Little Rock, Ark. For mail: 5117 "Q" St., Little Rock, Ark.
- BEERBOWER, R. G. (A'28), Broadcast Operator, Station WMMN, 105 Adams St., Fairmont, W. Va. For mail: 1109 Alexander Pl., Fairmont, W. Va.
- BEERS, G. LISLE (A'27-M'29), Radio Engineer, Westinghouse Electric and Manufacturing Company, East Pittsburgh, Pa. For mail: 435 Ave. D, Wilkensburg, Pa.
- BEEZER, JOSEPH E. (J'26-A'28), Technician, Brunswick-Balke-Collender Company, Muskegon, Mich. For mail: 1692 Peck St., Muskegon, Mich.
- BEHM, LUDWIG F. (A'15), Engineer, Division Des Etudes, Section Recepteurs, Societe Francaise Radioelectrique, 55 Rue Grefulthe, Levallois-Perret, Seine, France. For mail: 14 Rue Lacretelle, Paris (XVme), France.

- BEHNER, HERBERT C. (A'16-M'25), Lieutenant, U. S. Navy, Post-Graduate Instruction, U. S. Naval Academy, Annapolis, Md.
- BEHR, FRANCIS (A'13-M'13-F'20), Lieutenant Colonel, Harbor Defense Commander, Fort Preble, Me.
- BEIDLEMAN, HOWARD B. (A'28), Radio Service Engineer, Beller Electric Supply Company, 101 New Jersey Railroad Ave., Newark, N.J. For mail: 402 N. Grove St., East Orange, N.J.
- BEINDORF, LUCIEN J. (A'28), Chief Engineer, Scientific Development Laboratories, 1225 Diversey Parkway, Chicago, Ill.
- BELL, HAROLD H. (A'28), Radio Service, Broadway Department Store, 4th and Broadway, Los Angeles, Calif. For mail: 336 W. 69th St., Los Angeles, Calif.
- BELL, JOHN C. (A'26), Engineer, Birmingham Broadcasting Company, 2631-12th Ave. N., Birmingham, Ala.
- BELL, LEWIS M. (A'29), Manager, Confectionery Store, 606 Ridge Ave., Zanesville, Ohio.
- BELLEVILLE, LOGAN (J'29), 263-5th Ave., Twin Falls, Idaho.
- BELLEW, LEO T. F. (J'28), Engineer on Carrier Systems, Bell Telephone Company of Canada, 118 Notre Dame St., Montreal, P.Q., Canada. For mail: 45 Piedmont Ave., Montreal, P.Q., Canada.
- BELOCK, HARRY D. (A'29), Recording Engineer, Stanley Recording Company, 184 Broadway, New York, N.Y. For mail: 678 Pennsylvania Ave., Brooklyn, N.Y.
- BELTZ, WILLIS H. (A'28), Assistant Operating Engineer, Radio Corporation of America, 66 Broad St., New York, N.Y.
- BEMIS, EDWIN W. (A'22), Engineering Department, American Telephone and Telegraph Company, 195 Broadway, New York, N.Y.
- BENDER, LOUIS B. (M'23), Major, Signal Corps, U. S. Army, Fort Monmouth, Oceanport, N.J.
- BENDER, MARTIN, JR. (A'28), Electrical Contractor, 1343 Herschell St., New York, N.Y.
- BENGE, J. R. (A'29), Supervisor Radio Inspection, Victor Talking Machine Company, Camden, N.J. For mail: 843 E. Price St., Philadelphia, Pa.
- BENIN, ZOLMON (A'29), Engineer, King Manufacturing Corporation, 254 Rano St., Buffalo, N.Y.
- BENIOFF, HUGO (J'20-A'20), Physicist, Carnegie Institution of Washington, Seismological Laboratory, Pasadena, Calif. For mail: R. 1, Box 55, La Canada, Calif.
- BENJAMIN, ABRAHAM S. (A'22), Sales Engineer, Teletype Corporation, 1400 Wrightwood Ave., Chicago, Ill. For mail: 5710 N. Spaulding Ave., Chicago, Ill.
- BENJAMIN, WESLEY E. (A'28), Engineer, Brooklyn Radio Service Corporation, 577 Myrtle Ave., Brooklyn, N.Y. For mail: 137-42 Southgate Ave., Springfield, L.I., N.Y.
- BENKELMAN, GLEN F. (A'28), Treasurer and Electrical Engineer, Continental Carbon Company, Inc., 13904 Lorain Ave., Cleveland, Ohio.
- BENNER, HAROLD S. (A'27), Radiomarine Corporation of America, 35 S. 3rd St., Philadelphia, Pa. For mail: Schwenksville, Montgomery Co., Pa.
- BENNETT, EDWARD (M'17-F'18), Engineering Bldg., University of Wisconsin, Madison, Wis.
- BENNETT, F. T. (A'28), Proprietor, Wireless Telegraph Company, Rue Du Pre, Guernsey, Channel Islands, England.
- BENNETT, LESLIE W. (J'29), Watchmaker, Elgin National Watch Company, Carpentersville, Ill. For mail: P. O. Box 272, Carpentersville, Ill.
- BENNETT, MORRIS H. (A'26), Electrical Engineer, Scoville Manufacturing Company, Waterbury, Conn. For mail: R.F.D. 2, Waterbury, Conn.
- BENNETT, PORTER T. (A'29), Manager, Service Dept., Behrends, Inc., 4112 Oak Lawn Ave., Dallas, Tex. For mail: 2603 Madera St., Dallas, Tex.
- BENNETT, ROBERT W., JR. (A'26), Room 310, City Hall, Newark, N.J. For mail: 357 Lake St., Newark, N.J.
- BENSON, FRANCIS S. (A'28), Assistant Engineer, Dept. of Engineering, Pacific Gas and Electric Company, 245 Market St., San Francisco, Calif.
- BENSON, JOHN P. (A'27), Radio Electrician, General Distributors, 605 Dunsmuir St., Vancouver, B.C., Canada. For mail: 4304 Sophia St., Vancouver, B.C., Canada.
- BEREJKOFF, ANATOL PETROVICH (A'23), Member of Engineering Staff, General Electric Company, Radio Engineering Dept., 1 River Rd., Schenectady, N.Y. For mail: 51 Washington Ave., Schenectady, N.Y.
- BEREST, ANTON (A'28), Surveying Inst. and Experimental Worker, Wissler Inc. Company, 613 N. Broadway, St. Louis, Mo. For mail: 4956 Ashby Ave., St. Louis, Mo.
- BERG, ARTHUR A. E. (A'28), Service Manager, The Mathes Company, 412 Polk St., Amarillo, Tex.
- BERG, ERNEST J. (A'17), Consulting Engineer, General Electric Company, 1 River Rd., Schenectady, N.Y. For mail: 28 Lowell Rd., Schenectady, N.Y.
- BERGER, HENRY C. (A'24), Proprietor, Berger Battery Service, 25 Prospect St., Passaic, N.J.
- BERGER, MAURICE (M'24), Western Electric Company, Ltd., Bush House, Aldwych, London, W.C.2, England.
- BERGERON, ROSARIO (A'29), T.R.E. Laboratory, General Electric Company, 1 River Rd., Schenectady, N.Y. For mail: 338 Eleanor Ave., Schenectady, N.Y.
- BERGMAN, G. WILEY (J'25-A'25), Radio Engineer, Public Service Company of Northern Illinois, 72 W. Adams St., Chicago, Ill. For mail: 729 Seward St., Evanston, Ill.
- BERGMANN, HOWARD J. (J'29), Radio Station WKBW, Buffalo Broadcasting Corporation, 485 Main St., Buffalo, N.Y. For mail: 414 Northampton St., Buffalo, N.Y.
- BERKHEIMER, R. H. (A'21), Proprietor, Hardware and Furniture, Gig Harbor, Wash.

- BERKLEY, FRED (A'29), Manager, Service Dept., Dynamic Electric Stores, Inc., 178 Greenwich St., New York, N.Y. For mail: 3111 Astoria Ave., Astoria, L.I., N.Y.
- BERKNER, LLOYD V. (A'26), Radio Expert, Byrd Antarctic Expedition. For mail: 6301 Florida St., Chevy Chase, Md.
- BERKOWITZ, LOUIS (J'29), Radio Serviceman, Louis Berkowitz Radio Company, 849 Blue Hill Ave., Dorchester, Mass.
- BERNARD, HERMAN (A'25), General Manager, "Radio World" 145 W. 45th St., New York, N.Y. For mail: 8718 Ridge Blvd., Brooklyn, N.Y.
- BERNER, AARON (A'29), Service Engineer, Lincoln Radio Company, 5516-3rd Ave., Brooklyn, N.Y. For mail: 392 Sackman St., Brooklyn, N.Y.
- BERNHARD, FREDERICK S. (A'19), Radio Engineer, Bell Telephone Laboratories, Inc., 463 West St., New York, N.Y. For mail: 11 Buttonwood Rd., Essex Fells, N.J.
- BERRY, HENRY P. (A'24), Preliminary Plans Engineer, Chesapeake and Potomac Telephone Company, Charleston, W.Va. For mail: 103 Veasey St., Charleston, W.Va.
- BERRY, JAMES L. (A'27), Technical Assistant, Amplion Corporation of America, 531 W. 37th St., New York, N.Y. For mail: 203 W. 87th St., New York, N.Y.
- BERRY, JAMES S. (A'29), Radio Service, Sallito, Tenn.
- BERRY, ROBERT C. (A'27), Radio Operator, Radio Station WLW, Mason, Ohio.
- BERRYMAN, FORREST G. (A'27), Radio Set Builder and Repairman, Royston, Ga.
- BERTOLET, BENNEVILLE S. (A'29), Chief Service Engineer, Cristol Bros., 217-219 S. New St., Bethlehem, Pa. For mail: 648 Highland Ave., Bethlehem, Pa.
- BERTZOW, JOHANNES A. (A'29), Captain in Danish Army, Kastelsvej No. 3, Copenhagen, Denmark.
- BESHGETOOR, RAY V. (A'26), Component Parts Sales Manager, Engineering Products Div., Radio Corporation of America, 233 Broadway, New York, N.Y.
- BEST, GERALD M. (M'26), Recording Sound Pictures, Vitaphone Corporation, 5842 Sunset Blvd., Hollywood, Calif. For mail: 108 N. Harper Ave., Los Angeles, Calif.
- BETHENOD, J. F. J. (A'17), Consulting Engineer, 16 Rue de Varize, Paris 16e, France.
- BETTERLEY, JACK A. (A'21), Proprietor, Bear Valley Electric Company, Pine Knot P. O., Calif.
- BETTS, FREDERICK H. (A'28), Representative, Columbia Machine Works and M. I. Company, 255 Chestnut St., Brooklyn, N.Y.
- BETTS, PHILANDER H. (A'23), Radio Engineer, Bell Telephone Laboratories, Inc., 463 West St., New York City.
- BETZ, C. LEONARD (A'29), Radio Service, The Roeller Radio Shop, 53 N. Charlotte St., Pottstown, Pa. For mail: 130 Walnut St., Pottstown, Pa.
- BEUSMAN, ROBERT M. (A'29), Laboratory Assistant, Montgomery Ward and Company, 618 W. Chicago Ave., Chicago, Ill. For mail: 5054 Agatite Ave., Chicago, Ill.
- BEVER, ANTHONY J. M. (A'24), Bever, Dorling and Company, Bowling Iron Work, Bradford, England. For mail: No. 10 Spa Flats, Ilkley, Yorks, England.
- BEVERAGE, HAROLD H. (A'15-M'26-F'28), Radio Engineer, Radio Corporation of America, 66 Broad St., New York, N.Y.
- BEVERIDGE, JOHN A. (M'29), Engineer-in-charge, British Broadcasting Corporation, 87 George St., Edinburgh, Scotland. For mail: "Dunelm," 8 Cluny Drive, Edinburgh, Scotland.
- BEVITT, WILLIAM D. (A'28), Student, Cornell University, 31 Baker Tower, Ithaca, N.Y. For mail: 206 W. Embargo St., Rome, N.Y.
- BEYER, GLEN R. (A'28), Service Manager, Medo Electric Corporation, 18 E. Chippowa St., Buffalo, N.Y. For mail: 79 Roanoke Parkway, Buffalo, N.Y.
- BIAR, L. E. (J'28), 512 W. South St., Angola, Ind.
- BICKEL, HOWARD I. (A'27), Radio Engineer, Day-Fan Electric Company, Dayton, Ohio. For mail: 2130 W. 3rd St., Dayton, Ohio.
- BIDLACK, CECIL S. (A'27), Assistant Operator, Radio Station WEAO, Ohio State University, Columbus, Ohio. For mail: 1448 N. 6th St., Columbus, Ohio.
- BIEBER, CLARENCE G. (A'28), Research Assistant, International Nickel Company, Huntington, W.Va.
- BIELE, CHARLES E. (A'27), Assistant Sales Engineer, Edison Storage Battery Company, Orange, N.J. For mail: 40 Kent Place Blvd., Summit, N.J.
- BIELLENBERG, JOHN F. G. (A'27), Territory Representative Salesman, Fada Radio Company, 2015 Grand Ave., Kansas City, Mo.
- BIEVER, FRED H. (A'26), Manager, Backus Novelty Company, Smethport, Pa. For mail: 707 W. Water St., Smethport, Pa.
- BILES, FRANK V. (A'27), Telegrapher, Lehigh Valley Railroad, Geneva, N.Y. For mail: 159 E. North St., Geneva, N.Y.
- BILHEIMER, JOE A. (A'29), Manager, Radio Dept., Voss-Hutton Company, 214 W. 4th St., Little Rock, Ark.
- BILLINGS, JAMES H. (A'28), Radio Tester, General Electric Company, Bldg. 77, Schenectady, N.Y. For mail: 536 Vischer Ave., Schenectady, N.Y.
- BILLUPS, ROBERT W. (A'28), Field Engineer, Kolster Radio Corporation, 200 Mt. Pleasant Ave., Newark, N.J. For mail: Franklin Park, Roslyn P.O., Va.
- BILTCLIFFE, THOMAS (A'29), Radio Manager, Messrs. E. E. Squire, 21 Bond St., Ealing, W.5, England. For mail: 97 Windermere Rd., Ealing, S.W., England.
- BINDNER, THEODORE JOSEPH (A'29), Consulting Sound Engineer, Masterphone Sound Equipment Corporation, Seattle, Wash. For mail: 303 McDermott Apts., 1514 Bellevue Ave., Seattle, Wash.
- BINGHAM, JOHN M. (A'22), Engineer, Radio Broadcasting Company of New Zealand, Ltd., Box 1007, Christchurch, N.Z.
- BINNS, JOHN R. (A'26), Treasurer, Hazeltine Corporation, and Radio Editor of "Collier's," Room 2043, 42 Broadway, New York, N.Y.

- BINYON, BASIL (A'14-M'14), Managing Director, Radio Communication Company, Ltd., 34 Norfolk St., London, W.C.2, England. For mail: Hawthorndene, Hayes, Kent, England.
- BIRD, R. J. (M'29), Engineer-in-Charge, British Broadcasting Corporation, Broadcasting House, Piccadilly, Manchester, England.
- BIRKHAHN, ROBERT C. (A'22), Lawyer, 420 Lexington Ave., New York, N.Y. For mail: Woodmere, L.I., N.Y.
- BISHOP, ERNEST F. (A'26), Engineer, Radio Service Dept., Canadian General Electric Company, Notre Dame St., E. Winnipeg, Manitoba, Canada. For mail: 765 Beach Avenue, Elmwood, Winnipeg, Manitoba, Canada.
- BISHOP, NATHANIEL (A'26), 301 Park Pl., Bridgeport, Conn.
- BITTER, A. ROMEYN (A'26), Electrical Engineer, Electric Auto-Lite Co., Toledo, Ohio. For mail: 614 1/4 Euclid Ave., Toledo, Ohio.
- BIVER, CARL J. (A'29), United Reproducers Corporation, Springfield, Mass. For mail: 731 E. High St., Springfield, Ohio.
- BLACK, ALBERT J. (A'26), Chief Operator, Postal Telegraph Cable Company, 1449 W. 6th St., Cleveland, Ohio. For mail: 20866 Westwood Ave., Fairview Village, Ohio.
- BLACK, GARLAND C. (A'27), Captain, Signal Corps, U. S. Army, The Signal School, Fort Monmouth, N.J.
- BLACK, K. CHARLTON (M'29), Physicist, Boonton Research Corporation, Boonton, N.J.
- BLACK, OLIVER M. (A'27), Instructor in Radio, Radio Institute of America, 326 Broadway, New York, N.Y.
- BLACK, ROBERT (A'28), Transmission Engineer, Southern California Telephone Company, Los Angeles, Calif. For mail: 15734 Sherman Way, Rear, Van Nuys, Calif.
- BLACKBURN, JOHN F. (A'29), 1719 N. Gardner St., Hollywood, Calif.
- BLACKMAR, ABEL E., JR. (A'24), Attorney-at-Law, Sheffield and Betts, 27 Cedar St., New York, N.Y.
- BLACKWELL, GEORGE C. (A'28), Director Chain Operations, Continental Broadcasting Corporation, General Motors Bldg., Rm. 724, 1775 Broadway, New York, N.Y.
- BLACKWELL, OTTO B. (M'20-F'28), Transmission Development Engineer, American Telephone and Telegraph Company, 195 Broadway, New York, N.Y.
- BLAICH, J. RAY (A'27), Development Engineer, H. J. Gorke Estate, 146-152 James St., Syracuse, N.Y. For mail: 412 S. Alford St., Syracuse, N.Y.
- BLAIR, RUSSELL M. (A'23), Engineer, The Crosley Radio Corporation, 3401 Colerain Ave., Cincinnati, Ohio. For mail: 3930 Ivanhoe Ave., Norwood, Ohio.
- BLAIR, WILEY, JR. (A'27), 1215 Wood Ave., Colorado Springs, Colo.
- BLAIS, ALPHY L. (A'26), Radio and Chemical Engineer, Theford Mines City, County Megantic, P.Q., Canada.
- BLAKELY, ROBERT JOHN (A'28), Assembly Supervisor, Canadian Brandes, 207 Queens Quay, Toronto, Ontario, Canada. For mail: 61 Mutal St., Toronto, Ont., Canada.
- BLAKENEY, GEORGE H. (A'29), Manager, Radio and Victrola Dept., c/o Adams Glass and Company, Inc., 17-19-21 S. Royal St., Mobile, Ala.
- BLAN, MICHAEL (A'29), President, Blan, The Radio Man, Inc., 89 Cortlandt St., New York, N.Y.
- BLANFORD, EDWIN C. (J'28), Radio Service, Malcolm Music House, 115 W. Kearsley St., Flint, Mich. For mail: 2208 Cadillac St., Flint, Mich.
- BLENHEIM, WILLIAM J. (A'26-M'28), Traffic Manager, Western Union Telegraph Company, 40 Broad St., New York, N.Y.
- BLISS, ALONZO O., JR. (A'27), Bliss Bldg., Miami, Fla.
- BLISS, FLOYD D. (A'25), Aurora Radio Shop, Prairie and Calumet Sts., Aurora, Ill. For mail: Box 85, Prairie St., Aurora, Ill.
- BLITCH, JAMES D. (A'26), Radio Service, Southern Division, Georgia Power Co., Statesboro, Ga. For mail: Statesboro, Ga.
- BLIZIOTIS, GEORGE E. (M'28), Bliss Radio Company, 250 Springfield Ave., Newark, N.J. For mail: 32-3rd Ave., Newark, N.J.
- BLODGETT, EDWARD D. (A'29), Radio Engineer, Wireless Specialty Apparatus Company, 76 Atherton St., Jamaica Plain, Mass. For mail: 8 Craigie Circle, Cambridge, Mass.
- BLOM, ROY (A'29), Electrician, Mills Novelty Company, 4100 Fullerton Ave., Chicago, Ill. For mail: 3451 Beach Ave., Chicago, Ill.
- BLOOMENTHAL, SIDNEY (A'27), Research Department, Radio Corporation of America, Van Cortlandt Park South and Saxon Ave., New York, N.Y.
- BLUM, SIDNEY J. (A'29), D. D. S., X-Ray Specialist, 702 Shukert Bldg., Kansas City, Mo.
- BLUMENTHAL, RAYMOND W. (A'28), Radio Clerk, 1244 Randolph St., Detroit, Mich. For mail: 6221 Crane St., Detroit, Mich.
- BLUZAT, CLAUDE R. (A'27), Sales Engineer, Transformer Corporation of America, 1428 Orleans St., Chicago, Ill. For mail: 244 S. Maple Ave., Oak Park, Ill.
- BOAT, JOHN (A'28), Custom Set Builder, 1659 Madison St., Kansas City, Mo.
- BOBERTZ, W. E. (A'28), Student University of Michigan, Box 68, Alfred St. Sta., Detroit, Mich.
- BOCK, ASHLEY P. (A'27), Westinghouse Electric and Manufacturing Company, Chicopee Falls, Mass. For mail: 39 Pratt St., Springfield, Mass.
- BOCKHOVEN, LEWIS MURRAY (A'29), Division Plant Engineer, Southern California Telephone Company, 740 S. Olive St., Los Angeles, Calif. For mail: 1341-5th St., Glendale, Calif.
- BODDIE, CLARENCE A. (A'21), Research Engineer, Westinghouse Electric and Manufacturing Company, East Pittsburgh, Pa. For mail: 1513 Montier St., Wilkensburg, Pa.
- BOEHME, H. O. (M'15), President, H. O. Boehme, Inc., 117-119 E. 24th St., New York, N.Y.

- BOERNER, THOMAS J. (A'26), Engineering Dept., R.C.A. Communications, Inc., 66 Broad St., New York, N.Y. For mail: 6 Winthrop Pl., Maplewood, N.J.
- BOES, W. W. (A'27), Proprietor, W. W. Boes Company, 622 Broadway, Cincinnati, Ohio.
- BOESCHE, F. W. (A'29), Radio Engineer, Bell Telephone Laboratories, Inc., 463 West St., New York, N.Y.
- BOGARDUS, HENRY L. (A'20-M'23), Engineering Dept., Universal Wireless Communication Company, Inc., 4619 Ravenswood Ave., Chicago, Ill.
- BOGENBERGER, JOHN, JR. (A'27), President, Bogenberger Radio Corporation, 991-3rd St., Milwaukee, Wis.
- BOGER, CLAIR E. (A'26), Research Engineer, The Hoover Company, North Canton, Ohio. For mail: 607 McKinley St., North Canton, Ohio.
- BOHLING, C. F. (A'22), Radio Engineer, The Capehart Corporation, Ft. Wayne, Ind. For mail: 2351 Gay St., Ft. Wayne, Ind.
- BOHLKE, W. HOLLANDER (A'28), Student Engineer, 28 Cochran St., Chicopee Falls, Mass. For mail: 220 Amboy Ave., Metuchen, N.J.
- BOHN, WILLIAM C. (A'18), Development and Research Dept., American Telephone and Telegraph Company, 195 Broadway, N.Y. For mail: 51 Prospect Ave., Maplewood, N.J.
- BOISE, EVERETT B. (A'25), Assistant Engineer, R.C.A.-Victor Company, Inc., Camden, N.J. For mail: 307 Wildwood Ave., Pitman, N.J.
- BOJI, LOUIS D. (A'27), Radio Superintendent, U. S. Radio and Television, 33rd and Lincoln Blvd., Marion, Ind.
- BOLAN, ROBERT S. (A'27), Chief Lamp Engineer, Hygrade Lamp Company, 60 Boston St., Salem, Mass.
- BOLTSON, JACOB A. (A'29), Radio Engineer, Sears Roebuck and Co., Dept. 657, Chicago, Ill.
- BONANNO, JOSEPH L. (A'27), Engineer, Radio Corporation of America, 70 Van Cortlandt Park and Saxon Ave., New York, N.Y. For mail: 71 Colonial Ave., Forest Hills, L.I., N.Y.
- BOND, ELMER FREDERICK (A'29), Student Engineer, Radio Corporation of America, 70 Van Cortlandt Park South, New York, N.Y.
- BOND, M. E. (A'29), Audio Engineer, American Bosch Magneto Corporation, 3664 Main St., Brightwood, P.O. Springfield, Mass.
- BOND, ROYDEN J. (A'28), Foreman, Canadian Brandes Ltd., Queens Quay, Toronto, Ont., Canada. For mail: 171 Glenforest Ave., Toronto, Ont., Canada.
- BONDY, HUGO ALOIS, JR. (A'29), Radio Operator, Radiomarine Corporation of America, 326 Broadway, New York, N.Y. For mail: 21 Phelps Rd., Ridgewood, N.J.
- BONELL, RALPH K. (A'24), Engineer, American Telephone and Telegraph Company, Dept. of Development and Research, Rm. 1540, 195 Broadway, New York, N.Y.
- BONETT, DAVID J. (A'27), Assistant Patent Attorney, Radio Corporation of America, 233 Broadway, New York, N.Y.
- BONN, NORMAN E. (A'28), Research Engineer, Rubican Company, 24 N. 6th St., Philadelphia, Pa. For mail: 6963 Cedar Park, Philadelphia, Pa.
- BONONG, EDWARD (A'26), Radio Engineer, British Broadcasting Corporation, Savoy Hill, London, W.C.2, England.
- BOONE, VIRGIL (A'29), Sales and Serviceman, The Radio Shop, 511 Main St., Little Rock, Ark. For mail: 224 Vernon St., Little Rock, Ark.
- BOOTH, HOWARD A. (A'29), Chief Radio Electrician, U. S. Navy, Naval Research Laboratory, Bellevue, Anacostia, D.C.
- BOOTH, JAMES D. (A'27), Radio Engineer, Westinghouse Electric and Manufacturing Company, Chicopee Falls, Mass. For mail: 609 Longmeadow St., Longmeadow, Mass.
- BORGESON, CARL A. (A'27), American Telephone and Telegraph Company, 15 Dey St., Rm. 1100, New York, N.Y. For mail: 106 N. Grove St., Apt. F. 11, East Orange, N.J.
- BORISLAVSKY, MICHAEL A. (A'25), Consulting Engineer, J. E. Jackson, Inc., 72 Washington St., New York, N.Y. For mail: 240 E. 104th St., New York, N.Y.
- BORLAND, ALBERT S. (A'28), Technical Radio Electrician, Sears Roebuck and Company, Philadelphia, Pa. For mail: 2506 N. 34th St., Philadelphia, Pa.
- BORN, W. THEODORE (A'27), Physicist, Geophysical Research Corporation, 15 Ward St., Bloomfield, N.J.
- BORTHWICK, JAMES H. (A'26), Secretary-Treasurer, Borthwick Undertaking Company, Ltd., Honolulu, Hawaii. For mail: 1565 Nuuanu St., Honolulu, Hawaii.
- BORTHWICK, FREDERICK J. (A'26), Staff Engineer, Messrs. Kinemas, Ltd., Kinema House, 259 Jappe St., Johannesburg, South Africa.
- BOSCO, JOSEPH F. (J'29), Radio Technician and Instructor, Audio-Vision Appliance Company, Camden, N.J. For mail: 224 E. Sharpnack St., Philadelphia, Pa.
- BOSLER, GUSTAVE A. (A'29), Radio Mechanic, National Broadcasting Company, 711-5th Ave., New York, N.Y. For mail: 133 Vine St., Roselle, N.J.
- BOSSART, PAUL N. (A'29), Physicist, Research Dept., Union Switch and Signal Company, Swissvale, Pa.
- BOSTAD, JOHN (A'27), Assistant Engineer, Dubilier Condenser Corporation, 4377 Bronx Blvd., New York, N.Y. For mail: 2985 Botanical Square, Apt. 311, New York, N.Y.
- BOUCHERON, PIERRE H. (A'20-M'26), Sales Manager, Southern District, Radio Corporation of America, 101 Marietta St., Atlanta, Ga.
- BOUCK, ZEH (A'24-M'26), Consultant and Technical Writer, 36-20-168th St., Flushing, L.I., N.Y.
- BOUNDY, GLEN G. (A'28), Radio Engineer, West Virginia Broadcasting Corporation, Wheeling, W. Va. For mail: 1420 National Rd., Wheeling, W. Va.

- BOURGEOIS, ALLEN B.** (A'29), Camp Superintendent, Cia. Mexicana De Petroleo "El Aguila" S. A. Apartado 86, Puerto Mexico, Vera Cruz, Mexico. For mail: Apartado 86, Puerto Mexico, Vera Cruz, Mexico.
- BOURNE, ROLAND B.** (M'29), Research Engineer, Maxim Silencer Company, Box 2102, Hartford, Conn. For mail: 167 Palm St., Hartford, Conn.
- BOUSQUET, ARTHUR G.** (A'29), General Radio Company, 30 State St., Cambridge, Mass.
- BOUSON, HERBERT H.** (M'26), Lieutenant Commander, U. S. Navy, U. S. S. "Colorado," San Francisco, Calif.
- BOWDITCH, FRED T.** (A'24), Radio Engineer, Research Laboratory, Edgewater Plant, National Carbon Company, 1280 W. 73rd St., Cleveland, Ohio.
- BOWEN, CLYDE L.** (A'27), Radio Operator, Station KGDP, 2410 Spruce St., Pueblo, Colo. For mail: 1418 Bragdon Ave., Pueblo, Colo.
- BOWEN, HAROLD C.** (J'16-A'18), Jos. A. Bowen Company, 168 Belmont St., Fall River, Mass.
- BOWEN, HARRY L.** (A'26), Mulford Wireless Service Company, Ltd., 140c Victoria St., Bristol, England. For mail: 13 Daniel St., Bath, Somerset, England.
- BOWEN, LEONARD R.** (A'29), Radio Serviceman, Edgar Music Company, 700 S. Main St., Tulsa, Okla. For mail: 2808 E. 7th St., Tulsa, Okla.
- BOWER, JAMES** (A'29), Engineering Assistant, Research Bureau, Brooklyn Edison Company, Pearl and Johnson Sts., Brooklyn, N.Y. For mail: 253 Cumberland St., Brooklyn, N.Y.
- BOWER, WARD E.** (A'29), Assistant Radio Engineer, Naval Research Laboratory, Bellevue, Anacostia, D.C. For mail: 1705 Bay St., S.E., Washington, D.C.
- BOWERS, E. J.** (A'29), Chief Engineer, Radio Station, CFRB, Aurora, Ont., Canada. For mail: 37 Lowther Ave., Toronto, Ont., Canada.
- BOWKER, WINTHROP H.** (A'26), Electrical Engineer, New England Telephone and Telegraph Company, 50 Oliver St., Boston, Mass. For mail: 322 Harvard St., Brookline, Mass.
- BOWLES, EDWARD L.** (A'22-M'28), Instructor in Electrical Engineering, Massachusetts Institute of Technology, Cambridge, Mass.
- BOWLES, THEODORE C.** (A'26), Manager, Radio Dept., Western Auto Supply Company, 1100 S. Grand Ave., Los Angeles, Calif. For mail: 910 N. Geneva, Glendale, Calif.
- BOWMAN, CHARLES W.** (A'29), Repairman, H. K. Radio Engineering Company, 959 Turner St., Allentown, Pa. For mail: 246 S. Madison St., Allentown, Pa.
- BOWMASTER, J. M.** (A'29), Eastern Service Radio Representative, Sparks Withington Company, Jackson, Mich.
- BOWN, RALPH** (M'22-F'25), Telephone Engineer, American Telephone and Telegraph Company, 195 Broadway, New York, N.Y.
- BOWSER, JACOB W.** (A'27), Radio Service, The Wireless Shop, 206 Greenwood Ave., Punxsutawney, Pa.
- BOYCE, FRANK A.** (A'23), Radio Engineer, L. MacMichael, Ltd., Slough, England. For mail: Penguin, Garson Lane, Wraybury, Bucks, England.
- BOYD, W. FORBES** (A'28), The London Electric Wire Company, and Smiths, Ltd., Church Rd., London E. 10, England.
- BOYDEN, DAVIS S.** (A'28), Department Superintendent, The Edison Illuminating Company of Boston, 39 Boylston St., Boston, Mass. For mail: 1496 Commonwealth Ave., Boston, Mass.
- BOYER, WILLIAM P.** (A'28), Radio Dealer, 1921 K St., N.W., Washington, D.C.
- BOYLAN, E. BRANDT** (A'28), Proprietor and Operator, Radio Station WTBO, 708 Market St., Wilmington, Del. For mail: 2303 Franklin St., Wilmington, Del.
- BOYLE, CHARLES W.** (A'15-M'16), Marconi's Wireless Telegraph Company, Ltd., London, England. For mail: Brackendale, 18 Swiss Ave., Chelmsford, England.
- BOYLE, FRANK A.** (A'29), Radio Service Specialist, 91 S. Hamilton St., Poughkeepsie, N.Y.
- BOYNTON, FREDERICK L.** (A'27), 307 N. Main St., Sycamore, Ill.
- BOYSE, ROBERT E.** (A'28), Speaker Repairman, Sonora Phonograph, Inc., Saginaw, Mich. For mail: 210 N. 11th St., Saginaw, Mich.
- BRAATEN, ARTHUR M.** (A'27), Engineer, Receiver Design Dept., Radio Corporation of America, Riverhead, L.I., N.Y. For mail: Box 561, Riverhead, L.I., N.Y.
- BRACH, LEON S.** (A'22-M'29), President, L. S. Brach Manufacturing Corporation, 12 Sussex Ave., Newark, N.J.
- BRACK, G. S.** (A'27), Manufacturers' Representative, 32 S. Jefferson St., Chicago, Ill.
- BRACKEN, BEN** (A'29), Radiotrician, 403 W. 3rd St., Little Rock, Ark. For mail: 2579 W. 16th St., Little Rock, Ark.
- BRACKETT, HAROLD H.** (A'22), Engineer, Toll Plant, Extension and Transmission Dept., New Jersey Bell Telephone Company, 1060 Broad St., Newark, N.J. For mail: Summit Ave., Oradell, N.J.
- BRACKETT, QUINCY A.** (M'20), Technical Assistant to Manager, Radio Commercial Dept., Westinghouse Electric and Manufacturing Company, Chicopee Falls, Mass. For mail: 116 S. Park Ave., Longmeadow, Mass.
- BRACKETT, RICHARD T.** (A'27), Instructor, University of Nebraska, E.E. 106, Lincoln, Neb.
- BRADBURY, BURKE** (A'26), Radio Engineer, Radio Engineering Dept., General Electric Company, Schenectady, N.Y. For mail: 17 Wilson Ave., Schenectady, N.Y.
- BRADBURY, G. V.** (A'24), Contractor, 415 Ridge Bldg., Kansas City, Mo.
- BRADEN, RENE A.** (A'23), Engineer, Radio Corporation of America, 70 Van Cortlandt Park South, New York, N.Y. For mail: 11 Jacobus Pl., New York, N.Y.

- BRADER, NORWOOD H.** (A'27), 406 Union Bank Bldg., Pittsburgh, Pa.
- BRADFORD, HENRY K.** (A'29), Instructor, National Radio Institute, 16th and U Sts., N.W., Washington, D.C. For mail: 3541 Holmead Pl., N.W., Washington, D.C.
- BRADLEY, ERNEST A.** (A'29), Post and Telegraph Dept., Wanganui, New Zealand.
- BRADLEY, JOHN T.** (A'26), Aircraft and Radio Technician, Heintz and Kaufman, Inc., 219 Natoma St., San Francisco, Calif. For mail: P.O. Box 126, Belmac Post Office, San Mateo County, Calif.
- BRADSHAW, LYNWOOD** (A'25), Chief Technician, Pacific Broadcasting Corporation, 988 Market St., San Francisco, Calif. For mail: P.O. Box 2498, San Francisco, Calif.
- BRADSHAW, ROBERT C.** (A'27), The Radio Stores, 564 E. Colorado St., Pasadena, Calif. For mail: P.O. Box 302, Pasadena, Calif.
- BRADY, JOHN B.** (A'20-M'29), Counselor-at-Law, Ouray Bldg., Washington, D.C. For mail: 315 Cumberland Ave., Chevy Chase Post Office, Somerset, Md.
- BRADY, LESLIE R.** (A'29), Assistant U. S. Radio Inspector, U. S. Radio Service, Sub-treasury Building, Pine and Nassau Sts., New York, N.Y. For mail: 333-8th St., Brooklyn, N.Y.
- BRAFFET, DONALD H.** (J'29-A'29), Radio Serviceman, Paw Paw, Ill.
- BRAFFORD, CHARLES P.** (A'26), 3320 Galena St., Milwaukee, Wis.
- BRAKE, PAUL** (J'29), Student, Alabama Polytechnic Institute, Auburn, Ala.
- BRANCH, L. W.** (M'29), Manager, Hawaii Telephone System, P.O. Box 425, Hilo, Hawaii.
- BRANCH, WILLIAM E.** (M'25), Radio Engineer, Carter Publications, Inc., 400 W. 7th St., Fort Worth, Tex. For mail: 3721 Crestline Rd., Fort Worth, Tex.
- BRANDT, KRISTIAN** (A'26), Engineer, 119 Berkeley Pl., Brooklyn, N.Y.
- BRANDT, WILLIAM A.** (A'24), Operating Engineer, Automatic Electric, Inc., 1033 W. Van Buren St., Chicago, Ill. For mail: 4107 Rosemont Ave., Drexel Hill, Pa.
- BRANSON, ALBERT K.** (A'28), Radio Engineer, Federal Radio Corporation, Palo Alto, Calif. For mail: 8425 Foothill Blvd., Oakland, Calif.
- BRATTAIN, WALTER H.** (A'29), Assistant Physicist, Bureau of Standards, Washington, D.C.
- BRAUN, W. C.** (A'24), President, W. C. Braun Company, 563 W. Randolph St., Chicago, Ill. For mail: P.O. Box 589, Chicago, Ill.
- BREARTY, LAWRENCE S.** (A'29), Locomotive Engineer, S.P.R.R. Company, Roundhouse, West Oakland, Calif. For mail: 1208 E. 18th St., Oakland, Calif.
- BREEDING, CHARLES S.** (A'26), 1187 N. Normandie Ave., Hollywood, Calif.
- BREEDING, S. H.** (A'28), Radio Service and Repair, Dodge Electric Company, 318-320 S. Boulder, Tulsa, Okla. For mail: Rt. 10, Box 219A, Tulsa, Okla.
- BREEDLOVE, FREDERICK W.** (A'29), 2807 Jefferson Ave., New Orleans, La.
- BREIMER, S. H.** (A'28), Laboratory Engineer, Ned. Seintoostellen Fabriek, Hilversum, Holland. For mail: Neuweg 298, Hilversum, Holland.
- BREMER, FRANK V.** (A'27), President, Bremer Broadcasting Corporation, Plaza Hotel, Jersey City, N.J. For mail: 210 Jackson Ave., Jersey City, N.J.
- BREMER, HARRY A.** (A'25), Proprietor, Hudson City Radio Shop, 89-91 Franklin St., Jersey City, N.J.
- BRENNAN, JOHN B., JR.** (A'26), Radio Publicity, 9050-206th St., Bellaire, L.I., N.Y.
- BRENNECKE, CORNELIUS** (A'28), Communications Engineer, Radio Corporation of America, 66 Broad St., New York, N.Y. For mail: 168 W. 100th St., New York, N.Y.
- BRENT, HERBERT C.** (M'23), Telegraph Engineer, District Telegraph Engineer's Office, Wellington, New Zealand.
- BREWER, FRANCIS T.** (A'27), Radio Engineer, Bremer-Tully Manufacturing Company, 656 W. Washington Blvd., Chicago, Ill. For mail: 1755 N. McVicker Ave., Chicago, Ill.
- BREWER, NOBLE E.** (A'28), Assistant Engineer, United Electric Service Company, Abilene, Kan. For mail: P.O. Box 107, Abilene, Kan.
- BREWIN, ROBERT R.** (A'27), Radio Coordination, Georgia Power Company, 152 Edgewood Ave., Atlanta, Ga. For mail: 341 Clifford Ave., N.E., Atlanta, Ga.
- BREWINGTON, CARL W.** (A'23), Lieutenant Commander, U. S. Navy, U. S. S. "Pittsburg," Asiatic Station, c/o Postmaster, Seattle, Wash.
- BREWSTER, O. H.** (A'29), Production Engineer, "CeCo" Manufacturing Company, Providence, R.I. For mail: 1200 Eddy St., Providence, R.I.
- BRICK, FRANK R., JR.** (A'25-M'26), Engineer, Radio Corporation of America, New York, N.Y. For mail: 856 Colonial Rd., Elizabeth, N.J.
- BRICKHILL, G. A.** (A'28), Chief Engineer, African Broadcasting Company, Ltd., P.O. Box 2551, Cape Town, South Africa.
- BRICKSON, HERBERT O.** (A'25), Radio Engineer, Radio Station WLBI, Stevens Point, Wis. For mail: 1321 E. Briggs St., Stevens Point, Wis.
- BRIDGE, ROBERT B.** (A'27), Proprietor and Operator, Station KTAP, 822 W. Mulberry St., San Antonio, Tex.
- BRIDGMAN, FRANCIS K.** (A'25), Commercial Radio Representative, Illinois Bell Telephone Company, 212 W. Washington St., Chicago, Ill. For mail: 5807 Dorchester Ave., Chicago, Ill.
- BRIGGS, LOYD A.** (M'29), Chief Operating Electrician, Radio Corporation of America, 66 Broad St., New York, N.Y. For mail: 31 Spruce St., Cranford, N.J.
- BRIGHAM, CECIL E.** (A'28), Electrical Engineer, Kolster Radio Corporation, 200 Mt.

- Pleasant Ave., Newark, N.J. For mail: 116 Prospect St., East Orange, N.J.
- BRIGHAM, CYRIL A. (A'23)**, Research Engineer, Kolster Radio Corporation, 200 Mt. Pleasant Ave., Newark, N.J. For mail: 332 Park Ave., East Orange, N.J.
- BRIMBERG, ISAAC (A'26)**, Radio Engineer, City of New York, Rm. 2514, Municipal Bldg., New York, N.Y. For mail: 1062 Park Pl., Brooklyn, N.Y.
- BRINDLEY, WILLIAM E. (A'26-M'28)**, Radio Engineer, Westinghouse Electric and Manufacturing Company, East Pittsburgh, Pa. For mail: 706 Lamar St., Wilkinsburg, Pa.
- BRISTOW, FREDERICK R. (A'27)**, Supervisor, Radio Institute of America, 326 Broadway, New York, N.Y. For mail: 55 Hanson Pl., Brooklyn, N.Y.
- BRITO, ALBERTO R. (M'19)**, Correo De La Armada, Valparaiso, Chile, South America.
- BRITTON, FRANK L. (A'27-M'28)**, Radio Editor, "Popular Mechanics," 200 E. Ontario St., Chicago, Ill.
- BROCKMAN, FRANCIS C. (A'15)**, Radio Engineer, General Electric Company, Schenectady, N.Y. For mail: 81 Robinson St., Schenectady, N.Y.
- BROKAW, CHARLES A. (A'23)**, Radio Engineer, General Electric Company, Radio Engineering Dept., Schenectady, N.Y.
- BROKAW, HAL R. (A'26)**, Palace Drug Company, 405 Alvarado St., Monterey, Calif.
- BROLLY, A. H. (A'27)**, 274-17th Ave., San Francisco, Calif.
- BROMLEY, JOHN E., JR. (A'27)**, 818 E. Rittenhouse St., Germantown, Pa.
- BRONSON, G. E. (A'27)**, Division Engineer, City of Chicago, 207 City Hall, Chicago, Ill.
- BROOK, ALF (A'29)**, Draftsman, Radio Engineering Department, Westinghouse Electric and Manufacturing Company, Pittsburgh, Pa. For mail: Maple St., Irwin, Pa.
- BROOKE, ROBERT O. (J'29)**, Radio Construction Engineer, Radio Station WRHM, Andrews Hotel, Minneapolis, Minn. For mail: 3848 Harriet Ave., S., Minneapolis, Minn.
- BROOKER, VIVIAN M. (A'27)**, Engineer, Amalgamated Wireless, Ltd., Queen St., Melbourne, Victoria, Australia.
- BROOKS, KENNETH E. (A'28)**, Assistant Service Manager, Sparks Withington Company, Jackson, Mich.
- BROPHY, FRANCIS JOSEPH, JR. (A'29)**, Radio Operator, Wm. F. Gable Company, Radio Station WFBG, Altoona, Pa. For mail: Carrolltown, Pa.
- BROSE, FRED O. (A'29)**, Pirras Research Laboratory, 323 Garfield Ave., American Falls, Idaho.
- BROTHERS, JAMES T. (A'29)**, Engineer, Pilot Electric Manufacturing Company, 323 Berry St., Brooklyn, N.Y. For mail: 8640-110th St., Richmond Hill, L.I., N.Y.
- BROWER, WILLIAM M. (M'28)**, Engineer, Federal Telegraph Company, Palo Alto, Calif.
- BROWN, ALVIN H. (A'29)**, Branch Store Clerk, Toronto Radio Company, 2114 Danforth Ave., Toronto 13, Canada. For mail: 588 Bathurst St., Toronto 4, Ont., Canada.
- BROWN, ARCHIBALD S. (A'14)**, Radio Engineer, Federal Telegraph Company, Palo Alto, Calif. For mail: 703 Kingsley St., Palo Alto, Calif.
- BROWN, CHARLES J. (A'25)**, New York Representative, Samson Electric Company, 369 Lexington Ave., New York, N.Y.
- BROWN, D. S. (A'15)**, 50 Church St., Rm. 2055, New York, N.Y.
- BROWN, EDWIN C. (A'26)**, Peckham, Okla.
- BROWN, ELMER L. (A'26)**, Engineering Dept., Radio Corporation of America, 6th Floor, Victor Bldg. 2, Camden, N.J. For mail: 4504 Camden Ave., Camden, N.J.
- BROWN, GEORGE W. (A'28)**, Manager, Radio Service Dept., 1253 Boylston St., Boston, Mass. For mail: 38 Bay State Rd., Atlantic, Mass.
- BROWN, GORDON P. (A'26)**, Radio Repairman, Hickson Electric Company, 30 South Ave., Rochester, N.Y. For mail: 192 S. Goodman St., Rochester, N.Y.
- BROWN, HARRY S. (A'17)**, Toronto Hydro Electric System, Toronto, Ont., Canada. For mail: 185 Craighurst Ave., Toronto, 12, Ont., Canada.
- BROWN, HENRY J. (A'26)**, Division Superintendent of Service, Electrical Research Products, Inc., Fidelity Philadelphia Bldg., Philadelphia, Pa. For mail: 519 Pine Rd., Bywood, Del. Co., Pa.
- BROWN, HOWARD A. (A'26)**, Laboratory Engineer, Rochester Gas and Electric Corporation, 89 East Ave., Rochester, N.Y. For mail: 83 Adams St., Rochester, N.Y.
- BROWN, HOWELL C. (A'26)**, 120 N. E. Molino Ave., Pasadena, Calif.
- BROWN, HUGH A. (A'16-M'29)**, Professor of Electrical Engineering, University of Illinois, Urbana, Ill.
- BROWN, H. WILBUR (A'25)**, 422 Walnut St., Philadelphia, Pa.
- BROWN, JAMES F. (A'26)**, Engineering Dept., Heintz and Kaufman, 219 Natoma St., San Francisco, Calif. For mail: 287 Perkins St., Oakland, Calif.
- BROWN, JESSE E. (A'24-M'28)**, Assistant U. S. Supervisor of Radio, Radio Division, U. S. Department of Commerce, 2409 David Stott Bldg., Detroit, Mich.
- BROWN, J. KENNETH (A'26)**, Radio Engineer, 6511 Romaine St., Hollywood, Calif.
- BROWN, KENNETH L. (A'24)**, Radio Operator, Detroit Edison Company, Port Huron, Mich. For mail: P.O. Box 418, Port Huron, Mich.
- BROWN, ORLAN R. (A'27)**, 2454 Whiteley Ave., Niagara Falls, N.Y.
- BROWN, RALPH M. (A'25)**, Chief Engineer, Brown Radio Manufacturing Company, 777 Wyoming Ave., Kingston, Pa. For mail: S. Vaughn St., Kingston, Pa.
- BROWN, STANLEY W. (A'27)**, Consulting Radio Engineer, Ajax Radio Company, 15 Goodrich St., Buffalo, N.Y. For mail: Locust St., Buffalo, N.Y.

- BROWN, WALTER J. (M'25)**, Research Dept., The Gramophone Co., Ltd., Hayes, Middlesex, England. For mail: Danesmoor, Harefield Rd., Uxbridge, Middlesex, England.
- BROWN, WILFRED E. (A'29)**, Student, Purdue University, 330 N. Grant St., West Lafayette, Ind. For mail: Westfield, Indiana.
- BROWN, WILLIAM A. R. (A'25)**, Development Engineer, National Broadcasting Company, 711-5th Ave., New York, N.Y.
- BROWN, WILLIAM G. (A'28)**, Radio Editor, "Cheltenham Chronicle," Cheltenham, England. For mail: 52 Winstonian Rd., Cheltenham, England.
- BROWN, WILLIAM L. (A'25)**, District Manager, Industrial Works, Bay City, Mich. For mail: 6636 N. 10th St., Philadelphia, Pa.
- BROWN, WILLIAM W. (M'18)**, Assistant Engineer in Charge, Radio Engineering Dept., General Electric Company, Schenectady, N.Y. For mail: 119 Fairview Ave., Schenectady, N.Y.
- BROWNE, L. N. (A'25)**, Radio Technician, Brunswick-Balke-Collender Company, 623 S. Wabash Ave., Chicago, Ill.
- BROWNE, MERTON S. (A'28)**, Certified Radiotician, 443-3rd St., Toledo, Ohio.
- BROWNE, MONTE C. (A'29)**, Serviceman, M. Steinert and Son, 35 Arch St., Boston, Mass. For mail: 200 Huntington Ave., Boston, Mass.
- BROWNE, THEODORE C. (M'27)**, The Sparks Withington Company, Jackson, Mich. For mail: 6 Coolidge Hill Rd., Cambridge, Mass.
- BROWNE, WALRAM S. (A'14)**, Manufacturers Paper Company, 30 E. 42nd St., New York, N.Y. For mail: 1565 E. 12th St., Brooklyn, N.Y.
- BROWNING, GLENN H. (A'24-M'28)**, President, Browning-Drake Corporation, 110 Brookline St., Cambridge, Mass. For mail: Appalachian Rd., Winchester, Mass.
- BROWNING, ROY H. (A'26)**, President, Radio Engineering Company, 5735 Bartmer Ave., St. Louis, Mo. For mail: 5564 Bartmer Ave., St. Louis, Mo.
- BRUCE, EDMOND (A'26-M'29)**, Research Engineer, Bell Telephone Laboratories, Inc., Box 31, Cliffwood, N.J. For mail: 27 Buena Pl., Red Bank, N.J.
- BRUGGEMAN, JOHN T. (J'28)**, College Student, Polytechnic Institute of Brooklyn, Brooklyn, N.Y. For mail: 1297 Lexington Ave., New York, N.Y.
- BRUNET, MEADE (M'26)**, Manager, Radio Division, Radio Corporation of America, 233 Broadway, New York, N.Y.
- BRUNETTE, DEO Z. (A'29)**, Alternator Attendant, Radio Corporation of America, Marion, Mass.
- BRSCHI, LEWIS JOHN (A'29)**, Radio Merchant, 26 Market St., Bangor, Pa. For mail: 28 Market St., Bangor, Pa.
- BRYAN, HERMAN W. (A'27)**, Lumber Broker, Browne, Lockridge and Bryan, 2030 Grand Central Terminal, New York, N.Y. For mail: 402 Ocean Ave., Brooklyn, N.Y.
- BRYAN, WILLIAM J. (A'29)**, Radio Operator, Radio Station KFDM, Magnolia Petroleum Company, Beaumont, Tex.
- BUCHANAN, ARTHUR B. (A'26)**, Electrical Engineer, Detroit Edison Company, 2000-2nd Ave., Detroit, Mich.
- BUCHANAN, J. C. (A'27)**, 1st Captain (Infantry) and Radio Operator, War Dept., and Del Buen Tona S.A. (Buen Tona No. 12) Mexico, D.F. For mail: Calle del Buen Tono No. 12, Mexico, D.F., Mexico.
- BUCHER, E. E. (M'13-F'29)**, Executive Vice-President, R.C.A. Photophone, Inc., 411-5th Ave., New York, N.Y.
- BUCKINGHAM, WILLIAM D. (A'29)**, Engineering Assistant, Western Union Telegraph Company, Watermill, L.I., N.Y. For mail: P.O. Box 269, Southampton, L.I., N.Y.
- BUCKLER, JOHN J. (A'29)**, Manager, Radio Service, Gimbel Brothers, 120 W. 32nd St., New York, N.Y. For mail: 502 W. 152nd St., New York, N.Y.
- BUCKLEY, BEYTON E. (A'25)**, Independent Research, 108 Park Terrace E., New York, N.Y.
- BUDDEN, FRANK W. (A'28)**, Engineer, Pacific Telephone and Telegraph Company, 904 Telephone Bldg., Seattle, Wash.
- BUECHE, HARRY S. (A'26)**, Assistant Professor, Kansas State College, Manhattan, Kan. For mail: 1119 Kearney St., Manhattan, Kan.
- BUEHL, LOUIS H. (J'19-A'22)**, Telephone Engineer, Bell Telephone Laboratories, Inc., 416-7th Ave., 19th Floor, Pittsburgh, Pa.
- BUERGER, CHARLES B. (A'28)**, General Manager, Gulf Refining Company, P.O. Box 1214, Pittsburgh, Pa.
- BUFFINGER, W. G. (A'28)**, Instructor in Radio Theory, Radio College of California, 921 W. 6th St., Los Angeles, Calif. For mail: 1444 S. Norton Ave., Los Angeles, Calif.
- BULGIN, ARTHUR F. (A'23-M'26)**, Radio Engineer, A. F. Bulgin and Company, 9-11 Curistor St., Chancery Lane, London, E.C. 4, England.
- BULL, W. J. H. (A'25)**, c/o Lloyds Bank, Ltd., Hornby Rd., Bombay, India.
- BULLARD, WILLIAM R. (A'22)**, Assistant Electrical Engineer, Electric Bond and Share Company, 2 Rector St., New York, N.Y.
- BULLOCK, GILBERT D. (A'15)**, Electrician, Pedro Miquel Locks, Box 56, Pedro Miquel, Canal Zone.
- BULLOCK, WALTER H. (A'19)**, Secretary A. C. Neon Corporation, 122 Greenwich St., New York, N.Y. For mail: 93 Remsen St., Brooklyn, N.Y.
- BUMBAUGH, HAROLD L. (A'17)**, Vitaphone Engineer, Warner Brothers Studios, Hollywood, Calif. For mail: 215 S. New Hampshire Ave., Los Angeles, Calif.
- BURCHARD, JOHN C. (A'25-M'28)**, Sales Department, Radio Corporation of America, 100 Monroe St., Chicago, Ill.
- BURDETT, SAM (A'22)**, 8056 Blackstone Ave., Chicago, Ill.
- BURDICK, ADELBERT B. (A'27)**, Chief Code Instructor, Radio Institute of America, 326 Broadway, New York, N.Y. For mail: 729-56th St., Brooklyn, N.Y.

- BURGER, CLARENCE WALTER** (A'29), Superintendent of Factory, National Electric Supply Company, 1330 New York Ave., N.W., Washington, D.C.
- BURGESS, EDWARD R.** (A'27), 301 S. 11th St., Philadelphia, Pa.
- BURGESS, WARREN B.** (A'20), U. S. Navy, Naval Research Laboratory, Bellevue, Anacostia, D.C. For mail: 2900-26th St., N.E., Washington, D.C.
- BURGHARD, G. E.** (A'18-M'26), Merchant, Continental Radio Corporation, 160 Varick St., New York, N.Y.
- BURGOYNE, ROGER M.** (A'27), Physician, 407 Main St., Winchester, Mass.
- BURKE, CHARLES T.** (A'25-M'27), Engineer, General Radio Company, 30 State St., Cambridge, Mass.
- BURKE, DAVID J., JR.** (A'29), Assistant Radio Inspector, U. S. Navy, Radio Test Shop, Navy Yard, Washington, D.C. For mail: 2207 Franklin St., N.E., Washington, D.C.
- BURKE, JAMES W.** (A'29), Clerk, U. S. Navy Dept., Rm. 3024, Navy Bldg., Washington, D.C. For mail: 4637 Brewer Pl., N.W., Washington, D.C.
- BURKWEST, LEONARD G.** (A'28), General Manager, X-L Radio Laboratories, 1224 Belmont Ave., Chicago, Ill.
- BURKHARDT, KARL R.** (A'29), Transmission Engineer, American Telephone and Telegraph Company, 750 Huron Rd., Cleveland, Ohio. For mail: 7514 Renwood Dr., Parma, Ohio.
- BURLEIGH, JOHN A.** (A'27), Telephone Engineer, Pacific Telephone and Telegraph Company, 903 Telephone Bldg., Seattle, Wash. For mail: 2049 E. Newton St., Seattle, Wash.
- BURLEIN, LESTER F.** (A'29), Radio Technician, Service Dept., F. A. Jenkins Music House, Main St., Honesdale, Pa. For mail: 818 Court St., Honesdale, Pa.
- BURNETT, WILLIAM L.** (A'27), Radio Electrician, U. S. Naval Radio Station, Chollas Heights, San Diego, Calif. For mail: 4814 Idaho St., San Diego, Calif.
- BURNHAM, WALTER W.** (M'21-F'23), Manager, Radio Section, Edison and Swan Company, Ltd., 123 Queen Victoria St., London, England. For mail: Beechwood, Oaklands Rd., Bromley, Kent, England.
- BURNS, ELMER E.** (A'28), Physics Teacher, Austin High School, Chicago, Ill. For mail: 3515 Home Ave., Berwyn, Ill.
- BURNS, GEORGE D.** (A'28), Assistant Secretary, Daniel M. Hicks, Inc., 200-5th Ave., New York, N.Y. For mail: 8906 Colonial Rd., Brooklyn, N.Y.
- BURNS, G. AUSTIN** (A'20), Engineer, Sound Dept., Metro-Goldwyn-Mayer Studios, Culver City, Calif. For mail: 1320½ N. Formosa Ave., Hollywood, Calif.
- BURNS, LAURENCE** (A'27), Assistant in Physics, Massachusetts Institute of Technology, Cambridge, Mass. For mail: 65 Revere St., Revere, Mass.
- BURNS, ROBERT P.** (A'28), Vitaphone Engineer, Marks Brothers, Granada Theatre, Chicago, Ill. For mail: 3034 Leland Ave., Chicago, Ill.
- BURNSIDE, CAROL J.** (A'27), Radio Engineer, Westinghouse Electric and Manufacturing Company, Chicopee Falls, Mass. For mail: 120 Byers St., Springfield, Mass.
- BURNSIDE, DON G.** (A'13), Engineer, Atwater Kent Manufacturing Company, Philadelphia, Pa. For mail: 5135 Pulaski Ave., Germantown, Pa.
- BURRILL, CHARLES M.** (A'24), Receiver Development, RCA-Victor Company, Inc., Bldg. 5, Camden, N.J. For mail: 306 White Horse Pike, Haddon Heights, N.J.
- BURROUGHS, IRVING D.** (A'28), Partner and Manager, Radio Sales and Service, 215 E. Nottingham Way, Hamilton Sq., N.J. For mail: 818 President Ave., R.F.D. 36, Trenton, N.J.
- BURROWES, FRANCIS E.** (A'20), Engineer, Marconi's Wireless Telegraph Co., Ltd., Marconi House, Strand, London, W.C. 2, England.
- BURROWS, CHARLES R.** (A'24), Radio Research Engineer, Bell Telephone Laboratories, Inc., 463 West St., New York, N.Y. For mail: P.O. Box 68, West Long Branch, N.J.
- BURT, ANDREW G.** (A'26), 1033 W. Van Buren St., Chicago, Ill. For mail: 2529 Ashland Ave., Evanston, Ill.
- BUSCH, GUS A.** (A'26), Service Manager, Cowperthwait and Sons, 2222-3rd Ave., New York, N.Y. For mail: 2240 Tiebout Ave., New York, N.Y.
- BUSH, GEORGE P.** (M'25), Captain, U. S. Army, Signal Corps. For mail: R.R. 10, Box 64, Bethesda, Md.
- BUSH, WALTER S.** (A'29), 3330 Abner Pl., St. Louis, Mo.
- BUSSARD, E. J. H.** (A'24), Laboratory Assistant, Crosley Radio Corporation, 3401 Colerain Ave., Cincinnati, Ohio. For mail: 2701 Stratford Ave., Cincinnati, Ohio.
- BUSSEY, H. E.** (A'28), District Engineer, General Electric Company, P.O. Box 1698, Atlanta, Ga.
- BUTLER, E. W.** (M'29), Sales Engineer, E. T. Cunningham, Inc., 370-7th Ave., New York, N.Y.
- BUTLER, HARRY F.** (A'27), Superintendent, Pennsylvania Electric Light and Power Company, 129 N. 1st Ave., Lehighton, Pa. For mail: 129 Lentz Ave., Lehighton, Pa.
- BUTLER, H. R.** (A'23), Radio Engineer, Wired Radio, Inc., 4th Ave. and 13th St., Newark, N.J. For mail: 278 Rutledge Ave., East Orange, N.J.
- BUTLER, RICHARD A.** (A'28), Repairman, 3205 Unruh Ave., Philadelphia, Pa.
- BUTLER, RAYMOND H.** (A'26), Radio Service Dept., Rudolph Wurlitzer, 329 S. Wabash Ave., Chicago, Ill. For mail: 3411 Parnell Ave., Chicago, Ill.
- BUTLER, ROY** (A'27), Great Lakes Representative, Federal Telegraph Company, 392 E. 147th St., Cleveland, Ohio.
- BUTLER, WILSON M.** (J'28-A'29), 201 N. Front St., Milton, Pa.
- BUTMAN, CARL H.** (A'28-M'29), Secretary, Federal Radio Commission, Interior Bldg., Washington, D.C.

- PUTTERFIELD, CHARLES E.** (A'26-M'29), Radio Editor, The Associated Press, 383 Madison Ave., New York, N.Y.
- BUTTERFIELD, ROY O., JR.** (A'26), Service Manager, SLS Auto and Radio Company, 7044 N. Clark St., Chicago, Ill. For mail: 7205 N. Damen Ave., Rogers Park, Chicago, Ill.
- BUTTNER, HAROLD H.** (M'27), Assistant Vice-President, International Telephones and Telegraph Company, 67 Broad St., New York, N.Y.
- BUZZARD, A. J.** (J'23-A'26), Manager Radio and Music Depts., Spear and Company, 911-1 Penn Ave., Pittsburgh, Pa.
- BYERLAY, H. LE ROY** (A'28), Toll Transmission, Michigan Bell Telephone Company, 118 Clifford St., Detroit, Mich. For mail: 3026 Lothrop Ave., Detroit, Mich.
- BYERS, HARRISON O.** (A'25), Radio Interference Engineer, Kansas Gas and Electric Company, 3rd and Kelly Sts., Wichita, Kan. For mail: 333 Laura Ave., Wichita, Kan.
- BYERS, RUSSELL R.** (A'28), Service Manager, Vonnegut Hardware Company, Indianapolis, Ind. For mail: 1036 Eugene St., Indianapolis, Ind.
- BYRAM, F. CAMERON** (A'29), Student in Electrical Engineering, University of Michigan, Ann Arbor, Mich. For mail: 14061 Strathmoor Ave., Detroit, Mich.
- BYRNES, IRVING F.** (A'23), Electrical Engineer, General Electric Company, Radio Engineering Dept., Schenectady, N.Y. For mail: 1361 Nott St., Schenectady, N.Y.
- BYRNES, WALTER C.** (A'27), Technician, Lyon and Healy, Chicago, Ill. For mail: 4734 Ingleside Ave., Chicago, Ill.
- C**
- CABOT, GEORGE E.** (A'16), Cabot, Cabot and Forbes, Boston, Mass. For mail: 169 Marlborough St., Boston, Mass.
- CABOT, SEWELL** (M'14), Electrical Engineer, Electric Conversion Company, Boston, Mass. For mail: 100 Tappan St., Brookline, Mass.
- CADMAN, CLAUDE G.** (M'28), Engineer-in-Chief, Posts and Telegraphs, G. P. O. Kuala Lumpur, Federated Malay States.
- CADY, WALTER G.** (A'14-F'27), Professor of Physics, Scott Laboratory, Wesleyan University, Middletown, Conn.
- CAHILL, JAMES A.** (A'29), Salesman, Youngstown Sheet and Tube Company, 2009 Franklin Trust Bldg., 15th and Chestnut Sts., Philadelphia, Pa. For mail: 202 Heather Rd., Upper Darby, Pa.
- CAHILL, WILLIAM J.** (A'29), Research Engineer, Research Dept., International Communications Laboratory, 67 Broad St., New York, N.Y.
- CAIN, ROBERT E.** (A'27), Engineering Dept., RCA Photophone, Inc., 411-5th Ave., New York, N.Y.
- CALDWELL, LOUIS G.** (M'29), Member of Law Firm, Kirkland, Fleming, Green and Martin, 33 N. La Salle St., Chicago, Ill.
- CALDWELL, O. H.** (M'28), Editor, "Radio Retailing and Electrical Merchandising," McGraw Hill Publishing Company, 10th Ave. and 36th St., New York, N.Y.
- CALKINS, WILLIAM G.** (A'27), Radio Engineer, 8520 Carnegie Ave., Cleveland, Ohio.
- CALLAHAN, JOHN L.** (A'21), Radio Corporation of America, New York, N.Y. For mail: 2011 Newkirk Ave., Brooklyn, N.Y.
- CALLAHAN, THOMAS G.** (A'28), Assistant Radio Engineer, Station WBT, 500 W. Trade St., Charlotte, N.C.
- CALLENDER, EDWIN R.** (A'27), Engineer, New York, Ontario, and Western Railroad, Middletown, N.Y. For mail: 374½ North St., Middletown, N.Y.
- CALLIGHERIS, JOHN S.** (A'22), Electrical and Radio Engineer, The J. S. Calligheris Engineering Company, 1050 Coney Island Ave., Brooklyn, N.Y.
- CALVER, FRANK N.** (M'29), Engineer-in-Charge, British Broadcasting Corporation, Borough Hill, Daventry, England.
- CAMERON, HENRY L., JR.** (A'28), Radio Sales and Service, 448 Broadway, Decatur, Ill.
- CAMP, V. F.** (A'13), Brightwaters, L.I., N.Y.
- CAMPBELL, CHARLES H.** (A'23), Radio Engineer, National Broadcasting Company, Inc., 711-5th Ave., New York, N.Y. For mail: 66 Vine St., Bridgeport, Conn.
- CAMPBELL, DONALD O.** (A'27), Service Engineer, RCA-Victor Company, Inc., 1505 Santa Fe Bldg., Dallas, Tex.
- CAMPBELL, GEORGE R.** (A'29), R.F.D. No. 6, Ann Arbor, Mich.
- CAMPBELL, HAROLD G.** (A'26), Manager of Radio Dept., Weir and Savage E. S. Company, 76 Pearl St., Boston, Mass. For mail: 179 Harvard St., Brookline, Mass.
- CAMPBELL, HENRY LAWSON** (A'29), Assistant Manager, Loblaw Grocery Company, Ltd., 1709 St. Clair Ave., W., Toronto, Ont., Canada. For mail: 64 Hayden St., Toronto, Ont., Canada.
- CAMPBELL, HOWARD E.** (A'14-M'14), Director of Recording, Pathé Cinema, 6 Rue Francourt, Paris, France.
- CAMPBELL, JOHN A.** (A'27), Managing Editor, "Metropolitan Electrical News," 461-8th Ave., New York, N.Y.
- CAMPBELL, ROBERT H.** (A'25), Manager, Sales Dept., Lyon and Healy, Chicago, Ill. For mail: 6942 Jeffrey Ave., Chicago, Ill.
- CAMPBELL, WILLIAM N.** (A'28), 1731 E. 69th St., Los Angeles, Calif.
- CAMPBELL, WINIFERD H.** (A'27), Test Engineer, Amrad Corporation, Medford Hills, Mass. For mail: 6 Crawford St., Cambridge, Mass.
- CANADY, DONALD RAY** (A'16), Vice-President and Chief Engineer, Film Sound Corporation, 1825 E. 18th St., Cleveland, Ohio. For mail: 19570 S. Sagamore, Fairview Village, Cleveland, Ohio.
- CANAVACIOL, FRANK E.** (A'25-M'29), Assistant Professor, Polytechnic Institute of Brooklyn, 99 Livingston St., Brooklyn, N.Y. For mail: 326 Leonard St., Brooklyn, N.Y.

- CANFIELD, IRA A. (A'22), Manager, Radio Dept., Chardon Electric and Accessory Company, Chardon, Ohio.
- CANFIELD, N. A. (A'25), Assistant Engineer-in-Charge, R.C.A. Communications, Inc., Marion, Mass.
- CANFIELD, WILSON R. (A'29), Service Manager, Apollo Radio Company, 229 Halsey St., Newark, N.J. For mail: 820 Mt. Prospect Ave., Newark, N.J.
- CANN, JOHN O. G. (M'16-F'21), Chief Engineer, DeForest Phonofilm of Canada, Ltd., Albee Bldg., 12 Mayor St., Montreal, Canada. For mail: 2 Amesbury Ave., Montreal, P.Q., Canada.
- CANNER, WILLIAM (J'27-A'29), Service Manager, Commonwealth Radio Service, 1150 Commonwealth Ave., Boston, Mass. For mail: 343 S. Huntington Ave., Jamaica Plain, Mass.
- CANON, HARTMAN B. (J'26), Radio Engineer, Universal Battery Company, 3410 S. LaSalle St., Chicago, Ill. For mail: 1020 Wellington Ave., Chicago, Ill.
- CAPOALE, PETER (A'28), Graduate Student, University of Pennsylvania, Philadelphia, Pa. For mail: 1603 Ellsworth St., Philadelphia, Pa.
- CAPRON, E. S. (A'29), Tester, Consolidated Radio Company, Ann Arbor, Mich. For mail: Oxford, Mich.
- CAPUTO, NICHOLS J. (A'27), Transmission Engineer, New York Telephone Company, 360 Bridge St., Brooklyn, N.Y. For mail: 184-03-90th Ave., Hollis, L.I., N.Y.
- CARAZO, LOUIS A. (A'29), Radio Service, Messrs. Piza e Hijos, Piza, Costa Rica. For mail: P.O. Box 300, San Jose, Costa Rica.
- CARBONI, ANTHONY (A'27), Radioman, U. S. S. "Salt Lake City," c/o Postmaster, New York, N.Y.
- CARDNER, WILLIAM (A'28), Salesman, Klein's Radio, 30 Park Pl., New York, N.Y. For mail: 1065 Carroll Pl., New York, N.Y.
- CARDWELL, ALLEN D. (A'14), President, The Allen D. Cardwell Manufacturing Corporation, 81 Prospect St., Brooklyn, N.Y. For mail: 443 Lakeview Ave., Rockville Centre, L.I., N.Y.
- CARINI, LOUIS (J'28), Louis Carini Radio Laboratories, 246 Wolcott Hill Rd., Wethersfield, Conn.
- CARLE, NATHANIEL A. (A'22), Engineer, 392 Ridge St., Newark, N.J.
- CARLETON, THOMAS F. (J'27), Radio Operator, "S. S. Lempira," Pier 26, E. River, New York, N.Y.
- CARLSON, C. O. (J'29), Radio Operator, Radio Service Company, 1022 E-G Winnett St., Savannah, Ga.
- CARLSON, EINAR C. (A'28), Engineer, Sonora, Inc., 1738 Elmwood Ave., Buffalo, N.Y. For mail: 746 Amherst St., Buffalo, N.Y.
- CARLSON, WENDALL L. (A'19), Radio Electrician, Radio Engineering Dept., General Electric Company, 1 River Rd., Schenectady, N.Y.
- CARLTON, RAYMOND A. (J'25-A'26), Engineer, The Victoreen Radio Company, 2825 Chester Ave., Cleveland, Ohio. For mail: 15436 Lakeshore Blvd., Cleveland, Ohio.
- CARLTON, ROGER C. (A'29), Engineer, Bell Telephone Laboratories, Inc., 463 West St., New York, N.Y.
- CARMENT, JAMES M. (A'27), Engineer, Radio Stations WSOA-WORD, People's Pulpit Association, Deerfield, Ill. For mail: P.O. Box 227, Deerfield, Ill.
- CARNEY, PHILIP G. (A'27), Service Engineer, Faribault, Minn.
- CARNIE, BEN (A'28), 1st Wireless Operator, British Wireless Marine Service, 22 Chapel St., Liverpool, England. For mail: 105 Douglas St., Glasgow, Scotland.
- CAROTHERS, R. F. (A'29), Service Dept., National Carbon Company, 3642 Jasper Pl., Chicago, Ill. For mail: 6533 Woodlawn Ave., Chicago, Ill.
- CAROTHERS, WILLIAM D. MC L. (A'26), Engineer, Union Switch and Signal Company, Swissvale, Pa. For mail: 507 South Ave., Wilkinsburg, Pa.
- CARPENTER, ARCHIE V. (A'28), Rewey, Wis.
- CARPENTER, GLENN W. (A'18), 1435 Nott St., Schenectady, N.Y.
- CARPENTER, HUGH (A'29), Operator, Radio Station KVOO, Southwestern Sales Corporation, Tulsa, Okla. For mail: 2628 E. 6th St., Tulsa, Okla.
- CARPENTER, RALPH H. (A'29), Chief Operator, Radio Station WBCM, Bay City, Mich.
- CARPENTER, RUPERT E. H. (M'23), Research Engineer, R. M. Radio, Ltd., 21 Garrick St., London, W.C. 2, England. For mail: 21 Smithbottom Lane, Purley, Surrey, England.
- CARR, EDWARD MAYES (A'29), Tabulator, American Rolling Mill Company, 11th St. and Greenup Ave., Ashland, Ky.
- CARR, JOHN (A'29), 40 Marsolais Ave., Outremont, Montreal, P.Q. Canada.
- CARR, J. O. (A'22), Manager Sales Engineering Dept., Morkrum Company, 1410 Wrightwood Ave., Chicago, Ill. For mail: 901 S. Crescent Ave., Park Ridge, Ill.
- CARRANZA, JOSE J. (M'22), President-Manager, International Radio Company, Costa Rica, Central America. For mail: Apt. 54, San Jose, Costa Rica, Central America.
- CARROLL, JAMES H. (A'26), Laboratory Consultant, "Radio World," 145 W. 45th St., New York City. For mail: 937 Park Pl., Brooklyn, N.Y.
- CARROLL, MICHAEL J. (A'29), Laboratory Technician, E. T. Cunningham, Inc., 370-7th Ave., New York, N.Y.
- CARROLL, THOMAS D. (A'29), Radio Engineer, Radio Test Shop, Navy Yard, Washington, D.C. For mail: 3131 Newton St., N.E., Washington, D.C.
- CARSON, ANDREW H. (A'25), Engineer, Posts and Telegraphs Depts., Kuala Lumpur, F.M.S.
- CARSON, JOHN M. (A'26), Joint-Manager, Radio Maritime, Ltd., Broadway Chambers, Hammersmith, London, W. 6, England. For mail: Elan Valley Hotel, Rhayader Radnor, Wales, G.B.

- CARSON, JOHN R. (M'16), Telephone Research Engineer, American Telephone and Telegraph Company, 195 Broadway, New York, N.Y.
- CARSON, JOSEPH (J'28-A'29), Shift Engineer, R.C.A. Communications, Marion, Mass.
- CARSON, WALTER E. (A'29), Radio Specialist, 4217 McClellan Ave., Detroit, Mich.
- CARTER, A. J. (M'26), President, Carter Radio Company, 300 S. Racine Ave., Chicago, Ill.
- CARTER, E. FINLEY (A'23), Radio Engineer, United Research Corporation, 40-41 Harold Ave., Long Island City, L.I., N.Y. For mail: 158-15 Laburnum Ave., Flushing, L.I., N.Y.
- CARTER, EVERETT D. (A'28), Professional Set Builder, 944-10th St., Hermosa Beach, Calif.
- CARTER, F. C. (A'27), Radio Engineer, Radio Section, P.O. Research Station, Dollis Hill, London N.W. 2, England.
- CARTER, FRANK L. (A'26), Service Manager, L. Bauman and Company, 500-8th Ave., New York, N.Y. For mail: 9 W. Cook St., Bay Park, East Rockaway, L.I., N.Y.
- CARTER, PHILIP S. (A'29), Engineer, Design Section, Radio Corporation of America, Rocky Point, L.I., N.Y. For mail: 238 E. Broadway, Port Jefferson, L.I., N.Y.
- CARTER, WILLIAM H., JR. (A'29), Radio Service Dept., J. W. Carter Music Company, 1620 Main St., Houston, Tex.
- CARVER, ORIN H. (A'28), Manager, Sound Radio Service and Supply Company, 714-4th Ave., Seattle, Wash. For mail: 1115-36th St., Seattle, Wash.
- CASE, MYRON D. (A'29), Receiving Engineer, Radio Corporation of America, Marshall, Calif.
- CASE, NELSON P. (A'26), Research Investigator, Department of Physics, University of Michigan, Ann Arbor, Mich.
- CASEY, K. K. V. (A'26), Director of Sales, Rm. 5058, du Pont Bldg., Wilmington, Del.
- CASH, GEORGE B. (A'29), Radio Dept., Arcade Hardware Company, 5170 Grand River Ave., Detroit, Mich. For mail: 5711 Wabash Ave., Detroit, Mich.
- CASH, J. ALLAN (A'29), Movietone and Vitaphone Engineer, 637 Craig St., W., Montreal, P.Q., Canada.
- CASPER, CHRISTOPHER C. (A'21), Marconi House, Strand, London, W.C. 2, England.
- CASS, LEWIS S. (A'29), Chief Operator, Transmitter Dept., Station WABC, Crossbay Blvd., L.I., N.Y. For mail: 2040-7th Ave., Apt. 12, New York, N.Y.
- CASSADY, P. H. (A'25), Assistant Superintendent, Walter T. Bradley Company, Hershey, Pa. For mail: Swatara, Pa.
- CASSEDY, WILLIAM F. (A'26), Superintendent and Engineer, Foote Pictson and Company, Inc., 160 Duane St., New York, N.Y. For mail: Farley Rd., Milburn, N.J.
- CASELL, JOSEPH L. (A'29), Radio Engineer, Wired Radio, Inc., Ampere, N.J.
- CASSENS, FRED BENJAMIN (A'29), Service Manager, Lindenman-Hoffer Company, 2914 Washington Ave., St. Louis, Mo. For mail: c/o Mrs. L. Jorgensen, 701a Garfield Ave., Chicago, Ill.
- CASTANEDA, SANTIAGO (A'29), Radio Engineer, Telegraph Division, Bureau of Posts, Manila, P.I.
- CASTOR, AMASEA H. (A'25), District Service Manager, Radio Corporation of America, 168-39th St., Brooklyn, N.Y.
- CASWALL, HERBERT (A'14-M'14), Marconi Wireless Telegraph Company, Ltd., Marconi House, Strand, London, England.
- CATON, WILLIAM A. (A'27), Radio Inspector, Canadian Government, Dept. of Marines and Fisheries, Ottawa, Ont., Canada. For mail: P.O. Box 595, Toronto, Ont., Canada.
- CATT, JAMES E. (A'20-M'23), Radio Engineer, Royal Aircraft Establishment, Hampshire, England. For mail: Pretoria, Osborne Rd., South Farnborough, Hampshire, England.
- CATTELL, GILBERT W. (A'25), Radio Engineer, Federal Telegraph Company, Palo Alto, Calif. For mail: 628 Middlefield Rd., Palo Alto, Calif.
- CATTERALL, JOHN (J'28), Radio Serviceman, Chas. F. Wing Company, 790 Purchase St., New Bedford, Mass. For mail: 155 David St., New Bedford, Mass.
- CATTERALL, JOHN B. (A'27), Manager, Radio Dept., The O. F. Deal Hardware Company, 335-7 Tuscarawas St., E., Canton, Ohio. For mail: 523 Case Pl., N.W., Canton, Ohio.
- CATTON, W. R. (A'29), Research Products Dept., Northern Electric Company, Ltd., 65 Rorie St., Winnipeg, Man., Canada.
- CAUSSE, ROGER D. (J'27), Wireless Operator, Radio Corporation of America, 35 S. 3rd St., Philadelphia Pa. For mail: 3rd Ave. and Pontiac St., Lester, Pa.
- CENTER, EDGAR R. (A'26), Radio Service Department, Abbott and Son Hardware Company, 1 W. Main St., Marshalltown, Iowa. For mail: 609 E. Pleasant Ave., Estherville, Iowa.
- CERSTVIK, STEPHEN (A'29), Howson and Howson, 123 S. Broad St., Philadelphia, Pa.
- CESAR, AMAREL (A'28), Avenida Sao Joao, 24, Sao Paulo, Brazil, South America.
- CHADDER, E. G. (A'29), Engineer-in-Charge, The British Broadcasting Corporation, 15 Belmont St., Aberdeen, Scotland. For mail: 71 Braemar Pl., Aberdeen, Scotland.
- CHADWICK, RAY E. (J'29), Repairman, Peerless Radio Shop, 4433 N. Robey St., Chicago, Ill. For mail: 4509 N. Robey St., Chicago, Ill.
- CHAFFEE, E. LEON (M'17-F'21), Professor of Physics, Harvard University, Cruft Laboratory, Cambridge, Mass.
- CHAFFEE, JOSEPH G. (A'26), Engineer, Bell Telephone Laboratories, Inc., 463 West St., New York, N.Y.
- CHAGNON, ADOLPHE, Customs and Excise Examiner for Quebec National Revenue, St. Hyacinthe Distillery Company, Ltd., St. Hyacinthe, P.Q., Canada. For mail: 7 Bournassa St., St. Hyacinthe, P.Q., Canada.

- CHALLENGER, ANSEL** (J'25-A'26), Radio Engineer, The Radio Service Company, 3018 Paseo St., Oklahoma City, Okla. For mail: 530 W. 20th St., Oklahoma City, Okla.
- CHAMBERLAIN, ADOLPH B.** (A'27), Chief Engineer, Radio Stations WGR, WMAK, WKBW, and WKEN, British Broadcasting Corporation, Rand Bldg., Buffalo, N.Y.
- CHAMBERLAIN, NEWTON M.** (A'23), Professor of Physics, South Philadelphia High School for Boys, 32nd and Chestnut Sts., Philadelphia, Pa. For mail: 126 N. Lynn Blvd., Upper Darby, Del Co., Pa.
- CHAMBERLAIN, ROBERT R.** (A'16), Associate Radio Engineer, Munitions Bldg., Signal Corps, Washington, D.C. For mail: 1814 G St., N.W., Washington, D.C.
- CHAMBERS, ALBERT V.** (A'29), Radio Serviceman, Clarence Howard, Cameron, W.Va. For mail: Maple Ave., Cameron, W.Va.
- CHAMBERS, JOSEPH A.** (A'28), Radio Engineer, Crosley Radio Corporation, Cincinnati, Ohio. For mail: 597 Terrace Ave., Cincinnati, Ohio.
- CHAMBERS, WILLIAM B.** (J'28), Counter Salesman, Jos. N. Zamoiski Company, 121 S. 2nd St., Harrisburg, Pa. For mail: 1712 Forster St., Harrisburg, Pa.
- CHANDLER, C. G.** (A'26), Manager, Radio Department, The Chandler Electric Company, Siloam Springs, Ark.
- CHANDLER, CHARLES K.** (A'15), Royal Air Force, South Barnsborough, Hants, England.
- CHANG, TING CHIN** (M'18), Professor of Communication and Dean, Nanyang University, College of Electrical Engineering, Siccawei, Shanghai, China. For mail: 18 Shaio Yu Ly, Siccawei, Shanghai, China.
- CHAPEL, I. C.** (A'29), Service and Installation Instructor, Radio Division, Crescent Paper Company, 211 W. Georgia St., Indianapolis, Ind. For mail: 2136 N. De Quincy St., Indianapolis, Ind.
- CHAPMAN, ALAN B.** (A'29), Service Engineer, Radio Corporation of America, Unit 2, Santa Fe Bldg., Dallas, Tex.
- CHAPMAN, DAVID E.** (J'29), Radioman, Rhodes Burford House Furnishings, 800 W. Pecan St., Carbondale, Ill.
- CHAPMAN, THOMAS J.** (A'25), Marconi International Marine Com. Company, Ltd., Calcutta, India. For mail: 5 Temple Chambers, Calcutta, India.
- CHAPPLE, JAMES M.** (A'29), Assistant Radio Inspector, Radio Division, Dept. of Commerce, 317 New City Hall Bldg., Los Angeles, Calif.
- CHARBONNEAU, ALLAN P.** (J'27-A'29), 229 E. 7th St., Covington, Ky.
- CHARBONNEAU, L. H.** (A'28), Radio Repairs, Design, Building, etc., P.O. Box No. 145, Orange, Calif.
- CHARLAT, ARNOLD** (J'29), Radio Serviceman, Abraham and Strauss, Brooklyn, N.Y. For mail: 1272 E. 10th St., Brooklyn, N.Y.
- CHARTON, PAUL W.** (A'29), Research Engineer, Arcturus Radio Company, 220 Elizabeth Ave., Newark, N.J. For mail: 73 Orange Rd., Montclair, N.J.
- CHASE, LESLIE H.** (J'25-A'27), Radio Engineer, Chicago Talking Machine Company, 111 N. Canal St., Chicago, Ill. For mail: 431 N. Lombard Ave., Oak Park, Ill.
- CHATEAU, ARTHUR** (A'29), Proprietor, Chateau Radio Sales and Service Company, 3111 Louisiana Ave., Pkwy., New Orleans, La.
- CHATLOS, ALBERT** (A'29), Balancer, Silver-Marshall, Inc., 6401 W. 65th St., Chicago, Ill. For mail: 6258 Stewart Ave., Chicago, Ill.
- CHEFTEL, ALEXIS M.** (M'28), Consulting Engineer, 58, rue Michel Ange, Paris, 16e, France.
- CHEN, C. C.** (A'28), Radio Engineer and Director, Chinese Admiralty House, Shanghai, China.
- CHEN, C. MAYO** (A'27), Radio Engineer, Philip China Company, 41 Szechuen, Shanghai, China. For mail: 18 An Check Ln, Scott Rd., Shanghai, China.
- CHEN, SHUJEN** (A'26), Peking Radio Station, Temple of Heaven, Peking, China.
- CHEN, YING-CHIEN** (A'28), Manager, Leconte Company, 10, Recreation Rd., Tientsin, China.
- CHENEY, JOHN W.** (A'26), Radio Technician, 1759 W. 39th St., Los Angeles, Calif.
- CHENIK, AARON** (A'24), Director, P.O. Box 745, Johannesburg, Transvaal, South America.
- CHEJNIKOFF, LEO J.** (A'29), Radio Service, Atlas Stores, Inc., 226 S. Wabash, Chicago, Ill. For mail: 1634 S. Springfield Ave., Chicago, Ill.
- CHERNOW, MORRIS** (A'27), Engineer, Polyphase Radio Laboratories, 170 Clinton St., New York, N.Y. For mail: 11 Essex St., New York, N.Y.
- CHERRY, RICHARD O.** (A'29), Research Physicist, Natural Philosophy Laboratory, University of Melbourne, Melbourne, Australia.
- CHESLEY, ARTHUR D.** (A'29), City Mail Carrier, Post Office, Falls City, Neb. For mail: 1801 Morton St., Falls City, Neb.
- CHESNEY, JOHN J.** (A'29), Western Electric Co., 1601 Glenwood Ave., Philadelphia, Pa. For mail: 893 N. 48th St., Philadelphia, Pa.
- CHESSLER, MAXWELL A.** (A'28), Proprietor, M. T. Bowdoin Radio Service and Manufacturing Laboratory, 3 Eric St., Dorchester, Mass. For mail: 32 Wilder St., Dorchester, Mass.
- CHESTERTON, ARTHUR J.** (M'28), Resident Inspector, The Marconi International Marine Communication Company, Ltd., Marconi House, Strand, London, W.C.2, England. For mail: Silvestre, Charteris Road, Woodford Green, Essex, England.
- CETHAM, HARRY R.** (M'28), Instructor, R.C.A. Institute, 899 Boylston St., Boston, Mass.
- CHIEN, F. C.** (A'28), c/o T. K. Ting, 8 Yue Ming Yuen Rd., Shanghai, China.
- CHIN, TSUNYI** (J'29), Student, c/o Professor K. C. Chang, Nanyang University, Shanghai, China.

- CHINN, HOWARD A.** (A'27), Radio Research Assistant, Massachusetts Institute of Technology, Cambridge, Mass. For mail: P.O. Box 156, South Dartmouth, Mass.
- CHINSKI, GERALD R.** (A'26), Service Manager, W. C. Munn Company, Houston, Tex. For mail: 1919 Harold Ave., Houston, Tex.
- CHITTICK, K. A.** (A'26), Radio Engineer, General Electric Company, Schenectady, N.Y. For mail: 1 Mohawk Ave., Scotia, N.Y.
- CHOAT, WILLIAM F.** (A'25), Radio Salesman, Canadian Westinghouse Company, Ltd., 1920 Metropolitan Bldg., Toronto 2, Ont., Canada.
- CHOPSKY, PETER A.** (J'28), Electrician Helper, General Electric Company, Bridgeport, Conn. For mail: 91 Columbia St., Bridgeport, Conn.
- CHORPENING, GEORGE B.** (A'26), President, Palace Furniture Company of Clarksburg, Clarksburg, W.Va. For mail: P.O. Box 537, Clarksburg, W.Va.
- CHRISTENSEN, BERNARD J.** (A'27), P.O. Box 2688, c/o American Telephone and Telegraph Company, Miami, Fla.
- CHRISTENSEN, JENS P.** (A'16), Sortedams-gadi 1, Copenhagen, Denmark.
- CHRISTY, DONALD P. T.** (A'26), 201 E. Jefferson St., Seitz Bldg., Room 207, Syracuse, N.Y.
- CHROMY, B. J.** (J'25-A'26), Engineer, John B. Brady Co., Washington, D. C. For mail: 909-20th Ave., N.W., Washington, D.C.
- CHU, CHIH TEIH,** (A'29), Professor of Physics, Sun Yatsen University, Canton, China.
- CHU, K. T.** (A'21), No. 8, Shor Gili, Next to South Western Hospital, Outside Shan Wen Men, Shanghai, China.
- CHU, QUONG Y.** (J'28), 522 West 158th St., New York, N.Y.
- CHU, YUN** (J'28), c/o Professor Z. L. Tsoon, Nanyang University, Shanghai, China.
- CHUBB, LEWIS W.** (M'21), Assistant to Vice-President, RCA-Victor Company, Inc., Camden, N.J. For mail: 129 Derwen Rd., Cynwyd, Pa.
- CHUBB, WILLIAM M.** (A'15), Radio Engineer, Signal Corps., U. S. Army, Washington, D.C. For mail: 4210 Jennifer St., N.W., Washington, D.C.
- CHUN, HERBERT H.** (A'26), Sales Engineer, Arcturus Radio Company, 220 Elizabeth Ave., Newark, N.J. For mail: 3857 Cottage Grove Ave., Apt. 43, Chicago, Ill.
- CHURCH, ARTHUR B.** (A'25), Managing Director, Midland Broadcasting Company, Kansas City, Mo. For mail: 1410 W. Walnut St., Independence, Mo.
- CHURCH, VALLETTE S.** (A'27), 178 Oliver Rd., Waban, Mass.
- CHURCHILL, H. B.** (A'29), Proprietor, H. B. Churchill's Radio Shop, 555 Belmont St., Salem, Ore.
- CHUTE, DUDLEY H.** (A'29), Standardizing Laboratory, General Radio Company, 30 State St., Cambridge, Mass. For mail: 16 Cliff Ave., Lexington, Mass.
- CILIN, LOUIS** (A'29), 961 Tiffany St., New York, N.Y.
- CLAPP, JAMES K.** (A'24-M'28), Engineer, General Radio Company, 30 State St., Cambridge, Mass. For mail: 21 Lasell St., Auburndale, Mass.
- CLARK, BAYNARD H.** (A'26), Salesman, The Magnavox Company, 1315 S. Michigan Ave., Chicago, Ill. For mail: 411 West End Ave., New York, N.Y.
- CLARK, CHARLES F.** (A'28), 2215 Spruce St., Philadelphia, Pa.
- CLARK, CHARLES W.** (A'27), Clerk, Bethlehem Steel Company, Lackawanna, N.Y. For mail: Box 41, Maple Ave., Angola, N.Y.
- CLARK, CLARENCE M.** (A'27), District Sales Manager, Silver-Marshall, Inc., 6401 W. 65th St., Chicago, Ill. For mail: 1114 Gladys Ave., Pittsburgh, Pa.
- CLARK, EDGAR J.** (J'29), R.F.D. 4, Gibsonburg, Ohio.
- CLARK, GEORGE W.** (A'25), Receiving Station Engineer, Mackay Radio and Telegraph Company, 80 Merchant St., Honolulu, T.H.
- CLARK, LOUIS E.** (A'27), Glenwood Laboratories, 142 Market Street, Glen Rock, N.J. For mail: 98 Highwood Avenue, Glen Rock, N.J.
- CLARK, PAUL H.** (A'29), Radio Operator, Radio Station KYW, Radio Tower, Edgewater Beach Hotel, Chicago, Ill. For mail: 1925 Granville Ave., Chicago, Ill.
- CLARK, RALPH L.** (A'29), 348 Oakhill Ave., East Lansing, Mich.
- CLARK, ROBERT W.** (A'29), Radio Engineer, Radio Corporation of America, Bolinas, Calif.
- CLARK, R. W.** (A'29), Radio Sales Engineer, Amrad Corporation, Medford Hillside, Mass. For mail: 42 Brookfield Road, Waltham, Mass.
- CLARK, THOMAS E.** (M'13), President, Telclaco, Inc., 1507 Cass Ave., Detroit, Mich.
- CLARKE, ALLEN S.** (A'25), Engineer, Clarke Laboratories, 531 Main St., Danville, Va.
- CLARKE, DOUGLAS F.** (A'29), Beam Wireless Station, Imperial and International Communications, Ltd., Tetney, Grimsby, Lincs, England.
- CLARKE, GEORGE E.** (A'25), Engineering Dept., General Post Office, Cambridge, England. For mail: 14 Vinery Rd., Cambridge, England.
- CLARKE, GEORGE R.** (A'20), District Sales Manager, Sterling Manufacturing Company, Cleveland, Ohio. For mail: 5551 Vancouver Ave., Detroit, Mich.
- CLARKE, MAURICE H.** (A'26), Radio Operator, Station WIEC, Hickson Electric Company, 36 South Ave., Rochester, N.Y. For mail: Ridge Road, Greece, N.Y., Dewey Ave., P.O., Rochester, N.Y.
- CLARKE, RALPH S.** (A'21), Henrici Laundry Machinery Company, Mattapan, Mass. For mail: 27 Milton Ave., Dorchester, Mass.
- CLARKE, R. E.** (A'29), Assistant Sales Manager, Thordarson Electric Manufacturing Company, 500 W. Huron Street, Chicago, Ill. For mail: 936 Hinman Ave., Evanston, Ill.

- CLARKE, VARRO J.** (A'29), Radio Engineer, General Electric Company, 1 River Road, Schenectady, N.Y. For mail: 52 Washington Road, Scotia, N.Y.
- CLARKSON, CHARLES N.** (A'22), c/o Pacific Gas and Electric Company, Stockton, Calif.
- CLARRY, HAROLD E.** (A'27), Radio Engineer, Westinghouse Lamp Company, Bloomfield, N.J. For mail: 177 Dodd St., East Orange, N.J.
- CLAUSEN, H. P.** (A'16), Telephone and Telegraph Engineering, International Standard Electric Corporation, 67 Broad St., New York, N.Y.
- CLAUSING, LEROY M. E.** (A'19), 5651 N. Rockwell St., Chicago, Ill.
- CLAUSS, FRED W.** (A'27), Manager, Radio Dept., The Motor Accessories Company, 1041 Hamilton St., Allentown, Pa. For mail: 2020 Highland St., Allentown, Pa.
- CLAYCOMB, HUGH** (A'26), Engineer-in-Charge, Station KGBA, Shreveport, La. For mail: 212 Marshall St., Shreveport, La.
- CLAYTON, JOHN M.** (A'23-M'26), Secretary, Institute of Radio Engineers, 33 W. 39th St., New York, N.Y. For mail: 2 S. Chestnut St., Hempstead Gardens, L. I., N.Y.
- CLEGG, EDWARD B.** (A'26), 183 Greylock Parkway, Belleville, N.J.
- CLEMENT, IVAN C.** (A'26), Hydrophone Engineer, Submarine Signal Corporation, 247 Atlantic Ave., Boston, Mass. For mail: Morgan Ave., Greenwood, Mass.
- CLEMENT, JACK D.** (A'28), Sound Department, Columbia Picture Corporation, Hollywood, Calif. For mail: 5827 Willoughby St., Hollywood, Calif.
- CLEMENT, LEWIS M.** (A'14-M'17-F'26), Vice-President and Chief Engineer, Brandes Laboratories, Inc., 200 Mt. Pleasant Ave., Newark, N.J.
- CLEMENTS, THOMAS C.** (A'29), Service Engineer, Earl Radio Company, 1007 Davidson Bldg., Kansas City, Mo.
- CLEMMONS, WALLACE A.** (A'27), Gulf Radio School, 844 Howard Ave., New Orleans, La.
- CLIFTON, B. S. Y.** (M'15), Engineer-in-Charge, R.C.A. Communications, Inc., Rocky Point, L.I., N.Y.
- CLINE, RUSSELL A.** (J'27-A'29), Assistant Transmission Engineer, Central Plant Dept., Bell Telephone Company of Canada, Bloor and Bay Sts., Toronto, Ont., Canada. For mail: 550 Christie St., Toronto, Ont., Canada.
- CLOKE, PAUL** (A'22-M'26), Dean, College of Technology, University of Maine, Orono, Me. For mail: 49 Forest Ave., Orono, Me.
- CLOSSON, H. B., JR.** (J'27), Clerical Adjustment, Atwater Kent Manufacturing Company, 4700 Wissahickon Ave., Philadelphia, Pa. For mail: 1616 No. 60th St., Overbrook, Pa.
- CLOSSON, LUKE E.** (A'29), Assistant Engineer, Radio Corporation of America, Victor Talking Machine Company, Camden, N.J. For mail: Wellwood Manor Apts. G-6, 606 W. Maple Ave., Merchantville, N.J.
- CLOUGH, KENDALL** (A'27), Chief Engineer, Silver-Marshall, Inc., 6401 W. 65th St., Chicago, Ill. For mail: 529 Aldine Ave., Lakeview, Chicago, Ill.
- CLUFF, HAROLD D.** (A'25), The Signal Depot, Camp Borden, Ont., Canada.
- COATES, B. FRANKLIN** (A'29), R.F.D. 1, Tuttle, Okla.
- COATES, FRANK M.** (A'28), Assistant Radio Manager, McGraw Electric Company, Dace and Iowa Sts., Sioux City, Iowa. For mail: 3605-5th Ave., Sioux City, Iowa.
- COBB, F. ARTHUR** (A'26-M'28), Manager, Public Address Dept., Messrs. Philips Lamp Ltd., 145 Charing Cross Rd., London, W.C. 1, England. For mail: 28 Manor Gardens, Purely, Surrey, England.
- COBURN, E. D.** (A'29), Radiomarine Corporation of America, P.O. Box 471, Port Arthur, Tex.
- COCHRAN, EUGENE C.** (A'27), U.S. Radio Inspector, Subtreasury Bldg., Pine and Nassau Sts., New York, N.Y.
- COCKADAY, LAURENCE M.** (A'27), Technical Editor, New York "Herald Tribune", 225 W. 40th St., New York, N.Y.
- CODDINGTON, RAYMOND L.** (A'27), 3 Auburn St., Paterson, N.J.
- CODINGTON, JEROME H.** (J'27), Projectionist, Aztec Theatre, Albany, Tex. For mail: P.O. Box 127, Albany, Tex.
- COE, ALFRED** (A'26), Director, Coe Radio Institute, 78-80 Cortlandt St., New York, N.Y. For mail: 917 Newkirk Ave., Brooklyn, N.Y.
- COE, ERNEST W.** (A'26), Columbia Pictures Inc., 1438 N. Gower St., Hollywood, Calif. For mail: 828 N. Sweetzer Ave., Hollywood, Calif.
- COE, JAMES C.** (A'25), Assistant Radio Engineer, U. S. Govt. Ft. Sam Houston, Tex. For mail: General Delivery, Houston, Tex.
- COGGESHALL, IVAN S.** (A'26-M'29), General Traffic Supervisor, Western Union Telegraph Company, 195 Broadway, New York, N.Y.
- COHEN, EDWARD** (A'28), Certified Public Accountant, 109 Bank St., Waterbury, Conn. For mail: P. O. Box 188, Waterbury, Conn.
- COHEN, HYMAN A.** (A'29), Junior Radio Inspector, Radio Division, Department of Commerce, Fort McHenry, Baltimore, Md. For mail: 1626 Warwick Ave., Baltimore, Md.
- COHEN, ISAAC J.** (A'26), Assistant Engineer, P.O. Research Station, Dollis Lane, London, England. For mail: 13 E. Anns Hill, Wandsworth, London, England.
- COHEN, LOUIS** (M'14-F'15), North Central Mansions, Washington, D.C.
- COHEN, SAMUEL** (A'16-M'22), Vice-President, General Instrument Corporation, 22 Varick St., New York, N.Y. For mail: 43 76th St., Brooklyn, N.Y.
- COHEN, SAMUEL H.** (A'28), Technical Staff Marconiphone Company, Ltd., 212 Tottenham Court Rd., London, England. For mail: 6 Springfield Rd., Blackpool, Lancs, England.
- COHEN, THEODORE** (J'27), Electrical Engineer, Nilissner Manufacturing Company, S. Clinton St., Chicago, Ill. For mail: 1346 1/2 Estes Ave., Chicago, Ill.

- COHN, RALPH I.** (A'29), Radio Draftsman, Pilot Electrical Manufacturing Company, 323 Berry St., Brooklyn, N.Y. For mail: 165 Garfield Ave., Long Branch, N.J.
- COLBY, CHARLES C., JR.** (A'28), Radio Tube Engineer, Raytheon Manufacturing Company, Newton, Mass.
- COLBY, EDWARD B.** (A'27), Radio Operator, Radiomarine Corporation of America, 109 Congress St., Boston, Mass. For mail: 132 Dodge St., Beverly, Mass.
- COLE, ARTHUR B.** (M'15), President, Cole Radio Manufacturing Company, Bloomfield, N.J. For mail: 86 Westville Ave., Caldwell, N.J.
- COLE, FRED S.** (A'26), Heating and Ventilating Engineer, M. Friedman Company, 844 Sulter Ave., Brooklyn, N.Y. For mail: 221-8th Ave., Brooklyn, N.Y.
- COLE, G. C.** (A'29), Captain, Room 3315, Divisions Operations Training, U.S. Marine Corps, Washington, D.C. For mail: Headquarters, U.S. Marine Corps, Washington, D.C.
- COLE, NEIL D.** (A'29), Radio Engineer, Westinghouse Electric and Manufacturing Company, Chicopee Falls, Mass. For mail: 47 Florence St., Springfield, Mass.
- COLE, ROY H.** (A'27), Engineering Staff, Station WKY, Oklahoma City, Okla.
- COLEMAN, JOHN B.** (A'25-M'29), Radio Engineer, Westinghouse Electric and Manufacturing Company, Chicopee Falls, Mass. For mail: 137 Laurel St., Longmeadow, Mass.
- COLEMAN, ROBERT M.** (A'27), Serviceman, Rubins Auto and Service, 20 E. Park Ave., Niles, Ohio. For mail: 30 S. Chestnut St., Niles, Ohio.
- COLES, ROBERT R.** (J'26), 7 The Place, Glen Cove, L.I., N.Y.
- COLLINS, ARTHUR A.** (J'26), 514 Fairview Dr., Cedar Rapids, Iowa.
- COLLINS, FREDERICK V.** (J'22-A'26), Consulting Radio Engineer, 150 Puritan Ave., Highland Park, Detroit, Mich.
- COLLINS, JOHN** (J'27-A'28), Electrical Engineering Student, College of Engineering, Newark, N.J. For mail: 43 Union Place, North Arlington, N.J.
- COLLINS, LAURENCE H.** (A'29), Vice-President and Service Manager, Penn-Cliff Service Company, 2678 Pennsylvania Ave., Baltimore, Md.
- COLLINS, LEWIS R.** (A'28), 313 Deering Ave., Portland, Me.
- COLPITTS, EDWIN H.** (A'14-F'26), Assistant Vice-President, American Telephone and Telegraph Company, 195 Broadway, New York, N.Y.
- COLSON, JAMES L.** (J'27), Radio Tester, Westinghouse Electric and Manufacturing Company, East Springfield, Mass. For mail: P.O. Box No. 27, West Suffield, Conn.
- COLTON, HOWARD C.** (J'27), 88 Circuit Rd., Winthrop, Mass.
- COLVIN, RUEL** (A'27), Assistant Officer in Charge Aircraft Installations, Radio Laboratory, Naval Aircraft Station, Anacostia, D.C. For mail: 143 Quincy Place, N. E., Washington, D.C.
- COLVIN, R. S.** (A'27), Radio Receiving Engineer, Radio Corporation of America, Riverhead, L.I., N.Y. For mail: Jamesport, New York.
- COLWELL, FREDERICK E.** (A'26), Proprietor, North Shore Radio Laboratories, 6902 N. Clark St., Chicago, Ill. For mail: 6421 Greenview Ave., Chicago, Ill.
- COLWELL, ROBERT C.** (A'21-M'29), Professor of Physics, West Virginia University, Morgantown, W.Va. For mail: 332 Demain Ave., Morgantown, W.Va.
- COMACH, STANLEY I.** (A'29), Installation Engineer, Northern Electric Company, Ltd., 637 Craig St., W., Montreal, P.Q., Canada.
- COMAN, GEORGE E.** (A'29), Superintendent, Exhaust Dept., Areturus Radio Company, 255 Sherman Ave., Newark, N.J. For mail: 41-42nd St., Irvington, N.J.
- COMB, DAVID M.** (A'26), Technical Division, Brunswick-Balke-Collender Company, 623 Wabash Ave., Chicago, Ill.
- COMPTON, ROBIN D.** (J'27), 1213 Vermont St., Lawrence, Kans.
- CONAUGHTY, ROBERT B.** (A'29), Manager, Radio Division, Sunset Electric Company, San Diego, Calif. For mail: 4624 Biona Drive, San Diego, Calif.
- CONNETTE, T. W.** (A'29), Vice-President and General Manager, Lockport Light, Heat and Power Company, 115 Main St., Lockport, N.Y.
- CONRAD, FRANK** (M'17-F'27), Electrical Engineer, Westinghouse Electric and Manufacturing Company, East Pittsburgh, Pa.
- CONRAD, VICTOR A.** (A'27), Lieutenant Signal Corps, U.S. Army, Fort Monmouth, N.J.
- CONRAD, WILLARD OLIVER** (J'29), Assistant Engineer, Station WCAH, Commercial Radio Service Company, Hotel Fort Haynes, Columbus, Ohio. For mail: 75 W. 10th Ave., Columbus, Ohio.
- CONROY, JOSEPH M.** (A'23), Engineer, Canadian Marconi Wireless Telegraph Company, 173 Williams St., Montreal, P.Q., Canada.
- CONSOLI, VINCENT** (A'28), Bowler, Holmes and Hecker Company, 259 Greenwich St., New York, N.Y. For mail: 85 Montrose Ave., Brooklyn, N.Y.
- COOK, ARTHUR L.** (A'26), Head Engineering Dept., Pratt Institute, 215 Ryerson St., Brooklyn, N.Y.
- COOK, BERNARD L.** (A'28), Wireless Specialty Apparatus Company, Jamaica Plain, Mass. For mail: 26 Sunset Ave., Medford, Mass.
- COOK, EDWARD H.** (A'27), Assistant Engineer, Single Radio Company, East Pontiac St., Ft. Wayne, Ind. For mail: 1010 W. Wayne St., Ft. Wayne, Ind.
- COOK, ELLIS C.** (A'27), Engineer X-ray Work, Hettinger Bros., Manufacturing Company, P.O. Box 1126, Kansas City, Mo. For mail: 4555 Main St., Kansas City, Mo.
- COOK, ELLSWORTH D.** (A'21), 37 Mitchell Ave., Flushing, L.I., N.Y.

- COOK, JESSE A. (A'29), Service Engineer, Electrical Research Products, Inc., 520 Louderman Building, St. Louis, Mo. For mail: 5468 N. Kingshighway Blvd., Wade Station, St. Louis, Mo.
- COOK, JOHN W. (A'17), Instructor, Junior College, El Centro, Calif. For mail: 1016 El Centro Ave., El Centro, Calif.
- COOK, JOHN W. (A'26), Equipment Engineer, Telegraph Dept., A.T. & S-F. Ry., Topeka, Kan. For mail: 1500 Van Buren St., Topeka, Kan.
- COOK, J. M. (A'27), Southern Bell Telephone and Telegraph Company, Atlanta, Ga. For mail: 690 Piedmont Ave., N.E., Atlanta, Ga.
- COOK, ROBERT O. (A'26), Technician, Station KMTR, Radio Corporation, Hollywood, Calif. For mail: 843 1/2 N. Poinsettia Pl., Hollywood, Calif.
- COOK, TEDD W. (A'29), Manager Radio Dept., Fargo Plumbing and Heating Company, 123 Broadway, Fargo, N.D. For mail: No. 19 Rust Apts., 905-5th St., N., Fargo, N.D.
- COOK, WILBERT H. (A'27), Test Set Laboratories, Raytheon Manufacturing Company, 238 Main St., Cambridge, Mass. For mail: 350 N. Harvard St., Allston, Mass.
- COOKE, GERALD W. (A'26), Radio Engineer, Consolidated Gas, Electric Light and Power Company, 660 Lexington Bldg., Baltimore, Md.
- COOKSON, WALTER (M'25), Walford Cottage, Paget, Bermuda.
- COOLEY, ELIHU H. (A'28), Development and Research Dept., Victor Talking Machine Company, Camden, N.J.
- COOMBS, CLYDE F. (A'27), Radio Engineer, Radio Engineering Dept., General Electric Company, 1 River Rd., Schenectady, N.Y.
- COOPER, ASHTON B. (A'26), Ferranti Meter and Transformer Manufacturing Company, Ltd., 26 Noble St., Toronto, Ont., Canada.
- COOPER, C. B. (A'14), Manufacturer's Sales Representative, C. B. Cooper Company, 130 W. 42nd St., New York, N.Y.
- COOPER, GEORGE R. (A'29), Sound Dept., Columbia Picture Corporation, 1438 N. Gower Ave., Hollywood, Calif. For mail: 1224 N. Kenmore Ave., Hollywood, Calif.
- COOPER, GUSTAVUS A. (A'29), Production Supervisor, Colonial Radio Corporation, Wilbur Ave. and Sunswick St., Long Island City, N.Y. For mail: 7424 87th Ave., Woodhaven, L.I., N.Y.
- COOPER, HAROLD G. (A'28), Transmission Engineer, Radio Station KDB, Faulding Hotel, Santa Barbara, Calif.
- COOPER, J. A. (A'22), Engineer-in-Charge, British Broadcasting Corporation, 282 Broad St., Birmingham, England. For mail: Lindli, 122 Bournbrook Rd., Selly Oak, Birmingham, England.
- COOPER, JOHN C., JR. (A'17), Attorney-at-Law, Cooper, Knight, Adair, Cooper, and Osborne, Atlantic National Bank Bldg., Jacksonville, Fla.
- COOPER, ORVILLE T. (A'27), Naval Research Laboratory, Radio Material School, Bellevue, Anacostia, D.C.
- COOPER, SAMUEL J. (A'25), Engineer, Marconi Company, 11 St. Sacramento St., Montreal, P. Q. Canada.
- COOPER, W. H. B. (J'28), Telephone Engineering Dept., General Post Office, 2 The Parade, Marlborough, Wilts, England.
- COPELAND, HERMAN A. (A'28), Student and Laboratory Assistant, Wesleyan University, Middletown, Conn. For mail: R. R. 6, Wapakoneta, Ohio.
- COPP, ROY S. (A'25), Radio Engineering, Copp Radio Laboratories, 61 Stratford Ave., Dayton, Ohio. For mail: 912 Cumberland Ave., Dayton, Ohio.
- CORBETT, WALTER E. (A'26), Construction Manager, Lock-Joint Pipe Co., P.O. Box 21 Station A, Hartford, Conn.
- CORBIN, FRANCIS L. (A'27), Engineer, Forte-Presin and Company, 75 Hudson St., Newark, N.J. For mail: 671 Lincoln Ave., Orange, N.J.
- CORCORAN, EDWARD M. (A'27), Proprietor, E. M. Corcoran Radio Company, 436 N. Main St., Artesia, Calif. For mail: 438 N. Main St., Artesia, Calif.
- CORCORAN, GEORGE L. (J'27), Service Dept., E. M. Corcoran Radio Company, 436 N. Main St., Artesia, Calif. For mail: 438 N. Main St., Artesia, Calif.
- CORDELL, PETER C. (A'29), Laboratory Assistant, Radio Frequency Laboratories, Inc., Boonton, N.J. For mail: 302 Dawson Ave., Boonton, N.J.
- CORDERMAN, WILLIAM P. (A'27), Second Lieutenant Signal Corps, U.S. Army, c/o Adjutant General of the Army, Washington, D.C. For mail: 4401 Leland St., Washington, D.C.
- CORDES, EDWIN L. (A'26), Instructor, Dept. of Physics, Marquette University, Milwaukee, Wis. For mail: 138-17th St., Apt. 204, Milwaukee, Wis.
- CORDES, HENRY G. (A'15), Research Engineer, Federal Telegraph Company, Palo Alto, Calif. For mail: 371 Castilleja Ave., Palo Alto, Calif.
- CORDOVA, F. B. (A'27), 1712 Columbia, Philadelphia, Pa.
- CORDREY, E. E. (A'27-M'29), Manager, Dept. of Physical Science, State Teachers College, Conway, Ark.
- COREY, JAMES H. (A'27), Signal Maintainer, N.Y.C.R.R., c/o G. A. Gayer, Signal Supervisor, Union Station, Albany, N.Y. For mail: 78 Oxford Rd., Albany, N.Y.
- CORNFIELD, M. (A'29), Radio Engineer, The Indian Broadcasting Company, Ltd., Radio House, Apollo Bunder, Bombay, India. For mail: Y.M.C.A., Woodhouse Road, Fort, Bombay, India.
- CORNWELL, LIONEL B. (J'22 A'23), Chief Engineer, Amplex Corporation of America, 133 W. 21st St., New York, N.Y.
- CORRIGAN, JAMES T. (A'26), Recording Engineer, Pathe Sound News, 35 W. 45th St., New York, N.Y. For mail: 1819 G St., N.W., Washington, D.C.
- CORRY, HAL F. (A'25), President, The Radio Shop, Inc., 1918 Main St., Dallas, Tex.
- CORWIN, CHARLES I. (A'26), Advertising Dept., National Carbon Company, Inc., 39 E. 42nd St., New York, N.Y.

- CORWIN, WILLIS P. (A'27), 117 E. McCarty St., Jefferson City, Mo.
- CORWITH, HOWARD P. (M'26), Special Development Engineer, Western Union Telegraph Company, Water Mill, L.I., N.Y.
- COSANDEY, CHARLES J. (A'26), Instructor in Electrical Engineering and Physics, Duluth Junior College, Duluth, Minn. For mail: 1313 N. 56th Ave., W., Duluth, Minn.
- COSTELLO, JOHN J. (A'29), Gang Chief, Retail Coils, Western Electric Company, 100 Central Ave., Kearny, N.J. For mail: 33 Bergen Ave., Jersey City, N.J.
- COTA, PEDRO N. (A'23), Jefe del Dep. de Radio-Comunicacion, Direccion Gral de Telégs., Nacionales, Mexico, D.F.
- COTE, OMER E. (A'23), Coil Engineer, Valley Appliances, Inc., Rochester, N.Y. For mail: 98 Charlton Rd., Rochester, N.Y.
- COTTAM, DEAN F. (A'26), Radio Interference Man, Northern States Power Co., 15 S. 5th St., Minneapolis, Minn. For mail: 3538-3rd Ave. S., Minneapolis, Minn.
- COTTER, EDWIN MEREDITH (A'29), Sales Representative, Aitken Radio Corporation, 140 East Third St., Dayton, Ohio. For mail: 53 Stratford Ave., Dayton, Ohio.
- COTTER, WILLIAM F. (A'27), Radio Engineer, American Bosch Magneto Company, Springfield, Mass.
- COTTON, RICHARD J. (A'28), Student, University of Minnesota, Minneapolis, Minn. For mail: 1795 Lincoln Ave., St. Paul, Minn.
- COTTRELL, CASPER L. (A'29), Assistant Professor of Physics, Kenyon College, Gambier, Ohio.
- COTTRELL, MC KENZIE (A'28), Radio Engineer, General Electric Company, Schenectady, N.Y. For mail: 1426 Sumner Ave., Schenectady, N.Y.
- COULSON, EVERETT J. (A'27), Radio Operator, Radio Station WBJ, Springfield, Mass. For mail: 120 Federal St., Springfield, Mass.
- COULTER, HOWARD N. (M'29), Lieutenant, U.S. Navy, U.S. Naval Air Station, Lakehurst, N.J.
- CUMBE, J. B. H. (A'26), 1127 Euclid St., N.W., Washington, D.C.
- COURCHENE, HOMER B. (A'27), Transmission Engineer, Radio Station WLS, Crete, Ill.
- COURSEY, PHILIP R. (A'17), Dubilier Condenser Company, Ltd., Ducon Works, London, W.3, England. For mail: 67 Queens Rd., Richmond, Surrey, England.
- COURTENAY-PRICE, GEORGE (A'25), Captain, The Barracks, Gt. Brook St., Birmingham, England. For mail: 2 St. Annes Villas, Hewlett Rd., Cheltenham, Eng.
- COURTER, H. L. (A'29), Engineer, Thordarson Electric and Manufacturing Company, 500 W. Huron St., Chicago, Ill. For mail: 126 S. Vernon Ave., Brookfield, Ill.
- COURTIS, REGINALD P. (A'26), Apt. 13, 620 Parkview Ave., Detroit, Mich.
- COUSINS, MAURICE NICHOLAS (J'29), 119 James St., Bridgeport, Conn.
- COUSINS, VAN METER (A'25), Electrical Engineer, Bell Telephone Laboratories, Inc., 463 West St., New York, N.Y.
- COVEY, GERALD G. (A'25), Marine Dept., Radio Corporation of America, Cleveland, Ohio. For mail: 1847 E. 87th St., No. 202, Cleveland, Ohio.
- COWAN, EDWARD J. (A'28), Radio Engineer, 76 Atherton St., Jamaica Plain, Mass. For mail: 116 Riverside Dr., Dedham, Mass.
- COWLES, JOHN W., JR. (J'28), Superintendent Radio Service Dept., Riechman-Crosby Company, 223-229 S. Front St., Memphis, Tenn. For mail: 920 N. Barksdale St., Memphis, Tenn.
- COWLES, WALTER G. (A'23), Vice-President, Travelers' Insurance Company, Hartford, Conn. For mail: P. O. Box 1056, Hartford, Conn.
- COX, C. F. (A'27), Technical Dept., British Brunswick, Ltd., 34 George St., Hanover Square, London, England. For mail: Strathmore Station Rd., Bramley, Guildford, England.
- COX, CHARLES H. (A'26), Supervisor, Michigan Bell Telephone Company, 1365 Cass Ave., Detroit, Mich. For mail: 60 Euclid Ave., E., Detroit, Mich.
- COX, GEORGE C. (A'19), Major, War Dept., General Staff, War Plans Division, Washington, D.C.
- COX, HESTER S. (J'29), Ponsford, Minn.
- COX, RALPH V. (A'28), Train Dispatcher, C. B. and Q. R. R., Alliance, Neb. For mail: 523 Cheyenne Ave., Alliance, Neb.
- COXHEAD, HARRY B. (A'21-M'26), Telegraph Engineer, Dept. of Development and Research, American Telephone and Telegraph Company, 195 Broadway, New York, N.Y. For mail: American Telephone and Telegraph Test Station, Belfast, Me.
- COXON, WALTER E. (A'28), Manager and Engineer, Broadcasting Station 6 W. F., The Westralian Farmers, Ltd., 569 Wellington St., Perth, Western Australia. For mail: 5th Ave., Inglewood, Perth, Western Australia.
- COZZENS, BRADLEY (A'27), Research Engineer, Bureau of Power and Light of Los Angeles, 207 S. Broadway, Los Angeles, Calif. For mail: P. O. Box 529, San Jose, Calif.
- CRABTREE, ALFRED E. (A'26), Service Work, Texas Radio Sales Company, 411 N. Harwood St., Dallas, Tex. For mail: 1816 N. Garrett Ave., Dallas, Tex.
- CRAFT, E. B. (F'20), Executive Vice-President, Bell Telephone Laboratories, Inc., 463 West St., New York, N.Y.
- CRAIG, ALBERT G. (A'27), Electrical Engineer, "Popular Radio," Inc., 119 W. 57th St., New York, N.Y. For mail: 579 Van Cortlandt Park Ave., Yonkers, N.Y.
- CRAIG, JACK (J'27), 611 E. Gibson Ave., Connersville, Pa.
- CRAIG, PALMER H. (A'25), Physicist, Harris Hammond, 120 Broadway, New York, N.Y. For mail: 2545 Harrison Ave., Cincinnati, Ohio.
- CRAMPTON, WILLIAM J. (M'21), Electrical Engineer, 73 Queen Victoria St., London, E. C., England.
- CRANE, EDWIN S. (A'28), Partner, Radio Sales, Nassau Radio Service, 330 Fulton Ave., Hempstead, L.I., N.Y. For mail: 67 Front St., Hempstead, L.I., N.Y.

- CRARY, FREDERICK W.** (A'29), Radio Technician, Hughes-Cash Company, 5650 Grand River Ave., Detroit, Mich. For mail: 13166 Ward Ave., Detroit, Mich.
- CRAVEN, T. A. M.** (F'29), Lieutenant Commander, U. S. Navy, Naval Communications, Navy Department, Washington, D.C.
- CRAWFORD, ARTHUR B.** (A'29), Member Technical Staff, Bell Telephone Laboratories, Cliffwood, N.J.
- CRAWFORD, CECIL G.** (A'26), Engineer, Standard Telephones and Cables, Ltd., The Hyde, Hendon, London, N.W.9, England. For mail: 4 Holmwood Grove, Mill Hill, N.W.7, England.
- CRAWFORD, DAVID M.** (A'21), Major, Office Chief Signal Officer, Munitions Bldg., Washington, D.C.
- CRAWFORD, JOHN D.** (A'29), Engineering Dept., General Radio Company, 30 State St., Cambridge, Mass. For mail: 7 Goodwin Pl., Boston, Mass.
- CRAWFORD, J. B.** (A'27), Radio Sales and Service, Crawford and Ward, 219 S. 20th St., Omaha, Neb.
- CREAMER, W. J., JR.** (A'29), Professor of Electrical Communication, University of Maine, Orono, Me. For mail: 331 Center St., Bangor, Me.
- CREASER, ISAIAH** (A'26), Chief Electrician, Rolls Royce of America, East Springfield, Mass. For mail: 76 Cortland St., Springfield, Mass.
- CREDNER, LOUIS L.** (A'29), Acting Principal, Radio Institute, 109-123 W. 64th St., New York, N.Y.
- CRESPO, JOSE** (M'25), Lieutenant Commander, Spanish Royal Navy, Chief of Naval Dept., Compania Nacional de T.S.H., Alcalá 23, Madrid, Spain.
- CREWS, J. H.** (A'28), Radiomarine Corporation of America, 512 St. Peter St., New Orleans, La. For mail: P. O. Box 225, Hattiesburg, Miss.
- CRIPPEN, EUGENE G.** (A'23), 128 Division St., Schenectady, N.Y.
- CRISANTE, ALDO** (A'29), 400 W. 7th Ave., Columbus, Ohio.
- CRITE, MITCHEL** (A'26), Testing and Repairman, Freed-Eisemann Company, Brooklyn, N.Y. For mail: 240 E. 104th St., New York, N.Y.
- CRITTLE, W. J.** (A'28), Manager, Service Dept., Crawford Piano Company, 129 Dundas St., London, Ont., Canada. For mail: 599 King St., London, Ont., Canada.
- CROCUS, JOHN S.** (A'29), Tester, Sterling Manufacturing Company, 1890 E. 40th St., Cleveland, Ohio. For mail: 7617 Myron Ave., Cleveland, Ohio.
- CROFT, SAMUEL H.** (A'26), Purchasing Agent and Mechanical Engineer, Croft and Allen Corporation, Bethlehem, Pa. For mail: Bala-Cynwyd, Pa.
- CROFTS, CECIL T.** (A'29), Assistant Radio Engineer, Canadian Westinghouse Company, Hamilton, Ont., Canada. For mail: 267 Cannon St., E., Hamilton Ont., Canada.
- CROM, GEORGE C., JR.** (A'22-M'24), Research Engineer, American Transformer Company, 178 Emmet St., Newark, N.J. For mail: 51 S. Walnut St., East Orange, N.J.
- CRONKHITE, MINTON** (A'19-M'26), President, Liberty Electric Corporation, Stamford, Conn.
- CROSBY, GEORGE L.** (M'23), Vice-President, Roller Smith Company, 2136 Woolworth Bldg., New York, N.Y.
- CROSBY, MURRAY G.** (A'25), Radio Engineer, Radio Corporation of America, Riverhead, L.I., N.Y.
- CROSLEY, POWEL, JR.** (A'22-M'25), President, The Crosley Radio Corporation, 3401 Colerain Ave., Cincinnati, Ohio.
- CROSS, HARRY** (A'25), Equipment Engineer, Montevideo Telephone Company, Sarandi 444, Montevideo, Uruguay, South America.
- CROSSETT, EDWARD C.** (A'27), President, Crossett Western Company, 821 Railway Exchange Bldg., Chicago, Ill.
- CROSSLAND, HENRY A.** (A'28), Chief Operator, Radio Station KPRC, Houston-Post Dispatch, Houston, Tex. For mail: 1912 Mason St., Houston, Tex.
- CROSSLEY, ALFRED** (A'19-M'26), Chief Engineer, Howard Radio Company, South Haven, Mich.
- CROTEAU, CARLTON W.** (A'28), Radio Serviceman, South New England Electric Company, 27 W. Main St., Waterbury, Conn. For mail: Mount Carmel, Conn.
- CROTHERS, H. M.** (A'20), Dean, Division of Engineering, South Dakota State College, Brookings, S.D.
- CROUTER, LESLIE E.** (A'25), Automatic Switchman, Mountain States Telephone and Telegraph Company, Butte, Mont. For mail: 631 Y.M.C.A., Butte, Mont.
- CROW, JOHN B.** (J'28), Student, Dodge Radio Institute, Valparaiso, Ind. For mail: Taylor Pl., Uniontown, Pa.
- CROWELL, CLAUDE S.** (A'28), Radio Set Builder and Telegrapher, Logan and Bryan, 42 Broadway, New York, N.Y. For mail: 2042 Bedford Ave., Brooklyn, N.Y.
- CROWLEY, DAVID A.** (A'27), Radio Engineer, Wholesale Radio Equipment Company, 37 William St., Newark, N.J. For mail: 20 Rankin St., Elizabeth, N.J.
- CROXTON, GALEN B.** (A'27), Vice-President, Mississippi Valley Radio Company, 914 Pine St., St. Louis, Mo.
- CROZIER, WILLIAM D.** (A'27), Research Engineer, Newcomb-Hawley, Inc., St. Charles, Ill. For mail: Riverbank Laboratories, Geneva, Ill.
- CRUIKSHANK, OMAR T.** (A'27), 1107 Island Ave., N.S., Pittsburgh, Pa.
- CUBERT, JOSEPH R.** (A'25), Radio Engineer, United Air Cleaner Company, 9701 Cottage Grove Ave., Chicago, Ill. For mail: 6741 LaFayette St., Chicago, Ill.
- CUERVO, LUIS S.** (A'25), Managing Director, Sociadadiberica de Construcciones Electrica, Madrid, Spain. For mail: Apartado 990, Barquille 1, Madrid, Spain.
- CULLEY, LESTER D.** (A'27), Receiving Engineer, Radio Corporation of America, Marshall, Calif.
- CULLUM, A. EARL** (J'28), Student, Massachusetts Institute of Technology, Box 330, Cambridge, Mass.

- CULVER, CHARLES A.** (M'20), Professor of Physics, Carleton College, Northfield, Minn.
- CULVER, CLARENCE C.** (A'14-M'14), Colonel, General Air Staff, U. S. Army, Washington, D.C. For mail: 3420 Garfield St., N.W., Washington, D.C.
- CUMERFORD, ARTHUR S.** (A'26), Chief Engineer, Electrical Products Manufacturing Company, 69 Sprague St., Providence, R.I. For mail: 164 Pawtucket Ave., Edgewood, R.I.
- CUMMING, GEORGE** (A'27), Wood Pattern-maker, Illinois Malleable Iron Company, 1801 Diversey Blvd., Chicago, Ill. For mail: 2017 Grace St., Chicago, Ill.
- CUMMING, KENNETH N.** (A'16-M'28), Assistant Operating Engineer, R.C.A. Communications, Inc., 66 Broad St., New York, N.Y. For mail: 381 Harold St., North Plainfield, N.J.
- CUMMING, L. GORDON** (A'27), Sales Engineer, Atlantic Precision Company, 80 Federal St., Boston, Mass. For mail: 295 Beacon St., Boston, Mass.
- CUMMING, NOEL D.** (A'26), Assistant Engineer, Durban Broadcasting Station, African Broadcasting Company, Ltd., P. O. Box 2288, Durban, Natal, South Africa. For mail: 23 Overport Dr., Berea, Durban, Natal, South Africa.
- CUMMINGS, B. RAY** (A'18-M'20), Radio Engineer, General Electric Company, 1 River Rd., Schenectady, N.Y. For mail: 1313 Union St., Schenectady, N.Y.
- CUMMINGS, GEORGE B.** (A'28), Denver District Manager, R.C.A. Photophone, Inc., 411-5th Ave., New York, N.Y. For mail: Rm. 1014, U. S. National Bank Bldg., Denver, Colo.
- CUMMINGS, WILBUR H.** (J'25-A'28), Radio Instructor, Dodge Institute of Radio, 405 E. Monroe St., Valparaiso, Ind. For mail: 66 W. Indiana Ave., Valparaiso, Ind.
- CUNLIFFE, PAUL R.** (A'28), Engineer, Westinghouse Lamp Company, Bloomfield, N.J. For mail: 30 Edgewood Rd., Glen Ridge, N.Y.
- CUNNINGHAM, DAVID H.** (A'28), Radio Engineer, Westinghouse Electric and Manufacturing Company, East Pittsburgh, Pa. For mail: 513 Holmes St., Wilkinsburg, Pa.
- CUNNINGHAM, FREDERICK W.** (A'26-M'28), Member of Technical Staff, Bell Telephone Laboratories, Inc., 463 West St., New York, N.Y. For mail: 5 Park Ave., Maplewood, N.J.
- CUNNINGHAM, H. C.** (A'25), Member of the Technical Staff, Bell Telephone Laboratories, Inc., 463 West St., New York, N.Y. For mail: 2610 Halperin Ave., New York, N.Y.
- CUNNINGHAM, JOHN** (A'27), Radio Engineer, National Electrical Engineering Company, Ltd., 125 Stuart St., Dunedin, New Zealand. For mail: Burkes, Dunedin, New Zealand.
- CUNNINGHAM, K. S.** (A'24), Radio Service Dept., Zas. M. Zamoiski Company, 111 W. Redwood St., Baltimore, Md. For mail: 3412 Parkington Ave., Baltimore, Md.
- CUNNINGHAM, LODGE** (A'27), Sound Director, Christie Studios, 1140 N. Las Palmas St., Hollywood, Calif. For mail: 5918 Wiloughby Ave., Hollywood, Calif.
- CUNNINGHAM, THOMAS D.** (A'27), Radio Engineer, Westinghouse Electric and Manufacturing Company, East Pittsburgh, Pa. For mail: 1310 Hay St., Wilkinsburg, Pa.
- CURD, DAVID A.** (A'29), Wireless Engineer, British Broadcasting Corporation, Athenæum Chambers, Athenæum Arcade, Plymouth, England. For mail: 49 Greenbank Ave., Plymouth, England.
- CURRAN, GEORGE W.** (A'25), Chief Operator, Radio Station WHA, University of Wisconsin, Electrical Laboratory, Madison, Wis. For mail: 215 N. Mills St., Madison, Wis.
- CURRIER, GUY, JR.** (A'27), Assistant Director, Paramount-Famous-Lasky Corporation, Long Island City, L.I., N.Y. For mail: Hotel Montclair, Lexington Ave. and 49th St., New York, N.Y.
- CURRY, WALTER A.** (A'25), Teacher, Columbia University, New York, N.Y.
- CURTIS, AUSTEN M.** (A'12-M'13), Member of Technical Staff, Bell Telephone Laboratories, Inc., 463 West St., New York, N.Y. For mail: 132 N. 19th St., East Orange, N.J.
- CURTIS, EVERETT N.** (A'24), 1834 Sheridan Ave., San Diego, Calif.
- CURTIS, FRANCIS C.** (A'24), Captain, Royal Signals, School of Signals, Catterick Camp, Yorkshire, England.
- CURTIS, JAMES O.** (A'27), Service Manager, First Points Radio Company, 499 W. Exchange St., Akron, Ohio. For mail: 787 St. Clair St., Akron, Ohio.
- CURTIS, LESLIE F.** (A'18-M'29), Chief Engineer, American Bosch Magneto Corporation, Springfield, Mass. For mail: 162 Springfield St., Springfield, Mass.
- CURTIS, WESTLEY F.** (A'29), Junior Physicist, Naval Research Laboratory, Bellevue, Anacostia, D.C. For mail: 502 Trenton St., Washington, D.C.
- CUSACK, SIDNEY C.** (A'17), c/o Fred C. Parlett, 176 Duplex Ave., Toronto, Ont., Canada.
- CUTTING, FULTON** (M'15-F'21), Radio Engineer, Colonial Radio Corporation, East Ave., Long Island City, L.I., N.Y. For mail: 15 E. 88th St., New York, N.Y.

D

- DACK, ALLAN J. S.** (A'25), Wireless Operator, Radio Communication Company, Ltd., Strand, London, England. For mail: 17 Salisbury Rd., Harrow, Middlesex, England.
- DACK, JOHN H. A.** (A'26), Radio Inspector, Standard Telephone and Cable Company, Ltd., New Southgate, London N.11, England. For mail: 17 Salisbury Rd., Harrow, Middlesex, Eng.
- DADY, ARTHUR O.** (A'16), President and Chief Engineer, The Delta Company, Inc., North Chicago, Ill.
- DAGG, T. RALPH** (A'25), 446 W. 23rd St., New York, N.Y.

- DAHLSTROM, HUGO WOLF (J'29), Radio Serviceman, Interstate Electric Company, 643 Magazine St., New Orleans, La. For mail: 2434 Valence St., New Orleans, La.
- DALEY, FRANCIS T. (A'16), Chile Exploration Company, Tocopilla, Chile, South America.
- DALLIN, EDWIN B. (M'29), Engineering Dept., Wireless Specialty Apparatus Company, Jamaica Plain, Boston, Mass.
- DALTON, F. K. (M'27), Testing Engineer, Electrical Laboratory, Hydro Electric Power Commission of Ontario, 8 Strachan Ave., Toronto, Ont., Canada.
- DALTON, ROBERT E. (A'29), Assistant Wire Chief, Testing and Regulating Dept., 175 Congress St., Boston, Mass. For mail: 5 Fairland St., Roxbury, Mass.
- DALTON, STUART P. (A'28), Vice-President, Park Music Company, Inc., 6327 S. Pacific Blvd., Huntington Park, Calif. For mail: 2906 E. Walnut St., Huntington Park, Calif.
- DALY, EDMUND (A'29), Radio Dept., Daly's Garage, Seaford, Ont., Canada. For mail: Box 515, Seaford, Ont., Canada.
- DAMM, GEORGE J., JR. (A'26), Radio Service Dept., Jebens Company, 107 Western Ave., Blue Island, Ill. For mail: 463 Desplains St., Blue Island, Ill.
- DANA, ALAN S. (A'21), Research Engineer, Kerite Insulated Wire and Cable Company, Seymour, Conn.
- DANA, DAVID W. (A'28), Physicist, Cooper Hewitt Electric Company, Hoboken, N.J. For mail: 14 Edgewater Ave., Grantwood, N.J.
- DANE, FRANCIS W. (M'26), Engineering Dept., Wireless Specialty Apparatus Company, Boston, Mass. For mail: Main St., P. O. Box 28, Hamilton, Mass.
- DANFORTH, RICHARD S. (A'27), 16 California St., San Francisco, Calif.
- DANIELS, PAUL H. (J'25-A'27), Manager, Radio Dept., Kirby Electric Company, 215 Liberty Ave., Beaumont, Tex.
- DANIELSON, ERNEST G. (A'16), Gray and Danielson, 250-1st St., San Francisco, Calif.
- DANNALS, EARL W. (A'16-M'26), Research Engineer, Wired Radio, Inc., Ampere, N.J. For mail: 30 Lawton St., East Orange, N.J.
- DANZ, HERMAN (A'29), Treasurer, Ad. Auriema, Inc., 116 Broad St., New York, N.Y.
- DANZIGER, HAROLD I. (J'21-A'26-M'29), 40 E. 10th St., New York, N.Y.
- DARLINGTON, EDGAR T. (A'26), Chief Operator, Station WFI, Strawbridge and Clothier, Philadelphia, Pa. For mail: 2848 Idaho Rd., Camden, N.J.
- DARLINGTON, EUGENE S. (A'26), Vacuum-Tube Development, General Electric Company, Research Laboratory, 1 River Rd., Schenectady, N.Y.
- DARROW, LEO H. (A'17), Engineer, Building and Equipment Dept., New Jersey Bell Telephone Company, 1060 Broad St., Newark, N.J. For mail: 54 Cedar St., Maplewood, N.J.
- DART, HARRY F. (A'20-M'26), Radio Engineer, Westinghouse Lamp Company, Bloomfield, N.J. For mail: 33 Burnett St., Glen Ridge, N.J.
- DAUBER, ALBERT E., SR. (A'28), Millwright, Allison and Chambers Company, Adams and Preble Ave., N.S., Pittsburgh, Pa. For mail: 520 Bayne Ave., Bellevue, N.S., Pa.
- DAUBER, ARTHUR O. F. (A'29), Specifications and Drawings, Engineering Dept., Arc-turus Radio Tube Company, 226 Sherman Ave., Newark, N.J. For mail: 180 Runyon St., Newark, N.J.
- DAUGHERTY, CARL F. (A'27), Engineer, Station WSB, "Atlanta Journal," Atlanta, Ga.
- DAVEY, CEDRIC V. (A'26), Assistant Recorder, Tiffany Stahl Productions, 4500 Sunset Blvd., Hollywood, Calif. For mail: 1119 Poinsettia Dr., Hollywood, Calif.
- DAVID, BRUCE W. (A'22-M'27), Radio Engineer, Cleveland Electric Illuminating Company, 75 Public Square, Cleveland, Ohio.
- DAVID, WILLIAM R. (A'26), Radio Engineering Dept., General Electric Company, 1 River Rd., Schenectady, N.Y.
- DAVIDSON, MARTIN (A'27), Aircraft Radio Operator, U. S. Navy, V-O Squadron, Three-J, Hampton Rds, Va. For mail: 112 Cedar St., San Diego, Calif.
- DAVIS, CHESTER (A'29), Engineering Assistant, Michigan Bell Telephone Company, 1365 Cass Ave., Detroit, Mich. For mail: 4322 Grand Ave., W., Detroit, Mich.
- DAVIS, CHESTER L. (A'24-M'28), 519 Wentworth Ave., Santa Barbara, Calif.
- DAVIS, DARYL D. (A'14), Assistant Professor of Electrical Engineering, Dept. of Mechanics, University of California, Berkeley, Calif.
- DAVIS, DUDLEY J. (A'27), Technician, Western Radio Company, 16th and Walnut Sts., Kansas City, Mo. For mail: 3645 Genesee St., Kansas City, Mo.
- DAVIS, GLEN A. (A'29), Student, Dodge Radio School, 502 Union, Valparaiso, Ind. For mail: R.F.D., Mendota, Mo.
- DAVIS, GLENWOOD (A'26), Electrician, Idaho Power Company, Pocatello, Idaho. For mail: 735 S. 5th St., Pocatello, Idaho.
- DAVIS, IRVING C. (A'26), Engineer, Radio Station WLW, General Delivery, Mason, Ohio. For mail: General Delivery, Mason, Ohio.
- DAVIS, JOSEPH A. (A'23), Radio Engineer, Temple Corporation, 5254 W. 65th St., Chicago, Ill. For mail: 3438 W. 65th St., Chicago, Ill.
- DAVIS, NATHAN A. (A'28), Lubrication Engineer, Beacon Oil Company, 420 Lexington Ave., New York, N.Y. For mail: 22 N. 18th St., East Orange, N.J.
- DAVIS, R. K. (A'26), Naval Officer, U.S.S. "Trenton," c/o Postmaster, Seattle, Wash.
- DAVIS, ROBERT J. (A'27), Radio Engineer, Southern Radio Corporation, Rm. 508, 26 Broadway, New York, N.Y.
- DAVIS, ROBERT L. (A'25), Radio Engineer, Westinghouse Electric and Manufacturing Company, East Pittsburgh, Pa. For mail: 7015 Meade St., Pittsburgh, Pa.

- DAVIS, SHELDON IRWIN (A'28), Radio Engineer, Westinghouse Electric and Manufacturing Company, East Pittsburgh, Pa. For mail: 30 Winders St., Pittsburgh, Pa.
- DAVIS, THOMAS M. (M'28), Associate Radio Engineer, Naval Research Laboratory, Bellevue, Anacostia, D.C. For mail: 4302 Brandywine St., N.W., Washington, D.C.
- DAWSON, WILFRED M. (A'27), Technical Engineer, Philips Lamps, Ltd., Box 1673, Wellington, N.Z.
- DAVIS, WILLIAM G. (A'29), Radio Engineer, Wetmore Savage E. S. Company, 46 Hampden St., Springfield, Mass. For mail: 21 Oswego St., Springfield, Mass.
- DAWSON, W. ROBERT (J'28-A'29), Service Dept., California Victor Distributing Company, Los Angeles, Calif. For mail: 4522-18th St., N.E., Seattle, Wash.
- DAY, JOHN F. (A'29), Service Manager, Clines, Inc., 920-14th St., N.W., Washington, D.C. For mail: 3706-24th St., N.E., Washington, D.C.
- DAYMUDE, JOHN F. (A'29), Proprietor, Radio and Electrical Supplies, 4350 Pearl Rd., Cleveland, Ohio.
- DEACON, ALAN I. (A'26), Digby Radio, Prince Rupert, B.C., Canada.
- DEAKIN, GERALD (A'16), First Assistant Chief Engineer, International Telephone and Telegraph Company, 67 Broad St., New York, N.Y.
- DEAL, HARMON B. (A'22-M'29), Engineer, Atwater-Kent Manufacturing Company, 4700 Wissahickon Ave., Philadelphia, Pa. For mail: 570 W. Clapier St., Philadelphia, Pa.
- DE AMICIS, D. SICARI (A'29), Physicist, Television Corporation, 346 Claremont Ave., Jersey City, N.J. For mail: 821 Bergen Ave., Jersey City, N.J.
- DEAN, C. E. (A'29), Engineer, Hazeltine Service Corporation, 333 W. 52nd St., New York, N.Y.
- DEAN, LEON W. (A'29), Tester, F. A. D. Andrea, Inc., Long Island City, N.Y. For mail: 1121 Bedford Ave., Brooklyn, N.Y.
- DEAN, SAMUEL W. (J'14-A'18-M'26), Telephone Engineer, American Telephone and Telegraph Company, 195 Broadway, Rm. 1607, New York, N.Y.
- DEANER, HAYDN M. (A'29), Clerk, Reading Iron Company, 211 Church St., Danville, Pa.
- DEARDORFF, RALPH W. (A'14), Pacific Telephone and Telegraph Company, Dexter-Horton Bldg., Seattle, Wash.
- DE BARDELEBEN, JOHN F. (A'27), Chief Radio Operator, S.S. "Bessemer City" Isthmian S.S. Line, 50 Trinity Pl., New York, N.Y. For mail: 723 Elizabeth St., Brownsville, Tex.
- DE BAUN, GEORGE H. (A'26), Lieutenant, U. S. Navy, V.B. Squadron 2B, Fleet Air Base, San Diego, Calif.
- DE BELLESCIZE, HENRI J. J. M. (M'26), 47 Boulevard de La Seine, Neuilly (Seine), France.
- DE BOZAS, GUY DU BOURG (A'19), De lasko d'Enterprises Electro-Techniques, Paris, France. For mail: 35 Rue du General Foy, Paris, France.
- DE BURGH, DESMOND H. (A'24-M'26), Lloyd's Bank, 68 Warwick Square, London, S.W., England.
- DECINO, ALFRED (A'29), Research Work, Bell Telephone Laboratories, Inc., 463 West St., New York, N.Y.
- DECKER, DONALD PHILIPS (A'29), 156 Summit Ave., Mt. Vernon, N.Y.
- DE COLA, RINALDO (A'29), Radio Engineer and Technical Writer, 1044 Fenton St., Niles, Ohio.
- DE COUTOULY, GUSTAVE C. (A'20), Radio Engineer, Bell Telephone Laboratories, 463 West St., New York, N.Y. For mail: Burnet Terrace, Madison, N.J.
- DEELEY, PAUL M. (A'26-M'29), Vice-President, Buckingham Radio Corporation, 440 W. Superior St., Chicago, Ill. For mail: 5746 Drexel Blvd., Chicago, Ill.
- DE FOREST, LEE (M'14-F'18), Inventor and Scientific Director, De Forest Phonoflms, Inc., 318 E. 48th St., New York, N.Y. For mail: 232nd St. and Riverside Dr., Spuyten Duyvil, N.Y.
- DE FOREST, M. J. (A'26), Recording Engineer, Brunswick Recording Laboratories, 799-7th Ave., New York, N.Y.
- DE GRAAFF, ANTONIUS (A'23), Library Dept., Philips' Glowlampworks, Ltd., Eindhoven, Holland.
- DE GRAVE, CLAUDE (A'27), Supervisor, Canadian Brandes Company, Ltd., Queens Quay, Toronto, Ont., Canada. For mail: 17, The Oaks, 100 Bain Ave., Toronto, Ont., Canada.
- DE HAVEN, THOMAS V. (A'25), Radio Dept., General Electric Company, Schenectady, N.Y. For mail: 1429 Dean St., Schenectady, N.Y.
- DEHMEL, RICHARD C. (A'28), Engineer, Bell Telephone Laboratories, Inc., 463 West St., New York, N.Y.
- DEILER, THEODORE G. (A'27-M'27), U. S. Supervisor of Radio, Room 217 Custom House, New Orleans, La.
- DE LAND, ROBERT E. (A'27), Radio Research, 708-29th St., Milwaukee, Wis.
- DELBERT, SIMON, JR. (A'17), Media, Pa.
- DEL COURT, GEORGE (A'28), President, Forest Radio Company, 3308 Garrison Blvd., Baltimore, Md.
- DE LIME, THOMAS L., JR. (A'27), President, Oradell Radio and Electric, Inc., Oradell Ave., Oradell, N.J. For mail: Oradell Ave., Oradell, N.J.
- DELLA CORTE, J. P. (A'27), Sonora Phonograph Company, 16 E. 40th St., New York, N.Y. For mail: 4110 Bronxwood Ave., New York, N.Y.
- DELLENBAUGH, F. S., JR. (M'21), Massachusetts Institute of Technology, Cambridge, Mass. For mail: 91 Spooner Rd., Chestnut Hill, Mass.
- DELLINGER, J. H. (F'23) Chief Physicist, Bureau of Standards, Washington, D.C. For mail: 6607 Delfield St., Chevy Chase, Md.
- DE LONG, OSCAR A., JR. (A'20), American Telephone and Telegraph Company, 195 Broadway, New York, N.Y. For mail: P. O. Box 190, Montclair, N.J.

- DE LORAIN, EDMOND M. (M'25), Radio Engineer, International Standard Electric Corporation, 46th Ave., De Breteuil, Paris, France.
- DELP, PAUL L. (A'29), Custom Radio Building and General Repairing, South Tamaqua, Pa.
- DEL ROSARIO, MANUEL S. (A'29), Chief Radio Instructor, Philippine School of Arts and Trades, Manila, P.I.
- DELWORTH, LEE J. (A'26), Officer-in-Charge, U. S. Naval Radio Station, San Juan, Porto Rico.
- DE MANN, WILLIAM (J'26), Radio Technician, Landay Bros., Inc., Radio Service Dept., 521 W. 23rd St., New York, N.Y. For mail: 1504 Prospect Pl., Brooklyn, N.Y.
- DEMAREST, CHARLES S. (A'22-M'26), Electrical Engineer, American Telephone and Telegraph Company, 195 Broadway, New York, N.Y.
- DE MELLO, WILLIAM (A'25), Electrical Research Products, Inc., 250 W. 57th St., New York, N.Y. For mail: Hatchville, E. Falmouth, Mass.
- DEMIKIS, ANTON, JR. (J'28), Student, Armour Institute of Technology, 33rd and Federal Sts., Chicago, Ill. For mail: 3128 Warren Ave., Chicago, Ill.
- DEMMER, A. H. (A'28), Radio Engineering, General Electric Company, Schenectady, N.Y. For mail: 113 S. Ferry St., Schenectady, N.Y.
- DEMPSEY, WILLIAM E. (A'29), Radiotriician, Bates and Mead Piano Company, 90 North St., Middletown, N.Y. For mail: 174 W. Main St., Middletown, N.Y.
- DEMUTH, G. W. (J'29), Wiring Power Amplifier, Royaltone Company, 1510 E. Douglas Ave., Wichita, Kan. For mail: 320 S. Minnesota Ave., Wichita, Kan.
- DE NARDO, FEDERIGO (J'29), Radio Test Dept., General Electric Company, Schenectady, N.Y. For mail: 325 Van Vranken Ave., Schenectady, N.Y.
- DENNIS, FRANK L. (A'23), Radio Engineer, Bangkok, Siam. For mail: c/o Marconi's Wireless Telegraph Company, Marconi House, Strand, London, W.C. 2, England.
- DENNY, R. C. (A'20), Operating Engineer, San Joaquin Light and Power Corporation, Fresno, Calif. For mail: 1516 McKenzie Ave., Fresno, Calif.
- DENSHAM, ROBERT S. (A'26), Maintenance Engineer, New York Telephone Company, 360 Bridge St., Brooklyn, N.Y. For mail: 44 Willow St., Floral Park, L.I., N.Y.
- DENTON, FRANK O. (A'29), Clerk, New York Central and St. Louis Railroad, Rankin, Ill. For mail: Box 195, Rankin, Ill.
- DER BEDROSSYAN, MARK (A'28), Radio Inspector and Tester, American Bosch Magneto Corporation, Springfield, Mass. For mail: 3310 Main St., Springfield, Mass.
- DE REMER, C. W. (A'27-M'28), Chief Engineer, Research Laboratory, Utah Electric Radio Company, Salt Lake City, Utah. For mail: 925 Wilson Ave., Salt Lake City, Utah.
- DERING, FRED J. (A'26), Proprietor, National Radio Laboratory, 1071 1/2 N. Western Ave., Hollywood, Calif. For mail: 952 N. Hobart Blvd., Hollywood, Calif.
- DESNOES, ARNOLD B. (A'25), Telephone Engineer, New York Telephone Company, 1775 Grand Concourse, New York, N.Y.
- DE SOUSA, GEORGE S. (M'16), Treasurer, Radio Corporation of America, 233 Broadway, New York, N.Y.
- DETRICK, HAROLD M. (A'29), U. S. Radio and Television Corporation, Marion, Ind. For mail: 1725 S. Gallatin St., Marion, Ind.
- DETSKY, CHARLES F. (A'21), Technical Director, Standard Electric Company, Ltd., Ujpest, 4, Near Budapest, Hungary.
- DEWEILER, JAY E. (J'28), Experimenter, 2021 N. 6th St., Harrisburg, Pa.
- DETWILER, DONALD J. (A'29), Senior Scientific Radio Aid, Bureau of Standards, Radio Division, Washington, D.C. For mail: 1120 Virginia Ave., S.W., Washington, D.C.
- DEUTSCH, E. J. (A'29), Assistant Wire Chief, Postal Telegraph Company, West 6th and Superior Aves., Cleveland, Ohio. For mail: 4124 Baily Ave., Cleveland, Ohio.
- DEUTSCHMAN, BORAH (J'29-A'29), Student, Radio Institute of America, 326 Broadway, New York, N.Y. For mail: 17 S. 6th St., Easton, Pa.
- DEVAUD, ALBERT J. (A'26), Radio Engineer, General Electric Company, Bldg. 77, Room 408, Schenectady, N.Y.
- DEVENDORF, H. H. (A'14), Estimating Engineer, Electric Dept., Allis-Chalmers Manufacturing Company, Milwaukee, Wis. For mail: 202 Red Arrow Court, Wauwatosa, Wis.
- DEVINE, WILLIAM F. (A'26), Supervisor and Instructor of Installation, Western Electric Company, Ltd., Bush House, Aldwych, London, W.C. 2, England.
- DE WALT, K. C. (A'29), Research Assistant, Research Laboratory, General Electric Company, Schenectady, N.Y.
- DE WART, ROBERT G. (M'22), Engineer-in-Chief's Office, Alder House, Aldersgate, London, E.C., England.
- DE WESSE, HERBERT WILLIAM (A'29), Laboratory Assistant, Day-Fan Electric Company, Dayton, Ohio. For mail: 521 Nagley Pl., Dayton, Ohio.
- DEWEY, FRED L. (A'25), District Manager, Federal Telegraph Company, 730 S. Spring St., Los Angeles, Calif.
- DEWHIRST, THORNTON P. (A'25), Research Consultant, Power Cinephone Equipment Corporation, 723-7th Ave., New York, N.Y. For mail: 31-25-33rd St., Astoria, L.I., N.Y.
- DE WITT, HAROLD (A'29), Sales and Service Manager, O. A. Hesla Company, Box 658, Prescott, Ariz.
- DIAMOND, HARRY (A'26), Radio Engineer, Bureau of Standards, Washington, D.C. For mail: 3221 Connecticut Ave., N.W., Apt. 103, Washington, D.C.
- DIAMOND, HARVEY (A'16), General Manager, Compania Chilena de Elec. Ltd., Casilla 1557, Santiago, Chile, South America.
- DIAMOND, HYMAN (A'29), Engineer, Westinghouse Electric and Manufacturing Company, Radio Engineering Dept., Pittsburgh, Pa. For mail: 733 Cheslett St., Pittsburgh, Pa.

- DIAZ, ERNESTO (A'29), Assistant Research Engineer, United Scientific Laboratories, 117-119-4th Ave., New York, N.Y. For mail: 273 W. 113th St., New York, N.Y.
- DIBBLEE, JOHN (A'28), General Superintendent, Hydro-Electric Power Commission, P. O. Box 160, Niagara Falls, Ontario, Canada.
- DI BLASI, JOHN (A'19-M'28), General Manager, Radio Dept., Stanley and Patterson, Inc., 150 Varick St., New York, N.Y. For mail: 4310 Bay View Ave., Little Neck, L.I., N.Y.
- DICKEY, EDWARD T. (J'15-A'17-M'23), Engineer, RCA-Victor Company, Inc., Bldg. 5, Camden, N.J.
- DICKEY, J. W. (A'27), Proprietor, J. W. Dickey, Radio Engineering and Repairing, 1924 Ave. M., Galveston, Tex.
- DICKINS, GODFREY (J'29), Radio Repairman, P. O. Box 131, Lake Worth, Fla.
- DICKINSON, THEODORE M. (A'29), Vacuum-Tube Development Engineer, Research Laboratory, General Electric Company, Schenectady, N.Y. For mail: 205 Seward Pl., Schenectady, N.Y.
- DICKSON, H. L. (A'29), Production Engineer, Echophone Radio Manufacturing Company, Inc., 958 N. Formosa St., Hollywood, Calif. For mail: 315 La Bertha Apts., 960 S. Oxford Avenue, Los Angeles, Calif.
- DIECKMAN, WILLIAM (J'29), Radio Serviceman, The Durango Drug Company, Durango, Colo. For mail: P. O. Box 594, Durango, Colo.
- DIEHL, CHARLES B. (A'28), Telegrapher, Missouri Pacific Railway Company, 15th and Grace Sts., Omaha, Neb. For mail: 5605 Cedar St., Omaha, Neb.
- DIEHL, WILLIAM F. (A'19-M'29), Assistant Chief Engineer, RCA-Victor Company, Inc., Camden, N.J. For mail: 19 Evergreen Lane, Haddonfield, N.J.
- DIETRICH, FREDERICK (A'14), Vice-President, Kolster Radio Corporation, 200 Mt. Pleasant Ave., Newark, N.J. For mail: 1136-5th Ave., New York, N.Y.
- DIETSCH, CARL G. (J'18-A'23), Transmitting Engineer, Radio Corporation of America, Radio Central, Rocky Point, L.I., N.Y. For mail: 2214 Putnam St., Toledo, Ohio.
- DIETZE, EGINHARD (A'19), Engineering Dept., American Telephone and Telegraph Company, 195 Broadway, New York, N.Y.
- DIGGLE, A. J. (A'27), British Wireless Marine Service, East Ham, London, England. For mail: Sketchley Cottages, Hinckley, Leicestershire England.
- DIGHE, K. S. (A'29), D.R.E., Radio Electric Company, Kathiawad Diwanji's Wada, Bava-jipura, Borda, India.
- DI GIACOMO, ANIELLO (A'27), Radio Synchronizer, Colonial Radio Corporation, 25 Wilbu: St., Long Island City, L.I., N.Y. For mail: 270 Nagle Ave., New York, N.Y.
- DILL, GEORGE C. (A'16), Electrical Engineer, Westinghouse Electric and Manufacturing Company, East Pittsburgh, Pa. For mail: 1015 Farragut St., East Liberty Station, Pittsburgh, Pa.
- DILLABY, EDWIN F. (A'29), Engineering Laboratory, Raytheon Manufacturing Company, Cambridge, Mass. For mail: 46 Francesca Ave., Somerville, Mass.
- DILLENBECK, PRESTON VAN D. (A'27), Sales and Service Engineer, Lawler Bros., 920 Broadway, Bayonne, N.J. For mail: 15 Broadway, Bayonne, N.J.
- DILLOW, ARTHUR P. (A'27), Radioman, 1st Class, U.S.S. "Downes," New London, Conn. For mail: Alamosa, Colo.
- DIMOND, BENJAMIN D. (A'28), Telegrapher and Wire Chief, Missouri Pacific R.R., Union Station, Atchison, Kan. For mail: 202 N. 2nd St., Atchison, Kan.
- DINGA, EMIL (A'24), Engineer, National Broadcasting Company, 711-5th Ave., New York, N.Y. For mail: 179 Union Ave., Tarrytown, N.Y.
- DINGER, HAROLD E. (A'27), Instructor, McKim Radio Schools, Ash St., Akron, Ohio. For mail: 218 Westwood Ave., Akron, Ohio.
- DINGLEY, EDWARD N., JR. (A'28), Engineer, Mackay Radio and Telegraph Company, 67 Broad St., New York, N.Y.
- DINSDALE, ALFRED (A'26), Editor, "Television," Television Press, Ltd., 26 Charing Cross Rd., London, England. For mail: Mogador Cottage, Lower Kingsword, Walton Heath, Surrey, England.
- DISBROW, JOHN D. (A'25), Engineer, Radio Stations WTAM-WEAR, Inc., 1367 E. 6th St., Cleveland, Ohio.
- DISSER, WILLIAM G. (J'25), Telephone Engineer, American Telephone and Telegraph Company, 40 Rector St., New York, N.Y. For mail: 1340 Albany Ave., New York, N.Y.
- DITCHAM, WILLIAM T. (M'14), Research Engineer, Marconi's Wireless Telegraph Company, Ltd., Marconi Works, Chelmsford, England. For mail: Tudor House, Broomfield Rd., Chelmsford, England.
- DIVER, FREDERICK G. (J'24-A'26), Test Dept., L. McMichael, Ltd., Wexham Rd., Slough, Bucks, England. For mail: c/o Mr. J. E. Owen, 119 Valette Rd., Acton, London, W.3, England.
- DIXON, ASHLEY C. (A'28), Proprietor, Broadcast Station, Suite 620-22 Lumbermans Bldg., Portland, Ore. For mail: 1350 E. 36th St., Portland, Ore.
- DIXON, C. C. (A'27), Radio Sales and Promotion Dept., Milnor Electric Company, 129 Government Square, Cincinnati, Ohio. For mail: 3746 Wieman Ave., Cincinnati, Ohio.
- DIXON, RONALD (A'28), Sound Manager, Gaumont-British Picture Corporation, London Provincial Cinemas and Theaters, Ltd., 4-6 Denman St., Piccadilly Circus, London, W.1, England. For mail: 29 Lea Rd., Dronfield, Near Sheffield, England.
- DLUGATCH, IRWIN (J'29), Radio Technician, 825 De Kalb Ave., Brooklyn, N.Y.
- DOBBS, F. W. (A'26), Chief Engineer and Sales Manager, Square Deal Radio Company, Fenton, Mich. For mail: 217-1st St., Fenton, Mich.
- DOBBS, HARRY F. (A'22), President, Harry F. Dobbs, Inc., 245 Spring St. N.W., Atlanta, Ga.

- DOBLER, WILLIAM** (A'28), Elevator Electrician, Chase National Bank, 20 Pine St., New York, N.Y. For mail: 243 Sumner Ave., Brooklyn, N.Y.
- DODDS, LEE L.** (A'26), Superintendent, The Victoreen Radio Company, 2825 Chester Ave., Cleveland, Ohio.
- DODGE, ALBERT O.** (A'28), Radio Engineer, General Electric Company, Schenectady, N.Y. For mail: 170 McClellan St., Schenectady, N.Y.
- DODGE, JOSEPH B.** (A'20), Manager, Club Huts and Camps, Appalachian Mountain Club, 5 Joy St., Boston, Mass. For mail: Pinkham Notch Hut, Gorham, N.H.
- DOELLNER, LE ROY J.** (A'28), New City, Rockland County, N.Y.
- DOGERTY, GEORGE H. M.** (J'28), Student, Philadelphia School of Wireless Telegraphy, 1533 Pine St., Philadelphia, Pa. For mail: 1507 Porter St., Philadelphia, Pa.
- DOHERTY, WILLIAM H.** (A'29), Radio Engineer, Bell Telephone Laboratories, Inc., Whippany, N.J.
- DOIG, JOHN H.** (A'27), Instructor, Senior High School, San Diego, Calif. For mail: 4177 Alabama St., San Diego, Calif.
- DOKAS, KONSTANTINOS B.** (A'20), President, Dokas Radio and Physics Research Laboratories, 716 Jefferson St., Toledo, Ohio. For mail: 903 Addison St., Chicago, Ill.
- DOLBEAR, BENJAMIN L.** (A'14-M'15), Radio Engineer, Wireless Specialty Apparatus Company, Jamaica Plain, Boston Mass. For mail: 206 School St., Belmont, Mass.
- DOLESH, FRANK J.** (J'21-A'22), Engineer, Western Electric Company, Chicago, Ill. For mail: 38 Milford Ave., Newark, N.J.
- DOLID, ABRAHAM** (J'20-A'23), Tester, Western Electric Company, 397 Hudson St., New York, N.Y. For mail: 2113-63rd St., Brooklyn, N.Y.
- DOLPH, STANLEY E.** (A'15), President and General Manager, Scranton Pump Company, 1445 Meylert Ave., Scranton, Pa. For mail: 732 N. Webster Ave., Scranton, Pa.
- DOMÉ, ROBERT B.** (A'27), Engineer, General Electric Company, Schenectady, N.Y. For mail: 13-9th St., Schenectady, N.Y.
- DOMIZI, DANTE** (A'27), Radio Engineering, Rusdan Radio Corporation, 1743 Strathmore Ave., E. Cleveland, Ohio. For mail: 3097 West Boulevard, Cleveland, Ohio.
- DONALDSON, ROBERT O.** (A'25), Operator-in-Charge, Airways Communication Station, Dept. of Commerce, Municipal Airport, Cleveland, Ohio. For mail: 18000 Larchwood Ave., Cleveland, Ohio.
- DONBAR, C. FLOYD** (A'27), Chief Engineer, Radio Station KQV, 807 Plaza Bldg., Pittsburgh, Pa. For mail: 233 S. Starr Ave., Bellevue, Pa.
- DONLON, BERNARD J.** (A'25), Seneca Vocational School, Buffalo, N.Y. For mail: 359 Hampshire St., Buffalo, N.Y.
- DONOVAN, DANIEL R.** (A'26), Westinghouse Lamp Company, 210 Franklin St., Bloomfield, N.J.
- DOODY, WILLIAM R.** (A'29), Radio Service and Salesman, Majestic Distributing Company, N. 703 Division St., Spokane, Wash. For mail: W. 317-4th Ave., Spokane, Wash.
- DOOLITTLE, FRANKLIN M.** (A'13), President, The Doolittle Radio Corporation, Hotel Taft, New Haven, Conn. For mail: 167 Wilard St., New Haven, Conn.
- DORAZIL, A. F.** (A'28), Radio Service Manager, Cleveland Ignition Company, Chester Ave at E. 22nd St., Cleveland, Ohio. For mail: 2304 Tampa Ave., Cleveland, Ohio.
- DOREMUS, CORNELIUS W.** (A'29), Assistant Radio Inspector, Radio Test Shop, Navy Yard, Washington, D.C. For mail: 618 Morris St., N.E., Washington, D.C.
- DORN, HARRY P.** (A'27), Inventor, 9007 Detroit Ave., Cleveland, Ohio.
- DORSEY, HERBERT G.** (M'19), Senior Electrical Engineer, U. S. Coast and Geodetic Survey, Washington, D.C.
- DOTY, W. E.** (A'25), Research Engineer, Sanitarium Equipment Company, Battle Creek, Mich. For mail: R. 6, Box 786, Battle Creek, Mich.
- DOUBLES, DAVID J.** (A'29), Chief of Testing Dept., Aerovox Wireless Corporation, 78 Washington St., Brooklyn, N.Y. For mail: 118 E. 103rd St., New York, N.Y.
- DOUGLAS, EARL C.** (A'23), 5508 Montrose Ave., Altoona, Pa.
- DOUGLAS, JAMES M.** (A'27), Proprietor, Peerless Radio Shop, 4433 N. Robey St., Chicago, Ill.
- DOUGLAS, NORVEL** (J'27), Douglas Radio Company, 908 Mass. St., Lawrence, Kan. For mail: 1622 New Hampshire St., Lawrence, Kan.
- DOUGLAS, WILLIAM A.** (A'27), Engineer, The Pacific Telephone and Telegraph Company, 1200-3rd Ave., Rm. 1000, Telephone Bldg., Seattle, Wash.
- DOUTHIT, M. L.** (A'27), General Engineering Laboratory, General Electric Company, Schenectady, N.Y. For mail: 8 Grosvenor Square, Schenectady, N.Y.
- DOVER, M. H.** (J'28), Manager, Radio Dept., Standke Music Company, 225 Baronne St., New Orleans, La. For mail: 3706 Danned St., New Orleans, La.
- DOW, CLIFFORD J.** (A'28), Radio Engineer, Federal Telegraph Company, Palo Alto, Calif.
- DOW, J. B.** (M'26), Lieutenant, U. S. Navy, Radio Division, Bureau of Engineering, Navy Dept., Washington, D.C.
- DOW, M. THORNTON** (A'19), Engineer, American Telephone and Telegraph Company, Dept. of Development and Research, 195 Broadway, New York, N.Y. For mail: 605 Beecher St., Elmira, N.Y.
- DOWD, ALFRED** (J'27), Box 207, St. Louis College, Annapolis, Md.
- DOWIE, JAMES A.** (A'20-M'26), Chief Instructor, National Radio Institute, 1223 Connecticut Ave., N.W., Washington, D.C. For mail: Washington Ave., North Braddock, Alexandria, Va.
- DOWNEY, WILLIAM C.** (A'29), Westinghouse Electric and Manufacturing Company, East Pittsburgh, Pa. For mail: 718 Ross Ave., Wilkinsburg, Pa.
- DOWNEY, W. E.** (M'28), Assistant Chief, Radio Division, U. S. Dept. of Commerce, Washington, D.C.

- DOWNING, GEORGE E. C.** (A'28), Head of Radio Section, London Electric Wire Company, Smiths, Ltd., Church Rd., Leyton, London, E. 10, England. For mail: 15 Courtney Rd., London, N. 7, England.
- DOWNING, RICHARD E.** (A'29), Engineer, American Telephone and Telegraph Company, 406 E. Church St., Elmira, N.Y. For mail: P. O. Box 402, Elmira, N.Y.
- DOWSETT, HARRY M.** (M'16), Marconi's Wireless Telegraph Company, Ltd., Marconi House, Strand, London, W.C.2, England. For mail: 47 Drayton Gardens, Winchmore Hill, London, N. 21, England.
- DOYEL, LEE CONAN** (A'28), Radio Service Engineer, Community Radio Service, Crawfordsville, Ind. For mail: General Delivery, Linnburg, Ind.
- DOYLE, E. D.** (A'27), Assistant Director of Development, Leeds and Northrup Company, 4901 Stenton Ave., Philadelphia, Pa.
- DOYLE, E. J.** (A'29), Engineer, Transformer Corporation of America, 2309 S. Keeler Ave., Chicago, Ill. For mail: 206 Ayres Ave., Hinsdale, Ill.
- DRAIGH, CANTON V.** (A'28), Assistant Superintendent, RCA Communications, Inc., San Juan, Porto Rico.
- DRAKE, FREDERICK H.** (A'25-M'28), Radio Frequency Laboratories, Boonton, N.J. For mail: 334 Morris Ave., Boonton, N.J.
- DRAKE, GEORGE P.** (J'27-A'29), Marine Radio Operator, Blue Funnel Line, Alfred Holt and Company, Wireless Dept., India Bldgs., Water St., Liverpool, England. For mail: 53 Shepherds Lane, Harehills, Leeds, Yorks, England.
- DRAKE, NORMAN B.** (A'28), Civil Engineer and Draftsman, Mid-Continent Petroleum Corporation, 1006 Casden Bldg., Tulsa, Okla. For mail: 210 W. 8th St., Tulsa, Okla.
- DREHER, CARL** (A'17-M'23-F'28), Director of Sound Dept., RKO Studios, 780 Gower St., Los Angeles, Calif. For mail: R.C.A. Photophone, Inc., 411-5th Ave., New York, N.Y.
- DREISBACH, BLAIR** (A'29), Radiotrician, 614 N. 8th St., Allentown, Pa. For mail: 617 N. St. Elmo St., Allentown, Pa.
- DREISBACH, ROBERT H.** (A'28), Engineer, United Reproducers Corporation, Long Island City, L.I., N.Y. For mail: 47-10 S. Parsons Blvd., Flushing, L.I., N.Y.
- DRESHER, G. A.** (A'28), Radio Engineer, John M. Hough, 21 W. Center St., Shenandoah, Pa. For mail: 230½ W. Center St., Shenandoah, Pa.
- DRESSER, CARL C.** (A'27), 32 Cameron Ave., Windsor, Ont., Canada.
- DREW, CHARLES E.** (A'23-M'27), Technical Radio Instructor, Radio Institute of America, 326 Broadway, New York, N.Y. For mail: 21 Spruce St., Box 82, New York, N.Y.
- DREWS, ERNEST** (J'26-A'29), 102 Ogden Ave., Jersey City, N.J.
- DREYER, HARRY W.** (M'29), Engineer, R.C.A. Photophone, Inc., 411-5th Ave., New York, N.Y. For mail: 1244 E. 35th St., Brooklyn, N.Y.
- DRISKO, BENJAMIN B.** (A'28), Statistician, W. and J. Sloane Company, 575-5th Ave., New York, N.Y. For mail: c/o Technology Club of N.Y., 22 E. 38th St., New York, N.Y.
- DROBRIG, LEO** (A'26), Automotive Engineer, Transport Motor Company, Sprague and Madison, Spokane, Wash. For mail: 1408 W. Alice Ave., Spokane, Wash.
- DRUEDING, ALBERT J.** (A'18), Drueding Brothers, Philadelphia, Pa. For mail: Mountain and Prospect Aves., Melrose Park, Oak Lane Station, Pa.
- DRUMMOND, P.** (A'29), Manager, Machine Development Depts., Dry Cells Division, National Carbon Company, Cleveland, Ohio. For mail: 1288 Ramona Ave., Lakewood, Ohio.
- DRUMMOND, RALPH S.** (A'21), Acme Apparatus Company, 440 S. Dearborn St., Chicago, Ill. For mail: 933 N. East Ave., Oak Park, Ill.
- DRURY, PAUL O.** (A'27), Manager, Test and Design Dept., Splittorf Radio Corporation, Thomas A. Edison Industries, Orange, N.J. For mail: 242 Broad St., Newark, N.J.
- DRYLAND, ALAN G.** (M'29), Assistant Engineer-in-Charge, British Broadcasting Corporation, Savoy Hill, London, England. For mail: Windycot-Sugden Rd., Long Ditton, Surrey, England.
- DUBILIER, WILLIAM** (A'14-M'18-F'29), Executive and Consulting Engineer, 10 E. 40th St., New York, N.Y.
- DU BOIS, EDWARD P.** (J'28), Student, University of Detroit, Detroit, Mich. For mail: 7703 Sherwood Ave., Detroit, Mich.
- DUBUCLET, SIDONIO L.** (A'27), Director, Chah C'Mines, Inc., Central City, Colo. For mail: 3722 Concord Pl., Chicago, Ill.
- DUCATI, ADRIANO C.** (A'28), Technical Director, Societa Scientifica Radio, 51 Secondo, Guidotti, Bologna, Italy. For mail: 51 Viale Guidotti, Bologna, Italy.
- DUDLEY, BEVERLY** (J'24-A'27), Manager, Technical Information Bureau, American Radio Relay League, 1711 Park St., Hartford, Conn.
- DUDLEY, CHARLES B., JR.** (A'29), Radio Service Engineer, Sparks-Withington Company, Jackson, Mich. For mail: 1413 John St., Baltimore, Md.
- DUDLEY, D. CLINTON** (A'27), Assignment Supervisor, Bell Telephone Company, 2013 S. Broad St., Philadelphia, Pa. For mail: 282 Timberlake Rd., Stonelhurst, Upper Darby, P.O., Pa.
- DUFFY, CHARLES A.** (A'29), Radio Service, Famous and Barr Company, Spring and Market Sts., St. Louis, Mo. For mail: 2615 St. Vincent Ave., St. Louis, Mo.
- DU MARCE, HERMAN** (A'29), Manager and Operator, Radio Rm., 1st Signal Service Company, Seward, Alaska. For mail: Box 395, Seward, Alaska.
- DUMMETT, H. W.** (A'28), Experimental Radio Engineer, 626 Kings Highway, Brooklyn, N.Y. For mail: 1698 E. 21st St., Brooklyn, N.Y.
- DUNBAR, JAMES** (A'24), Radio Engineer, Thomson's Publications, Ltd., Albert Sq., Dundee, Scotland. For mail: 2 Birchwood Pl., Dundee, Scotland.

- DUNCAN, DON C. (A'29), Student, University of Illinois, Urbana, Ill. For mail: 804 S. Prospect Ave., Champaign, Ill.
- DUNCAN, JAMES E. (A'26), 8520-104th St., Edmonton, S., Alberta, Canada.
- DUNCAN, R. D., JR. (A'13-M'25), Chief Engineer, Wired Radio, Inc., 60 Broadway, New York, N.Y. For mail: 250 Harrison St., East Orange, N.J.
- DUNCAN, RUDOLPH L. (A'22-M'26), Director of Instruction, Radio Institute of America, 326 Broadway, New York, N.Y.
- DUNHAM, JOHN S. (A'26), President, QRV Radio Service, Inc., 155 W. 72nd St., New York, N.Y.
- DUNLAP, ORRIN E., JR. (M'25), Radio Editor, "New York Times," 229 W. 43rd St., New York, N.Y.
- DUNN, GANO (F'15), President, The J. E. White Engineering Corporation, 43 Exchange Pl., New York, N.Y.
- DUNN, JAMES C. (A'28), Draftsman, George W. Smith Woodworking Company, 1651 S. 51st St., Philadelphia, Pa. For mail: 1439 Sparkes St., Philadelphia, Pa.
- DUNN, LAWRENCE J. (A'24-M'26), Dentist, 80 Hanson Pl., Brooklyn, N.Y.
- DUNNIGAN, FRANK A. (A'29), Transmission Engineer, Pacific Telephone and Telegraph Company, 501-2nd Ave., Spokane, Wash. For mail: Roosevelt Apts., Apt. 207, Spokane, Wash.
- DUNNING, JOHN R. (A'28), Instructor, Dept. of Physics, Columbia University, New York, N.Y.
- DUNNING, ORVILLE M. (A'27), Chief Engineer, Sonora Phonograph Company, 1738 Elmwood Ave., Buffalo, N.Y.
- DUNPHY, THOMAS O. (A'27), Operator, Sea Going Staff, British Wireless Marine Service, Marconi House, Strand, London, England. For mail: 21 Shortcourse, Waterford City, Ireland.
- DUPREE, EDMUND M. (A'22-M'28), President, Star Electric and Engineering Company, 613 Fannin St., Houston, Tex.
- DUPUIS, ERNEST F. (J'29), Assistant Shipping Clerk, The Allen A. Smith Company, 1216 W. Bancroft St., Toledo, Ohio. For mail: 1357 Elmwood Ave., Toledo, Ohio.
- DURAN, ALBERT E. (A'29), Chief Engineer, Station WAPI, Protective Life Bldg., Birmingham, Ala. For mail: 901 S. 38th St., Birmingham, Ala.
- DURANTE, JEAN ANDRE (A'27), Service Manager, North America Radio Sales Company, 4608 Prospect Ave., Cleveland, Ohio. For mail: 8624 Wade Park Ave., Cleveland, Ohio.
- DURKEE, JAMES D. (M'29), Chief Communications Engineer, Universal Wireless Communication Company, Inc., 4111 Ravenswood Ave., E., Chicago, Ill.
- DURKEE, K. M. (A'29), Government Radio Inspector, 504 Connaught Bldg., Saskatoon, Sask., Canada.
- DURRANT, REGINALD F. (M'27), Civil Aviation Radio, Rm. 613, Air Ministry, London, England.
- DU TREIL, L. J. N. (A'14-M'26), Radio Inspector, U. S. Department of Commerce, New Orleans, La. For mail: 480 Audubon St., New Orleans, La.
- DUTTERA, W. S. (J'25-A'28), Radio Development Dept., General Electric Company, 306 Lenox Rd., Schenectady, N.Y.
- DUTTON, CHARLES E. (A'27), District Plant Engineer, American Telephone and Telegraph Company, 256 N. Meridian St., Indianapolis, Ind.
- DUTTON, GEORGE I. (A'28), 3523 Fremont St., Westleysville, Pa.
- DUVAL D'ADRIAN, A. L. (M'29), Chief Research Chemist, Illinois Glass Company, Alton, Ill. For mail: 1124 Washington St., Alton, Ill.
- DWYER, ROBERT J. (A'28), Student, University of Cincinnati, Cincinnati, Ohio. For mail: 2210 Madison Ave., Norwood, Ohio.
- DWYER, VINCENT J. (A'29), Laboratory Assistant, Valley Appliances, Inc., 634 Lexington Ave., Rochester, N.Y. For mail: 55 Hortense St., Rochester, N.Y.
- DYE, LEAMAN A. (A'26), Instructor in Mathematics, Cornell University, Ithaca, N.Y. For mail: 615 Highland Pl., Ithaca, N.Y.
- DYSON, H. R. (A'26), Radio Engineer, Westinghouse Electric and Manufacturing Company, Chicopee Falls, Mass. For mail: 7 Pomona St., Springfield, Mass.

E

- EARLE, RALPH P. (A'25), Teacher, Overbrook High School, Philadelphia, Pa. For mail: Aldan, Delaware County, Pa.
- EARNHART, GLEN W. (A'26), U. S. Assistant Radio Inspector, 302 Federal Bldg., Denver, Colo.
- EARNSHAW, DAVID P. (A'28), Radio Engineer, Philadelphia Storage Battery Company, Ontario and C Sts., Philadelphia, Pa. For mail: 252 Rochelle Ave., Philadelphia, Pa.
- EAST, LAWRENCE A. W. (A'25), Radio Engineer, General Electric Company, Schenectady, N.Y. For mail: 13 State St., Schenectady, N.Y.
- EASTHAM, MELVILLE (A'13-M'13-F'25), President, General Radio Company, 30 State St., Cambridge, Mass.
- EASTMAN, AUSTIN V. (A'23), Assistant Professor of Electrical Engineering, University of Washington, Seattle, Wash.
- EASTON, J. H. (A'29), Chief Radioman, U. S. Navy, U. S. S. "Gilmer," 233, c/o Postmaster, New York, N.Y.
- EATON, GEORGE W., JR. (A'27), 1915 S. 12th St., Philadelphia, Pa.
- EATON, WALDO W. (J'27-A'28), Student, Iowa State College, Ames, Iowa. For mail: 4217 Dodge St., Omaha, Neb.
- EBERHARD, LAWRENCE E. (A'25), Assistant Manager, New York Credit Men's Adjustment Bureau, 468-4th Ave., New York, N.Y. For mail: 12 Hanford Pl., Caldwell, N.J.
- EBERHARDT, GEORGE M. (A'26), Laboratory Assistant, Bell Telephone Laboratories, Inc., P.O. Box 122, Deal, N.J.
- EBERLE, WILBERT H. (A'26), Secretary, Hickok Electrical Institute Company, 10514 Dupont Ave., Cleveland, Ohio. For mail: 1410 E. 110th St., Cleveland, Ohio.
- EBERLY, AUSTIN D. (A'26), Manager, Radio Service Laboratories, Spokane Battery and Ignition Company, 1201-3 Sprague Ave., Spokane, Wash. For mail: E. 903-10th Ave., Spokane, Wash.
- EBERT, BURTON E. (A'26), Advertising and Sales Promotion Engineer, The Pooley Company, 1600 Indiana Ave., Philadelphia, Pa. For mail: 532 W. Ellet St., Philadelphia, Pa.
- EBERT, SYLVANUS J. (A'28), Radio Operator, Broadcasting Station WSUI, State University, Iowa. For mail: 314 B. Water St., Watertown, Wis.
- EBY, HUGH H. (A'26), President, H. H. Eby Manufacturing Company, 4710 Stenton Ave., Philadelphia, Pa.
- EBY, JOHN B. (A'27), Electrical Engineer, American Telephone and Telegraph Company, 534 Bourse Bldg., Philadelphia, Pa. For mail: 1218 Overington St., Philadelphia, Pa.
- ECKERSLEY, P. P. (F'25), The Gramophone Company, Ltd., Head Office, Hayes, Middlesex, England.
- ECKERT, BRYON H. (A'28), Radio Sales and Service, Bee Automobile Company, 618-20-22 Linden St., Allentown, Pa. For mail: 333 N. 10th St., Allentown, Pa.
- ECKERT, EDWARD J. (A'26), Radio Salesman, H. C. Roberts Electric Supply Company, 1101-05 Race St., Philadelphia, Pa. For mail: 4606 A St., Philadelphia, Pa.
- ECKERT, WALTER R. (A'29), Morse Telegraph Operator, Western Union Telegraph Company, 29 S. Main St., Fond du Lac, Wis. For mail: 284 Dixie St., Fond du Lac, Wis.
- ECKWEILER, WARREN M., JR. (A'25), 4 Hammond Pl., Elmhurst, L.I., N.Y.
- EDE, FRANK C. (A'28), Electrical Engineer, Andersen, Meyer and Company, Shanghai, China. For mail: 51 E. Burkill Rd., Shanghai, China.
- EDELMAN, PHILLIP E. (A'14), 6802 Jeffrey Ave., Chicago, Ill.
- EDES, NOEL H. (A'22), c/o Messrs. Lloyds Bank, Ltd., Cox's and King's Branch, 6 Pall Mall, London, S.W. 1, England.
- EDGAR, J. CLIFTON (A'27), New York Telephone Company, 140 West St., New York, N.Y. For mail: 46 S. Oxford St., Brooklyn, N.Y.
- EDGCOMB, A. J. (A'27), Proprietor, The Wireless Shop, 150 Glendale Blvd., Los Angeles, Calif.
- EDGERLY, ALBERT HENRY (A'29), Radio Serviceman, Edgerly's Radio Service Company, Kensington, Conn.
- EDGEWORTH, KENNETH E. (M'27), Chief Engineer, Posts and Telegraphs Dept., General Post Office, Khartoum, Sudan, Africa.
- EDISON, THEODORE M. (A'28), Research Director, Edison Laboratories, Orange, N.J. For mail: 106 Walnut St., East Orange, N.J.
- EDWARDS, CHARLES (A'29), Balancing, Grigsby, Grunow Company, 4500 Armitage Ave., Chicago, Ill. For mail: 2787 Frances Pl., Chicago, Ill.
- EDWARDS, CHARLES P. (M'13-F'15), Director of Radio, Canadian Marine Dept., Ottawa, Ont., Canada.
- EDWARDS, EDMUND P. (M'25), Manager, Radio Dept., General Electric Company, Schenectady, N.Y.
- EDWARDS, GEORGE W. (J'27), Switchboard Repairman, Illinois Bell Telephone Company, Waukegan, Ill. For mail: 117 Franklin Ave., River Forest, Ill.
- EDWARDS, HENRY W. (A'25), Brunswick-Balke-Collender Company, 426 S. 3rd St., Minneapolis, Minn. For mail: Central Y.M.C.A., Minneapolis, Minn.
- EDWARDS, JOSEPH B. (A'14), Electrical Engineer, Weston Electrical Instrument Corporation, 4 Weston Ave., Newark, N.J. For mail: 2213 Berwyn St., Union, N.J.
- EDWARDS, LYMAN M. (A'28), Chief Operator, Station KGFF, University of Oklahoma, 708 Asp Ave., Norman, Okla. For mail: 515 S. Lincoln Ave., Enid, Okla.
- EDWARDS, R. M. (J'28), Wireless Engineers' Assistant, British Broadcasting Corporation, 1 Lochee Rd., Dundee, Scotland. For mail: 22 Nelson St., Dundee, Scotland.
- EDWARDS, SAMUEL W. (M'28), U. S. Supervisor of Radio, Department of Commerce, 2909 David Stott Bldg., Detroit, Mich.
- EELLS, M. MERWIN (A'22), Consulting Engineer, 6028 Dorchester Ave., Chicago, Ill.
- EHLE, FRANCIS R. (A'27-M'29), President, International Resistance Company, 2006 Chestnut St., Philadelphia, Pa. For mail: 900 Main St., Riverton, N.J.
- EHLERS, PAUL (A'23), Vice-President, Gwen Manufacturing Company, 102 S. Brady St., Davenport, Iowa. For mail: 619 Gaires St., Davenport, Iowa.
- EHLERT, FRED C. (A'26), Technical Radio Editor, "The Sun," 280 Broadway, New York, N.Y. For mail: 18612 Jordan Ave., Chapelle Gardens, Hollis, L.I., N.Y.
- EHRET, CORNELIUS D. (F'16), Patent Attorney, 2121 Land Title Bldg., Philadelphia, Pa. For mail: 6911 Clearview St., Mt. Airy, Philadelphia, Pa.
- EHRLMAN, HENRY O. (A'29), Akron District Manager, Atlantic Precision Instrument Company, 220 Hermes Bldg., Akron, Ohio.
- EICHMAN, JOHN, JR. (A'26), Manager, Radio Dept., McCarthy Brothers and Ford, 75 W. Mohawk St., Buffalo, N.Y. For mail: 347 Carlton St., Buffalo, N.Y.
- EILER, E. E. (M'24), Captain, Signal Battalion, Marine Barracks, Quantico, Va.
- EILERS, JOHN (J'27), 115 N. Adams St., Glendale, Calif.
- EISENHUER, HARRY D. (A'29), Radio Engineer, P.O. Box 86, Mount Rainier, Md.
- EKLUND, GUS (A'28), 330 Gregory Ave., Passaic, N.J.
- EKSTRAND, EDWARD B. (J'27), 47 Hancock St., West Somerville, Mass.
- ELAM, DAVID L. (A'25), President and Chief Engineer, Unique Radio Corporation, 1411 Grace St., Chicago, Ill. For mail: 714 Grace St., Chicago, Ill.

- ELDRIDGE, FRANK E. (M'25), Commercial Engineer, Westinghouse Electric and Manufacturing Company, 150 Broadway, New York, N.Y.
- ELDRIDGE, ROBERT H. (A'28), Real Estate Bldg., 531 S. Mariposa Ave., Los Angeles, Calif.
- ELIAS, LOUIS W. (A'28), Manager of Assembly, East Plant, Columbia Phonograph Company, Bridgeport, Conn.
- ELLER, KEITH B. (A'29), Engineer, Western Union Telegraph Company, 195 Broadway, New York, N.Y.
- ELLER, WALTER H. (M'25), Professor of Physics, State Teachers College, Macomb, Ill. For mail: 230 Ward St., Macomb, Ill.
- ELLER, WILLARD H. (A'19), Instructor in Physics, University of Hawaii, Honolulu, Hawaii.
- ELLERT, CHARLES A. (A'26), Radio Engineer, Westinghouse Electric and Manufacturing Company, East Pittsburgh, Pa. For mail: 609 S. Regester St., Baltimore, Md.
- ELLINGHAM, IRVING (A'28), Research Engineer, Empire News Company, 224 W. 34th St., New York, N.Y. For mail: 1308 E. 37th St., Brooklyn, N.Y.
- ELLINWOOD, KENNETH M. (J'29), Laboratory Work, Atwater Kent Manufacturing Company, 4700 Wissahickon Ave., Philadelphia, Pa. For mail: Thouron Ave. and Gorgas Lane, Mt. Airy, Philadelphia, Pa.
- ELLIOTT, FRANK E. (A'28), Wireless Engineer, Station 6WF, The Westralian Farmers, Ltd., Perth, W. Australia. For mail: 36 Fairfield St., Mt. Hawthorn, Perth, W. Australia.
- ELLIOTT, FRANK W. (A'27), Manager, Radio Station WOC, Davenport, Iowa.
- ELLIOTT, H. F. (M'25), Kingsway Patents, Haddonfield, N.J.
- ELLIOTT, HARRY M. (A'29), Proprietor, Elliott Radio Service, 4515 Freret St., New Orleans, La.
- ELLIOTT, ISAAC (A'28), Radio Engineer, The Elliott Radio Manufacturing Company, Ltd., 87 Senhouse St., Maryport, Cumberland, England.
- ELLIOTT, RALPH W. (A'27), Mechanic and Electrician, Prairie Pipe Line Company, P.O. Box 460, Rm. E., Independence, Kan.
- ELLIOTT, WILLIAM H. (A'29), Sawyer, Pickering Lumber Company, Tuolumne, Calif. For mail: Box 124, Tuolumne, Calif.
- ELLIS, GEORGE D. (A'25), Sound Recording Dept., Talking Pictures, R.C.A. Telephone, Pathé Studios, Hollywood, Calif. For mail: 2065 B. Hillhurst Ave., Hollywood, Calif.
- ELLIS, JAMES G., JR. (J'28), Radio Technician, Penmar Company, Inc., 1022 Connecticut Ave., Washington, D.C. For mail: 945 Kay St., Washington, D.C.
- ELLIS, ROBERT MARCUS (A'29), Technical Correspondent, Silver-Marshall, Inc., 6401 W. 65th St., Chicago, Ill. For mail: 6429 S. May St., Chicago, Ill.
- ELLIS, WILLIAM G. (A'19-M'25), District Sales Manager, Ohio Electric and Controller Company, 515 Atlantic Bldg., Philadelphia, Pa.
- ELLSWORTH, WILLIAM C. (A'26), Engineering Dept., Radio Division, Westinghouse Electric and Manufacturing Company, Chicopee Falls, Mass. For mail: 15 Arlington St., Chicopee Falls, Mass.
- ELSEA, FARREL F. (A'28), Set Builder and Repairman, Electric Auto Lite Company, 642 Lynn St., Fostoria, Ohio.
- ELSER, F. JOHNSON (A'28), Student, Massachusetts Institute of Technology, Cambridge, Mass. For mail: 410 Memorial Dr., Cambridge, Mass.
- ELWELL, CYRIL F. (M'14-F'18), Technical Adviser, British Talking Pictures, Ltd., 197 Queens Gate, London, S.W. 7, England.
- EMANUEL, JOHN H. (A'17), 181 Linden Ave., Englewood, N.J.
- EMERSON, CHARLES W., JR. (A'24), Assistant Engineer, New York Telephone Company, 140 West St., New York, N.Y.
- EMERSON, KENNETH H. (A'29), Engineering Dept., U. S. Radio and Television Corporation, Marion, Ind. For mail: 334 N. Washington St., Marion, Ind.
- EMERSON, R. WALDO (A'28), Manufacturing Furrier, F. W. Emerson and Son, 3 St. Ann's Terrace, St. John's Wood, London, N.W. 8, England.
- EMERY, E. J. (M'29), Service Manager, Marcomphone Company, Ltd., 210-212 Tottenham Court Rd., London, W. 1, England.
- EMERY, R. C. (A'14), John S. Emery Company, Inc., Boston, Mass. For mail: 125 State St., Boston, Mass.
- EMES, KARL C. (A'27), Testing and Inspecting Dept., DeForest Radio Corporation, 245 Carlaw Ave., Toronto, Ont., Canada. For mail: 104 Kenilworth Ave., Toronto, Ont., Canada.
- EMMERICH, HENRY J. S. (A'26), Manager, Radio Service, Parks and Hull, Inc., 1035 Cathedral Bldg., Baltimore, Md.
- ENDERLE, JACKSON J. (A'29), Installation Supervisor, Western Electric Company, Ltd., Bush House, Aldwich, London, W.C. 2, England.
- ENDERS, CHARLES F. (A'26), Radio Engineer, University Radio Company, 80 W. Kingsbridge Rd., New York, N.Y. For mail: 37 Hildreth Pl., Yonkers, N.Y.
- ENGEL, ALBERT L. (J'29), Assistant Engineer, Bell Telephone Laboratories, Inc., 401 West St., New York, N.Y. For mail: 1431 Concord Pl., Elizabeth, N.J.
- ENGEL, FRANCIS H. (A'25-M'28), Engineering and Test Dept., RCA-Victor Company, Inc., Camden, N.J.
- ENGEL, G. C. (A'28), Thomas A. Edison, Orange, N.J. For mail: 181 Upper Blvd., Ridgewood, N.J.
- ENGEN, RALPH E. (A'27), Manager, Radio Service, Glendale Music Company, Glendale, Calif. For mail: 1712 Woodland Lane, Glendale, Calif.
- ENGHOLM, BERNARD A. (A'22-M'27), Vice-President, The Rola Company, 2570 E. Superior Ave., Cleveland, Ohio.
- ENGLUND, CARL R. (A'17-F'28), Member Technical Staff, Bell Telephone Laboratories, Inc., Box 31, Cliffwood, N.J. For mail: 34 Court St., Freehold, N.J.

- ENGST, NORBERT K. (A'13), Engineer, Inspections Development Dept., Western Electric Company, Hawthorne Works, Chicago, Ill. For mail: 1812 S. 51st Ct., Cicero, Ill.
- ENGSTROM, ELMER W. (A'25), Engineer, General Electric Company, Radio Engineering Dept., Schenectady, N.Y.
- ENGWICHT, HARRY (J'22-A'26), Graduate Student, Stanford University, Stanford, Calif. For mail: 405 N. 3rd St., San Jose, Calif.
- ENNIS, FRED E. (A'26), New York Telephone Company, Nyack, N.Y. For mail: 9 Park Ave., Suffern, N.Y.
- ENTREKIN, CARL A. (A'25), President and General Manager, The Entrekin Electric Company, 222 Aragon Ave., Coral Gables, Fla.
- EPPSTEIN, RALPH M. (A'29), 4849 Lawndale Ave., Chicago, Ill.
- ERDMAN, H. (A'29), Manager, Wireless Manufacturers, Hogarth Works, Chiswick, London, England. For mail: 42 Fairhazel Gardens, Hampstead, London, N.W. 6, England.
- ERHARD, JOHN A. (A'27), Radio Serviceman, Q.R.V. Radio Service, Inc., 140 Halsey St., Newark, N.J. For mail: 311-28th St., Union City, N.J.
- ERICKSON, CARL E. (A'26), Construction Engineer, Communication Dept., Pan American Airways, Inc., Miami, Fla.
- ERICKSON, HERMAN E. (A'23), Proprietor, Leonia Radio-Auto Supply Company, 301 Central Ave., Leonia, N.J.
- ERNST, MURRAY C. (A'29), Transmitting Station, c/o American Telephone and Telegraph Company, Lawrenceville, N.J.
- ERWIN, RAYMOND W. (A'22), Superintendent, Canadian National Carbon Company, 805 Davenport Rd., Toronto 4, Ont., Canada.
- ESCOLANO, MANUEL (M'19), Ingeniero Telec. Compania Nacional de T.S.H., Calle de Alcalá 43, Madrid, Spain.
- ESCRICH, JAMES P. (A'14), Avenida Isabel la Católica, No. 41, Aguascalientes-Agtes, Mexico.
- ESMAKER, JOHN B. (A'27), Instructor in Physics, St. Ignatius High School, Chicago, Ill. For mail: 1076 Roosevelt Rd., Chicago, Ill.
- ESPENSCHIED, LLOYD (M'13-F'24), Electrical Engineer, American Telephone and Telegraph Company, 195 Broadway, New York, N.Y.
- ESSARY, WILLIAM M. (A'29), Technician, Radio Serviceman, P.O. Box 541, Corinth, Miss.
- ESTEN, PERRY W. (A'29), Radio Operator, Station WHEC, Hickson Electric Company, 65 Broad St., Rochester, N.Y. For mail: 64 Grafton St., Rochester, N.Y.
- ESTEY, F. CLIFFORD (A'21), Assistant to President, United Reproducers Corporation, Springfield, Ohio.
- ESVELD, CLARENCE D. (A'28), Service Manager, General District Corporation, 221 N. Ottawa Ave., Grand Rapids, Mich. For mail: 819 Prospect Ave., N.E., Grand Rapids, Mich.
- ETKIN, HARRY (A'25), Test Engineer, Brooklyn Edison Company, Inc., 360 Pearl St., Brooklyn, N.Y. For mail: 520 McClellan St., Philadelphia, Pa.
- EVANS, GEORGE L. (A'28), Service Manager, The Robert Simpson Company, Ltd., Toronto, Ont., Canada. For mail: 581 Huron St., Toronto 5, Ont., Canada.
- EVANS, HARRY R. (A'27), Proprietor, Evans Radio Service, Albion, Ind. For mail: 315 N. York St., Albion, Ind.
- EVANS, JAMES C. (A'25), Teacher, West Virginia Collegiate Institute, Institute, W.Va.
- EVANS, LEON R. (A'27), Electrical Engineer, Rm. 402, City Hall, Tacoma, Wash. For mail: 2109 N. Anderson St., Tacoma, Wash.
- EVANS, LOUIS M. (A'14), Chief Engineer, Signal Corps Laboratory, War Dept., Washington, D.C. For mail: 912 Cameron St., Alexandria, Va.
- EVANS, PORTER H. (M'23), Electrical Engineer, Vitaphone Corp., 1400 Locust Ave., Brooklyn, N.Y.
- EVANS, WALTER C. (M'28), Radio Operations Dept., Westinghouse Electric and Manufacturing Company, East Pittsburgh, Pa.
- EVANS, W. J. (A'28), Service Engineer, 912 Commerce St., Rm. 500, Dallas, Tex.
- EVANS, YOUNG W. P. (A'23-M'25), Engineer and Manager, Radio Communication Company, 66 Oxford Rd., Manchester, England. For mail: 2 Parkside Rd., Alexandra Park, Manchester, England.
- EVELETH, LAURENCE NELSON (A'29), Electrical Engineering Draftsman, New York Dept. of Agriculture, Albany, N.Y. For mail: 89 Robinson St., Schenectady, N.Y.
- EVEREST, AUGUSTINE R. (A'15), Consulting Engineer, British Thompson Houston Company, Ltd., Rugby, England.
- EVERETT, LIONEL E. B. (M'27), Radio Specialist and Consultant, Chintford, The Crescent, Nr. Bognor, Sussex, England.
- EVERETT, LYNN C. (A'14-M'18), Estimating Engineer, Radio Corporation of America, 66 Broad St., New York, N.Y.
- EVERITT, WILLIAM L. (A'25-M'29), Assistant Professor, Dept. of Electrical Engineering, Ohio State University, Columbus, Ohio.
- EVERT, W. E. (A'27), Proprietor, Everts Photo and Radio Shop, Main St., Lodi, Wis. For mail: 221 Parr St., Lodi, Wis.
- EVISON, SAMUEL J. (A'26), Service Manager, American Bosch Magneto Corporation, 89 W. Hancock Ave., Detroit, Mich. For mail: 5469 Seneca Ave., Detroit, Mich.
- EWALD, FRED J., JR. (A'28), Research Dept., Kellogg Switchboard and Supply Company, Aberdeen and Adams Sts., Chicago, Ill. For mail: 4912½ Jackson Blvd., Chicago, Ill.

- FAHNESTOCK, HARRIS, JR.** (A'27), Student, Harvard University, Cambridge, Mass. For mail: 162 Coolidge Hill, Cambridge, Mass.
- FAIN, EDGAR A.** (A'27), Service Engineer, Texas Radio and Electric Company, Ft. Worth, Tex. For mail: P.O. Box 584, Denton, Tex.
- FAIRBURN, A. J. B.** (A'28), Instructor in Electrical Engineering, Cooper Union, Cooper Sq., New York, N.Y.
- FAIRCHILD, F. EARLE** (A'21), Electrical Engineer, Dept. of Development and Research, American Telephone and Telegraph Company, 195 Broadway, New York, N.Y. For mail: 13 Kent Pl. N., Summit, N.J.
- FALKNER, FRANK B.** (A'20-M'28), Rm. 422, 549 W. Washington Blvd., Chicago, Ill. For mail: 7620 Phillips Ave., Chicago, Ill.
- FALLAIN, FRANK D.** (A'26), Engineer and Proprietor, Flint Broadcasting Company, Station WFDF, 511½ S. Saginaw St., Flint, Mich. For mail: 321-1st Ave., Flint, Mich.
- FALLON, GLOVER P.** (A'26), Consolidated Gas, Electric Light and Power Company, Baltimore, Md. For mail: 6 Elmhurst Rd., Roland Park, Baltimore, Md.
- FARNHAM, RALPH E.** (A'27), Electrical Engineer, General Electric Company, Nela Pk., Cleveland, Ohio. For mail: 1064 Greyton Rd., Cleveland Heights, Ohio.
- FARNSWORTH, DANIEL W.** (A'29), R.F.D., Clove Rd., Little Falls, N.J.
- FARNSWORTH, EARL S.** (A'22-M'26), National Electric School, Los Angeles, Calif. For mail: 329 N. Kenwood St., Glendale, Calif.
- FARNSWORTH, PHILO T.** (A'28), Director of Research, Crocker Research Laboratory, 202 Green St., San Francisco, Calif.
- FARNSWORTH, PHILIP** (M'13-F'15), Counsellor at Law, 233 Broadway, New York, N.Y.
- FARNUM, WILLIS H.** (A'29), Technician, Radio Station KGB, 1012-1st St., San Diego, Calif. For mail: 736 York Ct., Mission Beach, Calif.
- FARRAND, C. L.** (A'14-M'23), President, Farrand Manufacturing Company, 11 Court St., Long Island City, L.I., N.Y.
- FARRINGTON, JOHN F.** (A'19-M'29), Radio Engineer, International Communications Laboratories, Inc., 67 Broad St., New York, N.Y.
- FASS, SYDNEY J.** (A'26), Radio Dept., The White House, San Francisco, Calif.
- FAST, JOHN E.** (A'27), Manufacturer, 3982 Barry Ave., Chicago, Ill.
- FAUDREE, R. F.** (A'27), Radio Serviceman, 325-3rd St., Chester, W.Va.
- FAULKNER, DOUGLAS** (A'29), Student, University of Michigan, Ann Arbor, Mich. For mail: 806 Lathrop Ave., Detroit, Mich.
- FAULKNER, HARRY** (M'24), Radio Section, Engineer-in-Chief's Office, G.P.O., Alder House, Aldersgate St., London, E.C. 1, England.
- FAULSTICH, C. J.** (A'29), Service Engineer, c/o R.C.A. Photophone, 51 Terminal Way, Pittsburgh, Pa.
- FAY, CLIFFORD E.** (A'26), Engineer, Bell Telephone Laboratories, Inc., 463 West St., New York, N.Y.
- FAY, LEWIS C.** (A'29), Student, Battle Creek College, Battle Creek, Michigan. For mail: 245 Lake Ave., Battle Creek, Mich.
- FEARING, JUSTIN L.** (A'19), Patent Attorney, International Telephone and Telegraph Corporation, 67 Broad St., New York, N.Y.
- FEATHERSTONE, WILLIAM A. E.** (A'20), c/o Messrs. Callanders Cable and Construction Company, Ltd., Hamilton House, London, England. For mail: Harbledown, The Drive, Tonbridge, Kent, England.
- FEDOTOFF, NICHOLAS V.** (A'26), Engineer, Hazeltine Corporation, 521 River St., Hoboken, N.J. For mail: 39 Robertson Rd., Lynbrook, L.I., N.Y.
- FEICKERT, CARL A.** (A'27), Secretary-Treasurer, American Body Company, 5115 E. Grand Ave., Dallas, Tex. For mail: 3029 Bryan St., Dallas, Tex.
- FEINDEL, ABBOTT** (A'29), Engineer, Arc-turus Radio Tube Company, 260 Sherman Ave., Newark, N.J. For mail: 33 Shepard Ave., Newark, N.J.
- FELCH, H. F.** (A'26), Manager, F. C. Nash Company, Colorado St., Pasadena, Calif. For mail: 86 N. Catalina Ave., Pasadena, Calif.
- FELDMAN, CARL B.** (A'26), Bell Telephone Laboratories, P.O. Box 31, Cliffwood, N.J.
- FELDSTEIN, M. A.** (A'29), General Manager, The Best Radio Laboratories, 895 Flatbush Ave., Brooklyn, N.Y.
- FELIO, ORIN J.** (A'29), Engineering Checker, Grigsby-Grunow Company, 5801 Dickens Ave., Chicago, Ill. For mail: 4318 Van Buren St., Chicago, Ill.
- FELIX, CLARENCE G.** (A'29), Engineering Dept., Crosley Radio Corporation, 3401 Colerain Ave., Cincinnati, Ohio. For mail: 3120 Montana Ave., Cincinnati, Ohio.
- FELIX, EDGAR** (J'17-A'19-M'25), Radio Consultant, National Electric Manufacturers' Association, 420 Lexington Ave., New York, N.Y. For mail: 8 Doremus Ave., Ridgewood, N.Y.
- FELMET, ALBERT** (A'29), Production Manager, Barber Asphalt Company, 178 Walden Ave., Buffalo, N.Y.
- FELSTEAD, CHARLES F.** (A'24), Movie-tone and Radio Technician, Universal Picture Corporation, Universal City, Calif. For mail: 2010-6th Ave., Los Angeles, Calif.
- FELTHOUSEN, A.** (A'27), Brunswick Recording Laboratories, 799-7th Ave. and 51st St., New York, N.Y.
- FENNER, PAUL R.** (A'17), Radio Inspector, Department of Commerce, Radio Division, 328 Custom House, San Francisco, Calif. For mail: 1338 Masonic Ave., San Francisco, Calif.
- FENTON, A. NORWOOD** (A'24), Transmission Engineer, Sound Dept., Metro-Goldwyn-Mayer Studios, Culver City, Calif. For mail: 843 Ocean Ave., Santa Monica, Calif.
- FENTON, WILLIAM C.** (A'19), 3901 A. N. Taylor Ave., St. Louis, Mo.
- FERDINAND, HARRY P.** (A'22), Proprietor, H. P. Radio Shop, 111 N. Wincelago St., Rockford, Ill. For mail: 215 Miriam Ave., Rockford, Ill.

- FERDINANDO, CHRISTIE** (A'28), Kshatriyalaya Moratuwa, Ceylon, India.
- FERGUSON, GEORGE W.** (A'29), Radio Engineer, Westinghouse Electric and Manufacturing Company, East Springfield, Mass. For mail: 62 Kimberly Ave., Springfield, Mass.
- FERGUSON, JOHN D.** (M'26), Assistant Staff Engineer, Dept. of Posts and Telegraphs, Leirim House, The Castle, Dublin, Ireland.
- FERINGER, WILLIAM** (A'27), P.O. Box 456, Tujunga, Calif.
- FERNALD, PAUL R.** (A'27), President and Treasurer, H. and F. Radio Laboratories, Inc., 72 Cortlandt St., New York, N.Y.
- FERNANDEZ, DAN T.** (A'26), Audio Engineer, Day Fan Electric Company, Dayton, Ohio. For mail: 4517 N. Paulina St., Chicago, Ill.
- FERNANDEZ, MANUEL A.** (A'27), President, Manuel Angel Fernandez and Company, Benito Juarez, 39 Vera Cruz, Mexico. For mail: Apartado Postal 18 Bis., Mexico, D.F.
- FERNANDO, K. A.** (A'27), Laboratory Assistant, Eastern Radio Service, Grand Central Terminal Bldg., New York, N.Y. For mail: Suite 309, 1560 Broadway, New York, N.Y.
- FERRELL, ENOCH B.** (A'25-M'29), Radio Research Engineer, Bell Telephone Laboratories, Inc., Box 122, Deal, N.J.
- FERRIE, GENERAL** (F'17), 51 Bis Blvd., Latour Maubourg, Paris, France.
- FERRIS, FRANK** (A'26), Control Operator, "Prairie Farmer" Radio Station WLS, Sherman Hotel, Chicago, Ill. For mail: 1357 S. California Ave., Chicago, Ill.
- FERRIS, MALCOLM** (A'14-M'29), Radio Engineer, Radio Frequency Laboratories, Inc., Bonton, N.J. For mail: Fairview Ave., Bonton, N.J.
- FERRIS, WARREN ROBERT** (A'29), Rm. 419, Building 37, General Electric Company, Schenectady, N.Y.
- FERROTTA, JOSEPH L.** (A'26), Transmission Man, American Telephone and Telegraph Company, 24 Walker St., New York, N.Y. For mail: 1296 Pacific St., Apt. 307, Brooklyn, N.Y.
- FETSCH, JOSEPH T.** (A'25), Assistant Radio Engineer, U. S. Naval Research Laboratory, Bellevue, Anacostia, D.C.
- FETTERMAN, D. M.** (J'27), 3222 Michigan Ave., Chicago, Ill.
- FETZER, JOHN E.** (A'24-M'28), Engineering Director, Radio Station WEMC, Berrien Springs, Mich.
- FICK, CLIFFORD G.** (A'25), General Electric Co., Schenectady, N.Y. For mail: 12 Riverside Ave., Scotia, N.Y.
- FIECHTNER, THEODORE G.** (A'28), Instructor (School), Department of Communications, Chanute Field, Rantoul, Ill.
- FIEGHEEN, MAURICE G.** (A'28), Service Manager, Music Company, Canada, Ltd., 310 Spadina Ave., Toronto, Ont., Canada. For mail: 37 Grenadier Rd., Toronto, Ont., Canada.
- FIELD, HARRY T. F.** (A'26), Post Office Engineering Dept., Post Office Wireless Station, Nr. Baldock, England.
- FIELD, JOHN** (A'26), Electrical Engineer, C. R. Leutz, Inc., Long Island City, N.Y. For mail: 3106 Washington Ave., Long Island City, L.I., N.Y.
- FIELD, ROBERT F.** (A'18), Assistant Professor of Applied Physics, Cruft Laboratory, Cambridge, Mass. For mail: 104 Church St., Watertown, Mass.
- FIELD, W. THAYER** (A'15), Hardwick, Field and Leeb, Inc., 231 Murray St., Newark, N.J. For mail: 262 Charlton Ave., South Orange, N.J.
- FIELDING, CHARLES F.** (M'29), Lieutenant, U. S. S. "Wyoming," c/o Postmaster, New York, N.Y.
- FIELDING, EDWARD J.** (A'29), Assistant Engineer, Madison Square Broadcasting Corporation, 319 W. 49th St., New York, N.Y. For mail: 452 W. 50th St., New York, N.Y.
- FILGATE, JOHN T.** (A'29), Radio Research Engineer, Research Laboratories, National Carbon Company, Cleveland, Ohio.
- FILL, JOHN V.** (J'27), Box 245, Melbourne, Fla.
- FILLMORE, FRANCIS A.** (J'26), Radio Operator, St. Louis Truth Center, 4030 Lindell St., St. Louis, Mo. For mail: 4222 Nebraska Ave., St. Louis, Mo.
- FILLMORE, HARRY P.** (A'28), Manager, Dealer Department, Radio Corporation of America, 233 Broadway, New York, N.Y.
- FILTNESS, ARTHUR W.** (A'24), The Canadian Marconi Company, 207 Hastings St., W., Vancouver, B. C., Canada. For mail: 3835-21st Ave., W., Vancouver, B. C., Canada.
- FINCH, JAMES L.** (A'19-M'28), Engineering Dept., Radio Corporation of America, Rocky Point, L.I., N.Y.
- FINCH, WILLIAM G. H.** (J'16-A'18-M'25), Radio Engineer and Patent Attorney, 303-5th Ave., New York, N.Y. For mail: 735 Walton Ave., Apt. 8-F, New York, N.Y.
- FINGADO, FRANCIS H.** (A'28), Principal, Rock Cliff Junior High School, Seibert, Colo. For mail: Seibert, Colo.
- FINLAY, ROBERT C. S.** (A'25), Radio Service, Home Radio Service, 7 West 42nd St., New York, N.Y.
- FINSETH, E. B.** (A'28), Radio Dealer, 113 East Commonwealth, Fullerton, Calif.
- FINTER, C. V.** (A'20), U. S. Air Service, 159 Victor Ave., Dayton, Ohio.
- FIRESTONE, SAMUEL** (A'28), Engineering Division, Detroit Edison Company, Rm. 615, 2000-2nd Ave., Detroit, Mich.
- FISCHER, ANDREW, JR.** (A'26), The Continental Fibre Company, Chicago, Ill. For mail: 3007 Blaine Pl., Chicago, Ill.
- FISCHER, HERBERT B.** (A'25), Engineer, Bell Telephone Laboratories, Inc., 463 West St., New York, N.Y.
- FISCHER, LEONARD O.** (A'27), 1700 Harrison Ave., New York, N.Y.
- FISH, ARTHUR S.** (M'29), U.S. Radio Inspector, Dept. of Commerce, Radio Service, Subtreasury Bldg., New York, N.Y.

- FISH, EDWARD H. (A'19), 27 Highland Ave., Middletown, N.Y.
- FISHBERG, SIDNEY (A'28), Radio Engineer, Polymet Manufacturing Corporation, 839 E. 134th St., New York, N.Y. For mail: 165 E. 31st St., Brooklyn, N.Y.
- FISHER, ALBERT E. (A'29), Radio Service, Long Hardware Company, 13 Wyandotte St., Walkerville, Ont., Canada. For mail: 260 Albert Road, East Windsor, Ont., Canada.
- FISHER, CARROLL S. (A'27), Director of Radio, Tampa Radio School, Tampa, Fla. For mail: P.O. Box 2483, Tampa, Fla.
- FISHER, CHARLES H. (A'28), Testing Dept., Atwater Kent Manufacturing Company, 4700 Wissahickon Ave., Philadelphia, Pa. For mail: 447 Chestnut St., Pottstown, Pa.
- FISHER, E. H. (A'29), Research Assistant, Stanford University, Calif. For mail: 221 River St., Santa Cruz, Calif.
- FISHER, FRANK E. (A'28), Research Laboratory, Phillips Petroleum Company, Bartlesville, Okla. For mail: 309 E. 13th St., Bartlesville, Okla.
- FISHER, JOSEPH J. (A'26), Radio Operator, U.S. Lighthouse Tender, Columbine, San Juan, Porto Rico. For mail: 28 West 116th St., New York, N.Y.
- FISHER, NORMAN (A'26), Test Engineer, RCA-Victor Company, Inc., Front and Cooper Sts., Camden, N.J. For mail: 51 Beoit Ave., Audubon, N.J.
- FISHER, ROY S. (A'27), Electrical Engineer, J. S. Timmons, Inc., 79 E. Wister St., Philadelphia, Pa. For mail: 1123 E. Rittenhouse St., Philadelphia, Pa.
- FISHER, THEODORE (A'27), Marine Wireless Operator, Standard Shipping Company, Rm. 556, 26 Broadway, New York, N.Y. For mail: S.S. "Polarine," Standard Oil Company of La., Baton Rouge, La.
- FISK, ERNEST T. (M'15-F'26), Amalgamated Wireless, Ltd., 47 York St., Wireless House, Sidney, N. S. W., Australia.
- FISK, LAWRENCE S. (A'28), Radio Operator, Stations WBBM-WJBT, 306 So. Wabash Ave., Chicago, Ill. For mail: 1502 Washington St., Evanston, Ill.
- FITCH, WILLIAM A. (J'27-A'29), Radio Engineer, General Electric Company, Schenectady, N.Y. For mail: 13-9th St., Schenectady, N.Y.
- FITHIAN, WILLIAM S. (J'15-A'18), Technical Service Dept., Victor Talking Machine Company, Camden, N.J. For mail: 212 Merion Ave., Haddonfield, N.J.
- FITTS, RUPERT A. (A'28), Radio Engineer, Station 3I.O., Melbourne, Australia. For mail: 6 Beech St., E. Camberwell, Melbourne, Australia.
- FITZGERALD, JOHN J. (A'29), Foreman, Grigsby-Grunow Company, 5801 Dickens Avenue, Chicago, Ill. For mail: 3701 N. Leclair Ave., Chicago, Ill.
- FITZPATRICK, GEORGE WILLIAM (A'29), Draftsman, Westinghouse Electric and Manufacturing Company, East Marginal Way and Spokane Ave., Seattle, Wash. For mail: 113 E. 55th St., Seattle, Wash.
- FLAGG, LEONARD B. (A'25), Recording Engineer, British Sound Production, Ltd., Raglan Gardens, Wendley, England. For mail: 148 North Road, Mt. Pleasant, Southall, Middlesex, England.
- FLANNAGAN, COKE (M'26), Assistant Theatre Systems Eng., Electrical Research Products, Inc., 250 W. 57th St., New York, N.Y. For mail: 10 Morris Ave., W. Mountain Lakes, N.J.
- FLATHMAN, EDWARD (J'27), Installation Div., Plant Dept., New York Telephone Company, Huntington, L.I., N.Y. For mail: P.O. Box 498, Huntington, L.I., N.Y.
- FLEMING, EDWARD E. (A'25), 9 Hippodrome Bldg., Warren, Ohio.
- FLEMING, SAMUEL (A'28), Assistant Maintenance Engineer, British Broadcasting Corporation, 1 Lochce Rd., Dundee, Scotland. For mail: 291 Arbroath Rd., Dundee, Forfarshire, Scotland.
- FLENTJE, LE ROY G. (A'29), Radio Research Work, Wisconsin Power and Light Company, 531 N. 8th St., Sheboygan, Wis. For mail: 922 Clara St., Sheboygan, Wis.
- FLESSEL, FRANK B., JR. (J'29), Radiotriician, 15 Wall St., Huntington, L.I., N.Y.
- FLETCHER, EARLE S. (A'26-M'27), Radio Electrician, U.S. Coast Guard, Rm. 417, Custom House, San Francisco, Calif.
- FLETT, WILLIAM J. (A'27), Radio Service and Repair, 2707 Pacific Ave., Atlantic City, N.J.
- FLEWELLING, EDMUND T. (A'24), R. R. 11, Dayton, Ohio.
- FLOCK, A. A., JR. (A'28), Engineer, Chicago-Jefferson Fuse and Electric Company, 501 S. Green St., Chicago, Ill.
- FLINTHAM, HERBERT (A'25), Electrical and Radio Engineer, 50 Burton Ave., Doncaster, England.
- FLOMENBAUN, HYMAN (J'26), 108 Sutter Ave., Brooklyn, N.Y.
- FLOYD, WILLIAM F. (J'29), Consulting and Research Engineer, 20 West Way, Neasden, Middlesex, England.
- FLYNN, ROY M. (A'27), Radio Technician, Dallas Radio Laboratories, 1610 Commerce St., Dallas, Texas. For mail: 1913 Pacific Ave., Dallas, Texas.
- FLYTHE, THOMAS Y. (J'29), Radio Corporation of America, 168-39th St., Brooklyn, N.Y. For mail: 1064 Woodycrest Ave., New York, N.Y.
- FOGEL, MORTIMER H. (J'26), Radio Salesman, Klein's Radio and Electric Supply Company, 235 West 42nd St., New York, N.Y. For mail: 1562 E. 8th St., Brooklyn, N.Y.
- FOIN, OWEN F., JR. (J'27), Manager, Service Dept., Hackett Cowan Music Company, 1253 Fulton St., Fresno, Calif. For mail: 827 Divisadero St., Fresno, Calif.
- FOLEY, JACK (J'27), 1615-29th St., Rock Island, Ill.
- FOLEY, J. W. B. (A'15), Instructor, Radio Communication, Toledo Public High School, Toledo, Ohio. For mail: 1124 Forsythe St., Toledo, Ohio.

- FOLEY, W. R. (J'29), Radio Operator, "Allentown Call" Publishing Company, 222 N. 6th St., Allentown, Pa. For mail: 38 S. Jefferson St., Allentown, Pa.
- FOORD, HENRY D. G. (M'19), Oak Cottage, Lymington, So. Devon, England.
- FORAKER, WILLIAM NELSON, (J'29), Student, Opportunity School, Denver, Colorado. For mail: 1237 Elizabeth St., Denver, Colo.
- FORBES, ALLAN C. (A'15-M'23), Sales Manager, Triangle Electric Company, 600 W. Adams St., Chicago, Ill. For mail: 5140 Bernard St., Chicago, Ill.
- FORBES, E. D. (M'12-F'14), Consulting Engineer, 60 Warren Road, Framingham, Mass.
- FORBES, HENRY C. (A'20-M'29), Electrical Engineer, Westinghouse Electric and Manufacturing Company, Chicopee Falls, Mass. For mail: 86 Dover Rd., Longmeadow, Mass.
- FORBEY, WILLIAM D. (A'27), Radio Serviceman, Shands Radio Shop, 203 W. Kearsley St., Flint, Mich. For mail: 5015 Baldwin Blvd., Flint, Mich.
- FORD, CHARLES Y. (A'29), Custom Built Receiving and Transmitting Sets, 627 Poirier St., Oakland, Calif.
- FORD, JOHN R. (J'28), Raytheon Manufacturing Company, Cambridge, Mass. For mail: 70 Bay State Road, Boston, Mass.
- FORD, J. S. (A'28), Demonstrator, University of Toronto, Toronto, Ont., Canada. For mail: 34 Coolmine Rd., Toronto 3, Ont., Canada.
- FORD, WALTER B. (A'24), Instructor, Radio and Electricity Dept., Eagle Rock High School, 1750 Yosemite Drive, Los Angeles, Calif. For mail: 1410 Cedaredge Ave., Eagle Rock, Calif.
- FORD, WARREN A. (A'19), Radio Engineer, General Electric Company, Schenectady, N.Y. For mail: 1491 Parkwood Blvd., Schenectady, N.Y.
- FORINGER, EDGAR C. (J'26-A'27), Engineer, Grigsby-Grunow Company, 4540 Armitage Ave., Chicago, Ill. For mail: 2208 Millard Ave., Chicago, Ill.
- FORSBERG, OTTO J. (A'20), Electrical Engineer, Vacua Electrical Specialty Company, 1111 Webster Ave., Chicago, Ill.
- FORSTALL, EDWARD L. (A'26), Assistant Engineer, Bell Telephone Company of Pennsylvania, Pittsburgh, Pa. For mail: Rosemont, Pa.
- FORTINGTON, WILLIAM H. (A'25-M'27), President, International Broadcasting Equipment Company, 3112 W. 51st St., Chicago, Ill.
- FORTNER, OBED D. (J'29), Service Engineer, Tuscola Radio Supply Station, Tuscola, Okla. For mail: 215 E. Sale St., Tuscola, Ill.
- FOSSETT, FRED E. (A'26), Research Laboratory, Atwater Kent Manufacturing Company, Philadelphia, Pa. For mail: 3419 N. 17th St., Philadelphia, Pa.
- FOSTER, CHARLES W. (A'29), Student, Mechanics Institute, 18 West 44th St., New York, N.Y. For mail: 24 Aster Drive, Brighton Station, Rochester, N.Y.
- FOSTER, DUDLEY E. (A'26), Chief Engineer, Case Electrical Corporation, Marion, Ind.
- FOSTER, NICH H. (A'28), Radio Specialist, Pacific States Electric Company, 570-1st Ave. S., Seattle, Wash.
- FOUSE, HAROLD (A'27), Transmission Man, American Telephone and Telegraph Company, 750 Huron Road, Cleveland, Ohio. For mail: 3111 Broadview Rd., Cleveland, Ohio.
- FOUTS, AVERY L. (A'29), Radio Service Manager, J. W. Jenkins Music Company, 21st and Wyandotte Sts., Kansas City, Mo. For mail: 4707 Grand Avenue, Kansas City, Mo.
- FOWLER, D. W. (A'27), Radio Engineer, U.S. Engineers' Depot, Fort of Arsenal, St. Louis, Mo. For mail: 4940 Botanical Ave., St. Louis, Mo.
- FOWLER, ELISHA (A'26), Salesman, Austin Organ Company, 101 Milk St., Rm. 209, Boston, Mass.
- FOWLER, J. RANDALL (A'29), Radio Inspector, The National Carbon Company, West 17th Street and Madison Ave., Cleveland, Ohio. For mail: 2049 Cornell Rd., Cleveland, Ohio.
- FOWLER, WALTER D. (A'16), McGill University, Montreal, P.Q. Canada. For mail: 105 Dinnick Crescent, Toronto 12, Ont., Canada.
- FOX, BERT M. (J'28), Directing Engineer, Aero Radio Corporation, 5927 Franklin Ave., Hollywood, Calif. For mail: 1907 Carmen Ave., Hollywood, Calif.
- FOX, FLORIAN J. (A'27), Radio Engineer, Standard Radio Manufacturing Company, 90 Chestnut St., Toronto, Ont., Canada.
- FOX, JOHN (A'28), 31 Rugby Road, Buffalo, N.Y.
- FOX, PAUL S. (A'29), Serviceman, Sears, Roebuck and Company, 829 S. 24th St., Easton, Pa.
- FOX, REGINALD A. (A'27), George Irish Paper Company, 21-25 River St., Buffalo, N.Y. For mail: 158 Box Ave., Buffalo, N.Y.
- FOX, ROBERT (A'29), Radio Service Manager, Decatur, Hopkins Hardware Company, 93 Berkeley St., Boston, Mass. For mail: 124 Williams St., Chelsea, Mass.
- FOX, ROBERT A. (A'26), Radio Engineer, Lorain Telephone Company, Lorain, Ohio.
- FRAME, FLOYD H. (A'26), Professor of Electrical Engineering, Missouri School of Mines and Metallurgy, Rolla, Mo. For mail: 703-12th St., Rolla, Mo.
- FRANCIONE, DOMINICK A., JR. (A'29), Commercial Engineering Assistant, The New York Edison Company, 130 East 15th St., New York, N.Y. For mail: 734A Fourth Ave., Brooklyn, N.Y.
- FRANCIS, THOMAS C. (A'27), Accountant, Hanley Oil Company, 2 Main Street, Bradford, Pa. For mail: 65 State St., Bradford, Pa.
- FRANK, CHARLES W. (A'28), Radio Engineering, General Electric Company, Schenectady, N.Y. For mail: 128 Elmer Ave., Schenectady, N.Y.

- FRANK, JAMES, JR. (A'29), Commercial Engineer, R.C.A. Photophone Company, 411 Fifth Ave., New York, N.Y.
- FRANK, K. G. (M'15), Consulting Engineer, 75 West St., New York, N.Y.
- FRANKEL, MORTIMER (M'29), President and General Manager, Audiola Radio Company, 430 S. Green St., Chicago, Ill.
- FRANKLIN, L. W. (A'29), Engineering Assistant, Western Union Telegraph Company, Rm. 1915, 195 Broadway, New York, N.Y.
- FRANKLIN, TOWNSEND U. (A'27), 22 Melrose Ave., Toledo, Ohio.
- FRANSSON, FRANS J. (A'20), c/o Svenska A-B, Gasaccumulator, Stockholm-Lidingo, Sweden.
- FRANZWA, FREDERICK J. (A'29), Radio Engineer, Day Fan Electric Company, Dayton, Ohio. For mail: 43 Victor Ave., Dayton, Ohio.
- FRASER, GRAHAM (A'27), Beggs Radio Shop, 201 N. Brand St., Glendale, Calif. For mail: 134 1/2 E. 53rd St., Los Angeles, Calif.
- FRASSA, CHARLES F. (A'29), Proprietor, 207 W. 34th St., Covington, Ky.
- FRAZIER, HOWARD S. (A'27), Chief Engineer, WPSV Radio Service Company, 1533 Pine St., Philadelphia, Pa. For mail: 255 Lampport Rd., Upper Darby, Pa.
- FREAD, HAROLD (A'26), Service Manager, W. A. Bohr, Irvington, N.J. For mail: 87-40th St., Irvington, N.J.
- FREDENDALL, BEVERLY (A'29), Student Engineer, National Broadcasting Company, 711 Fifth Ave., New York, N.Y. For mail: 7517-41st Ave., Jackson Heights, L.I., N.Y.
- FREDERICK, CALVIN M. (A'28), Communication Dept., Pan American Airways, Inc., Miami, Fla.
- FREDERICK, HALSEY A. (M'29), Transmission Instruments Engineer, Bell Telephone Laboratories, Inc., 463 West St., New York, N.Y.
- FREDERICKS, JOHN E. (A'15), Chief Radio Electrician, U.S. Navy, U.S.S. "Tennessee," c/o Postmaster, San Pedro, Calif.
- FREED, JOSEPH D. R. (J'15-A'18-M'23-F'28), President, Freed-Eisemann Corporation, Junius St. and Liberty Ave., Brooklyn, N.Y. For mail: 912-5th Ave., New York, N.Y.
- FREED, RUSSELL E. (A'27), Electrician, Buckwater Stove Company, Royersford, Pa. For mail: 236 Summer St., Royersford, Pa.
- FREEDMAN, H. J. (A'26), Electrical Construction Engineer, Keystone Electric Company, 907 Walnut St., Philadelphia, Pa. For mail: 413 S. 2nd St., Philadelphia, Pa.
- FREEDMAN, SAM (J'29), Radio Sales and Serviceman, Max Freedman Radio and Electric Store, 17 William St., Buffalo, N.Y.
- FREEMAN, ERNEST H. (M'27), Professor of Electrical Machinery, Armour Institute of Technology, 33rd and Federal Sts., Chicago, Ill.
- FREEMAN, EDWARD E. (A'23-M'26), Chief Engineer, Freeman Radio Engineering Service, 250 E. 57th St., New York, N.Y. For mail: 174 Ivy St., Elmhurst, L.I., N.Y.
- FREEMAN, ROBERT H. (A'28), Boeing Air Transport, Oakland, Calif.
- FREEMAN, STEPHEN, JR. (J'24-A'24), B. Walter and Company, Wabash, Ind. For mail: Syracuse, Ind.
- FREEMAN, WILLIAM (A'29), Supervisor, Canadian Brandes Company, 207 Queens Quay, Toronto, Ont., Canada. For mail: 578 Spadina Ave., Toronto, Ont., Canada.
- FREERICKS, LAMBERT (A'26), Laboratory Assistant, Freed-Eisemann Company, Sperry Building, Brooklyn, N.Y. For mail: 609 E. 221st St., New York, N.Y.
- FREIERMUTH, VINCENT J. (A'26), Engineer, The Pacific Telephone and Telegraph Company, 140 New Montgomery St., San Francisco, Calif. For mail: 5329 Princeton St., Oakland, Calif.
- FREIMANN, FRANK (A'24), Technical Editor, "Radio Age," Inc., 500 S. Dearborn Ave., Chicago, Ill. For mail: 3920 Nottingham Ave., Chicago, Ill.
- FREIS, J. H. (A'29), Manufacturer, 201 W. Lake St., Wilmette, Ill. For mail: 1025 Sheridan Rd., Wilmette, Ill.
- FRENCH, HENRY G. (A'26), Designing Engineer, General Electric Company, Building 77, Radio Dept., Schenectady, N.Y. For mail: 1105 Adams Rd., Schenectady, N.Y.
- FRENZ, HARRY J. (A'29), Manager, Amplifier Test and Inspection Dept., Victor Talking Machine Company, Camden, N.J. For mail: 1942 Lexington Ave., North Merchantville, N.J.
- FREY, ROBERT H. (A'27), Laboratory Engineer, John Wanamaker Company, 8th St. and Broadway, New York, N.Y. For mail: P.O. Box 167, Wyckoff, N.J.
- FRIDAY, WILBUR L. (A'27), Proprietor, Friday Radio Laboratories, 9530 S. Robey St., Chicago, Ill.
- FRIDGEN, EDWARD N. (A'29), Chief Operator, Radio Station KSV, Transcontinental Air Transport, Inc., Winslow, Ariz. For mail: P.O. Box 482, Winslow, Ariz.
- FRIEDENTHAL, ANDREW (A'28), Chief Operator, Station WJR, Inc., 2914 Book-Cadillac Hotel, Detroit, Mich.
- FRIEDLER, DEWEY P. (A'27), Robertson Cataract Electrical Company, 186 Clinton Ave., N. Rochester, N.Y. For mail: 762 Bay St., Rochester, N.Y.
- FRIEDMAN, HARRY (A'29), Laboratory Assistant, Day-Fan Electric Company, Dayton, Ohio. For mail: 16 Bremen St., Dayton, Ohio.
- FRIEND, HALTON H. (A'26), Engineer, P.O. and E. Dept., National Broadcasting Company, Chicago, Ill.
- FRIGAR, JOHN III (A'27), Supt. of Building, 1900 Rittenhouse Sq., Philadelphia, Pa. For mail: 2115 Stenton Ave., Philadelphia, Pa.
- FRIIS, H. T. (A'18-M'26-F'29), Research Engineer, Bell Telephone Laboratories, Cliffwood, N.J. For mail: Rumson, N.J.
- FRIMERMAN, FRANK (A'27), F. Z. Radio, 740 Prospect Ave., New York, N.Y.
- FRINK, FREDERICK WILLIAM (A'29), Radio Engineer, General Electric Company, Schenectady, N.Y. For mail: 2 Eagle St., Schenectady, N.Y.

- FRISH, BEN F. (J'26), Radio Technician, Kellogg Radio Sets, 182 Meinecke Ave., Milwaukee, Wis.
- FRITSCHER, EUGENE H. (A'26), Engineer, Radio Dept., General Electric Company, Schenectady, N.Y.
- FRITZ, HARRY R. (A'28), General Trans. and Prot. Engr., Southwestern Bell Telephone Company, 1921 Telephone Bldg., St. Louis, Mo.
- FRITZEL, JOSEPH (A'29), Metro Electric Company, 1900 Mohawk St., Chicago, Ill.
- FROST, CYRIL C. J. (M'29), Western Electric Company, Ltd., Bush House, Strand, London, W.C.2, England. For mail: Murree, 32 Alma Rd., Windsor, Berks, England.
- FRY, LLOYD L. (A'29), Radio and Accessories, 312 Franklin Ave., Wapello, Iowa.
- FUJIKURA, KEIHO (A'28), Nihon Musen Denshin Kaisha, Yosami-Mura, Hekkai-Gun, Aichi-Ken, Japan.
- FUJIMOTO, TADASHI (M'28), Research Fellow, Dept. of Electrical Engineering, Tohoku Imperial University, Tokyo, Japan. For mail: 429 Taishido Setagaya, Tokyo, Japan.
- FUKUSHIMA, T. (A'29), Radio Engineer, Tokyo Central Broadcasting Station, Atagoyama, Tokyo, Japan.
- FULGHUM, CHARLES K. (A'26), 315 Palmer St., Delta, Colo.
- FULLER, LEONARD F. (A'14-M'14-F'25), Executive, Federal Telegraph Company, Palo Alto, Calif.
- FULLMER, DON A. (A'29), Student, Brigham Young University, Provo, Utah. For mail: Spanish Forks, Utah.
- FULTZ, MILES E. (A'17), Electrical Engineer, Bell Telephone Laboratories, Inc., 463 West St., New York, N.Y. For mail: 368-87th St., Apt. B-4, Brooklyn, N.Y.
- FUNG, HUO-SIU (J'29), Student, c/o Professor K. C. Chang, Nanyang University, Shanghai, China.
- FURIA, JOHN J. (A'18), Instructor in Physics, Manhattan College, 242nd St. and Broadway, New York, N.Y. For mail: 1222 Tinton Avenue, New York, N.Y.
- FURNESS, GEORGE C. (M'26), Manager, Radio Division, National Carbon Company, 30 E. 42nd St., New York, N.Y.
- FUSSELL, LEWIS (A'26), Professor of Electrical Engineering, Swarthmore College, Swarthmore, Pa.
- FUTRAL, JOHN E. (A'29), Radio Operator, Roxana Petroleum Corporation, Houston, Texas. For mail: Port Barre, Louisiana.
- FUXA, ALBERT E. (J'25-A'26), Manager, Radio Dept., Strobeck Electric Company, Hopkins, Minn. For mail: 221-11th Ave., N., Hopkins, Minn.
- G
- GABEL MORRIS (J'28), Radio Serviceman, Spear and Company, 22 W. 34th St., New York, N.Y. For mail: 322 E. 31st St., Brooklyn, N.Y.
- GABRIELLINI, WILLIAM (A'27), Radio Mechanic, Village Radio Gift Shop, 313 Bleeker St., New York, N.Y. For mail: 210 W. 10th St., New York, N.Y.
- GABY, FREDERICK, A. (A'19), Hydro-Electric Power Commission, 190 University Ave., Toronto 2, Canada.
- GADE, WILLIAM H. F. (A'27), P.O. Box 188, West Hartford, Conn.
- GADSBY, S. J. (A'28), Comptroller, Rm. 408, 207 Queens Quay, Toronto, Ont., Canada. For mail: 80 Rose Ave., Toronto, Ont., Canada.
- GAGE, DAVID H. (A'19-M'26), Foreign Wire Relations Engineer, Postal Telegraph-Cable Company, 67 Broad St., New York, N.Y. For mail: 166 Mountain Way, Rutherford, N.J.
- GAGE, HENRY PHELPS (A'24), Corning Glass Works, Corning, N.Y.
- GAGER, F. MALCOLM (J'24-A'26), Dept. of Electrical Engineering, Massachusetts Institute of Technology, Cambridge, Mass. For mail: 52 Massachusetts Ave., Cambridge A, Mass.
- GAGNON, ELMORE G. (A'29), Commercial Engineer, Northern Electric Company, 121 Shearer St., Montreal, P.Q., Canada.
- GAINER, WILLIAM P. (J'27-A'28), Student, School of Engineering, Milwaukee Wis.
- GAINES, B. R. (A'26), P.O. Box 206, Placencia, Calif.
- GAINTNER, JOSEPH R. (A'25), Manager, Radio Dept., Watt and Shand, Inc., Lancaster, Pa. For mail: 560 W. Orange St., Lancaster, Pa.
- GALBRAITH, R. A. H. (A'29), Captain, Royal Canadian Signals, Dept. of National Defence, Ottawa, Ont., Canada. For mail: The University Club, 150 Elgin St., Ottawa, Ont., Canada.
- GALEA, VINCENT (A'28), Serviceman, Colonial Radio Corporation, 25 Wilbur Ave., Long Island City, L.I., N.Y. For mail: 282 Pennsylvania Ave., Brooklyn, N.Y.
- GALLAGHER, EDWARD M. (A'27), Technical Supervisor, Brunswick-Balke-Collender Company, 778 Washington St., Rochester, N.Y. For mail: 266 Oxford St., Rochester, N.Y.
- GALLO, LOUIS J. (A'27-M'27), Gallo Radio Laboratories, 2222 Lapeyrouse St., New Orleans, La.
- GALVEZ, MANUEL E. (A'28), Broadcast Technician, Radio Corporation of the Philippines, Manila, P.I. For mail: 1721 Franco St., Tondo, Manila, P.I.
- GALVIN, ROBERT (A'29), Radio Equipment, Galvin Radio Supply Company, 303 No. 6th St., Camden, N.J.
- GAMBRELL, HORACE W. (A'25), Edison Swan Electric Company, 123-5 Queen Victoria St., London, E.C.4, England.
- GANZ, ARTHUR W. (A'27), 39 Viola St., Providence, R.I.
- GARARD, EARL A. (A'26), Instructor in Radio Engineering, Dept. of Electrical Engineering, University of North Dakota, Grand Forks, N.D. For mail: P. O. Box 162, University Station, Grand Forks, N.D.
- GARDBERG, JOSEPH (J'26-A'27), 596 McAfee St., Atlanta, Ga.

- GARDINER, PAUL C.** (A'28), Radio Engineer, General Electric Company, 5555 E. 14th St., Oakland, Calif. For mail: 1729-D Seminary Ave., Oakland, Calif.
- GARDNER, FRANCIS S.** (A'26), Engineer, Western Electric Company, Hawthorne Station, Chicago, Ill. For mail: 187 Ivy St., Newark, N.J.
- GARDNER, WILLIAM L., JR.** (A'26), Service Manager, R. M. Peffer, 334 Chestnut St., Harrisburg, Pa. For mail: 2226 Boas St., Harrisburg, Pa.
- GARITY, WILLIAM E.** (M'26), Operation Engineer, De Forest Phonofilm, Inc., 318 E. 48th St., New York, N.Y. For mail: 439 Bainbridge St., Brooklyn, N.Y.
- GARLAND, J. ARNOLD** (A'28), Radio Technician, Nugent and Garland, 652 Forest Ave., W. Brighton, S. I., N.Y. For mail: 140 DuBoise Ave., West Brighton, S.I., N.Y.
- GARRETSON, OLIVER S.** (A'27), Chief Operator, Station KMTR, Hollywood, Calif. For mail: c/o General Delivery, Burbank, Calif.
- GARRETT, CHARLES R.** (A'28), Radio Engineer, Radio Engineering Dept., General Electric Company, Schenectady, N.Y.
- GARRISON, PAUL J.** (A'25), Radio Operator, 114 Seneca Rd., Clemson College, S.C.
- GARVEY, ARTHUR** (A'28), 806 Hickory St., St. Louis, Mo.
- GARVEY, EDMOND** (A'29), Manager, Radio Inspection and Testing, American Bosch Magneto Company, Springfield, Mass. For mail: 18 Rittenhouse Terrace, Springfield, Mass.
- GARY, L. A.** (A'26), Pacific Telephone and Telegraph Company, 140 New Montgomery St., Rm. 1021, San Francisco, Calif.
- GASPAROVITCH, STEPHEN** (A'26), Radio Electrician, U.S. Lighthouse Service, Detroit, Mich. For mail: 3747 Humboldt Ave., Detroit, Mich.
- GATI, BELA** (A'28), Consulting Electrical Engineer, 562 W. 183rd St., New York, N.Y.
- GAWLER, HENRY C.** (M'23), Engineer, General Radio Company, 30 State St., Cambridge, Mass. For mail: 102 N. 22nd St., East Orange, N.J.
- GAY, PAUL F.** (A'29), Radio Engineer, Beachley-Ralston Company, 52 W. 22nd St., Chicago, Ill. For mail: 3624 Paris Ave., Chicago, Ill.
- GEARHART, ERLE J.** (A'26), President, Gearhart-Schlueter Radio Corporation, Fresno, Calif. For mail: P.O. Box 666, Fresno, Calif.
- GEBHARD, LOUIS A.** (A'20), Radio Engineer, U.S. Naval Research Laboratories, Bellevue, D.C. For mail: 1820 Calvert St., N.W., Washington, D.C.
- GEBHARDT, PAUL B.** (A'27), Engineering Dept., Colin B. Kennedy Corp., South Bend, Ind. For mail: 1038 Woodward Ave., South Bend, Ind.
- GEE, HARRY T. P.** (A'25), Patent Agents, Gee and Company, Staple House, 51-52 Chancery Lane, London, W.C.2, England.
- GEE, WALTER C.** (A'26), 150 London Rd., Bishops Stortford, Herts, England.
- GEIGER, ARTHUR H.** (A'29), Electrician, A. H. Geiger and William Electric Company, 5719-4th Ave., Detroit, Mich.
- GEISE, HAROLD** (A'27), Radio Engineer, F.A.D. Andrea, Queens St. and Jackson Ave., Long Island City, L.I., N.Y. For mail: 2420-37th St., Astoria, L.I., N.Y.
- GEISE, JULIUS C., JR.** (A'28), Engineer, Station WKJC, Manager, Service Dept., Kirk Johnson and Company, Inc., 16-18 West King St., Lancaster, Pa.
- GELARDI, MATTHEW** (A'29), Radio Technician, Amrad Corporation, Medford Hillside, Mass. For mail: 36 George St., Roxey, Mass.
- GELDERT, GEORGE M.** (A'26), Physician, 282 Somerset St., W., Ottawa, Ont., Canada.
- GELOSO, JOHN** (A'27), Chief Engineer, Pilot Electric Manufacturing Company, Inc., 223 Berry St., Brooklyn, N.Y. For mail: 331 Rodney St., Brooklyn, N.Y.
- GENGENBACK, ALBERT W.** (J'27-A'28), Installation and Serviceman, Hanna-Fone Corporation of America, 1321 Vine St., Philadelphia, Pa. For mail: 5129 Keyser St., Germantown, Philadelphia, Pa.
- GENNER, GORDON W., JR.** (A'29), Radio Serviceman, Middle Neck Rd. at Baker Ave., Great Neck, L.I., N.Y. For mail: 20 Arandale Ave., Great Neck, L.I., N.Y.
- GEOGHEGAN, EAMONN D. A.** (A'29), Engineering and Test Dept., RCA-Victor Company, Inc., Camden, N.J.
- GEORGE, EDWARD M.** (A'29), Engineer-in-Charge, Radiophone WQBC, Vicksburg, Miss.
- GEORGE, EVERETT E.** (A'22), Superintendent of Electrical Operation, Tennessee Electric Power Company, Chattanooga, Tenn.
- GEORGE, PHILIP H. F.** (A'23), c/o Posts and Telegraphs, Singapore, S.S.
- GERBER, NATHAN** (A'26), Gerber Radio and Battery Service, 149-A Humboldt Ave., Roxbury, Boston, Mass.
- GEREL, ALEXANDER** (A'27), Engineering Division, Westinghouse Electric and Manufacturing Company, Brooklyn, N.Y. For mail: 7214-7th Ave., Brooklyn, N.Y.
- GERNS, WILLIAM H.** (M'29), Designer, Wired Radio, Inc., Ampere, N.J. For mail: 49 S. Clinton St., East Orange, N.J.
- GERRIE, WILLIAM H.** (A'28), Meter and Relay Engineer, Hydro-Electric Power Commission, Belleville, Ont., Canada. For mail: 155 Ann St., Belleville, Ont., Canada.
- GERRY, FRANK L.** (A'28), Service Manager, United Music Stores, 233 Weybosset St., Providence, R.I. For mail: 334-2nd Ave., Woonsocket, R.I.
- GERSTLE, JOHN** (A'28), Research Director, Chemical and Electrical Research Laboratories, 432 Ludlow Arcade Bldg., Dayton, Ohio.
- GHOSH, B. N.** (J'29), 24 Luxa, Bernares City, India.
- GIARD, E. A.** (A'27), Development Engineer, Vesta Battery Corporation, 6591 W. 65th St., Chicago, Ill.
- GIBBONS, JOSEPH W.** (A'28), Pioneer Radio Laboratory, 9 1/4 Front St., Port Jervis, N.Y.

- GIBBS, R. J.** (A'29), Radio Engineer, Charles Bennett and Company, 619 Colombo St., Christchurch, N.Z. For mail: 180 Rolleston St., Christchurch, N.Z.
- GIBSON, ROBERT D.** (A'18), Bell Telephone Laboratories, Inc., 463 West St., New York, N.Y. For mail: 144 Elm St., Rahway, N.J.
- GIER, WILLARD M.** (A'29), Sales Manager, Levin Radio Company, 407 Commercial St., Atchison, Kan.
- GIESE, RAYMOND C.** (A'22), Long Lines Engineering Dept., American Telephone and Telegraph Company, 195 Broadway, New York, N.Y.
- GIET, G. ROBERT** (A'25-M'29), Assistant Professor, Post-Graduate School, Naval Academy, Annapolis, Md.
- GIFFORD, DELBERT K.** (A'26), Airways Communication Station, Dept. of Commerce, Fresno, Calif.
- GIHRING, HERMAN E.** (A'29), Assistant Broadcast Engineer, Radio Corporation of America, 66 Van Cortlandt Park, S., New York, N.Y. For mail: 3985 Saxon Ave., New York, N.Y.
- GILBERT, GEORGE** (A'27), 514 Sturdee St., Esquimalt, Victoria, B.C., Canada.
- GILBERT, JOHN J.** (A'16), Engineer, Bell Telephone Laboratories, Inc., 463 West St., New York, N.Y.
- GILCHER, V. J.** (A'29), Plant Engineer, National Broadcasting Company, 711-5th Ave., New York, N.Y. For mail: 3986-47th St., Long Island City, L.I., N.Y.
- GILL, ARCHIBALD J.** (M'20), Executive Engineer, Engineering Department, General Post Office, London, E.C.1, England.
- GILLET, GLENN D.** (A'22-M'27), Engineer, Bell Telephone Laboratories, Inc., 463 West St., New York, N.Y. For mail: 279 Audubon Rd., Englewood, N.J.
- GILLIATT, LELAND W.** (A'26), Munder Electrical Company, 97 Orleans St., Springfield, Mass.
- GILLILAND, TED R.** (A'28), Junior Scientist, Radio Section, U. S. Bureau of Standards, Washington, D.C. For mail: 2067 Park Rd., N.W., Washington, D.C.
- GILLOTTI, ALBERT C.** (A'27), Radio Engineer and Experimenter, 10 Elmwood Pl., Danbury, Conn.
- GILLULE, WILLIAM J.** (A'28), Radio Engineer, Kolster Radio Corporation, Newark, N.J. For mail: 762 Hopkinson Ave., Brooklyn, N.Y.
- GILMAN, GEORGE W.** (A'29), American Telephone and Telegraph Company, Radio Station, Lawrenceville, N.J.
- GILMOUR, PETER** (A'29), Electrical Engineer, Main Road, Muizenberg Cape, South Africa.
- GIMM, NORMAN H.** (A'29), Student, Harvard University, Cambridge, Mass. For mail: 13503 Emily St., East Cleveland, Ohio.
- GIOGA, PETER C.** (A'26), Sound Engineer, Metropolitan Studios, 1040 N. Las Palmas Ave., Hollywood, Calif. For mail: 649 W. 43rd St., Los Angeles, Calif.
- GIOVANINI, FRANK** (A'28), Bell Telephone Laboratories, Inc., 463 West St., New York, N.Y. For mail: Netcong Inn, Netcong, N.J.
- GIRARD, EDWARD J.** (A'28), Superintendent, Marine Dept., Mackay Radio and Telegraph Company, 20 Broad St., New York, N.Y. For mail: 4637 Hudson Blvd., North Bergen, N.J.
- GIRO, DANIEL J.** (A'29), Clerk, Eastern News Company, 67-69 Union St., Portland, Me. For mail: 56 Lafayette St., Portland, Me.
- GJELHAUG, JOHN A.** (A'17), County Surveyor and Civil Engineer, Baudette, Minn.
- GLASER, MARCUS** (A'28), 2300 E. 13th St., Brooklyn, N.Y.
- GLASER, STANLEY** (A'26), Star Radio Company, 409-11th St., N.W., Washington, D.C. For mail: 2749 Macomb St., N.W., Washington, D.C.
- GLASGOW, ROY S.** (M'26), Associate Professor of Electrical Engineering, Washington University, St. Louis, Mo. For mail: 7373 Kingsbury Blvd., University City, Mo.
- GLASS, ROBERT Z.** (A'27), Chief Engineer, Radio Station KRLD, Adolphus Hotel, Dallas, Tex. For mail: 3216 Princeton St., Dallas, Tex.
- GLASSCOCK, GLEN R.** (A'28), Student, Pratt Institute, Brooklyn, N.Y. For mail: 236 Washington Ave., Brooklyn, N.Y.
- GLASSFORD, J. O.** (A'29), 2458 Orchard St., Chicago, Ill.
- GLASSMAN, GEORGE** (A'29), Radio Service Engineer, Bremer-Tully Manufacturing Company, 656 W. Washington Blvd., Chicago, Ill.
- GLATZ, HENRY** (A'28), Assistant Chief Electrician, Perfection Stove Company, 7609 Platt Ave., Cleveland, Ohio. For mail: 3102 Chestnutdale Ave., Cleveland, Ohio.
- GLATZEL, EARLE D.** (A'26), Radio Engineer, The Detroit Edison Company, 2000-2nd Ave., Detroit, Mich. For mail: 139 Grove Ave., Highland Park, Mich.
- GLAUBER, JOHN J.** (A'27), Laboratory Assistant, Areturus Radio Company, 255 Sherman Ave., Newark, N.J. For mail: 151 N. 12th St., Newark, N.J.
- GLEASON, ALBERT E.** (A'29), Heywood Shoe Company, Worcester, Mass. For mail: 45 Benefit St., Worcester, Mass.
- GLEASON, HAROLD H.** (A'25), Radio Test Engineer, Wireless Specialty Company, Boston, Mass. For mail: 48 Irving Pl., Cambridge, Mass.
- GLEASON, STERLING** (A'29), Writer, 650 California Ave., Venice, Calif.
- GLENDEENING, D. B.** (J'26-A'28), Radio Service, York Supply Company, 527 E. 3rd St., Dayton, Ohio.
- GLENN, EARL R.** (A'25), Professor of Physics, New Jersey State Teachers College, Upper Montclair, N.J.
- GLOSSOP, ARTHUR A.** (A'26), Consulting Radio Engineer, 33 Park Head Crescent, Ecclesall, Sheffield, England.
- GLOVER, GERALD W.** (A'29), Foreman, Sterling Manufacturing Company, 2831 Prospect Ave., Cleveland, Ohio. For mail: 1172 Argonne Rd., South Euclid, Ohio.

- GLOVER, PHILIP F. (M'27), Commander, Royal Naval College, Greenwich, London, S.E., England.
- GLOVER, RALPH P. (A'28), Radio Engineer, The Crosley Radio Corporation, Colrain and Sassafras Aves., Cincinnati, Ohio. For mail: 5818 Hamilton Ave., Apt. 25, College Hill, Cincinnati, Ohio.
- GLUCK, E. J. (A'26), General Manager, Radio Station WBT, Charlotte, N.C.
- GODARD, L. G. (A'29), Radio and Victrola Service, 1205 1/2 Elm St., Dallas, Tex.
- GODDARD, FREDERICK M. (A'26), Proprietor, Bay Ridge Radio Service, 509-76th St., Brooklyn, N.Y. For mail: 668-77th St., Brooklyn, N.Y.
- GODDARD, JOHN B. (J'29), Editorial Writer, "Fayette Tribune," Fayetteville, W.Va.
- GODDARD, RALPH W. (A'19-M'20), Dean of Engineering, New Mexico College of Agriculture and Mechanic Arts, State College, N.M.
- GODFREY, MASON (A'27), Radio Engineer, Phillips Lamps, Ltd., 145 Charing Cross Rd., London, W.C.2, England. For mail: 8 Fulford Mansions, London, N.19, England.
- GODLEY, PAUL F. (A'14), Secretary-Treasurer, Chalmers-Godley Corporation, 879 Broad St., Newark, N.J. For mail: 10 Marion Rd., Upper Montclair, N.J.
- GODSHO, ALBERT P. (A'21), Engineer of Transmission and Protection, Bell Telephone Company of Pa., 1835 Arch St., Philadelphia, Pa.
- GOEBEL, EUGENE S. (A'26), Secretary and Treasurer, Western Michigan Music Company, 59 Market St., Grand Rapids, Mich.
- GOGGINS, W. B. (M'27), Lieutenant, 203 Washington Ave., Aurora Hills, Alexandria, Va.
- GOLD, HERMAN (A'21), 282 Broadway, Paterson, N.J.
- GOLDBERG, EMANUEL (A'26), Proprietor, Eastern Radio Service Company, 323 Berry St., Brooklyn, N.Y. For mail: c/o Mittleman, 1617 Avenue V, Brooklyn, N.Y.
- GOLDENBERG, HENRY E. (J'23-A'26), Announcer and Operator, Station WHB, Sweeney School, Kansas City, Mo. For mail: 6009 Central St., Kansas City, Mo.
- GOLDER, FRANK E. (A'29), Chief Engineer, Radio Station KSAT, Fort Worth, Tex.
- GOLDIN, HYMAN C. (A'27), Service Manager, Independent Radio Company, 235 St. Catherine St., W., Montreal, Quebec, Canada. For mail: 260 Prud'homme Ave., N.D.G., Montreal, P.Q., Canada.
- GOLDING, ROBERT M. (A'28), Installation Dept., Western Electric Company, Inc., 111 W. Washington St., Chicago, Ill. For mail: 1529 Jefferson Ave., Waukesha, Wis.
- GOLDMAN, ARTHUR Z. (A'28), 536 W. 112th St., New York, N.Y.
- GOLDMAN, SHERMAN (A'29), Clerk, Postal Telegraph Company, 230 State St., Detroit, Mich. For mail: 5432 Livernois Ave., Detroit, Mich.
- GOLDMAN, STANLEY (A'27), Radio Serviceman, Lexington Electric Company, 2039 W. Madison St., Chicago, Ill. For mail: 3352-D Douglas Blvd., Chicago, Ill.
- GOLDSMAN, J. L. (A'29), Consulting Radio Engineer, 4 Great Queen St., London, W.C.2, England.
- GOLDSMITH, ALFRED N. (M'12-F'14), Vice-President and General Engineer, Radio Corporation of America, 233 Broadway, New York, N.Y.
- GOLDSMITH, LLOYD T. (A'27), Sound Recording Dept., Paramount-Famous Lasky Corporation, Astoria, L.I., N.Y. For mail: Homestead Hotel, Kew Gardens, L.I., N.Y.
- GOLDSTEIN, HENRY R. (A'29), Radio Sales and Service, 632 S. Peters St., New Orleans, La.
- GOLDSTINE, HALLAN E. (A'29), Radio Transmitter Design Engineer, Radio Corporation of America, Radio Central, Rocky Point, L.I., N.Y.
- GOLTEN, J. N. (A'27), Field Engineer, Stewart-Warner Speedometer Corporation, 1826 Diversey Pkwy., Chicago, Ill. For mail: 5242 Hyde Park Blvd., Chicago, Ill.
- GONZALES, JORGE L. (A'28), P. O. Box 1368, Havana, Cuba.
- GOOD, HORACE D. (A'28), Technician, Ave. Radio and Electric Shop, 460 Schuylkill Ave., Reading, Pa.
- GOODALL, WILLIAM M. (A'29), Member of Technical Staff, Bell Telephone Laboratories, P. O. Box 122, Deal, N.J.
- GOODE, KENNETH H. (A'27), Professor of Chemistry, Colgate University, Hamilton, N.Y. For mail: 30 Millford St., Hamilton, N.Y.
- GOODMAN, JOSEPH M. (A'24-M'26), Radio Engineer, Radio Apparatus Company of South Africa, 13 Old Arcade, Johannesburg, South Africa. For mail: P. O. Box 3814, Johannesburg, South Africa.
- GOODRICH, ROBERT R. (J'27-A'28), Student, Harvard Engineering School, Cambridge, Mass. For mail: 24 Beaumont Rd., Jamaica Plain, Boston, Mass.
- GOODSPEED, LYNMORE S. (A'27), Chief Technician, Brunswick-Balke-Collender Company of Canada, Ltd., Hanna Ave., Toronto, Ont., Canada.
- GOODWIN, ROBERT F. (A'27), Goodwin Research Laboratories, 791 Bergen Ave., Jersey City, N.J.
- GOODWIN, W. CARLYLE (A'25), Manager, Merchandise and Research Bureau, 455-7th Ave., New York, N.Y. For mail: 24 Seasongood Rd., Forest Hills, L.I., N.Y.
- GOODWIN, W. NELSON, JR. (A'15-M'29), Chief Electrical Engineer, Weston Electrical Instrument Corporation, Newark, N.J. For mail: 30 Scheerer Ave., Newark, N.J.
- GOORD, H. V. (A'29), Radio Operator, c/o Messrs. Siemens Bros., Wireless Dept., Woolwich, London, England. For mail: 10 Belsize Crescent, Hampstead, London, N.W.3, England.
- GORDON, EARL P. (A'27), Service Manager, H. N. Knight Supply Company, 901 W. Grand Ave., Oklahoma City, Okla. For mail: 618 E. 6th St., Oklahoma City, Okla.
- GORDON, GEORGE (A'25), Engineer, Triad Manufacturing Company, Inc., Pawtucket, R.I. For mail: 161 Elmwood Ave., Providence, R.I.

- GORDON, HARRY E. (A'26), Equipment Engineer, Rochester Telephone Company, 25 North St., Rochester, N.Y.
- GORDON, HERBERT C. (A'27), Commercial Results Supervisor, Southwestern Bell Telephone Company, Telephone Bldg., Kansas City, Mo. For mail: 5802 Garfield, Kansas City, Mo.
- GORDON, MALCOLM K., JR. (A'29), Radio Engineer, Brandes Laboratories, Inc., 200 Mt. Pleasant Ave., Newark, N.J.
- GORHAM, ROBERT C. (A'26), Assistant Professor of Electrical Engineering, University of Pittsburgh, Pittsburgh, Pa.
- GORTON, ROLLAND E. (A'24), Technical Engineering Assistant, Vreeland Research Laboratory, Stevens Institute of Technology, Hoboken, N.J.
- GOTTLIEB, MORRIS (A'27), Radiotrician, Yorktowne Radio Laboratory, 144 S. George St., York, Pa. For mail: 1499 Monroe St., York, Pa.
- GOULD, GEORGE B. (A'26), c/o All American Cables, Inc., Lima, Peru, South America.
- GOULD, HOWARD S. (A'25), University of Michigan, Detroit, Mich. For mail: 214 Tuxedo Ave., Highland Park, Mich.
- GOULD, LESLIE A. (A'27), Columbia Phonograph Company, 1819 Broadway, New York, N.Y.
- GOULD, PAYSON R. (J'28), Student, University of Minnesota, P. O. Box 7368, Minneapolis, Minn. For mail: 2515 Irving Ave., S., Minneapolis, Minn.
- GOULD, WILLIAM B., III (A'26), 84 Stoughton Ave., Hyde Park, Mass.
- GOULDEN, STANLEY W. (M'22), Commercial Engineer, Radio Corporation of America, 233 Broadway, New York, N.Y. For mail: 27 W. 96th St., Apt. 14-B, New York, N.Y.
- GOUNARIDES, A. D. (A'29), Radio Communications, 104 Lake Pl., New Haven, Conn.
- GOVE, EDWARD L. (A'28), Construction Engineer, Radio Air Service Corporation, Engineers' National Bank Bldg., Station WHK, Cleveland, Ohio.
- GOWAN, FRANK S. (A'26), Phono Division Manager, Amalgamated Electric Corporation, 372 Pape Ave., Toronto, Ont., Canada. For mail: 4 Mendel Ave., Toronto, Ont., Canada.
- GOWAN, HUBERT S. (A'25), Press Telegrapher, The Canadian Press, Ltd., "The Daily Star," Toronto, Ont., Canada. For mail: 60 Lakeview Ave., Toronto, Ont., Canada.
- GOWEN, ROBERT F. (M'20), Consulting Engineer and Director, The Robert F. Gowen Laboratories, Ossining-on-Hudson, N.Y. For mail: Overton Rd., Ossining, N.Y.
- GOWER, S. GIFFORD (A'28), Manager, Service Dept., Ryder Furniture and Carpet Company, Beaumont, Tex. For mail: 1007 Ewing St., Beaumont, Tex.
- GRACE, A. (A'27), Engineer, Dominion Broadcasting Company, 100 A Russell St., Melbourne, Australia.
- GRACIE, JOHN A. (A'28), Radio Engineer, Engineer-in-Chief's Office, G.P.O., Research Laboratories, Dollis Hill, London, N.W.2, England.
- GRAF, ALOIS W. (A'26), Patent Examiner, U. S. Patent Office, Washington, D.C. For mail: 1615 Kenyon St., N.W., Washington, D.C.
- GRAF, HERMAN, JR. (A'19), Radio Engineer, Bureau of Engineering, Navy Dept., Washington, D.C. For mail: 3035 Presstman St., Baltimore, Md.
- GRAF, JOSEPH J. (M'27), 820 Wheeler Ave., Scranton, Pa.
- GRAFE, HANS R. (M'26), Technical Sergeant, 4th Coast Artillery, U.S. Army, Ft. Amador, Canal Zone, Panama.
- GRAFT, J. EMMETT (A'26), 1637 Jaeger Ave., Louisville, Ky.
- GRAHAM, BURWELL (A'28), Radio Engineer, Toronto Radio Company, Ltd., 241 Yonge St., Toronto, Ont., Canada. For mail: 70 Byron Ave., London, Ont., Canada.
- GRAHAM, FRANK H. (A'23), Theatre System Engineering and Synchronized Pictures, Electrical Research Products, Inc., 250 W. 57th St., New York, N.Y.
- GRAHAM, GEORGE W. (A'26), Major, U. S. Army, Savanna Proving Ground, Savanna, Ill.
- GRAHAM, IRA H. (A'28), Proprietor, Radio Retail Store, 120 W. Pine St., El Dorado, Kan. For mail: 1137 W. Central Ave., El Dorado, Kan.
- GRAHAM, J. P. (A'29), Field Service Dept., Jeffrey Manufacturing Company, 1st Ave. and 4th St., Columbus, Ohio. For mail: 28 Longview Ave., Columbus, Ohio.
- GRAHAM, LLOYD E. (J'15-A'18), Pacific Telephone and Telegraph Company, 140 New Montgomery St., San Francisco, Calif. For mail: 1145 Pine St., Apt. 14, San Francisco, Calif.
- GRAHAM, VIRGIL M. (A'24-M'27), Radio Engineer, Stromberg-Carlson Telephone Manufacturing Company, 100 Carlson Rd., Rochester, N.Y.
- GRAHAM, WILLIAM A. (A'16-M'17), Manager, Radio Corporation of America, Service Division, 233 Broadway, New York, N.Y.
- GRAIN, EVERARD B. (A'27), Radio Engineer, Marshall and Company, 94 Dorrance St., Providence, R.I. For mail: Oak Ave., Greenwood, R.I.
- GRAINGER, MAURICE J. (A'29), Sound Engineer, Fox Case Corporation, 521 Monroe St., Brooklyn, N.Y.
- GRANGE, GIFFORD (A'27), Senior Radio Operator, Broadcasting Station WJAX, Jacksonville, Fla. For mail: Route 1, P. O. Box 103, South Jacksonville, Fla.
- GRANT, ERIC A. (J'27-A'29), Radiotrician, DeForest Radio Corporation, Carlaw Ave., Toronto, Ont., Canada. For mail: 145 Indian Rd., Toronto, Ont., Canada.
- GRANT, LAWRENCE E. (J'28-A'29), 20 Ware St., Suite 18, Cambridge, Mass.
- GRANT, R. L. C. (J'27-A'29), District Engineer's Office, Post and Telegraph Dept., Wellington, New Zealand.

- GRAVER, FRANK S. (A'29), Radio Dealer, Walnut St., Bath, Pa.
- GRAVES, WILLIAM S. (A'21), Cutting and Washington, New York, N.Y. For mail: Sunapee, N.H.
- GRAVESON, GEORGE L. (A'28), Acoustic Dept., Electrical Research Products, Inc., 250 W. 57th St., New York, N.Y.
- GRAVLIN, LEE F. (A'26), Manager and Service Engineer, Whiting Radio and Service, Inc., 308 Fairfield Ave., Bridgeport, Conn. For mail: 475 Washington Ave., Bridgeport, Conn.
- GRAY, ALFRED R. (A'27), Production Manager, Wireless Specialty Apparatus Company, Boston, Mass. For mail: 60 A Woodbine St., Wollaston, Mass.
- GRAY, DE WAYNE R. (J'29), Radioman, American Telephone and Telegraph Company, Long Lines Dept., Netcong, N.J. For mail: Stanhope, N.J.
- GRAY, FLOYD E. (A'25), Aircraft Radio Engineer, National Air Transport, Inc., Municipal Airport, Cleveland, Ohio.
- GRAY, HAROLD E. (A'25-M'29), Chief Engineer, Radio Station WJAY, Schofield Bldg., Cleveland, Ohio.
- GRAY, J. CALVIN (A'27), Supervising Engineer, Victor Talking Machine Company, Camden, N.J.
- GRAY, RICHARD E. (A'26), Radio Engineer, International Standard Electric Corporation, 46 Avenue De Breteuil, Paris, France.
- GREATHEAD, ARTHUR W. (A'29), Manager, Radio Service, Elliott-Lewis Electrical Company, Inc., 1017 Race St., Philadelphia, Pa. For mail: 2924 Poplar St., Philadelphia, Pa.
- GREAVES, V. FORD (F'28), Chief Engineer, United Reproducers Corporation, Newcombe-Hawley Division, St. Charles, Ill. For mail: 30 S. 5th St., Geneva, Ill.
- GRAVES, WALTER M. (A'24), Instructor, Plant Apprentice Training Dept., Western Electric Company, Chicago, Ill. For mail: 355 Batram Rd., Riverside, Ill.
- GREBE, ALFRED H. (A'17-F'27), 70 Van Wyck Blvd., Richmond Hill, L.I., N.Y.
- GREELEY, PHILIP H. (A'28), Technical Radio Editor, "Washington Herald," Advertising Dept., Washington, D.C. For mail: 2632 Garfield St., Washington, D.C.
- GREEN, ALFRED H. (A'29), Chief Engineer, Peffer Music Company, 42 South California St., Stockton, Calif. For mail: 723 N. Orange St., Stockton, Calif.
- GREEN, ALFRED L. (A'28), c/o Professor Madsen, University of Sydney, Sydney, Australia.
- GREEN, ASHBEL (A'19), New York Stock Exchange, 11 Wall St., New York, N.Y.
- GREEN, CHARLES M., JR. (A'27), President and General Manager, Radio Sales and Service Company, 30 E. Pine St., Orlando, Fla.
- GREEN, CHARLES M. (A'29), 42-A Balham Park Rd., London, S.W.12, England.
- GREEN, DARRELL B. (A'29), Assistant Professor, Physics and Electrical Engineering, Ohio University, Athens, Ohio. For mail: 291 E. State St., Athens, Ohio.
- GREEN, ERNEST (A'17), Penrose, Long Stomps Ave., Chelmsford, Essex, England.
- GREEN, ESTILL I. (A'27), Communication Engineering, Dept. of Development and Research, American Telephone and Telegraph Company, 195 Broadway, New York, N.Y.
- GREEN, WALTER M. (A'29), Proprietor and Manager, Central Radio Service, 12064-12th St., Detroit, Mich.
- GREEN, WILLIAM G. (A'25), Field Work, Geophysical Research Corporation, Odessa, Tex. For mail: P. O. Box 472, Odessa, Tex.
- GREENBLATT, LOUIS (A'28), Radio Expert and Engineer, C. B. Johnson Electric Shop, 72 E. Main St., Waterbury, Conn. For mail: 289 Cooke St., Waterbury, Conn.
- GREENE, C. FRANCIS (A'28), Broadcast Test, Amrad Corporation, Medford Hillside, Mass. For mail: 26 Bradbury Ave., Medford, Mass.
- GREENE, GEORGE J. (J'27-A'28), Radio Serviceman, Ditmars Radio and Electric Supply Company, 911-2nd Ave., Astoria, L.I., N.Y.
- GREENE, HARRY A. (J'16-A'20), Engineer, Remler Division, Gray and Danielson Manufacturing Company, 260-1st St., San Francisco, Calif. For mail: 80 Sea View Terrace, San Francisco, Calif.
- GREENE, HARRY A. (A'26), Ditmars Radio and Electrical Supply Company, 911-2nd Ave., Long Island City, L.I., N.Y.
- GREENE, LLOYD C. (A'22), Radio Editor, "Boston Globe," 244 Washington St., Boston, Mass.
- GREENE, PAUL A. (M'26), Technical Supervisor, Columbia Broadcasting System, Paramount Bldg., 1501 Broadway, New York, N.Y.
- GREENMAN, ROGER B. (A'26), Partner, Quality Radio Shop, 98 Croton Ave., Cortland, N.Y.
- GREENSTEIN, PHILIP (A'28), Assistant in Electrical Engineering, New York University, University Heights, New York, N.Y.
- GREENWALD, ARTHUR A. (A'28), Service Manager and Instructor, H. C. Roberts Electric Supply Company, 11th and Race Sts., Philadelphia, Pa. For mail: 141 N. Madison Ave., Highland Park, Pa.
- GREENWAY, WILLIAM L. (A'29), Examiner, Lumberman's Insurance, 5th and Walnut Sts., Philadelphia, Pa. For mail: 309 Florence Ave., Jenkintown, Pa.
- GREIFF, VICTOR (M'18), Research Engineer, Radio Receptor Company, 106-7th Ave., New York, N.Y. For mail: 202 W. 79th St., New York, N.Y.
- GREGER, J. G. (A'29), Recording Engineer, Metropolitan Sound Studio, 1040 Las Palmas St., Los Angeles, Calif. For mail: 6220 La Mirada Ave., Los Angeles, Calif.
- GREGORY, CHARLOTTE C. The John Crearer Library, Chicago, Ill. For mail: P. O. Box N, Winnetka, Ill.
- GREGORY, S. D. (A'29), Radio Engineer, Radio Operations Dept., Westinghouse Electric and Manufacturing Company, East Pittsburgh, Pa. For mail: 520 Wallace Ave., Wilkinsburg, Pa.

- GREIG, JOHN (A'25), Engineer, Bell Telephone Laboratories, Inc., 463 West St., New York, N.Y.
- GREIS, W. KARL (A'27), Radio Engineer, Westinghouse Electric and Manufacturing Company, Chicopee Falls, Mass. For mail: 679 Longmeadow St., Longmeadow, Mass.
- GRENIER, HENRY N. (A'28), Radio Service and Repair Work, 128 Clay St., North Cambridge, Mass.
- GREVES, GEORGE L. (A'20), Engineer, Pacific Telephone and Telegraph Company, 140 New Montgomery St., San Francisco, Calif. For mail: 2635 Woolsey St., Berkeley, Calif.
- GRIFFITH, CHARLES H. (A'26), Sales Division Manager, Kolster Radio Corporation, 39 Broadway, New York, N.Y. For mail: 23 Tyson Ave., Glenside, Pa.
- GRIFFITH, M. H. (A'25), Radio Electrician, U. S. Coast Guard, Radio Supply and Repair Base, Bldg. 67, Navy Yard, Philadelphia, Pa.
- GRIFFITH, PAUL E. (J'29-A'29), Research Assistant, Clinical Psychology, University of Iowa, 41-B Quadrangle, Iowa City, Iowa.
- GRIFFITH, ROY T. (A'24), Transmission Engineer, Bell Telephone Company of Pennsylvania, 416-7th Ave., Pittsburgh, Pa.
- GRIFFITHS, A. ELMER (A'29), Radio Maintenance Supervisor, Engineering Dept., General Office, Northwestern Public Service Company, Huron, South Dakota. For mail: Box 663, Huron, S.D.
- GRIFFITHS, CLARENCE M. (A'21), Design Engineer, Radio Corporation of America, 66 Broad St., New York, N.Y.
- GRIFFITHS, HERBERT V. (A'28), Research Dept., Marconi's Wireless Telegraph Company, Chelmsford, Essex, England.
- GRIFFITHS, W. H. F. (M'27), Chief Engineer, H. W. Sullivan, Ltd., Leo St., London, S.E.15, England. For mail: 22 Brewer St., London, S.E.18, England.
- GRIGGS, ELMER V. (A'16), Western Electric Company, New York, N.Y. For mail: 16 Ridgeview Ave., White Plains, N.Y.
- GRIM, CLAIR R. (A'24), Radio Specialist, R. M. Peffer, Harrisburg, Pa. For mail: 1940 Bellevue Rd., Harrisburg, Pa.
- GRIMES, DAVID (A'20-M'28), Research Engineer, Temple Corporation, 5253 W. 65th St., Chicago, Ill.
- GRIMES, WILLIAM F. (A'16), Electrical Engineer, Westinghouse Electric and Manufacturing Company, 420 S. San Pedro St., Los Angeles, Calif. For mail: 416 La France Ave., Alhambra, Calif.
- GRINAN, JOHN F. (A'17-M'27), Vice-President, Continental Radio and Electric Corporation, 160 Varick St., New York, N.Y.
- GRITZNER, FRED A. (A'24), Radio Operator, S.S. "Carrier," Gulf Refining Company, Port Arthur, Tex. For mail: c/o W. W. Rosson, 34-25 Astoria Ave., Astoria, L.I., N.Y.
- GRIVA, JOHN (A'28), Electrician, Engineering Dept., Hotel Stailer, Detroit, Mich.
- GROENDYCKE, RICHARD W. (A'25), Service Engineer, Brown Instrument Company, Philadelphia, Pa. For mail: 3808 Wyoming St., Kansas City, Mo.
- GRONOFF, HARRY (A'29), Radio Technician, 2408 Palmgrove Ave., Los Angeles, Calif.
- GROSS, BENJAMIN F. (A'27), Assistant Manager and Radiotrician, Stecker's Book Store, 20 N. Oak St., Mt. Carmel, Pa. For mail: 451 W. Ave., Mt. Carmel, Pa.
- GROSS, GERALD C. (A'27), Engineer, Federal Radio Commission, Washington, D.C. For mail: The Chevy Chase Apts., Washington, D.C.
- GROVE, GEORGE A. (A'26), Morley-Hotton Company, Inc., 137 E. Elizabeth St., Detroit, Mich.
- GROVER, FREDERICK W. (M'17), Union College, Engineering Dept., Schenectady, N.Y.
- GROVES, WAYLAND M. (A'27), Telegraph Operator, Humble Pipe Line Company, Pampa, Tex. For mail: P. O. Box 637, Baytown, Tex.
- GRUENBERG, EDWIN L. (A'23), Radio Retail Dealer, 730 Bergenline Ave., Union City, N.J. For mail: 52 Liberty St., Weehawken, N.J.
- GRUENWALD, HAROLD C. (A'29), Radio Serviceman, Miller Service, Inc., 3171 University Ave., San Diego, Calif. For mail: Box 32, Station C, San Diego, Calif.
- GRUETZKE, CHARLES P. E., JR. (A'27), Service Manager, Bludworth, Inc., 254 W. 31st St., New York, N.Y. For mail: 1831 E. 34th St., Brooklyn, N.Y.
- GRUNDMANN, GUSTAVE L. (A'29), Radio Engineer, Westinghouse Electric and Manufacturing Company, Engineering Dept., East Pittsburgh, Pa. For mail: 1643 Maplewood Avenue, Wilkinsburg, Pa.
- GRUNINGER, JOHN E. (J'27), 412 Conewango Ave., Warren, Pa.
- GRUNOW, OSCAR H. (A'26), Radio Service, Oscar H. Grunow, 3646 Seaburn Ave., Detroit, Mich.
- GRUPE, EMILIO (A'27), Engineer, Radio Corporation of The Philippines, Manila, P.I. For mail: P. O. Box 2518, Manila, P.I.
- GRZYBOWSKI, WLADYSLAW (A'27), Chief Radio Operator, Radio Station AS-RA3, Far Eastern University, Vladivostok, Siberia, U.S.S.R. For mail: Nijni Novgorod Radio Laboratory, Nijni-Novgorod, U.S.S.R.
- GUBER, FRED H. (A'25), Mechanical Design Dept., Radio Corporation of America, 70 Van Cortlandt Park S. and Saxon Ave., New York, N.Y. For mail: 428-5th Ave., Roselle, N.J.
- GUE, EARL M. (A'28), Radio Supervisor, Sears, Roebuck and Company, Dept. 57, Atlanta, Ga. For mail: 378 N. Highland Ave., N.E., Atlanta, Ga.
- GUILD, BALDWIN (J'16-A'17-M'26), Patent Attorney, Pennie, Davis, Marvin and Edmonds, 165 Broadway, New York, N.Y.
- GUILFORD, E. H. (A'20), General Manager, The Radiore Company of Canada, Ltd., 426 Transportation Bldg., Montreal, P.Q., Canada.
- GUNTHER, GEORGE (A'28), Radio Service, M. T. Grant Company, 2112 Main St., Niagara Falls, N.Y. For mail: Box 167, M.P.O., Niagara Falls, N.Y.

GUNBY, O. B. (A'29), Engineer, Radio Engineering Dept., Westinghouse Electric and Manufacturing Company, East Pittsburgh, Pa. For mail: 310 James St., Turtle Creek, Pa.

GUNDRUM, EDWARD (A'26), Radio Operator, Radio Station WBJ, Westinghouse Electric and Manufacturing Company, 653 Page Blvd., Springfield, Mass.

GUNTHER, CLARENCE A. (A'27), General Electric Company, Bldg. 77, Rm. 418, Schenectady, N.Y.

GUNTHER, FRANK A. (A'25), Radio Engineering and Designing of Apparatus, Radio Engineering Laboratories, 100 Wilbur Ave., Long Island City, N.Y. For mail: 32-23-38th St., Astoria, L.I., N.Y.

GUNTHER, W. J. (A'29), Chief Engineer, World Battery Company, 1241 S. Michigan Ave., Chicago, Ill. For mail: 7002 Chappel Ave., Chicago, Ill.

GURD, RONALD H. (A'28), Manager, Radio Dept., Wm. Gurd and Company, 185 Dundas St., London, Ont., Canada.

GUSTAFSON, GILBERT E. (A'27), Chief Engineer, Station WJAZ, Mt. Prospect, Ill.

GUTHRIE, FREDERICK P. (A'16-M'28), District Manager, Radio Corporation of America, 1112 Connecticut Ave., N.W., Washington, D.C.

GUTOFF, BORIS (A'28), Custom Built Sets and Service, 865 E. 180th St., New York, N.Y.

GUY, RAYMOND F. (A'25), Radio Engineer, National Broadcasting Company, 711-5th Ave., New York, N.Y.

H

HAAG, MERLIN W. (A'26), Radio Operator, Radio Station WMAQ, "Chicago Daily News," R.F.D. 1, Elmhurst, Ill.

HAAS, CLARENCE H. (A'29), Instructor, Los Angeles City Schools, 451 N. Hill St., Los Angeles, Calif.

HAAS, JOHN G. (A'27), Model Builder and Laboratory Assistant, Radio Frequency Laboratories, Inc., Boonton, N.J.

HAAS, PAUL (J'26), Design and Development Engineer, Valley Appliances, Inc., 634 Lexington Ave., Rochester, N.Y.

HACKBUSCH, RALPH A. (A'26), Engineering Dept., Canadian Brandes, Ltd., 207 Queens Quay, Toronto, Ont., Canada.

HACKETT, PAUL J. (A'28), Chief Engineer, Universal High Power Telephone Company, 6401 Carleton Ave., Seattle, Wash. For mail: 3209-15th Ave., Seattle, Wash.

HADDEN, HAROLD L. (J'26-A'28), Burwell's Beach, Milford, Conn.

HADDEN, WESTON (J'15-A'18), Toll Engineer, Long Lines Dept., New York Telephone Company, 360 Bridge St., Brooklyn, N.Y. For mail: 1716 Albemarle Rd., Brooklyn, N.Y.

HAFNER, GILBERT (A'27), Laboratory Assistant, American Telephone and Telegraph Company, 16 Walker St., New York, N.Y. For mail: 69 Summit Rd., Port Washington, L.I., N.Y.

HAFSTAD, L. R. (A'28), Assistant Physicist, Dept. of Terrestrial Magnetism, Carnegie Institution of Washington, Washington, D.C.

HAGAN, EDWARD J. (J'27), 2223 N. Colorado St., Philadelphia, Pa.

HAGEMAN, OLIVER C. (A'28), Manager, Radio Service Dept., Carl Hoffman Music Company, 722 Delaware St., Leavenworth, Kan.

HAGEN, B. W. R. (A'26), Radio Operator, Radiomarine Corporation of America, Wilmington, Calif. For mail: 101 S. 11th Ave., Yakima, Wash.

HAGEN, PAUL A. (A'29), President, Madison Radio Service, 408 W. Gilman St., Madison, Wis.

HAGMANN, NIKLAUS (A'27), Operator, National Broadcasting Company Station WJZ, Bound Brook, N.J.

HAHN, RICHARD W. (A'28), Student, Signal School Detachment, Fort Monmouth, Oceanport, N.J.

HAIGH, M. C. (A'27), Radio Engineer, Stewart-Warner Radio Division, 1443 Locust St., Des Moines, Iowa. For mail: 1541-31st St., Des Moines, Iowa.

HAIGH, NORMAN E. (A'28), Radio Engineer and Salesman, c/o Frank Riddiough and Sons, 8 Simes St., Bradford, England. For mail: 33 Bullroyd Ave., Allerton Rd., Bradford, W. Yorks, England.

HAINES, A. J. D. (A'29), Proprietor, 222 N. 6th St., Allentown, Pa.

HAINES, HOWARD J. (A'28), Service Manager, Fansteel Products Company, Inc., 54 Dey St., New York, N.Y. For mail: 90-34-54th Ave., Elmhurst, L.I., N.Y.

HAINES, JOSEPH, JR. (A'28), Supervisor, Philadelphia Storage Battery Company, Ontario and C. Sts., Philadelphia, Pa. For mail: 13 Catlin St., Wilkes-Barre, Pa.

HAIRE, A. F. (A'28), President, A.F. Haire and Co., Inc., 719 S. Kostner Ave., Chicago, Ill.

HAJIM, JACK (A'28), Experimenter, 2172-72nd St., Brooklyn, N.Y.

HAINY, GEORGE F. (A'29), 1718 C St. W., Cedar Rapids, Iowa.

HAKAM, SAMUEL (J'27-A'28), Radio Operator, Independent Wireless Telegraph Company, 67 Wall St., New York, N.Y. For mail: 192 Hageman St., Brooklyn, N.Y.

HALE, WILLIS L. (A'29), Proprietor, Quality Radio Shop, 9 Elm St., North Attleboro, Mass.

HALFPAP, BERT A. (A'27), Radio Instructor, Federal Railway Institute, 517 Wells St., Milwaukee, Wis.

HALL, ALBERT (M'27), Chief Radio Operator, Ferranti, Ltd., Eagle Iron Works, Tame St., Stalybridge, England. For mail: 14 Ellesmere Rd., Heaton Chapel, Stockport, England.

HALL, CLIFFORD A. (A'27), Secretary and Treasurer, Mechanical Equipment Company, 206 Centre St., New York, N.Y. For mail: North Ave., Fanwood, N.J.

HALL, EDWARD G. (A'22), Communication Engineer, 72 W. Adams St., Chicago, Ill.

HALL, E. L. (A'28), Associate Engineer, Bureau of Standards, Washington, D.C.

HALL, FRED F. (J'27), 702 Grant St., Crown Point, Ind.

HALL, HARLAN R. (A'19), President, H. R. Hall and Company, 1409 Howard St., Chicago, Ill. For mail: 2305 E. 81st St., Chicago, Ill.

HALL, HENRY D. (A'28), Student Northeastern University, 316 Huntington Ave., Boston, Mass. For mail: Concord, Mass.

HALL, HOWARD J. (A'28), Radiotrician, 521 McKenney St., Dixon, Ill.

HALL, NORMAN (A'17), The North Eastern Instrument Company, Gateshead, England. For mail: Westgarth, Lyndhurst, Low Fell, Gateshead-on-Tyne, England.

HALL, NORMAN C. (A'24), Engineering Dept., Jenkins Television Corporation, Jersey City, N.J. For mail: 96 Ella St., Bloomfield, N.J.

HALL, THOMAS, JR. (A'29), Proprietor, Hall's Radio and Tires, 218 Chestnut St., Harrisburg, Pa.

HALL, VICTOR E. (A'26), Serviceman, H. C. Roberts Electric Supply Company, Inc., 24 Water St., Binghamton, N.Y. For mail: 5 Chamberlain St., Binghamton, N.Y.

HALLAM, JOHN T. (A'26), Assistant Engineer, West Virginia Broadcasting Corporation, 1420 National Rd., Wheeling, W. Va.

HALLBORG, H. E. (A'12-M'14-F'27), Engineer, Radio Corporation of America, 66 Broad St., New York, N.Y. For mail: 26 Macopin Ave., Upper Montclair, N.J.

HALLER, GEORGE L. (A'28), Electrical Engineer, E. A. Myers and Sons, 3400 Forbes St., Pittsburgh, Pa. For mail: Hampton Hall Apt., Dithridge St., Pittsburgh, Pa.

HALLEY, SAMUEL R. (A'23), Assistant Cashier, First National Bank, Rapid City, South Dakota.

HALLIGAN, CLAIR W. (A'26), Engineer, American Telephone and Telegraph Company, 195 Broadway, New York, N.Y. For mail: 55 Hanson Pl., Brooklyn, N.Y.

HALLIGAN, WILLIAM J. (A'26), Chambers and Halligan, 549 W. Washington Blvd., Chicago, Ill.

HALLMAN, L. B. (J'27-A'29), Student, Alabama Polytechnic Institute, Box 59X, Auburn, Ala. For mail: 120 S. St. Andrews St., Dothan, Ala.

HALLORAN, A. H. (M'26), President, The Pacific Radio Publishing Company, 433 Pacific Bldg., San Francisco, Calif.

HALSTEAD, WILLIAM S. (J'23-A'25), Radio Consultant and Writer, 31 Greenridge Ave., White Plains, N.Y.

HAMADA, SHIGENORI (A'29), Research Staff, Vacuum-Tube Dept., Research Laboratory, The Tokyo Electric Company, Kawasaki, Japan. For mail: 1244 Hirahari, Magomemachi, Near Tokyo, Japan.

HAM, FRANK M. (A'16), Teacher of Physics, Bridgeport High School, Bridgeport, Conn. For mail: 34 Prescott St., Bridgeport, Conn.

HAMBLING, ARTHUR W. (A'22), Hambling, Clapp and Company, London, England. For mail: 80 Bronesbury Road, London, N.W.6, England.

HAMILTON, CHARLES E. (J'29), Serviceman, Montgomery Ward Company, 1948 Indiana Ave., Connersville, Ind.

HAMILTON, EDWARD A. (A'28), Radio Supervisor, Sears, Roebuck and Company, Seattle, Wash. For mail: 3234 Belvidere Ave., Seattle, Wash.

HAMM, ARTHUR (A'25), Diplomatic Engineer, Elektrisitatswerk Salescuay, A. G., Ulbrecht Str. 23, Breslau I, Germany. For mail: Guntherstr. 5, Breslau, Germany.

HAMMAN, G. B. (A'27), 2308 McKinley Ave., Lakewood, Ohio.

HAMMER, ROBERT H. (A'29), Professional Engineer, 220 Lincoln Pl., Brooklyn, N.Y.

HAMMOND, JOHN HAYS, JR. (A'12-M'14), Hammond Radio Research Laboratory, Gloucester, Mass.

HANCE, KENNETH M. (A'19), Production Manager, National Battery Broadcasting Company, Radio Station KSTP, St. Paul, Minn. For mail: 194 W. Summit Ave., St. Paul, Minn.

HANCE, P. D., JR. (A'28), Recording Engineer, Fox Movietone News, 460 W. 54th St., New York, N.Y.

HANCOCK, JOHN W., JR. (J'28), Student, Long Beach Junior College, Long Beach, Calif. For mail: 346 Molino Ave., Long Beach, Calif.

HANCOX, HAROLD (J'29), Gain Testing, Canadian Brandes Company, 207 Queens Quay, Toronto, Ont., Canada. For mail: 10 Kew Beach Ave., Toronto, Ont., Canada.

HAND, CARL A. (A'17), Electrical Research Products, Inc., 2105 Koppers Bldg., Pittsburgh, Pa.

HANDY, FRANCIS E. (A'26), Communications Manager, American Radio Relay League, 1711 Park St., Hartford, Conn. For mail: 228 Colebrook St., Hartford, Conn.

HANES, FRED B. (A'27), Hanes Radio Service, 629 Central Ave., Connersville, Ind.

HANKINS, MARVIN J. (A'27), Radio Engineer-in-Charge, Radio Station WGEF, Trinity Methodist Church, 1201 S. Flower St., Los Angeles, Calif. For mail: 1757 S. Magnolia St., Los Angeles, Calif.

HANKS, ALFRED J. (A'25), Engineer, Research Dept., Western Union Telegraph Company, 195 Broadway, New York, N.Y. For mail: 121 Garrison Ave., Jersey City, N.J.

HANLEY, JOHN F. (J'19-A'24), Technical Assistant, Electrical Testing Laboratories, 80th St. and East End Ave., New York, N.Y.

HANNA, CLINTON R. (M'28), Research Engineer, Westinghouse Electric and Manufacturing Company, East Pittsburgh, Pa.

HANNAH, GEORGE M. (A'24), Chesapeake and Potomac Telephone Company, 1919 Madison Ave., Baltimore, Md. For mail: 5231 Linden Heights Ave., Baltimore, Md.

HANNAH, W. J. (A'29), Technical Manager, Rothermel Radio Corporation, Inc., 24 Mad-dox St., London, W.1, England.

HANNON, JOHN P. (A'27), Seward, Alaska.

HANNUM, J. C. (A'28), Accountant and Attorney, The Hunt and Dorman Manufacturing Company, 1600 E. 24th St., Cleveland, Ohio. For mail: 19400 Shoreland Ave., Rocky River, Cleveland, Ohio.

- HANOVER, EDWARD A. (A'27), Purchasing Agent, Stromberg-Carlson Telephone Manufacturing Company, 1060 University Ave., Rochester, N.Y.
- HANSCOM, W. W. (A'12-M'14), Consulting Engineer, 848 Clayton St., San Francisco, Calif.
- HANSELL, CLARENCE W. (A'26-M'29), Transmitter Development Engineer, RCA-Communications, Inc., Rocky Point, L.I., N.Y. For mail: 115 Tuthill St., Port Jefferson, L.I., N.Y.
- HANSEN, CLARENCE A. (A'23), Mechanical Engineer, Western Electric Co., Hawthorne, Ill. For mail: 4512 N. Artesian Ave., Chicago, Ill.
- HANSEN, EDMUND H. (A'25-M'25), Engineer, Fox Film Company, Los Angeles, Calif. For mail: 1835 Garfield Ave., Apt. A, Hollywood, Calif.
- HANSEN, HARVEY BENNETT (A'29), Computer, Valuation Dept., A.T. and S.F. Railway, 1231 Railway Exchange Bldg., Chicago, Ill. For mail: 5317 Argyle St., Chicago, Ill.
- HANSEN, JOHN C. (A'29), Test Engineer, General Electric Company, Building 77, Rm. 414, Schenectady, N.Y.
- HANSEN, LELAND S. (A'17), Laboratory Engineer, Howard Radio Company, South Haven, Mich. For mail: 62 South Haven St., South Haven, Mich.
- HANSEN, WILLIAM H. (J'28), Inspector, Grigsby-Grunow Company, 4540 Armitage Ave., Chicago, Ill. For mail: 1905 N. California Ave., Chicago, Ill.
- HANSFORD, R. V. (M'22), Assistant Engineer, "Wireless Section," Engineer-in-Chief's Office, G.P.O., London, England.
- HANSON, EARL C. (A'26), Brunswick-Balke-Collender Company, Chicago, Ill. For mail: 5301 Kimbark Ave., Chicago, Ill.
- HANSON, ERNEST R. (A'28), Chief Chemist, Halowax Corporation, 230 Grove St., Bloomfield, N.J.
- HANSON, HARRY (A'28), Radio Serviceman, Wolfe Radio and Music Company, 547 S. Western Ave., Los Angeles, Calif. For mail: 1361 1/2 N. Wilton Pl., Hollywood, Calif.
- HANSON, HERBERT (A'27), Radio Repairman, Johnstown Auto Company, Johnstown, Pa. For mail: 711 Highland Ave., Johnstown, Pa.
- HANSON, MALCOLM P. (A'21-M'29), 3819 Military Rd., N.W., Washington, D.C.
- HANSON, OSCAR B. (A'18-M'27), Manager, Operations and Engineering, National Broadcasting Company, 711-5th Ave., New York, N.Y. For mail: 3983 Bliss St., Long Island City, L.I., N.Y.
- HANSON, RALPH L. (J'26-A'28), Radio Manager, R. L. Hanson Company, 110 W. Front St., Stockton, Ill.
- HARDIN, L. L., JR. (A'29), Technical and Test Dept., RCA-Victor Company, Inc., Camden, N.J.
- HARDISON, ARTHUR A., JR. (A'29), Radio Technician, E. B. Finseth Radio and Jewelry Company, 113 Commonwealth Ave., Fullerton, Calif. For mail: 754 N. Stephens Ave., Fullerton, Calif.
- HARDNER, FRANCIS J. (A'26), Radio Sales and Service Manager, Electrical Devices Company, Allentown, Pa. For mail: R.F.D. 6, Box 54, Allentown, Pa.
- HARDWICK, AMBROSE H. (A'26), President, Hardwick, Field, Inc., 215 Emmet St., Newark, N.J.
- HARDY, CARROLL N. (A'29), Partner and Radio Technician, The Urquhart-Hardy Radio Laboratories, 4 Arion St., Dorchester, Mass. For mail: 65 Monadnock St., Dorchester, Mass.
- HARDY, GEORGE E. (A'28), 1915 Brookwood St., Harrisburg, Pa.
- HARDY, HAROLD (A'27-M'28), Technical Adviser, Mayfair Electric Gramophones, Ltd., London, England. For mail: 199 Argyle Rd., Ealing, London, W.13, England.
- HARDY, WILLIAM H. (A'27), Chief Engineer, New Mexico Broadcasting Company, Inc., Franciscan Hotel, Albuquerque, New Mexico.
- HARGRAVE, W. A. (A'27), Student Radio Engineer, General Electric Company, Bldg. 77-4, Schenectady, N.Y.
- HARLAN, EDWIN W. (A'26), P.O. Box 248, Denville, N.J.
- HARLEY, JOHN B. (A'27), F.A.D. Andrea, Inc., 1581 Jerome Ave., New York, N.Y. For mail: 60 Beaver St., New York, N.Y.
- HARLOW, FRED G. (A'26), Testing Division, Westinghouse Electric and Manufacturing Company, Chicopee Falls, Mass. For mail: 121 East St., Chicopee Falls, Mass.
- HARMER, LESLIE B. (A'27), Shanghai Mutual Telephone Company, Shanghai, China.
- HARMON, W. S. (A'26), Radio Engineer, General Motors Radio Corporation, Wisconsin Blvd., Dayton, Ohio. For mail: Salem and Grand, Dayton, Ohio.
- HARNESS, SAM A. (A'27), Pate-Parkes Manufacturing Company, 2411 Kensington Pl., Nashville, Tenn.
- HARNETT, DANIEL E. (A'25), Hazeltine Service Corporation, 333 W. 52nd St., New York, N.Y.
- HARNISH, RAY M. (A'28), Engineer, Kirk, Johnson and Company, 16-18 W. King St., Lancaster, Pa. For mail: Brownstown, Pa.
- HAROLD, GEORGE (A'29), Radio Dept., W. G. Walz Company, El Paso, Tex.
- HARPER, A. E. (A'19-M'26), Engineer, American Telephone and Telegraph Company, 195 Broadway, New York, N.Y. For mail: 121 Pine St., Rockville Center, L.I., N.Y.
- HARPER, EDGAR (M'20), Chief Engineer, Posts and Telegraph Department, Ceylon, India.
- HARPER, W. W. (A'23-M'26), Consulting Engineer, 500 Diversey Blvd., Chicago, Ill.
- HARRIES, JOHN H. O. (A'28), Wireless Consultant, Shirley, Old Rd., Frinton-on-Sea, Essex, England.
- HARRINGTON, CARLTON E. (J'29), Assistant Chemist, Bridgeport Testing Laboratory, 41 Cannon St., Bridgeport, Conn. For mail: 165 Elm St., Bridgeport, Conn.
- HARRINGTON, FRED H. (A'26), Chief Engineer, Qualitone Corporation, 5360 Melrose Ave., Hollywood, Calif. For mail: 5846 Carleton Way, Hollywood, Calif.

- HARRINGTON, GEORGE N. (A'29), Service Manager, The Radio Shoppe, Main St., Stockbridge, Mass. For mail: P.O. Box 982, Stockbridge, Mass.
- HARRIS, ARTHUR L. (M'22), Major, China Command Signal Company, Hong Kong, China.
- HARRIS, C. C. (A'26-M'27), Radio Engineer, Tropical Radio Telegraph Company, 1 Federal St., Boston, Mass.
- HARRIS, DAVID D. (A'29), Radio Dealer, P.O. Box 232, St. Francisville, La.
- HARRIS, GWIN C. (A'29), Design Engineer, Splidorf Radio Corporation, 98 Warren St., Newark, N.J. For mail: 459 Heywood Ave., Orange, N.J.
- HARRIS, JOHN (A'22), Radio Operator, Station WCY, Radio Corporation of America, Cleveland, Ohio. For mail: Stop 46, Lake Rd., Avon Lake, Ohio.
- HARRIS, LEONARD F. (A'25), Assistant Engineer, New York Telephone Company, 104 Broad St., New York, N.Y. For mail: 464-47th St., Brooklyn, N.Y.
- HARRIS, MERION C. (A'27), Radio Repairman and Engineer, Forest Electric Company, Villisca, Iowa. For mail: 116 W. 6th St., Villisca, Iowa.
- HARRIS, PERCY W. (M'24), Editor, "The Wireless Constructor," Amalgamated Press, Ltd., Tallis House, Tallis St., London E.C., England. For mail: 29 S. Ridgway Pl., Wimbledon, London, S.W.19, England.
- HARRIS, RAYMOND (A'28), Road Research Worker, Long Crichel, Winborne, Dorset, England.
- HARRIS, SYLVAN (A'23-M'26), Radio Engineer, Kolster Radio Corporation, Newark, N.J. For mail: 116 Prospect St., East Orange, N.J.
- HARRISON, CHARLES I. (A'29), Radio Engineer, Federal Telegraph Company, Palo Alto, Calif.
- HARRISON, EDGAR (A'29), Associate Engineer, 339 Pennsylvania Ave., Washington, D.C. For mail: 1006 Cameron St., Alexandria, Va.
- HARRISON, JAMISON R. (A'26), Dept. of Physics, University of Pittsburgh, Pittsburgh, Pa.
- HARRISON, LOUIS A. (A'27), Chief Operator, Western Union Telegraph Company, Ellis, Kan. For mail: 503 W. Adams St., Ellis, Kan.
- HARRISON, PERRY (A'26), Radio Operator, Radio Corporation of America, 326 Broadway, New York, N.Y. For mail: 2055-32nd St., Long Island City, L.I., N.Y.
- HARRISON, RICHARD H. (J'29), Student, Tech. High School, Atlanta, Ga. For mail: 933 Oak St., Atlanta, Ga.
- HARRISON, WALTER L. (A'27), Education Dept., Metropolitan Vickers Electric Company, Ltd., Manchester, England.
- HART, ARTHUR H. (A'26), Radio Operator, S. S. "Frank G. Grum," Associated Oil Company, 79 New Montgomery St., San Francisco, Calif.
- HART, CLYDE ARMAND (A'29), Radioman, U. S. S. "California," Box 17, San Pedro, Calif. For mail: 442 W. A St., San Diego, Calif.
- HART, FRANK A. (A'12), Engineering Dept., Mackay Radio and Telegraph Company, Inc., 67 Broad St., New York, N.Y. For mail: P.O. Box 189, Sayville, N.Y.
- HART, JAMES J. (A'29), Serviceman, Bamberger and Company, Market St., Newark, N.J. For mail: 617 Grove St., Irvington, N.J.
- HART, LESTER B. (J'25-A'28), Radio Corporation of America, 326 Broadway, New York, N.Y. For mail: 157 Hempstead Ave., Rockville Center, L.I., N.Y.
- HART, M. E. (A'14), Secretary and Manager, Enterprise Electrical Company, New Orleans, La. For mail: 826 Baronne St., New Orleans, La.
- HART, ROY H. (M'20), Engineer, Recording Installation Dept., Electrical Research Products, Inc., 7046 Hollywood Blvd., Hollywood, Calif.
- HART, WILLIAM J. (A'28), Fuel and Furnace Efficiency Man, Standard Oil Company, El Segundo, Calif. For mail: P.O. Box 531, El Segundo, Calif.
- HARTLEY, RALPH V. L. (M'19-F'28), Transmission Research Director, Bell Telephone Laboratories, Inc., 463 West St., New York, N.Y. For mail: 332 Melrose Pl., South Orange, N.J.
- HARTLOFF, GORDON S. (A'27), Radio Operator, Erie Company, Hamburg, N.Y. For mail: Rt. 2, Erie Co., Hamburg, N.Y.
- HARTMAN, CHARLES D. (A'29), Bell Telephone Laboratories, 463 West St., New York, N.Y.
- HARVEY, CLYDE C. (A'27), Factory Manager, Colonial Radio Corporation, East Ave. and 10th St., Long Island City, L.I., N.Y. For mail: 93 Elm Ave., Flushing, L.I., N.Y.
- HARVEY, FRANCIS M. (A'29), Sales Representative, RCA-Victor Company, Inc., Santa Fe Bldg., Dallas, Tex. For mail: 5015 Air Line Dr., R. 2, Box 542-G, Houston, Tex.
- HARVEY, HERBERT J. (A'25), Radio Engineer and Manager, Modern Wireless Company, 17 High St., Hanley, Staffs, England.
- HARVEY, LIONEL (M'29), Engineer-in-Charge, Leeds-Bradford Station, British Broadcasting Corporation, Basinghall St., Leeds, Yorks, England. For mail: 35 Reginald Ter., Chapelton, Leeds, Yorks, England.
- HASHIMOTO, CHUJI (A'28), Lieutenant, Naval Staff College, Tsukiji, Kiobashiku, Tokyo, Japan. For mail: 1500 Shimo-Shibuya, Tokyo, Japan.
- HASHIMOTO, S. (A'20), 145 Aoyama Minamimachi 6-chome, Akasaka, Tokyo, Japan.
- HASSEL, KARL E. (A'19-M'23), Radio Engineer, Zenith Radio Corporation, 3620 Iron St., Chicago, Ill.
- HASSLER, W. DAN (A'27), Birmingham Broadcasting Company, Birmingham, Ala. For mail: 58 Vine St., Pratt City, Ala.
- HASTINGS, GERALD M. (A'29), Student Engineer, National Broadcasting Company, 711-5th Ave., New York, N.Y. For mail: 631 W. 152nd St., New York, N.Y.
- HASTINGS, HARRIS F. (A'28), 905 B St., N.E., Washington, D.C.

- HASTINGS, R. STUART (A'27), Fort Simpson, Northwest Territory, Canada.
- HASTON, CLAUDE W. (A'29), 2552 Gladwin Ave., Detroit, Mich.
- HATTON, ARTHUR THOMAS (J'29-A'29), Student Engineer, General Industries Corporation, 222 Grove St., Waltham, Mass. For mail: 11 Spruce St., Waltham, Mass.
- HAUCK, VERNON D. (A'26), Rm. 508, 26 Broadway, New York, N.Y.
- HAUFFE, OTTO (A'28), Radio Engineering Laboratories, 100 Wilbur Ave., Long Island City, L.I., N.Y. For mail: 404 E. 59th St., Apt. 6, New York, N.Y.
- HAUG, JOSEPH (A'29), Repairing of Test Equipment, F.A.D. Andrea Radio Corporation, Long Island City, N.Y. For mail: 1010-1st Ave., New York, N.Y.
- HAUGH, ARTHUR T. (M'28), Vice-President, Merchandising Dept., Valley Appliances, Inc., Rochester, N.Y.
- HAUSCHILD, JOHN P. (A'27), Engineering Dept., General Electric Company, 230 S. Clark St., Chicago, Ill.
- HAUSER, ALBERT (A'28), Chief Engineer, Brown and Caine, Inc., 2317 Calumet Ave., Chicago, Ill. For mail: 7417 Phillips Ave., Chicago, Ill.
- HAUSER, CARROLL R. (A'26), Proprietor, Hauser Radio, 4310 Melrose Ave., Los Angeles, Calif.
- HAUSMANN, ERICH (M'22), Professor of Physics and Electrical Communication, Polytechnic Institute of Brooklyn, 85 Livingston St., Brooklyn, N.Y.
- HAUSMANN, ERNEST O. (J'27-A'29), Electrical Testing and Research, The Celoron Company, Div. of Diamond State Fibre, Bridgeport, Conn. For mail: 500 Buttonwood St., Norristown, Pa.
- HAUTA, THEODORE (J'26-A'28), 120-6th St., S., Virginia, Minn.
- HAVILAND, LYMAN J. (A'28), Mechanical Engineer, Hammond Clock Company, 4115 Ravenwood Ave., Chicago, Ill. For mail: 282 E. Woodland Rd., Lake Forest, Ill.
- HAWES, R. NESBITT (M'23), Divisional Engineer, Wireless Experimental Division, Indian Telegraph Dept., Alipore, Calcutta, India.
- HAWK, WILLIAM K. (A'26), Engineer, Broadcasting Dept., Westinghouse Electric and Manufacturing Company, East Pittsburgh, Pa. For mail: P.O. Box 510, Greensburg, Pa.
- HAWKINS, ERNEST H. (A'28), Electrician, Murphy Electric Company, 722 Yates St., Victoria, B.C., Canada. For mail: 2084 Newton St., Victoria, B.C., Canada.
- HAWKINS, JOHN B. (A'28), P.O. Box E, St. Charles, Ill.
- HAWKINS, JOHN H. (A'27), Engineer, Marconi Beam Wireless Station, Dorchester, England. For mail: 235 Elmhurst Mansions, Clapham, London S.W. 4, England.
- HAWKINS, LESLIE S. (A'15-M'26), Canadian Marconi Company, 500 Beatty St., Vancouver, B.C., Canada.
- HAWLEY, DOUGLASS (A'26), Proprietor, Radiola Sales and Service Company, Minneapolis, Minn. For mail: 2717 Fremont Ave., Minneapolis, Minn.
- HAWN, ROBERT C. (A'26), Radio Repair and Service, Sterling Electric Company, 33 S. 5th St., Minneapolis, Minn. For mail: 1600 W. Lake St., Minneapolis, Minn.
- HAYDEN, GILBERT (A'29), Lieutenant, Fort Monmouth, N.J.
- HAYDEN, J. W. (J'28), Equipment Attendant, Pacific Telephone and Telegraph Company, Sacramento, Calif. For mail: 912-45th St., Sacramento, Calif.
- HAYES, ARTHUR J. (A'29), Student, Dodge Telegraph and Wireless Institute, Valparaiso, Ind. For mail: Siles Hotel, Valparaiso, Ind.
- HAYES, FRED D. (A'29), Slagle, La.
- HAYES, GEORGE W. (A'13), Radio Corporation of America, 576 Av. Pres. Roque Saenz Pena, Buenos Aires, Argentina, South America.
- HAYES, HAMMOND V. (A'21), President, Submarine Signal Corporation, 160 State St., Boston, Mass.
- HAYES, H. D. (M'29), U. S. Supervisor of Radio, Department of Commerce, 2022 The Engineering Bldg., Radio Division, Chicago, Ill.
- HAYES, RALPH S. (J'15-A'18), Assistant Engineer, Transmission School, Bell Telephone Company of Pennsylvania, 1312 Arch St., Philadelphia, Pa. For mail: 31 Oberlin Ave., Swarthmore, Pa.
- HAYMAN, WILLIAM G. (A'25), c/o Mrs. E. E. Chastney, 7 Carlton Ter., Cromer, England.
- HAYNES, A. J. (A'22), President, Northern Tube Lights, Inc., 250 W. 57th St., New York, N.Y. For mail: 333 Central Park, W., New York, N.Y.
- HAYS, HOWARD D. (A'27), Manager, Hays Radio and Electric Shop, Plano, Collin Co., Tex. For mail: P. O. Box 154, Plano, Tex.
- HAYSLETT, L. E. (A'27), Factory Engineer, United Reproducers Corporation, Springfield, Ohio. For mail: 916 Woodlawn Ave., Springfield, Ohio.
- HAZARD, WILLIS GILPIN (A'29), 35 Greenough Ave., Jamaica Plain, Mass.
- HAZEL, HERBERT C. (A'28), Critic Instructor, Indiana University, Bloomington, Ind. For mail: 1000 S. Lincoln St., Bloomington, Ind.
- HAZELTINE, LOUIS A. (A'16-M'18-F'21), 3644 Dimond Ave., Oakland, Calif.
- HEALD, MERWYN (A'27), Electrical Engineer, Robertson Davis Company, 412 Orleans St., Chicago, Ill. For mail: 488 Ashland Ave., River Forest, Ill.
- HEALEY, OLIVER (A'23), Bradford Representative, Marconi Wireless Telegraph Company, Ltd., 5 Charles St., Bradford, Yorkshire, England.
- HEAP, SHELDON S. (A'27), Machine Switching Traffic Engineer, New England Telephone and Telegraph Company, 50 Oliver St., Boston, Mass. For mail: 49 Hovey St., Atlantic, Mass.

- HEARTZ, LESLIE C. (A'27), Night Toll Wire Chief, New England Telephone and Telegraph Company, 11 Franklin St., Bangor, Me. For mail: 70 Cottage St., Bangor, Me.
- HEATHER, HAROLD (J'29), Radio Technician, Illinois Electric Company, 313-315 S. San Pedro St., Los Angeles, Calif. For mail: 2407 S. Highland Ave., Los Angeles, Calif.
- HEATON, VINCENT E. (A'27), Assistant Physicist, Radio Section, Bureau of Standards, Washington, D.C.
- HEBAL, WILLIAM H. (A'26), Radio Station WTMJ, R.F.D. No. 6, Box 130A, Waukesha, Wis.
- HEBBEL, CHARLES T. (A'27), Chief Clerk, King and Simcoe Sts., Toronto, Ont., Canada. For mail: 63 Balmoral Ave., Toronto, Ont., Canada.
- HEBERLEIN, ARTHUR (J'20-A'21), Engineer, American Telephone and Telegraph Company, Development and Research Dept., 195 Broadway, New York, N.Y.
- HEBERT, ARTHUR A. (A'15-M'26), Treasurer, American Radio Relay League, 1711 Park St., Hartford, Conn.
- HEBERT, A. AUBIN (J'27), 333 Washington St., Hartford, Conn.
- HECHT, ROYAL H. (A'25), 2115 Cedarhurst Dr., Los Angeles, Calif.
- HECKMAN, J. W. (A'29), Radio Engineer, Pennsylvania Power and Light Company, 401 Wiconisco St., Harrisburg, Pa.
- HECTOR, L. GRANT (A'26), Professor of Physics, Dept. of Physics, University of Buffalo, Buffalo, N.Y.
- HEDGES, ELLSWORTH J. (A'28), Radio Service Manager, Buttikofer Radio Stores, Inc., 80 W. Kingsbridge Rd., New York, N.Y. For mail: 3111 Heath Ave., New York, N.Y.
- HEEGAARD, FREDERIK D. (A'25), The Royal Danish States, Telephone Dept. of Radio Engineering, Copenhagen, Denmark. For mail: Markmandsgade 8, Copenhagen S., Denmark.
- HEFFERNAN, S. K. (A'29), Chief Operator, Radio Station WCKY, L. B. Wilson, Inc., 6th and Madison Aves., Covington, Ky.
- HEIM, CARL (A'27), President, H and H Radio Company, 216 W. Water St., Milwaukee, Wis.
- HEIM, RUPERT A. (A'27), Radio Dept., Arkansas Electric Company, 316 Louisiana St., Little Rock, Ark.
- HEIMBACH, CHARLES W. (A'29), Radio Service Engineer, 1015 Allen St., Allentown, Pa.
- HEIMBERGER, ALBERT E. (A'29), Chief Inspector, Colin B. Kennedy Corporation, 211 E. Ewing St., South Bend, Ind. For mail: 1508 Hermosa Ct., South Bend, Ind.
- HEINDEL, HAROLD J. (A'28), Radio Engineer, F.A.D. Andrea, Inc., Orchard and Queen Sts., Long Island City, L.I., N.Y. For mail: 1082 Brook Ave., New York, N.Y.
- HEINS, HENRY F. (A'27), President, Heins and Bolet Radio and Electric Supply Corporation, 68 Cortlandt St., New York, N.Y. For mail: 132-10-106th St., Richmond Hill, L.I., N.Y.
- HEINTZ, RALPH M. (A'21-M'27), President, Heintz and Kaufman, Inc., 219 Natoma St., San Francisco, Calif.
- HEISER, ALBERT E. (A'29), Export Clerk, Export Dept., Victor Talking Machine Company, Bldg. No. 1, Front and Market Sts., Camden, N.J. For mail: 633 Linden St., Camden, N.J.
- HEISER, EDWIN S. (A'28), Assistant Radio Inspector, Radio Division, Dept. of Commerce, Rm. 413, Federal Bldg., St. Paul, Minn.
- HEISING, RAYMOND A. (A'20-F'23), Engineer, Bell Telephone Laboratories, Inc., 463 West St., New York, N.Y.
- HELFENSTEIN, EDWIN (A'28), Service Manager, Atwater Kent Manufacturing Company, 4700 N. Wissahickon Ave., Philadelphia, Pa. For mail: 132 S. 57th St., Philadelphia, Pa.
- HELGREN, OIVA M. (A'28), Radio Electrician, U.S.C.G., 715 Republic Bldg., Seattle, Wash.
- HELLMAN, MILTON E. (A'29), Manager, Correspondence Dept., Allied Radio Corporation, 711 W. Lake St., Chicago, Ill. For mail: 619 E. 60th St., Chicago, Ill.
- HELLSTROM, G. (A'26), Laboratory Assistant, Copenhagen Telephone Company, Copenhagen K., Denmark. For mail: c/o Radio 1917, Cort Adelerstgade, 8, 3, Copenhagen K., Denmark.
- HELT, SCOTT (A'29), Preliminary Engineering Survey Work, P. O. Box 1462, Mobile, Ala.
- HEMBERGER, E. F., JR. (A'27), Installation Engineer, Electrical Research Products, Inc., 250 W. 57th St., New York, N.Y.
- HEMEDINGER, WILLARD (A'28), Instructor, Radio Telephony, Seneca Vocational School, 666 E. Delavan Ave., Buffalo, N.Y. For mail: 2730 Main St., Buffalo, N.Y.
- HEMRICH, WALTER A. (A'29), Radio, 520-2nd Ave., Seattle, Wash. For mail: 503 Melrose Ave., N., Seattle, Wash.
- HENDERSON, FRANCIS A. (A'27), Electrical Engineer, Standard Telephones and Cables, Ltd., Aerodome Rd., The Hyde, Hendon, London, England. For mail: 2 Whitefriars Dr., Wealdstone, Middlesex, England.
- HENDERSON, JOHN T. (A'28), Student, King's College, University of London, Strand, London N. 19, England. For mail: Royal Empire Society, Northumberland Ave., London W.C. 2, England.
- HENDERSON, J. P. (M'23), Assistant Astronomer, Dominion Observatory, Ottawa, Ont., Canada.
- HENDERSON, KEN L. (A'25), Engineering Dept., International Communication Laboratories, Inc., Radio Design Division, 89 Broad St., New York, N.Y.
- HENDERSON, ROY A. (A'27), Radio Engineer, Radio Engineering Dept., Westinghouse Electric and Manufacturing Company, Chicopee Falls, Mass. For mail: 132 Windmere St., East Springfield, Mass.
- HENDERSON, WALTER B. (A'28), Woodside Cottage, Sandy Lane, Cobham, Surrey, England.

- HENDRICKS, LESTER A. (A'23), Radio Laboratory Assistant, Signal Corps Radio Laboratory, Wright Field, Dayton, Ohio.
- HENDRICKS, PAUL S. (A'26), Research Assistant, Massachusetts Institute of Technology, Round Hill, South Dartmouth, Mass. For mail: P.O. Box 156, South Dartmouth, Mass.
- HENERY, R. S. (A'29), Receiving Engineer, c/o Radio Corporation of America, Rocky Point, L.I., N.Y.
- HENLINE, HARRIS D. (M'26), International Telephone and Telegraph Company, 67 Broad St., New York, N.Y. For mail: 825 W. 187th St., New York, N.Y.
- HENLINE, HENRY H. (A'24-M'29), Assistant National Secretary, American Institute of Electrical Engineers, 33 W. 39th St., New York, N.Y.
- HENNEY, JULIAN K. (A'18-M'26), Director, Radio Broadcast Laboratory, Doubleday Doran and Company, Garden City, L.I., N.Y.
- HENNING, CLARENCE I. B. (A'26), Assistant Director, Military Sales Division, du Pont Company, Rm. 5058, du Pont Bldg., Wilmington, Del.
- HENNINGER, ANDREW F., JR. (A'25), President, Henninger Radio Manufacturing Company, 4509 Ravenwood Ave., Chicago, Ill. For mail: 4437 N. Paulina St., Chicago, Ill.
- HENRY, ALLEN W. (A'27), General Electric Company, Welds Division, E. 152nd St., Cleveland, Ohio. For mail: 843 E. 154th St., Cleveland, Ohio.
- HENRY, CHARLES C. (A'27), Superintendent, Mechanical and Electrical Inspection, Grigsby-Grunow Company, 5801 Dickens Ave., Chicago, Ill. For mail: 1355 Austin Blvd., Chicago, Ill.
- HENRY, FRANKLIN M. (A'23), Research Physicist, McManis Laboratories, Kirkville, Mo. For mail: 1547 Jackson St., San Francisco, Calif.
- HENRY, GORDON I. (J'27), Radio Operator, Radio Stations KOIL-W9XU, Council Bluffs, Iowa. For mail: 5335 N. 27th St., Omaha, Neb.
- HENRY, T. J. (A'29), Radio Tube Development, Radio Engineering Dept., Westinghouse Lamp Company, Bloomfield, N.J. For mail: 25 Grace St., Bloomfield, N.J.
- HENTSCHEL, ERNEST R. (A'29), Assistant Radio Engineer, Naval Research Laboratory, Washington, D.C.
- HENYAN, GEORGE W. (A'20), Commercial Engineer, General Electric Company, Radio Dept., Schenectady, N.Y.
- HEPBURN, DUGALD (A'23-M'25), Radio Engineer, De Forest Radio Corporation, 245 Carlaw Ave., Toronto, Ont., Canada. For mail: 41 Wineva Ave., Toronto 8, Ont., Canada.
- HERBER, JOHN C. (A'23), Radio Development Engineer, Bell Telephone Laboratories, Inc., 463 West St., New York, N.Y.
- HERBERT, HAROLD R. (A'24-M'27), Resident Buyer, Radio Dept., Hahn Department Stores, Inc., 1440 Broadway, New York, N.Y. For mail: 42 W. 58th St., New York, N.Y.
- HERBRUCK, WILLIAM M. (A'25), 918-15th St., N.W., Canton, Ohio.
- HERBST, JOHN A. (A'26), 660 Palisade Ave., Grantwood, N.J.
- HERCHER, FREDERICK J. (A'27), 250 South St., Elmhurst, Ill.
- HERD, JAMES F. (A'19-M'22), Radio Research Station, Slough, England.
- HERDMAN, RAYMOND C. (A'29), Radio Serviceman, Stewart-Warner Speedometer Corporation, 37 W. 65th St., New York, N.Y. For mail: 166 Summer St., Orange, N.J.
- HERIDER, ERNEST D. (A'29), Radio Station WHBL, c/o Sheboygan "Press," Sheboygan, Wis.
- HERIS, GEORGE C. (A'29), Radio Salesman, Flint-Bruce Company, Hartford, Conn. For mail: 19 Willard St., Hartford, Conn.
- HERMAN, JOSEPH M. (A'26), Radio Engineer, Radiola Sales Company, 252 W. 72nd St., New York, N.Y. For mail: 2977 W. 3rd St., Brooklyn, N.Y.
- HERMANUTZ, RAY J. (A'29), Laboratory and Final Test Dept., Grigsby-Grunow Company, 5801 Dickens Ave., Chicago, Ill. For mail: 1621 N. Keystone Ave., Chicago, Ill.
- HERNDON, LANDON C. (A'27-M'28), U. S. Supervisor of Radio, U. S. Department of Commerce, Fort McHenry, Baltimore, Md.
- HEROLD, JOS. L. (A'29), Student, School of Engineering, 560 Milwaukee St., Milwaukee, Wis. For mail: Hamlin, Kan.
- HERON, LOUIS M. (M'27), Head, Electrical Dept., McKinley Technical High School, Washington, D.C. For mail: 1314 Belmont St., N.W., Washington, D.C.
- HERRMANN, ALBERT, JR. (J'29), Merchandise Dispatch Clerk, C.N.S. and M.R.R., No. 2, Glenview, Ill. For mail: 653 Mill Ct., Waukegan, Ill.
- HERRNFELD, FRANK P. (A'29), 3023 5th Ave., Los Angeles, Calif.
- HERSHEY, ARTHUR W. (A'28), Development Dept., Leeds and Northrup Company, 4901 Stenton Ave., Philadelphia, Pa.
- HERSHMAN, J. B. (A'28), Indiana State Teachers' College, Terre Haute, Ind.
- HERSON, JACOB S. (A'29), Junior Radio Engineer, Signal Corps Radio Laboratory, Oceanport, N.J. For mail: 165 Gorfield Ave., Long Branch, N.J.
- HERTEL, ROGER H. (J'28), Student, Clay Center, Neb.
- HERTWECK, C. (A'29), Radio-Journalist, Bockingen, Heilbronn, Germany.
- HERTZ, STANTON (A'22), Chief Engineer and Sales Manager, Copperwell Steel Company, Glassport, Pa.
- HERTZBERG, ROBERT (J'21-A'26), Editorial Director, Pilot Radio and Tube Corporation, 323 Berry St., Brooklyn, N.Y. For mail: 1645 Montgomery Ave., New York, N.Y.
- HERVEY, JOHN P. (A'27), Student, Harvard University, Cambridge, Mass. For mail: 54 Hawthorne Pl., Montclair, N.J.

- HESELTON, CHARLES C. (A'23-M'29), Salesman, Arcturus Radio Tube Company, 220 Elizabeth Ave., Newark, N.J. For mail: 6222 Woodlawn Ave., Chicago, Ill.
- HESSON, W. GORDON (A'27), Malvern, Gladstone St., West Mudgee, N.S. Wales, Australia.
- HESSE, HENRY R. (A'29), Radio Tester, Kolster Radio Corporation, Newark, N.J. For mail: 3119 Clarendon Rd., Brooklyn, N.Y.
- HETLAND, L. C. (A'29), Radio Servicing and Repairing, Detroit Lakes, Minn.
- HEUSCHKE, PAUL J. (A'27), Manager, Radio Division, Commercial Engineering Bureau, New York Edison Company, 4 Irving Pl., New York, N.Y.
- HEWETSON, GEOFFREY B. (J'29), Radio Operator, Messrs. A. Holt and Company, Water St., Liverpool, England. For mail: 10 Northolm Villas, Hesse, Yorks, England.
- HEWITT, C. TEFFT (A'17), Librarian, Hackley Public Library, Muskegon, Mich.
- HEWLETT, OSCAR H., JR. (A'27), Brooklyn Wireless Telegraph Company, 1035 Flatbush Ave., Brooklyn, N.Y. For mail: 499 E. 18th St., Brooklyn, N.Y.
- HEYEN, RUDOLF J. (A'29), Manager, Service Dept., Adams Glass Company, Inc., 17-21 S. Royal St., Mobile, Ala.
- HEYMANN, JOSEPH (J'25-A'27), Service Manager, Wholesale Radio Equipment Company, 902 Broadway, New York, N.Y. For mail: 1781 E. 51st St., Brooklyn, N.Y.
- HIBBETT, JAMES ORLIN (A'28), Radio Dept., Cuyamel Fruit Company, Masonic Temple, New Orleans, La. For mail: 3045 Royal St., New Orleans, La.
- HICKMAN, C. NICHOLS (A'29), Research Physicist, American Piano Company, 29 W. 57th St., New York, N.Y. For mail: 125-22nd St., Jackson Heights, L.I., N.Y.
- HICKMAN, ROGER W. (A'29), Assistant, Cruft Laboratory, Harvard University, Cambridge, Mass. For mail: Conant Hall 11, Cambridge, Mass.
- HICKS, KENNETH F. (A'28), Rodman, Engineering Dept., St. Louis, San Francisco Railway Company, Office of Division Engineer, Springfield, Mo. For mail: 517 E. Walnut St., Springfield, Mo.
- HIGGINS, ALFRED K. (A'26), Vice-President, Ewing-Jones and Higgins, 36 W. 44th St., New York, N.Y. For mail: Noroton Ave. and Pine St., Noroton Heights, Conn.
- HIGGY, ROBERT C. (A'26), Director, Broadcasting Station WEAQ, Ohio State University, Columbus, Ohio. For mail: 296 Piedmont Rd., Columbus, Ohio.
- HIGH, JOHN M., JR. (A'19), 254th St., Riverdale-on-Hudson, New York, N.Y.
- HIGHLEYMAN, RICHARD (M'26), 135 Idora Ave., San Francisco, Calif.
- HILD, GEORGE E. (A'25), 187 Woodward Ave., Rutherford, N.J.
- HILDGICK, W. C. (A'29), Supervisor, c/o Western Union Telegraph Company, New Orleans, La.
- HILL, ALFRED L. (A'28), Supervising Clerk, Southern California Telephone Company, 433 S. Olive St., Los Angeles, Calif. For mail: 1441 W. 51 Pl., Los Angeles, Calif.
- HILL, ARTHUR P. (M'23), Supervising Radio Engineer, Southern California Telephone Company, Los Angeles, Calif. For mail: 1301 N. Mansfield Ave., Hollywood, Calif.
- HILL, EARLE E. (A'24), Chief Operator, Tropical Radio Telegraph Company, Preston, Oriente, Cuba.
- HILL, ERNEST N. (A'28), Public Address Engineer, Mullard Wireless Service Company, Ltd., Mullard House, Charing Cross Rd., London, W.C. 2, England. For mail: 4 Matlock Rd., Caversham, Reading, England.
- HILL, FREDERICK A. (A'26), Managing Editor, "Citizens' Radio Call Book," 508 S. Dearborn St., Chicago, Ill. For mail: 10th and Grant Sts., Hinsdale, Ill.
- HILL, GUY (M'13-F'15), Signal Corps Laboratory, Bureau of Standards, Washington, D.C. For mail: 900-19th St., N.W., Washington, D.C.
- HILL, H. F. (A'27), Chief Operator, United Fruit Company, Santa Marta, Republic of Colombia, South America.
- HILL, JAMES H. (A'28), Proprietor, University Radio Shoppe, 1835 Dodge Ave., Evanston, Ill.
- HILL, ORVILLE (A'28), Chief Inspection Engineer, Stewart-Warner Alemite Corporation, Ltd., Belleville, Ont., Canada. For mail: 63 Chatham St., Belleville, Ont., Canada.
- HILLEBRAND, W. A. (M'28), Electrical Engineer, Ohio Insulator Company, Barberton, Ohio.
- HILLEGAS, JOHN W. (A'27), "Atlanta Journal," Station WSB, Atlanta, Ga. For mail: 744 Williams St., N.W., Atlanta, Ga.
- HILLEGAS-BAIRD, L. S. (A'22), 831 N. 1st St., Alhambra, Calif.
- HILLER, HARRY E. (A'22), Public Address Engineer, Roxy Theatre, 50th St. and 7th Ave., New York, N.Y. For mail: 364 Elmwood Ave., East Orange, N.J.
- HILLER, NICOLAI H., JR. (A'27), Assistant to Chief Engineer, The Texas Company, 17 Battery Pl., New York, N.Y.
- HILLIARD, JOHN K. (A'25-M'29), Transmission Engineer, United Artists' Studio Corporation, 1041 N. Formosa Ave., Hollywood, Calif.
- HILLIARD, WINFIELD E. (J'29), 438 Allen St., Allentown, Pa.
- HILLS, EUGENE K. (J'27), R.F.D. 1, East Pepperell, Mass.
- HILLS, CHARLES E., JR. (A'26), Commercial Manager, General Radio Company, 30 State St., Cambridge, Mass. For mail: 5 Green Lawn Ave., Wellesley Farms, Mass.
- HILTON, WALDO R. (A'29), Manager, Radio Service Dept., Great Lakes Radio Corporation, 157-16th St., Milwaukee, Wis. For mail: 192-22nd St., Milwaukee, Wis.
- HIMOE, CLIFFORD E. (J'25-A'27), Radio Engineer, DeForest Radio Company, Passaic, N.J.
- HINDERLICH, ALBERT (A'28), Quartz Oscillators, Ltd., 1, Lechmere Rd., London N.W. 2, England. For mail: 15 Lynecroft Gardens, London, N.W. 6, England.

- HINELINE, HARRIS D. (M'26), International Telephone and Telegraph Co., 67 Broad St., New York, N.Y. For mail: 825 West 187th St., New York, N.Y.
- HINEMON, JOHN H., JR. (A'20), Office Chief Signal Officer, Signal Corps, War Department, Washington, D.C.
- HINES, ALBERT D. (A'26), Supervisor, Radio Service, American Bosch Magneto Corporation, 3737 S. Michigan Ave., Chicago, Ill. For mail: 8327 S. Elizabeth St., Chicago, Ill.
- HINES, C. C. A. (A'25), "Watley," Twyford, Winchester, Hampshire, England.
- HINES, JOSEPH (A'27), Electrician, Holland Tunnel, Canal and Varick Sts., New York, N.Y. For mail: 5190-19th Ave., Apt. 15-B, Brooklyn, N.Y.
- HINES, OSCAR T. (A'27), Radio Operator, Elkhorn Piney Coal Mining Company, Weeksbury, Ky. For mail: 1922-12th Ave., Huntington, W. Va.
- HINKEL, WALTER A. (A'28), Foreman, Production Dept., Atwater Kent Manufacturing Company, 4700 Wissahickon Ave., Philadelphia, Pa. For mail: Churchville, Pa.
- HINKS, GEOFFREY D. (J'22-A'24), Wireless Engineer, The British General Radio, Inc., 36 Middle St., Yeovil, England.
- HINKS, HENRY J. (A'26), Engineer, Christchurch St., Ringwood, Hampshire, England.
- HINNERS, FRANK A. (M'15-F'26), 233 Raymond Ave., Rockville Center, L.I., N.Y.
- HINSON, MARCUS W. (A'28), 910 Linden Ave., Winnetka, Ill.
- HINTON, NORMAN P. (M'23), Wireless Engineering Dept., Metropolitan Vickers Company, Ltd., Trafford Park, Manchester, England.
- HIRDLER, F. C. (A'28), Traffic Supervisor, Southwestern Bell Telephone Company, Oklahoma City, Okla. For mail: 927 W. 10th St., Oklahoma City, Okla.
- HIROSE, M. (A'29), Radio Engineer, Station JOGK, Kumamoto Broadcasting Station, Near Kumamoto, Japan.
- HIRSCH, HARRY (A'29), Radio Receptor Company, Inc., 106-7th Ave., New York, N.Y. For mail: 1056 Boston Rd., New York, N.Y.
- HIRSCH, OSCAR C. (A'26), Proprietor and Manager, Hirsch Battery and Radio Company, 312 S. Frederick St., Cape Girardeau, Mo.
- HIRSHMAN, CYRIL L. (A'27), Radio-Engineering Dept., British Thomson-Houston Company, Ltd., Alma St., Coventry, England.
- HISAMOTO, MASYAUKI (J'28-A'29), Student, Massachusetts Institute of Technology, Cambridge, Mass.
- HITCHCOCK, JOSEPH F. (A'26), President, Automatic Utilities Corporation, 370 East Ave., Rochester, N.Y. For mail: 127 West Ave., Rochester, N.Y.
- HITCHCOCK, R. C. (A'28), Research Engineer, Research Dept., Westinghouse Electric and Manufacturing Company, East Pittsburgh, Pa.
- HITT, A. B. (A'28), Student Engineer, General Electric Company, Schenectady, N.Y. For mail: 1009 Union St., Schenectady, N.Y.
- HITZENHAMMER, ANTHONY DE V. (A'29), Manager, Service Dept., Silver Distributors, Inc., 2011 S. Michigan Ave., Chicago, Ill. For mail: 1450 Argyle St., Chicago, Ill.
- HJERMSTAD, HANS U. (J'29), Radio Serviceman, Fox Radio Service, Kenyon, Minn. For mail: Kenyon, Minn.
- HOAG, J. BARTON (M'28), Physics Instructor, University of Chicago, Chicago, Ill.
- HOARD, NORMAN F. (A'28), Radio Engineer, Wireless Specialty Apparatus Company, 76 Atherton St., Boston, Mass. For mail: Pierce Ave., East Taunton, Mass.
- HOBART, JAMES C., JR. (A'29), Sales Manager, La Boiteaux Company, 912 Candler Bldg., Atlanta, Ga.
- HOBBS, FRANK B. (A'28), Factory Representative, United Reproducers Corporation, 100 Taunton St., Buffalo, N.Y.
- HODGE, ALBERT WILLIAM (A'29), Manager, Radio Repair Laboratories, 1512 Main St., Kansas City, Mo. For mail: 2112 Aberdeen Ct., Kansas City, Mo.
- HODGE, V. W. (A'29), Salesman, Claremont Storage and Transfer Company, 227 Main St., Claremont, N.H.
- HODGES, ARTHUR T. (A'28), Radio Gunner, U. S. Navy, U.S.S. "Black Hawk," Seattle, Wash.
- HODGDON, HERBERT J. (A'28), Jeweler, Edward J. Hodgdon and Company, Bristol Bldg., New Bedford, Mass. For mail: 31 Jenny Lind St., New Bedford, Mass.
- HODGSON, EDWARD (A'23), Engineer-in-charge, Marconi Beam Receiving Station, Yamachiche, P.Q., Canada.
- HODKINSON, HENRY (A'28), Radio Engineer, 20 St. Huberts St., Great Harwood, Lancs., England.
- HODSOLL, MARTIN (A'26), Radio Service, Standard Radio Manufacturing Corporation, Toronto, Ont., Canada. For mail: 15 Lappin Ave., Toronto, Ont., Canada.
- HOERNEL, PAUL C. (J'15-A'24), Radio Engineer, Bell Telephone Laboratories, Inc., 463 West St., New York, N.Y.
- HOFBERG, ALF H. (A'29), Radio Engineer, Audio Vision Appliance Company, Camden, N.J. For mail: 5642 N. 7th St., Philadelphia, Pa.
- HOFERT, FRED A. (A'20), Foreman, Victor Electric Corporation, 236 S. Robey St., Chicago, Ill. For mail: 136 Malden Ave., La Grange, Ill.
- HOFFMAN, DONALD A. (A'27), 106 E. Glenaven Ave., Youngstown, Ohio.
- HOFFMAN, HENRY J. (A'26), Commercial Engineer, Westinghouse Lamp Company, Bloomfield, N.J.
- HOFFMAN, JOHN L. (J'29), S. Partan Radio Service, 308 Commercial St., Peoria, Ill. For mail: 130 E. Washington St., East Peoria, Ill.
- HOFFMAN, SAMUEL O. (A'23), Industrial Scientific Research, 355 Hayes St., San Francisco, Calif.

- HOFFMAN, WALTER R. (A'23), Chief Engineer, Detroit "News" Radio Station, WJZ, Detroit, Mich. For mail: 13565 Cherylaw Ave., Detroit, Mich.
- HOFFMAN, WALTER HENRY (A'29), Radiotrician, Chicago Phonograph Company, 5127 S. State St., Chicago, Ill. For mail: P.O. Box 552, Oak Park, Ill.
- HOFFMAN, W. HOLLIS (A'18), Radio Engineer, C. F. Burgess Laboratory, 1011 E. Washington Ave., Madison, Wis. For mail: 208 S. 1st St., Madison, Wis.
- HOFMANN, A. CLEMONS (A'25-M'28), Chief Engineer and Partner, G. Rohland and Company, G.m.b.H., Berlin N. 54, Rosenthalerstr. 40/41, Germany. For mail: Berlin-Lichterfelde-West, Brahmstrabe 35, Germany.
- HOFSTATTER, F. H. (A'28), Manager, Radio Service Dept., Arkansas Electric Company, 316 Louisiana St., Little Rock, Ark. For mail: 1000 State St., Little Rock, Ark.
- HOGAN, JOHN V. L. (M'12-F'15), Consulting Engineer, 41 Park Row, New York, N.Y.
- HOGENCAMP, HAROLD C. (A'26), Broadcast Engineer, Technical Radio Laboratory, Paterson, N.J. For mail: 670 E. 29th St., Paterson, N.J.
- HOGG, WILLIAM S., JR. (A'14-M'29), Lieutenant Commander, U. S. S. "Hannibal," c/o Postmaster, New York, N.Y.
- HOHENSTEIN, JAC. (A'29), President, Magnatron Corporation, 400 Madison Ave., New York, N.Y.
- HOLBEACH, WILLIAM M. (A'20), Radio Engineer, The Marconiphone Company, Ltd., Sterling Works, Dagenham, Essex, England. For mail: Hamm Strathe, Hamm Ct., Weybridge, Surrey, England.
- HOLBORN, FREDERICK A. (M'23), Chief Engineer, Gold Seal Electric Company, 122 S. 15th St., Newark, N.J. For mail: 7 Howard St., Verona, N.J.
- HOLCOMB, CLYDE A. (A'26), Substation Operator, Pacific Electric Railway, Azusa, Calif. For mail: 812 N. San Gabriel Ave., Azusa, Calif.
- HOLCOMB, E. RUSSELL (A'29), Acoustic Engineer, Electrical Research Products, Inc., 7046 Hollywood Blvd., Hollywood, Calif. For mail: 3517 Marathon, Los Angeles, Calif.
- HOLCOMBE, HENRY W. (A'24-M'26), 321 W. 9th St., New York, N.Y.
- HOLDEN, C. F. (M'29), Lieutenant Commander, U. S. Naval Mission to Brazil, c/o Postmaster, New York, N.Y.
- HOLDEN, ELLIS GRAY (A'29), Chief Radioman, U. S. Coast Guard, Bldg. 67, Navy Yard, Philadelphia, Pa.
- HOLDEN, HARRY H. (A'27), Radio Dealer, P.O. Box 153, Siasconset, Mass.
- HOLETZ, ALEXANDER C. (A'29), Technical Assistant, Bell Telephone Laboratories, 463 West St., New York, N.Y. For mail: 1104 Wood Ave., Linden, N.J.
- HOLLAND, JESSE W. (A'28), 5823 Ave. L., Brooklyn, N.Y.
- HOLLAND, LEWIS N. (A'27), 270 West Engineering Dept., University of Michigan, Ann Arbor, Mich.
- HOLLAND, WALTER E. (M'25), Chief Engineer, Philadelphia Storage Battery Company, Ontario and C Sts., Philadelphia, Pa.
- HOLLENBECK, A. T. (A'22), Chief Clerk, Telephone and Signal Dept., Chicago Great Western Railroad, 303 W. Harrison St., Chicago, Ill. For mail: 416 Grace St., Lombard, Ill.
- HOLLIDAY, F. S. (A'29), Student, Georgia Institute of Technology, Atlanta, Ga. For mail: 75-12th St., N.E., Atlanta, Ga.
- HOLLINGSWORTH, R. L. (A'27), P.O. Box 1116, Riverhead, L.I., N.Y.
- HOLLINSWORTH, V. E. (A'29), Engineering Dept., Canadian National Telegraph Company, 347 Bay St., Toronto, Ont., Canada. For mail: Queen's Dr., Weston, Ont., Canada.
- HOLLIS, HAMMOND H. (A'28), Assistant to Production Engineer, General Radio Company, 30 State St., Cambridge, Mass. For mail: 9 Brewster Pl., North Weymouth, Massachusetts.
- HOLLOWAY, JACK (A'26), Splindorf Radio Corporation, 146-160 Summit St., Newark, N.J. For mail: 61 E. 87th St., New York, N.Y.
- HOLM, HENRY R. (J'27), Operator, Radiomarine Corporation of America, 326 Broadway, New York, N.Y.
- HOLMAN, HENRY (J'27-A'28), Receiver, Repair Work, Forbes and Meagher Music Company, Main St., Madison, Wis. For mail: 1326 Morrison St., Madison, Wis.
- HOLMES, CYRIL T. (A'29), Marine Wireless Operator, c/o Siemens Brothers, Woolwich, London England. For mail: Palestine, Gorefield, Wisbeck, Cambs., England.
- HOLMES, GEORGE R. (A'16), Assistant Advertising Manager, SKF Industries, Inc., 40 E. 34th St., New York, N.Y. For mail: 135 Garrison Ave., Jersey City, N.J.
- HOLMES, RALPH S. (A'25), Radio Engineer, RCA-Victor Company, Inc., Camden, N.J. For mail: 403-2nd Ave., Haddon Heights, N.J.
- HOLMLUND, A. EARLE (A'29), Student, Dodge Institute, Chicago, Ill. For mail: Bucklin, Mo.
- HOLMQUIST, CARL T. (A'27), Assistant Vacuum Tube Engineer, Kellogg Switchboard and Supply Company, 1066 W. Adams St., Chicago, Ill. For mail: 529 N. LeClaire Ave., Chicago, Ill.
- HOLROYD, RICHARD J. (A'26), Engineer, Swift and Company, Chicago, Ill. For mail: 6208 S. Paulina St., Chicago, Ill.
- HOLST, ERNEST W. (A'27), President, Midwest Radio Company, Inc., 4630 North Ave., Milwaukee, Wis.
- HOLST, WENDELL L. (A'20-M'26), Radio Engineer, Grigsby-Grunow-Hinds Company, 4540 Armitage Ave., Chicago, Ill. For mail: 6142 Forest Glen Ave., Chicago, Ill.
- HOLT, HILLIS W. (A'26), Radio Engineer, Westinghouse Electric and Manufacturing Company, Chicopee Falls, Mass. For mail: 112 Cambridge St., Springfield, Mass.
- HOLT, PLINY E. (A'28), 1520 N. Eldorado St., Stockton, Calif.
- HOLTSIZER, RALPH (J'18-A'24), Editorial Writer, Curtis-Martin Newspapers, Inc., In-

- dependence Square, Philadelphia, Pa. For mail: 5428 Walnut St., Philadelphia, Pa.
- HOLTZ, FREDERICK C.** (A'18), Vice-President and Chief Engineer, Sangamo Electric Company, Springfield, Ill.
- HOLZINGER, THEODORE E.** (A'29), Assistant Commercial Engineer, The New York Edison Company, 4 Irving Pl., New York, N.Y. For mail: 481 Grand Ave., Long Island City, L.I., N.Y.
- HOLZMAN, LOUIS** (A'28), Proprietor, 34 Kingsway, London, W.C. 2, England.
- HOMER, EDWARD C.** (A'28), Assistant Special Development Engineer, Western Union Telegraph Company, 195 Broadway, New York, N.Y. For mail: Box 488, Southampton, L.I., N.Y.
- HONAMAN, R. KARL** (A'23), Telephone Engineer, Development and Research Dept., American Telephone and Telegraph Company, 195 Broadway, New York, N.Y.
- HONNELL, P. M.** (J'27-A'29), Student, A. and M. College of Texas, Dallas, Tex. For mail: P.O. Box 1647, College Station, Tex.
- HOOD, NORMAN R.** (A'27), Radio Operator, Radio Station KGCU, 37 Hughes Apt., Mandan, N.D. For mail: General Delivery, Mandan, N.D.
- HOOD, SAM** (J'29), Student, Commerce, Ga.
- HOOD, WILLIAM A.** (A'29), Production Foreman, National Carbon Company, Inc., Eveready Division, West 117th and Berea Rd., Cleveland, Ohio. For mail: 1237 Lakewood Ave., Lakewood, Ohio.
- HOOPER, EDGAR M.** (A'27), Chief Service Engineer, H. G. Small and Company, 357 P.O. Place, Melbourne Ct., Australia. For mail: 34 Brunswick St., Fitzroy, Melbourne N. 6, Australia.
- HOOPER, S. C.** (F'28), Director, Naval Communications, Navy Dept., Washington, D.C.
- HOOPES, THOMAS T.** (J'15-A'19), c/o Miss Norma Wolf, Dept. of Arms and Armor, Metropolitan Museum of Art, Fifth Ave. and 82nd St., New York, N.Y.
- HOOVEN, MORRIS D.** (A'26), Engineer, Public Service Electric and Gas Company, 80 Park Pl., Newark, N.J.
- HOOVER, HERBERT, JR.** (A'29), Chief Communications Engineer, Western Air Express, Inc., 117 W. 9th St., Los Angeles, Calif.
- HOOVER, REUBEN R.** (A'28), Radio Dealer, 1720 N. 3rd St., Harrisburg, Pa.
- HOOVER, RICHARD T.** (A'29), Chief of Radio Section, Hq. Company, 12th Brigade, Ft. Sheridan, Ill.
- HOPF, MAX H.** (A'27), Harper, Tex.
- HOPKINS, A. R.** (A'27), Radio Engineer, Engineering and Test Dept., RCA-Victor Company, Inc., Camden, N.J. For mail: 317 S. Browning Rd., Merchantville, N.J.
- HOPKINS, JOHN S.** (J'25), Test Foreman, General Electric Company, Schenectady, N.Y. For mail: 1424 State St., Schenectady, N.Y.
- HOPKINS, NELSON S.** (A'27), President, Phenix Aircraft Products Company, Williams-ville, N.Y. For mail: 5565 Main St., Williams-ville, N.Y.
- HOPKINS, STEPHEN** (A'22), 825 1/4 West 85th St., Los Angeles, Calif.
- HOPPER, C. L.** (A'29), Radio Operator, S.S. "Ashtabula," Ashtabula Harbor, Ohio.
- HOPPER, FRANCIS L.** (A'26), Engineer, Recording Dept., Electrical Research Products, Inc., 7046 Hollywood Blvd., Los Angeles, Calif. For mail: 599 S. Hudson Ave., Pasadena, Calif.
- HOPTON, ARCHIE T.** (A'28), Engineer, Broadcast Station 3AR, North Essendon, Victoria, Australia. For mail: North Essendon P.O., Melbourne, Victoria, Australia.
- HORIGUCHI, JIRO** (A'25), Musengakari Dept. of Communications, Tokyo, Japan. For mail: Musengakari, Komuka, Teihimshi, Tokyo, Japan.
- HORLE, LAWRENCE C. F.** (A'14-M'28-F'25), Consulting Radio Engineer, 50 Church St., New York, N.Y. For mail: 11 St. Paul Ave., Newark, N.J.
- HORN, CHARLES W.** (A'14-M'28), General Engineer, National Broadcasting Company, Inc., 711-5th Ave., New York, N.Y.
- HORNE, WILLIAM P.** (A'26), S. and W. Electric Company, Oak Bluffs, Mass. For mail: 52 Kennebec Ave., Oak Bluffs, Mass.
- HORNING, LOUIS P., JR.** (A'26), President and Chief Engineer, Radio-Fone-O-Graph Company, 27 S. Broad St., Elizabeth, N.J. For mail: 29 Broad St., Elizabeth, N.J.
- HORNUNG, JULIUS L.** (A'18), Technical Supervisor, Y.M.C.A. Radio Institute, 126 W. 64th St., New York, N.Y. For mail: 2902 Grand Concourse, New York, N.Y.
- HOROWITZ, SAUL** (A'27), Radio Service, Harmonie Radio Shop, 13 W. 116th St., New York, N.Y. For mail: 120 Vermilyea Ave., Apt. B 31, New York, N.Y.
- HORSFALL, JAMES R.** (A'27), Manager, Exile Battery Service Station, Anaconda, Mont. For mail: 619 E. 3rd St., Anaconda, Mont.
- HORTON, J. WARREN** (A'20-F'29), Chief Engineer, General Radio Company, 30 State St., Cambridge, Mass.
- HORWAT, PETER** (A'29), Radio Repairman, 320 Middle St., Frackville, Pa.
- HOSELTON, FRANK B.** (A'26), Salesman, Cuban Representative, Overseas Motor Service Corporation, 1775 Broadway, New York, N.Y. For mail: 3180 S. W. 26th St., Miami, Fla.
- HOSFORD, HAROLD B.** (A'26), Radio Engineer and Salesman, Wetmore and Savage A. E. Company, 588 Commonwealth Ave., Boston, Mass. For mail: 10 Tampa St., Mattapan, Mass.
- HOSKINS, LABAN A.** (A'26), Beacon Radio Shop, Radios, Repairs and Accessories, 6907 Harrisburg Blvd., Houston, Tex. For mail: 8002 Easton St., Houston, Tex.
- HOST, RAYMOND H.** (A'27), Service Manager, 629 Augusta St., Racine, Wis.
- HOSTETLER, AMOS C.** (A'26), Radio Electrician, 424 Federal Bldg., Milwaukee, Wis.
- HOTINE, LESLIE** (A'24-M'25), Radio Engineer, The British Broadcasting Company, Ltd., Great North Road, Hatfield, England.
- HOTOPP, ALFRED H.** (A'22-M'28), Development and Research Engineer, Trans-

- mission Dept., Kolster Radio Corporation, 200 Mt. Pleasant Ave., Newark, N.J. For mail: 45 Hillside Ave., Caldwell, N.J.
- HOTTEL, C. W.** (A'29), Proprietor of Hottel Bros. Radio Store, 520 West Broad St., Bethlehem, Pa.
- HOUCK, HARRY W.** (A'19-M'28), Chief Engineer, Dubilier Corporation, 4377 Bronx Blvd., New York, N.Y. For mail: Park Lane, Mt. Vernon, N.Y.
- HOUDYSHELL, LOWELL B.** (J'28-A'28), Technician, United Radio Products Company, 423 S. La Brea Ave., Los Angeles, Calif. For mail: 1043 S. Kingsley Dr., Los Angeles, Calif.
- HOUGE, CHARLES A.** (A'27), Manager, E. E. Polley and Company, Loveland, Colo. For mail: P.O. Box 32, Loveland, Colo.
- HOUGH, CLINTON WALLACE** (A'22), President, North American Company, 60 Broadway, New York, N.Y.
- HOUGH, WILLIAM E.** (A'29), Electrical Engineer, Hawthorne Works, Western Electric Company, Chicago, Ill. For mail: 1151 S. Taylor Ave., Oak Park, Ill.
- HOUGHTON, HENRY G., JR.** (A'29), Research Assistant, Massachusetts Institute of Technology, Cambridge, Mass. For mail: P.O. Box 156, South Dartmouth, Mass.
- HOUSTON, GEORGE P.** (A'28), Chief Engineer, Monumental Radio, Inc., 848 N. Howard St., Baltimore, Md. For mail: 841 McCabe Ave., Baltimore, Md.
- HOVGAARD, OLE M.** (A'24-M'26), Radio Engineer, Bell Telephone Laboratories, Inc., 463 West St., New York, N.Y.
- HOWARD, AUSTIN A.** (A'16-M'29), President, Howard Radio Corporation, South Haven, Mich. For mail: 306 S. Wabash Ave., Chicago, Ill.
- HOWARD, C. ALEXANDER** (A'29), Radio Engineer, 32 Slade Lane, Longsight, Manchester, England.
- HOWARD, C. G.** (A'29), Mechanic and Electrician, Indo-European Telegraph Company, Ltd., 18 Old Broad St., London, E.C.2, England. For mail: "Gateside," Sutton Common Rd., Sutton, Surrey, England.
- HOWARD, C. M.** (A'27-M'28), Designing Engineer, Metro Electric Company, 2161 N. California Ave., Chicago, Ill. For mail: 1018 N. Hamlin Ave., Chicago, Ill.
- HOWARD, EDWARD J.** (A'28), Member Technical Staff, Bell Telephone Laboratories, Inc., 463 West St., New York, N.Y. For mail: 144 E. 208th St., New York, N.Y.
- HOWARD, L. W.** (A'28), Engineer, Receiving Laboratory, Federal Telegraph Company, Palo Alto, Calif.
- HOWARD, W. B.** (A'29), Radio Dealer and Service, Tongaat, Natal, South Africa.
- HOWE, A. E.** (A'28), Shift Engineer, Marconi Beam Station, Drummondville, P.Q., Canada.
- HOWE, FRANKLIN JOACHIM** (A'29), Clerk, 200 South Los Angeles St., Los Angeles, Calif. For mail: 5308-3rd Ave., Los Angeles, Calif.
- HOWE, WILLARD C.** (A'29), Publisher and Writer, Bar Bldg., Garden City, L.I., N.Y. For mail: 5 Suffolk Lane, Garden City, L.I., N.Y.
- HOWELL, CLIFFORD ALEXANDER** (A'27), Long Lines Dept., 40 Rector St., New York, N.Y. For mail: 227 E. 239th St., New York, N.Y.
- HOWELL, ROGER A.** (A'29), Radio Retailer, 200 E. 4th St., Long Beach, Calif.
- HOWELL, WALTER J.** (A'14-M'23), Radio Service, U.S. Inspector, Subtreasury Bldg., New York, N.Y.
- HOWES, DOUGLAS E.** (A'27), Associate Professor of Electrical Engineering, Norwich University, Northfield, Vt.
- HOWES, EDGAR T.** (A'26), Reeves and Howes, Pasadena, Calif. For mail: 1164 Los Robles, Pasadena, Calif.
- HOWS, LEONARD J.** (A'28), Radio Engineer, 93 Albert Rd., Dalston, London E. 8, England.
- HOWSE, H. A. G.** (A'25-M'28), Plant Engineer, International Standard Electric Corporation, Development and Research Laboratories, Hendon, London, England. For mail: 3 Hilltop Way, Stanmore, Middlesex, England.
- HOXIE, CHARLES A.** (A'15), General Electric Company, Schenectady, N.Y. For mail: R.F.D. 7, Box 208, A, Schenectady, N.Y.
- HROMADA, JOSEPH C.** (J'27-A'27), Junior Radio Engineer, Airways Division, Dept. of Commerce, Bureau of Lighthouses, Washington, D.C. For mail: 1794 Lanier Place, N.W., Washington, D.C.
- HSU, C. L.** (J'28), Student, 57 Gorham St., Cambridge, Mass.
- HSU, PHILIP H.** (A'27), c/o Professor Johnnyin Mah, Nanyang University, Shanghai, China.
- HUBBARD, BEVERLY R.** (J'21-A'24), Director o. Laboratories, Submarine Signal Corporation, 247 Atlantic Ave., Boston, Mass. For mail: 29 Lynde St., Melrose, Mass.
- HUBBARD, FRANK A.** (A'24), Radio Engineer, Research Dept., Bell Telephone Laboratories, Inc., 463 West St., Rm. J40, New York, N.Y.
- HUBBARD, JAMES L.** (A'25), P.O. Box 244, Norwich, Conn.
- HUDACK, JOHN MARTIN** (A'29), Engineer, Bell Telephone Laboratories, Inc., 463 West St., New York, N.Y.
- HUDIBURG, REA S.** (A'29), Correspondent, National Radio Institute, 1536 You St., N.W., Washington, D.C. For mail: 1722-19th St., N.W., Washington, D.C.
- HUDSON, T. L. W.** (A'29), Radio Technician, Sears, Roebuck and Company, Ninth and Boyle Aves., Los Angeles, Calif. For mail: 8148 Virginia St., Southgate, Calif.
- HUDTWALKER, WILLIAM THEODORE** (A'29), Student Engineer, Radio Corporation of America, 70 Van Cortlandt Park S., New York, N.Y. For mail: 8512-110th St., Richmond Hill, L.I., N.Y.
- HUFFMAN, CHARLES E.** (A'29), Chief Engineer, Jenkins Television Corporation, 346 Claremont Ave., Jersey City, N.J. For mail: 41 N. Fullerton Ave., Montclair, N.J.
- HUGHES, A. MORRIS** (A'25), 21 Clover St., Belmont, Mass.
- HUGHES, D. W.** (A'27), Wireless Operator and Engineer, Marconi International Marine

- Company, Marconi House, Strand, London, W.C., England. For mail: 52 Limpsfield Ave., Thornton Heath, Surrey, England.
- HUGHES, EVERETT J. (A'26), Engineer, Algonquin Electric Company, Poughkeepsie, N.Y. For mail: 615 Church St., Boonton, N.J.
- HUGHES, KENNETH E. (A'27), Radio Service Laboratory, 2119 Ave. P, Galveston, Tex.
- HUGHES, LIONEL J. (A'23), The Telegraph Office, Mombasa, Kenya Colony, E. Africa. For mail: BM-Hughes, London W. C. 1, England.
- HUGHES, PETER (A'26), Electrician, Toronto Fire Dept., 132 Bellevue Ave., Toronto, Ont., Canada. For mail: 591 Ossington Ave., Toronto, Ont., Canada.
- HUGHES, ROBERT E. (A'25), Instructor in Physics and Radio, Evanston High School, Evanston, Ill. For mail: 1914 Colfax St., Evanston, Ill.
- HUGHES, WILLIAM P., JR. (A'26), Radio Engineering Laboratories, 100 Wilbur Ave., Long Island City, L.I., N.Y. For mail: 172-67th St., Brooklyn, N.Y.
- HUGENIN, GLENDA (J'29), Student, Dodge School of Radio, Valparaiso, Ind. For mail: Payne, Ohio.
- HUKLE, R. M. (A'29), Manager, Radio Test Dept., Bremer-Tully Manufacturing Company, Chicago, Ill. For mail: 4865 North Hermitage Ave., Chicago, Ill.
- HULAN, A. G. (A'29), Supervisor, Standards Division, R.C.A. Photophone, Inc., 411-5th Ave., New York, N.Y.
- HULL, BLAKE D. (A'22), Engineer, Southwestern Bell Telephone Company, Dallas, Tex.
- HULL, L. M. (J'17-A'19-M'27-F'28), Vice-President, Radio Frequency Laboratories, Boonton, N.J.
- HULL, ROSS A. (A'25-M'27), Charnwood Rd., St. Kilda, Victoria, Australia.
- HUMPHREY, HARTLEY C. (A'29), Engineer, Electrical Research Products, Inc., 250 West 57th St., New York, N.Y. For mail: 31 Burnett Place, Nutley, N.J.
- HUMPHREY, STANLEY M. (A'28), Engineer, Hygrade Lamp Company, Salem, Mass. For mail: 12 Humphrey Terrace, Swampscott, Mass.
- HUMPHREYS, IRL W. (A'29), Cable Splicer's Helper, Southwestern Bell Telephone Company, 3900 Chouteau, St. Louis, Mo. For mail: 5383 Geraldine, St. Louis, Mo.
- HUND, AUGUST (M'16-F'27), Consulting Engineer, Wired Radio, Inc., Ampere, N.J.
- HUNKINS, HAROLD R. (A'29), Research Engineer, International Communications, Inc., 67 Broad St., New York, N.Y.
- HUNT, FREDERICK V. (A'28), Assistant, Dept. of Physics, Cruft Laboratory, Harvard University, Cambridge, Mass. For mail: 15 Conant Hall, Cambridge, Mass.
- HUNT, LOUIS W. (A'27), Instructor, Cleveland School of Technology, 2200 Prospect Ave., Cleveland, Ohio.
- HUNTER, THEODORE A. (A'29), Supervisor of Loud Speaker Development, Crosley Radio Corporation, 3401 Colerain Ave., Cincinnati, Ohio.
- HUNTINGTON, MAURICE B. (A'26), Assistant Laboratory Engineer, Rochester Gas and Electric Corporation, Rochester, N.Y. For mail: 86 Rockingham St., Rochester, N.Y.
- HUNTLEY, KENNETH L. (A'29), 407 W. South St., Angola, Ind.
- HUNTSINGER, F. J. (A'27), Service Manager, Buffalo Factory, Sonora Phonograph Company, Buffalo, N.Y. For mail: 118 W. Humboldt Parkway, Buffalo, N.Y.
- HUNTSINGER, PAUL R. (J'28), Student, Iowa State College, Ames, Iowa. For mail: 131 N. Hyland, Ames, Iowa.
- HURD, VOLNEY D. (A'25), Radio Editor, "Christian Science Monitor," Boston, Mass.
- HURFF, JOSEPH L. (A'28), Radio Engineer, Westinghouse Electric and Manufacturing Company, Chicopee Falls, Mass. For mail: 26 Prentice St., East Springfield, Mass.
- HURLBUT, RONALD (A'25), F. A. D. Andree, Inc., Long Island City, L.I., N.Y. For mail: Y.M.C.A., 109 W. 54th St., New York, N.Y.
- HURWITZ, SOLOMON BERNARD (A'27), Yard Radio Station, Navy Yard, Brooklyn, N.Y.
- HUSTED, DONALD R. (A'23), Aeronautical Engineer, General Development Company, 2828 Broadway, New York, N.Y. For mail: 213 Glen Ave., Sea Cliff, L.I., N.Y.
- HUTCHESON, JOHN A. (A'28), Radio Engineer, Westinghouse Electric and Manufacturing Company, Chicopee Falls, Mass. For mail: Springfield, Mass.
- HUTCHISON, MILLER (M'29), Engineer and Instructor, 90 West St., New York City.
- HUTCHISON, SAM T. (A'29), Teller, Des Moines National Bank, Des Moines, Iowa. For mail: 1538-31st St., Des Moines, Iowa.
- HUTTENLOCH, ROBERT M. (J'29), Radio Technician, 653 No. 10th St., Philadelphia, Pa.
- HWANG, JU-TSU (J'29), Student, c/o Professor K. C. Chang, Nanyang University, Shanghai, China.
- HYATT, C. BROWN (A'29), Operating Engineer, Philadelphia Storage Battery Company, Philadelphia, Pa.
- HYBARGER, H. K. (J'29), Student, Case School of Applied Science, 2088 Cornell Rd., Cleveland, Ohio.
- HYLAND, LAWRENCE A. (A'29), Associate Radio Engineer, Naval Research Laboratory, Bellevue, Anacostia, D.C.

I

- IDE, JOHN M. (J'28), Student, Harvard Engineering School, Cambridge, Mass. For mail: 7 Hilliard Place, Cambridge, Mass.
- IINUMA, H. (A'28), Radio Engineer, Research Laboratory, Dept. of Communication, Denki-Shikenjo 4-Bu., Osaki-machi, Tokyo-fu, Japan.
- IMAOKA, YOSHIO (A'27), Research Staff, Tokyo Electric Company, P.O. Box 5, Kawasaki, Japan. For mail: No. 45, Minami-Machi, 5 Chome, Aoyama, Tokyo, Japan.
- IMLACH, GEORGE (A'25), Radio Operator, Tropical Radio Telegraph Company, Long Wharf, Boston, Mass.
- IMLER, GLENN M. (A'28), Radio Operator, Radio Station WLBW, Oil City, Pa.

- INADA, SANNOSUKE (M'22), 176 Kogaicho Azabu, Tokyo, Japan.
- INANAMI, SUCO (A'27), Radio Section, Komukyoku, Department of Communication, Tokyo, Japan.
- INGLIS, ALEXANDER W. (A'23), Service Manager, Elmhurst Majestic Company, 103 S. York St., Elmhurst, Ill. For mail: 607 Cambridge Ave., Elmhurst, Ill.
- INGERSOLL, WILLIAM P. (A'25), 251 East Chestnut St., Canton, Ill.
- INNES, RONALD G. (J'28), Radio Mechanic, Canadian Brandes, 207 Queens Quay, Toronto, Ont., Canada. For mail: 11 Avonlea Blvd., Toronto 13, Ont., Canada.
- INNS, STEPHEN H. (A'29), 480 E. 1st St., La Habra, Calif.
- INSKIP, LEONARD S. (A'25), Development and Research Dept., American Telephone and Telegraph Company, 195 Broadway, New York, N.Y. For mail: 876 E. 39th St., Brooklyn, N.Y.
- INSTRALL, REGINALD C. (A'28), Captain, British Regular Army, No. 2, Wireless Company, R. Signals, Sarafand, Palestine.
- IRVINE, BASIL (A'26), Radio Electrician, Dominion Govt. Radio Service, Vancouver, B. C., Canada. For mail: Port Coquitlam, B. C., Canada.
- IRVINE, ROBERT P. (A'29), Radio Interference Man, Cleveland Electric Illuminating Company, Cleveland, Ohio. For mail: 3516 Storer Ave., Cleveland, Ohio.
- IRVING, DONALD H. (A'27), Wireless Engineer, 43 Woodville Rd., Cardiff, Wales, G. B. For mail: 41 Woodville Rd., Cardiff, Wales, G.B.
- IRVING, EMMANUEL (J'27), 684 Astor St., Milwaukee, Wis.
- IRVING, HERBERT W. (A'26), Supervisor, Lines and Pickup Dept., Radio Station KDKA, Westinghouse Electric and Manufacturing Company, East Pittsburgh, Pa. For mail: 555 N. Lang Ave., Pittsburgh, Pa.
- IRVING, IRA M. (A'26), President, Northeastern Radio Company, 302 Adams Ave., Scranton, Pa. For mail: 1707 Green Ridge St., Scranton, Pa.
- ISAACSON, HERBERT M. (A'25), Service Engineer, QRV Radio Service, 1400 Broadway, New York, N.Y. For mail: 922 Ave. O., Station Y, Brooklyn, N.Y.
- ISBELL, G. TERRILL (A'28), Chief Engineer, Isbell Industries, Jacksboro, Tex. For mail: P.O. Box 213, Jacksboro, Tex.
- ISELE, HAROLD ADOLPH (A'26), Transmission Tests Engineer, New York Telephone Company, 102 Stevens Ave., Mount Vernon, N.Y. For mail: 22 W. 89th St., New York, N.Y.
- ISHIKAWA, SHOICHI (A'25), Radio Section of Denki-Shikenjo, Osakimachi, Suburbs of Tokyo, Japan.
- ISRAEL, DORMAN D. (A'23), Engineering Dept., Crosley Radio Corporation, Cincinnati, Ohio. For mail: 341 Hearne Ave., Cincinnati, Ohio.
- ISRAEL, JOHN O. (A'27), Engineer, Bell Telephone Laboratories, Inc., 463 West St., New York, N.Y.
- ITOW, YUTAKA (A'26), Radio Engineer, Japan Broadcasting Association, 1, Uchiyan-mashitachs, Kojimachiku, Tokyo, Japan. For mail: 36 Fujimicho, Azabaku, Tokyo, Japan.
- IVANKO, JOHN G. (J'28-A'29), Radio Dealer and Serviceman, 656 Warren St., Bridgeport, Conn. For mail: 209 Lewis St., Bridgeport, Conn.
- IVERSEN, I. VEE (A'26), Student, School of Electrical Engineering, University of Washington, Seattle, Wash. For mail: 6554-18 Ave., N.E., Seattle, Wash.
- IZENSTARK, MAURICE J. (A'24), Manager, Chicago Salvage Stock Store, 509 S. State St., Chicago, Ill. For mail: 2839 Palmier St., Chicago, Ill.
- IZZO, ANTHONY (A'28), Proprietor, Paramount Radio and Music Company, 624 Washington St., Hoboken, N.J.

J

- JACKER, EDWARD W. (A'28), Radio Engineer, Radio Station WMBI, Addison, Ill. For mail: 36 S. Euclid Ave., Villa Park, Ill.
- JACKSON, ALFRED C. (A'27), Radio Engineer, Queensland Radio Service, Broadcasting Station 4QG, Brisbane, Australia. For mail: Ashbey and Gilbert Sts., Fairfield, Brisbane, Queensland, Australia.
- JACKSON, ARTHUR (A'29), Installation and Service Engineer, Research Products Engineering Dept., Northern Electric Company, Ltd., 637 Craig St., West, Montreal, P.Q., Canada.
- JACKSON, BENJAMIN B. (A'25), Technical Supervisor, Columbia Broadcasting System, Paramount Bldg., New York City. For mail: 34 E. Newell Ave., Rutherford, N.J.
- JACKSON, DONALD S. (J'28), 141 S. Grove St., East Orange, N.J.
- JACKSON, FRANK P. (A'25), Proprietor, Jackson's Radio Engineering Laboratories, 102 S. 6th St., Waco, Tex.
- JACKSON, HENRY W. (M'23), General Electric Company, Research Laboratory, Schenectady, N.Y.
- JACKSON, LESLIE (A'28), Radio Service, Canadian Westinghouse Electric Company, Toronto, Ont., Canada.
- JACKSON, SYLVAN E. (J'26-A'28), 725-2nd St., Portsmouth, Ohio.
- JACKSON, WILLIAM E. (A'29), c/o Superintendent of Lighthouses, Detroit, Mich.
- JACKSON, WILLIE (A'28), Lecturer in Electrical Engineering, Technical College, Bradford, England. For mail: Ightenhill Park Lodge, Park Lane, Burnley, England.
- JACOBS, ALWYN J. (A'25), Manager, Radio Dept., Automobile Electric Supply Company, Ltd., P.O. Box 2964, Johannesburg, South Africa. For mail: 4 Loch Ave., Parktown West, Johannesburg, South Africa.
- JACOBS, LOUIS (A'28), Research Engineer, Splittorf Electric Company, 392 High St., Newark, N.J. For mail: 33 Bank St., New York, N.Y.
- JACOBS, MARCELLUS L. (A'29), Glendive Radio and Electric Company, Froid, Montana.
- JAKOSKY, JOHN J. (M'24), Consulting Engineer, The Radiore Company, 4800 Santa

- Fe Ave., Los Angeles, Calif. For mail: 1518 S. Canfield Ave., Los Angeles, Calif.
- JAMES, WALLACE MC NEAL** (A'29), Radio Engineer, RCA-Victor Company, Inc., Front and Cooper Sts., Camden, N.J. For mail: 7 Oriental Ave., Westmont, N.J.
- JAMES, WILLIAM P.** (A'27), Editor and Manager, Editorials and News, Ltd., 32 Shoe Lane, London, E. C. 4, England. For mail: 4 Hilltop Way, Stanmore, Middlesex, England.
- JAMIESON, WILLIAM E.** (A'27), Managing Director, Buglass and Jamieson, Ltd., Eagle Bldgs., 65 Trades Lane, Dundee, Scotland. For mail: 6 Home Terrace, Broughty Ferry, Dundee, Scotland.
- JAMISON, ALEXANDER** (A'29), Electrical Radio Engineer, 3A Market St., Bangor, County Down, Ireland. For mail: 60 Clifton Rd., Bangor, County Down, Ireland.
- JAMROSS, RUDOLPH** (A'26), 4231 Boyd Ave., New York, N.Y.
- JANES, CLINTON W.** (J'26-A'28), University of Minnesota, Minneapolis, Minn. For mail: 2161 Wellesley Ave., St. Paul, Minn.
- JANITSCHKE, E. O.** (A'21), Industrial Dept., U. S. Naval Station, Pearl Harbor, T.H.
- JANKE, ALFRED H.** (A'14-M'14), Electrical Engineer and Patent Attorney, 2 Rector St., New York, N.Y.
- JANSKY, C. M., JR.** (A'18-M'25-F'28), Rm. 930, Munsey Bldg., Washington, D.C.
- JANSKY, KARL G.** (A'28), Radio Engineer, Bell Telephone Laboratories, Inc., Box 31, Cliffwood, N.J.
- JAPPE, HOLGAR** (A'19-M'24), c/o H. Jappe Company, 46 Cornhill, Boston, Mass.
- JARABIN, FRANK G.** (A'25), Brands Products Corporation, 200 Mt. Pleasant Ave., Newark, N.J. For mail: 8-4th St., Mamaronck, N.Y.
- JARDINE, W. N.** (A'29), General Manager, National Radio Service Bureau, Tower Building, Washington, D.C.
- JARMAN, ALICK D.** (A'25), Chief Wireless Operator, Government Wireless Station, Georgetown, British Guiana, South America.
- JARNAK, PAUL** (A'25), Banevej 19, Hillerod, Denmark.
- JARVIS, KENNETH W.** (A'24-M'27), Chief Engineer, Sterling Manufacturing Company, 2831 Prospect Ave., Cleveland, Ohio.
- JATLOW, J. L.** (A'26), Research Engineer, Conner Crouse Corp., 343 Lexington Ave., New York, N.Y. For mail: 756 Linden Ave., Elizabeth, N.J.
- JEFFREY, BYRON B.** (A'27), Manager, Radio Dept., Baume-Anderson Company, 319 Jefferson St., Burlington, Iowa. For mail: 2101 Madison Ave., Burlington, Iowa.
- JEFFREY, JACK H.** (A'27), Wireless Engineer, Metro-Vick Supplies Ltd., 14 Long Millgate, Manchester, England. For mail: 10 Sandgate Squires Gate, Blackpool, Lancashire, England.
- JELEN, MATT J.** (A'25), Radio Engineer, Stewart-Warner Speedometer Corporation, 1826 Diversey Blvd., Chicago, Ill. For mail: 5235 Montrose Ave., Chicago, Ill.
- JEN, C. K.** (A'29), Graduate Student in Physics, Harvard University, Cambridge, Mass. For mail: 46 Carver St., Cambridge, Mass.
- JENG, L. Y.** (A'28), Engineering Dept., Crosley Radio Corporation, Cincinnati, Ohio. For mail: 312 W. McMillan Ave., Cincinnati, Ohio.
- JENKINS, C. FRANCIS** (A'28), 1519 Connecticut Ave., N.W., Washington, D.C.
- JENKINS, DAVID R.** (A'26), Professor of Electrical Engineering, University of North Dakota, Grand Forks, N.D.
- JENKINS, MYRON Z.** (A'27), Radio Receiver Design Engineer, Research Laboratories, National Carbon Company, 1280 W. 73rd St., Cleveland, Ohio.
- JENSEN, A. G.** (A'23-M'26), Research Engineer, Bell Telephone Laboratories, Inc., 463 West St., New York, N.Y.
- JENSEN, GEORGE L.** (A'29), Junior Radio Inspector, Radio Division, Dept. of Commerce, Subtreasury Bldg., New York, N.Y.
- JENSEN, JOHN C.** (M'19), Professor of Physics, Nebraska Wesleyan University, Lincoln, Neb. For mail: 4926 Leighton Ave., Lincoln, Neb.
- JENSEN, KARL K.** (A'28), Radio Broadcasting and Operator, Grigsby-Grunow Company, Chicago, Ill. For mail: 2704 Warsaw Ave., Logan Sq., Chicago, Ill.
- JENSEN, SVEN** (A'26), Radio Dept., Fisher Company, Tacoma, Wash. For mail: c/o E. T. Gilbert, R. F. D. Box 214, Tacoma, Wash.
- JENSEN, VALDEMAR** (A'27), Manager, Fairchild Motor Car Company, Inc., 700 St. Charles St., New Orleans, La. For mail: 119 S. St. Patrick St., New Orleans, La.
- JEPHCOFF, ERNEST L.** (A'29), Officer-in-Charge, Automatic Exchange, Box 391, G.P.O., Salisbury, S. Rhodesia, South Africa.
- JEPSON, WARREN F.** (A'20), Inspector of Radio Material, U. S. Coast Guard, Washington, D.C. For mail: 53 Highview Ave., Melrose, Mass.
- JESSOP, F. R.** (A'27), Manager Radio Dept., J. Jessop, 12 Cedar St., Sudbury, Ont., Canada. For mail: P. O. Box 1139, Sudbury, Ont., Canada.
- JETT, EWELL K.** (A'29), Lieutenant, U. S. Navy, Federal Radio Commission, Washington, D.C. For mail: 508 Rittenhouse St., N.W., Washington, D.C.
- JEWETT, F. B.** (F'20), Vice-President, American Telephone and Telegraph Company, 195 Broadway, New York, N.Y.
- JIPP, JOHN** (J'27-A'28), 18 College St., New Haven, Conn.
- JOHN, KENNETH B.** (A'28), Store Manager, Albany Radio Laboratories, 4749 N. Crawford Ave., Chicago, Ill.
- JOHNS, FRANCIS J.** (A'22), Design Engineer, Westinghouse Electric and Manufacturing Company, East Pittsburgh, Pa. For mail: Westinghouse Club, Wilkinsburg, Pa.
- JOHNSON, ALBERT E.** (A'26), Control Engineer, National Broadcasting Company, Station WRC, 3308-14th St., Washington, D.C. For mail: 3220 Connecticut Ave., Apt. 211-A, Washington, D.C.

- JOHNSON, ARTHUR A.** (A'28), Custom Set Builder, 320 S. Church St., Rockford, Ill. For mail: 1506 School St., Rockford, Ill.
- JOHNSON, ARTHUR R.** (A'28), Manager, Station WENR, Great Lakes Broadcasting Company, Downers Grove, Ill. For mail: 720 Maple Ave., Downers Grove, Ill.
- JOHNSON, CARL A.** (A'27), Chief Operator, Radio Station KGA, Northwest Broadcasting System, Sun Life Assurance Bldg., Spokane, Wash. For mail: 216 S. Cedar St., Spokane, Wash.
- JOHNSON, CARL C.** (A'29), Radio Service Engineer, 1909-19th St., S., St. Petersburg, Fla.
- JOHNSON, CHARLES A.** (A'27), Engineering Dept., Gulf States Utilities Company, Beaumont, Tex.
- JOHNSON, C. M.** (M'29), Lieutenant, U.S.N., U.S.S. "Bridge," c/o Postmaster, New York, N.Y.
- JOHNSON, EDGAR F.** (A'27), Co-Partner, E. F. Johnson Company, Waseca, Minn. For mail: Waseca, Minn.
- JOHNSON, E. O.** (A'29), Radiotron Test Engineer, RCA-Victor Company, Inc., 2001 W. Pershing Rd., Chicago, Ill. For mail: 5668 Ridge Ave., Apt. 3N, Chicago, Ill.
- JOHNSON, HARMON** (A'29), Service Manager, P. A. Starek Piano Company, 1125 Chestnut St., Philadelphia, Pa. For mail: 2216 S. Bancroft St., Philadelphia, Pa.
- JOHNSON, I. W.** (A'25), Technician, Brunswick-Balke-Collender Company, 125 N. 10th St., Portland, Ore.
- JOHNSON, JAMES A.** (A'27), Architect, 781 Ellicott Square, Buffalo, N.Y.
- JOHNSON, JOHN K.** (A'25), Assistant Chief Engineer, Silver-Marshall, Inc., 6401 W. 65th St., Chicago, Ill. For mail: 11110 S. Irving Ave., Chicago, Ill.
- JOHNSON, JULIAN S.** (J'29), R.F.D. No. 8, Box 393, Battle Creek, Mich.
- JOHNSON, J. L.** (A'27), 404 Bellevue St., Marietta, Ohio.
- JOHNSON, J. ROBERT** (A'27), Burmar Company, 624 Hampshire St., Quincy, Ill. For mail: 1026 1/2 Vermont St., Quincy, Ill.
- JOHNSON, KENNETH S.** (A'24-M'26), Research Dept., Bell Telephone Laboratories, Inc., 463 West St., New York, N.Y. For mail: 10 Lenox Terrace, South Orange, N.J.
- JOHNSON, MILTON L.** (A'28), Kansas University, Lawrence, Kan. For mail: Bendena, Kan.
- JOHNSON, MONTGOMERY H.** (J'28-A'29), Assistant in Physics, Harvard University, Cambridge, Mass. For mail: 1709 Cambridge St., Cambridge, Mass.
- JOHNSON, PAUL F.** (A'23-M'26), 3100 Maiden Lane, Altadena, Calif.
- JOHNSON, REVERDY** (A'26), Patent Engineer, Otis Elevator Company, 260-11th Ave., New York, N.Y. For mail: 444 E. 52nd St., New York, N.Y.
- JOHNSON, R. STANLEY** (A'29), Radio Operator, Radiomarine Corporation of America, 326 Broadway, New York, N.Y. For mail: 117 S. Elliott Pl., Brooklyn, N.Y.
- JOHNSON, T., JR.** (A'14-M'18), 189 McClellan St., Schenectady, N.Y.
- JOHNSON, V.** (A'26), Proprietor, Johnson Radio Service, 908 Gaffey St., San Pedro, Calif. For mail: 868-6th St., San Pedro, Calif.
- JOHNSON, VIVION A.** (A'29), Chief Engineer, Supreme Instruments Corporation, Greenwood, Miss. For mail: 800 Henry St., Greenwood, Miss.
- JOHNSON, WILLIAM J.** (A'28), Operating, Traffic Dept., Radio Corporation of America, 64 Broad St., New York, N.Y.
- JOHNSTON, DOUGLAS A.** (A'26), Vice-President, City Coal and Wood Company, 141 Elm St., New Britain, Conn.
- JOHNSTON, JOHN P.** (M'28), President, Automotive Royalties Corporation, French Bldg., New York, N.Y. For mail: Engineers' Club, 32 W. 40th St., New York, N.Y.
- JOHNSTON, IVAN F.** (A'29), 1735 Wilson Ave., Y.M.C.A., Chicago, Ill.
- JOHNSTONE, GEORGE A.** (A'19), President and General Manager, Great Lakes Electric Manufacturing Company, 655 N. Kedzie Ave., Chicago, Ill. For mail: 491 Hill Rd., Winnetka, Ill.
- JOHNSTONE, R. S.** (A'22), Draftsman, American Bridge Company, 51st St., Pittsburgh, Pa. For mail: 133 Edgcliffe St., Etna, Pa.
- JOICE, W. S.** (A'29), Radiotelegraphist, c/o Messrs. Siemens Bros., Wireless Section, Woolwich, London, S.E.18, England. For mail: 12 Dryden St., Southwick, Sunderland, England.
- JOLLER, CASPER R.** (A'27), Consulting Engineer, 817 Chianti St., Pittsburgh, Pa.
- JOLLIFFE, CHARLES B.** (M'25), Physicist, Bureau of Standards, Washington, D.C.
- JONES, ALBERT L.** (J'29), 1599 Langston St., Atlanta, Ga.
- JONES, ARTHUR B.** (A'23), 1-A Glenyon Rd., Eltham S.E.9, London, England.
- JONES, BURLE R.** (A'29), Proprietor, Jones Radio Company, 2316 E. 15th St., Tulsa, Okla.
- JONES, DRAMIN D.** (A'28), Assistant Chief Engineer, Stations WHN-WPAP-WQAO, Marcus Loew Booking Agency, 1540 Broadway, New York, N.Y. For mail: 1045 Anderson Ave., Palisade, N.Y.
- JONES, EDWARD T.** (A'19-M'25), Radio Engineer, Victor Talking Machine Company, 719 Masonic Temple Bldg., New Orleans, La. For mail: 857 Roosevelt Pl., New Orleans, La.
- JONES, FRANK E. B.** (A'25), Captain, Royal Signals, 48th Divisional Signals, Great Brook St. Barracks, Birmingham, England. For mail: Hill Crest, Birmingham Rd., Wyld Green, Birmingham, England.
- JONES, FRANK H.** (A'27), Chief Engineer, Tuinucu Sugar Company, Tuinucu, Cuba. For mail: Tuinucu, Cuba.
- JONES, FRANK M.** (A'29), Broadcast Engineer, Radio Station KGKL, Inc., 8-10 W. Concho Ave., San Angelo, Tex. For mail: 16 S. Milton St., San Angelo, Tex.
- JONES, F. BURTON** (J'27), 100 W. 27th St., Austin, Tex.
- JONES, GEORGE I.** (A'28), Operator, Station WREN, Jenny Wren Company, Law-

- rence, Kan. For mail: 1621 Edgehill Rd., Lawrence, Kan.
- JONES, H. GARFIELD (A'28), Secretary and Manager, Hutton and Jones, Inc., 9 Whiting St., Plainville, Conn.
- JONES, H. ROSSITER (A'28), 203 Elm Ave., Rivington, N.J.
- JONES, L. F., III (J'26-A'26), Radio Engineer, General Electric Company, Schenectady, N.Y. For mail: 61 Bedford Rd., Schenectady, N.Y.
- JONES, LESTER L. (A'12-F'25), President, Technidyne Corporation, 644 Broadway, New York, N.Y.
- JONES, NEWELL R. (A'22), 381 Park Ave., Collingswood, N.J.
- JONES, VARNAKALE L. (A'26), The Chelsea Pharmacy, Chelsea, Okla.
- JONES, WALTER R. (A'26), Sales Engineer, Sylvania Products Company, Emporium, Pa.
- JORDAN, JACOB (A'28), Associate Professor of Physics, Oregon State College, Corvallis, Ore. For mail: 554 Jefferson St., Corvallis, Ore.
- JORDAN, RALPH E. (A'28), Radio Repairman, 1019 E. 5th St., Erie, Pa.
- JORGENSEN, LAURITS (A'29), Radio Engineer, Philips Radio A/S, Studiestræde 24, Copenhagen K, Denmark. For mail: Thorvaldsensvej 184, Copenhagen V, Denmark.
- JORGENSEN, WESLEY J. (A'24), Southeastern District Manager, Crosley Radio Corporation, Cincinnati, Ohio. For mail: 1132 Virginia Ave., Atlanta, Ga.
- JORGENSEN, HAROLD (A'27), Final Inspector, Howard Radio Company, South Haven, Mich. For mail: Park View Hotel, South Haven, Mich.
- JOSEPH, J. (M'26), Managing Director, Radio Instruments, Ltd., 12 Hyde St., New Oxford St., London, W.C.1, England.
- JOWDY, MITCHELL (A'29), Radio Dealer, Washington, N.C.
- JOY, HENRY B. (A'22), President, Joy Realty Company, 1817 Penobscot Bldg., Detroit, Mich.
- JOYCE, HERBERT A. (J'24-A'25), 15027 Petrosky St., Detroit, Mich.
- JUCHTER, PIETER (A'28), Radio Engineer, General Electric Company, Schenectady, N.Y. For mail: 6 N. Toll St., Scotia, N.Y.
- JUDSON, ELBERT B. (A'26), Radio Engineer, Radio Transmission Research Laboratory, Bureau of Standards, Washington, D.C.
- JULIEN, IRA F. (A'15-M'26), Arc Engineer, Mackay Radio and Telegraph Company, Hillsboro, Ore. For mail: 934-5th St., Hillsboro, Ore.
- JUNKEN, L. H. (A'25), Electrical Engineer, General Electric Company, Schenectady, N.Y. For mail: 1520 Nott St., Schenectady, N.Y.
- K
- KAAR, IRA J. (J'22-A'26-M'29), Engineer, Radio Engineering Dept., Transmitter Section, General Electric Company, Schenectady, N.Y.
- KACOURINE, SERGE N. (A'26), Chief Radio Laboratory, Scientific Research Institute of Transport, Corohovskaia St. 8, Moscow, U.S.S.R. For mail: Stankevitch St., N. 11, Apt. 6, Moscow, U.S.S.R.
- KA DELL, HAROLD WILLIAM (A'29), Radio Engineer, Research Laboratories, National Carbon Company, 1280 W. 73rd St., Cleveland, Ohio. For mail: 17545 Madison Ave., Cleveland, Ohio.
- KA EHNI, FRANK J. (A'20), 3266 West Blvd., Cleveland, Ohio.
- KAETEL, HERBERT C. (J'27), President H. C. Gill, Inc., 3808 Burleigh St., Milwaukee, Wis.
- KAFER, MERLE D. (A'28), Dodge Telegraph Railway Accounting Institute, 207 Monroe St., Valparaiso, Ind. For mail: 712-6th Ave., Mt. Vernon, Iowa.
- KAFKA, H. T. (A'27), Doctor, Ladowitz, Czechoslovakia.
- KAHANT, CHARLES G. (A'13), District Sales Agent, Koller-Smith Company, 233 Broadway, New York, N.Y.
- KAHN, ALBERT R. (J'25-A'28), Partner, The Radio Engineers, 119 W. Collax Ave., South Bend, Ind.
- KAHN, FREDERICK J. (A'22-M'26), Service Manager, Kolster Radio Corporation, 200 Mt. Pleasant Ave., Newark, N.J.
- KAHN, LAMOS (A'27), Manager and Buyer, Radio Dept., Herris-Kahn Company, 8401 Buffalo Ave., S. Chicago, Ill. For mail: 7850 S. Shore Dr., S. Chicago, Ill.
- KAHN, MORTON B. (A'29), Engineer, RCA Photophone, Inc., 411-5th Ave., New York, N.Y. For mail: 617 W. 141st St., New York, N.Y.
- KAISER, FRED J. (A'27), 96 Ontario St., Albany, N.Y.
- KALE, SAMUEL S. (A'27), Radio Sales and Service, Raser and Kale, 330 Concord Ave., Trenton, N.J.
- KALIN, ALBERT (A'19), Electrical Engineer, Engineering Office, Washington Pulp and Paper Corporation, Port Angeles, Wash.
- KAMIN, VERNON A. (A'27), Manager, Radio Dept., Butler Bros., Randolph and Canal Sts., Chicago, Ill.
- KAMMERMAN, JOHN O. (A'23), Professor of Electrical Engineering, South Dakota State School of Mines, Rapid City, S.D. For mail: 921 Columbus St., Rapid City, S.D.
- KANAYAMA, TOYOSAKU (A'29), Engineer of Radio Broadcasting, Shimizu-Hosono, Near Kumamoto City, Japan.
- KANELY, NORMAN J. (A'28), Sales Dept., Atwater-Kent Manufacturing Company, Philadelphia, Pa. For mail: Baker Hotel, Dallas, Tex.
- KANKO, GO (A'28), Sub Engineer, Japan Wireless Telegraph Company, Tomiokamachi, Futabagum, Fukushima, Japan.
- KANNENBERG, WALTER F. (A'25), Telephone Engineer, Bell Telephone Laboratories, Inc., 463 West St., New York, N.Y. For mail: 745 Ten Eyck Ave., Lyndhurst, N.J.
- KANNENSTINE, F. M. (A'16), Director of Research Laboratory, Geophysical Research Corporation, 65 Broadway, New York, N.Y. For mail: 264 Liberty St., Bloomfield, N.J.
- KANNO, GENGO (A'29), Chief Engineer, JOHK, Sendai Broadcasting Station, Haranomachi Sending Station, Sendai City, Japan.

- KANOFKY, RAYMOND (A'29), Service Manager, Milam Radio Company, Inc., Milam Bldg., San Antonio, Tex.
- KANTEBET, S. R. (A'25), Assistant Professor of Electrical Communication, Engineering Dept., Indian Institute of Science, Hebbal, Bangalore, India.
- KAPLAN, BENJAMIN G. (A'29), Proprietor, Lexington Hardware and Radio Company, 1633 Lexington Ave., New York, N.Y.
- KAPLAN, JACOB (A'29), Patent Attorney, 900 F St., N.W., Washington, D.C.
- KARCHER, DONALD (J'27), Electrician, Independent Wiring Company, 1613 Sansom St., Philadelphia, Pa. For mail: 4433 Fleming St., Philadelphia, Pa.
- KARKER, EARL C. (A'25), Head, Electrical Dept., Rochester Mechanics Institute, Rochester, N.Y.
- KARR, HENRY P. (A'27), 706 Odell St., Great Bend, Kan.
- KARRAS, GEORGE S. (A'27), Proprietor, Electra Radio Shop, 119 W. Broadway, Princeton, Ind.
- KARSLAKE, JAMES S. (A'29), Graduate Student, Harvard University, Cambridge, Mass. For mail: 158 Linden Ave., Buffalo, N.Y.
- KATO, Y. (A'27), Japan Wireless Telegraph Company, 1, Ichome, Yasucho, Kojimachi, Tokyo, Japan. For mail: 48 Shimorokubancho, Kojimachi, Tokyo, Japan.
- KATZ, LOUIS S. (A'29), Proprietor, Grove Hall Radio Company, 653 Warren St., Roxbury, Mass. For mail: 25 Fernboro St., Roxbury, Mass.
- KATZIN, MARTIN (J'27-A'29), Radio Corporation of America, New York, N.Y. For mail: 1913-67th St., Brooklyn, N.Y.
- KAUFMAN, ARTHUR W. (J'27), Repairman, Pacific Telephone and Telegraph Company, 333 Grant Ave., San Francisco, Calif. For mail: 346 Sutter St., San Francisco, Calif.
- KAUL, WILLIAM (A'29), Radiotrician and Radio Dealer, Chelan Radio Service Company, Chelan, Wash.
- KAULBACK, HAROLD D. (A'26), Operating Engineer, Dept. of Commerce, Boston, Mass. For mail: 61 Warner St., Hudson, Mass.
- KAWAHARA, TAKEWO (A'25), Musengakari Communications Dept., Tokyo, Japan.
- KAYSER, HERBERT (J'15-A'17), Test Engineer, Freed-Eisemann Radio Corporation, Brooklyn, N.Y. For mail: 290 Empire Blvd., Brooklyn, N.Y.
- KEAR, FRANK G. (A'24), Assistant Physicist, U. S. Bureau of Standards, Radio Section, Washington, D.C. For mail: 3618 Conn. Ave., N.W., Washington, D.C.
- KEARNEY, L. E. (A'28), U. S. Radio Inspector, Radio Division, Dept. of Commerce, 105 S. 22nd St., Washington, D.C. For mail: 4047 Maywood St., Philadelphia, Pa.
- KEARNEY, WILLIAM A. (J'27), American Fork and Hoe Company, Frankford, Philadelphia, Pa. For mail: 4926 Garden St., Bridesburg, Philadelphia, Pa.
- KEARY, HUGH F. (J'26-A'27), 171 N. 17th St., East Orange, N.J.
- KEAST, PHILIP M. (A'27), Radio Operator, Radio Corporation of America, 35 S. 3rd St., Philadelphia, Pa. For mail: 81 E. Philadelphia St., Mt. Airy, Philadelphia, Pa.
- KECK, KENNETH K. (A'29), Proprietor, H. K. Radio Engineering Company, 959 Turner St., Allentown, Pa.
- KEEFE, OSCAR A. (A'26), Engineer, Theatre Installation Dept., Electrical Research Products, Inc., 250 W. 57th St., New York, N.Y.
- KEHM, CLARENCE H. (A'27), Consulting Engineer, 4940 Lowell Ave., Chicago, Ill.
- KEILY, DELBAR P. (A'28), Commercial Marine Operator, Portland Trawling Company, Groton, Conn. For mail: 46 Palisade Ave., Windsor, Conn.
- KEIM, J. D. (A'25), Technician, Brunswick-Balke-Collender Company, 314 Stuart St., Boston, Mass. For mail: 287 Warren St., Needham, Mass.
- KEIM, LLEWELLYN B. (J'28-A'29), 270 Park Ave., New York, N.Y.
- KEIR, JOHN (M'21), Managing Director, Rua de Rosario B9, Rio de Janeiro, South America. For mail: Caixa 126, Rio de Janeiro, South America.
- KELLER, PAUL A. (A'27), Service Manager, Standard Radio Company, 611 Market St., Philadelphia, Pa. For mail: 1246 W. Lehigh Ave., Philadelphia, Pa.
- KELLEY, GEORGE W., JR. (A'14), Radio Engineer, Design Section, Navy Dept., Bureau of Engineers, Washington, D.C. For mail: 4616 Norwood Drive, Chevy Chase, Md.
- KELLEY, HARVEY T. (A'23), Vice-President and Plant Manager, Acoustical Development Corporation, 230 E. Ohio St., Chicago, Ill. For mail: 3312 Warren Ave., Chicago, Ill.
- KELLEY, LEO A. (A'27), Engineering Dept., American Telephone and Telegraph Company, 195 Broadway, Rm. 1118, New York, N.Y.
- KELLIHER, JOHN E. (A'29), Radio Service Manager, Sherman Clay and Company, 141-145 S. 1st St., San Jose, Calif. For mail: 398 N. 8th St., San Jose, Calif.
- KELLOGG, LEONARD A. (A'25), District Sales Manager, Crosley Radio Corporation, Cincinnati, Ohio.
- KELLOGG, RICHARD B. (A'28), Assistant Electrical Engineer, Pacific Gas and Electric Company, 245 Market St., San Francisco, Calif.
- KELLOGG, WALTER D. (A'26), Engineer-in-Charge, Station KGO, General Electric Company, Russ Bldg., San Francisco, Calif.
- KELLY, CLAUDE H. (A'28), Proprietor and General Manager, Radio Engineering Laboratory, 3305 Chenevert St., Houston, Tex. For mail: 214 E. 3rd St., Houston, Tex.
- KELLY, C. MERRILL, JR. (A'12), Engineer, Electrical Research Products, Inc., 250 W. 57th St., New York, N.Y. For mail: 133-4th St., Pelham, N.Y.
- KELLY, DALE (A'29), Student Engineer, Radio Corporation of America, 66 Van Cortlandt Park S., New York, N.Y. For mail: 1465 Roosevelt Ave., Pelham Manor, N.Y.

- KELLY, DANIEL S. W. (A'23), Engineer, Allen Bradley Company, 286 Greenfield Ave., Milwaukee, Wis. For mail: 129-13th St., Milwaukee, Wis.
- KELLY, EARL L. (A'27), Consulting Radio Engineer, 615 Peoria Life Bldg., Peoria, Ill. For mail: 128 E. Rouse Ave., Peoria, Ill.
- KELLY, MERVIN J. (M'25), Research on Vacuum Tubes, Bell Telephone Laboratories, Inc., 463 West St., New York, N.Y.
- KELLY, MICHAEL P. (A'29), Chief Radio Operator, Station WBF, Tropical Radio Telegraph Company, 1 Federal St., Boston, Mass.
- KELSO, RUPERT E. (A'26), Kelso Electric Company, Arvada, Colo. For mail: P. O. Box 96, Arvada, Colo.
- KELTERBORN, W. H. (A'27), Radio Tube Engineering, Canadian Westinghouse Company, Ltd., Aberdeen Ave., Hamilton, Ont., Canada.
- KEMPF, FRANK J. (A'29), Professional Set Builder, 411 S. Ashland Blvd., Chicago, Ill.
- KEMPTON, WALTER D. (A'27), Proprietor, Radio Service Shop, 924 Chapala St., Santa Barbara, Calif.
- KENDALL, JOHN A. (A'27), Radio Engineer, Waltham Electric Corporation, 233 Spring St., New York, N.Y. For mail: 124 W. 134th St., New York, N.Y.
- KENNEDY, HAROLD E. (A'28), Chief Radio Operator, Station WEBJ, 130th St. and 3rd Ave., New York, N.Y. For mail: 755 Gravesend Ave., Brooklyn, N.Y.
- KENNEDY, JAMES P. (A'27), Manager, The Kennedy South Bend Company, 117 N. Main St., South Bend, Ind. For mail: 418 W. La Salle St., South Bend, Ind.
- KENNEDY, JOHN C. (A'28), Warrant Telegraphist, H. M. Wireless Telegraph Station, Castille, Malta. For mail: 4 Flat, 53 Strada San Tomasso, Floriana, Malta.
- KENNEDY, T. R., JR. (A'27), Radio News Dept., "New York Times," Times Annex Bldg., New York, N.Y. For mail: 601 W. 112th St., New York, N.Y.
- KENNEDY, WILLIAM A. (J'27), Radio Inspector, New York Edison Company, 124 W. 42nd St., New York, N.Y. For mail: 688-8th Ave., New York, N.Y.
- KENNELLY, ARTHUR E. (A'12-M'13-F'28), Professor of Electrical Engineering, Harvard University, Cambridge, Mass.
- KENNEY, M. W. (M'28), Assistant Chief Engineer, Grigsby-Grunow Company, 4540 W. Armitage Ave., Chicago, Ill. For mail: 265 W. North Ave., Elmhurst, Ill.
- KENNY, MATTHEW (A'15), United States Fleet, Base Force, Train Squadron One, U.S.S. "Vestal," Norfolk, Va.
- KENRICK, GLEASON W. (A'23-M'29), Assistant Professor, Electrical Communications, Tufts College, Mass.
- KENT, JAMES M. (A'27), Teacher and Engineer, Kansas City School District, Manual Training High School, Kansas City, Mo. For mail: 3241 Wabash Ave., Kansas City, Mo.
- KENT, OLIVER C. (A'25), 6631 Angeles Mesa Dr., Los Angeles, Calif.
- KENT, PAUL N. (A'27), Engineer and Manager, Engineering Dept., Kansas City Power and Light Company, 1330 Grand Ave., Kansas City, Mo. For mail: 3241 Wabash Ave., Kansas City, Mo.
- KERBY, EDWARD J. (A'28), Radio Engineer, A. A. Schneiderhahn Company, Sioux City, Iowa.
- KERSEY, RUSSELL (J'27-A'28), Radio Sales and Service, Blanchard, Mich.
- KERSTA, LAURENCE G. (A'29), Radio Engineer, Brandes Laboratories, Inc., 200 Mt. Pleasant Ave., Newark, N.J. For mail: 96 Washington Ave., Maywood, N.J.
- KERWIEN, ARTHUR E., JR. (A'29), Radio Engineer, Bell Telephone Laboratories, Inc., Box 122, Deal, N.J.
- KESSLER, P. W. (A'20), 7234 Ridge Blvd., Chicago, Ill.
- KEYES, EDWIN F. (A'15), 5958 N. Middleton, Huntington Park, Calif.
- KIDD, THORNTON L. (A'28), Station Operator, Liberto Radio Sales, 409 S. Flores St., San Antonio, Tex. For mail: 519 W. Summit Ave., San Antonio, Tex.
- KIENZLE, D. R. (A'29), Director and Chief Engineer, Station WHBW, 4916 Chestnut St., Philadelphia, Pa.
- KIERNAN, EARL F. (J'22-A'24), Technician, Station KGB, Pickwick Hotel, San Diego, Calif.
- KILBOURNE, COVINGTON G. (A'23), Electrical Engineer, T. E. Murray, Inc., 88 Lexington Ave., New York, N.Y.
- KILGOUR, CHARLES E. (A'25), Chief Engineer, The Crosley Radio Corporation, Cincinnati, Ohio. For mail: 2617 University Ave., Cincinnati, Ohio.
- KILMER, T. W., JR. (A'25), Assistant Engineer, New York Telephone Company, 1775 Grand Concourse, New York, N.Y. For mail: 438 W. 116th St., New York, N.Y.
- KIMBALL, GARDNER W. (A'27), Technical Dept., Brunswick-Balke-Collender Company, 40 N. 6th St., Philadelphia, Pa. For mail: 85 E. Stratford Ave., Lansdowne, Pa.
- KIMPARA, ATSUSHI (A'25), Radio Section, Komukyoku, Coms. Dept., Tokyo, Japan.
- KINASE, MATSUNAGA (M'25), Shuang Chiao Radio Station, Peking, China.
- KINCAID, OWEN D. (A'29), Service Manager, Willis Company, 104 Wick Ave., Youngstown, Ohio. For mail: 190 W. Laclede Ave., Youngstown, Ohio.
- KINCH, OSCAR A. (A'29), Product and Stores Dept., American Steam and Pump Company, Battle Creek, Mich.
- KING, FRANCIS N. (A'28), Technical Staff, Radio Station WIBX, Utica, N.Y.
- KING, FRANK (A'15), Consulting Radio Engineer, Amy, Aceves and King, Inc., 55 W. 42nd St., New York, N.Y. For mail: 120 W. 107th St., New York, N.Y.
- KING, HOWARD D. (A'26), Radio Corporation of America, 235 Montgomery St., San Francisco, Calif.
- KING, MAURICE V., JR. (A'27), Research Engineer, Sterling Manufacturing Company, 2845 Prospect Ave., Cleveland, Ohio. For mail: 2225 Olive Ave., Lakewood, Ohio.
- KINLEY, CLIFFORD B. (A'26), Assistant Radio Engineer, Office of Chief Signal Officer, War Dept., Munitions Bldg., Washington, D.C. For mail: 2012 R St., N.W., Washington, D.C.

- ton, D.C. For mail: 2012 R St., N.W., Washington, D.C.
- KINMAN, THOMAS H. (M'29), Radio Engineer, British-Thomson-Houston Company, Engineering Laboratory, Rugby, England. For mail: "Ladbroke" House, Bilton Rd., Rugby, England.
- KINNEAR, DONALD R. (A'29), Plant Maintenance, Bell Telephone Company of Canada, Hudson Office, Toronto 12, Ont., Canada. For mail: 1331 Avenue Rd., Toronto 12, Ont., Canada.
- KINNEY, ELY M. (A'25), Assistant Managing Engineer, Radio Dept., General Electric Company, Schenectady, N.Y. For mail: 1226 Parkwood Blvd., Schenectady, N.Y.
- KINNEY, E. S., JR. (A'29), Radio Dealer, Kinney Bros., 3000 "A" St., San Diego, Calif.
- KINSLEY, CARL (M'16), Consulting Research Engineer, Research Division, U. S. Steel Corporation, 71 Broadway, New York, N.Y. For mail: 22 Lynwood Rd., Scarsdale, N.Y.
- KINSMAN, WARREN D. (A'28), 53 William St., Chicopee Falls, Mass.
- KINTNER, DEANE S. (A'27), Radio Editor, "The Plain Dealer," Cleveland, Ohio. For mail: 3622 Lindholm Rd., Cleveland, Ohio.
- KINTNER, SAMUEL M. (M'13-F'15), Manager, Research Dept., Westinghouse Electric and Manufacturing Company, East Pittsburgh, Pa.
- KIPP, AARON (J'29), Shift Engineer, Operation Dept., RCA Communications, Inc., Rocky Point, L.I., N.Y.
- KIRBY, CORLEY W. (A'25), 3729 Boston Blvd., W., Detroit, Mich.
- KIRBY, MELVIN D. (A'29), Radio Engineer, Smith and Lowe Manufacturing Company, 2464 Randolph St., Huntington Park, Calif.
- KIRBY, OTTO I. (A'29), Radio Repairman, 5624 Grand River, Detroit, Mich. For mail: 2923 Kirby, W., Detroit, Mich.
- KIRBY, SAMUEL S. (A'27), Assistant Physicist, Bureau of Standards, Washington, D.C.
- KIRDAHY, EMIL (A'29), Radio Serviceman, 4 Dean St., Brooklyn, N.Y.
- KIRKE, HAROLD L. (M'25), Radio Engineer, The British Broadcasting Company, Ltd., 2 Savoy Hill, London, W.C.2, England.
- KIRKLAND, A. H. (A'29), Proprietor, Kirkland Jewelry Company, 15-12th St., Columbus, Ga. For mail: Box 69, Columbus, Ga.
- KISHPAUGH, ARTHUR W. (A'20), Member of Technical Staff, Bell Telephone Laboratories, Inc., 463 West St., New York, N.Y.
- KISSEL, ALFRED L. (A'24), Assistant Superintendent, Meter Dept., Compania Cubana de Electricidad, Havana, Cuba. For mail: Apartado Num. 475, Havana, Cuba.
- KISSINGER, J. HERBERT (A'21), Instructor, Boys' High School, Practical Arts Bldg., Reading, Pa. For mail: 243 Jameson Pl., Reading, Pa.
- KITCHIN, H. W. (A'14-M'26), Lieutenant U. S. Navy, U.S.S. "Texas," c/o Postmaster, New York, N.Y.
- KITCHEN, JAMES P. (A'26), Editor, "Irish Radio News," 179 Peorse St., Dublin, Ireland. For mail: 3 Charlemont Terrace, Dun Hooghair, County Dublin, Ireland.
- KITCHIN, J. E. (A'28), Senior Operator, Radio Branch, Dept. of Marine and Fisheries, Govt. of Canada, Alert Bay, B.C., Canada.
- KLEIN, HELEN (A'29), Engineering Dept., Crosley Radio Corporation, 3401 Colerain Avenue, Cincinnati, Ohio. For mail: 3881 Reading Rd., Cincinnati, Ohio.
- KLEIN, ISRAEL (A'24), Science Editor, NEA Service, Inc., 1200 W. 3rd St., Cleveland, Ohio.
- KLEIN, RENE H. (M'20), 18 Crediton Hill, W. Hampstead, London, N.W.6, England.
- KLEIN, WILLIAM S. (A'29), Student, Buxton Hall, Corvallis, Ore.
- KLEIST, ALFRED H. (A'26), 509 W. 110th St., New York, N.Y.
- KLEIST, WALTER A. (J'17-A'17), Engineer, Pacific Telephone and Telegraph Company, Dexter-Horton Bldg., Seattle, Wash.
- KLEMM, ROBERT CARL, JR. (A'29), Watchmaker, Morrow and Company, 306 High St., Holyoke, Mass. For mail: 49 Cleveland St., Holyoke, Mass.
- KLENK, JULIUS G. (A'28), Projection Engineer, Warner Bros. Lindley Theatre, 4902 N. 5th St., Philadelphia, Pa. For mail: 7162 Gillespie St., Philadelphia, Pa.
- KLESSE, WILLIAM (A'29), General Draftsman, The Texas Company, 17 Battery Pl., New York, N.Y.
- KLINE, ROBERT L. (A'28), Technician, Kludag Radio Laboratories, Box K, Kent, Ohio.
- KLOCK, R. A. (A'25), Sales Engineer, Fansteel Products Company, Inc., North Chicago, Ill. For mail: 33 North Ave., Lake Bluff, Ill.
- KLOSNER, MORRIS (J'20-A'21), Chief Engineer, Klosner Radio Corporation, 1022 E. 178th St., New York, N.Y.
- KLOSS, FREDERICK W. (A'26), Radio Engineer, 2504 N. Alder St., Philadelphia, Pa.
- KLUMB, HARVEY J. (A'26), Electric Laboratory, Director, Rochester Gas and Electric Corporation, 89 East Ave., Rochester, N.Y.
- KLUTH, WILLIAM J., JR. (A'29), Technician and Serviceman, Ellis Music Company, Nevada, Mo.
- KNAACK, FRANK E. (A'26), Manager, Warner Electric Company, Radio Dept., 133 N. Genesee St., Waukegan, Ill. For mail: 1729 Melville St., New York, N.Y.
- KNAPMAN, JACK (J'27), Radio Repair, Standard Radio Manufacturing Company, 90 Chestnut St., Toronto, Ont., Canada. For mail: 100 Admiral Rd., Toronto, Ont., Canada.
- KNAPP, HAROLD D. (A'29), Radio Engineer, Westinghouse Electric and Manufacturing Company, East Springfield, Mass. For mail: 32 Ardmore St., Springfield, Mass.
- KNAPP, JOSEPH F. (A'25), Manufacturing Director, American Lithographic Company, 52 E. 19th St., New York, N.Y.
- KNERR, G. RUSSELL (A'29), Secretary and Service Manager, Knerr, Inc., 1008 N. 3rd St., Harrisburg, Pa.

- KNIGHT, ARTHUR W. (A'25), 4 Highfield Rd., Rosebank, Cape Province, South Africa.
- KNIGHT, DONALD M. (A'29), Radio Interference, Detroit Edison, 2000-2nd Ave., Room 830, Detroit, Mich. For mail: 5615 Horger Ave., Fordson, Mich.
- KNIGHT, FRANK (J'29-A'29), General Clerk, Rowntree, Ltd., 72 Sterling Rd., Toronto, Ont., Canada. For mail: 86 Geoffrey St., Toronto, Ont., Canada.
- KNIGHT, GAYLORD A. (A'28), Radio Service, Bayless Hardware Company, Athens, Tenn. For mail: 12 Euclid Ave., Athens, Tenn.
- KNIGHT, HAROLD E. H. (J'20-A'24), Sales Engineer, Long Island Lighting Company, Suffolk County, N.Y. For mail: Manatuck Blvd., Brightwaters, L.I., N.Y.
- KNIGHT, J. B., JR. (A'29), Development Engineer, DeForest Radio Company, Manhattan and Factory Sts., Passaic, N.J. For mail: 583 Riverside Dr., New York, N.Y.
- KNIGHT, OCTAVIUS (A'26), Patent Lawyer, Knight Bros., 2 Rector St., New York, N.Y.
- KNIGHT, SIDNEY G. (A'26), Les Laboratoires Standard, 46 Avenue de Breteuil, Paris 7^e, France.
- KNIGHT, WINFIELD W. (A'25), Radio Inspector, Radio Office, Naval Aircraft Factory, Navy Yard, Philadelphia, Pa. For mail: 328 S. 8th St., Darby, Pa.
- KNIGHTS, ALEXANDER H. (A'28), Installation Engineer, RCA Photophone, Inc., 411-5th Ave., New York, N.Y. For mail: 2800 Sedgwick Ave., New York, N.Y.
- KNIPP, CHARLES T. (M'25), Professor of Experimental Electricity, Dept. of Physics, University of Illinois, Urbana, Ill.
- KNOLL, LLOYD M. (A'13-M'16), Professor of Physics, Central High School, Philadelphia, Pa. For mail: 6120 Carpenter St., West Philadelphia, Pa.
- KNOPP, ERNEST (A'26), Experimental Dept., H. O. Boehme, Inc., 117 E. 24th St., New York, N.Y. For mail: 2285 Andrews Ave., New York, N.Y.
- KNOTT, WILLIAM M. (A'25), Associate Radio Engineer, Signal Corps, Aircraft Radio Laboratory, Wright Field, Dayton, Ohio.
- KNOUF, RALPH J. (A'26), Engineer, Steinite Manufacturing Company, Fort Wayne, Ind.
- KNOWLES, EDWARD P., JR. (A'14), Radio Operator, Capitol Broadcasting Company, Radio Station WOAX, Trenton, N.J. For mail: 59 Colonial Ave., Trenton, N.J.
- KNOWLES, HUGH S. (A'25), Manager, Parts Division, Silver-Marshall, Inc., 640 W. 65th St., Chicago, Ill.
- KNOWLES, J. G. (A'26), Civil Service, Lockyards, Newark St., Greenock, Scotland.
- KNOWLES, JEROME H., JR. (A'28), Radio Corporation of America, Northeast Harbor, Me.
- KNOWLTON, EUGENE W. (A'27), Foreman, Federal Radio Corporation, 1738 Elmwood Ave., Buffalo, N.Y. For mail: P. O. Box 919, Buffalo, N.Y.
- KNOWLTON, JOHN J. (A'29), Inspection Engineer, Western Electric Company, Dept. 876-2, Kearny, N.J.
- KNOWLTON, ROBERT G. (A'27), Radio Service, 121-125 Merrimack St., Haverhill, Mass. For mail: 4 Hawthorne St., Bradford, Mass.
- KNUTSON, BEN M. (A'29), Development Engineer, Western Electric Company, Chicago, Ill. For mail: Glen Flora, Wis.
- KOBAYASHI, KICKIJIRO (A'28), Engineer, Electric Research Products, Inc. (Western Electric Company), Tokyo, Japan. For mail: No. 556 Koenji Suginami, Tokyo, Japan.
- KOBAYASHI, M. (A'27), Radio Engineer, Nippon Musen Denshin Kaisha, Shutchojo, Karia, Aichiken, Japan.
- KOBER, PAUL A. (A'25), Research Engineer, Claude Neon National Laboratories, 30-20 Thompson Ave., Long Island City, L.I., N.Y. For mail: 1 Gregory Ave., West Orange, N.J.
- KOBERUP, JACK R. (A'28), Foreman, Balance and Gain Test Dept., Grigsby-Grunow Company, 4540 Armitage Ave., Chicago, Ill. For mail: 1030 N. Austin Blvd., Oak Park, Ill.
- KOBERUP, JULIUS (A'28), Chief Inspector, Grigsby-Grunow Company, 4540 Armitage Ave., Chicago, Ill. For mail: 1030 N. Austin Blvd., Oak Park, Ill.
- KOBLITZ, AUGUST P. (A'27), Consulting Engineer, Robert K. Kennedy and Company, Chicago, Ill. For mail: 4620 N. Leamington Ave., Chicago, Ill.
- KOCH, EARL L. (A'25), Executive Engineer, Kellogg Switchboard and Supply Company, 1066 W. Adams St., Chicago, Ill. For mail: 1511 Byron St., Chicago, Ill.
- KOCH, J. WESLEY (J'29), Radio Service Work, 117 S. 17th St., Lincoln, Neb.
- KOCH, WINFIELD R. (A'26), Engineer, Westinghouse Electric and Manufacturing Company, East Pittsburgh, Pa. For mail: P.O. Box 343, Wilkinsburg, Pa.
- KOECHER, W. P. (A'22), Engineer, Ken-Rad Tube and Lamp Company, Owensboro, Ky. For mail: 224 W. 9th St., Owensboro, Ky.
- KOEHLER, ELMER F. (A'29), Bookkeeper and Draftsman, St. Louis Contracting Company, 4417 Clayton Ave., St. Louis, Mo.
- KOEHLER, GLENN (A'27), Electrical Laboratory, University of Wisconsin, Madison, Wis.
- KOERNER, ALLAN M. (A'28), Bell Telephone Laboratories, Inc., 463 West St., New York, N.Y.
- KOERNER, LAWRENCE F. (A'29), Electrical Engineer, Bell Telephone Laboratories, Inc., 463 West St., New York, N.Y.
- KOFES, ALBERT (M'29), Technical Director, North Genuau Broadcasting Company, Norag, Hamburg, Roshenbaunichausse 112, Germany. For mail: Fuhlsbuettelerstr. 46b, Hamburg, 33, Germany.
- KOLB, WALTER R. (A'27), Pelbrook Hall, Pelham, N.Y.
- KOLKS, RICHARD H. (A'29), Student, University of Cincinnati, Cincinnati, Ohio.

- For mail: 2861 Marshall Ave., Cincinnati, Ohio.
- KOLO, R. E. (A'27), Instructor, Training Division, Cincinnati and Suburban Bell Telephone Company, 225 E. 4th St., Cincinnati, Ohio. For mail: 206 Washington Ave., Newport, Ky.
- KOLSTER, CHARLES C. (M'28), Supervisor of Radio, Department of Commerce, Custom House, Boston, Mass. For mail: 18 Farragut Ave., W. Somerville, Mass.
- KOLSTER, FREDERICK A. (A'12-M'13-F'16), Chief Research Engineer, Federal Telegraph Company, Palo Alto, Calif.
- KOMM, PAUL M. (A'23), Electrical Engineer, Thordarson Electric and Manufacturing Company, 500 W. Huron St., Chicago, Ill. For mail: 6533 W. 26th Pl., Berwyn, Ill.
- KONKLE, PHIL (A'28), Radio Engineer, Station WOI, Iowa State College, Ames, Iowa. For mail: 716-6th St., Ames, Iowa.
- KONO, T. (M'29), Major, c/o Signal Corps School, Fort Monmouth, N.J.
- KOON, CECIL L. (A'29), Proprietor, Onslow Hardware Company, Onslow, Iowa.
- KORBEL, GEORGE W. (A'28), Serviceman, Korbel Radio Shop, 1119 S. Wood St., Chicago, Ill.
- KORNTVED, GEORGE W. (A'27), Radio Service Manager, Birkel Music Company, 446 S. Broadway, Los Angeles, Calif. For mail: 635½ N. Orange Dr., Los Angeles, Calif.
- KORTES, GEORGE T. (A'27), Radio Electrician, U. S. Coast Guard, c/o Commander, Norfolk Division, Custom House, Norfolk, Va.
- KOS, SIMON F. (M'19), Engineering Dept., General Post Office, Pretoria, South Africa.
- KOSHIKAWA, Y. (A'29), Radio Engineer, Tokyo Central Broadcasting Station, Atagoyama, Tokyo, Japan.
- KOTERA, WILLIAM J. (A'27), Radio Operator, Radio Station WOW, Omaha, Neb. For mail: 5223 Pacific St., Omaha, Neb.
- KOTSCH, ELMER G. (A'27), Radio Salesman, Spear and Company, Pittsburgh, Pa. For mail: 515 North Ave., Wilkinsburg, Pa.
- KOUTNIK, J. A. (A'29), Collector, U. S. Post Office, Hawthorne Station, Chicago, Ill. For mail: 2837 S. St. Louis Ave., Chicago, Ill.
- KOYAMA, KUMENOSUKE (A'27), Radio Engineer, Nippon Musen Denshin Kaisha, Haranomachi, Fukushimaken, Japan.
- KOZACZKO, WALTER H. (J'28), Production Test Engineer, Standard Radio Corporation, Worcester, Mass. For mail: 71 Hazel St., Uxbridge, Mass.
- KRAHL, WALTER L. (M'28), Chief Engineer, Arcturus Radio Company, 28 Longworth St., Newark, N.J. For mail: 73 Orange Rd., Montclair, N.J.
- KRAMER, ANDREW W. (A'27), Associate Editor, "Power Plant Engineering," 53 W. Jackson Blvd., Chicago, Ill. For mail: 7929 Harvard Ave., Chicago, Ill.
- KRAMER, V. J. (A'29), Radio Repair, T. E. Swann Company, 706 W. 2nd St., Oklahoma City, Okla. For mail: 124 W. 6th St., Oklahoma City, Okla.
- KRANZ, FREDERICK W. (A'23), Research Engineer, Riverbank Laboratories, Geneva, Ill. For mail: Geneva, Ill.
- KRANZ, HERMAN E. (M'23), Chief Engineer, 2030 N. Komer Ave., Chicago, Ill. For mail: 325 Cottage Hill Ave., Elmhurst, Ill.
- KRATOKVIL, FRANK M. (A'29), Junior U. S. Supervisor of Radio, 2909 David Stott Bldg., Detroit, Mich.
- KRATZ, C. F. (A'28), Manager, Radio Service, Philadelphia Storage Battery Company, 1145 Wall St., Los Angeles, Calif.
- KREB, WILLIAM N. (A'29), Assistant Radio Inspector, Radio Test Shop, Washington Navy Yard, Washington, D.C. For mail: 2811 Chelsea Ter., Baltimore, Md.
- KRETCHMAR, G. G. (A'27), Professor of Physics, Walla Walla College, College Place, Wash. For mail: College Place, Wash.
- KREUZER, A. R. (A'28), Al's Radio Service, Farmington, Mich. For mail: 139 Wadham Ave., Farmington, Mich.
- KREUZER, BARTON (A'29), Electro-Acoustic Research, c/o Radio Corporation of America, Van Cortlandt Park, S., New York, N.Y.
- KRIEDER, JAMES L. (A'28), Radio Engineer, 13 E. Main St., Palmyra, Pa.
- KRIVAN, FRED A. (A'26), Assistant Sales Manager, Freed-Eisemann Radio Corporation, Brooklyn, N.Y. For mail: 668 Argyle Rd., Brooklyn, N.Y.
- KRIVITZKY, GEORGE (A'29), Scottville, Mich.
- KRIZ, JOSEPH (A'27), Radio Engineer and Inspector, National Electrical Supply Company, 1330 New York Ave., Washington, D.C. For mail: 1628 Riggs Pl., N.W., Washington, D.C.
- KROGER, F. H. (M'13-F'28), Radio Engineer, Radio Corporation of America, 66 Broad St., New York, N.Y.
- KRUEGER, ALFRED (A'29), Grigsby-Grunow Company, 4540 Armitage Ave., Chicago, Ill. For mail: 4154 N. Tripp Ave., Chicago, Ill.
- KRUEGER, OTTO J. (A'29), Assistant to Chief Engineer, Marathon Battery Company, Wausau, Wis. For mail: 108 Grand Ave., Wausau, Wis.
- KRUGER, BERNARD (A'29), Pacific Coast Sales Manager, CeCo Manufacturing Company, 405 E. Pico St., Los Angeles, Calif.
- KRUMM, LOUIS R. (A'13-M'15), L. R. Krumm Sales Company, Rm. 201-3, 60 E. Broad St., Columbus, Ohio. For mail: Athletic Club, Columbus, Ohio.
- KRUSE, GERALD D. (A'29), Radio Sales and Development, P.O. Box 24, Gale, Iowa.
- KRUSE, ROBERT S. (A'18-M'26), Consultant, 103 Meadowbrook Rd., West Hartford, Conn.
- KUENNE, K. R. (A'27), Service and Maintenance Man, Public Service Radio Corporation, 15 Michigan St., Milwaukee, Wis. For mail: 143-4th St., Milwaukee, Wis.
- KUHN, ALFRED S. (A'12), Executive, H. Loeb and Company, Inc., 453-4th Ave., New York, N.Y. For mail: 1435 Lexington Ave., New York, N.Y.

- KUHN, FREDERICK S. (A'28), Radio Dealer, Kuhn Radio Corporation, 2305-24th Ave., N., Seattle, Wash. For mail: 5744-28th Ave., N.E., Seattle, Wash.
- KUNC, FRANK (A'29), Engineer, H. O. Boehme, Inc., 117 E. 24th St., New York, N.Y.
- KUNICKY, BARNEY F. (A'29), 2255-33rd St., Astoria, L.I., N.Y.
- KUNO, T. (A'29), Research Staff, Vacuum-Tube Dept., Research Laboratory, The Tokyo Electric Company, Kawasaki, Japan.
- KUNZ, H. L. (A'29), Manager, Radio Sales, Sangamo Electric Company, Springfield, Ill.
- KURAMOCHI, SHAJU (A'25), Musengakari Communication Department, Tokyo, Japan.
- KURTINAITIS, JOHN V. (A'29), Radio Research Work, Bell Telephone Laboratories, Inc., 463 West St., New York, N.Y.
- KURTZ, CLYDE R. (A'29), Radio Sales and Service, 1801 Liberty St., Allentown, Pa.
- KUSAKARI, T. (A'27), Bachelor of Engineering, Nippon Musen Denshin Kaisha, 2-18 Marunouchi, Kojimachi, Tokyo, Japan.
- KUSH, FRED W. (A'27), Installation Dept., Southwestern Bell Telephone Company, 302 Dakota Ave., San Antonio, Tex. For mail: 839 E. Texas Ave., San Antonio, Tex.
- KUSUNOSE, YUZIRO (A'25), Radio Engineer, Electrotechnical Laboratory, Shimosaki, Ebaragun, Tokyofu, Japan. For mail: 3559 Agariyasiki, Takatamachi, Tokyo, Japan.
- KUTSCHER, LOUIS F. (A'26), Manager, Wholesale Radio Div., The Auto Tire Company, Inc., 168 High St., Hartford, Conn. For mail: 28 Bretton Rd., West Hartford, Conn.
- KUWAJIMA, T. (A'29), Research Staff, Vacuum-Tube Dept., Research Laboratory, The Tokyo Electric Company, Kawasaki, Japan.
- KYNASTON, B. H. J. (A'27), Managing Director, The Harmonic Radio Company, Ltd., Nottingham, England. For mail: 172 Trent Blvd., W. Bridgford, Notts, England.
- KYNNERSLEY, CHARLES (A'27), Radio-trician, 110 Church St., Toronto, Ont., Canada. For mail: 297 St. Helen's Ave., Toronto, Ont., Canada.
- KYNOR, MERRILL W. (A'29), Engineer, Edison Laboratory, Orange, N.J. For mail: 454 Conover Ter., Orange, N.J.
- L
- LA BATT, MANOR D. (A'26), Radio Manager, Hoffman Music Company, 212-5th Ave., Clinton, Iowa. For mail: 334-6th Ave., Clinton, Iowa.
- LACABANNE, WASHINGTON D. (A'29), Engineer, Federal Telegraph Company, Palo Alto, Calif.
- LACK, FREDERICK R. (A'20), Bell Telephone Laboratories, Inc., 463 West St., New York, N.Y.
- LACOMBE, CARLOS G. (A'25), Engineer-in-Charge, Companhia Radio Telegraphica, Brasileira (P.O.B.), Caixa Postal 500, Rio de Janeiro, Brazil. For mail: Cosme Velho 105, Rio de Janeiro, Brazil.
- LADNER, ALAN W. (A'23), Marconi Works, Chelmsford, Essex, England.
- LAGANKE, H. C. (A'29), General Machine and Tool Designer, National Carbon Company, W. 117th and Madison Ave., Cleveland, Ohio. For mail: 1299 Cove Ave., Lakewood, Ohio.
- LAGASSE, ALBERT (A'29), Radio Engineer, Grigsby-Grunow Company, 2020 N. Austin Ave., Chicago, Ill. For mail: 1506 D. N. Kildare Ave., Chicago, Ill.
- LAHMAN, WILFORD C. (A'29), Transmitter Design Dept., Universal Wireless Communication Company, 4619 Ravenswood Ave., E., Chicago, Ill. For mail: 729 Maclean Ave., Kenilworth, Ill.
- LAKATOS, EMORY (A'28), Engineer, Transformer Group, Bell Telephone Laboratories, Inc., 463 West St., New York, N.Y.
- LAKE, THORNTON G. (J'27), Radio Service, 1020 Kirby St., Lake Charles, La.
- LAKER, EDWARD W. (A'29), Radio Engineer, 16 Bodge St., Guernsey, Channel Islands.
- LAMARQUE, JAMES W. (A'24), Graybar Electric Company, 401 Hudson St., New York, N.Y. For mail: 199 Davis Ave., White Plains, N.Y.
- LAMB, G. F. (A'28), Train Transmission Division, General Electric Company, Radio Test, Bldg. No. 77, Schenectady, N.Y.
- LAMB, HAROLD A. (A'29), Electrical Engineer, Western Electric Company, Inc., Chicago, Ill. For mail: 1706 N. Mayfield Ave., Chicago, Ill.
- LAMB, JAMES J. (A'28), Technical Information Service, American Radio Relay League, 1711 Park St., Hartford, Conn.
- LAMB, WILLIAM H. (A'25), Radio Engineer, National Bldg., St. Mary's Parsonage, Manchester, England. For mail: 1 Watford Rd., Burnage, Manchester, England.
- LAMPKIN, GUY F. (A'26), College of Engineering and Commerce, University of Cincinnati, Cincinnati, Ohio. For mail: 146 W. McMillan St., Cincinnati, Ohio.
- LAMSON, HORATIO W. (A'15-M'27), Engineer, General Radio Company, 30 State St., Cambridge, Mass. For mail: 72 Oakland Ave., Arlington Heights, Mass.
- LANCE, HUBERT H. (A'29), Radio Operator, Station WWNC, Asheville, N.C.
- LANCE, THOMAS M. C. (A'25), Research Laboratories, General Electric Company, North Wembley, England. For mail: 1 Kingsmead Rd., Tulsa Hill, London, S.W. 2, England.
- LAND, JOHN R. (M'27), Telegraph and Telephone Dept., Nukualofa, Tonga, Friendly Islands. For mail: Nukualofa, Tonga, Friendly Islands.
- LANDALE, S. E. A. (A'29), Radio Research Work, Corpus Christi College, Cambridge, England.
- LANDON, VERNON D. (A'27-M'29), Assistant Chief Engineer, Radio Frequency Laboratories, Boonton, N.J. For mail: 3 Oak Lane, Boonton, N.J.
- LANDONE, BROWN (A'28), President, Landone Villa Land, Inc., Stickle Pond Rd., Newton, N.J. For mail: Newton, N.J.

- LANE, FREDERIC A. (A'21), Engineering Dept., American Gas and Electric Company, 30 Church St., New York, N.Y.
- LANE, HENRY M. (A'26-M'29), Instructor, Massachusetts Institute of Technology, Cambridge, Mass. For mail: 350 Lake St., Belmont, Mass.
- LANE, HOWARD D. (A'25), Radio Service Manager, A. C. Doughty and Company, 4050 Geary St., San Francisco, Calif.
- LANG, WALTER T. (A'28), Student Engineer, General Electric Company, Schenectady, N.Y. For mail: 27 Mulberry St., Rhinebeck, N.Y.
- LANG, WILLIAM A. (A'26), Civil Engineer, Southern California Edison Company, Edison Bldg., Los Angeles, Calif. For mail: Apt. 7, 1155 N. Kenmore Ave., Los Angeles, Calif.
- LANGDELL, HENRY R. (A'28), Radio Operator, Gillette Rubber Company, c/o Radio Station WTAQ, 799 Wisconsin St., Eau Claire, Wis. For mail: R.R. No. 4, Box 82, Eau Claire, Wis.
- LANGDON, G. G. (A'28), Radio Engineering Dept., General Electric Company, Schenectady, N.Y. For mail: 21 Governors Lane, Schenectady, N.Y.
- LANGE, EDWARD H. (A'24), Professor, Johns Hopkins University, Dept. of Electrical Engineering, Baltimore, Md.
- LANGENDAM, S. G. C. (A'29), Engineer, Nederlandsche Seintsesteller Fabriek, Hilversum, Holland.
- LANGEVIN, CARL C. (M'29), Manager, General Radio Company, 274 Brannan St., San Francisco, Calif.
- LANGFORD, C. H. (A'25), Manager, Proprietor Radio Store, Langford Radio Company, 290 Dundas St., London, Ont., Canada. For mail: 258 Cheapside St., London, Ont., Canada.
- LANGLEY, RALPH H. (A'12-M'16-F'29), Director of Engineering, Crosley Radio Corporation, Cincinnati, Ohio. For mail: Glenwood Apts., 5449 Hamilton Ave., Cincinnati, Ohio.
- LANGLOIS, GERALD L. (A'27), Quality Radio Shop, 9 Elm St., North Attleboro, Mass.
- LANGMUIR, IRVING (A'14-F'22), Research Laboratory, General Electric Company, Schenectady, N.Y.
- LANGRICK, PAUL D. (A'26), Manager, Radio Dept., Simpson Battery and Electric Company, 3950 W. 10th St., Los Angeles, Calif. For mail: 1141 W. Blvd., Los Angeles, Calif.
- LANPHERE, MERLE (A'27), Radio Dealer, Belmont Radio Service, 115 Palouse St., Wenatchee, Wash.
- LANTERMAN, WALTER F. (A'26), Development Engineer, Universal Wireless Communication Company, 4111 Ravenwood Ave., Chicago, Ill. For mail: 4640 Kenmore Ave., Chicago, Ill.
- LAPHAM, JAMES B. (A'27), Technician, Cassidy's, Ltd., Vancouver, B.C., Canada. For mail: Suite 43, 784 Thurlow St., Vancouver, B.C., Canada.
- LAPHAM, OLIN J. (J'27), Wireless Operator, Intercity Radio Telegraph Company, 1004 Rockefeller Bldg., Cleveland, Ohio. For mail: R.F.D. 1, Osso, Mich.
- LAPORT, EDMUND A. (A'25-M'27), Engineer, Radio Engineering Dept., Westinghouse Electric and Manufacturing Company, Chicopee Falls, Mass.
- LARA, JOSE (A'26), Elektron Laboratoro Electrico, Habana, Cuba. For mail: Patrocinio 29 Loma del Mazo, Habana, Cuba.
- LARSEN, CARL L. (A'29), Student, Coe Radio Institute, 829 Main St., Greenport, N.Y.
- LARSEN, C. W. (A'29), Research Engineer, Fox Movietone Acoustical Laboratory, Fox Film Company, Beverley Hills, Calif.
- LARSON, CLIFFORD L. (A'28), Clerk, Walworth Company, Kewanee, Ill. For mail: 608 S. Grove St., Kewanee, Ill.
- LARSON, JOHN M. (A'27), Engineering Dept., Universal Wireless Communication Company, Inc., 4619 Ravenwood Ave., E., Chicago, Ill.
- LARSON, ROBERT W. (A'29), Electrical Engineer, Research Laboratory, General Electric Company, Schenectady, N.Y.
- LARZELERE, W. R., JR. (A'15), 1458-24th Ave., San Francisco, Calif.
- LASALLE-DILLEY, L. L. (A'27), Radio Operator, U. S. Lighthouse Service, U.S.L.V. Relief No. 92, Astoria, Oregon.
- LASKY, PHILIP G. (J'22-A'28), Assistant Manager, Intermountain Broadcasting Company, 1011 Ezra Thompson Bldg., Salt Lake City, Utah.
- LASSMAN, HENRY H. (A'26), Wireless Apparatus Manufacturers, East Ham Wireless Supplies, London, England. For mail: 429 Barking Rd., East Ham E. 6, England.
- LAST, GEORGE O. (A'26), Installation Supervisor, Philco Battery Company, 54 N. 10th St., Portland, Ore.
- LATHROP, F. A. (A'27), Electrical Research Engineer, 508 Francis Palms Bldg., 2111 Woodward Ave., Detroit, Mich.
- LATHROPE, KENNETH W. (J'29), California Victor Distributors, 536 Mission Ave., San Francisco, Calif.
- LATIMER, CHESTER W. (A'17-F'29), Operating Engineer, R.C.A. Communications, Inc., 66 Broad St., New York, N.Y.
- LAURIE, WILLIAM L. (A'24), Captain, Royal Canadian Signals, c/o Assistant Director of Signals, Elgin Bldg., Ottawa, Ont., Canada.
- LAWLER, L. A. C. (A'28), Radio Engineer, Lawler Electric Company, 67 Lucien Rd., London, S.W. 17, England.
- LAWRENCE, L. H. (A'28), Receiving Engineer, Radio Corporation of America, Marshall, Calif. For mail: Rt. B, Box 503, San Jose, Calif.
- LAWRENCE, WALTER L. (A'29), Student, Engineering School, Columbia University, New York, N.Y. For mail: 117 W. 89th St., New York, N.Y.
- LAWTHER, HARRY P., JR. (A'20), Telephone Engineer, Southwestern Bell Telephone Company, 1817 Hickory St., Dallas, Tex. For mail: 5124 Live Oak St., Dallas, Tex.
- LAWTON, HARVEY B. (A'27), 6 N. Lotus Ave., Chicago, Ill.

- LAYNG, GRANT (A'26), Vice-President, 20th Century Radio Corporation, 104 Flatbush Ave., Brooklyn, N.Y. For mail: 124 Waverly Pl., New York, N.Y.
- LAZAROVICH-HREBELIANOVICH, D. (A'18), 155 E. 47th St., New York, N.Y.
- LAZARUS, BENJAMIN N. (A'28), Public Address Operator, Roxy Theatre Corporation, 50th St. and 7th Ave., New York, N.Y. For mail: 1615 Quentin Rd., Apt. A-4, Brooklyn, N.Y.
- LAZICH, BRANKO (A'23), Union Switch and Signal Company, Swissvale, Pa. For mail: 16 Eureka St., Pittsburgh, Pa.
- LEA, GEORGE (A'23), Engineer, The Indian Radio Telegraph Company, Ltd., Central Telegraph Office, P.O. Box 895, Bombay, India.
- LEACH, HARVEY B. (A'27), General Foreman, United Electric Light and Power Company, 514 W. 147th St., New York, N.Y. For mail: 600 W. 144th St., New York, N.Y.
- LEAHY, JOHN E. (A'28), Assistant Radio Engineer, U. S. Naval Research Laboratory, Bellevue, Anacostia, D.C. For mail: 2620-33rd St., S.E., Washington, D.C.
- LEAMER, FRANK D. (A'29), Professor of Physics, Willamette University, Salem, Oregon.
- LEATHES, W. H. B. DE M. (A'27), Lieutenant Commander, R.N.A., A.M.I.W.T., The Royal Aero Club, 3 Clifford St., London, W., England.
- LE BEL, C. J. (J'25-A'27), Engineer, Hygrade Lamp Company, Salem, Mass. For mail: 12 Park St., Lynn, Mass.
- LE BOEUF, WILFRED F. (A'28), Radiotechnician, A. A. MacPherson Company, 557 Campbell Ave., West Haven, Conn. For mail: 121 Calhoun Pl., Bridgeport, Conn.
- LE CONCHE, CARL C. (A'29), Radiotrician, Crown Light Company, 109 Allyn St., Hartford, Conn. For mail: 33 Eastview St., Hartford, Conn.
- LEDERER, ERNEST A. (M'28), Research Engineer, Westinghouse Lamp Company, Bloomfield, N.J. For mail: 8 Winthrop Ter., East Orange, N.J.
- LEDERHAUS, HERMAN WILLIAM (A'29), Bell Telephone Laboratories, 463 West St., New York, N.Y. For mail: 149-20-23rd Ave., Whitestone, L.I., N.Y.
- LEE, ALBERT G. (M'27-F'29), Engineering Dept., General Post Office, Alder House, London, England.
- LEE, EMERY H. I. (A'18-M'23), U. S. Radio Inspector, Subtreasury Bldg., Pine and Nassau Sts., New York, N.Y.
- LEE, FAT CHANG (A'27), 557 W. 124th St., Apt. 21, New York, N.Y.
- LEE, GILBERT C. (A'29), President, The Insto Company, Inc., 110 Center St., Los Angeles, Calif.
- LEE, KENNETH G. (A'29), Service Manager, Cardon Phonocraft Corporation, Jackson, Mich. For mail: R.R. No. 1, Harding Rd., Jackson, Mich.
- LEE, SAMUEL T., JR. (J'29), Radio Tester, General Electric Company, Bldg. 77, Schenectady, N.Y. For mail: 1306 Broadway, Schenectady, N.Y.
- LEE, SHEE MOU (A'24), Setang, Kashai, Chekiang, China.
- LEE, STANLEY A. (A'26), District Signal Officer, Captain, Headquarters, Military District 10, Winnipeg, Man., Canada.
- LEE, WALTER O. (A'28), Radio Telegraph Operator, Radiomarine Corporation of America, 326 Broadway, New York, N.Y. For mail: P.O. Box 1322, Easthampton, L.I., N.Y.
- LEE, WILLIAM J. (A'28), Aster Restaurant, 14th and H Sts., N.W., Washington, D.C.
- LEE, WM. JUSTICE (A'25-M'26), Lieutenant Commander, U. S. Navy, Navy Department, Washington, D.C.
- LEEB, HENRY L. (A'17-M'23), Charles Freshman Company, Inc., 470 E. 133rd St., New York, N.Y. For mail: Brookside Rd., South Orange, N.J.
- LEEKA, WARREN C. (A'27), Transmission Engineering Dept., The Ohio Bell Telephone Company, Columbus, Ohio. For mail: 42-17th Ave., Columbus, Ohio.
- LEEMAN, ALVIN (J'27-A'28), Chief Engineer, Radio Station WKBH, 400 State St., La Crosse, Wis. For mail: P.O. Box 580, La Crosse, Wis.
- LEEMAN, WILSON (A'28), Engineer, Station WJAG, P.O. Box 226, Norfolk, Neb.
- LEFFERTS, B. (A'25), Plant and Research Engineer, General Instrument Corporation, 225 Varick St., New York, N.Y. For mail: 1939 Bergen St., Brooklyn, N.Y.
- LEFFLER, RALPH H. (A'24), Chief Engineer, Radio Air Service Corporation, Radio Station WHK, Cleveland, Ohio.
- LEFTWICH, E. H. (A'27), Manager, Radio Dept., Palm Beach Mercantile Company, West Palm Beach, Fla. For mail: 213-6th Ave. N., Nashville, Tenn.
- LEHDE, PENDLETON E. (A'14-F'27), Radio and Electrical Engineer, 1812 Masonic Bldg., New Orleans, La.
- LEHMAN, JAMES N. (A'29), Radio Engineer, Radio Engineering Dept., Westinghouse Electric and Manufacturing Company, East Pittsburgh, Pa. For mail: 815 Rebecca Ave., Wilkesburg, Pa.
- LEHNHOFF, RAYMOND G. (A'22), Sales Engineer, Frigidaire Sales Corporation, 811 Race St., Cincinnati, Ohio. For mail: 322 Joselin Ave., Cincinnati, Ohio.
- LEIBE, FRANK A. (A'26), Engineer, American Telephone and Telegraph Company, Development and Research Dept., 195 Broadway, New York, N.Y.
- LEIBING, JOSEPH K. (A'23), General Engineering Laboratory, General Electric Company, Schenectady, N.Y. For mail: Troy Rd., Box 181, Schenectady, N.Y.
- LEIBOW, SAUL A. (A'29), Manager, Radio and Electric Division, Chain Hardware Company, 142 Washington St., Providence, R.I. For mail: 89 Pleasant St., Providence, R.I.
- LEIDY, W. J. (A'25), President, Chicago Transformer Corporation, 2626 W. Washington Blvd., Chicago, Ill.
- LEIGH, CHARLES W. (A'26), Radio Specialty Salesman, Van Ness Electric Company, 68 W. Lincolnway, Valparaiso, Ind.

- LEIGHTON, HAROLD W. (A'25), Engineer, California Service, Inc., 1233 S. Hope St., Los Angeles, Calif. For mail: 2903 S. Rimpau Blvd., Los Angeles, Calif.
- LEINS, ERNEST P., JR. (J'26), Radiotechnician, E. Leins Piano Company, 520 W. 48th St., New York, N.Y. For mail: 601 W. 115th St., New York, N.Y.
- LEITCH, DONALD J. H. (J'26-A'28), Engineering Dept., Radio Industries of Canada, Ltd., 120 Fort St., Winnipeg, Man., Canada.
- LEMMON, WALTER S. (A'14), President, Malone-Lemmon Products, Inc., Plainfield, N.J. For mail: Hotel Narragansett, 94th St. and Broadway, New York, N.Y.
- LEMOINE, A. S. (A'20), Chief Engineer, Radio Dept., Royal Board of Telegraphs, 21 Radmangatan, Stockholm, Sweden.
- LEMON, CECIL G. (A'27), Technical Supervisor, Tungstrom Electric Lamp Works, 72 Oxford St., London, W. 1, England. For mail: 19, Lena Gardens, Hammersmith, London, England.
- LENZ, CHARLES S. (A'17), Research and Consulting Engineer, The Lenz Crystal Corporation, Pasadena, Calif. For mail: c/o George E. Jupp, 3147 Country Club Rd., New York, N.Y.
- LEONARD, JOHN M. (A'28), Consulting Engineer, F-108 Montevista, 63rd and Oxford Sts., Philadelphia, Pa.
- LEONARD, PERCY A. (A'25), Development Engineer, Canadian Marconi Company, 1070 William St., Montreal, P.Q., Canada.
- LEONARD, SYDNEY L. (A'29), Inspection Dept., Canadian Brandes, Ltd., 207 Queens Quay, Toronto, Ont., Canada. For mail: 277 Roncesvalles Ave., Toronto, Ont., Canada.
- LEONARD, S. EDWIN, JR. (A'26), Chief Engineer, Stations WTAM and WEAR, Inc., 2023 Union Trust Bldg., Cleveland, Ohio. For mail: 1745 N. Chapman Ave., East Cleveland, Ohio.
- LEONHARDT, CHARLES C. (A'28), Radio Operator, Intercity Radio Telegraph Company, 1004 Rockefeller Bldg., Cleveland, Ohio. For mail: 14 Olive St., Norwalk, Ohio.
- LEOSER, THOMAS S. (A'23), Engineer, Amrad Corporation, Medford Hillside, Mass.
- LE QUESNE, CHARLES A. (A'12), Engineer of Buildings, New York Telephone Company, 360 Brodgo St., Brooklyn, N.Y. For mail: 350-87th St., Brooklyn, N.Y.
- LESCAROURA, AUSTIN C. (M'26), Technical Advertising and Publicity Counsel, Depot Sq., Croton-on-Hudson, N.Y. For mail: P.O. Box 666, Croton-on-Hudson, N.Y.
- LESLIE, FRANK (A'28), Recording Engineer, Paramount-Famous-Lasky Corporation, 6th and Pierce Aves., Astoria, L.I., N.Y. For mail: 20-62-8th Ave., Astoria, L.I., N.Y.
- LESLIE, FRED D. (A'25), Engineer, Fox-Hearst Corporation, 460 W. 54th St., New York, N.Y. For mail: 22 Rue Pigalle, Paris IXe, France.
- LESLIE, JOHN M. (A'27), Canadian Westinghouse Company, Metropolitan Bldg., Toronto, Ont., Canada.
- LESTER, PAUL SABINE (A'29), Student, Polytechnic Institute, 99 Livingston St., Brooklyn, N.Y. For mail: 259 Raymond Ave., Rockville Centre, N.Y.
- LEUTERITZ, HUGO C. (A'20), Radio Engineer, Radio Corporation of America, 66 Broad St., New York, N.Y. For mail: 202 Autumn Ave., Brooklyn, N.Y.
- LEUTZ, CHARLES R. (A'27-M'29), President, C. R. Leutz, Inc., 27th and Industrial Ave., Altoona, Pa.
- LE VAN, JAMES D. (A'26), 282 Lyon St., Milwaukee, Wis.
- LEVER, PHILIP R. E. (A'26), Proprietor, Lever's Radio Service, 49 E. King St., York, Pa.
- LEVIN, SAM (A'29), Electrical and Radio Engineer, 1532 S. Homan Ave., Chicago, Ill.
- LEVINE, HARRY (A'29), Machine Assembly, Graham and Norton, 20th St. and 11th Ave., New York, N.Y. For mail: 269-15th St., Brooklyn, N.Y.
- LE VINNESS, JOHN E. (A'28), Field Serviceman, Kolster Radio Corporation, 200 Mt. Pleasant Ave., Newark, N.J. For mail: 1265 E. 94th St., Brooklyn, N.Y.
- LEVINSON, NATHAN (M'25), Western Division Manager, Electrical Research Products, Inc., 7046 Hollywood Blvd., Hollywood, Calif. For mail: 1761 N. Van Ness Ave., Hollywood, Calif.
- LEVY, A. KINGDOM (A'29), Kingdom Radio Company, 55 W. 95th St., New York, N.Y.
- LEVY, HENRY (A'27), Monarch Electric and Wire Company, 624 W. Adams St., Chicago, Ill. For mail: 1748 E. 72nd St., Chicago, Ill.
- LEVY, LESTER (A'29), Radio Receptor Company, 106-7th Ave., New York, N.Y. For mail: 1130 Anderson Ave., New York, N.Y.
- LEVY, LUCIEN (M'19), Administrator, Etablissements Radio-L.L., 5 Rue de Cirque, Paris, France.
- LEVY, MAURICE L. (A'29), Engineer, Stromberg Carlson Telephone Manufacturing Company, 100 Carlson Rd., Rochester, N.Y. For mail: 1392 Monroe Ave., Rochester, N.Y.
- LEVY, MORTIMER N. (A'23), President, Supercraft Products Corporation, 225 W. 46th St., New York, N.Y. For mail: 570 W. 156th St., New York, N.Y.
- LEVY, SAMUEL L. (A'29), Testing and Inspection Methods Development, Temple Corporation, 5354 W. 65th Pl., Chicago, Ill. For mail: 7444 S. Kensington Ave., Chicago, Ill.
- LEWELLING, RAYMOND (A'26), Federal Telegraph Company, Palo Alto, Calif. For mail: P.O. Box 81, San Lorenzo, Calif.
- LEWIS, BERTRAM L. (A'28), Service Manager, Rochester Gas and Electric Corporation, 89 East Ave., Rochester, N.Y. For mail: 6 Poppy St., Charlotte Station, Rochester, N.Y.
- LEWIS, CHESTER, JR. (A'27), Serviceman, Whitehall Cement Company, Cementon, Pa. For mail: 2226 Washington Ave., Northampton, Pa.

- LEWIS, EARL B. (A'26), Chief Engineer, Hartford Battery Company, Middale, Conn. For mail: P.O. Box 681, Southington, Conn.
- LEWIS, EARL W. (A'27), Radio Engineer, Stephens College, Columbia, Mo.
- LEWIS, ELMER H. (A'14), Partner, A. C. Lopez and Company, 245-5th Ave., New York, N.Y. For mail: 1812 Clay Ave., New York, N.Y.
- LEWIS, GEORGE H. (A'12-M'15), Vice-President, Arcturus Radio Company, 220 Elizabeth Ave., Newark, N.J.
- LEWIS, HAROLD M. (A'19-M'26), President, Le Mor Radio, Inc., Asbury Park, N.J. For mail: P.O. Box 348, Allenhurst, N.J.
- LEWIS, JOHN C. P. (A'28), Chief Storekeeper, United States Aluminum Company, Buffalo Fabricating Division, 2050 Elmwood Ave., Buffalo, N.Y. For mail: 1415 Michigan Ave., Buffalo, N.Y.
- LEWIS, L. V. (A'13), Electrical Engineer, Union Switch and Signal Company, Swissvale, Pa. For mail: 216 Oakview Ave., Edgewood, Pa.
- LEWIS, OLIVER I. (A'29), Radio Engineer, Atwater Kent Manufacturing Company, 4700 Wissahickon Ave., Philadelphia, Pa. For mail: 297, Springton Rd., Upper Darby, Pa.
- LEWIS, ROBERT V. W. (A'28), President, Brooklyn Wireless Corporation, 441 Neptune Ave., Coney Island, N.Y. For mail: 1725 Emmons Ave., Brooklyn, N.Y.
- LEWIS, WILLIAM S. (A'26), Service Engineer, Texas Radio Sales Company, Inc., 411 N. Harwood St., Dallas, Tex.
- LEYH, WILLIAM D. (A'25), Radio Engineer, Radio Station WHN, Loew's State Theatre Bldg., Broadway and 45th St., New York, N.Y. For mail: 134-22-95th Ave., Richmond Hill, L.I., N.Y.
- LIBERMAN, HENRY C. (A'28), Salesman, Aerovox Wireless Corporation, 70 Washington St., Brooklyn, N.Y.
- LIGHT, HENRY M. (A'26), Service Manager, Williams Hardware Company, Streator, Ill. For mail: 514 Powell St., Streator, Ill.
- LIDBURY, F. A. (A'27), President, Oldbury Electro-chemical Company, Niagara Falls, N.Y.
- LIEBERT, W. (M'21), Engineer-in-Chief, Nederlandsche Telegraaf My, "Radio Holland," Keizersgracht 562, Amsterdam-Centrum, Holland.
- LIEBNER, BARNEY (J'28), Salesman, Kleins Radio, 30 Park Pl., New York, N.Y. For mail: 6 Bay 23rd St., Brooklyn, N.Y.
- LIGHT, FRANK B. (A'26), Superintendent, Croton Falls Lighting Corporation, Carmel, N.Y. For mail: Carmel, N.Y.
- LIGHTY, RUSSELL D. (A'27), Rt. 7, Madison, Wis.
- LIMBERG, RAYMOND A. (A'29), Engineer-in-charge, Radio Station WOMT, Manitowoc, Wis. For mail: 914 Eastern Ave., Plymouth, Wis.
- LIMONE, JOSEPH (A'25), Experimental Mechanic, Wireless Specialty Apparatus Company, 76 Atherton St., Jamaica Plain, Boston, Mass. For mail: 146 Trenton St., East Boston, Mass.
- LINDEN, BERNARD H. (A'25), U. S. Supervisor of Radio, 328 Custom House, San Francisco, Calif.
- LINDMARK, ELMER S. (A'23), Assistant Personnel Manager, Standard Transportation Company, Rm. 1460, 26 Broadway, New York, N.Y.
- LINDSAY, W. W., JR. (A'24-M'26), Research Engineer, Movietone Dept., William Fox Studios, Hollywood, Calif. For mail: 1348 Club View Dr., Los Angeles, Calif.
- LINDSTROM, ARTHUR J. (A'27), Station WJZ, National Broadcasting Company, Bound Brook, N.J.
- LINE, F. M. (A'28), Radio Repairman, Aitken Radio Company, 134 Larned St., E., Detroit, Mich. For mail: R.F.D. No. 1, Holland, Ohio.
- LINNETT, DOUGLAS N. (A'29), Clerk, Executor Trustee and Agency Company, Ltd., of South Australia, Box 363D, G.P.O., Adelaide, South Australia. For mail: 42 Nelson St., St. Peters, South Australia.
- LINTZENICH, C. L. (A'28), Radio Station Operator, 405 W. Main St., Blytheville, Ark. For mail: 304 Davis Ave., Blytheville, Ark.
- LIPPINCOTT, DONALD K. (M'28), Radio and Electrical Engineer, 611 Crocker Bldg., San Francisco, Calif.
- LITCHFIELD, GORDON A. (A'23), Nottingham Radio Supplies, 33 Mansfield Rd., Nottingham, England.
- LITTLE, DONALD G. (A'20-M'27-F'29), Chief Engineer, Chicopee Falls Works, Westinghouse Electric and Manufacturing Company, Chicopee Falls, Mass.
- LITTLE, D. S. (J'22-A'24), Acting Superintendent, Great Lakes Div., Radio Corporation of America, 1599 St. Clair Ave., Cleveland, Ohio. For mail: 1594 Winton Ave., Lakewood, Ohio.
- LITTLE, NOEL C. (A'24), Professor of Physics, Bowdoin College, Brunswick, Me. For mail: 8 College St., Brunswick, Me.
- LITTLEDALE, H. A. P. (A'24), Major, Crabtree, Streatley-on-Thames, England.
- LITTEEN, LEON L. (A'29), Electrical Engineer, C. A. Earl Radio Corporation, 760 West End Ave., New York, N.Y. For mail: 82-88 Paulison Ave., Passaic, N.J.
- LITTON, CHARLES V. (A'25), Engineer, Federal Telegraph Company, Palo Alto, Calif. For mail: Box 21, R.F.D. 2, Redwood City, Calif.
- LLEWELLYN, FREDERICK B. (A'23), Telephone Engineer, Bell Telephone Laboratories, Inc., 463 West St., New York, N.Y.
- LLEWELLYN, GEORGE (A'27), 524 Post Office Bldg., Atlanta, Ga. For mail: P.O. Box 1593, Atlanta, Ga.
- LO, TSU ZUI (A'29), Engineering Student, General Electric Company, 3922 Pine St., Philadelphia, Pa.
- LOCK, M. J. (A'29), Engineer, Telefunken Gesellschaft für drahtlose Telegrafie, Hellesches Ufer 12, Berlin, S.W., Germany. For mail: Hildegardstr., 13 B., Berlin, Wilmersdorf, Germany.
- LOCKE, G. EDGAR (A'28), Engineer, Sound Film Apparatus Dept., Electrical Research Products, Inc., 250 W. 57th St., New York, N.Y. For mail: P.O. Box 221, White Plains, N.Y.

- LOCKWOOD, EDWARD C. (A'29), Chief Operator, Radio Station WFBE, Park View Hotel, Cincinnati, Ohio. For mail: Rt. 11, Mt. Healthy, Ohio.
- LOFTIN, EDWARD H. (M'26), Consulting Engineer, 74 Trinity Pl., New York, N.Y.
- LOFTIS, HOMER J. (A'27), Engineer, Day Fan Electric Company, Dayton, Ohio. For mail: 1601 Monroe Ave., Dayton, Ohio.
- LOGAN, JAMES S. (A'28), c/o Mrs Buchanan, Woodbine Cottage, Edinburgh Rd., Dumfries, Scotland.
- LOGAN, MASON A. (A'27), Member of Technical Staff, Bell Telephone Laboratories, Inc., 463 West St., Rm. 853, New York, N.Y.
- LOGAN, WILLIAM S. (A'14), Chief Clerk, Superintendent Telegraph and Signals, Pennsylvania Railroad Company, 15 N. 32nd St., Rm. 515, West Philadelphia, Pa.
- LOHMANN, ROBERT S. (A'24), The York Supply Company, 527 E. 3rd St., Dayton, Ohio.
- LONG, JOHN J., JR. (A'26), Chief Engineer, Station WHAM, Stromberg Carlson Telephone Manufacturing Company, Victor, N.Y.
- LONG, MARVIN (A'29), Instructor, Engineering Extension Dept., Pennsylvania State College, State College, Pa. For mail: Acacia Fraternity, State College, Pa.
- LONG, MAURICE B. (A'23), Educational Director, Bell Telephone Laboratories, Inc., 463 West St., New York, N.Y.
- LOOMIS, ALFRED L. (M'28), Director, Loomis Laboratory, Tuxedo Park, N.Y. For mail: Tuxedo Park, N.Y.
- LOOMIS, MARY TEXANNA (M'27), President, Loomis Radio College, 405-9th St., N.W., Washington, D.C.
- LOONEY, DON B. (A'27), National Radio Institute, 16th and U Sts., N.W., Washington, D.C.
- LOPES, JOHN (A'29), c/o Sorenson and Company, 64 Water St., New York, N.Y.
- LOPEZ, MELCHOR, JR. (A'29), Draftsman, Ward Leonard Electric Company, 35 South St., Mt. Vernon, N.Y. For mail: 21 Manhattan Ave., New York, N.Y.
- LORCH, ALBERT (A'29), Radio Engineer, Thomas A. Edison, Inc., West Orange, N.J. For mail: 201-14-50th Ave., Bayside, L.I., N.Y.
- LORCH, GEORGE H. (A'29), Patent Attorney, Wilson and McCanna, 122 S. Michigan Ave., Chicago, Ill.
- LORD, HARRY R. (A'28), Arcade Bldg., Cambridge Spring, Pa.
- LORD, WILFRED F. (J'29), U.S.C. and G. Steamer Ranger, P.O. Box 212, Norfolk, Va.
- LOSCALZO, PETER A. (A'27), Testing Engineer, Automobile Radio, Inc., 37-7 Queens Blvd., Long Island City, L.I., N.Y. For mail: 18-37 Ditmars Blvd., Astoria, L.I., N.Y.
- LOTTER, JOHN G. (A'29), Lyon and Healy, Inc., 243 S. Wabash Ave., Chicago, Ill. For mail: 1145 Bryn Mawr Ave., Chicago, Ill.
- LOUCKS, IVAN H. (A'26), Manager, Radio Dept., Baird Hardware Company, 507 N. Roper Ave., Gainesville, Fla.
- LOUGHLIN, WILLIAM D. (M'29), Radio Engineer, Radio Frequency Laboratories, Boonton, N.J.
- LOUGHREN, ARTHUR V. (A'24-M'29), Engineer, Radio Dept., General Electric Company, Schenectady, N.Y.
- LOUNSBERRY, ISAAC R., JR. (A'23-M'25), WMAK Broadcasting System, Liberty Bank Bldg., Buffalo, N.Y.
- LOVEJOY, EDWIN W. (A'14-M'26), U. S. Supervisor of Radio, Radio Division, Department of Commerce, 2116 L. C. Smith Bldg., Seattle, Wash.
- LOVELESS, LAWRENCE M. (A'28), Radio Dealer, Loveless and Hamilton, Bath, N.Y.
- LOVELL, HERMAN J. (A'28), Radio Operator, Radio Station WKY, Oklahoma City, Okla.
- LOVELL, WEBSTER A. (A'28), Radio Service Manager, United Music Company, 54-6 Main St., Plymouth, Mass. For mail: 24 Pearl St., Whitman, Mass.
- LOWE, CARR E. (A'29), Radiotechnician, Brunswick-Balke-Collender Company, 40 N. 16th St., Philadelphia, Pa. For mail: 72 Irwin Ave., Muskegon, Mich.
- LOWRER, R. W. (A'29), Service Manager, M. O'Neil Company, Akron, Ohio. For mail: Box 124, Hudson, Ohio.
- LOWRY, CHARLES A. (A'26), Radio Engineer, H. M. Kipp Company, Ltd., Toronto, Canada. For mail: 34 Humber Trail, Toronto, 9 Ont., Canada.
- LOWRY, LEWIS R. (A'27), Member of Technical Staff, Bell Telephone Laboratories, Inc., Box 31, Cliffwood, N.J.
- LOYNES, OWEN H. (A'23), Telephone Engineer, American Telephone and Telegraph Company, Rm. 1540, 195 Broadway, New York, N.Y.
- LUBCKE, HARRY R. (A'26), Assistant Director of Research, Crocker Research Laboratory, 202 Green St., San Francisco, Calif.
- LUCAS, EARLE F. (A'29), 118 Louis St., New Brunswick, N.J.
- LUCAS, STANLEY M. (A'27), Director-in-Charge of Engineering, Radio Station KFVR, Hoskins-Meyer Company, Bismarck, N.D.
- LUCIA, RAYMOND H. (A'27), Technical Staff, Stromberg-Carlson Company, Station WHAM, Sagamore Hotel, Rochester, N.Y. For mail: 109 W. Chestnut St., East Rochester, N.Y.
- LUCKEL, FRANK (A'29), Naval Officer, Naval Communications Office, Navy Department, Washington, D.C.
- LUDLOW, GILBERT H. (A'29), Sales and Serviceman, Batesman Radio Sales and Service, 501 E. Exchange St., Akron, Ohio. For mail: 642 E. Wilbeth Rd., Akron, Ohio.
- LUDLUM, W. F. (A'29), Proprietor, W. F. Ludlum Radio Service, 1607 S. Hope St., Los Angeles, Calif.
- LUCKER, FRED W., JR. (A'27), Proprietor, Commercial Radio Service, 598-17th., Milwaukee, Wis.
- LUKAT, JOHN FREDERICK (A'29), 62 Persimmon St., Malvern, Johannesburg, South Africa.

- LUMB, FRANK J. (A'29), Proprietor, Radio Sales and Repair Shop, 10½ Pleasant St., Auburn, N.Y.
- LUND, RUSSELL O. (A'29), Assistant Sales Manager, Thordarson Electric Manufacturing Company, 500 W. Huron St., Chicago, Ill. For mail: 1634 Chicago Ave., Evanston, Ill.
- LUNDAHL, TORE (A'26), Engineer, Pacent Electric Company, Inc., 91-7th Ave., New York, N.Y.
- LUNDIE ERNEST S. (J'25), Laboratory, Colonial Radio Corporation, 25 Wilbur Ave., Long Island City, L.I., N.Y. For mail: 84-33-60th Ave., Elmhurst, L.I., N.Y.
- LUNDY, STANLEY R. (A'28), Foreman, Canadian Brandes, Ltd., Toronto, Ont., Canada. For mail: 129 Broadway Ave., Toronto, 12, Ont., Canada.
- LUSH, WILLIAM G. (A'20-M'27), Assistant European Manager, Radio Corporation of America, 156 Rue de l'Universite, Paris, VII, France.
- LUSSIER, ELPHEGE ACHILLE (A'27), Maintaining Electrician, Woolco Realty Corporation, Woolworth Bldg., New York, N.Y. For mail: 359 Ovington Ave., Brooklyn, N.Y.
- LUTES CLIFFORD (A'29), Radio Service, 902 N. Saginaw, Flint, Mich. For mail: 830 Paddington Ave., Flint, Mich.
- LYFORD, ELMORE B. (A'26), R.C.A. Photophone, Inc., 411-5th Ave., New York, N.Y. For mail: 117 Waverly Pl., New York, N.Y.
- LYLE, HERBERT B. (A'24), Wireless Operator, Marconi I.M.M.C. Company, Strand, London, England. For mail: Rodwell, Ambleside Rd., Harlesden, London, England.
- LYMAN, REGINALD P. (A'23-M'26), 1st Lieutenant, Signal Corps, U. S. Army, Oceanport, Ft. Monmouth, N.J.
- LYNCH, ARTHUR H. (M'26), General Motors Bldg., Broadway and 57th St., New York, N.Y.
- LYNDON, WILLIAM L. (A'26), Radio Engineer, General Electric Company, Schenectady, N.Y.
- LYNN, L. H. (A'29), Radio Transmitter Dept., General Electric Company, Schenectady, N.Y. For mail: 422 Y.M.C.A. Bldg., Schenectady, N.Y.
- LYNN, ROLAND A. (A'29), Radio Tester, General Electric Company, Bldg. 77-4, Schenectady, N.Y. For mail: 607 Chapel St., Schenectady, N.Y.
- LYON, HARRY H. (A'14), Hyattsville, Md.
- LYONS, C. L. (M'27), Managing Director, Claude Lyons, Ltd., 76 Oldhall St., Liverpool, England. For mail: 8 York Ave., Sefton Pk., Liverpool, England.
- M
- MAC ADAM, MARK L. (A'26), Radio Technician, State Police, Massachusetts Department of Public Safety, Rm. 24, State House, Boston, Mass. For mail: R.F.D., High St., Hingham, Mass.
- MACALPINE, WILLIAM W. (A'29), International Communications Laboratories, 67 Broad St., New York, N.Y. For mail: 8 Beekman Ave., Mount Vernon, N.Y.
- MAC COUN, TOWNSEND D. (A'24), 9 Hyacinth Pl., Brooklyn, N.Y.
- MAC DERMID, L. D. (A'28), Superintendent, International Broadcasting Equipment Company, 3112 W. 51st St., Chicago, Ill. For mail: 6333 Ingleside Ave., Chicago, Ill.
- MAC DONALD, H. J. (J'29-A'29), Radio man, U. S. S. "West Virginia," c/o Postmaster, San Pedro, Calif.
- MAC DONALD, W. A. (A'19-M'26), Chief Engineer, Hazeltine Service Corporation Laboratory, 333 W. 52nd St., New York, N.Y.
- MAC DOUGALL, ARTHUR (A'27), Metal Alloys and Engineering Specialties, 243 Broadway, New York, N.Y.
- MAC DOWELL, EARL B. (A'25), General Manager, Benzo Gas Company, 3020 Roanoke Rd., Kansas City, Mo. For mail: 3115 Karnes Blvd., Kansas City, Mo.
- MAC DOWELL, THERON W. (A'25), Service Engineer, H. E. Erickson, 301 Central Ave., Leonia, N.J. For mail: 609 Freeman St., Lyndhurst, N.J.
- MAC FADDEN, WILFORD C. (A'19), Rhawn and Bingham Sts., Fox Chase, Philadelphia, Pa.
- MAC GREGOR, JOHN J. (A'29), Assistant Radio Engineer, U. S. Naval Research Laboratory, Bellevue, Anacostia, D.C. For mail: 2316-32nd St., S.E., Washington, D.C.
- MACHIORLETI, LOUIS (A'27), 648 Palisade Ave., West New York, N.J.
- MACHOTKA, MIROSLAV (J'27-A'28), Farming, Rowena, Tex.
- MACHOTKA, SLAVOMIR (J'27-A'29), The Texas Company, Drawer F., Houston, Tex.
- MAC HUGH, WILLIAM L. (A'26), Trilling and Montague, Philadelphia, Pa. For mail: 1933 E. Dauphin St., Philadelphia, Pa.
- MAC ILVAIN, KARL M. (A'26), Assistant Chief Engineer, Paramount-Famous-Lasky Corporation, 6th and Pierce Aves., Astoria, L.I., N.Y. For mail: 3056-87th St., Jackson Heights, L.I., N.Y.
- MAC INTYRE, JAMES R. (A'26), Mechanical Engineer, Nash Engineering Company, South Norwalk, Conn. For mail: 120 Drome Ave., Stratford, Conn.
- MACK, DAHL W. (A'28), Manager, Northeastern Radio Company, 302 Adams Ave., Scranton, Pa. For mail: Box 163, Waverly, Pa.
- MACKAY, WARREN S. (A'27), Officer-in-Charge, Naval Radio Station, Arlington, Va.
- MACKAY, WILLIAM ANDREW (A'27), 345 E. 33rd St., New York, N.Y.
- MACKIE, WILLIAM (A'28), Manager, Radiola Service Dept., P. Werlium, Ltd., New Orleans, La. For mail: 715-2nd St., New Orleans, La.
- MACKEN, H. I. (A'29), Engineer, New York Telephone Company, 140 West St., New York, N.Y. For mail: 62 Westervelt Ave., New Brighton, S.I., N.Y.
- MACKENZIE, D. G. (J'27-A'29), Wireless Operator, The British Wireless Marine Service, Marconi House, Strand, London, W.C. 2, England. For mail: 4 Melrose Pl., Clifton, Bristol, England.
- MAC KEOWN, SAMUEL S. (M'29), Assistant Professor of Electrical Engineering, California Institute of Technology, Pasadena, Calif.

- California Institute of Technology, Pasadena, Calif.
- MAC LAREN, WALLACE E. (A'27), 1756 Chapin Ave., East Cleveland, Ohio.
- MACLEAN, T. WENDELL (A'27), Radio Engineer, Washington Water Power Company, 825 Trent Ave., Spokane, Wash. For mail: 524 W. 17th Ave., Spokane, Wash.
- MAC LURCAN, CHARLES D. (A'26), Consulting Engineer, Pratten Bldg., 26 Jamieson St., Sydney, Australia.
- MAC MURPHY, F. (J'16-A'20), 937 E. California St., Pasadena, Calif.
- MAC NABB, VERNON C. (A'25), 576 Chapier St., Philadelphia, Pa.
- MAC NAUGHTON, A. K. (A'25), Planning Engineer, Georgia Power Company, Gas Bldg., Atlanta, Ga.
- MA DAN, EDWIN M. (A'21-M'28), Consulting Engineer, 9027-199th St., Hollis, L.I., N.Y.
- MADDOX, CHARLES H. (M'13), Commander, U. S. Navy, Rm. 2626, Navy Department, Washington, D.C.
- MADDOX, FRANCIS E. (A'25), Manager, Station WDBJ, Richardson Wayland Electric Company, 106 Church St., S.W., Roanoke, Va.
- MADGWICK, G. (M'28), Chief Radio Engineer, Administration of Posts and Telegraphs, Lima, Peru.
- MADISON, C. E. (A'29), Radio Service, Sherman Clay and Company, 14th and Clay St., Oakland, Calif. For mail: 7515 Weld St., Oakland, Calif.
- MADSEN, CARL J. (A'28), Radio Engineer, Westinghouse Electric and Manufacturing Company, Chicopee Falls, Mass. For mail: 92 Windemere St., East Springfield, Mass.
- MADSEN, NORMAN L. (A'26), Accountant, Haas Baruch and Company, Box 340, Arcade Sta., Los Angeles, Calif.
- MAEDA, M. (A'25), Shuang-Chiao, Radio Station, near Peking, China.
- MAG, ANTHONY (A'23), Radio Fieldman, Duquesne Light Company, Duquesne Bldg., Pittsburgh, Pa. For mail: 1027 Franklin Ave., Wilkinsburg, Pa.
- MAGNESS, SCOTT A. (J'26-A'28), Assistant Inspector of Navy Material, Office of Inspector of Naval Material, South and Whitehall Sts., New York, N.Y. For mail: Mayfair Ave., West Hempstead, L.I., N.Y.
- MAGOS, JOHN P. (A'24), Experimental Engineer, Crane Company, Works Office, Chicago, Ill. For mail: 7516 N. Hilldale Ave., Chicago, Ill.
- MAHONEY, JOSEPH N. (M'19), Manager of Engineering, Sperry Gyroscope Company, Sperry Bldg., Brooklyn, N.Y. For mail: 615-77th St., Brooklyn, N.Y.
- MAIER, OTTO T. (A'27), Engineer, New Orleans Public Service, Inc., 317 Baronne St., New Orleans, La. For mail: 4550 S. Galvez St., New Orleans, La.
- MAITLAND, JAMES L. (A'28), "Hazelhurst," High Pittington, Sherburn, County Durham, England.
- MAKER, ALBERT E. (A'28), Radio Service, United Music Company, 233 Weybosset St., Providence, R.I. For mail: 145 Congress Ave., Providence, R.I.
- MAKI, GEORGE J. (A'27), Signal Corps, U. S. Army, Seward, Alaska.
- MALE, SAMUEL C. (A'27), Radio Operator, British Wireless Marine Service, Marconi House, Strand, London, England. For mail: 91 Cambridge Park, Wanstead, Essex, England.
- MALO, CHARLES D. (A'27), President, Malo Studios, 1745 E. Grand Blvd., Detroit, Mich. For mail: 5716 Crane Ave., Detroit, Mich.
- MALOFF, IOURY G. (M'27), P.O. Box 105, Rochester, N.Y.
- MALONE, JAMES J. (M'19), Chief Inspector of Wireless, Postmaster General's Dept., Melbourne, Australia.
- MALTER, LOUIS (A'29), Research Engineer, Radio Corporation of America, 70 Van Cortlandt Park S., New York, N.Y.
- MANDERFELD, EMANUEL C. (A'26), Research Engineer, Bell Telephone Laboratories, Inc., 463 West St., New York, N.Y.
- MANKE, ARTHUR G. (A'26), Earl Radio Corporation, Bloomfield Ave., Clifton, N.J. For mail: 175 Broadway, Passaic, N.J.
- MANLEY, EDWARD (A'27), R.C.A. Photophone, Inc., 411-5th Ave., New York, N.Y. For mail: 136 W. 65th St., New York, N.Y.
- MANLY, HAROLD P. (A'29), Sales Manager, Thordarson Electric Manufacturing Company, 500 W. Huron St., Chicago, Ill. For mail: 934 Westmoor Rd., Winnetka, Ill.
- MANN, GEORGE F. (A'28), Radio Sales and Service, Ridgeway, Ont., Canada.
- MANN, THEODORE H. (A'28), Laboratory Assistant, Sound Dept., William Fox Studios, Fox Hills, Westwood and Western Aves., Hollywood, Calif. For mail: 1127 South St., Santa Monica, Calif.
- MANNEY, G. C. (A'27), 425 E. Water St., Milwaukee, Wis.
- MANNING, CHARLES T. (A'17-M'28), U. S. Radio Inspector, U. S. Department of Commerce, Radio Division, Subtreasury Bldg., Pine St., New York, N.Y. For mail: 14 Fairwoods Rd., Madison, N.J.
- MANNING, STANLEY R. (A'27), Public Address System and Radio Engineer, Michigan Bell Telephone Company, 1365 Cass Ave., Detroit, Mich. For mail: 5479 Stanton Ave., Detroit, Mich.
- MANNING, WILLIAM MONTAGU (A'29), Radio Engineer, W. M. Manning, Wireless Specialist, 6 King's Rd., Guernsey, Channel Islands. For mail: Millbrook, King's Rd., Guernsey, Channel Islands.
- MANSELL, LIONEL H. (M'25), Radio Engineer, Wireless Supply Depot, Edith Walk, Malvern, England. For mail: Woodfield, Madresfield Rd., Malvern, Worcestershire, England.
- MANSON, RAY H. (M'23), Chief Engineer, Stromberg-Carlson Telephone Manufacturing Company, Rochester, N.Y. For mail: 373 Beresford Rd., Rochester, N.Y.
- MAPES, HAROLD T. (A'28), Mining and Electrical Engineer, Guanajuato, Reduction and Mines Company, Guanajuato, Mexico. For mail: 200 Hazelwood Ave., Bridgeport, Conn.

- MARCH, HALLMAN W. (J'29), Assistant Operator, Egyptian Theatre, Bala-Cynwyd, Pa. For mail: 407 State Rd., Bala-Cynwyd, Pa.
- MARCH, PHILIP S. (A'27), Assistant Engineer, Federal Radio Corporation, 1738 Elmwood Ave., Buffalo, N.Y.
- MARCO, FREDERICK J. (A'24-M'28), Consulting Engineer, 2020 Farragut Ave, Ravenwood Sta., Chicago, Ill.
- MARCONI, GUGLIELMO (F'16), Marconi's Wireless Telegraph Company, Ltd., Marconi House, Strand, London, W.C. 2, England.
- MARGRAF, FRANK J. (A'28), Radiotrician, Michigan Home and Training School, Drawer A, Lapeer, Mich.
- MARRA, ANTHONY (A'29), Radio Sales and Service, Tollver Electric Company, 505 Nstrand Ave., Brooklyn, N.Y. For mail: 225-68th St., Brooklyn, N.Y.
- MARRINER, ALFRED W. (A'29), First Lieutenant, Air Corps, U. S. Army, Dodd Field, Fort Sam Houston, San Antonio, Tex.
- MARRIOTT, ROBERT H. (M'12-F'15), Consulting Engineer, 1470 E. 18th St., Brooklyn, N.Y.
- MARRISON, W. A. (M'28), Laboratory Engineer, Bell Telephone Laboratories, Inc., 463 West St., New York, N.Y.
- MARRON, GEORGE P. (A'27), Colonial Radio Corporation, Long Island City, N.Y. For mail: 520 W. 163rd St., New York, N.Y.
- MARSAL, PAUL A. (A'23), National Carbon Company, Research Laboratories, 1280 W. 73rd St., Cleveland, Ohio. For mail: 1266 W. Clifton Blvd., Lakewood, Ohio.
- MARSDEN, GEORGE K. (A'27), Radio Manager, Marsden Electric Company, Inc., 6255 Van Nuys Blvd., Van Nuys, Calif. For mail: 14707 Victory Blvd., Van Nuys, Calif.
- MARSH, CARLTON H. (J'26-A'27), Student, Georgia School of Technology, Atlanta, Ga. For mail: 786 Vernon Ave., Glencoe, Ill.
- MARSH, HALLOCK SNYDER (A'29), Receiving Engineer, Radio Corporation of America, Marshall, Calif.
- MARSHALL, ALBERT E. (A'24), Consulting Chemical Engineer, 501-5th Ave., Rm. 808, New York, N.Y.
- MARSHALL, CESAR B. (A'26), Foreign Advertising Manager, Radio Corporation of America, 233 Broadway, New York, N.Y.
- MARSHALL, CHARLES E. (A'27), Research Dept., Zenith Radio Corporation, 3620 Iron St., Chicago, Ill. For mail: 3553 N. Paulina St., Chicago, Ill.
- MARSHALL, CLOYD, JR. (A'27), Editor and President, Horwood Publishing Company, 407 E. Pico St., Los Angeles, Calif.
- MARSHALL, F. W. (A'29), Wireless Operator, S. S. "H. H. Rogers," 26 Broadway, Rm. 560, New York, N.Y.
- MARSHALL, GEORGE E. (A'25), Radio Service Engineer, Kansas Gas and Electric Company, Wichita, Kan. For mail: 3424 E. Waterman St., Wichita, Kan.
- MARSHALL, J. A. (A'27), Glenfield, 235 Maidstone Rd., Rochester, Kent, England.
- MARSTEN, JESSE (A'18-M'25), Radio Engineer, Freed-Eisemann Radio Corporation, Liberty Ave. and Junius St., Brooklyn, N.Y. For mail: 3249 E. 25th St., Brooklyn, N.Y.
- MARTIN, DE LOSS K. (A'14-M'26), Telephone Engineer, Bell Telephone Laboratories, Inc., 463 West St., Rm. K65, New York, N.Y.
- MARTIN, DONALD E. (A'27), Technician, Charles E. Wells Music Company, Casper, Wyo. For mail: 232 E. 2nd St., Casper, Wyo.
- MARTIN, E. F. (A'28), Engineer, Illinois Bell Telephone Company, 208 W. Washington St., Chicago, Ill.
- MARTIN, FRANK J. (A'29), Manager, Radio Service Dept., Smerda's Music House, 580 Broadway Ave., Cleveland, Ohio. For mail: 15001 Kingsford Ave., Cleveland, Ohio.
- MARTIN, GEORGE L. (A'29), Capital Radio Engineering Institute, 3166 Mt. Pleasant Ave., Washington, D.C. For mail: 1124-12th St., Washington, D.C.
- MARTIN, J. DOUGLAS, JR. (J'29), 946 Belt Ave., St. Louis, Mo. For mail: 1903 Elm St., Rolla, Mo.
- MARTIN, JULIUS (M'13), Navy Yard, Portsmouth, N.H.
- MARTIN, LOUIS (A'25), Manager, Service Division, Radio Corporation of America, 70 Van Cortlandt Park South and Saxon Ave., New York, N.Y. For mail: 2266-24th St., Astoria, L.I., N.Y.
- MARTIN, NEILL H. (A'23), Chief Engineer, Angus Radio Corporation, 1032 Rosemont Ave., Chicago, Ill. For mail: 6300 Kenmore Ave., Chicago, Ill.
- MARTIN, NORMAN A. (A'27), Attorney, Martin and Martin, Union Trust Bldg., New Castle, Pa.
- MARTIN, PAUL E. (A'25), Head, Physics Dept., Muskingum College, New Concord, Ohio. For mail: Ann Arbor Post Office, Ann Arbor, Mich.
- MARTIN, ROBERT D. (A'29), Junior U.S. Radio Inspector, U.S. Dept. of Commerce, Radio Division, 2909 David Stott Bldg., Detroit, Mich.
- MARTIN, V. G. (A'22), Engineer, Stromberg-Carlson Telephone Manufacturing Company, Inc., 1600 University Ave., Rochester, N.Y. For mail: 737 East Ave., Rochester, N.Y.
- MARTINO, ALPHONSE E. (A'29), Sub-Foreman, Victor Talking Machine Company, Camden, N.J. For mail: 2030 E. Hazard St., Philadelphia, Pa.
- MARUMO, NOBORU (A'25), Chief Engineer, Sendai Broadcasting Station, Haranomachi Hosoj, Sendai Hosokyoku, Sendai, Japan.
- MARUMOTO, KENJI (A'26), Professor, Utsunomiya Technical School, Japan. For mail: Utsunomiya Kogyo-Gakko, Nishiharamachi, Utsunomiya-Shi, Tochigi-Ken, Japan.
- MARZULLI, ANGELO N. (A'26), Radio Engineer, Temple Corporation, 5253 W. 65th St., Chicago, Ill. For mail: 233 Garfield St., Newark, N.J.
- MASALKOVICS, J. A. (A'29), Radio Serviceman, Colonial Radio Corporation, 25 Wilbur Ave., Long Island City, L.I., N.Y. For mail: 301-33rd St., Union City, N.J.
- MASER, HAROLD T. (A'29), Engineer, General Electric Company, Research Laboratory, Schenectady, N.Y. For mail: 111 Park Place, Schenectady, N.Y.

- MASON, CURTIS W. (A'26), Radio Operator, Station KFI, 1000 S. Hope St., Los Angeles, Calif. For mail: 4223 Latonia Ave., Los Angeles, Calif.
- MASON, HOWARD F. (A'27), 3325-36th Ave., South, Seattle, Wash.
- MATES, T. JOAQUIN (A'28), 1226-15th St., N.W., Washington, D.C.
- MATHERS, EARL S. (A'29), Assistant System Chief Operator, Pennsylvania Water and Power Company, 1611 Lexington Bldg., Baltimore, Md.
- MATHES, R. E. (J'22-A'24), Engineering Dept., R.C.A. Communications, Inc., 66 Broad St., New York, N.Y.
- MATHISON, GERALD (A'29), Commercial Radio Operator, 1009 Midland Ave., Midland, Mich.
- MATRES, TRINIDAD (M'27), Base Naval De Submarinos, De Cartagena, Cartagena, Spain.
- MATSUI, K. (A'29), Research Staff, Vacuum-Tube Dept., Research Laboratory, The Tokyo Electric Company, Kawasaki, Japan.
- MATSUMURA, SADA O (A'28), Research Engineer, Electrotechnical Laboratory, Ministry of Communications, Osaki, Tokyo, Japan.
- MATTEUCCI, ALDO (A'29), Lieutenant, Royal Italian Navy, c/o Ministero della Marina, Rome, Italy.
- MATTHEWS, A. C., JR. (A'28), Radio Engineer, United Research Corporation, 40 Harold Ave., Long Island City, L.I., N.Y. For mail: 144-25-33rd Ave., Flushing, L.I., N.Y.
- MATTHEWS, ALLEN A., JR. (J'27), 1593 Rodgers Ave., S.W., Atlanta, Ga.
- MATTHEWS, LESLIE A. (A'27), Electrical Engineer, Skurrays, Ltd., Swindon, England. For mail: 82A Croft Rd., Swindon, Wilts, England.
- MATTHEWS, P. H. (A'27), Radio Operator, Union Steamship Company, Wellington, N.Z.
- MATTHEWS, WALTER I. (A'25), Receiving Engineer, Radio Corporation of America, Riverhead, L.I., N.Y.
- MATTHIAS, LYNN H. (A'25), Research, Allen Bradley Company, Milwaukee, Wis. For mail: 717-7th Ave., Antigo, Wis.
- MATTIA, RALPH F. (A'29), Tester, Philadelphia Storage Battery Company, Ontario and "C" Sts., Philadelphia, Pa. For mail: 765 South 10th St., Philadelphia, Pa.
- MAUER, WILLIAM V. (J'26-A'27), Mauer Radio Laboratories, 56 S. Main St., Liberty, N.Y.
- MAURAN, JOHN (A'25), District Service Manager, R.C.A.-Victor Company, Inc., 168-39th St., Brooklyn, N.Y.
- MAWSON, JOHN T., JR. (A'28), Radio Service Engineer, 322 West Hastings, Vancouver, B.C., Canada. For mail: 4499 Pender St., E., Vancouver, B.C., Canada.
- MAXIM, HIRAM PERCY (A'15), President, Maxim Silencer Company, Box 2102, Hartford, Conn.
- MAXWELL, GEORGE G. (A'26), Station WMAK, Shawnee Rd., North Tonawanda, N.Y.
- MAXWELL, JOHN F. (A'28), Radio Engineer, General Electric Company, Oakland, Calif. For mail: 742 Clement St., San Francisco, Calif.
- MAY, ALBERT (A'24), Assistant, Physics Dept., Catholic University of America, Washington, D.C. For mail: 4315-12th Place, N.E., Washington, D.C.
- MAY, JOHN (A'29), Editorial Assistant, "The Broadcaster and Wireless Retailer, 93 Long Acre, London, W.C. 2, England. For mail: Four Winds, Newgatestreet Rd., Goffs Oak, Waltham Cross, Herts, England.
- MAYEA, LAWRENCE E. (A'29), Radio Engineer, U.S. Navy Yard, Radio Laboratory, Bldg. 77, Philadelphia, Pa. For mail: 1031 E. Price St., Philadelphia, Pa.
- MAYER, ARTHUR W. (A'14), President, A. W. Mayer Radio Company, 147 Massachusetts Ave., Boston, Mass. For mail: 7 Chestnut Sq., Jamaica Plain, Boston, Mass.
- MAYERS, HARVEY F. (J'27-A'29), Radio Inspector, Western Electric Company, 16th and Glenwood Sts., Philadelphia, Pa. For mail: 6154 Haverford Ave., Philadelphia, Pa.
- MAYLOTT, CARLETON (A'24), Instructor, Dept. of Electrical Engineering, Lehigh University, Bethlehem, Pa.
- MAYNARD, J. E. (A'29), Radio Test Dept., General Electric Company, Schenectady, N.Y. For mail: 1164 Wendell Ave., Schenectady, N.Y.
- MAYNARD, RAYMOND K. (A'25), Division Plant Supervisor, The Pacific Telephone and Telegraph Company, 140 New Montgomery St., San Francisco, Calif.
- MAYO, ROYAL E. (A'29), Electrical Engineer, Motor Dept., General Electric Company, West Lynn, Mass. For mail: 87 Myrtle St., Lynn, Mass.
- MAZIK, JOHN, JR. (A'26), Equipment Engineer, Western Electric Company, Inc., Kearny, N.J. For mail: 520 West End Ave., Elizabeth, N.J.
- MC ALEAVEY, HENRY V. (A'27), Radio Service Dept., The T. Eaton Company, Ltd., Toronto, Ont., Canada. For mail: 44 Arundel Ave., Toronto, Ont., Canada.
- MC ARDELL, WESLEY E. (A'25), Douglas Rd., Emerson Hill, Stapleton, S. I., N.Y.
- MC AVOY, EDWARD J. (A'29), 4629 Malden St., Chicago, Ill.
- MC CABE, LOUIS L. (A'26), Radio Inspector, Dept. of Commerce, Room 308, Custom House, New Orleans, La.
- MC CABE, WILLIAM E. (A'26), Proprietor, Emsee Radio Company, 1129 Maple Ave., Los Angeles, Calif. For mail: 1047 Crenshaw Blvd., Los Angeles, Calif.
- MC CACHREN, W. S. (A'27), Proprietor, Station WMBS, 60 S. Cameron St., Harrisburg, Pa.
- MC CAFFRY, JAMES A. (A'23), Manufacturers' Agent, 8656 Dumbarton Rd., Detroit, Mich.
- MC CALL, KEITH E. (A'27), Radio Service, Union Electric Company, 420 Duquesne Way, Pittsburgh, Pa. For mail: 36 Mayfield St., Rochester, N.Y.
- MC CAMMON, DONALD (J'29), Assistant Engineer, Sales Dept., Brunswick-Balke-Collender Company, 623 S. Wabash Ave., Chicago, Ill. For mail: 720 Buckingham Place, Chicago, Ill.

- MC CANDLISH, B. V. (A'27), Commander, U.S. Navy, U.S.S. "Maryland," c/o Postmaster, San Pedro, Calif.
- MC CANNE, LEE (A'27), Radio Engineer, Stromberg-Carlson Telephone Manufacturing Company, 1060 University Ave., Rochester, N.Y. For mail: 35 Douglas Rd., Rochester, N.Y.
- MC CANNE, W. ROY (M'27), President, Stromberg-Carlson Telephone Manufacturing Company, 1060 University Ave., Rochester, N.Y.
- MC CARGAR, S. HAROLD (A'29), President, West Coast Radio Corporation, 391 E. 50th St., Portland, Ore. For mail: 381 E. 60th St., Portland, Ore.
- MC CARROLL, MARSHALL G. (A'28), Sound Technician, Paramount News, 544 W. 43rd St., New York, N.Y. For mail: 1980 S. Vermont Ave., Los Angeles, Calif.
- MC CARTY, LAURENCE (A'25), Radio Service and Manufacturing Company, Plymouth, Mass. For mail: 6 Allerton St., Plymouth, Mass.
- MC CAULEY, E. RAY, JR. (A'29), Bookkeeper, Wm. Cameron Company, Inc., Moody, Texas.
- MC CAULEY, JOHN H. (A'27), Construction and Development Dept., United Radio and Electric Corporation, 500 Chancellor Ave., Irvington, N.J. For mail: 268 Conklin Ave., Hillside, N.J.
- MC CLAIN, GORDON W. (A'27), Chief Radio Engineer, Broadcasting Station CFCA, "Toronto Daily Star," S.W. Corner St. Clair St., Toronto, Ont., Canada. For mail: 342 Brunswick Ave., Toronto, Ont., Canada.
- MC CLARY, JAMES P. (A'26), Consulting Engineer, 402 N. Grove St., E. Orange, N.J.
- MC CLATCHIE, STANLEY (A'26), Designing Engineer, Huttenstr. 31, Berlin, N.W.87, Germany. For mail: Osnabrueckerstrasse 21, Berlin-Wilmersdorf, Germany.
- MC CLELLAND, HAROLD M. (M'26), Office, Chief of Air Corps, Munitions Bldg., Washington, D.C.
- MC CLIMANS, ABNER E. (A'29), Radio Service, Radio Dept., American Furniture Company, 1601 Lawrence, Denver, Colo. For mail: 3839 Yates, Denver, Colo.
- MC CLINTOCK, W. S., JR. (A'29), Sales Engineer, Ekko Company, 1865 Daily News Plaza, Chicago, Ill.
- MC COLLISTER, DONALD (A'27), 2228 West Boulevard, Cleveland, Ohio.
- MC CONNELL, W. G. (A'28), Engineer, Station WMU, Linden, N.J. For mail: 228 E. 1st Ave., Roselle, N.J.
- MC CONNELL, ALEXANDER F. (I'26-A'28), Radio Dept., Bloomingdale Bros., Hunters Point Ave., Long Island City, L.I., N.Y. For mail: 145 E. 117th St., New York, N.Y.
- MC COY, JULIUS C. (A'28), Instructor in Electrical Engineering, Dept. of Electrical Engineering, University of Notre Dame, Notre Dame, Ind. For mail: P. O. Box 148, Notre Dame, Ind.
- MC CREA, M. WALTER (A'27), Installation Engineer, Electrical Research Products, Inc., 250 W. 57th St., New York, N.Y. For mail: 883 S. 16th St., Newark, N.J.
- MC CREERY, M. E. (A'25), 1269 S. Citrus Ave., Los Angeles, Calif.
- MC CULLAGH, KARL G. (A'27), Officer, Military District 11, Victoria, B.C., Canada.
- MC CULLAH, ARTHUR B. (A'28), Radio Engineering, Wells-Gardner Division, 1720 N. Robey St., Chicago, Ill. For mail: 711 Buckingham Pl., Chicago, Ill.
- MC CULLOCH, GEORGE R. (J'27), Radio Mechanic, 26 Lydiard St., Ballarat, Victoria, Australia. For mail: 511 Havelock St., Ballarat, Victoria, Australia.
- MC CULLOUGH, F. S. (A'19-M'22), Research Engineer, 206 Beech St., Edgewood, Pa.
- MC CULLOUGH, MAURICE B. (J'22-A'26), RCA-Victor Company, Inc., 261-5th Ave., New York, N.Y.
- MC CUTCHEN, BRUNSON S. (A'21-M'26), Research Engineer, 17 State St., New York, N.Y.
- MC DANIEL, OTTO S. (A'23), Transmission Engineer, Southwestern Bell Telephone Company, R. 1804, Telephone Bldg., St. Louis, Mo.
- MC DERMOTT, EUGENE (A'25), Physicist-Geophysical Research Corporation, 713 Esperon Bldg., Houston, Tex.
- MC DONALD, A. H. (A'29), Service Manager, Myers and Keller Radio Company, 130 W. Washington Ave., North Little Rock, Ark. For mail: 2019 Elm St., Little Rock, Ark.
- MC DONALD, ARTHUR S. (M'23), Chief Engineer, Amalgamated Wireless, Ltd., 47 York St., Sydney, Australia.
- MC DONALD, GEORGE F. H. (A'24), 3 Curtis Rd., Hornchurch, Essex, England.
- MC DONELL, WILLIAM J. (A'29), U.S. Assistant Radio Inspector, 231 Federal Building, Room 231, Kansas City, Mo.
- MC DONOUGH, THOMAS F. (A'26), District Representative, Benjamin Electric Manufacturing Company, 543 I.W. Hellman Bldg., Los Angeles, Calif.
- MC DOWELL, ALBERT P., JR. (A'27), Commonwealth Title Insurance and Trust Company, 1201 Chestnut St., Philadelphia, Pa. For mail: 41 Carpenter Lane, Mt. Airy, Philadelphia, Pa.
- MC DOWELL, C. S. (A'13-M'15), Manager, U.S. Navy Yard, Pearl Harbor, Hawaii.
- MC DOWELL, L. S. (M'23), Professor of Physics, Wellesley College, Wellesley, Mass. For mail: 6 Norfolk Terrace, Wellesley, Mass.
- MC ELRATH, GEORGE (M'29), Radio Broadcaster, National Broadcasting Company, Inc., 711 Fifth Ave., New York, N.Y.
- MC ELROY, PAUL K. (A'25-M'27), Production Engineer, General Radio Company, 30 State St., Cambridge, Mass. For mail: 7 Craigie Circle, Suite 4, Cambridge, Mass.
- MC FARLAND, M. RALPH (A'28), Radio Salesman, Straus-Frank Company, 1211 Milam St., Houston, Tex.
- MC FARLANE, M. L. D. (A'26), Manager Bartlane Dept., "New York Daily News," 25 Park Pl., New York, N.Y.
- MC FAROUHAR, CHARLES CLIFTON (A'29), R. S. Williams Company, Ltd., 145 Yonge St., Toronto, Ont., Canada. For mail: 349 Grace St., Toronto, Ont., Canada.

- MC GARVEY, HAROLD R. (A'29), Radio Sales and Service, McGarvey and Kleuver, 357 Court St., Pekin, Ill. For mail: P.O. Box 233, Pekin, Ill.
- MC GEORGE, DONALD (A'27), 3289 Dellwood Rd., Cleveland, Ohio.
- MC GONAGIL, H. A. (A'29), Vice President, Radio College of California, 921 W. 6th St., Los Angeles, Calif.
- MC GONIGLE, WILLIAM J. (J'29), Proprietor, 679 Franklin Ave., Brooklyn, N.Y. For mail: 140 Vanderbilt Ave., Brooklyn, N.Y.
- MC GRATH, JOSEPH L. (A'27), Radio Queries, "Boston Globe," Washington St., Boston, Mass. For mail: 115 Clay St., Wollaston, Mass.
- MC GREGOR, ARTHUR M. (J'27-A'29), Radio Engineer, Oak Leaves Broadcasting Company, 128 N. Crawford Ave., Chicago, Ill. For mail: 5412 W. Quincy St., Chicago, Ill.
- MC ILLWRAITH, CHARLES G. (A'29), Assistant Physicist, Bureau of Standards, Washington, D.C.
- MC ILVAINE, H. A. (M'26), 419 Hatcher Ave., River Forest, Ill.
- MC ILVAINE, ORAN T. (M'27), President and Chief Engineer, The Continental Electric and Manufacturing Company, 1890 E. 40th St., Cleveland, Ohio. For mail: 3800 Delaware Rd., Cleveland, Ohio.
- MC INTOSH, FRANK H. (J'25-A'28), Technician, Station WOW, 14th and Farnum Sts., Omaha, Neb. For mail: 4160 Chicago St., Omaha, Neb.
- MC INTOSH, RONALD A. (A'28), Wireless Instructor, Royal Corps of Signals, 2 City Mill Lane, Gibraltar.
- MC INTYRE, DANIEL G. (A'29), Radio Manager and Engineer, Murdocks, Ltd., Park St., Sydney, Australia. For mail: "Glenroy," 19 Concord Rd., Strathfield, Australia.
- MC JILTON DEWITT (A'26), Radio Manufacturing, 2227 W. Adams St., Chicago, Ill.
- MC KAY, WILLIAM K. (J'27-A'29), Student, University of California, Berkeley, Calif. For mail: 1495 N. Van Ness Ave., Fresno, Calif.
- MC KESSON, LEWIS J. (A'27), Engineer, Radio Corporation of the Philippines, Manila, P.I.
- MC KEWEN, J. D. (A'29), Radio Set Builder, Barnett's Radio Octogen, Dunedin, New Zealand. For mail: 418 Anderson's Bay Rd., Dunedin, New Zealand.
- MC KINLEY, J. G. (A'24), Assistant Radio Engineer, West Penn Power Company, Wood St., Pittsburgh, Pa. For mail: 435 Argonne Drive, Parnassus, Pa.
- MC KINLEY, HOWARD W. (A'26), Assistant Radio Engineer, Bureau of Light-houses, Washington, D.C. For mail: 2013 G. St., N.W., Washington, D.C.
- MC KINNEY, JOE H. (A'29), Assistant U.S. Radio Inspector, 606 Burt Bldg., Dallas, Tex.
- MC LAGAN, DONALD R. (A'17), Electrical Engineer, Suite 1505, 21 E. 40th St., New York, N.Y.
- MC LAUGHLIN, JAMES L. (A'24), Design Engineer, Radio Station WRNY, Coytesville, N.J.
- MC LAUGHLIN, WILLIAM P. (A'26), Test-boardman, American Telephone and Telegraph Company, 125 Milk St., Boston, Mass. For mail: 32 Tower St., Somerville, Mass.
- MC LEAN, FRANCIS C. (A'26), Engineering Dept., Les Laboratoires Standard, 46, Avenue de Breteuil, Paris 7^e, France.
- MC LEAN, PHILIP S. (A'19), Patent Lawyer, 165 Broadway, New York, N.Y.
- MC LENNAN, MILES ARYVAULT (A'29), Laboratory Assistant, Radio Department, General Electric Company, Schenectady, N.Y. For mail: P.O. Box 981, Schenectady, N.Y.
- MC LENNAN, RODERICK ARTHUR (M'29), Instructor, Canterbury University College, Electrical Department, Christchurch, N.Z.
- MC LEOD, JOHN S. (A'26), Radio Engineer and Consultant, R. W. Proffitt, 49-51 Knowsley St., Bolton, Lancs., England. For mail: 48 Le Gendre St., Moorfield, Bolton, Lancs., England.
- MC MAHON, ALVIN (A'25), Radio Engineer, Radio Station WTAM, 1100 Chester Ave., Cleveland, Ohio.
- MC MICHAEL, LESLIE (M'20-F'25), L. McMichael, Ltd., Hastings House, Norfolk St., Strand, London, W.C.2, England. For mail: Everest, Princes Park Ave., Golders Green, London, N.W., England.
- MC MILLAN, DONALD B. (J'27), Canadian General Electric Company, 212 King St., W., Toronto, Ont., Canada. For mail: 476 Markham St., Toronto, Ont., Canada.
- MC MURTRY, CYRIL A. W. (A'17), Vice-President, YcMurtry Hardware, Ltd., 621 Talbot St., St. Thomas, Ont., Canada.
- MC NALLY, EUGENE C. (J'28), 918 E. 8th St., Tulsa, Okla.
- MC NALLY, JAMES O. (J'24-A'26), Member of Technical Staff, Bell Telephone Laboratories, Inc., 463 West St., New York, N.Y.
- MC NAMEE, B. F. (A'20), Chief Production Engineer, Colin B. Kennedy Corporation, South Bend, Ind.
- MC NARY, JAMES C. (J'22-A'27-M'28), Bell Telephone Laboratories, Inc., 463 West St., New York, N.Y.
- MC NICOL, DONALD (A'14-M'14-F'24), Vice-President, Pneumatic Tube Supply Company, Plainfield, N.J. For mail: 132 Union Rd., Roselle Park, N.J.
- MC QUEEN, HARRY D. (A'29), c/o Boeing Air Transport, Cheyenne, Wyo.
- MC SHANE, JOE BAILEY (A'27), Radio Engineer, San Antonio Public Service Company, San Antonio, Tex.
- MC SWEENEY, ROGER (A'29), Engineering Dept., International Telephone and Telegraph Corporation, 67 Broad St., New York, N.Y.
- MC VEIGH, JAMES P. (A'25), Radio Engineer, British Broadcasting Company, Ltd., 31 Linenhall St., Belfast, Ireland.
- MC WILLIAM, ERIC A. (A'26), Engineer, Marconi Wireless Telegraph Company, Drummondville Station, Drummondville, P.Q., Canada.

- MEACHAM, J. F. B. (A'28), Vice-President, Q. R. V. Radio Service, Inc., 140 Halsey St., Newark, N.J.
- MEAD, LEO R. (A'29), Technician and Laboratory Assistant, Electrical and Research Laboratories, 2500 Cottage Grove Ave., Chicago, Ill. For mail: 1612 Prairie Ave., Chicago, Ill.
- MEAD, MILTON S. (A'23), General Electric Company, Schenectady, N.Y. For mail: 1410 Regent St., Schenectady, N.Y.
- MEADOWS, CYRIL (A'25), Electrical and Mechanical Engineer, School House, King's Sutton, Banbury, England.
- MEHL, HARRY R. (A'29), Student Engineer, General Electric Company, Room 109, Bldg. 87, 1 River Rd., Schenectady, N.Y.
- MEALY, MAX B. (J'29), 1622 S. Newport, Tulsa, Okla.
- MEANS, PAUL S. (A'27), Commercial Operator, 22 E. Valerio St., Santa Barbara, Calif.
- MEGARITY, EVERETT A. (A'29), Radio Constructor and Designer, 16 Wall St., Saint John, N.B., Canada.
- MEGAW, E. C. S. (A'29), 256 Portstown Rd., Maida Vale, London, W. 9, England.
- MEIER, H. G. (A'29), Radio Sales and Service, Lakeside, Berrien County, Mich.
- MEINHARD, HERMAN (A'25), Engineer, Zenith Radio Corporation, 3620 Iron St., Chicago, Ill. For mail: 5445 Ludlam Ave., Chicago, Ill.
- MEISSNER, A. (M'14-F'15), Berlin-Dahlem, Im Schwarzen Grund 11, Berlin, S. W. 11, Germany.
- MEISSNER, EARL R. (A'26), Sound Dept., Tiffney Stahl Corporation, Los Angeles, Calif. For mail: 1736 N. Van Ness Ave., Los Angeles, Calif.
- MELANG, BJORN L. (A'27), 6047-6th Ave., N.E., Seattle, Wash.
- MELCHIORES, FRANTS ANSGAR, (A'29), Engineering Draftsman, Rochester Gas and Electric Corporation, 89 East Ave., Rochester, N.Y. For mail: 490 Ames St., Rochester, N.Y.
- MELHUISH, CHARLES A. (A'28), Engineer, Victorian State Railways, Melbourne, Australia. For mail: 6 Esplanade Ave., Brighton Beach, Victoria, Australia.
- MELHUISH, HAROLD T. (A'27-M'28), 23 Grace Court, Amityville, L.I., N.Y.
- MELLON, RALPH E. P. (J'28), 25 King St., Pottstown, Pa.
- MELLOR WILLIAM N. (A'27), Radio Engineer, Bell Telephone Laboratories, Box E, Whippany, N.J.
- MELNICOE, SAMUEL (A'26), Station Manager, Broadcasting Station KFBK, 7001 Eye St., Sacramento, Calif. For mail: 918-26th St., Apt. G., Sacramento, Calif.
- MELODY, BERNARD J. (A'29), Serviceman, Williams Hardware Company, Streator, Ill. For mail: 210 W. Lincoln Ave., Streator, Ill.
- MELROSE, JAMES W. (A'28), Melrose Radio Service, 8606 Garfield Blvd., Garfield Heights, Ohio.
- MELROY, HARRY C. (A'29), R. C. A., Unit No. 2, Santa Fe Bldg., Dallas, Texas. For mail: 5004 Goodwin Ave., Dallas, Texas.
- MENARD, J. L. (A'29), Radio Repairman, 365 St. Catherine St., West, Montreal, P.Q., Canada. For mail: 89 Laurier Ave., East, Montreal, P.Q., Canada.
- MERCER, ALVA (A'27), Radio Engineer, Stewart-Warner Service Station, 300 E. Long St., Columbus, Ohio. For mail: 1630 Kenmore Rd., Columbus, Ohio.
- MERCER, JOHN E. (A'26), Service Manager, Fada Radio Co., 2619 S. Michigan Ave., Chicago, Ill. For mail: 7403 Eggleston Ave., Chicago, Ill.
- MEREDITH, CLIVE B. (A'22), Proprietor and Technical Director, Radio Station WSYR, Hotel Syracuse, Syracuse, N.Y.
- MEREDITH, C. C. (A'25), Proprietor and Consulting Engineer, C. C. Meredith and Company, 45 Jarvis St., Toronto, Ont., Canada.
- MEREDITH, WILLIAM B. (A'29), Manager, Radio Dept., Tabor Furniture Company, 692 Purchase St., New Bedford Mass. For mail: 60 Mowdoin Ave., Dorchester, Mass.
- MERKEL, HENRY F. (A'27), Merkel Radio Shop, 447 Fern St., Philadelphia, Pa.
- MERRITT, ERNEST (M'15), Professor of Physics, Cornell University, Ithaca, N.Y. For mail: 1 Grove Place, Ithaca, N.Y.
- MERTIE, J. B., JR. (A'29), Geologist, U. S. Geological Survey, Washington, D.C. For mail: 218 Cedar St., Takoma Park, D.C.
- MERTZ, JOHN M. (A'27), Proprietor, Mertz Specialty Company, 1306 Stockton St., Wilmington, Del. For mail: 211 S. Grant Ave., Wilmington, Del.
- MESERVE, G. DONALD (A'28), Advertising Manager, "QST," 55 West 42nd St., New York, N.Y. For mail: 35-20-94th St., Jackson Heights, L.I., N.Y.
- MESERVE, WILBUR E. (A'26), Instructor in Electrical Engineering, School of Electrical Engineering, Cornell University, Ithaca, N.Y.
- MESSNER, ROY L. (A'24), Division Transmission Engineer, The Pacific Telephone and Telegraph Company, 1414 "K" St., Sacramento, Calif.
- METCALF, GEORGE F. (A'28), Engineer, Vacuum-Tube Research Laboratory, General Electric Company, Schenectady, N.Y. For mail: 958 Park Ave., Schenectady, N.Y.
- METTEY, BRADFORD JOSEPH (A'29), Radio Serviceman, Parsons Electric Company, 191 Main St., Northampton, Mass. For mail: 126 Franklin St., Northampton, Mass.
- MEVIUS, JOHN C. (J'27-A'27), Acoustic Dept., Electrical Research Products, Inc., 800 N. Delaware Ave., Philadelphia, Pa. For mail: 5135 N. Fairhill St., Philadelphia, Pa.
- MEYER, ALBERT (A'29), Radio Operator and Engineer, Station KGBZ, York, Neb. For mail: 1214 Lincoln Ave., York, Neb.
- MEYER, HENRY W. (A'27), Equipment Installer, Western Electric Company, 397 Hudson St., New York, N.Y. For mail: 523 E. 147th St., New York, N.Y.
- MEYER, R. B. (A'29), Radio Engineer, U.S. Navy, Naval Research Laboratory, Bellevue, Anacostia, D.C.
- MEYER, R. H. (A'29), Manager, Long's Radio Company, 2812 S. Main St., Los Angeles, Calif.

- MEYER, WINSTON F. (A'28), Radio Service and Repairman, Ridgeway Electric Company, 113 W. Stephenson St., Freeport, Ill. For mail: Route 1, Box 90, Freeport, Ill.
- MEYERS, PAUL F. (A'29), Hunkin Conkey Construction Company, Washington, D. C. For mail: Box 107, R. 4, Alexandria, Va.
- MEYROSE, HUBERT S. (A'27), Engineer's Assistant, Crosley Radio Corporation, 3401 Colerain Ave., Cincinnati, Ohio.
- MEZGER, GEORGE (A'25), District Plant Superintendent, American Telephone and Telegraph Company, Stratton Bldg., 103 Washington St., Albany, N.Y.
- MICHAEL, CHARLES (A'27), Radio Operator, Dept. of Commerce, Airways Communication Station, Elko, Nevada.
- MICHAEL, DAVID F. (A'29), Receiving Engineer, Marconi Wireless Telegraph Company, Apartado 166, Bogota, Colombia, South America.
- MICHALIC, C. T. (A'28), Certified Radiotriician, 908 Morrell Ave., Burlingame, Calif.
- MICHALOWICZ, LEON (A'29), Planning Engineer, Western Electric Company, Hawthorne Station, Chicago, Ill. For mail: 2611 N. Albany Ave., Chicago, Ill.
- MICHELMAN, EDWARD A. (J'26-A'29), Engineer, Design Division, R.C.A. Communications, Inc., Rocky Point, L.I., N.Y.
- MICHELSON, PETER (A'29), Radiotriician, Kingwood Mercantile Company, 134 Price St., Kingwood, W. Va.
- MICKELSON, C. D. (A'27), Engineering Assistant, Brooklyn Edison Company, Research Bureau, 55 Johnson St., Brooklyn, N.Y. For mail: P.O. Box 1071, Sea Cliff, L.I., N.Y.
- MICKEY, LEROY (A'26), Graduate Student, D-31, Morris Hall, Harvard University, Cambridge, Mass.
- MIER, C. W. (A'28), Engineer, Southwestern Bell Telephone Company, Oklahoma City, Okla.
- MILANIO, CLARENCE (A'27), Air Tester and Inspector Dept., Amplex Radio Instrument Laboratories, 132 W. 21st St., New York, N.Y. For mail: 66 Patchen Ave., Brooklyn, N.Y.
- MILES, LESTER F. (A'29), Chief Operator and Assistant Engineer, Radio Station WHP, Pennsylvania Broadcasting Company, 106 S. 4th St., Harrisburg, Pa. For mail: Vange Bldg., 4th and Chestnut Sts., Harrisburg, Pa.
- MILES, K. WALKER (A'25), Substation Dept., Commonwealth Edison Company, Chicago, Ill. For mail: 627 Pipestone St., Benton Harbor, Mich.
- MILES, WILLIAM E. (A'25), Manager, Code and Traffic Instruction Dept., R.C.A. Institutes, 560 Broad St., Newark, N.J.
- MILLEN, JAMES (J'24-A'25), General Manager, National Company, Inc., 61 Sheridan St., Malden, Mass. For mail: 84 Autumn St., Malden, Mass.
- MILLER, BURTON F. (J'24-A'26), Recording Engineer, Electrical Research Products, Inc., 7046 Hollywood Blvd., Hollywood, Calif. For mail: 515 N. Larchmont Blvd., Los Angeles, Calif.
- MILLER, CARL (A'28), Research Section, Sylvania Tube Production Co., Mill Hall, Pa.
- MILLER, CHARLES C. (A'27), Radio Technician, Sears, Roebuck and Company, Philadelphia, Pa. For mail: 5107 N. 11th St., Philadelphia, Pa.
- MILLER, CHARLES E. (A'25), 410 1/2 N. Stanley Ave., Los Angeles, Calif.
- MILLER, CLAIR R. (A'27), Chief Engineer and Operator, Station KWCR, Cedar Rapids Broadcasting Corporation, Cedar Rapids, Iowa. For mail: 526 C. Ave., E., Cedar Rapids, Iowa.
- MILLER, CLAUDE E. (A'28), Manager, Radio Service Dept., Edgar Music Company, 700 S. Main St., Tulsa, Okla.
- MILLER, ERDENE K. (A'28), Bookkeeper, Union National Bank, Bartlesville, Okla. For mail: 709 Wyandotte Ave., Bartlesville, Okla.
- MILLER, FRANCIS G. (A'29), Radio and Electrical Engineer, Bridge St., Murray Bridge, South Australia. For mail: Eleanor Terrace, Murray Bridge, South Australia.
- MILLER, GERALD E. (A'29), Service Engineer, Victor Talking Machine Division, Radio Victor Corporation of America, 952 N. Michigan Ave., Chicago, Ill.
- MILLER, GEORGE C. (A'27), Electrician, Tacoma Bus Company, 2813 Pacific Ave., Tacoma, Wash. For mail: P.O. Box 508 Tacoma, Wash.
- MILLER, GEORGE H. (A'28), Engineering Staff, Station WGR, Federal Radio Corporation, Buffalo, N.Y. For mail: 236 Barton St., Buffalo, N.Y.
- MILLER, HAROLD R. (A'16), Radio Engineer, Westinghouse Electric and Manufacturing Company, Chicopee Falls, Mass. For mail: 43 Bowles Park, East Springfield, Mass.
- MILLER, H. P., JR. (A'22-M'24), Radio Engineer, International Communication Laboratories, 89 Broad St., New York, N.Y.
- MILLER, JOHN G. C. (A'27), Radio Engineer, Lockport Light, Heat and Power Company, 15 Main St., Lockport, N.Y. For mail: 25 Gelston St., Buffalo, N.Y.
- MILLER, JOHN H. (A'19-M'25), Chief Electrical Engineer, Jewell Electric Instrument Company, 1646 Walnut St., Chicago, Ill. For mail: 627 N. Grove Ave., Oak Park, Ill.
- MILLER, JOHN M. (A'17-F'20), Radio Engineer, Atwater-Kent Manufacturing Company, 4700 Wissahickon Ave., Philadelphia, Pa.
- MILLER, JOSEPH ANTHONY (A'29), Chief Radioman, U. S. Navy, P. O. Box 506, Christiansted, St. Croix, Virgin Islands.
- MILLER, J. PURNELL (A'26), 2728 Hartford Ave., Baltimore, Md.
- MILLER, LEONARD H. (A'26), Radio Engineer, Radio Corporation of America, Bldg. 15-5th Floor, Front and Cooper Sts., Camden, N.J.
- MILLER, LE ROY J. (A'22), Radio Engineer, Freed-Eisemann Radio Corporation, Liberty Ave. and Junius St., Brooklyn, N.Y. For mail: 284 Ocean Parkway, Brooklyn, N.Y.
- MILLER, LOUIS (A'29), Radio Service, 1219 Home Ave., Anderson, Ind.

- MILLER, MARVIN L. (A'17), Industrial Sales, Willard Storage Battery Company, 551 5th Ave., New York, N.Y. For mail: 135 W. 33rd St., New York, N.Y.
- MILLER, PAUL E. (A'29), Broadcast Operator, Transmitter Dept., Radio Station WOWO, 215 W. Main St., Ft. Wayne, Ind. For mail: Rm. 701, YMCA, Ft. Wayne, Ind.
- MILLER, PAUL J. (A'28), Manager, Radio Dept., Doubleday-Hill Electric Company, 719 Liberty Ave., Pittsburgh, Pa. For mail: 1133 Creedmoor Ave., Pittsburgh, Pa.
- MILLER, REESE HUTCHISON (M'29), Engineer and Inventor, 90 West St., New York, N.Y.
- MILLER, ROBERT L. (A'25), Partner, The Electrical Shop, 116 W. 4th St., Royal Oak, Mich.
- MILLER, R. F. (A'18), College of Emporia, Emporia, Kan.
- MILLER, SAMUEL C. (A'16-M'22), 73 W. 105th St., New York, N.Y.
- MILLER, WALTER H. (A'28), Manager, Recording Dept., J. A. Edison, Inc., 79-5th Ave., New York, N.Y. For mail: 494 London Pl., Orange, N.J.
- MILLER, WAYNE (A'29), Radio Engineer, National Radio Manufacturing Company, Oklahoma City, Okla. For mail: 415½ N. Harvey Ave., Oklahoma City, Okla.
- MILLER, WILLIAM T. (A'27), Radio Advertising Manager, "Christian Science Monitor," Back Bay Station, Boston, Mass. For mail: 25 Bothfield Rd., Newton Center, Mass.
- MILLION, JOHN W., JR. (M'27), Radio Engineer, Bremer-Tully, 656 W. Washington Blvd., Chicago, Ill. For mail: 4881 N. Paulina, Chicago, Ill.
- MILLS, ELMER E. (A'26), Manufacturers Representative, Elmer E. Mills and Company, 38 S. Dearborn St., Chicago, Ill.
- MILLS, GILBERT H. (A'27), Broadcast Engineer, Manitoba Telephone System, Winnipeg, Manitoba, Canada. For mail: 100 Lenore St., Winnipeg, Manitoba, Canada.
- MILLS, H. LAWRENCE (A'29), Chief Engineer, Radio Station KSTP, St. Paul Hotel, St. Paul, Minn.
- MILLS, JOHN (M'16), Director of Publications, Bell Telephone Laboratories, Inc., 463 West St., New York, N.Y.
- MILLS, WILLIAM F. (A'25), Engineer-in-Charge, British Broadcasting Company, Ltd., Swansea, England. For mail: Nicholas Druslyn Rd., West Cross, Swansea, England.
- MILLS, WILLIAM P. (A'29), Manager, Final Test Radio Receivers, Wireless Specialty Apparatus Company, Boston, Mass. For mail: 7 Gott St., Rockport, Mass.
- MILNOR, JOSEPH W. (A'16-M'26), Radio Engineer, Western Union Telegraph Company, 195 Broadway, New York, N.Y.
- MINNIUM, BYRON B. (A'25), Director of Research, Radio Division, Stewart-Warner Speedometer Corporation, 1828 Diversey Parkway, Chicago, Ill. For mail: 1424 Greenleaf Ave., Chicago, Ill.
- MINOR, ROBERT LEE (A'29), Serviceman, O. K. Houck Piano Company, 311 Main St., Little Rock, Ark. For mail: 1909 N. Spruce St., Little Rock, Ark.
- MINTER, ROBERT W. (A'24), Maintenance Engineer, Hart Accumulator Company, Ltd., Marshgate Lane, Stratford, London, E. 15, England. For mail: 51 Foxbury Rd., Bromley, Kent, England.
- MINTON, JOHN P. (F'23), Consulting Engineer, 8 Church St., White Plains, N.Y.
- MINTZ, JOHN W. (A'26), Radiotrician, Buckeye Radio Service, 67 E. Mills St., Akron, Ohio. For mail: 931 Bloomfield Ave., Akron, Ohio.
- MIRICK, C. B. (A'15-M'29), Radio Engineer, U. S. Naval Research Laboratory, Bellevue, Anacostia, D.C. For mail: 3314 Newark St., Washington, D.C.
- MIRK, D. BLAIR (A'25), Les Laboratoires Standard, 46, Avenue de Breteuil, Paris 7^e, France.
- MISENHEIMER, HARVEY N. (A'22-M'29), Engineer, American Telephone and Telegraph Company, 195 Broadway, Rm. 1607, New York, N.Y.
- MISENHEIMER, ROBERT G. (A'29), Radio Operator, Radio Station WABC, P. O. Box 13, Ozone Park, L.I., N.Y.
- MITA, S. (A'29), Research Staff, Vacuum Tube Dept., Research Laboratory, The Tokyo Electric Company, Kawasaki, Japan. For mail: 59, Hitotsugicho, Akasakaku, Tokyo, Japan.
- MITCHELL, CLAIR D. (A'23-M'27), Technical Division, Radio Dept., Radio Corporation of America, 233 Broadway, New York, N.Y. For mail: 210 Franklin St., Bloomfield, N.J.
- MITCHELL, G. A. (A'29), 1501 E. Harty St., Wichita, Kan.
- MITCHELL, JAMES A. (A'27), Electrical Engineer, Hartford Electric Light Company, 266 Pearl St., Hartford, Conn. For mail: Box 108, Nott St., Wethersfield, Conn.
- MITCHELL, JOHN A. (A'27), Chamber of Commerce, Anderson, S.C. For mail: P. O. Box 415, Anderson, S.C.
- MITCHELL, LEONARD W. (J'27-A'29), Law Student, Fasken, Robertson, Aitchison, Pickup and Calvin, 1007 Excelsior Bldg., Toronto, Ont., Canada. For mail: 133 Pinewood Ave., Toronto, Ont., Canada.
- MITCHELL, THEODORE R. (A'27), Manager, Radio Laboratory of Wichita, 326 S. Topeka St., Wichita, Kan. For mail: 1501 E. Harty St., Wichita, Kan.
- MITSUISHI, HIDE KADZU (A'26), Wireless Dept., N.Y.K., Tokyo, Japan.
- MITSUTAKE, KATSUMI (A'28), Radio Engineer, Komuka, Teishinbu, Taihoku, Formosa, Japan.
- MIYAUCHI, T. (A'29), Research Staff, Vacuum Tube Dept., Research Laboratory, The Tokyo Electric Company, Kawasaki, Japan.
- MIZELL, M. H. (A'26), Lieut., U.S.M.C., Officer-in-Charge, Radio School, Signal Battalion, Quantico, Va. For mail: Marine Barracks, Signal Battalion, Quantico, Va.
- MKITARIAN, LUTHER M. (A'28), Doctor of Dental Surgery, 26th St. and Westfield Ave., Camden, N.J.
- MOAURO, JOSEPH S. (A'28), Small Motor Engineer, Westinghouse Electric and Manufacturing Company, East Springfield Works,

- Springfield, Mass. For mail: 50 Cherry St., Springfield, Mass.
- MOCK, ELMER E. (A'27), Radio Mechanic, DeForest Crosley Radio Company, 245 Carlaw Ave., Toronto, Ont., Canada. For mail: 55 Dagmar Ave., Toronto, Ont., Canada.
- MOCKFORD, FREDERICK S. (A'19), Radio Officer, The Aerodrome, Croydon, Surrey, England.
- MODRAK, PETER (A'23), Kompina, Lowicz, Poland.
- MOFFETT, LEROY, JR. (A'29), Student Engineer, Southwestern Bell Telephone Company, Oklahoma City, Okla. For mail: 223 E. 4th St., Oklahoma City, Okla.
- MOGRIDGE, J. NAIRN (A'27), Manager, W. J. Crogsdill Sales Company, 73 Adelaide St., Toronto, Ont., Canada.
- MOLER, A. R. (A'25), Chief Engineer, Midland Broadcasting Company, Kansas City, Mo. For mail: 1326 Kensington, Independence, Mo.
- MOLES, FRANK J. (A'29), Electrical Engineer, General Electric Company, Schenectady, N.Y. For mail: 129 Country Club Dr., R.F.D. 1, Schenectady, N.Y.
- MOLK, F. T. (A'27), Mechanical Draftsman, Pittsburgh Valve Foundry and Construction Company, P. O. Box 1016, Pittsburgh, Pa. For mail: P. O. Box 24, N. Side P. O., Pittsburgh, Pa.
- MOLONY, JOHN D. (J'20-A'22), Switchman, Illinois Bell Telephone Company, 725 Madison St., Gary, Ind. For mail: c/o Walter R. Laster, 4555 Harrison St., Gary, Ind.
- MOLZEN, CHARLES F. (A'26), Engineer, Dejur Amsco Company, 416 Broome St., New York, N.Y. For mail: 31 Park Terrace, W., New York, N.Y.
- MONMO, ERNEST J. (A'22), 11 Hennessy Pl., Irvington, N.J.
- MONFORT, RAY A. (J'28-A'29), Equipment Engineer, Western Electric Company, 100 Central Ave., Kearny, N.J. For mail: 102 N. Arlington, East Orange, N.J.
- MONTAGNES, HENRY (J'26-A'28), c/o J. Montagnes, Rm. 304, 465 Bay St., Toronto 2, Ont., Canada.
- MONTCALM, S. R. (A'13-M'28), Telephone Engineer, International Standard Electric Corporation, 67 Broad St., New York, N.Y.
- MONTGOMERY, A. PEERS (A'28), Engineer, A. H. Grebe and Company, 70 Van Wyck Blvd., Richmond Hill, L.I., N.Y. For mail: 118 Audley St., Kew Gardens, L.I., N.Y.
- MONTGOMERY, L. H., JR. (A'27), Chief Operator WSM Broadcasting Station, National Life and Accident Insurance Company, Nashville, Tenn.
- MONTGOMERY, MARTELL (A'28), Chief Engineer, Radio Broadcasting Station WIL, Missouri Broadcasting Corporation, Melbourne Hotel, St. Louis, Mo. For mail: 3626 Arsenal St., St. Louis, Mo.
- MONTGOMERY, PHILIP (A'27), Aetna Fire Insurance Company, Hartford, Conn. For mail: 80 Outlook Ave., West Hartford, Conn.
- MOOD, GEORGE T. (A'29), Manager, Radio Service, Standard Furniture Company, 2nd and Pine Sts., Seattle, Wash. For mail: 4055-42nd Ave., S.W., Seattle, Wash.
- MOONEY, RAYMOND (A'27), Secretary, Assistant Treasurer, Roach-Appleton Manufacturing Company, 3440 N. Kimball Ave., Chicago, Ill. For mail: 7526 N. Robey St., Chicago, Ill.
- MOORBECK, CLINTON (J'28-A'29), Radio Serviceman, H. C. Gill, Inc., 3808 Burleigh St., Milwaukee, Wis. For mail: 1278 W. 24th St., Milwaukee, Wis.
- MOORE, ADAM H. (A'29), Junior Physicist, Naval Research Laboratory, Bellevue, Anacostia, D.C. For mail: 3624 Horner Pl., Washington, D.C.
- MOORE, CHAS. G. (A'27), Manager, Corrugated Paper Products Company, 25-49 Inson St., Buffalo, N.Y. For mail: 77 Depew Ave., Buffalo, N.Y.
- MOORE, ERIC J. T. (M'27), Engineer, Stromberg-Carlson Telephone Manufacturing Company, 1060 University Ave., Rochester, N.Y. For mail: 29 Antlers Dr., Roselawn, Rochester, N.Y.
- MOORE, EUGENE A. (A'27), Engineering Dept., Aircraft Radio Corporation, Atchison, Kan. For mail: 324 Santa Fe, Atchison, Kan.
- MOORE, E. B. (A'28), Moore Radio Company, 72 Cortlandt St., Rm. 301, New York, N.Y.
- MOORE, FRANK C. (A'27), Radio Supervisor, Inland Waterways Corporation, 320 Magazine St., New Orleans, La. For mail: 2805 Pine St., New Orleans, La.
- MOORE, HAROLD A. (A'29), Student Engineer, Radio Corporation of America, New York, N.Y. For mail: Allen, Mich.
- MOORE, HENRY H. (A'26), Manager, Landay Bros., 8 Cortlandt St., New York, N.Y. For mail: 180 Lenox Rd., Brooklyn, N.Y.
- MOORE, JAMES S. (A'29), Radio Technician, Lyon and Healy, Inc., 243 S. Wabash Ave., Chicago, Ill. For mail: 2416 Bryn Mawr Ave., Chicago, Ill.
- MOORE, JOHN B. (A'26), Research and Design, Radio Corporation of America, Riverhead, L.I., N.Y. For mail: P. O. Box 321, Riverhead, L.I., N.Y.
- MOORE, JOHN T. (A'28), Radio Engineer, John Mills Sons, 63 Grainger St., W. Newcastle-on-Tyne, England. For mail: 23 Claremont Rd., Newcastle-on-Tyne, England.
- MOORE, J. BURTON (A'26), 1364 Drexel Ave., Detroit, Mich.
- MOORE, PAUL (A'18), Engineer, Pacific Telephone and Telegraph Company, Rm. 524, 140 New Montgomery St., San Francisco, Calif.
- MOORE, PAUL J. (A'29), Assistant Radio Engineer, Radio Station WKY, Radiophone Company, Oklahoma City, Okla. For mail: 1926 W. 22nd St., Oklahoma City, Okla.
- MOORE, RAYMOND C. (A'26), Ramor Studios, Long Beach, Calif. For mail: 907 Obispo Ave., Long Beach, Calif.
- MOORE, RAYMOND M. (A'23), Radio Technician, Earl C. Anthony, Inc., Radio Station KFI, 1000 Hope St., Los Angeles, Calif. For mail: 1627 N. Alvarado St., Los Angeles, Calif.
- MOORE, THOMAS H. (A'29), Service Engineer, P. O. Box 491, Charleston, W. Va.

- MOORE, WILLIAM H.** (J'27-A'28), Demonstrator, Physics Dept., McGill University, Montreal, P.Q., Canada. For mail: 466 Grosvenor Ave., Westmount, P.Q., Canada.
- MOORE, WILLIAM P.** (A'27), Engineer-in-Charge, Station WDAE, "Tampa Times," 710 Bell St., Tampa, Fla. For mail: 339 Plant Ave., Tampa, Fla.
- MOORHEAD, GEORGE H.** (A'26), Radioman, American Telephone and Telegraph Company, Netcong, N.J. For mail: P. O. Box 252, Stanhope, N.J.
- MOORE, CLIFTON C.** (A'29), General Electric Company, Schenectady, N.Y. For mail: 1061 Glenwood Blvd., Schenectady, N.Y.
- MORECROFT, J. H.** (A'13-F'22), Columbia University, New York, N.Y.
- MOREE, W.** (A'20), Kon. Inst. V.D. Marine, Den Helder, Holland.
- MOREHOUSE, DAYTON J.** (A'29), Proprietor, Radio Technician Service, 1283 Carew St., Springfield, Mass.
- MOREHOUSE, RAYMOND L.** (A'22), Engineer of Tests, Allen D. Cardwell Manufacturing Corporation, 81 Prospect St., Brooklyn, N.Y. For mail: 2401 Newkirk Ave., Brooklyn, N.Y.
- MOREHOUSE, TERRY B.** (A'27), Patent Attorney, Radio Corporation of America, 233 Broadway, New York City.
- MOREHOUSE, W. B.** (M'29), Research Engineer, Bell Telephone Laboratories, Inc., 463 West St., New York, N.Y.
- MOREY, W. J.** (A'28), Chief Engineer, All-American Radio Corporation, 4201 Belmont Ave., Chicago, Ill. For mail: 545 North Central Ave., Chicago, Ill.
- MORGAN, HOWARD K.** (A'27), Radio Engineer, General Electric Company, Schenectady, N.Y. For mail: 8 Water St., Schenectady, N.Y.
- MORGAN, NATHANIEL R.** (A'29), Chief Editor, Report Bureau, Federal Telegraph Company, Palo Alto, Calif. For mail: 430 Addison Ave., Palo Alto, Calif.
- MORGAN, J. T.** (A'22), Secretary and Sales Manager, Charleston Electrical Supply Company, P. O. Box 1624, Charleston, W.Va. For mail: 1538 Quarrier St., Charleston, W.Va.
- MORGAN, O. K.** (A'27), Manager, Radio Dept., The Ohio Public Service Company, 526 E. Main St., Alliance, Ohio. For mail: 461 South St., Alliance, Ohio.
- MORISON, BRUCE** (A'29), Radio Engineer and Salesman, Messrs. Hubert Davies and Company, Ltd., P. O. Box 34, Salisbury, S. Rhodesia.
- MORITA, K.** (A'29), Wireless Engineer, Kumamoto Broadcasting Station JOGK, Shimizu-Mura, Near Kumamoto, Japan.
- MORIWAKI, KATSUMI** (A'25), Yoshimura and Company, 53 Saichji-Machi, Shiva-Ku, Tokyo, Japan.
- MORLEY, WILLIAM L.** (A'27), Chief Service Engineer, Temple Corporation, 5253 W. 65th St., Chicago, Ill.
- MORRIS, CARLETON D.** (A'25-M'27), Superintendent of Radio, Wyandotte Transportation Company, Wyandotte, Mich. For mail: 667 Kings Highway, Wyandotte, Mich.
- MORRIS, GEORGE W.** (A'19), Captain, Signal Corps, The Armory, 32nd and Lancaster Ave., Philadelphia, Pa.
- MORRIS, HEDLEY B.** (A'28), Engineer-in-Charge, RCA Communications, Inc., Marion Plant, Marion, Mass.
- MORRIS, JAMES M.** (A'28), Teaching Fellow in Physics, Oregon State College, 211 N. 16th St., Corvallis, Ore.
- MORRIS, JAMES W.** (J'27-A'27), Los Angeles Wholesalers' Board of Trade, 111 W. 7th St., Los Angeles, Calif. For mail: 4959 College View Ave., Los Angeles, Calif.
- MORRIS, JOHN F.** (A'27), Control Room Engineer, Radio Station WENR, Great Lakes Broadcasting Company, 2320 Straus Bldg., Chicago, Ill. For mail: 537 Deming Pl., Chicago, Ill.
- MORRIS, LEON A.** (A'28), Assistant Engineer, Radio Corporation of America, Riverhead, L.I., N.Y.
- MORRIS, LLOYD P.** (A'27), Graduate, School of Electrical Engineering, University of Illinois, Urbana, Ill. For mail: 606 Elm St., W., Urbana, Ill.
- MORRIS, ROBERT** (A'26), Marine Radio Operator, Union Castle Mail S. S. Co., Ltd., Fenchurch St., London, England. For mail: S. View, Stag Rd., Sandown, Isle of Wight, England.
- MORRIS, ROBERT M.** (A'26), National Broadcasting Company of America, New York, N.Y. For mail: 47 Elm St., Elizabeth, N.J.
- MORRIS, ROBERT S.** (A'28), Radio Operator, Radio Station WRBU, Gastonia, N.C. For mail: 413 S. Broad St., Gastonia, N.C.
- MORRISON, HOWARD** (A'29), Member of Technical Staff, Bell Telephone Laboratories, Inc., 463 West St., New York, N.Y. For mail: 44 Evergreen Ave., East Orange, N.J.
- MORRISON, HUBER R.** (A'26), 2854 N. Clark St., Chicago, Ill.
- MORRISON, JOHN F.** (A'29), Technical Staff, Bell Telephone Laboratories, Inc., 463 West St., New York, N.Y. For mail: 153 Overlook Ave., Boonton, N.J.
- MORRISON, L. H.** (A'26), Master Mechanic, Milham Exploration Company, Los Angeles, Calif. For mail: P. O. Box 401, Wasco, Kern County, Calif.
- MORRISON, MONTFORD** (M'19), Consulting Engineer, 711 W. Lake St., Chicago, Ill.
- MORRO, JACK J.** (A'24), Radio Engineer, 114 E. 23rd St., New York, N.Y.
- MORROW, GRANVILLE P.** (A'28), Radio Service Engineer, Earl Radio Corporation, Clifton, N.J. For mail: 714 Canton St., Elizabeth, N.J.
- MORROW, LORENTZ A.** (A'29), A-associate, Insurance Trust Associates, 1101 Integrity Building, Philadelphia, Pa. For mail: 412 Qu Wayne Apts., 5220 Wayne Avenue, Philadelphia, Pa.
- MORSE, ARTHUR H.** (M'19), Chief Technical Adviser, Universal Wireless Communication Company, Inc., 4619 Ravenwood Ave., Chicago, Ill.
- MORSE, LOUIS R.** (A'26), Columbia Phonograph Company, Inc., Bridgeport, Conn.

- MORTIMER, HARRY H.** (A'22), Baker and Company, Inc., Newark, N.J. For mail: 58 Grant Pl., Irvington, N.J.
- MORTON, ALFRED H.** (M'28), Director of Traffic Production, Radio Corporation of America, 66 Broad St., New York, N.Y.
- MORTON, CLARENCE F.** (A'28), Radio Service, 31 Princeton St., Lowell, Mass.
- MOSS, W. HALL** (A'26), Radio Service, Normal, Tenn. For mail: Normal, Tenn.
- MOSS, TERRY L.** (A'29), Radiotrician, Martin Bros. Piano Company, Springfield, Mo. For mail: 906 East Grand, Springfield, Mo.
- MOTT, FREDERICK A.** (A'26), Electrical Engineer and Contract Manager, Wheeler-Green Electric Company, 29 St. Paul St., Rochester, N.Y. For mail: 218 Beresford Rd., Rochester, N.Y.
- MOTT, HAROLD E.** (A'22), Manager and Chief Engineer, Engineering and Production Dept., Rogers Majestic Corporation, Fleet St., Toronto, Ont., Canada.
- MOTT, LAWRENCE** (A'27), 3358 Deronda Dr., Hollywoodland, Calif.
- MOULDEN, ROY B.** (A'27), Proprietor and Manager, Moulden's Battery Company, 107 E. Sale St., Tuscola, Ill.
- MOULLIN, E. B.** (M'27), Lecturer, Dept. of Electrical Engineering, Cambridge University, Cambridge, England. For mail: 13 Brookside, Cambridge, England.
- MOULTON, THEODORE S.** (A'29), Accountant, Chamber of Commerce, 1615 H St., N.W., Washington, D.C. For mail: 2115 Pennsylvania Ave., N.W., Washington, D.C.
- MOURADIAN, H.** (A'16), Toll Fundamental Engineer, The Bell Telephone Company of Pennsylvania, 1835 Arch St., Philadelphia, Pa.
- MOUSLEY, FRANKLIN** (A'29), General Manager, Charles Mousley's and Sons, 257 N. 12th St., Philadelphia, Pa.
- MOXON, ALFRED W.** (A'27), Engineer, Panama No. 1, Ltd., Remance Mines, Santiago de Veraguas, Republic de Panama.
- MOYA, MIGUEL** (A'27), Mejia Lequerica 4, Madrid, Spain.
- MOYER, ELMO EMERSON** (A'29), Student, University of Notre Dame, Notre Dame, Ind. For mail: 326 Locust St., Clearfield, Pa.
- MRAZ, EDWIN** (A'27), Engineer, Electrical Research Products, Inc., 22nd and Paulina Sts., Chicago, Ill. For mail: 3812 Pine Grove Ave., Chicago, Ill.
- MUELLER, EUGENE L.** (A'27), 8012 Kimbark Ave., Chicago, Ill.
- MUELLER, PAUL M.** (A'26), Manager, Lock Division, Hartford Machine Screw Company, 475 Capitol Ave., Hartford, Conn. For mail: 1936 Boulevard, West Hartford, Conn.
- MUHLEMAN, MAURICE L.** (A'26), Editor, "Radio Engineering," 52 Vanderbilt Ave., New York, N.Y. For mail: Gramatan Court, 12 Gramatan Ave., Mt. Vernon, N.Y.
- MUIRHEAD, JOHN E.** (A'28), Engineer, Sanderson and Porter, 33 La Salle St., Chicago, Ill.
- MULHOLLAND, WILLIAM** (A'29), Electrical Engineer, Vickers-Armstrongs, Ltd., Powder Mill Lane, Dartford, Kent, England.
- MULLANE, J. W.** (A'29), Field Engineer, RCA Photophone, Inc., 411-5th Ave., New York, N.Y. For mail: 162 Mecker Ave., Brooklyn, N.Y.
- MULLANEY, DUDLEY A.** (A'24), Vacuum Tube Engineer, General Electric Company, Schenectady, N.Y. For mail: 1633 Rugby Rd., Schenectady, N.Y.
- MULLEN, JOSEPH A.** (A'26), Engineering Division, Raytheon Manufacturing Company, Cambridge, Mass. For mail: 16 Mercier St., Ashmont, Mass.
- MULLEN, JOSEPH G.** (A'15), Assistant General Manager, Brunswick-Balke-Collender Company of Canada, Ltd., 358 Bay St., Toronto, Ont., Canada.
- MULLETT, CHARLES B.** (A'27), 265 Hartwell Rd., Buffalo, N.Y.
- MULLIN, JAMES W.** (A'15-M'22), Engineer, Marconi Station, Drummondville, P.Q., Canada.
- MUMFORD, ALBERT H.** (A'28), Radio Section, P. O. Research Station, Dollis Hill, London, England. For mail: 27 Grendon Gardens, Wembley Park, Middlesex, England.
- MUMMA, EARLE L.** (A'26), Radio Engineer, Westinghouse Electric and Manufacturing Company, East Pittsburgh, Pa. For mail: Landisville, Lancaster County, Pa.
- MUMMERT, RUSSELL E.** (J'27), Service Engineer, General Auto Supply Company, 124 S. Cameron St., Harrisburg, Pa. For mail: 307 Lewis St., Harrisburg, Pa.
- MUNCEY, ALLEN R.** (A'25), Radio Engineer, Philadelphia Radio Engineering Company, 659 N. Markoe St., West Philadelphia, Pa. For mail: 6032 Latona St., West Philadelphia, Pa.
- MUNROE, A. D.** (A'29), Student, Dodge Institute, Valparaiso, Ind. For mail: 405 S. Monroe St., Valparaiso, Ind.
- MURCHIE, JOHN** (M'27), Manager, Wireless Dept., James Watt Memorial College, Greenock, Scotland.
- MURDOCH, G.** (A'29), Manager, Radio Dept., Fletcher Bros. (Vict.), Ltd., 1110 Douglas St., Victoria, B.C., Canada. For mail: 1518 Cook St., Victoria, B.C., Canada.
- MURDOCK, D. R. W.** (A'15), Treasurer, Wm. J. Murdock Company, 347 Washington Ave., Chelsea, Mass.
- MURPHY, BROWER** (A'27), 441 Seminole Ave., N.E., Atlanta, Ga.
- MURPHY, E. EDWARD** (A'29), Proprietor, Sherman Service, 69 Sherman Ave., New York, N.Y.
- MURPHY, FRANK** (A'29), Managing Director, Murphy Radio, Ltd., Broadwater Rd., Welwyn Garden City, Herts, England.
- MURPHY, PAUL L.** (A'29), Architect, 902 Kennedy Bldg., Tulsa, Okla. For mail: 2044 E. 12th Pl., Tulsa, Okla.
- MURPHY, WILLIAM H.** (M'25), Officer-in-Charge, Signal Corps Radio Laboratory, Fort Monmouth, Oceanport, N.J.
- MURRAY, ALBERT F.** (A'20-M'26), Engineering Dept., Jenkins Television Corporation, 346 Claremont Ave., Jersey City, N.J.

- MURRAY, CHARLES J. (A'28), Rate Clerk, Pennsylvania Freight Office, Dover, Ohio. For mail: 252-2nd St., N.W., New Philadelphia, Ohio.
- MURRAY, WILLIAM A. (A'20), Associate Professor of Electrical Engineering, Michigan State College, East Lansing, Mich.
- MURRI, JOSEPH (A'27), Engineering Dept., Philadelphia Storage Battery Company, Ontario and "C" Sts., Philadelphia, Pa. For mail: 3933 N. 7th St., Philadelphia, Pa.
- MUSCARI, PIETRO J. C. (A'28), Research Engineer, Radio Research Laboratory, Marietta, Ohio. For mail: 207 Curtis Terrace, Marietta, Ohio.
- MUSTCHIN, NORMAN (A'29), Radio Work, 11 Victoria Rd., Swindon, Wilts, England. For mail: 32 Prospect Hill, Swindon, Wilts, England.
- MUSTERMANN, H. G. A. (A'27), Engineer, Coldak Corporation, New York, N.Y. For mail: 8 Paulin Blvd., Leonia, N.J.
- MUTCH, W. W. (A'27), Research Engineer, Bell Telephone Laboratories, Inc., Box 31, Cliffwood, N.J.
- MUTHART, JOHN A. (A'29), Proprietor, Allentown Radio Hospital, 944 Hamilton St., Allentown, Pa. For mail: 2014 Highland Ave., Allentown, Pa.
- MYERS, DELBERT (A'29), Serviceman, Clyde Julian and Son, Radio and Electric Company, Sweetser, Ind.
- MYERS, GEORGE T. (A'28), Radio Engineer, British Broadcasting Corporation, Savoy Hill, London, England. For mail: 29 Lannett Rd., Gloucester, England.
- MYERS, GILBERT B. (A'27), Lieutenant, U. S. Navy, U.S.S. "West Virginia," c/o Postmaster, San Francisco, Calif.
- MYERS, H. (A'27), Central Telegraph Office, Durban, Natal, South Africa.
- MYERS, JAMES A. (A'29), Radio Serviceman, Ford Electric and Radio Company, 123 N. State St., Jackson, Miss. For mail: 944 W. Capitol St., Jackson, Miss.
- MYERS, THEOBALD (A'29), Engineer, National Broadcasting Company, 711-5th Ave., New York, N.Y. For mail: 2740 Marion Ave., New York, N.Y.
- MYERS, WALTER M. (A'27), 1661 Grand Ave., Piedmont, Calif.
- MYERS, WILLARD D. (A'28), Manager, Radio Dept., A. C. Myers and Son, Greentown, Ohio. For mail: Greentown, Ohio.
- N
- NACHEMSON, PAUL R. (A'29), Laboratory Supervisor, Brooklyn Radio Service Corporation, 1072 Atlantic Ave., Brooklyn, N.Y.
- NADIG, STANTON E. (A'27), Marine Estimator, Sun Shipbuilding Company, Chester, Pa. For mail: 19 W. Forestview Rd., Parkside, Chester, Pa.
- NAGAI, KENZO (A'29), Assistant Professor, Electrical Engineering Dept., Tohoku Imperial University, Sendai, Japan. For mail: No. 52, Kita-2-bancho, Sendai, Japan.
- NAGATA, CHARLES N. (A'27), Partner, Valley Battery Company, Auburn, Wash. For mail: P. O. Box 815, Auburn, Wash.
- NAGAO, R. (A'29), Research Staff, Research Laboratory, The Tokyo Electric Company, Kawasaki, Japan. For mail: c/o M. Kaneko, 2, 5-cho, Kojimachiku, Tokyo, Japan.
- NAGY, A. WHEELER (J'26-A'27), 319 Chauncey St., Astoria, L.I., N.Y.
- NAIMARK, BORIS S. (A'26), Free Lance Radio Writer, 35 Cumming St., New York, N.Y.
- NAKAGIMI, T. (M'20), Radio Engineer, Dept. of Communications, Tokyo, Japan. For mail: 1606 Nakano, Tokyo-fu, Japan.
- NAKAI, TOMOZO (A'29), Research Engineer, Electrotechnical Laboratory, Ministry of Communications, Osaki-Machi, Near Tokyo, Japan. For mail: Teishinsho Denki Shikenjo, Osaki-Machi, Near Tokyo, Japan.
- NAKAJIMA, S. (A'29), Radio Engineer, Naval Research Laboratory, Imperial Research Laboratory, Tokyo, Japan. For mail: 1512 Himonya, Hibusuma-machi, Ebara-gun, Tokyo-fu, Japan.
- NAKAMOURA, H. (A'25), Research Laboratory, The Tokyo Electric Company, Ltd., Kawasaki, Kanagawa-ken, Japan.
- NAKAMURA, T. (M'29), Commander, c/o Imperial Japanese Navy, Inspector's Office, No. 1 Madison Ave., New York, N.Y.
- NALLY, EDWARD J. (A'14), Otter Rock Drive, Belle Haven, Greenwich, Conn.
- NAMBA, SHOGO (A'29), Research Engineer, Electrotechnical Laboratory, Ministry of Communications, Osaki-Machi, Near Tokyo, Japan. For mail: Teishinsho Denki Shikenjo, Osaki-Machi, Near Tokyo, Japan.
- NAMBA, YASUKAZU (A'25), Radio Engineer, Electrotechnical Laboratory, Denki-Shikenjo, 4bu, Shimo-Osaki, Ebaragun, Tokyo, Japan. For mail: 15 Sakuragawacho, Shiba, Tokyo, Japan.
- NANCARROW, F. E. (M'22), Engineer-in-Chief's Office, G.P.O., London, England. For mail: 72 Chambers Lane, London, N.W. 10, England.
- NANCE, CURTIS H. (A'22-M'23), Manager, Radio Corporation of America, Pacific Bldg., Manila, P.I.
- NANGLE, W. O. (A'25), Inspection Development Engineer, Western Electric Company, Chicago, Ill. For mail: 922 Ontario St., Oak Park, Ill.
- NARDIN, GEORGE F., JR. (J'29), 7404 Bennett Ave., Chicago, Ill.
- NASH, JAMES C. (A'26), Draftsman, Canadian Westinghouse Company, Hamilton, Ont., Canada. For mail: 147 Mountain Park Ave., Hamilton, Ont., Canada.
- NATHNESS, SEMORE T. (A'29), Student, College of Engineering, University of Wisconsin, Madison, Wis. For mail: 320-13th Ave., Menomonie, Wis.
- NAUTH, RAYMOND (A'28), Director, Nauth-Cabana Laboratories, 76 Yarmouth St., Guelph, Ont., Canada. For mail: 172 Woolwich St., Guelph, Ont., Canada.
- NEAL, CHESTER T. (A'24), Chapin and Neal, 387 Main St., Springfield, Mass.
- NEE, SANGTA (A'25), c/o Physics Dept., National Central University, Nanking, China.
- NEELEY, CARL E. (J'29), Carpenter, Stillwell, Okla.

- NEIL, WILLIAM RUSSELL (J'28-A'29), Radio Engineer, Metropolitan-Vickers, Ltd., 74 Waterloo St., Glasgow, Scotland. For mail: 6 Viewpark Dr., Rutherglen, Scotland.
- NEILL, FRANK R. (A'27), Chartered Accountant, Jackson, McCann and Company, 37 Donegal Pl., Belfast, Ireland. For mail: "Chesterfield," Whitehead, County Antrim, Ireland.
- NEIN, HARRY R. (A'25), Engineer, American Telephone and Telegraph Company, 195 Broadway, New York, N.Y.
- NELSON, A. LEROY (A'26), Manager, Nelson Radio Company, 414 Santa Fe Ave., Pueblo, Colo.
- NELSON, EDWARD L. (A'19-M'25), Engineer, Bell Telephone Laboratories, Inc., 463 West St., New York, N.Y.
- NELSON, IVAR (A'28), Engineer-in-Charge, Station WNAX, Yankton, S.D. For mail: 603 Broadway, Yankton, S.D.
- NELSON, JAMES R. (A'27-M'29), Radio Engineer, Research Laboratories, National Carbon Company, Inc., Cleveland, Ohio.
- NELSON, ORRIN B. (A'28), Radio Operator, Station WTAQ, Eau Claire, Wis. For mail: Box 12, Osseo, Wis.
- NELSON, R. G. (A'29), Field Service Engineer, Temple Corporation, 4949 W. 65th St., Chicago, Ill. For mail: 2637 N. Troy St., Chicago, Ill.
- NERGAARD, LEON S. (A'29), Vacuum Tube Engineer, Research Laboratory, General Electric Company, Schenectady, N.Y.
- NESTLERODE, BOYD W. (A'20), Batteryman, Lutz Motor Company, Chicago and Jackson Aves., Freeport, Ill. For mail: 309 Walnut Ave., Freeport, Ill.
- NEUBAUER, EDWIN WILLIAM (A'29), Engineer, Power Plant Engineering Company, 443 Stark St., Portland, Ore. For mail: 901 E. Yamhill St., Portland, Ore.
- NEUTRA, BENJAMIN B. (A'24), Radio Sales, H. C. Roberts Electric Supply Company, 1101 Race St., Philadelphia, Pa.
- NEVE, GORDON H. (A'25), Australian General Electric Company, Ltd., G. P. O. Box 538F, Melbourne, Australia.
- NEVILLE, T. P. (A'28), Patent Attorney, 463 West St., New York, N.Y.
- NEWBOLD, W. H. (A'28), Victor Talking Machine Company, Langhorne, Pa. For mail: R.F.D., Langhorne, Pa.
- NEWBY, R. W. (A'27), Chief Engineer, American Insurance Union, A.I.U. Citadel, Columbus, Ohio. For mail: 886 Chittenden Ave., Columbus, Ohio.
- NEWCOMB, CARLETON A. (A'27), Proprietor, Carlos Radio Den, 207-5th St., Oxnard, Calif.
- NEWELL, GUY (A'28), Proprietor, Radio Sales and Service, 600 Bloomfield Ave., Bloomfield, N.J.
- NEWELL, HOBART H. (A'22), Assistant Professor, Experimental Electrical Engineering, Worcester Polytechnical Institute, Worcester, Mass.
- NEWHARD, STANLEY C. (A'29), Proprietor, Radio Sales and Service, 639 Main St., Slatington, Pa.
- NEWMAN, ALFRED C. (A'26), Hatheway and Company, 225 Varick St., New York, N.Y.
- NEWMAN, CLARENCE D. (A'29), Repeater-man, Long Lines Division, Pacific Telephone and Telegraph Company, Portland, Ore. For mail: Rt. 6, Box 63, Oregon City, Ore.
- NEWMAN, DAVID H. (M'28), Electrical and Research Products, Inc., 7046 Hollywood Blvd., Hollywood, Calif.
- NEWMAN, JOHN R. (A'28), Custom Set Builder, Silver Marshall and Hammarlund Roberts Service Station, P. O. Box 1827, Timmins, N. Ont., Canada.
- NEWMAN, JOSEPH S. (A'20), President, The Newman Stern Company, E. 12th St. at Walnut Ave., Cleveland, Ohio.
- NEWMAN, WILLIAM H. (A'28), Proprietor, Newman Radio and Electric Company, 1619 S. Broadway, Los Angeles, Calif.
- NEWNHAM, LEONARD E. (A'27), Master and Lecturer, Stanshaw School and Municipal College, Portsmouth, England. For mail: Taormina, Tangier Rd., Opp. The Pond, *Portsmouth, England.
- NEWSOM, T. (A'29), Radio Service, Ethell and Stafford Company, 2024 D Ave., Lawton, Okla. For mail: 309 Dearborn St., Lawton, Okla.
- NEWTON, JANE ELIZABETH (A'29), Associate Examiner of Patents, Division 53, U. S. Patent Office, Washington, D.C. For mail: The Chastleton, 1701-16th St., N.W., Washington, D.C.
- NEWTON, RAYMOND A. (A'29), Vacuum Tube Engineer, Bldg. 37, General Electric Company, Schenectady, N.Y.
- NICELY, RALPH N. (A'22), General Commercial Engineer, Long Lines Dept., American Telephone and Telegraph Company, 15 Dey St., New York, N.Y.
- NICHOLES, E. (J'27), Analyzer, Western Electric Company, 395 Hudson St., New York, N.Y. For mail: 807 St. Ann's Ave., New York, N.Y.
- NICHOLS, ELDON (A'29), Supervisor, Adjunct Service, American Telephone and Telegraph Company, Rm. 203, 24 Walker St., New York, N.Y.
- NICHOLS, FREDERICK A. (A'28), Manager, Eaton Radio, Inc., Oak St., Eaton, Colo.
- NICHOLS, HARRY J. (A'29), Radio Engineer, Westinghouse Electric and Manufacturing Company, Radio Engineering Dept., East Pittsburgh, Pa. For mail: 6801 McPherson Blvd., Pittsburgh, Pa.
- NICHOLS, H. L. (A'29), Foreman, Ferracute Machine Company, Bridgeton, N.J. For mail: 150 East Ave., Bridgeton, N.J.
- NICHOLS, J. J. (A'27), Engineering Assistant, Bell Telephone Company of Pennsylvania, 1835 Arch St., Philadelphia, Pa.
- NICHOLS, LEROY C. (A'22), Weston Electric Institute Corporation, 50 Church St., New York, N.Y.
- NICHOLS, RAYMOND DE H. (A'25), American Telephone and Telegraph Company, Rm. 900 Telephone Bldg., 44 Church St., Buffalo, N.Y.

- NICHOLS, W. A. (A'29)**, Electrical Engineer, Canadian National Telegraphs, Rm. 602, 347 Bay St., Toronto, Ont., Canada. For mail: 7 Delaware Ave., Toronto 4, Ont., Canada.
- NICHOLSON, E. J. (A'22)**, Chief Engineer, Nicholson Electric Company, 1407 First North St., Syracuse, N.Y.
- NICHOLSON, JAMES K. A. (M'29)**, Engineer-in-Charge, British Broadcasting Corporation, 54 New Bridge St., Newcastle-on-Tyne, England. For mail: 5 Selborne Gardens, Newcastle-on-Tyne, England.
- NICKERSON, FRED W. (A'29)**, Installation Engineer, Electrical Research Products, Inc., 250 W. 57th St., New York, N.Y.
- NICKLE, EMIL G. (A'28)**, Tester, South Schenectady Radio Development Station, Schenectady, N.Y. For mail: 606 Pleasant St., Schenectady, N.Y.
- NICKLESS, WILLIAM H. (A'29)**, Engineer, Perryman Electric Company, Inc., 30th St. and 5th Pl., North Bergen, N.J. For mail: 393 Morningside Ave., Fairview, N.J.
- NICOLAI, ERWIN W. (A'27)**, Radio Service, United Radio and Ignition Service, 4068 Broadway, New York, N.Y. For mail: 81 W. 119th St., New York, N.Y.
- NIELSEN, H. V. (A'25)**, Brunswick-Balke-Collender Company, 726 Watchung Ave., Plainfield, N.J.
- NIELSEN, JOHN E. (A'25)**, Bell Telephone Laboratories, Inc., 463 West St., New York, N.Y.
- NIEMAN, THOMAS A. (A'27)**, Technician, 824 W. 21st St., Chicago, Ill.
- NIIYA, TAKUJI (A'27)**, Nippon Musen Den-shin Kabushiki, Kaisha Shitsuchosho, Fuku-shimaken, Japan.
- NIKIRK, THOMAS E. (A'27)**, Protection Testman, Southern California Edison Company, Alhambra, Calif. For mail: 311 N. Gladys Ave., Monterey Park, Calif.
- NIKONENKO, PAUL (A'27)**, Radio Dept., Nathan-Dohrman Company, San Francisco, Calif. For mail: 1528 Broderick St., San Francisco, Calif.
- NILSON, ARTHUR R. (J'16-A'18-M'25)**, 33 Valley Rd., Larchmont Woods, Larchmont, N.Y.
- NIMMCKE, FREDERICK E. (A'29)**, Radio Engineer, Bell Telephone Laboratories, Inc., 463 West St., New York, N.Y.
- NISLEY, PAUL H. (A'27)**, Sales Engineer, A. N. Howard, 50 E. 42nd St., New York, N.Y. For mail: 2714 University Ave., New York, N.Y.
- NIVISON, THEODORE E. (A'28)**, General Supt., Marine Dept., Mackay Radio and Telegraph Company, 67 Broad St., New York, N.Y.
- NIWA, YASUJIRO (A'25)**, Nippon Electric Company, 2 Mita-Shikoku-Machi, Shiba-ku, Tokyo, Japan.
- NOBLE, DANIEL E. (A'25)**, Instructor, Connecticut Agricultural College, P. O. Box 125, Storrs, Conn.
- NODEN, JOSEPH (A'27)**, Radio Engineer, Fern Villa, Coppice Rd., Willaston, Nantwich, England.
- NOEL, LIONEL S. (A'27)**, Radio Engineer, King Manufacturing Corporation, Rano and Crowley Sts., Buffalo, N.Y.
- NOLAN, ARTHUR B. (A'27)**, Radio Operator, Western Air Express, Kingman, Ariz.
- NOLAN, JAMES J. (M'26)**, 2448 Greenleaf Ave., Chicago, Ill.
- NOLAN, JOHN M. (A'29)**, Radio Serviceman, 334 Minnich Ave., New Philadelphia, Ohio.
- NOLLER, ROY E. (A'28)**, Radio Student, Dodges Wireless Institute, Valparaiso, Ind. For mail: 351 Greenwich, Valparaiso, Ind.
- NOLTE, HENRY J. (A'18)**, Research Laboratory, General Electric Company, Schenectady, N.Y. For mail: 656 Rugby Rd., Schenectady, N.Y.
- NORBERG, CLIFFORD M. (A'25)**, Chief Engineer, Brunner Engineering Company, 11 E. 44th St., New York, N.Y. For mail: 333 Mosholu Pkwy., New York, N.Y.
- NORDAHL, JOHN G. (A'27)**, Engineer, Bell Telephone Laboratories, Inc., 463 West St., New York, N.Y.
- NORDHAUS, CHARLES H. (A'25)**, Chief Inspector, Grigsby-Grunow Company, 5491 Dickens Ave., Chicago, Ill. For mail: 3929 Cullom Ave., Chicago, Ill.
- NORRIS, WILLIAM C. (J'29)**, 2741 A St., Lincoln, Neb.
- NORTH, J. HAROLD (A'29)**, Student Engineer, American Telephone and Telegraph Company, 502 Bourse Bldg., Philadelphia, Pa. For mail: R.F.D. No. 1, Box No. 41A, Annapolis, Md.
- NORTHOVER, HAROLD W. (A'24)**, Factory Manager, Sonora Corporation of Canada, Ltd., 345 Adelaide St., West, Toronto, Ont., Canada.
- NORTON, FREDERICK A. (A'28)**, Patent Solicitor, 233 Broadway, New York, N.Y.
- NORTON, KENNETH A. (A'29)**, Physicist, Radio Section, Bureau of Standards, Washington, D.C. For mail: 2035 H St., N.W., Washington, D.C.
- NORWOOD, DONALD W. (A'26)**, March Field, Riverside, Calif.
- NORWOOD, VANDLE CLARENCE (A'29)**, Manager, Radio Dept., Varney Electric Supply Company, 209-211 S. 6th St., Evansville, Ind. For mail: 112 Jackson Ave., Evansville, Ind.
- NOTHNAGLE, GEORGE E. (A'24)**, 174 Waldemere Ave., Bridgeport, Conn.
- NOTTAGE, WILLIAM H. (A'15)**, Marconi's Wireless Telegraph Company, Ltd., Marconi House, Strand, London, W.C. 2, England. For mail: Mawbyns, Kings End, Ruiship, England.
- NOURSE, PHILIP R. (A'28)**, Laboratory Assistant, Grigsby-Grunow Company, 2038 N. Kolmar Ave., Chicago, Ill. For mail: 59 W. Burton Pl., Chicago, Ill.
- NOVAK, JOE J. (A'16)**, 4031 S. Campbell Ave., Chicago, Ill.
- NOVINGER, EARL M. (A'24)**, Proprietor, Radio Shop and Service Dept., 1128 Market St., Harrisburg, Pa. For mail: 1609 North St., Harrisburg, Pa.
- NOVOTNEY, HARRY J. (A'27)**, 2012-8th St., Bremerton, Wash.

- NOWAK, VICTOR V. (A'27)**, Electrical Research Work, Nowak Optical Company, Inc., 1105 Broadway, Buffalo, N.Y.
- NOYES, ATHERTON, JR. (A'29)**, Boonton Research Corporation, Boonton, N.J. For mail: 437 Cornelia St., Boonton, N.J.
- NOYES, ROBERT H. (A'29)**, Junior Physicist, Radio Division, Naval Research Laboratory, Bellevue, Anacostia, D.C.
- NUGENT, THOMAS (A'27)**, 401 N. Newstead Ave., St. Louis, Mo.
- NUNEZ, F. J. (A'29)**, Repair and Testman, Wireless Specialty Apparatus Company, 472 Massachusetts Ave., Boston, Mass.
- NUNN, E. D. (A'28)**, Secretary, Nunn-Landon Company, Inc., 1115-4th St., Milwaukee, Wis. For mail: 445 Kenwood Blvd., Milwaukee, Wis.
- NUTT, A. (A'29)**, Engineer-in-Charge, Wireless Station, Klipshevel, C.P., South Africa.
- NYHOLM, CHRISTIAN (A'22)**, Laboratory of Telegraphy and Telephony, Copenhagen, Denmark. For mail: Jydsk Telephone Company, Aarhus, Denmark.
- NYMAN, ALEXANDER (M'24)**, Vice-President, Radio Patents Corporation, 10 E. 43rd St., New York, N.Y.
- NYSTROM, RAYMOND A. (A'29)**, Radio Serviceman, M. Stienert and Sons Company, 1217 Main St., Springfield, Mass. For mail: 103 Dana St., Springfield, Mass.
- O
- OBOUKHOFF, NICHOLAI M. (M'23)**, Associate Professor of Electrical Engineering, Oklahoma A. and M. College, Stillwater, Okla.
- O'BRIEN, DANIEL L., JR. (A'28)**, Installation Engineer, Electrical Research Products, Inc., Rm. 404, Golden Gate Bldg., 25 Taylor St., San Francisco, Calif.
- O'BRIEN, ELWIN J. (A'27)**, Engineer, Western Electric Company, Chicago, Ill. For mail: 2133 S. 51st St., Cicero, Ill.
- O'BRIEN, WILLIAM J. (A'27)**, Laboratory Assistant, Bremer-Tully Company, 656 Washington Blvd., Chicago, Ill.
- O'BRIGHT, ALVIN C. (A'29)**, Radio Service Engineer, Sparks Withington Company, Jackson, Mich. For mail: c/o Baltimore Hotel, Kansas City, Mo.
- O'BYRNE, LEO C. (A'27)**, 3532 W. Adams St., Chicago, Ill.
- O'CALAGHAN, JEROME J. (A'28)**, Radio Engineer, Stewart-Warner Corporation, 1823 Diversey Pkwy., Chicago, Ill. For mail: 506 Oakdale Ave., Chicago, Ill.
- O'CONNELL, GERALD (A'27)**, Technician, O'Connell Radio Laboratories, 126½ Main St., Freeport, Ill.
- O'CONNOR, ALBERT J. (A'25)**, Engineer, A. O'Connor and Company, 9702 Euclid Ave., Cleveland, Ohio.
- O'CONNOR, JOHN G. (A'29)**, Operating Department, Mackay Radio and Telephone Company, Inc., 67 Broad St., New York, N.Y. For mail: P. O. Box 367, Southampton, L.I., N.Y.
- O'CONNOR, MORT F. (A'27)**, Field Expert, Kolster Radio Corporation, 200 Mt. Pleasant Ave., Newark, N.J. For mail: Bergenfield, N.J.
- O'DAY, MARCUS (A'28)**, Assistant Professor, Physics Dept., Reed College, Portland, Ore.
- ODELL, LESLIE F. (A'28)**, Recording Engineer, British Talking Pictures, Ltd., Regland Gardens, Wembley Park, England.
- ODENBACH, J. F. (A'25)**, Radio Draftsman and Designer, Experimenter Publishing Company, 53 Park Pl., New York, N.Y. For mail: 175 Orient Ave., Jersey City, N.J.
- O'DONOHUE, JAMES P. (A'27)**, Telegraph Engineer, Postal Telegraph and Cable Company, 253 Broadway, New York, N.Y. For mail: 99 N. 22nd St., East Orange, N.J.
- O'DOWD, THOMAS E. (A'28)**, Statistician, Brandes Products, Inc., 200 Mt. Pleasant Ave., Newark, N.J. For mail: 487 Summer Ave., Newark, N.J.
- OETTING, O. W. A. (M'27)**, Engineer, Globe Union Manufacturing Company, 14 Keeffe Ave., Milwaukee, Wis.
- OGG, GLEN R. (A'14)**, Officer-in-Charge, U. S. Naval Radio Station, Brownsville, Tex.
- OGG, JOHN G. (A'28)**, Technical Officer, Technical Aircraft Establishment, Farnborough, Hants, England. For mail: 108 Victoria Rd., Aldershot, England.
- OHL, RUSSELL S. (A'24-M'25)**, Radio Research, Bell Telephone Laboratories, Inc., 463 West St., New York, N.Y. For mail: Woodbine Ave., Foxwood Park, Little Silver, N.J.
- OIKLE, O. A. (A'25)**, Radio Engineer, Colonial Radio Corporation, East Ave. and 10th St., Long Island City, L.I., N.Y. For mail: 519 W. 143rd St., New York, N.Y.
- OKESON, HUGH BINGHAM (A'29)**, Radio Operator, Radio Station W1HK, Radio Air Service Corporation, Engineers Bank Bldg., Cleveland, Ohio. For mail: 1369 W. 112th St., Suite 102, Cleveland, Ohio.
- OLESEN, HAROLD L. (M'26)**, Electrical Engineer, 1640-50 Walnut St., Chicago, Ill. For mail: 21 Ravine Forest Dr., Lake Bluff Ill.
- OLINGER, ROBERT (A'29)**, Student, Dodges Telegraphy and Radio Institute, 505 E. Jefferson St., Valparaiso, Ind.
- OLIVE, GORDON W. (A'29)**, Technical Assistant, Radio Dept., Canadian National Railways, 355 McGill St., Rm. 1003, Montreal, P. Q., Canada.
- OLIVER, GEORGE E. (A'23-M'26)**, Manager, Linden Radio Station WMU, Southern Radio Corporation, 26 Broadway, New York, N.Y. For mail: 277 Bergen Ave., Jersey City, N.J.
- OLIVEIRA, A. MENEZES DE (M'20)**, Professor of Electrical Engineering, The Naval Academy, Rio de Janeiro, Brazil, South America. For mail: 25, Rua Santa Clara, Capachana, Rio de Janeiro, Brazil, South America.
- OLMSTEAD, CHARLES B. (A'29)**, Broadcast Technician, Broadcasting Station KFVD, Culver City, Calif. For mail: 563 N. Hoover St., Los Angeles, Calif.

- OLMSTEAD, NOEL C. (A'27), Radio Research Assistant, Massachusetts Institute of Technology, Cambridge, Mass. For mail: P. O. Box 156, South Dartmouth, Mass.
- OLSON, MARTIN N. (A'27), Radio Service, Radio Equipment Corporation, 119 Broadway, Fargo, N.D. For mail: Kent, Minn.
- OLSON, MARVIN S. (A'25), Electrical Engineer, Carver Radio and Electrical Laboratory, Carver, Minn. For mail: P. O. Box 136, Carver, Minn.
- OMAN, NILS JOHANN (A'29), Laboratory Assistant, Brandes Laboratories, Inc., 200 Mt. Pleasant Ave., Newark, N.J.
- O'NEILL, GEORGE D. (A'28), Radio Engineer, Hygrade Lamp Company, Salem, Mass.
- O'NEILL, JOHN J. (A'27), Director, Radio Dept., Brooklyn "Daily Eagle," Brooklyn, N.Y. For mail: 209 N. Long Beach Ave., Freeport, L.I., N.Y.
- O'NEILL, JOHN P. (A'29), RCA-Victor Company, Inc., Camden, N.J. For mail: 216 E. Evergreen Ave., Chestnut Hill, Philadelphia, Pa.
- O'NEIL, MAURICE B. (A'27), Manager, O'Neill Radio and Electric Laboratories, 511 S. Alexander St., New Orleans, La.
- O'NEILL, R. F. (A'29), Assistant Engineer, Research Dept., Marconi's Wireless Telegraph Company, Chelmsford, Essex, England. For mail: 26 Queen's Rd., Chelmsford, Essex, England.
- ONO, SHOJI (A'27), Radio Engineer, Nippon Musen Denshin Kaisha, Shutchojo, Yosami-mura, Hekikai-gun, Aichiken, Japan.
- ONO, TAKASHI (A'25), Radio Engineer, Musen, Komukyoku, Dept. of Communications, Tokyo, Japan.
- OODRYS, ARTHUR (A'29), Radio Technician, Fitzgerald Music Company, 727 S. Hill St., Los Angeles, Calif. For mail: 441 Amethyst St., Los Angeles, Calif.
- ORAM, DONALD K. (A'24), General Manager, Harold Herbert, Inc., 160 W. 46th St., New York, N.Y. For mail: 8505-120th St., Richmond Hill, L.I., N.Y.
- O'REILLY, GORDON A. (J'27), Radio Operator and Technician, P. O. Box 226, Torrington, Wyo.
- ORMISTON, KENNETH G. (A'17), Technical Editor, "Radio Doings," 407 E. Pico St., Los Angeles, Calif.
- O'ROURKE, SYDNEY P. (A'29), Murugalli Estate, Hardypet P.O., Pollachi, South India.
- ORR, ROBERT W. (A'29), Receiver Design, Radio Engineering Dept., General Electric Company, Schenectady, N.Y. For mail: 842 Union St., Schenectady, N.Y.
- OSBORN, BURR K. (A'26), Instructor in Electrical Engineering, Michigan State College, East Lansing, Mich. For mail: P. O. Box 817, East Lansing, Mich.
- OSBORN, PAUL I. (A'28), 6529 Grand River Ave., Detroit, Mich.
- OSBORN, PERRY H. (A'28), Radio Engineer, Westinghouse Electric and Manufacturing Company, East Pittsburgh, Pa. For mail: 757 North Ave., Wilkinsburg Station, Pittsburgh, Pa.
- OSBORN, WILLIAM R. (A'29), Proprietor, WRO Laboratory, Hamilton Ave., Croton-on-Hudson, N.Y.
- OSBORNE, HAROLD S. (A'14-M'29), Transmission Engineer, American Telephone and Telegraph Company, 195 Broadway, New York, N.Y.
- OSBORNE, ROBERT L. (A'27), Chief Engineer, Dongan Electric Manufacturing Company, 2987 Franklin St., Detroit, Mich. For mail: R.F.D. 1, St. Clair Shores, Mich.
- OSCANYAN, PAUL C., JR. (A'24), Cost Accounting, Materials, and Special Tests, Radio Corporation of America Communications, Inc., New Brunswick, N.J. For mail: 730 Park Ave., Plainfield, N.J.
- OSCHMANN, ADOLPH W. (A'28), Radio Engineer, Radio Station WQAN, "Scranton Times," 149 Penn Ave., Scranton, Pa. For mail: 627 Connell St., Scranton, Pa.
- OSGOOD, ALBERT S. (A'20), Student and Salesman, P. O. Box 502, Effingham, Ill.
- OSGOOD, VICTOR L. (A'24), Engineer, Conner-Crouse Corporation, 343 Lexington Ave., New York, N.Y. For mail: St. Cloud Ave., West Orange, N.J.
- O'SHAUGHNESSY, J. J. F. (M'20), Posts and Telegraphs, Accra, Gold Coast Colony, West Africa. For mail: The Royal Automobile Club, London, S.W. 1, England.
- OSIATINSKY, L. (M'29), Managing Director, c/o S.I.R.A.C., Corso Italia 13, Milan, Italy.
- OSTERBROCK, W. C. (A'24), Associate Professor of Electrical Engineering, University of Cincinnati, Cincinnati, Ohio.
- OSTERLAND, EDMUND (J'29), Student, Polytechnic Institute of Brooklyn, 99 Livingston St., Brooklyn, N.Y. For mail: 94 Washington Ave., Suffern, N.Y.
- OSTERMEIR, C. H. (A'29), Service Manager, Ludwig Hommel and Company, 929 Penn Ave., Pittsburgh, Pa. For mail: 2904 Cedar Ave., Pittsburgh, Pa.
- OSTRANDER, RUSSELL S. (J'29), Radio Operator, Radio Station WHK, Engineers National Bank Bldg., Cleveland, Ohio.
- OSTRANDER, R. M. (A'29), Service Representative, The Sparks-Withington Company, Jackson, Mich. For mail: Rives Junction, Mich.
- OSTROVE, WILLIAM (A'27), Service Engineer, Radio Receptor Company, Inc., 106-7th Ave., New York, N.Y. For mail: 704 New Jersey Ave., Brooklyn, N.Y.
- OSWALD, ARTHUR A. (A'18-M'25-F'28), Member of Technical Staff, Bell Telephone Laboratories, Inc., 463 West St., New York, N.Y.
- OTAL, CARLOS, JR. (J'27-A'29), Merchant, Solo Service Company, 1115 Hidalgo St., Laredo, Tex. For mail: 216 Matamoros St., Laredo, Tex.
- OTANI, S. (A'29), Manager, Vacuum Tube Department, The Tokyo Electric Company, Kawasaki, Japan.
- OTSUKA, Y. (A'29), Research Staff, Vacuum Tube Dept., Research Laboratory, The Tokyo Electric Company, Kawasaki, Japan.

- OTTERBEIN, MILTON HENRY (J'29), Assistant Radio Tube Engineer, Arcturus Radio Tube Company, 255 Sherman Ave., Newark, N.J. For mail: 26 Fairview Pl., Bloomfield, N.J.
- OUTZEN, ANDREW N. (A'25), Station Superintendent, Detroit City Gas Company, 415 Clifford St., Detroit, Mich.
- OVERACKER, HORACE E. (A'23), Federal Telegraph Company, Palo Alto, Calif. For mail: 344 Tennyson Ave., Palo Alto, Calif.
- OVERHOLT, RALPH, JR. (A'29), Radio Engineer, Westinghouse Electric and Manufacturing Company, Pittsburgh, Pa. For mail: 7211 Thomas Blvd., Pittsburgh, Pa.
- OVERMILLER, CLAIR M. (A'26), Technical Employee, Long Lines Div., American Telephone and Telegraph Company, 500 Bell Bldg., Harrisburg, Pa. For mail: 5119 Locust St., Philadelphia, Pa.
- OVERTON, DANIEL C. (A'28), Sawyer, Diamond Match Company, Stirling City, Calif. For mail: Stirling City, Calif.
- OWADA, MANKITSU (A'28), Up-Keep Dept., N.Y.K. Marunouchi, Tokyo, Japan.
- OWEN, CHARLES W. (J'26), 8964 Machinow Ave., Detroit, Mich.
- OWEN, ROBERT H. (A'27), Engineer-in-Charge Technical Operations, Station KOA, General Electric Company, 1370 Krameria St., Denver, Colo.
- OWENS, RAYMOND B. (M'27), Associate Radio Engineer, Naval Research Laboratory, Bellevue, Anacostia, D.C.
- OWENS, RICHARD M. (A'26), Service Engineer, RCA-Victor Company, Inc., 2001 W. Pershing Rd., Chicago, Ill.
- OWENS, ROBERT F. (A'29), Foreman, Parts Test Dept., Brunswick-Balke-Collender Company, Muskegon, Mich. For mail: 329 Merrill Ave., Muskegon, Mich.
- OWNER, JOHN S. (A'26), The Radio Electric Stores, Birmingham, England. For mail: 135 Springfield Rd., Moseley, Birmingham, England.
- OXLEY, ALLAN B. (A'25), Consulting Engineer and Manager, King Quality Products, Ltd., St. Clair and Prescott Aves., Toronto, Ont., Canada.
- OXNER, EDWIN K. (A'14), High Frequency Laboratories, 28 N. Sheldon St., Chicago, Ill. For mail: 1647 W. 81st St., Chicago, Ill.
- PACA, WILLIAM S. (A'29), Telephone, Box 514, Oil City, Pa.
- PACENT, LOUIS G. (A'12-M'15-F'27), President and Technical Director, Pacent Electric Company, Inc., 91-7th Ave., New York, N.Y.
- PACHOLKE, FRED (A'27), Engineer, Sparks-Withington Company, Jackson, Mich. For mail: 424 Stewart Ave., Jackson, Mich.
- PACKARD, ALDEN C. (A'29), Radio Engineer, Heintz and Kaufman, Inc., 219 Natoma St., San Francisco, Calif.
- PACKMAN, M. E. (A'13), Vice-President, Dodge Institute of Telegraphy, Valparaiso, Ind.
- PADDON, CECIL JOHN (A'29), Installation Supervisor, Societe de Materiel Acoustique, 1 Boul. Hausmann, Paris, France.
- PAESSLER, ROBERT T. (A'27), President and Manager, Robert T. Paessler Company, Inc., 105 Coal Exchange Bldg., Wilkes-Barre, Pa.
- PAGE, ATWOOD C. (A'27), The Whiting Manufacturing Company, Hartford, Conn. For mail: 314 Collins St., Hartford, Conn.
- PAGE, NEWELL C. (A'12), Professor of Electricity, Massachusetts Institute of Technology, Cambridge, Mass. For mail: 22 Maxwell Rd., Winchester, Mass.
- PAGE, ROBERT M. (A'27), Junior Physician, U. S. Naval Research Laboratory, Bellevue, Anacostia, D.C. For mail: 334 Raleigh St., S.E., Washington, D.C.
- PAINTER, CHARLES E. (A'27), Accountant, The Snodgrass Food Company, 1012 U. S. National Bank Bldg., Denver, Colo. For mail: 1538 Gilpin St., Denver, Colo.
- PAINTING, JOHN A. (A'28), Radio Engineer, Charles M. Ferm, 3 Manhattan Ave., Brooklyn, N.Y. For mail: 229 Nassau Ave., Brooklyn, N.Y.
- PAISLEY, STEWART R. (A'26), Electrical Inspector, Welland Ship Canal, St. Catharines, Ont., Canada. For mail: 627 Glenholme Blvd., Toronto, Ont., Canada.
- PALETHORPE, HAROLD J. (A'26), Radio Service, Newbery Electric Corporation, 726 Olive St., Los Angeles, Calif. For mail: 2501 Juliet St., Los Angeles, Calif.
- PALEY, ALBERT A. (A'26), Wireless Specialty Apparatus Company, 75 Atherton St., Jamaica Plain, Boston, Mass. For mail: 25 Nazing St., Roxbury, Mass.
- PALMER, C. WALTER (A'28), Associate Technical Editor, "Radio News," 236 St. Ave., New York, N.Y. For mail: 56 Duncan Ave., Jersey City, N.J.
- PALMER, EDWARD D. (J'27-A'29), 425 Cross St., Ann Arbor, Mich.
- PALMER, HARRY W. (A'25), Radio Service Engineer, 171 Bentvue St., Wellesley, Mass.
- PALMER, ROBERT T. (A'29), Patent Attorney, Duell, Dunn and Anderson, 426 Lexington Ave., New York, N.Y.
- PALMER, ROLAND F. (A'25), Manager, Columbus Branch, North American Radio Sales Company, 1456 N. High St., Columbus, Ohio. For mail: 470 E. Butchtel Ave., Akron, Ohio.
- PALMER, R. J. (A'29), Wireless Officer, Marconi Company, Lorraine, Maderia Rd., North End, Portsmouth, England.
- PAMPHILON, LEON E. (J'25), Instructor, Radio Institute, 109 W. 64th St., New York, N.Y. For mail: 470 E. 161st St., New York, N.Y.
- PANAGAKIS, HARRY (J'25-A'28), Wireless Specialist, 19 Manchester St., Liverpool, England.
- PANNILL, CHARLES JACKSON (F'29), Vice-President, Radiomarine Corporation of America, 66 Broad St., New York, N.Y.
- PARADISE, MAURICE E. (A'29), Radio Engineer, Grisby-Grunow Company, 4540 Armitage Ave., Chicago, Ill. For mail: 216 N. Michigan Ave., Chicago, Ill.

- PARISEK, EDWARD E. (A'27), Engineer, Carter Radio Company, 300 S. Racine Ave., Chicago, Ill. For mail: 1511 Sedgwick St., Chicago, Ill.
- PARK, CHARLES W. (A'27), Radio Corporation of America, Bolinas, Calif.
- PARKER, A. RAYMOND (J'25-A'26), 298 New Hey Rd., Oakes, Huddersfield, Yorks, England.
- PARKER, EVERT L. (A'26), Electrical Dept., Pacific Electric Railway, Los Angeles, Calif. For mail: 238 Walnut St., Pomona, Calif.
- PARKER, LEONARD E. (A'25), Chief Engineer, Radio Division, Stewart-Warner Speedometer Corporation, 1826-52 Diversey Blvd., Chicago, Ill.
- PARKER, OLIVER B. (A'23), Assistant Chief Engineer, Pacent Electric Company, 91-7th Ave., New York, N.Y. For mail: 402-75th St., Brooklyn, N.Y.
- PARKER, RAY H. (A'27), Transmission Engineer, Pacific Telephone and Telegraph Company, 140 New Montgomery St., Rm. 524, San Francisco, Calif.
- PARKER, R. D. (A'16), Engineer, American Telephone and Telegraph Company, 195 Broadway, New York, N.Y.
- PARKHURST, EDGAR L. (A'29), Radio Engineer, Radio Station KGO, National Broadcasting Company, 5555 E. 14th St., Oakland, Calif.
- PARKIN, JOHN, JR. (A'16), Manager, Parkin Manufacturing Company, Grand Ave., San Rafael, Calif.
- PARKIN, THOMAS D. (A'19), Marconi's Wireless Telegraph Company, Ltd., New St., Chelmsford, England. For mail: The Haven, Mill Lane, Broomfield, Nr. Chelmsford, England.
- PARKINSON, TAINTOR (A'26), Associate Physicist, Bureau of Standards, Washington, D.C. For mail: 2067 Park Rd., Washington, D.C.
- PARLAS, JOSEPH L. (A'28), Radio Engineer, Radio Service Engineering Laboratories, 736 Washington Ave., Niles, Ohio.
- PARNAGIAN, ARAM (A'28), Radio Service, Morgan, Inc., Boston, Mass. For mail: 3 Millford St., Boston, Mass.
- PARRISH, ROBERT R. (A'29), Student, Loomis Radio College, Washington, D.C. For mail: 24 Silver St., Great Barrington, Mass.
- PARRY, ALBERT H. (A'28), Wireless Operator, British Marine Wireless Service, Marconi House, Strand, London, England. For mail: 35 Stockmoor Rd., Liverpool, England.
- PARSONS, CHARLES (A'27), 218 Virginia Ave., Danville, Ill.
- PARSONS, J. B. (A'27), Radio Engineer, Canadian National Carbon Company, Ltd., 805 Davenport Rd., Toronto, Ont., Canada.
- PARTCH, PAUL C. (A'28), 5419 Buchanan St., Los Angeles, Calif.
- PASQUET, JEAN E. (A'28), Educational Director, Music Dept., D. H. Holmes Company, Ltd., 819 Canal St., New Orleans, La. For mail: 1222 Eagle St., New Orleans, La.
- PATA, YAROMIR J. (A'29), Radiotrician, H. N. Knight Supply Company, 901 W. Grand, Oklahoma City, Okla. For mail: 1624 E. Park Pl., Oklahoma City, Okla.
- PATE, CARLTON O. (A'25), 100 William St., New York, N.Y.
- PATEY, HAROLD W. (A'27), Broadcast Tester, King Radio Company, Buffalo, N.Y. For mail: 136 Parkdale Ave., Buffalo, N.Y.
- PATIENCE, A. MELBOURNE (A'23-M'28), Chief Research Engineer, Standard Radio Manufacturing Company, 90 Chestnut St., Toronto, Ont., Canada. For mail: 48 Wineva Ave., Toronto, Ont., Canada.
- PATRON, ALFONSO E. (A'28), Serviceman, Bush Electric Corporation, 334 Sutter St., San Francisco, Calif. For mail: 719 Scott St., San Francisco, Calif.
- PATTEN, STANLEY F. (A'27), Lieutenant, U. S. Navy, U. S. S. "New York," c/o Postmaster, New York, N.Y.
- PATTERSON, CURTIS B. (J'28), Service Manager, Buffalo Mechana-Kold Company, 177 High St., Buffalo, N.Y. For mail: 39 Charleston Ave., Kenmore, N.Y.
- PATTERSON, C. F. (A'28), Sales Engineer, Powerlite Devices, Ltd., 171 John St., Toronto, Ont., Canada.
- PATTERSON, EDWARD B. (A'24), Engineering Dept., Victor Talking Machine Company, Camden, N.J. For mail: 121 E. Rogers Ave., Merchantville, N.J.
- PATTERSON, FRANKLIN G. (A'27), General Engineering Laboratory, General Electric Company, Bldg. 5, Schenectady, N.Y. For mail: 1716 State St., Schenectady, N.Y.
- PATTERSON, JOSEPH A. (A'29), Servicing and Building Radios, 3823 S. Kedzie Ave., Chicago, Ill.
- PAUL, BYRON R. (J'28), Falls City, Ore.
- PAUL, ERNEST E. (A'27), Proprietor, The Philco Shop, 272 Murphy Ave., Sunnyvale, Calif.
- PAUL, GEORGE STEWART (A'29), Engineering Apprentice, Western Union Telegraph Company, 116 E. Wisconsin Ave., Milwaukee, Wis. For mail: 1007 Murray Ave., Milwaukee, Wis.
- PAULDING, HERBERT L. (A'28), Instructor, Electrical Engineering Dept., Stevens Institute of Technology, Hoboken, N.J.
- PAVLOW, NICHOLAS (A'29), Inspector, Frederick Loeser and Company, 484 Fulton St., Brooklyn, N.Y. For mail: 25 Megaw Pl., New York, N.Y.
- PAYETTE, WALTER S. (A'29), Technician, Portview Servicing Corporation, 43 Portview Ave., Ocean View, Norfolk, Va. For mail: 1508 Moran Ave., Norfolk, Va.
- PAYNE, CHARLES C. (A'28), Dentist, 8 W. 40th St., New York, N.Y.
- PAYNE, ERIC A. (A'23), Engineer, Marconi Wireless Telegraph Company, Ltd., Chelmsford, England. For mail: Hill Crest, Honeywood Rd., Colchester, England.
- PAYNE, JOHN H. (A'28), Operator, General Electric Company, Schenectady, N.Y. For mail: 1716 State St., Schenectady, N.Y.
- PAYNE, L. STANLEY (M'16), Engineer, Canadian Marconi Company, 11 St. Sacrament St., Montreal, P.Q., Canada.

- PEACHEY, C. ARTHUR (A'29), Vacuum Tube Engineer, Technical Dept., Northern Electric Company, Ltd., 121 Shearer St., Montreal, P.Q., Canada.
- PEARCE, ARTHUR (A'28), Technical Representative, Victor-Talking Machine Div., RCA-Victor Company, Inc., Camden, N.J. For mail: 148 Clarke Pl., Memphis, Tenn.
- PEARCE, HARRY G. (A'26), Pacific Wholesale, Inc., 12th and Wall Sts., Los Angeles, Calif. For mail: 4168-2nd Ave., Los Angeles, Calif.
- PEARCE, R. A. (A'21), Radio Engineer, Tucker and Pearce, 96 Victoria Rd., Swindon, England.
- PEARL, EUGENE S. (A'18-M'22), Sales Dept., Radio Corporation of America, 261-5th Ave., New York, N.Y. For mail: 58 Heights Rd., Rosemawr, Clifton, N.J.
- PEARLSTEIN, CHARLES D. (A'28), 125 Harvard Ave., Allston, Mass.
- PEARSON, HERBERT B. (A'14), 18-86th St., Brooklyn, N.Y.
- PEARSON, LAURENCE H. (A'26), Electrical and Radio Engineer, Pearson Brothers, 54-56 Long Row, Nottingham, England. For mail: Ellesmere, 29 Thorncliffe Rd., Nottingham, England.
- PEARSON, OSCAR A. (M'28), Managing Engineer, Thordarson Electric Manufacturing Company, 500 W. Huron St., Chicago, Ill. For mail: 551 Belleforte Ave., Oak Park, Ill.
- PEARY, MALCOLM J. (A'27), Superintendent, The Q-R-S Company, 4829 S. Kedzie Ave., Chicago, Ill. For mail: 1600 So. 14th Ave., Maywood, Ill.
- PEASE, REGINALD M. (A'25-M'27), Bell Telephone Laboratories, Inc., 463 West St., New York, N.Y. For mail: 3201 Oxford Ave., New York, N.Y.
- PECK, EMERSON P. (A'22), Electrical Engineer, New York Power and Light Corporation, 126 State St., Albany, N.Y.
- PECK, GEORGE T. (A'26), Research and Instruction Engineer, Post and Telegraphs Dept., Kuala Lumpur, Federated Malay States.
- PECK, GORDON V. (A'26), Yale Electric Corporation, Pillary and Pearl Sts., Brooklyn, N.Y. For mail: 88 Monroe Pl., Bloomfield, N.J.
- PECK, WILLIAM (A'29), Service Manager, Saul Birns Music Shop, 1730 Pitkin Ave., Brooklyn, N.Y. For mail: 1521 Eastern Pkwy., Brooklyn, N.Y.
- PECKHAM, J. H. (A'22), Manager, Radio Dept., Wetmore-Savage Company, Boston, Mass. For mail: 1887 Beacon St., Brookline, Mass.
- PECORINI, ROBERT R. (M'25), London General Omnibus Company, Ltd., London, S.W. 1, England. For mail: 188a Portsdown Rd., Maida Vale, London, W.9, England.
- PECOUL, F. A. (A'29), Oiler, Mississippi Power Company, Power House, Gulfport, Miss. For mail: P. O. Box 117, Mississippi City, Miss.
- PEDERSEN, MARTIN P. (A'14), Lille Strandstræde 14, Copenhagen, Denmark.
- PEDERSEN, PEDER OLUF (F'15), Professor and Principal, Royal Technical College, Copenhagen, Denmark. For mail: Amalievej 1, Copenhagen, Denmark.
- PEEL, DELACY J. (A'28), Manager, Radio Dept., Rush Brothers, Electrical Supply Dealers, 911-13 Central Ave., Hot Springs, Ark. For mail: 122 Harrell Ave., Hot Springs, Ark.
- PEERENBOOM, CYRIL A. (A'29), Publisher, George Banta Publishing Company, Menasha, Wis. For mail: 526 Keyes St., Menasha, Wis.
- PEFFER, RALPH M. (A'22), Radio Jobber, 334 Chestnut St., Harrisburg, Pa.
- PEGRAM, GEORGE B. (A'12), Professor of Physics, Columbia University, New York, N.Y.
- PEIRCE, GEORGE H. (A'23), Chief Engineer, Radio Station WDSU, De Soto Hotel, New Orleans, La. For mail: 5922 Pitt St., New Orleans, La.
- PELTON, GEORGE A. (J'29), Student, Montana State College, 201 S. 3rd St., Bozeman, Mont. For mail: 221 Alderson Ave., Billings, Mont.
- PEMBER, HAROLD H. (A'14), Factory Insurance Association, Hartford, Conn. For mail: 14 Goshen St., Hartford, Conn.
- PENICK, D. B. (A'29), Engineer, Bell Telephone Laboratories, 463 West St., New York, N.Y.
- PENNINGTON, D. J. (J'29), Student, University of Illinois, 61 E. Green St., Champaign, Ill. For mail: 744 N. Church St., Decatur, Ill.
- PENNINGTON, PAUL (A'18), Engineer, Illinois Bell Telephone Company, Chicago, Ill. For mail: 2230 Asbury Ave., Evanston, Ill.
- PENNOCK, P. L., SR. (A'29), Radio Sales Repair and Custom Bldg., 3630 Market St., Youngstown, Ohio.
- PENNOCK, P. L., JR. (A'28), Radio Technician and Service Manager, 236 N. Market St., Canton, Ohio. For mail: 2026-2nd St., N.E., Canton, Ohio.
- PENTHER, CARL JOSEPH (A'29), Research Engineer, Federal Telegraph Company, Palo Alto, Calif. For mail: 1040 Channing Ave., Palo Alto, Calif.
- PEPPER, ROBERT K. (A'28), Sales Manager, Radiola Studio, 106 E. 10th St., Newport, Ky. For mail: 1045 Washington Ave., Newport, Ky.
- PERCY, F. W. (A'24), Technician, Radio Electrical Service Laboratory, Tucson, Ariz. For mail: P. O. Box 375, University of Arizona Station, Tucson, Ariz.
- PERKINS, LAURENCE M. (A'27), Engineer, Delco Remy Corporation, Anderson, Ind. For mail: 2112 Nichol Ave., Anderson, Ind.
- PERKINS, LUCIUS J. (A'23), Recording Director, Brunswick-Balke-Collender Company, 2481 Porter St., Los Angeles, Calif. For mail: 607 N. Mansfield Ave., Los Angeles, Calif.
- PERRIN, ARTHUR G. (A'29), Proprietor, American Radio Service, 1420 Nostrand Ave., Brooklyn, N.Y. For mail: 330 Bainbridge St., Brooklyn, N.Y.

- PERRY, HAROLD D. (A'22), Engineer, Acoustic Dept., Electrical Research Products, Inc., 250 W. 57th St., New York, N.Y. For mail: 226 Halsey St., Brooklyn, N.Y.
- PERRY, IRVING D. (J'15-A'18), Engineering Assistant, Public Service Products Company, 80 Park Pl., Newark, N.J. For mail: 68 N. Parkway, East Orange, N.J.
- PERRY, WILLIAM A. (A'26), 383 Kings' Highway, Westport, Conn.
- PERRYMAN, G. H. (A'29), Treasurer and Secretary, Perryman Electric Company, 4899 Hudson Blvd., West New York, N.J. For mail: 30th St. and 5th Ave., North Bergen, N.J.
- PESSION, GIUSEPPE (F'29), Director General, Posts and Telegraphs, Rome, Italy. For mail: Via Tevere No. 20, Rome, Italy.
- PESTLIN, LEROY J. (A'26), Radio Engineer, New Radio Shop, 1937 W. 35th St., Chicago, Ill.
- PETERS, ARTHUR A. (J'29), Radio Serviceman, A. A. Peters, 108 N. 7th St., Allentown, Pa. For mail: 932 Linden St., Allentown, Pa.
- PETERS, C. W. (A'29), Chief Operator, Gulf Div., Radiomarine Corporation of America, New Orleans, La. For mail: 1716 Painter St., New Orleans, La.
- PETERS, JAY (A'25), Proprietor, Radio Station KOH, 38 W. 1st St., Reno, Nev.
- PETERS, JOHN L. (A'29), Tube Engineer, Raytheon Manufacturing Company, 42 Carleton St., Cambridge, Mass. For mail: Washington St., East Holliston, Mass.
- PETERS, LEO J. (A'19), Gulf Oil Company, 903 Law and Finance Bldg., Pittsburgh, Pa.
- PETERS, VERN (A'28), Manager, Radio Dept., Owl Drug Company, Havre, Mont. For mail: P. O. Box 544, Havre, Mont.
- PETERSEN, HOWARD E. (A'24), Proprietor, Illinois Radio Appliance Company, Chicago, Ill. For mail: 1426 W. 70th St., Chicago, Ill.
- PETERSEN, THOMAS G. (A'19), Marconi's Wireless Company, Ltd., London, W.C.2, England. For mail: 56 Whittington Rd., Bowes Park, London, N., England.
- PETERSON, ARTHUR C., JR. (A'29), Engineer, American Telephone and Telegraph Company, 195 Broadway, New York, N.Y. For mail: Box 261, Stanhope, N.J.
- PETERSON, A. W. (M'25), Lieutenant, U. S. Navy, District Radio Material Officer, Bremerton, Wash.
- PETERSON, CHARLES W. (A'15), Consulting Radio Engineer, Crosley Radio Corporation, Cincinnati, Ohio.
- PETERSON, CORNELIUS (A'26), Superintendent, R.C.A. Institutes, Inc., 560 Broad St., Newark, N.J.
- PETERSON, HAROLD O. (A'22), Development and Research, Radio Corporation of America, 66 Broad St., New York, N.Y. For mail: Box 987, Riverhead, L.I., N.Y.
- PETERSON, HOWARD E. (A'24), Proprietor, Illinois Radio Appliance Company, Chicago, Ill. For mail: 1426 E. 70th St., Chicago, Ill.
- PETERSON, L. C. (A'25), Telephone Engineer, American Telephone and Telegraph Company, Room 1611, 195 Broadway, New York, N.Y.
- PETRY, C. A. (A'28), Student Radio Engineer, Broadcast Transmitter Section, Westinghouse Electric and Manufacturing Company, Chicopee Falls, Mass. For mail: 1309 Vine St., Hamilton, Ohio.
- PETTENGILL, GEORGE W., JR. (A'20), Radio Engineer, RCA-Victor Company, Inc., Camden, N.J. For mail: 2000 Narbeth Ave., Haddon Heights, N.J.
- PETERSON, JUNIOR (A'29), Student, General Electric Company, Schenectady, N.Y. For mail: 1210 Van Vranken Ave., Schenectady, N.Y.
- PETTIT, ALBERT R. (A'29), Assistant Engineer, RCA-Victor Company, Inc., Camden, N.J. For mail: 425 Taylor Ave., West Colingswood, N.J.
- PETTS, RONALD G. (A'29), Technician and Manager, Radio Service Dept., M. H. Housel and Company, 141 W. 4th St., Williamsport, Pa. For mail: 904 Railway St., Williamsport, Pa.
- PETZING, ERWIN W. (A'19), 939 N. Drake Ave., Chicago, Ill.
- PEW, RICHARD K. (A'26), Technical Editor, "Citizens' Radio Call Book," 508 S. Dearborn St., Chicago, Ill.
- PFUFF, ERNEST R. (A'25-M'29), Vice-President, International Broadcasting Equipment Company, 3112 W. 51st St., Chicago, Ill. For mail: 3004 W. 66th St., Chicago, Ill.
- PFAUTZ, CHRISTIAN E. (A'20), Engineer-in-Charge, Radio Corporation of America, P. O. Box 131, Riverhead, L.I., N.Y.
- PFEIFER, JOSEPH W. (A'26), Pfeifer and Walter, 229 E. Wisconsin St., Milwaukee, Wis. For mail: 1190 Humboldt Blvd., Milwaukee, Wis.
- PFEILER, LAWRENCE F. (A'26), Radio Engineer, Universal Wireless Communication Company, 4111 Ravenwood Ave., E., Chicago, Ill. For mail: 1810 N. 5th St., Sheboygan, Wis.
- PFLEEGOR, CARROLL M. (A'28), Dupont Rayon Company, 225 Massachusetts Ave., Buffalo, N.Y. For mail: 106-19th St., Buffalo, N.Y.
- PFLEGER, ROBERT A. (A'27), Technician, H. E. Carse Radio Company, 3902 S. Grand Ave., Los Angeles, Calif. For mail: 6069 S. Citrus, Hyde Park Sta., Los Angeles, Calif.
- PHELPS, BOYD (A'21), 8505-167th St., Jrmaica, L.I., N.Y.
- PHELPS, ROGER E. (A'28), 27 Ruskin St., Springfield, Mass.
- PHELPS, WALTER A. (A'19), Telephone Engineer, Bell Telephone Laboratories, Inc., 461 West St., New York, N.Y. For mail: 19 Academy Rd., Madison, N.J.
- PHILBRICK, LAWRENCE S. (A'27), Radio Engineer, J. Murdock Company, 347 Washington Ave., Chelsea, Mass. For mail: 51 Malvern St., Melrose, Mass.
- PHILIPPSON, MAURICE (M'19), 57 Rue D'Arlon, Brussels, Belgium.

- PHILIPS, JAMES H. (A'25), Radio Engineer, Kellogg Switchboard and Supply Company, 106 W. Adams St., Chicago, Ill. For mail: 306 Chicago Ave., Oak Park, Ill.
- PHILLIPS, CHARLES F. (M'22), Chief Engineer, Burndept Wireless, Ltd., London, S. E. 3, England. For mail: 17 Eliot Vale, Blackheath, London, S. E. 3, England.
- PHILLIPS, EDWARD I. (A'29), Manager, Eddiesons Electric Service Company, 12 Ward Pl., West Haven, Conn.
- PHILLIPS, ELMO W. (A'25), Radio Expert, Mid-West Electric Company, 1207 Harney St., Omaha, Neb. For mail: 3916 N. 17th St., Omaha, Neb.
- PHILLIPS, HENRY B. (M'24), Associate Professor of Mathematics, Massachusetts Institute of Technology, Cambridge, Mass.
- PHILLIPS, HOWARD W. (A'28), Radiotician, J. W. Jenkins and Sons Music Company, Tulsa, Okla. For mail: 1524 E. Admiral Place, Tulsa, Okla.
- PHILLIPS, JOSEPH H., JR. (A'27), 5510 Baum Blvd., Pittsburgh, Pa.
- PHILLIPS, LEO E. (A'27), Telephone Standardization Engineer, Western Electric Company, Inc., 738 Central Ave., Westfield, N.J. For mail: 653 Hillcrest Ave., Westfield, N.J.
- PHILLIPS, LLOYD B. (J'22-A'24), 1374 Longmeadow St., Longmeadow, Mass.
- PHILLIPS, R. G. (A'28), Radio Dealer, 15 E. Boardman St., Youngstown, Ohio. For mail: 1019 Hawthorne St., Youngstown, Ohio.
- PICHON, RICHARD S. (J'26), 1625 Marlowe Ave., Lakewood, Ohio.
- PICHUMANI, K. K. (A'28), Deputy Assistant Wireless Engineer, Magpur Radio, Magpur, C. P., India.
- PICKARD, GREENLEAF W. (M'12-F'15), Consulting Engineer, Wireless Specialty Apparatus Company, Boston, Mass. For mail: 59 Dalton Ad., Newton Center, Mass.
- PICKARD, RICHARD W. (A'29), Development Dept., National Broadcasting Company, 711-5th Ave., New York, N.Y. For mail: 44 Clifford St., East Orange, N.J.
- PICKEN, WILLIAM J. (A'14), Marconi's Wireless Telegraph Company, Marconi House, Strand, London, W. C. 2, England.
- PICKETT, EARL L. (A'27), Operator, Station KFJB, Marshall Electric Company, 1603 W. Main St., Marshalltown, Iowa. For mail: 503 N. Second Ave., Marshalltown, Iowa.
- PICKETT, GLENN H. (A'26), Buffalo Broadcasting Corporation, Rand Bldg., Buffalo, N.Y.
- PICKLES, ARTHUR W. (A'28), Switchboard Repairman, Michigan Bell Telephone Company, Jackson Mich. For mail: 127 W. Mason St., Jackson, Mich.
- PIDGEON, HOWARD A. (M'29), Member, Technical Staff, Bell Telephone Laboratories, 463 West St., New York, N.Y. For mail: 26 Berkeley Rd., Maplewood, N.J.
- PIERCE, FRANCIS E. (M'28), Captain, Field Officer School, Marine Barracks, Quantico, Va.
- PIERCE, GEORGE W. (M'13-F'15), Rumford Professor of Physics and Director of Cruft High Tension Electric Laboratory, Harvard University, Cambridge, Mass. For mail: 7 Berkeley Pl., Cambridge, Mass.
- PIERCE, FRANKLIN W. (J'24-A'26), St. Francis Hotel, Hollywood, Calif.
- PIERI, DONALD (M'20), Sales Engineer, Allen-Hough Carryola Company, 279 Walker St., Milwaukee, Wis. For mail: 635 Fifth Ave., Wauwatosa, Wis.
- PIEROTTI, WILLIAM L. (A'26), Superintendent Backus Novelty Company, Smethport, Pa. For mail: 201 Franklin St., Smethport, Pa.
- PIERREPONT, JOHN JAY (A'29), Lieutenant, U.S. Navy, U.S.S. "Concord," c/o Postmaster, New York, N.Y.
- PIERSON, THEODORE (J'29), Service Manager, Onondaga Auto Supply Company, 353 E. Onondaga St., Syracuse, N.Y. For mail: 117 Henry St., Syracuse, N.Y.
- PIETY, RAYMOND G. (A'27), Engineer, Bremer-Tully Manufacturing Company, 532 S. Canal St., Chicago, Ill. For mail: 6072 Stony Island Ave., Jackson Park Station, Chicago, Ill.
- PIKE, OTIS W. (A'26-M'29), Electrical Engineer, General Electric Company, Research Laboratory, Schenectady, N.Y.
- PILKINGTON, E. J. (A'26), 10 Dana St., Cambridge, Mass.
- PILL, CECIL R. (A'28), 5 Hopewell Terrace, Horsforth, Nr. Leeds, England.
- PILZECKER, ARTHUR (A'28), Express Clerk, Electric Railway Express, 524 Huron Ave., Toledo, Ohio. For mail: 1121 Moore St., Toledo, Ohio.
- PINDER, A. (A'29), Manager, McCabes Radios, Auckland, N.Z. For mail: Dallinghoo Crescent, Milford, Auckland, N.Z.
- PINEAU, NORMAN T. (A'28), Telegrapher, United Press, 61 Park Row, New York, N.Y. For mail: 131 Beckman Ave., Tarrytown, N.Y.
- PINGREE, SAMUEL J. (A'25), President, Pingree Macdonald Patents, 1328 S. Kingshighway, St. Louis, Mo. For mail: 43 Washington Terrace, St. Louis, Mo.
- PINKNEY, J. L. (A'29), Serviceman, Pinkney's Electric Shop, 9 Duncan St., San Francisco, Calif.
- PINNOCK, L. W. J. (A'23), Nottingham Radio Supplies, 33 Mansfield Rd., Nottingham, England.
- PIPE, GORDON E. (A'25), Radio Engineer, Standard Radio Manufacturing Corporation, Toronto 2, Ont., Canada. For mail: 1049 Dufferin St., Toronto, Ont., Canada.
- PIPE, ROBERT E. (A'28), Wireless Engineer, c/o Marconi Wireless Telegraph Company, New Street, Chelmsford, Essex, England.
- PIROTE, PETE (A'29), Machinist Helper, Norfolk and Western Ry., Williamson, W. Va. For mail: P.O. Box 1253, Williamson, W. Va.
- PISCHZAN, HANS E. (A'25), Assistant Engineer, Radio Corporation of America, Victor Bldg. 15, 4th Floor, Camden, N.J. For mail: 726 W. Maple Ave., Apt. B, Merchantville, N.J.
- PITT, WILLIAM (A'28), Capitalist, 816 Dwight Bldg., Kansas City, Mo.
- PITTENGER, ARTHUR W. (A'28), Laboratory Assistant, Radio Frequency Laboratories, Inc., Boonton, N.J. For mail: 804 Main St., Boonton, N.J.

- PITTS, FRANCIS D.** (A'15), Radio Distributor, F. D. Pitts Company, 219-223 Columbus Ave., Boston, Mass.
- PLACE, SAMUEL W.** (A'19), Radio Engineer, Atwater-Kent Manufacturing Company, 4700 Wissahickon Ave., Philadelphia, Pa. For mail: 622 Stanbridge St., Norristown, Pa.
- PLANCK, R. M.** (A'29), Radio Engineer, Sparks-Withington Company, North St., Jackson, Mich. For mail: 305 West High St., Jackson, Mich.
- PLATT, J. E.** (A'29), Radio Maintenance Engineer, Vanadian Marconi Company, 11 St. Sacramento St., Montreal, P.Q., Canada. For mail: 7 Lafayette Ave., Montreal South, Montreal, P.Q., Canada.
- PLEASANTON, ARCHIE W.** (A'28), 1st Class Radioman, Coast Guard Depot, Curtis Bay, Md. For mail: Dover Plains, N.Y.
- PLEASANTON, DOUGLAS W.** (J'28), Radio Technician, Rocke International Electric Corporation, 154 Nassau St., New York, N.Y. For mail: 147-29 Hoover Ave., Jamaica, L.I., N.Y.
- PLETKA, JAMES** (A'29), Designer and Builder of Test Equipment, Temple Corporation, 5253 W. 65th St., Chicago, Ill. For mail: 5115 S. Winchester Ave., Chicago, Ill.
- POCH, WALDEMAR J.** (A'28), Testman, General Electric Company, Schenectady, N.Y. For mail: 134 Riverside Ave., Scotia, N.Y.
- POCOCK, HUGH S.** (M'22), Editor, Electrical Engineer, "Wireless World," Wireless Press, London, England. For mail: 43 Shoot Up Hill, London, N.W.2, England.
- POHLMAN, G. ANTON** (A'26), Toll Line Engineer, Pacific Telephone and Telegraph Company, Los Angeles, Calif. For mail: 1855 S. El Molino, San Marino, Calif.
- POLKINGHORN, FRANK A.** (A'25), Member of Technical Staff, Bell Telephone Laboratories, 463 West St., New York, N.Y.
- POLLARD, LEON G.** (A'26), Engineer, Western Union Telegraph Company, Water Mill, L.I., N.Y. For mail: P. O. Box 518, Southampton, L.I., N.Y.
- POLLOCK, C. A.** (A'28), Grimes Radio Corporation, Kitchener, Ont., Canada. For mail: Benton St., Kitchener, Ont., Canada.
- POLYDOROFF, W. J.** (M'24), Director of Research, Johnson Laboratories, Inc., 609 W. Lake St., Chicago, Ill.
- POMEROY, RUPERT C.** (A'26), Proprietor, Pomeroy's Variety Store, Watkins Glen, N.Y. For mail: 206 N. Madison Ave., Watkins Glen, N.Y.
- POND, EDWARD W.** (A'29), 1510 Liberty St., Allentown, Pa.
- PONSFORD, WALTER W.** (A'28), Radio and Telegraph Spec., Graybar Electric Company, Philadelphia, Pa.
- PONTO, AARON E.** (A'26), Radio Serviceman, Irving Zuelke, Neenah, Wis. For mail: 413 Nicolet Blvd., Neenah, Wis.
- POOLE, ROBERT J.** (A'24), Radio Engineer, Bell Telephone Laboratories, 463 West St., New York, N.Y. For mail: 85 Washington Ave., Morristown, N.J.
- POOR, WALTER E.** (A'29), Vice-President, Hygrade Lamp Company, Salem, Mass. For mail: 27 Chestnut St., Salem, Mass.
- POORMAN, ARTHUR E.** (A'29), Radio Operator and Engineer, Radio Station WBAK, State Arsenal, Harrisburg, Pa. For mail: 1722 Boas Street, Harrisburg, Pa.
- POORMAN, EDWIN H.** (J'29), Student, Pasadena Junior College, Pasadena, Calif. For mail: 1091 Wesley Ave., Pasadena, Calif.
- POPE, JAMES C.** (A'28), Radioman 1st Class, U. S. Navy, U.S.S. "Barry," 248, c/o Postmaster, New York, N.Y.
- POPSACK, ANDREW A.** (A'29), Engineer, Radio Engineering Dept., Westinghouse Electric and Manufacturing Company, East Pittsburgh, Pa. For mail: P. O. Box 719, Wall, Pa.
- PORTER, R. A.** (A'18), Professor of Physics, Syracuse University, Syracuse, N.Y. For mail: 861 Ostrom Ave., Syracuse, N.Y.
- PORTER, RALPH H.** (A'14), Merchants National Bank, Salem, Mass. For mail: 253 Essex St., Salem, Mass.
- PORTER, ROLAND G.** (A'26), Associate Professor of Electrical Engineering, School of Engineering, Northeastern University, Boston, Mass. For mail: 19 Woodbury St., Beverly, Mass.
- PORTER, SAMUEL** (A'29), Radio Serviceman, 135 Nevada, W., Detroit, Mich.
- PORTS, EARL G.** (A'25), Communication Engineer, International Communications Laboratories, Inc., 67 Broad St., New York, N.Y.
- POTEET, DANIEL P.** (A'17), 1st Lieutenant, Signal Corps School, Fort Monmouth, N.J.
- POTTER, MAX** (A'29), Projectionist, Congress Theatre, St. John's Place, Brooklyn, N.Y. For mail: 186 Hopkinson Ave., Brooklyn, N.Y.
- POTTER, MELVILLE R.** (A'22), Service Manager, Genesee Motor Car Company, Syracuse, N.Y. For mail: 248 Palmer Ave., Syracuse, N.Y.
- POTTER, M. L.** (A'26), Consulting Radio Engineer, 4833 Wright Terrace, Niles Center, Ill.
- POTTER, RALPH K.** (A'25-M'26), Radio Engineer, American Telephone and Telegraph Company, Development and Research Dept., Room 1606-A, 195 Broadway, New York, N.Y.
- POTTS, EDWARD** (A'29), Assistant Engineer, British General Post Office, Radio Section, Alder House, Aldergate St., London, E.C.1, England. For mail: 5 Gillingham Rd., Gillingham, Kent, England.
- POTTS, JOHN H.** (A'27), Technical and Test Dept., Radio Corporation of America, Camden, N.J.
- POUJADE, D. G.** (J'29), Serviceman, Radio Headquarters, 175 South High St., Salem, Oregon. For mail: 2405 Center St., Salem, Oregon.
- POULSEN, VALDEMAR** (F'15), Doctor of Philosophy, Møllegaardsvej 6, Gentofte, Denmark.
- POUND, ERNEST J.** (A'24), Technical Supervisor, L. McMichael, Ltd., Bucks, England. For mail: Kingstone House, Kingstone, Shrivendham, Berks, England.
- POUND, HARRIS D.** (A'28), Manager, Service Dept., Rodgers-Majestic Corporation, Ltd., Winnipeg, Canada. For mail: 529 Dominion St., Winnipeg, Man., Canada.

- POUNSETT, FRANK H. R.** (A'26), Laboratory Engineer, DeForest Radio Corporation, 245 Carlaw Ave., Toronto, Ont., Canada. For mail: 92 Hammersmith Ave., Toronto, Ont., Canada.
- POWELL, EDWIN L.** (A'14-M'29), Vice-President and Secretary, Charles R. Speaker and Company, Inc., "Evening Star," Bldg., Washington, D.C. For mail: 5425 Connecticut Ave., Washington, D.C.
- POWELL, LOUIS H.** (J'27), Pacific Telephone and Telegraph Company, San Francisco, Calif. For mail: 34 Athens St., San Francisco, Calif.
- POWELL, RALPH C., JR.** (A'15), Consulting Engineer, 350 Madison Ave., New York, N.Y. For mail: 61 Cleveland St., Orange, N.J.
- POWER, RALPH L.** (A'28), Radio Editor, "Los Angeles Record," Los Angeles, Calif. For mail: 580 Crane Blvd., Los Angeles, Calif.
- POWERS, WALTER P.** (A'14-M'26), Secretary, U.S. Tool Company, Inc., Ampere, N.J.
- POWNALL, ROGER F.** (A'27), 1 South Oxford St., Brooklyn, N.Y.
- POZEFSKY, LEONARD** (A'27), Consulting Engineer, 350 Second Ave., Albany, N.Y.
- PRATT, FEARING** (A'24), Engineer, New England Telephone and Telegraph Company, Boston, Mass. For mail: 120 Main St., Hingham, Mass.
- PRATT, HARADEN** (A'14-M'17-F'29), Chief Engineer, Mackay Radio and Telegraph Company, 67 Broad St., New York, N.Y.
- PRATT, P. W.** (A'25), Superintendent, R.C.A. Institutes, Inc., 899 Boylston St., Boston, Mass. For mail: 466 Putnam Ave., Cambridge, Mass.
- PREECE, RICHARD, JR.** (A'26), E. 421-10th Ave., North, St. Petersburg, Fla.
- PRELL, GEORGE R.** (A'29), Manager, Radio Dept., General Electric Corporation of Oklahoma, 127 East California St., Oklahoma City, Okla. For mail: 10 East 8th St., Oklahoma City, Okla.
- PRENTISS, HOWARD H.** (A'28), Superintendent, Utica Gas and Electric Company, Newport, N.Y. For mail: Poland, N.Y.
- PRENTISS, JOHN G.** (A'28), Engineering Dept., Zenith Radio Corporation, 3620 Iron St., Chicago, Ill. For mail: 4665 Lake Park Ave., Chicago, Ill.
- PRESCOTT, MAURICE L.** (M'28), Radio Engineer, General Electric Company, 1 River Rd., Schenectady, N.Y. For mail: 401 Rosa Rd., Schenectady, N.Y.
- PRESSLEY, JACKSON H.** (A'20), Chief Engineer, U. S. Radio and Television Corporation, Marion, Ind.
- PRESTON, CECIL W.** (A'25), Engineer, Test Design Dept., Grigsby-Grunow Company, 4553 Armitage Ave., Chicago, Ill. For mail: 156 E. Superior St., Chicago, Ill.
- PREUSS, ARTHUR C.** (A'29), Tester, Crosley Radio Corporation, Newport, Ky. For mail: 43-16th St., Clifton, Newport, Ky.
- PRICE, HAROLD W.** (A'28), Professor, Electrical Engineering, University of Toronto, Toronto, Ont., Canada. For mail: 474 Palm-erston Blvd., Toronto, Ont., Canada.
- PRICE, H. STEWART** (A'12-M'26), Supervising Engineer, Bell Telephone Laboratories, Inc., 463 West St., New York, N.Y. For mail: 845 West End Ave., New York, N.Y.
- PRICE, RONALD J. C.** (J'26-A'29), Wireless Operator, Dept. of Marine, Ottawa, Ont., Canada. For mail: 50 Isleworth Ave., Toronto, Ont., Canada.
- PRIEBE, FRANK** (A'28), Student Engineer, General Electric Company, Bldg. 77, Schenectady, N.Y.
- PRIEST, CONAN A.** (A'24), Radio Engineer, General Electric Company, Schenectady, N.Y. For mail: 101 Hawthorne St., Schenectady, N.Y.
- PRIEST, WARD C.** (A'26), Professor of Physics, St. Lawrence University, Canton, N.Y. For mail: 41 Judson St., Canton, N.Y.
- PRINCE, FRANK W.** (A'25), Technician, Spokane Radio Company, 528-1st Ave., Spokane, Wash.
- PRISTAS, JOHN E.** (A'27), Radio Consultant, Davega, Inc., 15 Cortlandt St., New York, N.Y. For mail: 305 E. 117th St., New York, N.Y.
- PROBERT, EDWARD** (A'25), Assistant General Auditor, Shaffer Oil and Refining Company, Tulsa, Okla. For mail: 1811 S. Yorktown, Tulsa, Okla.
- PROBST, JOHN E.** (A'28), Radio Service, Humback's, 333 High St., Hamilton, Ohio. For mail: 533 Ridgelaun Ave., Hamilton, Ohio.
- PROCTOR, JOHN A.** (A'13-M'13), Vice-President and General Manager, Wireless Specialty Apparatus Company, 76 Atherton St., Jamaica Plain, Boston, Mass.
- PROEHL, ROBERT O.** (A'29), Research Engineer, Tru-Tier Manufacturing Corporation, 1818 Washington Ave., St. Louis, Mo. For mail: 3631 Bamberger St., St. Louis, Mo.
- PROCUNIER, W. R.** (J'27), Engineer, Walbert Manufacturing Company, 1000 Fulerton Ave., Chicago, Ill. For mail: 1020 Wellington Ave., Chicago, Ill.
- PROSKAUER, JULIEN J.** (A'23), Chief Engineer, Trutone Radio Company, 114-116 Worth St., New York, N.Y. For mail: 70 E. 96th St., New York, N.Y.
- PRUCHA, ERNEST F.** (A'28), Radiotrician, Sales and Service, Howells Battery Company, Howells, Nebr.
- PRUITT, WILBUR C.** (A'26), Engineer, Station WTAM-WEAR, Inc., 1100 Chester Ave., Cleveland, Ohio. For mail: 1887 E. 70th St., Cleveland, Ohio.
- PUHALSKI, DONALD** (A'29), Service Work, Glenbard Radio Laboratories, Lombard, Ill. For mail: 7 East St., Charles Rd., Lombard, Ill.
- PULLEY, ALBERT A.** (A'25), Radio Engineer, General Electric Company, 1 River Rd., Schenectady, N.Y. For mail: 2176 Story Ave., Schenectady, N.Y.
- PULLEY, LESTER A.** (A'18), Engineer, Western Electric Company, 100 Central Ave., Kearny, N.J. For mail: 148 Hillcrest Ave., Cranford, N.J.
- PUMPHREY, WALTER H.** (A'14-M'15), Lawyer, 113 West 57th St., New York, N.Y.
- PUPIN, MICHAEL I.** (F'15), Instructor, Columbia University, New York, N.Y.

PURSELL, CLARENCE V. (A'14), Radio Research Engineer, 1257 Morton St., Dorchester, Mass.

PURVIS, CHARLES G. (A'29), Radio Tester, Dept. Q, Victor Talking Machine Company, State St., and River Road, Camden, N.J. For mail: 326 Broad St., Clayton, N.J.

PUTNAM, ERLE T. (A'26), Secretary-Treasurer, Vitrolite Construction Company, 407 E. Fort St., Detroit, Mich. For mail: 515 S. Chalmers Ave., Detroit, Mich.

PUTNAM, JOHN P. (A'25), Engineer, Wireless Specialty Apparatus Company, 76 Atherton St., Jamaica Plains, Boston, Mass. For mail: 535 Beacon St., Boston, Mass.

PUTNAM, RALPH E. A. (A'28), International Communications Laboratories, Inc., 67 Broad St., New York, N.Y.

PYE, HAROLD C. (A'20), Research Engineer, Automatic Electric, Inc., 1027 W. Van Buren St., Chicago, Ill. For mail: 424 S. Taylor Ave., Oak Park, Ill.

PLYLE, R. C. (J'27), Hardinsburg, Ky.

PLYLE, WILLIAM D. (A'24), President, Broadcasting Station KFXF, Colorado Radio Corporation, 202 Continental Oil Bldg., Denver, Colo.

Q

QUAINTANCE, LELAND C. (A'26), Radio and Telephone Technician, Station 3XT, Chesapeake and Potomac Telephone Company, 725-13th St., N.W., Washington, D.C. For mail: 732 Richmond Ave., Silver Spring, Md.

QUEMENT, FRANK J. (A'22), Accountant, Standard Oil Company, San Jose, Calif. For mail: 252 Hanchett Ave., San Jose, Calif.

QUIGLEY, JAMES H. (A'29), Auto mechanic, 1901 Stone St., Falls City, Neb. For mail: 2012 Abbott St., Falls City, Neb.

QUINBY, PORTER H. (A'25), Engineer, Concrete Engineering Company, 817 Lauderman Bldg., St. Louis, Mo.

QUIST, JESPER S. M. (A'29), Manager, U.S. Radio Station, Ketchikan, Alaska. For mail: Ketchikan, Alaska.

R

RABINOWITZ, MEYER (A'28), 4302 Ogden St., Philadelphia, Pa.

RACKE, CLARENCE (A'27), Test Supervisor, Federal Radio Corporation, 1738 Elmwood Ave., Buffalo, N.Y. For mail: 184 Grape St., Buffalo, N.Y.

RACLIFFE, CHARLES LIONEL (A'29), Engineer, Station WGBS, General Broadcasting Company, 45 Mill St., Astoria, L.I., N.Y. For mail: 2302-29th Ave., Long Island City, L.I., N.Y.

RAE, WILLIAM T. (A'25), British Broadcasting Corporation, The Parsonage, Manchester, England.

RAESLY, JAMES B. (A'29), Proprietor, Raesly Radio Service, 18 N. 9th St., Easton, Pa.

RAFFERTY, CHARLES H. (A'29), 5915 Alder St., E. E., Pittsburgh, Pa.

RAFFERTY, FRANK A. (A'24-M'24), Research Division, Zenith Radio Corporation, Chicago, Ill. For mail: 8205 Vernon Ave., Chicago, Ill.

RAMIREZ, EDUARDO GARCIA (M'29), Lieutenant Commander, Spanish Royal Naval Commission, 64 Victoria St., London, S.W.1, England.

RAMM, CARL H. (A'29), Grigsby-Grunow Company, 4540 Armitage Ave., Chicago, Ill. For mail: 5409 Agative Ave., Chicago, Ill.

RAMM, HAROLD W. (A'29), Manager and Engineer, Excel Radio Shop, 2925 Bowser Ave., Fort Wayne, Ind.

RAMSAY, ALAN N. (A'26), Engineer, Sound Pictures, Brunswick-Balke-Collender Company, Los Angeles, Calif. For mail: P. O. Box 672, Station C, Los Angeles, Calif.

RAMSAY, JOHN F. (J'27), Buchanan House, Greenhead, Glasgow, Scotland.

RAMSAY, R. R. (M'26), Professor, Dept. of Physics, Indiana University, Bloomington, Ind. For mail: 615 East 3rd St., Bloomington, Ind.

RAMSEY, R. W. (A'29), Radio Serviceman, Ramsey Radio Service, P. O. Box 139, Chambersburg, Pa.

RAND, GEORGE L. (A'29), Engineering Dept., Universal Wireless Communication Company, Plainfield, Ill.

RANDALL, DORMUS P. (A'19), Instructor, Syracuse University, Syracuse, N.Y. For mail: Box 28, University Station, Syracuse, N.Y.

RANDALL, HARRY K. (A'25), Silver-Marshall, Inc., 846 W. Jackson Blvd., Chicago, Ill. For mail: 6557 Harvard Ave., Chicago, Ill.

RANDALL, LEMUEL E. (A'29), Radio Tester, Grigsby-Grunow Company, 4540 Armitage Ave., Chicago, Ill. For mail: 9343 Richmond Ave., Evergreen Park, Ill.

RANDALL, J. CLAYTON (M'28), Radio Engineer, Station WTIC, Travelers' Insurance Company, 26 Grove St., Hartford, Conn. For mail: 400 Burnside Ave., East Hartford, Conn.

RANDOLPH, GEORGE T. (A'29), Service Engineer, J. E. Delworth Company, 4 Cummings Station, Nashville, Tenn.

RANDOLPH, L. F. (A'29), Sales Engineer, E. T. Cunningham, Inc., 370-7th Ave., New York, N.Y.

RANFT, WILLIAM Q. (A'27), Chief Operator, Station WFBR, Baltimore, Md. For mail: 4205 Oakford Ave., Forest Park, Baltimore, Md.

RANGACHARI, T. S. (A'28), Research Student in Wireless Telegraphy, Indian Institute of Science, Bangalore, India.

RANGER, RICHARD H. (A'19-M'21-F'28), Design Engineer, Radio Corporation of America, 66 Broad St., New York, N.Y.

RANKIN, GEORGE P., JR. (A'27), Assistant Electrician, City Hall, Macon, Ga.

RANKIN, SAMUEL A. (A'26), Salesman, The Buescher Company, 1310 Huron Rd., Cleveland, Ohio. For mail: 593 Primrose St., Sharon, Pa.

RANKINE, JAMES C. (A'27), Superintendent of Telegraph, Great Northern Railway Company, 820 Great Northern Bldg., St. Paul, Minn.

RANSOM, G. B. (A'28), 1365 Cass Ave., Room 822, Detroit, Mich.

RAPAGNANI, PETER A. (A'26), Manager, Radio Dept., 1203-1205 West 3rd St., Chester, Pa. For mail: 927 W. 3rd St., Chester, Pa.

RASER, EDWARD G. (A'25), Member of Firm, Raser and Kale Radio Specialists, 330 Concord Ave., Trenton, N.J. For mail: 315 Beechwood Ave., Trenton, N.J.

RASKHODOFF, NICHOLAS (A'29), Engineer, Radio Division, American-Bosch Magneto Corporation, 3664 Main St., Springfield, Mass.

RATCHFORD, WILLIAM J. (A'26), Engineer, The Canadian Marconi Company, Ltd., Marconi Station, Drummondville, P.Q., Canada.

RATCLIFFE, J. A. (M'29), University Demonstrator, Cavendish Laboratory, Sidney Sussex College, Cambridge, England.

RATCLIFFE, L. G. (A'29), Radio Engineer, Wireless Station, Stony Hill, St. Andrew's, Jamaica, B.W.I.

RATHBUN, HARRY (A'17), Associate Professor of Law, Stanford Law School, Stanford University, Calif. For mail: P. O. Box 2171, Stanford University, Calif.

RATHNER, JACK (A'29), Radio Service Technician, Ansonia Music Shop, 2139 Broadway, New York, N.Y. For mail: 894 Riverside Drive, New York, N.Y.

RATTS, BRUCE H. (A'29), Student, Dodge Institute of Radio and Telegraphy, 405 E. Monroe St., Valparaiso, Ind. For mail: R. F. D. 1, Butler, Ind.

RAU, DAVID S. (A'22), Chief Engineer, Radio Corporation of the Philippines, Manila, P.I.

RAUHOFER, FRANK (A'29), Proprietor, Rauhofer Radio Electric Company, 949 Hamilton St., Allentown, Pa.

RAVENHART, RONALD J. M. (M'25), Consulting Radio Engineer, c/o Westminster Bank, 22 Place Vendome, Paris, France.

RAWSON, CLIFFORD L. (A'29), Manager, Service Dept., Earl Wilson Electrical Company, 927 Brown St., Napa, Calif. For mail: 2143 Main St., Napa, Calif.

RAY, JOHN N. (A'27), Research Engineer, Kolster Radio Corporation, Palo Alto, Calif. For mail: 406 Central Ave., N. Palo Alto, Calif.

RAYBURN, GEOFFREY D. (A'25), Radio Operator, Texas Air Transport, Winburn Field, San Antonio, Tex. For mail: 1109 Main Ave., San Antonio, Tex.

RAYCROFT, LOUIS B. F. (A'28), Radio Sales Dept., The Electric Storage Battery Company, 19th St. and Allegheny Ave., Philadelphia, Pa. For mail: 6940 Cresheim Rd., Mt. Airy, Philadelphia, Pa.

RAYNOLDS, EDWARD F. (A'27), Central Valley, N.Y.

READ, GEORGE T. (A'26), P. O. Box 138, McKee City, N.J.

READY, WILLIAM A. (A'25), President, National Company, Inc., Cambridge, Mass. For mail: 219 Mason Terrace, Brookline, Mass.

REB, FRANK F. (A'25), Radiomarine Corporation, 326 Broadway, New York, N.Y.

REBER, SAMUEL (F'23), Director of Traffic Production, Radio Corporation of America, 233 Broadway, New York, N.Y.

RECH, CHARLES B. (A'29), Room 207, City Hall, Chicago, Ill. For mail: 4253 N. Winchester Ave., Chicago, Ill.

REDDY, WALTER G. (A'28), 38 Chettenham Rd., Rochester, N.Y.

REDEKER, HARRY E. (A'29), Chemist, Federal Telegraph Company, Palo Alto, Calif. For mail: 319 Ramona St., Palo Alto, Calif.

REDFERN, FOREST F. (A'27), Radio Inspector, Radio Division, Dept. of Commerce, Subtreasury Bldg., New York, N.Y. For mail: 1570 E. 48th St., Brooklyn, N.Y.

REEB, ALFRED (A'26), Experimental Dept., E. G. Budd Manufacturing Company, 8 Hunting Park Ave., Philadelphia, Pa. For mail: 1820 W. Glenwood Ave., Philadelphia, Pa.

REEBER, HERMAN E. (A'25), Assistant Engineer, Radio Corporation of America, 70 Van Cortlandt Park, S., New York, N.Y. For mail: 3111 Health Ave., Apt. 26-B, New York, N.Y.

REED, STANLEY C. (A'26), Division Bldg. Cable Engineer, Michigan Bell Telephone Company, Center Bldg., Flint, Mich. For mail: R.F.D. No. 2, P. O. Box 18, Lennon, Mich.

REES, DAVID (A'24), Maesgwyn, Neath Rd., Briton Ferry, S. Wales, G.B.

REES, HUBERT S. (A'28), Officer in Charge of Shift, The Wireless Station, Klipheuvell, Cape Province, South Africa.

REESOR, DELBERT A. (A'28), Production Division, RCA-Victor Company, Inc., 233 Broadway, New York, N.Y. For mail: 357-9th St., Brooklyn, N.Y.

REEVES, E. H. (A'29), Production Analyst, Victor Talking Machine Company, Camden, N.J. For mail: 5416 Whitty Ave., Philadelphia, Pa.

REEVES, J. RUSSELL (A'25), Engineer, Bell Telephone Laboratories, Inc., 463 West St., New York, N.Y.

REGAN, SMILEY I. (A'28), Chief Radioman, U.S. Navy, Navy Yard Transmitting Station, Norfolk, Va.

REGOTTAZ, JOSEPH M. (A'25), Assistant Export Manager, Radio Corporation of America, 233 Broadway, New York, N.Y.

REHBEIN, ARTHUR FREDERICK (A'29), Installation Engineer, Pacent Reproducer Corporation, Film Centre Bldg., 630-9th Ave., New York, N.Y. For mail: 616 Bainbridge St., Brooklyn, N.Y.

REICH, HERBERT J. (A'26), Assistant Professor, Electrical Engineering Dept., University of Illinois, Urbana, Ill. For mail: 707 S. Birch St., Urbana, Ill.

REID, A. J. (A'27), Engineer, Station WHBP, Johnstown Auto Company, 101 Main St., Johnstown, Pa. For mail: 720 Fronheiser St., Johnstown, Pa.

REID, FLOYD F. (J'28-A'29), Service Representative and Radio Instructor, Atwater Kent Manufacturing Company, Philadelphia, Pa.

REID, HALBERT G. (J'29), Student, Dodge's Institute, 155 College Ave., Valparaiso, Ind. For mail: P. O. Box 326, Liberal, Kan.

REID, HENRY L. (A'23), Henry L. Reid and Company, Atlanta, Ga. For mail: 800 Myrtle Ave., Atlanta, Ga.

- REID, IRL H. (A'20), Engineer-in-Charge, Radio Corporation of America, Marshall, Marin Co., Calif.
- REID, RALPH J. (A'28), Chief Transmitter Operator, Radio Station WCKY, Covington, Ky.
- REID, THOMAS A. (A'21), Radio Engineering Service, 132 W. Cecil St., Springfield, Ohio.
- REIMER, AUGUST CHARLES (A'26), Radio Dept., National Radio Tube Laboratories, 125 Church St., New York, N.Y. For mail: 137-88th St., Brooklyn, N.Y.
- REINER, LEONARD (A'29), Vacuum Tube Experimenter, Gold Seal Electric Company, 127 S. 15th St., Newark, N.J. For mail: 113 Huntington Terrace, Newark, N.J.
- REINHART, SIDNEY M. (A'26), Proprietor, Long Branch Radio Service, 145 Broadway, Long Branch, N.J.
- REINKEN, LOUIS W. (A'29), Research Dept., American Telephone and Telegraph Company, 195 Broadway, New York, N.Y.
- REKART, ARTHUR F. (A'28), Radio Operator, Main Auto Supply Company, 215 W. Main St., Fort Wayne, Ind. For mail: 825 W. Superior St., Fort Wayne, Ind.
- REMDE, JACK (A'28), Maintaining Working Standards, 1650 Walnut St., Chicago, Ill. For mail: 5042 W. Superior St., Chicago, Ill.
- REMEDI, DOMINIC (A'27), Custom Set Builder, 157 Rhoda Ave., Youngstown, Ohio.
- REMLEIN, C. D. (J'27-A'29), Chief Operator, S. S. "Lake Benbow," Radiomarine Corporation of America, 32 N. 5th St., Philadelphia, Pa. For mail: 1717 E. Brill St., Philadelphia, Pa.
- RENFRO, HAROLD E. (A'24), Radio Engineer, City Light Dept., Seattle, Wash. For mail: 1837 Hamlin St., Seattle, Wash.
- RENHARD, JULIUS A. (A'29), 5212-18th Ave., N.E., Seattle, Wash.
- RENKE, ADOLPH (A'29), Research Laboratory Assistant, Pacent Electric Corporation, 91-7th Ave., New York, N.Y. For mail: 689 Lenox Rd., Brooklyn, N.Y.
- RENTON, RALPH JAMES (A'29), U.S. Radio Inspector, U.S. Dept. of Commerce, Boston Custom House, Boston, Mass. For mail: 100 Bay View Ave., Quincy, Mass.
- REOCH, ALEXANDER E. (M'14-F'16), Vice-President, RCA Photophone, Inc., 411-5th Ave., New York, N.Y.
- REPLOGLE, DELBERT E. (M'29), 254 Christie St., Leonia, N.J.
- RETTENMEYER, FRANCIS X. (A'26-M'29), Chief Engineer, F.A.D. Andrea, Inc., 24 Orchard St., Long Island City, L.I., N.Y. For mail: 41-06-50th St., Woodside, L.I., N.Y.
- RETTIG, FLOYD A. (A'28), Electrical Contractor, Oak Grove St., Ravenna, Ohio. For mail: P. O. Box No. 4, Ravenna, Ohio.
- REUMAN, WILLIAM H. (A'25), Operator, Station WFBH, Hotel Majestic, West 72nd St., New York, N.Y. For mail: 4130-58th St., Woodside, L.I., N.Y.
- REUTHE, GUSTAV (M'17), Apartado 2016, Mexico, D.F.
- REVILLE, T. A., JR. (J'28), Radio Station 5VD, Route 3, Box 99-B, Amarillo, Tex.
- REWAK, C. T. (A'27), Engineer, Station KOMO, Fisher's Blend Station, Cobb Building, Seattle, Wash.
- REYNER, JOHN H. (M'25), Consulting Engineer, The Furzehill Laboratories, Boreham Wood, Herts, England.
- REYNOLDS, C. C. (A'29), Manager, Service Laboratory, 115-7th St., Pittsburgh, Pa. For mail: 215 Ross Ave., Wilkensburg, Pa.
- REYNOLDS, F. T. (A'26), Engineering Dept., Broadcasters' Service Bureau, San Antonio Bldg., San Jose, Calif. For mail: 85 E. San Antonio St., San Jose, Calif.
- REYNOLDS, JOHN L. (A'28), Recording Engineer, Electrical Research Products, Inc., 250 W. 57th St., New York, N.Y.
- REYNOLDS, WILLIAM D. (A'26), President Reynolds Radio Company, Inc., 1534 Glenarm, Denver, Colo. For mail: 1385 S. Marion St., Denver, Colo.
- RHOADES, A. L. (A'29), Lieutenant Colonel, Signal Corps, U.S. Army, Army War College, Washington, D.C.
- RHODES, L. G. E. (J'16-A'17), 202 S. Eastlake St., Los Angeles, Calif.
- RHODES, THOMAS B. (A'26), Vice-President, Rossiter and Company, Inc., 136 Liberty St., New York, N.Y.
- RHYS-JONES, JOHN E. (A'28), Radio Engineer, Marconiphone Company, Telephone House, Tottenham Court Rd., London, England. For mail: Hily, 16 Cedar Gardens, Upminster, Essex, England.
- RICCOBONO, SEBASTIAN (A'28), 896 Troy Ave., Brooklyn, N.Y.
- RICE, CHESTER W. (A'16-M'26-F'28), Assistant Vice President, in Charge of Engineering, General Electric Company, 1 River Rd., Schenectady, N.Y. For mail: 3 Lowell Rd., Schenectady, N.Y.
- RICE, HAROLD E. (A'28), Engineer, New England Telephone and Telegraph Company, 50 Oliver St., Boston, Mass. For mail: 11 James St., Portland, Me.
- RICH, C. E. (A'29), Engineer, Cardon Corporation, Jackson, Mich. For mail: 303 W. High St., Jackson, Mich.
- RICH, F. L. (A'28), Technician, Sanger Bros., Radio Dept., Dallas, Tex. For mail: 3912 Simpson St., Dallas, Tex.
- RICHARD, CHARLES W. (A'21-M'26), Radio Engineer, Air Corps at Large, U.S. Army, Chanute Field, Rantoul, Ill. For mail: P. O. Box 364, Rantoul, Ill.
- RICHARDS, A. R. (A'29), Student, Michigan State College, P. O. Box 611, East Lansing, Mich.
- RICHARDS, FOLKE (A'29), Designer, Westinghouse Electric and Manufacturing Company, Radio Engineering Dept., East Pittsburgh, Pa. For mail: 530 Kelly Ave., (21), Pittsburgh, Pa.
- RICHARDS, HORACE JEROME (A'29), Test Engineer, Electrical Test Dept., Electrical Research Products, Inc., 3931 S. Winchester Ave., Chicago, Ill. For mail: 2119 E. 67th St., Apt. 3B, Chicago, Ill.

- RICHARDS, PHILIP A. (A'29), Vacuum Tube Engineer, General Electric Company, 2001 W. Pershing Rd., Chicago, Ill. For mail: 5002 West End Ave., Chicago, Ill.
- RICHARDS, W. S. (A'29), Manager, Service Dept., C. C. Lawton Company, 1125 Wall St., Los Angeles, Calif. For mail: 1467 Temple St., Los Angeles, Calif.
- RICHARDSON, A. G. (A'25-M'29), Development Engineer, Allen Hough Carryola Company, 279 Walker St., Milwaukee, Wis. For mail: 1310 Farwell Ave., Milwaukee, Wis.
- RICHARDSON, CHARLES L. (M'25), Radio Engineer, Splittdorf Electrical Company, Ltd., Toronto, Ont., Canada. For mail: 1230 Shaw St., Toronto, Ont., Canada.
- RICHARDSON, F. C. (A'29), Radio Engineer, Phillips Lamps, Ltd., Phillips House, 145 Charing Cross Rd., London, England. For mail: 106 Western Rd., Leigh-on-Sea, Essex, England.
- RICHARDSON, GEORGE A. (J'29), H. Hersh Hardware Company, 618 N. 12th St., Allentown, Pa.
- RICHARDSON, L. WALTON (A'24), Electrical Radio Engineer, General Electric Company, 1 River Rd., Schenectady, N.Y. For mail: 110 Seeley St., Scotia, N.Y.
- RICHARDSON, MARSTON S. (A'26), Plant Inventory and Costs Engineer, Wisconsin Telephone Company, 418 Broadway, Milwaukee, Wis. For mail: 2435 Wisconsin Ave., Milwaukee, Wis.
- RICHMOND, HAROLD B. (A'14-M'23-F'29), Treasurer, General Radio Company, 30 State St., Cambridge, Mass.
- RICHMOND, L. P. (A'25), Radio Laboratory, Wright Field, Dayton, Ohio.
- RICKARD, CHARLES E. (M'15), Deputy Engineer-in-Chief, Marconi's Wireless Telegraph Company, Ltd., Marconi House, Strand, London, England. For mail: 5 Baldwyn Gardens, Acton, London, W., England.
- RICKER, NORMAN H. (A'19), Consulting Physicist, P. O. Box 1619, Houston, Tex.
- RICKEY, LAWRENCE (A'28), Engineer, Installation and Service Dept., RCA Photophone, 438 W. 37th St., New York, N.Y. For mail: Turner Inn, Keene, N.H.
- RIDDEL, O. A. (J'27), 5783 Ridge Ave., Chicago, Ill.
- RIDDIOUGH, JOHN W. (A'25), F. Riddiough and Son, Colonnade Westgate, Bradford, England. For mail: West Point, St. John's Park, Menston, Wharfedale, England.
- RIDDLE, ELMER R. (A'29), Chief Engineer, Radio Corporation of the Philippines, Manila, P.I.
- RIDDLE, RUSTON L. (A'29), Proprietor, Riddle Radio Company, 2703 S. 59th St., St. Louis, Mo.
- RIDDLE, WILLIAM E. (A'28), Proprietor, 9 Stevenson Lane, Saranac Lake, N.Y.
- RIDENOUR, WILLIAM S. (J'29), Radio-trician, The Ideal Music Shop, 548 N. Gay St., Baltimore, Md. For mail: 2449 Lauretta Ave., Baltimore, Md.
- RIDER, JOHN F. (A'23), Author and Radio Engineer, 1440 Broadway, New York, N.Y.
- RIDGEWAY, JOHN W. (A'28), Assistant Manager, Radio Dept., The Edison Swan Electric Company, Ltd., 1A Newman St., Oxford St., London, W. 1, England. For mail: Hill Crest, Middle Handley, Near Sheffield, England.
- RIDGEWAY, JAMES L. (A'27), Certified Public Accountant, Patterson and Ridgway, 74 Trinity Pl., New York, N.Y.
- RIDLING, CARROLL W. (A'29), Radio Technician, Nunn Electric Company, 917 Scott St., Wichita Falls, Tex.
- RIEGER, WILLIAM (A'27), Radioman, U. S. Navy, U.S.S. "Jason," c/o Postmaster, Seattle, Wash.
- RIETHMILLER, EARL R. (A'29), Engineer, Cardon Corporation, Jackson, Mich. For mail: 434 Stewart Ave., Jackson, Mich.
- RIETZKE, EUGENE H. (A'20), Vice-President, Capital Radio Engineering Institute, Inc., 3166 Mt. Pleasant St., N.W., Washington, D.C.
- RIFKIN, J. L. (A'29), Loud Speaker Development, F.A.D. Andrea, Inc., Long Island City, N.Y. For mail: 64 E. 103rd St., New York, N.Y.
- RIGGS, CLARE A. (A'26), Technician, Radio Station KELW, Burbank, Calif. For mail: 3658 Valleybrink Rd., Los Angeles, Calif.
- RIGGS, JOHN H. (A'29), Chief Inspector and Tester, All-American-Mohawk Radio Corporation, 4201 Belmont, Chicago, Ill. For mail: 4747 Kenmore, Chicago, Ill.
- RIGNEY, DOUGLAS (A'21-M'28), 20 Beverly Rd., Kensington, Great Neck, L.I., N.Y.
- RILEY, CONRAD D. (A'27), Chief Radioman, U. S. Naval Radio Compass Station, Cattle Point, Via Friday Harbor, Wash.
- RINES, DAVID (A'19), Lawyer, 20 Kilby St., Boston, Mass.
- RING, ANDREW D. (A'26), Radio Engineer, Federal Radio Commission, Washington, D.C. For mail: 2505-13th St., N.W., Washington, D.C.
- RINGEL, ABRAHAM (A'18-M'22), Electro-Acoustic Research Engineer, Radio Corporation of America, 70 Van Cortlandt Park South and Saxon Ave., New York, N.Y. For mail: 608 Jerome St., Brooklyn, N.Y.
- RINGOLD, H. RUSSELL (A'25), Clerk, Southern California Telephone Company, 433 S. Olive St., Los Angeles, Calif. For mail: 1819 1/2 Tamarind Ave., Hollywood, Calif.
- RIPLEY, HENRY P. (A'22), Managing Director, Guy V. Laycock, Ltd., 12 Cloth Hall St., Huddersfield, England. For mail: 7 Regent Rd., Edgerton, Huddersfield, England.
- RIPPERE, R. OLIVER (J'28), Telephone Engineer, Bell Telephone Laboratories, Inc., 463 West St., New York, N.Y. For mail: 1819 Newkirk Ave., Brooklyn, N.Y.
- RIPPETEAU, CHARLES W. (A'29), Radio Foreman, J. W. Jenkins Music Company, Kansas City, Mo. For mail: 6500 Paseo, Kansas City, Mo.
- RISER, MORRIS (A'25), Chelsea Radio Company, Atlantic City, N.J. For mail: 2815 Atlantic Ave., Atlantic City, N.J.

- RISHELL, GEORGE L. (A'25), Vice-President, Sylvania Products Company, Emporium, Pa.
- RISLEY, F. S. (A'28), President, West Virginia Broadcasting Corporation, Wheeling, W.Va. For mail: 1229 Main St., Wheeling, W.Va.
- RISSLER, HAROLD D. (A'28), Hughesville, Mo.
- RITZAU, K. (A'27), c/o Dr. Garrett Kemp, 3633 Binckley, University Park, Dallas, Tex.
- RIU, AGUSTIN (A'26), Ecole Speciale de Mecanique et d'Electricite, 161 Rue de Sevres, Paris, France.
- ROBB, FREDERICK G. (A'28), Engineer, Marconi's Wireless Telegraph Company, Ltd., Chelmsford, England. For mail: 11 Whitley Wood Rd., Reading, Berkshire, England.
- ROBB, JOSEPH S. (A'26), The Atchison Radio Manufacturing Company, 317 Commercial St., Atchison, Kan.
- ROBB, ROBERT J. (A'22), President, Radio Ltd., 202 Castle Bldg, Montreal, P.Q., Canada.
- ROBB, WILLIAM I. (A'24), Radio Engineer, The Radio Lamp Company, 152 New Bridge St., Newcastle-on-Tyne, England.
- ROBERSON, CARL (A'29), Farmer, Box 1064, Forsyth, Mont.
- ROBERTS, HAYDN P. (A'23-M'25), First Lieutenant, Signal Corps, Wright Field, Dayton, Ohio.
- ROBERTS, RICHARD P. (A'28), Technical Service Representative, RCA-Victor Co., Inc., Front and Cooper Sts., Camden, N.J. For mail: 3624 Westfield Ave., Camden, N.J.
- ROBERTS, RUSSELL B. (A'29), Radio Technician, Park Department, City Hall, Los Angeles, Calif. For mail: 5327 Monte Vista St., Los Angeles, Calif.
- ROBERTS, WALTER VAN B. (A'22-F'29), Engineer, Patent Dept., Radio Corporation of America, 233 Broadway, New York, N.Y. For mail: 155 Hodge Rd., Princeton, N.J.
- ROBERTSON, FRANK E. (A'27), Draftsman, The Domestic Electric Company, 7223 St. Clair Ave., Cleveland, Ohio. For mail: 19521 Pansow Ave., Cleveland, Ohio.
- ROBERTSON, JOSEPH J. C. (A'25), International Petroleum Company, Talara, Peru, S.A. For mail: Apartado 38, Talara, Peru, S.A.
- ROBINSON, ALOYSIUS V. (A'28), Inspector, Victor Talking Machine Company, Camden, N.J. For mail: 2445 E. Huntington St., Philadelphia, Pa.
- ROBINSON, FORREST D. (A'28), Supervisor, Radiomarine Corporation of America, Chatham, Mass. For mail: Box 631, Chatham, Mass.
- ROBINSON, FREDERICK (A'27), P. O. Box 163, La Crescenta, Calif.
- ROBINSON, FREDERICK H. (A'24), Editor, "The Broadcaster and Wireless Retailer," 93 Long Acre, London, W.C.2, England.
- ROBINSON, GORDON D. (A'19), U. S. Naval Academy, Annapolis, Md. For mail: 39 Southgate Ave., Annapolis, Md.
- ROBINSON, HARRIS A. (J'27-A'29), Student Engineer, Radio Dept., General Electric Company, Schenectady, N.Y. For mail: 302 Becker St., Schenectady, N.Y.
- ROBINSON, PHILIP F. (A'28), Chief Operator, Radio Station WBZA, Westinghouse Electric and Manufacturing Company, Boston, Mass. For mail: 149 Hollis Ave., Braintree, Mass.
- ROBINSON, R. J. (A'25), U. S. Navy Yard, Mare Island, Vallejo, Calif. For mail: 1036 York St., Vallejo, Calif.
- ROBISON, SAMUEL S. (A'14-M'14-F'15), U. S. Naval Academy, Annapolis, Md.
- ROCHFORD, JOHN (A'23), Radio Engineer, General Electric Company, 1 River Rd., Schenectady, N.Y. For mail: 1715 Wendell Ave., Schenectady, N.Y.
- ROCKWELL, RONALD J. (A'25), 717 Woodview Blvd., Fort Wayne, Ind.
- ROCKWOOD, ALAN C. (A'25), Electrical Engineer, Vacuum Tube Development, General Electric Company, Research Lab., Schenectady, N.Y.
- RODER, HANS (M'29), 3136 Buhre Ave., New York, N.Y.
- RODGERS, GEORGE H. (A'29), Radio Engineer, Laboratory Assistant, Brandes Laboratories, Inc., 200 Mt. Pleasant Ave., Newark, N.J. For mail: 23 Passaic Ave., Passaic, N.J.
- RODMAN, I. P. (M'27), 257 S. Ridgewood Rd., South Orange, N.J.
- RODRIGUEZ, ALEXANDER E. (A'26), Technical and Test Dept., National Union Radio Corporation, 355 Ogden St., Newark, N.J. For mail: 242 Broad St., Newark, N.J.
- RODWIN, GEORGE (A'25), Engineer, Radio Corporation of America, 70 Van Cortlandt Park South and Saxon Ave., New York, N.Y. For mail: 3512 Perry Ave., New York, N.Y.
- ROE, DOUGLAS J. (A'28), Service Work, F.A.D. Andrea, Inc., 24 Orchard St., Long Island City, N.Y. For mail: 916 S. Lombard Ave., Oak Park, Ill.
- ROEDELLE, LE ROY W. F. (A'27), General Delivery, Dubuque, Iowa.
- ROELLER, HENRY S. (A'29), Proprietor, Roeller's Radio and Electric Shop, 53 N. Charlotte St., Pottstown, Pa.
- ROESCH, ROBERT E. (A'25), Electrical Engineer, Virginia Public Service Company, Alexandria, Va.
- ROESER, EDWARD A. (A'26), Engineer, Rochester Gas and Electric Company, Rochester, N.Y. For mail: 110 Laburnam Cres., Rochester, N.Y.
- ROESS, HAROLD (M'26), Radio Engineer, Westinghouse Electric and Manufacturing Company, East Pittsburgh, Pa. For mail: 461 Cascade Rd., Wilkensburg, Pa.
- ROETKEN, A. A. (A'29), Research Dept., Bell Telephone Laboratories, Inc., 463 West St., New York, N.Y. For mail: 72 Harrison St., East Orange, N.J.
- ROGERS, ARTHUR H. E. (A'19-M'22), East London Technical College, P. O. Box 201, East London, South Africa.

- ROGERS, CLIFFORD H. (A'28), Radio Operator, Radio Station WMBS, Harrisburg, Pa. For mail: 861 Walnut St., Lemoyne, Pa.
- ROGERS, EDWARD S. (M'27), Engineer, Standard Radio Manufacturing Corporation, 90 Chestnut St., Toronto, Ont., Canada.
- ROGERS, HAROLD A. (A'27), Engineer-in-Charge, Station CFCF, Rm. 28, Mt. Royal Hotel, Montreal, P.Q., Canada.
- ROGERS, J. HARRIS (A'15-M'26), Electrical Research Work, Hyattsville, Md.
- ROHMAN, VICTOR A. (A'29), Radio Engineer, Radio Corporation of America, Radio Station, Brunswick, N.J.
- ROHRICH, GEORGE J. (A'26), Radio Instructor, National Radio Institute, 1223 Conn. Ave., N.W., Washington, D.C. For mail: 521 Sheridan St., Washington, D.C.
- ROHRMANN, EDWARD R. (A'29), Radio Dealer and Serviceman, Darlington Beaverlington, Pa. For mail: Darlington, Pa.
- ROHWER, PAUL C. (A'26), Radio Technician, Station KMMJ, M. M. Johnson Company, Clay Center, Neb. For mail: 2041 K St., Lincoln, Neb.
- ROLLEFSON, KARL E. (M'28), 355 Central Ave., Highland Park, Ill.
- ROLLINSON, JOHN W. (A'26), Assistant Sales Manager and Engineer, Savannah Electric and Power Company, Savannah, Ga.
- ROLLO, W. SMITH (A'26), Royal Engineer, Plean Castle, Stirlingshire, Scotland.
- ROMAN, FRANK E. (J'29), Radiomarine Corporation of America, 32 N. 5th St., Philadelphia, Pa.
- ROMANDER, HUGO (A'28), Engineer, Federal Telephone Company, Palo Alto, Calif. For mail: 209 Cowper St., Palo Alto, Calif.
- ROMEO, ANTHONY (A'29), Radio Serviceman, Abraham and Strauss Company, Fulton St., Brooklyn, N.Y. For mail: 1715 W. 13th St., Brooklyn, N.Y.
- ROOF, RAYMOND B. (A'25), Teacher, Battle Creek High School, Battle Creek, Mich. For mail: 185 Hubbard St., Battle Creek, Mich.
- ROORDA, J., JR. (A'27), Laboratory Engineer, Nederlandsche Seintooestellen Fabriek, Hilversum, Holland. For mail: Van Oldenbarneveldtlaan, Hilversum, Holland.
- ROOS, OSCAR C. (M'13-F'17), Consulting Engineer, 41-14 Hampton St., Elmhurst, L.I., N.Y.
- ROOSEVELT, H. L. (M'27), European Manager, Radio Corporation of America, 156 Rue de L'Universite, Paris, France.
- ROOT, HARRY (A'28), Radio Service, Root Radio Service, 476 Dartmouth Ave., Buffalo, N.Y.
- ROOT, LELAND B. (M'27), General Radio Company, 30 State St., Cambridge, Mass. For mail: 38 Woods Ave., Somerville, Mass.
- ROSE, ARTHUR F. (M'24), Telephone Engineer, American Telephone and Telegraph Company, Rm. 1731-B, 195 Broadway, New York, N.Y.
- ROSE, CHARLES F. P. (A'22), Engineer, Bell Telephone Laboratories, 463 West St., New York City.
- ROSE, F. W. (A'28), Radiotrician, Jim Bryant Company, 1417 Douglas St., Victoria, B.C., Canada. For mail: 981 Cloverdale Ave., Victoria, B.C., Canada.
- ROSE, JOHN A. (A'28), Radio Operator, Tropical Radio and Telegraph Company, Pier 9, Hudson River, New York, N.Y. For mail: 63 W. 73rd St., New York, N.Y.
- ROSE, JOSEPH K. (A'27), Service Manager, U. S. Radio and Television Corporation, 3301 S. Adams St., Marion, Ind. For mail: 333 N. Washington St., Marion, Ind.
- ROSE, SIDNEY (A'24), Electrician, Ontario Provincial Government, Canada. For mail: Box 21, Sub 10, London, Ont., Canada.
- ROSEBRUGH, THOMAS R. (A'15), Professor of Electrical Engineering, University of Toronto, Toronto, Ont., Canada. For mail: 92 Walmer Rd., Toronto, Ont., Canada.
- ROSENBAUM, JACOB (J'27), Radio Mechanic and Salesman, Radio Market Company, 175 Greenwich St., New York, N.Y. For mail: 985 Dumont Ave., Brooklyn, N.Y.
- ROSENBERG, IRVING (J'27-A'28), Serviceman, City Radio Store, 31 E. Fordham Rd., New York, N.Y. For mail: 1075 Home St., New York, N.Y.
- ROSENFELD, MILLARD (A'29), Student, Dept. of Electrical Engineering, Ohio State University, Columbus, Ohio. For mail: 25 W. Frambes Ave., Columbus, Ohio.
- ROSENWALD, EDWIN D. (A'27), Adjuster Ship's Compasses, Chas. C. Hutchinson, 154 State St., Boston, Mass.
- ROSER, CLARENCE O. (J'27-A'29), Plant Supervisors Staff, Wisconsin Telephone Company, 432 Broaivay, Milwaukee, Wis. For mail: 1621 Wels St., Milwaukee, Wis.
- ROSIN, ARTHUR (A'29), 6 Bay 23rd St., Brooklyn, N.Y.
- ROSS, FRANK C. (A'29), Sales and Technical Engineer, Shure Bros. Company, 335 W. Madison St., Chicago, Ill. For mail: 4540 Clifton Ave., Chicago, Ill.
- ROSS, J. D. (A'28), Supt. of Light and Power, Dept. of Lighting and Power, Seattle, Wash.
- ROSS, KENNETH B. (A'28), Proprietor, Ross Radio Laboratories, Inc., 5600 Ridge Ave., Chicago, Ill.
- ROSS, M. F. (A'29), Proprietor, Ross Radio Service, 165 W. Covina Blvd., Covina, Calif.
- ROSS, RUSSELL H. (A'24), Assistant Engineer, Minnesota Power and Light Company, Duluth, Minn. For mail: 1830 Jefferson St., Duluth, Minn.
- ROSS, STEWART C. (A'29), Radio and Electric Shop, 1929 E. Monmouth St., Philadelphia, Pa.
- ROSS, UDA B. (M'26), Technical Editor, "N.Y. Telegram," Telegram Square, New York, N.Y. For mail: 1957-61st St., Brooklyn, N.Y.
- ROSSI, RALPH J. T. (A'26), Construction Superintendent, Radio Corporation of America, 66 Broad St., New York, N.Y.
- ROSSITER, DONALD R. (J'26), Radio Engineer, Bremer-Tully Manufacturing Company, 656 W. Washington Blvd., Chicago, Ill. For mail: 7301 S. Michigan Ave., Chicago, Ill.

- ROSSMASSLER, EDWARD C. (A'26), Secretary, Sauquoit Manufacturing Company, 140-4th Ave., New York, N.Y.
- ROSSO, THOMAS (A'28), Radioman First Class, U. S. Coast Guard Cutter "Saucee," Key West, Fla.
- ROTTERS, HERBERT C. (A'27), Assistant Professor, Dept. of Electrical Engineering, Stevens Institute of Technology, Hoboken, N.J.
- ROTH, HAROLD B. (A'29), Radio Service Engineer, Boutell Bros., 5th and Marquette Aves., Minneapolis, Minn. For mail: 4912-41st Ave., S., Minneapolis, Minn.
- ROTH, JESSE E. (A'17), 210 Walter Ave., Hasbrouck Heights, N.J.
- ROTHBERG, JOSEPH (J'29), Manager, Service Dept., New York Radio Stores, 170 Washington St., Boston, Mass. For mail: 12 Tennis Rd., Mattapan, Mass.
- ROTHER, GORST (M'29), Doctor of Engineering, Telefunken, G.M.B.H., Berlin, Glaliches Ufer 12, Berlin, Germany.
- ROTHENBERGER, WILLIAM L. (A'28), Traveling Representative, RCA-Victor Company, Inc., 101 Marietta St., Atlanta, Ga.
- ROTHERA, W. F. (J'25-A'29), Radio Inspector, Canadian General Electric Company, Wallace Ave., Toronto, Ont., Canada. For mail: Denison Ave., Weston, Ont., Canada.
- ROTTA, ALLEN E. (A'29), 735 N. 67th St., Seattle, Wash.
- ROWE, CHARLES R. (J'19-A'21-M'27), Chief Inspection Engineer, Kolster Radio Corporation, 200 Mt. Pleasant Ave., Newark, N.J. For mail: 5 Owen Dr., Maplewood, N.J.
- ROWE, THOMAS L. (A'23), Chief Studio Engineer, Radio Station WLS, Hotel Sherman, Chicago, Ill. For mail: 3023 N. Park Side, Chicago, Ill.
- ROWE, VICTOR G. (A'25), Junior Radio Inspector, Dept. of Commerce, San Francisco, Calif. For mail: 36 Cervantes Blvd., San Francisco, Calif.
- ROWLAND, EDGAR S. (J'24-A'27), Consulting Radio Engineer, 27 Upper Brownhill Rd., Mursling, Southampton, England.
- ROYAL, ROSCOE (A'27), Designer and Manufacturer, Photo Electric Record and Responsive Devices, 2136 Indiana Ave., Chicago, Ill.
- ROYDEN, GEORGE T. (A'19-M'27), Division Engineer, Mackay Radio and Telegraph Company, Hobart Bldg., 582 Market St., San Francisco, Calif.
- ROYS, H. E. (A'27), Radio Engineering Dept., General Electric Company, Schenectady, N.Y.
- RUCKLE, ERNEST G. (A'27), Student, School of Engineering, Milwaukee, Wis. For mail: 113 Neilson St., New Brunswick, N.J.
- RUDDY, RALPH P. (A'29), Service Manager, Kaemmerer Music Shops, Inc., 3199 S. Grand Blvd., St. Louis, Mo. For mail: 3727 Juniata St., St. Louis, Mo.
- RUDEBOCK, EVERETT L. (A'27), Radio-technician, Zetka Radio Laboratories, 73 Winthrop St., Newark, N.J. For mail: 12 Brighton Ave., East Orange, N.J.
- RUE, WILLIAM F. (J'27-A'27), Radio Service Engineer, Rumsey Electric Company, 1007 Arch St., Philadelphia, Pa. For mail: Clearfield Ave., R.D.1, Norristown, Pa.
- RUNCIMAN, ARTHUR S. (A'17), Maintenance Engineer of Lines, Shawinigan Water and Power Company, Montreal, P.Q., Canada.
- RUNDQUIST, ELLIOT C. (A'22), Radio Engineer, Radio Corporation of America, Riverhead, L.I., N.Y.
- RUNGE, WILHELM T. (M'28), Dr. Ing. Oberingenieur, Telefunken Hallesches Ufer 12, Dessauerstrasse 7, Berlin-Lanwitz, Germany.
- RUNYON, CARMAN R., JR. (A'18), Vice-President, Burns Bros., New York, N.Y. For mail: 544 N. Broadway, Yonkers, N.Y.
- RUSCOE, CHARLES R. (A'29), Radio Engineer, Ngahina St., Marton, New Zealand.
- RUSE, ARTHUR (A'23), Radio Engineer, 35 Castlefield Ave., Toronto, Ont., Canada.
- RUSH, WALTER A. (M'13-F'24), General Superintendent, Canadian Govt., Radio Service, Dept. of Marine, Hunter Bldg., Ottawa, Ont., Canada. For mail: 200 Rideau Terrace, Ottawa, Ont., Canada.
- RUSHING, WALLACE E. (A'28), Member of Operating Staff, Broadcasting Station WTIC, Hartford, Conn. For mail: 332 Washington St., Hartford, Conn.
- RUSS, GEORGE H. (A'29), Special Test Engineer, Westinghouse Electric and Manufacturing Company, Chicopee Falls, Mass. For mail: 95 Ardmore St., East Springfield, Mass.
- RUSSELL, ARTHUR H. K. (A'26), Barrister, Lester and Russell, Toronto 2, Ont., Canada. For mail: 232 Lonsmount Dr., Toronto, 10, Ont., Canada.
- RUSSELL, B. A. (A'29), Sales and Serviceman, Fulton Bros. Electric Company, 135 Peachtree Arcade Bldg., Atlanta, Ga. For mail: 456 Page Ave., N.E., Atlanta, Ga.
- RUSSELL, CECIL R. (M'18), Radio Engineer, 194 Oxford Terrace, Christchurch, New Zealand. For mail: P. O. Box 606, Christchurch, New Zealand.
- RUSSELL, M. W. G. (M'29), Proprietor, North Eastern University of Wireless Telegraphy, Radio House 6 York Rd., Bridlington, East Yorkshire, England.
- RUSSELL, ROBERT D. (A'27), Grove St., Wellesley, Mass.
- RUSSELL, W. G. (A'28), Serviceman, Millbrook, Ont., Canada.
- RUSSELL-BOYLE, H. (A'29), Shipping Clerk, Commonwealth and Dominion Line, Customhouse Quay, Wellington, New Zealand. For mail: G. P. O. Box 188, Wellington, New Zealand.
- RUST, LESLIE W. (A'27), Edgerton, Minn.
- RYALL, HENRY (J'29), Manager, Congress Square Radio Shop, 574a Congress St., Portland, Me. For mail: 67 Bradley St., Portland, Me.
- RYAN, FRANCIS M. (J'14-A'17-M'26), Radio Engineer, Bell Telephone Laboratories, Inc., 463 West St., New York, N.Y.
- RYAN, HARRIS J. (M'15), Professor of Electrical Engineering, Stanford University, Calif.
- RYAN, LLOYD F. (J'29), 1210 Harney St., Vancouver, Wash.

- RYAN, M. JOHN (A'27), Proprietor, Ryan's Radio and Electric Shop, 47 Amherst St., Manchester, N.H.
- RYAN, R. (A'27), U.S.V.B. Hospital 102, Livermore, Calif.
- RYBNER, JOERGEN C. F. (A'25), Engineer, Royal Geodetic Institute, Proviantgaarden, Copenhagen K, Denmark. For mail: Syvens Alle 2, Copenhagen S, Denmark.
- RYDER, JACK D. (A'29), Radio Engineer, General Electric Company, Schenectady, N.Y. For mail: Y.M.C.A., Schenectady, N.Y.
- RYLEY, RAYMOND (A'28), Manager Service and Repair Depts., Marshall-Wellis, Ltd., Edmonton, Alberta, Canada. For mail: 12011-85th St., Edmonton, Alberta, Canada.
- RYPINSKI, MAURICE C. (A'20-M'28), Vice-President Kolster Radio Corporation, 200 Mt. Pleasant Ave., Newark, N.J. For mail: 309 Lawn Ridge Rd., Orange, N.J.
- RYZMOWSKI, E. (A'23), Polish Wireless Company, Warsaw, Poland. For mail: Mokotowska 26 m. 6, Warsaw, Poland.
- S
- SACHS, HAROLD S. (A'15), Envoy Apartments, 786 Osage Ave., Portland, Ore.
- SACIA, C. FRED (A'26), Engineer, Research Dept., Bell Telephone Laboratories, Inc., 463 West St., New York, N.Y.
- SADENWATER, HARRY (A'14-M'26), Technical Operation, Broadcasting Stations, General Electric Company, Schenectady, N.Y. For mail: 1084 Glenwood Blvd., Schenectady, N.Y.
- SAGE, FREDERIC H. (A'29), Manager, Reclamation Dept., Colonial Radio Corporation, 25 Wilbur Ave., Long Island City, N.Y. For mail: 19 Smart Ave., Flushing, L.I., N.Y.
- SAINÉ, HARRY (A'29), Chief Technician, Radio Station KQW, 87 E. San Antonio St., San Jose, Calif. For mail: 1148 Lincoln Ave., San Jose, Calif.
- SAITO, MASAO (A'28), Radio Engineer, Japan Wireless Telegraph Company, Harano-Machi Shutchojo, Harano-Machi, Fukushima-ken, Japan.
- SAITOW, KENJI (A'25), Shuang-Chiao Radio Station, Peking, China.
- SAKAI, SADA O. (A'27), Radio Engineer, Nippon Musen Denshin Kaisha, Shutchojo, Harano-machi, Fukushima-ken, Japan.
- SALOWITTS, LOUIS W. (A'29), Electrical and Gas Engineer, S. S. Electric Construction Company, 653 Warren St., Roxbury, Mass. For mail: 9 Hutchings St., Roxbury, Mass.
- SALTER, DAVID (A'23), Asst. Superintendent of Telegraphs, Radio Station VPN, Nassau, N.P., Bahamas, B.W.I.
- SALTMARSH, BEATRICE (J'23-A'25), Sandridge, Nr. St. Albans, Herts, England.
- SALTON, LYNN V. (M'23), T. Eaton Company, Ltd., 801 Somerset Bldg., Winnipeg, Man., Canada. For mail: 1164 Grosvenor Ave., Winnipeg, Man., Canada.
- SALZBERG, BERNARD (J'25), Student, Polytechnic Institute of Brooklyn, 99 Livingston St., Brooklyn, N.Y. For mail: 659 E. 165th St., New York, N.Y.
- SALZER, HERMAN M. (A'28), Technical Representative, Victor Talking Machine Division, RCA-Victor Company, Inc., Camden, N.J. For mail: 233 S. Scott Rd., New Orleans, La.
- SALZER, H. S. (A'27), Assistant Lighthouse Engineer, U. S. Dept. of Commerce, 224 Customs House Bldg., New Orleans, La. For mail: 6028 Catina St., New Orleans, La.
- SALZMAN, DAVID (A'27), Proprietor, National Radio Service, 137 Barrett St., Brooklyn, N.Y.
- SAMARASEKARA, V. R. (A'29), Electrical Engineer, c/o Thomas Cooke, Ltd., Berkeley, St., London, England.
- SAMOILOFF, LEON (A'28), Communication Engineer, International Communication Laboratories, 89 Broad St., New York, N.Y.
- SAMMONS, FLOYD (A'27), Mountain States Telephone and Telegraph Company, Fort Collins, Colo.
- SAMPSON, EDWARD J. F. (J'29), Assistant Foreman, Alden Manufacturing Company, Campello, Mass. For mail: 17 E. Ashland St., Brockton, Mass.
- SAMS, E. E. (A'28), 506 Market St., Muskogee, Okla.
- SAMUEL, ARTHUR L. (A'24), Research Engineer, Bell Telephone Laboratories, Inc., 463 West St., New York, N.Y.
- SANBORN, JOHN W. (A'28), Radio Engineering, International Telephone and Telegraph Corporation, 67 Broad St., New York, N.Y.
- SANDALLS, GEORGE T. JR. (J'15-A'17), Engineer, American Telephone and Telegraph Company, 195 Broadway, New York, N.Y. For mail: Harvard and Monroe Aves., North Tarrytown, N.Y.
- SANDORF, IRVING J. (A'29), Instructor, Electrical Engineering, University of Nevada, Reno, Nev.
- SANDS, LEO G. (J'27), Chief Engineer, Sands, Sebring Company, Sound Amplification Specialists, 2119 McDougall Ave., Everett, Wash.
- SANDS, WILLIAM F. (A'27), Laboratory, Atwater Kent Manufacturing Co., 4700 Wissahickon Ave., Germantown, Philadelphia, Pa. For mail: 739 Noble St., Norristown, Pa.
- SANMANN, EDGAR J. (A'28), P. O. Clerk, Arcade Station P. O., Los Angeles, Calif. For mail: 1012 E. Columbia St., Monterey Park, Calif.
- SANTOS, ANTHONY S. (A'14), International Standards Electric Corporation, Caixa Postal 219, Rio de Janeiro, Brazil.
- SARDANETA, RAYMUNDO (A'23), Radio Dept., Direction Telegrafos Nacionales, Mexico, D.F.
- SARGEANT, CHARLES E. (A'27), Service Manager, Wanner's Radio Shop, 522 Franklin Ave., Nutley, N.J. For mail: 6 E. Newell Ave., Rutherford, N.J.
- SARNOFF, DAVID (A'12-M'14-F'17), Vice-President-General Manager, Radio Corporation of America, 233 Broadway, New York, N.Y.

- SARVER, FRANK M. (A'28), Radio Engineer, Barker Brothers, Inc., Figueroa and Seventh Sts., Los Angeles, Calif. For mail: 1345 N. New Hampshire Ave., Hollywood, Calif.
- SASAKI, TEI (A'29), 1734 Tabatadaishita Tokyo Prefecture Japan, Teishin-kanrirenshusho, Department of Commerce, Siba Park, Tokyo, Japan.
- SASAKI, TOSHIRO (A'25), Radio Engineer, Department of Communications, Tokyo, Japan. For mail: 43 Nishi-Okubo, Tokyo, Japan.
- SASS, ISIDORE (A'29), 1859-62nd St., Brooklyn, N.Y.
- SATEREN, M. G. (A'27), Plaza Club Hotel, Camden, N.J.
- SATTERTHWAITE, WILLIAM F. (A'27), Research Dept., National Carbon Company, 1280 W. 73rd St., Cleveland, Ohio. For mail: 1471 Wager Ave., Lakewood, Ohio.
- SAUERWINE, CHARLES AUGUSTUS (A'29), Chief Operator, Broadcasting Station WCBA, 725 New St., Allentown, Pa.
- SAUNDERS, ALFRED W. (A'26), Recording Engineer, Electrical Research Products, Inc., 250 W. 57th St., New York, N.Y. For mail: 161 Walnut St., Nutley, N.J.
- SAUNDERS, WILLIAM P. (A'23), Gimbel Brothers, Philadelphia, Pa. For mail: 251 Trent Rd., Penn Wynne, Philadelphia, Pa.
- SAUNDERS, WILLIAM W. (A'29), Radio Engineer, Federal Telegraph Company, Palo Alto, Calif.
- SAWFORD, FRANK, JR. (A'26), Electrical and Mechanical Draftsman, Frank Sawford, Sr., 610 Credit Foncier Bldg., Vancouver, B.C., Canada.
- SAWYER, GORDON E. (A'27), Sound Dept., United Artists Corporation, 1041 N. Formosa Ave., Hollywood, Calif. For mail: 920 1/2 N. Martel Ave., Hollywood, Calif.
- SAXTON, ALFRED H. (A'29), Division Engineer, National Broadcasting Company, 111 Sutter St., San Francisco, Calif.
- SAYEKI, MITSURU (M'16-F'16), Chief Engineer, The Japan Wireless Telegraph Company, Nippon Musen Denshin, Kabushiki Kaisha, Jiji Bldg., Marunouchi, Kojimachi-Ku, Tokyo, Japan. For mail: 23 Kasymicho, Azabuku, Tokyo, Japan.
- SAYLOR, JAMES G. (A'28), Radio Mechanic, A. K. Sutton, Inc., 332 S. Tryon St., Charlotte, N.C. For mail: Y.M.C.A., Charlotte, N.C.
- SAYLOR, W. EDWIN (A'29), Chief Engineer, Mels Radio Sales and Service, Woodbourne, N.Y. For mail: 16 Hillcrest Ave., Ellenville, N.Y.
- SCANLAN, RICHARD J. (A'26), Hudson Motor Car Company, Engineering Dept., Detroit, Mich.
- SCANLON, DALE L. (A'25), Field Engineer, Kolster Radio Corporation, 3333 W. 33rd Ave., Denver, Colo.
- SCARR, HENRY F. (A'26), Radio Engineer, Bell Telephone Laboratories, Inc., 463 West St., New York, N.Y. For mail: 151 Sip Ave., Jersey City, N.J.
- SCELI, RUSSELL G. (A'25), Proprietor, Radio Inspection Service Company, 193 Trumbull St., Hartford, Conn.
- SCHAEFER, CARL A., JR. (A'26), Electrical Engineer, Buckeye Incubator Company, Research Dept., 1305 Innisfallen Ave., Springfield, Ohio. For mail: 1759 Walnut Ter., Springfield, Ohio.
- SCHAEFER, CARL T. (A'27), Proprietor and Manager, Radio Supply Shop, Honolulu, Hawaii. For mail: P. O. Box 3054, Honolulu, Hawaii.
- SCHAEFER, HAROLD W. (J'26), Grigsby-Grunow Company, 5801 Dickens Ave., Chicago, Ill.
- SCHAFER, J. PETER (A'24), Bell Telephone Laboratory, Inc., 463 West St., New York, N.Y. For mail: 1115-6th Ave., Neptun, N.J.
- SCHARF, JOACHIM BARSCHACH (A'29), Consulting Engineer, Railway and Manufacturers' Agents, 39 S. LaSalle St., Rm. 1115, Chicago, Ill.
- SCHAULER, VINCENT A. (A'23), Projectionist of Sound Pictures, Newark, N.J. For mail: Broad St., Newark, N.J.
- SCHUCHTER, JACK (A'27), 271 E. 169th St., New York, N.Y.
- SCHUCHTER, LEO (J'29), 1935 Semple Ave., St. Louis, Mo.
- SCHOFFER, ROY J. (A'29), Serviceman, Shuler Supply Company, 741 St. Charles St., New Orleans, La. For mail: 717 Greenwood St., New Orleans, La.
- SCHELDORF, MARVEL W. (A'26), Radio Engineer, General Electric Company, Schenectady, N.Y. For mail: 2501 Turner Ave., Schenectady, N.Y.
- SHELL, RICHARD, JR. (A'27), Chief Radio Operator, South Porto Rico Sugar Company, Enseñada, Porto Rico. For mail: Enseñada, Porto Rico.
- SHELLENG, JOHN C. (M'26-F'28), Member of Technical Staff, Bell Telephone Laboratories, Inc., 463 West St., New York, N.Y.
- SHELLING, ROBERT F. (A'27), Chief Engineer, Buffalo Radio Engineering Laboratories, 241 S. Elmwood Ave., Buffalo, N.Y.
- SCHENEMAN, HENRY WESLEY (A'29), 2333 S. University, Denver, Colo.
- SCHENKE, KURTISS P. (A'25), Sales Manager, Non-Capsizable Boat Works, E. 38th St., Flatlands Bay, Brooklyn, N.Y. For mail: 65 Ocean Ave., Brooklyn, N.Y.
- SCHERMERHORN, J. L. (A'12), General Manager and Chief Engineer, American Transformer Company, 178 Emmet St., Newark, N.J.
- SCHICK, WILLIAM H. (A'23), Chief Tester, A. H. Grebe and Company, Inc., Richmond Hill, L.I., N.Y. For mail: 67-05 Cooper Ave., Brooklyn, N.Y.
- SCHIEBER, LEONARD B. (A'29), Manager, Sales and Service Dept., Dickel Distributing Company, 1327 N. Broad St., Philadelphia, Pa. For mail: 122 E. 5th St., Lansdale, Pa.
- SCHIEFER, C. VREELAND (A'29), Laboratory Tester, Freshman Radio Company, 17 Elm St., Passaic, N.J. For mail: 814 N. Vista St., Hollywood, Calif.

- SCHIELE, ANTON A. (A'25), Electron Engineering Company, 1812 Masonic Bldg., New Orleans, La. For mail: 820 Bordeaux St., New Orleans, La.
- SCHIFFENHAUS, DANIEL H. (A'27), Engineer, Radio Broadcasting Station WNJ, 89 Lehigh Ave., Newark, N.J. For mail: 137-4th St., Newark, N.J.
- SCHIFFL, FRANK (A'25), Service Engineer, RCA Photophone, 411-5th Ave., New York, N.Y. For mail: 222 Williamson St., Elizabeth, N.J.
- SCHILLING, JOHN T. (A'20), Radio Engineer, Radio Station WIIIB, Kansas City, Mo. For mail: 4325 Bellefontaine, Kansas City, Mo.
- SCHLAACK, NORMAN F. (A'25), Bell Telephone Laboratories, New York, N.Y. For mail: P. O. Box 122, Deal, N.J.
- SCHLENKER, VESPER A. (A'28), Acoustical Engineer, Vitaphone Corporation, 1277 E. 14th St., Brooklyn, N.Y. For mail: 11 Park Ave., Baldwin, L.I., N.Y.
- SCHLESINGER, LOUIS B. (A'29), Technician, Joseph Horne Company, 5866 Burchfield Ave., Pittsburgh, Pa.
- SCHLITZ, KARL W. (A'26), I. W. Spiros Department Store, Hicksville, N.Y. For mail: 31 W. John St., Hicksville, N.Y.
- SCHLUETER, EDWARD A. (A'26), Engineer, Manufacturers' Radio Service, 1160 Howard St., San Francisco, Calif. For mail: 2436 Bay Island Ave., Alameda, Calif.
- SCHMALZRIEDT, T. (A'26), Manager, Radio Dept., S. S. Kresge Company, 1403 Woodward Ave., Detroit, Mich. For mail: 14239 Mark Twain Ave., Detroit, Mich.
- SCHMIDT, ERWIN (A'28), Laboratory Assistant, Radio Engineering Laboratories, Long Island City, L.I., N.Y.
- SCHMIDT, JOSEPH H. (A'26), Assistant Service Manager, Federal-Brandes, Inc., 200 Mt. Pleasant Ave., Newark, N.J. For mail: 64 Poe St., Newark, N.J.
- SCHMIED, JAMES W. (A'19), Patent Attorney, Bell Telephone Laboratories, Inc., 463 West St., New York, N.Y.
- SCHMIT, DOMINIC F. (A'25), Engineering Laboratory, E. T. Cunningham, Inc., 370-7th Ave., New York, N.Y.
- SCHMITTER, RAY M. (A'25), P. O. Box 66, Mercedes, Tex.
- SCHNEEBERGER, G. B. (A'27), Electrical Engineering Dept., Cleveland Electrical Illuminating Company, Box 392, Cleveland, Ohio.
- SCHNEIDER, MENDELL (A'25), Radio Service Shop, 48 Delevan St., Rochester, N.Y.
- SCHNEIDER, SAMUEL (A'21), 1165 Shakespeare Ave., New York, N.Y.
- SCHNEIDER, W. A. (M'28), Assistant Professor of Physics, Washington Square College, New York University, New York, N.Y.
- SCHNELL, FRED H. (A'19-M'26), c/o Aero Products Company, 4611 E. Ravenwood Ave., Chicago, Ill. For mail: 5741 N. Spaulding Ave., Chicago, Ill.
- SCHNELL, LOUIS J. (A'25), Dept. of Electrical Engineering, University of Minnesota, Minneapolis, Minn. For mail: 2316-9th St., S., Minneapolis, Minn.
- SCHNELL, WILLIAM J. (A'26), Chief Engineer, Electrical Research Laboratories 1731 W. 22nd St., Chicago, Ill. For mail: 1514 Wisconsin Ave., Berwyn, Ill.
- SCHNOLL, NATHAN (A'25), Radio Engineer, F. A. D. Andrea, Inc., Long Island City, N.Y. For mail: 852 Manida St., New York, N.Y.
- SCHOEN, ARTHUR L. (A'26), Eastman Kodak Company, Rochester, N.Y. For mail: 110 Parkdale Ter., Rochester, N.Y.
- SCHOENBORN, FERDINAND (A'29), Foreman, Experimental Shop, Radio Corporation of America, Riverhead, L.I., N.Y.
- SCHOENE, RUSSELL L. (A'25), 1628 Walnut St., Owensboro, Ky.
- SCHOENFELD, K. (A'26), Herald Electric Company, Inc., 29 E. End Ave., New York, N.Y. For mail: 428-20th St., West New York, N.J.
- SCHOENWOLF, FRED L. (A'25-M'29), Chief Engineer, Radio Station WKBI, Chicago, Ill. For mail: 1917 Warner Ave., Chicago, Ill.
- SCHOFIELD, WILLIAM D. (A'29), Radio Engineer, Federal Telegraph Company, Palo Alto, Calif. For mail: 285 Turk St., San Francisco, Calif.
- SCHOLLE, FREDERICK (A'18), Scholle Brothers, 5 Nassau St., New York, N.Y. For mail: 157 W. 57th St., New York, N.Y.
- SCHOLTEN, CHARLES H. (J'27-A'29), Frigidaire Serviceman, 1313 Marshall St., Manitowoc, Wis.
- SCHOLZ, CARL E. (M'26), Chief Engineer, Brandes Products Corporation, 200 Mt. Pleasant Ave., Newark, N.J. For mail: The All American Cables, Inc., Lima, Peru, South America.
- SCHOLEY, HAROLD (A'28), Radio Service Engineer, W. H. S. Radio Service, Alenwood, Pa.
- SCHOR, F. W. (A'29), Temple Corporation, Chicago, Ill. For mail: 3917 W. Adams St., Chicago, Ill.
- SCHOTEL, G. (M'28), Engineer, Technical Bureau of Colonial Office, Carel Van Bylandtlaan 12, The Hague, Holland. For mail: Van Swietenstraat 161, The Hague, Holland.
- SCHOU, CARL (A'20), Dronninggaards Alle, Holte, Denmark.
- SCHRAMM, FRED W. (A'25), Telephone Engineer, American Telephone and Telegraph Company, 195 Broadway, Rm. 1540, New York, N.Y.
- SCHRAMM, WILLIAM (A'27), Radio Service Engineer, Radio Parlor, 2671 Broadway, New York, N.Y. For mail: 319-16th Ave., Astoria, L.I., N.Y.
- SCHREGARDUS, DIRK (A'26), Transmission Engineer, Ohio Bell Telephone Company, 750 Euclid Ave., Cleveland, Ohio.
- SCHREIBER, ERNEST H. (A'28), Engineer, Southern California Telephone Company, 740 S. Olive St., Los Angeles, Calif.
- SCHRICKER, JOHN R. (A'25), Secretary, Schricker Marble and Granite Company, Davenport, Iowa. For mail: 2417 Western Ave., Davenport, Iowa.

- SCHRYVER, HENRY A.** (A'27), Chief Engineer, Slagle Radio Company, Ft. Wayne, Ind. For mail: 2918 Lillie St., Ft. Wayne, Ind.
- SCHUETZ, ROBERT F.** (J'28-A'28), Cadet Engineer, National Broadcasting Company, 711-Fifth Ave., New York, N.Y. For mail: 481 Summit Ave., South Orange, N.J.
- SCHULKE, ENNO** (A'29), Rising City, Neb.
- SCHULTES, MARTIN F.** (A'26), Sales Manager, Radio Engineering Laboratories, 100 Wilbur Ave., Long Island City, L.I., N.Y. For mail: Dwight Ave., Little Neck, L.I., N.Y.
- SCHULMERICH, G. J.** (A'27), Radio Engineer, Guarantee Radio Service Company, 1118 Chestnut St., Philadelphia, Pa. For mail: 7243 N. 21st St., Philadelphia, Pa.
- SCHULTZ, ARTHUR F.** (A'29), Radio Service Supervisor, Philadelphia Storage Battery Company, 1669 Main St., Buffalo, N.Y. For mail: 7 Teunis St., Albany, N.Y.
- SCHULZ, EMIL H.** (A'26), 2230 Farragut Ave., Chicago, Ill.
- SCHULZ, PAUL C.** (A'26), Manager, Radio Service Dept., Peffer Music Company, California and Market Sts., Stockton, Calif. For mail: 331 E. 3rd St., Stockton, Calif.
- SCHULZE, HERRI T.** (A'28), Radio Merchandise Superintendent, Sears, Roebuck and Company, Kansas City, Mo. For mail: 1310 Monroe Ave., Kansas City, Mo.
- SCHURR, WILLIAM A.** (A'27), Federal Radio Corporation, 1738 Elmwood Ave., Buffalo, N.Y. For mail: 84 Allen St., North Tonawanda, N.Y.
- SCHWAB, CHARLES B.** (A'25), Carrier Telephone Engineer, Ohio Public Service Company, Hanna Bldg., Cleveland, Ohio. For mail: 816 Roth Ave., N.E., Massillon, Ohio.
- SCHWANGER, ROBERT M.** (A'26), P. O. Box 1230, Harrisburg, Pa.
- SCHWARTZ, LYLE H.** (A'29), Radio Engineer, Bell Telephone Laboratories, Inc., 463 West St., New York, N.Y. For mail: P. O. Box 122, Deal, N.J.
- SCHWARTZ, NATHAN** (A'27), Radio Engineer, Brooklyn Radio Corporation, 577 Myrtle Ave., Brooklyn, N.Y. For mail: 150-26-116th St., Jamaica, L.I., N.Y.
- SCHWARZ, BERTRAM A.** (M'29), Chief Engineer, DeForest Radio Corporation, Ltd., 245 Carlaw Ave., Toronto, Ont., Canada. For mail: Windsor Arms Apts., St. Thomas and Sultan Sts., Toronto, Ont., Canada.
- SCHWARZ, HARVEY F.** (A'28), Radio Engineer, Brunswick-Balke-Collender Company, Muskegon, Mich.
- SCHWARTZHAUPT, PAUL J.** (M'26), Radio Engineer, General Electric Company, Schenectady, N.Y. For mail: 137 Mohawk Ave., Scotia, N.Y.
- SCHWEIKART, WILLIAM F.** (A'28), Philadelphia Storage Battery Company, and Ontario Sts., Philadelphia, Pa. For mail: 5219 Whitaker Ave., Philadelphia, Pa.
- SCOFIELD, P. F.** (A'27), 430 Kingsley Ave., Palo Alto, Calif.
- SCOFIELD, ROBERT W.** (A'27), Assistant Engineer, N.Y. and Q.E.L. and P. Company, 40-22 Lawrence St., Flushing, L.I., N.Y.
- SCOTT, CARL A.** (A'21), Aircraft Squadron B.F., San Diego, Calif.
- SCOTT, ERNEST P.** (A'27), Foreman, Battery Eliminator Division, The Sterling Manufacturing Company, 2931-53 Prospect Ave., Cleveland, Ohio. For mail: 14006 Clifton Blvd., Cleveland, Ohio.
- SCOTT, GILBERT H.** (A'28), Maintenance Essex Company, Engineering Dept., 98 State St., Newburyport, Mass. For mail: Box 544, Newburyport, Mass.
- SCOTT, HERBERT J.** (A'19), Engineer, Bell Telephone Laboratories, Inc., 463 West St., New York, N.Y.
- SCOTT, HOYT S.** (A'23-M'28), Manager, Radio Engineering Service, Inc., 1366 Hayden Ave., Cleveland, Ohio. For mail: 1740 Harland Ave., Cleveland, Ohio.
- SCOTT, KENNETH L.** (A'21), Chief of Permanent Magnet Development Dept., Western Electric Company, Chicago, Ill. For mail: 4604 Wolf Rd., Western Springs, Ill.
- SCOTT, LEO L.** (A'15), Traveling Auditor, Pacific Car Demurrage Bureau, 503 Wells Fargo Bldg., San Francisco, Calif.
- SCOTT, WALTER F.** (A'24), Assistant Engineer, New York Telephone Company, 1060 Broad St., Newark, N.J. For mail: 207 N. 11th St., Newark, N.J.
- SCOTT-TAGGART, JOHN** (A'18), Barrister-at-Law, Orient House, New Broad St., London, England.
- SCOVILLE, GEORGE A.** (A'27), Vice-President and Sales Manager, Stromberg-Carlson Telephone Manufacturing Company, Rochester, N.Y.
- SEABURY, RICHARD W.** (M'26), President, Radio Frequency Laboratories, Inc., Boonton, N.J. For mail: 245 Rockaway St., Boonton, N.J.
- SEAL, H. ROBERT** (A'29), Engineer, Federal Telegraph Company, Palo Alto, Calif. For mail: Box 163, Menlo Park, Calif.
- SEAMAN, GERALD C.** (A'29), Receiving Engineer, Radio Corporation of America, Riverhead, L.I., N.Y. For mail: Jamesport, N.Y.
- SEAMAN, JOHN C. M.** (A'27), Supervisor, Mechanical Inspection Radio Parts, Philadelphia Storage Battery Company, Ontario delphia Sts., Philadelphia, Pa. For mail: 208 Siegel St., Philadelphia, Pa.
- SEARING, HUDSON R.** (A'20), United Electric Light and Power Company, 130 E. 15th St., New York, N.Y.
- SEARS, GAROLD D.** (J'29), Manager, Broadcasting Station KGFF, Bell Hotel Bldg., Alva, Okla.
- SEAVERTON, OSWALD I.** (A'29), Radio Engineer, Westinghouse Electric and Manufacturing Company, East Pittsburgh, Pa. For mail: 301 South Ave., Wilkensburg Branch, Pittsburgh, Pa.
- SECAN, HARRY** (A'28), Service Manager, New York Band Instrument Company, 1225 Broadway, Brooklyn, N.Y. For mail: 1040 Bushwick Ave., Brooklyn, N.Y.
- SECOR, HARRY W.** (A'12), Consulting Electrical Engineer, Island Rd., Ramsey, N.J.
- SEELEY, SAMUEL W.** (A'26), Wynnewood, Pa.

- Electrical Engineering, Duke University, Durham, N.C.
- SEGAL, PAUL M.** (A'26-M'29), Attorney, Donovan and Bond, 534 Washington Bldg., Washington, D.C.
- SEIBT, GEORGE** (M'26), Engineer and Manufacturer, Hauptstr. 11, Berlin-Schoenberg, Germany.
- SEID, FRED C.** (J'25-A'28), Radio Serviceman, Lankering Company, 516 Washington St., Hoboken, N.J. For mail: 120-28th St., Woodcliff, N.J.
- SEIDLER, ABRAHAM** (A'27), Engineer, Radio Receptor Company, 106-7th Ave., New York, N.Y. For mail: 2144 Bronx Park, E., New York, N.Y.
- SEIDMAN, CHARLES** (A'29), Serviceman and Set Builder, Graymore Radio Corporation, 142 Liberty St., New York, N.Y. For mail: 87 Harrison Ave., Brooklyn, N.Y.
- SEIELSTAD, HAROLD** (A'28), Student, University of Michigan, Ann Arbor, Mich. For mail: 423 E. Lawn Ave., Detroit, Mich.
- SEIGAL, JOSEPH A.** (A'28), Plant Engineer, Central Manhattan, New York Telephone Company, 140 West St., New York, N.Y. For mail: 1054 Grant Ave., New York, N.Y.
- SEILS, HARRY A.** (A'28), Partner, The Radio Hospital, 413 Douglas Ave., Yankton, S.D.
- SEITZ, FRANK A., JR.** (J'29), Consultant, Plant Dept., Westchester Broadcasting Corporation, 100 Highland Ave., Yonkers, N.Y. For mail: 448 N. Broadway, Yonkers, N.Y.
- SEITZ, J. FRED** (A'27), Salesman, Jewel Supply and Equipment Company, 34 S. Calvert St., Baltimore, Md. For mail: 2502 Dulaney St., Baltimore, Md.
- SEITZ, VALENTINE** (A'27), Manager, Engineering Dept., Cleveland Clinic, Euclid Ave. at 93rd St., Cleveland, Ohio.
- SELBY, EUGENE O.** (A'28), Student Engineer, General Electric Company, Schenectady, N.Y. For mail: 318 Clinton St., Schenectady, N.Y.
- SELIGSOHN, MAX** (A'29), Serviceman, Brooklyn Radio Service Corporation, 1072 Atlantic Ave., Brooklyn, N.Y.
- SELLA, GIUSEPPE** (A'28), Radio Engineer, R. Senola d'Ingegneria, Via Ospedale Nr. 32, Torino, Italy. For mail: Corso Vittorio Emanuele N. 86, Torino, Italia.
- SELICK, A. M.** (A'24), Engineer, The Indian Radio Telephone Company, Ltd., P. O. Box 895, Bombay, India.
- SELS, HOLLIS K.** (A'18), Transmission and Substation Engineer, Electric Distribution Dept., Public Service Electric Company, 80 Park Pl., Newark, N.J.
- SEMONI, ANTHONY J.** (A'27), Radio Engineer, California Engineering Company, 1110 Jay St., Sacramento, Calif. For mail: 2181 Weller Rd., Sacramento, Calif.
- SENAUKE, ALEXANDER** (M'28), Assistant Director, Popular Science Institute, New York University, University Heights, New York, N.Y.
- SENIOR, DAVID B.** (A'27), U. S. Engineering Dept., Philadelphia, Pa. For mail: Garden Apts., 6364 Germantown Ave., Philadelphia, Pa.
- SERGE, IGOR BOBROVSKY** (M'26), Chief Engineer and Production Manager, Valley Appliances, Inc., P. O. Box 105, Rochester, N.Y.
- SERIG, HOWARD W.** (A'29), Lieutenant, West Point, N.Y.
- SERRELL, ROBERT** (A'28), Radio Engineering, General Electric Company, 1 River Rd., Schenectady, N.Y. For mail: 1012 Wendell Ave., Schenectady, N.Y.
- SERVICE, CHARLES A., JR.** (A'15), Proprietor and Manager, Service Radio Company, Sarasota, Fla. For mail: P. O. Box 1782, Sarasota, Fla.
- SERY, LESTER** (A'26), Member of Firm, General Radio Service, 43 William St., Newark, N.J. For mail: 639 Court St., Elizabeth, N.J.
- SETO, JOE N.** (A'28), c/o Professor Z. L. Tsoun, Nanyang University, Shanghai, China.
- SEYFERT, STANLEY S.** (M'19), Professor of Electrical Engineering, Lehigh University, Bethlehem, Pa. For mail: 55 W. Market St., Bethlehem, Pa.
- SEYMOUR, FRED M.** (A'27), Radio Engineer and Dealer, 5345 Lakepointe Ave., Detroit, Mich. For mail: 5347 Lakepointe Ave., Detroit, Mich.
- SHABINO, CLARKE L.** (A'29), Howard Radio Company, South Haven, Mich. For mail: 530 Laurel Ave., Wilmette, Ill.
- SHACKELFORD, BENJAMIN E.** (A'23-M'26), Head, Radio and Illuminating Engineering Dept., Westinghouse Lamp Company, Bloomfield, N.J. For mail: 377 Springfield Ave., East Orange, N.J.
- SHAFER, ALBERT G.** (A'26), Chief Engineer, Maxum Radio and Electric Corporation, 54th and Woodland Ave., Philadelphia, Pa. For mail: 4410 Bond Ave., Aronimink, Drexel Hill, Pa.
- SHAFER, WILLIAM L.** (A'23), Assistant Engineer, Bell Telephone Company of Pennsylvania, Pittsburgh, Pa. For mail: 271 Parker Dr., Mt. Lebanon, Pittsburgh, Pa.
- SHAPPER, FRANK** (J'29), Student, Merced Union High School, Merced, Calif. For mail: 861-20th St., Merced, Calif.
- SHAPPER, IRVING R.** (J'26-A'27), 3064 E. 3rd St., Brighton Beach, Brooklyn, N.Y.
- SHAFER, PAUL E.** (A'26), Sales Manager, Leonard Lynn Radio Company, 302 S. Wells St., Chicago, Ill. For mail: 2747 N. Laverne Ave., Chicago, Ill.
- SHALKHAUSER, ERIC GEORGE** (A'20-M'29), General Manager, Radio Dept., Central Electric Company, 238 S. Jefferson Ave., Peoria, Ill. For mail: 147 Cooper Ave., Peoria, Ill.
- SHANNON, FRANK J.** (A'28), Radio Engineer and Operator, WCAU Universal Broadcasting Company, 1940 Market St., Philadelphia, Pa. For mail: 43 N. Farson St., Philadelphia, Pa.
- SHANNON, JAMES E.** (A'26), Service Manager, Colonial Radio Corporation, 25 Wilbur Ave., Long Island City, L.I., N.Y. For mail: 43-39-41st St., Sunnyside, L.I., N.Y.
- SHANNON, JOSEPH H.** (M'16), Design Engineer, Radio Corporation of America, 66 Broad St., New York, N.Y.

- SHAPIRO, L. (A'18-M'22), Chief Engineer, The Rudolph Wurlitzer Manufacturing Company, North Tonawanda, N.Y.
- SHARP, WATKIN W. (A'26), Proprietor, The Peninsula Radio and Electric Company, 1917 Mott Ave., Far Rockaway, L.I., N.Y.
- SHARPLESS, A. ROBERTS (A'19), Radio Engineer, U. S. Navy Yard, Philadelphia, Pa. For mail: 824 N. Drexel Ave., Drexel Hill, Del. Co., Pa.
- SHARPLESS, WILLIAM M. (A'28), Radio Engineer, Bell Telephone Laboratories, Inc., Cliffwood, N.J.
- SHAUGHNESSY, E. H. (M'20), Engineering Dept., G.P.O., London, England.
- SHAW, A. C. (M'29), Engineer-in-Charge, London Station, British Broadcasting Corporation, Savoy Hill, London, W.C., England. For mail: 119 Headcorn Rd., Newbury, S.W., England.
- SHAW, FREDERICK L. (A'27), Publicity Director, United Reproducers Corporation, Suite 245, Third National Bldg., Dayton, Ohio.
- SHAW, HENRY S. (A'17-M'21), Chairman of Board of Directors, General Radio Company, 30 State St., Cambridge, Mass.
- SHAW, JAMES (J'28), Student, Polytechnic Institute of Brooklyn, 304 Denton Ave., Lynbrook, L.I., N.Y.
- SHAW, JOHN J. (A'28), General Manager, Abernathy Radio Service Company, 2360 N. Clark St., Chicago, Ill.
- SHAW, RAYMOND H. (A'28), Manufacturing Radio Engineer, Southern Radio Engineering Company, Tunstall Ave., S. Kensington, Sydney, Australia. For mail: "The Nest," Tunstall Ave., Kensington, Sydney, Australia.
- SHAW, ROBERT C. (A'29), Radio Research, Bell Telephone Laboratories, Box 122, Deal, N.J.
- SHAW, ROBERT E. (A'27), Laboratory Technician, Grigsby-Grunow Company, 4540 Armitage Ave., Chicago, Ill. For mail: 1523 W. 89th St., Chicago, Ill.
- SHAW, ROBERT M. (A'26), Signal Officer, Signal Corps Headquarters, Fort Lewis, Wash.
- SHEA, RICHARD F. (A'29), Radio Engineer, Atwater Kent Manufacturing Company, Philadelphia, Pa. For mail: 6526 Uber St., Philadelphia, Pa.
- SHEFFER, OLAN N. (A'25), Stafford, N.Y.
- SHEFFIELD, H. M. (A'27), Engineering Dept., Southwestern Bell Telephone Company, Dallas, Tex.
- SHELBY, R. E. (A'29), Student, National Broadcasting Company, 711-5th Ave., New York, N.Y. For mail: 100 Morningside Dr., New York, N.Y.
- SHELDON, CLINTON C. (A'26), Sheldon Radio Company, 605 S. Fairfax Ave., Hollywood, Calif.
- SHELTON, RAYMOND W. (A'28), Radio Service, P. O. Box 440, Paducah, Ky.
- SHEN, PAO-GUAY (A'29), Student, Harvard University, Cambridge, Mass. For mail: 28 Gorham St., Cambridge, Mass.
- SHEN, P. L. (A'28), c/o G. C. Yun, 52 Joffre Terrace, Avenue Joffre, Shanghai, China.
- SHEN, PINLU (A'28), Government Student, Automatic Electric Company, Inc., c/o Orange County Telephone Company, John St., Middletown, N.Y.
- SHEN, S. Z. (A'29), Engineer, Radio Corporation of America, 70 Van Cortlandt Park South and Saxon Ave., New York, N.Y. For mail: c/o B. H. Louison, 500 Riverside Dr., New York, N.Y.
- SHEPARD, MAXWELL (J'28), Country Agent, Pewton MacLaren, Ltd., Box 393A, G.P.O., Adelaide, South Australia. For mail: 185 Hutt St., Adelaide, South Australia.
- SHERMAN, JESSE B. (J'28), Radio Serviceman, Musical Products Distributing Company, 22 W. 19th St., New York, N.Y. For mail: 847 Manida St., New York, N.Y.
- SHERMAN, KENNETH S. (A'27), Student Engineer, Radio Dept., General Electric Company, Schenectady, N.Y. For mail: 1075 Park Ave., Schenectady, N.Y.
- SHERMAN, RUSSELL H. (A'19), Telephone Engineer, Illinois Bell Telephone Company, Gary Ind. For mail: 891 Calumet Ave., Hammond, Ind.
- SHERMAN, WARREN K. (A'28), Lieutenant, U. S. Navy, U. S. S. "New Mexico," c/o Postmaster, San Pedro, Calif.
- SHERMUND, RALPH C. (A'29), Engineer, Federal Telegraph Company, Palo Alto, Calif.
- SHERRATT, JOSEPH B. (A'28), 4 Queensbury Ave., Toronto 13, Ontario, Canada.
- SHESTACOVSKY, JOHN (A'27), Student, Columbia University, New York, N.Y. For mail: 195 Ocean Ave., Brooklyn, N.Y.
- SHIMAYAMA, TSURUO (A'28), Radio Engineer, Shimizu Hosojio, Shimizumura, Nr. Kumamotoshu, Japan.
- SHIPMAN, CHARLES H. (A'27), Clerk, The Dodd Company, 652 Huron Rd., Cleveland, Ohio. For mail: 14805 Ardenall Ave., East Cleveland, Ohio.
- SHIRE, LEO E. (A'27), Charge of Radio Telephone Equipment, Andean National Corporation, Ltd., Apartado 130, Cartagena, Colombia, South America.
- SHIRK, KENNETH C. (J'26-A'28), Radio Operator, Station KOIL, Mona Motor Oil Company, Council Bluffs, Iowa. For mail: 2407 Evans St., Omaha, Neb.
- SHOLES, S. R. (A'28), Correspondent in Radio, Stewart-Warner Speedometer Corporation, 1826 Diversey Pkwy., Chicago, Ill. For mail: 1507 Highland Ave., Wilmette, Ill.
- SHOMLER, H. B. (A'28), Radiotechnician, Ungar and Watson, Inc., 1363 1/2 S. Figueroa St., Los Angeles, Calif. For mail: 408 Wing St., Glendale, Calif.
- SHORE, ANAK (A'19), Marconi Wireless Telegraph Company, Chelmsford, England. For mail: 26 Rectory Rd., Chelmsford, Essex, England.
- SHORE, HENRY (A'27), Design Engineer, RCA Communications, Inc., New Brunswick, N.J.
- SHORT, DONALD WILLIAM (A'29), Television Division, General Electric Company, Schenectady, N.Y. For mail: 337 Summit Ave., Schenectady, N.Y.

- SHORT, HERBERT M. (A'14-M'16), Managing Director, Canadian Marconi Company, 11 St. Sacramento St., Montreal, P.Q., Canada.
- SHORTLAND, JAMES W. (A'27), Radio Service Company, Inc., 6 Church St., New York, N.Y. For mail: 135 Clarkson Ave., Brooklyn, N.Y.
- SHOTWELL, HAROLD H. (J'16-A'18), Chief Engineer, Operadio Manufacturing Company, St. Charles, Ill. For mail: 728 Prairie St., St. Charles, Ill.
- SHOU, ALLEN (A'28), Radio Engineer, Westinghouse Electric and Manufacturing Company, East Pittsburgh, Pa. For mail: 841 Holland Ave., Wilkinsburg, Pa.
- SHREVE, A. FRENCH (A'29), Radio Serviceman, Equitable Sales Company, 427 Liberty Ave., Pittsburgh, Pa. For mail: 7141 Thomas Blvd., Pittsburgh, Pa.
- SHUEY, PAUL F. (A'25), Radio Engineer, Westinghouse Electric and Manufacturing Company, East Pittsburgh, Pa. For mail: 214 Lehigh St., Swissvale, Pa.
- SHUHART, JOHN H. (A'25), Telephone Engineer, American Telephone and Telegraph Company, 195 Broadway, New York, N.Y. For mail: Valley Forge Rd., Phoenixville, Pa.
- SHULER, JOHN H. (A'28), Engineer, Westinghouse Electric and Manufacturing Company, Mansfield, Ohio. For mail: R.F.D. No. 2, Lexington, Ohio.
- SHULTISE, Q. M. (A'29), Radio Engineer, Universal Wireless Communication Company, 4619 Ravenwood Ave., E., Chicago, Ill. For mail: 4606 Hermitage Ave., Chicago, Ill.
- SHULTZ, E. PATTERSON (J'28), Student, University of Oklahoma, 902 S. 7th St., Chickasha, Okla.
- SHUMARD, CHARLES C. (M'27), Radio Engineer, RCA Bldg., Van Cortlandt Park, S., New York, N.Y. For mail: 400 Stanwick Ave., Moorestown, N.J.
- SHUSTER, EDMUND F. (J'26), Radio Service Company, 31 Hazle St., Wilkes-Barre, Pa.
- SHUTE, EMMETT R. (M'25), Operating Engineer, Western Union Telegraph Company, 195 Broadway, New York, N.Y.
- SIDDALL, RICHARD (A'27), Erie Radio Company, Cleveland, Ohio. For mail: 1880 Wymore Ave., East Cleveland, Ohio.
- SIEBEN, CLARENCE M. (A'29), Manager, Testing Dept., High Frequency Laboratories, 28 N. Sheldon St., Chicago, Ill. For mail: 1464 Larrabee St., Chicago, Ill.
- IEGEL, RALPH (A'27), Vitaphone and Movietone Engineer, Electrical Research Products, Inc., 250 W. 57th St., New York, N.Y. For mail: 1366 E. 40th St., Brooklyn, N.Y.
- IEGEL, SAMUEL (M'28), President, Aero-vox Wireless Corporation, 70 Washington St., Brooklyn, N.Y.
- IEGER, J. (A'29), Manager, Design Receivers, Technical Dept., Amateur Wireless Magazine, 58-61 Fetter Lane, London, E.C. 4, England. For mail: 156 Kensington High St., London, W. 8, England.
- SIGETY, LOUIS (J'27), Radio Operator, National Broadcasting Company, 711-5th Ave., New York, N.Y. For mail: 242 E. 77th St., New York, N.Y.
- SIGL, A. J. (A'25), Radio Editor, 136 St. Paul St., Rochester, N.Y. For mail: 35 Alameda St., Rochester, N.Y.
- SIGMON, L. C. (A'29), 46 Albion Rd., Wollaston, Mass.
- SIGNER, JOHN J. (A'29), 1123 Poinsettia Dr., Hollywood, Calif.
- SILCOX, ALBERT S., JR. (A'28), Service Manager, Golde Radio Company, Connellsville, Pa. For mail: 1325 S. Pittsburgh St., Connellsville, Pa.
- SILENT, HAROLD C. (A'19), Engineer, Electrical Research Products, Inc., 7046 Hollywood Blvd., Los Angeles, Calif.
- SILVER, BENJAMIN L. (A'20), Radio Engineer, 509-12th St., Brooklyn, N.Y.
- SILVER, MC MURDO, (A'24), President, Silver-Marshall, Inc., 6401-51 W. 65th St., Chicago, Ill.
- SIMBORI, MASAYOSI (A'28), Radio Engineer, Japan Wireless Telegraph Company, Ltd., 18-2-chome, Marunouchi, Kojimachiku, Tokyo, Japan.
- SIMMONDS, E. J. (M'25), Bank House, Barclays Bank, West Drayton, Middlesex, England.
- SIMON, ARTHUR (A'17), Electrical Engineer, Cutler-Hammer Manufacturing Company, Milwaukee, Wis.
- SIMON, ISAAC B. (A'29), Teacher, Eastern High School, Washington, D.C. For mail: 1123 E. Capitol St., Washington, D.C.
- SIMONDS, D. T. (A'18), Research Laboratory, General Electric Company, Schenectady, N.Y. For mail: 1256 Courtland St., Schenectady, N.Y.
- SIMONS, ORLIN B. (A'26), Service Manager, Empire Radio Service, Detroit, Mich. For mail: 13234 Stoepel Ave., Detroit, Mich.
- SIMPSON, ALEXANDER V. (A'23-M'26), Radio Engineer, 28 Westgate, Burnley, Lancs., England.
- SIMPSON, BURTON T. (A'27), Director, State Institute Study of Malignant Diseases, 113 High St., Buffalo, N.Y.
- SIMPSON, FRED H., JR. (J'26), President, Universal Radio, Inc., P. O. Box 2318, Boston, Mass. For mail: P. O. Box 51, Newark, N.J.
- SIMPSON, LE ROY C. (J'28), Student, Bagdad Rd., Durham, N.H. For mail: 8 Mynderse St., Schenectady, N.Y.
- SIMPSON, PAUL A. (A'28), 3655 W. 102nd St., Cleveland, Ohio.
- SIMS, JAMES W. (A'27), General Merchandise, J. W. Sims and Company, LaGrange, Tenn.
- SINGER, EMANUEL (A'21), Radio Service and Maintaining Company, 2309 Broadway, New York, N.Y. For mail: 760 W. End Ave., New York, N.Y.
- SINGH, HARBAKSH (J'29), Wireless Operator, Wireless Station, Kuala Lumpur, Federated Malay States. For mail: 271 Kota Rd., Taiping, Federated Malay States.

- SINGLETON, HAROLD C. (A'25), RCA-Victor Company, Inc., 235 Montgomery St., San Francisco, Calif.
- SINNETT, CHESTER M. (A'29), Radio Engineer, Westinghouse Electric and Manufacturing Company, Radio Engineering Dept., East Pittsburgh, Pa. For mail: R.F.D. No. 1, Box 223, Wilkinsburg, Pa.
- SINSHEIMER, ARTHUR (A'26), Radio Editor and Dealer, 8th Floor, 239 W. 39th St., New York, N.Y. For mail: 1155 Brooklyn Ave., Brooklyn, N.Y.
- SIOVIC, JOHN E. (A'29), Manager, Service Dept., H. A. Heinsen and Company, 3027 E. 92nd St., Chicago, Ill. For mail: 3621 E. 107th St., Chicago, Ill.
- SIRMS, WISWALD J. (A'27), Service Engineer, Electrical Research Products, Inc., Rm. 1607, Philadelphia Fidelity Bldg., Philadelphia, Pa.
- SIVIAN, LEON J. (A'18), Research Engineer, Bell Telephone Laboratories, Inc., 463 West St., New York, N.Y.
- SKEELS, DUDLEY K. (A'29), Service Manager, Skeels Brothers, 1752 Pilgrim Rd., Toledo, Ohio. For mail: P. O. Box 214, Station C, Toledo, Ohio.
- SKELTON, KENNETH W. (A'28), Director of Broadcasting, Radio Station WDBO, Orlando Broadcasting Company, Fort Gatlin Hotel, Orlando, Fla.
- SKINKER, MURRAY F. (A'29), Assistant Director of Research, Brooklyn Edison Company, 55 Johnson St., Brooklyn, N.Y.
- SKINKLE, MYRON H., JR. (A'26), E.S. and E. Company, Albany N.Y. For mail: 273 Livingston Ave., Albany, N.Y.
- SKINNER, CLIFTON ROSS (A'29), Radio Repairman, Palo Alto Hardware, 278 University Ave., Palo Alto, Calif. For mail: P. O. Box 1331, Stanford University, Calif.
- SKINNER, OSCAR E. (A'28), Manager, Wiamo Club, Wiamo, Mass. For mail: Dennis Port, Mass.
- SKIRROW, JOHN F. (M'27), Vice-President and Chief Engineer, Postal Telegraph-Cable Company, 67 Broad St., New York, N.Y.
- SKOV, JENS INGVAR (A'20), Radiomarine Corporation of America, Wilmington, Calif. For mail: P. O. Box 297, San Pedro, Calif.
- SLATER, F. ROBERT (A'26), Radio Corporation of the Philippines, Plaza Moraga, Manila, P.I.
- SLATER SAUL I. (J'23-A'26), Engineer, Gold Seal Electrical Company, 129 S. 15th St., Newark, N.J. For mail: 1564 St. John's Pl., Brooklyn, N.Y.
- SLATER, WILFRED (A'29), Radio Engineer, W. Slater and Company, 26 High St., Skipton, Yorks, England. For mail: Spring Bank House, Skipton, Yorks, England.
- SLATTERY, JOHN J. (J'29), 6994 Ruskin Lane, Upper Darby, Pa.
- SLAUGHTER, JACK D. (A'28), Manager, Maintenance Dept., Tennessee Electric Power Company, Cleveland, Tenn. For mail: W. 26th St., Cleveland, Tenn.
- SLAVICK, HENRY WILLIAM (A'28), Broadcast Engineer, Station WMC, Commercial Appeal, Inc., Memphis, Tenn. For mail: 1582 Tutwiler Ave., Memphis, Tenn.
- SLAVIN, SAMUEL B. (A'29), Radio Engineer, General Electric Company, 5441 E. 14th St., Oakland, Calif. For mail: 524 Apgar St., Oakland, Calif.
- SLEE, JOHN A. (F'29), Assistant General Manager, Marconi International Marine Communication Company, Marconi House, Strand, London, England. For mail: 16 Raphael St., London, S.W. 7, England.
- SLEEPER, J. LLOYD (A'28), Manager, Liggett-Sleeper Radio Company, 213 N. Broadway, Santa Ana, Calif. For mail: 1334 S. Parton St., Santa Ana, Calif.
- SLETMOE, A. M. (A'28), Engineer, The Pacific Telephone and Telegraph Company, 904 Telephone Bldg., Seattle, Wash. For mail: 4026 Evanston, Seattle, Wash.
- SLOAN, DAVID H. (A'27), Research, General Electric Company, Schenectady, N.Y. For mail: 6 Hawk St., Schenectady, N.Y.
- SLOAN, FERGUS M. (A'29), Broadcast Engineer, Radio Station WOS, State Marketing Bureau, Capitol Bldg., Jefferson City, Mo.
- SLOAN, FRANCIS V. (A'25-M'28), U. S. Radio Inspector, Department of Commerce, 2022 The Engineering Bldg., Chicago, Ill.
- SLOCUM, K. W. (A'28), Fokker Aircraft Corporation, Passaic, N.J. For mail: 5 Anderson St., Hackensack, N.J.
- SMALL, PERCY L. (A'26), Doctor Dental Surgery, 738 Lexington Ave., New York, N.Y.
- SMEBY, LYNNE C. (A'27), Engineer, Station WDCY, Twin City Broadcasting Company, 900 W. Broadway, Minneapolis, Minn. For mail: 1504 W. Broadway, Minneapolis, Minn.
- SMITH, ARTHUR (A'23), Director of Physics, Central Technical School, Toronto, Ont., Canada. For mail: 52 Parkway Ave., Toronto, Ont., Canada.
- SMITH, ARTHUR E. (A'15), Inspection Dept., Bell Telephone Laboratories, Inc., 495 Hudson St., New York, N.Y. For mail: 44 Arthur St., Ridgefield Park, N.J.
- SMITH, ARTHUR Z. (A'29), Receiving Engineer, Radio Corporation of America, Riverhead, L.I., N.Y.
- SMITH, B. J. (A'28), Radio Mechanic, Canadian Westinghouse Company, Ltd., Toronto, Ont., Canada. For mail: 234 Glenholme Ave., Toronto, Ont., Canada.
- SMITH, CHARLES S., JR. (A'25), Supervisor, Long Lines Maintenance, Pacific Telephone and Telegraph Company, Room 1504, 140 New Montgomery St., San Francisco, Calif.
- SMITH, C. BERNARD (A'26), Research Engineer, Echophone Manufacturing Company, 968 N. Formosa Ave., Los Angeles, Calif. For mail: 958 1/2 S. Kenmore Ave., Los Angeles, Calif.
- SMITH, C. C. (A'28), Radio Inspector, Dominion Government, 41 Morrow St., Peterboro, Ont., Canada.
- SMITH, DAVID H. (A'28), Instructor, National Radio Institute, 1536 You St., N.W., Washington, D.C.

- SMITH, EARL D. (J'24), Engineer, Research Engineering Company, 915 Duff Ave., Ames, Iowa.
- SMITH, EDWIN W. (A'27), Research Engineer, Nathaniel Baldwin, Inc., 3474 S. 23rd St., E., Salt Lake City, Utah. For mail: 4730 S. 13th St. E., Murray, Utah.
- SMITH, ERNEST F. (M'24), Superintendent of Substations, Commonwealth Edison Company, Chicago, Ill.
- SMITH, FRANKLIN S. (A'25), Consulting Engineer, Products Protection Corporation, New Haven, Conn. For mail: Hotel Bossert, Brooklyn, N.Y.
- SMITH, FREDERICK A. (J'16-A'19), Radio Engineer, Canadian Marconi Company, 11 St. Sacramento St., Montreal, P.Q., Canada. For mail: P. O. Box 1690, Montreal, P.Q., Canada.
- SMITH, F. J. (A'28), Graduate Student, University of Minnesota, Minneapolis, Minn. For mail: 1584 E. 43rd St., Cleveland, Ohio.
- SMITH, HAROLD E. (A'28), Engineer, Station WOKO, 800 South St., Peekskill, N.Y. For mail: Hotel Windsor, Poughkeepsie, N.Y.
- SMITH, HAROLD I. (A'28), Radio Engineer, 50 High St., Buxton, England.
- SMITH, HERBERT H. (A'29), U. S. Radio Inspector, Department of Commerce, Radio Division, 328 Custom House, San Francisco, Calif. For mail: 25 Cervantes Blvd., Apt. 304, San Francisco, Calif.
- SMITH, HOWARD L. (A'29), Serviceman, Chicago Motor Supply Company, 432 E. 63rd St., Chicago, Ill. For mail: 4919 N. Lawndale Ave., Chicago, Ill.
- SMITH, JAMES E. (A'20-M'26), President, National Radio Institute, Washington, D.C. For mail: 1333 Fairmont St., N.W., Washington, D.C.
- SMITH, JAMES H. (A'26), Radio Engineer and Analytical Chemist, Radio Stores, Duke St., Dartmouth, England.
- SMITH, JESSE H. (A'26), Lieutenant Commander, U. S. Navy, c/o Bureau of Navigation, Navy Dept., Washington, D.C. For mail: U. S. Navy Yard, Charleston, S.C.
- SMITH, JESSE W. (A'29), Student, Dodge Institute, Valparaiso, Ind. For mail: Box 102, Knox, Pa.
- SMITH, JOHN S. (M'28), American Representative, Marconi International Marine Commercial Company, Ltd., 40 Rector St., New York, N.Y.
- SMITH, JOHN W. (A'27), Bell Telephone Laboratories, Inc., 463 West St., New York, N.Y.
- SMITH, J. O. (A'20-M'26), Manager, Commercial Dept., R.C.A. Photophone, Inc., 411-5th Ave., New York, N.Y. For mail: 26 Mason Ave., Babylon, L.I., N.Y.
- SMITH, J. P. (A'29), Radio Engineer, Bldg. 89, General Electric Company, Schenectady, N.Y. For mail: 136 Glen Ave., Scotia, N.Y.
- SMITH, K. R. (M'28), Manager, Technical Division, Brunswick-Balke-Collender Company, 623 S. Wabash Ave., Chicago, Ill.
- SMITH, L. E. (J'26-A'28), Radiotechnician, Western Air Express, 117 W. 9th St., Los Angeles, Calif. For mail: 340 N. Painter Ave., Whittier, Calif.
- SMITH, MALCOLM H. (A'14), 17 Methyll St., Providence, R.I.
- SMITH, OLIVER C. (A'27), District Transmission Engineer, The Pacific Telephone and Telegraph Company, 500 Telephone Bldg., Spokane, Wash.
- SMITH, PAUL CLARENCE (A'29), Instructor in Electrical Engineering, University of Akron, Akron, Ohio. For mail: 179 Ido Ave., Akron, Ohio.
- SMITH, PERCY DE WILLARD (A'28), District Supervisor, Electrical Research Products, Inc., 340 Board of Trade, Kansas City, Mo.
- SMITH, SAMUEL B. (A'27), Patent Attorney, Radio Corporation of America, 233 Broadway, New York, N.Y.
- SMITH, SERENO E. (A'27), Chief Engineer, Radio Station WCAH, Hotel Ft. Hayes, Columbus, Ohio.
- SMITH, SIDNEY B. (A'14-M'18), Research Dept., Marconi Wireless Telegraph Company, Ltd., New St., Chelmsford, Essex, England.
- SMITH, STANLEY C. (A'29), Tester, Federal Radio Corporation, Buffalo, N.Y. For mail: 62 Manden St., Buffalo, N.Y.
- SMITH, THEODORE A. (J'25-A'26), Assistant Engineer, Radio Corporation of America, 70 Van Cortlandt Park South and Saxon Ave., New York, N.Y. For mail: 20 Heights Rd., Ridgewood, N.J.
- SMITH, VICTOR G. (A'27), Lecturer, Department of Electrical Engineering, University of Toronto, Toronto, Ont., Canada.
- SMITH, WADE H. (A'27), 849 Elwood St., Sherman, Calif.
- SMITH, WALTER C. (A'18), Assistant Protection Engineer, Michigan Bell Telephone Company, 1365 Cass Ave., Detroit, Mich. For mail: 1245 Lake Pointe Ave., Grosse Pointe Park, Mich.
- SMURTHWAITE, F. W. (A'27), Manufacturer, Radio Apparatus, 15A Onslow Gardens, Wallington, Surrey, England.
- SMYTH, EARLE (A'29), Accountant, Delaware Electric and Supply Company, 213 Shipley St., Wilmington, Del. For mail: 418 S. Grant Ave., Wilmington, Del.
- SMYTHE, EDWIN H. (A'15-M'26), 1162 Monadnock Bldg., Chicago, Ill.
- SNAVELY, B. L. (A'29), Graduate Student, Princeton University, Princeton, N.J. For mail: 2644 E. King St., Lancaster, Pa.
- SNEAD, SAM (A'25), Proprietor, Sam Snead Radio Service, 421-27th St., Milwaukee, Wis.
- SNOOK, H. CLYDE (M'19), Electrical Engineer, Bell Telephone Laboratories, Inc., 463 West St., New York, N.Y. For mail: Beachwood Apts., Summit, N.J.
- SNOW, ALBERT E. (A'21), Radio Compass Section, Wireless Specialty Apparatus Company, Jamaica Plain, Mass. For mail: Orleans, Cape Cod, Mass.
- SNOW, HAROLD A. (A'24), Radio Engineer, Radio Frequency Laboratories, Boonton, N.J.
- SNOW, LOUIS A. (A'27), Radio Service, 35 Ventura Ave., Ventura, Calif.

- SNOW, WILLIAM B. (A'26), Member of Technical Staff, Bell Telephone Laboratories, 463 West St., New York, N.Y.
- SNYDER, CHRISTOPHER L. (A'29), Radio Engineer, Philadelphia Storage Battery Company, C and Ontario Sts., Philadelphia, Pa.
- SNYDER, LESLIE T. (A'29), Manager, Radio Dept., Howe Music Store, Alpena, Mich. For mail: 111 Tawas St., Alpena, Mich.
- SNYDER, NORMAN (A'26), Engineer, General Electric Company, Schenectady, N.Y. For mail: 1454 Glenwood Blvd., Schenectady, N.Y.
- SNYDER, RICHARD L. (A'26), Bell Telephone Company of Pennsylvania, 1835 Arch St., Philadelphia, Pa.
- SNYDER, ROBERT E. (A'27), Foreman, Sterling Manufacturing Company, Cleveland, Ohio. For mail: 2797 Avondale Road, Cleveland Heights, Ohio.
- SNYDER, ROY A. (A'29), Radio Diagnostician, Nailon Corporation, 108-110 Liberty St., Peoria, Ill.
- SNYDER, WILLIAM R. (A'26), Sound Dept., Metropolitan Sound Studios, 1040 Las Palmas, Hollywood, Calif. For mail: 7220 Waring Ave., Hollywood, Calif.
- SNYDER, W. GILMAN, JR. (A'29), Transmission Engineer, Pacific Telephone and Telegraph Company, Sacramento, Calif. For mail: 115 Court St., Jackson, Calif.
- SO, MANABU (A'29), Research Staff, Vacuum Tube Dept., Research Laboratory, The Tokyo Electric Company, Kawasaki, Japan.
- SODERBERG, ARNOLD J. (A'27), Radio Technician, Wurlitzer Company, 250 Stockton St., San Francisco, Calif. For mail: c/o D. I. Englund, Kerman, Calif.
- SODERHOLM, ARTHUR E. (A'26), Electrical Engineering, N.Y.S. Rys., 267 State St., Rochester, N.Y. For mail: 12 Congress Ave., Rochester, N.Y.
- SOETERS, RAYMOND A. (A'29), Tool-maker, 571 Linden Rd., Birmingham, Mich.
- SOHON, HARRY (A'28), Graduate Student, Cornell University, Ithaca, N.Y. For mail: 201 Highland Ave., Ithaca, N.Y.
- SOHOR, P. H. (A'25-M'28), Service Manager, Pacific Coast Division, Charles Freshman Company, Inc., 160-10th St., San Francisco, Calif.
- SOKOLCOW, DMITRI M. (M'29), Vice-Director, Instytut Radjotechniczny, Warszawa, Poland.
- SOLARI, FRANK (J'22-A'28), Superintendent, Holbrook Hall Realty Company, 150 Gramatan Ave., Mt. Vernon, N.Y. For mail: 38 Darvall St., Corona, L.I., N.Y.
- SOLOV, ABRAHAM (A'27), Assistant Service Manager, Radio Dept., J. A. Hearn and Son, 6 W. 14th St., New York, N.Y. For mail: 1721 Bathgate Ave., New York, N.Y.
- SOMERS, BROCK A. (A'29), Vacuum Tube Development Engineer, Research Laboratory, General Electric Company, Schenectady, N.Y. For mail: 509 Craig St., Schenectady, N.Y.
- SOMERS, RICHARD M. (A'29), Research Engineer, Thomas A. Edison, Inc., West Orange, N.J. For mail: 242 North Oraton Parkway, East Orange, N.J.
- SOMERSALO, G. A. (A'24), Consulting Engineer, 2136 N. Kedzie Ave., Chicago, Ill.
- SOMERSET, E. T. (A'29), G2DT, The Brackens, Deepdene Park, Dorking, Surrey, England.
- SOMMER, EMITT H. (J'14-A'16), Installation Supervisor, Philadelphia Storage Battery Company, Ontario and C Sts., Philadelphia, Pa. For mail: 90 Sanford Ave., North Plainfield, N.J.
- SONKIN, DAVID (J'18-A'18-M'23), Development and Inspection Engineer, F.A.D. Andrea, Inc., Long Island City, L.I., N.Y. For mail: 1855 Loring Place, New York, N.Y.
- SONOYAMA, HARUTOSHI (A'28), Radio Engineer, Japan Wireless Telegraph Company, Jiji Bldg., Marunouchi, Tokyo, Japan. For mail: Tobisumura Hikawa-gun, Shimane-ken, Japan.
- SO RELLE, J. L. (A'29), Service Manager, Radio Dept., Asheville Battery Company, Asheville, N.C.
- SORENSEN, CARL P. (A'28), 3705 Byron St., Chicago, Ill.
- SORGE, BARTHOLD W. (A'28), Radio Service Engineer, The Emsee Radio Company, 1129 S. Maple Ave., Los Angeles, Calif.
- SORKNESS, HARDUS (A'29), Radio Technician, Sorkness Super-Service Station, 311 E. Florida Ave., Hemet, Calif.
- SOSEBEE, FRANK E. (A'29), Radio Instructor, The Infantry School, U.S. Army, P. O. Box 615, Fort Benning, Ga.
- SOUCY, CHESTER I. (A'26), Service Superintendent, Research Products Engineering Dept., Northern Electric Company, 637 Craig St., West, Montreal, P.Q., Canada.
- SOULE, HAROLD (A'28), Recording Engineer, General Recording Studios, 200 W. 57th St., New York, N.Y.
- SOURS, M. D. (A'27), Room 605, Capitol Bldg., Harrisburg, Pa. For mail: 324 S. 16th St., Harrisburg, Pa.
- SOUTHWORTH, G. C. (M'26), Engineer, American Telephone and Telegraph Company, 195 Broadway, New York, N.Y.
- SOWELL, GEORGE O. (A'29), Manager Radio Laboratory, Kosciusko, Miss.
- SPARROW, A. W. (A'29), Wireless Officer, Marconi International Marine Comm. Company, Ltd., Marconi House, Strand, London, W.C.2, England. For mail: Branston, Lindoln, England.
- SPEERS, JOHN C. (A'25), R. D. Speers Company, 329 W. 3rd St., Davenport, Iowa.
- SPEICHER, ELLSWORTH J. (A'28), Service Manager, Laundau's Music and Jewelry Store, 21 N. Main St., Pittston, Pa. For mail: 429 George Ave., Wilkes-Barre, Pa.
- SPEICHER, JOHN D. (A'20), Telephone Electrician, Western Electric Company, New York, N.Y. For mail: 9303-244th St., Belrose, L.I., N.Y.
- SPEIRS, GEORGE E. (J'27), Student, Northeastern University, Boston, Mass. For mail: 1621 North Shore Rd., Revere, Mass.
- SPENCE, P. W. (A'22), Engineer, American Telephone and Telegraph Company, 193 Broadway, New York, N.Y.

- SPENCER, ALBERT H. (A'26), General Manager, Spencer Manufacturing Company, Aurora, Neb. For mail: Aurora, Neb.
- SPENCER, GEORGE E. (A'26), Electrical Engineer, Victor Talking Machine Company, Camden, N.J.
- SPENCER, LEONARD (A'22-M'27), Chief Engineer, Station CKAC La Presse, Montreal, P.Q., Canada.
- SPENCER, MILLARD C. (A'16), Electrical Engineer, Crocker-Wheeler Electric Manufacturing Company, Ampere, N.J. For mail: 105 Park Ave., East Orange, N.J.
- SPHAR, CLARK H. (J'27-A'29), Student, Polytechnic College of Engineering, Oakland, Calif. For mail: 790 Oak St., San Francisco, Calif.
- SPICER, FLOYD O. (A'24), Sales Engineer, Export Dept., Radio Corporation of America, 233 Broadway, New York, N.Y.
- SPIELMAN, H. MAX (A'26), Manager, Gormac Electric Company, Inc., 131 W. 65th St., New York, N.Y. For mail: 2080 Grand Ave., New York, N.Y.
- SPIES, MARK C. (A'27), Manager, Broadcasting Station WJBL, Decatur, Ill. For mail: 1538 N. Edward St., Decatur, Ill.
- SPIKE, J. EDWARD, JR. (A'29), Assistant in Physics, Harvard University, Cambridge, Mass. For mail: 70 Lake View Avenue, Cambridge, Mass.
- SPILLER, CECIL CHARLES (J'29), 1446 Saltair Ave., Sawtelle, Calif.
- SPITZER, EDWIN E. (A'28), Research Engineer, Research Laboratory, General Electric Company, Schenectady, N.Y. For mail: 155 Elmer Ave., Schenectady, N.Y.
- SPRAGUE, CLARENCE A. (A'14-M'16), Patent Attorney, Bell Telephone Laboratories, Inc., 463 West St., New York, N.Y.
- SPRAYBERRY, FRANK L. (A'28), Instructor, National Radio Institute, National Radio Institute, Washington, D.C.
- SQUIER, GEORGE O. (F'16), 2400-16th St., Washington, D.C.
- SREBROFF, CHARLES M. (A'24-M'28), Engineer-in-Charge, Radio Engineering Laboratories, 100 Wilbur Ave., Long Island City, L.I., N.Y. For mail: 186-24 Jordan Ave., Chapel Gardens, Hollis, L.I., N.Y.
- STAEGE, STEPHEN A. (A'21), Industrial Engineer, Westinghouse Electric and Manufacturing Company, East Pittsburgh, Pa. For mail: 6624 Beacon St., Pittsburgh, Pa.
- STAGG, CARL (A'29), Receiving Engineer, Radio Corporation of America, Riverhead, L.I., N.Y. For mail: P. O. Box 1133, Riverhead, L.I., N.Y.
- STAGNARO, JOHN A. (A'27), Radio Engineer, Columbus Electric Company, 2121 Chestnut St., San Francisco, Calif. For mail: 1869 Stockton St., San Francisco, Calif.
- STAHL, BARTON E. (A'29), Supervisor, Station WRC, 3308-14th St., Washington, D.C.
- STAHL, THEODORE H. (J'26-A'28), Assistant Power Operator, Blackstone Substation, Consumers Power Company, Jackson, Mich.
- STAIR, DANIEL N. (A'25), Engineer-in-Charge, National Broadcasting Company, River Rd., Bound Brook, N.J.
- STALNAKER, BURR (A'28), Operator and Engineer-in-Charge, Charleston Radio Broadcasting Company, Hotel Ruffner, Charleston, W. Va. For mail: R.F.D. No. 2, Charleston, W. Va.
- STANESBY, HAROLD (A'28), Inspector, Radio Station, Post Office Engineering Dept., Post Office Research Station, Dollis Hill, London, N.W.2, England. For mail: 19 Earlsfield Rd., S.W., 8, London, England.
- STANKO, EDWARD (A'24), Installation and Survey Engineer, Electrical Research Products, Inc., 250 W. 57th St., New York, N.Y. For mail: 182 Locust St., Fall River, Mass.
- STANSEL, FRANK R. (A'26), Engineer, Bell Telephone Laboratories, Inc., 463 West St., New York, N.Y.
- STANSFIELD, SELWYN (J'26-A'29), Public Service Address Operator, Wardell Realty Company, The Wardell, 15 E. Kirby Ave., Detroit, Mich.
- STANTLEY, J. J. (A'15-M'27), Secretary, Treasurer and General Manager, Continental Radio and Electric Corporation, 160 Varick St., New York, N.Y. For mail: 686 Maywood Ave., Maywood, N.J.
- STANTON, CLAIR F. (A'27), Radio Engineering Station, Ridgeroad Experimental Laboratory, R.D.8, Box 180, Schenectady, N.Y.
- STANTON, JAMES M. (A'29), Installation Engineer, Electrical Research Products, Inc., 458 Skinner Bldg., Seattle, Wash. For mail: 430-25th St., Apt. 6, Ivy Apts., Ogden, Utah.
- STANTON, R. E. (A'26), 4600 Kutztown Rd., Temple, Pa.
- STANWICK, CHARLES A. (A'15), 33 Beech St., E. Orange, N.J.
- STARK, ELDON E. (A'27), 100 Franklin St., Boston, Mass. For mail: 258 Linwood Ave., Newtonville, Mass.
- STARK, L. P. (A'29), Meter Tester, Texas Power and Light Company, 305 Center St., Brownwood, Tex. For mail: 1503-3rd St., Brownwood, Tex.
- STARR, ALFRED R. (A'17), Radio Engineer, International Telephone and Telegraph Corporation, 67 Broad St., New York, N.Y. For mail: 463 1/2-1st St., Brooklyn, N.Y.
- STARR, C. HARRY (A'26), Engineering Dept., Northern Electric Company, 121 Shearer St., Montreal, P.Q., Canada.
- STARR, TROY S. (A'26), Transmission Man, American Telephone and Telegraph Company, 44 Church St., Buffalo, N.Y. For mail: P. O. Box 96, Gerry, N.Y.
- STARRETT, JOHN S. (A'22), Radio Engineer, International Telephone and Telegraph Company, 67 Broad St., New York, N.Y. For mail: c/o Standard Electrica Argentina, 185 Paseo de Colon, Buenos Aires, Argentina, South America.
- STAUFFER, J. LUKE (A'27), Engineer, Edison Electric Company, Lancaster, Pa.
- STAUFFER, RAY EVERETT (A'29), Radio Dept., General Electric Company, Schenectady, N.Y. For mail: 814 Union St., Schenectady, N.Y.

- STAYER, DAVID (A'29), Radio Engineer, Westinghouse Electric and Manufacturing Company, Radio Engineering Dept., East Pittsburgh, Pa. For mail: 6503 Landview St., Pittsburgh, Pa.
- STEEL, W. ARTHUR (M'19), Chief Technical Officer, Dept. of National Defence, c/o Asst. Director of Signals, Ottawa, Ont., Canada.
- STEFFIN, V. J. (A'28), Radio Service Engineer, People's Outfitting Company, Detroit, Mich. For mail: 344 Orchard St., Wyandotte, Mich.
- STEIGER, CHARLES H. (A'26), Operator, Station WMBS, 210 Locust St., Harrisburg, Pa. For mail: 1938 Green St., Harrisburg, Pa.
- STEIN, ADAM, JR. (M'15-F'17), P. O. Box 25, Silver Lake, Plymouth County, Mass.
- STEIN, FREDERICK W. (A'26), President, Steinite Radio Company, Atchison, Kan.
- STEIN, HAROLD A. (A'29), Western Electric Manufacturing Company, 128 W. Lake St., Chicago, Ill. For mail: 139 Custer Ave., Evanston, Ill.
- STEINBERGER, ARTHUR W. (A'27), Acoustic Engineer, Colonial Radio Corporation, 25 Wilbur Ave., Long Island City, L.I., N.Y. For mail: 289 Amherst Ave., Jamaica, L.I., N.Y.
- STEINBERGER, LOUIS (M'15), Inventor, 1715 Avenue H, Brooklyn, N.Y. For mail: 664 E. 18th St., Brooklyn, N.Y.
- STEINER, HARRY C. (A'29), Engineer, Research Laboratory, General Electric Company, 1 River Rd., Schenectady, N.Y. For mail: 102 James St., Scotia, N.Y.
- STEINHAUSER, CLARENCE J. (A'29), Berco Coal Company, 10800 Devine St., Detroit, Mich.
- STELLWAGEN, FRANK W. (A'29), Student, Columbia Engineering School, Columbia University, New York, N.Y. For mail: 8637-77th St., Woodhaven, L.I., N.Y.
- STEMPEL, WALDEMAR M. (A'15), Assistant Professor of Physics, Stevens Institute of Technology, Hoboken, N.J.
- STENERI, ARTHUR J. (A'29), Trudeau, New York.
- STENGER, J. H., JR. (A'26), Proprietor and Director, Radio Broadcasting Station WBAX, P. O. Box 104, Wilkes Barre, Pa.
- STEPHENS, WILLIAM H. (J'27-A'29), Box 395, Honesdale, Pa.
- STEPHENSON, MARTIN A. (A'27), Radio Service Manager, Hutton and Jones, Inc., Plainville, Conn. For mail: 125 Broad St., Plainville, Conn.
- STERBA, E. J. (A'20), Radio Engineer, Bell Telephone Laboratories, Inc., P. O. Box 122, Deal, N.J.
- STERKY, HAKON K. A. (A'25), Graduate Electric Engineer, Svenska Radioaktiebolaget, 12 Alstromergatan, Stockholm, Sweden. For mail: Norrbackagatan, Stockholm, Sweden.
- STERLING, GEORGE E. (A'27-M'28), U.S. Radio Inspector, Radio Division, Dept. of Commerce, Baltimore, Md.
- STERNBERG, F. B. (A'27), Vice-President, Superb Bldg., Room 300, 128 Market St., Newark, N.J.
- STERN, MORTON W. (A'16-M'25), President, Cresradio Corporation, 166-32 Jamaica Ave., Jamaica, L.I., N.Y. For mail: 89-30-146th St., Jamaica, L.I., N.Y.
- STEVENS, ARCHIE M. (A'12-M'25), Diagonal Roque Pena 501, Oficina 210, Buenos Aires, Argentina, South America.
- STEVENS, CARL T. (A'27), Vice-President, Reinhard Brothers Company, 13 S. 9th St., Minneapolis, Minn.
- STEVENS, RONALD C. (J'28-A'29), Radio Technician, C. A. Munro, Ltd., 20-22 Canterbury St., St. John, N.B., Canada.
- STEVENS, STERLING M. (A'28), 1050 Cloverdale Ave., Los Angeles, Calif.
- STEVENS, WALDO W. (A'29), Associate Examiner, United States Patent Office, Washington, D.C. For mail: 1814 Jackson St., Woodridge, Washington, D.C.
- STEVENS, WILBUR C. (A'26), Service Manager, Penn Electrical Engineering Company, 517 Ash St., Scranton, Pa. For mail: 1211 Marion St., Scranton, Pa.
- STEVENS, WILLIAM J. (A'27), Radio Service, 1017 Peniston St., New Orleans, La.
- STEWART, ARTHUR C. (A'27), Manager, Radio Service Dept., Beckley Ralston Company, 1801 S. Michigan Ave., Chicago, Ill. For mail: 3942 Eddy St., Chicago, Ill.
- STEWART, CHARLES H. (A'14-M'27), Vice-President, American Radio Relay League, Hartford, Conn. For mail: St. David's, Delaware County, Pa.
- STEWART, G. EDWIN (A'28), Chief Recording Engineer, Paramount Famous Lasky Corporation, 6th and Pierce Aves., Astoria, L.I., N.Y. For mail: 3988-49th St., Sunnyside, L.I., N.Y.
- STEWART, JAMES W. (A'27), 135 W. Jackson St., York, Pa.
- STEWART, JESSICA DEE (M'29), Patent Attorney, 406 International Bldg., Washington, D.C.
- STEWART, RALPH B. (A'19-M'26), Patent Lawyer, 406 International Bldg., Washington, D.C.
- STEWART, RONALD B. (A'28), Engineer, Electrical Research Products, Inc., 7046 Hollywood Blvd., Hollywood, Calif.
- STEWART, W. H. (A'29), Radio and Electrical Engineer, Sun Oil Company Laboratory, 1501 Caruth St., Dallas, Tex.
- STILLHAMER, ARTHUR G. (A'23), Director Research Laboratory and Radio Engineer, Shratt Laboratory, 705 N. East St., Bloomington, Ill.
- STINCHFIELD, J. M. (A'29), Engineer, E. T. Cunningham, Inc., 370-7th Ave., New York, N.Y. For mail: 6 Winthrop Place, Maplewood, N.J.
- STINSON, LAWRENCE W. (A'29), Chief Operator, Broadcasting Station KVOO, Wright Bldg., Tulsa, Okla.
- ST. JAMES, ROBERT T. (M'26), 401 Bendix Drive, South Bend, Ind.
- ST. LOUIS, A. R. (A'29), Communication Engineer, Aviation Exploration, Inc., Dolmar Bldg., Shanghai, China.
- STOBBE, JOHN A. (A'28), Princeton University, Princeton, N.J. For mail: 654 E. 23rd St., Brooklyn, N.Y.

- STOCKELLBURG, ARTHUR A. (A'28), Manager, Radio Division, W. T. Grant Company, 395 Washington St., Boston, Mass. For mail: 12 Osborne Rd., West Medford, Mass.
- STOCKER, ARTHUR C. (A'28), Student Engineer, General Electric Company, Schenectady, N.Y. For mail: 23 Hawk St., Apt. 7, Schenectady, N.Y.
- STOEKLE, ERWIN R. (M'26), President, Central Radio Laboratories, 14-28 Keefe Ave., Milwaukee, Wis.
- STOKES, RAY (A'29), Service Manager, Wallace Radio Service Company, 103 West 13th St., Oklahoma City, Okla. For mail: 1633 West 11th St., Oklahoma City, Okla.
- STOLLE, R. A. (A'29), Technical Radio Engineer, 150 Glendale Blvd., Los Angeles, Calif. For mail: 1619 N. Benton Way, Los Angeles, Calif.
- STOLZENBACH, R. W. (A'29), Instructor in Physics and Radio, Wittenberg College, Springfield, Ohio. For mail: 273 W. 2nd St., Springfield, Ohio.
- STONE, CARRINGTON H. (A'14-M'25), Assistant Chief Engineer, Stewart-Warner Speedometer Corporation, Chicago, Ill. For mail: 2815 Mildred Ave., Chicago, Ill.
- STONE, CLARENCE G., JR. (A'15), Professor of Physics, Columbia University, New York, N.Y. For mail: 304 S. 1st Ave., Mt. Vernon, N.Y.
- STONE, C. D. (A'27), Route 1, Albuquerque, New Mexico.
- STONE, C. W. (A'27), Radio Operator, The Shepard Stores, Radio Station WNAC, Boston, Mass.
- STONE, ELLERY W. (A'14-M'16-F'24), Federal-Brandes, Inc., Woolworth Bldg., New York, N.Y. For mail: 1016-5th Ave., New York, N.Y.
- STONE, ELMER F. (A'29), Radio Sales and Service, Radio Shack, 16-19 Brattle St., Boston, Mass. For mail: 130 Marcella St., Roxbury, Mass.
- STONE, F. BYRON (A'28), Radio Dept., General Electric Company, Schenectady, N.Y. For mail: 105 Seward Pl., Schenectady, N.Y.
- STONE, G. EDGAR (A'26), Radio Engineer, Radio Frequency Laboratories, Boonton, N.J. For mail: 452 Rockaway Ave., Boonton, N.J.
- STONE, JOHN STONE (M'13-F'15), 3942 Alameda Dr., San Diego, Calif.
- STOOS, JOSEPH A. (A'29), Electrical Draftsman, Delta Star Electric Company, 2400 Block, W. Fulton St., Chicago, Ill. For mail: R.F.D. No. 3, Naperville, Ill.
- STORCK, HOWARD C. (A'29), Proprietor, Columbus Radio Laboratory, 247 E. Livingston Ave., Columbus, Ohio. For mail: 694 Carpenter St., Columbus, Ohio.
- STORMFELTZ, S. H. (A'27), 1603 Derry St., Harrisburg, Pa.
- STORMS, HENRY J. (A'29), Assistant Chief Operator, Western Union Telegraph Company, 808 W. Sprague Ave., Spokane Wash. For mail: 4611 N. Jefferson St., Spokane, Wash.
- STORRY, THOMAS G. (A'27), Manager Radio Engineering Dept., Storrays, Ltd., 143 Eastbank St., Southport, Lancs, England. For mail: 67 Virginia St., Southport, Lancs, England.
- STOTLER, ALBERT (A'29), Instructor, Board of Education, 345 E. 15th St., New York, N.Y. For mail: 78-84th St., Jackson Heights, L.I., N.Y.
- STOVER, ARTHUR R., JR. (J'29), Radio Serviceman, Moses Melody Shop, 708 Main St., Little Rock, Ark. For mail: 723 Wright Ave., Little Rock, Ark.
- STOVER, WILMER A. (A'27), Plant Supervisor, Bell Telephone Company of Pennsylvania, 1835 Arch St., Philadelphia, Pa. For mail: 6435 Woodcrest Ave., W. Philadelphia, Pa.
- STRAIT, CLARENCE L. (A'29), Territory Service Manager, Sparks-Withington Company, Jackson, Mich.
- STRASSMAN, IRVING (A'29), Engineer-in-Charge, Radio Station WHAS, Jefferson-town, Ky.
- STRASSNER, FRANK J. (A'26), Consulting Electrical Engineer, 48 Burnett Terrace, Maplewood, N.J.
- STRATMAN, FRED W. (J'29), Radiotrician, Benson Radio Company, 6059 Military Ave., Omaha, Neb. For mail: 4328 Erskine St., Omaha, Neb.
- STRATTON, ROSS A. (A'26), Secretary-Treasurer, Larchmont Radio Salon, Inc., 139 N. Larchmont Blvd., Los Angeles, Calif.
- STRAUSSMAN, ARNOLD D. (J'26), 601 Asbury Ave., Asbury Park, N.J.
- STRELESKY, HERBERT J. (A'29), Radio Dept., Fritch Hardware Company, 14th and Wazee Sts., Denver, Colo. For mail: 1140 S. Sherman St., Denver, Colo.
- STRNAD, JOSEPH (A'27), Ministry of Posts and Telegraphs, Prague, Czechoslovakia.
- STROCK, REEVE O. (A'23), Recording Engineer, Acoustic Dept., Electrical Research Products, Inc., 250 W. 57th St., New York, N.Y. For mail: 197-25-90th Ave., Hollis, L.I., N.Y.
- STROEBEL, JOHN C., JR. (A'14-M'26), c/o Southern Equipment Company, San Antonio, Tex.
- STROMEYER, CHARLES F. (A'29), Chief Engineer, Cable Supply Company, 90 N. 9th St., Brooklyn, N.Y.
- STRONG, CHARLES E. (A'25-M'27), Engineer, The International Standard Electric Corporation, Connaught House, Aldwych, London, W.C.2, England.
- STROUT, EVERETT M. (A'29), Operator, Radio Station KSTP, St. Paul, Minn.
- STRUTHERS, G. A. (M'29), Engineer-in-Charge, Radio Station, Rugby, England.
- STRUTHERS, FRANCIS W. (A'29), Assistant Radio Engineer, Naval Research Laboratory, Bellevue, Anacostia, D.C.
- STUART, JOHN F. (A'26), Columbus Electric and Power Company, Columbus, Ga.
- STUDIER, WALTER A. (J'27-A'29), Electric Meter Tester, Rochester Gas and Electric Corporation, 89 East Ave., Rochester, N.Y. For mail: 189 Fairgate St., Rochester, N.Y.

- STUEDLE, EMRY C. (A'26), Seismograph Observer, Geophysical Research Corporation, Espenson Bldg., Houston, Tex. For mail: c/o Pure Oil Company, Houston, Tex.
- STULTZ, ERLE D. (J'27), American Railway Express Company, Union Station, Omaha, Neb. For mail: 4112 N. 23rd St., Omaha, Neb.
- STURMAN, GEORGE M. (A'29), Chief Engineer, Central Radio Service, 12064-12th St., Detroit, Mich.
- STURTEVANT, JAMES W. (A'25), Radio Service Manager, The Erner Electric Company, 1430 W. 9th St., Cleveland, Ohio. For mail: 15220 Hilliard Rd., Lakewood, Ohio.
- STURTEVANT, MARK (A'27), 1864 W. 54th St., Cleveland, Ohio.
- STYLES, THOMAS J. (A'26), Assistant, E. H. Armstrong, 204 Philosophy Hall, Columbia University, New York, N.Y. For mail: 160-01-84th Dr., Jamaica, L.I., N.Y.
- SUADICANI, GUENTHER (M'28), Commander, German Navy, Koenigin Augustastrasse 38/42, Berlin W. 10, Germany. For mail: Marineleitung, Berlin W. 10, Germany.
- SUARES, JOSE B. (A'28), Senior Operator, Posts and Telegraph Dept., Perak, Naiping, Federated Malay States. For mail: 47 Barrack Rd., Naiping, Federated Malay States.
- SUEZ, ROBERT K. W. (J'27), Student, University of Michigan, Ann Arbor, Mich. For mail: 410 E. Jefferson, Ann Arbor, Mich.
- SUGA, Y. (A'29), Research Staff, Vacuum Tube Dept., Research Laboratory, The Tokyo Electric Company, Kawasaki, Japan.
- SUGGS, THOMAS B. (A'29), Radio Serviceman, West Side Radio Company, 5179 Easton Ave., St. Louis, Mo.
- SULLINGER, FERRIS W. (A'29), Assistant Communication Engineer, Pan American Airways, Inc., Miami, Fla.
- SULLIVAN, EDWARD S. (A'28), Field Service, Federal Brands Company, Inc., 200 Mt. Pleasant Ave., Newark, N.J. For mail: 276 Summit Ave., Jersey City, N.J.
- SULLIVAN, J. R. (A'26), Operator, Radio WRR, City of Dallas, Dallas, Tex. For mail: 912 Oak Grove St., Fort Worth, Tex.
- SULLIVAN, ROBERT J. (A'29), 708 Throop St., Saginaw, Mich.
- SUMMERS, LLEWELYN L. B. (A'29), Radio Engineer, Radio Corporation of America, Rocky Point, L.I., N.Y. For mail: White-stone, L.I., N.Y.
- SUMNER, RAYMOND STOKES (A'29), Radio Serviceman, 28 West 42nd St., New York, N.Y. For mail: 315 N. 27th St., Camden, N.J.
- SUNNERGREN, ARVID P. (A'28), Chief Electrical Designer, West Penn Power Company, Room 1304, West Penn Bldg., 14 Wood St., Pittsburgh, Pa.
- SURETTE, DENNIS C. (A'29), Service Manager, Prime Furniture Company, 16 Stuart St., Boston, Mass. For mail: 18 Greene St., Wollaston, Mass.
- SUSNICH, EUGENE W. (A'26), President, Neo-Electric Production Company, Ann Arbor, Mich. For mail: 602 S. Ashley St., Ann Arbor, Mich.
- SUTHERLAND, ALEXANDER (A'16), Division Superintendent, East Coast Radio Service, H. M. C. Dockyard, Halifax, N.S., Canada.
- SUTHERLAND, GEORGE B. (A'25), Western Australian Farmers, Ltd., Perth, West Australia. For mail: 36 Fairfield St., Mt. Hawthorn, Perth, West Australia.
- SUTHERLAND, J. G. A. (M'29), Senior Electrical Engineer, United Engineers, Ltd., 19 Battery Road, Singapore, Straits Settlements.
- SUTHERLIN, LEE (A'19-M'28), Radio Research Engineer, Westinghouse Electric and Manufacturing Company, East Pittsburgh, Pa. For mail: 124 Ave. A, Wilkinsburg, Pa.
- SUTTON, WILLIAM F. P. (A'23), Technician Sales Staff, Messrs. Pettigrew and Merriman, Ltd., 2 Bucknall St., London, W.C.1, England. For mail: 7 Cockfosters Rd., Hadley Wood, Hertfordshire, England.
- SUYDAM, C. H. (A'29-M'29), Acting Chief Engineer, Federal Telegraph Company, Palo Alto, Calif.
- SUZUKI, HISAO (A'29), Research Staff, Vacuum Tube Dept., Research Laboratory, The Tokyo Electric Company, Kawasaki, Japan.
- SVEEN, ERWING A. (A'28), Research Engineer, French Battery Company, 2317 Winnebago St., Madison, Wis.
- SVEGEL, PETER J., JR. (J'28), Student, Electrical Engineering, Carnegie Institute of Technology, Night School, Pittsburgh, Pa. For mail: 303 Maplewood Ave., Ambridge, Pa.
- SVENNINGSEN, KARL (A'29), Engineer, Postmyngningen Bernstorffsgade Opg. B. Copenhagen, Denmark. For mail: Vennemindedvej 3, 3 Str., Copenhagen, Denmark.
- SVOBODA, JAROMIR (M'26), Radio Engineer, Prague Ministry of Posts and Telegraphs, Prague, Czechoslovakia. For mail: Americka 11, Prague XII, Czechoslovakia.
- SWAIN, ROBERT R. (A'27), American Telephone and Telegraph Company, 195 Broadway, Room 1637, New York, N.Y.
- SWANSON, CARL R. (A'29), Radio Operator, M. M. Johnson Company, P.O. Box 163, Clay Center, Nebr.
- SWANSON, JOHN W. (A'17-M'23), Vice-President, Southern Radio Corporation, 26 Broadway, New York, N.Y. For mail: 14 Caryl Ave., Yonkers, N.Y.
- SWANSON, MERRILL J. (A'29), Engineer, WRAC Broadcasting Company, Erie, Pa.
- SWEENEY, HAROLD V. (A'29), Experimental Dept., Atwater Kent Manufacturing Company, 4700 Wissahickon Ave., Philadelphia, Pa. For mail: 64 Ashland Ave., W. Manayunk, Philadelphia, Pa.
- SWEENEY, WALTER M. (M'25), Manager, Radio Communication (Pacific) Company, 507 Collins St., Melbourne, Australia. For mail: Box 1362, G. P. O., Melbourne, Australia.
- SWEENEY, CAREY P. (A'22), Engineer, Bell Telephone Laboratories, Inc., 463 West St., New York, N.Y.

- SWISHER, CHARLES L. (A'27), Professor of Physics, State College, Fargo, N.D.
- SWISHER, O. V. (A'28), District Supervisor, Installation and Service Dept., R.C.A. Photophone, Inc., 3932 S. Lincoln St., Chicago, Ill.
- SYKES, RODGER ALLEN (A'29), 129 Perry St., New York, N.Y.
- SYLVESTER, ARTHUR (A'29), Radio Sales and Service, 17 Ave. D, Rochester, N.Y.
- SYLVESTER, JOHN C. (A'28), Radiotrician, 157 Foster Ave., Brighton, Mass.
- T
- TABER, C. KENNETH (A'28), P. O. Box 28, Milton-on-Hudson, N.Y.
- TABER, HAROLD E. (A'24), Lieutenant, Dawson City, Yukon, Alaska. For mail: Carleton Pl., Ont., Canada.
- TABER, WILLIAM T. (A'25), Designing and Production Engineer, Stevens Manufacturing Corporation, 42-48 Spring St., Newark, N.J. For mail: 95 Waldo Ave., Bloomfield, N.J.
- TAGART, SAM W. (A'29), Instructor in Factory, Central Radio Laboratories, 36 Keeffe Ave., Milwaukee, Wis. For mail: 672 Van Buren St., Milwaukee, Wis.
- TAGGART, SAMUEL E. (A'29), 70 Maple St., Chicopee Falls, Mass.
- TAGUCHI, MINORU (A'27), Radio Engineer, Nihon Musen, Kaizo Shutchojo, Yokkaichi-shi-gai, Mie-ken, Japan.
- TAKEBAYASHI, K. (A'25), Radio Engineer, Dept. of Communications, Denmukyoku, Tokyo, Japan.
- TALLEY, DAVID (A'26), Equipment Engineer, New York Telephone Company, 1421 Ocean Ave., Brooklyn, N.Y. For mail: 2222 Ave. O., Brooklyn, N.Y.
- TAMBURINO, ANTHONY C. (A'25), Victor Talking Machine Company, 925 N. Michigan Ave., Chicago, Ill.
- TAMI, JOSEPH, JR. (A'29), Radio Salesman, Electrical Appliance Shop, 336 South Broadway, Los Angeles, Calif. For mail: 1839 E. Vernon Ave., Los Angeles, Calif.
- TAMMARO, JOSEPH C. (A'28), Shift Engineer, Radio Corporation of America, Rocky Point, L.I., N.Y.
- TAMMINEN, NESTOR (A'29), General Radio Work, P. O. Box 32, R. D. No. 2, Paris, Me. For mail: Greeley Rd., Yarmouth, Me.
- TANCK, HENRY (A'26), Laboratory Engineer, Federal Telegraph Company, Palo Alto, Calif. For mail: 209 Cowper St., Palo Alto, Calif.
- TANGEN, REIDER (J'26), Commercial Radio Operator, Independent Wireless Telegraph, New York, N.Y. For mail: P. O. Box 773, Sea Cliff, L.I., N.Y.
- TANQUE, HAROLD F. (A'29), Student, Purdue University, West Lafayette, Ind. For mail: 315 University St., West Lafayette, Ind.
- TANNER, CHARLES J. (A'29), Service Engineer, Northern Electric Company, Ltd., 637 Craig St., W., Montreal, Canada. For mail: 164 Queen St., Kingston, Ont., Canada.
- TANTON, JOHN H. (A'25), R. A. F. Camp, Halton, Bucks, England. For mail: 47A Akerman Rd., Brixton, London, S.W.9, England.
- TARTAK, PAUL H. (A'28), Engineer, Temple Inc., 1925 S. Western St., Chicago, Ill. For mail: 1213 Emerald Ave., Chicago Heights, Ill.
- TARZIAN, SARKES (A'27), Electrical Engineer, Atwater Kent Manufacturing Company, Germantown, Philadelphia, Pa. For mail: 3064 N. Howard St., Philadelphia, Pa.
- TASKER, J. T. (A'29), 61 Hadfield St., Georgetown, Demerara, British Guiana, South America.
- TATE, JOSEPH R. (A'27), Radiotrician, 1 N. Main St., Harrisburg, Ill. For mail: P. O. Box 80, Harrisburg, Ill.
- TATE, ROBERT L. (A'29), Radio Corporal, Headquarters Battery, 83rd Field Artillery Bu., Fort Benning, Ga.
- TATNALL, JOSEPH T. (A'28), Engineer, Radio Station WDEL, 405 Delaware Ave., Wilmington, Del. For mail: Claymont, Del.
- TATREAU, LEON E. (A'26), Service Engineer, Illinois Electric Company, 313 S. San Pedro St., Los Angeles, Calif. For mail: 1716 West Ave. 46, Eagle Rock, Calif.
- TAUFFENBACH, LESLIE E. (A'22-M'26), President, Western Radio, Inc., 1135 Wall St., Los Angeles, Calif.
- TAUSSIG, CHARLES W. (A'22), President, American Molasses Company, 111 Wall St., New York, N.Y.
- TAUSSIG, WILLIAM S. (A'29), Service Manager, Charles Freshman Company, 122 E. 42nd St., New York, N.Y. For mail: 1065 Lexington Ave., New York, N.Y.
- TAYLOR, AFFRED O. (A'24), 96 Laburnum Grove, Portsmouth, Hants, England.
- TAYLOR, ALFRED R. (A'29), Naval Officer, Navy Dept., Washington, D.C. For mail: Wakefield, R.I.
- TAYLOR, A. HOYT (M'15-F'20), Superintendent of Radio Division, U.S. Naval Research Laboratory, Bellevue, Anacostia, D.C.
- TAYLOR, B. H. (A'27), Postal Telegraph Cable Company, 2 Essex St., Haverhill, Mass.
- TAYLOR, CHARLES H. (M'13-F'15), Radio Corporation of America, 66 Broad St., New York, N.Y.
- TAYLOR, CONWAY M. (A'25 M'27), Chief Instructor, Dept. of Physics and Electrical Engineering, Technical College, Auckland, New Zealand. For mail: 78 Remuera Rd., Auckland, New Zealand.
- TAYLOR, DALE L. (A'28), Manager, Radio Sales and Service, Wright Electric Company, Inc., 118 N. Main St., Elmira, N.Y. For mail: 314 Sly St., Elmira, N.Y.
- TAYLOR, E. KENNETH (A'29), 505 Bank of Italy Bldg., Los Angeles, Calif. For mail: 230 South Hudson Ave., Pasadena, Calif.
- TAYLOR, EDMUND R. (A'22), Telephone Engineer, American Telephone and Telegraph Company, 195 Broadway, New York, N.Y.
- TAYLOR, EDWARD C. (A'28), Patent Attorney, Fisk Rubber Company, Chicopee Falls, Mass. For mail: 46 Roseland Terrace, Longmeadow, Mass.

- TAYLOR, FRANCIS WILLIAM** (A'28), Assistant Manager, Warren Fish Company, Pensacola, Fla. For mail: 911 N. Spring St., Pensacola, Fla.
- TAYLOR, G. WESLEY** (A'29), Draftsman, California and Hawaiian Sugar Corporation, California State Highway, San Francisco, Calif. For mail: P. O. Box 931, Crockett, Calif.
- TAYLOR, HAROLD E.** (A'24), Supervisor of Transmission and Maintenance, Michigan Bell Telephone Company, 1365 Cass Ave., Detroit, Mich.
- TAYLOR, HAWLEY O.** (M'16), Professor of Physics, Wheaton College, Wheaton, Ill.
- TAYLOR, H. S.** (J'29), Radio Repair and Service, Balhite Radio Company, Building No. 16, N. Chicago, Ill. For mail: 1510 Sheridan Road, N. Chicago, Ill.
- TAYLOR, JAMES C.** (A'25), Radio Engineer, Florida Power and Light Company, P. O. Box 1468, Ft. Pierce, Fla.
- TAYLOR, JAY L.** (A'27), Engineer, Colonial Radio Corporation, 25 Wilbur Ave., Long Island, L.I., N.Y. For mail: 210 E. 73rd St., New York, N.Y.
- TAYLOR, JOHN PRATT** (A'29), Room 384, Y.M.C.A., Schenectady, N.Y.
- TAYLOR, LAURENS A.** (A'24), Development Dept., General Electric Company, Schenectady, N.Y. For mail: 144 S. Country Club Dr., Schenectady, N.Y.
- TAYLOR, R. B.** (A'27), Student Engineer, General Electric Company, Schenectady, N.Y. For mail: 7 Elm St., Schenectady, N.Y.
- TAYLOR, SAMUEL** (A'29), Naval Station, Pago Pago, American Samoa.
- TAYLOR, S. GORDON** (A'26), Radio Consultation Service, 40 E. 49th St., New York, N.Y.
- TAYLOR, THEODORE** (A'25), 1710 N. Kingsley Drive, Hollywood, Calif.
- TAYLOR, W. H., JR.** (A'19-M'21), Patent Lawyer, Pennie, Davis, Marvin and Edmonds, 165 Broadway, New York, N.Y.
- TEACHMAN, ALFRED E.** (A'27), Manager, Radio Service Dept., La Roe Radio Store, 283 Main St., Woonsocket, R.I. For mail: 25 Crawford St., Woonsocket, R.I.
- TEAGUE, T. T.** (A'18-M'21), Lieutenant, Kelly Field, Tex.
- TEETER, ALBERT A.** (A'24), Charles Pfizer Company, 81 Maiden Lane, New York, N.Y.
- TELAAK, THEODORE J.** (A'28), Assistant Service Manager, Federal Radio Corporation, 1738 Elmwood Ave., Buffalo, N.Y. For mail: 331 Sherman St., Buffalo, N.Y.
- TEN CATE, ARTHUR C.** (A'21), 9219 S. Marshfield Ave., Chicago, Ill.
- TERAHATA, MATSUTARO** (A'24), Radio Engineer, Musen Denshiinka, Komukyoku, Dept. of Communications, Tokyo, Japan.
- TERMAN, FREDERICK E.** (A'25), Assistant Professor of Electrical Engineering, Stanford University, Calif. For mail: 659 Salvatierra St., Stanford University, Calif.
- TERNOW, HELMUT G.** (A'26), Junior Engineer, The Pacific Telephone and Telegraph Company, 140 New Montgomery St., San Francisco, Calif.
- TERRELL, JOHN A.** (A'19), Electrical Engineer, General Electric Company, Radio Dept., Schenectady, N.Y. For mail: 179 Division St., Schenectady, N.Y.
- TERRELL, ROBERT L.** (A'26), Operator, National Broadcasting Company, National Press Bldg., Washington, D.C. For mail: 1937 Calvert St., Washington, D.C.
- TERRELL, W. D.** (A'12-F'29), Chief, Radio Division, Dept. of Commerce, Washington, D.C.
- TERRILL, W. NESSLER** (J'25-A'27), Service Manager, The Inter-State Lighting Company, Inc., 508 Charlotte St., Utica, N.Y. For mail: 5 Emerson Ave., Utica, N.Y.
- TERRY, LAURENCE M.** (A'26), Consulting Engineer, The Radio Laboratory, Aiken, S.C.
- TERVEN, LEWIS A.** (A'24-M'26), West Penn. Power Company, 14 Wood St., Pittsburgh, Pa.
- TERWILLIGER, DONALD J.** (A'26), Radio Field Engineer, Stewart-Warner Speedometer Corporation, 1826 Diversey Parkway, Chicago, Ill. For mail: 108 Highland Ave., Yonkers, N.Y.
- TESCH, WALTER L.** (M'24), Resident Engineer, RCA-Victor Company, Inc., Mitsui Bldg., No. 3, Honcho, Nihonbashi-ku, Tokyo, Japan.
- TEUNISSON, JOHN F.** (A'27), Radio Operator, Airways Communication Station, Municipal Airport, Cleveland, Ohio. For mail: 17101 Laverne Ave., Cleveland, Ohio.
- TEVIS, GRAHAM L.** (A'29), Radio Operator, KMOX, The Voice of St. Louis, Hotel Mayfair, 8th and St. Charles Sts., St. Louis, Mo. For mail: 8224 Fairham Ave., University City, St. Louis, Mo.
- THACKER, M. S.** (A'28), Outside Contract Dept., Siemens Bros. and Company, Ltd., 251 Coronation Rd., Bristol, England. For mail: c/o Thomas Cook and Sons, Berkeley St., London, W.1, England.
- THEBERGE, ALBERT R.** (A'29), Assistant Tube Engineer, Raytheon Manufacturing Company, 42 Carleton St., Cambridge, Mass. For mail: 223 Hampshire St., Lawrence, Mass.
- THEREMIN, LEON** (A'29), 24 W. 59th St., New York, N.Y.
- THIEL, HAROLD A.** (A'28), Field Representative, Kolster Radio Corporation, 625 Market St., San Francisco, Calif. For mail: 27 Elgin Park, Apt. 5, San Francisco, Calif.
- THIELEN, E. J.** (J'23-A'26), Member of Technical Staff, Bell Telephone Laboratories, Inc., 463 West St., New York, N.Y. For mail: 735 Walton Ave., New York, N.Y.
- THIESSEN, ARTHUR E.** (A'29), Engineering Staff, General Radio Company, 30 State St., Cambridge, Mass.
- THING, K.** (A'29), Radio Operator, c/o Radio Corporation of America, Chatham, Mass.
- THOLSTRUP, HENRY** (A'26), Electrical Engineer, Radio Engineering Dept., Westinghouse Electric and Manufacturing Company, Chicopee Falls, Mass.
- THOMAS, CHARLES C.** (A'29), Engineer, Federal Telegraph Company, Palo Alto, Calif. For mail: 1119 Fulton St., Palo Alto, Calif.

- THOMAS, CHARLES V.** (A'28), Radio Serviceman, Electrical Devices Company, 616 Linden St., Allentown, Pa. For mail: 806 Union St., Allentown, Pa.
- THOMAS, CLARENCE W.** (A'28), Radio Electrician, Dominion Government Radio Service, 928 Old Esquimalt Rd., Esquimalt, B.C., Canada.
- THOMAS, EDWARD H.** (A'29), Distributor's Serviceman, Boley-Oliver Company, 1440 Broadway, New York, N.Y. For mail: 64 Linden St., Brooklyn, N.Y.
- THOMAS, EINION** (A'19), Broadcast Engineer, Marconi's Wireless Telegraph Company, Ltd., Marconi House, Strand, London, England. For mail: The Croft, Avenue Rd., Chelmsford, Essex, England.
- THOMAS, GEORGE G.** (A'28), Radio Engineer, General Electric Company, Schenectady, N.Y. For mail: 12 Riverside Ave., Scotia, N.Y.
- THOMAS, GUY H.** (A'29), Wireless Engineer, Metropolitan Vickers Electric Company, Ltd., Trafford Park, Manchester, England.
- THOMAS, HAROLD** (A'29), Chief Engineer, Radio Station WEAN, Shepard Stores, Providence, R.I. For mail: 69 Wellesley Ave., North Providence, R.I.
- THOMAS, HARRY E.** (A'28), 921 Worthington St., Springfield, Mass.
- THOMAS, HOWARD H.** (A'28), Ger-Alt Radio Laboratories, 859 Flatbush Ave., Brooklyn, N.Y. For mail: 446 Ocean Ave., Brooklyn, N.Y.
- THOMAS, JOSEPH D.** (A'27), Radio Salesman, American Phonograph Company, 61 Hudson Ave., Albany, N.Y. For mail: 140 Grove Ave., Albany, N.Y.
- THOMAS, MORRIS W.** (A'27), Radio Engineer, "Wisconsin News," 15 Michigan St., Milwaukee, Wis. For mail: 175 Farwell Ave., Milwaukee, Wis.
- THOMAS, WALTER J.** (A'26), Welding Engineer, Tractor Plant, Stalingrad, U.S.S.R. For mail: c/o Mr. Eaton, Fidelity Trust Company, Detroit, Mich.
- THOMAS, WILLIAM A.** (A'24-M'27), Assistant to Vice-President, Acoustic Products Company, Inc., 50 W. 57th St., New York, N.Y. For mail: 259 Milbank Ave., Greenwich, Conn.
- THOMAS, WILLIAM K.** (A'24), Ludwig, Hommel and Company, Pittsburgh, Pa. For mail: 1136 Illinois Ave., Dormont, Pa.
- THOMAS, WILLIAM M.** (A'26), Radio Electrician, U. S. Navy, Officer-in-Charge, Los Banos, Laguna, P.I.
- THOMAS, W. RAYMOND** (A'29), Radio Doctor, Russells Point, Indian Lake, Ohio.
- THOMASON, MARVIN** (A'29), Electrical Engineer, Charles L. Smith Radio Company, Kearney, Mo.
- THOMPSON, ALBERT C.** (A'25), American Telephone and Telegraph Company, 195 Broadway, Rm. 1540, New York, N.Y.
- THOMPSON, ALFRED E.** (M'26), Radio Engineer, International Standard Electric Corporation, Aldwych, London, England. For mail: 37 Grove Rd., Surbiton, Surrey, England.
- THOMPSON, B. J.** (A'29), Vacuum Tube Engineer, Research Laboratory, General Electric Company, 1 River Rd., Schenectady, N.Y.
- THOMPSON, CECIL** (A'26), c/o "West Australian," P. O. Box D162, G.P.O., Perth, West Australia.
- THOMPSON, EDWARD PHILIP** (A'29), Electrical Draftsman, International Telephone and Telegraph Corporation, 67 Broad St., New York, N.Y. For mail: 194 E. Main St., Babylon, L.I., N.Y.
- THOMPSON, F. S.** (A'28), No. 2 Wireless Company, Sarafand, Palestine.
- THOMPSON, JOHN H.** (A'15), Chief Engineer, Canadian Marconi Company, 11 St. Sacramento St., Montreal, P.Q., Canada.
- THOMPSON, JOHN M.** (J'27-A'28), Radio Technician, Corner Book Store, Main St., Canandaigua, N.Y. For mail: Chapin Rd., Canandaigua, N.Y.
- THOMPSON, MILTON L.** (A'26), Test and Engineering Dept., DeForest Radio Corporation, 245 Carlaw Ave., Toronto, Ont., Canada. For mail: 398 Sammon Ave., Toronto, Ont., Canada.
- THOMPSON, ROLAND F.** (A'26), Laboratory Assistant, Atwater-Kent Radio Manufacturing Company, 4700 Wissahickon Ave., Philadelphia, Pa. For mail: 264 W. Greenwood Ave., Lansdowne, Pa.
- THOMPSON, ROY E.** (A'12-M'13), 16 Beaver St., New York, N.Y.
- THOMPSON, STANLEY W.** (A'29), Radio Engineer, Stewart-Warner Sales Company, 609 Main St., Springfield, Mass. For mail: South St., Hazardville, Conn.
- THOMPSON, W. H.** (A'28), Lawyer, 204 Central National Bank Bldg., Tulsa, Okla.
- THOMSEN, PAUL H.** (A'28), Radio Engineer, Jenkins Laboratories, 1519 Connecticut Ave., N.W., Washington, D.C. (For mail: 903 Philadelphia Ave., Silver Spring, Md.)
- THOMSETT, H. S.** (A'29), P. O. Engineering Dept., Radio Section, Rugby, Warwick, England.
- THOMSON, HOWARD M.** (J'29), Student, University of Washington, Seattle, Washington. For mail: 7811 Stroud Ave., Seattle, Wash.
- THOMSON, JOHN MORTON** (A'26), Radio Engineer, Ferranti Electrical Company, Ltd., 26 Noble St., Toronto, Ont., Canada. For mail: 238 John St., Weston, Ont., Canada.
- THORBURN, JAMES M.** (A'23-M'28), Chief Recording Engineer, The Caddo Company, Inc., 804 Taft Bldg., Hollywood, Calif.
- THORNE, FRANK A.** (A'29), Superintendent, Radio Station CFBO, P. O. Box 1225, St. John, N.B., Canada.
- THORNTON, HENRY P.** (A'27), Division Engineer, c/o Postal Telegraph Cable Company, Atlanta, Ga.
- THORPE, STEWART MELVILLE** (A'29), Teacher, Electrical Engineering, Technical Institute, Eastbourne, Sussex, England.
- THORSEN, ORVILLE T.** (A'29), Field Representative, 3401 Colerain Ave., Cincinnati, Ohio. For mail: 3547 Pierce Ave., Chicago, Ill.

- THOW, KEITH H.** (M'29), Radio and Carrier Telephone Engineer, Standard Telephones and Cables, Ltd., 24-26 Ballance St., Wellington, New Zealand. For mail: G.P.O. Box 638, Wellington, New Zealand.
- THRELKELD, HOWARD M.** (A'28), Technician, Engineering Dept., Grigsby-Grunow Company, 2030 North Kalmar Ave., Chicago, Ill.
- THRUSH, PAUL W.** (A'26), Chief Radioman, American Telephone and Telegraph Company, P. O. Box 346, Houlton, Me. For mail: 16 Bowdein St., Houlton, Me.
- THURSTON, GEORGE (A'21)**, Engineer, Bell Telephone Laboratories, Inc., 463 West St., New York, N.Y.
- TIERNEY, WALTER L.** (M'26), Radio Engineer, Bell Telephone Laboratories, Inc., 463 West St., New York, N.Y.
- TILGNER, SHELTON R.** (J'29), Sanator, S.D.
- TILLETT, JESSE** (A'29), Manager Radio Service Dept., Sutcliffe Company, 225 S. 4th St., Louisville, Ky. For mail: 133 Shady Lane, Lexington, Ky.
- TILLSON, BENJAMIN F.** (M'22), Assistant Superintendent, New Jersey Zinc Company, Franklin, N.J.
- TILTMAN, RONALD F.** (A'27), Wireless Editor, "The Sphere," 346 Strand, London, W.C., England. For mail: Maron, Stucley Rd., Hounslow, England.
- TIMMINGS, GEORGE H.** (A'29), Radio Engineer, c/o Colin B. Kennedy Radio Company, South Bend, Ind.
- TINDEL, CHARLES G.** (A'27), Laboratory Assistant, "Public Ledger," 1533 Pine St., Philadelphia, Pa. For mail: 6341 Hergerman St., Philadelphia, Pa.
- TINGEY, ROBERT** (M'21), Radio Engineer, 45 Nevery Square, Earl's Court, S.W.5., England.
- TINGLEY, FREEMAN T.** (A'27), Graduate Student, University of Illinois, Chicago, Ill. For mail: 101 S. Coler Ave., Urbana, Ill.
- TINNEY, FRANCIS B.** (A'24), Electrical Engineer, P. O. Box 134, Palo Alto, Calif.
- TISCHER, FRANK A.** (A'27), Radio Engineer, Ungar and Watson, Inc., 1363 1/2 S. Figueroa St., Los Angeles, Calif. For mail: P. O. Box 44-R1, Manhattan Beach, Calif.
- TISSHAW, HENRY S.** (A'26), Companhia Portuguesa, Radio Marconi, Rua S. Juliao, 131, Lisbon, Portugal.
- TITTLE, HULBERT C.** (A'27), Radio Engineer, Stewart-Warner Corporation, 1826 Diversey Parkway, Chicago, Ill. For mail: 712 Diversey Parkway, Chicago, Ill.
- TKACH, GEORGE** (A'27), Certified Radio-technician and Custom Set Builder, Lakefield, Minn.
- TOBEY, E. S.** (A'28), Manager, Radio Repair and Service Plant, 1145 S. Wall St., Los Angeles, Calif. For mail: 8474 Sunset Blvd., Hollywood, Calif.
- TODD, HAROLD C.** (A'27), Merchant, Iron and Steel, Rm. 3655, 120 Broadway, New York, N.Y. For mail: Fanwood, N.J.
- TODD, STEDMAN F.** (A'15), c/o Dr. B. F. Gray, Rm. 1207, 209 Post St., San Francisco, Calif.
- TODD, WILLIAM F.** (A'26), Engineer, Radio Station KGRS, Gish Radio Service, 112 E. 8th St., Amarillo, Tex. For mail: 1408 Hughes St., Amarillo, Tex.
- TOIVONEN, EGON O.** (J'26-A'28), Westinghouse Electric and Manufacturing Company, Chicopee Falls, Mass. For mail: 112 Town Hill St., Quincy, Mass.
- TOLMIE, J. R.** (J'15-A'28), Engineer, The Pacific Telephone and Telegraph Company, Dexter Horton Bldg., Seattle, Wash. For mail: 615 Boren Ave., Seattle, Wash.
- TOLSON, W. A.** (M'28), Radio Engineer, General Electric Company, Schenectady, N.Y.
- TOMCHUCK, JOHN** (J'29), Telephone Installer, Michigan Bell Telephone Company, 1365 Cass Ave., Detroit, Mich. For mail: 3600 Clippert St., Detroit, Mich.
- TOMLINSON, FRANK** (A'26), Radio Engineer, Standard Telephones and Cables, Ltd., London, N.W.9, England. For mail: "Denston," 13 Neeld Crescent, Hendon, London, N.W.4, England.
- TOMLINSON, HARRY E.** (A'25), Sheet Metal Worker, Locomobile Company, Bridgeport, Conn. For mail: 52 Allen St., Bridgeport, Conn.
- TOMPSETT, F. J.** (A'29), Assistant Engineer, Research Dept., Marconi's Wireless Telegraph Works, Chelmsford, England. For mail: 20 Hill Rd., Chelmsford, England.
- TOPOLINSKI, LEO J.** (A'23), Lawyer, Loose and Topolinski, 230 Wisconsin Ave., Milwaukee, Wis.
- TORRELL, ROY VERNER** (A'29), Supervisor, Freed-Eisemann Company, Junius St. and Liberty Ave., Brooklyn, N.Y. For mail: 683 Lincoln Pl., Brooklyn, N.Y.
- TOTH, ALBERT F.** (A'22), Member Technical Staff, Bell Telephone Laboratories, Inc., 463 West St., Rm. 605, New York, N.Y.
- TOWERS, ROBERT** (A'27), P. O. Radio Station, Baldock, Hertfordshire, England.
- TOWNER, ORRIN W.** (A'24-M'29), Radio Engineer, Bell Telephone Laboratories, New York, N.Y. For mail: 102 N. Arlington, East Orange, N.J.
- TOWNSEND, FRANK T. G.** (M'26), P. O. Engineer, Head Post Office, Ipswich, Suffolk, Eng. For mail: 670 Foxhall Rd., Ipswich, Suffolk, England.
- TOWNSEND, SAMUEL W.** (A'26), Secretary-Manager, W. F. Jones Broadcasting, Inc., Beacon Journal Bldg., Akron, Ohio. For mail: 79 Marvin Ave., Akron, Ohio.
- TOZER, WILLIAM C.** (A'28), District Engineer and Manager, Western Electricity Supply Company, Ltd., Electricity Office, Abingdon, Berks, England.
- TRAGO, ROBERT A.** (A'26), Radio Broadcasting, WMAK Broadcasting System, Inc., Liberty Bank Bldg., Buffalo, N.Y. For mail: 40 Pfohl Pl., Williamsville, N.Y.
- TRAINER, GEORGE T.** (A'28), Technical Inspector, Electrical Research Products, Inc., Francis-Palms Bldg., Detroit, Mich.
- TRAPKIN, JACK H.** (A'29), Radio Service, Bryant Radio Service Company, 1820 Bryant Ave., New York, N.Y.
- TRAUGOTT, PAUL** (A'26), 2134 W. Erie Ave., Philadelphia, Pa.

- TRAVIS, CHARLES** (A'29), Engineer, Atwater-Kent Manufacturing Company, 4700 Wissahickon Ave., Philadelphia, Pa. For mail: 5205 Akron St., Philadelphia, Pa.
- TRAVIS, IRVEN A.** (A'29), Instructor, Moore School of Electrical Engineering, University of Pennsylvania, Philadelphia, Pa. For mail: 32 Bonsall Ave., Sharon Hill, Pa.
- TREFFRY, LAURENCE D.** (A'27), Manager, Radio Dept., Amrad Corporation, Medford Hillside, Mass. For mail: 20 Lake St., Arlington, Mass.
- TREMBLAY, JOSEPH** (A'29), Radio Service Manager, The Canadian Fairbanks Morse Company, Ltd., Montreal, P.Q., Canada. For mail: 835 Ave. Laurier est., Montreal, P.Q., Canada.
- TRENOR, ALBERT D.** (A'14), Engineer, Hammond Radio Research Laboratory, Gloucester, Mass. For mail: Crows Nest, Gloucester, Mass.
- TREVEY, C. B.** (A'26), Chief Operator and Technician, Magnolia Petroleum Company, Radio Station KFDN, P. O. Box 798, Beaumont, Tex.
- TREVOR, BERTRAM** (A'29), Engineer, Radio Corporation of America, P. O. Box 982, Riverhead, L.I., N.Y.
- TRIFARI, EDMUND** (A'29), Radio Expert, Paris Phonograph and Radio Shop, 78 Main St., Paterson, N.J. For mail: 489 Main St., Paterson, N.J.
- TRIGGER, VERNON A.** (A'28), Radio Operator, S.S. "Oakley L. Alexander," c/o Pocahontas Steamship Company, 117 W. Main St., Norfolk, Va.
- TRIMBLE, LOREN** (A'27), Operator, Commonwealth Edison Company, 72 W. Adams St., Chicago, Ill. For mail: 4649 1/2 A. Elston Ave., Chicago, Ill.
- TRINKLE, WILMER S.** (A'26), Sales and Publicity, L. P. Clark, 1207 Race St., Philadelphia, Pa. For mail: 1438 N. 13th St., Philadelphia, Pa.
- TRIPPIER, FRANCIS J.** (A'25), The Marconi International Marine Company, London, W.C.2, England. For mail: 58 Colly Ave., Kendray, Barnsley, Yorks, England.
- TRITTENBACH, JOHN M. P.** (A'25), Radio Service Manager, Ernst Kern Company, 1030 Woodward Ave., Detroit, Mich. For mail: 1933 Blake Ave., Detroit, Mich.
- TROGNER, ARTHUR M.** (M'28), Radio Engineer, Wired Radio, Inc., 60 Broadway, New York, N.Y. For mail: 20 Colonial Terrace, Maplewood, N.J.
- TROTT, BARNET** (A'23), Engineering Dept., Freed-Eisemann Radio Corporation, Brooklyn, N.Y. For mail: 1535-77th St., Brooklyn, N.Y.
- TROUANT, VIRGIL E.** (A'26), Radio Engineer, Westinghouse Electric and Manufacturing Company, East Pittsburgh, Pa. For mail: 822 Woodworth St., Wilkesburg, Pa.
- TROUP, EVERETT O.** (A'29), Service Manager, Sparks-Withington Company, Jackson, Mich. For mail: Bryant Ave., R.8, Jackson, Mich.
- TROUTBECK, WILFRID H.** (A'29), Engineer-in-Charge, Radio Broadcasting Laboratories, Standard Telephones and Cables Company, Ltd., The Hyde, Hendon, London, England. For mail: 52 Eaton Terrace, Westminster, London, S.W.1, England.
- TROWBRIDGE, O. H.** (A'27), Detroit Radio Service, 1425 Park Pl., Detroit, Mich.
- TROXLER, LUCIEN J., JR.** (A'17), Radio Engineer, Hazeltine Service Corporation, 333 W. 52nd St., New York, N.Y. For mail: 40-31A-201st St., Bayside, L.I., N.Y.
- TRUAX, JOHN** (A'27), Brokerage, 30 Broad St., New York, N.Y.
- TRUBEY, LESTER E.** (J'28), Radio Operator, Marquette St., Marine Post Office, Detroit, Mich. For mail: 21-8th St., N.E., Massillon, Ohio.
- TRUM, ALEXANDER D.** (A'27), Accountant, State Highway Dept. of Alabama, Montgomery, Ala. For mail: 217 Catoma St., Montgomery, Ala.
- TRUMBLE, L. A.** (A'27), Vice-President, Walton-Morse, Inc., 1044 Genesee Ave., Saginaw, Mich.
- TRUMBULL, A. F.** (A'29), Fuel Clerk, O.W.R.R. and N. Company, 429 Pittock Block, Portland, Ore. For mail: 605 Marguerite Ave., N., Portland, Ore.
- TRUMP, WILLIAM H.** (A'27), Electrical Material Inspector, Pennsylvania Railroad Company, c/o Resident Inspector, 15 N. 32nd St., Philadelphia, Pa. For mail: Apt. 32-C, 511 W. King St., Philadelphia, Pa.
- TRUMPY, JAY W.** (J'28), Laboratory Assistant, H. H. Eby Manufacturing Company, 4710 Stenton Ave., Philadelphia, Pa. For mail: 5737 N. Lawrence St., Philadelphia, Pa.
- TSAO, T. C.** (A'29), The China Christian Educational Association, 23 Yuen Ming Yung Rd., Shanghai, China.
- TSAO, ZEUSON C.** (A'28), Engineer, China Radio Corporation, Rue du Marechal Foch, Tientsin, China.
- TSIA, HOCK L.** (A'28), 87 Bonham Strand E., Hong Kong, China.
- TSIANG, C. Y.** (A'29), Radio Engineer, Chinese Government Electric Works, 862 Avenue Haig, Shanghai, China.
- TSUMURA, KAZUO** (A'28), Radio Engineer, Japan Wireless Telegraph Company, Jiji Bldg., Marunouchi, Tokyo, Japan. For mail: No. 14 Kamiyanagi-machi, Hiroshima, Japan.
- TSUSHIMA, YONEKICHI** (A'26), Chief Radio Operator Wireless Dept., N.Y.K., Marunouchi, Tokyo, Japan.
- TUCKER, GEORGE B.** (A'27), Radio Technician, Wired Radio, Inc., 4th Ave. and 13th St., Newark, N.J. For mail: 13 N. 20th St., East Orange, N.J.
- TUCKER, G. LLOYD** (A'28), Radio Operator, Radiophone Broadcasting Corporation, Deerfield, Ill. For mail: 519 Oakwood Ave., Highland Park, Ill.
- TUCKER, JOHN, JR.** (A'25), 19 Pingry Pl., Elizabeth, N.J.
- TUCKER, MURRAY E.** (A'28), 41 Park Row, New York, N.Y. For mail: 7 Helen Ave., West Orange, N.J.
- TUCKERMAN, LUCIEN P.** (A'25), Electrical Engineer, Kolster Radio Corporation, 200 Mt. Pleasant Ave., Newark, N.J. For mail: 3518 Farragut Rd., Brooklyn, N.Y.
- TUEL, A. Y.** (A'28), Vice-President and General Manager, Mackay Radio and Telegraph Company, 67 Broad St., New York, N.Y.

- TUMMONDS, HARRY A.** (A'26), Production Engineer, National Carbon Company, W. 117th St. and Madison Ave., Cleveland, Ohio. For mail: 2073 W. 85th St., Cleveland, Ohio.
- TUNG, KAI** (J'28), Student, 57 Gorham St., Cambridge, Mass. For mail: c/o Chun Yui Book Company, Honan Rd., Shanghai, China.
- TURENNE, WILFRED J.** (A'26), Factory Manager, Lectrodio Corporation, 186 Market St., Lynn, Mass. For mail: 59 Holton St., Danvers, Mass.
- TURLE, EDGAR H.** (M'25), Chief Electrical Engineer, H. J. Cash and Company, Ltd., Caxton House, Westminster, London, S.W.1, England. For mail: Deerpur, Beckenham, Kent, England.
- TURNBULL, ALLISON D.** (A'29), Sound Pictures Service Engineer, Northern Electric Company, Ltd., 637 Craig St., W., Montreal, P.Q., Canada.
- TURNER, ALVA** (A'22), Assistant Professor of Physics, Hunter College, 68th St. and Park Ave., New York, N.Y.
- TURNER, C. G.** (A'28), Engineer, Grigsby-Grunow Company, Tube Plant, 2020 N. Austin Ave., Chicago, Ill. For mail: 4110 Keystone Ave., Chicago, Ill.
- TURNER, GEORGE S.** (A'22-M'28), U. S. Radio Inspector, 2022 The Engineering Bldg., Chicago, Ill.
- TURNER, HARRY E.** (A'23), Stromberg-Allen and Company, Chicago, Ill. For mail: 7040 Woodlawn Ave., Chicago, Ill.
- TURNER, H. M.** (A'14-M'20), Associate Professor of Electrical Engineering, Yale University, New Haven, Conn.
- TURNER, LAURENCE B.** (A'24), Cambridge University, Cambridge, England. For mail: 61 Bateman St., Cambridge, England.
- TURNER, RUSSEL S.** (A'29), Radio Inspector, Radio Corporation of America, 9402 Ewing Ave., Chicago, Ill.
- TURNER, W. E.** (A'27), Thomas Turner and Son, Richmond, Ind. For mail: 421 S. 15th St., Richmond, Ind.
- TURNEY, EUGENE T., JR.** (A'29), Bunnell Aircraft Corporation, 404 Riverside Dr., New York, N.Y.
- TURVEY, HENRY C.** (A'28), Consultant, Jessop and Turvey, Ecclesall, Sheffield, England. For mail: 913 Ecclesall Rd., Sheffield, England.
- TUSKA, CLARENCE D.** (A'14), Radio Engineer, The Atwater-Kent Manufacturing Company, Philadelphia, Pa. For mail: 717 W. Mt. Airy Ave., Philadelphia, Pa.
- TUSTIN, JOHN L.** (A'26), Proprietor, Tustin Radio and Electric Company, 428 Sutter St., San Francisco, Calif.
- TUTTLE, C. W.** (A'23), Colonial Radio Corporation, 179 East Ave., Long Island City, L.I., N.Y.
- TUTTLE, ELBERT B.** (A'16), Transmission Engineer, Bell Telephone Company of Pennsylvania, 1631 Arch St., Philadelphia, Pa.
- TUTTLE, WILLIAM N.** (A'26), Student, Harvard University, Cambridge, Mass. For mail: County Line Rd., Bryn Mawr, Pa.
- TYKOCINER, J. T.** (M'21), Research Assistant, Professor, Dept. of Electrical Engineering, University of Illinois, Urbana, Ill.
- TYLER, KENNETH G.** (A'28), Radio Engineering Dept., General Electric Company, 1 River Rd., Schenectady, N.Y. For mail: 8 Union St., Schenectady, N.Y.
- TYNAN, THOMAS E.** (A'29), Radio Service Manager, W.S. Nott Company, 201 N. 3rd St., Minneapolis, Minn. For mail: 915 Queen Ave., N., Minneapolis, Minn.
- TYZZER, HOWARD J.** (A'20), Chief Radio Engineer, Harold J. Power, Inc., 5 High St., Medford Hillside, Mass. For mail: 26 Glendale Ave., Melrose, Mass.

U

- UCHIDA, SATOSHI** (A'25), Engineer, Nanao Radio Company, 34 Higashi Machi, Azabu, Tokyo City, Japan.
- UEHLING, EDWIN A.** (A'26), 917 Edgewood Pl., Ann Arbor, Mich.
- UENO, SHUZO** (A'27), Engineering Dept., Japan Broadcasting Association, Shiseikaikan, Uchiyamashita-cho, Tokyo, Japan.
- ULLRICH, EDWARD H.** (M'26), Engineer, Les Laboratories Standard, 46, Avenue de Breteuil, Paris, 7^e, France.
- ULREY, DAYTON** (A'28), Research Physicist, Westinghouse Electric and Manufacturing Company, East Pittsburgh, Pa. For mail: Forest Hills Rd., Wilkensburg, Pa.
- UMBACH, WALTER R.** (A'27), Superintendent, Radio Tube Manufacturing, Westinghouse Lamp Company, Bloomfield, N.J. For mail: 5 Pierson Pl., Glen Ridge, N.J.
- UMBREIT, STANTON** (A'29), Engineer, Sterling Manufacturing Company, Cleveland, Ohio. For mail: 2845 Prospect Ave., Cleveland, Ohio.
- UNDERHILL, CHARLES R.** (A'14), Wappeler Electric Company, Inc., 162 Harris Ave., Long Island City, L.I., N.Y.
- UNDERHILL, CHARLES R., JR.** (J'16-A'20), Installation and Service Engineer, R.C.A. Photophone, Inc., 438 W. 37th St., New York, N.Y. For mail: c/o F. A. Barrows, 60 Stanley St., New Haven, Conn.
- UNDERWOOD, CLIFFORD C.** (A'26), Student Apprentice, Canadian Westinghouse Company, Ltd., Hamilton, Ont., Canada. For mail: 29 Hazel Ave., Hamilton, Ont., Canada.
- UNDERWOOD, ERNEST G.** (A'28), Technical Director, Don Lee, Inc., Station KIII, 1076 W. 7th St., Los Angeles, Calif. For mail: 579 Ellis Ave., Inglewood, Calif.
- UNDERWOOD, O. DE LOS** (A'25), Manufacturers' Representative, 1311 Elder Blvd., Ann Arbor, Mich.
- UNRUH, FRANKLIN T.** (A'28), Instructor of Radio Personnel, Sears, Roebuck and Company, Tulsa, Okla.
- UREY, GEORGE M.** (A'29), Student, Indiana University, Bloomington, Ind. For mail: Ashley, Ind.
- URGOITI, RICARDO M. DE** (A'25), Managing Director, Union Radio, S.A., Madrid, Spain. For mail: Florida 8, Madrid, Spain.
- URIE, SOL J.** (A'29), First Sergeant, First Signal Service Company, Signal Corps, Seward, Alaska.

- USSELMAN, GEORGE L.** (A'20), Radio Engineer, Radio Corporation of America, Rocky Point, L.I., N.Y.
- UTZ, WILLIAM C.** (A'27), Service Manager, C. D. Messenger Company, 133 E. North Ave., Baltimore, Md. For mail: 93 Liberty St., Westminster, Md.
- UZMANN, GEORGE J.** (A'25-M'26), Engineer, Dubilier Condenser Corporation, 4377 Bronx Blvd., New York, N.Y. For mail: 439-78th St., Brooklyn, N.Y.

V

- VAIL, LESLIE G.** (A'28), Radio Sales and Service, Orient, N.Y.
- VAILL, EDWARD W.** (A'24), Lawyer and Engineer, Partner, Sheffield and Betts, 27 Cedar St., New York, N.Y.
- VALENTINE, RUSSELL D.** (A'27), 40 Broad St., Newark, N.J.
- VALESIO, MARIO J.** (A'28), Assistant Manager, Electrad, Inc., 175 Varick St., New York, N.Y. For mail: 263 W. 68th St., New York, N.Y.
- VANACORE, THOMAS** (A'28), Chief Radio Engineer, King Manufacturing Corporation, 254 Rano St., Buffalo, N.Y.
- VAN ANTWERP, MAX C.** (A'26), Transmission Dept., American Telephone and Telegraph Company, 4701 S. Kedzie Ave., Chicago, Ill. For mail: 1346 E. 49th St., Chicago, Ill.
- VAN BROCKLIN, WILLIAM S.** (A'22), Radio Dealer, 1036 South St., Roslindale, Mass.
- VAN DER BIJL, HENDRIK J.** (M'17-F'28), Chairman, Electricity Supply Commission, Box 1091, Johannesburg, South Africa. For mail: 67 Harley St., Yoeville, Johannesburg, South Africa.
- VAN DER BILT, CORNELIUS L.** (A'25), Professor, Technical University, Delft, Holland. For mail: Wassenaarschweg 126, The Hague, Holland.
- VAN DER POL, BALTH., JR.** (M'20-F'29), 12 Jan Smitzlaan, Eindhoven, Holland.
- VANDERPOEL, FLOYD L.** (A'12), Litchfield, Conn.
- VAN DOEREN, C. A.** (A'29), Installation Engineer, Electrical Research Products, Inc., 130 N. Wells St. Chicago, Ill. For mail: 3323 E. 8th St., Tulsa, Okla.
- VAN DUSEN, PAUL F.** (A'28), Service Dept., Sunset Electric Company, 228 Pacific Ave., Spokane, Wash.
- VAN DUYNE, EUGENE D.** (A'28), Technical Representative, New York Talking Machine Company, 460 W. 34th St., New York, N.Y. For mail: 41 Waldo Ave., East Rockaway, L.I., N.Y.
- VAN DYCK, ARTHUR F.** (A'13-M'18-F'25), Radio Corporation of America, 233 Broadway, New York, N.Y. For mail: 14 Martin Rd., Bryn Mawr Knolls, Yonkers, N.Y.
- VAN DYKE, KARL S.** (A'15-M'26), Professor of Physics, Scott Laboratory, Wesleyan University, Middletown, Conn.
- VANEK, LAWRENCE J.** (A'28), Production Foreman, Crosley Radio Corporation, Colerain and Sassafras Aves., Cincinnati, Ohio. For mail: 3158 Bishop St., Cincinnati, Ohio.
- VAN HEININGEN, WILLARD A.** (J'27), R.F.D. No. 57, Wilton, Conn.
- VAN HORN, J. C.** (A'15-M'26), Superintendent, R.C.A. Institutes, Inc., 1211 Chestnut St., Philadelphia, Pa.
- VAN HOUSEN, C. H.** (A'26), Radio Editor, "Public Ledger," Independence Sq., Philadelphia, Pa. For mail: 3521 Vaux St., Philadelphia, Pa.
- VAN LOAN, CULLEN G.** (A'25), Radio Dealer, W. A. Roosevelt Company, La Crosse, Wis. For mail: P. O. Box 461, La Crosse, Wis.
- VAN NIMAN, ROY T.** (J'25-A'28), Engineer, Electrical Research Products, Inc., 1020 Grand Rapids National Bank Bldg., Grand Rapids, Mich.
- VAN SICKEL, R. E.** (A'29), Shop Superintendent, Sampson Electric Company, 3201 S. Michigan Ave., Chicago, Ill. For mail: 7728 Calumet Ave., Chicago, Ill.
- VAN SICKLE, GEORGE W.** (A'27), 210 N. 10th St., St. Louis, Mo.
- VAN SICKLE, MELVIN E.** (A'28), Resident Engineer, Canadian Brander, Ltd., 207 Queens Quay, Toronto, Ont., Canada. For mail: 23 Oakdene Crescent, Toronto, Ont., Canada.
- VAN THIEL, JAN** (A'27), Radiotechnician and Engineer, National Hotel, Jackson, Calif.
- VAN WHY, FORBES W.** (A'24-M'28), Engineer-in-Charge, Station KTMR, 1025 N. Highland Ave., Hollywood, Calif. For mail: Box 1111, Hollywood Station, Hollywood, Calif.
- VAN WYCK, WILLIAM PATERSON** (A'26), Purchasing Agent, Radio Corporation of America, 233 Broadway, New York, N.Y. For mail: 1349 Lexington Ave., New York, N.Y.
- VARCOE, H. R.** (A'29), Installation Engineer, Northern Electric Company, 637 Craig St., W., Montreal, P.Q., Canada. For mail: 627-13th St., Brandon, Man., Canada.
- VASEN, GUSTAVE** (A'29), Serviceman, Townley Metal and Hardware Company, 200 Walnut St., Kansas City, Mo. For mail: 3654 Campbell St., Kansas City, Mo.
- VAUGHAN, CARROLL B.** (A'28), Research and Development Engineering Dept., Radio Systems, Inc., Hotel Lincoln, New York, N.Y. For mail: 252 Lexington Ave., New York, N.Y.
- VAUGHAN, FRANK P.** (A'18), Engineer and Manager, The Vaughan Electric Company, Ltd., 94 Germain St., St. John, N.B., Canada.
- VAUGHAN, KENNETH A.** (A'29), Radiotrician, Radio Service Laboratories, R.F.D. No. 1, Cresson, Pa.
- VAUGHN, F. A.** (A'27), Consulting Engineer, F. A. Vaughn, Inc., 275-31st St., Milwaukee, Wis.
- VEIRUP-JENSEN, J. G.** (A'23), Superintendent, Colin B. Kennedy Company, 140-2nd St., San Francisco, Calif. For mail: 232 Lytton Ave., Palo Alto, Calif.
- VELASCO, JOSE M.** (A'22), Manager, Radio Dept., C. A. Richards, Inc., 304 E. 45th St., New York, N.Y. For mail: 674 Locust St., Mount Vernon, N.Y.

- VENABLE, RICHARD NEEL (A'29), Radio Serviceman, James A. Hearn, 20 W. 14th St., New York, N.Y. For mail: 358 Wadsworth Ave., New York, N.Y.
- VENNES, H. J. (M'26), Transmission Engineer, Northern Electric Company, 121 Shearer St., Montreal, P.Q., Canada.
- VERDAM, NICHOLAS H. (M'21), Office of Wireless Service of Dutch East Indies, Bandoeng, Java, Dutch East Indies.
- VERKLEY, B. M. (A'29), Radio Merchandise Inspector, Crosley Radio Corporation, 1213 Sassafras St., Cincinnati, Ohio.
- VERMAN, LAL C. (A'28), Research Assistant, Engineering Research Dept., University of Michigan, New Physics Bldg., Ann Arbor, Mich. For mail: Rockefeller Hall, Ithaca, N.Y.
- VERMILYA, IRVING (M'26), President, New Bedford Broadcasting Company, New Bedford, Mass. For mail: New Bedford Hotel, New Bedford, Mass.
- VERNON, BASIL H. (A'24), Engineer-in-Charge, British Broadcasting Corporation, 85 Lord St., Liverpool, Lancashire, England.
- VERRALLS, J. MAYNARD (A'29), Wireless Officer, Marine Service of Marconi Company, Ltd., c/o W. H. Verralls and Company, Ltd., 26 Grant St., Birmingham, England. For mail: c/o British Marine Wireless Service, 40 Rector St., New York, N.Y.
- VERSFELT, EMERY L. (J'19-A'25), Manager, United Kingdom Service, U. S. Navigation Company, Inc., 17 Battery Pl., New York, N.Y. For mail: 76 Oakwood Ave., Upper Montclair, N.J.
- VICTOREEN, CHARLES J. (A'27), Pioneer Radio Shop, Plano, Ill.
- VICTOREEN, JOHN A. (A'24-M'27), Engineer, Victoreen Radio Company, 2825 Chesinger Ave., Cleveland, Ohio. For mail: 3041 Fairfax Rd., Cleveland, Ohio.
- VICTORIA, JOSEPH LAWRENCE (A'29), Serviceman, Waltham Electric Company, 233 Spring St., New York, N.Y. For mail: 145 W. 4th St., New York, N.Y.
- VIERLING, GUSTAV (A'29), Chief Engineer, Radio Transandino, Foelsch and Company, Esmeralda No. 2, Valparaiso, Chile, South America. For mail: Casilla 1653, Valparaiso, Chile, South America.
- VOEGTLIN, ELMO (A'29), Radio Service, C. T. Potterson, 800 S. Peters St., New Orleans, La. For mail: 605 Belleville St., New Orleans, La.
- VOGEL, ERWIN WILLIAM (A'28), Radio Research, Empire News Company, 225 W. 34th St., New York, N.Y. For mail: 713 Avenue O, Brooklyn, N.Y.
- VOIGHT, RICHARD J. (A'25), Assistant Manager, Radio Dept., Herb and Meyer Company, Sandusky, Ohio. For mail: 912-2nd St., Sandusky, Ohio.
- VOLKENANT, GORDON W. (J'25-A'29), Sparks Withington Company, Jackson, Mich.
- VOLKMANN, JOHN E. (A'29), Engineer-in-Acoustics, R.C.A. Photophone, Inc., 411-5th Ave., New York, N.Y.
- VOLNEY, S. C. (A'27), Designer, Western Electric Company, New York, N.Y. For mail: 39 W. 51st St., New York, N.Y.
- VON ARDENNE, MANFRED (J'27-A'29), Radio Engineer, Jungfernstieg 19, Berlin-Lichterfelde-Ost, Germany.
- VOORHAAR, FREDERICK R. (A'25), Engineering Dept., Operadio Manufacturing Company, St. Charles, Ill. For mail: 407 S. 6th St., St. Charles, Ill.
- VOORHEES, LEE J. (A'28), Patent Attorney, N.C. and C. Corporation, Inc., 30 E. 42nd St., New York, N.Y.
- VOS, ARTHUR, JR. (J'26), Student, University of Colorado, Boulder, Colo. For mail: 3209 W. Fairview Pl., Denver, Colo.
- VOSE, CHARLES H. (A'25), Phonograph Design Engineer, General Electric Company, Schenectady, N.Y. For mail: 47 Furman St., Schenectady, N.Y.
- VREELAND, FREDERICK K. (M'16-F'26), Research Engineer, 521 River St., Hoboken, N.J. For mail: Vreeland Corporation, 99 West St., New York, N.Y.

W

- WAAS, ALBERT (A'27), Radio and Electrical Engineer, United Radio and Ignition Service, 4068 Broadway, New York, N.Y.
- WADDELL, GEORGE G. (A'26), Waddell Garage, West Liberty, Ill.
- WADE, C. F. NEWTON (A'19-M'26), St. Hilary, London Rd., Portsmouth, England.
- WADE, DAVID (J'25-A'29), Clerk, Canadian Car and Foundry Company, 307 Craig St., W., Montreal, P.Q., Canada. For mail: 5502 Verdun Ave., Verdun, P.Q., Canada.
- WAGENER, W. HALL (A'27), Radio Sales and Service, Wagener Radio Service, 1415 Hartel Ave., Buffalo, N.Y.
- WAGNER, ELMER H. (A'26), Chief Relief Operator, Commonwealth Edison Company, Chicago, Ill. For mail: 3741 Sheffield Ave., Chicago, Ill.
- WAGNER, HARRY S. (A'28), W. Main St., Clinton, N.J.
- WAGNER, KARL W. (F'27), Director, Heinrich Hertz Institut für Schwingungsforschung, Berlin, Germany. For mail: 1 Franklinstrasse, Berlin, N.W. 87, Germany.
- WAINWRIGHT, ALBERT (A'28), Chief Electrician, Skurray's, Ltd., Swindon, Wilts, England. For mail: Normandy, 29 Evelyn St., Swindon, England.
- WAINWRIGHT, STUART F. (A'26), Technical Engineer and Manager, Station KELW, Earl L. White Corporation, Magnolia Park, Burbank, Calif.
- WAITE, HOWARD G. (A'27), Service Manager, Radio Engineering Service, Inc., 1366 Hayden Ave., East Cleveland, Ohio. For mail: 15632 Euclid Ave., N. 310, Cleveland, Ohio.
- WAITE, SAMUEL A. (A'22), Sound Dept., Fox Film Corporation, Los Angeles, Calif. For mail: 217 N. Palm Dr., Beverly Hills, Calif.
- WALANKA, M. R. (A'25), 106 Park Ter., Harrisburg, Pa.
- WALD, DAVID (A'26), President, United Scientific Laboratories, Inc., 113-4th Ave., New York, N.Y.
- WALDO, GEORGE V. (A'27), Student in Electrical Engineering, Alabama Polytechnic Institute, Auburn, Ala. For mail: P. O. Box 2034, Auburn, Ala.
- WALDORF, E. T. (A'28), Manager, Radio Dept., Corner Book Store, 28 S. Main St., Canandaigua, N.Y. For mail: 176 N. Main St., Canandaigua, N.Y.
- WALGREN, C. A. (A'27), Engineering Dept., Raymond Brothers, Impact Pulverizer Company, 1319 Branch St., Chicago, Ill. For mail: 1714 Foster Ave., Chicago, Ill.
- WALKER, C. L. (A'26), Inspection Dept., Radio Engineering Dept., American Bosch Magneto Company, Springfield, Mass. For mail: 376 Union St., Springfield, Mass.
- WALKER, C. ROBERT (A'26), Technical Employee, American Telephone and Telegraph Company, 40 Rector St., New York, N.Y. For mail: 158 Summit Ave., Jersey City, N.J.
- WALKER, FRANK (A'27), Laboratory Assistant, Colerain and Sassafras Aves., Cincinnati, Ohio. For mail: 2612 Marsh Ave., Cincinnati, Ohio.
- WALKER, GUY P. (A'29), Junior Physicist, Naval Research Laboratory, Bellevue, Anacostia, D.C.
- WALKER, HAROLD S. (A'21), Development and Research Engineer, British Broadcasting Corporation, London, W.C.2, England. For mail: Park Lodge, 9, The Butts, Brentford, Middlesex, England.
- WALKER, H. S. (A'29), Installation Supervisor, Research Products Engineering Dept., Northern Electric Company, Ltd., 637 Craig St., W., Montreal, P.Q., Canada. For mail: 3529 Bordeaux St., Montreal, P.Q., Canada.
- WALKER, JOSEPH R. (A'28), Designer, Georgia Power Company, Atlanta, Ga. For mail: 1045 Kentucky Ave., N.E., Atlanta, Ga.
- WALKER, NOLAN S. (A'29), Radio Engineer, East Sparta, Ohio.
- WALKER, RAYMOND E. (A'29), 525 W. Diamond St., Butte, Mont.
- WALKER, ROBERT M. (A'27), Firlands, Richmond Highlands, Wash.
- WALL, LEAVELL D. (A'27), Engineer, Southern Equipment Company, San Antonio, Tex. For mail: 1126 McKinley Ave., San Antonio, Tex.
- WALLACE, ALEX T. (A'23), 75, The Mall, Southgate, N.14, England.
- WALLACE, DAVID R. (A'26), President, Wallace Radio Institute, 103 W. 13th St., Oklahoma City, Okla.
- WALLACE, DONALD C. (A'25), Manufacturers' Representative, Don C. Wallace, 209 Pine Ave., Long Beach, Calif.
- WALLACE, GORDON S. (A'17), Division Toll Wire Chief, New England Telephone and Telegraph Company, 125 Milk St., Rm. 708, Boston, Mass. For mail: 15 Bothwell Rd., Brighton 35, Mass.
- WALLACE, G. A. (A'29), Assistant Professor of Electrical Engineering, Engineering Bldg., McGill University, Montreal, P.Q., Canada.
- WALLACE, H. EDWARD (A'28), Radio Engineer, Westinghouse Electric and Manufacturing Company, East Pittsburgh, Pa. For mail: 328 Stratford Ave., Pittsburgh, Pa.
- WALLACE, JAMES D. (A'29), Assistant Physicist, Radio Division, U. S. Naval Research Laboratory, Bellevue, Anacostia, D.C.
- WALLACE, J. M. (A'16), c/o A. J. Mellin, 551 Gladstone Ave., Toronto, Ont., Canada.
- WALLACE, LAWRENCE T. (A'28), Radio Sales and Service, W. T. Grant Company, Whitehall St., Atlanta, Ga. For mail: 1331 Lucile Ave., S.W., Atlanta, Ga.
- WALLACE, L. E. (A'29), Manager, Radio and Service Dept., Texarkana Electric Company, Texarkana, Tex. For mail: 209 S. 5th St., McGehee, Tex.
- WALLACE, MARTIN J. (A'28), Operating Engineer, South Schenectady Development Station, Schenectady, N.Y. For mail: 802 Webster St., Schenectady, N.Y.
- WALLACH, MOSES U. (A'26), Secretary, J. and J. Wallach, 330-334 E. 59th St., New York, N.Y.
- WALGREN, ALRIC E. (A'28), Baltimore Victor Distributing Company, Candler Bldg., Baltimore, Md. For mail: 4105 Groveland Ave., Baltimore, Md.
- WALLS, HOY J. (M'28), Radio Engineer, Department of Commerce, Bureau of Light-houses, Washington, D.C. For mail: 6619 Summit Ave., Chevy Chase, Md.
- WALMSLEY, THOMAS (M'26), Engineer-in-Charge, Engineer-in-Chief's Office, Radio Section, Alders House, London, E.C.1, England.
- WALSH, A. L. (A'25), Dentist, 220 W. 42nd St., New York, N.Y.
- WALSH, ARTHUR L. (A'28), Vice-President, Thomas A. Edison, Inc., Orange, N.J. For mail: 332 Redmond Rd., South Orange, N.J.
- WALSH, HAROLD E. (A'26), Radio Branch, Department of Marines, Ottawa, Ont., Canada.
- WALSH, LINCOLN (A'27), Consulting Engineer, 34 DeHart Pl., Elizabeth, N.J.
- WALTER, EDWARD F. (A'29), Foreman, Service Dept., c/o Charles Freshman Company, 800 N. Spring St., Los Angeles, Calif. For mail: 1609 Hipoint St., Los Angeles, Calif.
- WALTER, LOREN E. (A'26), Radio Service Dept., Kansas Gas and Electric Company, Wichita, Kan. For mail: 831 Porter Ave., Wichita, Kan.
- WALTZ, WILLIAM W. (A'28), Installation Engineer, Electrical Research Products, Inc., 250 W. 57th St., New York, N.Y. For mail: 5811 Merville Ave., Baltimore, Md.
- WALWORTH, FRED (A'28), Broadcast Control Supervisor, Columbia Broadcasting System, Inc., 485 Madison Ave., New York, N.Y. For mail: 207 Dyckman St., New York, N.Y.
- WANG, THEODORE J. (A'24), Student, University of Illinois, Chicago, Ill. For mail: 4519 N. Whipple St., Chicago, Ill.
- WARD, CHARLES (A'29), Radio Superintendent, Ontario Forestry Branch, Parliament Bldg., Toronto, Ont., Canada.
- WARD, DONALD G. (A'22), Radio Corporation of America, New Brunswick, N.J.
- WARD, DONALD H. (A'23), Radio Engineer, Starks-Withington Company, Jackson, Mich. For mail: 104-2nd St., Jackson, Mich.

- WARD, DONALD O. (A'28), Service Manager, Haas Electric Sales Company, 512 Huron Ave., Cleveland, Ohio. For mail: 1875 Lampson Rd., Cleveland, Ohio.
- WARD, G. PEARSON (A'28), Manager, Radio Dept., Martin Brothers Piano Company, Springfield, Mo.
- WARD, JACK (A'26), Radio Builder, Ward Manufacturing Company, 3108 S. Vermont Ave., Los Angeles, Calif. For mail: 6022 Byrnhurst Ave., Los Angeles, Calif.
- WARD, LLOYD S. (A'26), Proprietor, L. S. Ward Radio Service, 603-14th St., Rockford, Ill. For mail: 1121-18th St., Rockford, Ill.
- WARDWELL, ARTHUR S. (A'26), Toll Engineer, New York Telephone Company, 360 Bridge St., Brooklyn, N.Y. For mail: 541 Lincoln Pl., Brooklyn, N.Y.
- WARE, PAUL (A'17), Consulting Engineer, Princeton, N.J.
- WARE, WILLIAM (A'28), Inspector, Post Office Beam Wireless Station, Bridgwater, Somerset, England. For mail: 12 Kingscliff Terrace, Taunton Rd., Bridgwater, Somerset, England.
- WAREING, HERBERT F. (A'22), Engineer-in-Charge, Transmission Laboratory, Universal Wireless Communication Company, Inc., 4111 Ravenswood Ave., Chicago, Ill. For mail: 4539 N. Paulina St., Chicago, Ill.
- WARING, ALFRED (A'26), Assistant Engineer, Broadcasting Station WEVD, 3 W. 16th St., New York, N.Y. For mail: 100-17 Pilgrim St., Forest Hills, L.I., N.Y.
- WARNER, BARNEY H. (J'26-A'28), Radiotriician, Ludwig Company, 50 S. Main St., Wilkes-Barre, Pa. For mail: 14 N. Grant St., Wilkes-Barre, Pa.
- WARNER, EARLE H. (A'22), Professor of Physics, University of Arizona, Tucson, Ariz. For mail: 510 E. 4th St., Tucson, Ariz.
- WARNER, FREDERICK F. (A'29), Radio Engineer, 87 Mosley St., Nr. Stockton, England. For mail: Northdene, High Lane, Nr. Stockton, England.
- WARNER, HERBERT M. (J'17-A'21), Great Notch, N.J.
- WARNER, H. J. (M'28), Technical Officer, Royal Aircraft Establishment, Farnborough, Hants, England. For mail: Ruhtra, Elm Grove Rd., S. Farnborough, Hants, England.
- WARNER, JOHN C. (A'19-M'26), Research Engineer, Research Laboratory, General Electric Company, Schenectady, N.Y.
- WARNER, KENNETH B. (A'18-M'22), Secretary and Editor, American Radio Relay League, Hartford, Conn. For mail: 282 Fern St., West Hartford, Conn.
- WARREN, A. C. (A'29), Assistant Engineer, Radio Section, General Post Office, London, E.C.1, England.
- WARREN, CHESTER L. (A'29), Engineering Dept., Weston Electric Instrument Corporation, 602 Frelinghuysen Ave., Newark, N.J. For mail: 307 Hollywood Ave., Hillside, N.J.
- WARREN, S. REID, JR. (A'29), Research Assistant to Professor Weyl, Moore School of Electrical Engineering, University of Pennsylvania, Philadelphia, Pa. For mail: 260 Green Ave., Lansdowne, Pa.
- WARREN, WILLIAM A. (A'27), Hurley, Ulster County, N.Y.
- WARWOOD, W. E. (A'28), Radio Service, Robert Simpson Company, Dept. P. C., Toronto 12, Ont., Canada. For mail: 309 Bedford Ave., Toronto 12, Ont., Canada.
- WASHBURN, CYRUS, JR. (A'28), Certified Radiotriician, 226 E. 15th St., Jacksonville, Fla.
- WASHINGTON, BOWDEN (A'14-M'16-F'23), 107 Waverly Pl., New York, N.Y.
- WASS, HOWARD H. (A'29), Radio Serviceman, 468 Massachusetts Ave., Boston, Mass.
- WASSERVOGEL, GUNTHER (A'29), Engineering Laboratory, Wells-Garner and Company, 816 N. Kedzie St., Chicago, Ill. For mail: 1439 W. Van Buren St., Chicago, Ill.
- WATANABE, YASUSI (M'29), Professor of Electrical Engineering, Tohoku Imperial University, Sendai, Japan.
- WATERMAN, FRANK N. (A'12-M'15), St. Paul Bldg., 220 Broadway, New York, N.Y.
- WATERS, JAMES S. (A'28), Instructor in Electrical Engineering, Rice Institute, Houston, Tex.
- WATERS, JOHN E. (A'26), Doctor Dental Surgery, Bank of Italy Bldg., Anaheim, Calif. For mail: RR2, Box 12C, Orange, Calif.
- WATLING, WILLIAM J. (A'28), Radio Production Foreman, H. M. Kepp Company, 447 Yonge St., Toronto, Ont., Canada. For mail: 226 Caledonia Rd., Toronto, Ont., Canada.
- WATSON, GEORGE H. (A'19), Lecturer, Wireless Telegraph Dept., Municipal College, Portsmouth, England. For mail: "Kinders," Aberdare Ave., E. Cosham, Hants, England.
- WATSON, PAUL E. (A'28), Junior Radio Engineer, Research Dept., U. S. Signal Corps, Fort Monmouth, N.J. For mail: 45 Jackson St., Long Branch, N.J.
- WATTS, D. E. (A'27), Radio Development, General Electric Company, Bldg. 77, Schenectady, N.Y.
- WATTS, E. GERALD (J'26-A'28), Engineer, Murton Laboratories, Inc., 1540 Hillcrest Rd., Cleveland, Ohio. For mail: 2423 Overlook Rd., Cleveland, Ohio.
- WATTS, HAROLD F. (A'27), Radio Operator, Radio Station KFEQ, Robidoux Hotel, St. Joseph, Mo. For mail: 1102 Elwood St., St. Joseph, Mo.
- WATTS, IVOR B. (J'27), Inspection and Testing of Radio Equipment, American Transformer Company, 178 Emmet St., Newark, N.J. For mail: 370 Clifton Ave., Clifton, N.J.
- WATTSON, HARRY B. (A'29), Radio Engineer, Radio Corporation of America, 66 Broad St., New York, N.Y. For mail: Box 35, 1 Erie Ave., Rutherford, N.J.
- WAUD, EUGENE C. (A'28), Engineer, New York Fire Insurance Rating Organization, Buffalo Division, 840 Marine Trust Bldg., Buffalo, N.Y.
- WAY, HARRY C. (A'28), Sales Representative, Canadian Brandes, Ltd., 207 Queens Quay, Toronto, Ont., Canada.
- WEAGANT, ROY A. (M'13-F'15), Electrical Engineer, 233 Broadway, New York, N.Y. For mail: 101 Forest Rd., Douglas Manor, L.I., N.Y.

- WEARE, JOHN (A'28), 1558 Massachusetts Ave., Cambridge, Mass.
- WEAVER, KARL S. (A'29), Radio Engineer, Westinghouse Lamp Company, Bloomfield, N.J. For mail: 18 Austin Pl., Bloomfield, N.J.
- WEAVER, RAYMAN E. (A'26), Fire Department Mechanic, City of Akron Fire Department, No. 5 Shop, Buchtel Ave., Akron, Ohio. For mail: 1349 Killingly St., Akron, Ohio.
- WEAVER, WILLIAM E. (A'27), Electrical Engineering, Canadian General Electric Company, Peterboro, Ont., Canada. For mail: Hespeler, Ont., Canada.
- WEBB, JAMES H. (A'27), Managing Director, British School of Geography, 179 Clapham Rd., London, S.W.9, England.
- WEBB, J. S. (A'17), Instructor in Physics, Department of Physics, Cornell University, Ithaca, N.Y.
- WEBER, CARL F. (A'26), Service Dept., National Radio Institute, 1536 You St., N.W., Washington, D.C. For mail: 1420 Harvard St., Washington, D.C.
- WEBER, GLENN L. (A'25), Plant Training Supervisor, Pacific Telephone and Telegraph Company, 140 New Montgomery St., San Francisco, Calif.
- WEBER, HAROLD C. (A'27), Assistant Professor, Massachusetts Institute of Technology, Cambridge, Mass. For mail: 160 Brook Rd., Mattapan, Mass.
- WEBER, H. S. (A'29), Secretary and Treasurer, The Kramer-Weber Company, 313 Factory St., Dover, Ohio.
- WEBER, PAUL (A'25), Serviceman, 1822 Bleecker St., Brooklyn, N.Y.
- WEBER, RENNIE I. (A'28), Standard Radio Manufacturing Corporation, Ltd., 90 Chestnut St., Toronto, Ont., Canada. For mail: 1352 Bathurst St., Toronto, Ont., Canada.
- WEBER, WALTER (A'29), Assistant Chief Engineer, Station WBMS, 970 Bergenline Ave., Union City, N.J. For mail: 169 Zabriskie St., Jersey City, N.J.
- WEBRE, ANDREW S. (A'28), Student, Louisiana State University, Baton Rouge, La. For mail: 830 North St., Baton Rouge, La.
- WEBSTER, B. M., JR. (A'29), General Counsel, Federal Radio Commission, Washington, D.C.
- WEED, C. BRONSON (A'27), 224 St. Ronan St., New Haven, Conn.
- WEEDEN, EDWARD H. (A'27), Associate Professor of Electrical Engineering, MacKenzie College, Sao Paulo, Brazil, South America.
- WEEDEN, WILLIAM N. (A'26), Commercial Engineer, Western Electric Company, Inc., Rm. 410, American Telephone and Telegraph Company Bldg., 195 Broadway, New York, N.Y. For mail: Standish Hall, Apt. 4A, 12 Midland Ave., Bronxville, N.Y.
- WEEKS, MILES W. (A'26), Insurance Broker, O'Brien, Russell and Company, Boston, Mass. For mail: 40 Norfolk Rd., Chestnut Hill, Brookline, Mass.
- WEEKS, NORMAN E. (A'24), Engineer, Transmission and Protection Methods and Results Dept., New York Telephone Company, 360 Bridge St., Brooklyn, N.Y. For mail: 78 Liberty Ave., Rockville Center, L.I., N.Y.
- WEEKS, PAUL T. (A'19-M'28), Engineer, Raytheon Manufacturing Company, 238 Main St., Cambridge, Mass.
- WEEKS, ROBERT H. (A'26), 226 N. Jackson St., Waukegan, Ill.
- WEGNER, CHARLES W. (J'28), Radio Operator, Intercity Radio Company, 1004-6 Rockefeller Bldg., Cleveland, Ohio. For mail: 3725 N. Tripp Ave., Chicago, Ill.
- WEIBLER, CARLETON T. (A'29), Chief Engineer, The Webster Company, 850 Blackhawk St., Chicago, Ill. For mail: 4003 N. Kildare Ave., Chicago, Ill.
- WEIGAND, JOS. S. (A'28), Chief Radio Electrician, U. S. Navy Yard, Mare Island, Calif.
- WEIGEL, RICHARD C. (A'27), Manager, Radio Dept., Stough and Lucas, 141 W. Market St., York, Pa. For mail: 258 W. Market St., York, Pa.
- WEIGHT, H. AUBREY (A'27), Wireless Engineer, Weight and Bradley, 14 Cross St., Reading, Berks, England. For mail: Kynance, Winnersh, Berks, England.
- WEIK, ADOLPH L. (A'28), Supervisor, Mackay Radio and Telegraph Company, Southampton, L.I., N.Y.
- WEILAND, CHRISTIAN F. (A'29), Associate Editor, "Engineering Index," 33 W. 39th St., Room 1205, New York, N.Y. For mail: 1020 Walton Ave., New York, N.Y.
- WEILMINSTER, CHARLES (A'27), Service Engineer, 8722 Jamaica Ave., Woodhaven, L.I., N.Y. For mail: 8605-95th Ave., Ozone Park, L.I., N.Y.
- WEIMER, EARL W. (A'27), 42 Poplar Ave., Woodlawn, Wheeling, W.Va.
- WEINBERG, ISAAC (J'21-A'23), Electrician and Radio Serviceman, New York Electric Company, 98 Madison St., Passaic, N.J.
- WEINBERG, SIDNEY (J'29), Production and Radio Engineer, 113-4th Ave., Brooklyn, N.Y. For mail: 24 Bay 31st St., Brooklyn, N.Y.
- WEINBERGER, JULIUS (A'13-F'25), Division Engineer, Radio Corporation of America, Van Cortlandt Park S. and Saxon Ave., New York, N.Y.
- WEINWURM, ROBERT (A'22), Service Engineer, Freed-Eisemann Radio Corporation, Junius St. and Liberty Ave., Brooklyn, N.Y. For mail: 109-41-125th St., Richmond Hill, L.I., N.Y.
- WEIR, F. TORRES (A'28), 33 Henry St., San Francisco, Calif.
- WEIR, HAROLD G. (A'28), Radio Service Manager, Aikenhead Hardware Company, 17-21 Temperance St., Toronto, Ont., Canada. For mail: 207 Carlton St., Toronto, Ont., Canada.
- WEIR, IRWIN R. (A'25), Radio Engineer, Radio Engineering Dept., General Electric Company, Schenectady, N.Y.

MEMBERSHIP (Alphabetical)

- WEIS, F. J. (A'29), Treasurer, Fidelity Investment Association, 1229 Main St., Wheeling, W. Va.
- WEISER, CARL (A'29), Vice-President, Weiser and Sons, 2100 S. Kedzie Ave., Chicago, Ill. For mail: 701 S. Kenilworth Ave., Oak Park, Ill.
- WEISS, EARL (J'28), Bookkeeper, Hickman and Squire, Inc., 127 Fillmore Ave., Buffalo, N.Y. For mail: 88 Florida St., Buffalo, N.Y.
- WEISS, TOBIAS (A'28), District Sales Manager, The Ideal Electric and Manufacturing Company, 221 Wisconsin Ave., Milwaukee, Wis. For mail: 1395 Prospect Ave., Milwaukee, Wis.
- WEISSMANTEL, C. H. (A'27), Assisting Radio Engineer, Electron Radio Laboratories, 3047 N. Robey St., Chicago, Ill. For mail: 6244 N. Fairfield Ave., Chicago, Ill.
- WEITZEL, LE ROY B. (A'25), Universal Wireless Communications Company, 4619 Ravenwood Ave., Chicago, Ill. For mail: 4847 N. Lincoln St., Apt. 1-B, Chicago, Ill.
- WELDON, JAMES O. (A'26), Chief Engineer, Station KFKB, Milford, Kan.
- WELKER, PAUL L. (A'28), Radio Editor, "Science and Invention," 230-5th Ave., New York, N.Y. For mail: 273 Clermont Ave., Brooklyn, N.Y.
- WELLER, EARL SELWYN (J'29), Telephone Operator, Capitol Theatre, E. Ryden St., Litchfield, Ill. For mail: 224 Van Buren St., Litchfield, Ill.
- WELLER, EVERETT C. (A'29), Service Engineer, Wil-Bor Radio and Electric Company, 485 S. 21st St., Easton, Pa. For mail: 1815 Fairview Ave., Easton, Pa.
- WELLMAN, WILLIAM R. (A'27), Laboratory Assistant, Brandes Products Corporation, 350 Thomas St., Newark, N.J. For mail: 1531 Jesup Ave., New York, N.Y.
- WELLS, DANIEL W. (A'27), Foreman, Radio Testing, Westinghouse Electric and Manufacturing Company, Springfield, Mass. For mail: 20 Monrovia St., Springfield, Mass.
- WELLS, JOHN M. (A'26), Production Control Work, American Optical Company, Southbridge, Mass. For mail: Southbridge, Mass.
- WELLS, LAWRENCE V. (A'29), Radio Service, Henkel's Radio Shop, 121 W. Wash-tenaw St., Lansing, Mich. For mail: 325 Smith Ave., Lansing, Mich.
- WELLS, LELAND E. (M'27), Electrical Engineer, Willard Storage Battery Company, E. 131st St., Cleveland, Ohio.
- WELLS, MARTIN M. (A'29), Technical Advisor and Assistant to Chief Inspector, Crosley Radio Corporation, Cincinnati, Ohio. For mail: P. O. Box 500, South Charleston, Ohio.
- WELLS, W. BRUCE (A'28), Radio Engineer, Radio Material Office, U. S. Navy Yard, Mare Island, Calif.
- WELSH, FRED E. (A'29), Advertising Designer, 25 W. 45th St., New York, N.Y. For mail: 170 Spring St., Rochester, N.Y.
- WELSHER, CARL E. (A'26), Installation Engineer, Electrical Research Products, Inc., 250 W. 57th St., New York, N.Y. For mail: P. O. Box 64, Sanborn, N.Y.
- WENDELL, EDWARD N. (A'26), Compania Telefonica Nacional De Espana, Madrid, Spain.
- WENDLER, ERWIN, JR. (A'29), School of Engineering, Milwaukee, Wis. For mail: 989 Cramer St., Milwaukee, Wis.
- WENGEL, RAYMOND W. (A'28), Electrical Engineer, Geophysical Exploration Company, Beaumont, Tex. For mail: 1495 Johns Ave., Beaumont, Tex.
- WENSLEY, ROY J. (A'27), Engineer-in-Charge, Automatic Section, Switchboard Engineering Dept., Westinghouse Electric and Manufacturing Company, East Pittsburgh, Pa. For mail: 431 Ardmore Bldg., Forest Hills, Pittsburgh, Pa.
- WENSTROM, W. E. (A'25), Lieutenant, Signal Corps, U. S. Army, U. S. Military Academy, West Point, N.Y. For mail: West Point, N.Y.
- WENTZEL, AMANDUS G., JR. (J'22-A'25), Chief Electrician, Essex Rubber Company, Trenton, N.J. For mail: 318 Gardner Ave., Trenton, N.J.
- WERHAN, ALFRED B. (A'27), Radio Sales and Service, 1077-6th Ave., Akron, Ohio.
- WERSEN, DAVID T. (A'29), Soundman, Hal Roach Studios, Victor Talking Machine Company, Culver City, Calif. For mail: Hotel Washington, Culver City, Calif.
- WESSELMAN, EUGENE (A'27), Rudolph Wurlitzer Manufacturing Company, North Tonawanda, N.Y. For mail: 537 Falls Blvd., North Tonawanda, N.Y.
- WEST, CLARENCE H. (A'27), Property Custodian, U. S. Public Health Service, U. S. Marine Hospital, Stapleton, S.I., N.Y.
- WEST, GLENN EDWIN (M'29), Research Engineer, Research Laboratories, Federal Telegraph Company, Palo Alto, Calif.
- WEST, L. E. (A'27), Engineer, E. T. Cunningham, Inc., 370-7th Ave., New York, N.Y.
- WEST, WILLIAM H. (J'23-A'26), The Voice of St. Louis, Station KMOX, Hotel Mayfair, St. Louis, Mo. For mail: 8135 Lynn Ave., St. Louis, Mo.
- WESTCOTT, PHILIP S. (A'24), Special Representative, The Pyle-National Company, 1334 N. Kostner Ave., Oak Park, Ill. For mail: 928 N. Grove Ave., Oak Park, Ill.
- WESTENDORP, W. F. (A'29), General Electric Company, Bldg. 77, Room 411, Schenectady, N.Y. For mail: Y.M.C.A., Schenectady, N.Y.
- WESTERVELT, H. P. (A'23), Division Transmission and Protection Engineer, Michigan Bell Telephone Company, Menominee, Mich.
- WESTLUND, J. V. (A'29), Westlund and Leadke, 118 N. 1st St., Rockford, Ill.
- WESTMAN, HAROLD P. (J'24-A'25-M'30), Assistant Secretary, Institute of Radio Engineers, 33 W. 39th St., New York, N.Y. For mail: 21 S. Woodfield Rd., West Hempstead, L.I., N.Y.
- WESTON, IRVING L. (A'29), Junior Radio Operator, U. S. Department of Commerce, 12th Floor, Custom House, Boston, Mass.
- WESTON, JOHN L. (A'26), Engineering Dept., Wired Radio, Inc., 4th Ave. and 13th St., Newark, N.J. For mail: 55 N. 21st St., East Orange, N.J.

MEMBERSHIP (Alphabetical)

- WESTPHAL, RICHARD D. (A'28), Technical Representative, Victor Talking Machine Company, 119 N. Main St., Salt Lake City, Utah.
- WETTERMANN, JOHN A. (A'29), Superintendent, Chapace Realty Corporation, 1115 College Ave., New York, N.Y.
- WETZEL, JOSEPH A. (A'27), Kemper Radio Corporation, 1259 Market St., San Francisco, Calif. For mail: 303 Webster St., San Francisco, Calif.
- WEYL, CHARLES N. (M'25), University of Pennsylvania, Philadelphia, Pa. For mail: 255 Harvey St., Germantown, Philadelphia, Pa.
- WHALE, GORDON S. (A'26), Professor of Wireless, North Wales Wireless College, Colwyn Bay, North Wales, G.B.
- WHAN, LOREN H., JR. (A'27), Engineer, Minerva Radio Company, 154 E. Erie St., Chicago, Ill. For mail: 5934 W. Huron St., Chicago, Ill.
- WHANNEL, RAYMOND L. (A'27), City Hall, Room 300, Springfield, Ill. For mail: 1544 W. Cook St., Springfield, Ill.
- WHEELER, C. M. (A'28), Engineer, Westinghouse Lamp Company, Bloomfield, N.J. For mail: Union St., Cedar Grove, N.J.
- WHEELER, EDMUND F. (A'27), Engineer-in-Charge, British Broadcasting Corporation, 31 Lincenhall St., Belfast, Ireland.
- WHEELER, FREDERICK (J'29), Radio Operator, Station WREN, Jenny Wren Company, Lawrence, Kan. For mail: 1024 Alabama St., Lawrence, Kan.
- WHEELER, GEORGE D. (A'29), Inspector, Telephone Apparatus and Installations, The United Electric Company, 56-58 W. 45th St., New York, N.Y. For mail: 269 E. 194th St., New York, N.Y.
- WHEELER, HAROLD A. (A'27-M'28), Radio Engineer, Hazeltine Corporation, 333 W. 52nd St., New York City. For mail: 78-22nd St., Jackson Heights, L.I., N.Y.
- WHEELER, HARVEY T. (J'27-A'29), Radio Operator, Station KPRC, Houston "Post Dispatch," 2204 "Post Dispatch" Bldg., Houston, Tex. For mail: 204 Roberts St., Houston, Tex.
- WHEELER, LYNDE P. (F'28), Physicist, Naval Research Laboratory, Bellevue, Anacostia, D.C.
- WHEELER, WALTER R. (A'26), Exide Battery and Radio Shop, Bishop, Calif. For mail: P. O. Box 233, Bishop, Calif.
- WHELAN, DOW O. (A'25), Assistant to Receiver Design Engineer, Radio Dept., General Electric Company, Schenectady, N.Y.
- WHIDDEN, IRA P. (A'28), Manager, Sales and Service Dept., The John Elliott Clark Company, 224 S. Main St., Butte, Mont.
- WHISTON, R. WILLIAM (A'26), Radio Service, Electric Lighting Supply Company, 216 W. 3rd St., Los Angeles, Calif. For mail: 1808 Buckingham Rd., Los Angeles, Calif.
- WHITAKER, JAMES N. (A'27), Assistant Engineer, Engineering Dept., Radio Corporation of America, 66 Broad St., New York, N.Y. For mail: Sherwood Park, Yonkers, N.Y.
- WHITAKER, JOHN C. (A'26), 336 S. Crescent Dr., Beverly Hills, Calif.
- WHITE, CHARLES P. (A'25), Radio Operator, Independent Wireless Telegraph Company, 23 South St., New York, N.Y. For mail: 223 Inslee Pl., Elizabeth, N.J.
- WHITE, EDWIN L. (A'24), Radio Engineer, Signal Office, Headquarters, Hawaiian Dept., Ft. Shafter, Hawaii.
- WHITE, HAROLD D. (A'27), Employer, Richfield Oil Company of California, Bartlett Bldg., Los Angeles, Calif. For mail: 2754 E. Walnut St., Pasadena, Calif.
- WHITE, HERBERT G. (A'24), 47 Fernleigh Dr., Leigh-on-Sea, Essex, England.
- WHITE, JOHN A. (A'26), Vice-President, U. S. L. Radio, Inc., Niagara Falls, N.Y.
- WHITE, JOHN W. (A'29), Electrical and Radio Engineer, 107 Commercial Rd., Parkstone, Dorset, England. For mail: St. Nicholas, Castledene Rd., Parkstone, Dorset, England.
- WHITE, KARL K. (J'29), Operator, Broadcast Station KVOO, Tulsa, Okla.
- WHITE, KENNETH E. (A'28), Laboratory, National Carbon Company, W. 117th and Madison Sts., Cleveland, Ohio. For mail: P. O. Box 112, Shiloh, Ohio.
- WHITE, MILTON (A'24), Radio Repairs and Service, Rix Radio Supply House, Inc., 5505-4th Ave., Brooklyn, N.Y. For mail: 1318-55th St., Brooklyn, N.Y.
- WHITE, PHILIP S. (A'27), Consultant and Industrial Engineer, George S. May Company, Chanin Bldg., 42nd St. and Lexington Ave., New York, N.Y. For mail: Eagle Pencil Company, 710 E. 14th St., New York, N.Y.
- WHITE, RAY H. (A'29), Junior Engineer, Federal Telegraph Company, Palo Alto, Calif. For mail: 603 Fulton St., Palo Alto, Calif.
- WHITE, R. JORDAN (A'28), Radiotron Specialist, Radio Corporation of America, 302 Santa Fe Bldg., Dallas, Tex. For mail: P. O. Box 334, Okmulgee, Okla.
- WHITE, WARREN (A'26), Sales Engineer, Stromberg-Carlson Telephone Manufacturing Company, Export Dept., 1060 University Ave., Rochester, N.Y.
- WHITE, WILLIAM C. (A'15-M'25), Manager, Vacuum Tube Engineering Section, General Electric Company, Schenectady, N.Y.
- WHITEHEAD, JESSE C. (A'25), Assistant Engineer, Radio Corporation of America, Camden, N.J. For mail: 720 W. Maple Ave., Merchantville, N.J.
- WHITEHOUSE, JOSEPH E. (A'25), Resident Engineer, Stations WLW-WSAI, Crosley Broadcasting Stations, Mason, Ohio.
- WHITING, DONALD F. (A'15-M'26), Engineer-in-Charge, Development Laboratory, Fox Case Corporation, 460 W. 54th St., New York, N.Y. For mail: P. O. Box 123, Port Washington, L.I., N.Y.
- WHITLOCK, FRED (A'27), Engineer-in-Charge, Development Dept., Cardon-Phonograph Corporation, Jackson, Mich. For mail: 1012 1/2 William St., Jackson, Mich.
- WHITMER, ROBERT M. (A'29), Engineer, Bell Telephone Laboratories, Inc., 463 West St., New York, N.Y.

- WHITMORE, WALTER R. (A'27), Test Dept., Engineer, DeForest Crosley Radio Company, 245 Carlaw Ave., Toronto, Ont., Canada. For mail: 18 Ladykirk Ave., Toronto, Ont., Canada.
- WHITNAH, R. B. (J'28), Proprietor and Operator, Radio Station W-9DBT, 307 W. Tarkio St., Clarinda, Iowa.
- WHITTAKER, EDMUND (A'29), Control Engineer, Columbia Broadcasting System, 113 W. 57th St., New York, N.Y. For mail: 32 Zabriskie St., Paterson, N.J.
- WHITTEMORE, L. E. (A'16-M'25-F'27), Engineer, American Telephone and Telegraph Company, Development and Research Dept., 195 Broadway, New York, N.Y.
- WHITTERN, RAY (A'28), Manager, Radio Dept., Ralph C. Dodson Company, Palo Alto, Calif. For mail: 219 Hawthorne Ave., Palo Alto, Calif.
- WHITTIER, ELLERTON W. (A'18), Laboratory Assistant and Assistant Treasurer, Atlantic Precision Instrument Company, 61 Sheridan St., Malden, Mass. For mail: 38 Ellery St., Cambridge, Mass.
- WHITWAM, LLOYD F. (A'29), Radio Engineer, Federal Telegraph Company, Palo Alto, Calif.
- WICHERN, LEONARD (A'27), Sales Engineer, Colonial Radio Corporation, 25 Wilbur Ave., Long Island City, L.I., N.Y. For mail: 5385 Hudson Blvd., North Bergen, N.J.
- WICKERSHEIM, L. W. (A'19), Engineer, Toll Development Dept., Bell Telephone Laboratories, Inc., 463 West St., New York, N.Y.
- WICKIZER, GILBERT S. (A'28), Radio Engineer, Radio Corporation of America, Riverhead, L.I., N.Y.
- WICKS, FRANK W. (A'19), Chief Instructor, British School of Telegraphy, 179 Clapham Rd., London, S.W.9, England. For mail: 38 West St., Bromley, Kent, England.
- WICKS, REGINALD P. (A'24), Instructor, British School of Telegraphy, 179 Clapham Rd., London, S.W.9, England. For mail: 20 Manor Rd., Wallington, Surrey, England.
- WIDELL, E. GIDEON (M'26), Research Chemist, Westinghouse Lamp Company, Bloomfield, N.J.
- WIDMANN, ERWIN (A'29), Assistant Engineer, Research Division, Colonial Radio Corporation, 25 Wilbur Ave., Long Island City, L.I., N.Y. For mail: 2076-66th St., Brooklyn, N.Y.
- WIEBACH, WILLIAM T. (A'29), Laboratory Assistant, 25 Leighton Ave., Rochester, N.Y. For mail: 207 Ave. C., Rochester, N.Y.
- WIESMANN, EDWARD T. (J'27), Electrical Worker, 1368 Herman St., N.S., Pittsburgh, Pa.
- WIJEYERATNE, P. DE S. (A'29), Holmwood, 58, Madampitiya, Colombo, Ceylon, India.
- WILBER, DELBERT J. (A'26), District Representative, Robert Bosch Magneto Company, Inc., Long Island City, L.I., N.Y. For mail: 4882 Cortland St., Detroit, Mich.
- WILBUR, EDWIN C. (A'26), Substation Operator, The United Electric Light and Power Company, 130 E. 15th St., New York, N.Y. For mail: 108 Park Terrace East, New York, N.Y.
- WILBURN, FRANK (A'28), Wilburn Radio Service, 838 N. Central Ave., Phoenix, Ariz.
- WILCOX, B. B. (A'29), Assistant Division Transmission Engineer, Bell Telephone Company of Canada, 256 Notre Dame St., W., Montreal, P.Q., Canada.
- WILCOX, ERNEST C. (A'19), President, Connecticut Telephone and Electric Company, Meriden, Conn. For mail: 658 Colony St., Meriden, Conn.
- WILCOX, G. M. (M'21), Professor of Physics, Armour Institute of Technology, 33rd and Federal Sts., Chicago, Ill. For mail: 5225 Ingleside Ave., Chicago, Ill.
- WILCOX, NATHAN (A'27), Chief Engineer, Radio Station KSO, Clarinda, Iowa.
- WILCOX, ROBERT L. (A'28), Radio Service Manager, H. E. Kaighn Radio, 215 W. 4th St., Wilmington, Del. For mail: 625 N. Grant Ave., Wilmington, Del.
- WILD, SYDNEY J. (A'29), Chief of Test Dept., Sherman and Clay Company, 14th and Clay Sts., Oakland, Calif. For mail: 1609 Grand Ave., Oakland, Calif.
- WILDE, S. F. M. (A'27), Messrs. Johnson and Phillips, Charlton, London, S.E.7, England.
- WILDER, MARSHALL P. (A'28), Student, Massachusetts Institute of Technology, 420 Memorial Dr., Cambridge, Mass.
- WILDES, KARL L. (A'24), Assistant Professor of Electrical Engineering, Massachusetts Institute of Technology, Room 4-205, Cambridge, Mass.
- WILDMAN, THOMAS S. (A'27), Radio Operator, Radio Station WOC, Davenport, Iowa. For mail: 2416 Tremont Ave., Davenport, Iowa.
- WILHELM, JULIAN A. (A'26), Proprietor, 169 S. Schuyler Ave., Kankakee, Ill. For mail: P. O. Box 365, Kankakee, Ill.
- WILKENS, BERNARD T. (A'28), Assistant Engineer, W. F. Jones Broadcasting Company, Radio Station WFJC, Beacon Journal Bldg., 140 E. Market St., Akron, Ohio.
- WILKIE, HARRY (A'29), Junior Electrical Engineer, Naval Research Laboratory, Bellevue, Anacostia, D.C.
- WILKINSON, ALLAN E. (A'27), Traffic Engineer, Bell Telephone Company of Canada, Toronto, Ont., Canada. For mail: 53 Triller Ave., Toronto, Ont., Canada.
- WILKINSON, BERNARD (A'17), Managing Director, Wilkinson Process Rubber Company, Ltd., Batu Caves, Selangor, Federated Malay States.
- WILKINSON, GORDON O. (A'25), Experimental Work, Ardmore, Pa. For mail: Llanfair and Wister Rds., Ardmore, Pa.
- WILKINSON, L. G. (A'27), Manager, Radio Dept., Grigsby-Grunow Hinds Company, 4540 Armitage Ave., Chicago, Ill. For mail: 3111 Grove Ave., Berwyn, Ill.
- WILLARD, JOSEPH M. (A'27), Radio Engineer, RCA-Victor Company, Inc., Camden, N.J. For mail: 712 Blythe Ave., Drexel Hill, Pa.

- WILLERS, THEODORE H., SR. (A'27), Engineer, Rockland Light and Power Company, 32 Front St., Port Jervis, N.Y. For mail: P. O. Box 119, Matamoras, Pa.
- WILLES, EMERSON T. (A'29), Radioman, American Telephone and Telegraph Company, Transatlantic Radio Station, Houlton, Me. For mail: P. O. Box 69, Houlton, Me.
- WILLHOFFT, FREDERICK O. (A'25), Consulting Engineer, 11 W. 42nd St., New York, N.Y.
- WILLIAMS, BILLY G. (A'29), Service Engineer, Sparks-Withington Company, Jackson, Mich. For mail: 1024 Lansing Ave., Jackson, Mich.
- WILLIAMS, CECIL G. (A'26), Proprietor, British Radio Manufacturing Company, 9 S. Castle St., Liverpool, England. For mail: 86 Rullerton Rd., Wallasey, Cheshire, England.
- WILLIAMS, CHARLES E. (J'15-A'17-M'24), Radio Engineer, Navy Dept., Puget Sound, Bremerton, Wash. For mail: 2340 Delmar Dr., Seattle, Wash.
- WILLIAMS, CHARLES HADDON (A'29), Assistant Radio Engineer, Naval Research Laboratory, Bellevue, Anacostia, D.C.
- WILLIAMS, ERIC (A'27), Assistant Engineer, British Broadcasting Corporation, Savoy Hill, London, England. For mail: 23 Park Rd., Wimbledown, Surrey, England.
- WILLIAMS, G. H. (A'24), Design Engineer, Communication Section, Southeastern Engineering Company, Birmingham, Ala. For mail: 1620-14th Ave., Birmingham, Ala.
- WILLIAMS, HOLLIE (A'28), Engineer, The Ohio Bell Telephone Company, 750 Huron Rd., Cleveland, Ohio. For mail: 2175 Middlefield Rd., Cleveland Heights, Ohio.
- WILLIAMS, JAMES (A'28), Radio Service, Canadian Westinghouse Company, 355 King St., W. N. Hamilton, Ont., Canada. For mail: 38 Emerald St., N. Hamilton, Ont., Canada.
- WILLIAMS, JOHN C. (A'27), Research Engineer, O'Neil Manufacturing Corporation, 715 Palisade Ave., W. New York, N.J. For mail: 504 Merrick Rd., Lynbrook, L.I., N.Y.
- WILLIAMS, N. B. (A'27), Vice-President, Williams Hardware Company, 115 S. Vermillion St., Streator, Ill.
- WILLIAMS, PALMER H. (A'26), Chief Engineer, Paramount Radio Manufacturing Company, Inc., 1406 Walnut St., Kansas City, Mo. For mail: 2544 Groost Ave., Kansas City, Mo.
- WILLIAMS, THOMAS E. (A'26), Radio Equipment, 28 Front St., Saranac Lake, N.Y.
- WILLIAMS, THOMAS R. (A'29), Manager, Radio Department, S. S. Kresge Company, 715 Hamilton St., Allentown, Pa. For mail: 953 Cedar St., Allentown, Pa.
- WILLIAMS, WARREN R. (A'29), Candor, N.Y.
- WILLIAMSON, CHARLES G. (A'26), Michigan Alkali Company, Wyandotte, Mich. For mail: 128 N. 4th St., Trenton, Mich.
- WILLIAMSON, FREDERICK E. (A'27), Student, Electrical Engineer, Armour Institute of Technology, 33rd and Federal Sts., Chicago, Ill. For mail: 535 Denning Pl., Chicago, Ill.
- WILLING, WILLIAM P. (A'29), Radio Adjuster, Public Service Company of Northern Illinois, 1610 S. 1st Ave., Maywood, Ill. For mail: 610 N. Grove Ave., Oak Park, Ill.
- WILLIS, EDWARD N. (J'26-A'27), 2658-30th St., Santa Monica, Calif.
- WILLIS, ELLSWORTH D. (A'26), Radio Instructor, Boys' Vocational School, 400 N. Penn. Ave., Lansing, Mich.
- WILLIS, FREDERICK C. (A'20), Member of Technical Staff, Electrical Research Products, Inc., 250 W. 57th St., New York, N.Y. For mail: Passaic Ave., R.F.D., West Caldwell, N.J.
- WILLIS, F. H. (A'26), P.O. Box 346, Houlton, Me.
- WILLITS, ANDREW A. (A'28), Willits Radio Service, 700 S. 20th St., Fort Dodge, Iowa.
- WILLOUGHBY, JOHN A. (A'19-M'29), Research Engineer, Mantle Lamp Company of America, 609 W. Lake St., Chicago, Ill. For mail: 238 N. Pierce Ave., Chicago, Ill.
- WILLS, DAVID C. (A'22), Western Electric Company, Chicago, Ill. For mail: 224 Herick Rd., Riverside, Ill.
- WILLS, HARRY L. (M'27), Georgia Power Company, Atlanta, Ga.
- WILLSON, ABNER R. (A'22), Manager, Radio Dept., Fobes Supply Company, 560-1st Ave., Seattle, Wash. For mail: 8055-14th Ave. N.E., Seattle, Wash.
- WILLSON, CLARENCE L. (A'27), Radio Service, Broadway Dept. Stores, 4th and Broadway, Los Angeles, Calif. For mail: 303 E. Graves Ave., Monterey Park, Calif.
- WILLSON, P. L. (A'28), Proprietor, Willson Radio Laboratory, 206 E. 15th St., Tulsa, Okla.
- WILM, CARL F. (A'29), Tester, Grigsby-Grunow Company, 5891 Dickens Ave., Chicago, Ill. For mail: 3745 Addison St., Chicago, Ill.
- WILMOTTE, R. M. (M'29), Engineer, Radio Frequency Laboratories, Inc., Boonton, N.J.
- WILSON, A. J. (A'28), 1621 Ohio St., Quincy, Ill.
- WILSON, A. T. (A'27), Engineer, Mechanical Dept., Merchant and Evans Company, 2035 Washington Ave., Philadelphia, Pa. For mail: 242 W. Marshall Rd., Lansdowne, Pa.
- WILSON, CLIFFORD A. (A'25), Canadian Marconi Company, Ltd., 11 St. Sacramento St., Montreal, P. Q., Canada.
- WILSON, C. T. R. (A'24), Assistant Engineer, Marconi Beam Receiving Station, Canadian Marconi Company, Yamachiche, P.Q., Canada.
- WILSON, DONALD (A'25), General Electric Company, Bldg. 37, Schenectady, N.Y. For mail: Rosendale Road, Schenectady, N.Y.
- WILSON, F. CLINTON (A'27), Shipping Supt., Toronto Radio Company, 241 Yonge St., Toronto, Ont., Canada. For mail: 27 Hepburne St., Toronto, Ont., Canada.
- WILSON, GEORGE F. (A'23), Radio Inspector, Radio Laboratory, Navy Yard, Puget Sound, Wash. For mail: 825 Veneta Ave., Bremerton, Wash.

- WILSON, H. WARDEN (A'29), Student Engineer, National Broadcasting Company, 711-5th Ave., New York, N.Y. For mail: 607 W. 137th St., New York, N.Y.
- WILSON, LEON T. (M'22), Development and Research Dept., American Telephone and Telegraph Company, 195 Broadway, New York, N.Y.
- WILSON, LUTHER E. (A'28), Soldier, 12th Infantry, Fort Howard, Md.
- WILSON, R. A. (A'29), Radio Engineer, Westinghouse Electric and Manufacturing Company, Chicopee Falls, Mass. For mail: 2713 Main St., Springfield, Mass.
- WILSON, S. EARLE (A'27), President, Texas and Southern Petroleum Company, P. O. Box 40, Rockland, Tex.
- WILSON, WALTER B. (A'29), Assistant Professor of Electrical Engineering, Clemson College, S.C.
- WILSON, WILLIAM (M'26-F'28), Assistant Director of Research, Bell Telephone Laboratories, Inc., 463 West St., New York, N.Y.
- WILSON, WILLIAM P. (A'27), Development Engineer, British Broadcasting Corporation, 2 Savoy Hill, London, W.C.2, England. For mail: 54 Princes Ave., Church End, Finchley, London, N.3, England.
- WIMBERLEY, W. BEN (J'28), 605 E. 4th St., Amarillo, Tex. For mail: 512 W. 7th St., Amarillo, Tex.
- WIMMER, JOSEPH (A'24), Engineer, The Home Telephone and Telegraph Company, Spokane, Wash. For mail: 3704 N. Normandie St., Spokane, Wash.
- WINCHELL, ALFRED M. (J'25-A'27), Radio Service, R.D.1, Waterbury, Conn.
- WINCHELL, WALTER H. (A'28), 137 Berkeley Place, Brooklyn, N.Y.
- WING, ARTHUR K., JR. (J'28), 857 E. 18th St., Brooklyn, N.Y.
- WING, WILLIS K. (M'26), Editor, "Radio Broadcast," Doubleday, Doran and Company, Inc., Garden City, L.I., N.Y.
- WINKEL, HERBERT C. K. (J'25-A'28), Laboratory Tester, Bremer-Tully Manufacturing Company, 532 S. Clinton St., Chicago, Ill. For mail: 1239 S. 14th St., Maywood, Ill.
- WINNEGAR, W. A. (A'27), Laboratory Assistant, Frank Rieber, Inc., 170-2nd St., San Francisco, Calif. For mail: 300 Stanyan St., San Francisco, Calif.
- WINNER, LEWIS (A'25), Director, The Lewis Winner Bureau, 125 W. 45th St., New York, N.Y. For mail: 3235 Hull Ave., New York, N.Y.
- WINNER, WILLIAM LANE, JR. (M'29), Assistant Radio Engineer, Ninth Corps Area, Signal Office, Presidio of San Francisco, Calif.
- WINNINGHAM, H. W. (A'28), Manager and Engineer, Station KVI, 20 N. Tacoma Ave., Tacoma, Wash. For mail: 5811-5th Ave., N.E., Seattle, Wash.
- WINSTEAD, THEODORE BERNARD (A'29), Tester, Westinghouse Electric and Manufacturing Company, 121 East St., Chicopee Falls, Mass.
- WINTERBOTTON, WILLIAM A. (A'15-M'28), Traffic Manager, Radio Corporation of America, 66 Broad St., New York, N.Y.
- WINTRINGHAM, WILLIAM T. (A'26), Telephone Engineer, American Telephone and Telegraph Company, 195 Broadway, New York, N.Y.
- WISE, JAMES O. (A'29), Service Dept., Tulsa Radio Company, 627 South Main, Tulsa, Okla.
- WISE, ROGER M. (A'26), Grigsby-Grunow Company, 2020 N. Austin Ave., Chicago, Ill.
- WISE, S. J. (A'19), Manager and Director of Engineering, S. J. Wise and Company, 47, Rue Nationale, Antwerp, Belgium.
- WISEGARVER, ORTON H. (A'29), Service Supervisor, R.C.A. Photophone Inc., 438 W. 37th St., New York, N.Y.
- WISEMAN, WILLIAM W. (A'29), Chief Radioman, Naval Research Laboratory, Bellevue, Anacostia, D.C. For mail: Apt. 707, The Chastleton, 16th at R St., N.W., Washington, D.C.
- WISHART, WILLIAM R. (A'28), Operating Radio Laboratory, Wishart Radio Laboratories, 55 Tacoma St., Rochester, N.Y.
- WISNER, FRED L. (A'27), Associate Radio Engineer, U.S. Navy Department, 11th Naval District Headquarters, Radio Material, San Diego, Calif. For mail: 1346-30th St., San Diego, Calif.
- WISSLER, BENJAMIN F. (A'29), Instructor in Physics, Muhlenberg College, Allentown, Pa.
- WISSMANN, JOSEPH T. (A'27), Radio Corporation of America, Marshall, Marin Co., Calif.
- WITKOWSKI, JOSEPH F. (A'23), Principal, School of Telephone and Telegraph Engineering, International Correspondence Schools, Scranton, Pa.
- WITTSTRUCK, HAROLD H. (A'28), 311-14th St., N., St. Petersburg, Fla.
- WITTY, W. M. (A'28), District Service Manager, RCA-Victor Company, Inc., Santa Fe Bldg., Unit 2, Dallas, Tex.
- WOCKEY, PETER F. (J'26-A'29), Electrical Draftsman, Electrical Service Supplies Company, 17th and Cambria Sts., Philadelphia, Pa. For mail: 418 W. Dauphin St., Philadelphia, Pa.
- WOLCOTT, C. FREDERICK (J'26-A'28), Research Engineer, L. S. Gordon Company, 1800 Montross Ave., Chicago, Ill. For mail: 1315 Oak Ave., Evanston, Ill.
- WOLF, BENJAMIN (A'13-M'15), Manager, U.S. Dept. of Commerce, Radio Monitoring Station, Grand Island, Neb.
- WOLF, CLARENCE, JR. (J'27), Hercules Cement Corporation, Nazareth, Pa. For mail: 1521 N. 16th St., Philadelphia, Pa.
- WOLF, EDWIN A. (A'28), Serviceman and Stock Clerk, M. Steinert and Sons Company, 35 Arch St., Boston, Mass. For mail: 115 Church St., W. Roxbury, Mass.
- WOLF, LESTER J. (A'24), Electrical Engineer, Westinghouse Electric and Manufacturing Company, East Pittsburgh, Pa. For mail: Stonehaven Hotel, Springfield, Mass.
- WOLFF, IRVING (A'27), Physicist, Radio Corporation of America, 70 Van Cortlandt Park South, New York, N.Y.
- WOLVERTON, BYRON C. (A'16), Chief Engineer, Friendship Telephone Company, Syracuse, N.Y. For mail: Yates Hotel, Syracuse, N.Y.

- WOMBACHER, JOSEPH A. (A'27), Radio Electrician, Dept. of Commerce, Bureau of Lighthouses, Washington, D.C. For mail: 36 University Pl., West Brighton, S.I., N.Y.
- WOOD, CHARLES E. (A'23), Partner, Russell, Jones and Wood, 25 Victoria St., London, S.W.1, England. For mail: 121 Bournemouth Rd., Parkstone, Dorset, England.
- WOOD, HERBERT H. (A'28), Radio Operator, Radio Station WTIC, Hartford, Conn.
- WOOD, H. W. T. (A'28), Television Development, 35 Simpson Ave., Mimico, Ont., Canada.
- WOOD, MERRILL A. (A'26), Proprietor, Wood Radio and Electrical Service, Rochester, N.Y. For mail: 175 Winbourne Rd., Rochester, N.Y.
- WOOD, ROBERT H. (A'24-M'26), Radio Engineer, British Broadcasting Company, Ltd., 2 Savoy Hill, London, W.C.2, England. For mail: 112 Sternhold Ave., Streatham, London, S.W., England.
- WOOD, STANFORD J. (A'24), 186 Pacific Ave., Pacific Grove, Calif.
- WOOD, WILBERT C. (A'29), Radio Repair Service, 60 Clinton Ave., Brooklyn, N.Y.
- WOOD, WILLIAM (A'24), 75 Jubilee Rd., Halifax, N.S., Canada.
- WOOD, W. H. (A'28), Station Manager, Station WMBG, 914 W. Broad St., Richmond, Va.
- WOODBURY, STEPHEN E. (A'25), Research Engineer, United Shoe Machinery Corporation, Beverly, Mass. For mail: 18 James St., Beverly, Mass.
- WOODCOCK, N. A. (A'14), Radio Engineer, The Allen D. Cardwell Manufacturing Corporation, 87 Prospect St., Brooklyn, N.Y. For mail: 4260 Broadway, New York, N.Y.
- WOODHEAD, H. C. (A'28), Civil Servant, Radio Section, P. O. Engineering Dept., Bodmin Beam Station, Cornwall, England.
- WOODHEAD, H. C. (A'28), Rugby Radio Station, Rugby, Warwick, England.
- WOODHOUSE, GEOFFREY ARTHUR (A'29), Student, Montana State College, 301 N. Grand St., Bozeman, Mont.
- WOODLARD, E. W. (A'29), Proprietor, Radio Sales Company, 116 N. Williams St., Henderson, N.C. For mail: Henderson, N.C.
- WOODROW, JAMES A. S. (A'26), Proprietor, Woodrow Radio Company, 166 Prospect St., Cambridge, Mass.
- WOODROW, WILLIAM (A'15), Instructor, Vocational School for Boys and Evening Trade School, Board of Education, 138th St. and 5th Ave., New York, N.Y. For mail: 904 Ogden Ave., Highbridge, New York, N.Y.
- WOODRUFF, ALBERT E. (A'26), Automatic Electric Company, Inc., Chicago, Ill. For mail: 614 S. Cuyler Ave., Oak Park, Ill.
- WOODRUFF, B. H. (A'26), Box 178, Meridian, Miss.
- WOODRUFF, EUGENE C. (M'29), Professor, Electrical Railways Engineering, Pennsylvania State College, 234 W. Fairmount Ave., State College, Pa.
- WOODS, A. A. (A'13), Diversey Arms Hotel, 644 Diversey Blvd., Chicago, Ill.
- WOODS, T. DE WITT (A'29), Box 282, McGregor, Iowa.
- WOODWARD, BRUCE J. (A'26), Radio Service, Burcher and Schiessler, 513 S. Main St., Honesdale, Pa. For mail: Adelia, Wayne Co., Pa.
- WOODWARD, CLARENCE H. (A'25), Manager, Radio Service Dept., Lyon and Healy, Inc., Chicago, Ill. For mail: 3540 Bosworth Ave., Chicago, Ill.
- WOODWARD, P. J. (M'16), Marconi's Wireless Telegraph Company, Ltd., Marconi House, Strand, London, England.
- WOODWARD, V. M. (A'28), Radio Operator, Airways Radio Station, Dept. of Commerce, Iowa City, Iowa.
- WOODWORTH, E. C. (J'29), Technician, Empire Radio Sales, 34 Lyell Ave., Rochester, N.Y. For mail: 325 Columbia Ave., Rochester, N.Y.
- WOODWORTH, FRED B. (A'29), Engineer, Bell Telephone Laboratories, Inc., 463 West St., New York, N.Y. For mail: 71 Leslie St., East Orange, N.J.
- WOODWORTH, JOHN L. (A'28), Radio Engineering Dept., General Electric Company, 1 River Rd., Schenectady, N.Y. For mail: 323 Ave. B, Schenectady, N.Y.
- WOOLEY, W. C. (A'29), Moloney Electric Company, 5390 Kingshighway, N.W., St. Louis, Mo.
- WOOLVERTON, R. B. (A'13-M'13-F'15), Post Signal Officer, Presidio of San Francisco, Calif.
- WORDEN, RALPH P. (A'29), Radio Editor, "Cleveland News," Cleveland, Ohio. For mail: 2171 Ebur Ave., Lakewood, Ohio.
- WOREL, FRANK (A'27), Engineering Assistant, Michigan Bell Telephone Company, Detroit, Mich. For mail: 3104 Maybury Gd. Ave., Detroit, Mich.
- WORRALL, ROBERT H. (A'17), Radio Engineer, U. S. Naval Research Laboratory, Bellevue, Anacostia, D.C. For mail: 1821 Riggs Pl., N.W., Washington, D.C.
- WORRALL, W. W. (A'27), Salesman, Standard Oil Company, of New Jersey, Mt. Airy, N.C.
- WORRELL, HOWARD S. (A'26), Consulting Engineer, 100 E. Montgomery Ave., Ardmore, Pa.
- WORRELL, RICHARD A. (A'28), Agriculture Work, Box 5, Brighton Station, Rochester, N.Y.
- WORST, J. S. (A'29), Radio Engineer, Bennett Radio Service, 1407 Contant Ave., Lakewood, Ohio. For mail: 1280 Norwood Rd., N.E., Cleveland, Ohio.
- WORTHEN, CHARLES E. (A'28), Assistant Engineer, General Radio Company, Cambridge, Mass.
- WORTMAN, E. C. (A'29), Chief Radio Electrician, U.S.S. "New York," c/o Postmaster, New York, N.Y.
- WORTMAN, FRANK W. (A'27), Radio Electrician, U.S. Coast Guard, Washington, D.C. For mail: Communication Engineering School, U.S. Naval Research Laboratory, Bellevue, Anacostia, D.C.

- WRIGHT, HARRY M. (A'27), Teacher of Science, Board of Education, New York, N.Y. For mail: 920 Prospect Ave., New York, N.Y.
- WRIGHT, JAMES LANG, JR. (A'29), Metro-Goldwyn-Mayer Studios, Culver City, Calif. For mail: 1046 S. Sherbourne Drive, Los Angeles, Calif.
- WRIGHT, J. WARREN (A'23), Radio Division, Bureau of Engineering, Navy Dept., Washington, D.C.
- WRIGHT, MARSHALL C. (A'26), Plant Dept., National Broadcasting Company, Bellmore, L.I., N.Y. For mail: P. O. Box 223, Bellmore, L.I., N.Y.
- WRIGHT, OLIVER (A'26), Technical Employee, American Telephone and Telegraph Company, Lawrenceville Radio Station, Lawrenceville, N.J.
- WRIGHT, SYDNEY R. (A'24-M'28), Radio Engineer, Messrs. C. Pratt and Sons, Ltd., North Parade, Bradford, Yorks, England. For mail: 14 Bankfield Dr., Nab Wood, Shipley, Yorkshire, England.
- WRIGHT, WILFORD C. (J'29), Student, Dodge's Radio Institute, Valparaiso, Ind. For mail: Harbor Springs, Mich.
- WRIGHT, WILLIAM L. (A'16), 195 Main St., Brockton, Mass.
- WROUGHTON, THOMAS H. (A'26), Automobile and Wireless Engineer, High St., Swadlincote, Nr. Burton-on-Trent, England.
- WUERTZ, JOHN L. (A'28), Ken-Rad Corporation, Owensboro, Ky.
- WULLENWEBER, MILTON O. (A'27), Proprietor, Queen City Radio Service, 19 Allen St., Buffalo, N.Y. For mail: 40 Enola Ave., Kenmore, L.I., N.Y.
- WUNDERLICH, H. A. F., JR. (J'25-A'29), Engineer, Ward Leonard Electric Company, Mt. Vernon, N.Y. For mail: 1034 St. John Ave., New York, N.Y.
- WUNDERLICH, NORMAN E. (A'23-M'26), Chief Radio Engineer, Victor Talking Machine Company, Camden, N.J. For mail: 200 White Horse Pike, West Collingswood, N.J.
- WYCKOFF, RALPH D. (M'29), Research Engineer, Geophysical Dept., Gulf Oil Companies, 903 Law and Finance Bldg., Pittsburgh, Pa.
- WYLES, DAVID G. (A'20-M'23), Technical Manager, Philips Lamps Australia, Ltd., 354 Post Office Place, Melbourne, Australia.
- WYMAN, RAYMOND C. (A'27), Technician, 51 Central Ave., Medford, Mass.
- WYNNE, WALTER M. (A'24), Lieutenant Commander, U.S. Navy, Navy Yard, Philadelphia, Pa. For mail: 151-68th St., Brooklyn, N.Y.
- Y
- YAGI, HIDETSUGU (M'16-F'24), Professor of Electrical Engineering, College of Engineering, Tohoku Imperial University, Sendai, Japan.
- YAMAGUCHI, USABURO (A'28), Haranomati, Station of Japan Wireless Telegraph Company, Haranomati, Fukusumaken, Japan.
- YANCEY, E. F. (A'28), Manager, Service Station, Stewart-Warner Pro. Service Station, Atlanta, Ga. For mail: 431 Peachtree St., N.E., Atlanta, Ga.
- YAPP, WILLIAM G. (A'28), Power Station, Victoria Falls and Transvaal Power Company, Ltd., P. O. Box 27, Vereeniging, Transvaal, South Africa.
- YATES, CLARENCE C. (A'26), Engineering Dept., Southwestern Bell Telephone Company, Kansas City, Mo. For mail: 4023 Walnut St., Kansas City, Mo.
- YATES, IVAN (A'29), Wireless Operator, c/o British Wireless Marine Service, Ltd., 8 New St., Cardiff, S. Wales, England.
- YATES, WILFRED (A'29), Finishing Room, Hamilton Woolen Company, 53 Oliver St., Southbridge, Mass.
- YEATES, EPHRAIM LE ROY (A'27), Radio Engineer, Nathaniel Baldwin, Inc., 3474 S. 23 E., Salt Lake City, Utah. For mail: 1253 Sherman Ave., Salt Lake City, Utah.
- YENOLI, DOMINICK J. (A'29), Service Dept., F. A. D. Andrea, Inc., Jackson Ave., Orchard and Queens Sts., Long Island City, L.I., N.Y. For mail: 146-64 Shore Ave., Jamaica, L.I., N.Y.
- YODER, LEO E. (A'29), Radio Engineer and Operator, Purdue University, Radio Broadcasting Station WBAA, West Lafayette, Ind. For mail: 222 Marsteller St., West Lafayette, Ind.
- YODER, RAYMOND S. (A'25), Radio Engineer, Brunswick-Balke-Collender Company, Muskegon, Mich. For mail: 1560 Acorn St., Muskegon, Mich.
- YOKOYAMA, EITARO (M'17), Electrotechnical Laboratory, Ministry of Communications, Osaki, Tokyo-fu, Japan. For mail: Kiharayama 1621, Ohmori, Nr. Tokyo, Japan.
- YOKOYAMA, TETSUMI (A'28), Engineer, Tsukisapp Broadcasting Station, Nr. Sapporo, Hokkaido, Japan.
- YOLLES, JACOB (A'29), Research Engineer, c/o Technidyne Corporation, 644 Broadway, New York, N.Y.
- YORK, PETER J. (A'27), Engineer, The Prine Radio Service and Testing Laboratory, 148 Oak Ave., Torrington, Conn.
- YOSHIRO, KURODA (A'25), Instructor, Radio Section, Dept. of Communications, Tokyo, Japan. For mail: 448 Tokumochi, Ikegami-Mura, Ebaragun, Tokyo-fu, Japan.
- YOST, JOHN C. (A'27), Service Engineer, A. H. Grebe and Company, Inc., 113 W. 57th St., New York, N.Y. For mail: 5010 Catherine St., Philadelphia, Pa.
- YOUNG, ALFRED W. (A'28), Managing Director, Bath Electrics, Ltd., Foxcombe Road Works, Bath, England. For mail: Warwick Villa, Kennington Rd., Bath, England.
- YOUNG, CHARLES J. (A'23), 1065 Avon Rd., Schenectady, N.Y.
- YOUNG, CHARLES S. (A'29), Inductive Coordination Engineer, Pennsylvania Power and Light Company, Allentown, Pa. For mail: 204 S. Fulton Street, Allentown, Pa.
- YOUNG, FRANK A. (A'20), Chief Engineer, Connecticut Telephone and Electric Company, Meriden, Conn. For mail: 523 W. Main St., Meriden, Conn.
- YOUNG, HAROLD H. (A'25), Eakins Road, Munsey Park, Manhasset, L.I., N.Y.

- YOUNG, JOHN W. (A'27), Associate Radio Engineer, U.S. Navy, 15th Naval District, Box "M", Balboa, Canal Zone. For mail: P. O. Box 35, Balboa, Canal Zone.
- YOUNG, LEO C. (A'19-M'29), Radio Engineer, U.S. Naval Research Laboratory, Bellevue, Anacostia, D.C. For mail: 1018 Douglas St., N.E., Washington, D.C.
- YOUNG, OWEN D. (M'22-F'28), Chairman of the Board of Directors, General Electric Company, 120 Broadway, New York, N.Y.
- YOUNG, SUMNER B. (J'16-A'19), Attorney, Prendergast and Flannery, 705 First National Soo Line Bldg., Minneapolis, Minn. For mail: 2309-1st Ave., S., Minneapolis, Minn.
- YOUNG, WILLIAM M. K. (A'27), Chief Clerk and Cashier, Norris Grain Company, 940 Board of Trade, Kansas City, Mo. For mail: 5208 Prospect Ave., Kansas City, Mo.
- YOUNGER, CHARLES (J'24-A'28), Radio Operator, Station WHN, Loew's, Inc., 1540 Broadway, New York, N.Y. For mail: 247 Neal Dow Ave., Staten Island, N.Y.
- YOUNGKIN, ERNEST E. (J'28), Radio Sales and Serviceman, Montgomery, Ward and Co., 16th St., Altoona, Pa. For mail: 602 E. Grant Ave., Altoona, Pa.
- YOUNGS, HOWARD E. (A'26), Radio Engineer, Crosley Radio Corporation, 3401 Cole-rain Ave., Cincinnati, Ohio.
- YOUNGSTROM, NELS C. (A'26), Bell Telephone Laboratories, Inc., 463 West St., New York, N.Y.
- YURGIONAS, JOHN A. (J'26-A'29), Assistant Technician, Research Laboratories, National Carbon Company, West 73rd St., Cleveland, Ohio. For mail: 5000 McBride Ave., Cleveland, Ohio.
- Z
- ZACEK, AUGUST (M'29), Professor of Physics, Charles University, Prague II, U Karlova 5, Czechoslovakia.
- ZALUSKEY, EUGENE R. (A'27), Technician, America Radio Telephone Company, Bigelow Bldg., Seattle, Wash. For mail: 8237 Stroud Ave., Seattle, Wash.
- ZANDONINI, ELIZABETH M. (A'28), Radio Aid, Radio Laboratory, Bureau of Standards, Washington, D.C. For mail: 3320 19th St., N.W., Washington, D.C.
- ZATORSKY, E. F. (A'25), c/o Paramount Famous Lasky Corporation, 6th and Pierce Aves., Astoria, L.I., N.Y.
- ZEAMANS, HAROLD R. (A'12), Attorney-at-Law, 1834 Broadway, New York, N.Y.
- ZEE, LIANG (A'24), Radio Engineer, Ministry of Communication, Peking, China. For mail: Lili, Soochow, Kiangsu, China.
- ZEHR, NICHOLAS J. (A'27), Radio Engineer, c/o Voice of St. Louis, Hotel Mayfair, St. Louis, Mo. For mail: 1538 Bradford Ave., St. Louis, Mo.
- ZEIDLIK, WILLIAM J. (A'29), Installation Engineer, Electrical Research Products, Inc., 1426 Allen Bldg., Dallas, Tex.
- ZEIGLER, T. W. (A'27), Pharmacist, Ziegler's Pharmacy, Inc., 209 Rutledge Ave., Charleston, S.C. For mail: 188 Tradd Blvd., Charleston, S.C.
- ZENNECK, JONATHAN (M'13-F'14), Professor, Technische Hochschule, Muenchen, Germany.
- ZIEGLER, FREDERICK J. (A'18), The Willows, Woodmere, L.I., N.Y.
- ZIMMERMAN, GEORGE E. (A'26), Supervisor, Radio Station KPRC, "Houston Post Dispatch," Houston, Tex.
- ZIMMERMAN, ROBERT F. (A'28), Student, Ohio State University, Columbus, Ohio. For mail: 267 Park St., Dayton, Ohio.
- ZUEV, VITALY V. (A'28), Chief of Transmission Valves, Departmental and Transmission Dept., Phillips S. A. E. C. O., Rivadavia 1451, Buenos Aires, South America. For mail: Rivadavia 1447, Buenos Aires, South America.
- ZURIAN, P. D. (J'27), 3001 Addison St., Chicago, Ill.
- ZWEIGER, OWEN (J'27), 1259 S. Harcourt Ave., Los Angeles, Calif.

CATALOG OF MEMBERSHIP

January 1, 1930

Arranged Geographically

UNITED STATES

ALABAMA

Auburn

Brake, Paul (J)
Waldo, George V. (A)

Birmingham

Bell, John C. (A)
Duran, Albert E. (A)
Williams, G. H. (A)

Dothan

Hallman, L. B. (A)

Mobile

Blakeney, George H. (A)
Helt, Scott (A)
Heyen, Rudolph J. (A)

Montgomery

Trum, Alexander D. (A)

Pratt City

Hassler, W. Dan (A)

ARIZONA

Kingman

Nolan, Arthur B. (A)

Phoenix

Wilburn, Frank (A)

Prescott

De Witt, Harold (A)

Tucson

Bannister, M. W. (A)
Percy, F. W. (A)
Warner, Earle H. (A)

Winslow

Fridgen, Edward N. (A)

ARKANSAS

Blytheville

Lintzenich, C. L. (A)

Conway

Cordrey, E. E. (M)

Fort Smith

Barry, James A. (A)

Hot Springs

Peel, Delacy J. (A)

Little Rock

Beem, Arthur W. (A)
Beem, Raymond M. (A)
Bilheimer, Joe A. (A)
Boone, Virgil (A)
Bracken, Ben (A)
Heim, Rupert A. (A)
Hofstatter, F. H. (A)
McDonald, A. H. (A)
Minor, Robert Lee (A)
Stover, Arthur R., Jr. (J)

McGehee

Wallace, L. E. (A)

Siloam Springs

Chandler, C. G. (A)

CALIFORNIA

Alameda

Schlueter, Edward A. (A)

Alhambra

Grimes, William F. (A)
Hillegas-Baird, L. S. (A)

Altadena

Johnson, Paul F. (M)

Artesia

Corcoran, Edward M. (A)
Corcoran, George L. (J)

Azusa

Holcomb, Clyde A. (A)

Bell

Anderson, Edward R. (A)

Berkeley

Albin, Frederick G. (A)
Armer, Austin A. (A)
Davis, Daryl D. (A)
Greves, George L. (A)

Beverly Hills

Balsley, James R. (A)
Larsen, C. W. (A)
Waite, Samuel A. (A)
Whitaker, John C. (A)

Bishop

Wheeler, Walter R. (A)

Bolinas

Baker, Thomas S. (A)
Clark, Robert W. (A)
Park, Charles W. (A)

Burbank

Garretson, Oliver S. (A)
Wainwright, Stuart F. (A)

Burlingame

Michalic, C. T. (A)

Covina

Ross, M. F. (A)

Crockett

Taylor, G. W. (A)

Culver City

Wersen, David T. (A)

Eagle Rock

Ford, Walter B. (A)
Tatreault, Leon E. (A)

El Centro

Cook, John W. (A)

El Segundo

Hart, William J. (A)

Fresno

Denny, R. C. (A)
Foin, Owen F., Jr. (J)
Gearhart, Erle J. (A)
Gifford, Delbert K. (A)
Mc Kay, William K. (A)

CALIFORNIA (Continued)

Fullerton

Atherton, Malcolm J. V. (A)
 Finseth, E. B. (A)
 Hardison, Arthur A., Jr. (A)

Glendale

Bockhoven, Louis Murray (A)
 Bowles, Theodore C. (A)
 Eilers, John (J)
 Engen, Ralph E. (A)
 Farnsworth, Earl S. (M)
 Shomler, H. B. (A)

Hemet

Sorkness, Iardus (A)

Hermosa Beach

Carter, Everett D. (A)

Hollywood

Blackburn, John F. (A)
 Breeding, Charles S. (A)
 Brown, J. Kenneth (A)
 Burns, G. Austin (A)
 Clement, Jack D. (A)
 Coe, Ernest W. (A)
 Cook, Robert O. (A)
 Cooper, George R. (A)
 Cunningham, Lodge (A)
 Davey, Cedric V. (A)
 Dering, Fred J. (A)
 Ellis, George D. (A)
 Fox, Bert M. (J)
 Hansen, Edmund H. (M)
 Hanson, Harry (A)
 Harrington, Fred H. (A)
 Hart, Roy H. (M)
 Hill, Arthur P. (M)
 Hilliard, John K. (M)
 Levinson, Nathan (M)
 Newman, David H. (M)
 Pierce, Franklin W. (A)
 Ringold, H. Russell (A)
 Sarver, Frank M. (A)
 Sawyer, Gordon E. (A)
 Schiefer, C. Vreeland (A)
 Sheldon, Clinton C. (A)
 Signer, John J. (A)
 Snyder, William R. (A)
 Stewart, Ronald B. (A)
 Taylor, Theodore (A)
 Thorburn, James M. (M)
 Tohey, E. S. (A)
 Van Why, Forbes W. (M)

Hollywoodland

Mott, Lawrence (A)

Huntington Park

Dalton, Stuart P. (A)
 Keyes, Edwin F. (A)
 Kirby, Melvin D. (A)

Inglewood

Underwood, Ernest G. (A)

Jackson

Snyder, W. Gilman, Jr. (A)
 Van Thiel, Jan (A)

Kerman

Soderberg, Arnold J. (A)

La Canada

Benioff, Hugo (A)

La Crascenta

Robinson, Frederick (A)

La Habra

Inns, Stephen H. (A)

Livermore

Ryan, R. (A)

Long Beach

Hancock, John W., Jr. (J)
 Howell, Roger A. (A)
 Moore, Raymond C. (A)
 Wallace, Donald C. (A)

Los Angeles

Alverson, James G. (A)
 Andersen, H. W. (A)
 Appleton, Harry (A)
 Barlow, Roy G. (A)
 Bell, Harold H. (A)
 Best, Gerald M. (M)
 Buffinger, W. G. (A)
 Bumbaugh, Harold L. (A)
 Campbell, William N. (A)
 Chapple, James M. (A)
 Cheney, John W. (A)
 Dewey, Fred L. (A)
 Dickson, H. L. (A)
 Edgcomb, A. J. (A)
 Eldridge, Robert H. (A)
 Felstead, Charles F. (A)
 Fraser, Graham (A)
 Gioga, Peter C. (A)
 Greger, J. G. (A)
 Gronoff, Harry (A)
 Haas, Clarence H. (A)
 Hankins, Marvin J. (A)
 Hauser, Carroll R. (A)
 Heather, Harold (J)
 Hecht, Royal H. (A)
 Herrfeld, Frank P. (A)
 Hill, Alfred L. (A)
 Holcomb, E. Russell (A)
 Hoover, Herbert, Jr. (A)
 Hopkins, Stephen (A)
 Houdysell, Lowell B. (A)
 Howe, Franklin Joaquin (A)
 Jakosky, John (M)
 Kent, Oliver C. (A)
 Korntved, George W. (A)
 Kratz, C. F. (A)
 Kruger, Bernard (A)
 Lang, William A. (A)
 Langrick, Paul D. (A)
 Lee, Gilbert C. (A)
 Leighton, Harold W. (A)
 Lindsay, W. W., Jr. (M)
 Ludlum, W. F. (A)
 Madsen, Norman L. (A)
 Marshall, Cloyd, Jr. (A)
 Mason, Curtis W. (A)
 McCabe, William E. (A)
 McCarroll, Marshall G. (A)
 McCreery, M. E. (A)
 McDonough, Thomas F. (A)
 McGonagill, H. A. (A)
 Meissner, Earl R. (A)
 Meyer, R. H. (A)
 Miller, Burton F. (A)
 Miller, Charles E. (A)
 Moore, Raymond M. (A)
 Morris, James W. (A)
 Newman, William H. (A)
 Olmstead, Charles B. (A)
 Oodrys, Arthur (A)
 Ormiston, Kenneth G. (A)
 Palethorpe, Harold J. (A)
 Partch, Paul C. (A)
 Pearce, Harry G. (A)
 Perkins, Lucius J. (A)
 Pflieger, Robert A. (A)
 Power, Ralph L. (A)
 Rhodes, L. G. E. (A)
 Ramsay, Alan N. (A)
 Ramsay, W. S. (A)
 Richards, W. S. (A)
 Riggs, Clare A. (A)

CALIFORNIA (Continued)

Los Angeles (Continued)

Roberts, Russell B. (A)
 Schreiber, Ernest H. (A)
 Silent, Harold C. (A)
 Smith, C. Bernard (A)
 Sorge, Barthold W. (A)
 Stevens, Sterling M. (A)
 Stolle, R. A. (A)
 Stratton, Ross A. (A)
 Tami, Joseph, Jr. (A)
 Taufenbach, Leslie E. (M)
 Walter, Edward F. (A)
 Ward, Jack (A)
 Whiston, R. William (A)
 Wright, James Lang, Jr. (A)
 Zweiger, O. (J)

Manhattan Beach

Tischer, Frank A. (A)

Mare Island

Weigand, Joseph S. (A)

Marshall

Case, Myron D. (A)
 Culley, Lester D. (A)
 Marsh, Hallock S. (A)
 Reid, Irl H. (A)
 Wissman, Joseph T. (A)

Menlo Park

Seal, H. Robert (A)

Merced

Shaffer, Frank (J)

Mission Beach

Farnum, Willis H. (A)

Monterey

Brokaw, Hal R. (A)

Monterey Park

Alker, Charles (A)
 Nikirk, Thomas E. (A)
 Sanmann, Edgar J. (A)
 Willson, Clarence L. (A)

Napa

Rawson, Clifford L. (A)

Oakland

Allen, Preston D. (A)
 Branson, Albert K. (A)
 Brearty, Lawrence S. (A)
 Brown, James F. (A)
 Ford, Charles Y. (J)
 Freeman, Robert H. (A)
 Freiermuth, Vincent J. (A)
 Gardiner, Paul C. (A)
 Hazeltine, Louis A. (F)
 Madison, C. E. (A)
 Parkhurst, Edgar L. (A)
 Slavin, Samuel B. (A)
 Wild, Sydney J. (A)

Orange

Charbonneau, L. H. (A)
 Waters, John E. (A)

Oxnard

Newcomb, Carleton A. (A)

Pacific Grove

Anderson, Adrien L. (A)
 Wood, Stanford J. (A)

Palo Alto

Beal, Ralph R. (A)
 Brower, William M. (M)
 Brown, Archibald S. (A)
 Cattell, Gilbert W. (A)
 Cordes, Henry G. (A)
 Dow, Clifford J. (A)
 Fuller, Leonard F. (F)
 Harrison, Charles I. (A)

Howard, L. W. (A)
 Kolster, Frederick A. (F)
 Lacabanne, Washington D. (A)
 Morgan, Nathaniel R. (A)
 Overacker, Horace E. (A)
 Penther, Carl Joseph (A)
 Ray, John N. (A)
 Redeker, Harry E. (A)
 Romander, Hugo (A)
 Saunders, William W. (A)
 Scofield, P. F. (A)
 Shermund, Ralph C. (A)
 Suydam, C. H. (M)
 Tanck, Henry (A)
 Thomas, Charles C. (A)
 Tinney, Francis B. (A)
 Veirup-Jensen, J. G. (A)
 West, Glenn Edwin (M)
 White, Ray H. (A)
 Whitwam, Lloyd F. (A)
 Whittern, Ray (A)

Pasadena

Bradshaw, Robert C. (A)
 Brown, Howell C. (A)
 Felch, H. F. (A)
 Hopper, Francis L. (A)
 Howes, Edgar T. (A)
 MacKeown, Samuel S. (M)
 MacMurphy, F. (A)
 Poorman, Edwin H. (J)
 Taylor, E. Kenneth (A)
 White, Harold (A)

Piedmont

Myers, Walter M. (A)

Pine Knot

Betterley, Jack A. (A)

Placentia

Gaines, B. R. (A)

Pomona

Farker, Evert L. (A)

Redwood City

Litton, Charles V. (A)

Riverside

Norwood, Donald W. (A)

Sacramento

Hayden, J. W. (J)
 Melnicoe, Samuel (A)
 Messner, Roy L. (A)
 Semoni, Anthony J. (A)

San Diego

Burnett, William L. (A)
 Conaughty, Robert B. (A)
 Curtis, Everett N. (A)
 Davidson, Martin (A)
 DeBaun, George H. (A)
 Doig, John H. (A)
 Gruenwald, Harold C. (A)
 Hart, Clyde Armand (A)
 Kiernan, Earl F. (A)
 Kinney, E. S., Jr. (A)
 Scott, Carl A. (A)
 Stone, John Stone (F)
 Wisner, Fred L. (A)

San Francisco

Arrigoni, Arthur (A)
 Baker, Lewis C. (A)
 Bear, William P. (A)
 Benson, Francis S. (A)
 Bouson, Herbert H. (M)
 Bradshaw, Lynwood (A)
 Brolly, A. H. (A)
 Danforth, Richard S. (A)
 Danielson, Ernest G. (A)
 Farnsworth, Philo T. (A)

CALIFORNIA (Continued)

San Francisco (Continued)

Fass, Sydney J. (A)
 Fenner, Paul R. (A)
 Fletcher, Earle S. (M)
 Gary, L. A. (A)
 Graham, Lloyd E. (A)
 Greene, Harry A. (A)
 Halloran, A. H. (M)
 Hanscom, W. W. (M)
 Hart, Arthur H. (A)
 Heintz, Ralph M. (M)
 Henry, Franklin M. (A)
 Highleyman, Richard (M)
 Hoffman, Samuel O. (A)
 Kaufman, Arthur W. (J)
 Kellogg, Richard B. (A)
 Kellogg, Walter D. (A)
 King, Howard D. (A)
 Lanc, Howard D. (A)
 Langevin, Carl C. (M)
 Larzelere, W. R., Jr. (A)
 Lathrope, Kenneth W. (J)
 Linden, Bernard H. (A)
 Lippincott, Donald K. (M)
 Lubeke, Harry R. (A)
 Maxwell, John F. (A)
 Maynard, Raymond K. (A)
 Moore, Paul (A)
 Myers, Gilbert B. (A)
 Nikonenko, Paul (A)
 O'Brien, Daniel L., Jr. (A)
 Packard, Alden C. (A)
 Parker, Ray H. (A)
 Patron, Alfonso E. (A)
 Pinkney, J. L. (A)
 Powell, Louis H. (J)
 Rowe, Victor G. (A)
 Royden, George T. (M)
 Saxton, Alfred H. (A)
 Schofield, William D. (A)
 Scott, Leo L. (A)
 Singleton, Harold C. (A)
 Smith, Charles S., Jr. (A)
 Smith, Herbert H. (A)
 Sohor, P. H. (M)
 Sphar, Clark H. (A)
 Stagnaro, John A. (A)
 Ternow, Helmut G. (A)
 Thiel, Harold A. (A)
 Todd, Stedman F. (A)
 Tustin, John L. (A)
 Weber, Glen L. (A)
 Weir, F. Torres (A)
 Wells, W. Bruce (A)
 Wetzel, Joseph A. (A)
 Winnegar, W. A. (A)
 Winner, William Lane, Jr. (M)
 Wolf, Benjamin (M)
 Wooiverton, R. B. (F)

San Gabriel

Ashbrook, Roy B. (A)

San Jose

Cozzens, Bradley (A)
 Engwicht, Harry (A)
 Kelliher, John E. (A)
 Lawrence, L. H. (A)
 Quement, Frank J. (A)
 Reynolds, F. T. (A)
 Saine, Harry (A)

San Lorenzo

Lewelling, Raymond (A)

San Marino

Pohlman, G. Anton (A)

San Mateo

Bradley, John T. (A)

San Pedro

Fredericks, John E. (A)
 Johnson, V. (A)
 MacDonald, H. J. (A)
 McCandlish, B. V. (A)
 Sherman, Warren K. (A)
 Skov, Jens Ingvard (A)

San Rafael

Parkin, John, Jr. (A)

Santa Ana

Sleeper, J. Lloyd (A)

Santa Barbara

Cooper, Harold G. (A)
 Davis, Chester L. (M)
 Kempton, Walter D. (A)
 Means, Paul S. (A)

Santa Cruz

Fisher, E. H. (A)

Santa Monica

Fenton, A. Norwood (A)
 Mann, Theodore H. (A)
 Willis, Edward N. (A)

Sawteille

Spiller, Cecil Charles (J)

Sherman

Smith, Wade H. (A)

Southgate

Hudson, T. L. W. (A)

Stanford University

Rathbun, Harry (A)
 Ryan, Harris J. (M)
 Skinner, Clifton Ross (A)
 Terman, Frederick E. (A)

Stirling City

Overton, Daniel C. (A)

Stockton

Clarkson, Charles N. (A)
 Green, Alfred H. (A)
 Holt, Pliny E. (A)
 Schulz, Paul C. (A)

Sunnyvale

Paul, Ernest E. (A)

Tujunga

Feringer, William (A)

Tuolumne

Elliott, William H. (A)

Vallejo

Robinson, R. J. (A)

Van Nuys

Black, Robert (A)
 Marsden, George K. (A)

Venice

Gleason, Sterling (A)

Ventura

Snow, Louis A. (A)

Wasco

Morrison, L. H. (A)

Whittier

Smith, L. E. (A)

COLORADO

Alamosa

Dillow, Arthur P. (A)

Arvada

Kelso, Rupert E. (A)

Colorado Springs

Blair, Wiley, Jr. (A)

Delta

Fulghum, Charles K. (A)

COLORADO (Continued)

Denver

Cummings, George B. (A)
 Earnhart, Glen W. (A)
 Foraker, William Nelson (J)
 McClimans, Abner E. (A)
 Owen, Robert H. (A)
 Painter, Charles E. (A)
 Pyle, William D. (A)
 Reynolds, William W. D. (A)
 Scanlon, Dale L. (A)
 Scheneman, Henry Wesley (A)
 Strelsky, Herbert J. (A)
 Vos, Arthur, Jr. (J)

Durango

Dieckman, William (J)

Eaton

Nichols, Frederick A. (A)

Fort Collins

Sammons, Floyd (A)

Loveland

Houge, Charles A. (A)

Pueblo

Bowen, Clyde L. (A)
 Nelson, A. LeRoy (A)

Seibert

Fingado, Francis H. (A)

CONNECTICUT

Bridgeport

Appleby, Bertie (A)
 Bishop, Nathaniel (A)
 Campbell, Charles H. (A)
 Chopsky, Peter A. (J)
 Cousins, Maurice Nicholas (J)
 Elias, Louis W. (A)
 Graylin, Lee F. (A)
 Ham, Frank M. (A)
 Harrington, Carlton E. (J)
 Ivanko, John G. (A)
 Le Boeuf, Wilfred F. (A)
 Mapes, Harold T. (A)
 Morse, Louis R. (A)
 Nothnagle, George E. (A)
 Tomlinson, Harry E. (A)

Danbury

Gillotti, Albert C. (A)

East Hartford

Randall, J. Clayton (M)

Greenwich

Nally, Edward J. (A)
 Thomas, William A. (M)

Hartford

Beckwith-Ewell, Starr L. (A)
 Bourne, Roland B. (M)
 Corbett, Walter E. (A)
 Cowles, Walter G. (A)
 Dudley, Beverly (A)
 Handy, Francis E. (A)
 Hebert, Arthur A. (M)
 Heris, George C. (A)
 Lamb, James J. (A)
 Le Conche, Carl C. (A)
 Maxim, Hiram Percy (A)
 Page, Atwood C. (A)
 Pember, Harold H. (A)
 Rushing, Wallace E. (A)
 Scell, Russell G. (A)
 Wood, Herbert H. (A)

Hazardville

Thompson, Stanley W. (A)

Kensington

Edgerly, Albert Henry (A)

Litchfield

Vanderpoel, Floyd L. (A)

Meriden

Wilcox, Ernest C. (A)
 Young, Frank A. (A)

Middletown

Cady, Walter G. (F)
 Van Dyke, Karl S. (M)

Millford

Hadden, Harold L. (A)

Mount Carmel

Croteau, Carlton W. (A)

Naugatuck

Backlund, Louis R. (J)

New Britain

Johnston, Douglas A. (A)

New Haven

Doolittle, Franklin M. (A)
 Gounarides, A. D. (A)
 Jipp, John (A)
 Turner, H. M. (M)
 Underhill, Charles R. (A)
 Weed, C. Bronson (A)

Noroton Heights

Higgins, Alfred K. (A)

Norwich

Hubbard, James L. (A)

Plainville

Jones, H. Garfield (A)
 Stephenson, Martin A. (A)

Seymour

Dana, Alan S. (A)

Southington

Lewis, Earl B. (A)

Stamford

Cronkhite, Minton (M)

Stratford

MacIntyre, James R. (A)

Storrs

Noble, Daniel E. (A)

Torrington

York, Peter J. (A)

Waterbury

Bennett, Morris H. (A)
 Cohen, Edward (A)
 Greenblatt, Louis (A)
 Winchell, Alfred M. (A)

West Hartford

Beckley, F. Cheyney (M)
 Gade, William H. F. (A)
 Kruse, Robert S. (M)
 Kutscher, Louis F. (A)
 Montgomery, Philip (A)
 Mueller, Paul M. (A)
 Warner, Kenneth B. (M)

West Haven

Phillips, Edward I. (A)

Westport

Perry, William A. (A)

West Suffield

Colson, James L. (J)

Wethersfield

Carini, Louis (J)
 Mitchell, James A. (A)

Wilton

Van Heiningen, Willard A. (J)

Windsor

Keily, Delbar P. (A)

DELAWARE

Claymont

Tatnall, Joseph S. (A)

Wilmington

Boylan, E. Brandt (A)
Casey, K. K. V. (A)
Henning, Clarence I. B. (A)
Mertz, John M. (A)
Smyth, Earle (A)
Wilcox, Robert L. (A)

DISTRICT OF COLUMBIA

Anacostia

Booth, Howard A. (A)
Cooper, Orville T. (A)
Fetsch, Joseph T., Jr. (A)
Hyland, Lawrence A. (A)
Meyer, R. B. (A)
Noyes, Robert H. (A)
Owens, Raymond B. (M)
Struthers, Francis W. (A)
Taylor, A. Hoyt (F)
Walker, Guy P. (A)
Wallace, James D. (A)
Wheeler, Lynde P. (F)
Wilkie, Harry (A)
Williams, Charles Haddon (A)
Wortman, Frank W. (A)

Takoma Park

Mertie, J. B., Jr. (A)

Washington

Appich, William H. (A)
Arnold, Prescott N. (A)
Austin, Louis W. (F)
Backus, Cyrus D. (M)
Barron, J. H., Jr. (M)
Bower, Ward E. (A)
Boyer, William P. (A)
Bradford, Henry K. (A)
Brattain, Walter H. (A)
Burger, Clarence Walter (A)
Burgess, Warren B. (A)
Burke, David J., Jr. (A)
Burke, James W. (A)
Butman, Carl H. (M)
Carroll, Thomas D. (A)
Chamberlin, Robert R. (A)
Chromy, B. J. (A)
Chubb, William M. (A)
Cohen, Louis (F)
Cole, G. C. (A)
Colvin, Ruel (A)
Corderman, William P. (A)
Corrigan, James T. (A)
Coulme, J. B. H. (A)
Cox, George C. (A)
Craven, T. A. M. (F)
Crawford, David M. (A)
Culver, Clarence C. (M)
Curtis, Westley F. (A)
Davis, Thomas M. (M)
Day, John F. (A)
Detwiler, Donald J. (A)
Diamond, Harry (A)
Doremus, Cornelius W. (A)
Dorsey, Herbert G. (M)
Dow, J. B. (M)
Downey, W. E. (M)
Ellis, James G., Jr. (J)
Gebhard, Louis A. (A)
Gilliland, Ted R. (A)
Glaser, Stanley (A)
Graf, Alois W. (A)
Greeley, Philip H. (A)
Gross, Gerald C. (A)

Guthrie, Frederick P. (M)
Hafstad, L. R. (A)
Hall, E. L. (A)
Hanson, Malcolm P. (M)
Hastings, Harris F. (A)
Heaton, Vincent E. (A)
Hentschel, Ernest R. (A)
Heron, Louis M. (M)
Hill, Guy (F)
Hinemon, John H., Jr. (A)
Hooper, S. C. (F)
Hromada, Joseph C. (A)
Hudiburg, Rea S. (A)
Jansky, C. M., Jr. (F)
Jardine, W. N. (A)
Jenkins, C. Francis (A)
Jett, Ewell K. (A)
Johnson, Albert E. (A)
Jolliffe, Charles B. (M)
Judson, Elbert B. (A)
Kaplan, Jacob (A)
Kear, Frank G. (A)
Kinley, Clifford B. (A)
Kirby, Samuel S. (A)
Kriz, Joseph (A)
Leahy, John E. (A)
Lee, Wm. Justice (M)
Lee, William J. (A)
Loomis, Mary Texanna (M)
Looney, Don B. (A)
Luckel, Frank (A)
MacGregor, John J. (A)
Maddox, Charles H. (M)
Martin, George L. (A)
Mates, T. Joaquin (A)
May, Albert (A)
McClelland, Harold M. (M)
McIlwraith, Charles G. (A)
McKinley, Howard W. (A)
Mirick, C. B. (M)
Moore, Adam H. (A)
Moulton, Theodore S. (A)
Newton, Jane Elizabeth (A)
Norton, Kenneth A. (A)
Page, Robert M. (A)
Parkinson, Taintor (A)
Powell, Edwin L. (M)
Rhoades, A. L. (A)
Rietzke, Eugene H. (A)
Ring, Andrew D. (A)
Rohrich, George J. (A)
Segal, Paul M. (M)
Simon, Isaac B. (A)
Smith, David H. (A)
Smith, James E. (M)
Sprayberry, Frank L. (A)
Squier, George O. (F)
Stahl, Barton E. (A)
Stevens, Waldo W. (A)
Stewart, Jessica Dee (M)
Stewart, Ralph B. (M)
Terrell, Robert L. (A)
Terrell, W. D. (F)
Weber, Carl F. (A)
Webster, B. M., Jr. (A)
Wiseman, William W. (A)
Worrall, Robert H. (A)
Wright, J. Warren (A)
Young, Leo C. (M)
Zandonini, Elizabeth M. (A)

FLORIDA

Coral Gables

Entrekin, Carl A. (A)

Fort Pierce

Taylor, James C. (A)

FLORIDA (Continued)

Gainesville

Loucks, Ivan H. (A)

Hialeah

Angle, G. B. (A)

Jacksonville

Cooper, John C., Jr. (A)
Washburn, Cyrus, Jr. (A)

Key West

Rosso, Thomas (A)

Lake Worth

Dickins, Golfrey (J)

Melbourne

Fill, John V. (J)

Miami

Adams, George G. (A)
Bliss, Alonzo O., Jr. (A)
Christensen, Bernard J. (A)
Erickson, Carl E. (A)
Frederick, Calvin M. (A)
Hoselton, Frank B. (A)
Sullinger, Ferris W. (A)

Orlando

Green, Charles M., Jr. (A)
Skelton, Kenneth W. (A)

Pensacola

Taylor, Francis William (A)

Sarasota

Service, Charles A., Jr. (A)

South Jacksonville

Grange, Gifford (A)

St. Petersburg

Johnson, Carl C. (A)
Preece, Richard, Jr. (A)
Wittstruck, Harold H. (A)

Tampa

Fisher, Carroll S. (A)
Moore, William P. (A)

GEORGIA

Atlanta

Alexander, David C. (A)
Allen, Otis, T. (A)
Boucheron, Pierre H. (M)
Brewin, Robert R. (A)
Bussey, H. E. (A)
Cook, J. M. (A)
Daugherty, Carl F. (A)
Dobbs, Harry F. (A)
Gardberg, Joseph (A)
Gue, Earl M. (A)
Harrison, Richard H. (J)
Hillegas, John W. (A)
Hobart, James C., Jr. (A)
Holliday, F. S. (A)
Jones, Albert L. (J)
Jorgenson, Wesley J. (A)
Llewellyn, George (A)
MacNaughton, A. K. (A)
Matthews, Allen A., Jr. (J)
Murphy, Brower (A)
Reid, Henry L. (A)
Rothemberger, William L. (A)
Russell, B. A. (A)
Thornton, Henry P. (A)
Walker, Joseph R. (A)
Wallace, Lawrence T. (A)
Wills, Harry L. (M)
Yancey, E. F. (A)

Avondale Estates

Bangs, Philip C. (A)

Columbus

Kirkland, A. H. (A)
Stuart, John F. (A)

Commerce

Hood, Sam (J)

Fort Benning

Sosebee, Frank E. (A)
Tate, Robert L. (A)

Macon

Rankin, George P., Jr. (A)

Royston

Berryman, Forrest G. (A)

Savannah

Carlson, C. O. (J)
Rollinson, John W. (A)

Statesboro

Blitch, James D. (A)

IDAHO

American Falls

Brose, Fred O. (A)

Pocatello

Davis, Glenwood (A)

Twin Falls

Belleville, Logan (J)

ILLINOIS

Alton

Duval d'Adrian, A. L. (M)

Aurora

Bliss, Floyd D. (A)

Beardstown

Barregarye, Laurence H. (J)

Berwyn

Burns, Elmer E. (A)
Komm, Paul M. (A)
Schnell, William J. (A)
Wilkinson, L. G. (A)

Bloomington

Stillhamer, Arthur G. (A)

Blue Island

Damm, George J., Jr. (A)

Brookfield

Courter, H. L. (A)

Canton

Ingersoll, William P. (A)

Carbondale

Chapman, David E. (J)

Carpentersville

Bennett, Leslie W. (J)

Champaign

Duncan, Don C. (A)

Chicago

Adair, Samuel E. (M)
Albee, Norman E. (A)
Alexander, Donald W. H. (A)
Alexander, Wayne (A)
Allain, Joseph A. (J)
Andres, Lloyd J. (A)
Andres, Paul G. (A)
Andrews, Edward F. (A)
Ankersen, G. W. (A)
Armstrong, Harold W. (J)
Arthur, Guy B. (A)
Bank, Maurice (A)
Barlow, William H. (A)
Barrett, Herman R. (A)
Beane, E. A. (M)
Beindorf, Lucien J. (A)
Benjamin, Abraham S. (A)
Beusman, Robert M. (A)

ILLINOIS (Continued)

Chicago (Continued)

Blom, Roy (A)
 Boltson, Jacob A. (A)
 Bogardus, Henry I. (M)
 Brack, G. S. (A)
 Braun, W. C. (A)
 Brewer, Francis T. (A)
 Bridgman, Francis K. (A)
 Brittin, Frank L. (M)
 Bronson, G. E. (A)
 Browne, L. N. (A)
 Burchard, John C. (M)
 Burdett, Sam (A)
 Burkwest, Leonard G. (A)
 Burns, Robert P. (A)
 Butler, Raymond H. (A)
 Butterfield, Roy O., Jr. (A)
 Byrnes, Walter C. (A)
 Caldwell, Louis G. (M)
 Campbell, Robert H. (A)
 Canon, Hartman B. (J)
 Carothers, R. F. (A)
 Carter, A. J. (M)
 Cassens, Fred Benjamin (A)
 Chadwick, Ray E. (J)
 Chatlos, Albert (A)
 Chernikoff, Leo J. (A)
 Chun, Herbert H. (A)
 Clausing, LeRoy M. E. (A)
 Clark, Paul H. (A)
 Clough, Kendall (A)
 Cohen, Theodore (J)
 Colwell, Frederick E. (A)
 Comb, David M. (A)
 Crossett, Edward C. (A)
 Cubert, Joseph R. (A)
 Cumming, George (A)
 Davis, Joseph A. (A)
 Deeley, Paul M. (M)
 Demikis, Anton, Jr. (J)
 Dokas, Konstantinos B. (A)
 Douglas, James M. (A)
 Dubuclet, Sidonio L. (A)
 Durkee, James D. (M)
 Edelman, Phillip E. (A)
 Edwards, Charles (A)
 Eells, M. Merwin (A)
 Elam, David L. (A)
 Ellis, Robert Marcus (A)
 Eppstein, Ralph M. (A)
 Esmaker, John B. (A)
 Ewald, Fred J., Jr. (A)
 Falknor, Frank B. (M)
 Fast, John E. (A)
 Felio, Orin J. (A)
 Fernandez, Dan T. (A)
 Ferris, Frank (A)
 Fetterman, D. M. (J)
 Fischer, Andrew, Jr. (A)
 Fitzgerald, John J. (A)
 Flick, A. A., Jr. (A)
 Forbes, Allan C. (M)
 Foringer, Edgar C. (A)
 Forsberg, Otto J. (A)
 Fortington, William H. (M)
 Frankel, Mortimer (M)
 Freeman, Ernest H. (M)
 Freimann, Frank (A)
 Friday, Wilbur L. (A)
 Friend, Halton H. (A)
 Fritzel, Joseph (A)
 Gay, Paul F. (A)
 Giard, E. A. (A)
 Glassford, J. O. (A)
 Glassman, George (A)
 Goldman, Stanley (A)

Golten, J. N. (A)
 Grimes, David (M)
 Gunther, W. J. (A)
 Haire, A. F. (A)
 Hall, Edward G. (A)
 Hall, Harlan R. (A)
 Halligan, William J. (A)
 Hansen, Clarence A. (A)
 Hansen, Harvey Bennett (A)
 Hansen, William H. (J)
 Hanson, Earl C. (A)
 Harper, W. W. (M)
 Hassel, Karl E. (M)
 Hauschild, John P. (A)
 Hauser, Albert (A)
 Hayes, H. D. (M)
 Hellman, Milton E. (A)
 Henninger, Andrew F. (A)
 Henry, Charles C. (A)
 Hermanutz, Ray J. (A)
 Heselton, Charles C. (M)
 Hillegas-Baird, L. S. (A)
 Hines, Albert D. (A)
 Hitzhammer, De V. (A)
 Hoag, J. Barton (M)
 Holmquist, Carl T. (A)
 Holroyd, Richard J. (A)
 Holst, Wendell L. (M)
 Howard, Austin A. (M)
 Howard, C. M. (M)
 Hukle, R. M. (A)
 Izenstark, Maurice J. (A)
 Jelen, Matt J. (A)
 Jensen, Karl K. (A)
 John, Kenneth B. (A)
 Johnson, E. O. (A)
 Johnson, John K. (A)
 Johnston, Ivan F. (A)
 Kahn, Lamos (A)
 Kamin, Vernon A. (A)
 Kehm, Clarence H. (A)
 Kelley, Harvey T. (A)
 Kempf, Frank J. (A)
 Kessler, P. W. (A)
 Knowles, Hugh S. (A)
 Koblitz, August P. (A)
 Koch, Earl L. (A)
 Korb, George W. (A)
 Koutnik, J. A. (A)
 Kramer, Andrew W. (A)
 Krueger, Alfred (A)
 Lagasse, Albert (A)
 Lamb, Harold A. (A)
 Lanterman, Walter F. (A)
 Larson, John M. (A)
 Lawton, Harvey B. (A)
 Leidy, W. J. (A)
 Levin, Sam (A)
 Levy, Henry (A)
 Levy, Samuel L. (A)
 Lorich, George H. (A)
 Lotter, John G. (A)
 MacDermaid, L. D. (A)
 Magos, John P. (A)
 Marco, Frederick J. (M)
 Marshall, Charles E. (A)
 Martin, E. F. (A)
 Martin, Neill H. (A)
 McAvoy, Edward J. (A)
 McCammon, Donald (J)
 McClintock, W. S., Jr. (A)
 McCullah, Arthur B. (A)
 McGregor, Arthur M. (A)
 McJilton, De Witt (A)
 Mead, Leo R. (A)
 Meinhard, Herman (A)
 Mercer, John E. (A)

ILLINOIS (Continued)

Chicago (Continued)

Michalowicz, Leon (A)
 Miller, Gerald E. (A)
 Million, John W., Jr. (M)
 Mills, Elmer E. (A)
 Minnium, Byron B. (A)
 Mooney, Raymond (A)
 Moore, James S. (A)
 Morey, W. J. (A)
 Morley, William L. (A)
 Morris, John F. (A)
 Morrison, Huber R. (A)
 Morrison, Montford (M)
 Morse, Arthur H. (M)
 Mraz, Edwin (A)
 Mueller, Eugene L. (A)
 Muirhead, John E. (A)
 Nardin, George F., Jr. (J)
 Nelson, R. G. (A)
 Nieman, Thomas A. (A)
 Nolan, James J. (M)
 Nordhaus, Charles H. (A)
 Nourse, Philip R. (A)
 Novak, Joe J. (A)
 O'Brien, William J. (A)
 O'Byrne, Leo C. (A)
 O'Callaghan, Jerome J. (A)
 Owens, Richard M. (A)
 Oxner, Edwin K. (A)
 Paradise, Maurice E. (A)
 Parisek, Edward E. (A)
 Parker, Leonard E. (A)
 Patterson, Joseph A. (A)
 Pestlin, Le Roy J. (A)
 Petersen, Howard E. (A)
 Petzing, Erwin W. (A)
 Pew, Richard K. (A)
 Pfaff, Ernest R. (M)
 Pietz, Raymond G. (A)
 Plekka, James (A)
 Polydoroff, W. J. (M)
 Prentiss, John G. (A)
 Preston, Cecil W. (A)
 Procunier, W. R. (J)
 Rafferty, Frank A. (M)
 Ramm, Carl H. (A)
 Randall, Harry K. (A)
 Rech, Charles B. (A)
 Remde, Jack (A)
 Richards, Horace Jerome (A)
 Richards, Philip A. (A)
 Riddel, O. A. (J)
 Riggs, John H. (A)
 Ross, Frank C. (A)
 Ross, Kenneth B. (A)
 Rossiter, Donald R. (J)
 Rowe, Thomas L. (A)
 Royal, Roscoe (A)
 Schaefer, Harold W. (J)
 Scharf, Joachim Barschach (A)
 Schnell, Fred H. (M)
 Schoenwolf, Fred L. (M)
 Schor, F. W. (A)
 Schulz, Emil H. (A)
 Shaffer, Paul E. (A)
 Shaw, Robert E. (A)
 Shultise, Q. M. (A)
 Sieben, Clarence M. (A)
 Silver, McMurdo (A)
 Siovic, John E. (A)
 Sloan, Francis V. (M)
 Smith, Ernest F. (M)
 Smith, Howard L. (A)
 Smith, K. R. (M)
 Smith, Sereno E. (A)
 Smythe, Edwin H. (M)

Somersalo, G. A. (A)
 Sorensen, Carl P. (A)
 Stewart, Arthur C. (A)
 Stone, Carrington H. (M)
 Swisher, O. V. (A)
 Tamburino, Anthony C. (A)
 Ten Cate, Arthur (A)
 Thorsen, Orville T. (A)
 Threlkeld, Howard M. (A)
 Tittle, Hulburt C. (A)
 Trimble, Loren (A)
 Turner, C. G. (A)
 Turner, George S. (M)
 Turner, Harry E. (A)
 Turner, Russel (A)
 Van Antwerp, Max C. (A)
 Van Sickle, R. E. (A)
 Wagner, Elmer H. (A)
 Walgren, C. A. (A)
 Wang, Theodore J. (A)
 Wareing, Herbert F. (A)
 Wasservogel, Gunther (A)
 Wegner, Charles W. (J)
 Weibler, Carleton T. (A)
 Weissmantel, C. H. (A)
 Weitzel, Leroy B. (A)
 Whan, Loren H., Jr. (A)
 Wilcox, G. M. (M)
 Williamson, Frederick E. (A)
 Willoughby, John A. (M)
 Wilm, Carl F. (A)
 Wise, Roger M. (A)
 Woods, A. A. (A)
 Woodward, Clarence H. (A)
 Zurian, P. D. (A)

Chicago Heights

Tartak, Paul H. (A)

Cicero

Engst, Norbert K. (A)
 O'Brien, Elwin J. (A)

Crete

Courchene, Homer B. (A)

Danville

Parsons, Charles (A)

Decatur

Cameron, Henry L., Jr. (A)
 Pennington, D. J. (J)
 Spies, Mark C. (A)

Deerfield

Carment, James M. (A)

Dixon

Hall, Howard J. (A)

Downers Grove

Allen, Justus (A)
 Johnson, Arthur R. (A)

East Peoria

Hoffman, John L. (J)

Effingham

Osgood, Albert S. (A)

Elmhurst

Haag, Merlin W. (A)
 Hercher, Frederick J. (A)
 Inglis, Alexander W. (A)
 Kenney, M. W. (M)
 Kranz, Herman E. (M)

Evanston

Bergman, G. Wiley (A)
 Burt, Andrew G. (A)
 Clarke, R. E. (A)
 Fisk, Lawrence S. (A)
 Hill, James H. (A)
 Hughes, Robert E. (A)
 Lund, Russell O. (A)
 Pennington, Paul (A)
 Stein, Harold A. (A)
 Wolcott, C. Frederick (A)

ILLINOIS (Continued)

Evergreen Park
Randall, Lemuel E. (A)

Fort Sheridan
Hoover, Richard T. (A)

Freeport
Meyer, Winston F. (A)
Nestlerode, Boyd W. (A)
O'Connell, Gerald (A)

Geneva
Crozier, William D. (A)
Greaves, V. Ford (F)
Kranz, Frederick W. (A)

Glencoe
Marsh, Carlton H. (A)

Harrisburg
Tate, Joseph R. (A)

Highland Park
Rollefson, Karl E. (M)
Tucker, G. Lloyd (A)

Hinsdale
Doyle, E. J. (A)
Hill, Frederick A. (A)

Kankakee
Wilhelmi, Julian A. (A)

Kenilworth
Lahman, Wilford C. (A)

Kewanee
Larson, Clifford L. (A)

La Grange
Hofert, Fred A. (A)

Lake Bluff
Klock, R. A. (A)
Olesen, Harold L. (M)

Lake Forest
Baker, James M. (A)
Haviland, Lyman J. (A)

La Salle
Arnold, Elmer J. (A)

Litchfield
Weller, Earl Selwyn (J)

Lombard
Hollenbeck, A. T. (A)
Puhalski, Donald (A)

Macomb
Eller, Walter H. (M)

Maywood
Peary, Malcolm J. (A)
Winkel, Herbert C. K. (A)

Mt. Prospect
Gustafson, Gilbert E. (A)

Naperville
Stoos, Joseph A. (A)

Niles Center
Potter, M. L. (A)

North Chicago
Dady, Arthur O. (A)
Taylor, H. S. (J)

Oak Park
Armstrong, H. M. (A)
Augustine, Roy W. (M)
Bluzat, Claude R. (A)
Chase, Leslie H. (A)
Drummond, Ralph S. (A)
Hoffman, Walter Henry (A)
Hough, William E. (A)
Kobberup, Jack R. (A)
Kobberup, Julius (A)
Miller, John H. (M)
Nangle, W. O. (A)

Pearson, Oscar A. (M)
Phillips, James H. (A)
Pye, Harold C. (A)
Roe, Douglas J. (A)
Weiser, Carl (A)
Westcott, Philip S. (A)
Willing, William P. (A)
Woodruff, Albert E. (A)

Park Ridge
Carr, J. O. (A)

Paw Paw
Braffet, Donald H. (A)

Pekin
McGarvey, Harold R. (A)

Peoria
Kelly, Earl L. (A)
Shalkhauser, Eric George (M)
Snyder, Roy A. (A)

Plainfield
Rand, George L. (A)

Plano
Victoreen, Charles J. (A)

Quincy
Johnson, J. Robert (A)
Wilson, A. J. (A)

Rankin
Denton, Frank O. (A)

Rantoul
Arnold, Thomas E. (A)
Fiechtner, Theodore G. (A)
Richard, Charles W. (M)

River Forest
Edwards, George W. (J)
Heald, Merwyn (A)
Mellvaine, H. A. (M)

Riverside
Greaves, Walter M. (A)
Wills, David C. (A)

Rockford
Ferdinand, Harry P. (A)
Johnson, Arthur A. (A)
Ward, Lloyd S. (A)
Westlund, J. V. (A)

Rock Island
Foley, Jack (J)

Savanna
Graham, George W. (A)

Springfield
Holtz, Frederick C. (A)
Kunz, H. L. (A)
Whannel, Raymond L. (A)

St. Charles
Hawkins, John B. (A)
Shotwell, Harold H. (A)
Voorhaar, Frederick R. (A)

Stockton
Hanson, Ralph L. (A)

Streator
Licht, Henry M. (A)
Melody, Bernard J. (A)
Williams, N. B. (A)

Sycamore
Boynnton, Frederick L. (A)

Tuscola
Barnett, Louis W. (J)
Fortner, Obed D. (J)
Moulden, Roy B. (A)

Urbana
Brown, Hugh A. (M)
Knipp, Charles T. (M)

ILLINOIS (Continued)

Urbana (Continued)
Morris, Lloyd P. (A)
Reich, Herbert J. (A)
Tingley, Freeman T. (A)
Tykociner, J. T. (M)

Villa Park
Jacker, Edward W. (A)

Waukegan
Herrmann, Albert, Jr. (J)
Weeks, Robert H. (A)

Western Springs
Scott, Kenneth L. (A)

West Frankfort
Alley, Kenneth G. (A)

West Liberty
Waddell, George G. (A)

Wheaton
Taylor, Hawley O. (M)

Wilmette
Freis, J. H. (A)
Shabino, Clarke L. (A)
Sholes, S. R. (A)

Winnetka
Gregory, Charlotte C. (A)
Hinson, Marcus W. (A)
Johnstone, George A. (A)
Manly, Harold P. (A)

INDIANA

Albion
Evans, Harry R. (A)

Anderson
Miller, Louis (A)
Perkins, Laurence M. (A)

Angola
Biar, L. E. (J)
Huntley, Kenneth L. (A)

Ashley
Urey, George M. (A)

Aurora
Achatz, Raymond V. (A)

Bloomington
Hazel, Herbert C. (A)
Ramsey, R. R. (M)

Butler
Ratts, Bruce H. (A)

Connersville
Hamilton, Charles E. (J)
Hanes, Fred B. (A)

Crown Point
Hall, Fred F. (J)

Evansville
Norwood, Vandle Clarence (A)

Fort Wayne
Baker, Dean R. (A)
Bohling, C. F. (A)
Cook, Edward H. (A)
Knouf, Ralph J. (A)
Miller, Paul E. (A)
Ramm, Harold W. (A)
Rekart, Arthur F. (A)
Rockwell, Ronald J. (A)
Schryver, Henry A. (A)

Gary
Molony, John D. (A)

Hammond
Sherman, Russell H. (A)

Indianapolis
Byers, Russell R. (A)
Chapel, I. C. (A)
Dutton, Charles E. (A)

Kokomo
Ashlock, H. D. (A)

Linnsburg
Doyel, Lee Conan (A)

Marion
Boji, Louis D. (A)
Detrick, Harold M. (A)
Emerson, Kenneth H. (A)
Foster, Dudley E. (A)
Pressley, Jackson H. (A)
Rose, Joseph K. (A)

Notre-Dame
McCoy, Julius C. (A)

Princeton
Karras, George S. (A)

Richmond
Turner, W. E. (A)

South Bend
Gebhardt, Paul B. (A)
Heimberger, Albert E. (A)
Kahn, Albert R. (A)
Kennedy, James P. (A)
McNamee, B. F. (A)
St. James, Robert T. (M)
Timmings, George H. (A)

Sweetser
Myers, Delbert (A)

Syracuse
Freeman, Stephen, Jr. (A)

Terre Haute
Hershman, J. B. (A)

Valparaiso
Cummings, Wilbur H. (A)
Hayes, Arthur J. (A)
Leigh, Charles W. (A)
Munroe, A. D. (A)
Noller, Roy E. (A)
Olinger, Robert (A)
Packman, M. E. (A)

Westfield
Brown, Wilfred E. (A)

West Lafayette
Tanke, Harold T. (A)
Yoder, Leo E. (A)

IOWA

Ames
Huntsinger, Paul R. (J)
Konkle, Phil (A)
Smith, Earl D. (J)

Blairsburg
Baughman, Raymond C. (A)

Burlington
Jeffrey, Byron B. (A)

Cedar Rapids
Collins, Arthur A. (J)
Hajny, George F. (A)
Miller, Clair R. (A)

Clarinda
Whitnah, R. B. (J)
Wilcox, Nathan (A)

Clinton
La Batt, Manor D. (A)

Council Bluffs
Anderson, Gordon A. (A)

Davenport
Ehlers, Paul (A)
Elliott, Frank W. (A)
Schricker, John R. (A)
Speers, John C. (A)
Wildman, Thomas S. (A)

IOWA (Continued)

Des Moines
Haigh, M. C. (A)
Hutchison, Sam T. (A)

Dubuque
Roedell, LeRoy W. F. (A)

Estherville
Center, Edgar R. (A)

Fort Dodge
Willits, Andrew A. (A)

Hale
Kruse, Gerald D. (A)

Iowa City
Griffith, Paul E. (A)
Woodward, V. M. (A)

Marshalltown
Pickett, Earl L. (A)

McGregor
Woods, T. DeWitt (A)

Mt. Vernon
Kafer, Merle D. (A)

Muscatine
Baker, Norman G. (A)

Onslow
Koon, Cecil (A)

Sioux City
Coates, Frank M. (A)
Kerby, Edward J. (A)

Villisca
Harris, Merion C. (A)

Wapello
Fry, Lloyd L. (A)

KANSAS

Abilene
Brewer, Noble E. (A)

Atchison
Dimond, Benjamin D. (A)
Gier, Willard Marion (A)
Moore, Eugene A. (A)
Robb, Joseph S. (A)
Stein, Frederick W. (A)

Bendena
Johnson, Milton L. (A)

El Dorado
Graham, Ira H. (A)

Ellis
Harrison, Louis A. (A)

Emporia
Miller, R. F. (A)

Great Bend
Karr, Henry P. (A)

Hamlin
Herold, Jos. L. (A)

Independence
Elliott, Ralph W. (A)

Lawrence
Anderson, Harold W. (A)
Compton, Robin D. (A)
Douglas, Norvel (J)
Jones, George I. (A)
Wheeler, Frederick (J)

Leavenworth
Hageman, Oliver C. (A)

Liberal
Reid, Halbert G. (J)

Manhattan
Bueche, Harry S. (A)

Milford
Weldon, James O. (A)

Topeka
Cook, John W. (A)

Wichita
Byers, Harrison O. (A)
Demuth, G. W. (J)
Marshall, George E. (A)
Mitchell, G. A. (A)
Mitchell, Theodore R. (A)
Walter, Loren E. (A)

KENTUCKY

Ashland
Carr, Edward Mayes (A)

Covington
Frassa, Charles F. (A)
Charbonneau, Allan P. (A)
Heffernan, S. K. (A)
Reid, Ralph J. (A)

Hardinsburg
Pyle, R. C. (J)

Jeffersonton
Strassman, Irving (A)

Lexington
Tillett, Jesse (A)

Louisville
Graft, J. Emmet (A)

Newport
Kolo, R. E. (A)
Pepper, Robert K. (A)
Preuss, Arthur C. (A)

Owensboro
Koechel, W. P. (A)
Schoene, Russell L. (A)
Wuertz, John L. (A)

Paducah
Shelton, Raymond W. (A)

LOUISIANA

Baton Rouge
Fisher, Theodore (A)
Webre, Andrew S. (A)

Lake Charles
Lake, Thornton G. (J)

New Orleans
Adler, Leonard E. (A)
Alcus, Isaac (A)
Allston, William F. (A)
Ammen, Charles E. (A)
Andres, Charles, Jr. (A)
Breedlove, Frederick W. (A)
Chateau, Arthur (A)
Clemmons, Wallace A. (A)
Dahlstrom, Hugo Wolf (J)
Deller, Theodore G. (M)
Dover, M. H. (J)
Du Treil, L. J. N. (M)
Elliott, Harry M. (A)
Gallo, Louis J. (M)
Goldstein, Henry R. (A)
Hart, M. E. (A)
Hibbett, James Orlin (A)
Hilgedick, W. C. (A)
Jensen, Valdemar (A)
Jones, Edward T. (M)
Lehde, Pendleton E. (F)
Macke, William (A)
Maier, Otto T. (A)
McCabe, Louis L. (A)
Moore, Frank C. (A)
O'Neil, Maurice B. (A)

LOUISIANA (Continued)

New Orleans (Continued)
Pasquet, Jean E. (A)
Peirce, George H. (A)
Peters, C. W. (A)
Salzer, Herman M. (A)
Salzer, H. S. (A)
Scheffer, Roy J. (A)
Schiele, Anton A. (A)
Stevens, William J. (A)
Voegtlin, Elmo (A)

Port Barre
Futral, John E. (A)

Shreveport
Claycomb, Hugh (A)

Slagle
Hayes, Fred D. (A)

St. Francisville
Harris, David D. (A)

MAINE

Bangor
Creamer, W. J., Jr. (A)
Hartz, Leslie C. (A)

Belfast
Ashmore, J. W. (A)
Coxhead, Harry B. (M)

Brunswick
Little, Noel C. (A)

Fort Preble
Behr, Francis (F)

Houlton
Thrush, Paul W. (A)
Wilkes, Emerson T. (A)
Willis, F. H. (A)

Northeast Harbor
Knowles, Jerome H., Jr. (A)

Orono
Cloke, Paul (M)

Portland
Collins, Lewis R. (A)
Giro, Daniel J. (A)
Rice, Harold E. (A)
Ryall, Henry (J)

Yarmouth
Tamminen, Nestor (A)

MARYLAND

Annapolis
Behner, Herbert C. (M)
Dowd, Alfred (J)
Giet, G. Robert (M)
North, J. Harold (A)
Robinson, Gordon D. (A)
Robison, Samuel S. (F)

Baltimore
Allen, John E. (A)
Allner, Frederick A. (A)
Ault, Arthur K. (A)
Cohen, Hyman A. (A)
Collins, Laurence H. (A)
Cooke, Gerald W. (A)
Cunningham, K. S. (A)
Del Court, George (A)
Dudley, Charles B., Jr. (A)
Ellert, Charles A. (A)
Emmerich, Henry J. S. (A)
Fallon, Glover P. (A)
Graf, Herman, Jr. (A)
Hannah, George M. (A)
Herndon, Landon C. (M)
Houston, George P., III, (A)
Kreb, William N. (A)

Lange, Edward H. (A)
Mathers, Earl S. (A)
Miller, J. Purnell (A)
Ranit, William Q. (A)
Ridenour, William S. (J)
Seitz, J. Fred (A)
Sterling, George E. (M)
Wallgren, Alric E. (A)
Waltz, William W. (A)

Bethesda

Bush, George P. (M)

Chevy Chase
Berkner, Lloyd V. (A)
Dellinger, J. H. (F)
Kelley, George W., Jr. (A)
Walls, Hoy J. (M)

Ft. Howard
Wilson, Luther E. (A)

Hyattsville
Lyon, Harry H. (A)
Rogers, J. Harris (M)

Mount Rainier
Eisenhauer, Harry D. (A)

Silver Spring
Quaintance, Leland C. (A)
Thomsen, Paul H. (A)

Somerset
Brady, John B. (M)

Westminster
Utz, William C. (A)

MASSACHUSETTS

Adams
Barschdorf, Harry Oliver (J)

Allston
Cook, Wilbert H. (A)
Pearlstein, Charles D. (A)

Arlington
Asten, Oliver B. (A)
Treffry, Laurence D. (A)

Arlington Heights
Lamson, Horatio W. (M)

Ashmont
Mullen, Joseph A. (A)

Atlantic
Brown, George W. (A)
Heap, Sheldon S. (A)

Auburndale
Clapp, James K. (M)

Belmont
Anthony, A. W., Jr. (A)
Dolbear, Benjamin L. (M)
Hughes, A. Morris (A)
Lane, Henry M. (M)

Beverly
Appleton, Samuel (A)
Colby, Edward B. (A)
Porter, Ronald G. (A)
Woodbury, Stephen E. (A)

Boston
Baird, Hollis S. (A)
Beakes, William E. (M)
Boyd, Davis S. (A)
Browne, Monte C. (A)
Cabot, George E. (A)
Chetham, Harry R. (M)
Crawford, John D. (A)
Cumming, L. Gordon (A)
Emery, R. C. (A)
Ford, John R. (J)
Fowler, Elisha (A)
Gerber, Nathan (A)

MASSACHUSETTS (Continued)

Boston (Continued)

Goodrich, Robert R. (A)
Greene, Lloyd C. (A)
Harris, C. C. (M)
Hayes, Hammond V. (A)
Hurd, Volney D. (A)
Imlach, George (A)
Jappe, Holger (M)
Kelly, Michael P. (A)
Nunez, F. J. (A)
Parnagian, Aram (A)
Pitts, Francis D. (A)
Proctor, John A. (M)
Putnam, John P. (A)
Rines, David (A)
Rosenwald, Edwin D. (A)
Stone, C. W. (A)
Wass, Howard H. (A)
Weston, Irving L. (A)

Bradford

Knowlton, Robert G. (A)

Braintree

Robinson, Philip F. (A)

Brighton

Wallace, Gordon S. (A)
Sylvester, John C. (A)

Brockton

Sampson, Edward J. F. (J)
Wright, William L. (A)

Brookline

Bowker, Winthrop H. (A)
Cabot, Sewell (M)
Campbell, Harold G. (A)
Peckham, J. H. (A)
Ready, William A. (A)
Weeks, Miles W. (A)

Cambridge

Barrow, W. L. (A)
Batchelder, Laurence (A)
Bauer, Paul S. (A)
Blodgett, Edward D. (A)
Bousquet, Arthur G. (A)
Bowles, Edward L. (M)
Browne, Theodore C. (M)
Burke, Charles T. (M)
Campbell, Winifred H. (A)
Chaffee, E. Leon (F)
Cullum, A. Earl (J)
Eastham, Melville (F)
Elser, F. Johnson (A)
Fahnestock, Harris, Jr. (A)
Gager, F. Malcolm (A)
Gleason, Harold H. (A)
Grant, Lawrence E. (A)
Hickman, Roger W. (A)
Hisamoto, Masyauki (A)
Horton, J. Warren (F)
Hsu, C. L. (J)
Hunt, Frederick V. (A)
Ide, John M. (J)
Jen, C. K. (A)
Johnson, Montgomery H., Jr. (A)
Kennelly, Arthur E. (F)
Mc Elroy, Paul K. (M)
Mickey, Leroy (A)
Phillips, Henry B. (M)
Pierce, George W. (F)
Pilkington, E. J. (A)
Pratt, P. W. (A)
Richmond, Harold B. (F)
Shaw, Henry S. (M)
Shen, Pao-Guay (A)
Spike, J. Edward, Jr. (A)
Thiessen, Arthur E. (A)
Weare, John (A)
Weeks, Paul T. (M)

Whittier, Ellerton W. (A)
Wilder, Marshall P. (A)
Wildes, Karl L. (A)
Woodrow, James A. S. (A)
Worthen, Charles E. (A)

Chatham

Robinson, Forrest D. (A)
Thing, K. (A)

Chelsea

Fox, Robert (A)
Murdock, D. R. W. (A)

Chestnut Hill

Dellenbaugh, F. S., Jr. (M)

Chicopee Falls

Andrew, Victor J. (A)
Ellsworth, William C. (A)
Harlow, Fred G. (A)
Kinsman, Warren D. (A)
Lapori, Edmund A. (M)
Little, Donald G. (F)
Taggart, Samuel E. (A)
Tholstrup, Henry (A)
Winstead, Theodore Bernard (A)

Concord

Hall, Henry D. (A)

Danvers

Turenne, Wilfred J. (A)

Dedham

Cowan, Edward J. (A)

Dennis Port

Skinner, Oscar E. (A)

Dorchester

Barry, Francis J. (J)
Berkowitz, Louis (J)
Chessler, Maxwell A. (A)
Clarke, Ralph S. (A)
Hardy, Carroll N. (A)
Meredith, William B. (A)
Purssell, Clarence V. (A)

East Boston

Limonc, Joseph (A)

East Falmouth

De Mello, William (A)

East Holliston

Peters, John L. (A)

East Pepperell

Hills, Eugene K. (J)

East Springfield

Batchelder, S. P. (A)
Henderson, Roy A. (A)
Hurff, Joseph L. (A)
Madsen, Carl J. (A)
Miller, Harold R. (A)
Russ, George H. (A)
Trigger, Vernon A. (A)

East Taunton

Hoard, Norman F. (A)

Fall River

Bowen, Harold C. (A)
Stanko, Edward (A)

Framingham

Forbes, E. D. (F)

Gloucester

Hammond, John Hays, Jr. (M)
Trenor, Albert D. (A)

Great Barrington

Barkley, Howard F. (A)
Parrish, Robert R. (A)

Greenwood

Clement, Ivan C. (A)

MASSACHUSETTS (Continued)

Hamilton

Dane, Francis W. (M)

Haverhill

Taylor, B. H. (A)

Hingham

Macadam, Mark L. (A)
Pratt, Fearing (A)

Holyoke

Klemin, Robert Carl, Jr. (A)

Hudson

Kaulback, Harold D. (A)

Hyde Park

Gould, William B., III

Jamaica Plain

Canner, William (A)
Dallin, Edwin B. (M)
Hazard, Willis Gilpin (A)
Mayer, Arthur W. (A)

Lawrence

Theberge, Albert R. (A)

Lexington

Chute, Dudley H. (A)

Longmeadow

Booth, James D. (A)
Brackett, Quincy A. (M)
Coleman, John B. (M)
Forbes, Henry C. (M)
Greis, W. Karl (A)
Phillips, Lloyd B. (A)
Taylor, Edward C. (A)

Lowell

Morton, Clarence F. (A)

Lynn

Abrahams, Samuel L. (A)
Amato, Peter (A)
Bailey, W. M. (M)
Le Bel, C. J. (A)
Mayo, Royal E. (A)

Malden

Millen, James (A)

Marion

Brunette, Deo Z. (A)
Canfield, N. A. (A)
Carson, Joseph (A)
Morris, Hedley B. (A)

Mattapan

Hosford, Harold B. (A)
Rothberg, Joseph (J)
Weber, Harold C. (A)

Medford

Cook, Bernard L. (A)
Greene, C. Francis (A)
Wyman, Raymond C. (A)

Medford Hillside

Leoser, Thomas S. (A)

Melrose

Hubbard, Beverly R. (A)
Jepson, Warren F. (A)
Philbrick, Lawrence S. (A)
Tyzzler, Howard J. (A)

Needham

Keim, J. D. (A)

New Bedford

Catterall, John (J)
Hodgdon, Herbert J. (A)
Vermilya, Irving (M)

Newburyport

Scott, Gilbert H. (A)

Newton

Colby, Charles C., Jr. (A)

Newton Center

Miller, William T. (A)
Pickard, Greenleaf W. (F)

Newtonville

Stark, Eldon E. (A)

North Attleboro

Hale, Willis L. (A)
Langlois, Gerald L. (A)

North Cambridge

Grenier, Henry N. (A)

Northampton

Metty, Bradford Joseph (A)

North Weymouth

Hollis, Hammond H. (A)

Oak Bluffs

Horne, William P. (A)

Orleans

Snow, Albert E. (A)

Plymouth

McCarty, Laurence (A)

Quincy

Renton, Ralph J. (A)
Toivonen, Egon O. (A)

Revere

Burns, Laurence (A)
Gelardi, Matthew (A)
Speirs, George E. (J)

Rockport

Mills, William P. (A)

Roslindale

Van Brocklin, William S. (A)

Roxbury

Dalton, Robert E. (A)
Katz, Louis S. (A)
Paley, Albert A. (A)
Salowitts, Louis W. (A)
Stone, Elmer F. (A)

Saler

Bolan, Robert S. (A)
O'Neill, George D. (A)
Poor, Walter E. (A)
Porter, Ralph H. (A)

Siasconset

Holden, Harry H. (A)

Silver Lake

Stein, Adam, Jr. (F)

Somerville

Dillaby, Edwin F. (A)
McLaughlin, William P. (A)
Root, Leland B. (M)

Southbridge

Wells, John M. (A)
Yates, Wilfred (A)

South Dartmouth

Chinn, Howard A. (A)
Hendricks, Paul S. (A)
Houghton, Henry G., Jr. (A)
Olmstead, Noel C. (A)

Springfield

Beard, J. Gregson (A)
Bock, Ashley P. (A)
Bord, M. E. (A)
Burnside, Carrol J. (A)
Cole, Neil D. (A)
Cotter, William F. (A)
Coulson, Everett J. (A)
Creaser, Isaiah (A)
Curtis, Leslie F. (M)
Davis, William G. (A)
Der Bedrossyan, Mark (A)
Dyson, H. R. (A)

MASSACHUSETTS (Continued)

Springfield (Continued)

Ferguson, George W. (A)
 Garvey, Edmond (A)
 Gilliatt, Leland W. (A)
 Gundrum, Edward (A)
 Holt, Hillis W. (A)
 Hutcheson, John A. (A)
 Knapp, Harold D. (A)
 Moauro, Joseph S. (A)
 Morehouse, Dayton J. (A)
 Neal, Chester T. (A)
 Nystrom, Raymond A. (A)
 Phelps, Roger E. (A)
 Raskhodoff, Nicholas (A)
 Walker, C. L. (A)
 Wells, Daniel W. (A)
 Wilson, R. A. (A)
 Wolf, Lester J. (A)

Stockbridge

Harrington, George N. (A)

Swampscott

Humphrey, Stanley M. (A)

Tufts College

Kenrick, Gleason W. (M)

Uxbridge

Kozaczko, Walter H. (J)

Waban

Church, Vallette S. (A)

Waltham

Clark, R. W. (A)
 Hatton, Arthur Thomas (A)

Watertown

Field, Robert F. (A)

Wellesley

McDowell, L. S. (M)
 Palmer, Harry W. (A)
 Russell, Robert D. (A)

Wellesley Farms

Hills, Charles E. (A)

West Medford

Stockellburg, Arthur A. (A)

West Roxbury

Wolf, Edwin A. (A)

West Somerville

Ekstrand, Edward B. (J)
 Kolster, Charles C. (M)

Whitman

Lovell, Webster A. (A)

Winchester

Allen, Albert, (A)
 Browning, Glenn H. (M)
 Burgoyne, Roger M. (A)
 Page, Newell C. (A)

Winthrop

Colton, Howard C. (J)

Wollaston

Gray, Alfred R. (A)
 McGrath, Joseph L. (A)
 Sigmon, L. C. (A)
 Surette, Dennis C. (A)

Worcester

Adams, Stuart (A)
 Anderson, Paul E. (J)
 Bates, Lee A. (A)
 Gleason, Albert E. (A)
 Newell, Hobart H. (A)

MICHIGAN

Allen

Moore, Harold A. (A)

Alpena

Snyder, Leslie T. (A)

Ann Arbor

Campbell, George R. (A)
 Case, Nelson P. (A)
 Holland, Lewis N. (A)
 Martin, Paul E. (A)
 Palmer, Edward D. (A)
 Suez, Robert K. W. (J)
 Susnich, Eugene W. (A)
 Uehling, Edwin A. (A)
 Underwood, O. De Los (A)

Battle Creek

Doty, W. E. (A)
 Fay, Lewis C. (A)
 Johnson, Julian S. (J)
 Kinch, Oscar A. (A)
 Roof, Raymond B. (A)

Bay City

Carpenter, Ralph H. (A)

Benton Harbor

Miles, K. Walker (A)

Berrien Springs

Fetzer, John E. (M)

Birmingham

Soeters, Raymond A. (A)

Blanchard

Kersey, Russell (A)

Detroit

Allen, Albert B. (A)
 Almas, Stan L. (A)
 Alston, Vernon C. (A)
 Bailey, Stuart L. (A)
 Ball, I. Dale (A)
 Blumenthal, Raymond W. (A)
 Bobertz, W. E. (A)
 Brown, Jesse E. (M)
 Buchanan, Arthur B. (A)
 Byerlay, H. Le Roy (A)
 Byram, F. Cameron (A)
 Carson, Walter E. (A)
 Cash, George B. (A)
 Clark, Thomas E. (M)
 Clarke, George R. (A)
 Collins, Frederick V. (A)
 Courtis, Reginald P. (A)
 Cox, Charles H. (A)
 Cray, Frederick W. (A)
 Davis, Chester (A)
 Du Bois, Edward P. (J)
 Edwards, Samuel W. (M)
 Evison, Samuel J. (A)
 Faulkner, Douglas (A)
 Firestone Samuel (A)
 Friedenthal, Andrew (A)
 Gasparovitch, Stephen (A)
 Geiger, Arthur H. (A)
 Goldman, Sherman (A)
 Green, Walter M. (A)
 Griva, John (A)
 Grove, George A. (A)
 Grunow, Oscar H. (A)
 Haston, Claude W. (A)
 Hoffman, Walter R. (A)
 Jackson, William E. (A)
 Joy, Henry B. (A)
 Joyce, Herbert A. (A)
 Kirby, Corley W. (A)
 Kirby, Otto I. (A)
 Kratokvil, Frank M. (A)
 Lathrop, F. A. (A)
 Malo, Charles D. (A)
 Manning, Stanley R. (A)
 Martin, Robert D. (A)
 McCaffry, James A. (A)
 Moore, J. Burton (A)
 Osborn, Paul I. (A)

MICHIGAN (Continued)

Detroit (Continued)

Outzen, Andrew N. (A)
 Owen, Charles W. (J)
 Porter, Samuel (A)
 Putnam, Erle T. (A)
 Ransom, G. B. (A)
 Scanlan, Richard J. (A)
 Schmalzriedt, T. (A)
 Seielstad, Harold (A)
 Seymour, Fred M. (A)
 Simons, Orlin B. (A)
 Stansfield, Selwyn (A)
 Steinhauser, Clarence J. (A)
 Sturman, George M. (A)
 Taylor, Harold E. (A)
 Thomas, Walter J. (A)
 Tomchuck, John (J)
 Trainer, George T. (A)
 Trittenbach, John M. P. (A)
 Trowbridge, O. H. (A)
 Wilber, Delbert J. (A)
 Worel, Frank (A)

East Lansing

Clark, Ralph L. (A)
 Murray, William A. (A)
 Osborn, Burr K. (A)
 Richards, A. R. (A)

Farmington

Kreuzer, A. R. (A)

Fenton

Dobbs, F. W. (A)

Flint

Blanford, Edwin C. (J)
 Fallain, Frank D. (A)
 Forbey, William D. (A)
 Lutes, Clifford (A)

Fordson

Knight, Donald M. (A)

Grand Rapids

Esveld, Clarence D. (A)
 Goebel, Eugene S. (A)
 Van Niman, Roy T. (A)

Grosse Pointe Park

Smith, Walter C. (A)

Harbor Springs

Wright, Wilford C. (J)

Highland Park

Gould, Howard S. (A)
 Glatzel, Earle D. (A)

Jackson

Atkins, Carl Edward (J)
 Bowmaster, J. M. (A)
 Brooks, Kenneth E. (A)
 Lee, Kenneth G. (A)
 Pacholke, Fred (A)
 Pickles, Arthur W. (A)
 Planck, R. M. (A)
 Rich, C. E. (A)
 Richmiller, Earl R. (A)
 Stahl, Theodore H. (A)
 Strait, Clarence L. (A)
 Troup, Everett O. (A)
 Volkenant, Gordon W. (A)
 Ward, Donald H. (A)
 Whitlock, Fred (A)
 Williams, Billy G. (A)

Lakeside

Meier, H. G. (A)

Lansing

Wells, Lawrence V. (A)
 Willis, Ellsworth D. (A)

Lapeer

Margraf, Frank J. (A)

Lennon

Reed, Stanley C. (A)

Menominee

Westervelt, H. P. (A)

Midland

Mathison, Gerald (A)

Muskegon

Beezer, Joseph E. (A)
 Hewitt, C. Tefft (A)
 Lowe, Carr E. (A)
 Owens, Robert F. (A)
 Schwarz, Harvey F. (A)
 Yoder, Raymond S. (A)

Osseo

Lapham, Olin J. (J)

Oxford

Beardsley, Franklin (A)
 Capron, E. S. (A)

Port Huron

Brown, Kenneth L. (A)

Rives Junction

Ostrander, R. M. (A)

Royal Oak

Miller, Robert L. (A)

Saginaw

Boyse, Robert E. (A)
 Sullivan, Robert J. (A)
 Trumble, L. A. (A)

Scottville

Krivitsky, George (A)

South Haven

Arthur, Ralph L. (A)
 Crossley, Alfred (M)
 Hansen, Leland S. (A)
 Jorgenson, Harold (A)

St. Clair Shores

Osborne, Robert L. (A)

Trenton

Williamson, Charles G. (A)

Wyandotte

Morris, Carleton D. (M)
 Steffin, V. J. (A)

Ypsilanti

Augustus, Lee M. (A)

MINNESOTA

Baudette

Gjelhaug, John A. (A)

Carver

Olson, Marvin S. (A)

Chisholm

Ambrozich, John L. (A)

Detroit Lakes

Hetland, L. C. (A)

Duluth

Cosandey, Charles J. (A)
 Ross, Russell H. (A)

Edgerton

Rust, Leslie W. (A)

Faribault

Carney, Philip G. (A)

Hopkins

Fuxa, Albert E. (A)

Kent

Olson, Martin N. (A)

Kenyon

Hjermstad, Hans U. (J)

Lakefield

Tkach, George (A)

MINNESOTA (Continued)

Minneapolis

Anderson, Chester H. (A)
Brooke, Robert O. (J)
Cottam, Dean F. (A)
Edwards, Henry W. (A)
Gould, Payson R. (J)
Hawley, Douglass (A)
Hawn, Robert C. (A)
Roth, Harold B. (A)
Schnell, Louis J. (A)
Smeby, Lynne C. (A)
Stevens, Carl T. (A)
Tynan, Thomas E. (A)
Young, Sumner B. (A)

Northfield

Culver, Charles A. (M)

Ponsford

Cox, Hector S. (J)

St. Paul

Cotton, Richard J. (A)
Hance, Kenneth M. (A)
Heiser, Edwin S. (A)
Janes, Clinton W. (A)
Mills, H. Lawrence (A)
Rankine, James C. (A)
Strout, Everett M. (A)

Virginia

Hauta, Theodore (A)

Waseca

Johnson, Edgar F. (A)

MISSISSIPPI

Corinth

Essary, William M. (A)

Greenwood

Johnson, Vivion A. (A)

Hattiesburg

Crews, J. H. (A)

Jackson

Myers, James A. (A)

Kosciusko

Sowell, George O. (A)

Meridian

Woodruff, B. H. (A)

Mississippi City

Pecoul, F. A. (A)

Vicksburg

George, Edward M. (A)

MISSOURI

Bucklin

Holmlund, A. Earle (A)

Cape Girardeau

Hirsch, Oscar C. (A)

Columbia

Lewis, Earl W. (A)

Hughesville

Rissler, Harold D. (A)

Independence

Church, Arthur B. (A)
Moler, A. R. (A)

Jefferson City

Corwin, Willis P. (A)
Sloan, Fergus M. (A)

Kansas City

Bielenberg, John F. G. (A)
Blum, Sidney J. (A)
Boat, John (A)
Bradbury, G. V. (A)

Clements, Thomas C. (A)
Cook, Ellis C. (A)
Davis, Dudley J. (A)
Fouts, Avery L. (A)
Goldenberg, Henry E. (A)
Gordon, Herbert C. (A)
Groendycke, Richard W. (A)
Hodge, Albert William (A)
Kent, James M. (A)
Kent, Paul N. (A)
McDonell, William J. (A)
MacDowell, Earl B. (A)
Obright, Alvin C. (A)
Pitt, William (A)
Rippeteau, Charles W. (A)
Schilling, John T. (A)
Schulze, Heri T. (A)
Smith, Percy De Willard (A)
Vasen, Gustave (A)
Williams, Palmer H. (A)
Yates, Clarence C. (A)
Young, William M. K. (A)

Kearney

Thomason, Marvin (A)

Mendota

Davis, Glen A. (A)

Nevada

Kluth, William J., Jr. (A)

Rolla

Frame, Floyd H. (A)
Martin, J. Douglas, Jr. (J)

Springfield

Hicks, Kenneth F. (A)
Moss, Terry L. (A)
Ward, G. Pearson (A)

St. Joseph

Abercrombie, Julius B. (A)
Bauer, Fritz (A)
Watts, Harold F. (A)

St. Louis

Althoff, Frederick E. (A)
Berest, Anton (A)
Browning, Roy H. (A)
Bush, Walter S. (A)
Cook, Jesse A. (A)
Croxtton, Galen B. (A)
Duffy, Charles A. (A)
Fenton, William C. (A)
Fillmore, Francis A. (J)
Fowler, D. W. (A)
Fritz, Harry R. (A)
Garvey, Arthur (A)
Humphreys, Irl W. (A)
Koehler, Elmer F. (A)
McDaniel, Otto S. (A)
Montgomery, Martell, (A)
Nugent, Thomas (A)
Pingree, Samuel J. (A)
Proehl, Robert O. (A)
Quinby, Porter H. (A)
Riddle, Ruston L. (A)
Ruddy, Ralph P. (A)
Schechter, Leo (J)
Suggs, Thomas B. (A)
Tevis, Graham L. (A)
Van Sickle, George W. (A)
West, William H. (A)
Wooley, W. C. (A)
Zehr, Nicholas J. (A)

University City

Glasgow, Roy S. (M)

Waldron

Barker, L. T. (A)

MONTANA

Anaconda

Horsfall, James R. (A)

Billings

Pelton, George A. (J)

Bozeman

Woodhouse, Geoffrey Arthur (A)

Butte

Crouter, Leslie E. (A)
Walker, Raymond E. (A)
Whidden, Ira P. (A)

Forsyth

Roberson, Carl (A)

Froid

Jacobs, Marcellus L. (A)

Havre

Peters, Vern (A)

NEBRASKA

Alliance

Cox, Ralph V. (A)

Aurora

Spencer, Albert H. (A)

Clay Center

Hertel, Roger H. (J)
Swanson, Carl R. (A)

Falls City

Chesley, Arthur D. (A)
Quigley, James H. (A)

Howells

Prucha, Ernest F. (A)

Lincoln

Brackett, Richard T. (A)
Jensen, John C. (M)
Koch, J. Wesley (J)
Norris, William C. (J)
Rohwer, Paul C. (A)

Norfolk

Leeman, Wilson (A)

Omaha

Badgerow, Bert E. (J)
Crawford, J. B. (A)
Diehl, Charles B. (A)
Eaton, Waldo W. (A)
Henry, Gordon I. (J)
Kotera, William J. (A)
McIntosh, Frank H. (A)
Phillips, Elmo W. (A)
Shirk, Kenneth C. (A)
Stratman, Fred W. (J)
Stultz, Earl D. (J)

Rising City

Schulke, Enno (A)

York

Meyer, Albert (A)

NEVADA

Elko

Michael, Charles (A)

Reno

Peters, Jay (A)
Sandorf, Irving J. (A)

NEW HAMPSHIRE

Claremont

Hodge, V. W. (A)

Gorham

Dodge, Joseph B. (A)

Keene

Rickey, Lawrence (A)

Manchester

Ryan, M. John (A)

Portsmouth

Martin, Julius (M)

Sunapee

Graves, William S. (A)

NEW JERSEY

Allenhurst

Lewis, Harold M. (M)

Ampere

Cassell, Joseph L. (A)
Hund, August (F)
Powers, Walter P. (M)

Asbury Park

Straussman, Arnold D. (A)

Atlantic City

Flett, William J. (A)
Riser, Morris (A)

Audubon

Fisher, Norman (A)

Bayonne

Dillenbeck, Preston van D. (A)

Belleville

Clegg, Edward B. (A)

Bergenfield

O'Connor, Mort F. (A)

Bloomfield

Born, W. Theodore (A)
Donovan, Daniel R. (A)
Hall, Norman C. (A)
Hanson, Ernest R. (A)
Henry, T. J. (A)
Hoffman, Henry J. (A)
Kannenstine, F. M. (A)
Mitchell, Clair D. (M)
Newell, Guy (A)
Otterbein, Milton Henry (J)
*eck, Gordon V. (A)
Taber, William T. (A)
Weaver, Karl S. (A)
Widell, E. Gideon (M)

Boonton

Albert, William H. (A)
Ballantine, Stuart (F)
Black, K. Charlton (M)
Cordell, Peter C. (A)
Drake, Frederick H. (M)
Ferris, Malcolm (M)
Haas, John G. (A)
Hughes, Everett J. (A)
Hull, L. M. (F)
Landon, Vernon D. (M)
Loughlin, William D. (M)
Morrison, John F. (A)
Noyes, Atherton, Jr. (A)
Pittenger, Arthur W. (A)
Seabury, Richard W. (M)
Snow, Harold A. (A)
Stone, G. Edgar (A)
Willemotte, R. M. (M)

Bound Brook

Hagmann, Nicklaus (A)
Lindstrom, Arthur J. (A)
Stair, Daniel N. (A)

Bridgeton

Nichols, H. L. (A)

Caldwell

Cole, Arthur B. (M)
Eberhard, Lawrence E. (A)
Hotopp, Alfred H. (M)

NEW JERSEY (Continued)

Camden

Ackerman, Milton J. (A)
Brown, Elmer L. (A)
Cooley, Elihu H. (A)
Darlington, Edgar T. (A)
Dickey, Edward T. (M)
Engel, Francis H. (M)
Galvin, Robert (A)
Geoghegan, Eamonn D. A. (A)
Gray, J. Calvin (A)
Hardin, L. L., Jr. (A)
Heiser, Albert E. (A)
Miller, Leonard H. (A)
Mkitarian, Luther M. (A)
Potts, John H. (A)
Roberts, Richard P. (A)
Satern, M. G. (A)
Spencer, George E. (A)
Sumner, Raymond Stokes (A)

Cedar Grove

Attmore, William B. (A)

Clayton

Purvis, Charles G. (A)

Clementon

Attmore, William B. (A)

Cliffwood

Crawford, Arthur B. (A)
Feldman, Carl B. (A)
Jansky, Karl G. (A)
Lowry, Lewis R. (A)
Mutch, W. W. (A)
Sharpless, William M. (A)

Clifton

Pearl, Eugene S. (M)
Watts, Ivor B. (J)

Clinton

Wagner, Harry S. (A)

Collingswood

Barton, Loy E. (M)
Jones, Newell R. (A)

Coytesville

McLaughlin, James L. (A)

Cranford

Briggs, Loyd A. (M)
Pulley, Lester A. (A)

Deal

Eberhardt, George M. (A)
Ferrell, Enoch B. (M)
Goodall, William M. (A)
Kerwien, Arthur E., Jr. (A)
Schlaack, Norman F. (A)
Schwartz, Lyle H. (A)
Shaw, Robert C. (A)
Sterba, E. J. (A)

Denville

Harlan, Edwin W. (A)

East Orange

Ackerman, Rudolph W. (M)
Akers, Dallas C. (A)
Beidleman, Howard B. (A)
Borgeson, Carl A. (A)
Brigham, Cecil E. (A)
Brigham, Cyril A. (A)
Butler, H. R. (A)
Clarry, Harold E. (A)
Crom, George C., Jr. (M)
Curtis, Austen M. (M)
Dannals, Earl W. (M)
Davis, Nathan A. (A)
Duncan, R. D., Jr. (M)
Edison, Theodore M. (A)
Gawler, Henry C. (M)

Gerns, William H. (M)
Harris, Sylvan (M)
Hiller, Harry E. (A)
Jackson, Donald S. (A)
Keary, Hugh F. (A)
Lederer, Ernest A. (M)
McClary, James P. (A)
Monfort, Ray A. (A)
Morrison, Howard (A)
O'Donohue, James P. (A)
Perry, Irving D. (A)
Pickard, Richard W. (A)
Roetken, A. A. (A)
Rudebeck, Everett L. (A)
Shackelford, Benjamin E. (M)
Somers, Richard M. (A)
Spencer Millard C. (A)
Stanwick, Charles A. (A)
Towner, Orrin W. (M)
Tucker, George B. (A)
Weston, John L. (A)
Woodworth, Fred B. (A)

Elizabeth

Brick, Frank R., Jr. (M)
Crowley, David A. (A)
Engel, Albert L. (J)
Horning, Louis P., Jr. (A)
Jatlow, J. L. (A)
Mazik, John, Jr. (A)
Morris, Robert M. (A)
Morrow, Granville P. (A)
Schiff, Frank (A)
Sery, Lester (A)
Tucker, John, Jr. (A)
Walsh, Lincoln (A)
White, Charles P. (A)

Englewood

Ashton, John E. (J)
Emanuel, John H. (A)
Gillett, Glenn D. (M)

Essex Fells

Bernhard, Frederick S. (A)

Fairview

Nickless, William H. (A)

Fanwood

Hall, Clifford A. (A)
Todd, Harold C. (A)

Fort Monmouth

Bender, Louis B. (M)
Black, Garland C. (A)
Conrad, Victor A. (A)
Hahn, Richard W. (A)
Hayden, Gilbert (A)
Kono, T. (M)
Lyman, Reginald P. (M)
Murphy, William H. (M)
Poteet, Daniel P. (A)

Franklin

Tillson, Benjamin F. (M)

Freeport

Englund, Carl R. (F)

Glen Ridge

Cunliffe, Paul R. (A)
Dart, Harry F. (M)
Umbach, Walter R. (A)

Glen Rock

Bailey, Ralph G. (A)
Clark, Louis E. (A)

Grantwood

Dana, David W. (A)
Herbst, John A. (A)

Great Notch

Warner, Herbert M. (A)

NEW JERSEY (Continued)

Hackensack

Slocum, K. W. (A)

Haddonfield

Barnes, John L. (A)
Dichl, William F. (M)
Elliott, H. F. (M)
Fithian, William S. (A)

Haddon Heights

Burrill, Charles M. (A)
Holmes, Ralph S. (A)
Pettengill, George W., Jr. (A)

Hasbrouck Heights

Baker, Neil D. (A)
Beach, Chester L. (A)
Roth, Jesse E. (A)
McLaughlin, James L. (A)

Hillside

McCauley, John H. (A)
Warren, Chester L. (A)

Hoboken

Gorton, Rolland E. (A)
Izzo, Anthony (A)
Paulling, Herbert L. (A)
Roters, Herbert C. (A)
Stempel, Waldemar M. (A)

Irvington

Bazley, Paul B. (A)
Coman, George E. (A)
Fread, Harold (A)
Hart, James J. (A)
Momon, Ernest J. (A)
Mortimer, Harry H. (A)

Jersey City

Bremer, Frank V. (A)
Bremer, Harry A. (A)
Costello, John J. (A)
DeAmicis, D. Sicari (A)
Drews, Ernest (A)
Goodwin, Robert F. (A)
Hanks, Alfred J. (A)
Holmes, George R. (A)
Murray, Albert F. (M)
Odenbach, J. F. (A)
Oliver, George E. (M)
Palmer, C. Walter (A)
Scarr, Henry F. (A)
Sullivan, Edward S. (A)
Walker, C. Robert (A)
Weber, Walter (A)

Kearny

Knowlton, John J. (A)

Lakehurst

Coulter, Howard N. (M)

Lawrenceville

Ernst, Murray C. (A)
Gilman, George W. (A)
Wright, Oliver (A)

Leonia

Erickson, Herman E. (A)
Mustermann, H. G. A. (A)
Replogle, Delbert E. (M)

Linden

Holetz, Alexander C. (A)

Little Falls

Farnsworth, Daniel W. (A)

Little Silver

Ohl, Russell S. (M)

Long Branch

Cohn, Ralph I. (A)
Herson, Jacob S. (A)
Reinhart, Sidney M. (A)
Watson, Paul E. (A)

Lyndhurst

Kannenberg, Walter F. (A)
MacDowell, Theron W. (A)

Madison

De Coutouly, Gustave C. (A)
Manning, Charles T. (M)
Phelps, Walter A. (A)

Maplewood

Barkley, William J. (M)
Boerner, Thomas J. (A)
Bohn, William C. (A)
Cunningham, Frederick W. (M)
Darrow, Leo H. (A)
Pidgeon, Howard A. (M)
Strassner, Frank J. (A)
Trogner, Arthur M. (M)
Rowe, Charles R. (M)
Stinchfield, J. M. (A)

Maywood

Kersta, Laurence G. (A)
Stanley, J. J. (M)

McKee City

Read, George T. (A)

Merchantville

Closson, Luke E. (A)
Hopkins, A. R. (A)
Patterson, Edward B. (A)
Pischzan, Hans E. (A)
Whitehead, Jesse C. (A)

Metuchen

Bohlke, W. Hollander (A)

Milburn

Cassedy, William F. (A)
Schauler, Vincent A. (A)

Montclair

Charlton, Paul W. (A)
De Long, Oscar A., Jr. (A)
Hervey, John P. (A)
Huffman, Charles E. (A)
Krahl, Walter L. (M)

Moorestown

Shumard, Charles C. (M)

Morristown

Poole, Robert J. (A)

Mountain Lakes

Asserson, Raymond (M)
Flannagan, Coke (M)

Neptune

Schafer, J. Peter (A)

Netcong

Giovanini, Frank (A)

Newark

Amick, William M. (A)
Barnes, T. Dana (A)
Barone, Salvatore A. (A)
Bennett, Robert W., Jr. (A)
Bliziotis, George E. (M)
Brach, Leon S. (M)
Canfield, Wilson R. (A)
Carle, Nathaniel A. (A)
Clement, Lewis M. (F)
Dauber, Arthur O. F. (A)
Dolesh, Frank J. (A)
Drury, Paul O. (A)
Feindel, Abbott (A)
Gardner, Francis S. (A)
Glauber, John J. (A)
Goodwin, W. Nelson, Jr. (M)
Gordon, Malcolm K., Jr. (A)
Hardwick, Ambrose H. (A)
Hooven, Morris D. (A)
Horle, Lawrence C. F. (F)

NEW JERSEY (Continued)

Newark (Continued)

Kahn, Frederick J. (M)
 Lewis, George H. (M)
 Marzulli, Angelo N. (A)
 McCrea, M. Walter (A)
 Meacham, J. F. B. (A)
 Miles, William E. (A)
 O'Dowd, Thomas E. (A)
 Oman, Niles Johann (A)
 Peterson, Cornelius (A)
 Reiner, Leonard (A)
 Rodriguez, Alexander E. (A)
 Schermerhorn, J. L. (A)
 Schiftenhaus, Daniel H. (A)
 Schmidt, Joseph H. (A)
 Scott, Walter F. (A)
 Sels, Hollis K. (A)
 Simpson, Fred H., Jr. (J)
 Sternberg, F. B. (A)
 Valentine, Russell D. (A)

New Brunswick

Lucas, Earle F. (A)
 Rohman, Victor A. (A)
 Ruckle, Ernest G. (A)
 Shore, Henry (A)
 Ward, Donald G. (A)

Newton

Landone, Brown (A)

North Arlington

Collins, John (A)

North Bergen

Girard, Edward J. (A)
 Perryman, G. H. (A)
 Wichern, Leonard (A)

North Merchantville

Frenz, Harry J. (A)

North Plainfield

Cumming, Kenneth N. (M)
 Sommer, Emitt H. (A)

Nutley

Humphrey, Hartley C. (A)
 Saunders, Alfred W. (A)

Oradell

Brackett, Harold H. (A)
 De Lime, Thomas L., Jr. (A)

Orange

Corbin, Francis L. (A)
 Harris, Gwin C. (A)
 Herdman, Raymond C. (A)
 Kynor, Merrill W. (A)
 Miller, Walter H. (A)
 Powell, Ralph C., Jr. (A)
 Rypinski, Maurice C. (M)

Palisade

Jones, Dramin D. (A)

Passaic

Berger, Henry C. (A)
 Eklund, Gus (A)
 Himoe, Clifford E. (A)
 Littman, Leon L. (A)
 Manke, Arthur G. (A)
 Rodgers, George H. (A)
 Weinberg, Isaac (A)

Paterson

Coddington, Raymond L. (A)
 Gold, Herman (A)
 Hogencamp, Harold C. (A)
 Trifari, Edmund (A)
 Whittaker, Edmund (A)

Pitman

Boise, Everett B. (A)

Plainfield

Nielsen, H. V. (A)
 Oscanyan, Paul C., Jr. (A)

Princeton

Roberts, Walter Van B. (F)
 Ware, Paul (A)

Rahway

Gibson, Robert D. (A)

Ramsey

Secor, Harry W. (A)

Red Bank

Bruce, Edmond (M)

Ridgefield Park

Smith, Arthur E. (A)

Ridgewood

Affel, Herman A. (A)
 Bondy, Hugo Alois, Jr. (A)
 Engel, G. C. (A)
 Felix, Edgar (M)
 Smith, Theodore A. (A)

Riverton

Ehle, Francis R. (M)
 Jones, H. Rossiter (A)

Roseland

Arnold, Lowell George (A)

Roselle

Bosler, Gustave A. (A)
 Guber, Fred H. (A)
 McConnell, W. G. (A)

Roselle Park

McNicol, Donald (F)

Rumson

Friis, H. T. (F)

Rutherford

Gage, David H. (M)
 Hild, George E. (A)
 Jackson, Benjamin B. (A)
 Sargeant, Charles E. (A)
 Wattson, Harry B. (A)

South Orange

Field, W. Thayer (A)
 Hartley, Ralph V. L. (F)
 Johnson, Kenneth S. (M)
 Lee, Henry L. (M)
 Schuetz, Robert F. (A)
 Walsh, Arthur L. (A)
 Rodman, I. P. (M)

Stanhope

Gray, DeWayne R. (J)
 Moorhead, George H. (A)
 Peterson, Arthur C., Jr. (A)

Summit

Biele, Charles E. (A)
 Fairchild, F. Earl (A)
 Snook, H. Clyde (M)

Trenton

Burrroughs, Irving D. (A)
 Kale, Samuel S. (A)
 Knowles, Edward P., Jr. (A)
 Raser, Edward G. (A)
 Wentzel, Amandus G., Jr. (A)

Tuckerton

Baldwin, Preston de Grauw (A)

Union

Edwards, Joseph B. (A)

Union City

Erhard, John A. (A)
 Masalkovics, J. A. (A)

Upper Montclair

Glenn, Earl R. (A)
 Godley, Paul F. (A)

NEW JERSEY (Continued)

Upper Montclair (Continued)

Hallborg, H. E. (F)
 Versiell, Emery L. (A)

Verona

Holborn, Frederick A. (M)

Weehawken

Gruenberg, Edwin L. (A)

West Caldwell

Willis, Frederick C. (A)

West Collingswood

Pettit, Albert R. (A)
 Wunderlich, Norman E. (M)

Westfield

Baukat, Henry W. (M)
 Phillips, Leo E. (A)

West Long Branch

Burrows, Charles R. (A)

Westmont

James, Wallace McNeal (A)

West Orange

Kober, Paul A. (A)
 Osgood, Victor L. (A)
 Tucker, Murray E. (A)

West New York

Machiorletti, Louis (A)
 Schoenfeld, K. (A)

Whippany

Doherty, William H. (A)
 Mellor, William N. (A)

Woodcliff

Seid, Fred C. (A)

Wyckoff

Frey, Robert H. (A)

NEW MEXICO

Albuquerque

Hardy, William H. (A)
 Stone, C. D. (A)

Raton

Abshere, Lilburn O. (A)

State College

Goddard, Ralph W. (M)

NEW YORK

Albany

Corey, James H. (A)
 Kaiser, Fred J. (A)
 Mezger, George (A)
 Peck, Emerson P. (A)
 Pozelsky, Leonard (A)
 Schultz, Arthur (A)
 Skinkle, Myron H., Jr. (A)
 Thomas, Joseph D. (A)

Amityville, L.I.

Melhuish, Harold T. (M)

Angola

Clark, Charles W. (A)

Astoria, L.I.

Anderson, J. E. (A)
 Berkley, Fred (A)
 Dewhurst, Thornton P. (A)
 Geise, Harold (A)
 Greene, George J. (A)
 Greene, Harry A. (A)
 Gritzner, Fred A. (A)
 Gunther, Frank A. (A)
 Kunicky, Barney F. (A)
 Leslie, Frank (A)
 Loscalzo, Peter A. (A)
 Martin, Louis (A)
 Nagy, A. Wheeler (A)

Schramm, William (A)
 Zatorsky, E. F. (A)

Auburn

Lumb, Frank J. (A)

Babylon, L.I.

Smith, J. O. (M)
 Thompson, Edward Philip (A)

Baldwin, L.I.

Schlenker, Vesper A. (A)

Bath

Loveless, Lawrence M. (A)

Bayside, L.I.

Babcock, Wallace C. (A)
 Lorch, Albert (A)
 Troxler, Lucien J., Jr. (A)

Bellaire, L.I.

Brennan, John B., Jr. (A)

Bellerose, L.I.

Speicher, John D. (A)

Bellmore, L.I.

Wright, Marshall C. (A)

Binghamton

Adams, William E. (A)
 Hall, Victor E. (A)

Brightwaters, L.I.

Camp, V. F. (A)
 Knight, Harold E. H. (A)

Bronxville

Weeden, William N. (A)

Brooklyn

Abraham, Irving (A)
 Adachi, William Y. (A)
 Alexander, Louis (A)
 Aymar, Erwin (A)
 Bartal, Otto (A)
 Bartnosky, Harry (A)
 Baum, Sydney H. (A)
 Baunach, Edward L. (A)
 Belock, Harry D. (A)
 Bernard, Herman (A)
 Berner, Aaron (A)
 Betts, Frederick H. (A)
 Bower, James (A)
 Brady, Leslie R. (A)
 Brandt, Kristian (A)
 Brimberg, Isaac (A)
 Bristow, Frederick R. (A)
 Browne, Walram S. (A)
 Bryan, Herman W. (A)
 Bullock, Walter H. (A)
 Burdick, Adelbert B. (A)
 Burns, George D. (A)
 Callahan, John L. (A)
 Calligheris, John S. (A)
 Canavaciol, Frank E. (M)
 Carroll, James H. (A)
 Castor, Amasea H. (A)
 Charlat, Arnold (J)
 Coe, Alfred (A)
 Cohen, Samuel (M)
 Cole, Fred S. (A)
 Consoli, Vincent (A)
 Cook, Arthur L. (A)
 Crowell, Claude S. (A)
 Dean, Leon W. (A)
 De Mann, William (J)
 Dissar, William G. (J)
 Dlugatch, Irwin (J)
 Dobler, William (A)
 Dolid, Abraham (A)
 Dreyer, Harry W. (M)
 Dummett, H. W. (A)
 Dunn, Lawrence J. (M)

NEW YORK (Continued)

Brooklyn (Continued)

Edgar, J. Clifton (A)
 Ellingham, Irving (A)
 Evans, Porter H. (M)
 Feldstein, M. A. (A)
 Ferrotta, Joseph L. (A)
 Fishberg, Sidney (A)
 Flomenbaum, Hyman (J)
 Fogel, Mortimer H. (J)
 Francione, Dominick A., Jr. (A)
 Fultz, Miles E. (A)
 Gabel, Morris (J)
 Galea, Vincent (A)
 Garity, William E. (M)
 Geloso, John (A)
 Gerel, Alexander (A)
 Gillule, William J. (A)
 Glaser, Marcus (A)
 Glasscock, Glen R. (A)
 Goddard, Frederick M. (A)
 Goldberg, Emanuel (A)
 Grainger, Maurice J. (A)
 Gruetzke, Charles P. E., Jr. (A)
 Hadden, Weston (A)
 Hajim, Jack (A)
 Hakam, Samuel (A)
 Halligan, Clair W. (A)
 Hammer, Robert H. (A)
 Harris, Leonard F. (A)
 Hausmann, Erich (M)
 Herman, Joseph M. (A)
 Hesse, Henry R. (A)
 Hewlett, Oscar H., Jr. (A)
 Heymann, Joseph (A)
 Hines, Joseph (A)
 Holland, Jesse W. (A)
 Hughes, William P., Jr. (A)
 Hurwitz, Solomon Bernard (A)
 Inskip, Leonard S. (A)
 Isaacson, Herbert M. (A)
 Johnson, R. Stanley (A)
 Katzin, Martin (A)
 Kayser, Herbert (A)
 Kennedy, Harold E. (A)
 Kirdahy, Emil (A)
 Krivan, Fred A. (A)
 Lazarus, Benjamin N. (A)
 Leferts, B. (A)
 Le Quesne, Charles A. (A)
 Leuteritz, Hugo C. (A)
 Levine, Harry (A)
 Le Viness, John E. (A)
 Lewis, Robert V. W. (A)
 Liberman, Henry C. (A)
 Liebner, Barney (J)
 Lussier, Elphege Achille (A)
 MacCoun, Townsend D. (A)
 Mahoney, Joseph N. (M)
 Marra, Anthony (A)
 Marriott, Robert H. (F)
 Marsten, Jesse (M)
 Mauran, John (A)
 McGonigle, William J. (J)
 Milano, Clarence (A)
 Miller, Le Roy J. (A)
 Moore, Henry H. (A)
 Morehouse, Raymond L. (A)
 Mullane, J. W. (A)
 Nachemson, Paul R. (A)
 Ostrove, William (A)
 Painting, John A. (A)
 Parker, Oliver B. (A)
 Pearson, Herbert B. (A)
 Peck, William (A)
 Perrin, Arthur G. (A)
 Perry, Harold D. (A)

Potter, Max (A)
 Pownall, Roger F. (A)
 Redfern, Forest F. (A)
 Reesor, Delbert A. (A)
 Rehbein, Arthur Frederick (A)
 Reimer, August Charles (A)
 Renke, Adolph (A)
 Riccobono, Sebastian (A)
 Ringel, Abraham (M)
 Rippere, R. Oliver (J)
 Romeo, Anthony (A)
 Rosenbaum, Jacob (J)
 Rosin, Arthur (A)
 Ross, Uda B. (M)
 Salzman, David (A)
 Sass, Isidore (A)
 Schenke, Kurtiss P. (A)
 Schich, William H. (A)
 Secan, Harry (A)
 Seidman, Charles (A)
 Seligsohn, Max (A)
 Shaffer, Irving R. (A)
 Shestacovsky, John (A)
 Shortland, James W. (A)
 Siegel, Ralph (A)
 Siegel, Samuel (M)
 Silver, Benjamin L. (A)
 Sinsheimer, Arthur (A)
 Skinker, Murray F. (A)
 Slater, Saul I. (A)
 Smith, Franklin S. (A)
 Starr, Alfred R. (A)
 Steinberger, Louis (M)
 Stobbe, John A. (A)
 Stromeyer, Charles F. (A)
 Talley, David (A)
 Thomas, Edward H. (A)
 Thomas, Howard H. (A)
 Thomas, Roy Verner (A)
 Torrell, Roy (A)
 Trott, Barnet (A)
 Tuckerman, Lucien P. (A)
 Uzman, George J. (M)
 Vogel, Erwin William (A)
 Wardwell, Arthur S. (A)
 Weber, Paul (A)
 Weinberg, Sidney (J)
 Welker, Paul L. (A)
 White, Milton (A)
 Widmann, Erwin (A)
 Winchell, Walter H. (A)
 Wing, Arthur K., Jr. (J)
 Wood, Wilbert C. (A)

Buffalo

Banditson, Harry (A)
 Barker, Howard T. (A)
 Benin, Zolmon (A)
 Bergmann, Howard J. (J)
 Beyer, Glen R. (A)
 Brown, Stanley W. (A)
 Carlson, Einar C. (A)
 Chamberlain, Adolph B. (A)
 Donlon, Bernard J. (A)
 Dunning, Orville M. (A)
 Eichman, John, Jr. (A)
 Felmet, Albert (A)
 Fox, John (A)
 Fox, Reginald A. (A)
 Freedman, Sam (J)
 Hector, L. Grant (A)
 Hemedinger, Willard (A)
 Hobbs, Frank B. (A)
 Huntsinger, F. J. (A)
 Johnson, James A. (A)
 Karslake, James S. (A)
 Knowlton, Eugene W. (A)
 Lewis, John C. P. (A)
 Lounsbury, Isaac R., Jr. (M)
 March, Philip S. (A)

NEW YORK (Continued)

Buffalo (Continued)

Miller, George H. (A)
 Miller, John G. C. (A)
 Moore, Charles G. (A)
 Mullett, Charles B. (A)
 Nichols, Raymond De H. (A)
 Noel, Lionel S. (A)
 Nowak, Victor V. (A)
 Patey, Harold W. (A)
 Pilegor, Carroll M. (A)
 Pickett, Glenn H. (A)
 Racke, Clarence (A)
 Root, Harry (A)
 Schelling, Robert F. (A)
 Simpson, Burton T. (A)
 Smith, Stanley C. (A)
 Telaar, Theodore J. (A)
 Vanacore, Thomas (A)
 Wagoner, W. Hall (A)
 Waud, Eugene C. (A)
 Weiss, Earl (J)

Canandaigua

Thompson, John M. (A)
 Waldorf, E. T. (A)

Candor

Williams, Warren R. (A)

Canton

Priest, Ward C. (A)

Carmel

Light, Frank B. (A)

Central Valley

Raynolds, Edward F. (A)

Corning

Gage, Henry Phelps (A)

Corona, L.I.

Solari, Frank (A)

Cortland

Greenman, Roger B. (A)

Croton-on-Hudson

Lescarboura, Austin C. (M)
 Osborn, William R. (A)

Douglas Manor, L.I.

Weagant, Roy A. (F)

Dover Plains

Pleasanton, Archie W. (A)

Easthampton, L.I.

Lee, Walter O. (A)

East Rockaway, L.I.

Carter, Frank L. (A)
 Van Duyne, Eugene D. (A)

Ellenville

Saylor, W. Edwin (A)

Elmhurst, L.I.

Banks, Adrian C. (A)
 Eckweiler, Warren M., Jr. (A)
 Freeman, Edward E. (M)
 Haines, Howard J. (A)
 Lundie, Ernest S. (J)
 Roos, Oscar C. (F)

Elmira

Dow, M. Thornton (A)
 Downing, Richard E. (A)
 Taylor, Dale L. (A)

Far Rockaway, L.I.

Sharp, Watkin W. (A)

Floral Park, L.I.

Densham, Robert S. (A)

Flushing, L.I.

Baker, Brothwell H. (A)
 Bouck, Zeh (M)
 Carter, E. Finley (A)

Cook, Ellsworth D. (A)
 Dreisbach, Robert H. (A)
 Harvey, Clyde C. (A)
 Matthews, A. C., Jr. (A)
 Sage, Frederic H. (A)
 Scofield, Robert W. (A)

Forest Hills, L.I.

Bonanno, Joseph L. (A)
 Goodwin, W. Carlyle (A)
 Waring, Alfred (A)

Freeport, L.I.

O'Neill, John J. (A)

Garden City, L.I.

Henney, Julian K. (M)
 Howe, Willard C. (A)
 Wing, Willis K. (M)

Geneva

Biles, Frank V. (A)

Gerry

Starr, Troy S. (A)

Glen Cove, L.I.

Coles, Robert R. (J)

Great Neck, L.I.

Gemmer, Gordon W., Jr. (A)
 Rigney, Douglas (M)

Greenport

Larsen, Carl L. (A)

Hamburg

Hartloff, Gordon S. (A)

Hamilton

Goode, Kenneth H. (A)

Hastings-on-Hudson

Baker, Judd O. (A)

Hempstead, L.I.

Crane, Edwin S. (A)

Hempstead Gardens, L.I.

Clayton, John M. (M)

Hicksville

Schlitz, Karl W. (A)

Holts, L.I.

Batcher, Ralph R. (M)
 Caputo, Nicholas J. (A)
 Ehlert, Fred C. (A)
 Ma Dan, Edwin M. (M)
 Srebroff, Charles M. (M)
 Stroock, Reeve O. (A)

Huntington, L.I.

Flathman, Edward (J)
 Flessel, Frank B., Jr. (J)

Hurley

Warren, William A. (A)

Ithaca

Ballard, William C. (M)
 Dye, Leaman A. (A)
 Merritt, Ernest (M)
 Meserve, Wilbur E. (A)
 Sohon, Harry (A)
 Verman, Lal C. (A)
 Webb, J. S. (A)

Jackson Heights, L.I.

Atwood, Warren S. (A)
 Fredendall, Beverly (A)
 Hickman, C. Nichols (A)
 Mac Ilvain, Karl M. (A)
 Meserve, G. Donald (A)
 Stotler, Albert (A)
 Wheeler, Harold A. (M)

Jamaica, L.I.

Phelps, Boyd (A)
 Pleasanton, Douglas W. (J)
 Schwartz, Nathan (A)

NEW YORK (Continued)

Jamaica, L.I. (Continued)
 Steinberger, Arthur W. (A)
 Sterns, Morton W. (M)
 Styles, Thomas J. (A)
 Yenoli, Dominick J. (A)

Jamesport
 Colvin, R. S. (A)
 Seaman, Gerald C. (A)

Jamestown
 Beaumont, William Frederick (A)

Kenmore, L.I.
 Patterson, Curtis B. (J)
 Wullenweber, Milton O. (A)

Kew Gardens, L.I.
 Goldsmith, Lloyd T. (A)
 Montgomery, A. Peers (A)

Larchmont
 Nilson, Arthur R. (M)

Liberty
 Mauer, William V. (A)

Little Neck, L.I.
 Di Blasi, John (M)
 Schultes, Martin F. (A)

Lockport
 Connette, T. W. (A)

Long Island City, L.I.
 Asch, Marcus (A)
 Farrand, C. L. (M)
 Field, John (A)
 Gilcher, V. J. (A)
 Hanson, Oscar B. (M)
 Harrison, Perry (A)
 Holzinger, Theodore E. (A)
 Ractliffe, Charles Lionel (A)
 Schmidt, Erwin (A)
 Tuttle, C. W. (A)
 Underhill, Charles R. (A)

Lynbrook, L.I.
 Fedotoff, Nicholas V. (A)
 Shaw, James (J)
 Williams, John C. (A)

Malverne, L.I.
 Aubry, Pierce J. (A)

Manhasset, L.I.
 Young, Harold H. (A)

Mamaroneck
 Jarabin, Frank G. (A)

Middletown
 Callender, Edwin R. (A)
 Dempsey, William E. (A)
 Fish, Edward H. (A)
 Shen, Pinlu (A)

Milton-on-Hudson
 Taber, C. Kenneth (A)

Mt. Vernon
 Decker, Donald Philips (A)
 Houck, Harry W. (M)
 Macalpinc, William W. (A)
 Muhleman, Maurice L. (A)
 Stone, Clarence G., Jr. (A)
 Velasco, Jose M. (A)

New Brighton, S.I.
 Macken, H. I. (A)

New City
 Doellner, Le Roy J. (A)

New Rochelle
 Annucci, Louis M. (A)

New York
 Adams, Ira J. (M)
 Adams, Quinton (M)
 Aiken, Charles B. P. (A)

Aikens, Andrew J. (A)
 Alderman, Lawrence T. (A)
 Allyn, R. S. (A)
 Almquist, Milton L. (A)
 Alverson, George S. (A)
 Amy, Ernest V. (M)
 Anderson, Clifford N. (A)
 Anderson, Edwin C. (A)
 Anderson, Pierson A. (M)
 Anderson, Sidney E. (A)
 Andrews, Joseph F. (M)
 Appel, Henry W. (A)
 Armstrong, Edwin H. (F)
 Arnold, John W. (A)
 Arps, Mervin W. (M)
 Ashbaugh, Edwin C. (A)
 Aster, Alvin K. (A)
 Atkin, Robert (A)
 Aull, Wilson, Jr. (M)
 Bailey, Arnold B. (A)
 Bailey, Austin (M)
 Bair, Ralph S. (A)
 Barnes, James C. (A)
 Barnueba, Richard (A)
 Batcheller, Arthur (M)
 Batsel, Max C. (F)
 Bauer, Brunton (A)
 Baxter, Charles E. (A)
 Bayles, Joseph (A)
 Beatty, W. E. (A)
 Beltz, Willis H. (A)
 Bemis, Edwin W. (A)
 Bender, Martin, Jr. (A)
 Berry, James L. (A)
 Beshgetoor, Ray V. (A)
 Betts, Philander H. (A)
 Beverage, Harold H. (F)
 Binns, John R. (A)
 Black, Oliver M. (A)
 Blackmar, Abel E., Jr. (A)
 Blackwell, George C. (A)
 Blackwell, Otto B. (F)
 Blan, Michael (A)
 Blenheim, William J. (M)
 Bloomenthal, Sidney (A)
 Boehme, H. O. (M)
 Boesche, F. W. (A)
 Bond, Elmer Frederick (A)
 Bonell, Ralph K. (A)
 Bonett, David J. (A)
 Borislavsky, Michael A. (A)
 Bostad, John (A)
 Bown, Ralph (F)
 Braden, Rene A. (A)
 Brennecke, Cornelius (A)
 Brown, Charles J. (A)
 Brown, D. S. (A)
 Brown, William A. R. (A)
 Bruggeman, John T. (J)
 Brunet, Meade (M)
 Bucher, E. E. (F)
 Buckler, John J. (A)
 Buckley, Beyton E. (A)
 Bullard, William R. (A)
 Burghard, G. E. (M)
 Busch, Gus A. (A)
 Butler, E. W. (M)
 Butterfield, Charles E. (M)
 Buttner, Harold H. (M)
 Cahill, William J. (A)
 Cain, Robert E. (A)
 Caldwell, O. H. (M)
 Campbell, John A. (A)
 Carboni, Anthony (A)
 Carduner, William (A)
 Carleton, Thomas F. (J)
 Carlton, Roger C. (A)

NEW YORK (Continued)

New York (Continued)
 Carroll, Michael J. (A)
 Carson, John R. (M)
 Cass, Lewis S. (A)
 Chaffee, Joseph G. (A)
 Chernow, Morris (A)
 Chu, Quong Y. (J)
 Cilin, Louis (A)
 Clark, Baynard H. (A)
 Clausen, H. P. (A)
 Cochran, Eugene C. (A)
 Cockatlay, Laurence M. (A)
 Coggshall, Ivan S. (M)
 Colpitts, Edwin H. (F)
 Cooper, C. B. (A)
 Cornwall, Lionel B. (A)
 Corwin, Charles I. (A)
 Cousins, Van Meter (A)
 Craft, E. B. (F)
 Credner, Louis L. (A)
 Crite, Mitchel (A)
 Crosby, George L. (M)
 Cunningham, H. C. (A)
 Currier, Guy, Jr. (A)
 Curry, Walter A. (A)
 Cutting, Fulton (F)
 Dagg, T. Ralph (A)
 Danz, Herman (A)
 Danziger, Harold I. (M)
 Davis, Robert J. (A)
 Deakin, Gerald (A)
 Dean, C. E. (A)
 Dean, Samuel W. (M)
 Decino, Alfred (A)
 De Forest, M. J. (A)
 Dehmel, Richard C. (A)
 Della Corte, J. P. (A)
 Demarest, Charles S. (M)
 Desnoes, Arnold B. (A)
 De Sousa, George S. (M)
 Diaz, Ernesto (A)
 Dietrich, Frederick (A)
 Dietze, Eginhard (A)
 Di Giacomo, Aniello (A)
 Dingley, Edward N., Jr. (A)
 Doubles, David J. (A)
 Dreher, Carl (F)
 Drew, Charles E. (M)
 Drisko, Benjamin B. (A)
 Dubilier, William (F)
 Duncan, Rudolph L. (M)
 Dunham, John S. (A)
 Dunlap, Orrin E., Jr. (M)
 Dunn, Gano (F)
 Dunning, John R. (A)
 Easton, J. H. (A)
 Eldredge, Frank E. (M)
 Eller, Keith B. (A)
 Emerson, Charles W., Jr. (A)
 Espenschied, Lloyd (F)
 Everett, Lynn C. (M)
 Facey, John W. (A)
 Fairburn, A. J. B. (A)
 Farnsworth, Philip (F)
 Farrington, John F. (M)
 Fay, Clifford E. (A)
 Fearing, Justin L. (A)
 Felthousen, A. (A)
 Fernald, Paul R. (A)
 Fernando, K. A. (A)
 Fielding, Charles F. (M)
 Fielding, Edward J. (A)
 Fillmore, Harry P. (A)
 Finch, William G. H. (M)
 Finlay, Robert C. S. (A)
 Fischer, Herbert B. (A)

Fischer, Leonard O. (A)
 Fish, Arthur S. (M)
 Fisher, Joseph J. (A)
 Flythe, Thomas Y. (J)
 Frank, James, Jr. (A)
 Frank, K. G. (M)
 Franklin, L. W. (A)
 Frederick, Halsey A. (M)
 Freed, Joseph D. R. (F)
 Freericks, Lambert (A)
 Frimmerman, Frank (A)
 Furia, John J. (A)
 Furness, George C. (M)
 Gabriellini, William (A)
 Gati, Bela (A)
 Giese, Raymond C. (A)
 Gihring, Herman E. (A)
 Gilbert, John J. (A)
 Goldman, Arthur Z. (A)
 Goldsmith, Alfred N. (F)
 Gould, Leslie A. (A)
 Goulden, Stanley W. (M)
 Graham, Frank H. (A)
 Graham, William A. (M)
 Graveson, George L. (A)
 Green, Ashbel (A)
 Green, Estill I. (A)
 Greene, Paul A. (M)
 Greenstein, Philip (A)
 Greiff, Victor (M)
 Greig, John (A)
 Griffiths, Clarence M. (A)
 Grinan, John F. (M)
 Guild, Baldwin (M)
 Gutoff, Boris (A)
 Guy, Raymond F. (A)
 Hance, P. D., Jr. (A)
 Hanley, John F. (A)
 Harley, John B. (A)
 Harnett, Daniel E. (A)
 Hartman, Charles D. (A)
 Hastings, Gerald M. (A)
 Hauck, Vernon D. (A)
 Hauffe, Otto (A)
 Haug, Joseph (A)
 Haynes, A. J. (A)
 Heberlein, Arthur (A)
 Hedges, Ellsworth J. (A)
 Heindel, Harold J. (A)
 Heising, Raymond A. (F)
 Hemberger, E. F., Jr. (A)
 Henderson, Ken L. (A)
 Henline, Henry H. (M)
 Herber, John C. (A)
 Herbert, Harold R. (M)
 Hertzberg, Robert (A)
 Heuschkel, Paul J. (A)
 Hiller, Nicolai H., Jr. (A)
 Hineine, Harris D. (M)
 Hirsch, Harry (A)
 Hoernel, Paul C. (A)
 Hogan, John V. L. (F)
 Hogg, William S., Jr. (M)
 Hohenstein, Jac. (A)
 Holcombe, Henry W. (M)
 Holden, C. F. (M)
 Holloway, Jack (A)
 Holm, Henry R. (J)
 Honaman, R. Karl (A)
 Hoopes, Thomas T. (A)
 Horn, Charles W. (M)
 Hornung, Julius L. (A)
 Horowitz, Saul (A)
 Hough, Clinton Wallace (A)
 Hovgaard, Ole M. (M)
 Howard, Edward J. (A)
 Howell, Clifford Alexander (A)

NEW YORK (Continued)

New York (Continued)

Howell, Walter J. (M)
 Hubbard, Frank A. (A)
 Hudack, John Martin (A)
 Hulan, A. G. (A)
 Hunkins, Harold R. (A)
 Hurlbut, Ronald (A)
 Hutchison, Miller (M)
 Isele, Harold Adolph (A)
 Israel, John O. (A)
 Jacobs, Louis (A)
 Jamross, Rudolph (A)
 Janke, Alfred H. (M)
 Jensen, A. G. (M)
 Jensen, George L. (A)
 Jewett, F. B. (F)
 Johnson, C. M. (M)
 Johnson, Reverdy (A)
 Johnson, William J. (A)
 Johnston, John P. (M)
 Jones, Lester L. (F)
 Kahant, Charles G. (A)
 Kahn, Morton B. (A)
 Kaplan, Benjamin G. (A)
 Keefe, Oscar A. (A)
 Keim, Llewellyn B. (A)
 Kelley, Leo A. (A)
 Kelly, Mervin J. (M)
 Kendall, John A. (A)
 Kennedy, T. R., Jr. (A)
 Kennedy, William A. (J)
 Kilbourne, Covington G. (A)
 Kilmer, T. W., Jr. (A)
 King, Frank (A)
 Kishpaugh, Arthur W. (A)
 Kitchin, H. W. (M)
 Kleist, Alfred H. (A)
 Klesse, William (A)
 Klosner, Morris (A)
 Knaack, Frank E. (A)
 Knapp, Joseph F. (A)
 Knight, J. B., Jr. (A)
 Knight, Octavius (A)
 Knights, Alexander H. (A)
 Knopp, Ernest (A)
 Koerner, Allan M. (A)
 Koerner, Lawrence F. (A)
 Kreuzer, Barton (A)
 Kroger, F. H. (F)
 Kuhn, Alfred S. (A)
 Kunc, Frank (A)
 Kurtinaitis, John V. (A)
 Lack, Frederick R. (A)
 Lakatos, Emory (A)
 Lane, Frederic A. (A)
 Latimer, Chester W. (F)
 Lawrence, Walter L. (A)
 Layng, Grant (A)
 Lazarovich-Hrebelianovich, D. (A)
 Leach, Harvey B. (A)
 Lee, Emery H. I. (M)
 Lee, Fat Chang (A)
 Leibe, Frank A. (A)
 Leins, Ernest P., Jr. (J)
 Lemmon, Walter S. (A)
 Lenz, Charles S. (A)
 Levy, A. Kingdon (A)
 Levy, Lester (A)
 Levy, Mortimer N. (A)
 Lewis, Elmer H. (A)
 Lindmark, Elmer S. (A)
 Llewellyn, Frederick B. (A)
 Loftin, Edward H. (M)
 Logan, Mason A. (A)
 Long, Maurice B. (A)
 Lopes, John (A)
 Lopez, Melchor, Jr. (A)
 Loynes, Owen H. (A)
 Lundahl, Tore (A)
 Lyford, Elmore B. (A)
 Lynch, Arthur H. (M)
 MacDonald, W. A. (M)
 MacDougall, Arthur (A)
 Mackay, William Andrew (A)
 Malter, Louis (A)
 Manderfeld, Emanuel C. (A)
 Manley, Edward (A)
 Marrison, W. A. (M)
 Marron, George P. (A)
 Marshall, Albert E. (A)
 Marshall, Cesar B. (A)
 Marshall, F. W. (A)
 Martin, De Loss K. (M)
 Mathes, R. E. (A)
 McConnell, Alexander F. (A)
 McCullough, Maurice B. (A)
 McCutchen, Brunson S. (M)
 McElrath, George (M)
 McFarlane, M. L. D. (A)
 McLagan, Donald R. (A)
 McLean, Phillip S. (A)
 McNally, James O. (A)
 McNary, James C. (M)
 McSweeney, Roger (A)
 Meyer, Henry W. (A)
 Miller, H. P., Jr. (M)
 Miller, Marvin L. (A)
 Miller, Reese Hutchison (M)
 Miller, Samuel C. (M)
 Mills, John (M)
 Milnor, Joseph W. (M)
 Misenheimer, Harvey N. (M)
 Molzen, Charles F. (A)
 Montcalm, S. R. (M)
 Moore, E. B. (A)
 Morecroft, J. H. (F)
 Morehouse, Terry B. (A)
 Morehouse, W. B. (M)
 Morro, Jack J. (A)
 Morton, Alfred H. (M)
 Murphy, E. Edward (A)
 Myers, Theobald (A)
 Naimark, Boris S. (A)
 Nakamura, T. (M)
 Nein, Harry R. (A)
 Nelson, Edward L. (M)
 Neville, T. P. (A)
 Newman, Alfred C. (A)
 Nicely, Ralph N. (A)
 Nicholides, E. (J)
 Nichols, Eldon (A)
 Nichols, Leroy C. (A)
 Nickerson, Fred W. (A)
 Nicolai, Erwin W. (A)
 Nielsen, John E. (A)
 Nimmcke, Frederick E. (A)
 Nisley, Paul H. (A)
 Nivison, Theodore E. (A)
 Norberg, Clifford M. (A)
 Nordahl, John G. (A)
 Norton, Frederick A. (A)
 Nyman, Alexander (M)
 Oikle, O. A. (A)
 Osborne, Harold S. (M)
 Oswald, Arthur A. (F)
 Pacent, Louis G. (F)
 Palmer, Robert T. (A)
 Pamphilon, Leon E. (J)
 Pannill, Charles Jackson (F)
 Parker, R. D. (A)
 Pate, Carlton O. (A)
 Patten, Stanley F. (A)
 Pavlow, Nicholas (A)
 Payne, Charles C. (A)

NEW YORK (Continued)

New York (Continued)

Pease, Reginald M. (M)
 Pegram, George B. (A)
 Penick, D. B. (A)
 Peterson, L. C. (A)
 Pierrepoint, John Jay (A)
 Polkinghorn, Frank A. (A)
 Pope, James C. (A)
 Ports, Earl G. (A)
 Potter, Ralph K. (M)
 Pratt, Haraden (F)
 Price, H. Stewart (M)
 Pristas, John E. (A)
 Proskauer, Julien J. (A)
 Pumphrey, Walter H. (M)
 Pupin, Michael I. (F)
 Putnam, Ralph E. A. (A)
 Randolph, L. F. (A)
 Ranger, Richard H. (F)
 Rathner, Jack (A)
 Reb, Frank F. (A)
 Reber, Samuel (F)
 Reeber, Herman E. (A)
 Reeves, J. Russell (A)
 Regottaz, Joseph M. (A)
 Reinken, Louis W. (A)
 Reoch, Alexander E. (F)
 Reynolds, John L. (A)
 Rhodes, Thomas B. (A)
 Rider, John F. (A)
 Ridgway, James L. (A)
 Rifkin, J. L. (A)
 Roder, Hans (M)
 Rodwin, George (A)
 Rose, Arthur F. (M)
 Rose, Charles F. P. (A)
 Rose, John A. (A)
 Rosenberg, Irving (A)
 Rossi, Ralph J. T. (A)
 Rossmassler, Edward C. (A)
 Ryan, Francis M. (M)
 Sacia, C. Fred (A)
 Salzberg, Bernard (J)
 Samoiloff, Leon (A)
 Samuel, Arthur L. (A)
 Sanborn, John W. (A)
 Sarnoff, David (F)
 Schechter, Jack (A)
 Schelleng, John C. (F)
 Schmied, James W. (A)
 Schmit, Dominic F. (A)
 Schneider, Samuel (A)
 Schneider, W. A. (M)
 Schnoll, Nathan (A)
 Scholle, Frederick (A)
 Schramm, Fred W. (A)
 Scott, Herbert J. (A)
 Searing, Hudson R. (A)
 Seidler, Abraham (A)
 Seigal, Joseph A. (A)
 Senauke, Alexander (M)
 Shannon, Joseph H. (M)
 Shelby, R. E. (A)
 Shen, S. Z. (A)
 Sherman, Jesse B. (J)
 Shute, Emmett R. (M)
 Sigety, Louis (J)
 Singer, Emanuel (A)
 Sivian, Leon J. (A)
 Skirrow, John E. (M)
 Small, Percy L. (A)
 Smith, John S. (M)
 Smith, John W. (A)
 Smith, Samuel S. (A)
 Snow, William B. (A)
 Solov, Abraham (A)
 Sonkin, David (M)
 Soule, Harold (A)
 Southworth, G. C. (M)
 Spence, P. W. (A)
 Spicer, Floyd O. (A)
 Spielman, H. Max (A)
 Sprague, Clarence A. (M)
 Stansel, Frank R. (A)
 Stone, Ellery W. (F)
 Swain, Robert R. (A)
 Sweeney, Carey P. (A)
 Sykes, Rodger Allen (A)
 Taussig, Charles W. (A)
 Taussig, William S. (A)
 Taylor, Charles H. (F)
 Taylor, Edmund R. (A)
 Taylor, Jay L. (A)
 Taylor, S. Gordon (A)
 Taylor, W. H., Jr. (M)
 Teeter, Albert A. (A)
 Theremin, Leon (A)
 Thielen, E. J. (A)
 Thompson, Albert C. (A)
 Thompson, Roy E. (M)
 Thurston, George (A)
 Tierney, Walter L. (M)
 Toth, Albert F. (A)
 Trapkin, Jack H. (A)
 Truax, John (A)
 Tuel, A. Y. (A)
 Turner, Alva (A)
 Turney, Eugene T., Jr. (A)
 Vaill, Edward W. (A)
 Valesio, Mario J. (A)
 Van Wyck, William Paterson (A)
 Vaughan, Carroll B. (A)
 Venable, Richard Neel (A)
 Verralls, J. Maynard (A)
 Victoria, Joseph Lawrence (A)
 Volkmann, John E. (A)
 Volney, S. C. (A)
 Voorhees, Lee J. (A)
 Vreeland, Frederick K. (F)
 Waas, Albert (A)
 Wald, David (A)
 Wallach, Moses U. (A)
 Walsh, A. L. (A)
 Walworth, Fred (A)
 Washington, Bowden (F)
 Waterman, Frank N. (M)
 Weiland, Christian F. (A)
 Weinberger, Julius (F)
 Wellman, William R. (A)
 West, L. E. (A)
 Wettermann, John A. (A)
 Wheeler, George D. (A)
 White, Philip S. (A)
 Whitmer, Robert M. (A)
 Whittemore, L. E. (F)
 Wickersheim, L. W. (A)
 Wilbur, Edwin C. (A)
 Willhofft, Frederick O. (A)
 Wilson, H. Warden (A)
 Wilson, Leon T. (M)
 Wilson, William (F)
 Winner, Lewis (A)
 Winterbottom, William A. (M)
 Wintringham, William T. (A)
 Wisegarver, Orton H. (A)
 Wolf, Irving (A)
 Woodcock, N. A. (A)
 Woodrow, William (A)
 Wortman, E. C. (A)
 Wright, Harry M. (A)
 Wunderlich, H. A. F., Jr. (A)
 Yolles, Jacob (A)
 Young, Owen D. (F)

NEW YORK (Continued)

New York (Continued)

Youngstrom, Nels C. (A)
Zeamans, Harold R. (A)

Niagara Falls

Brown, Orlan R. (A)
Guinther, George (A)
Lidbury, F. A. (A)
White, John A. (A)

North Tarrytown

Sandalls, George T., Jr. (A)

North Tonawanda

Maxwell, George G. (A)
Schurr, William (A)
Shapiro, L. (M)
Wesselman, Eugene (A)

Orient

Vail, Leslie G. (A)

Ossining

Akin, Robert M., Jr. (A)
Gowen, Robert F. (M)

Ozone Park, L.I.

Misenheimer, Robert G. (A)
Weilminster, Charles (A)

Pelham

Kelly, C. Merrill, Jr. (A)
Kolb, Walter R. (A)

Pelham Manor

Kelly, Dale (A)

Poland

Prentiss, Howard H. (A)

Port Jefferson, L.I.

Carter, Phillip S. (A)
Hansell, Clarence W. (M)

Port Jervis

Gibbons, Joseph W. (A)

Port Washington, L.I.

Hafner, Gilbert (A)
Whiting, Donald F. (M)

Poughkeepsie

Boyle, Frank A. (A)
Smith, Harold E. (A)

Rhinebeck

Lang, Walter T. (A)

Richmond Hill, L.I.

Brothers, James T. (A)
Grebe, Alfred H. (F)
Heins, Henry F. (A)
Hudtwalker, William Theodore (A)
Leyh, William D. (A)
Oram, Donald K. (A)
Weinwurm, Robert (A)

Riverdale-on-Hudson

High, John M., Jr. (A)

Riverhead, L.I.

Braaten, Arthur M. (A)
Crosby, Murray G. (A)
Hollingsworth, R. L. (A)
Matthews, Walter I. (A)
Moore, John B. (A)
Morris, Leon A. (A)
Peterson, Harold O. (A)
Pfautz, Christian E. (A)
Rundquist, Elliot C. (A)
Schoenborn, Ferdinand (A)
Smith, Arthur Z. (A)
Stagg, Carl (A)
Trevor, Bertram (A)
Wickizer, Gilbert S. (A)

Rochester

Bachofer, C. L. (A)
Balling, Alfred W. (A)

Barfield, A. R. (A)
Bedford, Donald D. (A)
Brown, Gordon P. (A)
Brown, Howard A. (A)
Clarke, Maurice H. (A)
Cote, Omer E. (A)
Dwyer, Vincent J. (A)
Ester, Perry W. (A)
Foster, Charles W. (A)
Friedler, Dewey P. (A)
Gallagher, Edward M. (A)
Gordon, Harry E. (A)
Graham, Virgil M. (M)
Haas, Paul (J)
Hanover, Edward A. (A)
Haugh, Arthur T. (M)
Hitchcock, Joseph F. (A)
Huntington, Maurice B. (A)
Karker, Earl C. (A)
Klumb, Harvey J. (A)
Levy, Maurice L. (A)
Lewis, Bertram L. (A)
Lucia, Raymond H. (A)
Maloff, Ioury G. (M)
Manson, Ray H. (M)
Martin, V. G. (A)
McCall, Keith E. (A)
McCanne, Lee (A)
McCanne, W. Roy (M)
Melchior, Frants Ansgar (A)
Moore, Eric J. T. (M)
Mott, Frederick A. (A)
Reddy, Walter G. (A)
Roesser, Edward A. (A)
Schneider, Mendell (A)
Schoen, Arthur L. (A)
Scoville, George A. (A)
Serge, Igor Bobrovsky (M)
Sigl, A. J. (A)
Soderholm, Arthur E. (A)
Studier, Walter A. (A)
Sylvester, Arthur (A)
Welsh, Fred E. (A)
White, Warren W. (A)
Wiebach, William T. (A)
Wishart, William R. (A)
Wood, Merrill A. (A)
Woodworth, E. C. (J)
Worrell, Richard A. (A)

Rockville Center, L.I.

Cardwell, Allen D. (A)
Harper, A. E. (M)
Hart, Lester B. (A)
Hinnners, Frank A. (F)
Lester, Paul Sabine (A)
Weeks, Norman E. (A)

Rocky Point, L.I.

Abbott, Walter (A)
Clifton, B. S. Y. (M)
Finch, James L. (M)
Goldstine, Hallan E. (A)
Henery, R. S. (A)
Kipp, Aaron (J)
Michelman, Edward A. (A)
Tammara, Joseph C. (A)
Usselman, George L. (A)

Rome

Bevitt, William D. (A)

Sanborn

Welsler, Carl E. (A)

Saranac Lake

Riddle, William E. (A)
Williams, Thomas E. (A)

Sayville, L.I.

Hart, Frank A. (A)

NEW YORK (Continued)

Scarsdale

Appel, Joseph H., Jr. (A)
Kinsley, Carl (M)

Schenectady

Acheson, Marcus A. (A)
Alexanderson, E. F. W. (F)
Andrews, Paul D. (M)
Anson, C. T. (A)
Austin, Kirby B. (A)
Ayer, Raymond B. (A)
Baker, W. R. G. (F)
Ballentine, Edwin C. (M)
Berejkoff, Anatol Petrovich (A)
Berg, Ernest J. (A)
Bergeron, Rosario (A)
Billings, James H. (A)
Bradbury, Burke (A)
Brockman, Francis C. (A)
Brokaw, Charles A. (A)
Brown, William W. (M)
Byrnes, Irving F. (A)
Carlson, Wendell L. (A)
Carpenter, Glenn W. (A)
Coombs, Clyde F. (A)
Cottrell, McKenzie (A)
Crippen, Eugene G. (A)
Cummings, B. Ray (M)
Darlington, Eugene S. (A)
David, William R. (A)
De Haven, Thomas V. (A)
Demmer, A. H. (A)
De Nardo, Federico (J)
Devaud, Albert J. (A)
De Wait, K. C. (A)
Dickinson, Theodore M. (A)
Dodge, Albert O. (A)
Dome, Robert B. (A)
Douthit, M. L. (A)
Duttera, W. S. (A)
East, Lawrence A. W. (A)
Edwards, Edmund P. (M)
Engstrom, Elmer W. (A)
Eveleth, Laurence Nelson (A)
Ferris, Warren Robert (A)
Fitch, William (A)
Ford, Warren A. (A)
Frank, Charles W. (A)
French, Henry G. (A)
Frink, Frederick William (A)
Fritschel, Eugene H. (A)
Garrett, Charles R. (A)
Grover, Frederick W. (M)
Gunter, Clarence A. (A)
Hansen, John C. (A)
Hargrave, W. A. (A)
Henyman, George W. (A)
Hitt, A. B. (A)
Hopkins, John S. (J)
Hoxie, Charles A. (A)
Jackson, Henry W. (M)
Johnson, T., Jr. (M)
Jones, L. F., III (A)
Junken, L. H. (A)
Kaar, Ira J. (M)
Kinney, Ely M. (A)
Lamb, G. F. (A)
Langdon, G. G. (A)
Langmuir, Irving (F)
Larson, Robert W. (A)
Lee, Samuel T., Jr. (J)
Leibing, Joseph K. (A)
Loughren, Arthur V. (M)
Lyndon, William L. (A)
Lynn, L. H. (A)
Lynn, Roland A. (A)

Scotia

Allen, Hugh E. (A)
Artzt, Maurice (A)
Chittick, K. A. (A)
Clarke, Varro J. (A)
Fick, Clifford G. (A)
Juchter, Pieter (A)
Poch, Waldemar J. (A)
Richardson, L. Walton (A)
Schwarzaupt, Paul J. (M)
Smith, J. P. (A)
Steiner, Harry C. (A)
Thomas, George G. (A)

Maser, Harold T. (A)
Maynard, J. E. (A)
McLennan, Miles Aryault (A)
Mead, Milton S. (A)
Meahl, Harry R. (A)
Metcalf, George F. (A)
Moles, Frank J. (A)
More, Clifton C. (A)
Morgan, Howard K. (A)
Mullaney, Dudley A. (A)
Nergaard, Leon S. (A)
Newton, Raymond A. (A)
Nickle, Emil G. (A)
Nolte, Henry J. (A)
Orr, Robert W. (A)
Patterson, Franklin G. (A)
Payne, John H. (A)
Petterson, Junior (A)
Pike, Otis W. (M)
Prescott, Maurice L. (M)
Priebe, Frank (A)
Priest, Conan A. (A)
Pulley, Albert A. (A)
Rice, Chester W. (F)
Robinson, Harris A. (A)
Rochford, John (A)
Rockwood, Alan C. (A)
Roys, H. E. (A)
Ryder, Jack D. (A)
Sadenwater, Harry (M)
Scheldorf, Marvel W. (A)
Selby, Eugene O. (A)
Serrell, Robert (A)
Sherman, Kenneth S. (A)
Short, Donald William (A)
Simonds, D. T. (A)
Simpson, Le Roy C. (J)
Sloan, David H. (A)
Snyder, Norman (A)
Somers, Brock A. (A)
Spitzer, Edwin E. (A)
Stanton, Clair F. (A)
Stauffer, Ray Everett (A)
Stocker, Arthur C. (A)
Stone, F. Byron (A)
Taylor, John Pratt (A)
Taylor, Laurens A. (A)
Taylor, R. B. (A)
Terrell, John A. (A)
Thompson, B. J. (A)
Tolson, W. A. (M)
Tyler, Kenneth G. (A)
Vose, Charles H. (A)
Wallace, Martin J. (A)
Warner, John C. (M)
Watts, D. E. (A)
Weir, Irwin R. (A)
Westendorp, W. F. (A)
Whelan, Dow O. (A)
White, William C. (M)
Wilson, Donald (A)
Woodworth, John L. (A)
Young, Charles J. (A)

NEW YORK (Continued)

Sea Cliff, L.I.
Husted, Donald R. (A)
Mickelson, C. D. (A)
Tangen, Reider (J)

Sheepshead Bay
Asch, Moe (A)

Southampton, L.I.
Buckingham, William D. (A)
Homer, Edward C. (A)
O'Connor, John G. (A)
Pollard, Leon G. (A)
Weik, Adolph L. (A)

Springfield, L.I.
Benjamin, Wesley E. (A)

Spuyten Duyvil
De Forest, Lee (A)

Stafford
Sheffer, Olan N. (A)

Stapleton, S.I.
McArdell, Wesley E. (A)
West, Clarence H. (A)

Staten Island
Younger, Charles (A)

Suffern
Ennis, Fred E. (A)
Osterland, Edmund (J)

Sunnyside, L.I.
Shannon, James E. (A)
Stewart, G. Edwin (A)

Syracuse
Blaich, J. Ray (A)
Christy, Donald P. T. (A)
Meredith, Clive B. (A)
Nicholson, E. J. (A)
Pierson, Theodore (J)
Porter, R. A. (A)
Potter, Melville R. (A)
Randall, Dormus P. (A)
Wolverton, Byron C. (A)

Tarrytown
Dinga, Emil (A)
Pineau, Norman T. (A)

Trudeau
Steneri, Arthur J. (A)

Tuxedo Park
Loomis, Alfred L. (M)

Utica
King, Francis N. (A)
Terrill, W. Nessler (A)

Victor
Long, John J. (A)

Water Mill, L.I.
Corwith, Howard P. (M)

Watkins Glen
Pomeroy, Rupert C. (A)

West Brighton, S.I.
Garland, J. Arnold (A)
Wombacher, Joseph A. (A)

West Hempstead, L.I.
Magness, Scott A. (A)
Westman, Harold P. (M)

West New Brighton, S.I.
Bedford, George W. (A)

West Point
Serig, Howard W. (A)
Wenstrom, W. H. (A)

White Plains
Griggs, Elmer V. (A)
Halstead, William S. (A)

Lamarque, James W. (A)
Locke, G. Edgar (A)
Minton, John P. (F)

Whitestone, L.I.
Adler, Benjamin (A)
Lederhaus, Herman William (A)
Summers, Llewelyn L. B. (A)

Williamsville
Hopkins, Nelson S. (A)
Trago, Robert A. (A)

Woodhaven, L.I.
Cooper, Gustavus A. (A)
Stellwagen, Frank W. (A)

Woodmere, L.I.
Birkhahn, Robert C. (A)
Ziegler, Frederick J. (A)

Woodside, L.I.
Reitenmeyer, Francis X. (M)
Reuman, William H. (A)

Yonkers
Craig, Albert G. (A)
Enders, Charles F. (A)
Runyon, Carman R., Jr. (A)
Seitz, Frank A., Jr. (J)
Swanson, John W. (M)
Terwilliger, Donald J. (A)
Whitaker, James N. (A)
Van Dyck, Arthur F. (F)

NORTH CAROLINA

Asheville
Lance, Hubert H. (A)
So Relle, J. L. (A)

Charlotte
Callahan, Thomas G. (A)
Gluck, E. J. (A)
Saylor, James G. (A)

Durham
Seeley, Walter J. (A)

Gastonia
Morris, Robert S. (A)

Henderson
Woodlard, E. W. (A)

Mt. Airy
Worrall, W. W. (A)

Washington
Jowdy, Mitchell (A)

NORTH DAKOTA

Bismarck
Lucas, Stanley M. (A)

Fargo
Cook, Tedd W. (A)
Swisher, Charles L. (A)

Grand Forks
Garard, Earl A. (A)
Jenkins, David R. (A)

Mandan
Hood, Norman R. (A)

OHIO

Akron
Aitkenhead, John, Jr. (A)
Curtis, James O. (A)
Dinger, Harold E. (A)
Ehrisman, Henry O. (A)
Ludlow, Gilbert H. (A)
Mintz, John W. (A)
Palmer, Roland F. (A)
Smith, Paul Clarence (A)

OHIO (Continued)

Akron (Continued)
Townsend, Samuel W. (A)
Weaver, Rayman E. (A)
Werhan, Alfred B. (A)
Wilkens, Bernard T. (A)

Alliance
Ackerman, F. R. (A)
Morgan, O. K. (A)

Ashtabula
Andrus, Roy E. (A)

Ashtabula Harbor
Hopper, C. L. (A)

Athens
Green, Darrell B. (A)

Avon Lake
Harris, John (A)

Barberton
Hillebrand, W. A. (M)

Berea
Anderson, Raymond T. (A)

Canton
Catterall, John B. (A)
Herbruck, William M. (A)
Pennock, P. L., Jr. (A)

Chardon
Canfield, Ira A. (A)

Cincinnati
Aughenbaugh, William K. (A)
Austin, Edward (A)
Boes, W. W. (A)
Bussard, E. J. H. (A)
Chambers, Joseph A. (A)
Craig, Palmer H. (A)
Crosley, Powel, Jr. (M)
Dixon, C. C. (A)
Felix, Clarence G. (A)
Glover, Ralph P. (A)
Hunter, Theodore A. (A)
Israel, Dorman D. (A)
Jeng, L. Y. (A)
Kellogg, Leonard A. (A)
Kilgour, Charles (A)
Klein, Helen (A)
Kolks, Richard H. (A)
Lampkin, Guy F. (A)
Langley, Ralph H. (F)
Lehnhoff, Raymond G. (A)
Meyrose, Hubert S. (A)
Osterbrock, W. C. (A)
Peterson, Charles W. (A)
Vanek, Lawrence J. (A)
Verkley, B. M. (A)
Walker, Frank (A)
Youngs, Howard E. (A)

Cleveland
Ackerman, E. K. (A)
Ayer, Oliver G. (A)
Baeckler, Walter (A)
Benkelman, Glen F. (A)
Bowditch, Fred T. (A)
Butler, Roy (A)
Calkins, William G. (A)
Canady, Donald Ray (A)
Carlton, Raymond A. (A)
Covey, Gerald G. (A)
Crocus, John S. (A)
David, Bruce W. (M)
Daymude, John F. (A)
Deutsch, E. J. (A)
Disbrow, John N. (A)
Dodds, Lee L. (A)
Domizi, Dante (A)
Donaldson, Robert O. (A)
Dorazil, A. F. (A)

Cleveland Heights
Baier, Arthur H. (A)
Baier, Henry J. (A)
Farnham, Ralph E. (A)
Snyder, Robert E. (A)
Williams, Hollie (A)

Columbus
Bidlack, Cecil S. (A)
Conrad, Willard Oliver (J)
Crisante, Aldo (A)
Everitt, William L. (M)
Graham, J. P. (A)
Higgy, Robert C. (A)
Krumm, Louis R. (M)
Leeka, Warren C. (A)
Mercer, Alva (A)
Newby, R. W. (A)
Rosenfeld, Millard (A)
Smith, Sereno E. (A)
Storck, Howard C. (A)

Dorn, Harry P. (A)
Durante, Jean Andre (A)
Eberle, Wilbert H. (A)
Engholm, Bernard A. (M)
Filgate, John T. (A)
Fouse, Harold (A)
Fowler, J. Randall (A)
Glatz, Henry (A)
Gove, Edward L. (A)
Gray, Floyd E. (A)
Gray, Harold E. (M)
Hannum, J. C. (A)
Henry, Allen W. (A)
Hunt, Louis W. (A)
Hybarger, H. K. (J)
Irvine, Robert P. (A)
Jarvis, Kenneth W. (M)
Jenkins, Myron Z. (A)
KaDell, Harold William (A)
Kaehni, Frank J. (A)
Kintner, Deane S. (A)
Klein, Israel (A)
Lefler, Ralph H. (A)
Martin, Frank J. (A)
McCollister, Donald (A)
McGeorge, Donald (A)
McIlvaine, Oran T. (M)
McMahon, Alvin (A)
Melrose, James W. (A)
Nelson, James R. (M)
Newman, Joseph S. (A)
O'Connor, Albert J. (A)
Okeson, Hugh Bingham (A)
Ostrander, Russell S. (J)
Pruitt, Wilbur C. (A)
Robertson, Frank E. (A)
Schneeberger, G. B. (A)
Schregardus, Dirk (A)
Scott, Ernest P. (A)
Scott, Hoyt S. (M)
Seitz, Valentine (A)
Shaw, John J. (A)
Simpson, Paul A. (A)
Smith, F. J. (A)
Sturtevant, Mark (A)
Teunisson, John F. (A)
Tummonds, Harry A. (A)
Umbreit, Stanton (A)
Victoreen, John A. (M)
Waite, Howard G. (A)
Ward, Donald O. (A)
Watts, E. Gerald (A)
Wells, Leland E. (M)
Worst, J. S. (A)
Yurgionas, John A. (A)

OHIO (Continued)

Dayton

Anderson, J. E. (A)
 Barbulesco, Constantin D. (M)
 Bickel, Howard I. (A)
 Copp, Roy S. (A)
 Cotter, Edwin Meredith (A)
 De Wesse, Herbert William (A)
 Finter, C. V. (A)
 Flewelling, Edmund T. (A)
 Franzwa, Frederick J. (A)
 Friedman, Harry (A)
 Gerstle, John (A)
 Glendenning, D. B. (A)
 Harmon, W. S. (A)
 Hendricks, Lester A. (A)
 Knott, William M. (A)
 Loftis, Homer J. (A)
 Lohmann, Robert S. (A)
 Richmond, L. P. (A)
 Roberts, Haydn P. (M)
 Shaw, Frederick L. (A)
 Zimmerman, Robert F. (A)

Dover

Weber, H. S. (A)

East Cleveland

Beasley, Ira E. (A)
 Gimmy, Norman H. (A)
 Leonard, S. Edwin, Jr. (A)
 MacLaren, Wallace E. (A)
 Siddall, Richard (A)
 Shipman, Charles H. (A)

East Sparta

Walker, Nolan S. (A)

Fairview Village

Black, Albert J. (A)

Fostoria

Elsca, Farrel F. (A)

Gambier

Cottrell, Casper L. (A)

Gibsonburg

Clark, Edgar J. (J)

Green Camp

Barber, D. G. (A)

Greentown

Myers, Willard D. (A)

Hamilton

Petry, C. A. (A)
 Probst, John E. (A)

Holland

Line, F. M. (A)

Hudson

Lowrer, R. W. (A)

Indian Lake

Thomas, W. Raymond (A)

Kent

Kline, Robert L. (A)

Lakewood

Drummond, P. (A)
 Hamman, G. B. (A)
 Hood, William A. (A)
 King, Maurice V., Jr. (A)
 La Ganke, H. C. (A)
 Little, D. S. (A)
 Marsal, Paul A. (A)
 Pichon, Richard S. (J)
 Satterthwaite, William F. (A)
 Sturtevant, James W. (A)
 Worden, Ralph P. (A)

Lexington

Shuler, John H. (A)

Lorain

Fox, Robert A. (A)

Marietta

Johnson, J. L. (A)
 Muscari, Pietro J. C. (A)

Massillon

Schwab, Charles B. (A)
 Trubey, Lester E. (J)

Mason

Berry, Robert C. (A)
 Davis, Irving C. (A)
 Whitehouse, Joseph E. (A)

Mt. Healthy

Lockwood, Edward C. (A)

New Philadelphia

Murray, Charles J. (A)
 Nolan, John M. (A)

Niles

Coleman, Robert M. (A)
 DeCola, Rinaldo (A)
 Parlas, Joseph L. (A)

North Canton

Boger, Clair E. (A)

Norwalk

Leonhardt, Charles C. (A)

Norwood

Blair, Russell M. (A)
 Dwyer, Robert J. (A)

Parma

Burkhardt, Karl R. (A)

Payne

Huguenin, Glenda (J)

Port Clinton

Anderson, Gilbert J. C. (A)

Portsmouth

Jackson, Sylvan E. (A)

Ravenna

Rettig, Floyd A. (A)

Sandusky

Voight, Richard J. (A)

Shiloh

White, Kenneth E. (A)

South Charleston

Wells, Martin M. (A)

South Euclid

Glover, Gerald W. (A)

Springfield

Biver, Carl J. (A)
 Estey, F. Clifford (A)
 Hayslett, L. E. (A)
 Reid, Thomas A. (A)
 Schaefer, Carl A., Jr. (A)
 Stolzenbach, R. W. (A)
 Thomas, Harry E. (A)

Toledo

Bitter, A. Romeyn (A)
 Browne, Merton S. (A)
 Dietsch, Carl G. (A)
 Dupuis, Ernest F. (J)
 Foley, J. W. B. (A)
 Franklin, Townsend U. (A)
 Pilzecker, Arthur (A)
 Skeels, Dudley K. (A)

Wapakoneta

Copeland, Herman A. (A)

Warren

Fleming, Edward E. (A)

Youngstown

Hoffman, Donald A. (A)
 Kincaid, Owen D. (A)

OHIO (Continued)

Youngstown (Continued)

Pennock, P. L., Sr. (A)
 Phillips, R. G. (A)
 Remedio, Dominic (A)

Zanesville

Bell, Lewis M. (A)

OKLAHOMA

Alva

Sears, Garold D. (J)

Bartlesville

Fisher, Frank E. (A)
 Miller, Erdene K. (A)

Chelsea

Jones, Varnakale L. (A)

Chickasha

Shultz, E. Patterson (J)

Enid

Edwards, Lyman M. (A)

Lawton

Newsom, T. (A)

Muskogee

Sams, E. E. (A)

Oklahoma City

Allen, Roy (A)
 Bathe, Charles E. (A)
 Challenner, Ansel (A)
 Cole, Roy H. (A)
 Gordon, Earl P. (A)
 Hirdler, F. C. (A)
 Kramer, V. J. (A)
 Lovell, Herman J. (A)
 Mier, C. W. (A)
 Miller, Wayne (A)
 Moffett, Leroy, Jr. (A)
 Moore, Paul J. (A)
 Pata, Yaromir J. (A)
 Prell, George R. (A)
 Stokes, Ray (A)
 Wallace, David R. (A)

Okmulgee

White, R. Jordan (A)

Peckham

Brown, Edwin C. (A)

Stillwater

Oboukhoff, Nicholai M. (M)

Stillwell

Necley, Carl E. (J)

Tulsa

Banks, J. Vernon (A)
 Bowen, Leonard R. (A)
 Breeding, S. H. (A)
 Carpenter, Hugh (A)
 Drake, Norman B. (A)
 Jones, Burle R. (A)
 McNally, Eugene C. (J)
 Mealy, Max B. (J)
 Miller, Claude E. (A)
 Murphy, Paul L. (A)
 Phillips, Howard W. (A)
 Probert, Edward (A)
 Stinson, Lawrence W. (A)
 Thompson, W. H. (A)
 Unruh, Franklin T. (A)
 Van Doeren, C. A. (A)
 White, Karl K. (J)
 Willson, P. L. (A)
 Wise, James O. (A)

Tuttle

Coates, B. Franklin (A)

OREGON

Astoria

LaSalle-Dilley, L. L. (A)

Corvallis

Jordan, Jacob (A)
 Klein, William S. (A)
 Morris, James M. (A)

Falls City

Paul, Byron R. (J)

Hillsboro

Julien, Ira F. (M)

Oregon City

Newman, Clarence D. (A)

Portland

Dixon, Ashley C. (A)
 Johnson, I. W. (A)
 Last, George O. (A)
 McCargar, S. Harold (A)
 Neubauer, Edwin William (A)
 O'Day, Marcus (A)
 Sachs, Harold S. (A)
 Trumbull, A. F. (A)

Salem

Churchill, H. B. (A)
 Leamer, Frank D. (A)
 Poujade, D. G. (J)

PENNSYLVANIA

Adelia

Woodward, Bruce J. (A)

Aldan

Earle, Ralph P. (A)

Allentown

Bowman, Charles W. (A)
 Clauss, Fred W. (A)
 Dreisbach, Blair (A)
 Eckert, Byron H. (A)
 Foley, W. R. (J)
 Haines, A. J. D. (A)
 Hardner, Francis J. (A)
 Heimbach, Charles W. (A)
 Hilliard, Winfield E. (J)
 Keck, Kenneth K. (A)
 Kurtz, Clyde R. (A)
 Muthart, John A. (A)
 Peters, Arthur A. (J)
 Pond, Edward W. (A)
 Rauhofer, Frank (A)
 Richardson, George A. (J)
 Sauerwine, Charles Augustus (A)
 Thomas, Charles V. (A)
 Williams, Thomas R. (A)
 Wissler, Benjamin F. (A)
 Young, Charles S. (A)

Allenwood

Schooley, Harold (A)

Altoona

Douglas, Earl C. (A)
 Leutz, Charles R. (M)
 Youngkin, Ernest E. (J)

Ambridge

Svegel, Peter J., Jr. (J)

Ardmore

Wilkinson, Gordon O. (A)
 Worrell, Howard S. (A)

Avalon

Allen, James G. (A)

Bala-Cynwyd

Croft, Samuel H. (A)
 March, Hallman W. (J)

Bangor

Bruschi, Lewis John (A)

PENNSYLVANIA (Continued)

Bath Graver, Frank S. (A)

Bellevue
Armor, James C. (A)
Dauber, Albert E. (A)
Donbar, C. Floyd (A)

Bethlehem
Bertolet, Benneville S. (A)
Hottel, C. W. (A)
Maylott, Carleton F. (A)
Seyfert, Stanley S. (M)

Bradford
Francis, Thomas C. (A)

Brownstown
Harnish, Ray M. (A)

Bridensburg
Kearney, William A. (J)

Bryn Mawr
Tuttle, William N. (A)

Bywood
Brown, Henry J. (A)

Cambridge Springs
Lord, Harry R. (A)

Carrolltown
Brophy, Francis Joseph, Jr. (A)

Chambersburg
Ramsey, R. W. (A)

Chester
Nadig, Stanton E. (A)
Rapagnani, Peter A. (A)

Chestnut Hill
O'Neill, John P. (A)

Churchville
Hinkel, Walter A. (A)

Clearfield
Moyer, Elmo Emerson (A)

Connellsville
Craig, Jack (J)
Silcox, Albert S., Jr. (A)

Crescon
Vaughan, Kenneth A. (A)

Cynwyd
Chubb, Lewis W. (M)

Danville
Deaner, Haydn M. (A)

Darby
Knight, Winfield W. (A)

Darlington
Rohrmann, Edward R. (A)

Dormont
Thomas, William K. (A)

Drexel Hill
Brandt, William A. (A)
Shafer, Albert G. (A)
Sharpless, A. Roberts (A)
Willard, Joseph M. (A)

Easton
Beans, Floyd (A)
Deutschman, Borah (A)
Fox, Paul S. (A)
Raesly, James B. (A)
Weller, Everett C. (A)

East Pittsburgh
Conrad, Frank (F)
Evans, Walter C. (M)
Hanna, Clinton R. (M)
Hitchcock, R. C. (A)
Kintner, Samuel M. (F)

Edgewood
Lewis, L. V. (A)
McCullough, F. S. (M)

Emporium
Jones, Walter R. (A)
Rishell, George L. (A)

Eric
Jordan, Ralph E. (A)
Swanson, Merrill J. (A)

Etna
Johnstone, R. S. (A)

Fox Chase
MacFadden, Wilford C. (A)

Frackville
Horwat, Peter (A)

Fullerton
Bachman, Edwin J. (A)

Germantown
Bromley, John E., Jr. (A)
Burnside, Don G. (A)
Weyl, Charles N. (M)

Glassport
Hertz, Stanton (A)

Glenside
Griffith, Charles H. (A)

Greensburg
Hawk, William K. (A)

Harrisburg
Beachley, Vance E. (A)
Chambers, William B. (J)
Detweiler, Jay E. (J)
Gardner, William L., Jr. (A)
Grim, Clair R. (A)
Hall, Thomas, Jr. (A)
Hardy, George E. (A)
Heckman, J. W. (A)
Hoover, Reuben R. (A)
Knerr, G. Russell (A)
McCachren, W. S. (A)
Miles, Lester F. (A)
Mummert, Russell E. (J)
Novinger, Earl M. (A)
Peffer, Ralph M. (A)
Poorman, Arthur E. (A)
Schwanger, Robert M. (A)
Sours, M. D. (A)
Steiger, Charles H. (A)
Stormfeltz, S. H. (A)
Walanka, M. R. (A)

Highland Park
Greenwald, Arthur A. (A)

Honesdale
Burlein, Lester F. (A)
Stephens, William H. (A)

Irwin
Brook, Alf (A)

Jenkintown
Greenway, William L. (A)

Johnsonburg
Baldwin, Arthur V. (A)

Johnstown
Hanson, Herbert (A)
Reid, A. J. (A)

Kane
Beatty, Rue Thompson (A)

Kingston
Brown, Ralph M. (A)

Knox
Smith, Jesse W. (A)

MEMBERSHIP (Geographical)

PENNSYLVANIA (Continued)

Lancaster
Gaintner, Joseph R. (A)
Geise, Julius C., Jr. (A)
Snavey, B. L. (A)
Stauffer, J. Luke (A)

Landisville
Mumma, Earle L. (A)

Langhorne
Newbold, W. H. (A)

Lansdale
Schieber, Leonard B. (A)

Lansdowne
Kimball, Gardner W. (A)
Thompson, Roland F. (A)
Warren, S. Reid, Jr. (A)
Wilson, A. T. (A)

Lehigh
Butler, Harry F. (A)

Lemoine
Rogers, Clifford H. (A)

Lester
Causse, Roger D. (J)

Mill Hall
Miller, Carl (A)

Narberth
Bates, Clifford W. (A)

Matamoras
Willers, Theodore H., Sr. (A)

Media
Delbert, Simon, Jr. (A)

Melrose Park
Druecking, Albert J. (A)

Mill Hall
Miller, Carl (A)

Milton
Butler, Wilson M. (A)

Mt. Airy
Ehret, Cornelius D. (F)
Ellinwood, Kenneth M. (J)
Keast, Philip M. (A)
McDowell, Albert P., Jr. (A)
Raycroft, Louis B. F. (A)

Mt. Carmel
Gross, Benjamin F. (A)

New Castle
Martin, Norman A. (A)

Norristown
Hausmann, Ernest O. (A)
Place, Samuel W. (A)
Rue, William F. (A)
Sands, William F. (A)

Northampton
Lewis, Chester, Jr. (A)

Oil City
Imler, Glenn M. (A)
Paca, William S. (A)

Overbrook
Closson, H. B., Jr. (J)

Palmyra
Balsbaugh, Clair L. (A)
Krieder, James L. (A)

Parnassus
McKinley, J. G. (A)

Pennbrook
Amsden, Frank Power (A)

Penn Wynne
Saunders, William P. (A)

Philadelphia

Apker, Charles L. (A)
Barton, R. W., Jr. (A)
Bechler, W. C., Jr. (A)
Benge, J. R. (A)
Bonn, Norman E. (A)
Borland, Albert S. (A)
Bosco, Joseph F. (J)
Brown, H. Wilbur (A)
Brown, William L. (A)
Burgess, Edward R. (A)
Butler, Richard A. (A)
Caporale, Peter (A)
Cerstvik, Stephen (A)
Chesney, John J. (A)
Clark, Charles F. (A)
Cordova, F. B. (A)
Deal, Harmon B. (M)
Doherty, George H. M. (J)
Doyle, E. D. (A)
Dunn, James C. (A)
Earnshaw, David P. (A)
Eaton, George W., Jr. (A)
Ebert, Burton E. (A)
Eby, Hugh H. (A)
Eby, John B. (A)
Eckert, Edward J. (A)
Ellis, William G. (M)
Etkin, Harry (A)
Fisher, Roy S. (A)
Fossett, Fred E. (A)
Freedman, H. J. (A)
Frigar, John, III (A)
Gengenbach, Albert W. (A)
Godsho, Albert P. (A)
Greathead, Arthur W. (A)
Griffith, M. H. (A)
Hagan, Edward J. (J)
Helfenstein, Edwin (A)
Hershey, Arthur W. (A)
Hofberg, Alf H. (A)
Holden, Ellis Gray (A)
Holland, Walter E. (M)
Holtzizer, Ralph (A)
Huttenloch, Robert M. (J)
Hyatt, C. Brown (A)
Johnson, Harmon (A)
Karcher, Donald (J)
Kearney, L. E. (A)
Keller, Paul A. (A)
Kienzle, D. R. (A)
Klenk, Julius G. (A)
Kloss, Frederick W. (A)
Leonard, John M. (A)
Lo, Tsu Zui (A)
MacHugh, William L. (A)
MacNabb, Vernon C. (A)
Martino, Alphonse E. (A)
Mattia, Ralph F. (A)
Mayea, Lawrence E. (A)
Mayers, Harvey F. (A)
Merkel, Henry F. (A)
Mevius, John C. (A)
Miller, Charles C. (A)
Miller, John M. (F)
Morris, George W. (A)
Morrow, Lorentz A. (A)
Mouradian, H. (A)
Mousley, Franklin (A)
Murri, Joseph (A)
Neutra, Benjamin B. (A)
Nichols, J. J. (A)
Overmiller, Clair M. (A)
Ponsford, Walter W. (A)
Rabinowitz, Meyer (A)
Reeb, Alfred (A)
Reeves, E. H. (A)

PENNSYLVANIA (Continued)

Philadelphia (Continued)

Reid, Floyd F. (A)
Remmlin, C. D. (A)
Robinson, Aloysius V. (A)
Roman, Frank E. (J)
Ross, Stewart C. (A)
Schulmerich, G. J. (A)
Schweikart, William F. (A)
Seaman, John C. M. (A)
Senior, David B. (A)
Shannon, Frank J. (A)
Shea, Richard F. (A)
Sirms, Wiswald J. (A)
Snyder, Christopher L. (A)
Snyder, Richard L. (A)
Stover, Wilmer A. (A)
Tarzian, Sarkes (A)
Tindel, Charles G. (A)
Traugott, Paul (A)
Travis, Charles (A)
Trinkle, Wilmer S. (A)
Trump, William II. (A)
Trumpy, Jay W. (J)
Tuska, Clarence D. (A)
Tuttle, Elbert B. (A)
Van Horn, J. C. (M)
Van Housen, C. H. (A)
Wockey, Peter F. (A)
Wolf, Clarence, Jr. (J)
Wynne, Walter M. (A)
Yost, John C. (A)

Phoenixville

Shuhart, John H. (A)

Pittsburgh

Armstrong, Ralph W. (A)
Baumgarten, Frank A. (A)
Brader, Norwood H. (A)
Buehl, Louis H. (A)
Buerger, Charles B. (A)
Buzzard, A. J. (A)
Clark, Clarence M. (A)
Cruikshank, Omar T. (A)
Davis, Robert L. (A)
Davis, Sheldon Irwin (A)
Diamond, Hyman (A)
Dill, George C. (A)
Faulstich, C. J. (A)
Gorham, Robert C. (A)
Griffith, Roy T. (A)
Haller, George L. (A)
Hand, Carl A. (A)
Harrison, Jamison R. (A)
Irving, Herbert W. (A)
Joller, Casper R. (A)
Lazich, Branko (A)
Miller, Paul J. (A)
Molk, F. T. (A)
Nichols, Harry J. (A)
Osborn, Perry H. (A)
Ostermeir, C. H. (A)
Overholt, Ralph, Jr. (A)
Peters, Leo J. (A)
Phillips, Joseph H., Jr. (A)
Rafferty, Charles H. (A)
Richards, Folke (A)
Schlesinger, Louis B. (A)
Seaverson, Oswald I. (A)
Shafer, William L. (A)
Shreve, A. French (A)
Staeger, Stephen A. (A)
Stayer, David (A)
Sunnergren, Arvid P. (A)
Terven, Lewis A. (M)
Wallace, H. Edward (A)

Wensley, Roy J. (A)
Wiesmann, Edward T. (J)
Wyckoff, Ralph D. (M)

Pottstown

Betz, C. Leonard (A)
Fisher, Charles H. (A)
Mellon, Ralph E. P. (J)
Roeller, Henry S. (A)

Punxsutawney

Bowser, Jacob W. (A)

Quakertown

Bartholomew, Robert G. (A)

Reading

Albert, William V. (A)
Good, Horace D. (A)
Kissinger, J. Herbert (A)

Ridgway

Anderson, Thure C. (A)

Rosemont

Forstall, Edward L. (A)

Royersford

Freed, R. E. (A)

Schwenksville

Benner, Harold S. (A)

Scranton

Dolph, Stanley E. (A)
Graf, Joseph J. (M)
Irving, Ira M. (A)
Oschmann, Adolph W. (A)
Stevens, Wilbur C. (A)
Witkowski, Joseph F. (A)

Sharon

Rankin, Samuel A. (A)

Sharon Hill

Travis, Irven A. (A)

Shenandoah

Dresher, G. A. (A)

Slatington

Newhard, Stanley C. (A)

Smethport

Biever, Fred H. (A)
Pierotti, William L. (A)

South Tamaqua

Delp, Paul L. (A)

Springdale

Armstrong, Reece M. (A)

State College

Long, Marvin (A)
Woodruff, Eugene C. (M)

St. David's

Stewart, Charles H. (M)

Sunbury

Bartlett, Millard C. (A)

Swarthmore

Alpern, Dwight K. (A)
Fussell, Lewis (A)
Hayes, Ralph S. (A)

Swatara

Cassady, P. H. (A)

Swissvale

Bossait, Paul N. (A)
Shuey, Paul F. (A)

Temple

Stanton, R. E. (A)

Turtle Creek

Gunby, O. B. (A)

Uniontown

Crow, John B. (J)

PENNSYLVANIA (Continued)

Upper Darby

Cahill, James A. (A)
Chamberlain, Newton M. (A)
Dudley, D. Clinton (A)
Frazier, Howard S. (A)
Lewis, Oliver I. (A)
Slattery, John J. (J)

Wall

Popsack, Andrew A. (A)

Warren

Gruninger, John E. (J)

Waverly

Mack, Dahl W. (A)

Wayne

Adelberger, Paul J. (A)

Wesleyville

Dutton, George L. (A)

West Manayunk

Sweeney, Harold V. (A)

West Philadelphia

Knoll, Lloyd M. (M)
Logan, William S. (A)
Muncey, Allan R. (A)

Wilkes-Barre

Haines, Joseph, Jr. (A)
Paessler, Robert T. (A)
Shuster, Edmund F. (J)
Speicher, Ellsworth J. (A)
Stenger, J. H., Jr. (A)
Warner, Barney H. (A)

Wilkesburg

Baudino, Joseph E. (A)
Beers, G. Lisle (M)
Boddie, Clarence A. (A)
Brindley, William E. (M)
Carothers, William D. McL. (A)
Cunningham, David H. (A)
Cunningham, Thomas D. (A)
Downey, William C. (A)
Gregory, S. D. (A)
Grundmann, Gustave L. (A)
Johns, Francis J. (A)
Koch, Winfield R. (A)
Kotsch, Elmer G. (A)
Lehman, James N. (A)
Mag, Anthony (A)
Reynolds, C. C. (A)
Roess, Harold (M)
Shoup, Allen (A)
Sinnott, Chester M. (A)
Sutherland, Lee (M)
Trouant, Virgil E. (A)
Ulrey, Dayton (A)

Williamsport

Petts, Ronald G. (A)

Wynnewood

Secley, Samuel W. (A)

York

Gottlieb, Morris (A)
Lever, Philip R. E. (A)
Stewart, James W. (A)
Weigel, Richard C. (A)

Zelienople

Bassler, Sherman G. (A)

RHODE ISLAND

Cranston

Bargamian, John (A)

Edgewood

Cumerford, Arthur S. (A)

Greenwood

Grain, Everard B. (A)

North Providence

Thomas, Harold (A)

Providence

Andrews, Howard L. (A)
Brewster, O. H. (A)
Ganz, Arthur W. (A)
Gordon, George (A)
Leibow, Saul A. (A)
Maker, Albert E. (A)
Smith, Malcolm H. (A)

Wakefield

Taylor, Alfred R. (A)

Woonsocket

Gerry, Frank L. (A)
Teachman, Alfred E. (A)

SOUTH CAROLINA

Aiken

Terry, Laurence M. (A)

Anderson

Mitchell, John A. (A)

Charleston

Smith, Jesse H. (A)
Zeigler, T. W. (A)

Clemson College

Garrison, Paul J. (A)
Wilson, Walter B. (A)

SOUTH DAKOTA

Brookings

Crothers, H. M. (A)

Huron

Griffiths, A. Elmer (A)

Rapid City

Halley, Samuel R. (A)
Kammerman, John O. (A)

Sanator

Tilgner, Shelton R. (J)

Yankton

Nelson, Ivar (A)
Seils, Harry A. (A)

TENNESSEE

Athens

Knight, Gaylord A. (A)

Chattanooga

George, Everett E. (A)

Cleveland

Slaughter, Jack D. (A)

Knoxville

Adcock, Stuart E. (A)

La Grange

Sims, James W. (A)

Memphis

Cowles, John W., Jr. (J)
Pearce, Arthur (A)
Slavick, Henry William (A)

Nashville

Harness, Sam A. (A)
Leftwich, E. H. (A)
Montgomery, L. H., Jr. (A)
Randolph, George T. (A)

Normal

Moss, W. Hall (A)

Saltillo

Berry, James S. (A)

TEXAS

Albany
Codrington, Jerome H. (J)

Amarillo
Berg, Arthur A. E. (A)
Reville, T. A., Jr.
Todd, William F. (A)
Wimberly, W. Ben (J)

Austin
Jones, F. Burton (J)

Bastrop
Barrow, Lemuel T. (A)

Baytown
Groves, Wayland M. (A)

Beaumont
Bryan, William J. (A)
Daniels, Paul H. (A)
Gower, S. Gifford (A)
Johnson, Charles A. (A)
Trevey, C. B. (A)
Wengel, Raymond W. (A)

Brownsville
De Bardeleben, John F. (A)
Ogg, Glen R. (A)

Brownwood
Stark, L. P. (A)

College Station
Honnell, P. M. (A)

Dallas
Anderson, Donald T. (A)
Bennett, Porter T. (A)
Campbell, Donald O. (A)
Chapman, Alan B. (A)
Corry, Hal F. (A)
Crabtree, Alfred E. (A)
Evans, W. J. (A)
Feickert, Carl A. (A)
Flynn, Roy M. (A)
Glass, Robert Z. (A)
Godard, L. G. (A)
Hull, Blake D. (A)
Kancely, Norman J. (A)
Lawther, Harry P., Jr. (A)
Lewis, William S. (A)
McKinney, Joe H. (A)
Melroy, Harry C. (A)
Rich, F. L. (A)
Ritzau, K. (A)
Sheffield, H. M. (A)
Stewart, W. H. (A)
Witty, W. M. (A)
Zeidlik, William J. (A)

Denton
Fain, Edgar A. (A)

El Paso
Harold, George (A)

Ft. Worth
Abey, Robert E. (A)
Branch, William E. (M)
Golder, Frank E. (A)
Sullivan, J. R. (A)

Galveston
Dickey, J. W. (A)
Hughes, Kenneth E. (A)

Harper
Hopf, Max H. (A)

Houston
Austin, Francis M. (A)
Carter, William H., Jr. (A)
Chinski, Gerald R. (A)
Coe, James C. (A)

Crossland, Henry A. (A)
Duprec, Edmund M. (M)
Harvey, Francis M. (A)
Hoskins, Laban A. (A)
Kelly, Claude H. (A)
Machotka, Slavomir (A)
McDermott, Eugene (A)
McFarland, M. Ralph (A)
Ricker, Norman H. (A)
Stuedle, Emry C. (A)
Waters, James S. (A)
Wheeler, Harvey T. (A)
Zimmerman, George E. (A)

Jacksboro
Isbell, G. Terrill (A)

Kelly Field
Teague, T. T. (M)

Laredo
Otal, Carlos, Jr. (A)

Lubbock
Abbitt, William H. (A)

Mercedes
Schmitter, Ray M. (A)

Moody
McCauley, E. Ray, Jr. (A)

Odessa
Green, William G. (A)

Plano
Hays, Howard D. (A)

Port Arthur
Coburn, E. D. (A)

Rockland
Wilson, S. Earle (A)

Rowena
Machotka, Miroslav (A)

San Angelo
Jones, Frank M. (A)

San Antonio
Bridge, Robert B. (A)
Kanoofsky, Raymond (A)
Kidd, Thornton L. (A)
Kush, Fred W. (A)
Marriner, Alfred W. (A)
McShane, Joe Bailey (A)
Rayburn, Geoffrey D. (A)
Stroebe, John C., Jr. (M)
Wall, Leavell D. (A)

Waco
Jackson, Frank P. (A)

Wichita Falls
Ridling, Carroll W. (A)

UTAH

Murray
Smith, Edwin W. (A)

Ogden
Stanton, James M. (A)

Salt Lake City
Baldwin, John M. (A)
Baldwin, Nathaniel (M)
DeRemer, C. W. (M)
Lasky, Philip G. (A)
Westphal, Richard D. (A)
Yeates, Ephraim LeRoy (A)

Spanish Forks
Fullmer, Don A. (A)

VERMONT

Northfield
Howes, Douglas E. (A)

VIRGINIA

Alexandria
Dowie, James A. (M)
Evans, Louis M. (A)
Goggins, W. B. (M)
Harrison, Edgar (A)
Meyers, Paul F. (A)
Roesch, Robert E. (A)

Arlington
Mackay, Warren S. (A)

Danville
Clarke, Allen S. (A)

Norfolk
Kenny, Matthew (A)
Kortes, George T. (A)
Lord, Wilfred F. (J)
Payette, Walter S. (A)
Regan, Smiley I. (A)

Portsmouth
Baart, John C. (A)

Quantico
Eiler, E. E. (M)
Mizell, M. H. (A)
Pierce, Francis E. (M)

Richmond
Auckerman, U. H. (A)
Wood, W. H. (A)

Roanoke
Avery, Robert D. (J)
Maddox, Francis E. (A)

Rosslyn
Billups, Robert W. (A)

WASHINGTON

Auburn
Nagata, Charles N. (A)

Bremerton
Novotney, Harry J. (A)
Peterson, A. W. (M)
Wilson, George F. (A)

Cattle Point
Riley, Conrad D. (A)

Chelan
Kaul, William (A)

College Place
Kretchmar, G. G. (A)

Everett
Sands, Leo G. (J)

Fort Lewis
Shaw, Robert M. (A)

Gig Harbor
Berkheimer, R. H. (A)

Port Angeles
Kalin, Albert (A)

Richmond Highlands
Walker, Robert M. (A)

Seattle
Albert, J. H. (A)
Austin, Leslie C. (A)
Avery, Alfred L. (A)
Bach, Roy O. (A)
Binder, Theodore Joseph (A)
Brewington, Carl W. (A)
Budden, Frank W. (A)
Burleigh, John A. (A)
Carver, Orin H. (A)
Davis, R. K. (A)
Dawson, W. Robert (A)
Deardorff, Ralph W. (A)
Douglas, William A. (A)

Eastman, Austin V. (A)
Fitzpatrick, George William (A)
Foster, Nich H. (A)
Hackett, Paul J. (A)
Hamilton, Edward A. (A)
Helgren, Oiva M. (A)
Hemrich, Walter A. (A)
Hodges, Arthur T. (A)
Iverson, I. Vee (A)
Kleist, Walter A. (A)
Kuhn, Frederick S. (A)
Lovejoy, Edwin W. (M)
Mason, Howard F. (A)
Melang, Bjorn L. (A)
Mood, George T. (A)
Renfro, Harold E. (A)
Renhard, Julius A. (A)
Rewak, C. T. (A)
Rieger, William (A)
Ross, J. D. (A)
Rotta, Allen E. (A)
Sletmoe, A. M. (A)
Thomson, Howard M. (J)
Tolmie, J. R. (A)
Williams, Charles E. (M)
Willson, Abner R. (A)
Winningham, H. W. (A)
Zaluskey, Eugene R. (A)

Spokane
Doody, William R. (A)
Drobrig, Leo (A)
Dunnigan, Frank A. (A)
Eberly, Austin D. (A)
Johnson, Carl A. (A)
MacLean, T. Wendell (A)
Prince, Frank W. (A)
Smith, Oliver C. (A)
Storms, Henry J. (A)
Van Dusen, Paul F. (A)
Wimmer, Joseph (A)

Tacoma
Evans, Leon R. (A)
Jensen, Sven (A)
Miller, George C. (A)

Vancouver
Ryan, Lloyd F. (J)

Wenatchee
Lanphere, Merle (A)

Yakima
Hagen, B. W. R. (A)

WEST VIRGINIA

Cameron
Chambers, Albert V. (A)

Charleston
Berry, Henry P. (A)
Moore, Thomas H. (A)
Morgan, J. T. (A)
Stalnaker, Burr (A)

Chester
Faudree, R. F. (A)

Clarksburg
Chorpening, George B. (A)

Fairmont
Beerbower, R. G. (A)

Fayetteville
Goddard, John B. (J)

Huntington
Bieber, Clarence G. (A)
Hines, Oscar T. (A)

Institute
Evans, James C. (A)

WEST VIRGINIA (Continued)

Kingwood
Michelson, Peter (A)

Morgantown
Colwell, Robert C. (M)

Wheeling
Boundy, Glen G. (A)
Hallam, John T. (A)
Risley, F. S. (A)
Weimer, Earl W. (A)
Weis, F. J. (A)

Williamson
Pirotte, Pete (A)

WISCONSIN

Antigo
Matthias, Lynn H. (A)

Eau Claire
Langdell, Henry R. (A)

Fond du Lac
Eckert, Walter R. (A)

Glen Flora
Knutson, Ben M. (A)

La Crosse
Lecman, Alvin (A)
Van Loan, Cullen G. (A)

Lodi
Evert, W. E. (A)

Madison
Austin, Otto C. (A)
Bennett, Edward (F)
Curran, George W. (A)
Hagen, Paul A. (A)
Hoffman, W. Hollis (A)
Holman, Henry (A)
Kochler, Glenn (A)
Lighty, Russell D. (A)
Sveen, Erwing A. (A)

Manitowoc
Scholten, Charles H. (A)

Menasha
Peerenboom, Cyril A. (A)

Menomonie
Nathness, Semore T. (A)

Milwaukee
Almes, William E. (A)
Bogenberger, John, Jr. (A)
Brafford, Charles P. (A)
Cordes, Edwin L. (A)
De Land, Robert E. (A)
Frish, Ben F. (J)
Gainer, William P. (A)
Halfpap, Bert A. (A)
Heim, Carl (A)
Hilton, Waldo R. (A)
Holst, Ernest W. (A)
Hostetler, Amos C. (A)
Irving, Emmanuel (J)
Kaetel, Herbert C. (J)
Kelly, Daniel S. W. (A)
Kuenne, K. R. (A)
Le Van, James D. (A)
Luecker, Fred W., Jr. (A)
Manney, G. C. (A)
Moorbeck, Clinton (A)
Nunn, E. D. (A)
Oetting, O. W. A. (M)
Paul, George Stewart (A)
Pfeifer, Joseph W. (A)
Richardson, A. G. (M)
Richardson, Marston S. (A)
Roscr, Clarence O. (A)

Simon, Arthur (A)
Snead, Sam (A)
Stoekle, Erwin R. (M)
Tagart, Sam W. (A)
Thomas, Morris W. (A)
Topolinski, Leo J. (A)
Vaughn, F. A. (A)
Weiss, Tobias (A)
Wendler, Erwin, Jr. (J)

Neenah
Ponto, Aaron E. (A)

Osseo
Nelson, Orrin B. (A)

Plymouth
Limberg, Raymond A. (A)

Racine
Host, Raymond H. (A)

Rewey
Carpenter, Archie V. (A)

Sheboygan
Flentje, Le Roy G. (A)
Herider, Ernest D. (A)
Pfeiler, Lawrence F. (A)

Stevens Point
Brickson, Herbert O. (A)

Watertown
Ebert, Sylvanus J. (A)

Waukesha
Golding, Robert M. (A)
Hebal, William H. (A)

Wausau
Krueger, Otto J. (A)

Wauwatosa
Devendorf, H. H. (A)
Pierl, Donald (M)

WYOMING

Casper
Martin, Donald E. (A)

Cheyenne
McQueen, Harry D. (A)

Torrington
O'Reilly, Gordon A. (J)

ALASKA

Du Marce, Herman (A)
Hannon, John P. (A)
Maki, George J. (A)
Quist, Jesper S. M. (A)
Urie, Sol J. (A)

CANAL ZONE

Bullock, Gilbert D. (A)
Grafe, Hans R. (A)
Young, John W. (A)

HAWAII

Balch, J. A. (M)
Borthwick, James H. (A)
Branch, L. W. (M)
Clark, George W. (A)
Eller, Willard H. (A)
Janitschke, E. O. (A)
McDowell, C. S. (M)
Schaefer, Carl T. (A)
White, Edwin L. (A)

PHILIPPINE ISLANDS

Castaneda, Santiago (A)
Del Rosario, Manuel S. (A)
Galvez, Manuel E. (A)
Grupe, Emilio (A)
McKesson, Lewis J. (A)
Nance, Curtis H. (M)
Rau, David S. (A)
Riddle, Elmer R. (A)
Slater, F. Robert (A)
Thomas, William M. (A)

PORTO RICO

Agusty, Joaquín (A)
Delworth, Lee J. (A)
Draigh, Canton V. (A)
Schell, Richard, Jr. (A)

CANADA

ALBERTA

Duncan, James E. (A)
Ryley, Raymond (A)

BRITISH COLUMBIA

Barclay, Hugh N. (A)
Bartholomew, Francis J. (A)
Benson, John P. (A)
Deacon, Alan I. (A)
Filtness, Arthur W. (A)
Gilbert, George (A)
Hawkins, Ernest H. (A)
Hawkins, Leslie S. (M)
Irvine, Basil (A)
Kitchin, J. E. (A)
Lapham, James B. (A)
Mawson, John T., Jr. (A)
McCullagh, Karl G. (A)
Murdoch, G. (A)
Rose, F. W. (A)
Sawford, Frank, Jr. (A)
Thomas, Clarence W. (A)

MANITOBA

Bishop, Ernest F. (A)
Cotton, W. R. (A)
Lee, Stanley A. (A)
Leitch, Donald J. H. (A)
Mills, Gilbert H. (A)
Pound, Harris D. (A)
Salton, Lynn V. (M)
Varcoe, H. R. (A)

NEW BRUNSWICK

Megarity, Everett A. (A)
Stevens, Ronald C. (A)
Thorne, Frank A. (A)
Vaughan, Frank P. (A)

NORTHWEST TERRITORY

Hastings, R. Stuart (A)

NOVA SCOTIA

Sutherland, Alexander (A)
Wood, William (A)

ONTARIO

Ainsworth, A. L. (A)
Anderson, John F. (A)
Annett, Earl (A)
Bailey, Ambrose L. (J)
Bain, J. R. (A)
Baldwin, George (A)
Barber, Walter G. (A)
Bayne, R. R. (A)
Blakely, Robert John (A)

Bond, Roydon J. (A)
Bowers, E. J. (A)
Brown, Alvin H. (A)
Brown, Harry S. (A)
Campbell, Henry Lawson (A)
Caton, William A. (A)
Choat, William F. (A)
Cline, Russell A. (A)
Cluff, Harold D. (A)
Cooper, Ashton B. (A)
Crittler, W. J. (A)
Crofts, Cecil T. (A)
Cusack, Sidney C. (A)
Dalton, F. K. (M)
Daly, Edmund (A)
De Grave, Claude (A)
Dibblee, John (A)
Dresser, Carl C. (A)
Edwards, Charles P. (F)
Emes, Karl C. (A)
Erwin, Raymond W. (A)
Evans, George L. (A)
Fiegehen, Maurice G. (A)
Fisher, Albert E. (A)
Ford, J. S. (A)
Fowler, Walter D. (A)
Fox, Florian J. (A)
Freeman, William (A)
Gaby, Frederick A. (A)
Gadsby, S. J. (A)
Galbraith, R. A. H. (A)
Geldert, George M. (A)
Gerric, William H. (A)
Goodspeed, Lynmore S. (A)
Gowan, Frank S. (A)
Gowan, Hubert S. (A)
Graham, Burwell (A)
Grant, Eric A. (A)
Gurd, Ronald H. (A)
Hackbusch, Ralph A. (A)
Hancox, Harold (J)
Hebbel, Charles T. (A)
Henderson, J. P. (M)
Hepburn, Dugald (M)
Hill, Orville (A)
Hodsoll, Martin (A)
Hollinsworth, V. E. (A)
Hughes, Peter (A)
Innes, Ronald G. (J)
Jackson, Leslie (A)
Jessop, F. R. (A)
Kelterborn, W. H. (A)
Kinnear, Donald R. (A)
Knapman, Jack (J)
Knight, Frank (A)
Kynnersley, Charles (A)
Langford, C. H. (A)
Laurie, William L. (A)
Leonard, Sydney L. (A)
Leslie, John M. (A)
Lowry, Charles A. (A)
Lundy, Stanley R. (A)
Mann, George F. (A)
McAleavey, Henry V. (A)
McClain, Gordon W. (A)
McFarquhar, Charles Clifton (A)
McMillan, Donald B. (J)
McMurtry, Cyril A. W. (A)
Meredith, C. C. (A)
Mitchell, Leonard W. (A)
Mock, Elmer E. (A)
Mogridge, J. Nairn (A)
Montagnes, Henry (A)
Mott, Harold E. (A)
Mullen, Joseph G. (A)
Nash, James C. (A)
Nauth, Raymond (A)

ONTARIO (Continued)

Newman, John R. (A)
 Nichols, W. A. (A)
 Northover, Harold W. (A)
 Oxley, Allan B. (A)
 Paisley, Stewart R. (A)
 Parsons, J. B. (A)
 Patience, A. Melbourne (M)
 Patterson, C. F. (A)
 Pipe, Gordon E. (A)
 Pollock, C. A. (A)
 Pounsett, Frank H. R. (A)
 Price, Harold W. (A)
 Price, Roland J. C. (A)
 Richardson, Charles L. (M)
 Rogers, Edward S. (M)
 Rose, Sidney (A)
 Rosebrugh, Thomas R. (A)
 Rothera, W. F. (A)
 Ruse, Arthur (A)
 Rush, Walter A. (F)
 Russell, Arthur H. K. (A)
 Russell, W. G. (A)
 Schwarz, Bertram A. (M)
 Sherratt, Joseph B. (A)
 Smith, Arthur (A)
 Smith, B. J. (A)
 Smith, C. C. (A)
 Smith, Victor G. (A)
 Steel, W. Arthur (M)
 Taber, Harold E. (A)
 Tanner, Charles J. (A)
 Thompson, Milton L. (A)
 Thomson, John Morton (A)
 Underwood, Clifford C. (A)
 Van Sickle, Melvin (A)
 Wallace, J. M. (A)
 Walsh, Harold E. (A)
 Ward, Charles (A)
 Warwood, W. E. (A)
 Watling, William J. (A)
 Way, Harry C. (A)
 Weaver, William E. (A)
 Weber, Rennie I. (A)
 Weir, Harold G. (A)
 Whitmore, Walter R. (A)
 Wilkinson, Allan E. (A)
 Williams, James (A)
 Wilson, F. Clinton (A)
 Wood, H. W. T. (A)

QUEBEC

Acton, Edward H. (A)
 Andrac, Robert T. (A)
 Barrow, Frederick A. (A)
 Bellaw, Leo T. F. (J)
 Blais, Alphy L. (A)
 Cann, John O. G. (F)
 Carr, John (A)
 Cash, J. Allan (A)
 Chagnon, Adolphe (A)
 Comach, Stanley I. (A)
 Conroy, Joseph M. (A)
 Cooper, Samuel J. (A)
 Gagnon, Elmore G. (A)
 Goldin, Hyman C. (A)
 Guilford, E. H. (A)
 Hodgson, Edward (A)
 Howe, A. E. (A)
 Jackson, Arthur (A)
 Leonard, Percy A. (A)
 McWilliam, Eric A. (A)
 Menard, J. L. (A)
 Moore, William H. (A)
 Mullin, James W. (M)
 Olive, Gordon W. (A)
 Payne, I. Stanley (M)

Peachey, C. Arthur (A)
 Platt, J. E. (A)
 Ratchford, William J. (A)
 Robb, Robert J. (A)
 Rogers, Harold A. (A)
 Runciman, Arthur S. (A)
 Short, Herbert M. (M)
 Smith, Frederick A. (A)
 Soucy, Chester I. (A)
 Spencer, Leonard (M)
 Starr, C. Harry (A)
 Thompson, John H. (A)
 Tremblay, Joseph (A)
 Turnbull, Allison D. (A)
 Vennes, H. J. (M)
 Wade, David (A)
 Walker, H. S. (A)
 Wallace, G. A. (A)
 Wilcox, B. B. (A)
 Wilson, Clifford A. (A)
 Wilson, C. T. R. (A)

SASKATCHEWAN

Durkec, K. M. (A)

BRITISH ISLES

CHANNEL ISLANDS

Laker, Edward W. (A)
 Manning, William Montagu (A)

ENGLAND

Abraham, F. X. J. (A)
 Adams, Frank S. (A)
 Addey, Frederick (F)
 Agate, Carlton S. (M)
 Albiston, William A. (A)
 Allan, J. T. (A)
 Allen, Charles G. (A)
 Allinson, Cyril P. (A)
 Amis, Frederick H. (M)
 Andrewartha, H. C. (A)
 Andrews, W. A. (M)
 Appleton, Edward V. (A)
 Appleton, William A. (M)
 Armstrong, L. J. Heaton (A)
 Ashwin, Cecil W. H. (A)
 Atkinson, Cyril T. (A)
 Axten, Bernard J. (A)
 Bagshaw, George W. (A)
 Bailey, Walter H. (M)
 Bainbridge-Bell, L. H. (A)
 Baird, Frederick (A)
 Baker, Thomas T. (M)
 Barber, William E. (M)
 Barker, Percy L. (A)
 Barrington, R. N. (M)
 Bartlett, A. C. (A)
 Bartlett, Wallace A. (A)
 Bates, Cyril R. (A)
 Bennett, F. T. (A)
 Berger, Maurice (M)
 Bever, Anthony J. M. (A)
 Biltcliffe, Thomas (A)
 Binyon, Basil (M)
 Bird, R. J. (M)
 Bonong, Edward (A)
 Bowen, Harry L. (A)
 Boyce, Frank A. (A)
 Boyd, W. Forbes (A)
 Boyle, Charles W. (M)
 Brown, Walter J. (M)
 Brown, William G. (A)
 Bulgin, Arthur F. (M)
 Burnham, Walter W. (F)
 Burrowes, Francis E. (A)
 Calver, Frank N. (M)

ENGLAND (Continued)

Carpenter, Rupert E. H. (M)
 Carter, F. C. (A)
 Casper, Christopher C. (A)
 Caswall, Herbert (M)
 Catt, James E. (M)
 Chandler, Charles K. (A)
 Chesterton, Arthur J. (M)
 Clarke, Douglas F. (A)
 Clarke, George E. (A)
 Cobb, F. Arthur (M)
 Cohen, Isaac J. (A)
 Cohen, Samuel H. (A)
 Cooper, J. A. (A)
 Cooper, W. H. B. (J)
 Coursey, Philip R. (A)
 Courtenay-Price, George (A)
 Cox, C. F. (A)
 Crampton, William J. (M)
 Crawford, Cecil G. (A)
 Curd, David A. (A)
 Curtis, Francis C. (A)
 Dack, Allan J. S. (A)
 Dack, John H. A. (A)
 De Burgh, Desmond H. (M)
 Dennis, Frank L. (A)
 Devine, William F. (A)
 De Wardt, Robert G. (M)
 Diggle, A. J. (A)
 Dinsdale, Alfred (A)
 Ditcham, William T. (M)
 Diver, Frederick G. (A)
 Dixon, Ronald (A)
 Downing, George E. C. (A)
 Dowssett, Harry M. (M)
 Drake, George P. (A)
 Dryland, Alan G. (M)
 Durrant, Reginald F. (M)
 Eekersley, P. P. (F)
 Edes, Noel H. (A)
 Elliott, Isaac (A)
 Elwell, Cyril F. (F)
 Emerson, R. Waldo (A)
 Emery, E. J. (M)
 Enderle, Jackson J. (A)
 Erdman, H. (A)
 Evans, Young W. P. (M)
 Everest, Augustine R. (A)
 Everett, Lionel E. B. (M)
 Faulkner, Harry (M)
 Featherstone, William A. E. (A)
 Field, Harry T. F. (A)
 Flagg, Leonard B. (A)
 Flintham, Herbert (A)
 Floyd, William F. (J)
 Foord, Henry D. G. (M)
 Frost, Cyril C. J. (M)
 Gambrell, Horace W. (A)
 Gee, Harry T. P. (A)
 Gee, Walter C. (A)
 Gill, Archibald J. (M)
 Glossop, Arthur A. (A)
 Glover, Phillip F. (M)
 Godfrey, Mason (A)
 Goldsman, J. L. (A)
 Goord, H. V. (A)
 Gracie, John A. (A)
 Green, Charles M. (A)
 Green, Ernest (A)
 Griffiths, Herbert V. (A)
 Griffiths, W. H. F. (M)
 Haigh, Norman E. (A)
 Hall, Albert (M)
 Hall, Norman (A)
 Hambling, Arthur W. (A)
 Hannah, W. J. (A)
 Hansford, R. V. (M)

Hardy, Harold (M)
 Harries, John H. O. (A)
 Harris, Percy W. (M)
 Harris, Raymond (A)
 Harrison, Walter L. (A)
 Harvey, Herbert J. (A)
 Harvey, Lionel (M)
 Hawes, R. Nesbitt (M)
 Hawkins, John H. (A)
 Hayman, William G. (A)
 Healey, Oliver (A)
 Henderson, Francis A. (A)
 Henderson, John T. (A)
 Henderson, Walter B. (A)
 Herd, James F. (M)
 Hewetson, Geoffrey B. (J)
 Hill, Ernest N. (A)
 Hinderlich, Albert (A)
 Hines, C. C. A. (A)
 Hinks, Geoffrey D. (A)
 Hinks, Henry J. (A)
 Hinton, Norman P. (M)
 Hirshman, Cyril L. (A)
 Hodgkinson, Henry (A)
 Holbeach, William M. (A)
 Holmes, Cyril T. (A)
 Holzman, Louis (A)
 Hotine, Leslie (M)
 Howard, C. Alexander (A)
 Howard, C. G. (A)
 Hows, Leonard J. (A)
 Howse, H. A. G. (M)
 Hughes, D. W. (A)
 Hughes, Lionel J. (A)
 Jackson, Willie (A)
 James, William P. (A)
 Jeffery, Jack H. (A)
 Joice, W. S. (A)
 Jones, Arthur B. (A)
 Jones, Frank E. B. (A)
 Joseph, J. (M)
 Kinman, Thomas H. (M)
 Kirke, Harold L. (M)
 Klein, Rene H. (M)
 Kynaston, B. H. J. (A)
 Ladner, Alan W. (A)
 Lamb, William H. (A)
 Lance, Thomas M. C. (A)
 Landale, S. E. A. (A)
 Lassman, Henry H. (A)
 Lawler, L. A. C. (A)
 Leathes, W. H. B. De M. (A)
 Lee, Albert G. (F)
 Lemon, Cecil G. (A)
 Litchfield, Gordon A. (A)
 Littledale, H. A. P. (A)
 Lyle, Herbert B. (A)
 Lyons, C. L. (M)
 MacKenzie, D. G. (A)
 Maitland, James L. (A)
 Male, Samuel C. (A)
 Mansell, Lionel H. (M)
 Marconi, Guglielmo (F)
 Marshall, J. A. (A)
 Matthews, Leslie A. (A)
 May, John (A)
 McDonald, George F. H. (A)
 McLeod, John S. (A)
 McMichael, Leslie (F)
 Meadows, Cyril (A)
 Megaw, E. C. S. (A)
 Mills, William F. (A)
 Minter, Robert W. (A)
 Mockford, Frederick S. (A)
 Moore, John T. (A)
 Morris, Robert (A)
 Moulin, E. B. (M)

ENGLAND (Continued)

Mulholland, William (A)
 Mumford, Albert H. (A)
 Murphy, Frank (A)
 Mustchin, Norman (A)
 Myers, George T. (A)
 Nancarrow, F. E. (M)
 Newnham, Leonard E. (A)
 Nicholson, James K. A. (M)
 Noden, Joseph (A)
 Nottage, William H. (A)
 Odell, Leslie F. (A)
 Ogg, John G. (A)
 O'Neill, R. F. (A)
 O'Shaughnessy, J. J. F. (M)
 Owner, John S. (A)
 Palmer, R. J. (A)
 Panagakis, Harry (A)
 Parker, A. Raymond (A)
 Parkin, Thomas D. (A)
 Parry, Albert H. (A)
 Payne, Eric A. (A)
 Pearce, R. A. (A)
 Pearson, Laurence H. (A)
 Pecorini, Robert R. (M)
 Petersen, Thomas G. (A)
 Phillips, Charles F. (M)
 Picken, William J. (A)
 Pill, Cecil R. (A)
 Pinnock, L. W. J. (A)
 Pipe, Robert E. (A)
 Pocock, Hugh S. (M)
 Potts, Edward (A)
 Pound, Ernest J. (A)
 Rae, William T. (A)
 Ramirez, Eduardo Garcia (M)
 Ratcliffe, J. A. (M)
 Reyner, John H. (M)
 Rhys-Jones, John E. (A)
 Richardson, F. C. (A)
 Rickard, Charles E. (M)
 Riddiough, John W. (A)
 Ridgeway, John W. (A)
 Ripley, Henry P. (A)
 Robb, Frederick G. (A)
 Robb, William I. (A)
 Robinson, Frederick H. (A)
 Rowland, Edgar S. (A)
 Russell, M. W. G. (M)
 Saltmarsh, Beatrice (A)
 Samarasekara, V. R. (A)
 Scott-Taggart, John (A)
 Shaughnessy, E. H. (M)
 Shaw, A. C. (M)
 Shore, Anak (A)
 Sieger, J. (A)
 Simmonds, E. J. (M)
 Simpson, Alexander V. (M)
 Slater, Wilfred (A)
 Slee, John A. (F)
 Smith, Harold I. (A)
 Smith, James H. (A)
 Smith, Sidney B. (M)
 Smurtwaite, F. W. (A)
 Somerset, E. T. (A)
 Sparrow, A. W. (A)
 Stanesby, Harold (A)
 Storry, Thomas G. (A)
 Strong, Charles E. (M)
 Struthers, G. A. (M)
 Sutton, William F. P. (A)
 Tanton, John H. (A)
 Taylor, Alfred O. (A)
 Thacker, M. S. (A)
 Thomas, Einion (A)
 Thomas, Guy H. (A)

Thompson, Alfred E. (M)
 Thomsett, H. S. (A)
 Thorpe, Stewart Meville (A)
 Tiltman, Ronald F. (A)
 Tingey, Robert (M)
 Tomlinson, Frank (A)
 Tompsett, F. J. (A)
 Towers, Robert (A)
 Townsend, Frank T. G. (M)
 Tozer, William C. (A)
 Trippier, Francis J. (A)
 Troutbeck, Wilfrid H. (A)
 Turlle, Edgar H. (M)
 Turner, Laurence B. (A)
 Turvey, Henry C. (A)
 Vernon, Basil H. (A)
 Wade, C. F. Newton (M)
 Wainwright, Albert (A)
 Walker, Harold S. (A)
 Wallace, Alex T. (A)
 Walmsley, Thomas (M)
 Ware, William (A)
 Warner, Frederick F. (A)
 Warner, H. J. (M)
 Warren, A. C. (A)
 Watson, George H. (A)
 Webb, James H. (A)
 Weight, H. Aubrey (A)
 White, Herbert G. (A)
 White, John W. (A)
 Wicks, Frank W. (A)
 Wicks, Reginald P. (A)
 Wilde, S. F. M. (A)
 Williams, Cecil G. (A)
 Williams, Eric (A)
 Wilson, William P. (A)
 Wood, Charles E. (A)
 Wood, Robert H. (M)
 Woodhead, H. C. (A)
 Woodward, P. J. (M)
 Wright, Sydney R. (M)
 Wroughton, Thomas H. (A)
 Young, Alfred W. (A)

IRELAND

Dunphy, Thomas O. (A)
 Ferguson, John D. (M)
 Jamison, Alexander (A)
 Kitchen, James P. (A)
 McVeigh, James P. (A)
 Neill, Frank R. (A)
 Wheeler, Edmund F. (A)

SCOTLAND

Allan, Ernest J. (A)
 Beveridge, John A. (M)
 Carnie, Ben (A)
 Chadder, E. G. (A)
 Dunbar, James (A)
 Edwards, R. M. (J)
 Fleming, Samuel (A)
 Jamieson, William E. (A)
 Knowles, J. G. (A)
 Logan, James S. (A)
 Murchie, John (M)
 Neil, William Russell, Jr. (A)
 Ramsay, John F. (J)
 Rollo, W. Smith (A)

WALES

Carson, John M. (A)
 Irving, Donald H. (A)
 Rees, David (A)
 Whale, Gordon S. (A)
 Yates, Ivan (A)

AFRICA

EAST AFRICA

Ball, George F. (A)

EGYPT

Baroudi, Kamel S. (A)

SOUTH AFRICA

Adendorff, Gerald V. (M)
 Allaway, George N. (A)
 Archer, C. (A)
 Barnett, Eric E. (A)
 Borthwick, Roderick J. (A)
 Brickhill, G. A. (A)
 Chenik, Aaron (A)
 Cumming, Noel D. (A)
 Gilmour, Peter (A)
 Goodman, Joseph M. (M)
 Howard, W. B. (A)
 Jacobs, Alwyn J. (A)
 Jephcott, Ernest L. (A)
 Knight, Arthur W. (A)
 Kos, Simon F. (M)
 Lukat, John Frederick (A)
 Morison, Bruce (A)
 Myers, H. (A)
 Nutt, A. (A)
 Rees, Hubert S. (A)
 Rogers, Arthur H. E. (M)
 van der Bijl, Hendrik J. (F)
 Yapp, William G. (A)

SUDAN

Edgeworth, Kenneth E. (M)

ASIA

CHINA

Chang, Ting Chin (M)
 Chen, C. C. (A)
 Chen, C. Mayo (A)
 Chen, Shujen (A)
 Chen, Ying-Chien (A)
 Chien, F. C. (A)
 Chin, Tsunyi (J)
 Chu, Chih Teih (A)
 Chu, K. T. (A)
 Chu, Yun (J)
 Ede, Frank C. (A)
 Fung, Huo-Siu (J)
 Harmer, Leslie B. (A)
 Harris, Arthur L. (M)
 Hsu, Philip H. (A)
 Hwang, Ju-Tsu (J)
 Kinase, Matsunaga (M)
 Lee, Shee Mou (A)
 Maeda, M. (A)
 Nec, Sangta (A)
 Saitow, Kenji (A)
 Seto, Joe N. (A)
 Shen, P. L. (A)
 St. Louis, A. R. (A)
 Tsao, T. C. (A)
 Tsao, Zeuson C. (A)
 Tsia, Hock L. (A)
 Tsiang, C. Y. (A)
 Tung, Kai (J)
 Zee, Liang (A)

FEDERATED MALAY STATES

Cadman, Claude G. (M)
 Carson, Andrew H. (A)
 Peck, George T. (A)
 Singh, Harbaksh (J)
 Suares, Jose B. (A)
 Wilkinson, Bernard (A)

INDIA

Bull, W. J. H. (A)
 Chapman, Thomas J. (A)
 Cornfield, M. (A)
 Dighie, K. S. (A)
 Ferdinando, Christie (A)
 Ghosh, B. N. (J)
 Harper, Edgar (M)
 Kantebet, S. R. (A)
 Lea, George (A)
 O'Rourke, Sydney P. (J)
 Pichumani, K. K. (A)
 Rangachari, T. S. (A)
 Sellick, A. M. (A)
 Wijeyeratne, P. De S. (A)

JAPAN

Akasaka, Toshi (A)
 Akutsu, Shuji (A)
 Anazawa, Chuhei (A)
 Arakawa, Daitaro (A)
 Fujikura, Keijiro (A)
 Fujimoto, Tadashi (M)
 Fukushima, T. (A)
 Hamada, Shigenori (A)
 Hashimoto, Chuji (A)
 Hashimoto, S. (A)
 Hirose, M. (A)
 Horiguchi, Jiro (A)
 Inuma, H. (A)
 Imaoka, Yoshio (A)
 Inada, Sannosuke (M)
 Inanami, Suco (A)
 Ishikawa, Shoichi (A)
 Itow, Yutaka (A)
 Kanayama, Toyosaku (A)
 Kanko, Go (A)
 Kanno, Gengo (A)
 Kato, Y. (A)
 Kawahara, Takewo (A)
 Kimpura, Atsushi (A)
 Kobayashi, Kichijiro (A)
 Kobayashi, M. (A)
 Koshikawa, Y. (A)
 Koyama, Kumenosuke (A)
 Kuno, T. (A)
 Kuramochi, Shaju (A)
 Kusakari, T. (A)
 Kusunose, Yuziro (A)
 Kuwajima, T. (A)
 Marumo, Noboru (A)
 Marumoto, Kenji (A)
 Matsui, K. (A)
 Matsumura, Sadao (A)
 Mita, S. (A)
 Mitsubishi, Hide Kadzu (A)
 Mitsutake, Katsumi (A)
 Miyauchi, T. (A)
 Morita, K. (A)
 Moriwaki, Katsumi (A)
 Nagai, Kenzo (A)
 Nagao, R. (A)
 Nakagimi, T. (M)
 Nakai, Tomozo (A)
 Nakajima, S. (A)
 Nakamura, H. (A)
 Namba, Shogo, (A)
 Namba, Yasukazu (A)
 Niiya, Takuji (A)
 Niwa, Yasujiro (A)
 Ono, Shoji (A)
 Ono, Takashi (A)
 Otani, S. (A)
 Otsuka, Y. (A)
 Owada, Mankitsu (A)
 Saito, Masao (A)
 Sakai, Sadao (A)
 Sasaki Tei (A)

JAPAN (Continued)

Sasaki, Toshiro (A)
 Sayeki, Mitsuru (F)
 Shimayama, Tsuruo (A)
 Simbori, Masayosi (A)
 So, Manabu (A)
 Sonoyama, Harutoshi (A)
 Suga, Y. (A)
 Suzuki, Hisao (A)
 Taguchi, Minoru (A)
 Takebayashi, K. (A)
 Terahata, Matsutarō (A)
 Tesch, Walter L. (M)
 Tsumura, Kazuo (A)
 Tsushima, Yonekichi (A)
 Uchida, Satoshi (A)
 Ueno, Shuzo (A)
 Watanabe, Yasusi (M)
 Yagi, Hidetsugu (F)
 Yamaguchi, Usaburo (A)
 Yokoyama, Eitaro (M)
 Yokoyama, Tetsumi (A)
 Yoshiro, Kuroda (A)

PALESTINE

Instrall, Reginald C. (A)
 Thompson, F. S. (A)

STRAITS SETTLEMENTS

George, Philip H. F. (A)
 Sutherland, J. G. A. (M)

CENTRAL AMERICA

COSTA RICA

Carazo, Louis A. (A)
 Carranza, Jose J. (M)

REPUBLIC OF PANAMA

Moxon, Alfred W. (A)

EUROPE

BELGIUM

Phillipson, Maurice (M)
 Wise, S. J. (A)

CZECHOSLOVAKIA

Kafka, H. T. (A)
 Strnad, Josef (A)
 Svoboda, Jaromir (M)
 Zacek, August (M)

DENMARK

Bertzow, Johannes A. (A)
 Christensen, Jens P. (A)
 Heegaard, Frederik D. (A)
 Hellstrom, G. (A)
 Jarnak, Paul (A)
 Jorgensen, Laurits (A)
 Nyholm, Christian (A)
 Pedersen, Martin P. (A)
 Pedersen, Peder Oluf (F)
 Poulsen, Valdemar (F)
 Rybner, Joergen C. F. (A)
 Schou, Carl (A)
 Svenningsen, Karl (A)

FRANCE

Behm, Ludwig F. (A)
 Bethenod, J. F. J. (A)
 Campbell, Howard E. (M)
 Cheffel, Alexis M. (M)
 De Bellescize, Henri J. J. M. (M)
 De Bozas, Guy Du Bourg (A)
 Deloraine, Edmond M. (M)
 Ferrie, General (F)
 Gray, Richard E. (A)

Knight, Sidney G. (A)
 Leslie, Fred D. (A)
 Levy, Lucien (M)
 Lush, William G. (M)
 McLean, Francis C. (A)
 Mirk, D. Blair (A)
 Paddon, Cecil John (A)
 Raven-Hart, Ronald J. M. (M)
 Riu, Agustin M. (A)
 Roosevelt, S. L. (M)
 Ullrich, Edward H. (M)

GERMANY

Barkhausen, H. (A)
 Hamm, Arthur (A)
 Hertweck, C. (A)
 Hofmann, A. Clemons (M)
 Kofes, Albert (M)
 Lock, M. J. (A)
 McClatchie, Stanley (A)
 Meissner, A. (F)
 Rothe, Glorst (M)
 Runge, Wilhelm T. (M)
 Seibt, George (M)
 Suadicani, Guenther (M)
 Von Ardenne, Manfred (A)
 Wagner, Karl W. (F)
 Zenneck, Jonathan (F)

GIBRALTAR

McIntosh, Ronald A. (A)

HOLLAND

Bartelink, E. H. B. (A)
 Breimer, S. H. (A)
 De Graaff, Antonius (A)
 Langendam, S. G. C. (A)
 Liebert, W. (M)
 Moree, W. (A)
 Roorda, J., Jr. (A)
 Schotel, G. (M)
 van der Bilt, Cornelius L. (A)
 van der Pol, Balth., Jr. (F)

HUNGARY

Detsly, Charles F. (A)

ITALY

Banfi, Alessandro (A)
 Ducati, Adriano C. (A)
 Matteucci, Aldo (A)
 Osiatinsky, L. (M)
 Pession, Giuseppe (F)
 Sella, Giuseppe (A)

MALTA

Kennedy, John C. (A)

POLAND

Modrak, Peter (A)
 Rzymowski, E. (A)
 Sokolcow, Dmitri M. (M)

PORTUGAL

Tisshaw, Henry S. (M)

SPAIN

Alonso, Julio (A)
 Crespo, Jose (M)
 Cuervo, Luis S. (A)
 Escolano, Manuel (M)
 Matres, Trinidad (M)
 Moya, Miguel (A)
 Urgoiti, Ricardo M. de (A)
 Wendell, Edward N. (A)

SWEDEN

Fransson, Frans J. (A)
 Lemoine, A. S. (A)
 Sterky, Hakon K. A. (A)

SWITZERLAND

Anselmi, S. C. (A)

U.S.S.R. (RUSSIA)

Bashenoff, Valerian I. (M)
 Grzybowski, Wladyslaw (A)
 Kacourine, Serge N. (A)

MEXICO

Bourgeois, Allen B. (A)
 Buchanan, J. C. (A)
 Cota, Pedro N. (A)
 Escrich, James P. (A)
 Fernandez, Manuel A. (A)
 Reuthe, Gustav (M)
 Sardaneta, Raymundo (A)

OCEANIA

AUSTRALIA

Bain, John L. (M)
 Bardin, William F. (A)
 Bearup, T. W. (M)
 Brooker, Vivian M. (A)
 Cherry, Richard O. (A)
 Coxon, Walter E. (A)
 Elliott, Frank E. (A)
 Fisk, Ernest T. (F)
 Fitts, Rupert A. (A)
 Grace, A. (A)
 Green, Alfred L. (A)
 Hesson, W. Gordon (A)
 Hooper, Edgar M. (A)
 Hopton, Archie T. (A)
 Hull, Ross A. (M)
 Jackson, Alfred C. (A)
 Linnett, Douglas N. (A)
 MacLurean, Charles D. (A)
 Malone, James J. (M)
 McCulloch, George R. (J)
 McDonald, Arthur S. (M)
 McIntyre, Daniel G. (A)
 Melhuish, Charles A. (A)
 Miller, Frances G. (A)
 Neve, Gordon H. (A)
 Shaw, Raymond H. (A)
 Shephard, Maxwell (J)
 Sutherland, George B. (A)
 Sweeney, Walter M. (M)
 Thompson, Cecil (A)
 Wyles, David G. (M)

JAVA

Verdam, Nicholas H. (M)

FRIENDLY ISLANDS

Land, John R. (M)

NEW ZEALAND

Barnett, M. A. F. (A)
 Bingham, John M. (A)
 Bradley, Ernest A. (A)
 Brent, Herbert C. (M)
 Cunningham, John (A)
 Dawson, Wilfred M. (A)
 Gibbs, R. J. (A)
 Grant, R. L. C. (A)
 Matthews, P. H. (A)
 McKewen, J. D. (A)
 McLennan, Roderick Arthur (M)

Pinder, A. (A)
 Ruscoe, Charles R. (A)
 Russell, Cecil R. (M)
 Russell-Boyle, H. (A)
 Taylor, Conway M. (M)
 Thow, Keith H. (M)

SAMOA

Taylor, Samuel (A)

SOUTH AMERICA

ARGENTINE

Hayes, George W. (A)
 Starrett, John S. (A)
 Stevens, Archie M. (M)
 Zuev, Vitaly V. (A)

BRAZIL

Barreto, M. De Barros (F)
 Cesar, Amarel (A)
 Keir, John (M)
 Lacombe, Carlos G. (A)
 Oliveira, A. Menezes de (M)
 Santos, Anthony S. (A)
 Weeden, Edward H. (A)

BRITISH GUIANA

Jarman, Alick D. (A)
 Tasker, J. T. (A)

CHILE

Basauré, Aliro (A)
 Brito, Alberto R. (M)
 Daley, Francis T. (A)
 Diamond, Harvey (A)
 Vierling, Gustav (A)

COLOMBIA

Hill, H. F. (A)
 Michael, David F. (A)
 Shire, Leo E. (A)

PERU

Gould, George B. (A)
 Madgwick, G. (M)
 Robertson, Joseph J. C. (A)
 Scholz, Carl E. (M)

URUGUAY

Cross, Harry (A)

WEST INDIES

BAHAMAS

Salter, David (A)

BERMUDA

Cookson, Walter (M)

CUBA

Gonzales, Jorge L. (A)
 Hill, Earle E. (A)
 Jones, Frank H. (A)
 Kissel, Alfred L. (A)
 Lara, Jose (A)

JAMAICA

Ratcliffe, L. G. (A)

VIRGIN ISLANDS

Miller, Joseph Anthony (A)

POLYMET
POLYMET
POLYMET
POLYMET

WE, too, can shout our name from the house-tops. ¶ But—can such shouting be one-half so impressive as this truthful statement, quietly made: "Over 80% of the great radio set manufacturers of the country are users of POLYMET PRODUCTS."

Condensers
Connectors

Resistances
Transformers

Coils
Plugs

by



POLYMET MANUFACTURING CORP.
829-J E. 134th Street, New York City

Outstanding Performance
PROVES They're The Best

FLECHTHEIM SUPERIOR CONDENSERS

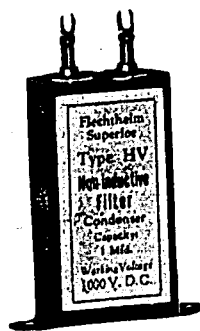

THOROUGHLY DEPENDABLE
 CONSERVATIVELY RATED
 HIGHEST QUALITY
 OF MATERIALS
 FINEST WORKMANSHIP
 SUPERIOR ELECTRICAL
 CHARACTERISTICS
 REASONABLY PRICED



TWO NEW REMARKABLE CONDENSERS

Type HV

Rated 500 rms RAC—800 DC
 (for 245 or 345 tubes)

Type HS

Rated 660 rms RAC—1000 DC
 (for 250 or 350 tubes)

Both are Non-Inductively wound and are extremely small in size—
 have a high voltage breakdown and are dependable under all normal
 operating conditions.

**USED IN LOFTIN-WHITE'S LATEST VOLTAGE
 COUPLED AMPLIFIER**

Also—A Most Complete Line of By-pass, Filter, Midget and
 Superior Condenser Blocks for All Purposes and Uses.

**FLECHTHEIM SUPERIOR TRANSMITTING CONDENSERS
 ARE USED BY MORE THAN 35% OF THE
 BROADCAST STATIONS**

Write for 1930 catalog

A. M. FLECHTHEIM & CO. Inc.
 136 Liberty St., New York, N. Y.

Solid Molded

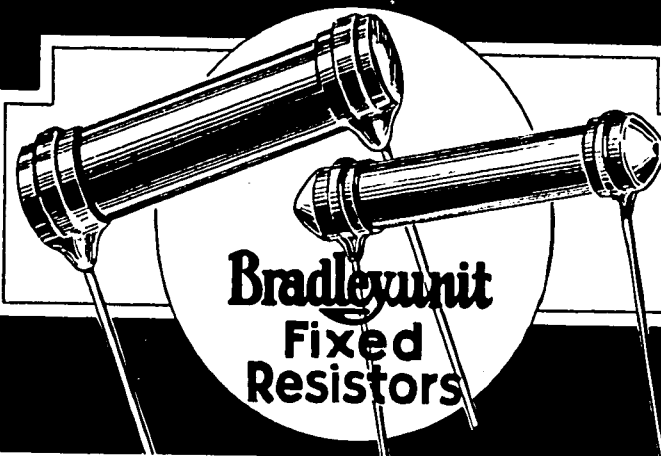

Rugged-Accurate-Permanent

Compare These
 Oscillograms



Oscillogram showing noiseless performance of Bradleyunit Resistors.

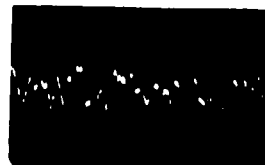

Oscillogram showing noisy performance of other types of resistors.

SOLID MOLDED—that is the secret of the superior performance of the Bradleyunit. Made in ratings from 500 ohms to 10 megohms, these accurate, noiseless fixed resistors are the choice of the leading set manufacturers for grid leaks and plate coupling resistors.

All Bradleyunits are color-coded for quick and easy identification. They are not fragile. There are no production losses due to breakage. Temperature, moisture, and age do not affect Bradleyunit accuracy.

Follow the example of leading radio manufacturers, and standardize on the Bradleyunit. Write for further information and prices.

ALLEN-BRADLEY CO., 282 Greenfield Ave., Milwaukee, Wis.

Allen-Bradley

PERFECT RADIO  RESISTORS.

This New Clear Thinking--Hard-- Fast--In New Directions

It's Here--Right Now--Everywhere--Sweeping
Into Every Industry

Something is happening--
Headed "Upward."

Moving Faster--Spreading Deeper.

Permanent--
Nothing can stop it now.

Industry's Next Great Stage is
Starting

THE new prosperity, now preparing, will be based on new thinking, new ways, new thoroughness. New conditions are ahead of us. Some are here now. Production-thinking and equipment-thinking are sharper, faster, more complete. And with a stronger will to mesh perfectly with every aim and problem of business.

Just the hint of a business dip was enough. Even if it is over by the time you read this, the fast, keen, fresh thinking that it started is going on. It is getting more momentum. Its results in business and industry will be permanent. The new direction of industry's advance is being determined right now.

Already you feel it everywhere. Nothing escapes the sharp scrutiny of this new thinking. Methods, materials, equipment, designs, models, old ways, old slots, old neglects of opportunities, old "leech wastes"; all are in the crucible now.

From top to bottom in industry the best thought of all workers is being enlisted by executives.

The Fact-Sheets of Industry aim to help the scope and thoroughness of the new thinking, by supplying it with practical material; facts that

Write NOW. There is no charge. First of FACT-SHEETS of INDUSTRY, now in preparation, will be mailed free to ANY Worker, any Executive, if quick. . . .

State work you do, your company's product or business; and whether request is for self. Address: Librarian (B-3), National Vulcanized Fibre Company, Wilmington, Del. (Card will do.)

every executive and every worker may find useful now. Facts no worker can do without, if he looks ahead and wants to be in step with his company's new aims and efforts.

The publication of this, the first of the Fact-Sheets of Industry, is the start of a plan which, when at its full growth, will supply freely to thinking workers in ALL levels of industry, practical knowledge which hitherto has not been readily accessible; facts from many other industries which may stimulate their own productive thinking; and which, (though they affect practically every business, every department and every worker), are usually known only in part and only by a limited group of specialists in each industry.

NVF

As a movement in line with national measures for further improvement of business conditions and of the circuit of producing, earning, consuming, equipping, etc.;—and as the initial step in this democratizing of inter-industry knowledge (which, under present conditions, is more needed by thinking workers, and can yield more important results than ever before);—all expenses of issuing the first of the Fact-Sheets of Industry are being borne by The National Vulcanized Fibre Company and its various divisions and associated industries.

ROLLER-SMITH PRODUCTS

ROLLER-SMITH products comprise complete lines of electrical measuring instruments, indicating and graphic, relays and air and oil circuit breakers. Bulletins covering the various devices will be sent promptly on request.

SWITCHBOARD INSTRUMENTS

D. C. Ammeters, Voltmeters and Volt-ammeters, 3½" and 4" sizes..	Bulletin No. K-400
A. C. Ammeters, Voltmeters and Wattmeters, 3½" and 4" sizes....	" " 420
D. C. Ammeters and Voltmeters, large sizes.....	" " 430
A. C. Ammeters, Voltmeters, Wattmeters, Power Factor Meters, Frequency Meters, large sizes.....	" " 450
Radio Frequency Ammeters, all sizes.....	" " 810

PORTABLE INSTRUMENTS

A. C. and D. C. Ammeters, Voltmeters and Volt-ammeters; Ohmmeters and Circuit Testers for signal system and train control apparatus testing.....	Bulletin No. 100
A. C. Ammeters, Voltmeters, Volt-Ammeters, Wattmeters, Frequency Meters and Power Factor Meters, small and large sizes.....	" " 160
Rail Bond Testers.....	" " 200
D. C. Ammeters, Voltmeters, Volt-Ammeters and Galvanometers, small and large sizes.....	" " 210
Precision Torsion Balances for weighing lamp filaments and other small bodies.....	" " 240
Ohmmeters and Circuit Testers.....	" " 300

INSTRUMENT TRANSFORMERS

Portable types.....	Bulletin No. 160
Switchboard types.....	" " 450

AIR CIRCUIT BREAKERS

A. C. and D. C., Industrial Type, all styles of trips, 100 amperes and less	Bulletin No. 520
A. C. and D. C., Standard Type, all styles of trips, all ampere capacities	" " 530
A. C. and D. C., Enclosed Type, 800 amperes and less.....	" " 580

OIL CIRCUIT BREAKERS

All classes.....	Bulletin No. 600
------------------	------------------

RELAYS

D. C. Relays, reverse current, etc.....	Bulletin No. 550
---	------------------

ROLLER-SMITH COMPANY
Electrical Measuring and Protective Apparatus

Main Office:
2134 Woolworth Bldg.
NEW YORK



Works:
Bethlehem
Pennsylvania

Offices in principal cities of U. S. A. and Canada.

Representatives in Australia, Cuba, Japan and Philippine Islands.

From Line Voltage to Loud-Speaker

Years of specialization in radio resistance problems have gone into the development of the CLAROSTAT line. We pioneered in the compression type variable resistor, serving the radio industry during the trying days of battery radio and the uncertain days of Beliminators. We pioneered in the development of inexpensive wire-wound flexible and flat type resistors. We pioneered in hum control for A-C operated tubes. We pioneered in the development of a satisfactory line voltage ballast, and more recently in a really satisfactory volume control. And so

CLAROSTAT

is more than the name of a good product; more than the name of a line of good radio aids; it is the hallmark of a research and engineering service dedicated to better resistance technique and production.

From LINE BALLAST CLAROSTAT, the ideal line voltage control device now standard in better type broadcast sets, to HUM-DINGER or adjustable center-tap resistor, and again to FLEXIBLE and FLAT TYPE RESISTORS, and still again to the perfected WIRE-WOUND VOLUME CONTROL CLAROSTAT, you are assured of thorough engineering and honestly manufactured products as insurance on your radio assemblies against commonplace service troubles. Specify CLAROSTAT and you specify satisfaction.

Write for engineering data regarding CLAROSTAT aids to better radio. Better still, present your special engineering problems, and we shall be more than happy to co-operate with you in their solution, even to the extent of providing samples made to your specifications.

CLAROSTAT MANUFACTURING CO., Inc.

Specialists in Aids to Better Radio

289 North Sixth Street, Brooklyn, N.Y.

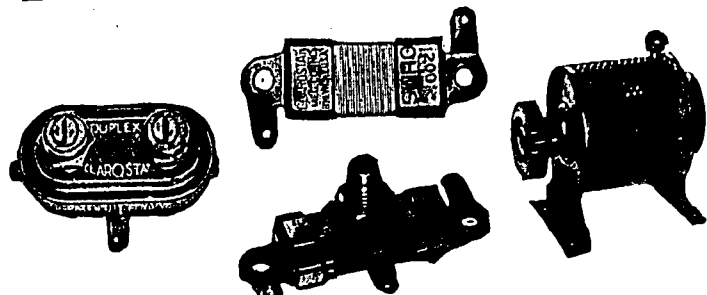

VI

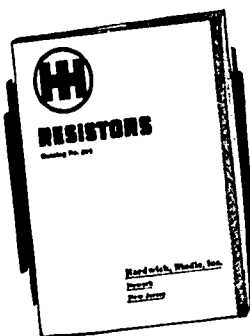
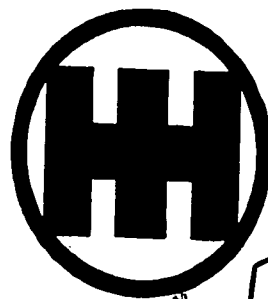

This book brings helpful Charts and Exhibits

Many Radio Engineers have asked for our catalog, gladly sent on request. It contains simplified Resistance Tables specially prepared for rapid calculating, and not published elsewhere to our knowledge. In addition it describes our complete line of resistor types, contacts, connections and mountings, with suggested combinations.

Write for
"Catalog
No. 429"

Hardwick, Hindle, Inc.
215 Emmet Street Newark, N. J.

VII



RESISTORS

.. a dependable Supply, with Rapid Delivery all the Time

WE specialize in wire wound Resistors. Our products can be judged "by the companies they keep." Six of the many organizations we serve are shown above.

We are equipped to produce *your* type and capacity of Resistors in quantity, on reliable production schedules, at logical costs.

HH units have successfully passed the most rigid tests to which resistors have ever been subjected. In daily use by well known radio manufacturers—in the careful analysis of the Electrical Testing Laboratories and the Boards of Underwriters—they have consistently proved their dependability.

Because we specialize and are geared for steady mass production, we can also make unusually rapid deliveries. In addition, we usually can have finished *Samples*, exactly to your specifications, in the mail to you within 72 hours.

Whether your resistor requirements are large or small, our staff of engineers and production specialists is at your command. Let us work with you—furnish samples—send our catalog. Write, wire or phone.

“ESCO” Power Supply for Radio Equipment

Machines for operating 60-cycle A. C. Radio Receivers, Loud Speakers and Phonographs from Direct Current Lighting Sockets Without Objectionable Noises of any Kind.

The dynamotors and motor generators are suitable for radio receivers and for combination instruments containing phonographs and receivers. Filters are usually required. The dynamotors and motor generators with filters give as good or better results than are obtained from ordinary 60-cycle lighting sockets. They are furnished completely assembled and connected and are very easily installed.

These machines are furnished with wool-packed bearings which require very little attention, and are very quiet running.

Write for Bulletin No. 243-D



Type NA Aircraft Generator

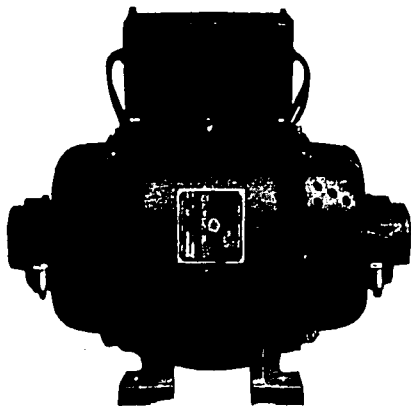

Dynamotor with Filter for Radio Receivers

Low wind resistance, light weight, non-corroding parts, ball bearings, tool steel shafts, steel shells, cast steel pole pieces, weather proof construction, many sizes to choose from, high voltage and low voltage windings to suit individual requirements, are a few of the many reasons for “ESCO” generators or dynamotors being the first choice.

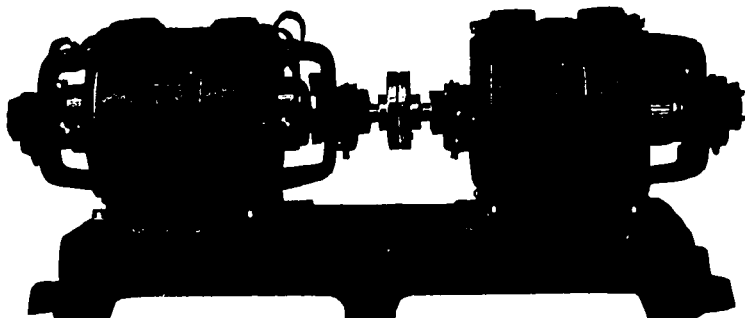

Type BFR, Two Unit Motor Generator Set

“ESCO” two and three unit sets have become the accepted standards for transmission. The “ESCO” line consists of over 300 combinations. These are covered by Bulletin 237G.

“ESCO” also manufactures synchronous motors for television and “talkie” projectors. Motor generators and dynamotors for power amplifiers and public address systems.

ELECTRIC SPECIALTY

COMPANY

300 SOUTH ST., STAMFORD, CONN.

Manufacturers of motors, generators, dynamotors and rotary converters.

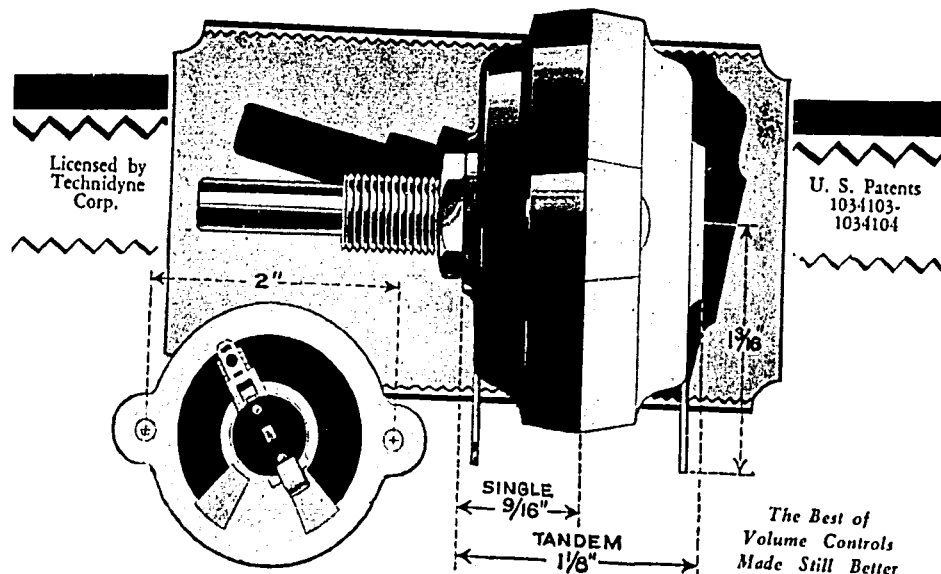

Resistances and Voltage Controls for MODERN RADIO

THE name “ELECTRAD” on a resistance or voltage control is a mark of highest quality and perfect adaptability to present day requirements. It stands for superior performance, too, due to intelligent pioneering and specialization in the resistance field, where Electrad intends to remain.

Send your resistance problems to the Electrad Laboratory Staff. Their cooperation will be cheerful, thorough, complete.

The Super-Tonatol Model “B” For Manufacturers

The Model “B” has all of the outstanding characteristics of the remarkable Model “A” Super-Tonatrol, plus greater compactness, finer finish and availability in tandem units, if desired, controlled by a single shaft.

The Special resistance element is permanently fused to an enameled metal plate. Dissipates 3-watts. Pure silver floating contact provides amazingly smooth operation with stepless variation. Completely enclosed Bakelite case. Practically immune to temperature and humidity changes. Single or tandem units can be made with all usual resistance ratings and curves. Ask for blueprint and data.

Write Dept. PE-A for details of all Electrad Products

175 Varick St., New York, N.Y.
ELECTRAD
 INC.

Electrad manufactures a complete line of resistances and voltage controls for all radio and power supply requirements, including Television.

CARDWELL

SOMEWHERE IN OUR LINE THERE'S
A CONDENSER FOR YOU

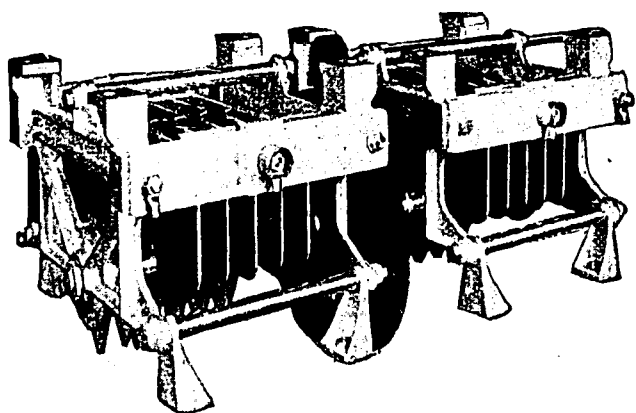

Fixed and Variable Transmitting
Condensers for High Voltages.

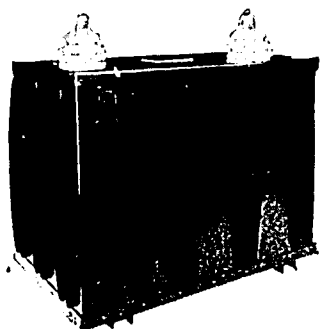

Oil Dielectric Fixed Condensers
for Induction Furnaces and Tube
Bombarders—Indestructible—the
Logical Replacement Unit. The
First Cost is the Last Cost.

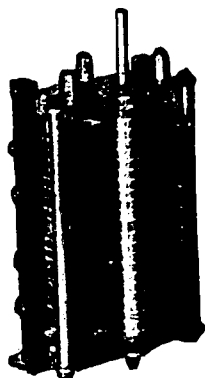

Many Types and Capacities in the smaller Trans-
mitting Condensers and a Wide Variety of Re-
ceiving Condensers are Included in the Cardwell
Line.

Send for literature

THE ALLEN D. CARDWELL
MANUFACTURING CORPN.

81 PROSPECT ST., BROOKLYN, N.Y.

Since the beginning of Broadcasting

“THE STANDARD OF COMPARISON”

X

What are your exact requirements?

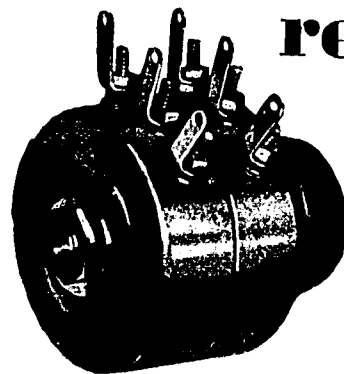

No. 280-280. Combination metal shell
wire wound and composition elements.
Wire wound up to 15,000 ohms. Composi-
tion, 5,000 to 1 megohm. Rheostat or poten-
tiometer type in either unit. Units insulated
from each other. Diameter, 1 11-16 in.
Depth of shell, 1 3-8 in.

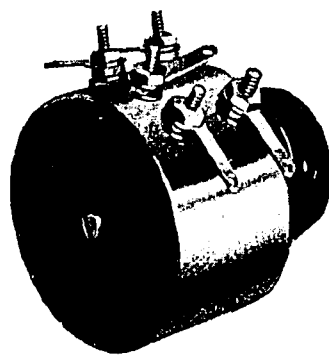

No. 890. Double depth metal shell
unit in rheostat or potentiometer type.
Rotors in same electrical connection.
Composition elements, 5,000 ohms to
1 megohm in each unit. Diameter,
1 7-8 in. Depth of shell, 1 3-16 in.

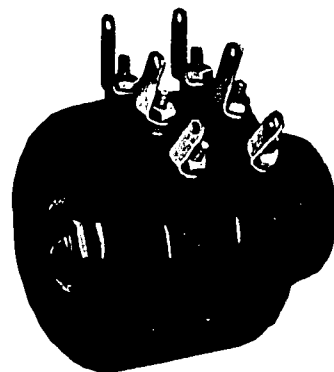

No. 1880-1880. Same as 280-280 ex-
cept all bakelite.

Your volume control requirements—
what are they?

We know, if you are at all like
most manufacturers, that your re-
quirements as to volume controls are
exceedingly precise. That is why we
ask you: What are your *exact* re-
quirements?

Not knowing how we can best
serve you, we invite you to tell us.
We ask you to use our very con-
siderable facilities to help you secure
precisely the volume controls that
you require. We maintain a large
research department whose sole
function is to cooperate with manu-
facturers who seek perfection in fixed
and variable high resistors—and who
have not yet found what they want.

Won't you do this? To start on a
solution of your volume control
problem, we suggest you mail the
coupon below for fuller, more com-
plete information about the unique
service this company offers. Do this
today.

HERBERT H. FROST, INC.

Largest manufacturers in the world of high
grade variable resistors

Main Offices and Factory
ELKHART, IND.

160 North La Salle Street, Chicago

Herbert H. Frost, Inc.
Elkhart, Ind.

YB-30

We are interested in securing further facts
about your ability to supply us with suitable
variable resistors for our.....

Name.....
Address.....
City.....State.....

XI

CONSULTING & CONSTRUCTING
RADIO ENGINEERS



311 CALIFORNIA ST.
SAN FRANCISCO, U.S.A.

CABLE ADDRESS
HEIKAU

YOU CAN **HEAR** THE DIFFERENCE
AND **SEE** THE REASON
IN EVEREADY RAYTHEON
4-PILLAR TUBES « «

HERE is an entirely new type of tube . . . Eveready Raytheon! It combines the highest degree of sensitivity with lasting, rugged strength. The patented Eveready Raytheon 4-Pillar construction—a revolutionary improvement—safeguards fragile elements against the dangers of shipment and handling. Eveready Raytheon elements are assembled on jigs, to put them in most sensitive relation to each other. The 4-Pillar construction anchors these elements where they belong—assuring you of a new standard of reception.

You can see this exclusive construction inside an Eveready Raytheon. Look at the diagram on this page. See the solid, four-cornered glass stem. Notice, imbedded in it, the four sturdy pillars supporting the elements. That shows why Eveready Raytheons are stronger than ordinary tubes—and why they give you the best reception you can possibly get from your present receiver. No other tube can be made like this, because the 4-Pillar construction is patented.

Eveready Raytheons come in all types. They fit the sockets in every standard A. C. and battery-operated receiver in use today. They are built by the makers of the famous Eveready Layerbilt "B" Batteries—another radical improvement in radio. Get a set of new Eveready Raytheons from your dealer, and enjoy their reception today.

NATIONAL CARBON CO., Inc.
General Offices: New York, N. Y.

Branches: Chicago, Kansas City, New York,
San Francisco



Unit of Union Carbide
and Carbon Corporation



4-PILLAR TUBES

Showing the exclusive, patented EVEREADY RAYTHEON 4-Pillar construction with its solid, four-cornered glass stem, its four rigid pillars, and anchorage to a stiff mica plate at the top.



Trade-marks

Volume Controls

TO vary the intensity of the faithful reproduction built into radio receivers without introducing noise or distortion, can only be accomplished by a careful and complete consideration of both mechanical and electrical features of the volume control.

Mechanically—The Centralab exclusive and patented rocking disc contact precludes any possibility of wear on the resistance material. This feature adds to the smoothness of operation since the contact shoes ride only on the disc. The shaft and bushing are completely insulated from the current carrying parts—eliminating any hand capacity when volume control is placed in a critical circuit.

Electrically—Centralab engineers have evolved tapers of resistance that produce a smooth and gradual variation of volume. These tapers have been thoroughly tried and tested for each specific application for current carrying capacity and power dissipation.

Centralab volume controls have been specified by leading manufacturers because of their quality and ability to perform a specific duty—Vary the intensity of faithful reproduction—faithfully.

Write for full particulars of specific application.

Centralab

CENTRAL RADIO LABORATORIES

36 Keefe Ave. Milwaukee, Wis.

A CENTRALAB VOLUME CONTROL IMPROVES THE RADIO SET

Manufactured in three sizes

Standard

Junior

Midget

Also Double Standard
and Double Junior

Special Combination
Wire Wound and
Graphite Control

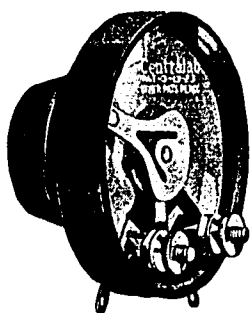

The Institute of Radio Engineers

Yr.Bk.

Incorporated

33 West 39th Street, New York, N. Y.

APPLICATION FOR ASSOCIATE MEMBERSHIP

(Application forms for other grades of membership are obtainable from the Institute)

To the Board of Direction
Gentlemen:

I hereby make application for Associate membership in the Institute. I certify that the statements made in the record of my training and professional experience are correct, and agree if elected, that I will be governed by the constitution of the Institute as long as I continue a member. I furthermore agree to promote the objects of the Institute so far as shall be in my power, and if my membership shall be discontinued will return my membership badge.

Yours respectfully,

(Sign with pen)

(Address for mail)

(Date)

(City and State)

References:

(Signature of references not required here)

Mr. Mr.

Address Address

Mr. Mr.

Address Address

Mr.

Address

The following extracts from the Constitution govern applications for admission to the Institute in the Associate grade:

ARTICLE II—MEMBERSHIP

Sec. 1: The membership of the Institute shall consist of: * * * (d) Associates, who shall be entitled to all the rights and privileges of the Institute except the right to hold the office of President, Vice-president and Editor. * * *

Sec. 5: An Associate shall be not less than twenty-one years of age and shall be: (a) A radio engineer by profession; (b) A teacher of radio subjects; (c) A person who is interested in and connected with the study or application of radio science or the radio arts.

ARTICLE III—ADMISSION

Sec. 2: * * * Applicants shall give references to members of the Institute as follows: * * * for the grade of Associate, to five Fellows, Members, or Associates; * * * Each application for admission * * * shall embody a concise statement, with dates, of the candidate's training and experience.

The requirements of the foregoing paragraph may be waived in whole or in part where the application is for Associate grade. An applicant who is so situated as not to be personally known to the required number of members may supply the names of non-members who are personally familiar with his radio interest.

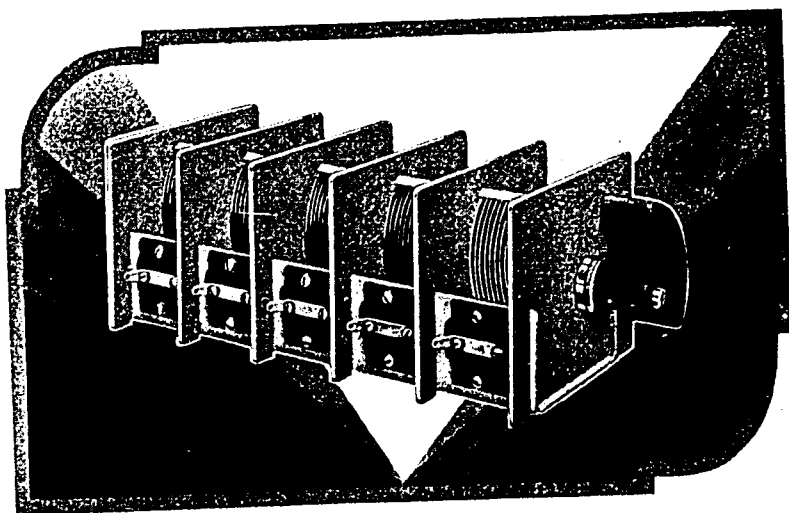

THE Scovill Manufacturing Company through its engineering and sales force offers you intelligent cooperation on your manufacturing problems. Scovill engineers have worked with several nationally known radio set manufacturers to produce radio condensers to meet their exact requirements.

The Scovill manufacturing departments have the equipment and the capacity for the production of quantities of condensers and radio parts constructed and tested to meet their specifications.

Scovill can help you on your radio condenser and radio metal parts problems. Why not consult Scovill about your next order?

PRODUCTS

Made to Order

Variable radio condensers
Metal stampings
Screw machine products
Special machine screws
Parts from brass, bronze, nickel silver, aluminum and other metals

Carried in Stock

Brass, bronze and nickel silver sheet, rod, wire and tubing
Standard cap and machine screws
High Speed brass rod for automatic screw machines
Etching brass

SCOVILL

Established 1802

MANUFACTURING COMPANY
· WATERBURY · CONNECTICUT ·



NEW YORK
PROVIDENCE
ATLANTA
CHICAGO

CLEVELAND
SAN FRANCISCO
BOSTON
SAN FRANCISCO
LOS ANGELES

PHILADELPHIA
DETROIT
IN EUROPE—THE
HAGUE, HOLLAND

XVIII

SHAKEPROOF'S PLACE

in the

RADIO

LEADERS in the radio field—the big manufacturers producing sets by the million—have turned to SHAKEPROOF as the final solution of their locking and terminal problems. SHAKEPROOF—the lock washer with twisted teeth of steel forms a multiple lock on nuts and bolts—a lock that won't let go—a lock that will loosen only on applied pressure with a wrench.

SHAKEPROOF Locking Terminals form perfect connections and eliminate all the troubles due to loose connections. SHAKEPROOF Lock Washers and Terminals will speed up your production and save their cost many times over in their application—they cannot tangle or link.

The roll call of SHAKEPROOF users is the roll call of America's Big Business. It will pay you to investigate why radio manufacturers large and small alike have almost unanimously turned to SHAKEPROOF. Complete information and samples will be mailed on request without obligation.

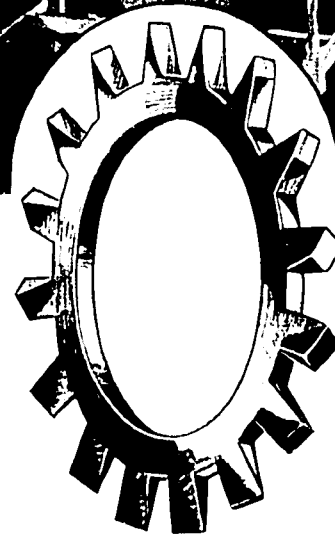

SHAKEPROOF

Lock Washer Company

(Division of Wilson Tool Works)

2501 North Keeler Avenue Chicago, Illinois



Type 20 Log Terminals

Type 12 Internal Teeth

Type 11 External Teeth

Type 15 Countersunk

XIX

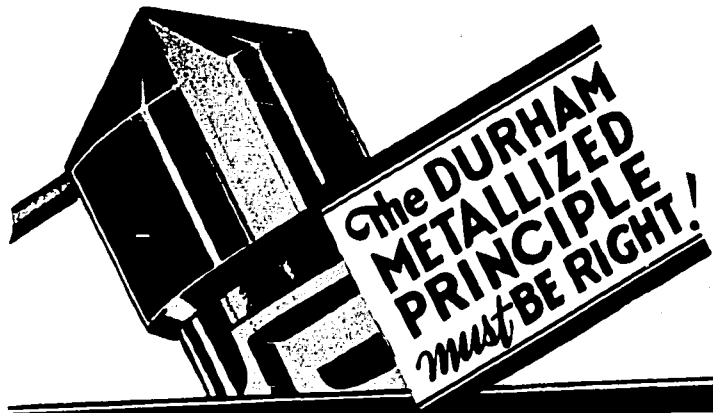

A Million and a half used Monthly during 1929
in American Radio

To keep pace with 1930 receiver developments, Durham Metallized resistors and powerohms are now more accurate, have a greater power safety factor and can be obtained in even greater variety.

The advantages of the Durham Metallized principle have been proven by the millions of Durham resistors and powerohms now used by America's foremost manufacturers of radio receivers and allied products.

These units are now in standard production in all ratings, all types of tips for radio work.

Engineering data and samples for testing sent upon request. Please state ratings required.

International Resistance Company

2006 Chestnut Street, Philadelphia, Pa.

DURHAM
METALLIZED
**RESISTORS &
POWEROHMS**

XX



A.H.GREBE & CO., Inc.

RICHMOND HILL, NEW YORK

**Grebe
radio**

SUPER-SYNCHROPHASE 

WESTERN BRANCH

443 South San Pedro Street

Los Angeles, California

MAKERS OF QUALITY RADIO SINCE 1909

XXI

the Coils the thing!

In every radio hook-up an ideal coil is specified for each function in the set.

Each Dudlo coil is backed by its reputation as the utmost in coil perfection, and though tucked away in the chassis of a set . . . forgotten, yet depended upon . . . will give years of faithful performance.

Continuous performance is *assumed*. Tubes may come and tubes may go . . . condensers may break down . . . but the coils must go on forever.

Dudlo coils are superbly engineered, and constructed by experts to fit individual requirements . . . no matter how complex or difficult.

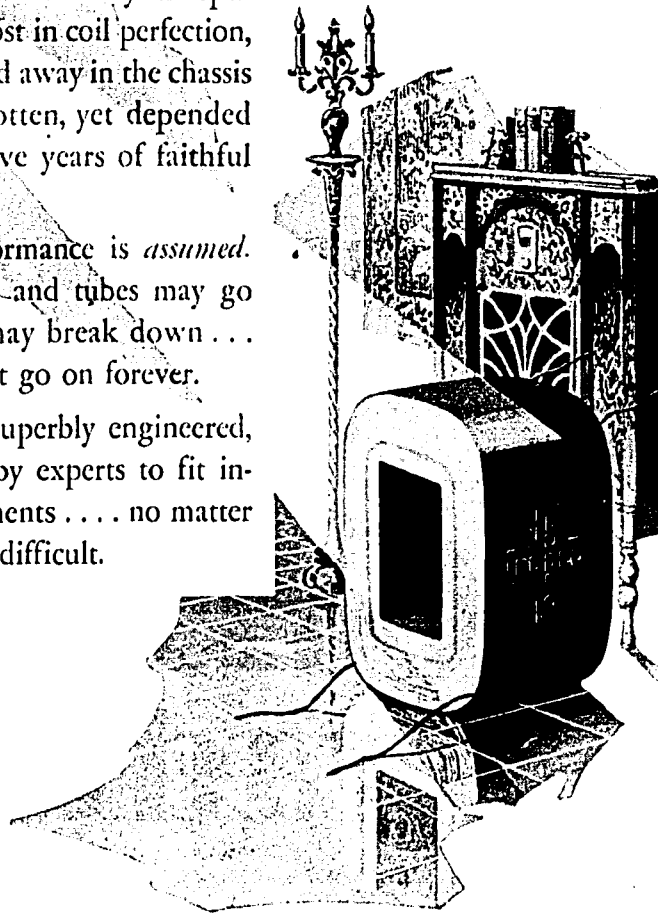

DUDLO

DUDLO MANUFACTURING COMPANY, FORT WAYNE, INDIANA
Division of General Cable Corporation

XXII

The important syllable in manufacture - is FACT!

Design and build your products with insurance of electrical accuracy.
Here are four instruments that furnish important facts
—Protecting prestige and profit.

Model 526 Radio Tube Tester

This is an extremely precise laboratory instrument, yet entirely suitable for production testing. It affords quick and accurate measurements, giving the true A. C. values of the tube constants without the use of telephone or other complicated devices.

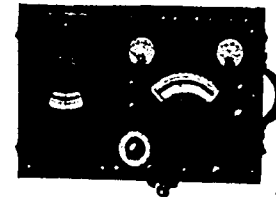

It will measure the voltage amplification factor, plate impedance in ohms, mutual conductance in micromhos, and the plate, filament and grid bias voltage.

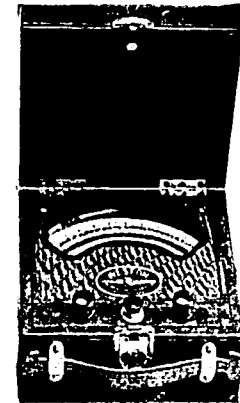

Model 322 Microammeter

A laboratory D. C. instrument, made in single, double and quadruple ranges for the measurement of very small electrical quantities. Accuracy, $\frac{1}{2}$ of 1 %.

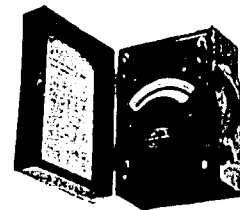

Model 1 Ohmmeter. A direct reading instrument like an ordinary voltmeter, offering speed of operation in making resistance measurements. May be operated on ordinary dry cells. No auxiliary apparatus required. A most valuable instrument for the electrical manufacturer.



Model 372 Microfaradmeter. A portable direct-reading instrument for capacity measurements where speed and accuracy are essential. For A. C. only.

WESTON ELECTRICAL INSTRUMENT CORPORATION
589 Frelinghuysen Ave. Newark, N.J.

Weston
PIONEERS
SINCE 1888
INSTRUMENTS

XXIII



Without A Doubt The Most Complete Line of Condensers & Resistors

NO matter what your requirements may be in the fixed condenser or resistor field, you are sure to find an Aerovox unit exactly suited to your needs.

Filter Blocks	Pyrohm Heavy Duty
Buffer Blocks	Edison Base Pyrohms
Socket Power	Tapped Pyrohms
High Voltage	Wire Wound Units
Transmitting	Grid Suppressors
Bypass	Center-Tapped Units
"A" Power	Non-Inductive Lavite
Bakelite Moulded Mica	Grid Leaks
Condenser	Resistorformer Kits
Interference Filters	Resistor Mountings

In addition to the large number of stock sizes of condensers and resistors, the Aerovox Wireless Corporation is equipped to supply to manufacturers special types and sizes of condensers, filter blocks and resistors in all fixed and tapped combinations on short notice.

SEND FOR COMPLETE CATALOG

Complete specifications of all Aerovox units, including insulation specifications of condensers, carrying capacities of resistors and all physical dimensions, electrical characteristics and list prices of condensers and resistors, are contained in a complete 1929-30 catalog which will be sent gladly on request.



The Aerovox Research Worker is a free monthly publication that will keep you abreast of the latest developments in radio. Your name will be put on the mailing list free of charge on request.

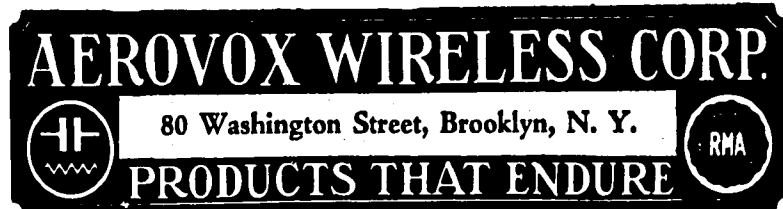

Special Transformers

FERRANTI special transformers are designed to meet the requirements of any audio frequency circuit wherein uniform frequency response between 35 and 8000 cycles is required.

FERRANTI special transformers have unusually flat frequency characteristics comparable with the standard AF-5 audio transformers as shown in the following tabulation.

	35 cycles	1000 cycles	8000 cycles
AF-5 standard audio.....	-.8 DB	0.0 DB	-.4 DB
500 ohm Line to tube.....	-.8 DB	0.0 DB	-.4 DB
600 ohm Line to 600 ohm Line	-.5 DB	0.0 DB	-.5 DB

FERRANTI standard and special transformers are improving the frequency characteristics of: Broadcast Stations, Recording Studios, Television Equipment, Radio Receivers, Laboratories, when used in Speech Amplifiers, Telephone Circuits, Test Equipment, Radio Receivers, Public Address System, Disc and Film Recording Devices and all types of equipment requiring flat characteristics over a very wide frequency range.

Some of the more usual types of special transformers are carried in stock for immediate shipment. Others can usually be made and shipped in 48 hours or less.

ALTERNATING CURRENT METERS

Rectifier type 1% accuracy 0-6000 cycles, Thermal Type accurate at very high frequencies.

FERRANTI has developed the Rectifier Type AC meter to the accuracy required for laboratory measurements and testing of mass production radio and audio products. Their wide frequency response and low current consumption makes them ideal for the measurement of audio frequency voltages and currents, "Hum Voltage," and a host of laboratory uses.

RANGES OF RECTIFIER TYPE

750 Microamperes to 50 Milliamperes
1 volt to 400 volts

Made in two types—667 ohms per volt and 133 ohms per volt.

Write for complete description of Ferranti:

Power Amplifiers Meters
Transformers Chokes
Non-Inductive Wire Wound Resistors

FERRANTI, Inc.

130 West 42nd St., New York City

Alphabetical Index to Advertisements

A	
Acrovox Wireless Corp.....	XXIV
Allen-Bradley Company.....	III
Arcturus Radio Tube Co.....	XXIX
C	
Cardwell, Allen D., Mfg. Corpn.....	X
Central Radio Laboratories.....	XIV
Clarostat Mfg. Co., Inc.....	VI
D	
Dubilier Condenser Corp.....	XXXI
Dudlo Manufacturing Co.....	XXII
E	
Electrad, Inc.....	IX
Electric Specialty Co.....	VIII
F	
Ferranti, Inc.....	XXV
Flechtheim, A. M., & Co., Inc.....	II
Formica Insulation Company.....	XVII
Frost, Herbert H., Inc.....	XI
G	
General Radio Company.....	Inside Back Cover
Grebe, A. H., & Company, Inc.....	XXI
H	
Hammarlund Mfg. Co.....	XXVII
Hardwick, Hindle, Inc.....	VII
Heintz and Kaufman, Ltd.....	XII
I	
International Resistance Co.....	XX
I. R. E.....	XV, XVI and XXX
N	
National Carbon Co., Inc.....	XIII
National Vulcanized Fibre Co.....	IV
P	
Pacent Electric Co.....	XXVIII
Polymet Mfg. Corp.....	I
R	
Roller-Smith Co.....	V
S	
Scovill Manufacturing Co.....	XVIII
Shakeproof Lock Washer Co.....	XIX
T	
Thermal Syndicate, Ltd.....	XXXII
W	
Weston Electrical Instrument Corporation.....	XXIII

Hammarlund QUALITY

at a PRICE!

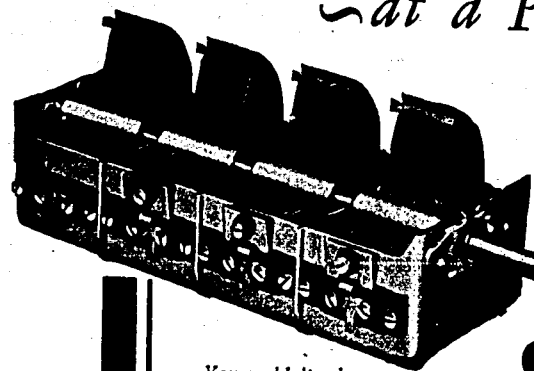

You couldn't ask more of a condenser and you can't get more at the price.

The New

"M-Q"

(Multiple-Quadruple)

CONDENSER

for

Manufacturers

VALUE, above all, the radio public will demand in 1930. But there is a limit to which quality can be sacrificed for price.

In this new "M-Q" model condenser, Hammarlund engineers have packed quality. In every detail it is worthy of the Hammarlund name. But simplified design has reduced manufacturing costs to a point where the careful buyer need not compromise on condensers of lesser value.

Rigid, die-cast frame, shielded between sections; long, hand-reamed bearings; reinforced non-microphonic plates; closely matched sections; wiping rotor contacts prevent coupling of circulating currents; separate high-resistance stator insulation; large, easily-adjusted trimmer condensers.

Let us quote on your requirements.

HAMMARLUND MANUFACTURING COMPANY

424-438 W. 33RD ST., NEW YORK.

For Better Radio
Hammarlund
 PRECISION
PRODUCTS



1919

10 YEARS of RADIO MANUFACTURING

*Plus Over 12 Years of Pioneering in
Electrical Reproduction of Sound*

1930

IN 1919 when the Pacent Electric Company began to manufacture radio essentials, the industry was truly in its infancy. The years since have seen a steady and healthy growth, until today, the company enjoys the distinction of being one of the oldest and most far-sighted manufacturers.

Today Pacent Electric Company has the largest engineering and research staff in its history. All Pacent devices are examples of modern leadership in engineering and in sound, creative manufacturing.

Pacem Quality and Service are enemies of business depression.

PACENT ELECTRIC CO.

91 Seventh Avenue, New York

Manufacturing Licensee for Great Britain and Ireland:
IGRANIC ELECTRIC CO., Ltd., Bedford, England
Licensee for Canada: White Radio Limited, Hamilton, Ont.

XXVIII

WHAT MORE
CAN YOU EXPECT FROM TUBES?

1. quick action

2. clear tone

3. long life

they're



blue!

ARCTURUS
LONG-LIFE
RADIO TUBES

STANDARD for EVERY
leading set

XXIX

INSTITUTE SUPPLIES

EMBLEMS

Three styles of Institute emblems, appropriately colored to indicate the various grades of membership in the Institute, are available. The approximate size of each emblem is that of the illustrations.



The lapel button is of 14k gold, the background being enamelled in the membership color, the lettering being gold. The button is supplied with a screw back with jaws which fasten it securely to the coat. This style emblem can be obtained for \$2.75, postpaid, for any grade.

The pin is also of 14k gold. It is provided with a safety catch and is appropriately colored for the various grades of membership. Price, for any grade, \$3.00 postpaid.

The watch charm is handsomely finished on both sides and is of 14k gold. The charm is equipped with a suspension ring for attaching to a watch fob or chain. Price for any grade \$5.00 postpaid.

BINDERS

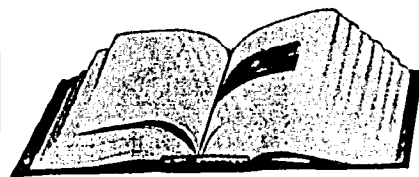
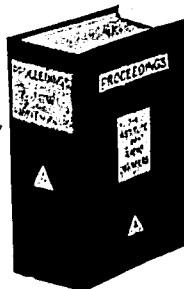

The binder pictured here contains over three inches of filing space. It serves either as a temporary transfer binder or as a permanent cover. It is made of handsome Spanish Grain Fabrikoid in blue and gold. The binder is so constructed that each individual copy

of the PROCEEDINGS will lie flat when the pages are turned. Copies can be removed from the binder in a few seconds and can be permanently preserved in undamaged condition. Hundreds of these binders are sold each year. Price, \$1.50 each, or \$2.00 with the member's name or the PROCEEDINGS Volume Number stamped in gold.

BACK ISSUES OF THE PROCEEDINGS

Back issues of the PROCEEDINGS are available in unbound form for the years 1918, 1920, 1921, 1922, 1923, and 1926 at \$6.75 per year (six issues). Single copies for any of the years listed to 1927 are \$1.13 each. From 1927 on (where available) the single copy price is \$0.75. Foreign postage on the volume is \$0.60 additional. On single copies \$0.10.

A number of individual copies for years other than those listed above are available. For a list of these, members should apply to the Secretary. Bound volumes in Blue Buckram binding are available for the years 1920, 1921, 1922, 1923, and 1926 at \$8.75 per year. The bound volume for 1928 is priced at \$9.50. Foreign postage is \$1.00 per volume.

Bound volumes, for the above years, in Morocco Leather binding are available at \$11.00 each.

These prices are to members of the Institute.

FOURTEEN YEAR INDEX

The PROCEEDINGS Index for the years 1909-1926, inclusive, is available to members at \$1.00 per copy. This index is extensively cross indexed.

YEAR BOOK

The 1927 and 1928 year books are available to members at \$0.75 per copy, per year. The 1929 year book, including the report of the 1928 Committee on Standardization, is available to members at \$1.00 per copy.

When ordering any of the above, send remittance, with order to The Secretary, The Institute of Radio Engineers, 33 West 39th Street, New York, N.Y.

You Can forget the Condensers if they are DUBILIER'S

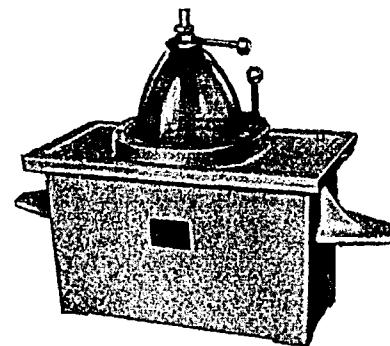

There is a Dubilier mica dielectric condenser available for any radio telegraph, telephone, signal or laboratory requirement.

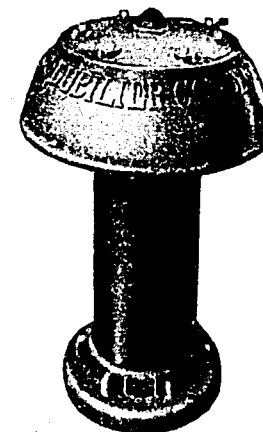

Dubilier Mica Capacitors have stood the test of time and are recognized by the principal public utility companies as the only safe and dependable coupling medium for carrier current systems.

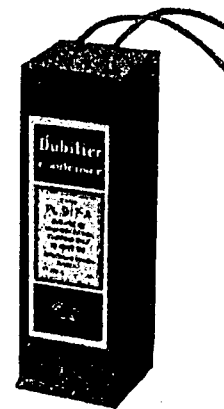

The ideal electrical characteristics and long life of Dubilier Chemical Condensers, which are used by leading manufacturers and laboratories, have shown the wisdom of not offering designs until a perfect product is assured.



Dubilier Filter Blocks are standard equipment for most receiving set makers. Condensers designed for all voltages. And in high voltage types, including 10,000 volts.

Dubilier

CONDENSER CORPORATION

342 Madison Avenue
New York, N. Y.

VITREOSIL

(Fused Pure Silica)

FOR RADIO TUBE MANUFACTURE

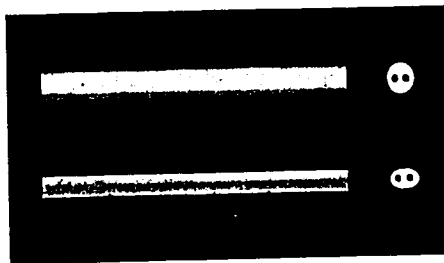

CATHODE INSULATION

Vitreosil is chemically inert, producing long life tubes. It does not crumble nor crack from temperature changes, is gas-free and contains no undesirable components. Vitreosil is obtainable in single, twin or multibore tubing in oval or circular cross-section from stock. Samples will be gladly sent upon request.

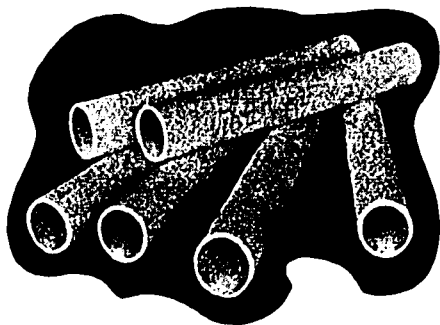

DEGASSING

Vitreosil tubes are particularly suitable for this work because of their gas-tight structure and their ability to withstand temperatures in excess of 1,000° C. and sudden cooling and heating without breakage. They may be obtained promptly in practically any diameter and length with open ends or one end closed. Vitreosil tubes are long-lived, and unexcelled for treating nickel plates, decarbonizing, etc.

*Write for complete particulars
(Other details also for television)*

THE THERMAL SYNDICATE, Ltd.

1734 Atlantic Avenue

Brooklyn, New York