

february 1959  
the  
institute  
of  
radio  
engineers

# Proceedings of the IRE

SPECIAL ISSUE ON  
THE NATURE OF  
THE IONOSPHERE—  
AN IGY  OBJECTIVE

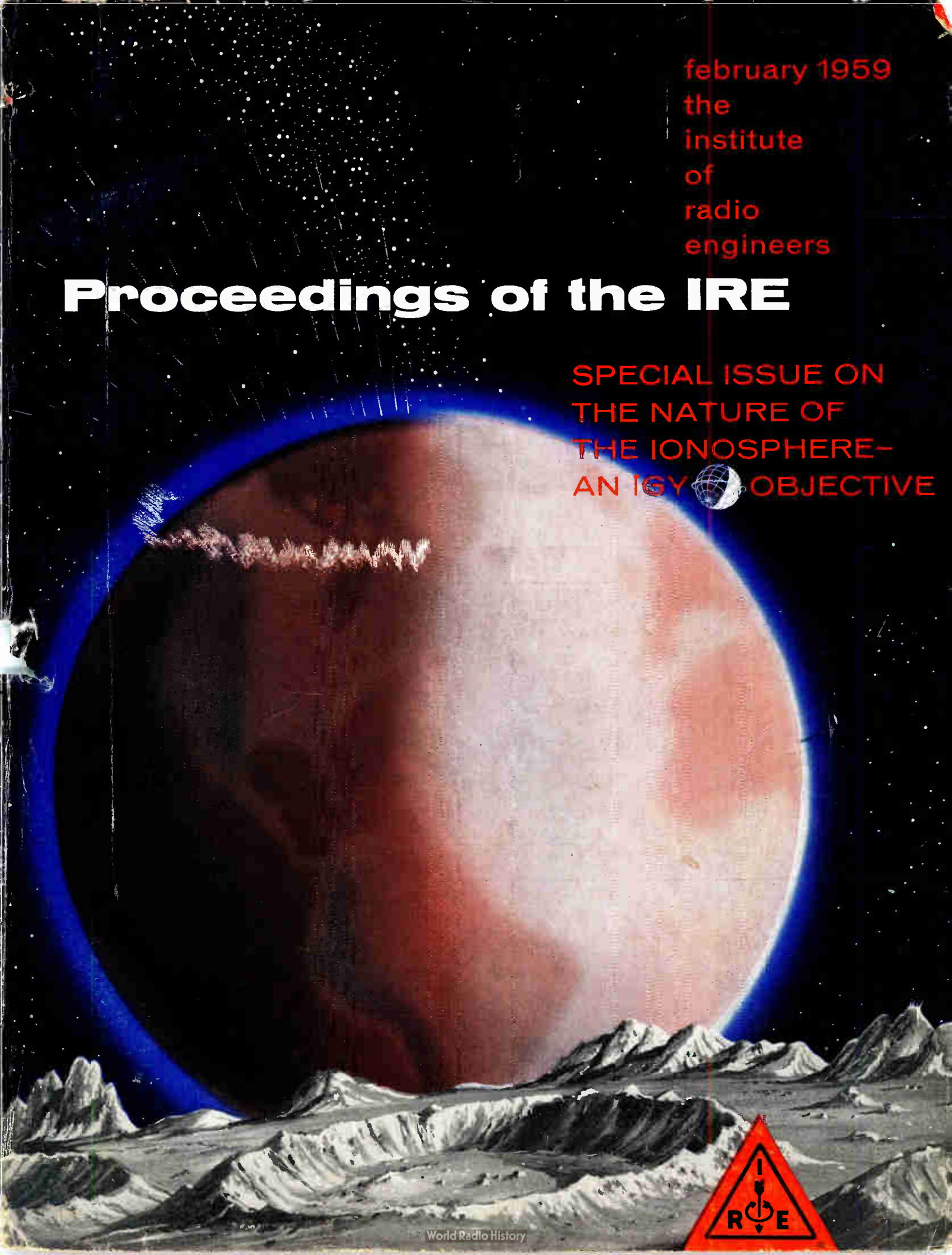



# FILTERS

HERMETICALLY SEALED TO MIL-T-27A & MIL-F-18327

FOR ALL  
APPLICATIONS  
FROM STOCK

## UTC INTERSTAGE AND LINE FILTERS

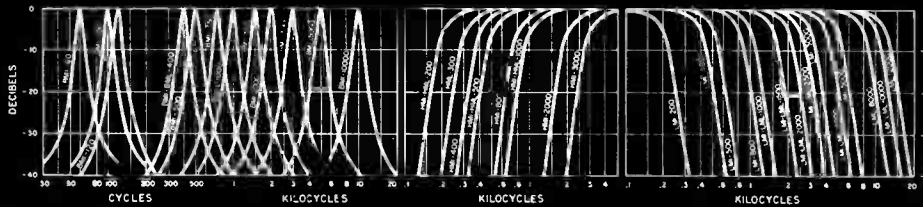

This standardized group of filters covers most popular filter applications and frequencies. Units are in compact, drawn, magnetic shielding cases... 1 1/2 x 1 1/2 base, 1 1/2 high for BMI, LMI, BML; others 2 1/2 high. There are six basic types:

**BMI** band pass units are 10K input, output to grid 2:1 gain. Attenuation is approximately 2 db at 3% from center frequency, then 40 db per octave.

**HMI** high pass units are 10K in and out. Attenuation is less than 6 db at cut-off frequency and 35 db at .67 cut-off frequency.

**LMI** low pass units are 10K in and out. Attenuation is less than 6 db at cut-off frequency and 35 db at 1.5 cut-off frequency.

**HML** high pass filters are same as HMI but 500/600 ohms in and out.

**LML** low pass filters are same as LMI but 500/600 ohms in and out.

**BML** band pass units are same as BMI but 500/600 ohms input, output to grid, 9:1 gain.

### STOCK TYPES (number in figure is cycles)

BMI-60	BMI-1000	LMI-800	HML-300
BMI-100	HMI-200	LMI-1000	HML-500
BMI-120	HMI-400	LMI-1500	HML-1000
BMI-400	HMI-500	LMI-2000	LML-1000
BMI-500	HMI-800	LMI-2500	LML-1500
BMI-750	HMI-1000	LMI-3000	LML-2000
BMI-1000	HMI-2000	LMI-4000	LVL-2500
BMI-1500	HMI-3000	LMI-5000	LVL-4000
BMI-2000	LMI-200	LMI-10000	LML-8000
BMI-3000	LMI-400	BML-400	LML-10000
BMI-4000	LMI-500	BML-1000	LML-12000
BMI-5000		HML-200	



### STOCK TYPES (number in figure is KC)

TMN-4	TMN-2.3	TMN-14.5	TMW-22
TMN-56	TMN-3.0	TMN-22	TMW-30
TMN-73	TMN-3.9	TMN-30	TMW-40
TMN-96	TMN-5.4	TMN-40	TMW-52.5
TMN-1.3	TMN-7.35	TMN-52.5	TMW-70
TMN-1.7	TMN-10.5	TMN-70	



TMN-4 thru TMN-1.7  
1 1/2 x 1 1/2 x 2 inches  
Weight ..... 3.5 oz.



TMN-2.3 thru TMW-70  
2 3/2 x 2 3/2 x 1 3/8 inches  
Weight ..... 1.2 oz.

## UTC TELEMETERING BAND PASS FILTERS

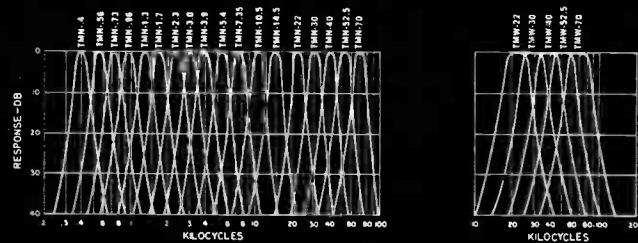

UTC standard telemetering filters provide extreme miniaturization with maximum stability, a complete set of 18 filters taking 19 cubic inches. They are 100K in and out and have an insertion loss of less than 6 db, 4 pin header for small Winchester socket.

TMN units are within 3 db at  $\pm 7.5\%$  of center frequency... down more than 18 db at  $\pm 25\%$ ... more than 40 db beyond 1.75 and .58 center frequency.

TMW are within 3 db at  $\pm 15\%$  of center frequency... down more than 20 db at  $\pm 50\%$ ... more than 40 db beyond 2.5 and .4 center frequency.

## UTC TELEGRAPH TONE CHANNEL FILTERS

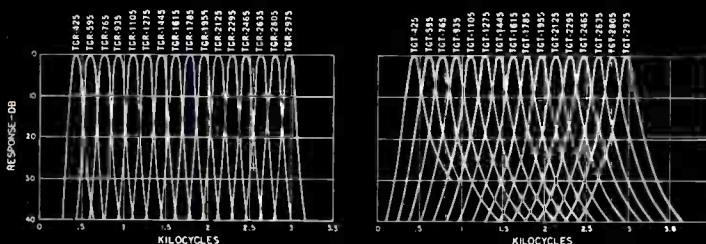

These band pass filters for multiplex transmitting and receiving provide maximum stability in miniature sizes. Both receiving and transmitting types are 600 ohms in and out, and employ 7 terminal header for sub-miniature 7 pin socket.

TGR receiving filters are within 3 db at  $\pm 42.5$  cycles from center frequency... down more than 30 db at  $\pm 170$  cycles... down more than 15 db at adjacent channel cross-over.

TGT transmitting filters are within 3 db at  $\pm 42.5$  cycles from center frequency... down more than 16 db at  $\pm 170$  cycles... down more than 7.5 db at adjacent channel cross-over.

### STOCK TYPES (number in figure is cycles)

RECEIVING	
TGR-425	TGR-1785
TGR-595	TGR-1955
TGR-765	TGR-2125
TGR-935	TGR-2295
TGR-1105	TGR-2465
TGR-1275	TGR-2635
TGR-1445	TGR-2805
TGR-1615	TGR-2975

### TRANSMITTING

TGT-425	TGT-1785
TGT-595	TGT-1955
TGT-765	TGT-2125
TGT-935	TGT-2295
TGT-1105	TGT-2465
TGT-1275	TGT-2635
TGT-1445	TGT-2805
TGT-1615	TGT-2975



TGT CASE

1 1/2 x 1 1/2 x 2 1/2 in. 8 oz.

TGR CASE

1 1/2 x 1 1/2 x 4 1/4 in. 15 oz.

And Special Units to  
Your Specifications

**UNITED TRANSFORMER CORP.**  
150 Varick Street, New York 13, N. Y.

PACIFIC MFG. DIVISION: 4008 W. JEFFERSON BLVD., LOS ANGELES 16, CALIF.

EXPORT DIVISION: 13 EAST 40th STREET, NEW YORK 16, N. Y.

CABLES: "ARLAB"

World Radio History



55507  
9-

# February, 1959

published monthly by The Institute of Radio Engineers, Inc.

## Proceedings of the IRE

contents

<b>Poles and Zeros</b> .....	129
<b>Donald B. Sinclair, Vice-President, 1959</b> .....	130
<b>PAPERS</b>	
Preface, The Nature of the Ionosphere—An IGY Objective, <i>Millett G. Morgan, Guest Editor</i> ..	131
The International Geophysical Year, <i>L. V. Berkner</i> .....	133
The Earth and Its Environment, <i>Sydney Chapman</i> .....	137
The Constitution and Composition of the Upper Atmosphere, <i>Marcel Nicolet</i> .....	142
The Normal <i>F</i> Region of the Ionosphere, <i>D. F. Martyn</i> .....	147
The Normal <i>E</i> Region of the Ionosphere, <i>Sir Edward V. Appleton</i> .....	155
The Normal <i>D</i> Region of the Ionosphere, <i>J. J. Gibbons and A. H. Waynick</i> .....	160
The Distribution of Electrons in the Ionosphere, <i>J. O. Thomas</i> .....	162
Motions in the Ionosphere, <i>C. O. Hines</i> .....	176
Meteors in the Ionosphere, <i>L. A. Manning and V. R. Eshleman</i> .....	186
Atmospheric Whistlers, <i>R. A. Helliwell and M. G. Morgan</i> .....	200
Radiation and Particle Precipitation upon the Earth from Solar Flares, <i>L. Biermann and R. Lüst</i> .....	209
The Very-Low-Frequency Emissions Generated in the Earth's Exosphere, <i>Roger M. Gallet</i> ..	211
The <i>F</i> Region During Magnetic Storms, <i>K. I. Maeda and T. Sato</i> .....	232
Auroral Phenomena, <i>E. N. Parker</i> .....	239
Auroral Ionization and Magnetic Disturbances, <i>Benjamin Nichols</i> .....	245
Abnormal Ionization in the Lower Ionosphere Associated with Cosmic-Ray Flux Enhancements, <i>D. K. Bailey</i> .....	255
The Night Airglow, <i>Franklin E. Rowch</i> .....	267
Rocket Observations of the Ionosphere, <i>Herbert Friedman</i> .....	272
Earth Satellite Observations of the Ionosphere, <i>Warren W. Berning</i> .....	280
Exploration of the Upper Atmosphere with the Help of the Third Soviet Sputnik, <i>V. I. Krassovsky</i> .....	289
Automatic Sweep-Frequency Ionosphere Recorder, Model C-4, <i>J. N. Brown</i> .....	296
The IGY Three-Frequency Backscatter Sounder, <i>A. M. Peterson, R. D. Egan, and D. S. Pratt</i> ..	300
The Riometer—A Device for the Continuous Measurement of Ionospheric Absorption, <i>C. G. Little and H. Leinbach</i> .....	315
A Low Power VHF Radar for Auroral Research, <i>Robert S. Leonard</i> .....	320
The Day-to-Day Coordination of IGY Observations, <i>A. H. Shapley</i> .....	323
<b>CORRESPONDENCE</b>	
Path Combinations in Whistler Echoes, <i>M. G. Morgan, H. W. Curtis, and W. C. Johnson</i> ..	328
WWW Standard Frequency Transmissions, <i>National Bureau of Standards</i> .....	329
Optimum Coupled-Resonator Band-Pass Filter, <i>Richard La Rosa</i> .....	329
A Small Mind, Normal for Its Size, <i>H. E. Kallmann</i> .....	330
Resonance Isolator at 70 KMC, <i>L. C. Kravitz, and G. S. Heller</i> .....	331
Wavelength Dependence in Transhorizon Propagation, <i>Ralph Bolgiano, Jr.</i> .....	331
On Monotonic Response Filters, <i>A. Papoulis</i> .....	332
Theoretical Error Rates of "Differentially Coherent" Binary and "Kineplex" Data Transmission Systems, <i>John G. Lawton</i> .....	333
Reduction of Electron Beam Noisiness by Means of a Low-Potential Drift Region, <i>A. W. Shaw, A. E. Siegman, and D. A. Watkins</i> .....	334
Receivers with Zero Intermediate Frequency, <i>J. C. Greene and J. F. Lyons</i> .....	335
Corrections of Davisson-Calbick Aperture-Lens Formula for Space Charge and Magnetic Field, <i>V. Brvc and C. Süsskind</i> .....	336
<b>REVIEWS</b>	
Scanning the TRANSACTIONS .....	344
Books:	
"The Junction Transistor and Its Applications," edited by E. Wolfendale, <i>Reviewed by Donald O. Pederson</i> .....	345
"Control System Components," by John E. Gibson and Franz B. Tuteur, <i>Reviewed by Don Lebell</i> .....	345
"Electronic Components Handbook, Vol. 2," edited by Keith Henney and Craig Walsh, <i>Reviewed by F. A. Paul</i> .....	345

FEBRUARY

# Proceedings of the IRE<sup>®</sup>

continued

	"Switching Circuits: with Computer Applications," by Watts S. Humphrey, Jr., <i>Reviewed by M. Karnaugh</i> .....	346
	"Electronic Digital Computers," by Franz L. Alt, <i>Reviewed by C. J. Sacift</i> .....	346
	"Engineering Electromagnetics," by W. H. Hayt, Jr., <i>Reviewed by M. G. Morgan</i> .....	346
	"Introduction to the Design of Servomechanisms," by John L. Bower and Peter M. Schultheiss, <i>Reviewed by William M. Pease</i> .....	346
	"Propriétés et Applications des Transistors," by Jean Pierre Vasseur, <i>Reviewed by Jacques I. Pankove</i> .....	347
	"Single Sideband for the Radio Amateur, A Digest, 2nd ed." <i>Reviewed by Keith Henney</i> "Theory of A-C Circuits," by Sylvan Fich and James L. Potter, <i>Reviewed by R. R. Shank</i> "Electronics of Microwave Tubes," by W. J. Kleen, translated by P. A. Lindsay, A. Reddish, and C. R. Russell, <i>Reviewed by C. W. Barnes</i> .....	347
	"Network Synthesis," by Norman Balabanian, <i>Reviewed by E. S. Kuh</i> .....	348
	"Transistor Technology, Vol. I," edited by H. E. Bridgers, J. H. Scaff, and J. N. Schive, <i>Reviewed by I. A. Lesk</i> .....	348
	"Transistor Technology, Vol. II," edited by F. J. Biondi, <i>Reviewed by I. A. Lesk</i> <i>and A. P. Stern</i> .....	349
	"Transistor Technology, Vol. III," edited by F. J. Biondi, <i>Reviewed</i> <i>by Howard E. Tompkins</i> .....	350
	"Network Synthesis, Vol. I," by D. F. Tuttle, Jr., <i>Reviewed by John G. Truxal</i> .....	350
	Recent Books .....	350
<b>ABSTRACTS</b>	Abstracts of IRE TRANSACTIONS .....	351
	Abstracts and References .....	356
<b>IRE NEWS AND NOTES</b>	Calendar of Coming Events .....	14A
	Professional Group News .....	18A
<b>DEPARTMENTS</b>	Contributors .....	337
	IRE News and Radio Notes .....	14A
	IRE People .....	30A
	Industrial Engineering Notes .....	36A
	Meetings with Exhibits .....	8A
	Membership .....	98A
	News-New Products .....	26A
	Positions Open .....	122A
	Positions Wanted by Armed Forces Veterans .....	116A
	Professional Group Meetings .....	80A
	Section Meetings .....	56A
	Advertising Index .....	177A

**COVER** This view of the earth as seen from the moon, about 240,000 miles or 60 earth radii away, depicts a few of the many features of the earth's atmosphere and its external environment which have been studied during the IGY. Particles from the sun, some of which are visible among the stars at the upper left, are caught in the earth's magnetic field many thousands of miles out and are channeled by it toward the earth. As the speeding particles penetrate the invisible outer atmosphere their concentration and energy near the magnetic poles is at times sufficiently great to produce an aurora in a band which encircles the poles and extends upward within the ionosphere about 500 miles in the direction of the earth's magnetic field. The lower atmosphere below the ionosphere, being less than 60 miles high, is barely discernible along the rim of the earth. The predawn twilight tends to be more pronounced and to penetrate farther west in the middle latitudes due to the light-scattering action of cosmic dust which is heavily concentrated in the orbital plane of the earth.

**BOARD OF DIRECTORS, 1959**

- \*Ernst Weber, *President*
- \*D. B. Sinclair, *Vice President*
- \*W. R. G. Baker, *Treasurer*
- \*Haraden Pratt, *Secretary*
- \*J. D. Ryder, *Editor*
- \*J. T. Henderson, *Senior Past-President*
- \*D. G. Fink, *Junior Past-President*

1959

- L. V. Berkner
- R. I. Cole (R3)
- G. A. Fowler (R7)
- A. N. Goldsmith
- \*R. L. McFarlan (R1)

- D. E. Noble
- E. H. Schulz (R5)
- Samuel Seely
- G. K. Teal

1959-1960

- A. P. H. Barclay (R8)
- G. S. Brown
- W. H. Doherty
- C. E. Harp (R6)
- H. F. Olson (R2)
- A. H. Waynick (R4)

1959-1961

- F. Hamburger, Jr.
- B. M. Oliver

\*Executive Committee Members

**EXECUTIVE SECRETARY**

- George W. Bailey
- Evelyn Benson, *Assistant to the Executive Secretary*
- John B. Buckley, *Chief Accountant*
- Laurence G. Cumming, *Technical Secretary*
- Emily Sirjane, *Office Manager*

**ADVERTISING DEPARTMENT**

- William C. Copp, *Advertising Manager*
- Lillian Petranek, *Assistant Advertising Manager*

**EDITORIAL DEPARTMENT**

- Alfred N. Goldsmith, *Editor Emeritus*
- J. D. Ryder, *Editor*
- E. K. Gannett, *Managing Editor*
- Helene Frischauer, *Associate Editor*

**EDITORIAL BOARD**

- J. D. Ryder, *Chairman*
- F. Hamburger, Jr., *Vice-Chairman*
- E. K. Gannett
- Keith Henney
- E. W. Herold
- T. A. Hunter
- G. K. Teal
- A. H. Waynick



PROCEEDINGS OF THE IRE, published monthly by The Institute of Radio Engineers, Inc. at 1 East 79 Street, New York 21, N. Y. Manuscripts should be submitted in triplicate to the Editorial Department. Responsibility for contents of papers published rests upon the authors, and not the IRE or its members. All republication rights, including translations, are reserved by the IRE and granted only on request. Abstracting is permitted with mention of source.

Thirty days advance notice is required for change of address. Price per copy: members of the Institute of Radio Engineers, one additional copy \$1.25; non-members \$3.00. Yearly subscription price: to members \$9.00, one additional subscription \$13.50; to non-members in United States, Canada, and U. S. Possessions \$18.00; to non-members in foreign countries \$19.00. Second-class postage paid at Menasha, Wisconsin under the act of March 3, 1879. Acceptance for mailing at a special rate of postage is provided for in the act of February 28, 1925, embodied in Paragraph 4, Section 412, P. L. and R., authorized October 26, 1927. Printed in U.S.A. Copyright © 1959 by the Institute of Radio Engineers, Inc.



# TAKE YOUR CHOICE... of these two dependable wirewound resistors

MINIATURE  
**Blue Jacket**<sup>®</sup>  
VITREOUS-ENAMEL POWER RESISTORS

Sprague's new improved construction gives even greater reliability and higher wattage ratings to famous Blue Jacket miniature axial lead resistors.

A look at the small *actual sizes* illustrated, emphasizes how ideal they are for use in miniature electronic equipment with either conventional wiring or printed wiring boards.

Get complete data on these dependable minified resistors, write for **Engineering Bulletin 7410**.

**TAB-TYPE BLUE JACKETS:** For industrial applications, a wide selection of wattage ratings from 5 to 218 watts are available in Sprague's famous Tab-Type Blue Jacket close-tolerance, power-type wirewound resistors. Ideal for use in radio transmitters, electronic and industrial equipment, etc. For complete data, send for **Engineering Bulletin 7400A**.

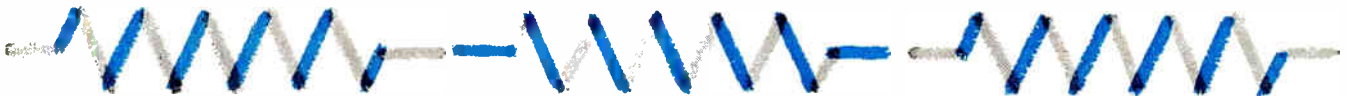
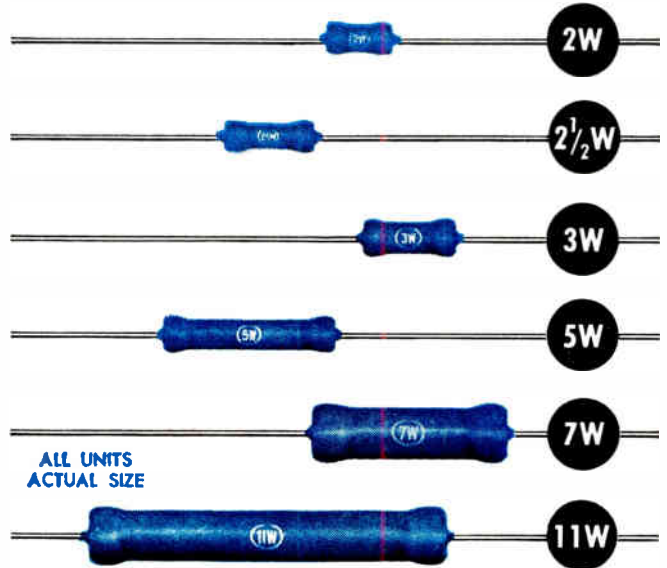

NEW SMALLER SIZE  
**KOOLOHM**<sup>®</sup>  
INSULATED-SHELL POWER RESISTORS

New Koolohm construction features include welded leads and winding terminations—Ceron ceramic-insulated resistance wire, wound on special ceramic core—multi-layer non-inductive windings or high resistance value conventional windings—sealed, insulated, non-porous ceramic outer shells—aged-on-load to stabilize resistance value.

*You can depend upon them to carry maximum rated load for any given physical size.*

Send for **Engineering Bulletin 7300** for complete technical data.

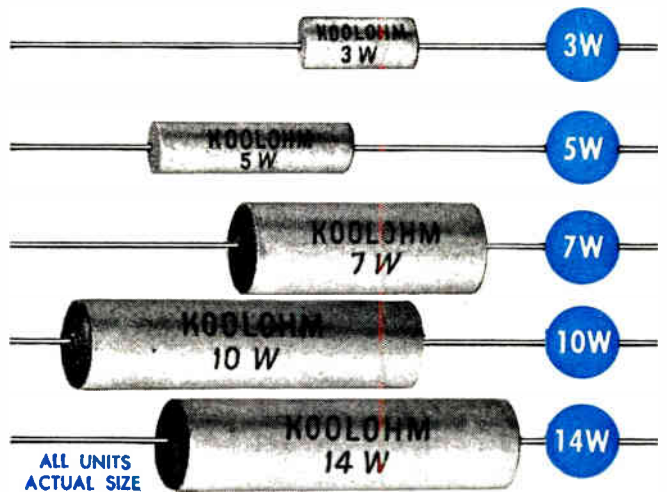

**SPRAGUE ELECTRIC COMPANY**

235 MARSHALL STREET • NORTH ADAMS, MASS.



RESISTORS • CAPACITORS • MAGNETIC COMPONENTS • TRANSISTORS • CERAMIC-BASE PRINTED NETWORKS  
INTERFERENCE FILTERS • PULSE NETWORKS • HIGH TEMPERATURE MAGNET WIRE • PACKAGED COMPONENT ASSEMBLIES



Anything connected with space travel receives a great deal of attention these days and since AIL has a substantial effort in this new and highly romantic field we hasten to share a few interesting observations on space problems with our IRE readers. Karle Packard, Manager of Reliability of our Project STAR, describes some of the difficulties that may be encountered by equipment designers.

## When is a Solid Not Solid?

The development and design of equipment for space applications presents many new and challenging problems. The environment is so different from that to which we are accustomed that it is necessary to reorient our approach to certain problems. The recently discovered band of intense radiation at altitudes of a few thousand miles, for example, will have deleterious effects on many of the materials we ordinarily use in fabricating electronic equipment. The absence of gravity in an orbiting vehicle presents new problems in mechanical design. If one screw shakes loose during take-off, it might float into any or many dangerous positions. An unnoticed drop of solder might do the same. The lack of atmospheric pressure also presents unique problems, far different from those encountered in high altitude aircraft applications. We no longer have an arcing problem; there isn't enough air to ionize. Instead, we must worry about whether or not our materials will stay together.

The role our atmosphere plays in holding things together is well known, but not always appreciated. Although molecules are constantly being emitted from the surface of any material, collisions with air molecules at sea level maintain the number returning to the surface very nearly equal to the number leaving, in the case of solids. This is due to the enormous number of molecules present, resulting in a mean-free-path of about  $10^{-5}$  cm at sea level. At altitudes of a few hundred miles, however, the mean-free-path is about 1 mile and molecules leaving do not return.

The state of matter is dependent on the pressure, temperature and volume of the material considered. The phase (solid, liquid or gas), or mixture of phases will be determined by the environmental conditions and certain constants of the material. These phases may be represented on a P-T diagram as shown in Figure 1, where point A may represent normal (sea-level) conditions and point B may represent the conditions at extremely high altitudes. It is obvious that, under these conditions, the nat-

ural state of the "normally" solid material is gaseous. Unfortunately, many of our ordinarily useful materials are in this state at altitudes of

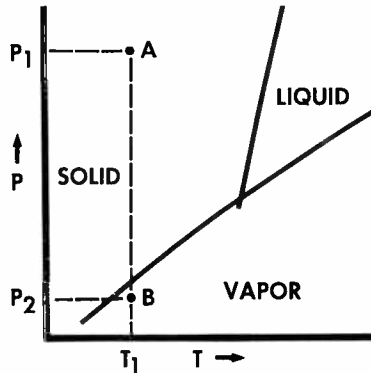

only a few hundred miles above the earth's surface. These include most of our lubricants and at least some high-polymer crystalline solids, particularly thermoplastics.

This does not mean, however, that these materials cannot be used. The change of state from solid (or liquid) to a gas cannot take place instantaneously. In fact the *maximum* rate of sublimation (or evaporation) may be found readily from kinetic theory and is

$$z = A \frac{p_s(T) \sqrt{M}}{\sqrt{2\pi RT}} \text{ gm/sec/cm}^2,$$

where A = numerical coefficient (discussed below)

$p_s(T)$  = saturated vapor pressure in dynes/cm<sup>2</sup>.

M = gram-molecular weight of vapor

R = gas constant

T = absolute temperature

The coefficient A depends on several factors; the mean-free-path, the surface purity, and the constituents of the material. For small mean-free-path A is very small, accounting for the normal stability of solids and liquids which do not have a high saturated vapor pressure. When the

mean-free-path is large compared with the size of the sample, and the surface is reasonably pure, the coefficient A approaches unity. It is this condition which exists in space applications.

An obvious solution to this problem is to seal the equipment. This may introduce other problems, however, and is not always possible. This is a problem that might be encountered in the use of materials such as polytetrafluoroethylene and an estimate of its sublimation rate is illustrative of the problem. Assuming  $A = 0.5$ ,  $M = 1000$  and  $T = 350$  deg. K, we find

$$z \approx 0.5 \text{ gm/cm}^2/\text{month},$$

or assuming only one exposed surface, the thickness will decrease at a rate of

$$Z \approx 0.25 \text{ cm/month}.$$

The unknown factors here are, the coefficient, A, and M, the gram-molecular weight of the vapor; the latter could be as low as 100 ( $z = 0.025$  cm/month) or as high as 100,000 ( $z = 25$  cm/month)! Although much work has been done on the decomposition of polymers at high temperatures, very little has been done at low pressures. The molecular content of the vapor at moderate temperatures is, therefore, not well known. We are at present investigating this sublimation problem and hope to have more exact results in the near future.

In case anyone is contemplating a trip to Venus and is now worried about his metal space ship—have no fear. The saturated vapor pressure of magnesium, at 25 deg. C. is  $7 \times 10^{-18}$  mm of mercury, as compared to  $10^{-7}$  mm of mercury for polytetrafluoroethylene. The sublimation rate is about  $10^{-15}$  cm per year. If the trip cannot be completed before the skin is gone it really doesn't matter.

A complete bound set of our third series of articles is available on request. Write to Harold Hechtman at AIL for your set.

*Airborne Instruments Laboratory*  
A DIVISION OF CUTLER-HAMMER, INC.  
**160 OLD COUNTRY ROAD, MINEOLA, L. I., N. Y.**  
Phone Pioneer 2-0600

# new transistors from Sprague\*

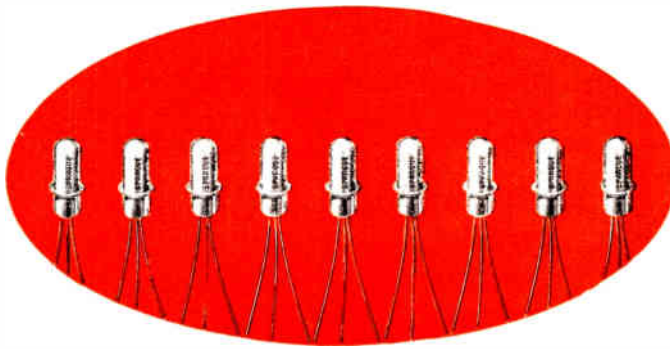

## SUPER HIGH-SPEED SWITCHING TRANSISTORS TYPE 2N501

	Typical	Maximum	Units
Rise Time ( $t_r$ )	9	18	$\mu\text{sec}$
Storage Time ( $t_s$ )	9	12	$\mu\text{sec}$
Fall Time ( $t_f$ )	7	10	$\mu\text{sec}$

In circuit with current gain of 10 and voltage turnoff.

Also available as special type 2N501A for 100° C. maximum storage and junction temperatures.

This table tells the story. Sprague Type 2N501 germanium micro-alloy diffused-base transistors are the fastest mass-produced transistors available anywhere! They are unexcelled for high-speed computer applications. The ultra-low rise, storage, and fall time cannot be matched by any other transistor.

Ultra-precise process control in manufacture results in superb and consistent high quality. The basic electrochemical process of fabrication takes the guesswork out of transistor manufacturing. The result is outstanding uniformity of product.

Because of the electrochemical process, Sprague is able to fabricate a graded-base transistor with no intrinsic base region. The Type 2N501 can thus maintain its super high-speed switching characteristics right down to its saturation voltage, providing all the advantages of direct-coupled circuitry with no impairment of switching speeds.

Type 2N501 Transistors are available from Sprague now at extremely reasonable prices. They are transistors you can use today! You need not delay your development work for the future when you design high-speed switching circuits with Type 2N501 Micro-Alloy Diffused-Base Transistors.

Write for complete engineering data sheet to the Technical Literature Section, Sprague Electric Company, 235 Marshall Street, North Adams, Massachusetts.

**\*** *Sprague micro-alloy, micro-alloy diffused-base, and surface barrier transistors are fully licensed under Philco patents. All Sprague and Philco transistors having the same type numbers are manufactured to the same specifications and are fully interchangeable.*

### SPRAGUE COMPONENTS:

TRANSISTORS • CAPACITORS • RESISTORS  
 MAGNETIC COMPONENTS • INTERFERENCE FILTERS  
 PULSE NETWORKS • HIGH TEMPERATURE MAGNET WIRE  
 CERAMIC-BASE PRINTED NETWORKS  
 PACKAGED COMPONENT ASSEMBLIES





From Bell Telephone Laboratories...

# Brainpower for the brawny Nike-Hercules

The Army's newest surface-to-air guided missile—the lethal Nike-Hercules—is now operational. Because it is, no unfriendly plane will be able to fly sufficiently high, fast or evasively to escape a fatal rendezvous with it.

For Hercules has a “brain”—an intellect that makes it a prodigy among today's electronic robots. Bell Telephone Laboratories developed it. Western Electric (prime contractor for the entire missile system) is producing it. Douglas Aircraft Company is giving it its body.

This “brain” is a fully integrated guidance system, almost entirely land-based. Only the vital signal-receiving apparatus is expendable within the missile itself. Other highly practical features: it defies “jamming,” is completely mobile, is designed in separate “building block” units which are replaceable in seconds—and is deadly accurate.

Bell Labs scientists and engineers designed the world's largest and most intricate telephone communications network for the Bell System. They developed about half of the Armed Forces' radar equipment during World War II. And they pioneered the nation's *first* successful air defense guided missile system—Nike-Ajax.

They were eminently qualified to give Hercules the brainpower it needed.



**BELL TELEPHONE LABORATORIES**

World center of communications research and development

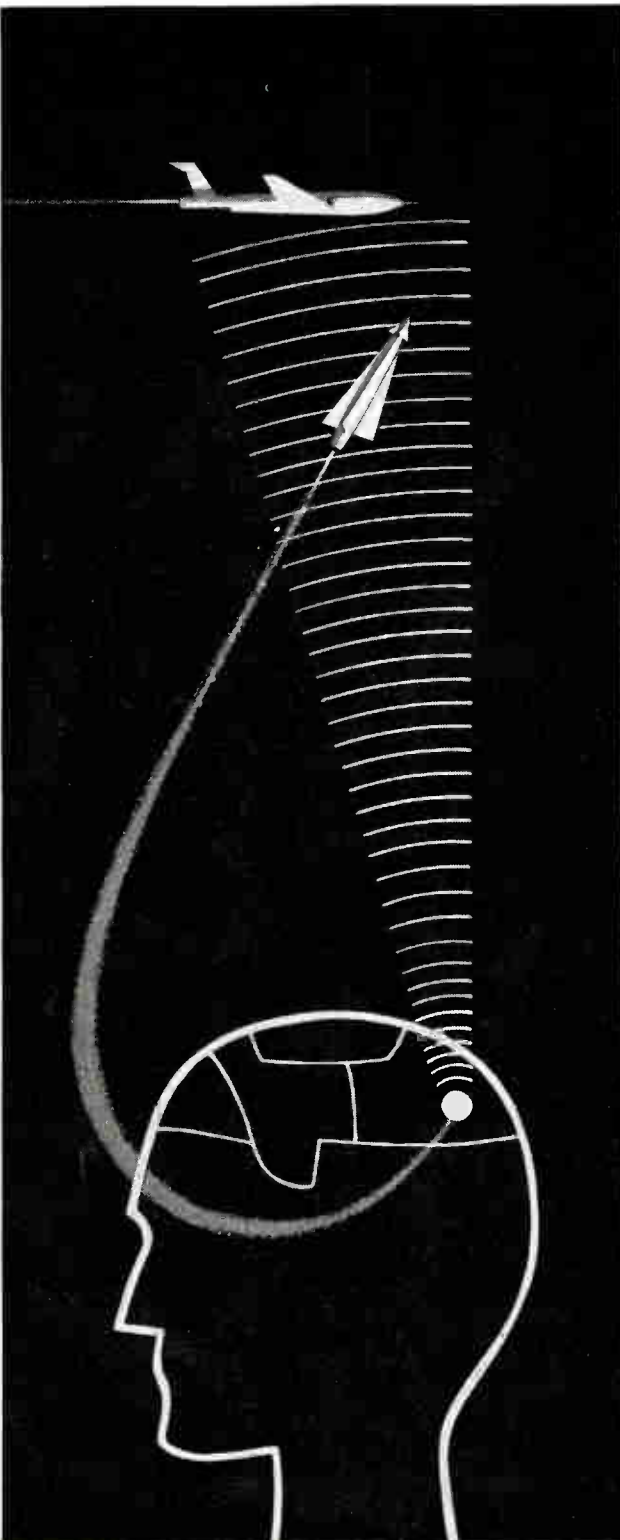

Vigilant acquisition radar for Nike-Hercules first detects approach of distant aircraft, pinpoints its location and instantly signals to battery control.



Two tracking-radar antennas, housed in radomes, take over. One feeds target azimuth, elevation, range data to computers; other tracks Hercules.



Two sets of radar data are electronically computed and plotted. Hercules is “steered” by radio signals, then detonated at precise point of interception.



# FASTEST TUNING PULSE MAGNETRON TUNES HYDRAULICALLY

## adapts to current systems

This is the first public announcement of the first hydraulically-tuned pulse magnetron. It permits a powerful new capability in anti-jamming pulse-to-pulse frequency diversity operation.

Designated L-3211 and equipped with an hydraulic tuning actuator we developed, *this is the fastest tuning, medium power magnetron in production today.*

The L-3211 is designed for X-band operation with electrical characteristics similar to those of our standard field-proved 6543 magnetron. The principles of its design make it adaptable to other power levels and frequency bands.

Tubes of this family greatly enhance system

tuning capability, approaching that of voltage-tuned tubes, with much greater efficiency and less system complexity. The L-3211 affords a means of upgrading both new and existing radar systems in operational effectiveness. (We also can provide information on a "need-to-know" basis on classified tubes that have even greater capabilities than the L-3211.)

In constructing the L-3211 we use certain techniques proprietary with us . . . techniques which guarantee a long operating life and a long shelf life. Ageing-in prior to full-power operation is unnecessary.

It is another one of a large number of micro-wave tubes used in radar and countermeasures

built to specifications established by Litton Industries . . . specifications which have become recognized as standards by the military services.

Our Applications Engineering Lab is well equipped\* to analyze your problem. It has been remarkably successful in finding fast and accurate solutions to difficult system problems. Let it solve yours. We'll be glad to answer your specific inquiries, or to send you a copy of our catalog. Litton Industries Electron Tube Division, Office P3, 960 Industrial Road, San Carlos, California.

\*Incidentally, so is our Personnel Department.

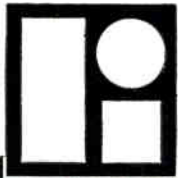

## LITTON INDUSTRIES Electron Tube Division

MAGNETRONS • GAS DISCHARGE TUBES • CARCINOTRONS • TRAVELING WAVE TUBES  
KLYSTRONS • BACKWARD WAVE OSCILLATORS • NOISE SOURCES • DISPLAY TUBES

# CAPABILITY THAT CAN CHANGE YOUR PLANNING



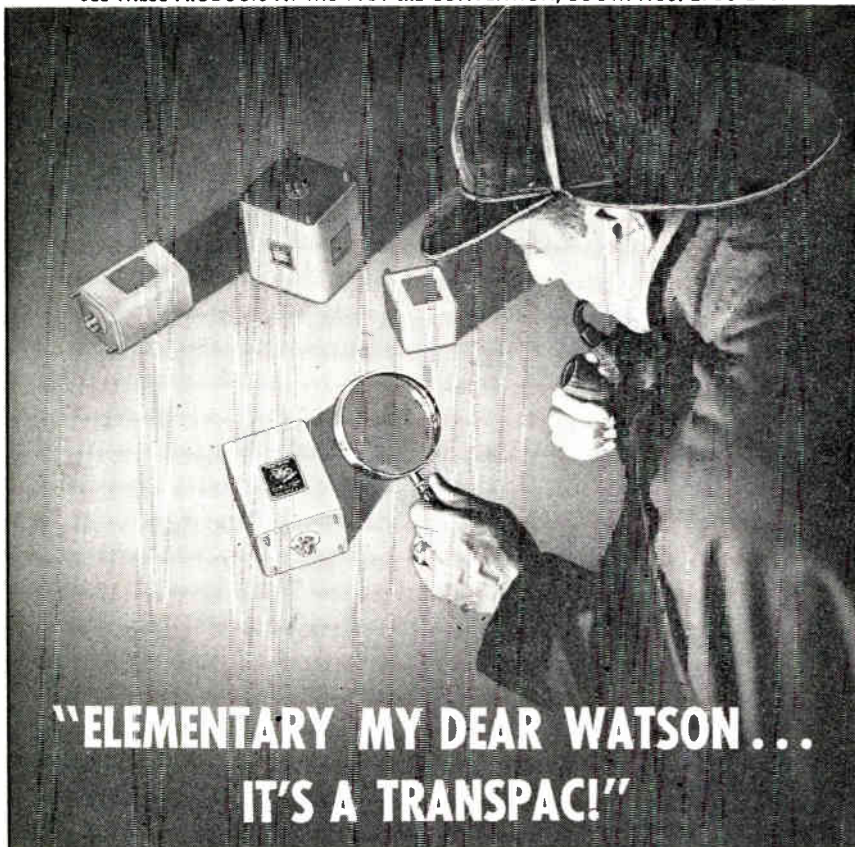

**"ELEMENTARY MY DEAR WATSON...  
IT'S A TRANSPAC!"**

## ERA's MINIATURE TRANSISTORIZED POWER PACK

For Aircraft, Guided Missiles and All Miniaturized Applications

Save space, wiring and weight with TRANSPAC, miniaturized self-contained AC operated DC power packs. Wired into circuits TRANSPAC supplies a rugged, reliable source of DC power. Units are for 105-125 VAC, 60 or 400 cps, and are in transformer type housings, specially potted to resist shock and vibration. Design features include line isolation, rectification using semiconductor diodes, use of transistor, gas, zener, or magnetic regulators (dependent on model type) and high efficiency filtering.

Special designs also available to customers specifications. Write for quotation and complete literature.

Write For ERA's New Solid State Power Supply Catalogue.

**HIGH AMPERAGE TRANSPACS**  
Outputs 2.5 through 25 VDC, currents up to 3 amps. For DC filament, solenoid and all high ampere applications.

**CONSTANT CURRENT TRANSPACS**  
Available in a full range of constant current regulated outputs. For electronic, electrical, chemical and medical applications.

**TRANSISTORIZED REGULATED TRANSPACS**  
Available for DC outputs 5 through 300 VDC, currents up to 200 ma. Line and load regulated. For both tube and transistor applications.

**ADJUSTABLE TRANSISTORIZED TRANSPACS**  
Voltage variable for closely regulated applications (by means of a screwdriver adjustment). Voltage ranges 5 through 300 VDC. Currents up to 200 ma.

**CONSTANT VOLTAGE TRANSPACS**  
Voltage ranges 75 through 900 VDC output, currents up to 40 ma. Line and load regulated. For general tube and transistor applications.

**DUAL OUTPUT TRANSPACS**  
For AC operated PNP or NPN transistor equipment. Supplies constant current emitter bias and regulated collector bias.

**LOW VOLTAGE TRANSPACS**  
Available in voltage ranges 5 through 60 VDC output. Line and load regulated. Ideal for all types of regulated low voltage applications.

**UNREGULATED TRANSPACS**  
Voltage ranges 5 through 2400 VDC output, currents up to 100 ma. For general tube and transistor applications.

**HIGH TEMPERATURE TRANSPACS**  
All TRANSPAC models are available in high temperature designs for military and similar critical applications. Temperature ratings of these units extend to 85°C.

### Pioneers in Semi-Conductor and Transistorized Products.

First Miniaturized Power Packs.  
First Transistorized Power Supplies.  
First Automatic Transistor Test Equipment.  
First Dual Output Tubeless Supplies.  
First Packaged Transistor Circuits.

First Transistor Application Power Supplies.  
First Constant Current Generators.  
First High Current Semi-Conductor Regulated Supplies.  
First "E" Core Transistorized Converters/Inverters.  
First High Power Semi-Conductor Frequency Changers.



**ELECTRONIC RESEARCH ASSOCIATES Inc.**

67 Factory Place, Cedar Grove, N. J.

Center 9-3000

SUBSIDIARIES

ERA PACIFIC INCORPORATED • SANTA MONICA, CALIFORNIA  
ERA ELECTRIC CORPORATION • NUTLEY, NEW JERSEY

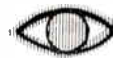

**Meetings  
with Exhibits**



● As a service both to Members and the industry, we will endeavor to record in this column each month those meetings of IRE, its sections and professional groups which include exhibits.

▲

March 3-5, 1959

**Western Joint Computer Conference,**  
Fairmont Hotel, San Francisco, Calif.  
*Exhibits:* Mr. H. K. Farrar, Pacific Tel. & Tel. Co., 140 New Montgomery St., San Francisco 5, Calif.

March 23-26, 1959

**Radio Engineering Show and National IRE Convention,** New York Coliseum and Waldorf-Astoria Hotel, New York, N.Y.  
*Exhibits:* Mr. William C. Copp, Institute of Radio Engineers, 72 West 45th St., New York 36, N.Y.

April 5-10, 1959

**Fifth Nuclear Congress,** Cleveland, Ohio.  
*Exhibits:* Dr. John C. Simons, Jr., National Research Corp., 70 Memorial Drive, Cambridge 42, Mass.

April 16-18, 1959

**SWIRECO, Southwestern IRE Regional Conference & Electronics Show,** Dallas Memorial Auditorium & Baker Hotel, Dallas, Tex.  
*Exhibits:* Mr. John McNeely, Southwestern Bell Telephone Co., 308 South Akard St., Dallas 1, Tex.

May 4-6, 1959

**National Aeronautical Electronics Conference,** Dayton Biltmore Hotel, Dayton, Ohio.  
*Exhibits:* Mr. Edward M. Lisowski, General Precision Lab., Inc., Suite 452, 333 West First St., Dayton 2, Ohio.

May 6-8, 1959

**Seventh Regional Technical Conference and Trade Show,** University of New Mexico, Albuquerque, N.M.  
*Exhibits:* Mr. Earl C. Davis, P.O. Box 3262, Albuquerque, N.M.

June 3-5, 1959

**Armed Forces Communications & Electronics Association Convention & Exhibit,** Sheraton-Park Hotel, Washington, D.C.  
*Exhibits:* Mr. William C. Copp, 72 West 45th St., New York 36, N.Y.

June 4-5, 1959

**Third National Conference on Production Techniques,** Villa Hotel, San Mateo, Calif.  
*Exhibits:* Mr. Estrada Fanjul, Stanford Research Institute, Menlo Park, Calif.

June 13-22, 1959

**International Conference on Information Processing,** UNESCO House & Palais d'Exhibition, Paris, France.  
*Exhibits:* Mr. E. M. Grabbe, Ramo Wooldridge Corp., Box 45067, Airport Station, Los Angeles 45, Calif.

(Continued on page 10A)



# SWEEPING OSCILLATORS for RADAR and TELEMETERING IF's 1-1,200 mc by **KAY ELECTRIC**

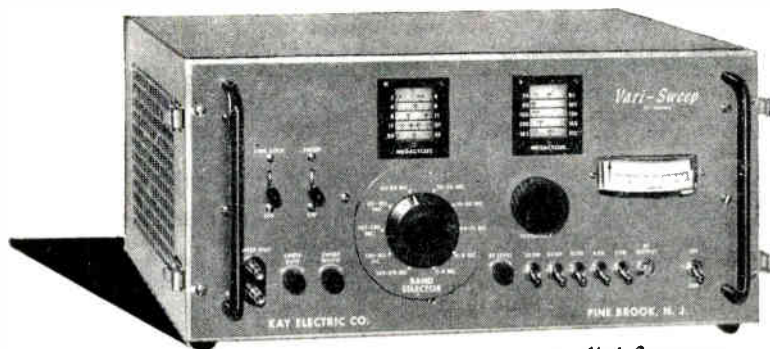

Kay Vari-Sweep 860-A

The Kay sweeping oscillators are a line of high level lab and field test instruments designed for the alignment of radar and telemetering IF strips from 1 to 1,200 mc. The line offers a wide choice of precision-built units which are simple to operate, highly stable, and extremely flexible.

- Wide Range, Wide Sweep
- High Output
- Fundamental Frequency
- Constant Output (Fast-Acting AGC)
- Continuously Variable Centers
- Fixed, Crystal-Controlled Markers
- All Electronic Operation

Instrument	Cat. No.	Range	Sweep Width	RF Output	Markers	Price†
Vari-Sweep	860-A	2-220 mc (center)	Contin. Variable to 60% center freq. below 50 mc; 30 mc plus, above 50 mc.	1.0 V rms AGC'd, 70 ohms	None	\$745.
Vari-Sweep Model IF	866-A*	4-120 mc (center)		1.0 V rms AGC'd, 70 ohms	11 Fixed Crystals 1 Variable, Direct reading dial	\$985.
Vari-Sweep Model Radar	865-A*	10-145 mc (center)		1.0 V rms AGC'd, 70 ohms	11 Fixed Crystals 1 Variable, Direct reading dial	\$985.
Vari-Sweep Model 400	867-A	15-470 mc in 10 bands	Same as above to 400 mc; 20 mc max. above 400 mc.	1.0 V rms into 70 ohms to 220 mc; 0.5 V rms to 470 mc; all AGC'd	None	\$795.
Mega-Sweep	110-A**	50 kc-950 mc	50 kc-40 mc	100 mv at 50 ohms	None	\$545.
Rada-Sweep	380-A*	2 Switched bands 20-40 mc; 50-70 mc	2 Switched bands, Wide 20 mc, Nar. 3 mc	250 mv rms, 70 ohms	9 Fixed Crystals	\$425. (with 4 crystals)
Rada-Sweep 300	386	Between 1 & 350 mc center	70% of center to 100 mc; 60-70 mc to 350 mc	0.5 V rms into 70 or 50 ohms.	Up to 30 crystal pulse marks	\$695. plus \$15. per marker ordered

\*\*Other Mega-Sweeps to 1200 mc; and with Markers.

\*Wider sweep widths, additional crystal markers available on special order.

† All prices F.O.B. Pine Brook, N. J.



Write for New Kay Catalog

## KAY ELECTRIC COMPANY

Dept. I-2 Maple Avenue, Pine Brook, N.J. Capital 6-4000

See us at the IRE Show, Booths 2608-09 and 3025-26 © 1958 BY KAY ELECTRIC CO.

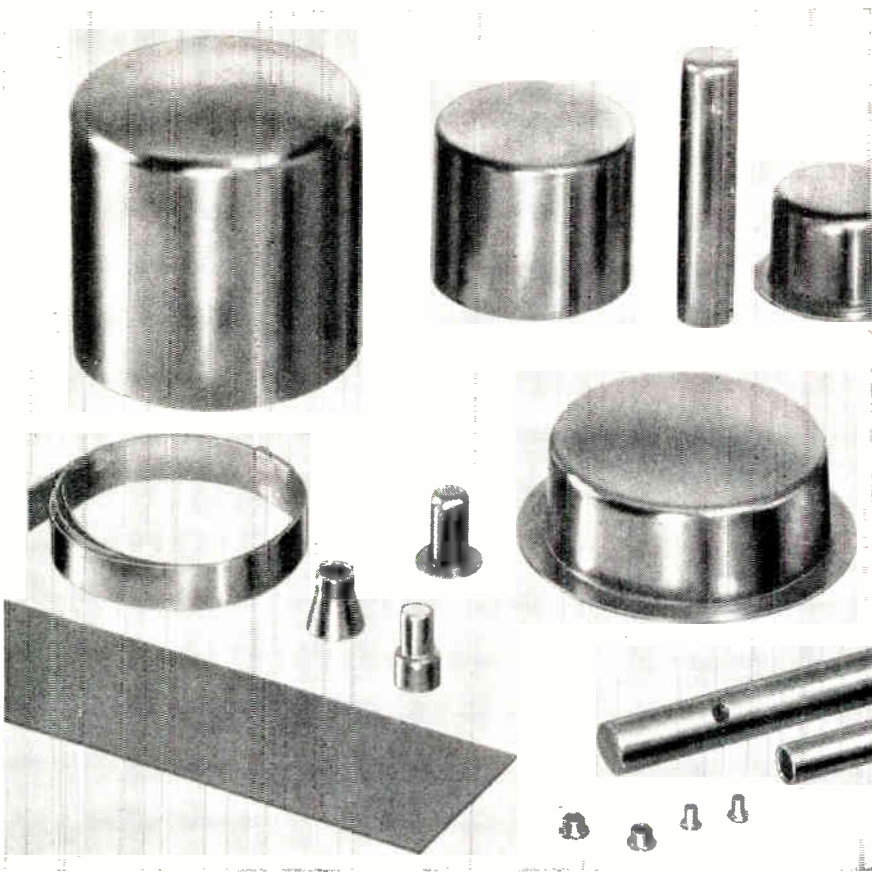

# Use KOVAR alloy for strain-free pressure and vacuum-tight seals

KOVAR's\* thermal expansion rate, when used with matching hard glasses and ceramics, is the key property of this unique alloy. Unlike most metals, it expands at a variable rate with increasing temperatures, matching almost perfectly the corresponding curves of several hard glasses and closely approaches the expansivity of high alumina ceramics.

The photo above shows some of the common shapes in which KOVAR alloy is carried in stock for immediate shipment.

An iron-nickel-cobalt alloy, KOVAR is easily formed. An oxide bond is made with hard glass, and KOVAR may be brazed to metallized ceramics. Permanent vacuum and pressure tightness is assured . . . even under severe temperatures or vibration.

KOVAR can be welded, brazed or soldered, —also plated with other metals, either by electrolytic or chemical methods.

Technical service is available to help you solve processing and application problems. Contact The Carborundum Company, Refractories Division, Dept. PI-29, Latrobe Plant, Latrobe, Pa.

\*Registered trade mark

**FIND OUT ABOUT KOVAR—  
WHERE IT IS USED AND WHY**

This new book gives data on composition, fabricating techniques and applications of KOVAR alloy. Send for your copy of this free book today.

# CARBORUNDUM

Registered Trade Mark

## Meetings with Exhibits

(Continued from page 8A)

**June 29-July 1, 1959**  
**Third National Convention on Military Electronics**, Sheraton-Park Hotel, Washington, D.C.  
*Exhibits:* Mr. L. David Whitelock, Bu-Ships, Electronics Div., Dept. of Navy, Washington, D.C.

**August 18-21, 1959**  
**WESCON, Western Electronic Show and Convention**, Cow Palace, San Francisco, Calif.  
*Exhibits:* Mr. Don Larson, WESCON, 1435 La Cienega Blvd., Los Angeles, Calif.

**September 28-30, 1959**  
**National Symposium on Telemetering**, Civic Auditorium & Whitcomb Hotel, San Francisco, Calif.  
*Exhibits:* Mr. Robert A. Grimm, Dymec, Inc., 395 Page Mill Road, Palo Alto, Calif.

**October 7-9, 1959**  
**IRE Canadian Convention**, Exhibition Park, Toronto, Ont., Canada.  
*Exhibits:* Mr. F. G. Heath, IRE Canadian Convention, 1819 Yonge St., Toronto 7, Ont., Canada.

**October 12-15, 1959**  
**National Electronics Conference**, Hotel Sherman, Chicago, Ill.  
*Exhibits:* Mr. Arthur H. Streich, National Electronics Conference, Inc., 84 E. Randolph St., Chicago 1, Ill.

**October 26-28, 1959**  
**East Coast Aeronautical & Navigational Electronics Conference**, Lord Baltimore Hotel & 7th Regiment Armory, Baltimore, Md.  
*Exhibits:* Mr. R. L. Pigeon, Westinghouse Electric Corp., Air Arm Div., P.O. Box 746, Baltimore, Md.

**November 9-11, 1959**  
**Fourth Instrumentation Conference**, Atlanta, Ga.  
*Exhibits:* Dr. B. J. Dasher, School of E.E., Georgia Institute of Technology, Atlanta 13, Ga.

**November 30-December 3, 1959**  
**Eastern Joint Computer Conference**, Hotel Statler, Boston, Mass.  
*Exhibits:* Mr. John M. Broomall, Burroughs Corporation, Paoli, Pa.

Δ

Note on Professional Group Meetings: Some of the Professional Groups conduct meetings at which there are exhibits. Working committeemen on these groups are asked to send advance data to this column for publicity information. You may address these notices to the Advertising Department and of course listings are free to IRE Professional Groups.

# PERKIN

**6 TO 36  
VOLTS  
@ 15 AMPS**

**THE NEW "TRANSIENT  
FREE"  
PERKIN  
TRANSISTORIZED**

**MODEL MTR 636-15  
D. C. POWER SUPPLY**



**NOW . . . from PERKIN - "TRANSIENT FREE" D. C. POWER IN A  
VERSATILE WIDE VOLTAGE RANGE D. C. POWER SUPPLY**

OTHER STANDARD CATALOG  
UNITS AVAILABLE WITH  
COMPARABLE SPECIFICATIONS

MODEL NO.	D. C. OUTPUT VOLTS	AMPS
MTR060-1	0-60	1
MTR060-5	0-60	5
MTR615-5	6-15	5
MTR636-30	6-36	30
MTR28-2	24-32	2
MTR28-5	24-32	5
MTR28-10	24-32	10
MTR28-30	24-32	30
MTR28-100	24-32	100

FOR ADDITIONAL DATA AND  
PRICE INFORMATION, WIRE COLLECT TO:

**PERKIN**  
ENGINEERING CORPORATION

345 Kansas St.  
OREgon 8-7215

El Segundo, Calif.  
EAStgate 2-1375

AT LAST!! — A POWER SUPPLY WITH PRECISE  
REGULATION THAT IS UNAFFECTED BY LINE AND  
LOAD TRANSIENTS . . . INSTANTANEOUS CHANGES IN  
LINE AND LOAD WILL NOT CAUSE TRANSIENT  
VOLTAGE "SPIKES" IN THE D. C. OUTPUT.

### SPECIFICATIONS

<b>D. C. OUTPUT:</b>	6-36 Volts @ 15 Amperes
<b>A. C. INPUT:</b>	105-125 Volts, 1 phase, 60 cps
<b>STATIC REGULATION:</b>	Line — ±25 MV; Load — ±50 MV
<b>DYNAMIC REGULATION:</b>	Line: ±50MV; Load: ±.75 V. No Load to full load & FL to NL
<b>RIPPLE:</b>	5 MV RMS Maximum
<b>DYNAMIC IMPEDANCE:</b>	50 Milliohms (0 CPS to 20 KC)
<b>PROTECTION:</b>	Short Circuit Proof — Automatic Current Limiting at 18 Amperes. (Short Circuits and Overloads can be sustained indefinitely without damage to the power supply.)
<b>WEIGHT:</b>	Approximately 125 Lbs.
<b>DIMENSIONS:</b>	19" W x 15" D x 12¼" H (Rack panel mount) 20½" W x 16¼" D x 14" H (in cabinet)
<b>SPECIAL FEATURE:</b>	Through the use of a special combination magnetic amplifier-transistor circuit and conservative design techniques, this power supply provides full load output even in the case of a transistor failure.

REPRESENTATIVES IN PRINCIPAL CITIES

# PERKIN





# For Every Fuse Application ..

*there's a safe and dependable  
BUSS or FUSETRON Fuse*

## The complete BUSS and FUSETRON fuse line includes:

Single-element fuses for circuits where quick-blowing is needed; — or single-element fuses for normal circuit protection; — or dual-element, slow-blowing fuses for circuits where harmless current surges occur; — or indicating fuses for circuits where signals must be given when fuses open. Fuses range in sizes from 1/500 amperes up — and there's a companion line of fuse clips, blocks and holders.

## Each fuse electrically tested to assure you dependability

Every BUSS or FUSETRON fuse is tested in a sensitive electronic device that automatically rejects any fuse not correctly calibrated, properly constructed and right in all physical dimensions.

You get the safest, most modern protection possible when you specify BUSS or FUSETRON fuses. You'll save time and trouble too, by using this one source for all your fuse needs.

*For more information,  
write for bulletin SFB.*

BUSSMANN MFG. DIVISION McGraw-Edison Co.  
University at Jefferson, St. Louis 7, Mo.

259

*Tell us your requirements and we'll have a fuse to match, for example:*

For fuses that abolish needless blows .. specify .. **Fusetron fuses**

1/4 x 1 1/4 inch.  
Glass tube.



dual-element — slow blowing type

These fuses avoid needless blows from starting currents or surges. Yet protection is afforded against short-circuits or continued overloads.

Test specifications — carry 110%, open at 135% within 1 hour.

Voltage	Amperes
250 or less	up to 2
125 or less	up to 7
32 or less	up to 30

For Signal or Visual indicating fuses ... specify ... **Fusetron FNA fuses**

13/32 x 1 1/2 inch.



Fusetron fuse with indicating pin which extends when fuse is blown. Can be used in BUSS fuseholders to give visual signal or, if desired, pin can be used to actuate a light or audible signal by using fuses in BUSS Signal Fuse block.

0 to 2 1/2 ampere sizes and 12 to 15 ampere sizes listed as approved by Underwriters' Laboratories.

Voltage	Amperes
250 or less	1/10 to 30.

For fast acting fuses for protection of instruments specify **BUSS AGC fuses**

1/4 x 1 1/4 inch.  
Glass tube.



In sizes up to 2 ampere, for circuits of 250 volts or less, they provide high speed action necessary to protect sensitive instruments or delicate apparatus.

Listed as approved by Underwriters' Laboratories.

Test specifications — carry 110%, open at 135% in 1 hour or less. 1/500 to 2 ampere sizes also will open at 200% load in 5 seconds or less.

For high interrupting capacity fuses ... specify .. **BUSS KTK fuses**

13/32 x 1 1/2 inch.

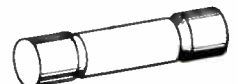

Capable of safely interrupting 68,000 amperes at voltages of 500 or less, AC or DC.

Test specifications — Carry 110%, open at 135% in 1 hour or less.

Voltage	Amperes
500 or less.	1/10 to 30.

**BUSS fuses are made to protect,—not to blow, needlessly.**

*BUSS makes a complete line of fuses for home, farm, commercial, electronic, automotive and industrial use.*



for



ampere,  
high frequency  
switching

use



# RELIABLE COMPUTER TRANSISTORS

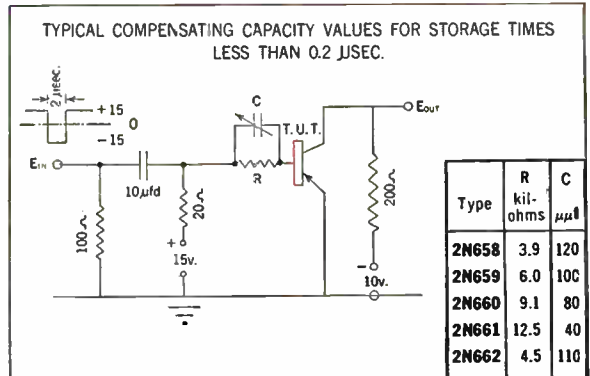
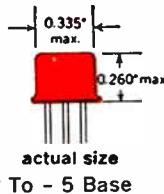
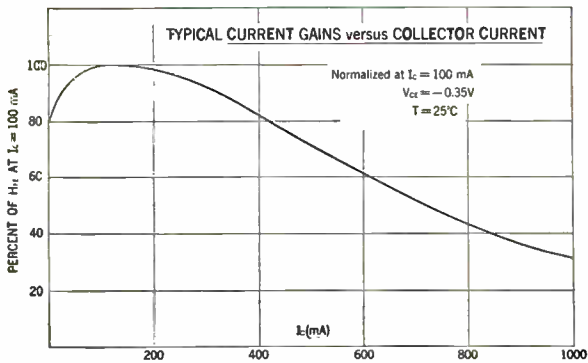

Type	Punch through Voltage max.	$f_{\alpha b}$ ave. Mc	$H_{FE1}$ ave. $I_B = 1 \text{ mA}$ $V_{CE} = -0.25 \text{ v}$	$H_{FE2}$ ave. $I_B = 10 \text{ mA}$ $V_{CE} = -0.35 \text{ v}$	$I_{C0}$ at $-12 \text{ v}$ $\mu\text{A}$	$r_b'$ $I_C = -1 \text{ mA}$ ohms	$C_{ob}$ $V_{CB} = -6 \text{ v}$ $\mu\text{f}$
2N658	-24	5	50	40	2.5	60	12
2N659	-20	10	70	55	2.5	65	12
2N660	-16	15	90	65	2.5	70	12
2N661	-12	20	120	75	2.5	75	12
2N662	-16	8	30 min.	50	2.5	65	12

Typical values at 25°C unless otherwise indicated

Dissipation Coefficients: In air 0.35°C/mW; Infinite Sink 0.18°C/mW

These new PNP Germanium Computer Transistors made by Raytheon's reliable *fusion-alloy* process add to the already comprehensive line of Raytheon Reliable Computer Transistors which include several in the *Submin* (0.160" high, 0.130" dia.) package. Write for Data Sheets.



## SEMICONDUCTOR DIVISION

RAYTHEON MANUFACTURING CO.

SILICON AND GERMANIUM DIODES AND TRANSISTORS • SILICON RECTIFIERS

New York, Plaza 9-3900 • Boston, Hillcrest 4-6700 • Baltimore, Southfield 1-1237 • Washington, D. C., REpublic 7-6565  
Chicago, National 5-4000 • Cleveland, Winton 1-7005 • Kansas City, Plaza 3-5330 • Los Angeles, NOrmandy 5-4221



## Calendar of Coming Events and Authors' Deadlines\*

1959

- Solid-State Circuits Conf.**, Sheraton Hotel and Univ. of Pa., Philadelphia, Pa., Feb. 12-13
- Cleveland Electronics Conf.**, Cleveland Engineering Soc. Bldg., Cleveland, Ohio, Feb. 12-13
- Western Joint Computer Conf.**, Fairmont Hotel, San Francisco, Calif., Mar. 3-5
- IRE Nat'l Convention**, Coliseum and Waldorf-Astoria, New York City, Mar. 23-26
- Millimeter Waves Int'l Symp.**, Engineering Societies Bldg., New York City, Mar. 31, Apr. 1-2
- Silicon-Carbide Conf.**, Boston, Mass., Apr. 2-3 (DL\*: Mar. 1, J. R. O'Connor, Elec. Mat'l Sci. Lab. AF Cambridge Res. Ctr., Bedford, Mass.)
- Nuclear Cong.**, Cleveland, Ohio, Apr. 5-10
- Industrial Instrumentation & Control Conf.**, Ill. Inst. Tech., Chicago, Ill., Apr. 14-15
- SWIRECO (Southwestern Regional Conference)**, Dallas, Texas, Apr. 16-17 (DL\*: Nov. 1, Frank Seay, Texas Instr. Inc., 6000 Lemmon Ave., Dallas 9, Tex.)
- Conf. on Analog and Digital Recording and Controlling Instrumentation**, Bellevue-Stratford Hotel, Phila., Pa., April 20-21
- Spring Tech. Conf. of Cincinnati Sec. of the IRE**, April 21, 22.
- Nat'l Aero Elec.**, Conf. Biltmore and Miami-Pick Hotel, Dayton, Ohio, May 4-6
- Fifth Annual Flight Test Instr. Symp.**, Seattle, Wash., May 4-7
- URSI Spring Meeting**, Washington, D. C., May 5-7
- Elec. Components Conf.**, Ben Franklin Hotel, Philadelphia, Pa., May 6-8
- 7th Reg. Tech. Conf. and Trade Show**, Univ. of N. M., Albuquerque, N. M., May 6-8
- Joint Conf. on Auto. Tech.**, Pick-Congress Hotel, Chicago, Ill., May 11-13
- Internat'l Conv. on Transistors and Associated Semiconductor Devices**, Earls Court, London, May 25-29
- Australian IRE Radio Eng. Conv.**, Univ. of Melbourne, Victoria, Aus., May 25-20
- Internat'l Conf. on Med. Elec.**, Paris, France, June
- Microwave Theory & Tech.**, 1959 Nat'l Symp., Harvard Univ., Cambridge, Mass., June 1-3 (DL\*: Feb. 15, Dr. H. J. Riblet, 92 Broad St., Wellesley, Mass.)
- Prod. Tech. Symp.**, Villa Hotel, San Mateo, Calif., June 4-5

\* DL = Deadline for submitting abstracts.

(Continued on page 15A)

## IRE NATIONAL CONVENTION TO FEATURE MANY NEW TOPICS

The rapid strides which have been made in the past year in space technology and other major new fields of electronics have given a radically new look to the program of the 1959 IRE National Convention, scheduled for the Waldorf-Astoria Hotel and New York Coliseum on March 23-26.

Highlighting the 54 sessions will be a special Tuesday evening symposium at which ten of the nation's foremost experts will discuss "Future Developments in Space." Present developments, too, will receive a good deal of attention in two additional sessions devoted to Space Electronics.

Two new entries of unusual interest have been included in the program this year: a symposium on Psychology and Electronics in the Teaching-Learning System, and a session on Theory and Practice in Russian Technology. Other sessions range over the fields of all 28 Professional Groups and include such timely topics as Widening Horizons in Solid State Electronics, Frontiers of Industrial Electronics, Man-Machine System Design, and Military Electronics Looks Forward. A full list of sessions, papers and abstracts will appear in the March PROCEEDINGS.

Exhibit space at the mammoth New York Coliseum has been completely sold out, assuring visitors that the Radio Engineering Show will provide them with the most complete showcase of new apparatus and products ever assembled under one roof. 850 exhibitors will display thousands of the latest developments, many for the first time.

Convention activities begin on Monday morning, March 23, with the Annual Meeting of IRE in the Grand Ballroom of the Waldorf. D. B. Sinclair, vice-president of the IRE, will be the principal speaker.

The social activities include a get-together cocktail party Monday evening and the Annual Banquet Wednesday evening, at which the 1959 IRE award winners will be honored. Because an attendance of over 55,000 is expected at the convention, members are urged to send in their reservations for these functions immediately. Tickets may be purchased from IRE headquarters, 1 East 79 Street, New York 21, N. Y. at \$4.50 each for the cocktail party and \$15.00 each for the banquet.

A ladies' program has been arranged.

## PGMTT PLANS SYMPOSIUM AND SOLICITS PAPERS

The Professional Group on Microwave Theory and Techniques, Boston Section, in cooperation with the Division of Engineering and Applied Physics, Harvard University, announces the 1959 PGMTT National Symposium. It will be held June 1-3 at Harvard, in Cambridge, Mass. Papers are being solicited, and abstracts should be sent to Dr. H. J. Riblet, 92 Broad Street, Wellesley, Mass., not later than February 15.

Six technical sessions will be held, covering the latest advances in microwave theory

and techniques, microwave components, physics, and systems.

The welcoming address will be given by McGeorge Bundy, dean of the Faculty of Arts and Sciences, Harvard University. Social activities will center around a cocktail hour and banquet on June 2. The banquet's master of ceremonies will be W. L. Pritchard, and speakers will be Professors H. Brooks and E. M. Purcell, both of Harvard.

In addition, a ladies' program is being organized to avail the women of the many historical and cultural attractions of the Boston area.

Chairman and Assistant Chairman of the Symposium Committee are, respectively, W. L. Pritchard and H. Scharfman, both of Raytheon. In charge of the technical program is H. Riblet, Microwave Development; of publicity, R. Rivers, Aircorn; and of local arrangements, T. Saad, Sage Laboratories.

## SYMPOSIUM TO BE HELD ON ELECTROMAGNETIC THEORY

A Symposium on Electromagnetic Theory is to be held at the University of Toronto, Toronto, Ontario, Canada, June 15-20, 1959, sponsored by Commission VI of URSI and the University of Toronto, with support from the U. S. National Science Foundation and the National Research Council of Canada.

Included in the program will be a series of invited papers on topics of current interest, and a number of discussion sessions. The general fields to be covered are: scattering and diffraction; surface waves; electromagnetic problems of large radio telescopes; propagation in anisotropic media; and antenna theory. A detailed program will be issued later. Reprints of the papers will be available at or before the meetings, and a Proceedings will be published.

## WESCON PAPERS DEADLINE SET FOR MAY 1

Authors wishing to present papers at the 1959 Western Electronic Show and Convention technical sessions, to be held in San Francisco, August 18-21, must submit them by May 1. Required are 100-200 word abstracts, together with complete texts or additional detailed summaries, which should be sent to the Chairman of the Technical Program: Dr. Karl R. Spangenberg, c/o WESCON, 60 West 41st Ave., San Mateo, Calif.

This year there will be an important innovation. The IRE WESCON CONVENTION RECORD will be made available at the Convention. Convention authors will be expected to submit complete manuscripts by July 1, prepared for the RECORD in accordance with special instructions which will be sent at the time the paper is accepted.

Authors will be notified of acceptance or rejection by June 1.



## NATIONAL ULTRASONICS SYMPOSIUM INVITES CONTRIBUTIONS

The 1959 National Ultrasonics Symposium will be held at Stanford University, Stanford, Calif., on August 17. The PGUE will combine this one-day meeting with one or two sessions at WESCON (August 18-21) to provide a well-integrated program.

Papers are invited. A list of suggested topics, but not all-inclusive, follows: 1) design, calibration, and use of high-power transducers for use in industrial processing and in sonar; 2) antenna design and its analog in sonar transducers; 3) electro-mechanical filters; 4) survey of, new developments in, and circuit problems associated with ultrasonic delay lines; 5) ultrasonic modulation in optical systems; 6) non-destructive testing by energy absorption; 7) effectiveness of ultrasonic cleaning by pulsed vs steady-state cavitation; and 8) noncontacting measurement of surface velocity by ultrasonic probe beam using Doppler effect.

Prospective authors are requested to submit the following information by April 1, 1959: 100-word abstract in triplicate, title of paper, name and address; 500-word summary in triplicate, title of paper, name and address. Acceptance or rejection notices will be mailed by May 1.

All material should be addressed to Dr. Vincent Salmon, 1959 National Ultrasonics Symposium, Stanford Research Institute, Menlo Park, Calif.

## AERONAUTICAL ELECTRONICS CONFERENCE SCHEDULED

The Eleventh National Aeronautical Electronics Conference has been officially scheduled for May 4-6, 1959, at the Biltmore and Miami Hotels, Dayton, Ohio. It is sponsored by the Dayton Section of the IRE and the IRE Professional Group on Aeronautical and Navigational Electronics.

The theme of the conference is Electronics Systems in the Space Age. In addition to comprehensive technical presentations, a forum is planned for an exchange of ideas on better electronic systems management. Also, leading aeronautical equipment concerns will present their latest equipment designs.

## GEOPHYSICAL RESEARCH JOURNAL PLANS REVISION AND EXPANSION

To meet the challenge presented by the rapid growth of basic geophysical research in the United States brought about by the International Geophysical Year, an expanded *Journal of Geophysical Research* will be issued monthly, beginning with the January, 1959 issue. It will be published by the American Geophysical Union with assistance from the Carnegie Institution of Washington and support from the National Science Foundation. Dr. M. A. Ture will serve as associate editor.

The traditional editorial and scientific standards of the *Journal of Geophysical Research* will be maintained in the expanded *Journal*. A better balance of papers in all fields of geophysics will be attained, by combining the scientific papers formerly published in *Transactions, American Geophysical Union* with those traditionally published in the *Journal of Geophysical Research*. The new

publication will consist of original research reports, a letters department to provide for prompt but brief publication of unusual results or brief discussion of previous papers, and abstracts of papers given at AGU meetings. It will also include advertising. All fields of geophysics are to be discussed. Papers which provide an insight into the interrelationships of different fields, or which are authoritative review articles, will be sought. Papers will be accepted on a basis of scientific merit regardless of source.

Manuscripts should be sent to J. A. Peoples, Jr., Geology Department, University of Kansas, Lawrence, Kans. Subscriptions, renewals, and orders for back numbers should be addressed to American Geophysical Union, 1515 Massachusetts Ave., NW, Washington 5, D. C. Subscriptions to the *Journal* are included in AGU membership dues; nonmember subscriptions are \$16 per calendar year and \$2 per copy.

## SSB DINNER AND HAMFEST SET

The SSB Amateur Radio Association will sponsor the Eighth Annual SSB Dinner and Hamfest on Tuesday, March 24, 1959, at the Hotel Statler Hilton, 33rd St. and 7th Ave., N.Y.C. All amateurs and their friends are invited to attend.

Equipment displays open at 10 A.M. and the dinner will be at 7:30 P.M. Bill Leonard, W2SKE, of radio and television, will be master of ceremonies. Tickets purchased in advance are \$8 each, and at the door, \$9.

Reservations can be placed by writing to SSBARA, c/o Irv Binger, W2CMM, 1741 Andrews Ave., N. Y. 53, N. Y.

## HEROLD, FORMER DIRECTOR, SPEAKS TO DETROIT SECTION

On November 21, over 250 members and guests of the Detroit Section heard E. W. Herold present a talk on "Controlled Thermonuclear Fusion." Mr. Herold, Associate Project Manager of the C-Stellarator Associates, Princeton, N. J., and Director of Electronic Research at RCA, also in Princeton, was a Director of the IRE in 1958 and a member of the IRE Editorial Board. The meeting, sponsored jointly by the Electrical Engineering Department of the University of Michigan, was preceded by a tour of the Ford nuclear reactor in the Phoenix Memorial Laboratory on the Ann Arbor Campus.



E. W. Herold speaks to the Detroit Section on "Controlled Thermonuclear Fusion."

## Calendar of Coming Events and Authors' Deadlines\*

(Continued from page 14A)

- Symp. on Electromagnetic Theory, Univ. of Toronto, Toronto, Can., June 15-20
  - Int'l Conf. on Info. Processing, UNESCO House, Paris, France, June 15-20
  - Int'l Symp. on Circuit & Information Theory, Univ. of Calif. at Los Angeles, Los Angeles, Calif., June 16-18 (DL\*: Dec. 22, Dr. G. L. Turin, Hughes Research Labs., Culver City, Calif.)
  - Nat'l Conv. on Mil. Elec., Sheraton Park Hotel, Washington, D. C., June 29-July 1 (DL\* Feb. 15, L. R. Everingham, Radiation, Inc., Orlando, Fla.)
  - Denver Res. Inst. Sixth Annual Symp. on Computers and Data Processing, Stanley Hotel, Estes Park, Colo., July 30, 31
  - Natl. Ultrasonics Symp., Stanford Univ., Stanford, Calif., Aug. 17
  - WESCON, San Francisco, Calif., Aug. 18-21
  - Nat'l Symp. on Telemetry, Civic Aud. & Whitcomb Hotel, San Francisco, Calif., Sept. 28-30
  - IRE Canadian Conv., Toronto, Can., Oct. 7-9
  - Nat'l Elec. Conf., Sherman Hotel, Chicago, Ill., Oct. 12-15
  - East Coast Conf. on Aero. and Nav. Elec., Baltimore, Md., Oct. 26-28
  - Electron Devices Mtg., Shoreham Hotel, Washington, D. C., Oct. 29-31
  - Nat'l Conf. on Automatic Control, New Sheraton Hotel, Dallas, Tex., Nov. 4-6
  - Radio Fall Mtg., Syracuse, N. Y., Nov. 9-11
  - Eastern Joint Comp. Conf., Hotel Statler, Boston, Mass., Nov. 30-Dec. 3
  - PGVC Annual Meeting, St. Petersburg, Fla., Dec.
- 1960
- Natl. Symp. on Reliability and Quality Control, Hotel Statler-Hilton, Washington, D. C., Jan. 11-13
  - Transistor and Solid-State Circuits Conf., Univ. of Pa., Phila., Pa., Feb. 11-12
  - IRE National Conv., N. Y. Coliseum and Waldorf-Astoria Hotel, Mar. 21-24
  - SWIRECO (Southwestern Regional Conference), Houston, Texas, Apr. 20-22
  - Nat'l Aeronautical Electronics Conf., Dayton, Ohio, May 2-4
  - Western Joint Computer Conf., San Francisco, Calif., May 2-6
  - 7th Reg. Tech. Conf. & Trade Show, Olympic Hotel, Seattle, Wash., May 16-18
  - Cong. Int'l Federation of Automatic Control, Moscow, USSR, June 25-July 9
  - WESCON, Ambassador Hotel & Pan Pacific Aud., Los Angeles, Calif., Aug. 23-26
  - Nat'l Symp. on Telemetry, Washington, D. C., Sept.
  - Industrial Elec. Symp., Sept. 21-22
  - Nat'l Elec. Conf., Chicago, Ill., Oct. 10-12
  - East Coast Conf. on Aero & Nav. Elec., Baltimore, Md., Oct. 24-26
  - Electron Devices Mtg., Hotel Shoreham, Washington, D. C., Oct. 27-29
  - Radio Fall Mtg., Hotel Syracuse, Syracuse, N. Y., Oct. 31, Nov. 1-2

\* DL = Deadline for submitting abstracts.

## AIR FORCE MARS ANNOUNCES BROADCASTING SCHEDULE

The Air Force MARS Eastern Technical Network, which broadcasts every Sunday from 2-4 P.M. (EST) on 3295, 7540, and 15,715 kc, announces the following programs.

- February 1—"Electronics in Medicine," Dr. Joseph Ragoff.  
February 8—"Future Atomic Powered Generator Stations," Minot H. Pratt, Chief Engineer, Niagara Mohawk Corp.  
February 15—"Electronic Seeing with Low Level Illumination," Dr. M. L. E. Chwalow, Frankford Arsenal.  
February 22—"Modern Quality Control Principles," Norman Miller, Frankford Arsenal.

## SCHEDULE SET FOR PAPERS FOR INTERNATIONAL CONGRESS ON AUTOMATIC CONTROL

The American Automatic Control Council has set the review committees and schedules for U.S.A. papers to be presented at the First Congress of the International Federation of Automatic Control (IFAC) in Moscow, June 25-July 9, 1960.

Russian hosts for the 1960 meeting have prepared an ambitious agenda for the technical sessions covering three main areas: theory; components and measurements; and applications. Papers on automatic control theory will cover discrete data systems, continuous data systems, systems using computing devices, optimizing, multivariable systems, systems including a human operator, information theory, switching theory, stochastic processes, and simulators.

Papers on components and measurements will be sought covering the design and performance of transducers, amplifiers, computers, logic elements, characteristics of components, methods of dynamic testing, and reliability.

Each paper on application will pertain to a particular industry or type of controlled equipment. Typical examples are electrical machines, power systems, petroleum processing, chemical processing, ore refining, metal production, metalworking, transportation, materials handling, nuclear reactors, and heating and air conditioning.

U. S. A. papers may be submitted in the following ways.

- 1) Directly to a member of the AACC review committee:

Chairman—E. M. Grabbe, The Thompson-Ramo-Wooldrige Corp., P. O. Box 45215, Airport Station, Los Angeles 45, Calif.;

Automatic control theory—John Truxal, EE Dept., Polytechnic Inst. of Brooklyn, Brooklyn, N. Y.;

Components and measurements—John Johnston, Jr., Instrument Dept., Engineering Services Div., E. I. duPont de Nemours & Co., Inc., Louviers Bldg., Newark, Del.

Industry applications—D. M. Boyd, Universal Oil Products, Des Plaines, Ill.

- 2) Through the appropriate professional divisions of the societies affiliated with AACC:

ASME, Instruments and Regulators Div., Chairman—D. J. Bergman, Universal Oil Products, Des Plaines, Ill.;

AIEE, Feedback Control Committee, Chairman—H. Chestnut, General Electric Co., 1 River Road, Schenectady 5, N. Y.;

IRE, Professional Group on Automatic Control, Chairman—John E. Ward, Servomechanisms Lab., M.I.T., Cambridge 39, Mass.;

ISA, Instrument Society of America—R. P. Bigliano, Engineering Dept., E. I. duPont de Nemours & Co., Inc., Wilmington 98, Del.;

AIChE, Process Control Committee, Chairman—D. M. Boyd, Universal Oil Products, Des Plaines, Ill.

- 3) Directly to the congress chairman, A. M. Letov, Institute of Automatics and Telemechanics, Kalanchovskaya 15 A, Moscow 1-53, U.S.S.R.

Deadlines are:

March 1, 1959—Abstracts and rough drafts of outlines in the hands of the AACC Review Committee.

July 15, 1959—Completed papers delivered to AACC Review Committee.

The Committee will review and evaluate for publication all U.S.A. papers. Papers may be presented in English. Russian hosts to the congress will handle translation into Russian and will publish Russian proceedings. AACC will arrange for publication of English proceedings.

For more information contact: W. E. Vannah, Secretary-Treasurer, American Automatic Control Council, 330 W. 42nd St., N. Y. 36, N. Y.

## NBS TO PUBLISH RADIO PROPAGATION JOURNAL

Starting in July, 1959, the National Bureau of Standards is to publish a quarterly journal devoted to radio wave propagation. Some of the topics to be covered in the new *Journal of Radio Propagation* are upper atmospheric physics, propagation in ionized media, scattering by turbulence in the troposphere and the ionosphere, effect of irregular terrain on radio propagation, diffraction and scattering by solid obstacles, propagation through time-varying media, and surface waves.

An editorial advisory board consisting

of well known radio scientists has been chosen. These include D. G. Fink (representing the IRE), K. M. Siegel (representing the PGAP), A. D. Wheelon, F. E. Roach, R. L. Helliwell, R. N. Thomas and A. D. Watt. Associate editors are J. W. Herbstreit, T. N. Gautier, and C. G. Little. The editorial assistant is J. F. Brockman, and J. R. Wait is editor.

## FEBRUARY SPEAKERS SET FOR ARMY TECHNICAL NET

The First Army MARS SSB Technical Network, operating each Wednesday evening at 9 P.M. (EST) on 4030-kc upper sideband, has announced the speaker schedule for February as follows.

February 4—"Observation of Radio Signals Transmitted from Earth Satellites," Lloyd H. Mananton, Chief of the Communications Facilities Section, Long Range Radio Branch, U. S. Army Signal Res. and Dev. Lab., Fort Monmouth.

February 11—"Vehicular Noise Problems in Mobile Communications Systems," Stuart F. Meyer, Mobile Engineering Manager, Allen B. DuMont Labs.

February 18—"Experience with Video Tape Recording," Lawrence Weiland, Staff Engineer, National Broadcasting Co.

February 25—"Mobile SSB Communications," Werner Brach, Chief Engineer, Eldico Electronics.

## PGEWS HOLDS SECOND ANNUAL SYMPOSIUM

The Second Annual Symposium sponsored by the Professional Group on Engineering Writing and Speech was held in New York, October 1-2, 1958. The program of fourteen papers, most of which will be published in the next two issues of the PGEWS TRANSACTIONS, was prepared through the efforts of Theodore T. Patterson and Chester W. Sall.

The program stressed the quality of technical speaking and illustration, which has been much criticized. Four of the papers were specifically devoted to problems of presenting lantern slides and other illustrative material, and five dealt with speaking.



The Fifth National Meeting of the Professional Group on Nuclear Science, held in San Mateo, Calif., November 6-7, included 18 papers in 4 technical sessions and held trips to the Univ. of Calif. at Livermore, the Vallecitos Atomic Lab. in Pleasanton, the High-Energy Physics Lab. at Stanford Univ., the Navy's Radiological Defense Lab. in San Francisco, and the high-energy, solid-state, shock-tube, and computer facilities of Lockheed Missile Systems Division in Palo Alto. The banquet speaker, J. M. Harrer (seated, third from right), described the Geneva Conference. Attending the banquet are (standing, left to right) H. E. Shaw, Lockheed, Chairman of Registration Committee; C. W. Carnahan, Varian Associates, Chairman of Finance Committee; H. M. Ogle, General Electric Co., General Chairman; S. J. Reisman, Lockheed, Chairman of Publicity Committee; L. D. Test, General Electric Co., Chairman of Program Committee; F. M. White, Jr., White & Co., Chairman of Inspection Trips Committee; (seated, left to right) R. F. Shea, Knolls Atomic Power Lab.; A. S. Rawcliffe, Los Alamos Scientific Lab.; J. N. Grace, Westinghouse; J. M. Harrer, Argonne National Lab.; A. B. Van Rennes, Bendix Aviation Corp.; and R. A. Thomas, Atomic Power Development Associates.



# The perfidious electron tube

Languishing in his cell after his defeat by Cortez, the Aztec emperor Montezuma filled out his lonely hours by penning one of the most remarkable war memoirs of all time.

It was called, strangely enough, "The Perfidious Electron Tube". Only recently discovered after having been lost for centuries, it throws new light on one of the key events in New World history.

In it, Montezuma sums up his defeat in one word: "Skaflangz". For those of you whose Aztec isn't what it might be, the word means "radar".\* (And for those of you who may feel a commercial

coming on, you just may have something there. But honest, that's what the man said.)

As Monty saw it, his radar tubes zigged when they should have zagged. Today, more sophisticated electronics people would simply say the radar was unable to obtain a fix on moving targets. Monty simply didn't have any monopulse tubes. But the truth is clear. A few Bomac tubes in the right place might have changed history. Your children might now be studying Aztec in school instead of Spanish. You yourself might be eating Aztec omelettes—or wearing feathers for trousers.

Come to think of it, maybe it's better things turned out the way they did.

No.12 of a series . . . BOMAC LOOKS AT RADAR THROUGH THE AGES



\* Today, Bomac makes the finest microwave tubes and components this side of Mexico City.

WRITE FOR FREE SIX PAGE FOLDER

## Bomac

LABORATORIES, INC.

Salem Road, Beverly, Massachusetts

Leaders in the design, development and manufacture of TR, ATR, Pre-TR tubes; shutters; reference cavities, crystal protectors; silicon diodes; magnetrons; klystrons; duplexers; pressurizing windows; noise source tubes; high frequency triode oscillators; surge protectors.

© BOMAC

World Radio History

Offices in major cities— Chicago • Kansas City • Los Angeles • Dallas • Dayton • Washington • Seattle • San Francisco • Canada: R-O-R Associates Limited 1470 Don Mills Road, Don Mills, Ontario • Export: Maurice I. Parisier, 741-745 Washington St., N. Y. C. 14, N. Y.





Seated at the Banquet Head Table of the Fourth National Aero-Com Symposium are (left to right) Dr. J. H. Vogelmann, *Chairman of the Scholarship Fund Committee*; Mr. J. Lewis Powell, *Banquet Speaker*; Mr. Bernard H. Baldrige, *Guest Speakers Chairman*; Mr. Walt Carlson, *Local Westinghouse Representative*; Colonel Charles Brombach, *representing ROAMA*; Mr. J. W. Worthington, *member of the advisory staff*; and Mr. William J. Kuehl, *member of the advisory staff*.

## FOURTH NATIONAL AERO-COM SYMPOSIUM MEETS IN UTICA

The Fourth National Symposium on Aeronautical Communications was held in the Hotel Utica, Utica, N. Y., on October 20-21, 1958, under the auspices of the Rome-Utica Chapter of the IRE Professional Group on Communications Systems.

Mr. H. J. Crowley was Chairman, Mr. R. A. Zachary, Executive Vice-Chairman, and Mr. W. L. Roberts, Secretary. The Advisory Staff consisted of A. A. Kunze, J. Kuehl, E. E. Mitchell, and J. W. Worthington, Jr. Committee Chairmen were: Dr. J. H. Vogelmann, scholarship; G. F. Baldwin, finance; R. L. Marks, technical programs; R. E. Gaffney, exhibits; B. H. Baldrige, guest speaker; R. C. Benoit, Jr., public relations; F. R. Priest, arrangements; T. G. Knight, classified program; and L. R. Pangburn, registration.

Approximately 850 persons from most of the 48 states and several foreign lands attended the Symposium which featured 32 exhibits by leading engineering and manufacturing concerns, a Junior Science Exhibit, in which approximately 18 area youths participated, and twenty technical papers which were presented at the technical sessions.

A luncheon attended by approximately 200 was held on October 20, at which Brig. General Francis F. Uhrhane, Deputy Chief of Staff, Communications and Electronics NORAD, spoke on "NORAD and Its Communications Problems." An industry sponsored cocktail party was held on October 21 and was followed by a banquet at which Mr. J. Lewis Powell, member of the Staff of the Assistant Secretary of Defense, Supply and Logistics, spoke on "The Collapse of Time."

The National Administration Committee of the IRE Professional Group on Communications Systems met during the Symposium on October 21; Captain Edward N. Dingley, National Chairman, presided.

The Scholarship Fund Committee awarded four prizes totaling \$1350 to local area students to further their engineering and scientific education in an accredited college or university of their choice. The first prize of \$500 was donated by Hoffman Labs., Los Angeles, Calif.; Westinghouse Electric Co. donated the second prize of \$400; the third prize of \$300 was jointly donated by the employees of Rome Air Dev. Center and Rome Air Force Depot and the H. L. Hoffman Co. Long Island, N. Y.; and the fourth prize of \$150 was donated by

Mr. G. R. Wilson, Editor of *Flying Magazine*.

Upon completion of the Symposium in Utica a one day classified Symposium was held on October 22, at Griffiss Air Force Base, Rome, N. Y. under the sponsorship of the Directorate of Communications, Rome Air Dev. Center and was attended by approximately 300. Ten papers were presented at the classified sessions. Participation was limited to those possessing a confidential clearance and the "need to know."

The Fifth National Aero-Com Symposium is scheduled for October 5, 6, and 7, 1959, in the Rome-Utica area.

## ADVISORS NAMES FOR 1959 THIRD NATIONAL CONVENTION ON MILITARY ELECTRONICS

Dr. T. Keith Glennan, Administrator, National Aeronautics and Space Administration, heads a list of eminent civilians and military officers who will serve as advisors for the Third National Convention on Military Electronics, sponsored by the IRE Professional Group on Military Electronics, and to be held at the Sheraton Park Hotel, Washington, D. C., on June 29-July 1, 1959.

Other advisors, as announced by Lt. Gen. William Kepner, USAF (Ret.), Convention President, and Chairman of the Board of Radiation, Inc., Orlando, Fla., are: Adm. Arleigh Burke, USN, Chief of Naval Operations; Lt. Gen. Arthur G. Trudeau, USA, Chief of Army Research and Development; Lt. Gen. Roscoe C. Wilson, USAF, Deputy Chief of Staff for Development; Rear Adm. Rawson Bennett, USN, Chief of Naval Research; Roy W. Johnson, Director, Advanced Research Projects Agency, Dept. of Defense; Christian L. Engleman, President, Engleman and Co., Inc., and Treasurer, PGME; Edwin A. Speakman, Manager of Planning, Radio Corp. of America, and Chairman, PGME; Dr. Robert M. Page, Director of Research, U. S. Naval Research Lab., and Chairman, Washington, D. C. Section of the IRE; and Brig. Gen. Walter B. Larew, USA (Ret.), Staff Assistant to the Manager of Communications and Navigation Systems Engineering, Melpar, Inc., (1958 Convention President).

At the 1958 Convention, also held in Washington, more than 3300 engineers, scientists, and executives from industry, Government agencies and laboratories, the Armed Forces, universities, and embassies listened to more than 100 technical papers

and looked at 71 exhibits of new developments in the field of military electronics. Included in this branch of electronics are such major topics as: satellite electronics, space navigation, guidance and control systems, electronic propulsion, reconnaissance systems simulation, and communication systems.

## OFFICERS CHOSEN FOR 1959 WESCON

Officers of the Western Electronic Show and Convention for 1959 were installed on November 29 at the annual meeting of the board of directors in Honolulu. Representing the cosponsoring organizations of WESCON (the West Coast Electronic Manufacturers Association and the San Francisco and Los Angeles Sections of the IRE Seventh Region), the eight-member board convened to establish general plans for the 1959 show and convention to be held next August in San Francisco.

The chief executive officers are H. Myrl Stearns, president of Varian Associates, Palo Alto, Calif., chairman of the WESCON board, and Bernard M. Oliver, vice-president for research and development of Hewlett-Packard Co., Palo Alto, chairman of the WESCON executive committee. Show director is O. H. Brown, director of marketing for Eitel-McCullough, Inc., San Carlos, Calif. Convention director is Albert J. Morris, vice-president of Levinthal Electronic Products, Inc., Palo Alto.

Other directors of WESCON for 1959 are: Bruce S. Angwin, western regional manager of the Electronic Components Division, General Electric Co., Los Angeles; Donald C. Duncan, director of contract sales for Beckman Instruments, Inc., Fullerton, Calif.; Hugh P. Moore, chairman of the board of Lercro Electronics, Inc., Burbank, Calif.; and Walter E. Peterson, director of the Electronics Division of Radioplane Co., Van Nuys, Calif. Messrs. Duncan and Angwin will serve four-year terms. L. W. Howard, president of Triad Transformer Corp., Venice, Calif., retired as chairman of the board. Also participating in the meetings was Don Larson, business manager of WESCON and member of the executive committee.

## SIDNEY KRASIK AWARD DESIGNATED BY PGNS

A. B. Van Rennes, 1958-1959 Chairman IRE Professional Group on Nuclear Science announces that the PGNS Administrative Committee, at its meeting in November, 1958, voted to designate the annual award for the best PGNS Transactions paper, the Sidney Krasik Award, in honor of Dr. Krasik who has for several years served as Editor. The committee chose this way to express its appreciation of a job well done, and to permanently identify Dr. Krasik's part in the growth of PGNS.

## PROFESSIONAL GROUP NEWS

The following Chapters were approved by the IRE Executive Committee at its meeting on December 8: Professional Group on **Antennas and Propagation**, Dayton Chapter; Professional Group on **Microwave Theory and Techniques**, Omaha-Lincoln Chapter; and Professional Group on **Production Techniques**, Boston Chapter.

# Finest line of High Frequency Cables in the communications field!

- No radiation
- Low attenuation
- Excellent frequency response
- Uniform electrical properties over wide temperature variations
- Unlimited operating life
- Continuous 1000' lengths

Matching fittings for all cables are available from several sources.

The advertisement displays three types of coaxial cables in a vertical stack. Each cable is shown in a cutaway view within a cylindrical metal housing. The top cable, Styroflex, has a white braided shield and a red inner conductor. The middle cable, Spirafil, has a black braided shield and a red inner conductor. The bottom cable, Foamflex, has a silver braided shield and a red inner conductor. To the left of each cable is a circular logo with the product name and 'COAXIAL CABLE'. The bottom logo also includes the company name 'PHELPS DODGE COPPER PRODUCTS CORPORATION' and the year '1927'. Below the cables, the company name 'PHELPS DODGE COPPER PRODUCTS CORPORATION' is written in large, bold, black letters, with 'COPPER' in orange. Below the company name is the address '300 PARK AVENUE, NEW YORK 22, N. Y.'. The background of the advertisement is black and white, with orange accents.

**Styroflex**  
COAXIAL  
CABLE

**Spirafil**  
COAXIAL  
CABLE

**Foamflex**  
COAXIAL  
CABLE

X CABLE 1/2 50Ω

**PHELPS DODGE COPPER PRODUCTS CORPORATION**  
CORPORATION

300 PARK AVENUE, NEW YORK 22, N. Y.



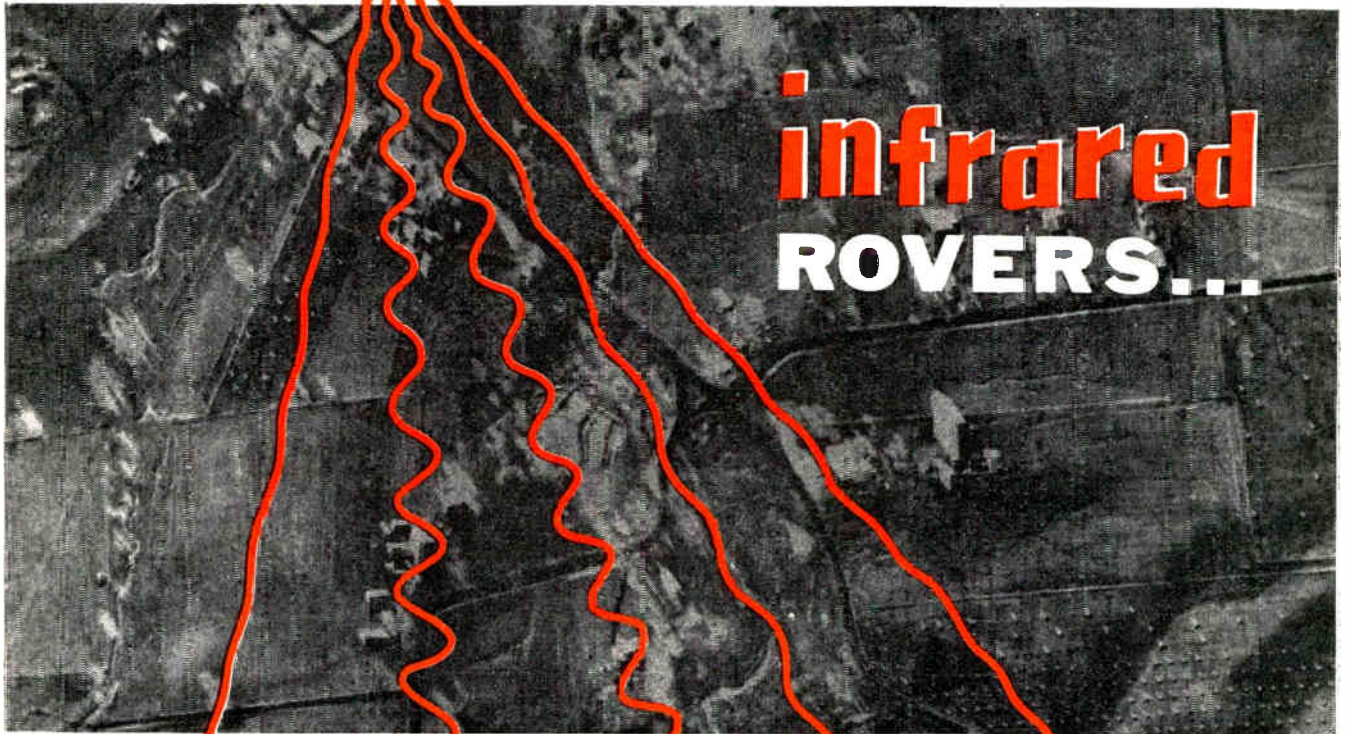
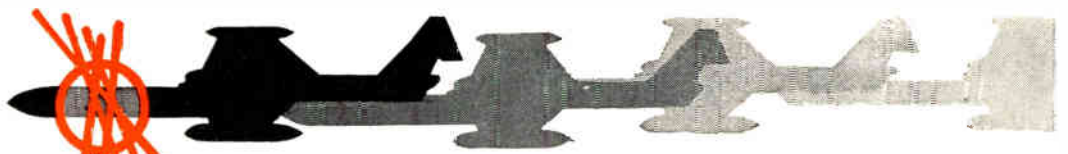

# infrared ROVERS...

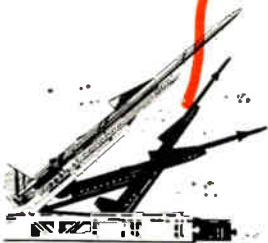

## fast-maturing TI infrared systems advance IR early warning, reconnaissance, tail-warning...

ALL-OUT DEVELOPMENT of the precocious infrared sciences at Texas Instruments has brought this versatile field to new levels of sophistication — a maturity that spells design simplicity in complex systems, and permits expert use by inexperienced personnel. The keys to this new status for infrared are *new optical materials, new materials/systems/application matching techniques, advanced detector cells, and low-noise transistorized circuitry* — all pioneered by Texas Instruments.

This experience can work for you immediately, whether your particular interest is reconnaissance, distant detection, early warning, tracking, tail-warning, or merely curbing a heat-seeking missile's tendency to chase the sun. To obtain IR technical services, backed up by the capacity to produce in any quantity the systems you require, properly cleared military or industrial personnel contact **SERVICE ENGINEERING DEPARTMENT:**

**TEXAS**  **INSTRUMENTS**  
INCORPORATED  
6000 LEMMON AVENUE DALLAS 9, TEXAS

### apparatus division

#### systems management

**systems** — airborne early warning, airways control, antisubmarine warfare, attack-bomb navigation systems, countermeasures, engine instrumentation, missile systems, portable ground equipment, reconnaissance, space electronics.

**equipments** — radar, infrared, sonar, magnetic detection, computers, timers, telemetering, intercom, microwave, optics, detector cells, engine instruments, transformers, time standards, and other precision devices.

research/design/development/manufacture

# A Tektronix Oscilloscope that **DOUBLES UP** for you

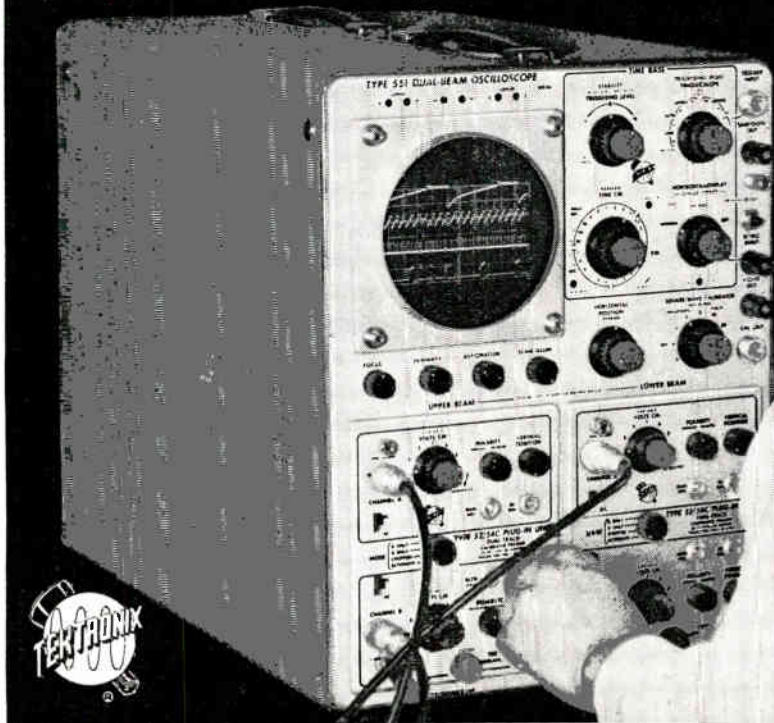

## TWO BEAMS

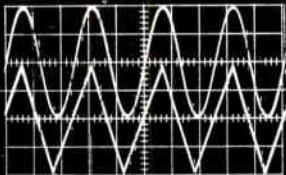

## FOUR TRACES

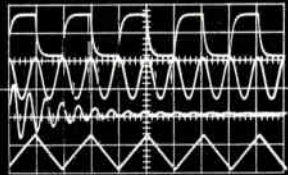

## TYPE 551

DC-to-25 MC

### Special Features

#### WIDE-BAND VERTICAL AMPLIFIERS

Main-unit risetimes—12  $\mu$ sec.  
Passbands and risetimes with type K (53/54K) units—  
dc-to-25 mc, 0.014  $\mu$ sec.

#### SIGNAL-HANDLING VERSATILITY

All Tektronix Plug-In Preamplifiers can be used in both channels.

#### 0.2 $\mu$ sec DELAY NETWORKS

WIDE SWEEP RANGE  
0.02  $\mu$ sec/cm to 12 sec/cm.

#### SINGLE SWEEPS

Lackout-reset circuitry.

#### COMPLETE TRIGGERING

Fully-automatic or amplitude-level selection with preset or manual stability control.

#### 10-kv ACCELERATING POTENTIAL

Brighter display for fast sweeps and low repetition rates.

When the job requires it, you can double up and display four different waveforms at once with this dual-beam oscilloscope. Type 53/54C and/or Type C-A Dual-Trace Plug-In Units in both channels make possible the four-trace display.

Less spectacular but more frequent uses of this versatile fast-rise oscilloscope include waveform comparison measurements on a dual-beam display in the dc-to-25 mc range, and all the usual and unusual applications of a high-performance laboratory oscilloscope.

#### PRICE

- without plug-in units.....\$1725
- Type 500/53A Scope-Mobile.....\$108
- Type K Fast-Rise Plug-In Preamplifiers, each.....\$125
- Type C-A Dual-Trace Plug-In Preamplifiers, each.....\$250

(f.a.b. factory)

**No production delay!**  
Shipments within a very few days of receipt of order.

Please call your Tektronix Field Engineer or Representative for complete specifications and, if desired, to arrange for a demonstration at your convenience.

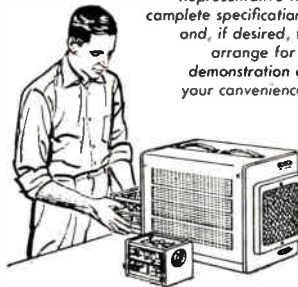

# Tektronix, Inc.

P. O. Box 831 • Portland 7, Oregon  
Phone CYpress 2-2611 • TWX-PD 311 • Cable: TEKTRONIX

TEKTRONIX FIELD OFFICES: Albertson, L.I., N.Y. • Albuquerque • Atlanta, Ga. • Bronxville, N.Y. • Buffalo • Cleveland • Dallas • Dayton • Elmwood Park, Ill. • Endwell, N.Y. • Houston Lothrop Village, Mich. • East Los Angeles • West Los Angeles • Minneapolis • Mission, Kansas • Newtonville, Mass. • Orlando, Fla. • Palo Alto, Calif. • Philadelphia • Phoenix • San Diego • St. Petersburg, Fla. • Syracuse • Towson, Md. • Union, N.J. • Washington, D.C. • Willowdale, Ont.

TEKTRONIX ENGINEERING REPRESENTATIVES: Hawthorne Electronics, Portland, Oregon.; Seattle, Wash.; Hytronic Measurements, Denver, Colo.; Salt Lake City, Utah

Tektronix is represented in 20 overseas countries by qualified engineering organizations.



# NOW!

Constant output level

Constant modulation level

3 volt output into 50 ohms

Low envelope distortion

# 50 kc to 65 MC

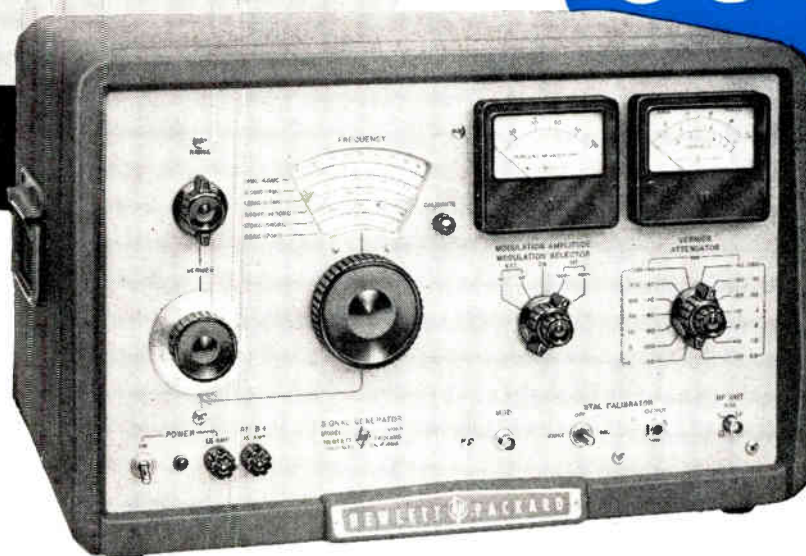

## NEW -hp- 606A HF Signal Generator

Here at last is a compact, convenient, moderately-priced signal generator providing constant output and constant modulation level plus high output from 50 kc to 65 MC. Tedious, error-producing resetting of output level and % modulation are eliminated.

Covering the high frequency spectrum, (which includes the 30 and 60 MC radar IF bands) the new -hp- 606A is exceptionally useful in driving bridges, antennas and filters, and measuring gain, selectivity and image rejection of receivers and IF circuits.

Output is constant within  $\pm 1$  db over the full frequency range, and is adjustable from +20 dbm (3 volts rms) to -110 dbm ( $0.1 \mu\text{v}$  rms). No level adjustments are required during operation; the instrument has a minimum of con-

trols and high accuracy results are assured due to the constant internal impedance. The generator can be provided with a 10:1 voltage divider and dummy antenna lowering minimum output to  $0.01 \mu\text{v}$  (from 5 ohms) and simulating IRE standards for precision receiver measurements. (See Accessories Available in Specifications.)

The new -hp- 606A may be modulated by sine waves and complex waveforms from dc to 20 KC. A meter indicates percent modulation. Distortion in sine waves is extremely low due to use of a feedback circuit.

To insure maximum accuracy of frequency setting, the 606A includes an internal crystal calibrator providing check points at 100 kc and 1 MC intervals with error less than 0.01%.



offers the world's most complete

# Specifications

**Frequency Range:** 50 kc to 65 MC in 6 bands.  
 50—170 kc      1.76—6.0 MC  
 165—560 kc      5.8—19.2 MC  
 530—1800 kc      19.0—65.0 MC

**Frequency Accuracy:** Within  $\pm 1\%$ .

**Frequency Calibrator:** Crystal oscillator provides check points at 100 kc and 1 MC intervals accurate within 0.01% from 0° to 50° C.

**RF Output Level:** Continuously adjustable from 0.1  $\mu$ v to 3 volts into a 50 ohm resistive load. Calibration is in volts and dbm (0 dbm is 1 milliwatt).

**Output Accuracy:** Within  $\pm 1$  db into 50 ohm resistive load.

**Frequency Response:** Within  $\pm 1$  db into 50 ohm resistive load over entire frequency range at any output level setting.

**Output Impedance:** 50 ohms, SWR less than 1.1:1 at 0.3 v and below. BNC Output connector mates with UG-88A/B/C/D.

**Spurious Harmonic Output:** Less than 3%.

**Leakage:** Negligible; permits sensitivity measurements down to 0.1  $\mu$ v.

**Amplitude Modulation:** Continuously adjustable from 0 to 100%. Indicated by a panel meter. Modulation level is constant within  $\pm 1/2$  db regardless of carrier frequency.

**Internal Modulation:** 0 to 100% sinusoidal modulation at 400 cps  $\pm 5\%$  or 1000 cps  $\pm 5\%$ .

**Modulation Bandwidth:** Dc to 20 kc maximum, depends on carrier frequency,  $f_c$ , and percent modulation as shown in the following table:

	30% Mod.	70% Mod.	Squarewave Mod.
Max. Mod. Frequency	0.06 $f_c$	0.02 $f_c$	0.003 $f_c$ (3 kc max)

**External Modulation:** 0 to 100% sinusoidal modulation dc to 20 kc. 4.5 volts peak produces 100% modulation at modulating frequencies from dc to 20 kc. Input impedance is 600 ohms. May also be modulated by square waves and other complex signals.

**Envelope Distortion:** Less than 3% envelope distortion from 0 to 70% modulation at output levels of 1 volt or less.

**Modulation Meter Accuracy:** Within  $\pm 5\%$  of full scale reading from 0 to 90%.

**Spurious FM:** 0.0025% or 100 cps, whichever is greater, at an output of 1 v or less and 30% AM modulation.

**Spurious AM:** Hum and noise sidebands are 70 db below carrier.

**Power:** 115/230 volts  $\pm 10\%$ , 50 to 1000 cps, 135 watts.

**Accessories Available:** -hp- AC-606A-34 Output Voltage Divider with 50 and 5 ohms termination (10:1 voltage divider) and 1RE standard dummy antenna (10:1 voltage divider). \$50.00.

**Price:** (cabinet) \$1,200.00. (rack mount) \$1,185.00.

*Data subject to change without notice. Prices f.o.b. factory.*

## Other -hp- Signal Generators—10 to 21,000 MC

Instrument	Frequency Range	Characteristics	Price
-hp- 608C	10 to 480 MC	Output 0.1 $\mu$ v to 1 v into 50 ohm load. AM, pulse, or CW modulation. Direct calibration	\$1,000.00
-hp- 608D	10 to 420 MC	Output 0.1 $\mu$ v to 0.5 v. Incidental FM 0.001% entire range	1,100.00
-hp- 612A	450 to 1,230 MC	Output 0.1 $\mu$ v to 0.5 v into 50 ohm load. AM, pulse, CW or square wave modulation. Direct calibration	1,200.00
-hp- 614A	800 to 2,100 MC	Output 0.1 $\mu$ v to 0.223 v into 50 ohm load. Pulse, CW or FM modulation. Direct calibration	1,950.00
-hp- 616A	1,800 to 4,000 MC	Output 0.1 $\mu$ v to 0.223 v into 50 ohm load. Pulse, CW or FM modulation. Direct calibration	1,950.00
-hp- 618B	3,800 to 7,600 MC	Output 0.1 $\mu$ v to 0.223 v into 50 ohm load. Pulse, CW, FM or square wave modulation. Direct calibration	2,250.00
-hp- 620A	7,000 to 11,000 MC	Output 0.1 $\mu$ v to 0.223 v into 50 ohm load. Pulse, FM or square wave modulation. Direct calibration	2,250.00
-hp- 623B	5,925 to 7,725 MC	Output 70 $\mu$ v to 0.223 v into 50 ohm load. FM or square wave modulation. Separate power meter and wave meter section.	1,900.00
-hp- 624C	8,500 to 10,000 MC	Output 3.0 $\mu$ v to 0.223 v into 50 ohm load. Pulse, FM or square wave modulation. Separate power meter and wave meter section	2,265.00
-hp- 626A	10 to 15.5 KMC	Output 10 dbm to -90 dbm. Pulse, FM, or square wave modulation. Direct calibration	3,250.00
-hp- 628A	15 to 21 KMC	Output 10 dbm to -90 dbm. Pulse, FM, or square wave modulation. Direct calibration	3,250.00

$\Delta$ Rack mounted instrument available for \$15.00 less.



**HEWLETT-PACKARD COMPANY**  
 4873D PAGE MILL ROAD • PALO ALTO, CALIFORNIA, U.S.A.  
 CABLE "HEWPACK" • DAVENPORT 5-4451  
 Field representatives in all principal areas



### -hp- 608D vhf Signal Generator



10 to 420 MC. Highest stability. No incidental FM or frequency drift. Calibrated output 0.1  $\mu$ v to 0.5 v throughout range. Built-in crystal calibrator provides frequency check accurate within 0.01% each 1 and 5 MC. Master-oscillator, intermediate and output amplifier circuit design. Premium quality performance, direct calibration, ideal for aircraft communications equipment testing. \$1,100.00.

**-hp- 608C vhf Signal Generator.** High power (1 v max.) stable, accurate generator for lab or field use. 10 to 480 MC. Ideal for testing receivers, amplifiers, driving bridges, slotted lines, antennas, etc. \$1,000.00.

**-hp- 626 A/628A shf Signal Generators**



New instruments, bringing high power, wide range, convenience and accuracy to 10 to 21 KMC range. Frequencies, output voltage directly set and read. Output 10 to 20 db better than previous spot-frequency sets

SWR better than 1.2 at 0 dbm and lower. Internal pulse, FM or square wave modulation; also external pulsing or FM'ing. -hp- 626A, 10 to 15.5 KMC, \$3,250.00. -hp- 628A, 15 to 21 KMC, \$3,250.00.

# line of precision signal generators



check  
**RCA**  
for standard  
or special  
ferrite cores!

...for a wide range of computer applications!

Now—commercially available from RCA—a comprehensive line of fast-switching, low- and high-drive, memory cores and several new memory-plane designs to provide equipment designers with one of the broadest lines of memory core products in the industry.

**MEMORY CORES** • In addition to a line of standard ferrite cores developed for coincident-current memory applications (ranging in switching time from 0.2  $\mu$  sec. to 3  $\mu$  sec.), RCA now offers a new group of ferrite cores particularly suited for both high-speed, word-address memories, and slow-speed, low-drive coincident-current memories. These cores are available for an applied field (H) ranging from 0.2 to 1 oersted, and in sizes from 0.050" x 0.030" to 0.370" x 0.290". The smaller-size cores make possible the design of high-speed memory devices with driving currents suitable for either transistor or tube drivers. Typical characteristics are given in the table.

**MEMORY FRAMES** • A compact, rugged aluminum frame utilizing a new stack-wiring concept makes possible a "bit-packing factor" greater than ever before. 8,192 bits may be stored in a 7" x 7" x 0.3" frame.

For more economical designs and even greater compactness, a laminated frame accommodating 8,192 bits in a 5 1/2" x 5 1/2" x 1/4" space (including terminals) is also available.

**FERRITE APERTURE PLATES** • RCA's apertured-plate construction utilizing ferrite-core material having low-drive, medium-speed characteristics, can store 256 bits of information in a space less than 0.9" x 0.9" x 0.025", thus making possible the design of compact memories for transportable equipment in which minimum weight and space are vital considerations.

The aperture memory plates have a nominal full driving current requirement of 320 ma., a switching time of about 1.8  $\mu$  sec., and an undisturbed output (1) signal ( $\mu V_1$ ) of greater than 40 mv. making them especially suitable for use in transistorized circuits. In addition, the precision registration of the holes makes it possible to stack the aperture plates quickly and accurately.

Rigid production controls insure excellent uniformity of undisturbed output signal and peaking time... testing assures dependable performance of each storage element.

For ferrite cores having uniformity to meet your most exacting design requirements, and for dependable delivery schedules, contact your local RCA Sales Representative.



**RADIO CORPORATION OF AMERICA**

Semiconductor and Materials Division

Special Ferrites

Somerville, New Jersey

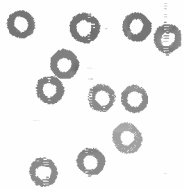

RCA MEMORY CORES



RCA FERRITE APERTURE PLATE



RCA MEMORY FRAME

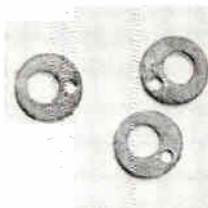

RCA TRANSFLUXORS

Typical Characteristics of Ferrite Cores for 2:1 Coincident-Current Applications						
RCA Type <sup>a</sup>	T <sub>r</sub> $\mu$ sec.	T <sub>f</sub> $\mu$ sec.	$\mu V_1$ mv.	dV <sub>2</sub> mv.	Driving Current ma. (I <sub>cc</sub> /I <sub>sw</sub> )	T <sub>p</sub> $\mu$ sec.
XF-3806	.27	.13	160	26	1100/660	.12
XF-4019	.67	.32	106	14	725/450	.12
XF-3018H	1.8	.53	55	9	460/275	.20
XF-4028	1.08	.60	72	4	380/190	.50
XF-3873	1.28	.71	48	5	350/215	.40
XF-3673	2.80	1.35	22	4	210/126	.50
XF-4003	2.60	1.45	24	3	190/95	.50
XF-4004	2.36	1.26	26	5	190/95	.50
XF-4005	4.10	2.35	10	5	125/63	.50
XF-4106	9.0	4.8	4.5	4.5	90/45	.50
XF-4107	7.5	4.3	4.5	5.0	70/35	.50
XF-4108	13.0	6.5	2.0	3.5	40/20	.50

Time t<sub>r</sub> measured from 10% of current rise to 10% of voltage ( $\mu V_1$ ) fall.  
All type numbers are for .050" x .030" x .015" size.

Typical Characteristics of Ferrite Cores for Switching Applications							
RCA Type <sup>a</sup>	Switching Time (T <sub>s</sub> )— $\mu$ sec. vs. Applied Field (H) in oersteds						
	H = .5	H = 1.0	H = 1.5	H = 2.0	H = 3	H = 4	H = 5
XF-3106						.22	.18
XF-4119				.41	.24		.161
XF-3118H			1.12	.75	.36	.226	.161
XF-3873			.73	.42	.22	.138	.105
XF-3673		1.16	.63	.40	.22	.15	
XF-4003		1.04	.60	.39			
XF-4004	3.84	.90	.52	.34	.194	.129	
XF-4005	3.69	.81	.48	.312	.174		
XF-4006	2.36	.71	.41	.260	.142		
XF-4007	1.38	.48	.28	.194			
XF-4008	1.53	.41	.242	.165			

Time t<sub>s</sub> measured from 10% rise to 10% fall of  $\mu V_1$ . Rise time of current pulse is approximately 35 millimicro-seconds. To convert drive in oersteds to current in amperes: For core size of .050 OD x .030 ID, multiply H x 0.25. For core size of .080 OD x .050 ID, multiply H x 0.41. All type numbers are for .050" x .030" x .015" size.

- East: 744 Broad St., Newark, N. J. HUmboldt 5-3900
- Northeast: 64 "A" Street, Needham Heights 94, Mass. Hillcrest 4-7200
- East Central: 714 New Center Bldg., Detroit 2, Mich. TRinity 5-5600
- Central: Suite 1154, Merchandise Mart Plaza, Chicago, Ill., WHitehall 4-2900
- West: 6355 E. Washington Blvd., Los Angeles, Calif., RAymond 3-8361
- Gov't: 224 N. Wilkinson Street, Dayton, Ohio BALdwin 6-2366
- 1625 "K" Street, N.W., Washington, D.C. DIstrict 7-1260
- Route 202, Somerville, N. J. RAndolph 5-4500

# STODDART

## COAXIAL ATTENUATORS AND TERMINATIONS

made with exclusive Stoddart Filmistors for highly accurate and stable resistive values from dc to 3000 mc.

2, 6 and 10-position  
**TURRET ATTENUATORS**  
with simple "PULL-TURN-PUSH"  
operation, small and rugged.

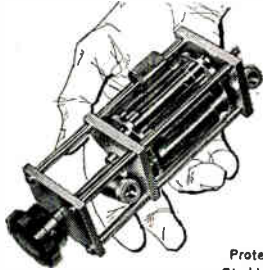

Protected under  
Stoddart Patents

## ATTENUATOR PADS



Available in any conceivable combination of male and female Type C and Type N connectors. Maximum length of 3" for any attenuation value.

**GENERAL SPECIFICATIONS**  
VSWR: Less than 1.2 to 3000 mc.  
Characteristic Impedance: 50 ohms.  
Attenuation Value: Any value from 0 db to 60 db including fractional values.  
Accuracy:  $\pm 0.5$  db; values above 50 db, have rated accuracy of attenuation through 1000 mc only.  
Power Rating: 1.0 watt sine wave.

## COAXIAL TERMINATIONS



Small-stable-50 or 70 ohms  
 $\frac{1}{2}$ -Watt: 50 ohms impedance, TNC or BNC connectors, dc to 1000 mc, VSWR less than 1.2.

1-Watt: 50 ohms impedance, dc to 3000 mc or dc to 7000 mc, Type N or Type C connectors, male or female; VSWR less than 1.2; 70 ohm, Type N, male or female terminations available.

Fast delivery on all items.  
Send for complete literature.

**STODDART**  
AIRCRAFT RADIO CO., INC.  
6644 Santa Monica Blvd., Hollywood 38, Calif.  
Hollywood 4-9292

LOOKING  
FOR THE



**TELEPHONE  
TYPE?**

TRY  
THIS  
NUMBER

**TQ-2C/24VD**

(At right) Advance TQ type is our smallest telephone relay: Length,  $1\frac{1}{2}$ " ; Width,  $\frac{3}{4}$ " ; Height, from  $\frac{1}{2}$ " to  $1\frac{1}{2}$ ".



### SPECIFICATIONS

**Coil resistance, 2C:** From 40 Ohms at 6 volts, DC, to 12,000 Ohms at 110 volts, DC.  
**Coil resistance, 6C:** From 10 Ohms at 6 volts, DC, to 5,000 Ohms at 110 volts, DC.  
**Nominal power required:** 2C, 1.0 watts nominal (appr.); 6C, 3.0 watts nominal, (appr.).  
**Contact rating:** 3 amps resistive, 1 amp inductive at 115 volts AC or 26.5 DC.  
**Contact arrangement:** Available in form A, B, C, D, or E, up to a maximum of 6 Poles.

All Advance Telephone Relays feature small size, short armature travel, and highly efficient magnetic structure. In addition to the type TQ "Miniature" telephone relay (illustrated), which has a contact rating of 3 amps resistive, Advance also offers the TF "Midget" the TD "Small" and the TS "Sensitive." All with a contact rating of 5 amps.

Available From Leading Distributors

**WRITE FOR COMPLETE DETAILS**

You'll want all 4 data sheets for your file: TQ, TF, TD & TS.



**ADVANCE RELAYS**



A PRODUCT OF ELECTRONICS DIVISION  
**ELGIN NATIONAL WATCH COMPANY**  
Dept. D, 2435 N. Naomi St., Burbank, Calif.



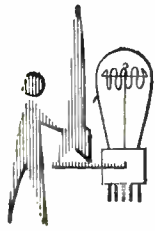

# NEWS New Products

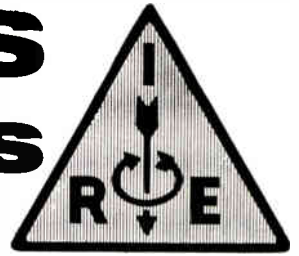

## Transistorized Gaussmeter

Completely transistorized and modified to operate on either 105-125 volt power supply or on internal batteries, the new model D-855 Gaussmeter designed by **Dyna-Empire, Inc.**, 1075 Stewart Ave., Garden City, N. Y., will deliver accurate measurement of flux fields up to 30,000 gauss.

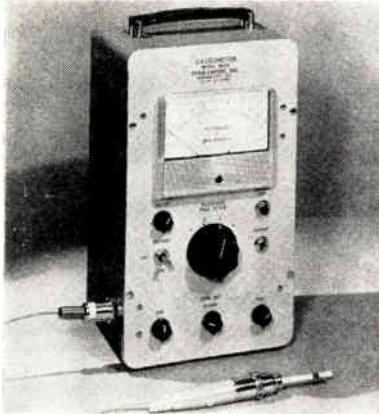

It gives accurate flux density measurement and determines "flow" direction, is ideal for locating and measuring stray fields, plotting variations in strength and checking production lots against a standard. It gives no ballistic reading, requires no jerk or pull. It can be equipped to measure the earth's field flux density.

Provision for internal battery operation makes the 8½ pound instrument readily adaptable for field use. The D-855 measures 13½×8¼×7¼ inches, utilizes a probe 0.025 inch thick with an active area of 0.01 square inch.

## Microwave Frequency Calibrator



Harmonics up to 25 mc can be generated with a new Microwave Frequency Calibrator Model #101 manufactured by **Micro-Now Instrument Co.**, 6340 N. Tripp Ave., Chicago 46, Ill. The 450 mc crystal controlled signal is designed to feed directly into a waveguide or coaxial crystal holder. A 5 mc fundamental crystal provides a convenient means of calibrating the instrument against wvw. Lower in-

These manufacturers have invited PROCEEDINGS readers to write for literature and further technical information. Please mention your IRE affiliation.

tensity markers at 150 & 50 mc are present for wavemeter or receiver calibration.

## Variable Speed Drive

A new lightweight miniature variable speed drive, so small it can fit in the palm of your hand, is being produced by **Humphrey Products Div., Humphrey, Inc.**, 3794 Rosecrans St., San Diego 10, Calif.

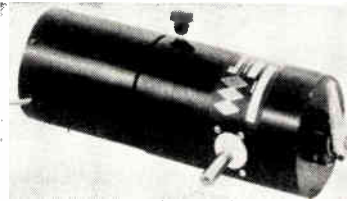

Designated the Servotran, the unit offers frequency response equivalent to a hydraulic system and triple that of an electrical system in a mechanical drive weighing 1¼ pounds. The drive without motor is 3¼ long by 2 inches in diameter.

A maximum of two inch/ounces on the control shaft changes speed from full forward to full reverse in 0.05 second. Output torque is constant and efficiency is between 85 and 95 per cent.

The Servotran is available with several modifications to meet specific needs. Positive speed adjustment can be obtained by using an accurately calibrated dial. A flexible push-pull cable for manual remote control and solenoid control for electrical remote control can be supplied.

Applications for the new miniature Servotran include actuators, computers, recorders, integrators and in airborne instrumentation where low torque shifting, high efficiency, wide speed range and low noise levels are important.

For additional information write to the firm.

## Toroidal Inductors

**Magnetico, Inc.**, 6 Richter Court, East Northport, L. I., N. Y., specializing in toroidal winding, has just released a new line of standard inductance coils. These coils are toroidally wound on molybdenum permalloy powder cores, giving them a stable and high Q inductance over the audio frequency range.

Stock values range from 5 mh to 5

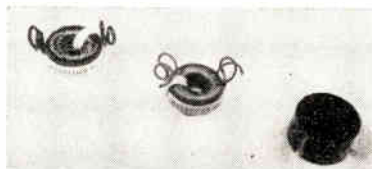

henries, with a tolerance of 1 per cent. Standard finishes available as indicated in the photo are: open construction for low costs, epoxy encapsulation for moisture proof sealing, and molded types for moisture and shock resistance and for easy mounting and stacking.

Overall size is 1½ diameter by ½ inch high, in keeping with current trends toward miniaturization.

Special values of inductance, Q, frequency and temperature range are available on short schedule.

These units are useful in filter work, resonant tuned circuits, and delay lines.

## New Firm

The formation of **Continental Device Corp.**, Hawthorne, Calif., was announced here today by Joseph S. O'Flaherty who will serve as the new company's president. Continental Device Corporation will specialize in the research, development, and production of semiconductor devices. Up-to-date laboratory and production facilities are being installed in a modern 25,000 sq. ft. building.

O'Flaherty stated: "Our corporate objective is to design and build devices in the semiconductor field which will utilize



to the maximum the semiconductor industry's experience gained from millions of hours of device operation to pinpoint those characteristics which require improvement." He went on to say, "This experience indicates that while new and superior devices will be required to meet the needs of industrial and military systems of every increasing complexity, the first job of the semiconductor manufacturer is to produce reliable devices through better design and controlled production."

(Continued on page 135A)

# Creative Microwave Technology

Published by MICROWAVE AND POWER TUBE DIVISION, RAYTHEON MANUFACTURING COMPANY, WALTHAM 54, MASS., Vol. 1, No. 2

## NEW ONE-WATT COMMUNICATION KLYSTRONS COVER GOVERNMENT AND COMMON CARRIER BANDS

Designed primarily for use in microwave relay links, the QK-661 and the QK-754, one-watt transmitter klystrons, operate at frequencies of 7,125 to 8,500 Mc and 5,925 to 6,425 Mc, respectively. The QK-661 is the first tube of its kind to cover the entire government band. The QK-754 is the first of a planned series of tubes to cover the entire communications band.

Both are mechanically tuned, integral-cavity, long-life, reflex-type tubes. The QK-754 uses a coaxial output; the QK-661, a waveguide output.

To insure efficient operation the tubes are available with integral cooling fins or with a heat-sink attachment suitable for connection to the chassis.

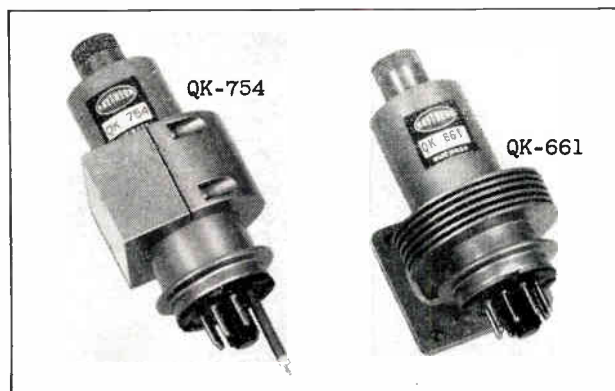

Typical operating characteristics

	QK-754	QK-661
Frequency Range	5925 to 6425 Mc	7125 to 8500 Mc
Power Output	1.5 watts	1.6 watts
Electronic Tuning (to half-power pts)	50 Mc	25 Mc
Modulation		
Sensitivity	1 Mc/V	600 Kc/V
(10 V pk-to-pk mod volt)		
Temp. Coefficient	$\pm 0.1$ Mc/°C	$\pm 0.1$ Mc/°C

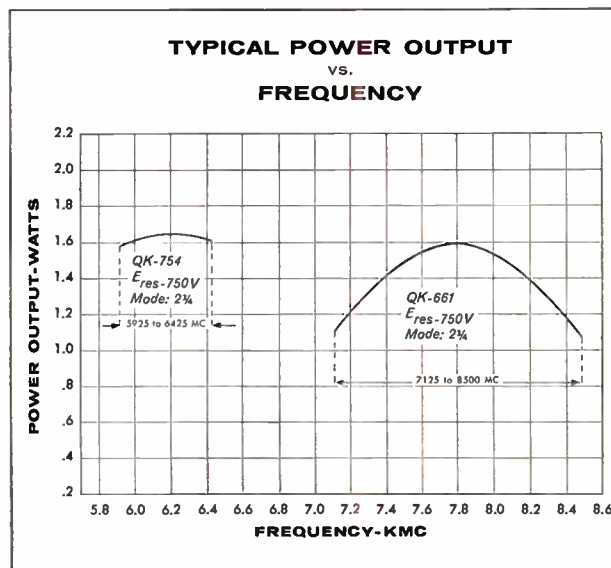
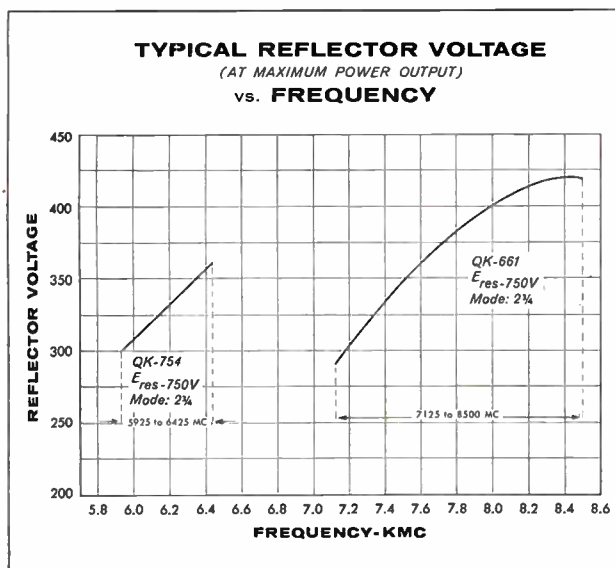

You can obtain detailed application information and special development services by contacting: Microwave and Power Tube Division, Raytheon Manufacturing Company, Waltham 54, Massachusetts

Excellence in Electronics



A LEADER IN CREATIVE MICROWAVE TECHNOLOGY







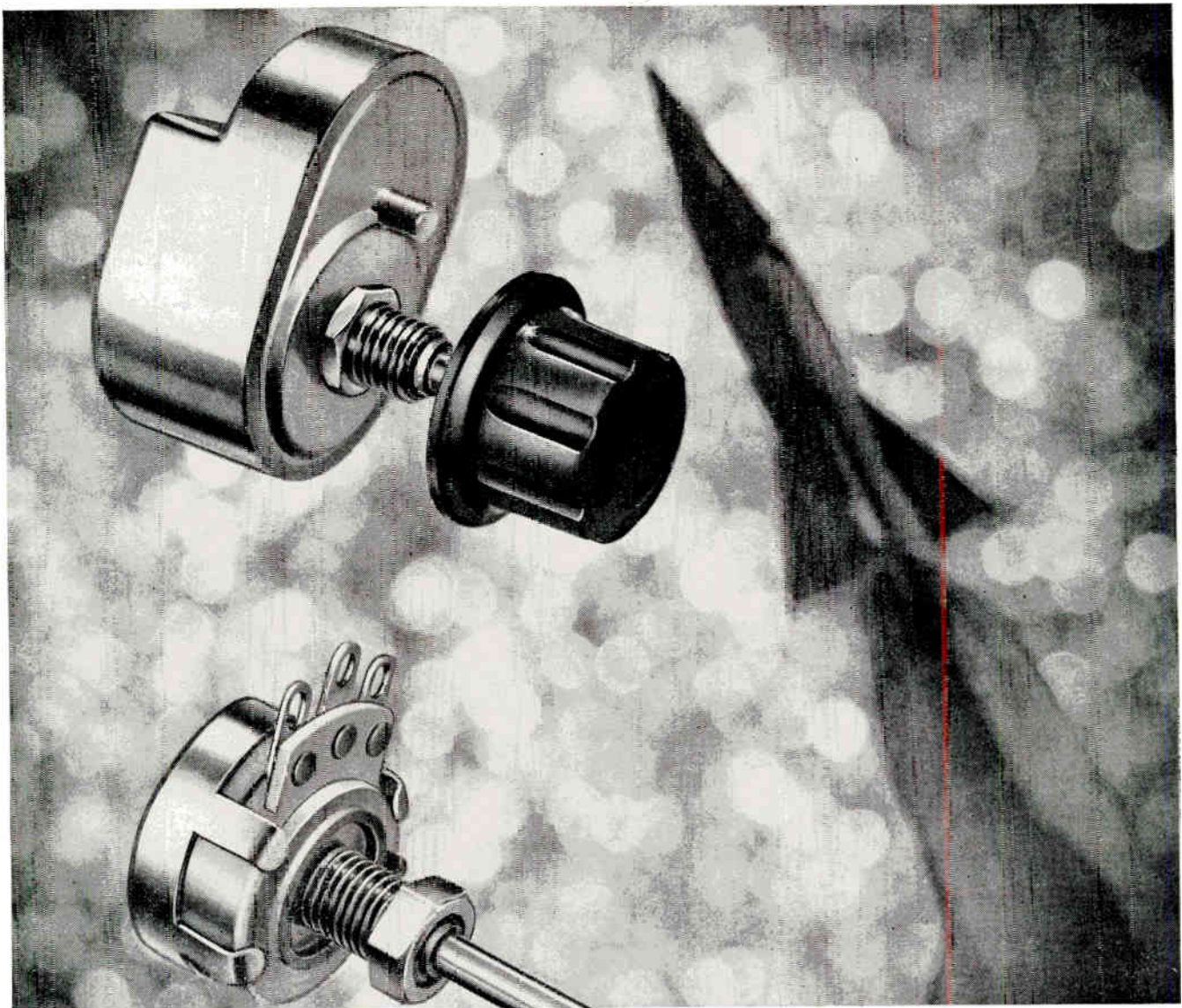

## New Miniature Sealed Wire-Wound Control For Service Up To 250° C

Need a high-reliability control for hot spots in military or missile circuits? Take a look at the new Mallory Type S miniature wire-wound.

**Designed to meet MIL-E-5272**, it can be used at ambients as high as 250°C. At 200°C ambient, it's rated at 2.5 watts.

**Gold plating** of the complete assembly ends corrosion problems, gives maximum heat transfer.

**Hermetically sealed model** (at top of illustration above) uses glass or ceramic feed-through terminals and high-temperature solder case seals to prevent entry of moisture.

**Panel-Sealed Model** (lower part of illustration) a unit is also available which has bushing-to-shaft seal plus provision for panel-to-control seal. This unit can be mounted in a sealed circuit container. Both models are supplied in linear tapers from 10 to 20,000 ohms. Standard tolerance is  $\pm 5\%$ ; other tolerances on request. All have a  $\frac{1}{8}$ " shaft, with  $\frac{1}{4}$ "—32 bushing.

Write today for data, and for a consultation with a Mallory resistor engineer on your particular circuit requirements.

#### Serving Industry with These Products:

**Electromechanical**—Resistors • Switches • Tuning Devices • Vibrators  
**Electrochemical**—Capacitors • Mercury and Zinc-Carbon Batteries  
**Metallurgical**—Contacts • Special Metals • Welding Materials





**SPECIAL  
PRE-PUBLICATION OFFER  
SAVES YOU \$3.00**

## ENCYCLOPEDIA ON CATHODE-RAY OSCILLOSCOPES & THEIR USES

(2nd edition)

by JOHN F. RIDER &  
SEYMOUR USLAN

On May 1st, 1959, the second edition of this famous book—completely revised, updated and expanded—will be available. The price will be \$21.95 for this 1100 page (8½x11") 'bible' of oscilloscopes. However, you pay only \$18.95 a savings of \$3.00 by reserving your copy at your bookstore, jobber or at the publisher before April 30, 1959. The second edition of the fabulously successful book—the first was considered a classic of useful oscilloscope information by engineers, educators, lab technicians and service technicians—has been greatly expanded to include many new types of oscilloscopes and their applications. *It is completely up-to-date!*

Whatever your field—geophysics, aviation, automotive, medical research, television, audio, computers, automatic control or any other branch of industrial and communication electronics—you'll find the cathode-ray oscilloscope today's basic instrument. The newly revised 2nd edition of this best-selling classic begins with cathode-ray tube construction and theory, then carries you through a thorough analysis of modern oscilloscope circuitry, commercial scope types and maintenance, to a detailed treatment of how the scope is operated for all applications.

The 2nd edition includes more than twice as many new scope applications. It covers the latest in special purpose cathode-ray tubes, new data on probes, related information on scope photography. A new section on pulse measurements has been added and also a new illustrated section on square wave testing. The chapter on "Commercial Oscilloscopes and Maintenance" covers the latest commercial types.

### COVERS EVERY PHASE OF OSCILLOSCOPES

*Cathode-ray tubes—theory of operation and basic construction—*

Basic Characteristics of Cathode-Ray Tubes; Principles of Focusing and Deflection; Deflection Systems in Cathode-Ray Tubes; Screens of Cathode-Ray Tubes.

### *Oscilloscope Circuitry and Operation—*

The Basic Oscilloscope; Vertical and Horizontal Amplifiers; Time Bases; Sweep Circuits; Synchronization; Power Supplies; Auxiliary Equipment and Accessories; Commercial Cathode-Ray Oscilloscopes and Maintenance; Special Purpose Cathode-Ray Tubes.

### *Oscilloscope Applications—*

Basic Signal Observation and Pulse Measurement; Phase and Frequency Measurements; Audio Frequency Circuit Testing; Transmitter Testing; Visual Alignment of A-M, F-M, and Television Receivers; Waveform Observation in Television Receivers; Electrical Testing; Medical, Scientific and Engineering Applications; Oscilloscope Photography.

### *Waveform Analysis—*

Complex Waveforms; Square Waveforms.

**Reserve your copy by April 30th at your jobber, bookstore or at the publisher—and pay only \$18.95, a saving of \$3.00.**

**JOHN F. RIDER PUBLISHER, INC.** IR-2  
116 West 14th Street, N. Y. 11, N. Y.

Enclosed is \$\_\_\_\_. Please send me \_\_\_\_ copies at \$18.95 each.

**ENCYCLOPEDIA ON CATHODE-RAY OSCILLOSCOPES & THEIR USES** (2nd edition, revised) by Rider & Uslan

Pre-publication price of \$18.95 good until April 30, 1959. After that date, \$21.95. All books returnable within 10-days for full refund.

Name.....  
Address.....  
City.....Zone.....State.....

In Canada 5% higher; add state & city taxes where applicable

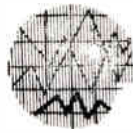

# IRE People



Appointment of **Richard C. Hess** (S'43-A'45-M'53) as sales manager of Microlab, Livingston, N. J., was announced recently. Microlab is a leading manufacturer of microwave filters, attenuators, and other coaxial components.



R. C. HESS

Prior to joining Microlab, Mr. Hess had been sales manager, instruments, for the Industrial Products Division of I. T. and T. He had also served in various other sales and Engineering positions, both here and abroad, with I. T. and T., with whom he was associated for 14 years.

Mr. Hess is a graduate of M.I.T.

**Andrew A. Mueller** (S'46-A'48-M'55) has joined Mark Products Company of Morton Grove, Ill. as Plant Manager. In this capacity he will direct the production and engineering departments of the firm. Mark Products Co. specializes in the design and manufacture of antenna systems for communications services, including parabolas for microwave point to point and heliwhips for mobile use.



A. A. MUELLER

Mr. Mueller received the B.S.E.E. degree in 1946, from Northwestern University, Evanston, Ill., where he also attended the Graduate School.

He was previously employed by the Glenn L. Martin Co., Baltimore, Md.; A. C. Nielson Co., Chicago, Ill.; and as Chief of the Engineering Laboratories at Chicago Aerial Industries in Chicago.



D. R. PROCTOR



L. S. PRESTON

Announcement of the promotion of **Don R. Proctor** (SM'53) to chief engineer of the Electronic Engineering Company of California has been made. He will replace **L. S. Preston** (SM'56), who has resigned to take a position with Space Technology Laboratories.

Mr. Proctor was formerly assistant chief engineer under Mr. Preston, having been named to that post in December, 1955. He joined the company in 1951 as a project engineer. He received the B.S.E.E. degree from the University of California.

Mr. Preston joined the company in 1949, and became chief engineer in 1955. From 1950-1955 he headed its Florida Division.

The Electronic Engineering Company of California designs and develops electronic instrumentation timing equipment, data processing equipment, guided missile test range equipment, and other special electronic systems for the armed forces and industry.

**James A. Montllor** (A'47-M'55) has been appointed Vice-President of Essex Electronics, Berkeley Heights, N. J., manufacturers of delay lines, coils, RF chokes, and pulse transformers. Mr. Montllor, who attended Brooklyn Polytechnic Institute, Brooklyn, N. Y., has been with Essex since 1945 as Chief Engineer, and will retain that title as Vice-President of the Company.

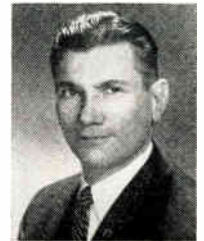

J. A. MONTLLOR

He was previously employed by the Allen B. Cardwell Co., Western Electric Co., and Automatic Manufacturing Corp. He has worked extensively on the development of military communications equipment and radiosonde transmitters, and has broad experience in coil design problems. In this respect, Mr. Montllor was active in the design and development of the new "X-L" RF Coil which was patented and introduced by Essex last year. His contribution concerned the coil design as well as the design and development of the specialized machinery required to build this unique coil which consists of a core and outer case molded into a single unit of rugged plastic, making it suitable for hopper feeding in the automatic assembly of video IF strips.

(Continued on page 32A)

There is  
No Substitute  
for  
Reliability—

# NEW *miniaturized* "MAG MOD" Magnetic Modulators

All Magnetic Modulators strictly conform to MIL-T-27A. Some typical circuit applications for Magnetic Modulators are algebraic addition, subtraction, multiplying, raising to a power, controlling amplifier gains, mechanical chopper replacement in DC to fundamental frequency conversion, filtering and low signal level amplification.

Especially Engineered for Printed Circuit Wafer  
Designed Structures and Circuit Assemblies Featuring:



Actual Size

- FASTER RESPONSE TIME
- NEGLIGIBLE HYSTERESIS
- EXTREME STABILITY  
(Ambient Temp. Range from  $-65^{\circ}\text{C}$  to  $+135^{\circ}\text{C}$ )
- COMPACT SIZE
- LIGHTWEIGHT
- INFINITE LIFE
- COMPLETE RELIABILITY

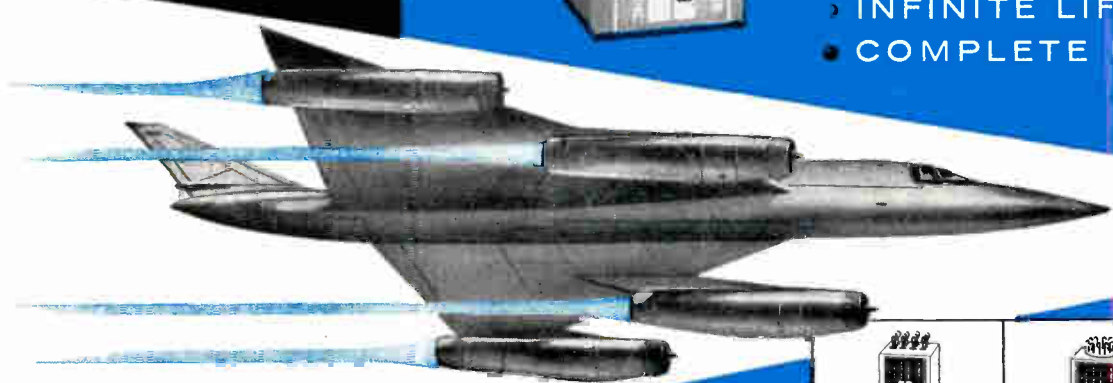

Miniaturization of the new Magnetic Modulator makes it possible to incorporate this component into wafer type structures and transistorized printed circuit assemblies without sacrificing ruggedness or reliability.

CONSULT GENERAL MAGNETICS on magnetic amplifier components for automatic flight, fire control, analog computers, guided missiles, nuclear applications, antennas, gun turrets, commercial power amplifiers and complete control systems. Call or write for Catalog B on miniature and standard components.



Magnetic  
Input  
Modulator



Magnetic  
Input  
Modulator



Magnetic  
Thermocouple  
Converter

TYPE NUMBER	IMM - 436 - 2	IMM - 436 - 3	MTC - 435 - 2
Excitations Frequency—Carrier	400 cps	400 cps	400 cps
Signal Winding DC Resistance	1000 ohms $\pm 15\%$ each signal winding	1000 ohms $\pm 15\%$ each signal winding	10 ohms $\pm 15\%$
AC Excitation Volts	5.5 V. @ 400 cps	2.5 V. @ 400 cps	6 V. RMS
Input DC Signal Range	0 to $\pm 100 \mu\text{a.}$	0 to $\pm 80 \mu\text{a.}$	0 to $\pm 10 \text{mv.}$
AC Output Range	0 to 2.2V. @ 400 cps (sine wave)	0 to 1.5V. @ 400 cps (sine wave)	0 to 2.7V. @ 400 cps (sine wave)
Overall Dimensions (Inches)	27/32x27/32x1 5/16	27/32x27/32x1 3/16	1 1/4 x 7/8 x 5/8
Null Amplitude (Noise Level)	20 mv. RMS	15 mv. RMS max.	25 mv. RMS max.
Output Impedance	7000 ohms	7000 ohms	10,000 ohms
Null Drift (In terms of input signal) $-65^{\circ}\text{C}$ to $+100^{\circ}\text{C}$	$\pm 0.5 \mu\text{a.}$ max.	$\pm 0.5 \mu\text{a.}$ max.	$\pm 0.1 \text{mv.}$ max.
Hysteresis — % of maximum input signal	0.5% maximum	0.5% maximum	0.5% maximum
Type of Mounting	Male Stud	Female Insert	Male Stud
Maximum % Distortion in Output	25%	15%	20%
Weight Ounces	1.3 oz.	1.2 oz.	1.5 oz.

**GENERAL MAGNETICS • INC.**

135 BLOOMFIELD AVE., BLOOMFIELD, NEW JERSEY





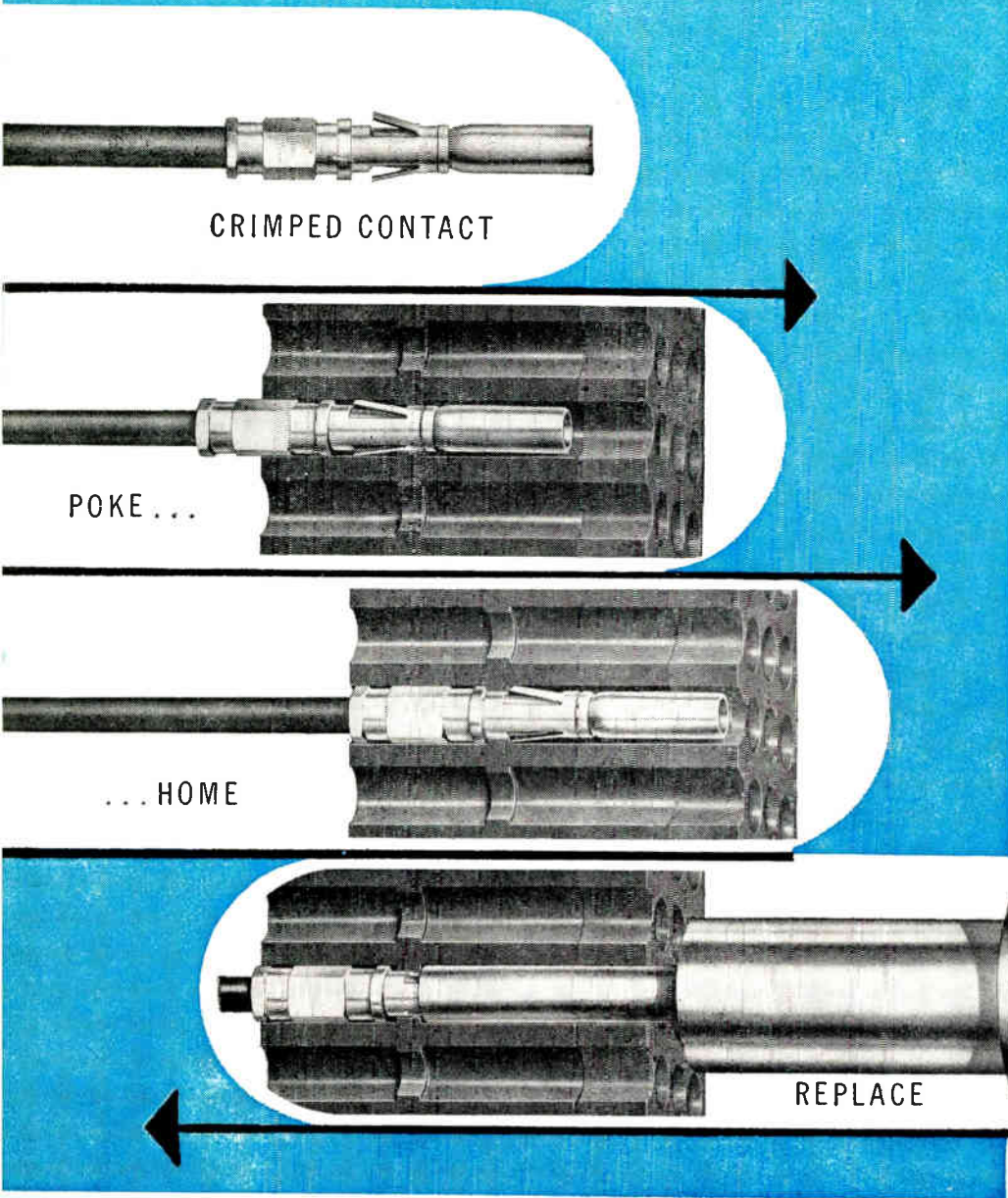

(Continued from page 30A)

**Jared Scott Smith** (S'48-A'49-SM'55) has been named manager of standard mobile design engineering for General Electric Communication Products Department, Syracuse, N. Y., with responsibility for coordinating design activities on new G. E. two-way radioproducts. He previously was supervisor of mobile transmitter design.



J. S. SMITH

Other G. E. appointments include **A. G. Manke** (A'26-SM'46), circuit design engineer; **G. M. Dewire** (M'58), standard systems engineer; and **F. D. Hannell** (S'42-A'45-M'55), product production engineer.

In announcing the appointments, Richard P. Gifford, manager of engineering, G. E. Communication Products Department, said the assignments are part of an expansion of G. E.'s mobile communications engineering organization. The engineers are being given new functions, Mr. Gifford said, in anticipation of a personnel increase in 1959, when a number of engineers will be added at G.E.'s new communications location at Lynchburg, Va.



**Dr. Julius A. Stratton** (M'42-SM'43-F'45) became President of the Massachusetts Institute of Technology on January 1, 1959. He had been Chancellor and Acting President. His appointment was made by the M.I.T. Corporation, acting on the recommendation of Dr. James R. Killian, Jr., President since 1948.



J. A. STRATTON

Dr. Killian, who continues on leave as Special Assistant to President Eisenhower for Science and Technology, was at the same time elected Chairman of the Corporation, a post to which he will devote full time when he returns from his service in Washington. Dr. Vannevar Bush, who has served as Chairman of the Corporation for the past two years, was elected Honorary Chairman of the Corporation.

In commenting on Dr. Stratton's election to the Presidency, Dr. Killian said: "Dr. Stratton's election recognizes his immense contributions to M.I.T. and his leadership in science and education both at M.I.T. and nationally. He possesses to an extraordinary degree those qualities of mind, and character, and spirit, which are required for an outstanding academic ad-

(Continued on page 36A)

**AMPHENOL** POKE-HOME contacts\*

AMPHENOL connectors with Poke Home contacts provide the electronics industry with a new and realistic answer to the problems of wire termination. Contacts, shipped separately from the connector, are crimped to their individual wire leads and then "poked home" into the insert. Each can be easily removed and replaced in case of circuit change.

Crimping of the contacts provides increased reliability through elimination of soldering. It permits inspection of each termination before insertion. And, mechanically and electrically, the millionth crimped termination is consistent with the first.

A Poke Home contact connector thus consists of individual circuits which may be strung through bulkheads or branched from different electrical sources and are quickly adaptable to any wiring change. Fewer manufacturing breaks in circuitry are assured; the number of steps in wire termination are reduced; the need for "J-boxes", terminal strips and other accessory components is similarly reduced.

\*CONCEPT COVERED BY U.S. PATENT 2,419,018

Send for full information on AMPHENOL connectors with Poke Home contacts!



AMPHENOL-BORG ELECTRONICS CORPORATION  
chicago 50, illinois



# New

## ALLEN-BRADLEY Power Ferrites for Audio Frequencies (400 to 15,000 cps)

With the development of these two new power ferrites, it is now possible for you to gain the advantages of high-efficiency operation at the lower frequencies. These new ferrites are available in a wide range of shapes and sizes. A-B engineers will be glad to assist you in the application of these new ferrites.



### Typical Applications for Allen-Bradley Power Ferrites

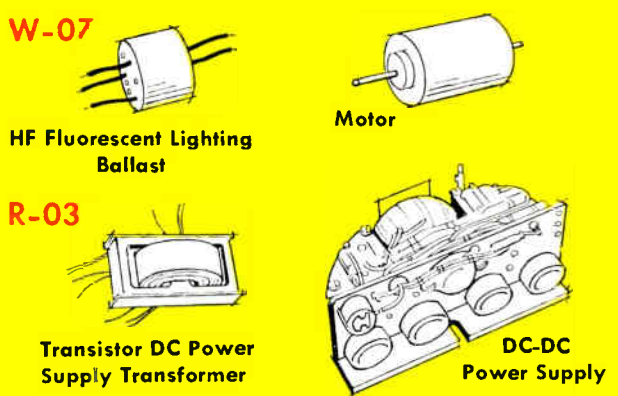

**W-07** NEW POWER FERRITE with maximum flux density in excess of 5000 gauss—Here's an A-B ferrite that opens new fields for the use of ferrites in continuous power applications at frequencies between 400 and 15,000 cps—where even special laminated iron alloys are impractical. And its lower material costs bring tremendous savings in high-frequency fluorescent lighting ballasts, power transformers, motors, and high-frequency converters.

**R-03** NEW POWER FERRITE has rectangular hysteresis loop—The many unique properties of this R-03 ferrite offer unusual opportunities for designing intermediate frequency magnetic amplifiers, static switching devices, transistorized inverters, and power supplies. At operation above 500 cps, the cost and weight of this new ferrite is less than one half that of square loop, metallic tape wound cores . . . and core losses are much less. In addition, the extreme squareness of the hysteresis loop minimizes transient spikes which can damage transistors.

Allen-Bradley Co., 222 W. Greenfield Ave.  
Milwaukee 4, Wis.  
In Canada: Allen-Bradley Canada Ltd., Galt, Ont.

# ALLEN-BRADLEY Electronic Components



# New Allen-Bradley Power Ferrites Open New Design Horizons

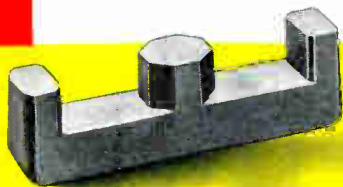

**W-07**

**R-03**

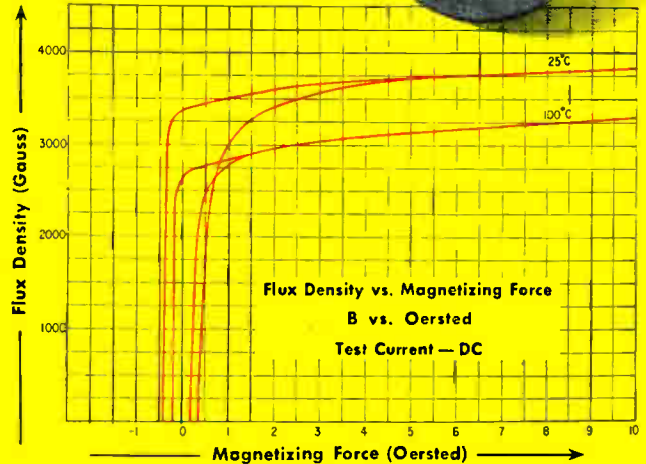
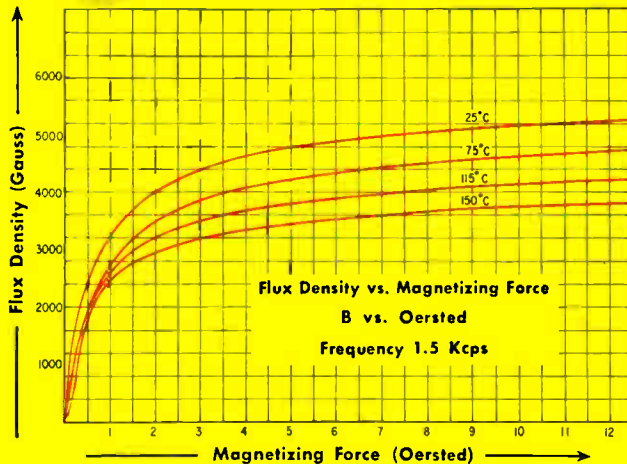

**W-07 MAGNETIZATION CURVES** show the extremely high flux density available. Also, it reveals that the maximum flux density does not decrease appreciably in increasing temperature. Technical Bulletin 5655 has complete specifications—send for your copy.

**R-03 HYSTERESIS LOOPS** show the high flux density provided with low levels of drive. The reduction in area with temperature shows that the loss per cycle is less at higher temperatures. For complete specifications, write for Technical Bulletin 5658.

TABLE OF MAGNETIC PROPERTIES (TOROIDAL)

Property	Symbol	Unit	Nominal Value	Test Current
Sat. Flux Density @ 10 Oersted	$B_s$	Gauss	5,200	1.5 Kcps
Residual Mag.	$B_r$	Gauss	1,000	1.5 Kcps
Coercive Force	$H_c$	Oersted	.24	1.5 Kcps
Initial Permeability	$\mu_0$	—	1,300	1.5 Kcps
Maximum Permeability	$\mu_{max}$	—	4,000	1.5 Kcps
Curie Point	CP	+ °C	280	—

TABLE OF MAGNETIC PROPERTIES (TOROIDAL)

Property	Symbol	Unit	Nominal Value	Test Current
Sat. Flux Density @ 10 Oersted	$B_s$	Gauss	3,900	D.C.
Residual Mag.	$B_r$	Gauss	3,360	D.C.
Coercive Force	$H_c$	Oersted	.37	D.C.
Initial Permeability	$\mu_0$	—	325	1.5 Kcps
Maximum Permeability	$\mu_{max}$	—	3,500	1.5 Kcps
Maximum Differential Permeability $\left(\frac{\Delta B}{\Delta H}\right)_{B=0}$	$\mu_d$	—	40,000	D.C.
Switching Time @ 2.5 $H_c$	$t_s$	$\mu$ sec	2.9	—
Curie Point	CP	+ °C	315	—

Allen-Bradley Co., 222 W. Greenfield Ave., Milwaukee 4, Wis.  
In Canada: Allen-Bradley Canada Ltd., Galt, Ont.

1-59-E

**ALLEN-BRADLEY**  
**ELECTRONIC COMPONENTS**  
QUALITY

# PHILCO

## MADT\* Transistors

# RATED AT 100°C

## deliver outstanding switching performance



High frequency, high gain Transistor offers excellent stability and operating efficiency in extensive environmental testing

Modern advances in electronics necessitate highest possible temperature performance from germanium transistors. Philco 2N501A transistors are designed for switching speeds of less than 18 millimicroseconds rise time, 12 m $\mu$ sec. storage time and 10 m $\mu$ sec. fall time . . . AND STORAGE TEMPERATURES UP TO 100° C. (see curve at right for derating factor). In extensive life tests (see graphs at right) these transistors exhibit excellent parameter stability at 7500 hours.

Philco's long and successful experience with electrochemical techniques and automatic transistor production, assures precise control of micro alloy diffused-base transistor performance. Philco know-how pays off for you . . . in outstanding uniformity and reliability of all transistors produced at Transistor Center, U.S.A.

Make Philco your prime source for all Transistor information.

Write to Lansdale Tube Company, Division of Philco Corporation, Lansdale, Pa., Dept. 1R 259

COLLECTOR TO BASE BREAKDOWN VOLTAGE  
TYPE 2N501A

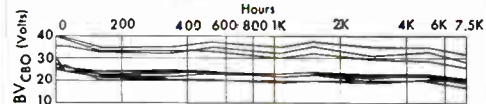

COLLECTOR CUTOFF CURRENT  
TYPE 2N501A

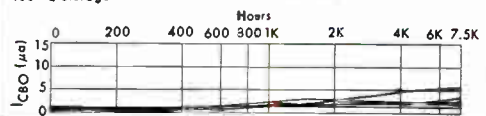

GAIN BANDWIDTH PRODUCT  
TYPE 2N501A

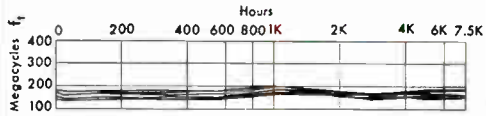

DERATING CURVE  
TYPE 2N501A

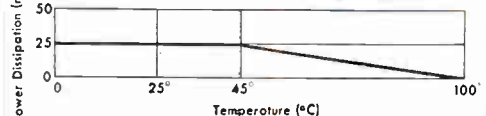

\*Trademark Philco Corporation for Micro Alloy Diffused-base Transistor.

# PHILCO CORPORATION

## LANSDALE TUBE COMPANY DIVISION

### LANSDALE, PENNSYLVANIA

World Radio History





THOR TITAN ATLAS BOMARC POLARIS TALOS



# D-C POWER

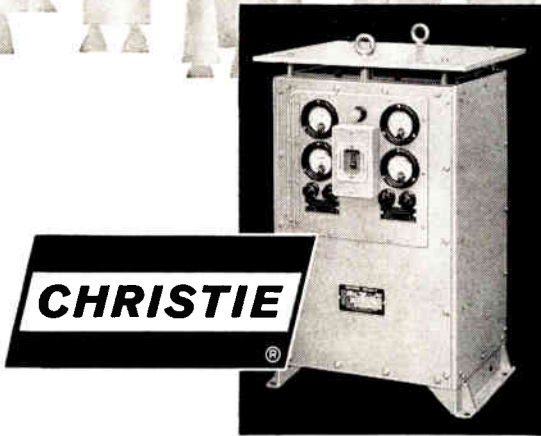

**THERE IS A REASON...why *CHRISTIE* was selected as the principal source of D-C Power Supplies for all the above projects...**RELIABILITY****

CHRISTIE'S rigid Quality Control is approved by the A. E. C. and leading Aircraft and Missile Manufacturers.

### **CHRISTIE ELECTRIC CORP.**

3410 W. 67th St., Los Angeles 43, Calif., Dept. IR

Precisely regulated Power Supplies of permanent stability. Ratings up to 1500 amperes. Bulletin on Standard Militarized units available on request.



**IRE People**



(Continued from page 32A)

ministrator and specifically for the Presidency of M.I.T.?"

Holder of two degrees from M.I.T., a world-traveler, and a pioneer in electronics research, Dr. Stratton has been serving as an administrator since 1949, when he was appointed Provost. This appointment followed a career of more than 20 years teaching and doing research as a faculty member. In 1951 he was named a Vice-President and a member of the Corporation. Five years later he was appointed Chancellor, becoming responsible for administration of the entire academic program at M.I.T., and on November 7, 1957, he became Acting President as well.



Eitel-McCullough, Inc., San Carlos, Calif., manufacturer of Eimac electron-power tubes, has announced the appointment of **Robert G. Siff** (A'51) as its field representative at Wright-Patterson Air Force Base and Gentile Air Force Station in Dayton, Ohio.



R. G. SIFF

Mr. Siff's education includes four years of mechanical engineering at Purdue University, Lafayette, Ind., and a year of electrical engineering at Princeton University, Princeton, N. J. He also studied applied electronics at Massachusetts Institute of Technology, Cambridge, Mass., before joining the Airborne Coordinating Group, Naval Research Laboratory and the Early Warning System in Johnsonville, Pa.

After release from the Navy, Siff joined a major electronics company and then became a manufacturers representative and liaison engineer.



**Industrial Engineering Notes**\*

### EIA ACTIVITIES

A year-end review of the electronic industry, released on December 22, by EIA President David R. Hull, depicts a growing industry which established a new sales record during 1958 and one which will reach \$8.3 billion in factory sales in 1959. Despite a decline in sales of consumer products during 1958, Mr. Hull noted, military and industrial electronic sales increased during the year—a clear indication that "the industry has the capacity and the know-how to serve both an expanding

(Continued on page 38A)

\* The data on which these NOTES are based were selected by permission from *Weekly Reports*, issues of November 24, December 8, 15 and 22, published by the Electronic Industries Association whose helpfulness is gratefully acknowledged.

# VARACTORS NOW!

YESTERDAY . . . a multiple breakthrough  
in the laboratory.

TODAY . . . a production fact from  
Microwave Associates.

This Microwave Associates varactor is a diffused silicon PN junction diode designed to be a variable capacitance with low loss at high frequencies. The unit complies with MIL-E-1 outline 7-1 for cartridge type crystal rectifiers and will fit most standard crystal holders.

In the standard form, the pin end of the diode is connected to P-type material on the top of a small "mesa" and the N-side of the silicon element is connected to the base. Reverse polarity units are also available. Mechanically reversible units in both polarities may be ordered but the single-ended units are generally recommended because they insure placement in holders with the proper end in contact with a heat sink.

TYPE	CUT OFF FREQUENCY (kMc)	CAPACITY AT ZERO BIAS ( $\mu\mu\text{f}$ )
MA-460A	20	8
MA-460B	30	6
MA-460C	40	4
MA-460D	50	4
MA-460E	60	3

VOLTAGE TUNED MICROWAVE CIRCUITS

PARAMETRIC AMPLIFIERS

HIGH LEVEL MODULATORS

REACTIVE LIMITERS

HARMONIC GENERATORS

## VOLTAGE TUNED MICROWAVE CIRCUITS

The high Q of the varactor at microwave frequencies and its voltage variable capacitance provide excellent qualities for use in circuits as AFC, voltage variable filter networks, tuned microwave oscillators.

## PARAMETRIC AMPLIFIERS

The varactor used in very simple circuits requiring no refrigeration has demonstrated low noise, high gain performance from 1 to 6000 mc. Noise figures of approximately 1 db at UHF and 5 db at 6000 mc. are typical. We believe the varactor will be the component of choice for receiver inputs from 30 to 6000 mc.

## HIGH-LEVEL MODULATORS

For the difficult problem of imposing VHF and UHF intelligence on a microwave carrier, the varactor is a top performer. The varactor accomplishes the mixing function with signal gain in the side bands as opposed to present low efficiency techniques.

## REACTIVE LIMITERS

The varactor has been used as a passive reactive limiter at UHF frequencies. It is believed that the varactor will be an ideal "receiver protector" as an adjunct to present UHF radar duplexing systems.

## HARMONIC GENERATORS

The unique properties of the varactor provide highly efficient harmonic generation. Useful harmonics have been generated up to 100 kMc. With inputs at HF, VHF, UHF and lower microwave frequencies, conversion losses of considerably less than 1 db per harmonic have been observed. The varactor driven by transistor or tube oscillators appears very promising as a signal source in the microwave region.

Send for catalog 59V



**MICROWAVE ASSOCIATES, INC.**

BURLINGTON, MASSACHUSETTS • Telephone: Browning 2-3000



New Speed...Versatility...Reliability...



**TRANSISTORIZED DIGITAL  
MAGNETIC TAPE HANDLER  
MODEL 906**

• Check these new standards  
of reliability and performance

- Completely transistorized for maximum reliability
- Trouble free brushless motors
- Over 50,000 passes of tape without signal degradation
- Linear servo system
- Life expectancy of pinchroll mechanism: over 100,000,000 operations
- Skew  $\pm 3 \mu\text{sec}$   $\frac{1}{2}$ " tape, center clock at 100 i.p.s.
- Vacuum loop buffer
- Continuous flutter free cycling 0 to 200 cps
- Normal speed up to 100 i.p.s.
- Rewind or search speed constant at 300 i.p.s.
- Six speeds forward or reverse up to 150 i.p.s.
- Better than 3 milliseconds start, 1.5 millisecc. stop
- Front panel accessibility
- In line threading
- End of tape and tape break sensing
- All functions remotely controllable
- Tape widths to  $1\frac{1}{4}$ "

The 906 is usually supplied with the Potter 921 transistorized Record-Playback Amplifier, a unit that features:

- |                        |   |
|------------------------|---|
| Pulse or level outputs | Manual, relay, or electronic function switching |
| Output gating          | Dual read-write operation                       |
| 1 i.p.s. to 150 i.p.s. |   |

Potter also manufactures a complete line of Perforated Tape Readers, High Speed Printers and Record-Playback Heads.

Contact your Potter representative or call or write direct for further information.



**POTTER INSTRUMENT COMPANY, INC.**  
Sunnyside Boulevard, Plainview, N. Y.  
OVERbrook 1-3200

Potter has career opportunities for qualified engineers who like a challenge, and the freedom to meet it.

(Continued from page 36A)

national economy and an adequate defense program."

The complete text of Mr. Hull's year-end review follows:

Electronic manufacturers emerged from the 1958 recession as one of the few industries to establish a new sales record. While the industry's recent rate of growth was slowed, it nevertheless reached a new peak of \$7.7 billion in factory sales. This was \$100 million above the previous high in 1957 and was nearly four times the industry's sales record ten years ago.

The production of military electronic equipment passed the \$4 billion mark and represented well over half of the total dollar volume. The 1958 record was \$4.1 billion compared with \$3.9 billion, according to estimates of the EIA Marketing Data Department. Electronic equipment and components now account for 28 per cent of all military purchasing for major production and procurement.

Consumer goods, composed chiefly of radio and TV sets, were the only electronic product category which declined in sales in 1958 along with other household appliances. Despite a strong resurgence this fall and early winter, especially in stereo and hi fi equipment, the year's volume dropped from \$1.5 to \$1.3 billion.

(Continued on page 42A)

The new **NORTHERN RADIO** catalog is your buyers guide to **FREQUENCY SHIFT COMMUNICATION EQUIPMENT**



Complete descriptions and specifications... the only book of its kind in the field!

- 68 Pages • 34 Items
- 34 Photographs • 20 Block Diagrams
- the Industry's FOREMOST and COMPLETE line of Quality Communication Equipment!

Write on your letterhead for your copy today  
**NORTHERN RADIO COMPANY, INC.**  
149 W. 22nd St., New York 11, N. Y.  
IN CANADA: NORTHERN RADIO MFG. CO. LTD., OTTAWA, ONT.

# ATLAS

**Air Force  
"Sunday  
Punch"**

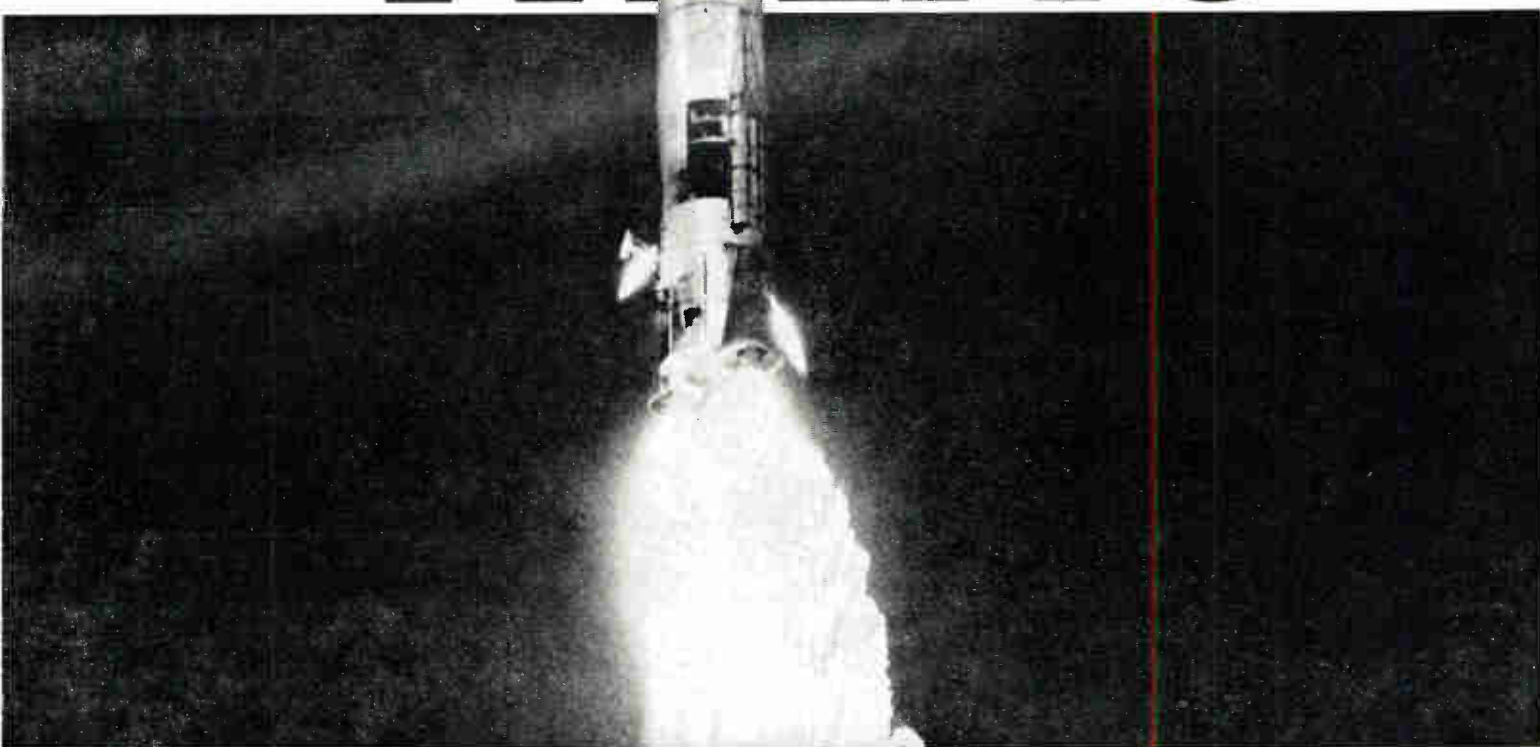

Boosted into space by the fiery thrust of three huge rocket engines, the seven-story Atlas intercontinental ballistic missile roars upward from its Cape Canaveral launching pad. Quickly it sheds the frost encrusting the liquid oxygen tank and races to its predetermined destination in the far reaches of the globe. In its size and range and capability, the Air Force Atlas is a

commentary for all the world to heed, of the necessity to maintain the peace. RCA's Missile and Surface Radar Department has been privileged to design and develop ground check-out, launch control and cabling equipment as a major subcontractor to Convair (Aeronautics) Division of General Dynamics Corporation, the Atlas prime weapons systems contractor.



TRADE MARK

**RADIO CORPORATION of AMERICA**

DEFENSE ELECTRONIC PRODUCTS

CAMDEN, N. J.





## Frontiers are extended by the practical visionary

*Appointments at APL offer  
exceptional opportunities. For detailed information,  
address your inquiry to:  
Professional Staff Appointments*

It is the practical visionary who has given us much of what we enjoy today. And it will be the visionary—the man with ability to seek concepts beyond the existing limitations of science—who will guide our developments of tomorrow.

The Applied Physics Laboratory (APL) of The Johns Hopkins University seeks men who will be engaged in advanced research problems—who will find solutions to problems yet to be posed. Their findings will provide guidelines for the space and missile hardware research of the future.

Your endeavors will be heightened by the professional atmosphere of APL. This atmosphere, created by men dedicated to the furtherance of science, has earned APL a reputation as a leader in programs vital to the national security.

## The Johns Hopkins University Applied Physics Laboratory

8603 Georgia Avenue, Silver Spring, Maryland

*Tung-Sol moves ahead!*

# NOW



## High power transistors with new **cold-weld** seal

Improved cold-weld seal  
gives new Tung-Sol  
high-power transistors  
three-way quality boost

- True hermetic, copper-to-copper seal improves transistor thermal characteristics.
- Elimination of heat-damage, heat-caused moisture and "splash" increase reliability.
- Vacuum-tight, moisture-proof cold-weld seal lasts even through "breathing" over long life operation.

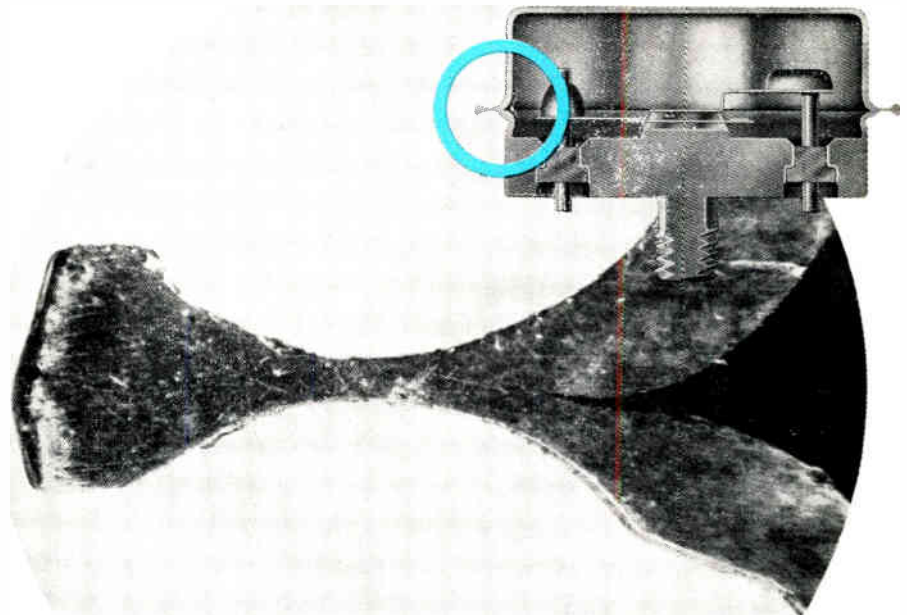

Photomicrograph (45X) shows circled area of cross section of Tung-Sol high-power germanium transistor cold-weld seal. Note absence of seam, indicating actual integration of copper molecules and a true, hermetic, copper-to-copper seal.

Once again Tung-Sol shows the way. Now, for the first time, Tung-Sol brings designers high-power germanium transistors with quality benefits of the advanced cold-weld seal.

The new Tung-Sol types feature a stud-mounted package and maximum collector current of 13 amps. Military environmental tests combine with the radioactive gas leak detection test to assure maximum reliability.

Technological advancements such as this keep Tung-Sol ahead of the field. For full data on the new high-power switching transistors . . . to meet any need with the latest in transistor design and efficiency, contact: Semiconductor Division, Tung-Sol Electric Inc., Newark 4, New Jersey.

 **TUNG-SOL®**



# Tarzian F Series Silicon Rectifiers . . .

# UTMOST

. . . in Performance

S.T. Type	Max. Peak Inverse Volts	Max. RMS Volts	Current Ratings—Amperes											
			Max. D.C. Load			Max. RMS			Max. Recurrent Peak			Surge 4MS Max.		
			55°C	100°C	150°C	55°C	100°C	150°C	55°C	100°C	150°C	55°C	100°C	150°C
F-2	200	140	.75	.5	.25	1.875	1.25	.625	7.5	5.	2.5	75	75	35
F-4	400	280	.75	.5	.25	1.875	1.25	.625	7.5	5.	2.5	75	75	35
F-6	600	420	.75	.5	.25	1.875	1.25	.625	7.5	5.	2.5	75	75	35

. . . in  
**Ultra  
Small  
Size**

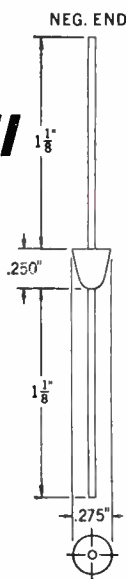

. . . in  
**Low  
Price**

## Tarzian

research, engineering and production know-how have combined to develop the "utmost" in a small size, very low cost silicon rectifier with giant performance. If your problem is miniaturization, or cost, or tough application, the solution is in the Tarzian F series.

Send for Design Note #31

**Sarkes Tarzian, Inc., Rectifier Division**  
DEPT. P-2, 415 NORTH COLLEGE AVE., BLOOMINGTON, INDIANA

IN CANADA: 700 WESTON RD., TORONTO 9, TEL. ROGER 2-7535 EXPORT: AD AURIEMA, INC., NEW YORK CITY

  
**Industrial Engineering Notes**

(Continued from page 38A)

Retail sales of television receivers in 1958 declined to about 5 million units from 6.6 million in 1957. Radio receivers of all types dropped from 15.2 to 12.6 million despite a sharp rise in the popularity of transistor portables. Phonographs declined from 4.9 million in 1957 to 4.2 million although fall and winter sales were at a much higher annual rate.

Industrial electronic products continued to rise, although at a slower rate, and for the first time passed consumer goods in the dollar volume. Industrial sales rose from \$1.3 to \$1.4 billion. Computer and data processing equipment represented the largest single product in this area, amounting to \$290 million. Replacement tubes, semiconductors, and parts increased from \$900 to \$975 million.

The outlook for a continuing interest in electronic production in 1959 appears excellent at the year-end. Indications are that factory sales will reach \$8.3 billion and that all segments of the industry will show gains.

Consumer goods sales are expected to return to \$1.5 billion next year and may go higher. The growing popularity of stereo and hi fi equipment for the home, the increasing number of TV sets in the home as well as obsolescence of present receivers, and the normal rise in the total

(Continued on page 10-A)

**NEW  
1959**



**miniature  
transformer  
catalog**

Approved MIL-T-27A Designs

**NEW TRANSISTOR  
TRANSFORMERS:**

DC to DC Converter, Silicon Rectifier-Power, Input, Driver, Output, Chopper

 **write for detailed  
1959 catalog**

**IMMEDIATE DELIVERY  
FROM STOCK AT  
FRANCHISED STOCKING  
DISTRIBUTORS**

**MICROTRAN** company, inc.  
145 E. MINEOLA AVE.,  
VALLEY STREAM, N. Y.

VARIAN

PRESENTS



VA-225



VA-220



VA-222

A COMPLETE COMPLEMENT OF 1 WATT RELAY TUBES

...WITH FREQUENCY RANGES COVERING THE COMMON CARRIER, STL, AND GOVERNMENT BANDS

The well known VA-220 Klystron series, long the accepted standard of the relay industry, is now guaranteed for 5000 hours.

The VA-222 series has all the desirable qualities of the VA-220 series but it is conduction cooled making possible added economies in equipment design...no cooling blower required

Write for free comprehensive catalog on Varian Microwave tubes, produced by the world's largest manufacturer of Klystrons.

The VA-225A and B are the newest additions to this group of efficient Klystrons. Each provides a 1000 megacycle tuning range within the 7.0 kMc to 8.5 kMc range. The electrical specifications are similar to those of the VA-220.

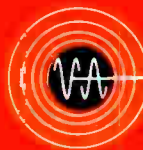

VARIAN associates  
PALO ALTO 2, CALIFORNIA  
Representatives in all principal cities

MECHANICAL TUNING RANGE	
VA-220A and VA-222A	7.25-7.75 Mc
VA-220B and VA-222B	7.25-7.425 Mc
VA-220C and VA-222C	6.675-7.125 Mc
VA-220D and VA-222D	6.575-6.875 Mc
VA-220E and VA-222E	6.25-6.425 Mc
VA-220F and VA-222F	5.925-6.225 Mc
VA-220G and VA-222G	6.425-6.575 Mc
VA-220Z and VA-222Z	7.750-8.100 Mc
VA-225A	7.500-8.500 Mc
VA-225B	7.900-8.000 Mc

KLYSTRONS, TRAVELING WAVE TUBES, BACKWARD WAVE OSCILLATORS, HIGH VACUUM PUMPS, LINEAR ACCELERATORS, MICROWAVE SYSTEM COMPONENTS, R.F. SPECTROMETERS, MAGNETS, MAGNETOMETERS, STALOS, POWER AMPLIFIERS, GRAPHIC RECORDERS, RESEARCH AND DEVELOPMENT SERVICES.



*Weston offers a broad new line  
of long-scale instruments*

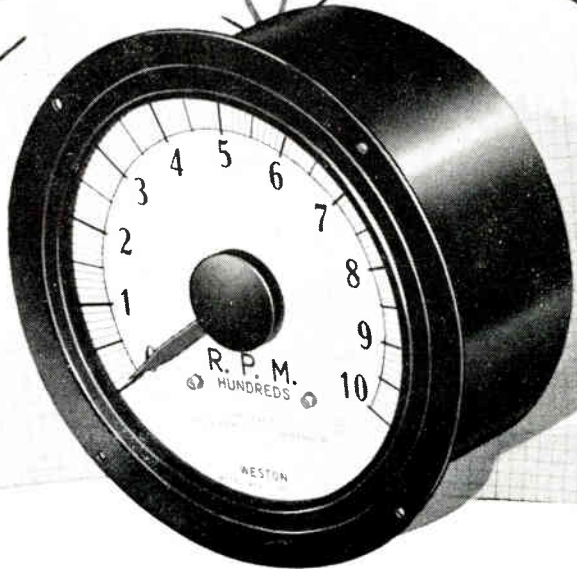
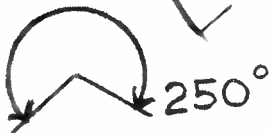
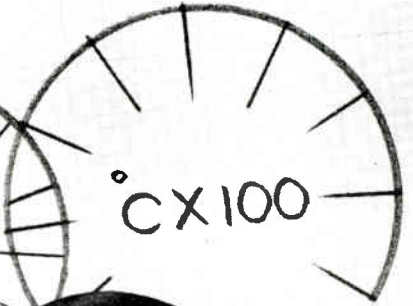
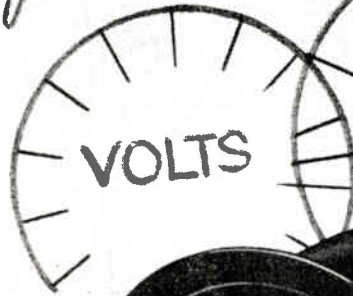
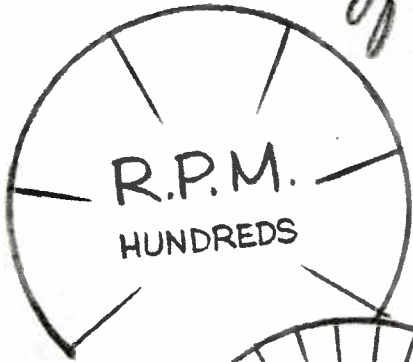

## 250° SCALES MEAN GREATER READABILITY FROM EACH SQUARE INCH OF PANEL SPACE

Weston's new series of Long-Scale Instruments now fills the requirements of a wide variety of special applications. Rugged, spring-backed-jewel mechanisms are self-shielded for immunity to the effects of stray magnetic fields. The instruments may be mounted without concern for panel thickness or material. Thus, exceptional stability (both mechanical and electrical) teams up with unequalled readability for a new high in panel instrument value. Accuracies are within  $\pm 1\%$  of full-scale range.

Weston Long-Scale Instruments are available in Aircraft and Standard Flanged cases for a wide range of current, voltage, tachometric and temperature indications. Consult your local Weston representative for complete details on Long-Scale Instruments . . . or write for Catalog A-50. Address: Weston Instruments, Division of Daystrom, Inc., Newark 12, N. J. In Canada: Daystrom Ltd., 840 Caledonia Rd., Toronto 10, Ont. Export: Daystrom Int'l., 100 Empire St., Newark 12, N. J.

*Take advantage of Weston's unusually fast prototype service!*

# WESTON

*Instruments*



# SETTING THE PACE IN

# KLYSTRON

**Power Supplies**  
on the production line or in the laboratory  
*a leader in the*

## PRD PACEMAKER LINE

For lower voltage klystron tubes, PRD type 809 Klystron Power Supply provides flexible, economical performance. Built to the same highest quality standards as type 812, this compact, low cost unit insures optimum performance of a wide variety of klystron oscillators. A clamping circuit in the reflector supply reduces the possibility of double-moding the klystron.

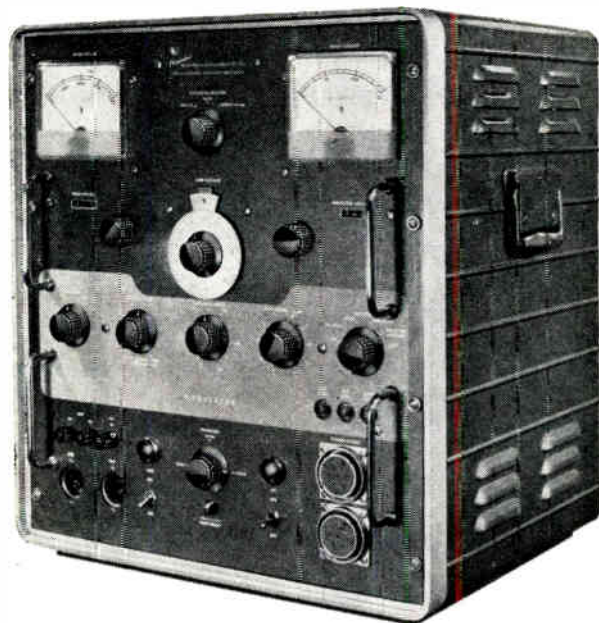
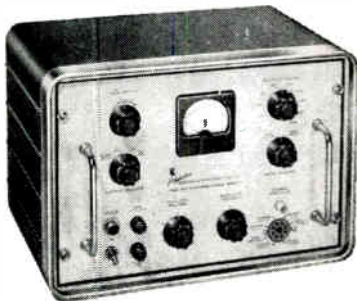

For use with all available klystrons in the low power range and for klystrons at power levels up to 5 watts, the completely new type 812 Universal Klystron Power Supply provides:

- widest application
- closest regulation
- greatest range
- minimum ripple and noise
- pulse, square wave, sawtooth and sine wave modulation.

### PLUS THESE SPECIAL FEATURES:

- digital read-out for beam and reflector voltages.
- dual outputs for simultaneous operation of two klystrons.
- grid and reflector voltage clamped to CW level in square wave or pulse operation.
- front panel check calibration of grid and reflector voltages.
- multi-range overload protection for beam current.
- safety lock when transferring from + to - grid voltage.
- external triggering of internal pulse generator.

For additional details, contact your local PRD Engineering Representative or write to Technical Information Group, Dept. TIG-1.

**POLYTECHNIC RESEARCH & DEVELOPMENT CO., INC.**

202 Tillary Street • Brooklyn 1, N. Y.



SPECIFICATIONS			
OUTPUT		Type 812	Type 809
Beam	Volts, dc	200 to 3600	250 to 600
	Current, ma	0-125	0-65
	Ripple, mv rms	5 max.	5 max.
Reflector	Volts, dc	0 to -1000	0 to -900
	Current, $\mu$ a	50 max.	50 max.
	Ripple, mv rms	1 max.	10 max.
Grid	Volts, positive	0 to 150	—
	negative	0 to 300	—
	Current, ma	5 max.	—
	positive grid Ripple, mv rms	3 max.	—
MODULATION		Type 812	Type 809
Square Wave	Frequency, cps	500 to 5000	400 to 2000
	Volts*	0 to 150 (clamped)	0 to 90
Pulse	Frequency, cps	500 to 5000	—
	Volts*	0 to 150 (clamped)	—
Sawtooth	Frequency, cps	40 to 120	60, fixed
	Volts*	0 to 200	0 to 125
Sine Wave	Frequency, cps	60, fixed	—
	Volts*	0 to 200	—

\*volts, peak to peak



(Continued from page 42A)

homes in the nation are factors which support this optimism.

The EIA Board of Directors recently authorized Dr. W. R. G. Baker, Director of our Engineering Department, to form a National Stereophonic Radio Committee for the purpose of developing standards for stereophonic radio transmissions which will be recommended to the Federal Communications Commission. While its conclusions can hardly be expected to affect the 1959 market, they doubtless will even-

tually provide a new stimulant for radio and the consumer market.

Emphasis on missiles and a decline in military aircraft procurement will add further to the electronic industry's sales to the Armed Services. Total electronic expenditures in 1959 are expected to rise to \$4.4 billion. The electronic guidance system is rapidly becoming the most important part of the missile next to propulsion.

Electronic guidance and communication are even more vital in the missiles and satellites which are ushering in the space age. Without them the moon and universe probes now being tried would be useless toys. Electronic systems transmit information back to earth which soon will enable man to explore outer space in person, but he will still rely on radio to maintain his contacts with earth.

Sales of industrial electronic equipment, which have more than doubled during the past five years, should continue to rise in 1959, and probably will reach \$1.5 billion. Computer and data processing equipment will again lead the field.

At present there seems to be no limit to the expansion of the electronics industry. As proven products increase in volume, new markets are continually opening through research and development. Most of the experimentation is now in the military field, and new industrial segments such as nuclear instrumentation and telemetry have flashed like meteors on the electronic horizon. However, many of these military developments have commercial applications which will add to the industry electronic markets as well.

The striking technical improvements in sound production which have brought high fidelity and stereo into the home, the transistor which has made the pocket radio a reality, the slimming silhouette of TV all indicate that the consumer goods market is not to become static. While radio, TV, and the phonograph are perhaps old hat in their widespread acceptance, the initial excitements with which they were hailed are renewed now and then by another technical development.

Meanwhile, electronic devices and processes are steadily working their way into a growing number of other industries. Electronic aids in commerce and business, traffic control, cooking, and medical and scientific operations are increasing in variety and in volume.

While the balance today is on the side of military electronics because of national security requirements, other markets are not being neglected. The industry has the capacity and the know-how to serve both an expanding national economy and an adequate defense program.

Climaxing a five-day industry conference at the Roosevelt Hotel in New York City, Dec. 1-5, the EIA Board of Directors established a National Stereophonic Radio Committee with authorization to develop a set of standards for stereophonic radio broadcasting for recommendation to the Federal Communications Commission. Dr. W. R. G. Baker, Director of the Engineering Department, presented the plan for the National Stereophonic Radio Committee. The responsibility of NSRC, he said, would be to "develop a set of standards for stereophonic radio which, in the opinion of the industry as represented by the EIA represents the most economical method of serving the American public. This set of standards," he continued, "must permit full compatibility to the extent economically feasible; that is, all reasonable systems of multiplexing plus regular FM transmissions." Operations of NSRC will be directed by an administrative committee, headed by Dr. Baker and with David B. Smith, of Philco Corp., as Vice-Chairman. The operating committee will be headed by Graydon Lloyd, of General Electric Co. Panels of industry engineers will be formed to study the various problems of stereophonic radio, Dr. Baker said, and participation in the NSRC will be open to all qualified engineers regardless of whether they are members of EIA. Dr. Baker predicted the development of stereophonic

(Continued on page 50A)



**The further we progress,  
the more important  
experience becomes in solving  
today's most urgent problems.**

**ECM**

One company actively and continuously engaged in advanced ECM research and development since 1952 is ... **hallicrafters**

4401 W. Fifth Ave., Chicago 24, Ill.

**SERVICES**—research and development  
• electronic equipment production  
• reliability evaluation

**EQUIPMENTS**—communications • radar  
• countermeasures • reconnaissance  
• infra red devices • heat exchangers  
• pulse generators • antennas

# 105 db gain in 60 mc I-F strip



Six-stage, 90 db gain, silicon i-f amplifier designed and built by TI's Apparatus division.

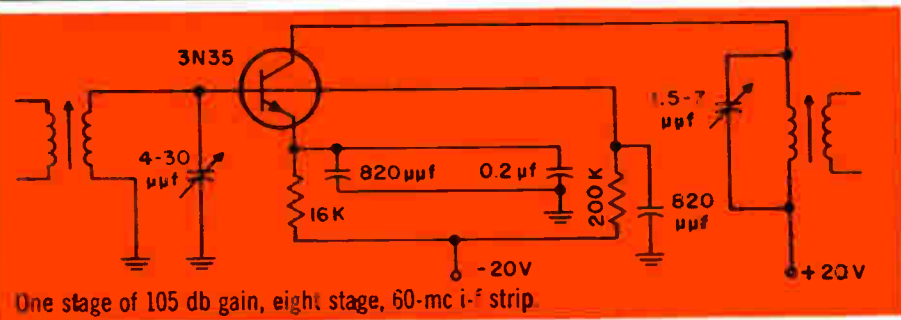

One stage of 105 db gain, eight stage, 60-mc i-f strip.

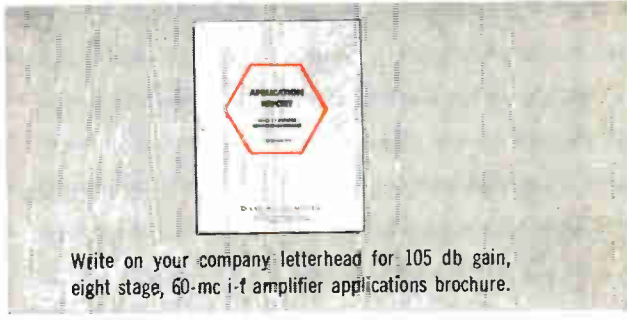

## ...with TI 3N35 silicon transistors



**105 db I-F STRIP CHARACTERISTICS**  
**Bandwidth: 20 mc at 3-db down**  
**Center Frequency: 60 mc**  
**No neutralization required**

The high gain of TI 3N35 transistors at high frequencies permits mismatch in the interstage coupling networks to eliminate complicated neutralizing circuitry. You save extra component costs, design with ease and gain added reliability . . . because the mismatch in this application sacrifices only 2.55 db gain per stage!

Designed for your high frequency oscillators, i-f, r-f, and video amplifier circuits, the TI 3N35 features . . . 20-db power gain at 70 mc . . . typical 150-mc alpha cutoff . . . operation to 150°C. These characteristics make transistorization feasible for radar, communications, missile, and other high reliability military applications.

*In commercial production at TI for two years, the 3N35 has a product-proved record of high performance and high reliability. These units are in stock now! For immediate delivery, contact your nearby TI distributor for 1-249 quantities at factory prices . . . or call on your nearest TI sales office for production quantities.*



from THE WORLD'S LARGEST SEMICONDUCTOR PLANT



**TEXAS INSTRUMENTS**  
**INCORPORATED**  
 SEMICONDUCTOR-COMPONENTS DIVISION  
 POST OFFICE BOX 312 • 13500 N. CENTRAL EXPRESSWAY  
 DALLAS, TEXAS



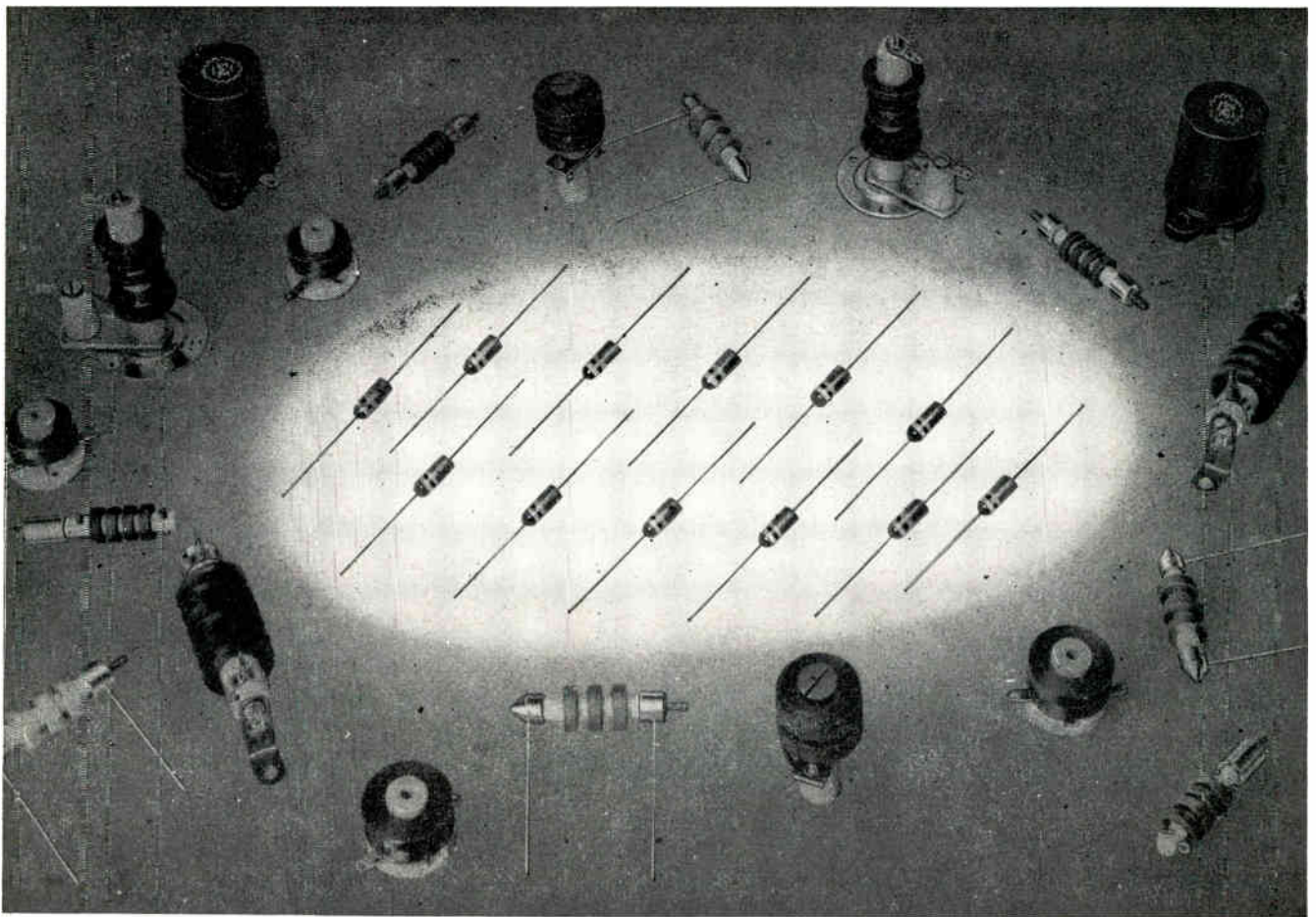

## Encapsulated Inductances

Millen DESIGNED for APPLICATION encapsulated coils provide another advance in the r-f inductor field. Modern application requires miniature, heat and cold resistant, hermetically sealed, and abrasion resistant r-f inductor assemblies. The James Millen Manufacturing Company has pioneered many advances in the r-f inductor field, including the now standard 4 pi r-f choke, the axial lead r-f choke, and the miniature r-f choke. Developments have now made possible another advance, the No. 34301 and No. J301 encapsulated inductors—hermetically sealed—miniature size. Ambient temperature minus 55 degrees to plus 100 degrees C.

### NO. J301 MINIATURE ENCAPSULATED INDUCTANCES

DESIGNED for APPLICATION miniature inductances are: extremely small (see table at right)—hermetically sealed—wound on axial lead Carbyl cores—color coded. Coils are available in RETMA standard values plus 25, 50, 150, 250, 350, 500, and 2500 microhenries. Coils are three layer solenoids up to 350 microhenries. From 360 to 2500 microhenries coils are pi-wound. Current rating 50 to 600 milliamperes depending on coil size. Inductance = 5%. Special coils on order.

### NO. 34301 STANDARD ENCAPSULATED INDUCTANCES

Encapsulated DESIGNED for APPLICATION axial lead phenolic form r-f inductances. Hermetically sealed—heat resistant—abrasion proof—color coded. 1 to 350 microhenries available in RETMA standard values plus 25, 50, 150, 250, and 350 microhenries. Inductance = 5%. Values available in same progression as J301 coils listed in the table at the right. Solenoid winding for 1 to 15 microhenries. Universal pi winding from 20 microhenries to 350 microhenries. Current rating 250 to 1500 milliamperes, depending on coil size. Ambient temperature range—minus 55 degrees to plus 100 degrees Centigrade. Size: 3/8 inches diameter X 3/8 inches long. Special coils on order.

COIL NUMBER	INDUCTANCE MICROHENRIES	DIAMETER INCHES	LENGTH INCHES
J301-25	25	3/16	7/16
J301-33	33	3/16	7/16
J301-47	47	3/16	7/16
J301-50	50	3/16	7/16
J301-82	82	3/16	7/16
J301-100	100	3/16	7/16
J301-120	120	3/16	7/16
J301-150	150	3/16	7/16
J301-200	200	3/16	7/16
J301-220	220	3/16	7/16
J301-250	250	3/16	7/16
J301-300	300	3/16	7/16
J301-330	330	3/16	7/16
J301-350	350	3/16	7/16
J301-360	360	7/32	7/8
J301-390	390	7/32	7/8
J301-430	430	7/32	7/8
J301-470	470	1/4	11/16
J301-500	500	1/4	11/16
J301-510	510	1/4	11/16
J301-560	560	1/4	11/16
J301-620	620	1/4	11/16
J301-680	680	7/32	7/8
J301-750	750	7/32	7/8
J301-820	820	7/32	7/8
J301-910	910	7/32	7/8
J301-1000	1000	7/32	7/8
J301-1200	1200	3/16	13/16
J301-1300	1300	3/16	13/16
J301-1500	1500	3/16	13/16
J301-1800	1800	3/16	13/16
J301-2000	2000	3/8	7/8
J301-2200	2200	3/8	7/8
J301-2400	2400	3/8	7/8
J301-2500	2500	3/8	7/8

JAMES MILLEN



MFG. CO., INC.

MAIN OFFICE

AND FACTORY

MALDEN, MASSACHUSETTS, U. S. A.



### DUAL HIGH DIRECTIVITY COUPLERS

Narda Dual High Directivity Directional Couplers are designed for reflectometer measurements in waveguide systems, and exhibit the same flat response ( $\pm 0.4$ ) and high directivity (40 db min.) as Narda's single units. Primary line VSWR: 1.05 max. (1.10 for M1027); secondary line VSWR: 1.15 max. Coupling factor: 20 db.

Coupling structures are on opposite broad walls of the primary line; secondary output arms are on the same side. Detector mounts can be attached readily to facilitate connecting detector mounts.

BAND	FREQUENCY (kmc)	WAVEGUIDE O.D. (in.)	NARDA Model	PRICE
S	2.60-3.95	3 x 1 1/2	1034	\$650.
C	3.95-5.85	2 x 1	1033	400.
XN	5.40-8.20	1 1/2 x 3/4	1032	255.
XB	7.05-10.0	1 1/4 x 3/4	1031	220.
X	8.20-12.4	1 x 1/2	1030	175.
KU	12.4-18.0	7/2 x 3/8	1029	180.
K	18.0-26.5	3/2 x 1/4	1028	295.
L	26.5-40.0	3/2 x 2/20	V1027	330.
M	50.0-75.0	228 x 154	M1027	900.



3, 6, 10 and 20 DB

40 DB HIGH POWER

### HIGH DIRECTIVITY COUPLERS

The 40 db High Power Coupler is another exclusive Narda product. Similar to standard types, except that coupling irises are in the narrow wall, it may be used at full rated power of the waveguide size. Nominal coupling value is 40 db, directivity 40 db. Directivity for 3, 6, 10 and 20 db couplers is also 40 db. Standard cover flanges on primary line; low VSWR termination and standard cover flange on secondary. All bands—2600 to 90,000 mc.



### STANDARD REFLECTIONS

Narda offers five values of reflections for each of six different waveguide sizes. The most complete choice we know of! Provides calibrated reflections or VSWR's for use in standardizing reflectometers or calibrating slotted line impedance meters.

#### SPECIFICATIONS

Reflection Coefficient	0.00	0.05	0.10	0.15	0.20
Accuracy	0.002	0.0025	0.0035	0.0045	0.007
VSWR Equivalent	1.00	1.105	1.222	1.353	1.50

Models for 2.60 to 18.0 kmc, from \$125 to \$300

## Microwave engineers—

# Where can you use these exclusive features offered by NARDA?

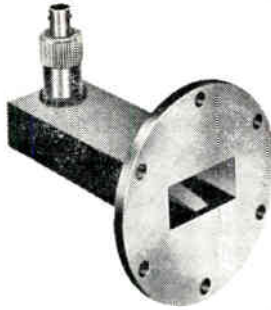

### BOLOMETER & THERMISTOR BROADBAND MOUNTS

- Exclusive plug-in elements

This new series of Narda matched Bolometer-Thermistor Mounts offers the optimum in accuracy and flexibility. At the same time, they permit instant replacement of the element. Bolometers and Thermistors, available from stock, simply plug in, without the use of tools, without the need of adjustments.

In addition, these mounts offer an extremely low VSWR over the full waveguide band, and require no tuning. Using bolometers, these units are designed for highest accuracy square law detection and power measurements. The thermistors are particularly recommended for accurate pulse power measurement.

BAND	FREQ (KMC.)	WAVE GUIDE (IN.)	NARDA MODEL	DETECTOR TYPE AND MODEL	MAX. VSWR	CRYSTALS†	LENGTH (IN.)	PRICE
L	1.12-1.70	6.66x3.41	536	BOLOMETER N-605 THERMISTOR N-333D	1.35 1.5	1N21 or 1N23	14	\$210.
LS	1.70-2.60	4.46x2.31	535	BOLOMETER N-605 THERMISTOR N-333D	1.35 1.5	1N21 or 1N23	9	210.
S	2.60-3.95	3x1 1/2	534	BOLOMETER N-605 THERMISTOR N-333D	1.35 1.5	1N21 or 1N23	7 1/2	110.
C	3.95-5.85	2x1	533	BOLOMETER N-605 THERMISTOR N-333D	1.5 1.5	1N21 or 1N23	5 1/2	80.
XN	5.40-8.20	1 1/2 x 3/4	532	BOLOMETER N-605	1.5	1N23	4 1/2	90.
			542	THERMISTOR N-333D	1.5	1N23	4 1/2	75.
XB	7.05-10.0	1 1/4 x 3/4	531	BOLOMETER N-605	1.5	1N23	3 1/2	85.
			541	THERMISTOR N-333D	1.5	1N23	3 1/2	65.
X	8.20-12.4	1 x 1/2	530	BOLOMETER N-604	1.5		2 1/2	65.
			540	THERMISTOR N-336	1.5		2 1/2	60.
KU	12.4-18.0	7/2 x 3/8	529	BOLOMETER N-604	1.5		2	65.
			539	BUILT-IN THERMISTOR	1.5		2 1/2	95.
K	18.0-26.5	1/2 x 1/4	538	BUILT-IN THERMISTOR	1.85		1 1/2	150.

### Complete Coaxial and Waveguide Instrumentation for Microwave and UHF — including:

DIRECTIONAL COUPLERS  
TERMINATIONS  
FREQUENCY METERS  
HORNS  
VSWR AMPLIFIERS

200 to 90,000 mc.  
TUNERS  
ECHO BOXES  
SLOTTED LINES  
BENDS  
COAXIAL HYBRIDS

ATTENUATORS  
STANDARD REFLECTIONS  
BOLOMETERS  
THERMISTORS  
LOW PASS FILTERS

### MAIL COUPON TODAY FOR FREE 1959 CATALOG AND NAME OF NEAREST REPRESENTATIVE

The Narda Microwave Corporation  
118-160 Herricks Road  
Mineola, L. I., N. Y.  
Dept. PIRE-13



NAME \_\_\_\_\_

COMPANY \_\_\_\_\_

ADDRESS \_\_\_\_\_

CITY \_\_\_\_\_ ZONE \_\_\_\_\_ STATE \_\_\_\_\_

 the narda  
microwave corporation

118-160 HERRICKS ROAD, MINEOLA, L. I., N. Y. • PIONEER 6-4650



alpha).003922

Platinum-wound temperature sensing elements require

**PLATINUM WIRE**

of highest purity, homogeneity, and reproducibility . . .



SINCE 1901



Write for list of products

**SIGMUND COHN CORP.** 121 So. Columbus Ave. • Mt. Vernon, N. Y.

**SWITCHCRAFT**® *Always First*  
INC. **NEW "LAMP JAX" DESIGN**

2 7/8" LAMP TERMINALS 9/16" 4.47 DIA.  
3/8" 2 1/2" 34.0 DIA HOLE FOR LAMP CAP  
3/16" DIA 9/32" DIA 3/32" DIA 3/32" DIA 3/32" DIA 3/32" DIA  
A FRAME C FRAME

Ideal for mounting on regular Jack Panels. Choice of 2 frame designs. Nylon Lamp Housing molded directly to frame. Lamp completely insulated from mounting frame. Can be mounted singly or in multiple on standard Switchboard Panels. Accepts standard Switchboard Lamps, and Lamp Caps.

Write for Supplement S-593.

LOOK TO SWITCHCRAFT FOR NEW PRODUCTS—NEW DESIGNS

**SWITCHCRAFT**® INC. 5545 N. Elston Ave., Chicago 30, Ill.  
Canadian Rep.: Atlas Radio Corp., Ltd., 50 Wingold Avenue, Toronto, Ontario  
AVAILABLE AT ALL LEADING RADIO PARTS JOBBERS •

(Continued from page 46A)

radio transmission standards will create considerable new business for the electronics industry in consumer products. He said NSRC would operate in a manner similar to the two National Television System committees which brought about industry accord on both black and white and color television transmission standards.

**MILITARY ELECTRONICS**

Lieutenant General Donald L. Putt (USAF-ret.) is the new Chairman of the Air Force Science Advisory Board, succeeding Lieutenant General James F. Doolittle (USAF-ret.). Gen. Putt was long-time Deputy Chief of the Air Staff (Development). Other changes in the Board are in the making.

**GOVERNMENT AND LEGISLATIVE**

The Office of Civilian Defense Mobilization recently took what appeared to be the first step toward launching a long range study of the radio spectrum and its administration as recommended by the EIA Board of Directors. It announced the appointment of a 5-man Special Advisory Committee on Telecommunications with instructions to submit recommendations to OCDM Director Leo A. Hoegh by the end of 1958. The committee is headed by Victor E. Cooley, former Chairman of the Board of Southwestern Bell Telephone Co. and Deputy Director of the Office of Defense Mobilization from 1953 to 1958. The Committee, which held its initial meeting November 18, was created, Mr. Hoegh said, "to review the role of the Federal Government in the management of U. S. telecommunications, including the allocation of the radio spectrum." An OCDM press release further noted: "Mr. Hoegh said the Committee's main task is to recommend methods to bring about improvements in the use of telecommunications resources. It will examine the existing governmental policies, use of facilities, and administrative arrangements and procedures for the allocation, management and control of telecommunications including the radio frequency spectrum for government and nongovernment use. The Committee will not be concerned with existing regulatory powers or procedures of the Federal Communications Commission nor will it make studies of detailed problems such as radio frequency usage. In addition to Mr. Cooley, the following are members of the Committee: Irvin Stewart, former Commissioner of the Federal Communications Commission (1934 to 1937) and past President of West Virginia University. He was Chairman of the President's Communication Policy Board in 1951. Frank Gregg Kear, a consulting radio engineer with the firm of Kear and Kennedy, engaged in general consulting engineering practice since 1934. William Glasgow Thompson, retired Assistant Vice President of the American Telephone and Tele-

(Continued on page 54A)

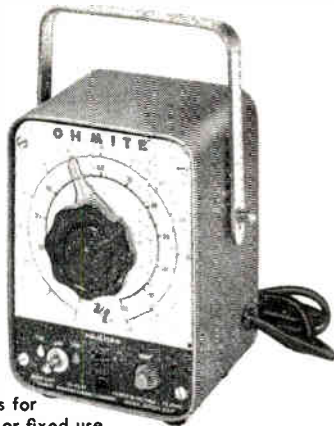

Enclosures for portable or fixed use.

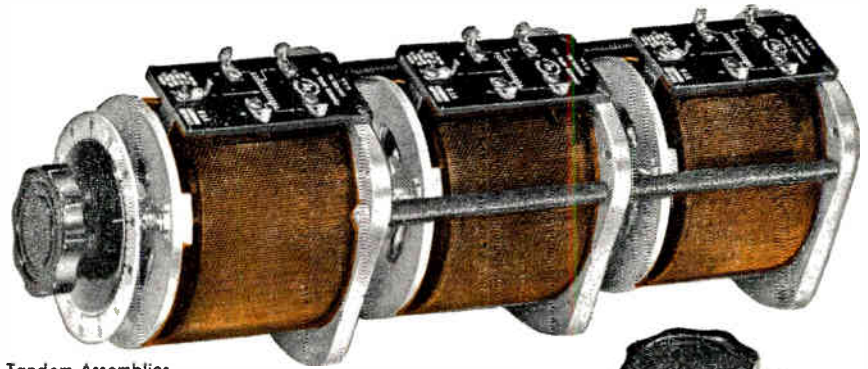

Tandem Assemblies in all three sizes of Ohmite Variable Transformers.

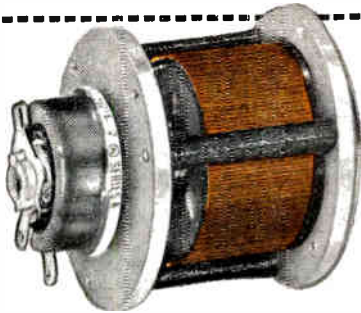

RHEOSTAT-TRANSFORMER  
TANDEM ASSEMBLIES, EXCLUSIVE WITH OHMITE



VT2  
VT2N

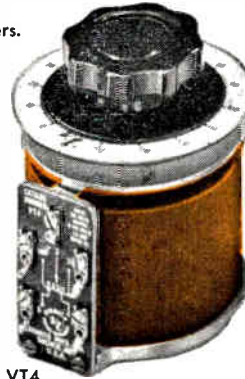

VT4  
VT4N



VT8  
VT8N

# OHMITE® "vt." Variable Transformers

## Give a "Bonus" in Current Capacity

**EXPANDED LINE**—Ohmite now offers industry six basic models with current ratings sufficient to meet a large percentage of industrial applications. The new line includes enclosed units and tandem assemblies. Two models, VT2 and VT4, offer capacity greater than competitive units of comparable size and price. *An additional and sizeable "bonus" in current* is given in all sizes when the overvoltage feature is not required ("N" suffix, see below).

**ADVANCED FEATURES**—Positive current transfer achieved with direct brush to slip-ring, pig-tailed connection; table or panel mounting—on VT4 and VT8 sizes, adjustable shaft moves to brush or base side; interchangeable with other popular types both electrically and "mounting-wise"; durable rhodium plating on brush track for longer life.

**SPECIALS ENGINEERED FOR YOUR NEEDS**—Transformers can be modified to meet different requirements such as special shafts for nonstandard panel thicknesses, auxiliary switches, taps on transformer winding for fixed intermediate voltages, and motor drives for remote control or servo-operation. The only manufacturer in the industry concurrently producing power rheostats, tap switches, and variable transformers, OHMITE can also offer in-tandem combinations of these items.

**BASIC MODELS (with overvoltage) All inputs 120 v ac\***

MODEL VT2  
Volts output: 0-120/132  
Amps output: 1.5

MODEL VT4  
Volts output: 0-120/140  
Amps output: 3.5

MODEL VT8  
Volts output: 0-120/140  
Amps output: 7.5

**BASIC MODELS (without overvoltage) All inputs 120 v ac\***

MODEL VT2N  
Volts output: 0-120  
Amps output: 1.8

MODEL VT4N  
Volts output: 0-120  
Amps output: 4.75

MODEL VT8N  
Volts output: 0-120  
Amps output: 10.0

\*Units available for 240-volt input also

Write for Bulletin 151

Available from  
Ohmite  
Distributors or  
direct from  
factory



OHMITE MANUFACTURING COMPANY

RHEOSTATS RESISTORS  
VARIABLE TRANSFORMERS

RELAYS TAP SWITCHES  
TANTALUM CAPACITORS

3617 Howard Street  
Skokie, Illinois  
R.F. CHOKES  
DIODES



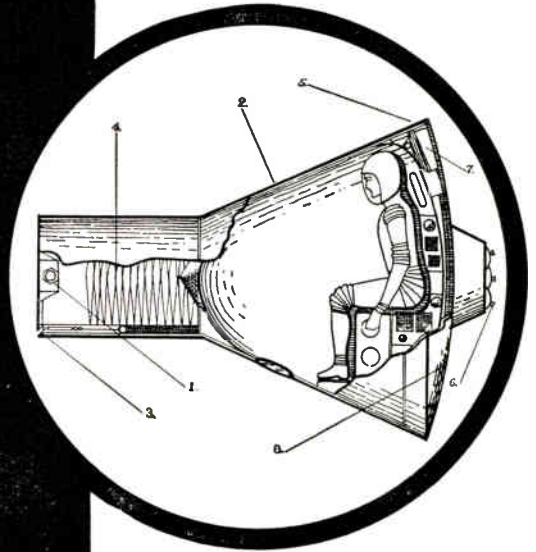
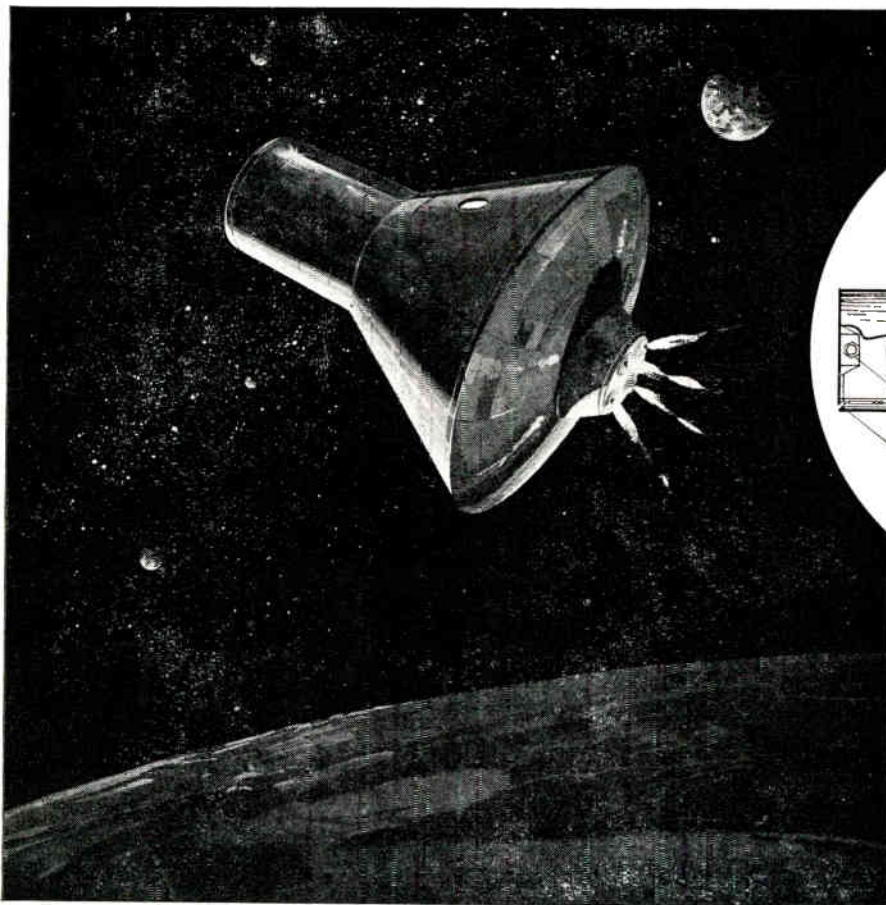

1. Horizon Scanner
2. Entrance Hatch
3. Pitch & Yaw Jets
4. Packed Parachute
5. Roll Jets
6. Retro-Rockets
7. Inflatable Landing Impact Bag
8. Heat Shield

NASA Manned Satellite Capsule

*NASA blueprint for the future*

## PROJECT MERCURY

At this moment NASA engineers and scientists are hard at work to make Project Mercury a reality. And in time a manned satellite will become reality . . . the result of outstanding professional contributions in many disciplines. This program to place man in space is typical of the projects and goals of NASA, whose responsibility it is to direct and implement U.S. research efforts in aeronautics and the exploration of space, for peaceful purposes and the benefit of all mankind.

**NASA offers unique opportunities in basic and applied research in aeronautics and space technology—**

**For Engineers:**

Aeronautical, Engineering Physics, Electronic, Mechanical, Electrical, Metallurgical, Chemical, Civil, Naval Architects.

**For Scientists:**

Astronomers, Physicists, Mathematicians, Chemists, Metallurgists.

*Please address your inquiry to the Personnel Director of any of the following NASA research centers:*

- Langley Research Center, Hampton, Virginia
- Ames Research Center, Mountain View, California
- Lewis Research Center, Cleveland, Ohio
- High-Speed Flight Station, Edwards, California
- Beltsville Space Center, 4555 Overlook Ave., Wash., D. C.

(Positions are filled in accordance with Aeronautical Research Announcement 61B)

**NASA** National Aeronautics and Space Administration



EIMAC Klystrons are used in most tropo-scatter installations



EIMAC 4KM50,00CLQ klystron

## NOW, 400 TO 985 MEGACYCLES SPANNED WITH JUST TWO EIMAC 10KW KLYSTRONS

Exceptionally wide frequency coverage, 400 to 985 megacycles, is now available with just two interchangeable klystron amplifiers using the Eimac 4KM50,000LA and LQ 10 KW klystrons. This important tropo-scatter and UHF-TV range can now be covered with a single transmitter. In addition, both tube types offer exclusive design advantages that have made Eimac klystrons the most widely used power tubes in tropo-scatter networks.

### Field-Proved External Cavity Design

Extra wide tuning range with single set of tuning cavities. Lower original cost. Tube replacement cost much lower since external tuning circuitry need not be replaced.

Uniform bandwidth through inductive tuning plus greater broadbanding by external cavity loading.

### Wide Range Load Coupler

One coupler covers entire frequency range.

### Modulating Anode

Provides simplified overload protection.

Protects cathode from internal arc damage.

### EMA Cathode

Combines ruggedness and long life of a pure metal emitter with the high efficiency of an oxide cathode.

Extra large area cathode conservatively rated for exceptional reliability.

Eliminates need for high voltage bombarder power supply, reducing system cost and total power consumption.

### Series Connected Body Magnet Coils

Permits use of single power supply and control for body magnets.

### Performance Proved Reliability

In tropo-scatter service, individual Eimac klystrons have logged more than 25,000 hours air time.

**EITEL-McCULLOUGH, INC.**



San Carlos, California



# NEW IDEAS IN PACKAGED POWER

for lab, production test,  
test maintenance, or as a  
component or subsystem  
in your own products

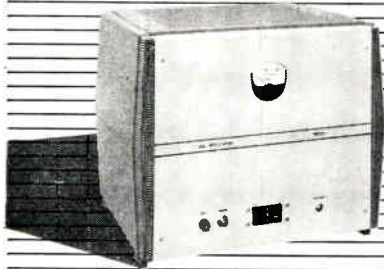

**New tubeless 0.1% a-c line regulators give up to 5kva out.** High output and fast response result from a unique combination of semi-conductor and magnetic amplifier principles in the new Sorensen Model R3010 and R5010 a-c line regulators. Model R5010 (left) puts out up to 5kva and Model R3010, 3kva. Provision for remote sensing allows you to hold regulation accuracy at the load despite length of output leads, and, with an external transformer, permits regulation of any a-c voltage.

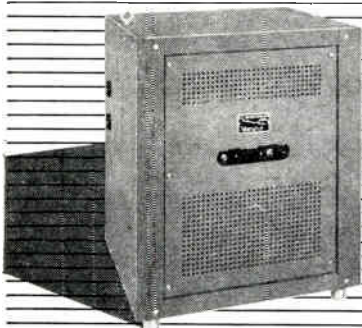

**Broadest line of a-c regulators.** A complete line of electronic a-c regulating equipment, supplying powers as high as 15kva, is manufactured by Sorensen. Single phase and 3 phase, 50, 60, 400 cps, 115 and 230 vac models are available. Good example of these is the 10kva Model 10000S supply (left). Others: Precision a-c regulators ( $\pm 0.01\%$ ) for labs or meter calibration; and fast-response low-distortion a-c regulators where line transients must be reduced to a minimum.

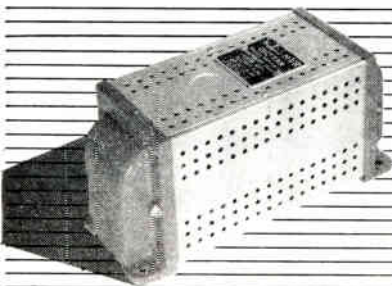

**... and rugged, economical MVR's.** Low cost, low distortion, long life and a broad selection of models are outstanding features of Sorensen MVR's (Magnetic Voltage Regulators). Capacities range from 30 to 2000 va. Regulation is on the order of  $\pm 0.5\%$ . Both harmonic-filtered and unfiltered models are available with 115vac out. Models for 6.3 and 12.6 out, unfiltered, also available.

Sorensen makes a complete line of packaged power equipment—including regulated d-c supplies, inverters, converters and frequency changers. Despite the breadth of the standard Sorensen line, our engineers are always ready to discuss your specialized power requirements up to complete power systems for complex computers or other critical equipment. Write for complete data. 8.43



## SORENSEN & COMPANY, INC.

Richards Avenue, South Norwalk, Connecticut

WIDEST LINE OF CONTROLLED-POWER  
EQUIPMENT FOR RESEARCH AND INDUSTRY

IN EUROPE, contact Sorensen-Ardag, Zurich, Switzerland. IN WESTERN CANADA, ARVA. IN EASTERN CANADA, Bayly Engineering, Ltd. IN MEXICO, Electro Labs, S. A., Mexico City.

## Industrial Engineering Notes

(Continued from page 50-A)

graph Company, formerly in charge of operations of overseas radio and cable communications, W. Preston Corderman, Major General, U. S. A. (Ret.), member of the Signal Corps, U. S. Army from 1926 to 1958 and Deputy Chief Signal Officer from 1955 to 1957. General Corderman is now a Vice President of Litton Industries, Inc. Should the Special Committee make recommendations which involve the establishment of a joint study commission by the White House and Congress or any legislative changes in the administration of the radio spectrum, it is expected that these will be transmitted to Congress through the President shortly after the new Congress convenes. . . . Philco Corp. recently petitioned the Federal Communications Commission to institute rule-making proceedings looking toward the adoption of AM stereophonic transmission standards. Philco noted that it has carried on a research and development program for a compatible AM stereo broadcasting system for some time and that the laboratory development phase of its program is completed. Philco revealed its system which covers both AM stereo broadcasting and home radio receivers. Its petition to the FCC asks the Commission to establish an experimental field test program for the purpose of testing Philco's system under

(Continued on page 56A)

send for this

**FREE**

**EICO  
Electronics  
Catalog**



you save 50% on Top-Quality  
Test Instruments  
Hi-Fi • Ham Gear

**KITS AND WIRED**

for professional and home use

**TEST INSTRUMENTS**  
battery eliminators  
battery testers  
bridges  
decade boxes  
electronic switch  
flyback tester  
oscilloscopes  
probes  
signal and  
sweep generators  
tube testers  
transistor tester  
vacuum tube  
voltmeters  
volt-ohm-  
milliammeters

**HI-FI**  
stereo and monaural  
tuners  
preamplifiers  
power amplifiers  
integrated amplifiers  
speaker systems

**HAM GEAR**  
cw transmitter  
modulator-driver  
grid dip meter

OVER 1½ MILLION  
EICO instruments in  
use throughout  
the world.

LIFETIME service and calibration guarantee.  
IN STOCK at your neighborhood EICO dealer.  
Send now for FREE catalog P-2



33-00 N. Blvd., L. I. C. 1, N. Y.

... praised by the experts  
as BEST BUYS IN ELECTRONICS

© 1958 ELECTRONIC INSTR. CO., INC.

# NPN switching transistors PROVE MORE RELIABLE than PNP

Some design engineers specify PNP switching transistors because they consider them inherently more reliable. Actually NPN transistors can give you superior reliability along with their well-known higher speed. Life tests covering hundreds of thousands of CBS-Hytron NPN alloy-junction germanium switching transistors proved this during the past year. See graphs comparing these transistors with typical military-approved PNP transistors.

The superiority of CBS-Hytron NPN transistors is achieved by special processing: For example, advanced surface chemistry techniques seal out moisture and contamination. Precise control of alloying produces high back voltages. Thorough bake-out stabilizes gain. The result is reliable NPN computer-type switching transistors featuring fast switching . . . high voltage . . . low cutoff current . . . and low saturation resistance . . . in a welded JETEC TO-9 package.

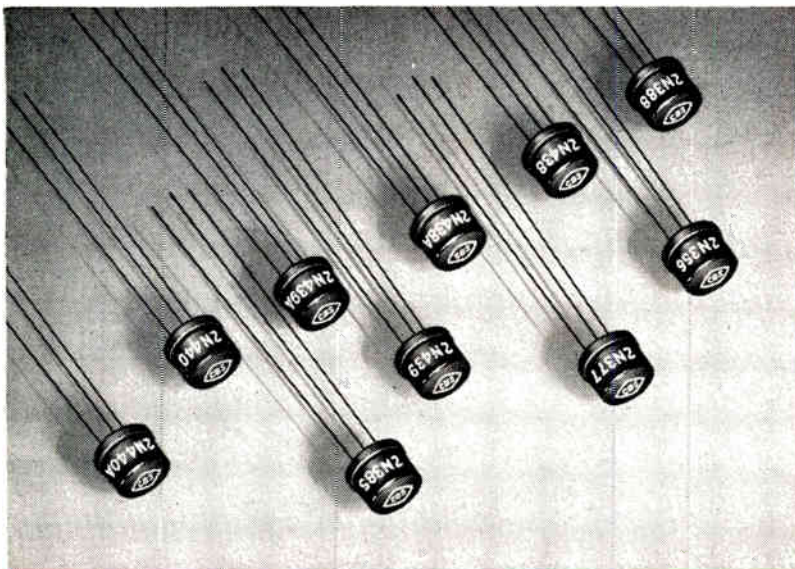

**CBS-Hytron NPN Switching Transistors**

Type	Minimum $BV_{CBO}$ (Volts)	Dissipation @ 25°C (Milliwatts)	Minimum $h_{FE}$ @ $I_C$ (Ma)		Typical $f_{ab}$ (Megacycles)	Application
<b>2N356</b>	20	100	20	100	3	Core Driver
<b>2N377</b>	25	150	20	200	6	Core Driver
<b>2N385</b>	25	150	20	200	6	Core Driver
<b>2N388</b>	25	150	30	200	8	Core Driver
<b>2N438</b>	30	100	20	50	4	Logic Circuit
<b>2N438A</b>	30	150	20	50	4	Logic Circuit
<b>2N439</b>	30	100	30	50	8	Logic Circuit
<b>2N439A</b>	30	150	30	50	8	Logic Circuit
<b>2N440</b>	30	100	40	50	12	Logic Circuit
<b>2N440A</b>	30	150	40	50	12	Logic Circuit

Operating and storage temperature,  $T_j = -55$  to  $+85^\circ\text{C}$

**Comparative Life Tests  
NPN vs. PNP Switching Transistors.**

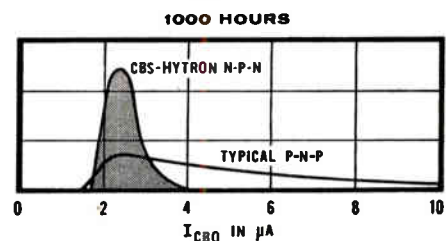
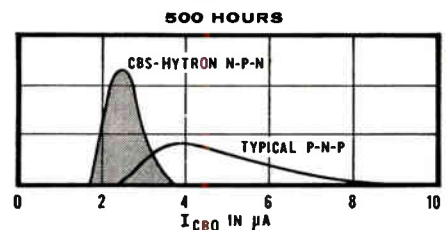
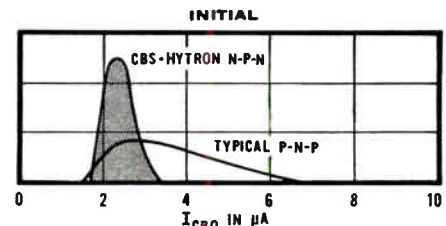

A comprehensive line of these reliable CBS-Hytron NPN high-speed switching transistors is available now in production quantities. Check the table. Order types you need . . . or write for Bulletin E-293-302 giving complete data...today.

*More reliable products through Advanced-Engineering*



**semiconductors**

**CBS-HYTRON, Semiconductor Operations**  
A Division of Columbia Broadcasting System, Inc.

*Sales Offices:* Lowell, Mass., 900 Chelmsford St., Glenview 4-0446 • Newark, N. J., 32 Green St., Market 3-5832 • Melrose Park, Ill., 1990 N. Mannheim Rd., EStebrook 9-2100 • Los Angeles, Calif., 2120 S. Garfield Ave., Raymond 3-9081





... for Complete Reliability Under Severe Environmental Conditions

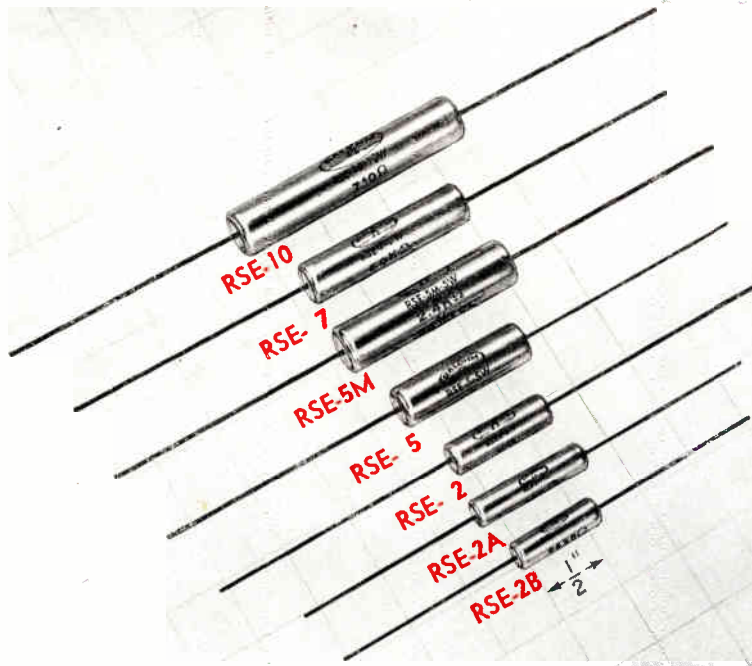

## TYPE RSE POWER RESISTORS

Wire Wound, Precision, Miniature, Ruggedized

RSE-2A DERATING CURVE

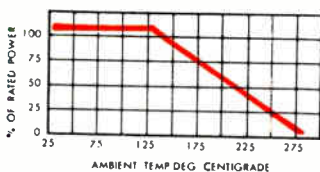

### JUST ASK US

The DALOHM line includes precision resistors (wire wound and deposited carbon); trimmer potentiometers; resistor networks; collet fitting knobs and hysteresis motors designed specifically for advanced electronic circuitry.

If none of the DALOHM standard line meets your needs, our engineering department is ready to help solve your problem in the realm of development, engineering, design and production.

Just outline your specific situation.

**DALE PRODUCTS INC.**

1302 28th AVE.  
COLUMBUS, NEBRASKA

A precision wire wound power resistor encapsulated in shock absorbing material; then encased and sealed in a metal tube to overcome demanding environmental conditions, yet maintains miniature size.

This ruggedized resistor will surpass the most severe mechanical shock and vibration requirements.

- Rated at 2, 3, 5, 7 and 10 watts
- Resistance range from .5 ohms to 175K ohms, depending on size and type
- Tolerances:  $\pm 0.05\%$ ,  $\pm 0.1\%$ ,  $\pm 0.25\%$ ,  $\pm 0.5\%$ ,  $\pm 1\%$  and  $\pm 3\%$ .

**TEMPERATURE COEFFICIENT:** Within  $\pm 0.00002$  Deg. C.

**COMPLETE PROTECTION:** 100% impervious to moisture and salt spray.

**WELDED CONSTRUCTION:** Complete welded construction from terminal to terminal.

**RUGGED HOUSING:** Sealed and inserted in metal tubing.

**SMALLEST IN SIZE:** .220 x 11/16" to .395" x 1-61/64".

**MILITARY SPECIFICATIONS:** Surpasses MIL-R-26C

Write for Bulletin R-25



(Continued from page 54A)

normal broadcast conditions and upon successful completion of the field test program to establish transmission standards for stereo broadcasting based upon Philco's research and engineering developments. In light of this, Philco offered to work with the FCC's engineering staff and with any AM broadcast station licensee who wishes to engage in a bona fide field test program with respect to its system. Also, the company said, "We will also be glad to cooperate with the proposed industry National Stereo Radio Committee (see Lead Story) and recommend that the field test program be carried out under their auspices if the Commission so wishes."

### INDUSTRY MARKETING DATA

TV production in October totaled 495,617 compared with 621,734 TVs made in September and 661,994 television receivers produced in October 1957. The number of TV receivers made with UHF tuners totaled 42,171 in October compared with 40,712 made in September and 83,372 such receivers made during October 1957. Cumulative output of TVs capable of receiving UHF signals declined to 353,980 in 1958 compared with 669,277 such sets made at the same time in 1957. Cumulative TV output during the January-October period of 1958 amounted to 4,067,806 compared with 5,251,158 TV receivers made in the same ten months period of 1957. Radio receiver production in October totaled 1,305,857 including 296,067 automobile radios compared with 1,572,001 radios made in September which included 489,738 automobile receivers, and 1,569,180 radios made in October 1957 which included 522,746 auto sets. Cumulative radio receiver production during the first 10 months of 1958 totaled 9,489,544 including 2,679,618 automobile receivers, compared to the 11,945,534 radios made during the corresponding period of 1957, which included 4,362,091 automobile radios. The number of FM radios produced in October totaled 59,586 compared with 41,408 such radios made in September, and 21,335 in August and 11,816 in July, bringing the total number of FM radios produced during the July-October period to 235,647. Figures on FM radio output during the like 1957 period are not available.



### Section Meetings

ARRON

"Medical Electronics," A. Miller. Sanborn Co.; 11/18 58.

ALBUQUERQUE-LOS ALAMOS  
"The First Year in Space," B. L. Basore, Dikewood Corp.; 11/17 58.

#### ANCHORAGE

"Pioneer Communication Systems in Alaska," A. Johnson, Western Electric Co.; Annual Meeting and Election of Officers; 12/1/58.

#### ATLANTA

Region III Technical Meetings; 11/17/58 and 11/18/58.

"Aeronautical Single Sideband," W. B. Bruene, Collins Radio Co.; Election of Officers; 12/5/58.

#### BAY OF QUINTE

"Connection of Non-Linearities in Vacuum Tube Amplifiers," G. W. Holbrook, Royal Military College; 11/18/58.

#### BEAUMONT-PT. ARTHUR

"Electrical Servomechanisms," W. B. Hunter, Diel Mfg. Co.; 11/24/58.

#### BUENOS AIRES

"Introduction to Electronics Digital Computers," L. F. Rocha; 8/7/58.

"Technology of Transistors and Their Future in Argentina," M. Margulius; 8/21/58.

"Radio-Electric Propagation," A. Jacobo; 9/4/58.

"Technical Film Showing"; 10/2/58.

"Commentary on Color Television," Ing. J. Guilbourg; 10/23/58.

"Rocket Projection to the Moon," T. Tabanera; 11/20/58.

#### BUFFALO-NIAGARA

"Infrared Principles and Techniques," E. McAllister, Eastman Kodak; 12/10/58.

#### CHINA LAKE

"Discussion of IRE Organizational Matters," Mr. Donald G. Fink, IRE President; "Inertial Guidance," C. F. O'Donnell, North Am. Aviation; 8/15/58.

"Microlock Receiving Systems," D. Stevenson, U. S. Naval Ordnance Test Sta.; 9/24/58.

"Fifth Assembly of USAGI in Moscow Aug. 1958," a report, H. L. Richter, Jr., Jet Propulsion Lab.; 11/24/58.

#### CINCINNATI

"Nuclear Effects in Electronic Equipment," J. R. Crittenden; 10/21/58.

"High Temperature Electronic Components," T. N. Stanzola, Gen. Elec. Co.; 11/18/58.

#### CLEVELAND

"Compatible Color Television," J. W. Wentworth, RCA; 11/13/58.

#### DALLAS

"Microwave Amplification by Stimulated Emission of Radiation—MASER," C. F. Davis, Jr., Texas Instruments Inc.; 11/25/58.

#### DETROIT

"Controlled Thermonuclear Fusion," E. W. Herold, RCA; 11/21/58.

#### EGYPT

"Electronics in the Service of Statistics," F. Botrous, IBM; 11/16/58.

#### EMPORIUM

"Glass Components in Industry," R. Setzko, Corning Glass Co.; 11/18/58.

#### EVANSVILLE-OWENSBORO

Tour of Potter & Brunfield Plant; 11/12/58.

#### FLORIDA WEST COAST

"Microwave Link Planning for Broadcast Service," J. L. Elmore, Motorola Communications & Electronics Co.; 11/19/58.

(Continued on page 58A)

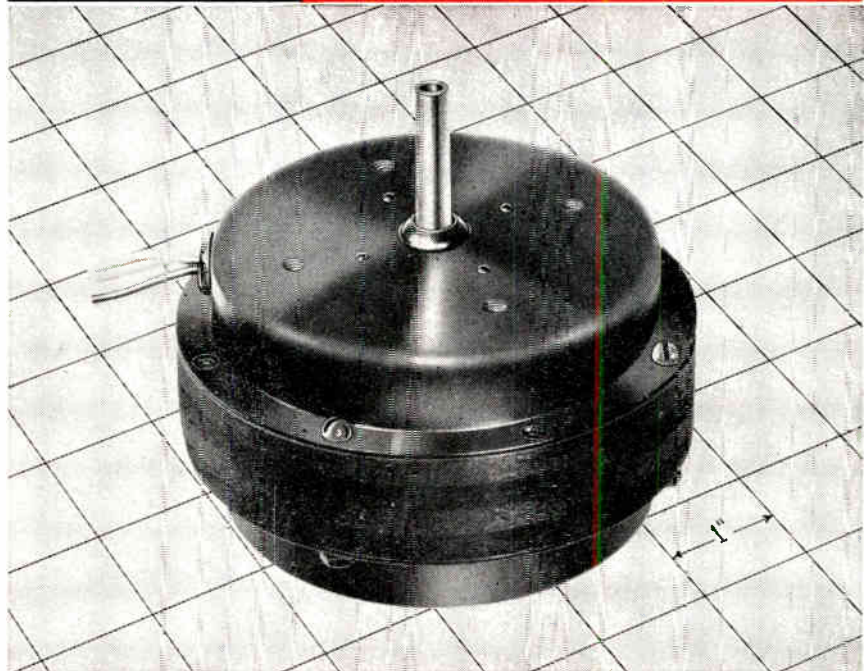

## HEAT RISE BARRIER IS LOWERED TO ONLY 20° - 38° C., DEPENDING ON H.P. RATING

Sub-Fractional • Low Noise • No Vibration • Synchronous

The new DALOHM Hysteresis motor provides all the desirable characteristics of such motors, yet doesn't have the usual heat rise handicaps. Small and lightweight, its new pancake configuration is space saving.

- Low noise
- Maintains synchronous speed at rated load
- No vibration or magnetic strays
- Reaches full RPM in 1 revolution
- Exceptionally low cost
- Operates on any frequency up to 120 c.p.s., giving an infinite selection of speeds up to 3600 RPM

**RUNNING TORQUE:** 2.8 inch/oz. to 28 inch/oz.

**VOLTAGE:** 115 V., 60 c.p.s.

**SPEED:** 1800 RPM

Write for Bulletin R-80

Ideally suited for facsimile machines, Hi-Fi turntables, tape recorders, tele-metering and many other types of equipment where constant synchronous speed is essential.

#### JUST ASK US

The DALOHM line includes precision resistors (wire wound and deposited carbon); trimmer potentiometers; resistor networks; collet fitting knobs and hysteresis motors designed specifically for advanced electronic circuitry.

If none of the DALOHM standard line meets your needs, our engineering department is ready to help solve your problem in the realm of development, engineering, design and production.

Just outline your specific situation.





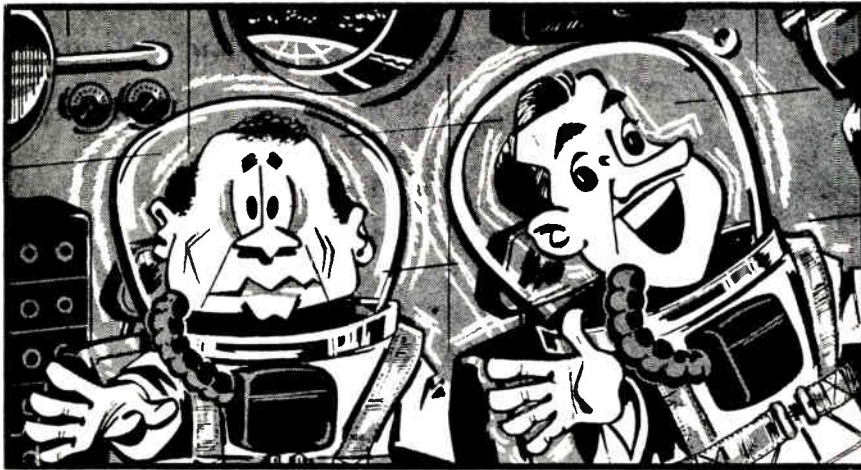

Don't worry, Mac, the Oscillator is built to take it!

## NEW AUDIO FREQUENCY OSCILLATOR HAS $\pm 0.002\%$ STABILITY AT 100 G's

Reeves-Hoffman's new audio frequency oscillator provides exceptionally reliable performance under high shock and vibration. Rugged construction and highly dependable oven control enables it to withstand as much as 100 G's while maintaining frequency stability of  $\pm 0.002\%$  over a temperature range of from  $-55^\circ$  to  $+85^\circ\text{C}$ . Equally reliable operation is assured under vibration of 2000 cycles at 10 G's! This new, hermetically sealed oscillator has a frequency range of 400 to 2000 cps, is compact, low in weight and meets applicable portions of specifications MIL-E-5272A. Available in transistor or tube types. Write for Bulletin TCO/300-OC.



DIVISION OF DYNAMICS CORPORATION OF AMERICA  
CARLISLE, PENNSYLVANIA

## COLOR TV SHADOW MASKS

—A development of  
BUCKBEE MEARS through close  
cooperation with TV industry  
engineers. Containing 400,000 close  
tolerance holes ( $.010" \pm .0005"$ ).

Now produced in quantity  
on our especially designed  
continuous etching machines.



**BUCKBEE MEARS COMPANY**

TONI BUILDING  
.....  
SAINT PAUL 1, MINN.

## ETCHED AND ELECTRO-FORMED PRECISION PARTS

—Electric shaver combs, metal  
reticles for optical instruments,  
fine tube mesh and code discs.

These are but a few of the  
variety of parts that can be  
quickly produced to precise toler-  
ances by our process. Send  
your specific problem and  
specifications to our engineers.

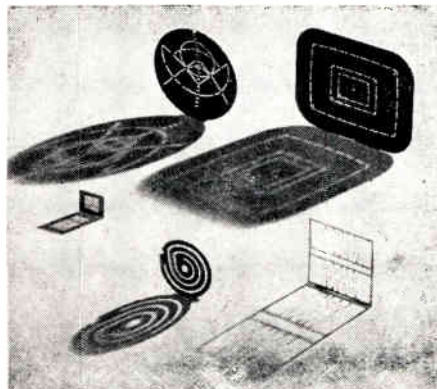

## Section Meetings

(Continued from page 57A)

### FORT HUACHUCA

"Modern Analysis of Communications Sys-  
tems." B. A. Trevor, RCA; 11/24/58.

### FORT WORTH

Tour of Radar Facilities. Lieut. Bowen, USAF;  
11/18 58.

### HAMILTON

"The Trans-Canada Telephone System's Mi-  
crowave Radio Project." A. J. Groleau, Bell Tel.  
Co. of Canada; 11/12/58.

### HOUSTON

"New Amplifier Techniques." W. K. Volkers,  
Cohn Electronics; 11/18/58.

### HUNTSVILLE

"Telemetry Techniques for Satellites." O. B.  
King, Army Ballistic Missile Agency; "Telemeter  
for Redstone & Jupiter Missiles." W. O. Frost,  
Army Missile Agency; 11/25 58

### ITHACA

"Radio Astronomy Polarization Measure-  
ments." M. Cohen, Cornell Univ.; 12/1/58.

### LITTLE ROCK

"Megacycles, Microwaves and Monopolies."  
Mr. Donald G. Fink, IRE President; 11/24/58.

### LONG ISLAND

"Space Guidance." C. D. Bock, Am. Bosch  
Arma Corp.; 11/20 58.

### LUBBOCK

"The Guidance of Sidewinder Missiles by In-  
frared Methods." O. E. Becklund, Texas Instru-  
ments; 10 7 58.

### MILWAUKEE

"Electronics in the Space Age." E. A. Halbach,  
Gen. Controls Co.; 11/18/58.

### NEW ORLEANS

"Transistor Break-throughs in Communica-  
tions Equipment." R. Peth, Motorola, Inc.;  
11/18/58.

"Affairs of the Institute of Radio Engineers,"  
Mr. Donald G. Fink, IRE President; 11/25/58.

### NORTHERN ALBERTA

"Chief Uses of Telemetering Devices in Oil  
Field Production." L. Alexander, Imperial Oil Ltd.;  
9 16 58.

"Telemetering Facilities as Used in the Red-  
water Oil Field." L. Alexander, Imperial Oil Ltd.;  
10/14 58.

"A Microwave System in the Canadian  
Rockies." G. F. C. Weedon, Canadian Motorola  
and Electronics Ltd.; 11/24/58.

### OMAHA-LINCOLN

"What Management Expects of the Chief  
Engineer." A. J. Ebel, KOLN-TV; Tour of Ne-  
braska State Trade School Electronics Dept., H.  
Gatliff, NSTS; 11/14/58.

### PHILADELPHIA

"Transoceanic Communications by Means of  
Space Satellites." J. R. Pierce, Bell Tel. Labs.;  
12/8 58.

(Continued on page 62A)



# specify **OHMITE**<sup>®</sup> Relays for Reliability

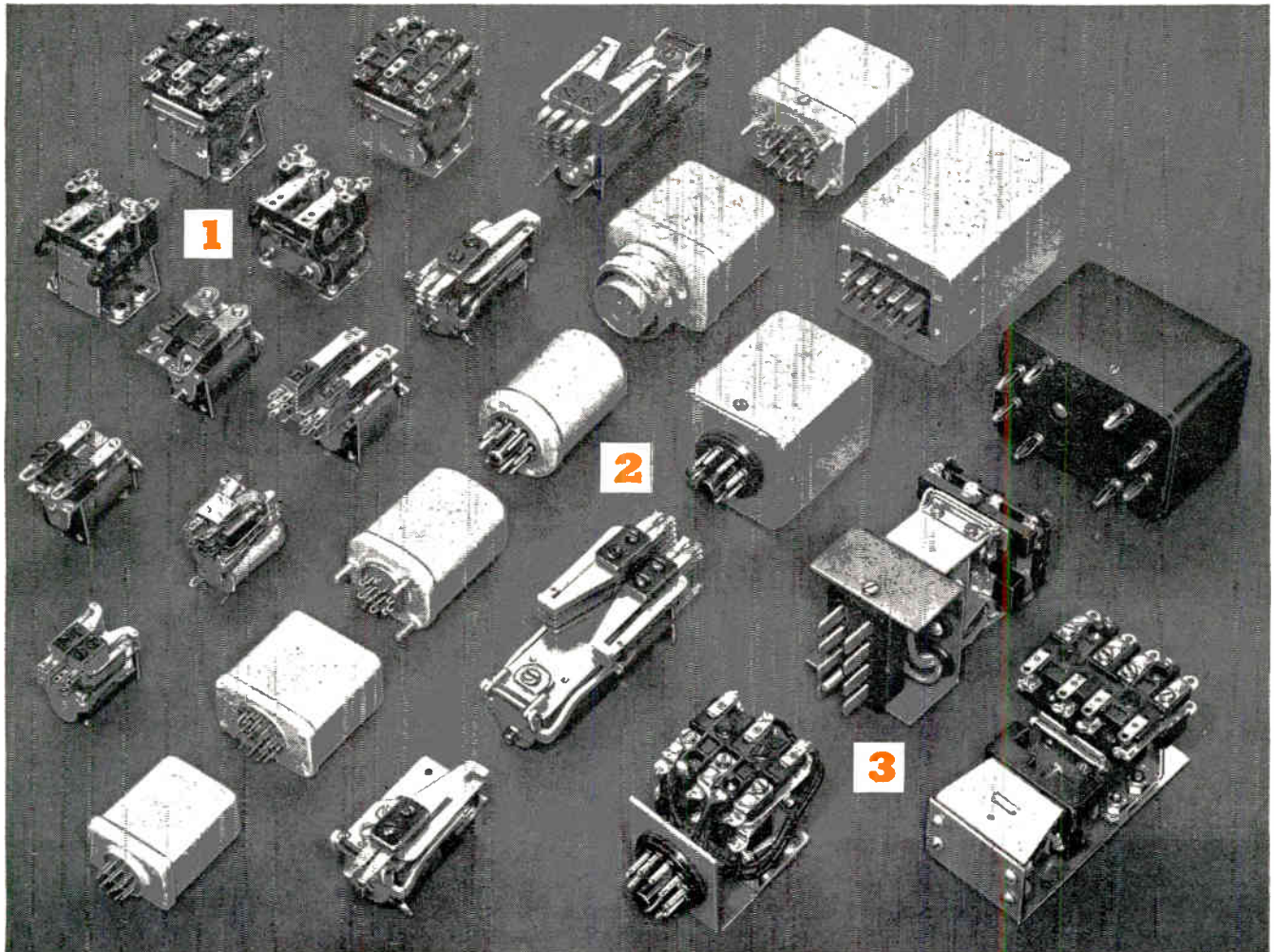

1. Eleven Standard Models

2. Typical Relay Enclosures

3. Relays with Special Construction

**EXCLUSIVE! Contact Combinations on New Ohmite Relays Are MOLDED\***

Permanence and ease of adjustment of the individual contact springs are the result of a revolutionary, new innovation found in two new Ohmite Relays—Models TT and TS. This innovation is the unique "Molded Module" contact spring construction. The "module" is a standard, single-pole, double-throw spring combination molded into a single compact assembly. As many as six modules can be incorporated into a relay. *\*(Pat. Applied For)*

**QUALITY CONSTRUCTION**—All Ohmite relays embody the same meticulous engineering, strict quality control, and generous use of high quality materials which have made Ohmite components the standard of the industry. Parts are plated where necessary for corrosion resistance. Springs are of nickel-silver or phosphor-bronze. Contacts are fine silver. Special contact materials, such as silver, tungsten, palladium, or gold alloy, can be supplied. Protection against humidity and moisture is paramount and is accomplished in layer-wound coils, through complete sealing with cellulose-acetate. Relays are available in a wide range of coil operating voltages and contact combinations in both AC and DC types.

**65 TYPES IN FOUR STOCK MODELS**—For fast service, four

models in the Ohmite relay line are carried in stock in 65 types at the factory, and by Ohmite Distributors from coast to coast.

**HERMETICALLY SEALED AND DUST-TIGHT RELAYS**—You can specify many of the basic Ohmite relays in nonremovable, hermetically sealed enclosures for applications requiring complete relay protection. These high-quality relays are sealed in seamless steel enclosures which are exhausted and filled with dry, inert gas under control of Ohmite engineers. Ohmite hermetically sealed relays are available with either plug-in or solder terminals. Relays are also made with nonremovable dust-tight covers and removable dust covers.

**RELAYS WITH SPECIAL CONSTRUCTION**—Ohmite relays are available with special terminals or special construction, such as relays with push-on or screw terminals, relays with binding-post terminals. Where quantities warrant, Ohmite will manufacture relays made to your specifications. Ohmite can furnish not only special terminals, special contact combinations, contact materials, and coils but also special enclosures, connectors, impregnation, or frames. Ohmite relays can be engineered to meet your special pull-in, drop-out, or time-delay requirements.

*For your special or unusual relay applications, let Ohmite's experienced engineers help you work out the best solution.*

Write on company letterhead for Catalog and Engineering Manual 58.



- RESISTORS
- RHEOSTATS
- R.F. CHOKES
- RELAYS
- TAP SWITCHES
- TANTALUM CAPACITORS
- VARIABLE TRANSFORMERS
- DIODES



**IMPROVED  
CHARACTERISTICS**

**...OF  
SPECIAL  
INTEREST  
TO EVERY  
ENGINEER**

**DELCO  
HIGH POWER  
TRANSISTORS**



**UNEXCELLED FOR SWITCHING, POWER HANDLING, EFFICIENCY, RELIABILITY**

TYPICAL CHARACTERISTICS AT 25°C.

	2N1100	2N1099	2N174A	2N174	2N173	2N278	2N277	2N443	2N442	2N441
Maximum Collector Current	15	15	15	15	15	15	15	15	15	15 amps
Maximum Collector Voltage (Emitter Open)	100	80	80	80	60	50	40	60	50	40 volts
Saturation Resistance	.02	.02	.02	.02	.03	.03	.03	.03	.03	.03 ohms
Thermal Gradient (Max.) (Junction to Mounting Base)	.8	.8	.8	.8	.8	1.0	1.0	1.0	1.0	1.0 °C/watt
Base Current $I_b$ ( $V_{ec}=2$ volts, $I_c=5$ amps)	135	100	135	135	100	100	100	150	150	150 ma
Collector to Emitter Voltage (Min.) Shorted Base ( $I_c=.3$ amps)	80	70	70	70	50	45	40	50	45	40 volts
Collector to Emitter Voltage Open Base ( $I_c=.3$ amps)	70	60	60	60	50	45	40	55	45	40 volts

\*Designed to meet MIL-T-19500/13A (Jan) 8 January 1958 †Formerly DT100 ‡Formerly DT80

Check your requirements against the *new, improved* characteristics of Delco High Power transistors. You will find improved collector-to-emitter voltage . . . higher maximum current ratings—15 amperes, and extremely low saturation resistance. Also, note the new solid pin terminal design.

*And of special importance to you is the fact that diode voltage ratings are at the maximum rated temperature (95°C.) and voltage.*

Write today for engineering data on the *new, improved* characteristics of *all* Delco High Power transistors.

**DELCO RADIO**

Division of General Motors • Kokomo, Indiana

BRANCH OFFICES

Newark, New Jersey  
1180 Raymond Boulevard  
Tel: Mitchell 2-6165

Santa Monica, California  
726 Santa Monica Boulevard  
Tel: Exbrook 3-1465



## When airborne performance hangs in the balance

Reliability, weight, and size are critical in every aircraft and missile component. Hydro-Aire's new dc-to-dc power supply, being completely transistorized, is smaller and lighter than conventional dynamotors, offers many other advantages: No moving parts, no brush wear or replacement, no brush dust, no arcing. Increased efficiency (up to 90%) means further weight savings since smaller 28-volt batteries can be used.

Model 50-021, shown above contrasted with conventional dynamotor it replaces, has these characteristics:

Output voltage: 150vdc  $\pm$  1%

Output current: 100ma to 200 ma

Input voltage: 28vdc  $\pm$  10%

Hydro-Aire solid-state power supplies are available built to any special requirements up to 10kv and 3kw, with regulation down to  $\pm$  0.1%. Write today for details on Hydro-Aire's extensive line of solid-state devices.

Life: 1000 hours plus

Overload characteristics: short-circuit-proof

Temperature range:  $-55^{\circ}\text{C}$  to  $+71^{\circ}\text{C}$

Size: 2 x 3 $\frac{3}{8}$  x 4 $\frac{3}{8}$  inches

Weight: 27 oz.

Applicable specifications: MIL-E-5272, MIL-I-6181, MIL-E-7894, MIL-E-8189

# HYDRO-AIRE

BURBANK, CALIFORNIA

Division of CRANE CO.

Solid-State Power Supplies

Frequency Converters • Amplifiers

Electric Motors • Solenoids

Actuators • A.C. Voltage Regulators

Generators • Regulators

Producing Controls for Every Basic Airborne System

World Radio History



# Marconi in Telecommunications

The post and  
telegraph  
authorities  
of more than  
80 countries  
use Marconi  
equipment

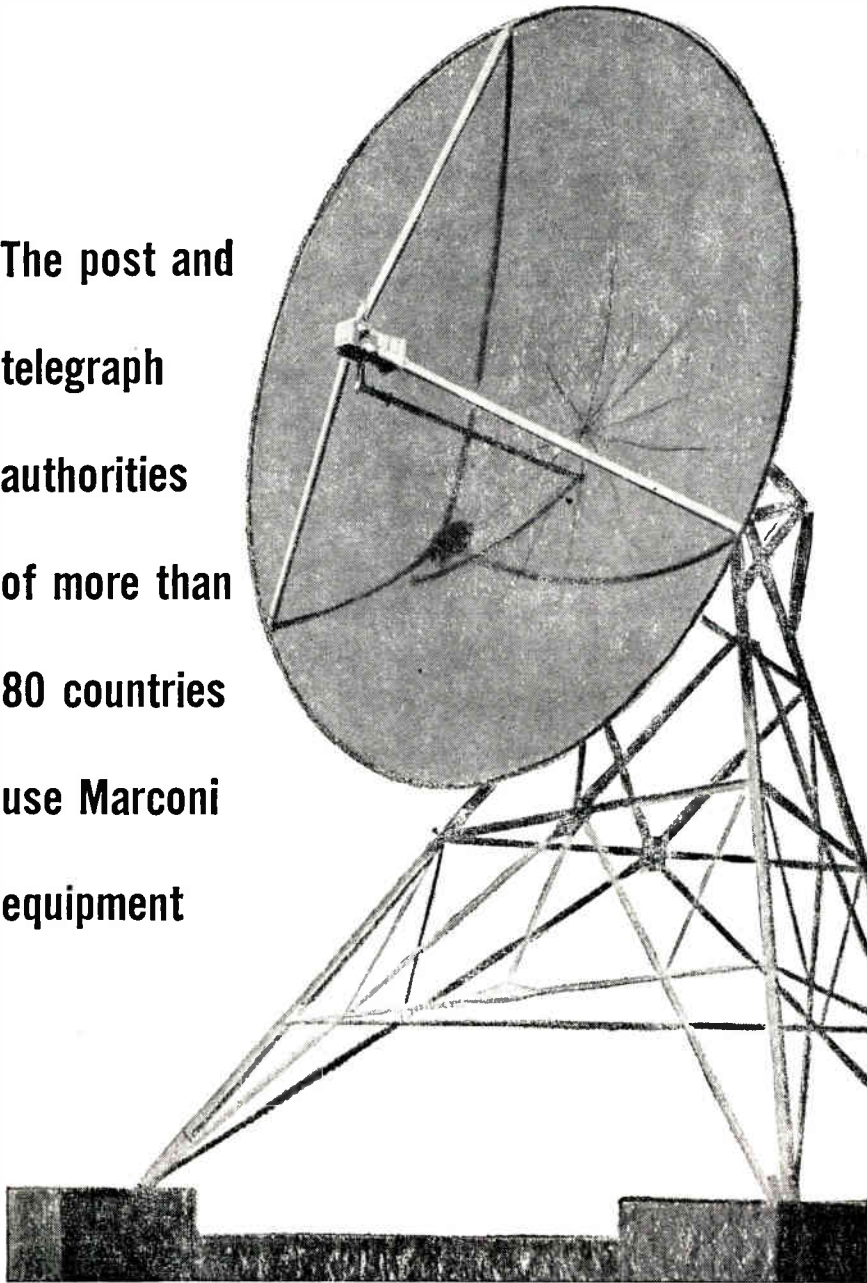

## MARCONI

**COMPLETE COMMUNICATION SYSTEMS**  
SURVEYED · PLANNED · INSTALLED · MAINTAINED

MR. J. S. V. WALTON, MARCONI'S WIRELESS TELEGRAPH COMPANY LIMITED,  
23 - 25 BEAVER STREET, NEW YORK CITY 4, U.S.A.

MARCONI'S WIRELESS TELEGRAPH COMPANY LIMITED, CHELMSFORD, ESSEX, ENGLAND  
M1



## Section Meetings

(Continued from page 58A)

### PHOENIX

Annual IRE Treasure Hunt. Bob Peterson; 11/1 '58.

"The Design of an Electronic Organ." F. Maynard. Motorola, Inc.; 12/5 '58.

### QUEBEC

"The Expanding Horizons of Magnetic Tape Recording." B. H. Simpson. Ampex Corp.; 11/25 '58.

### REGINA

"The Modern Concept of the Atom." L. H. Greenburg. Univ. of Saskatchewan; 11/4 '58.

"Engineering and Installation of Microwave System for Pacific Great Eastern Railway." G. Weedon. Canadian Motorola Electronics Co., Ltd.; 11/20 '58.

### SACRAMENTO

"Explosive Devices." E. J. Stecker. Holec Corp.; 10/22 '58.

### SAN ANTONIO-AUSTIN

"Extrinsic Semiconductors." L. Taylor. Texas Instruments Corp.; 10/8 '58.

"P-N Junctions." J. Thornhill; 10/15 '58.

"Semiconductor Diodes." R. Stewart; 10/22 '58.

"Transistor Action." J. Lathrop; 10/29 '58.

"Modern Polar Exploration." J. C. Cook. Southwest Research Institute; 11/21 '58.

(Continued on page 66A)



the most complete line of  
POWER SUPPLIES

**TRANSISTORIZED  
MAGNETIC TUBELESS  
VACUUM TUBE TYPE**

\* VOLTAGE  
REGULATED  
POWER  
SUPPLIES



## KEPCO

LABORATORIES, INC.

131-38 SANFORD AVENUE

FLUSHING 55, N.Y.

INDEPENDENCE 1-7000



# ESC DELAY LINES are CUSTOM-BUILT, CUSTOM-CHECKED!

At ESC, America's leading producer of custom-built delay lines, the challenge of perfection is renewed with every prototype assignment. Each delay line must meet precise, individual specs...each is painstakingly built under close engineering supervision...each is rigorously custom-checked against specially devised test standards.

In addition, complete and definitive laboratory reports—which include submitted electrical requirements, photo-oscillo-

grams (which indicate input and output pulse shape and output rise-time), the test equipment used and an evaluation of the electrical characteristics are submitted with all prototypes.

This is the way ESC custom-builds and custom-checks every unit. Backed by exciting new developments at ESC's research laboratories, these facilities insure a steady flow of custom-built delay lines for the most stringent requirements of military and commercial applications.



# ESC

**CORPORATION**

WRITE TODAY FOR COMPLETE TECHNICAL DATA.

*exceptional employment opportunities for engineers experienced in computer components...excellent profit-sharing plan.*

534 Bergen Boulevard, Palisades Park, New Jersey

Distributed constant delay lines • Lumped-constant delay lines • Variable delay networks • Continuously variable delay lines • Pushbutton decade delay lines • Shift registers • Pulse transformers • Medium and low-power transformers • Filters of all types • Pulse-forming networks • Miniature plug-in encapsulated circuit assemblies



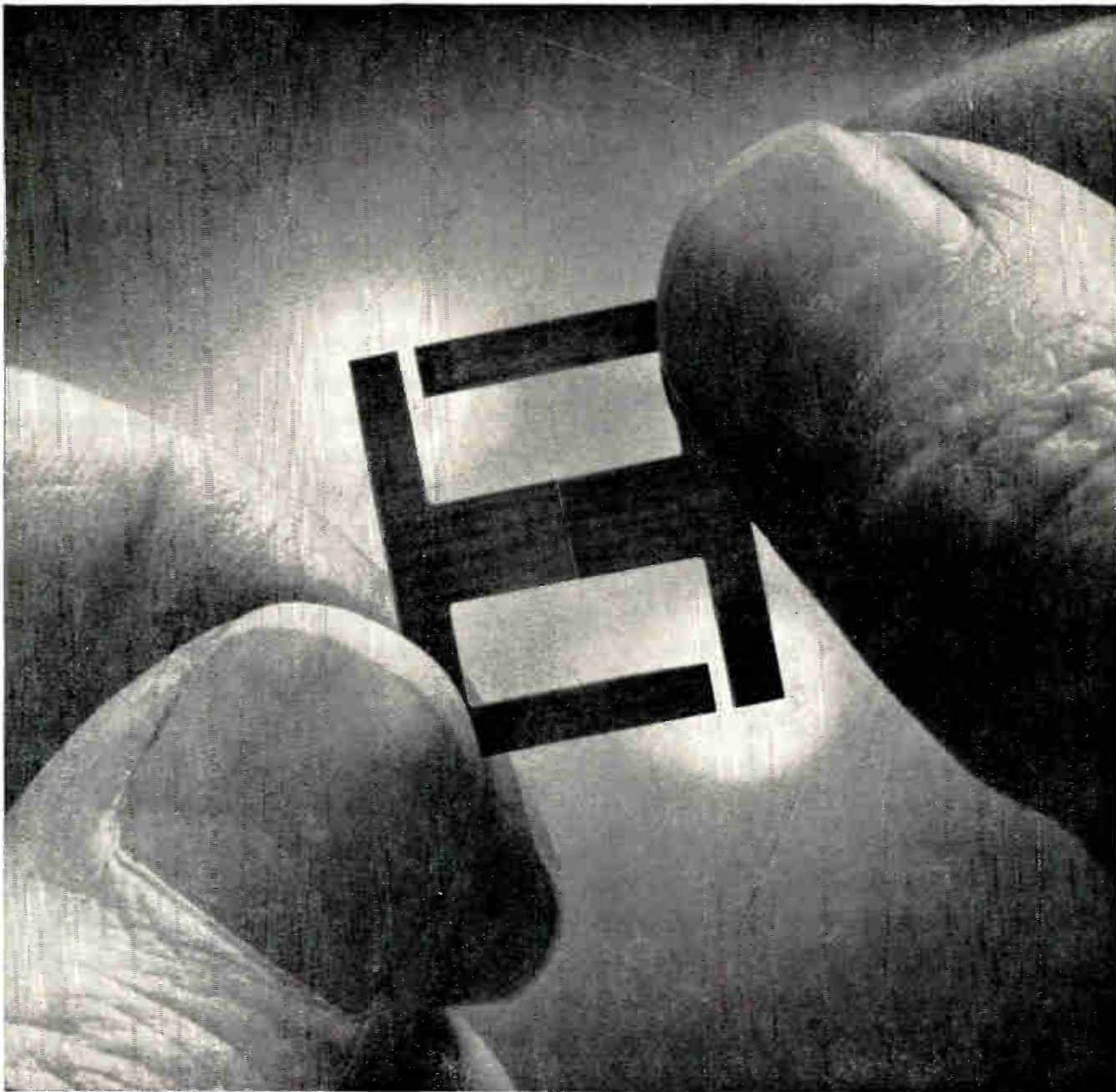

## See the air-gap on this new lamination for miniaturization

Look at the air-gaps on this new performance-guaranteed lamination we have developed and are stocking. The F-187's fixed air-gap provides constant inductance or linear inductance, as needed, because it prevents d-c saturation of the stacked core.

The F-187  $\frac{3}{16}$ " wide center leg is designed for miniaturized filter circuits for communication applications. It is ideal for carrier equipment, and can be used most successfully for microwave, computer or other applications where frequency control is critical.

Being an "F" shape, the new standard stacks more easily than EI-187, and thus offers welcome savings on the production line. There can be advantages to you, too,

in being able to order any quantity, prototype or production, directly from stock.

There's more detailed information on this new member of Magnetics, Inc. family of "Performance-Guaranteed" laminations—and all of our other standard laminations. Just write—*Magnetics, Inc., Dept. P49, Butler, Pa.*



# Why do I specify RCA Industrial Preferred-Type Tubes?

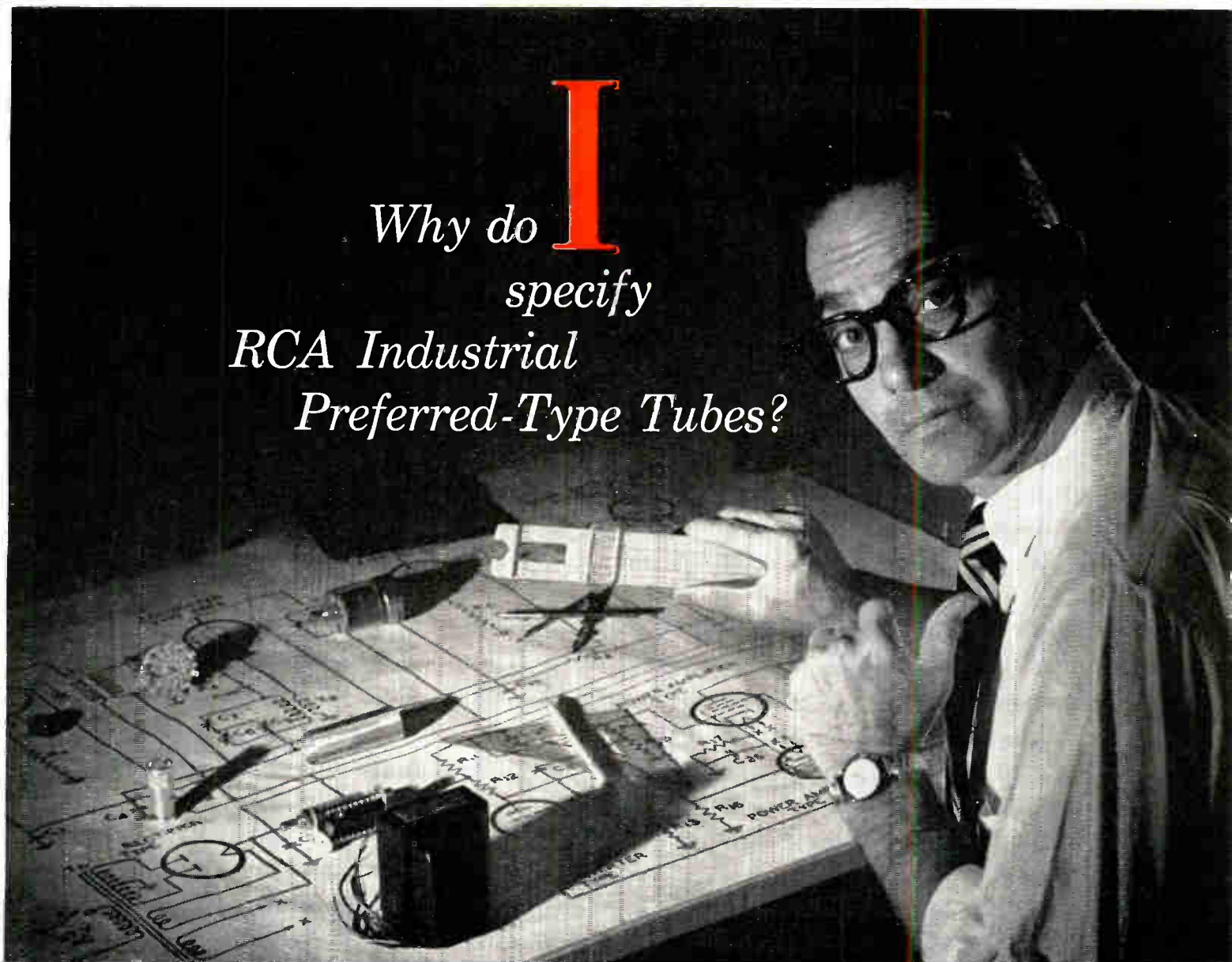

The answer to this leading question, Mr. Designer, is contained in the following four straightforward reasons:

*Lower tube costs can be achieved by concentrating on fewer types. This concentration makes possible lower tube production costs, lower warehousing and stocking expense—all of which can contribute to lower prices to equipment manufacturers.*

*Greater uniformity of tube quality can be realized because manufacturing skills increase—through longer tube production runs of fewer types.*

*Fewer types of circuit components—through the use of fewer types of tubes—enable you to standardize on fewer accessory parts such as transformers, capacitors, resistors. Benefits to you: Savings in purchasing, stocking, and renewals.*

*Better tube availability supports continuous production of equipment. And that's not all. Your customers will be glad to know that when replacement tubes are needed, they are readily available from RCA Industrial Tube Distributors.*

So when you are specifying tubes for the industrial equipment on your drawing board, find out how RCA Industrial Preferred-Type Tubes can improve your product picture. Call your RCA Field Representative to discuss the RCA Industrial Preferred Tube Types best suited for your application.

Free chart on RCA Preferred-Type Tubes for industrial applications. For your copy, write RCA Commercial Engineering, Section B-35-Q Harrison, N. J.



RCA Field Representatives are here to help you  
**INDUSTRIAL TUBE PRODUCTS SALES**

- Newark 2, N. J., 744 Broad Street, Humboldt 5-3900
- Chicago 54, Illinois, Suite 1154, Merchandise Mart Plaza, Whitehall 4-2900
- Detroit 2, Michigan, 714 New Center Bldg., TRinity 5-5600
- Los Angeles 22, Calif., 6355 E. Washington Blvd., RAymond 3-8361

**GOVERNMENT SALES**

- Newark 2, N. J., 744 Broad St., HUmboldt 5-3900
- Dayton 2, O., 224 N. Wilkinson St., BAldwin 6-2366
- Washington 6, D. C., 1625 "K" St., N. W. DIstrict 7-1260



**RADIO CORPORATION OF AMERICA**

Electron Tube Division

Harrison, N. J.



# LAPP COOLING GIVES LONGER LIFE

## TO HIGH-POWER TUBES



### WATER-COOLED

Carrying cooling water which must undergo a change in potential is a job best handled by Lapp Porcelain Water Coils. These coils are completely vitrified, non-absorbent porcelain, white glazed inside and out, providing very low resistance to water flow and eliminating all possibility of contamination in the water. Assuring positive cooling and long tube life, a Lapp Porcelain Water Coil installation represents a permanent investment—a completely trouble-free cooling system.

### AIR-COOLED

Use of Lapp standard-design tube supports facilitates circuit design, improves production economy, provides interchangeability and easy replacement. They are compact, efficient and attractive in appearance, with polished nickel-plated brass hardware permanently attached to the body. Equipment manufacturers will realize a triple service from these supports, for they support the tubes and act as an insulator, and channel air over the fins for maximum cooling of tubes.

WRITE for Bulletin 301 containing complete description and specification data. Lapp Insulator Co., Inc., 216 Sumner Street, Le Roy, New York.



# Lapp



## Section Meetings

(Continued from page 62A)

### SAN DIEGO

"Under the Ice to the Pole." E. LaFonde, Naval Electronics Lab.; 12/2/58.

### SHREVEPORT

"New Arts in Communications." J. J. Landry, Southern Bell Tel. & Tel. Co.; 12/2/58.

### SOUTH BEND-MISHAWAKA

Laboratory and Production Facilities, a Tour of Dage Corp.; 10/23/58.

"Air Traffic Control Radar." K. F. Molz, Bendix Radio; 11/21/58.

### SYRACUSE

"CBS Television New York Tape Facilities." K. B. Benson, CBS; 11/6/58.

### TOLEDO

"Experiences on Installation of the 'Dew' Line," with Color Slides of Alaska. Western Elec. R. Pockmire, Ohio Bell Tel. Co.; 10/9/58.

A Tour of Closed Circuit and Broadcast TV Station. M. Stahl, Univ. of Toledo; 11/12/58.

### TUCSON

Field Trip. Mt. Lemmon Radar Station. W. Peck, USAF; B. Harrison and W. Andres, RCA; 11/26/58.

### TULSA

"Transistors—Little Elements with a Big Future." P. F. Hawley, Pan American Petroleum Corp.; 11/20/58.

### TWIN CITIES

"Tape Recording." R. Youngquist, Minn Mining & Mfg. Co.; Joint with AIEE; 12/4/58.

### VIRGINIA

"Stereophonic Sound." J. L. Albers and A. D. Burt, RCA; 11/21/58.

### WESTERN MICHIGAN

"Electronic Tubes—Quality Control." A. Putnam, Sylvania Electric Products, Inc.; 5/14/58.

"Sage Project Story." Lecture and Motion Pictures. Col. Nagy, USAF; 6/11/58.

"Flight Reference Systems for Aircraft and Missiles." V. J. Burns, Lear, Inc.; 9/9/58.

Plant Tour of Anaconda Wire and Cable Company. C. G. Henricks, Anaconda; 10/8/58.

"Signals from Outer Space—Radio Astronomy." Mr. Donald G. Fink, IRE President; 10/30/58.

"Michigan State Police Radio Network." J. Evans, Mich. State Police Dept.; 11/12/58.

"Flying Saucers." P. Price, Price & Heneveld; 12/10/58.

### WICHITA

"History of Engineering Education at University of Wichita." M. Snyder, Univ. of Wichita;

"Past and Present Training Program of Engineers." J. W. Dunn, Univ. of Wichita; "New 1959 Education of Engineers at University of Wichita." A. T. Murphy, Univ. of Wichita; 11/18/58.

### SUBSECTIONS

#### BUENAVENTURA

"Nuclear Reactors." J. H. Schroeder, USNMC; 11/12/58.

(Continued on page 70A)

# CALIBRATED MICROWAVE FIELD INTENSITY RECEIVER

1000 to 10,000 mc

Absolute measurements of microwave interference and susceptibility



Polarad Model FIM is approved Class A MIL SPEC under MIL-I-006181C (MIL-I-22600) and Ramo-Woolridge Weapons System Specification WDD-M-PRU-2

For the first time, one single microwave test system—Polarad Model FIM Field Intensity Receiver—is capable not only of measuring the absolute level of radiated or conducted interference, but also of determining the signal susceptibility of other instruments and components to such external interference. It combines a calibrated antenna system, a calibrated receiver and an internal calibrated signal generator.

This versatile precision test instrument serves also for field intensity measurements, propagation studies, antenna pattern analysis, r-f leakage measurements, analysis of r-f signals—and characteristics of transmitters, receivers, and other microwave components.

Four sensitive plug-in tuning units, each with UNI-DIAL control. Meter indicates average, peak or quasi-peak value of r-f signals. Audio, video and recorder outputs.

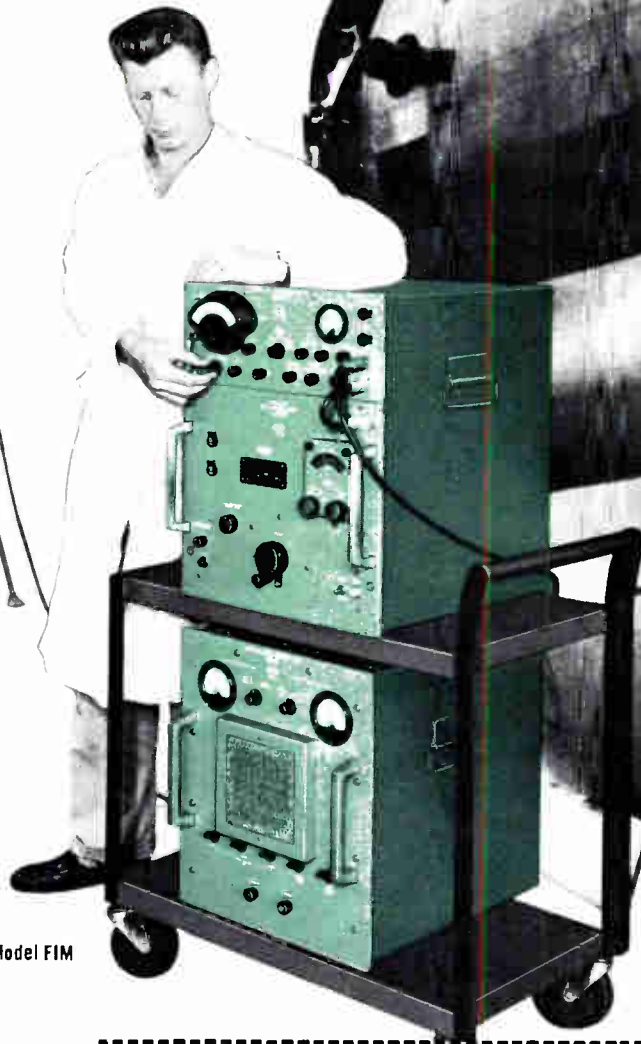
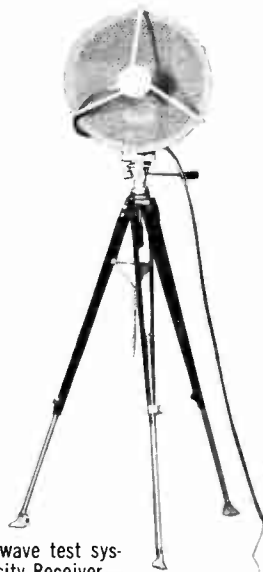

Model FIM



MAIL THIS CARD for detailed specifications. Ask your nearest Polarad representative (in the Yellow Pages) for a copy of "Notes on Microwave Measurements"

**POLARAD ELECTRONICS CORPORATION**

43-20 34th Street, Long Island City 1, N. Y.  
Representatives in principal cities

**POLARAD ELECTRONICS CORPORATION:**

Please send me information and specifications on:

- Model FIM Calibrated Field Intensity Receiver
- Model K-200 Microwave Tube Tester\*
- Model P-3 Transistorized Power Meter\*

IRE

My application is: \_\_\_\_\_

Name \_\_\_\_\_

Title \_\_\_\_\_ Dept. \_\_\_\_\_

Company \_\_\_\_\_

Address \_\_\_\_\_

City \_\_\_\_\_ Zone \_\_\_\_\_ State \_\_\_\_\_

\*See reverse side of this page.



# PORTABLE TRANSISTORIZED MICROWAVE POWER METER

- 10 to 39,000 mc
- Battery or line operated
- Light and rugged
- Measures absolute r-f power instantly without tuning

Used for: field or laboratory measurement of absolute r-f power levels; testing and calibration of signal generators, attenuators, traveling wave tubes; testing coax and waveguide systems; measurement of power at locations where AC power lines are not available.

Thermistor elements make the unit safe from accidental overload. Thermistor mounts available in coaxial and waveguide sizes.

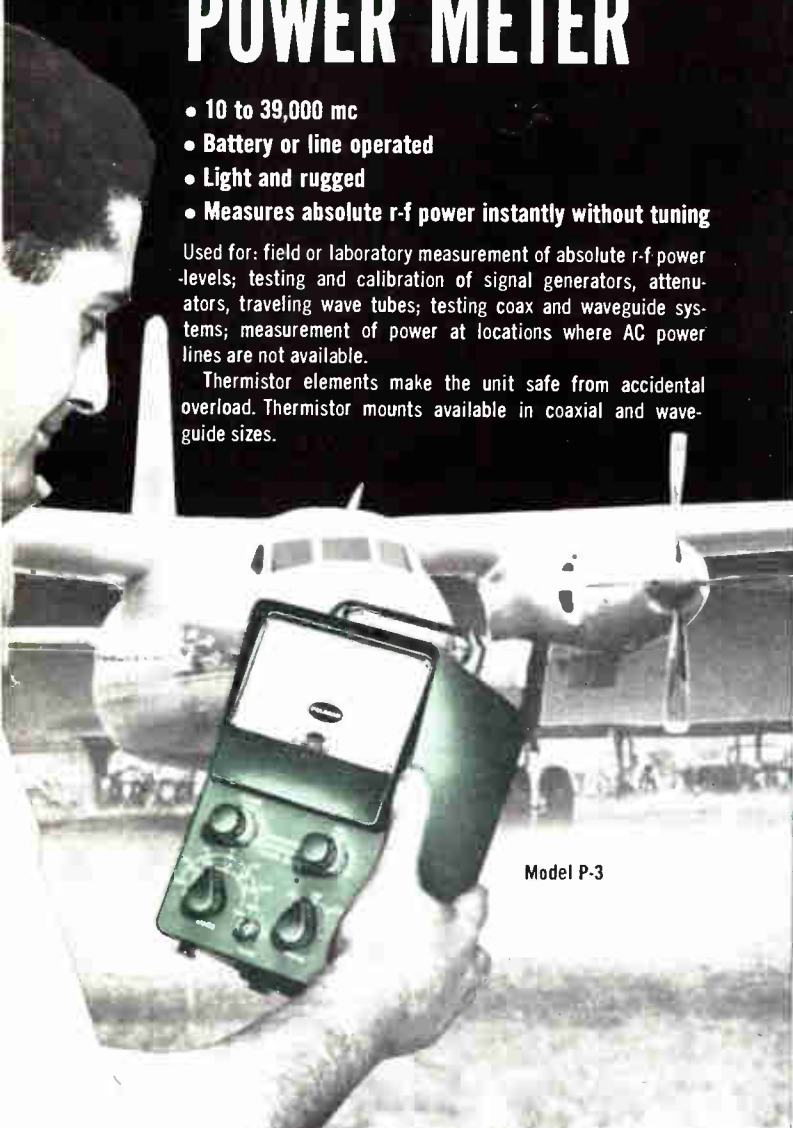

Model P-3

# MICROWAVE TUBE TESTER

## Simplified Test Saves Engineering Man Hours

No guesswork. No need to fire up complete equipments to determine microwave tube performance. Model K-200 gives rapid, positive decision on costly microwave tubes. Quickly pays for itself by enabling you to reclaim questionable tubes from salvage. Allows Incoming Inspection to check tubes upon receipt and throughout warranty period, without tying up expensive personnel.

Tests all microwave tubes including internal and external cavity types, pencil triodes, rocket and lighthouse tubes. A scroll indicates quick setups to test for filament continuity, short circuits, static d-c tests, life tests, and dynamic tests.

Model K-200



Postage  
Will be Paid  
by  
Addressee

No  
Postage Stamp  
Necessary  
If Mailed in the  
United States

**BUSINESS REPLY CARD**  
First Class Permit No. 18, Long Island City 1, N. Y.

**POLARAD ELECTRONICS CORP**  
43-20 34th St., Long Island City 1, N. Y.



**MAIL THIS CARD**  
for detailed specifications.  
Ask your nearest Polarad  
representative (in the  
Yellow Pages) for a copy  
of "Notes on Microwave  
Measurements"

**FREE LIFETIME SERVICE  
ON ALL POLARAD  
INSTRUMENTS**

## **POLARAD ELECTRONICS CORPORATION**

43-20 34th Street, Long Island City 1, N. Y.  
Representatives in principal cities

# GAF CARBONYL IRON POWDERS

*For the production of superior cores  
for high frequency induction coils.*

*lower cost · higher quality · proven stability · ease in handling*

HERE ARE FACTS THAT PROVE THE VALUE OF GAF CARBONYL IRON POWDERS AS CORE MATERIALS —

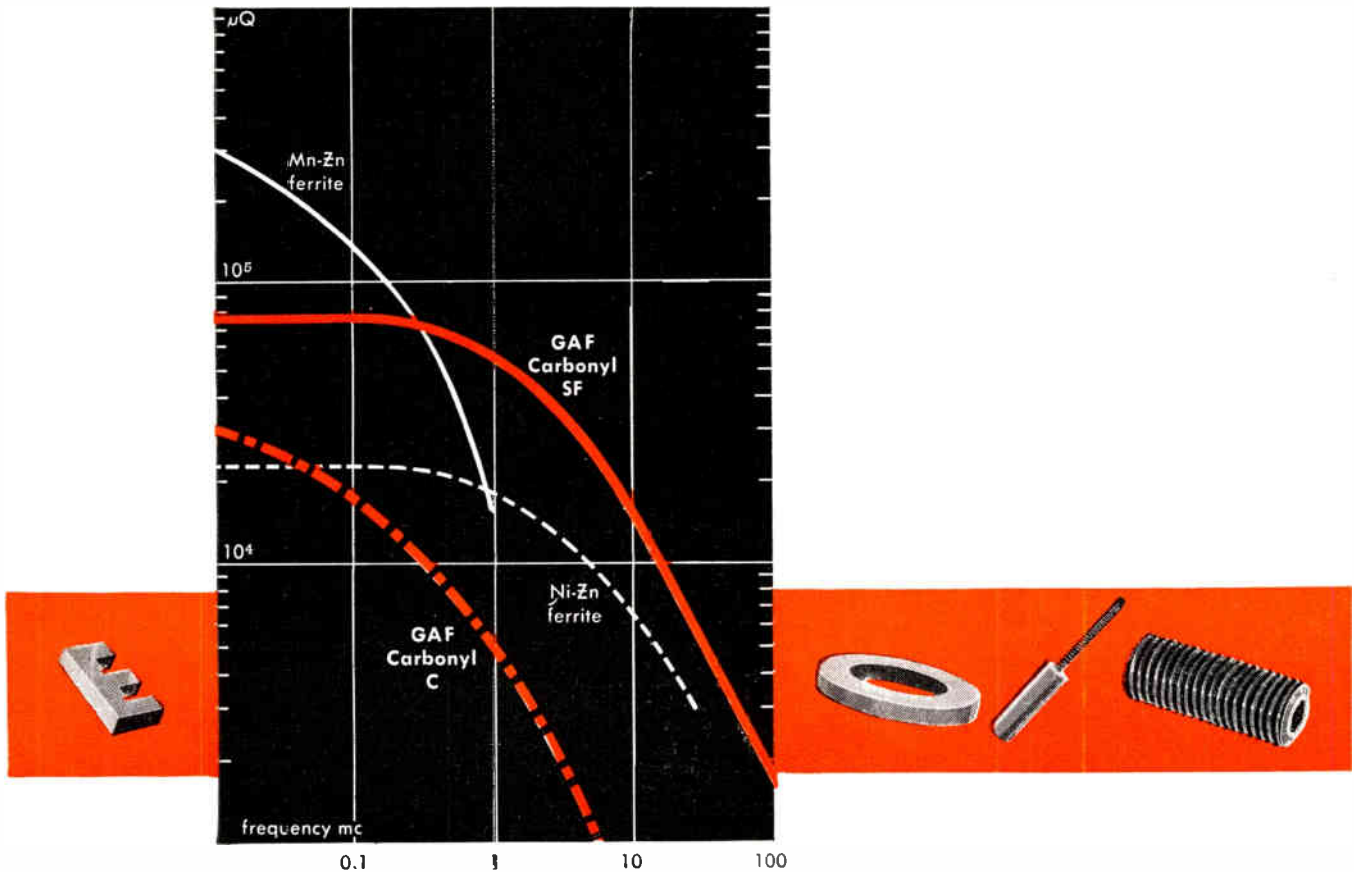

The selection of the proper magnetic core material for the frequency range an inductance coil will be used is of utmost importance.

GAF Carbonyl Iron Powders are the proper materials in the frequency range 100 kc to 150 mc and higher. The above chart proves the value of the selection using the highly desirable relationship of the  $\mu Q$  product versus frequency.

Heat, cold, humidity, atmospheric influences, stray fields and similar con-

ditions — any of these can have an adverse effect on the core materials and on the final performance of the equipment.

An iron core made with GAF Carbonyl Iron Powders has a high degree of stability — and is thereby protected against these many influences.

We urge you to ask your core maker, your coil winder, your industrial designer, how GAF Carbonyl Iron Powders can increase the efficiency and performance of the equipment or prod-

uct you make, while reducing both the cost and the weight.

This 32-page book offers you the most comprehensive treatment yet given to the characteristics and applications of GAF Carbonyl Iron Powders. 80% of the story is told with photomicrographs, diagrams, performance charts and tables. Write today for your free copy.

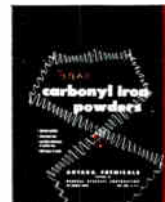

*From Research to Reality*



**ANTARA CHEMICALS**

A SALES DIVISION OF  
**GENERAL ANILINE & FILM CORPORATION**  
435 HUDSON STREET · NEW YORK 14, NEW YORK

Sales Offices: New York · Providence · Philadelphia · Charlotte · Chattanooga · Chicago · Portland, Ore. · San Francisco · Los Angeles  
In Canada: Chemical Developments of Canada, Ltd., Montreal





# new, high power pulse transformers and components

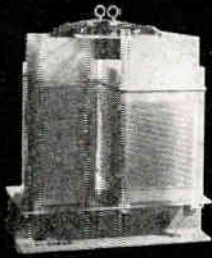

Catalog No. 816  
Pulse Transformer

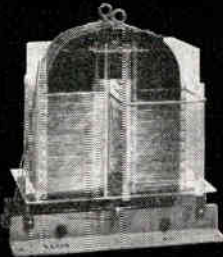

Catalog No. 817  
Pulse Transformer



Catalog No. 922  
Filament Transformer

Catalog No. 814  
Pulse Coupling Transformer

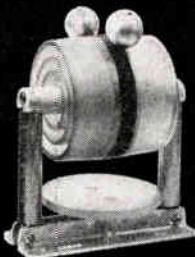

Catalog No. 1902  
Capacity Voltage Divider

**carad**  
**corp**

When the design parameters include high power and high reliability—in applications such as super-powered radar, linear accelerators and tube evaluation—the answer will be found in Carad's complete line of pulse transformers, components and integrated pulse packages, available in many standard and special configurations.

The broad scope of Carad's experience in pulse packages—the most diversified in the industry—involves the origination of basic new materials, circuitry and techniques, all designed to produce higher power of greater reliability with increased economy of space.

**816 PULSE TRANSFORMER**  
Secondary Peak Voltage 275 KV  
Secondary Peak Current 220 Amperes  
Turns Ratio 1:13  
Pulse Width 2.0  $\mu$ sec.  
Rise Time 0.3  $\mu$ sec.  
Droop 2.5%  
Repetition Rate 180 PPS  
Load Klystron, 1250 $\Omega$   
Size, Weight 10' x 18' x 22½' high; approx. 200 lbs.

**817 PULSE TRANSFORMER**  
Secondary Peak Voltage 250 KV maximum  
Secondary Peak Current 234 Amperes max.  
Turns Ratio 1:17  
Pulse Width 3 - 8  $\mu$ sec.  
Rise Time 0.5  $\mu$ sec. min., 1.0  $\mu$ sec. max.  
Droop 1.5 KV per  $\mu$ sec. of pulse length max.  
Repetition Rate 360 PPS max.  
Load Klystron, 1070 $\Omega$   
Size, Weight 11' x 21' x 24' high; approx. 400 lbs.

**922 FILAMENT TRANSFORMER**  
Primary Voltage 208 V, 60 cycles  
Secondary Voltage 18 V at 10 Amps.  
Insulation Voltage 260 KV Pulse  
Capacitance 40  $\mu$ mf in oil, approx.  
Size, Weight 9' x 12.5' x 10' high; approx. 40 lbs.

**814 PULSE COUPLING TRANSFORMER**  
Secondary Insulation 220 KV DC  
Primary/Secondary Turns Ratio 1:2  
Primary Voltage 4 KV; Secondary Voltage 8 KV  
Secondary to Primary & Core Capacitance 50  $\mu$ mf approx.  
Pulse Length & Rate 2-5  $\mu$ sec. 60 PPS max.  
Pulse Droop, Overshoot, Backswing 15%  
Size, Weight 7' x 10' x approx. 11' high; approx. 25 lbs.

**1902 CAPACITY VOLTAGE DIVIDER**  
Peak Voltage Rating 300 KV  
Maximum Pulse Width 10  $\mu$ sec.

Additional details, related to your specific requirements, available on request.

**carad corporation**  
2850 Bay Road  
Redwood City California  
EMerson 8-2969



## Section Meetings

(Continued from page 66A)

### EASTERN NORTH CAROLINA

"Television Studio Equipment," V. Duncan, WRAL TV Station; 11/14/58.

"Optimum Switching Servomechanisms," J. Mayo, Bell Tel. Labs.; 2/12/58.

### GAINESVILLE

"Some Reflections on the IRE and Looking Forward in Communications," Mr. Donald G. Fink, IRE President; Joint with Central Florida Section; 12/5/58.

### LAS CRUCES

"Three Dimensional Vector Cardiography," Lecture and Slides, W. E. Ingerson, Bell Tel. Labs.; 11/20/58.

### LEHIGH VALLEY

"Closed Circuit Television," A. Inglis, RCA; 10/29/58.

### NORTHERN VERMONT

"Electronics in Medicine (Communication Within the Heart)," F. J. Siebel, Univ. of Vermont; 11/24/58.

### PANAMA CITY

Business Meeting, Mine Defense Laboratory; 11/26/58.

### RICHLAND

"Semi-conductor Applications to Nuclear Instrumentation and Control," R. F. Shea, Gen. Elec. Co.; 11/11/58.

### SAN FERNANDO VALLEY

"Ramo's Plans for the Valley," Dr. Branch, Ramo-Woolridge Corp.; 11/12/58.

# 1959 Western Joint Computer Conference

March 3-5, 1959  
Fairmont Hotel  
San Francisco, Calif.

Sponsors:  
Institute of Radio Engineers  
American Institute of Electrical Engineers  
Association for Computing Machinery

### TECHNICAL PROGRAM

For further information on program, address program chairman:

Mr. Richard W. Melville  
Stanford Research Institute  
Menlo Park, Calif.

(Continued on page 74A)

# are you **fighting** SPACE ?

No need to suffer from engineering claustrophobia, if you design with **CANNON PLUGS** in mind!



Coaxials.  
Screw-type  
coupling  
Low VSWR.  
for 50-, 70-,  
93-ohm cable



K miniatures  
3 to 50 contacts  
13 different  
arrangements



DP Type  
Rack-Panel-  
chassis  
style 2 to 57  
contacts



MC Sub-  
Miniatures  
3, 6, 12 contacts  
Built for  
rugged use



D Sub-Miniatures  
9 to 50 contacts  
Same space . . .  
same weight!

**Cannon Miniature and Sub-Miniature Plugs are rugged, easy mating, unusually versatile, neat and compact.**

When you design with Cannon Miniatures in mind you'll get complete electrical circuit dependability in a very small space. Up to 50 contacts in 1/2 or 1/3 the area taken by standard multi-contact connectors!

Rectangular and circular types. Hermetically sealed, vibration and moisture resistant, and general purpose designs. Contacts for 5, 10, 15, 25 amps . . . and miniature coaxial connectors. Practically all five ampere contacts are gold plated. High dielectric insulation in phenolics, resilient materials, glass seals, Zytel, Diallyl Phthalate and Melamine. Aluminum alloy or steel shells, depending upon application.

**Miniature lines include:** DPA, DPX, DPM, DPG, K, MM, MR and Diamond MB and SM Coaxial connectors. **Sub-miniatures:** D, MC, and Diamond DIC Coaxial connectors.

Write **TODAY** for new 32-page 2-color Miniatures Bulletin HMC-2. Also, write for Bulletin SM-1, "Soldering Small Contacts."



For an interesting discussion of the broad subject of "Reliability," write for Cannon Bulletin R-1.

## **CANNON PLUGS**

WHERE RELIABILITY  
IS THE 5<sup>TH</sup> DIMENSION



Please refer to Dept. 377

CANNON ELECTRIC CO., 3208 Humboldt Street, Los Angeles 31, California. Factories in Los Angeles; Salem, Massachusetts; Toronto, Canada; Melbourne, Australia; London, England. Manufacturing licensees in Paris and Tokyo. Representatives and distributors in all principal cities. See your Telephone Yellow Book.





# KEARFOTT PRECISION RESOLVERS FOR EVERY SYSTEM APPLICATION

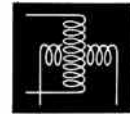

Kearfott has available a complete line of precision resolvers for every system application. Computing resolvers range in functional accuracy from .05% to .005%, in bridge accuracy from 3 minutes to 20 seconds of arc and in size from 11 to 25. Non-compensated resolvers range from 5 minutes to 20

seconds of arc in accuracy, from 8 to 25 in size. All Kearfott resolvers feature stainless housing, shafts and bearings and corrosion-resistant lamination materials for maximum environmental resistance. Optional designs available for operation at 200°C and in environment of 2000 cps vibration at 30 g's.

## Computing Resolvers

Available with integral compensating windings. Can be provided with trimming networks to match existing isolation amplifiers or Kearfott-designed transistorized amplifiers.

### Size 11

For applications where size and good functional accuracy are of paramount importance. Functional accuracy as good as .05% and bridge errors of 3 minutes of arc are in production.

### Size 15

A 2:1 improvement in functional accuracy and bridge error obtained in this configuration. Unit tabulated is the direct equivalent of standard Navy BuOrd Mark 4 Mod 3 and contains necessary trimming net-

work for standard buffer amplifiers. Transformation ratio is 1.000 ± .0001, phase shift 0° ± 1 minute. Functional accuracy of .025% and bridge error of 1.5 minutes of arc are standard.

### Size 25

For applications demanding the highest order of accuracy. Close attention has been paid to design parameters.

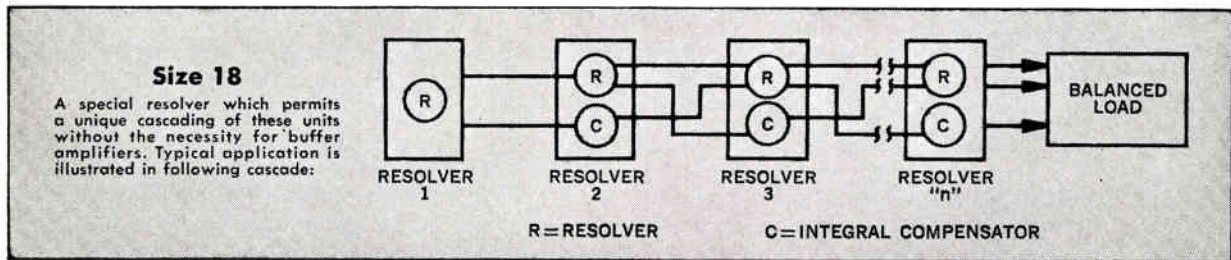

### Size 18

A special resolver which permits a unique cascading of these units without the necessity for buffer amplifiers. Typical application is illustrated in following cascade:

COMPENSATED RESOLVERS FOR PRECISE COMPUTER APPLICATIONS

SIZE	11		15	18	25
PART NUMBER	R980-01	R980-41	T980-51	V980-004	425506-1
Excitation Volts—(Max.)	60	60	26	26	25
Frequency—(cps)	400	400	400	400	400
Primary Impedance	629 + j2510	450 + j2200	220 + j1000	3000 + j (0 ± 40)	1630 / 78.5°
Secondary Impedance	695 + j2750	500 + j2300	240 + j1100	3000 + j (0 ± 40)	1620 / 80°
Transformation Ratio (Primary to Secondary)	.980	.980	.980	.775	.980
Transformation Ratio (Compensator to Rotor)	.985	.985	.950	.775	.985
Phase Shift (Lead)	8.5°	7.5°	8.5°	0° ± 10'	1°
Fundamental Null (MV)	15	15	8	15	15
Bridge Error From E.Z. (Max.)	7 mins.	5 mins.	3 mins.	3 mins.	20 Seconds
Primary	Stator	Stator	Stator	Stator	Stator

## Non-Compensated Resolvers

Basically for application in precise data transmission systems. These synchro resolvers permit system designer to achieve system errors of better than 1 minute of arc without using 2-speed servos and elaborate electronics. By proper impedance matches up to 64 resolver control transformers can also operate from one resolver transmitter.

### Size 11

Where size is important. These units have a maximum unit error of 3 minutes of arc.

### Size 25

Where highest accuracy is required. These units have a maximum error as low as 20 seconds of arc.

NON-COMPENSATED RESOLVERS FOR PRECISE DATA TRANSMISSION

	SIZE 11			SIZE 25		
	Transmitter R982-004	Differential R982-011	Control Transformer R982-012	Transmitter Z5161-001	Differential Z5191-001	Control Transformer Z5151-003
Type Resolver Part Number	R982-004	R982-011	R982-012	Z5161-001	Z5191-001	Z5151-003
Excitation Volts (Max.)	26	11.8	11.8	115	90	90
Frequency (cps)	400	400	400	400	400	400
Primary Impedance	170 / 77°	850 / 80°	2000 / 80°	400 / 80°	800 / 80°	8500 / 80°
Secondary Impedance	42 / 80.5°	1000 / 79°	8000 / 76°	260 / 80°	900 / 80°	14000 / 80°
Transformation Ratio	.454	1.000	1.906	.7826	1.000	1.278
Max. Error from E.Z.	3 mins.	3 mins.	3 mins.	20 seconds	20 seconds	20 seconds
Primary	Rotor	Stator	Stator	Rotor	Stator	Stator

Write for complete data.

**KEARFOTT COMPANY, INC., Little Falls, N. J.**

A subsidiary of General Precision Equipment Corporation

Sales and Engineering Offices: 1378 Main Ave., Clifton, N. J.

Midwest Office: 23 W. Calendar Ave., La Grange, Ill.

South Central Office: 6211 Denton Drive, Dallas, Texas

West Coast Office: 253 N. Vinado Avenue, Pasadena, Calif.

**Kearfott**





# FROZEN TRANSIENTS

with the Hughes MEMO-SCOPE® Oscilloscope

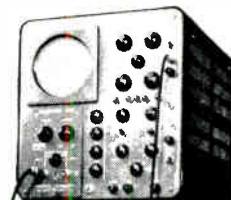

Trial and error methods necessary to capture elusive transients on conventional scopes waste time, film, and precious research dollars. Never again need this happen. With the Hughes MEMO-SCOPE® oscilloscope you may instantly “freeze” wave forms with brilliant clarity for careful study, comparison and analysis.

The Hughes MEMO-SCOPE® oscilloscope retains these frozen transients until intentionally erased. Selected transient information may be triggered externally or internally. Successive wave forms may be written above, below or directly over the original information.

SWEEP SPEED FOR STORAGE: 10 microseconds to 10 seconds per division (0.33”).

FREQUENCY RESPONSE: DC to 250 KC down 3 db.

SENSITIVITY: 10 millivolts to 50 volts per division or with optional high sensitivity preamplifier 1 millivolt to 50 volts per division.

APPLICATIONS: Trouble shooting data reduction equipment... switch and relay contact study... ballistics and explosives research... ultrasonic flaw detection... physical testing — shock — stress — strain.

*A Hughes representative will gladly demonstrate the MEMO-SCOPE® oscilloscope in your company. Simply address your request to: Hughes Products, Marketing Dept.—MEMO-SCOPE® International Airport Station, Los Angeles 45, California*

Creating a new world with *ELECTRONICS*

**HUGHES PRODUCTS**

© 1958, HUGHES AIRCRAFT COMPANY

SEMICONDUCTOR DEVICES • STORAGE AND MICROWAVE TUBES • CRYSTAL FILTERS • OSCILLOSCOPES • RELAYS • SWITCHES • INDUSTRIAL CONTROL SYSTEMS



# HI RELIABILITY TERMINAL BOARDS AND SUB-ASSEMBLIES TO MILITARY SPECIFICATIONS

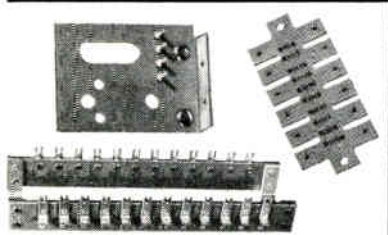

**C**USTOM fabrication of all insulating materials to Government specs. Send us your requirements for an immediate quote.

## PLUGS AND JACKS FOR STEREO and HI-FI APPLICATIONS

**A**LL types of terminal strips and connectors for Stereo and Hi-Fi as well as Radios, Phonographs, Recorders and TV. Write for catalog and prices today.



**NATIONAL TEL-TRONICS CORPORATION**  
52 ST. CASIMIR AVENUE  
YONKERS, N.Y.

Versatile in Readout and Display

# MULTICHANNEL DATA RECORDER

up to 1000 discrete marks (or channels) on 19 inch wide  
dry electrosensitive paper

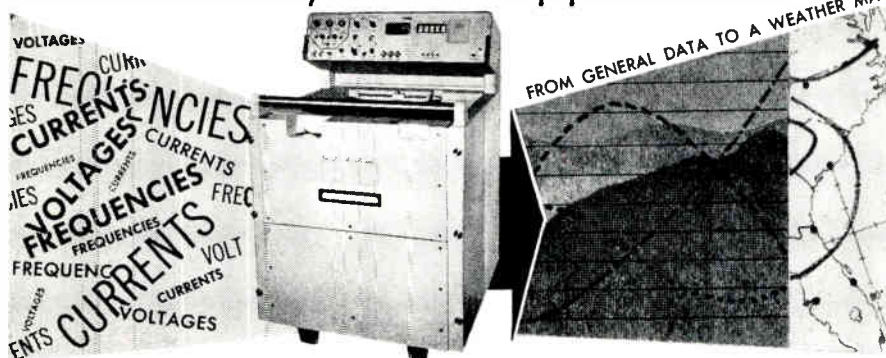

**DATA PROCESS OUTPUT TRANSLATED INTO VISIBLE, PRECISE, RECORDS**

- Records analog, digital and alpha numeric data

Write or phone for further information

## TIMES FACSIMILE CORPORATION

540 West 58th Street, New York 19, New York • JUdson 2-3030  
1523 L St., N.W., Washington 5, D.C. • STerling 3-9030

## 1959 Western Joint Computer Conference

(Continued from page 70A)

- March 3—9 a.m. to 12 noon*
- 1-A New Components and Circuits
  - 1-B Information Retrieval and Machine Translation
  - A Industry's Role in Supporting High School Science Programs
- March 3—2 to 5 p.m.*
- 2-A Computer Communication
  - 2-B Education & Methodology for use of Computers
  - B Information Retrieval and Machine Translation
- March 4—9 a.m. to 12 noon*
- 3-A Achieving Reliability in Operation Control
  - 3-B Learning Concepts & Pattern Analysis
  - C Military Applications
- March 4—2 to 5 p.m.*
- 4-A New Machines & Systems
  - 4-B Computer Applications in Business Environments
- March 5—9 a.m. to 12 noon*
- 5-A Numerical Analysis
  - 5-B "Blue Sky" Session
- March 5—2 to 5 p.m.*
- 6-A New Applications of Computer Technology
  - 6-B Philosophy and Responsibility of Computers in Society
  - 7 Analog Simulation

### REGISTRATION

- Registration Fees:
- Members of sponsoring organizations, \$6
  - Non-members, \$7
  - Students, \$2
- No advance registrations—all registration at Fairmont Hotel, 6 to 9 p.m., March 2; 7:30 a.m. to 5 p.m., March 3 & 4; 7:30 a.m. to 1 p.m., March 5.

### LUNCHEON

Noon, March 4, Tonga Room, Fairmont Hotel, \$4.50

Speaker:

Colonel Darwin E. Ellett  
Chief, Data Systems Plans Division  
Directorate of Plans and Programs  
Air Materiel Command  
Subject: "New Horizons in Systems"

### FIELD TRIPS

- Wednesday Afternoon, March 4*  
University of California Radiation Laboratory, Livermore, Calif.
- Wednesday Evening, March 4*  
Philco Corporation Western Development Laboratories, Palo Alto, Calif.
- Thursday Afternoon, March 5*  
Ampex Corp., Redwood City, Calif.

### EXHIBITS

- Nob Hill, Gold, Empire, Green and Garden Rooms, Fairmont Hotel
- Exhibits open:
- March 3, 12 noon to 6 p.m.
  - March 4, 12 noon to 9 p.m.
  - March 5, 9 a.m. to 6 p.m.

(Continued on page 79A)

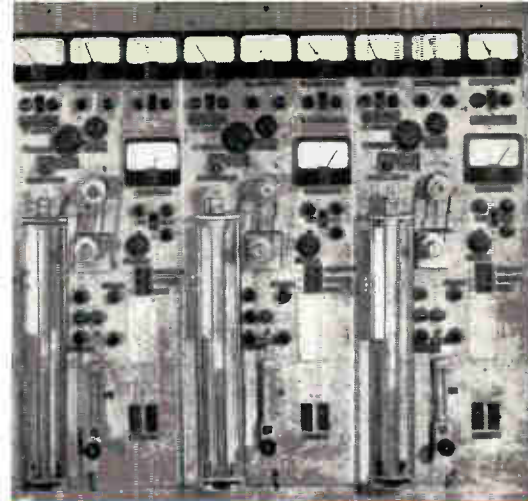

Trancoa's unique automated process assures product uniformity.



# TRANCOA SILICON...

Key  
to  
increased  
yields!



Multiple Zone Refining of every lot permits accurate boron content measurement

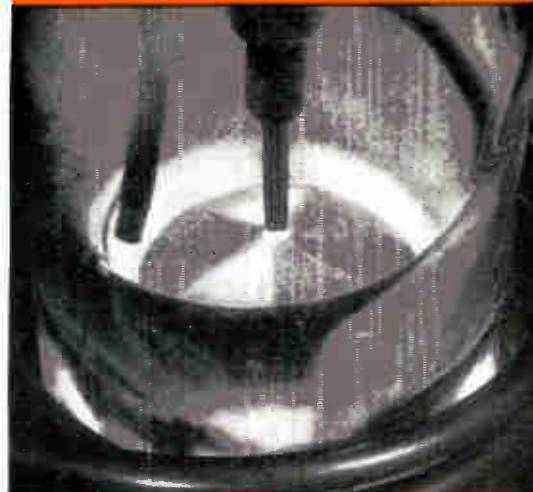

Rigid cleanliness test requires three-sixteenths inch clearance between test crystal and crucible.



Three characterization crystals are grown from each lot — one for resistivity, type and lifetime determination, another for cleanliness a third for boron content.

Higher quality silicon can improve your semiconductor device yields. *Trancoa* offers this higher quality at no increase in price!

Grade for grade, the superior quality of *Trancoa* Silicon is assured by our unique process and exacting specifications. In addition to the standard tests for resistivity, lifetime and base boron level — every lot of *Trancoa* Silicon must also meet two other important requirements:

**Cleanliness** — the vital factor directly affecting your crystal yield! *Trancoa* specifications require that a doped single crystal be drawn with only three-sixteenths of an inch clearance between crystal and crucible. Any fuming, dross, or wetting of the quartz is cause for internal rejection.

**Resistivity Ratio** — resistivity uniformity of doped crystals is improved perpendicular and parallel to the growing axis. Furthermore, the occurrence of P-N junctions is eliminated. Ratio of the resistivities at the 10% and 60% points on the test crystal may not exceed 3:1.

This combination of a new improved process plus added quality standards assures you of receiving better silicon, thus better yields, at no increase in cost.

Grade	Resistivity		Max. Resistivity Ratio for 10% & 60% Points	Max. Boron Content (ppb)
	P-Type	N-Type		
IA	500	250	3:1	0.5
I	100	50	3:1	0.5
II	50	20	3:1	1.0
III	25	10	3:1	2.0
IV	2.5	1.0	3:1	4.0

For complete information write for brochure, *Trancoa Methods for Evaluating Silicon*, *Trancoa* Chemical Corporation, Dept. P-1, 312-326 Ash Street, Reading, Massachusetts.

**Trancoa**  
chemical corporation

312-326 Ash Street, Reading, Massachusetts, Tel: REading 2-3900





## Professional Group on Electron Devices

Developments in the field of electron devices have probably had a greater influence on radio-electronic progress than the developments of any other field. For it is the electron device which is the active, working element around which the rest of the equipment is built. It is this component which generates, modulates, converts, detects, and amplifies signals, and which enables the apparatus to perform its prescribed functions.

It is not surprising, therefore, that a great deal of effort has been directed toward improvements in electron tubes and semiconductors, and that the resulting advances have received close and widespread attention. The rewards have been impressive. Work on cathode-ray tubes, for example, was a prime factor in the successful evolution of television. The advent of klystrons, magnetrons and traveling-wave tubes made possible the development of equipment capable of operating in the microwave portion of the spectrum. The transistor opened up a whole new era of solid-state electronics.

IRE members who wished to keep abreast of the many developments in this important and rapidly moving field were greatly aided by the formation of the IRE Professional Group on Electron Devices in 1951. The Group immediately began to organize technical sessions in its field at many of the national meetings held during the year. This was followed by the formation of Group Chapters throughout the country which collaborate with IRE Sections to sponsor meetings locally.

Perhaps of greatest importance, the Group began publishing its own technical publication, called Transactions, which is distributed free to all members who pay the assessment fee of \$3.00. The Transactions is now issued quarterly to some 4200 members, and has become an invaluable source of information on the latest technical developments in the field of electron devices.

*W. R. G. Baker*

Chairman, Professional Groups Committee



## At least one of your interests is now served by one of IRE's 28 Professional Groups

Each group publishes its own specialized papers in its *Transactions*, some annually, and some bi-monthly. The larger groups have organized local Chapters, and they also sponsor technical sessions at IRE Conventions.

Aeronautical and Navigational Electronics (G 11)	Fee \$2
Antennas and Propagation (G 3)	Fee \$4
Audio (G 1)	Fee \$2
Automatic Control (G 23)	Fee \$2
Broadcast & Television Receivers (G 8)	Fee \$2
Broadcasting (G 2)	Fee \$2
Circuit Theory (G 4)	Fee \$3
Communication Systems (G 19)	Fee \$2
Component Parts (G 21)	Fee \$3
Education (G 25)	Fee \$3
Electron Devices (G 15)	Fee \$3
Electronic Computers (G 16)	Fee \$2
Engineering Management (G 14)	Fee \$3
Engineering Writing and Speech (G 26)	Fee \$2
Human Factors in Electronics (G 28)	Fee \$2
Industrial Electronics (G 13)	Fee \$2
Information Theory (G 12)	Fee \$3
Instrumentation (G 9)	Fee \$2
Medical Electronics (G 18)	Fee \$3
Microwave Theory and Techniques (G 17)	Fee \$3
Military Electronics (G 24)	Fee \$2
Nuclear Science (G 5)	Fee \$3
Production Techniques (G 22)	Fee \$2
Radio Frequency Interference (G 27)	Fee \$2
Reliability and Quality Control (G 7)	Fee \$2
Space Electronics and Telemetry (G 10)	Fee \$2
Ultrasonics Engineering (G 20)	Fee \$2
Vehicular Communications (G 6)	Fee \$2

IRE Professional Groups are only open to those who are already members of the IRE. Copies of Professional Group Transactions are available to non-members at three times the cost-price to group members.



**The Institute of Radio Engineers**  
1 East 79th Street, New York 21, N.Y.

### USE THIS COUPON

Miss Emily Sirjane

PG-2-59

IRE—1 East 79th St., New York 21, N.Y.

Please enroll me for these IRE Professional Groups

..... \$.....  
..... \$.....

Name .....

Address .....

Place .....

Please enclose remittance with this order.

# WESTINGHOUSE SILICON POWER RECTIFIERS



**302** Up to  
35 amperes  
half-wave. Weight:  
0.65 ounce.



**303** Up to  
18 amperes  
half-wave. Weight:  
0.65 ounce.



**304** Up to  
12 amperes  
half-wave. Weight:  
0.25 ounce.

For efficient medium-power rectification on land, at sea and in the air

Westinghouse types 304, 303, and 302 rectifiers offer a range of current and voltage ratings which are ideal for efficient medium-power rectification.

All three types are immediately available from stock—and at an attractive price! They are characterized by long life, high efficiency, low regulation, low cost, and operation at high ambient temperatures (up to 190°C junction temperature). They meet or exceed requirements of all applicable military tests. And they are available in a variety of rectifier assemblies.

Listed below are some suggested applications.

- DC power supplies for ground and airborne

- 6-12-24-48 volt AC-DC generator systems
- Battery chargers
- Small plating supplies for laboratory use
- Power supplies for business machines
- Computer power supplies
- Transistor power supplies
- Telephone exchange DC power supplies
- Power supplies for marine smallcraft
- Electronic tube filament supplies

For further design data, contact your Westinghouse representative or write to Westinghouse Electric Corporation, Semiconductor Department, Youngwood, Pennsylvania.

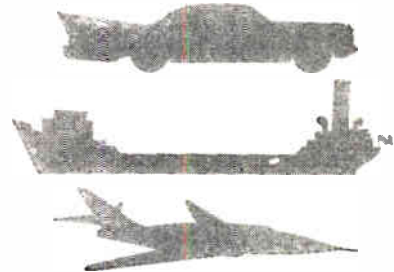

**SILICON POWER RECTIFIERS • GERMANIUM TRANSISTORS • SILICON POWER TRANSISTORS**

YOU CAN BE SURE...IF IT'S **Westinghouse**

**COMING SOON—HIGH-SPEED GERMANIUM  
DIYNIATOR SWITCH**

featuring low stand-by currents, low internal power loss, and switching time in the milli-microsecond range. Watch for announcement of availability.





**NUMBER TWO\*** in a series of candid camera studies planned, frankly, to impress you with the efficient service rendered by—

# BURLINGAME ASSOCIATES

SERVING SCIENCE AND INDUSTRY SINCE 1928

510 S. FULTON AVE., MT. VERNON, N. Y. • MOUNT VERNON 4-7530  
WASHINGTON, D.C. • WALTHAM, MASS. • UPPER DARBY, PA. • SYRACUSE, N. Y.

— EASTERN FIELD ENGINEERS FOR: —

ADVANCED ELECTRONICS • ALLISON LABORATORIES • BRUSH INSTRUMENTS  
• CARDINAL INSTRUMENTS • DEMDLAB • DONNER SCIENTIFIC CO  
ELECTRO INSTRUMENTS • ELECTRO-PULSE • EMPIRE DEVICES PRODUCTS  
• HOLT INSTRUMENT LABORATORIES • LEVINHAL ELECTRONIC PRODUCTS  
MAGNETICS RESEARCH • NARDA MICROWAVE • NJE • SYSTRON  
WAYNE-KERR LABORATORIES.

*\*An attractive corner of the technical literature library in our beautiful new main office building in Mt. Vernon. Miss Scott is stretching herself to maintain our just-about-perfect record of same-day service on all routine requests for catalogs, technical information and quotations. One more reason to "Get the Burlingame Habit".*



**ACCURACIES  
BETTER THAN  
1 PART IN  
50 MILLION  
are free!**

**WHY NOT USE THEM!**

The standard time and frequency transmissions of the National Bureau of Standards radio stations WWV and WWVH provide an invaluable service to laboratories and experimenters throughout the world. Extremely precise (normal transmission stability is within 1 part in  $10^9$  at WWV and 5 parts in  $10^9$  at WWVH) audio and radio frequency standards, as well as accurate time intervals and radio frequency propagation warnings, are placed at the disposal of anyone having a receiver capable of tuning to one or more of the transmitting frequencies. Proper use of these facilities can be made to supplement the instrumentation of any laboratory.

The Model WWVC Standard Frequency Comparator is just such an instrument . . . a highly sensitive crystal-controlled radio receiver utilizing WWV and WWVH transmissions.



**MODEL WWVC  
COMPARATOR**

A 5-position dial switches *precisely* to any Standard Frequency—2.5, 5, 10, 15, or 20MC. It features built-in oscilloscope and speaker, comparator function selector, Collins plug-in filter for high selectivity, automatic gain and volume controls and adjustable threshold control which eliminates noise and other modulation in tick position.

Send for bulletin #557, "Using Standard Time and Frequency Broadcasts"

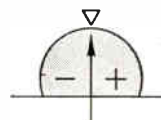

**SPECIFIC PRODUCTS**

Box 425, 21051 Costanso  
Woodland Hills, Calif.

1959  
Western Joint  
Computer Conference

(Continued from page 74A)

For further information on exhibits, address exhibits chairman:  
Mr. Harry K. Farrar  
Pacific Telephone & Telegraph Co.  
San Francisco, Calif.

Booth Numbers	Exhibitors
1	Rese Engineering, Inc.
2, 3	AMP Incorporated
4	Digital Equipment Corporation
5	Laboratory For Electronics
6	C. P. Clare & Company
7, 8	Ferranti Electric, Inc.
9, 10	The Pacific Telephone & Telegraph Co.
11, 12	Philco Corp.
	(See ad on page 35A)
13	Soroban Engineering, Inc.
14	Royal McBee Corporation
15, 40	Telemeter Magnetics, Inc.
16, 17	Librascope, Inc.
18	Bryant Computer Products Division
19, 20	The Thompson-Ramo-Wooldridge Products Co.
	(See ad on page 92A)
21	RESEARCH & ENGINEERING, The Magazine of Datamation
22, 23	Friden, Inc.
24, 25, 26	ElectroData Division of Burroughs Corporation
27	Sprague Electric Company
	(See ads on pages 3A, 5A)
28, 29	Hughes Aircraft Company
	(See ad on page 73A)
30	John Wiley & Sons, Inc.
31	F. L. Moseley Company
32, 33, 34	International Business Machines Corp.
35, 36	G. E. Moxon Sales
37, 38	Radio Corporation of America
	(See ads on pages 24A, 39A, 65A, 96A)
39	Aeronutronic Systems, Inc.
41	E. L. Berman Company
42, 43	Tally Register Corporation
44	Data Instruments Division of Telecomputing Corporation
45, 46, 47, 48	Remington Rand Division of Sperry Rand Corporation
49, 50	Computer Control Company, Inc.
51, 52	Bendix Computer Division of Bendix Aviation Corporation
53	Collins Radio Company
54	Electronic Associates, Inc.
101	Electronic Engineering Company of California
102, 103, 104	Ampex Corporation
201, 202, 203	Stromberg-Carlson—San Diego
301	General Electric Co. (Light Military Electronics Department)
302, 303	Berkeley Division of Beckman Instruments

featuring the unique

**Amperex**<sup>®</sup>

**FRAME  
GRID\***

...the world's most modern  
high-gain twin triode

**Amperex 6922**

a **RELIABLE** premium-quality tube for military systems requirements and exacting industrial applications

- low noise
- long-life cathode
- new "dimple" anode
- frame grid construction
- reliable radar cascode stages
- high-speed computer operation
- for HF, IF, mixer and phase-inverter stages
- high transconductance

**TYPICAL OPERATION**

Plate Supply Voltage .....	100 volts
Grid Supply Voltage .....	+9 volts
Cathode Bias Resistor .....	680 ohms
Plate Current .....	15 ma
Transconductance .....	12,500 $\mu$ mhos
	(min. 10,500; max. 15,000)
Amplification Factor .....	33
Equivalent Noise Resistance	300 ohms
Grid Voltage (rms).....	0.75 volts



**It's the  
FRAME GRID CONSTRUCTION  
that makes the difference!**

The frame grid is the closest approach to the ideal "physicist's grid"—the grid with only electrical characteristics but no physical dimensions.

**It results in:**

- higher transconductance
- tighter  $G_m$  and plate current tolerance
- low transit time
- low capacitances
- lower microphonics
- rugged construction

**Amperex FRAME GRID**

The grid-to-cathode spacing tolerance is determined by the carefully controlled diameter of grid support rods (center-less ground) and by frame cross-braces between these rods. Extremely fine grid wire eliminates the "island effect" usually encountered in conventional tubes with equally close grid-to-cathode spacing. Rigid support of fine wires reduces mechanical resonance and microphonics in the grid.

**CONVENTIONAL GRID**

Grid-to-cathode spacing tolerance depends on accuracy of grid dimension, obtained by stretching on a mandrel, and on tolerances of holes in top and bottom mica rod supports. Diameter of grid wire must be large enough to be self-supporting.

Other **Amperex** Premium Quality (PQ) frame grid tubes available in production quantities:

- 5847.....broadband amplifier pentode
  - 6688.....ruggedized broadband amplifier pentode
- plus other PQ and frame grid tubes for special reliability requirements and exacting industrial applications

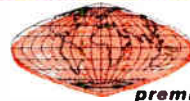

**Ask Amperex  
about  
premium-quality tubes  
for  
special reliability requirements**

Semiconductor and Special Purpose Tube Division  
**AMPEREX ELECTRONIC CORP.**  
230 Duffy Avenue, Hicksville, L. I., N. Y.

In Canada: Rogers Electronic Tubes & Components, 116 Varderhoof Avenue, Toronto 17, Ontario





## Precision-Matched Crystal and Oven Design

**Frequency Calibration Accuracy:**  $\pm 2$  ppm.

**Frequency Stability:** Better than  $\pm 1 \times 10^{-7}$  per 24 hrs. over ambient temperature range of  $-55^{\circ}\text{C}$  to within  $5^{\circ}\text{C}$  of specified temperature when used with appropriate oscillator.

**Secular Stability:** Better than  $1 \times 10^7$  per week after first 3 months usage.

**Thermostat:** Long life Edison glass-sealed thermostat for precise temperature control.

**Crystal Unit:** 1 mc JK G7AS, sealed in glass, Q in excess of 1 million. Series resistance 20 ohms max.

**Warm Up Time:** 15 min. from room temperature ambient. 30 min. from  $-55^{\circ}\text{C}$  temperature ambient.

**Size:** 1-7/16" x 1-7/8" x 3-5/8" seated height.

**Weight:** Seven Oz.



JK G7AS

Oven can be supplied to operate from either 117V AC or 28V DC. Average power at  $-55^{\circ}\text{C}$  less than 10W; at room temperature less than 5W. Maximum current @ 117V .2 Amps; @ 28V .8 Amps. Unit is available with hermetic seal octal plug header, or with complete package hermetically sealed. Meets applicable military specifications.

For further information write or call  
**JAMES KNIGHTS COMPANY**  
Sandwich, Illinois

## From CMC—0 cps to 220 kc



### INLINE-INPLANE FREQUENCY-PERIOD METER

CMC's Model 211B provides the most intelligent approach to production line and laboratory measurements of events-per-unit-time or period. The 211B combines a highly desirable large numeral ( $2\frac{1}{4}$ " H), inline-inplane digital readout with a high speed electronic counter and time base.

The Model 211B incorporates an automatic decimal point indication and provision for driving the CMC Model 40013 Digital Printer

Write for 4 page brochure which gives complete technical and applications information. Address CMC, 5528 Vineland Avenue, North Hollywood, California, Dept. 432.



**BURNDY**

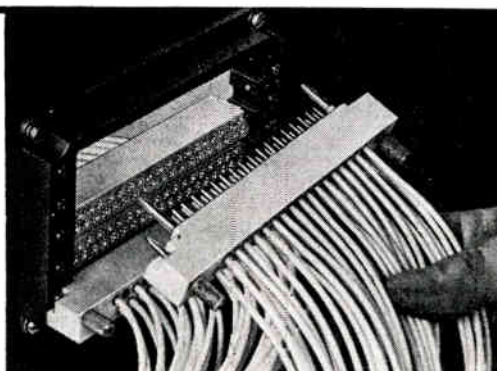

For complete information, write: DMAZON DIVISION, BURNDY—Norwalk, Connect.

59-1

## Professional Group Meetings

### ANTENNAS AND PROPAGATION

Albuquerque-Los Alamos—September 17

"Receiving Antenna Theory," D. Sparks, Sandia Corp.

Boston—November 24

"The Parabolic Torus and Its Variations," L. J. Dolan, Radiation Engineering, Inc.

Los Angeles—November 13

"Antenna Pattern Correlation," Robert K. Dahlin, North American Aviation.

San Francisco—November 18

Report on the Fifth Assembly of the Comité Spécial de l'Année Géophysique Internationale. (Committee on IGY Satellite and Tracking Program.) Henry L. Richter, Jr., California Institute of Technology Jet Propulsion Lab.

### ANTENNAS AND PROPAGATION

#### MICROWAVE THEORY AND TECHNIQUES

Philadelphia—October 22

"Measurement of Higher Order Modes in Rectangular Waveguide," David Lewis, University of Pennsylvania.

(Continued on page 82A)

## Here's Hughes-Treitler Know-How in Action!

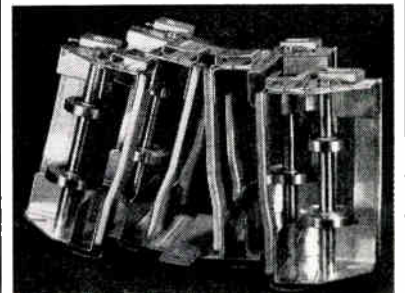

**Ammo Idler Booster**—The epitome of precision sheet metal fabrication—combining special forming, welding and spotwelding of stainless steel held to tolerance of  $\pm .010$ .

Hughes-Treitler development and production facilities are geared to today's challenging requirements. Our modern new plant is fully equipped to serve your metal manufacturing needs from simple parts to complex assemblies, from prototype to production work. Today, more industry leaders than ever depend on Hughes-Treitler for precision-quality and prompt availability. Send us your requirements for action!

Your reliable source for Chassis, Cabinets, Spinings, Enclosing Cases, Metal Stampings, Tools-Dies, Fixtures, Fabricated Sheet Metal, Precision Sheet Metal Parts, Arc, Acetylene and Spot Welding (certified for Army, Navy and Air Force Work).

### HUGHES-TREITLER MANUFACTURING CORP.

1045 39th Street  
Brooklyn 19, New York  
Phone: ULter 3-2950-1



where quality and service make the difference

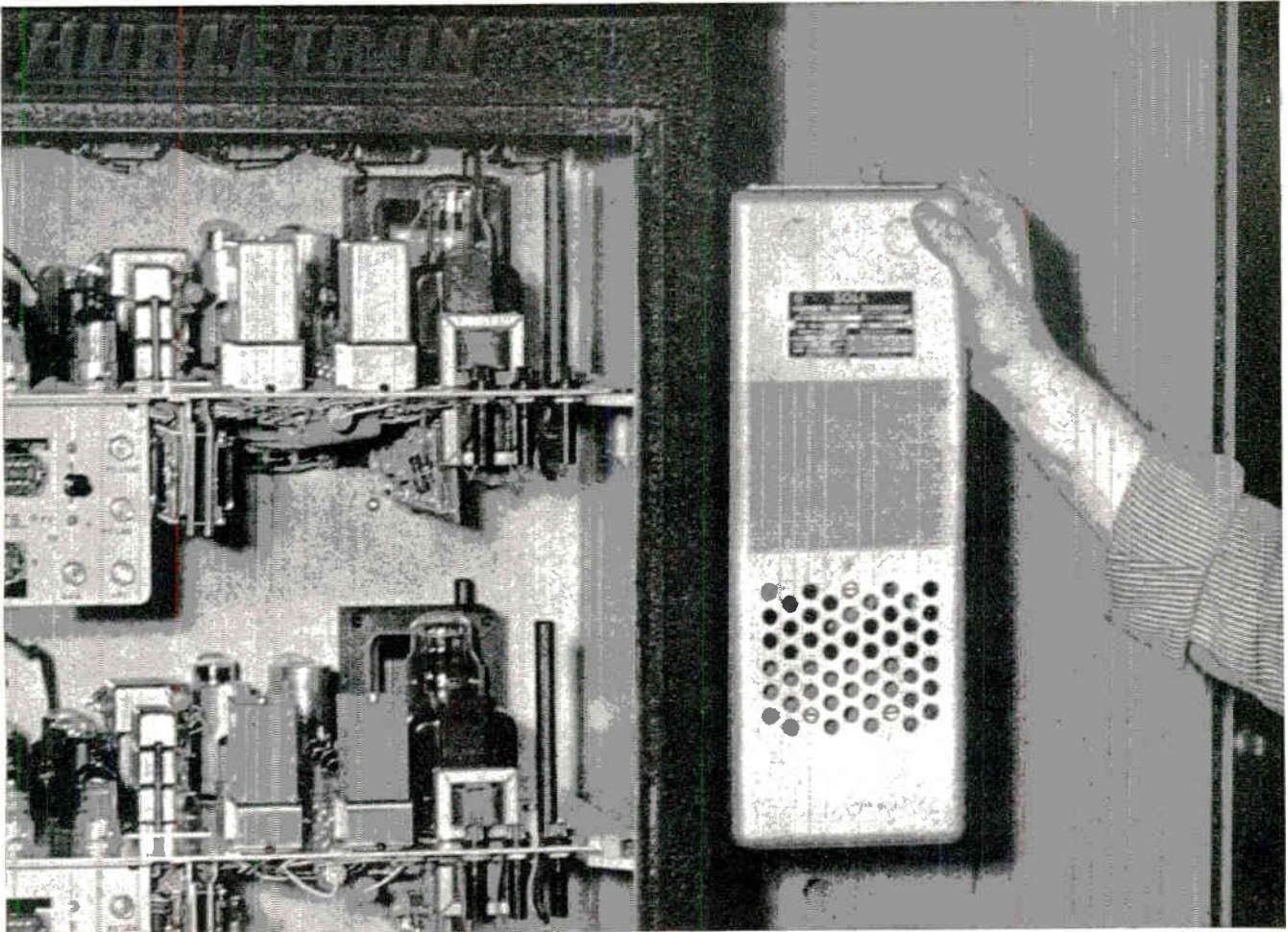

*Sola's Standard-type Constant Voltage Transformer, mounted at right of control cabinet, supplies regulated input voltage for dependable operation of Hurlertron printing register control.*

## Equipment delivers full-efficiency performance with input voltage Sola-regulated within $\pm 1\%$

Built in or added as an accessory, Sola Constant Voltage Transformers permit voltage-sensitive equipment to operate at full efficiency. Variations in line voltage as great as  $\pm 15\%$  are stabilized to within  $\pm 1\%$  of equipment nameplate voltage. This eliminates performance variations and failures caused by irregular voltage—highs, lows, or most transients. Sola-regulated input voltage also gives tubes and other components the correct electrical environment for full life.

The Sola Constant Voltage Transformer is a static-magnetic regulator whose action is automatic and virtually instantaneous—it responds to variations in input

voltage within 1.5 cycles. It has no tubes or moving parts and requires no manual adjustments or maintenance.

The Standard-type CV illustrated is only one of a complete line of Sola voltage regulators having wide application in electrical and electronic devices. Such special types as harmonic-free, filament, plate-filament, and adjustable harmonic-free transformers all provide the benefits of regulated input voltage. More than 40 models of these economical, compact regulators are available from stock. Sola also manufactures custom-designed units (in production quantities) to meet special needs.

**For complete data write for Bulletin 18-CV-170.**

Sola Electric Co., 4633 W. 16th St., Chicago 50, Ill., Bishop 2-1414 • Offices in principal cities • In Canada, Sola Electric (Canada) Ltd., 24 Canmotor Ave., Toronto 18, Ont.



CONSTANT VOLTAGE TRANSFORMERS

REGULATED DC POWER SUPPLIES

MERCURY LAMP TRANSFORMERS

FLUORESCENT LAMP BALLASTS

**A DIVISION OF BASIC PRODUCTS CORPORATION**



# See



# First.....

## TRAVELING-WAVE TUBES

Huggins Laboratories continues to offer the industry's broadest line of Traveling Wave Tubes. To maintain pace with demands for TWTS having increasingly stringent performance specifications, research and development programs are expanding rapidly at Huggins.

The studies involve extensions at both ends of the frequency spectrum as well as more detailed efforts on broadband low noise performance.

Heavy emphasis is given to light weight structures able to provide specific performance in severe environments.

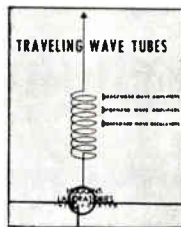

Write today for our latest short form catalog



### HUGGINS LABORATORIES, INC.

999 East Arques Avenue · Sunnyvale, California  
REgent 6-9330 TWX Sunnyvale, Calif. 116

(Continued from page 80A)

#### AUDIO

Albuquerque-Los Alamos—October 9

This meeting was principally a panel discussion of stereophonic techniques, Al Fite, Ray Avery, A. D. Pepmueller, Al Windblad, Jim Palmer, Gordon Bachand.

Boston—November 6

"Acoustic Noise Test Equipment," Merwin T. Anderson, Avco Mfg. Corp.

Milwaukee—November 11

"Audio Applications of Magnetic Tape," Jim Kamiske, Minnesota Mining and Mfg. Co.

San Francisco—October 28

"Loudspeaker Developments at Ampex Audio," Ward Widsner, Ampex Audio Inc.

Syracuse—November 6

"CBS Television New York Video Tape Facilities," K. B. Benson, Columbia Broadcasting Network.

#### AUDIO BROADCAST TRANSMISSION SYSTEMS

San Francisco—November 19

"The Crosby FM Multiplex System," Murray D. Crosby, Crosby Labs.

#### BROADCAST AND TELEVISION RECEIVERS

Los Angeles—November 20

"Automatic Television," Frank Pike, Kin Tel.

#### BROADCAST TRANSMISSION SYSTEMS

Omaha-Lincoln—November 14

Guided Tour of KOLN-TV XMTR, Tour leader, D. R. Taylor, KOLN-TV "What Management Expects of the Chief Engineer," A. J. Ebel; Guided Tour of the Nebraska State Trade School, Electronics Dept., Howard Gatliff.

Philadelphia—December 4

"The 50KW RCA Ampliphase Transmitter," C. J. Starmer, RCA.

#### CIRCUIT THEORY

Syracuse—November 18

"New High Frequency Transistors and Their Equivalent Circuits," J. M. Early, Bell Labs.

(Continued on page 85A)

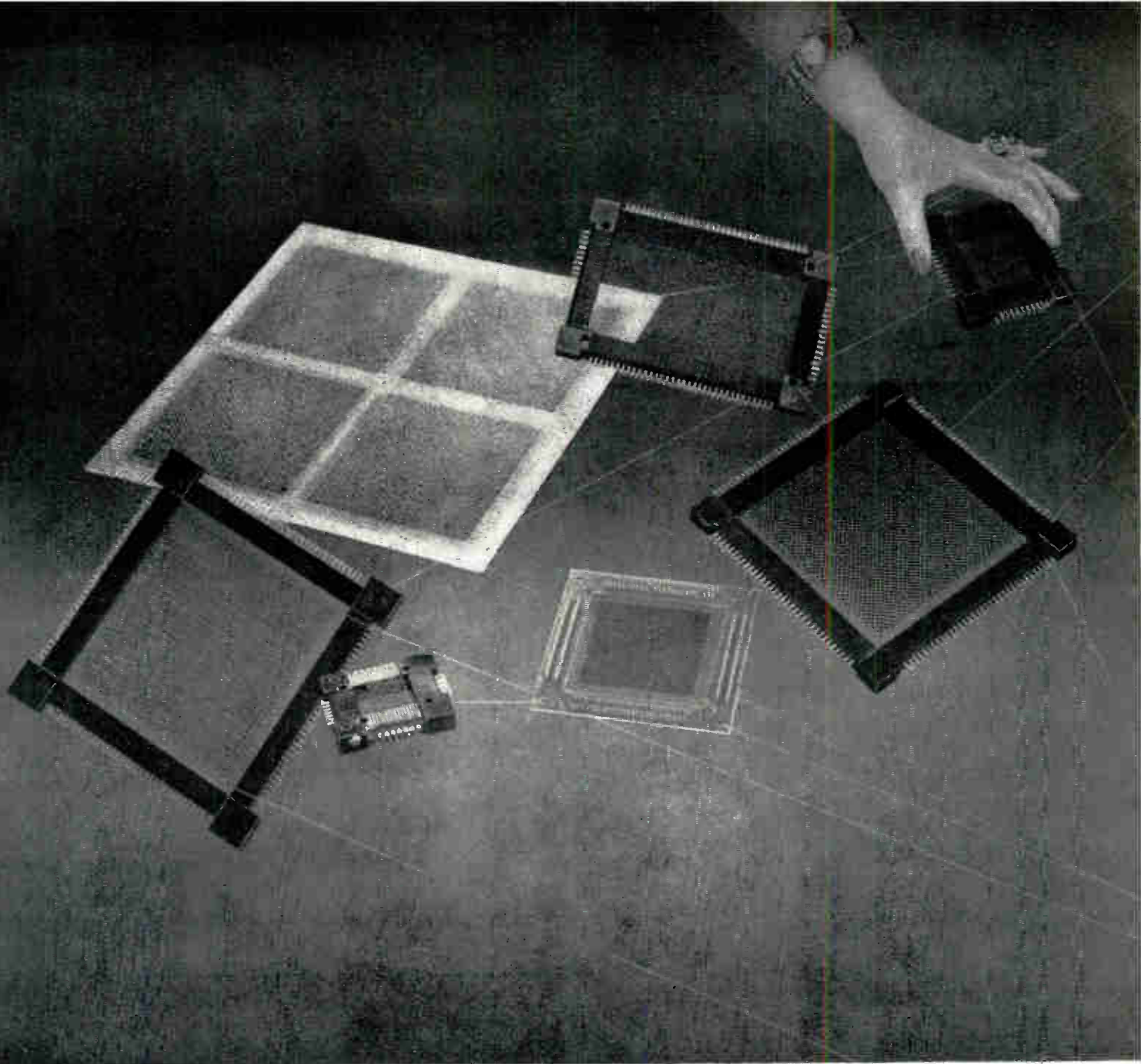

## Find the missing memory plane

The seven memory planes above each solved some special memory problem. There is one plane missing. It's the one which will solve your problem. You'll find the plane at General Ceramics which offers a complete memory plane service, backed by broad experience in the design, engineering and mass production of planes, frames and cores.

**DESIGN SERVICE**—An experienced design engineering staff stands ready to analyze your memory plane requirement, recommend and develop the plane that will meet your application in the most efficient and least expensive manner.

**MANUFACTURE**—Skilled factory personnel, utilizing the most advanced equipment and techniques and continually working in all phases of memory plane development and manufacture will produce the plane. General Ceramics has developed and

wired memory planes containing from 64 to 16,384 cores each. (Core sizes range from 50 mil OD to 80 mil OD.)

**QUALITY CONTROL**—An expanded testing department with fully automatic and semi-automatic testing equipment, developed at General Ceramics, assures you complete quality control and the highest standards of manufacture.

**STANDARD LINE**—Perhaps some of General Ceramics' line of standard memory frames will meet your requirements. Write for literature on General Ceramics standard planes. Address inquiries to General Ceramics Corporation, Kearsbey, N. J.—Dept. P.

**GENERAL CERAMICS**

ORIGINATOR OF THE SQUARE LOOP FERRITE

Manufacturers of FERRAMIC CORES, MAGNETIC MEMORY CORES, MEMORY PLANES, MICROWAVE FERRITES, SOLDERSEAL TERMINALS, HIGH TEMPERATURE SEALS, STEATITE, ALUMINA and CHEMICAL STONEWARE



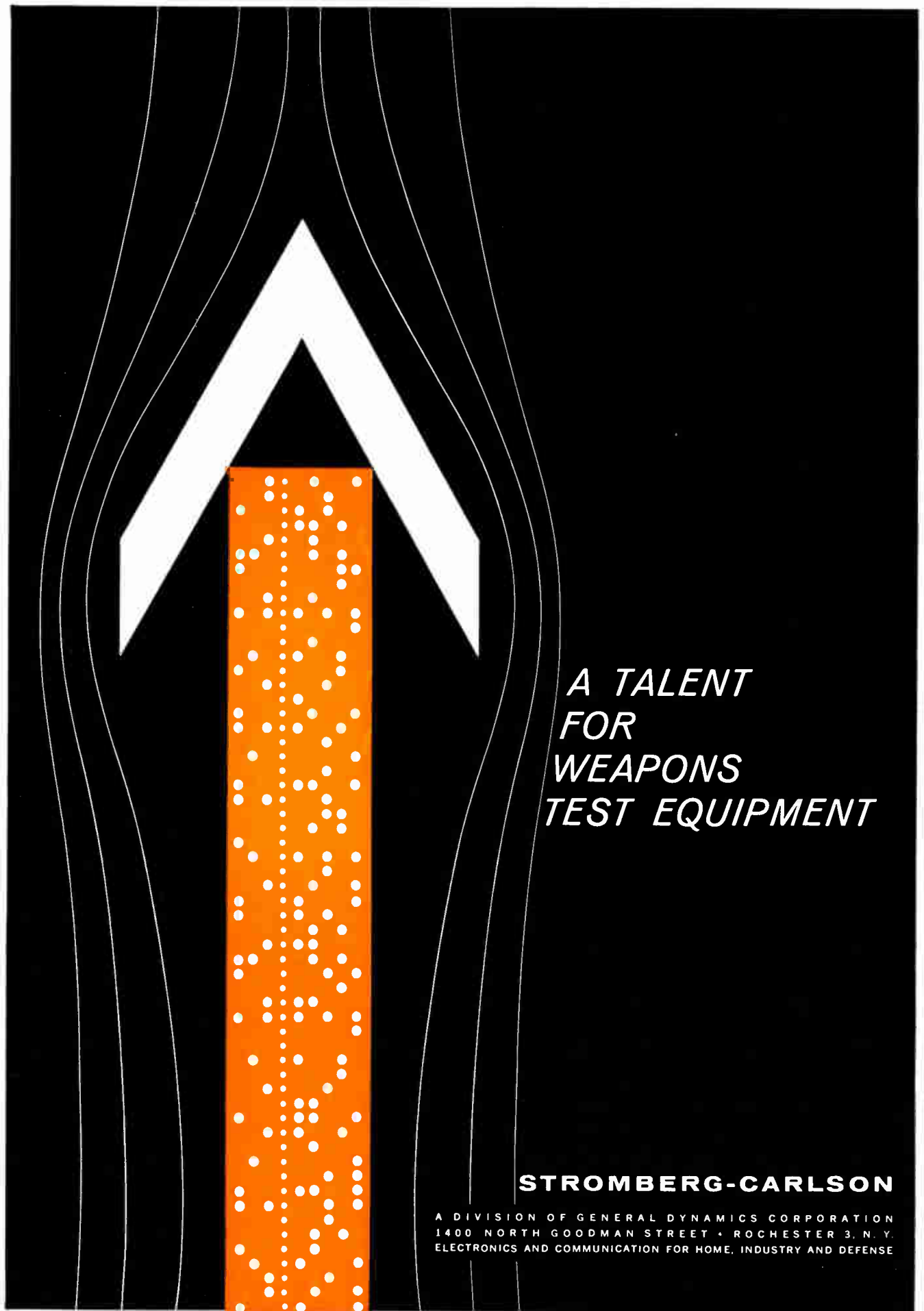

*A TALENT  
FOR  
WEAPONS  
TEST EQUIPMENT*

**STROMBERG-CARLSON**

A DIVISION OF GENERAL DYNAMICS CORPORATION  
1400 NORTH GOODMAN STREET • ROCHESTER 3, N. Y.  
ELECTRONICS AND COMMUNICATION FOR HOME, INDUSTRY AND DEFENSE

 **Professional Group Meetings**

(Continued from page 82A)

**COMPONENT PARTS**

Washington—November 3

"Recent Developments in Micro-Miniaturization at DOFL," N. J. Doctor, Diamond Ordnance Fuze Lab.

"Role of Semi-Conductors in DOFL's Micro-Miniaturization Program," J. R. Nall, Diamond Ordnance Fuze Lab.

"Micro-Circuitry," Mr. Stanton, Varro Mfg. Co.

**ELECTRON DEVICES**

Boston—November 18

"High Sensitivity Parametric Amplifiers," David L. Bobroff, Raytheon Mfg. Co.

Los Angeles—November 17

"Impressions From the Geneva Conference on Peaceful Uses of Atomic Energy," Ronald C. Knechtli, Hughes Aircraft Co.

Washington, D. C.—November 17

"Image Converters and Image Intensifiers for Military and Scientific Use," Myron W. Klein, U. S. Engineering Res. and Dev. Lab.

**ELECTRONIC COMPUTERS**

Akron—October 28

"Applications of Electronic Analog Computers," P. J. Hermann, Goodyear Aircraft Corp.

Binghamton—December 1

"GEVIC—General Electric Variable Increment Digital Computer," Donald Merz, General Electric Co.

Boston—November 17

"An Intelligent Machine for Proving Geometry Theorems," N. Rochester, M.I.T. (H. Gelernter—joint author).

Philadelphia—November 5

"Evolution of Automation," Nathan Cohn, Leeds and Northrup Co.

Twin Cities—November 5

"Transistor Circuits for Computer Application," Q. W. Simkins, Bell Telephone Labs.

**ENGINEERING MANAGEMENT**

Philadelphia—November 5

"A Significant Advance in Computer Reliability," A. P. Hendrickson, Remington Rand Univac.

Los Angeles—November 13

"Attitudes and Personalities in Evaluation Engineers," Gilbert Brighthouse, Occidental College.

(Continued on page 90A)

*Critical problems in weapons system testing: the reduction of test time with increased test reliability . . . the reduction of equipment costs with increased test flexibility.*

The search for a system meeting these requirements has led to the SCATE concept of standardized block design.

SCATE—Stromberg-Carlson Automatic Test Equipment—embodies existing hardware as a nucleus.

Implementation with special stimulus generators and response monitors rounds out the SCATE system, which meets the testing needs of any weapons system, component, or sub-assembly . . .

and is flexible, self-checking, self-calibrating . . . brings lower cost, new speed and reliability to weapons testing.

Brochure available on request.



**MUCON**

**SUBminiature ceramic capacitors**

offer the **BEST** solution



. . . through greater **DIMENSIONAL VERSATILITY**

The unlimited variety of MICRO-SMALL shapes and lead arrangements available in custom-made MUCON SUBminiature Ceramic Capacitors immediately result in space-saving assemblies. Almost any capacitance value, obtainable in any one of 12 different ceramic dielectric materials gives you the specific capacitor needed for your ideal REDUCED package.

MUCON's custom facilities are geared to an

**"IMMEDIATE SERVICE"**

policy no matter the quantity. Send for catalog/representative.

**MUCON CORPORATION**  
9 ST. FRANCIS ST., NEWARK 5, N. J.



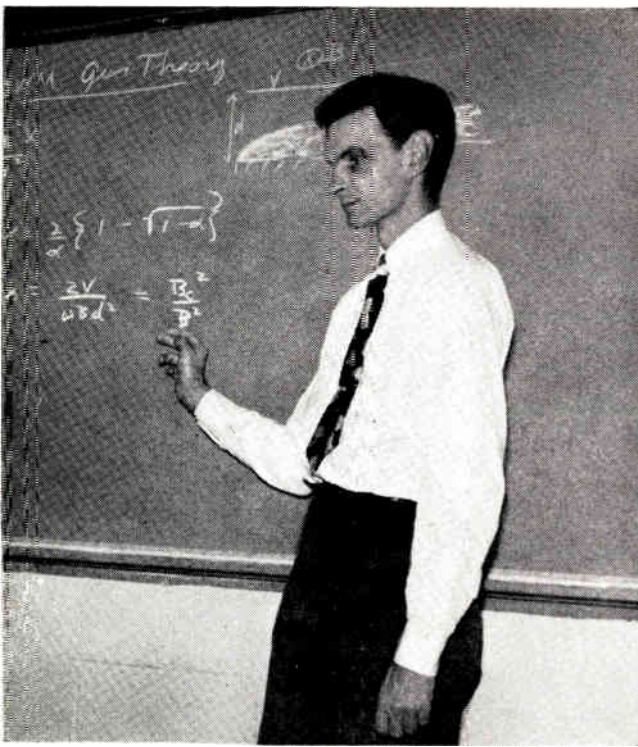

SCIENTISTS at Sylvania's Microwave Components Laboratory are probing advanced concepts in magnetic ferrites, gaseous electronics, and electromagnetic wave propagation.

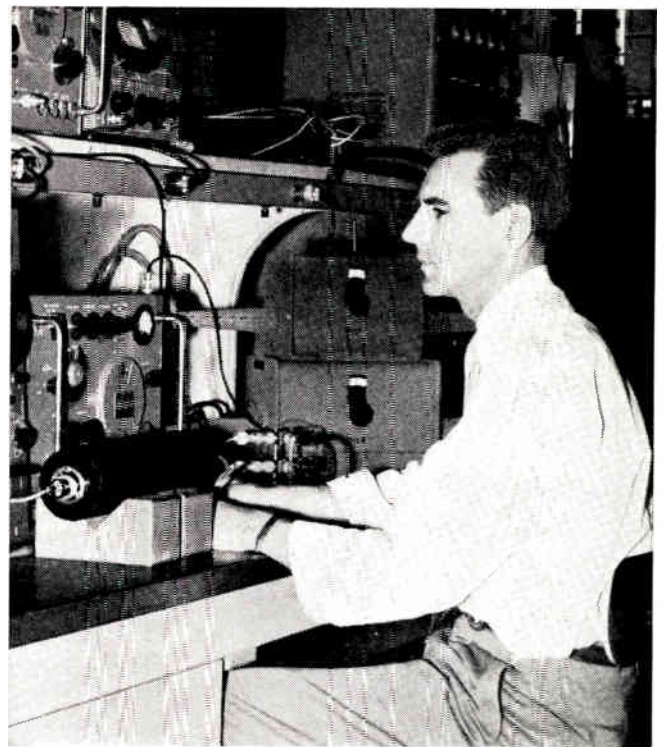

ENGINEERS at Sylvania's Mountain View microwave tube plant are incorporating the findings of advanced research into new microwave components for mass production.

## A SPECIAL REPORT ON SYLVANIA

# MEN OF MICROWAVE

**TWT, BWO, BWM, TR, ATR**—At Sylvania's Special Tube Operations, vital microwave components like these are the products of dedicated scientists and integrated plant facilities

### ADVANCED RESEARCH AND DEVELOPMENT

Today, nearly 500 scientists, engineers and technicians in three integrated facilities make up Sylvania's Special Tube Operations. Sylvania scientists, physicists and mathematicians, all leaders in their fields, are making bold new investigations in the fields of magnetic ferrites, gaseous electron physics, electromagnetic wave propagation and microwave circuitry. Their findings are being applied to the development of advanced microwave devices to meet the increasing needs of industry and government.

Some of the important developments already made possible include PM focus Traveling-Wave Tubes, Ka Band and Backward Wave Magnetrons, Coaxial Transmit-Receive

Tubes, Four-port ferrite circulators and C-Band Klystrons.

### TRAVELING-WAVE TUBES

PM Focus Traveling-Wave Tubes sharply reduce size and weight and eliminate the need of a power supply. Sylvania is producing over 15 Traveling-Wave Tube types, one of the most complete lines available in terms of frequency coverage and power levels.

### MAGNETRONS AND KLYSTRONS

New Sylvania magnetrons range from six-ounce miniatures and rugged Ka band types to Backward Wave Magnetrons. New BWM's have been developed for several frequency bands in medium to high power outputs. Current Klystron production includes over 20 types—from Disc Seal types to C-Band metal types.

### TR-ATR TUBES AND FERRITE DEVICES

Transmit-Receive Tubes in the new coaxial construction are also in production at Sylvania, along with over 20

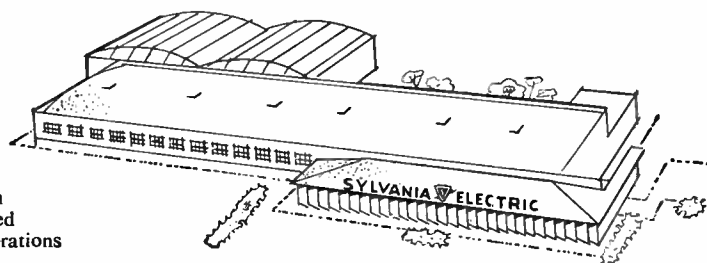

Microwave tube plant, Mountain View, Calif.—one of the integrated facilities of the Special Tube Operations



TECHNICIANS, shown here working side by side with engineers at Sylvania's Williamsport, Pa., plant, are applying new testing techniques to mass production.

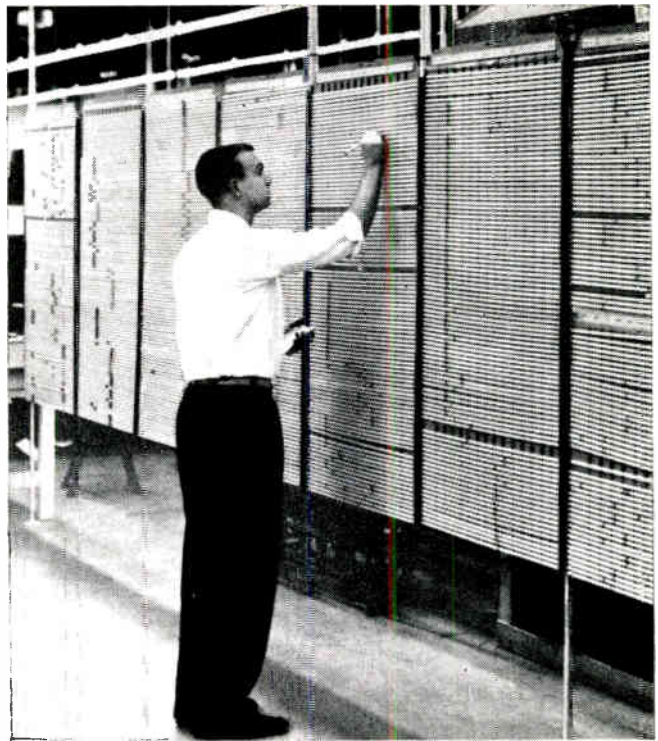

PRODUCTION engineers and specialists are developing new control techniques for better mass production of microwave components.

# LETTERS

different types of Klystrons. A full commercial line of ferrite devices ranges from wave guide and coaxial isolators to variable attenuators and other ferrite devices.

## MICROWAVE DIODES

Long an acknowledged leader in microwave crystal diodes, Sylvania is continuing to add new and improved versions to its extensive line. New mixer diodes are available that can extend radar coverage by as much as 18 per cent. New dual duty S and X band types that can be used in either forward or reverse applications are also available.

## OTHER S.T.O. PRODUCTS

In addition to a full range of microwave components Sylvania's Special Tube Operations also produces a complete line of counter tubes, planar triodes and trigger thyatrons.

S.T.O. stands ready to meet the industry's microwave components needs—for present production items in volume—for custom modifications—or for pure research and development in microwave electronics.



A. Microwave Crystal Diode, B. Ferrite Isolator, C. Coaxial TR Tube, D. Traveling-Wave Tube, E. Ka Band Magnetron.



# SYLVANIA

SYLVANIA ELECTRIC PRODUCTS INC.  
Special Tube Operations  
500 Evelyn Ave., Mountain View, Calif.

LIGHTING • TELEVISION • RADIO • ELECTRONICS • PHOTOGRAPHY • ATOMIC ENERGY • CHEMISTRY-METALLURGY



# 140 KMC

## ULTRAMICROWAVE\* EQUIPMENT BY

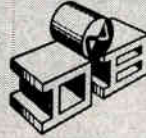

*-it works - it's accurate - it's available*

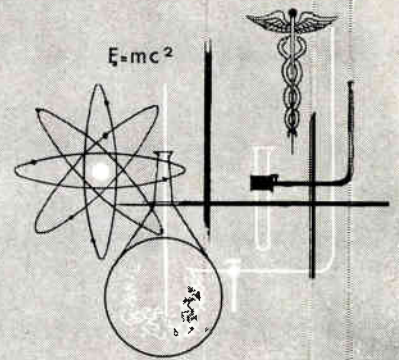

These millimeter wave units can greatly enlarge your scope of microwave activity. Research previously considered impractical at 140 KMC can now be carried on successfully.

De Mornay-Bonardi manufactures cavity wave-meters, crystal multipliers, crystal mounts, E-H tuners, and standing wave detectors specifically for use at 140 KMC. They work — we've been using these units effectively in our own laboratories for developing other items. These instruments are accurate — functionally as accurate as De Mornay-Bonardi equipment used at 90 KMC. You can order these units now — we're currently filling orders on 140 KMC instruments.

*Write for complete data*



**DE MORNAY-BONARDI**  
780 SOUTH ARROYO PARKWAY • PASADENA, CALIF.



CRYSTAL MULTIPLIERS

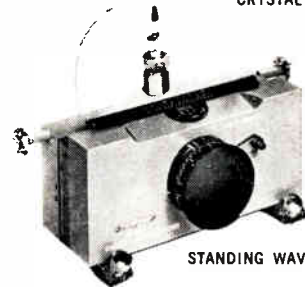

STANDING WAVE DETECTORS



CRYSTAL MOUNTS

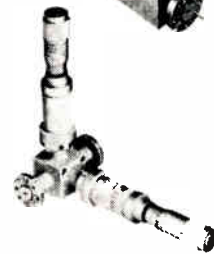

E-H TUNERS



CAVITY WAVEMETERS

\*TRADE MARK DE MORNAY-BONARDI

# GENERAL TRANSISTOR

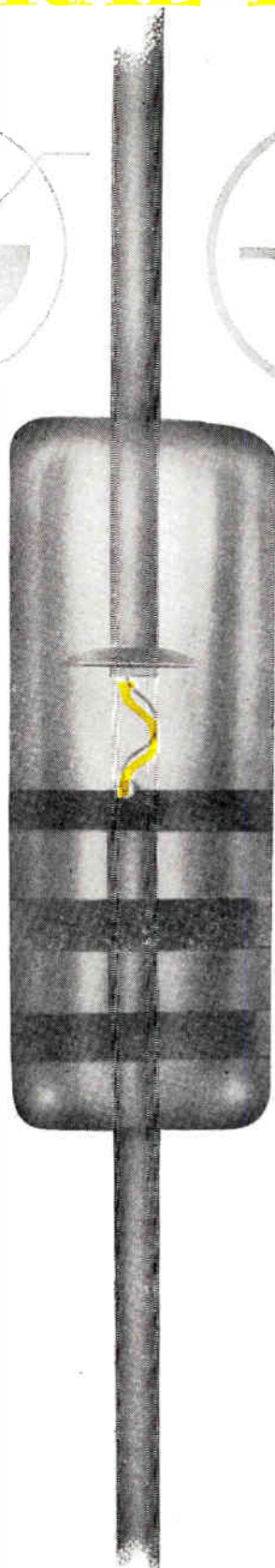
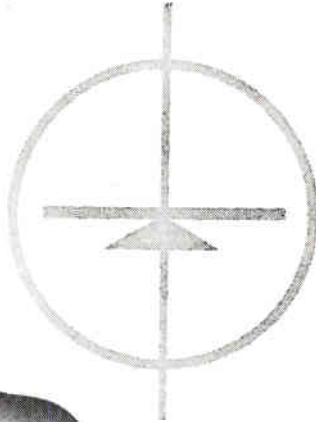
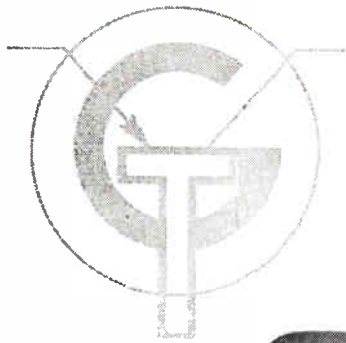

*another*  
QUALITY PRODUCT  
FROM GENERAL TRANSISTOR.

**new  
complete line of**

## GERMANIUM GOLD BONDED DIODES

**GENERAL TRANSISTOR IS NOW MAKING  
GERMANIUM SUBMINIATURE GOLD  
BONDED DIODES**

You may be assured that this new product line has the same high quality and reliability that has made General Transistor the Fastest Growing Name in Transistors. Experienced design engineers, quality materials, proven production techniques, and strictly enforced quality controls are your guarantees.

These diodes have been designed for computer, industrial and military applications where high reliability is of prime importance. They are hermetically sealed in a glass case with tinned leads. Their rugged construction makes them resistant to humidity, shock and vibration, and impervious to extreme environmental conditions.

Write today for Bulletin GD-10 showing complete specifications, diagrams and other engineering data.



ACTUAL SIZE



**GENERAL TRANSISTOR**  
C O R P O R A T I O N

91-27 138th Place  
Jamaica 35, N. Y.

In Canada: Desser E-E Ltd., 441 St. Francis Xavier, Montreal 1, Quebec  
FOR IMMEDIATE DELIVERY FROM STOCK, CONTACT YOUR NEAREST AUTHORIZED GENERAL TRANSISTOR DISTRIBUTOR OR  
GENERAL TRANSISTOR DISTRIBUTING CORP., 95-27 SUTPHIN BLVD., JAMAICA 35, NEW YORK FOR EXPORT: GENERAL  
TRANSISTOR INTERNATIONAL CORP., 91-27 138TH PLACE JAMAICA 35, NEW YORK



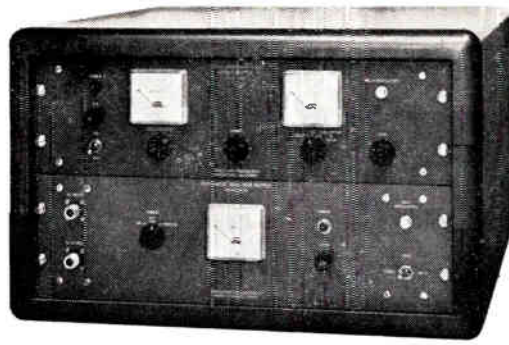

## BROAD BAND TWT AMPLIFIERS

M  
P  
E

DESIGNED TO OPERATE LOW AND MODERATELY POWERED TWT'S IN THE RANGE .5 TO 12.0 KMC.

THE TRANSISTORIZED CURRENT REGULATED SUPPLY FOR THE SOLENOID ASSURES CONSTANT FIELD.

MODULAR CONSTRUCTION USED WHICH IS READILY ADAPTABLE TO MEET YOUR SYSTEM REQUIREMENTS.

## MENLO PARK ENGINEERING

711 Hamilton Avenue

Menlo Park, California

Davenport 6-9080

PLEASE WRITE FOR COMPLETE SPECIFICATIONS

FOR PUBLIC  
ADDRESS, RADIO,  
and kindred fields,  
**JONES** 400  
SERIES  
**PLUGS & SOCKETS**  
*of proven quality!*



P-406-CCT



5-406-AB

### Double Contact Area

Phosphor bronze knife-switch socket contacts engage both sides of flat plug contacts.

Socket contacts phosphor bronze, cadmium plated. Plug contacts hard brass, cadmium plated. Insulation molded bakelite. Plugs and sockets polarized. Steel caps with baked crackle enamel. 2, 4, 6, 8, 10, 12 contacts. Cap or panel mounting.

Information on complete line, in Jones Catalog 22. Electrical Connecting Devices, Plugs, Sockets, Terminal Strips. Write



**Jones**

**HOWARD B. JONES DIVISION**  
CINCH MANUFACTURING CORPORATION  
CHICAGO 24, ILLINOIS  
SUBSIDIARY OF UNITED-CARR FASTENER CORP.



**Professional  
Group Meetings**

(Continued from page 85A)

### INSTRUMENTATION MILITARY ELECTRONICS

Washington—November 17

"Ultrasonic Light Modulator," Leo Levi, Fairchild Camera and Instrument Corp.

### MICROWAVE THEORY AND TECHNIQUES

Boston—November 13

"Microwave Amplification, Harmonic Generation, and Switching with Silicon Junction Diodes," Arthur Uhler, Microwave Associates.

Long Island—November 25

"Logarithmic Periodic Antennas," R. H. DuHamel, Collins Radio Co.

San Francisco—October 22

"Back-biased Diode Parametric Amplifiers," Hubert Hefner, Stanford Univ.

San Francisco—October 29

"Large Signal Properties of Parametric Amplifiers," Kenneth Kotzebue, Stanford Univ.

San Francisco—November 5

"Characteristics of Back-biased Diodes for Parametric Devices," James Gibbons, Stanford Univ.

San Francisco—November 12

"Ferrimagnetic Parametric Amplifiers," Perry Vartanaian, Microwave Engineering Labs.

San Francisco—November 19

"Beam-type Parametric Amplifiers," Robert Adler, Zenith Radio Corp.

Washington—November 4

"Frequency Translation by Phase Modulation," Dr. Elizabeth Ruta, Emerson Res. Lab.

### MILITARY ELECTRONICS

Boston—November 25

"The Coding of Sensory Information by Insect Nerves," Kenneth Roeder, Tufts College.

### PRODUCTION TECHNIQUES

Boston—November 17

"Value Analysis," Fred Sherwin, Raytheon Mfg. Co.

San Francisco—November 25

"Pilot Runs: A Function of Research Engineering, Product Engineering, or Manufacturing Engineering?" J. Hussey, Beckman-Berkeley.

(Continued on page 94A)

# cooling avionic systems

During World War II, Eastern Industries pioneered cooling systems for aircraft electronic systems. Now, thousands of installations later, and as the leader in this challenging field, Eastern is still pioneering.

Experience has been a springboard to new developments . . . compactness, simplification, refrigeration cycles. Research and development continue to play their vital parts in perfecting systems to overcome the new problems as expanded aircraft performance produces fantastic rises in temperatures.

If you have a challenging problem, come to the leader in the field for complete and creative engineering help.

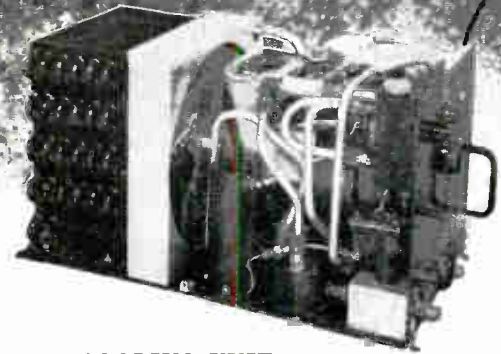

**COOLING UNIT**



**REFRIGERATION-TYPE**

## ELECTRONIC TUBE COOLING UNITS

Custom-made units, with or without refrigeration cycles, provide a method of maintaining safe operating temperature limits in electronic equipment. Standard sub-assemblies and components normally are used to create a custom-made design to fit your exact needs. Costs are minimized for these completely self-contained units by combining heat exchangers, fans or blowers, liquid pumps, reservoirs, flow switch, thermostat, and other common components.

Write for Eastern AVIONICS BULLETIN 340

**PIONEER OF THE THERMAL FRONTIER**



**Eastern**

**INDUSTRIES, INC.**  
100 Skiff St., Hamden 14, Conn.  
West Coast Office: 1608 Centinela Avenue • Inglewood 3, California



# THE DIVISIONS OF THOMPSON RAMO WOOLDRIDGE INC.



## RAMO-WOOLDRIDGE

While it is now a division of **Thompson Ramo Wooldridge Inc.** instead of a separate corporation, **Ramo-Wooldridge** remains an integrated organization for research, development, and manufacture of electronic systems for military and commercial applications. R-W's military work is covered by thirty-four contracts with the Army, Navy, Air Force, and other government and industrial organizations. These support a broad technical and—in some cases—manufacturing program in such varied fields as Electronic Reconnaissance and Countermeasures; Microwave Techniques; Infrared; Analog and Digital Computers; Air Navigation and Traffic Control; Antisubmarine Warfare; Electronic Language Translation; and advanced Radio and Wireline Communication.

In the commercial field, the well-known RW-300 industrial process control computer and associated equipment—the basis of the expanding business that **The Thompson-Ramo-Wooldridge Products Company** is doing with process industries—was developed and is manufactured by the Ramo-Wooldridge division.

Men, machines, and manufacturing know-how from other TRW divisions will be added as needed to build up the growing production strength of the Ramo-Wooldridge division. In other ways, too, the availability of the special skills and facilities of the rest of the corporate family will broaden the services R-W can offer to its customers. However, R-W's major systems work will continue to be done in an organizational framework that brings the engineering and manufacturing groups into close-knit project teams in the division's own integrated development and manufacturing facilities in both Los Angeles and Denver.

Ramo-Wooldridge is production-oriented in the sense that its end objective is the manufacture and sale of equipment. However, because of the highly technical nature of its product lines, the R-W division will continue to give unusual emphasis to maintaining a high degree of professional scientific and engineering competence.



The completely transistorized RW-30 airborne digital computer has a volume of 4.19 cu. ft. and weighs only 203 lbs., including power supply



Ramo-Wooldridge is responsible for advanced electronic sub-systems development for application with both current and projected missile programs

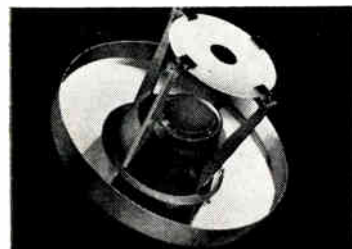

Important infrared "search and track" equipment is now being developed by Ramo-Wooldridge for applications in modern U.S. Military aircraft

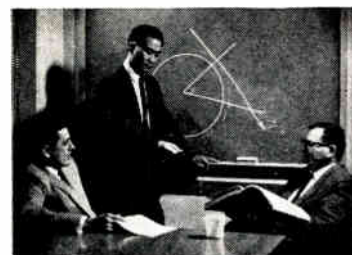

R-W is one of the major participants working with the Boeing Airplane Co. Systems Management Office on the U.S. Air Force Dyna-Soar project

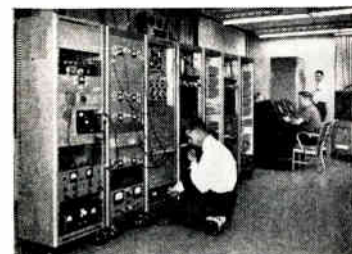

New type of radar data processing system developed by R-W materially increases the capabilities of ground defense radar

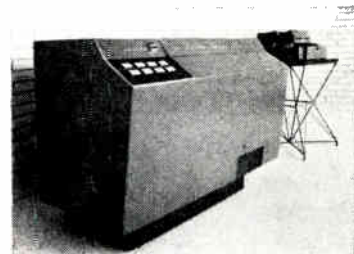

The RW-300 digital control computer has broad applications in automatic process control, data reduction and test facility operation



Systems are being developed for the ground processing and interpretation of photographic and other data collected by aerial reconnaissance devices



The Military and Ramo-Wooldridge are studying the use of automatic data processing techniques



In research laboratory studies at Ramo-Wooldridge, electrically-charged particles are contained and supported in a vacuum by an alternating electric field



# Thompson Ramo Wooldridge Inc.

MAIN OFFICES  
CLEVELAND 17, OHIO  
LOS ANGELES 45, CALIFORNIA

# PERFORMANCE

is the best proof of  
**SANBORN "350"**  
System Quality

- Flat frequency response from 0 to 100 cps
- Galvanometer natural frequency 55 cps
- Hysteresis less than  $\pm 0.1$  div.
- True velocity damping for galvanometer at all times — limiting ahead of output stage
- Current feedback power amplifiers eliminate effect of galvanometer resistance changes due to temperature
- Linearity 0.2 div. over entire 50 div. chart width
- Gain stability better than 1%
- Base line drift less than 0.2 div. over 20°C. changes
- Automatic stylus heat control
- Inkless recording in true rectangular coordinates

Only the Sanborn "350" oscillographic recording system offers *both* superior performance *and* operating versatility. You can interchange the plug-in preamplifiers — or use them separately with their own power supplies to drive a scope, meter, or optical oscillograph. The compact recorder (17½ inches tall), complete with transistorized power amplifiers and power supply, may also be used separately (sensitivity 0.1 volt/chart division). That's real versatility!

Recorder features include built-in paper footage indicator, paper take-up, 8" of visible record, simple paper loading from the front. Nine electrically controlled chart speeds are selected by pushbuttons, and have provision for remote control. Connections are also provided for output monitoring.

All these features — plus well-known Sanborn reliability — are yours in the Sanborn "350" system. Ask your local Sanborn Industrial Sales-Engineering Representative for complete facts — or write the Industrial Division in Waltham.

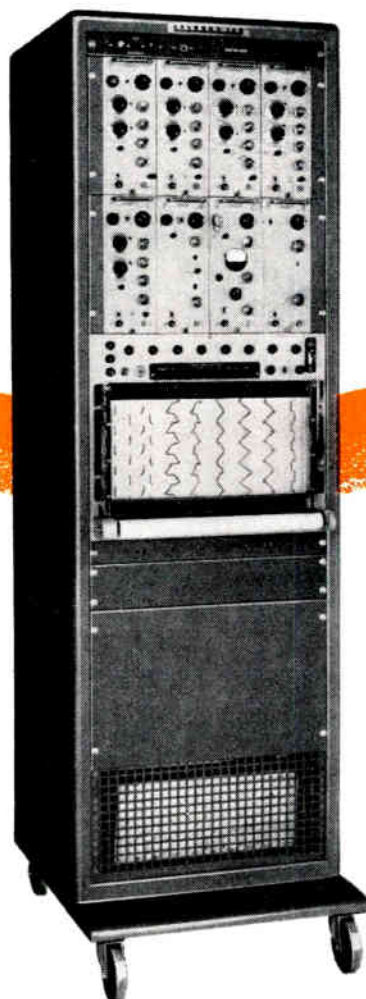

## 8-CHANNEL SANBORN "350"

Direct Writing Oscillographic  
Recording System . . .

also available  
with 6 channels

At the I.R.E. Show — Booths 3601-3605

**SANBORN COMPANY**  
175 Wyman Street, Waltham 54, Mass.





## FROM DESIGN TO PRODUCTION

**Stock Reflectors** — solid spun, 4 in. to 10 ft. in diameter • mesh, 4 ft. to 18 ft. in diameter • larger sizes or special shapes on request.

**Antennas** — up to 10,000 mc

**Large Waveguide Components**

*Prompt Delivery of any type antenna or reflector  
— precision built to your specifications.  
Write for technical data.*

# Ainslie

CORPORATION

312 Quincy Ave., Quincy, Massachusetts

## MARTIN OFFERS OPPORTUNITIES FOR CREATIVE ENGINEERS

Immediate openings in these areas:

**CIRCUIT DESIGN**

**SYSTEMS**

**INERTIAL GUIDANCE**

**COUNTERMEASURES**

**DIGITAL COMPUTERS**

**TEST EQUIPMENT DESIGN**

Top jobs for top men! New developments at Martin have created exciting and exceptional career opportunities for experienced electronic engineers.

For these creative and responsible assignments, we need high caliber men whose salaries will range from \$9,000 to \$15,000.

**WRITE TO:** William Spangler, Manager—Professional Employment  
Department P-2, The Martin Company  
Baltimore 3, Maryland

# MARTIN

BALTIMORE



**Professional  
Group Meetings**

(Continued from page 90A)

### RELIABILITY AND QUALITY CONTROL

Los Angeles—October 20

"Environmental Testing of Explorer Satellites," William S. Shipley, Jet Prop. Lab., Cal. Tech.

Philadelphia—November 5

"A 100,000 Component Failure-Free System, A Credit to Management, Engineering, or Manufacturing?" A. P. Hendrickson, Remington Rand Corp.

### TELEMETRY AND REMOTE CONTROL

Detroit—December 3

"Increasing Transmission Distance in Radio Telemetry," Lawrence Rauch, University of Michigan.

San Francisco—November 18

"A High Speed Air to Ground Telemetry Link," Jack T. Nawrocki, Philco Corp.

### VEHICULAR COMMUNICATIONS

Detroit—Nov. 26

"The Wire Line and Your Mobile Radio System," Arden Johnson, Michigan Bell Telephone Co.

Florida West Coast—November 19

"Microwave System Planning and Applications," Lee Elmore, Motorola Communications and Electronics Inc.

### VEHICULAR COMMUNICATIONS COMMUNICATIONS SYSTEMS

Philadelphia—November 5

"Speech, Hearing and Communications," E. E. David, Jr., Bell Telephone Labs.

Philadelphia—November 24

"Microwave and Scatter Communications for the Eglin Gulf Missile Testing Range," T. Jack Heckleman, Philco Corp.

Because the product listings in the IRE DIRECTORY are logically arranged the way an engineer thinks, under four great major classifications that cover the entire radio-engineering field, you can find the product you want, and the names of the firms who make it, faster and more easily than in "terminology-index" types of listings. Advertisements are logically positioned near the product listings which describe them, to give you more information on the companies you'll want to deal with, and the easy-to-use Reader Service Card brings you quick additional data.

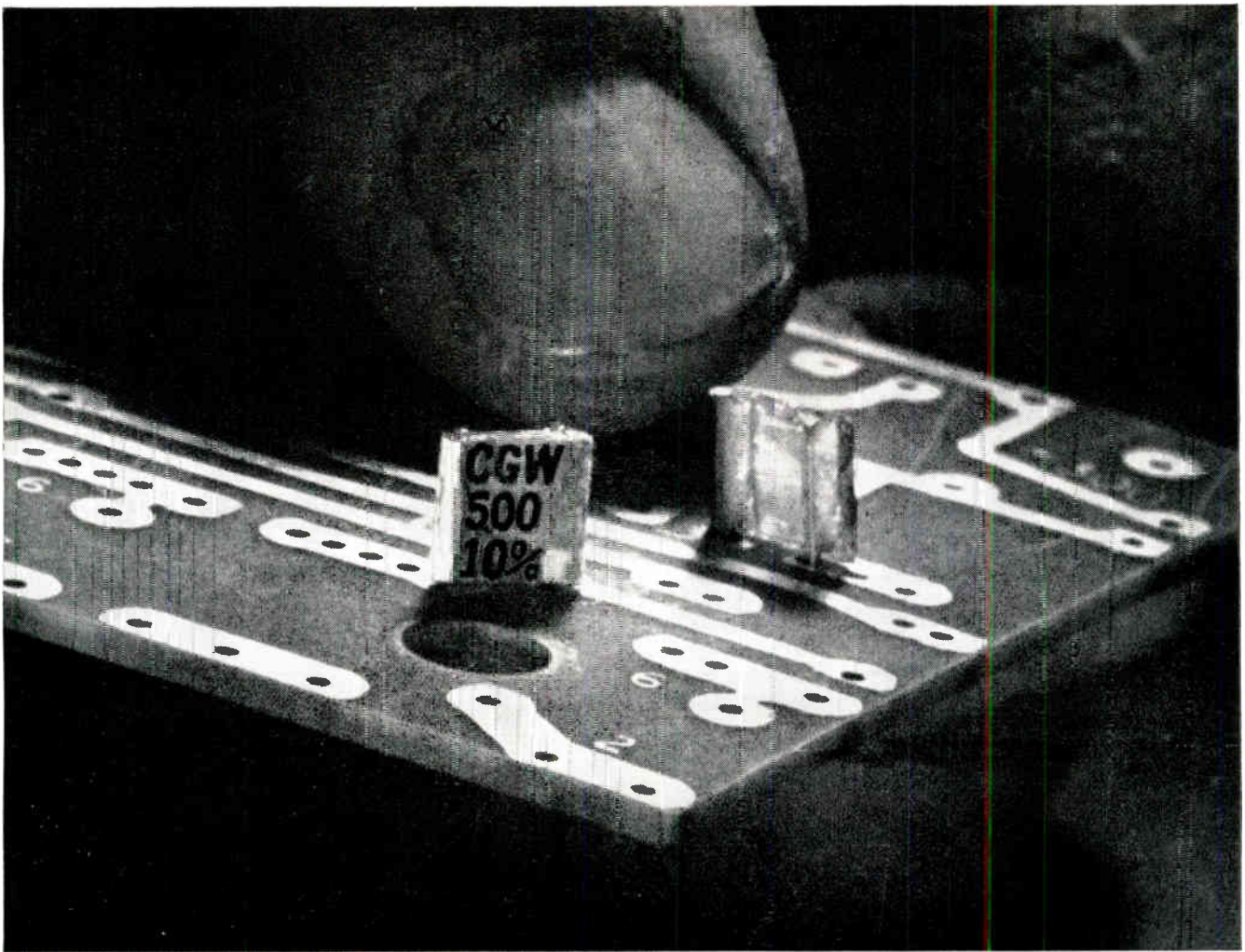

Truly sub-miniature, these capacitors were devised especially for printed circuits and automatic assembly. Since they retain all the properties of larger, pig-tail capacitors, they are well suited to general circuitry as well.

## Now—Corning Fixed Glass Capacitors in new sub-miniature size

Packing up to 1,000 uuf at 300 V. and 125°C. into 0.010 cubic inches, these new capacitors are designed for use on printed circuit boards and all applications requiring high-quality components. Advantages include fixed temperature coefficient, high insulation resistance, low dielectric absorption, the ability to operate under high humidity and high temperature conditions, plus the added advantage of increased miniaturization.

You can now up-grade your specs for miniature capacitors used on printed circuits.

These new capacitors measure only  $\frac{9}{32} \times \frac{19}{64} \times .115$ , yet have capacitances up to 1000 uuf at a full 300 V. rating at 125°C. Such exceptional thinness makes these capacitors particularly well suited for vertical mounting in small, high-rated units.

The capacitors have high temperature soldered leads which allow direct connection to circuit boards. The leads are .100 inches long, fitting most circuit board thicknesses and eliminating any trimming.

**Reliable** • Since the new construction is extremely simple, reliability is correspondingly high.

**Rugged** • These capacitors, when mounted, successfully withstand a standard five-hour vibration cycling test at 10 to 55 cycles, 15G Max.

Known as WL-4 capacitors, these units are in mass production. Your inquiries concerning data and prices are welcome.

### FEATURES

1. to MIL C-11272A except smaller
2. 1 to 1,000 uuf
3. 300 volts
4. 125°C. full rating
5. .010 cubic inches

*Corning means research in Glass*



**CORNING GLASS WORKS, Bradford, Pennsylvania**

*Electronic Components Department*



# 3 = 1

3 thoroughly competent departments—Research, Engineering and Manufacturing—equal one complete systems capability. The Mechanical Division of General Mills is your single source for technical problem-solving!

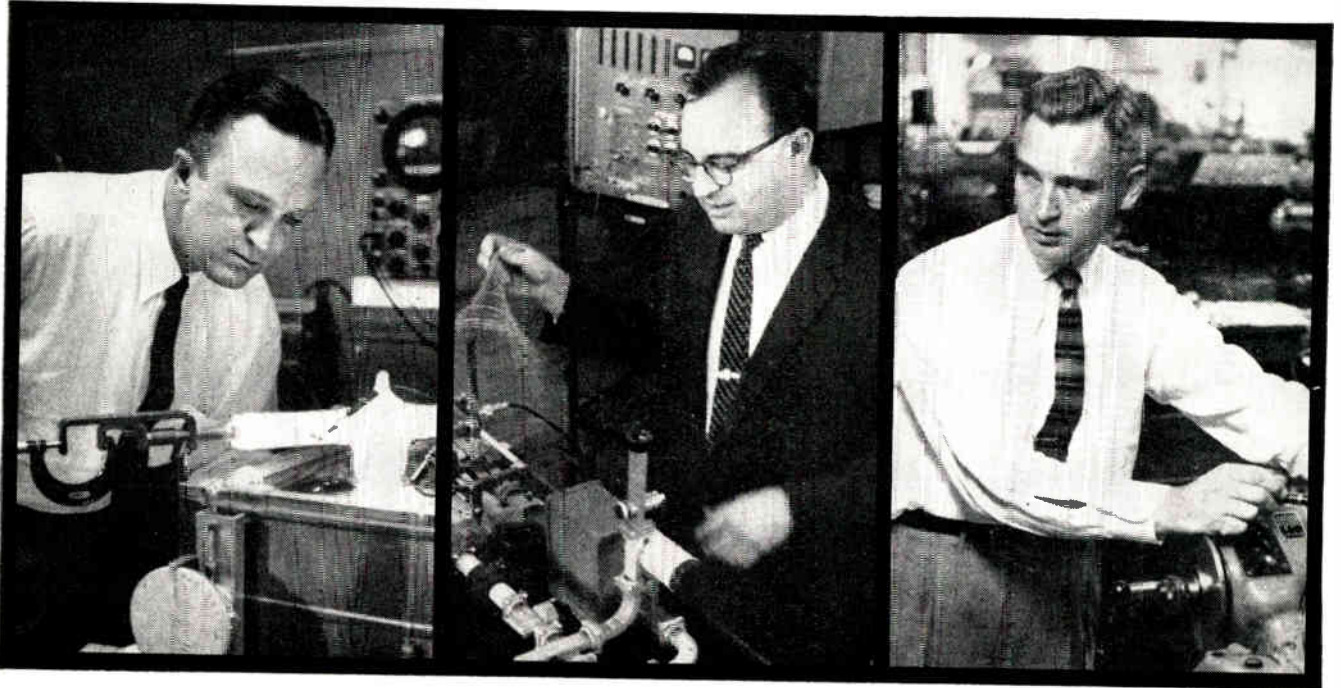

Left—*Dr. John Barkley*, Director of Research, heads the department that moves from hypotheses to facts, clarifying the present, probing the future, recording findings for comparison and evaluation.

Center—*Dr. Howard Baller*, Director of Engineering. His department gives substance to ideas, showing *how* these ideas can be converted into practical military and industrial products.

Right—*Kenneth J. Carlson*, Director of Manufacturing, and his men transform theories and designs into physical realities, utilizing the skills of all three departments to meet every production requirement—*on schedule!*

Mechanical Division teamwork plays a vital role in *all* our current activities, including: *Search and Track Systems* (infrared optics, visual optics, radar, antennas, slave platforms) *Guidance and Navigation Systems* (computers, and inertial or navigational platforms) *Underwater Ordnance Weapons* (torpedoes, depth charges and related mechanisms) and *Missile Sub-Systems* (mechanical, electro-mechanical or electronic controls). For complete details, address inquiries to: Dept. P1-2,

## MECHANICAL DIVISION

1620 Central Avenue, Minneapolis 13, Minnesota



To wider worlds—through intensive research • creative engineering • precision manufacturing

# MOTOROLA mesa transistors

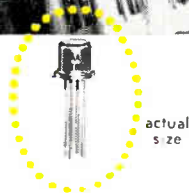

*a progress report*

BY DR. C. LESTER HOGAN / General Manager

The first two Motorola Mesa transistors, the 2N695 switch (with a rise time less than  $3 \mu\text{sec}$ ) and the 2N700 (a 200 mc amplifier), were announced in August, 1958. Our pilot line facility at that time had a capacity to produce several hundred devices per day and our plans were to move into full scale production during the first few months of 1959. We expected this capacity to be able to meet any possible demand which our customers might place on us. However, the reception of these devices surpassed all expectations and requests for samples far exceeded our pilot production. Naturally, we have been very happy with the response, but our main concern has been the integrity of our product, and we have steadfastly refused to proceed with expanded production until we satisfied ourselves that each new process would yield the extremely high quality and reliability which we intend to be synonymous with the name Motorola Mesa.

As many of you already know, the two Motorola Mesa transistors now available are unusual devices. The active region of these transistors covers an area less than that of a human hair. Yet they are manufactured by methods so precise that they do not need to be selected, as are most transistors today, but are made within extremely close tolerances to the electrical and mechanical characteristics desired. The elements which are used in their fabrication have

been carefully selected so that each and every transistor can be baked out under high vacuum at  $300^\circ\text{C}$  before being hermetically sealed.

This is just one of the extra steps we at Motorola are taking to insure the integrity and reliability of these devices. The size of the transistor, the ultra-precise methods which we use in its fabrication, and the basic design of the Motorola Mesa itself all combine to give you the most reliable transistor the industry has yet seen. There is no doubt in our minds that the Mesa is "the" transistor of the future.

With this conviction guiding us we have been putting great emphasis on production tooling for Motorola Mesas and within a few weeks we shall swing into large scale manufacture of the Mesa transistor. At that time, we shall be in a position to accept production orders for these transistors of the future.

Even with this emphasis on production, basic research and development has not been neglected. Motorola's development team has expanded its study of the Mesas. Extensions of the design to higher power and higher frequency are ready for introduction in the very near future. Before long, we shall have a whole family of Motorola Mesas with the same integrity and reliability of these first two devices . . . a family of devices that will open up entirely new areas of transistor application.

REGIONAL  
OFFICES:

RIDGEFIELD, NEW JERSEY  
540 Bergen Boulevard  
Whitney 5-7500

CHICAGO 44, ILLINOIS  
4900 West Flournoy Street  
Esterbrook 9-5200

HOLLYWOOD 28, CALIFORNIA  
6555 Sunset Boulevard  
Hollywood 5-3250



"DEPENDABLE QUALITY - IN QUANTITY"

**MOTOROLA  
SEMICONDUCTORS**

MOTOROLA INC., 5005 E. McDOWELL, PHOENIX, ARIZONA



# BALLANTINE VOLTMETER

Model 300-D

Price: \$235.

gives you  
utmost

Accuracy,

Stability

and

Reliability

... plus  
these  
features



- Long life • High input impedance • Wide voltage range
- Large easy to read meter with overlap • High accuracy at any point on the scale • Light, compact, rugged

## SPECIFICATIONS

**VOLTAGE RANGE:** 1 millivolt to 1000 volts rms. in 6 decade ranges (.01, .1, 1, 10, 100 and 1000 volts full scale).

**FREQUENCY RANGE:** 10 to 250,000 cps.

**ACCURACY:** 2% throughout voltage and frequency ranges and *at all points on the meter scale.*

**INPUT IMPEDANCE:** 2 megohms shunted by 15  $\mu$ f except 25  $\mu$ f at lowest range.

**DECIBEL RANGE:** -60 to +60 decibels referred to 1 volt.

**STABILITY:** Less than 1/2% change with power supply voltage variation from 105 to 125 volts.

**SCALES:** Logarithmic voltage scale reading from 1 to 10 with 10% overlap at both ends; auxiliary linear scale in decibels from 0 to 20.

**AMPLIFIER CHARACTERISTICS:** Maximum voltage gain of 60-DB; maximum output 10 volts; output impedance is 300 ohms. Frequency response flat within 1 DB from 10 to 250,000 cps.

**POWER SUPPLY:** 115/230 volts, 50-420 cps, 35 watts approx.

Write for catalog for complete information.



**BALLANTINE LABORATORIES, INC.**

Boonton, New Jersey



Membership



The following transfers and admissions have been approved and are now effective:

### Transfer to Senior Member

Adams, R., Washington, D. C.  
 Benner, B., St. Charles, Mo.  
 Brannum, D. R., Livermore, Calif.  
 Briggs, G. R., Princeton, N. J.  
 Burnett, J. H., Upper Montclair, N. J.  
 Byrne, G. C., Mountain View, Calif.  
 Fournier, R. V., Somerville, N. J.  
 Friedrich, S., Bayside, L. I., N. Y.  
 Frost, W. O., Huntsville, Ala.  
 Gariano, W. F., Newtown Square, Pa.  
 George, E. M., Daytona Beach, Fla.  
 Glowacki, W. V., Jr., Anaheim, Calif.  
 Greene, K., Rockaway, N. J.  
 Hannan, P. W., Great Neck, N. Y.  
 Helwig, W. J., Kearny, N. J.  
 Hess, H. M., Detroit, Mich.  
 Hill, G. V., Winston-Salem, N. C.  
 Hoeln, G. L., Jr., Dallas, Tex.  
 Hoffman, C. H., South Bend, Ind.  
 Irvine, M. M., Morristown, N. J.  
 Jacobson, R. E., Los Angeles, Calif.  
 Jacques, G. E., Independence, Ohio  
 Johl, M. J., North Bellmore, L. I., N. Y.  
 Kaufmann, W., Huntington, L. I., N. Y.  
 Kelly, R. W., Houston, Tex.  
 Kirsch, A. L., Elkins Park, Pa.  
 Lee, F. B., Pointe Claire, Que., Canada  
 Lempert, I. E., Metuchen, N. J.  
 Maglathlin, R. N., Norwell, Mass.  
 Marsh, R. F., Northfield, Vt.  
 Meissinger, H. F., Los Angeles, Calif.  
 Miller, H. M., Nyack, N. Y.  
 Mochan, H. L., University City, Mo.  
 O'Connor, R. A., River Edge, N. J.  
 Orlmer, R. E., Northport, L. I., N. Y.  
 Priest, F. R., New Hartford, N. Y.  
 Robinson, J. H., III, San Pedro, Calif.  
 Rudwick, B. H., Johnson City, N. Y.  
 Salerno, J., Washington, D. C.  
 Scott, H. A., Encino, Calif.  
 Segal, R. J., Philadelphia, Pa.  
 Serang, A. M., Palo Alto, Calif.  
 Sheridan, T. R., Shoreham, L. I., N. Y.  
 Sienkiewicz, L. J., Metuchen, N. J.  
 Soja, M., South Plainfield, N. J.  
 Spaulding, G. B., Dallas, Tex.  
 Unger, H. G., Red Bank, N. J.  
 Unger, J. H., Houston, Tex.  
 Vorndran, J. W., Los Angeles, Calif.  
 Willibald, G. E., Holloman AFB, N. M.

### Admission to Senior Member

Abercrombie, S. D., Tadley, Hants., England  
 Ahearn, J. L., Jr., Washington, D. C.  
 Allen, F. W., Los Angeles, Calif.  
 Aoyagi, K., Kyoto, Japan  
 Caruso, C., Verona, N. J.  
 Coleman, S. B., North Andover, Mass.  
 Enderle, T. L., San Antonio, Tex.  
 Filkoff, H. L., Los Angeles, Calif.  
 Freeman, A. B., Flushing, L. I., N. Y.  
 Gee, W. S., Washington, D. C.  
 Gibbs, T. E., Arlington, Tex.  
 Gold, A., Riverton, N. J.  
 Grubbs, W. C., Jr., Garland, Tex.  
 Gutowski, J. L., Harrison, N. J.  
 Kimball, D. E., Yellow Springs, Ohio  
 Lapp, D. N., Woodbury, N. J.  
 Lavine, J. M., Walrham, Mass.  
 Lehr, S. N., Cincinnati, Ohio  
 Locke, A. S., Mountain Lakes, N. J.  
 Lynch, C. F., Rinebeck, N. Y.

(Continued on page 101A)

LARGE CAPACITY FILES / RAPID RANDOM ACCESS / EFFICIENT ROUTINE PROCESSING

A system with *complete* files, *complete* data and *complete* processing . . . to handle all operations.

It's a proven fact . . . that of the total work necessary to put a missile into the air, a staggering 90% is primarily logistical and involves the control of many individual maintenance parts. This figure becomes compounded as the number of inactive, but ready-to-fire missiles increases . . . and keeping track of their individual needs becomes a herculean task.

It is clear that an efficient system of organizing, filing and searching great masses of data at high speeds, and at realistic costs is necessary. *The Magnavox Company* answers the need for "discrete" unit data record handling for both government and industry with *Magnacard*.

*You are invited to investigate and make use of these new techniques . . . write today for illustrated brochure.*

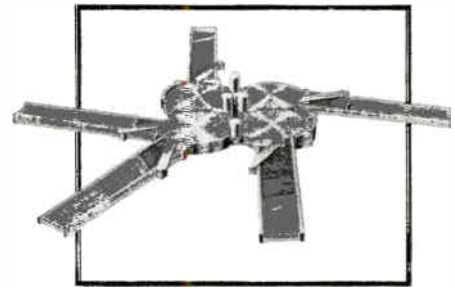

**Magnacard**

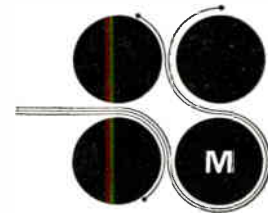

DATA HANDLING EQUIPMENT BY

# Magnavox

FOR MILITARY LOGISTICS AND INDUSTRY

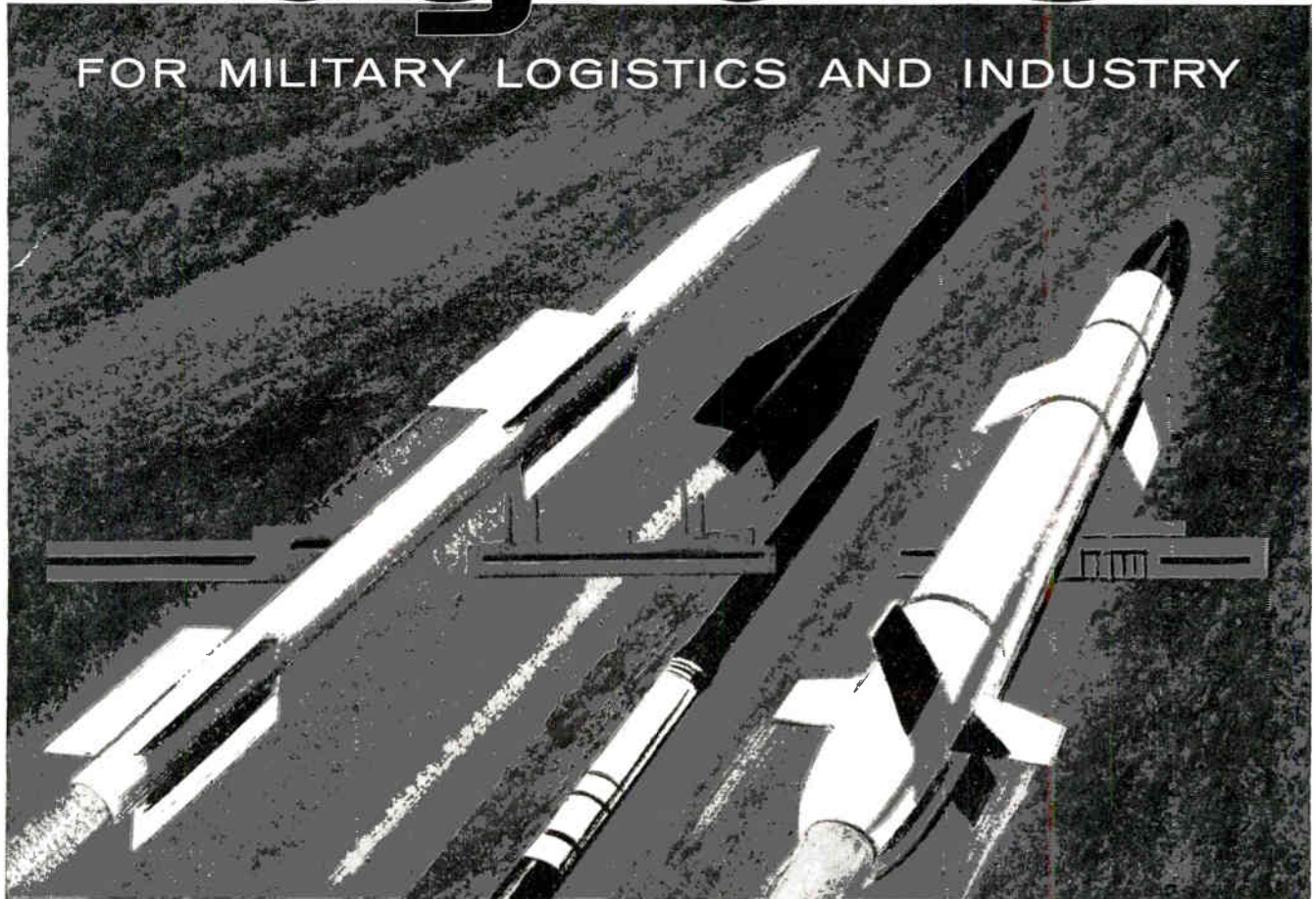

THE MAGNAVOX CO. • DEPT. 42 • Government and Industrial Division • FORT WAYNE, IND.





Preferred  
Tube Type

**RCA-6L6-GB** offers



# RECORD PERFORMANCE

to designers of "juke" box, public address and home phonograph equipment



Twenty-two years ago RCA introduced the 6L6 beam-power tube and a new era in high power audio system designs was born. Today, the modern version of this famous prototype, the 6L6-GB is one of 62 Preferred Tube Types available to meet your TV, AM and FM receiver requirements.

As a Preferred Tube Type, the 6L6-GB receives thorough and continuous evaluation for performance, quality and low cost. For example, the RCA-6L6-GB was developed with a smaller envelope than the 6L6-G to meet the need for compact modern design. The cathode is made of a specially selected alloy to provide increased strength

and rigidity...plate and mica supports are thicker and sturdier for increased heat dissipation.

Ask your RCA Field Representative for full information on the RCA Preferred Tube Types. Or write for technical data to RCA Commercial Engineering, Section B-95-DE, Harrison, N. J.

**FREE! SLIDE GUIDE TO PREFERRED TUBE TYPES** helps you quickly select the tube needed for a specific service. Puts base diagrams and other important characteristics at your fingertips. Call or write your RCA Field Office for your free Slide Guide.



**RADIO CORPORATION OF AMERICA**

*Electron Tube Division*

*Harrison, N. J.*

**RCA Field Offices:**

**EAST:** 744 Broad St., Newark 2, N. J.  
Humboldt 5-3900

**MIDWEST:** Suite 1154, Merchandise Mart Plaza  
Chicago 54, Ill., Whitehall 4-2900

**WEST:** 6355 E. Washington Blvd.  
Los Angeles 22, Calif., RAYmond 3-8361

# Proceedings of the IRE



## Poles and Zeros

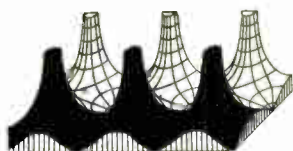

**"Give Me But A Place To Stand . . ."** To the ancients the world was flat and bounded by the horizon as seen from the shores of the land masses. Columbus and Magellan believed and proved the world to be round, but it was still observed from the quarterdeck of a tiny ship as a two-dimensional surface. During this past International Geophysical Year the scientists and engineers of the world have explored the interior, the crust, the oceans, the atmosphere, the ionosphere, and the space around the earth, so that it now seems almost possible to stand off as an observer at a point in space, to study the earth as an isolated spherical object, immersed in its own magnetic and gravitational fields. Perhaps we have now almost prepared a place for Archimedes to stand in carrying out his boast to move the world with a lever.

To the scientists and engineers responsible for the achievements of the IGY, and particularly its study of the ionosphere, this Special Issue of the PROCEEDINGS is dedicated. As better stated in the Preface by Dr. M. G. Morgan, the principal objective of the issue is to provide a basic knowledge of the properties of the earth's external environment and the upper atmosphere, so important as a basis for much of our space transmission. Without an ionosphere, would Marconi's letter "s" signal have reached St. John's, Newfoundland, that cold day in December, 1901? Would our science of electronics have died aborning?

The fitness of the ionosphere as a subject for a Special Issue was recognized by the 1956 IRE Editorial Board, and early planning work was undertaken by Dr. Joseph Kaplan, chairman of the U. S. IGY committee, A. H. Shapley, Hugh Odishaw, and Dr. Morgan, who subsequently became Guest Editor for the issue. Dr. Morgan, professor of electrical engineering at Dartmouth, is also chairman of the U. S. panel on ionosphere physics for the IGY and an eminent authority on the effects of the ionosphere on radio. Herein he has put together a series of papers which lead the reader step by step from a general view of the earth's environment, through the early knowledge gained from ionospheric sounding, to the latest refined results of rocket and satellite observations, and finally to a discussion of some of the equipment used in modern studies.

That this is really basic and "pure" research is demonstrated by the sources of the papers, all but one being from university or government laboratory sources. That this research is indeed well founded is illustrated by the eminence of the authors, each a world authority in his segment of the field. Thus we have a truly international issue with papers from Australia, Belgium, Canada, England, Germany, Japan, Scotland, and the U.S.S.R., as well as the United States. That these men are great writers as well as scientists is demonstrated by a truly readable issue. Managing Editor Gannett reports that even our young lady editors enjoyed reading the papers. Go thou and do likewise!

**Your Vote Is Needed.** Our voting members have recently received a ballot on questions of IRE constitutional changes—a matter briefly referred to in P & Z last month. The changes in our basic legal boundaries are made necessary by certain changes in the New York membership corporations law and by other shortcomings which have naturally crept into the usage of a document now nearly fifty years old in basic form.

Specifically the legal needs are met by election of a person as a Delegate and Director, whereas before a Director only was elected. Operational changes are taken care of by placement in the Bylaws of details of procedure, leaving to the Constitution the spelling out of the fundamental broad principles of IRE purpose and program. Responsibility for properly carrying out your wishes then lies with your elected Directors.

The third Constitutional change will permit election of more than one Vice-President, recognizing that the President of this Institute needs help in representing the IRE in its many public relations and governmental contacts.

It should be noted that for changes to be made the Constitution requires receipt of ballots from twenty per cent of those eligible to vote. Thus, not to vote is a silent vote against the issue. Let us hear your voice—get out that ballot and vote as you believe—but VOTE.

**Are We Going Into Space?** Perusal of the advertising pages of a recent PROCEEDINGS seems to indicate that the prime target of much electronic research of today is space. A mere glance at the advertising illustrations provides an education in the shape of things to come, from gravity analogues to antimissile defense systems to moon relays to space ship design. Because of additional activities in solid-state transducers of many types, low-noise detection equipment, and massive antenna structures, it is rather easy to deduce where our field is taking us.

As preparation for this lifting of our horizons we are attempting to keep you on the precipice of scientific knowledge through the pages of these PROCEEDINGS. Thus we carry out a major duty of a professional organization, not just to report to its members the accomplishments of the present but to prepare for the achievements of the future. Only thus can the limitations of our educations be overcome, related as they mostly were to a universe of earthly bounds.

To measure the size of this job which we must undertake several of us spent a few minutes at a recent Board meeting in listing space-related projects in electronics and here are some results: solar energy utilization, inertial instrumentation, gravimeters, molecular resonance magnetometers, vehicle control, flight prediction, space platforms, astral navigation, photonic propulsion, radio relays for space communication, infrared instrumentation, and electronic and ionic propulsion systems.

Still with us or are you already in orbit?—J.D.R.





## *Donald B. Sinclair*

*Vice-President, 1959*

Donald B. Sinclair (J'30-A'33-M'38-SM'43-F'43) was born in Winnipeg, Manitoba, Canada, on May 23, 1910. He attended the University of Manitoba from 1926 to 1929, and worked part-time as a radio operator for Western Canada Airways. He then transferred to Massachusetts Institute of Technology, where he received the degrees of S.B. in 1931, S.M. in 1932, and Sc.D. in 1935. During this period he was enrolled in a cooperative course in electrical engineering, and worked at the New York Telephone Company, the Western Electric Company at Hawthorn, and the Bell Telephone Laboratories. While studying for his doctorate he was a research assistant in the Department of Electrical Engineering at M.I.T., and spent one year working on his dissertation at the General Radio Company. He remained at M.I.T. for one year after receiving his degree.

He was employed by General Radio Company in 1936, and subsequently became Assistant Chief Engineer, and Chief Engineer. In 1955 he was appointed Vice-President, and in 1956 was elected a Director. He is also a member of General Radio's Management and New Products Committees, chairman of the Patents and Development Committees, and a trustee of the General Radio Profit-Sharing Trust.

During World War II he was in charge of the search-receiver work for radar countermeasures at the Radio Research

Laboratory at Harvard University, and was a member of Division Five of the National Defense Research Committee on guided missiles. In 1943 he went to North Africa with the first *Ferret* plane to be sent to the European theater of operations. For his work on countermeasures and guided missiles he received the President's Certificate of Merit in 1948. From 1954 to 1958 he was a member of the Technical Advisory Panel on Electronics of the Department of Defense.

Dr. Sinclair was President of the IRE in 1952, following a term as Treasurer in 1949-1950. He served on the Executive Committee in 1948-1950 and again in 1952-1953, and was on the Board of Directors from 1945 to 1954 and in 1958. He has represented the Institute on the Radio Technical Planning Board, the Joint IRE-AIEE Coordination Committee, and most recently, at the 1958 meeting of the A. S. Popov Society in Moscow.

In the Boston Section he has been a member of the Executive Committee, 1946-1948 and 1952-1958, member and chairman of the Awards Nominating Committee, and chairman of the Program Committee. This latter term of office included the first NEREM meeting in 1947.

He is a Fellow of the American Institute of Electrical Engineers, and a member of Sigma Xi and the American Association for the Advancement of Science.

## Preface

# The Nature of the Ionosphere—An IGY Objective\*

MILLETT G. MORGAN†, GUEST EDITOR

PUCK'S jesting lines

I'll put a girdle round about the earth  
In forty minutes  
from *A Midsummer Night's Dream*, II i

have come within a factor of two-and-a-half of literality! From remarkable, primitive beginnings in ancient times, through an age of suppression of learning, and in the presence of sporadic but unslackening violence and cruelty, man has finally expanded his knowledge of the earth itself to the point where he can admit a compelling urge to place it in his own hands and see revealed its full-scale appearance, constitution, and processes. Surely it is the crowning achievement of engineering that it has become possible today for man virtually to do such a thing. Through transportation he has been able to set up points of observation over the entire earth. Through instrumentation he has equipped these stations to make many kinds of observations. And through telecommunication, he has been able to operate the whole as one coordinated enterprise. This is called synoptic observation and it has been the essence of the International Geophysical Year. Literally surmounting this accomplishment have been the earth-encircling satellite vehicles making direct measurements on a global scale.

The IGY developed from a proposal for a Third International Polar Year, made by L. V. Berkner, a radio engineer and IRE Fellow. From its beginnings in Prof. J. A. Van Allen's living room in College Park, Md., one night in 1950, the enterprise became in six years the greatest nonpolitical international project ever undertaken. In the accompanying guest editorial, Dr. Berkner describes the development and operation of this great success in which almost every major nation on earth has participated.

In devoting this issue of the PROCEEDINGS to the IGY it has seemed best to discuss mainly scientific objectives, rather than the instrumentation and telecommunication necessary to gain these objectives. There is a heavy responsibility upon those who determine what goes into an established and respected engineering journal for it has been said that the simplest and best formulation of an objective for engineering education is to bring the student to the point where he can read his professional journals. The Institute of Radio Engineers has long been a leader in recognizing that only by di-

recting his attention more and more to the physical science underlying his field, can the radio engineer cope with the uninhibited expansion of technology with which he must deal.

The earth embodies three great dynamical systems, coupled to one another and under strong external gravitation and radiation influences. There are what is believed to be a molten interior; the oceans; and the atmosphere. Man has no direct means of access to the interior but must rely solely upon seismic probing and deductions from the earth's main magnetic field which has been shown to have its source within the earth. The oceans and lower atmosphere have long been directly accessible. The upper atmosphere has been probed by radio waves with increasing refinement until now man's fantastic engineering accomplishments have brought it under direct observation by rockets and satellites.

As a medium for the propagation of radio waves, the upper atmosphere is of principal interest. There the irradiation ionizes the air and provides free electrons which are accelerated by the electric field of any passing radio wave and which therefore interact with it. The pervading earth's magnetic field gives rise to additional force on the moving electrons and greatly complicates their interaction with the passing wave. In addition, there are of course ions present. They are moved mainly by air mass transport and are also subject to additional force due to their motion in the magnetic field. Mitra's book,<sup>1</sup> is the standard treatise on the upper atmosphere and it includes, as well, the most comprehensive treatment available on the propagation of radio waves in the ionosphere.

In studying propagation in the ionosphere, all of the atmosphere above about 70 km, one must understand the complex physical environment in which the propagation occurs. The important IGY objective, to which this issue of the PROCEEDINGS is mainly devoted, is the better understanding of that environment. In preparation for reading the results in this field as they are developed over the years to come, from the data obtained in the IGY, the radio engineer can obtain from this compendium issue an extremely authoritative background, for the best available authors have been called upon wherever they might be in the world, to produce the material for this issue. They have set forth in a comprehensive yet stimulating and exciting way, a description of

\* Original manuscript received by the IRE, November 10, 1958.  
† Thayer School of Eng., Dartmouth College, Hanover, N. H.

<sup>1</sup> S. K. Mitra, "The Upper Atmosphere," The Asiatic Society, Calcutta 16, India, 2nd ed.; 1952.



where the frontiers of knowledge concerning the ionosphere lie, where the IGY has already advanced them, and where it may yet advance them further.

Although it is but twenty-five years since the Second International Polar Year, the available means and knowledge have become so much greater in that time that the current study of the earth through concerted international effort has completely dwarfed that undertaking. At that time, the reflection of radio-wave pulses from the ionosphere at vertical incidence had recently been achieved by Breit and Tuve at the Carnegie Institution of Washington, and Appleton had only recently recognized that the ionosphere was stratified and had suggested the designations *E* and *F* layers which came into accepted use. In fact it was in the same year that Watson-Watt proposed the very term "ionosphere." Thus the papers in this issue are a record of the outstanding progress of a mere twenty-five years.

The issue opens with a guest editorial by L. V. Berkner. The first papers describe the undisturbed ionosphere, and the succeeding ones, the severe disturbances which are produced by solar flares. Following these are papers describing rocket and satellite measurements in both the undisturbed and the disturbed ionosphere. As an addendum, papers have been added describing some of the special purpose radio equipment used in making ionospheric measurements, and the global system of warning and communication developed for the IGY.

A contemporary of Shakespeare, William Gilbert, first recognized the essential nature of the earth's magnetic field. Because the effect of this field on the ionosphere is so great, this short technical note describing its rudiments is appended.

It can be shown on the basis of potential theory that the earth's main field rises from sources within the earth itself. The nature of the source is a continuing enigma but the most plausible theory is that it is due to an ordered turbulence within the liquid core. The external field approximates that of a uniformly magnetized sphere or, what is equivalent, that of a small dipole placed at the center of the earth. The axis of this field is inclined  $11.4^\circ$  to the spin or geographic axis. Geomagnetic coordinates are often used; they are merely spherical coordinates based upon the geomagnetic axis rather than the spin axis.

There are marked perturbations in the field near the earth's surface, presumably due to nonuniformity in the permeability of the earth's crust. The effect of these perturbations is significant well beyond the ionospheric *F* region. The *magnetic* or *dip* poles are the places where the field is perpendicular to the surface. Because of the

surface perturbations, these do not coincide with the *geomagnetic* poles defined for the unperturbed field.

The field undergoes long-term (secular) changes which are barely significant from year to year. Currents in the ionosphere produce regular daily changes, and irregular disturbances known as geomagnetic storms. The latter commence abruptly with the arrival of particles from the sun after a solar flare.

The field outside a uniformly magnetized sphere is given by

$$H = \frac{1}{3} M a^3 \text{ grad } \frac{\cos \theta}{r^2} \text{ amp/m}$$

where

- $M$  = magnetization or magnetic moment per unit of volume,
- $a$  = the radius of the sphere ( $6.37 \times 10^6$  m for the earth),
- $\theta$  = the usual polar angle of spherical coordinates.

This expression gives the geomagnetic field in geomagnetic coordinates. For the year 1945,

$$M = \frac{1}{4\pi} 0.935 \text{ amp/m}^2$$

and the geographical coordinates of the geomagnetic axis were at

$$N 78.6^\circ, W 70.1^\circ \text{ (near Thule, Greenland)}$$

and at

$$S 78.6^\circ, E 109.9^\circ \text{ (in Antarctica).}$$

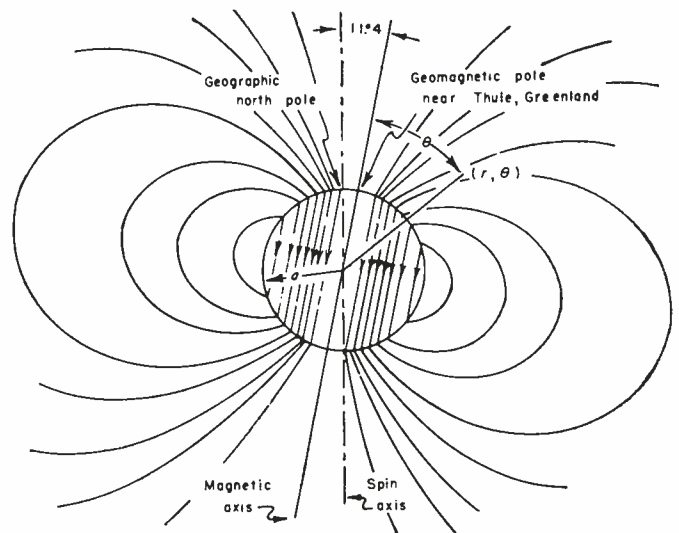

The accompanying illustration shows the essential features of the undistorted, geomagnetic field.

# The International Geophysical Year\*

L. V. BERKNER†, FELLOW, IRE

THE International Geophysical Year has been a unique experiment in international cooperation.

Despite the political tensions of the world, men of sixty-six nations have submerged their differences to join in a genuine effort to understand the planet which is their common home.

The scale of the International Geophysical Year was set by the size of our planet and the variety of phenomena that together provide the environment that enables man to inhabit that planet and to turn its natural phenomena to his benefit. The objective of the International Geophysical Year (IGY) has been to bring us a step nearer to unifying our comprehension of these phenomena into an orderly and coherent whole. To achieve this objective, the joint effort of the participating nations has extended from pole to pole and has involved expenditures equivalent to several hundred millions of dollars.

Although nature has not arranged itself in well-defined compartments, science finds it convenient to subdivide its problems into manageable units related to the several types of possible measurements. Thus, the researches of the IGY have been carried out under the headings of world days and communications, meteorology, geomagnetism, physics of the ionosphere, aurora and airglow, cosmic rays, oceanography, latitudes and longitudes, glaciology, gravity, seismology, rockets and satellites, nuclear radiation, and solar activity.

The programs of the IGY call for the highest sophistication to be found in present-day research activity. Over the whole of Planet Earth, thousands of highly specialized stations have been established to observe Earth simultaneously according to prearranged plan. The scientific effort in the Antarctic is illustrative of the immense scale of IGY activity. Before, not more than one or two elementary expeditionary activities pioneered simultaneously the unknown Antarctic areas; now more than 50 stations have opened up the unknown seventh continent and revealed its interaction with the remainder of the planet. As many as ten thousand men have now inhabited that continent with the most advanced forms of transportation by air and surface to aid their researches.

Underlying the IGY plan are a variety of new standards and procedures of measurement, internationally agreed, to permit a synthesis of measurement into complete planetary descriptions of the phenomena around us. These standards can be found in the first nine volumes of the *Annals of the International Geophysical*

*Year*.<sup>1</sup> It is hardly necessary to add that radio engineering has provided the central nervous system of the whole effort.

Perhaps the most spectacular accomplishment of the IGY has been the projection of the first instrumented earth satellites into outer space. Man is now able to supplement surface observations by new and powerful methods. Thus, the IGY marks man's escape into three-dimensional geography.

The success of the IGY plan suggests that national leaders might examine rather closely the methods used by the scientists to achieve their objectives. We have witnessed a carefully-planned experiment in international cooperation whose features would seem to be worthy of careful study. Just how was the cooperation of the IGY brought about?

The scientists of the world are organized into a number of Unions covering such general fields as physics, chemistry, astronomy, biology, and geophysics; and specialized fields such as radio, biochemistry, physiology, and crystallography. Altogether thirteen general and special Unions represent a large proportion of the world's scientific activity. These Unions are non-governmental and are organized and run by the scientists themselves. Scientists adhere to the Unions through their principal national scientific body; the scientists of the United States adhere to the Unions through the National Academy of Sciences. Under these national adhering agencies are national committees of scientists for each of the Unions, through which active participation in the Unions is carried on. Through frequent world assemblies and special symposia, each Union stimulates scientific growth by discussion and interpretation of scientific progress with emphasis on fruitful and exciting opportunities, specification of cooperative programs of research, agreement on standards and nomenclature, and advice to other international agencies on scientific matters in response to requests.

The Unions are organized under a single body, the International Council of Scientific Unions (or ICSU) which coordinates their common interests. The ICSU is composed of scientific representatives of the Unions, and of national representatives of the principal scientific body of each adhering nation, so that it provides a common meeting ground for the scientists and the national scientific bodies of the world.

In addition to basic responsibilities for coordination of affairs of common interest among Unions and nations, the ICSU has, among others, three purposes of special interest to us here:

\* Original manuscript received by the IRE, November 10, 1958.  
† Pres., Associated Universities, New York 19, N. Y.

<sup>1</sup> Pergamon Press, London, Eng.; 1958.





CSAGI, the special committee which planned the IGY, meets at the office of Secretary-General Marcel Nicolet. From left are Emile Herbays (Belgium), Vladimir Belousov (U.S.S.R.), Lloyd V. Berkner (U.S.A.), Marcel Nicolet (Belgium), Jean Coulomb (France), and Sidney Chapman (Great Britain), President of CSAGI. (Photo courtesy LIFE magazine, © 1957 Time Inc.)

- 1) To encourage international scientific activity;
- 2) To enter into relations with the governments of the countries adhering to the Council to promote scientific investigation in these countries;
- 3) To maintain relations with the United Nations and its specialized agencies, particularly UNESCO.

In the stimulation of research on an international scale, the ICSU has used the device of the special committee, of which the Comité Spécial de l'Année Géophysique Internationale (CSAGI) is the outstanding example. To describe events on the earth as an observer might see them from outside the earth, the scientists of several interested Unions realized that a simultaneous and well-standardized international effort was needed. Simultaneous world-wide cooperation of all nations seemed the only way to achieve this significant advance in the knowledge of our environment. The ICSU, as the scientists' own international organization, provided the obvious mechanism to undertake the task. Therefore, three scientific Unions, Astronomy, Geophysics, and Radio (URSI), asked the ICSU in 1950-1951 to appoint a special committee (the CSAGI) to plan the effort.

This Committee was first convened at Brussels by Colonel E. Herbays, Secretary General of URSI and Treasurer of ICSU, in October 1952, where the basic principles of the IGY operation were laid down. The CSAGI asked that each nation organize a national committee to advise how its nation could contribute to the achievement of specified IGY objectives and to plan and supervise its national contributions. The first full-dress meeting of the CSAGI came in July 1953, when Professor Sydney Chapman, Sedleian Professor of Natural Philosophy, Oxford, and distinguished geophysicist, was named President of the CSAGI, and Marcel Nicolet, Chairman of the Solar Radiation Laboratory,

Institute of Meteorology, Brussels, became Secretary General. Subsequently, CSAGI meetings were held in Rome in 1954; Brussels, 1955; Barcelona, 1956; and Moscow, 1958. The last meeting will be in Washington, 1959. These meetings have been interspersed with regional planning meetings on the Arctic at Stockholm, on the Antarctic at Paris, and on other regions: Africa south of the Sahara, Bukavu; Rio de Janeiro; Moscow; and Tokyo. The administration of the IGY has been carried on by the "Bureau of the CSAGI" consisting of the officers together with Professor Belousov of Moscow and Professor Coulomb of Paris. Through integration of the national plans, and negotiation and appeals to fill the gaps, the CSAGI forged the world-wide program of simultaneous geophysical observation now specified in the *Annals of the IGY*.

Several points about this method of organization are worthy of notice:

1) *It is successful in catalyzing extensive research.* This specification of particular objectives tends to inspire the desire for participation by every national group, since it satisfied a sense of national aspiration.

2) *The organization of the research is through national machinery.* Consequently, the governments of the world respond favorably to requests by their own national committees for support of specific measures planned and endorsed by the world's leaders in science but carried out by the individual nations.

3) *Research can be stimulated that would not otherwise be done.* As examples of the power of cooperative planning, the scientific exploration of the Antarctic continent and instrumented earth satellite stand out. Moreover, the value of the research of one nation is augmented by the corresponding and supplementary planned researches of other nations.

4) *The organizational machinery of the Special Com-*

mittee is financed from international funds, in which UNESCO has properly played a leading role. The amount of such administrative funds is small (a few hundred thousand dollars), compared to the huge research funds of hundreds of millions of dollars that are catalyzed by this international stimulus.

5) *The Special Committee is entirely nonpolitical.* It states over-all objectives, plans, and requirements, but makes no recommendations that would involve one nation working in the territory of another. Instead, it encourages bilateral or multilateral negotiations where cooperation between specific nations would be advantageous. It adheres to the principle of universality by permitting any bona fide scientific group representing the science of an area to adhere to the plan.

6) *The method captures the imaginations of the world's best research scientists.* The working together of scientists of many nations toward a common objective inspires enthusiasm for otherwise unattainable goals. It is the stuff of which the Renaissance was made.

The outstanding feature of the IGY plan has been its completely decentralized operations with its provision for intimate and voluntary international collaboration. Thus the plan has been predicated on the fundamental honesty of educated human beings who have come to realize that their joint welfare depends upon unselfish contribution to the advantage of all. Among the great family of nations, with only one exception, nothing has permitted political considerations to stand in the way of full contribution of the IGY to man's study of Earth.<sup>2</sup> This higher understanding by nations everywhere of man's welfare in our age is reminiscent of a directive sent by Benjamin Franklin to the commanders of all armed ships acting by commission from the Congress of the United States at war with Great Britain in 1779:

Gentlemen, a ship was fitted out from England before the commencement of this war to make discoveries in unknown seas under the conduct of that most celebrated Navigator and Discoverer Captain Cook. This is an undertaking truly laudable in itself, because the increase of geographical knowledge facilitates the communication between distant nations and the exchange of useful products and manufactures, extends the arts, and science of other kinds is increased to the benefit of mankind in general. This, then, is to recommend to you that should the said ship fall into your hands, you would not consider her as an enemy, nor suffer any plunder to be made of the effects contained in her, nor obstruct her immediate return to England.

Establishment of the World Data Centers to insure complete collection and free access of all IGY data to scientists everywhere is an innovation in international scientific activity that is likely to persist and grow.

<sup>2</sup> In 1958, the government of the Peoples Republic of China forced their scientists to withdraw from formal participation in the IGY because of its objection to the participation of the scientists of Formosa. This political interference with international scientific activity is unique in the annals of civilized international scientific cooperation. It is understood that scientists of the Chinese mainland are still carrying on their IGY program of observations, and it is hoped that their government may yet permit them to join their data with those of their colleagues of the rest of the world.

These three World Data Centers are:

*IGY World Data Center A*

National Academy of Sciences  
2101 Constitution Avenue  
Washington 25, D. C., U.S.A.

*IGY World Data Center B*

Academia Nauk, SSSR  
Kaluzhakoye sh. 71a  
Moscow B-134, U.S.S.R.

*IGY World Data Center C*

A decentralized group of centers for different disciplines in Western Europe and Japan.

The idea of multiple centers insures against accidental loss of data and minimizes the likelihood that artificial barriers arising from political or military action could restrict access of any scientist to the data he needs. While Centers A and B have central coordination and cataloguing of data, all centers are more or less decentralized into disciplines, whose records are maintained at scientific or institutional activities that are expert in the discipline concerned. Thus, under Data Center A, the records are actually stored and catalogued by:

1) *Meteorology*

National Weather Records Center  
Asheville, North Carolina, U.S.A.

2) *Geomagnetism*

Geophysics Division  
U. S. Coast and Geodetic Survey  
Washington, D. C., U.S.A.

3) *Aurora*

*All-sky photographs*  
Geophysical Institute  
University of Alaska  
College, Alaska, U.S.A.

*Visual observations*

Physics Department  
Cornell University  
Ithaca, New York, U.S.A.

*Airglow*

Central Radio Propagation Laboratory  
Boulder, Colorado, U.S.A.

4) *Ionosphere*

Central Radio Propagation Laboratory  
Boulder, Colorado, U.S.A.



5) *Solar Activity*

Central Radio Propagation Laboratory  
Boulder, Colorado, U.S.A.

6) *Cosmic Rays*

Physics Department  
University of Minnesota  
Minneapolis, Minnesota, U.S.A.

7) *Longitude and Latitude*

U. S. Naval Observatory  
Washington 25, D. C., U.S.A.

8) *Glaciology*

American Geographical Society  
Broadway at 156th St  
New York, N. Y., U.S.A.

9) *Oceanography*

Department of Oceanography and Meteorology  
Agricultural and Mechanical College of Texas  
College Station, Texas, U.S.A.

10) *Rockets and Satellites*

IGY WDC for Rockets and Satellites  
National Academy of Sciences  
2101 Constitution Avenue, N.W.  
Washington 25, D. C., U.S.A.

11) *Seismology*

Geophysics Branch  
U. S. Coast and Geodetic Survey  
Washington, D. C., U.S.A.

12) *Gravimetry*

Geophysics Branch  
U. S. Coast and Geodetic Survey  
Washington, D. C., U.S.A.

13) *Nuclear Radiation*

IGY WDC  
National Weather Records Center  
Asheville, North Carolina, U.S.A.

Scholars can go to the centers for perusal of the data or research, by arrangement, or the data can be obtained by duplication at actual cost which to some extent may be subsidized.

The success of the observational phase of the IGY is now assured. Data from all nations are now flowing freely to the three World Data Centers. A recent review of the situation with the Coordinator of Operations for the IGY, Admiral Sir Archibald Day, at Brussels disclosed that data are flowing from both East and West at a comparable rate. Moreover, catalogues of data stored at the centers are now appearing regularly as the data are received and registered.

The second great phase, the analysis and synthesis of the data into an advanced description of our planet, lies ahead. This phase will take many years to complete and requires money, vision, determination, and courage. With the continued imaginative support of the world's leaders that has characterized the observational phase, we can confidently predict that the job will be done, thereby enhancing man's stature and safeguarding his welfare.

# The Earth and Its Environment\*

SYDNEY CHAPMAN†

**Summary**—The IGY observations of the earth were related to all its parts, core, crust, oceans, and atmosphere. The sun, the dominant feature in the earth's environment, has been observed more fully and with greater continuity than ever before. The moon's position in the sky has been intensively measured for geodetic reasons. Meteors, observed both visually and by radio, will tell us much about the upper atmosphere. The satellites have revealed new features of the region above the *F* layer. The sun's atmosphere envelops the earth and is extremely hot. The heat conducted from it warms the earth's outermost atmosphere and helps to extend it, perhaps to half the distance to the moon.

## THE EARTH

THE International Geophysical Year has been a period of many-sided efforts to gain a better understanding of the physical aspects of the earth and its environment.

The earth itself is commonly thought of as a massive globe, mainly solid—although water lying in shallow depressions covers the major part of its surface. Deep within the globe the earth-matter is hot, and more than ten times as dense as water. Below about half the radius the material is liquid, though at the very center there is thought to be a small, solid nucleus. The liquid core is in slow irregular motion. By dynamo action this produces electric currents. These maintain and slowly change the magnetic field, that is well measured at the surface, and is now being explored above the earth.

Far slower changes occur in the solid outer layers of the earth's crust and mantle. They are also influenced by deposition and melting of snow and ice on the surface, and by erosion and sedimentation. Such changes build up strains that are relieved from time to time by sudden displacements which set up waves that are felt as earthquakes. Traveling over and through the earth the seismic waves are a chief means of sounding the earth's inaccessible interior down even to the greatest depths. To lesser depths—tens and hundreds of kilometers—the state of the crust and mantle is illuminated by the study of the earth's gravitational attraction, and of its magnetism and electrical conductivity.

The directly accessible layers of the land and of the sea-bed enshrine a record of the earth's past. Its tangled skein is slowly becoming unravelled.

The oceans, great in surface but small in relative volume, are fully open to investigation. This has been actively pursued during the IGY. The oceans are important in the surface economy of the globe and of man-

kind as a scene of transport, a source of food and minerals, and a powerful influence on weather and climate.

Above the solid earth lies the atmosphere. This and the liquid oceans and massive globe constitute the earth. The atmosphere is of vital interest to mankind in many ways. Its water content, gained by evaporation from the oceans, is borne overland by winds. Deposition of this water upon the earth is a powerful factor in the earth's fertility. Weather and climate deeply concern mankind, but their complexity is still largely beyond our understanding. During the IGY a great effort has been made to obtain more factual knowledge of the lower atmosphere all over the earth. This should lead to a much improved understanding of the troposphere and stratosphere.

## THE SUN

By far the most important feature of the earth's environment is the sun. This, though so distant, is the great energizer of life and motion on the earth. Its presence and the earth's rotation determine our rhythm of day and night. Its powerful gravitational attraction controls the orbital motion of the earth. Thereby, and owing to the inclination of the earth's axis to the orbital plane, the sun determines the annual changes of season. In addition to these regular and predictable influences, the earth is affected by changing phenomena on the sun itself: the growth and decay of sunspots, the uprushing prominences and surges, the brilliant flares. Throughout most of man's history these intrinsic changes on the sun were unknown; indeed the Greeks regarded the sun as serene, unsullied, perfect. The Chinese, however, have recorded spots on the sun for more than a millennium. In Europe, after Galileo first saw the sunspots, they were merely objects of curiosity and speculation for a quarter of a millennium. Only about a century ago came the recognition of their cycle of frequency change, from maximum to minimum and back in about eleven years. This was soon followed by the discovery of a corresponding cycle of change in the degree of disturbance of the geomagnetic field. A similar cycle was later found also in the degree of auroral activity, whose association with magnetic disturbance became known one and a half centuries ago. Not until the invention of electric telegraphy did these linked solar and terrestrial occurrences impinge on man's affairs.

This impact was enhanced when radio telegraphy was developed. Long-distance transmission was found to depend greatly on the state of the atmosphere far above the region of weather studies. This state changes regularly by day and night and through the seasons. It

\* Original manuscript received by the IRE, November 10, 1958.

† Geophys. Inst., College, Alaska. High Altitude Observatory, Boulder, Colo.; there engaged in a program of research supported by the National Bureau of Standards and the Sacramento Peak Observatory of the Air Force Cambridge Research Center.



changes also irregularly, in evident though not simple association with the intrinsic solar changes that affect the aurora and the geomagnetic field.

For these reasons the physical observation of the sun has been a leading part of the IGY enterprise. The sun was observed with a continuity and by a variety of means never before approached.

#### THE MOON, THE PLANETS AND ASTEROIDS, AND THE COMETS

The moon comes second to the sun as a part of the earth's environment. Though much smaller than the sun, with a diameter indeed only a quarter that of the earth, it looks to us as big as the sun. This is because it is so near. Half of it is brightly lit up by the sun's light. It is like a lantern in the void, a light to shine upon us by night. Monthly it revolves around the earth, turning always almost the same part toward us. It shares in the earth's annual journey round the sun. Its most important influence on the earth is tidal: in this respect it is 2.4 times more powerful than the sun, approximately in the ratio of the densities of the two bodies. The irregular boundaries and contours of the ocean beds complicate the tides. The solid earth is also subject to these tidal influences, and during the IGY, tidal observations have been made in numerous places where they had been lacking.

Also during the IGY, the moon has been observed at night more accurately than before against the background of the stars, by a number of special telescopes distributed over the earth. These observations will be used to determine with improved accuracy the size and form of the earth and the distances between its continents.

The moon itself, however, has not been a special subject of IGY observation. It is a dead, almost unchanging body, that has been observed for millennia. The IGY satellites have brought nearer the time when the moon can be observed from close at hand, but this was not part of the IGY program.

The planets and asteroids, as members of the solar system, may also be considered as part of the earth's environment; they affect the earth even less than the moon, and their observation has not been enhanced during the IGY. The same is true of the comets—bodies of far less than planetary mass. A number of these are known to describe orbits of some regularity, though if they happen to approach a planet their paths may be appreciably changed thereafter. They are subject to change, perhaps to disappearance, during centuries or even in decades. Some of them, like Halley's comet, mostly inhabit the outer confines of the solar system, whence they approach the sun at long intervals. Those far regions may contain comets that at some future time, journeying towards or away from the sun, will come near the earth. Then they will be of great interest, and perhaps concern, to mankind. But during a brief period like the IGY there is little chance of this,

and cometary observation, as at other times, goes on its accustomed way, availing itself of such interesting but unexciting occasions as nature provides.

#### METEORS

Far more numerous and widespread throughout the solar system are the small bodies called meteors. Some of these form great clusters that traverse fairly definite orbits; they are distributed irregularly along these orbits, and may be specially concentrated in some parts. Some of these meteor streams are associated with comets, indeed some appear to be the residue or debris of comets that have disappeared. Their orbits, like those of comets, have no special preference for the ecliptic, the plane in or near which the planets and asteroids move round the sun. Like cometary orbits, the orbits of meteor streams may be deflected by an occasional near passage past a planet; such a passage may in fact partly break up the stream.

Besides these clusters or streams of meteors there are stray meteors, called sporadic, that are lone wanderers in interplanetary space. Like the clustered meteors, they move under the all-pervading attraction of the sun in orbits nearly elliptical but perturbed by the planets.

A meteor becomes known to us only when it approaches the earth closely enough to impinge on or be drawn into our atmosphere. Then, if the meteor is large enough, it may be seen as a shooting star. The paths of some regular meteor streams pass close to the earth's orbit. If, at the time when the earth passes the region of such approach, there are meteors in that part of the meteor stream, a meteor shower will be seen. In successive years the mutual approach will happen on nearly the same date. But owing to nonuniform density of distribution of the meteors along the orbit they traverse, the shower of shooting stars may differ much from year to year. Hence, although from past observations of meteor showers it has been possible to predict the dates of such showers during the IGY and in future years, one cannot say with any certainty whether the showers will be rich or sparse in any particular year.

A regular meteor stream may have an orbit that passes close to some point on the earth's orbit. The meteors near that point may be moving towards the sun or away from it. In the former case any that fall on the earth will impinge on the night side, and if big enough will be seen as shooting stars; in the other case they will fall on the day side of the earth, and the sky brightness will prevent them from being seen (unless they are quite exceptionally big and bright). The meteor streams discovered by the observations of astronomers over a century or more are those of the former kind. Only in the last quarter-century have the daytime meteor showers become known, by new methods using radar.

During the IGY many kinds of observation have been stepped up in number or range on particular days or intervals. There has been an IGY calendar giving such days and intervals. It shows also the dates of special

expected meteor showers, both night-time and day-time, and astronomers and radio astronomers have been on the lookout for meteors especially at such times.

Shooting stars with their sudden beauty have always interested and impressed mankind; sometimes they have aroused superstitious fear. But otherwise they have impinged on human affairs only in the rare cases when they were big enough to traverse the whole of our atmosphere and fall to the ground as meteorites. Only an extremely small percentage of meteors are as large as this. Meteorites during the ages have fallen upon the earth at irregular and unpredictable intervals, sometimes singly, sometimes in great numbers. Only rarely do they cause damage to property or living things. In a very few cases their size and energy have been so considerable as to devastate considerable areas, and leave notable craters that have endured for centuries or millennia. A few rather great meteorites have fallen in Siberia and elsewhere during the present century.

The IGY interest in meteors arose from their ionizing action in the upper atmosphere. This enables them to be observed by radar methods, and such observations have much to tell us both about the meteors and about the atmosphere. At some future time a knowledge of the changing location of the most abundant parts of meteor streams may be of interest and importance to travelers in interplanetary space. An astronaut setting out on a journey into space might certainly prefer to keep clear of such specially dense meteor clouds as those that produced the historic great meteor showers of the past, such as the Leonids of 1833 and 1866–1867. He may also be interested in the thought that our knowledge of the existence of meteor streams is limited to that provided by somewhat more than a century of night-time visual observations and a quarter century of day-time radar observations. This knowledge relates only to the streams that pass near the earth's orbit. It is incomplete even as regards those meteors that are there moving sunward; it is seriously incomplete as regards those whose motion there is away from the sun. Of the streams whose orbits do not come near that of the earth we have no present knowledge.

#### INTERPLANETARY GAS AND DUST

The earth's cohabitants of the solar system range widely in size and mass. The most outstanding is our far neighbor, the great planet Jupiter. Then come the other planets, the moon and other satellites, and the asteroids. Compared with the greater of these the comets are insubstantial. Then come the meteors; a relative few are big chunks of matter. The others, in numbers increasing with decreasing size, range downwards to objects no bigger than a pin's head, and to still smaller dust particles. Even a pin's head meteor, speeding through our atmosphere, becomes vaporized and luminous, and may be seen by the naked eye. Telescopes enable the passage of still smaller meteors to be seen.

The meteors and interplanetary dust particles are solids. They reflect and scatter the sunlight, and thereby they contribute to the zodiacal light—that faint cone of light, rather concentrated towards the plane of the ecliptic, that can be seen under good sky conditions, especially in the lower latitudes, after sunset and before dawn.

These solid particles, however, do not exist in a vacuum. They are immersed in interplanetary gas, of low density. This gas likewise scatters the sunlight and contributes to the zodiacal light. The gas particles mainly thus effective are electrons, sundered particles broken off from neutral atoms and molecules, leaving behind a positive nucleus or ion. Any remaining neutral gas particles are much less effective light scatterers, and do not reveal themselves in the zodiacal light.

What is the source of the interplanetary gas? The most probable answer is that the sun is the source. The sun is wholly gaseous, and from time to time it is seen to eject gas violently outward, sometimes with speed sufficient to enable it to escape altogether from the sun's attraction. It is not unlikely that there is a more nearly constant and gentler outflow from all or a great part of its surface.

Moreover, most of the planets have gaseous atmospheres. The molecular speeds in a gas at any temperature range about a mean value; there are always a few with sufficient energy to enable them to escape from the planet's attraction, if they have a free run, as do those at the outer limits of the atmospheres. Thus there must be some escape of gas from every planetary atmosphere into interplanetary space; but almost all the escaping particles have insufficient energy to escape from the attraction of the sun. Hence they will only contribute to the interplanetary gas. Such escaping planetary gas will have a mean motion similar to that of its parent planet, and thus will tend to move round the sun in the same direction as the planets, and be concentrated towards the ecliptic plane.

However, some of the interplanetary gas must be regarded as constituting part of the atmosphere of the sun itself. That is to say, the planets—even Pluto, the furthest—are moving within the sun's far extended outermost envelope.

This conclusion is based on the remarkable nature of the solar corona, the intensely hot outer part of the solar atmosphere. From a value of about 5000° at the photosphere (the apparent sharp limit of the sun), the temperature rises through the overlying layer, the chromosphere, to a value of order 1 million in the corona, at about 40,000 km above the photosphere. The coronal gas is mainly hydrogen, with a few per cent of helium, and other gases in amounts reckoned in small numbers in parts per thousand down to parts per million. The hydrogen and helium are practically completely ionized,—broken up into electrons and protons or alpha particles. Other particles have lost many electrons, but may retain some.



The coronal gas, even at the above level, is very rare, with a number density of perhaps  $10^9$ /cc (equivalent to that existing high in the *F* layer of the earth's atmosphere). It probably has a varying supply of heat from below, and it can radiate little. It is, however, an excellent heat conductor. In this way it continually loses heat by downward flow to the photosphere. It must also lose heat by outward flow into interplanetary space. If its condition were steady, without rotation and without interference from jets of gas escaping through it, the distribution of temperature and density in the outer layers would be easily calculable. In fact, calculations made on this ideal simplified basis agree reasonably well with estimates of the density of the corona made by astronomers. The estimates for the more outlying parts are derived from observations made from balloons and aircraft; they extend to about 20 solar radii from the sun—about a tenth of the way from the sun to the earth.

A main conclusion drawn from these results is that the coronal gas is very hot, of order  $200,000^\circ$  at the distance of the earth: even as far away as Pluto the temperature is of order  $70,000^\circ$ . These figures imply that little recombination of ions and electrons can occur throughout this immense volume, so that the proportion of neutral atoms and molecules is small.

At the distance of the earth the density indicated by the idealized calculation for the interplanetary solar atmosphere is of order 1000 electrons and ions per cc. Disturbing circumstances not taken into account in the calculation (rotation and escaping gas jets, and perhaps cooling by the intermingled dust) may alter this by a factor 10 or more, but seem unlikely to be able to reduce the temperature by a material factor.

Thus, the earth and other planets are likely to be moving along their orbits through a slightly dust-laden, far-extended solar atmosphere, of high temperature and very low density. This gas must offer some resistance to the passage of meteors (or of space vehicles) through it. It will also retard the motions of the planets, except in so far as it has itself been set in motion round the sun with the orbital speed appropriate to the distance from the sun. These retarding effects are likely to be slight. They may be more important for the jets of gas that are thrown outward from the sun, and that cause magnetic and ionospheric storms and auroras when they impinge on the earth. They may also affect the comets and their tails, as Professor Biermann has urged.<sup>1</sup>

#### THE SOLAR ENERGY SUPPLY TO THE EARTH

The sun energizes the winds and the life processes on the earth by its continual and immense outpouring of radiant energy. Most of this radiation that is incident on the sunward-facing hemisphere reaches and warms

the sunlit surface of the earth, be it land or sea. Only a small part of the radiation is intercepted during its passage through the atmosphere, except by reflection from clouds. The ozone layer in our atmosphere absorbs a few per cent of the radiation, and a still smaller fraction is absorbed in the ionosphere.

But the interplanetary extended atmosphere of the sun conveys heat outwards in another way, by thermal conduction. The amount thus conducted is far smaller than that of the radiant energy: the ratio is of order a million. As the planets are very cold compared with the interplanetary gas, they act like sinks of heat. A temperature gradient is set up in the outer atmospheres. In the case of the earth the temperature must decline downwards from that of the interplanetary gas—perhaps  $200,000^\circ$ —to the low temperature ( $150^\circ$ – $200^\circ$ K) that we know exists at about 80-km height. The inflow of heat occurs on all sides of the earth, not only on the sunward hemisphere.

The earth's atmosphere may be considered to end where its density has declined to that of this gas.

The temperature gradient in the ionosphere is at present not known at all accurately, but is perhaps not more than  $10^\circ$ C/km. With increasing height the rising temperature must increase at an ever slower rate because the same flow of heat crosses an ever greater spherical surface, and still more because the thermal conductivity of the gas increases with the increasing temperature. The gradient must ultimately fall to and below  $1^\circ$ C/km. To attain a temperature of  $200,000^\circ$  would require a distance of 20,000 km even if the gradient had everywhere the value of  $10^\circ$ /km. That would imply that the radius of the boundary between the earth's atmosphere and the interplanetary gas is more than four times the radius of the earth. In view of the decrease of the temperature gradient with increasing height, the actual radius of the boundary may be ten times greater, so that the atmosphere would extend more than half the distance to the moon. This astounding inference would imply that the massive earth-globe is only a small nucleus within a vastly extended atmosphere, altogether altering our conception of the full size of the earth. Similar considerations would apply in varying measure to the other planets that have atmosphere—excluding the moon, but including Mars. Thus the immense extension of the hot solar atmosphere, enveloping the planets, swells also the planetary atmospheres. This is a remarkable and far-spread consequence of the turbulent processes on the sun that produce the solar corona.

Such inferences can at present be only tentative. The outer atmosphere also gains heat from the "radiation belt" revealed by the IGY earth satellites and explored by the moon rockets. The additional energy is supplied by cosmic rays and by streams and clouds of ionized gas from the sun.

<sup>1</sup> See Biermann and Lüist, this issue, p. 209.

## MAGNETIC FIELDS

The sunspots have powerful magnetic fields, and the sun as a whole may possess a general magnetic field. But it seems likely that this general field differs in character from that of the earth, except possibly near the poles of the sun's rotation. There the form of the coronal plumes suggests the presence of dipole lines of magnetic force. If the sun had dipole lines of magnetic force extending from one rotation pole to the other, the thermal conductivity of the outer solar gas would be much reduced for radial flow of heat. The temperature and the density would fall off more rapidly than is indicated by the observations, and by the idealized thermal calculations mentioned above. An idea now widely current is that outflowing solar gas stretches the lines of magnetic force outward, so that they are nearly radial: if so, they would not reduce the conductive flow of heat from the corona.

The earth has a general magnetic field, mainly of dipole type, certainly not distorted radially as is suggested for the solar magnetic field. The outermost layer of the earth's atmosphere, like the coronal gas, is almost completely ionized, above the level at which the temperature is 30,000°. Hence, the geomagnetic field will reduce the conductive heat flow into our atmosphere, in low and middle magnetic latitudes. Only in high magnetic latitudes can the heat flow in freely, nearly along the lines of magnetic force. This unequal flow of heat in different latitudes will distort the isothermal surfaces from the spherical form.

Below the 30,000° isothermal surface there is a thick layer of partly neutral gas. The neutral atoms can conduct heat, unaffected by the magnetic field. In the lower part of this layer the isothermal surfaces will tend again to be spherical. The greater supply of heat from above, conducted to this layer in polar as compared with equatorial latitudes, may set up in it an extensive general circulation, different from that in the troposphere and

stratosphere, where the heat supply is greatest in low latitudes.

## THE COMPOSITION OF THE HIGH ATMOSPHERE

In the atmosphere below the *E* layer, the air is composed mainly of molecules, mostly nitrogen, partly oxygen. In the ionosphere there is a change of composition, so that at the  $F_2$  peak the main constituent is atomic oxygen. Above the  $F_2$  peak there is a further change, in a moderately thick transition region, from atomic oxygen to atomic hydrogen. The hydrogen layer is partly neutral up to the 30,000° isothermal surface, above which it is almost completely ionized. Thus, entering the earth's atmosphere from outside, the air has at first the same nature (protons and electrons) as the interplanetary gas. This outermost layer may be called the *protosphere*. The partly neutral hydrogen layer between the 30,000° isothermal surface and the oxygen-hydrogen transition region may be called the *metasphere*.

The whole region above the mesopause (at about 80 km) is one of mounting temperature (that is, the temperature increases upwards). The name *thermosphere* applies to all this region, comprising the *E* and *F* ionospheric layers, and the metaspheric and protospheric hydrogen layers. The electron density declines slowly above the  $F_2$  peak, and may have a minimum value in the metasphere, but nowhere above the  $F_2$  peak does it actually become zero. The metasphere is probably the region in which radio whistlers travel from hemisphere to hemisphere across the equator. Also it is probably the region where jets of solar gas generate magnetic storms, and are partly diverted polewards to produce auroras. It includes part of the satellite-revealed layer of hitherto unknown energetic charged particles that are trapped in the geomagnetic field. It doubtless holds many other surprises in store for future investigators of the earth's gaseous envelope.



# The Constitution and Composition of the Upper Atmosphere\*

MARCEL NICOLET†

**Summary**—A general survey is made of various observations and theoretical possibilities which concern the problems involved in the study of the constitution and composition of the upper atmosphere. The basic problem of the composition of the homosphere and heterosphere is studied after considering the nature of dissociation processes and vertical transport by diffusion. Finally, the effect of thermal conduction on the temperature distribution is shown to be of importance over the entire thermosphere above the *E* layer.

## INTRODUCTION

A SYSTEMATIC account on the subject of the constitution and composition of the upper atmosphere is difficult when all of the various aspects of our knowledge are considered. First, it is not possible to summarize what has been deduced about the constitution of the upper atmosphere if the basic properties related to the diffusion of gases in the earth's gravitational field are ignored. Second, any analysis of the high atmosphere composition depends on the analysis made of the various processes of heat transport. Furthermore, investigations of the solar spectrum that cannot be carried out from the ground are of particular importance to atmospheric physics in that they yield information on an important parameter related to photodissociation and photoionization processes.

Finally, even if the data obtained from various methods which have been developed for the exploration of the upper atmosphere lead to consistent results, it is by no means certain that deductions are free from systematic errors. No attempt will be made here to discuss the little that is known concerning relationships between the physical parameters, but attention will be confined to general conditions.

## THE DESCRIPTION OF THE ATMOSPHERE

The vertical distribution of the temperature is the basis of the nomenclature of the upper atmosphere. Starting from the definition used in meteorology that the lowest atmospheric region is the *troposphere* heated by the earth's surface and its upper boundary the *tropopause* where the temperature gradient changes, it is possible to define regions presenting alternately negative and positive gradients of the temperature. In such a system the stratosphere extends up to the temperature peak in the neighborhood of 50 km where the upper atmosphere studied by physicists and radio engineers begins.

Thus, the atmosphere can be described as follows:

Earth's surface:	Temperature, $273^{\circ}\text{K} \pm 20^{\circ}\text{K}$ .
Troposphere:	Temperature decreases with height.
Tropopause:	Temperature minimum, $210^{\circ}\text{K} \pm 20^{\circ}\text{K}$ , and altitude $13 \pm 5$ km.
Stratosphere:	Temperature increases with height.
Stratopause:	Temperature maximum, $273^{\circ}\text{K} \pm 20^{\circ}\text{K}$ , and altitude $50 \pm 5$ km.
Mesosphere:	Temperature decreases with height.
Mesopause:	Temperature minimum, $190^{\circ}\text{K} \pm 25^{\circ}\text{K}$ , and altitude $85 \pm 5$ km.
Thermosphere:	Temperature increases.
Thermopause:	Should be the beginning of an isothermal region.

The temperature and its gradient may vary with latitude, time of day, season and solar activity. But the observational data of the upper atmosphere showing variations do not yet permit one to distinguish between accidental errors and real variations. More observations are still needed before deducing the true fluctuations of the temperature in the upper atmosphere.

The vertical distribution of the temperature depends on the localization of the source of heating and is related to the process of heat transport.

In the troposphere, the heat source is the earth's surface and convection is the principal process of heat transport. Absorption of solar ultraviolet radiation by ozone and emission of infrared radiation in the stratosphere show that the heat budget involves radiative processes. The mesosphere, in which absorption processes are unimportant compared to the heat loss processes, is a relatively unstable region.

Above the mesopause all ultraviolet radiation of wavelength shorter than  $1750\text{\AA}$  is gradually absorbed and a fraction of the absorbed energy may be used for the heating of the thermosphere. Atomic oxygen can radiate in the infrared at about  $63\mu$  but convection in the lower thermosphere and conduction in the upper thermosphere are the principal processes of heat transport. There are still other sources of heating such as conduction or arrival of particles at the top of the atmosphere, but it is not yet possible to determine the efficiency of all the possible heating processes.

Composition must be introduced in the atmospheric nomenclature, for it is necessary to consider two essential divisions: the *homosphere* in which the composition is uniform despite the presence of minor constituent layers (*i.e.*, ozone), and the *heterosphere* in which the mean molecular mass varies because such physical processes as molecular dissociation or diffusion of gases alter the composition. It is safe to conclude that the *homopause* cannot be situated below the *mesopause*. Effective dissociation of molecular oxygen could begin

\* Original manuscript received by the IRE, December 16, 1958.

† Dept. of Radiation, Royal Meteorological Institute, Brussels, Belgium.

as low as the mesopause and diffusion cannot be important below 100 km.

Since the earth's atmosphere in static equilibrium is considered as a perfect gas composed of molecules and atoms of which only a small fraction is represented by charged particles, the *ionosphere* includes all atmospheric regions in which the behavior of ions and electrons influenced by the geomagnetic field is studied. Thus, it may be said that the ionosphere begins at the lowest height and extends up to highest altitudes where dynamic processes are the rule.

#### THE INTERRELATIONS BETWEEN PRESSURE, TEMPERATURE, AND DENSITY

The mean hydrostatic pressure  $p$  is given<sup>1</sup> by the following equation of state:

$$p = nkT \quad (1)$$

in which  $k = 1.38 \times 10^{-16}$  erg deg<sup>-1</sup> denotes Boltzmann's constant,  $n$  is the number density or concentration of the molecules, and  $T$  is the absolute temperature.

In the air assumed in hydrostatic equilibrium, the height distribution of the atmospheric pressure is obtained from the differential equation relating the density  $\rho$  to the pressure  $p$ :

$$\frac{dp}{dz} = -g\rho \equiv nmg \quad (2)$$

where  $g$  denotes the acceleration of gravity and  $m$  is the mean molecular mass defined by

$$m = \frac{\sum n_i m_i}{\sum n_i} \quad (3)$$

On combining the equation of state (1) with the static equation (2) the general law governing the physical parameters is obtained:

$$\frac{dp}{p} = \frac{dn}{n} + \frac{dT}{T} = - \frac{dz}{kT/mg} \quad (4)$$

The scale height  $H = kT/mg$  depends on three parameters (temperature, mean molecular mass and gravitational acceleration) and, therefore, the height variation of pressure or density will depend upon the simultaneous variation of these three parameters.

In the homosphere there is a direct relation between pressure or density and temperature since the mean molecular mass is constant. The rocket observations on pressure (or density) lead to the knowledge of the temperature and its gradient, and also of the density (or pressure).

In the heterosphere, where the mean molecular mass varies with height, a simultaneous determination of the density and pressure should give the value of the ratio  $T/m$ . The variation of this ratio depends on the simul-

taneous variation with height of the temperature related to various heat transports (and production and loss processes) and of the mean molecular mass related to the sum of the concentrations of various constituents subject to diffusion. Therefore, a direct knowledge of the temperature or the mean molecular mass is needed in order to obtain the vertical distribution of the principal constituents in the thermosphere.

#### THE COMPOSITION OF THE HOMOSPHERE

The mean molecular mass of dry air is determined by the relative concentration of N<sub>2</sub> (78.084 per cent per volume), of O<sub>2</sub> (20.946 per cent), of A (0.934 per cent), and CO<sub>2</sub> (0.03 per cent). This leads to a mean molecular mass  $M = 28.973$ , to a ratio of the two principal constituents

$$n(\text{O}_2)/n(\text{N}_2) = 0.2683, \quad (5)$$

and to a law of vertical distribution of mass density

$$\rho = 1.3n(\text{N}_2)m(\text{N}_2) \quad (6)$$

$$\rho = 4.3n(\text{O}_2)m(\text{O}_2). \quad (7)$$

Since the mass of atmospheric nitrogen,  $M_{\text{N}_2} = 28.022$ , is not too different from the air molecular mass, the behavior of N<sub>2</sub> can represent almost the conditions of the atmosphere in perfect mixing. Furthermore, any direct determination of the mass or number density of molecular oxygen may lead to a determination of a *minimum* value for the total density, where there is dissociation or diffusion.

In Table I, we show an atmospheric model for the homosphere between 50 km and 100 km. The temperature at the stratopause is of the order of 273°K and the temperature at the mesopause is about 190°K. Comparing such a model with observational data of temperatures at the stratopause<sup>2,3</sup> there is a variation indicating that  $T = 273^\circ\text{K} \pm 20^\circ\text{K}$ . At the level of the mesopause, observational data are less precise, but large variations must occur also, and if  $T = 190 \pm 20^\circ\text{K}$ , low temperatures such as 160°K are not excluded.

Measurements of the density have been made by different methods. According to Jones, Fischbach and Peterson,<sup>4</sup> there is a trend of decreasing density at 50 km with increasing latitude and, furthermore, a variation by a factor of 2 at latitude 58°N in the neighborhood of 70 km, *i.e.*, between  $5 \times 10^{-8}$  and  $10^{-7}$  gm cm<sup>-3</sup>. The results of LaGow, Horowitz and Ainsworth<sup>5</sup> seem to indicate that the Arctic densities coincide with those

<sup>2</sup> W. G. Stroud, W. Nordberg and J. R. Walsh, "Atmospheric temperatures and winds between 30 and 80 km," *J. Geophys. Res.*, vol. 61, pp. 45-56; 1956.

<sup>3</sup> W. G. Stroud, W. R. Bandeen, W. Nordberg, D. F. L. Bartman, J. Otterman and P. Titus, "Temperatures and winds in the arctic as obtained by the rocket grenade experiments," *IGY Rocket Rep. Ser.*, Natl. Acad. Sci., Washington, D. C., no. 1, pp. 58-79; 1958.

<sup>4</sup> L. M. Jones, F. F. Fischbach and J. W. Peterson, "Seasonal and latitudes variations in upper-air density," *IGY Rocket Rep. Ser.*, Natl. Acad. Sci., Washington, D. C., no. 1, pp. 47-57; 1958.

<sup>5</sup> H. E. LaGow, R. Horowitz and J. Ainsworth, "Arctic atmospheric structure to 250 km," *IGY Rocket Rep. Ser.*, Natl. Acad. Sci., Washington, D. C., no. 1, pp. 38-46; 1958.

<sup>1</sup> M. Nicolet, "Dynamic effects in the high atmosphere," in "The Earth as a Planet," G. P. Kuiper (ed.), Univ. of Chicago Press, Chicago, Ill., ch. 13, pp. 644-711; 1954.



TABLE I  
ATMOSPHERIC DATA BETWEEN 50 KM AND 100 KM

Altitude (km)	Temperature (°K)	Pressure (mm Hg)	Density (gm cm <sup>-3</sup> )	Concentration (cm <sup>-3</sup> )
50.0	274	0.67	1.1 10 <sup>-6</sup>	2.4 10 <sup>16</sup>
52.5	274	0.49	8.3 10 <sup>-7</sup>	1.7 10 <sup>-16</sup>
55.0	274	0.36	6.1 10 <sup>-7</sup>	1.3 10 <sup>16</sup>
57.5	263	0.27	4.7 10 <sup>-7</sup>	9.7 10 <sup>15</sup>
60.0	253	0.19	3.5 10 <sup>-7</sup>	7.3 10 <sup>15</sup>
62.5	242	0.14	2.6 10 <sup>-7</sup>	5.4 10 <sup>15</sup>
65.0	232	9.6 10 <sup>-2</sup>	1.9 10 <sup>-7</sup>	4.0 10 <sup>15</sup>
67.5	221	6.6 10 <sup>-2</sup>	1.4 10 <sup>-7</sup>	2.9 10 <sup>15</sup>
70.0	210	4.5 10 <sup>-2</sup>	9.9 10 <sup>-8</sup>	2.1 10 <sup>15</sup>
72.5	207	3.0 10 <sup>-2</sup>	6.7 10 <sup>-8</sup>	1.4 10 <sup>15</sup>
75.0	203	2.0 10 <sup>-2</sup>	4.6 10 <sup>-8</sup>	9.5 10 <sup>14</sup>
77.5	200	1.3 10 <sup>-2</sup>	3.1 10 <sup>-8</sup>	6.4 10 <sup>14</sup>
80.0	197	8.7 10 <sup>-3</sup>	2.0 10 <sup>-8</sup>	4.3 10 <sup>14</sup>
82.5	193	5.7 10 <sup>-3</sup>	1.4 10 <sup>-8</sup>	2.8 10 <sup>14</sup>
85.0	190	3.7 10 <sup>-3</sup>	9.0 10 <sup>-9</sup>	1.9 10 <sup>14</sup>
87.5	193	2.4 10 <sup>-3</sup>	5.7 10 <sup>-9</sup>	1.2 10 <sup>14</sup>
90.0	197	1.6 10 <sup>-3</sup>	3.7 10 <sup>-9</sup>	7.6 10 <sup>13</sup>
92.5	200	1.0 10 <sup>-3</sup>	2.4 10 <sup>-9</sup>	4.9 10 <sup>13</sup>
95.0	203	6.8 10 <sup>-4</sup>	1.5 10 <sup>-9</sup>	3.2 10 <sup>13</sup>
97.5	207	4.5 10 <sup>-4</sup>	1.0 10 <sup>-9</sup>	2.1 10 <sup>13</sup>
100.0	210	3.0 10 <sup>-4</sup>	6.6 10 <sup>-10</sup>	1.4 10 <sup>13</sup>

at 33°N. Consequently, the existence of variations in the density and temperature measurements in the mesosphere show that the essential physical parameters are not yet known with sufficient precision. Such variations can affect the computation of electron collision frequencies in the lower ionosphere and the rate of chemical reactions sensitive to the temperature effect.

At 100 km, observational data are very different. The Rocket Panel<sup>6</sup> adopted  $4.5 \times 10^{-4}$  mm of Hg; Havens, Koll and LaGow<sup>7</sup> gave a determination of  $4.2 \times 10^{-4}$  mm Hg; Kallmann, White, and Newell<sup>8</sup> have used  $4.3 \times 10^{-4}$  mm Hg; Johnson<sup>9</sup> introduced  $2.2 \times 10^{-4}$  mm Hg; and Miller<sup>10</sup>  $3.47 \times 10^{-4}$  mm Hg. However, Horowitz and LaGow<sup>11</sup> after correcting the pressures measured by the Viking 7 rocket, have obtained data leading to a value of  $1.1 \times 10^{-4}$  mm Hg. All these values which are for White Sands (33°N) show a variation of a factor of 4. However, density measurements deduced from the incident X-ray flux by Byram, Chubb and Friedman<sup>12,13</sup> indicate that the Rocket Panel values are too high by a

<sup>6</sup> F. L. Whipple, "Density, pressure, and temperature data above 30 kilometers," in "The Earth as a Planet," G. P. Kuiper (ed.), Univ. of Chicago Press, Chicago, Ill., ch. 10, pp. 491-513; 1954.

<sup>7</sup> R. J. Havens, R. T. Koll, and H. E. LaGow, "The pressure, density, and temperature of the earth's atmosphere to 160 kilometers," *J. Geophys. Res.*, vol. 57, pp. 59-72; March, 1952.

<sup>8</sup> H. K. Kallmann, W. B. White, and H. E. Newell, Jr., "Physical properties of the atmosphere from 90 to 300 kilometers," *J. Geophys. Res.*, vol. 61, pp. 513-524; September, 1956.

<sup>9</sup> F. S. Johnson, "Temperature distribution of the ionosphere under control of thermal conductivity," *J. Geophys. Res.*, vol. 61, pp. 71-76; January, 1956.

<sup>10</sup> L. E. Miller, "Molecular weight of air at high altitudes," *J. Geophys. Res.*, vol. 62, pp. 351-365; September, 1957.

<sup>11</sup> R. Horowitz and H. E. LaGow, "Upper air pressure and density measurements from 90 to 220 kilometers with the Viking 7 rocket," *J. Geophys. Res.*, vol. 62, pp. 57-78; January, 1957.

<sup>12</sup> E. T. Byram, T. A. Chubb and H. Friedman, "The solar x-ray spectrum and the density of the upper atmosphere," *J. Geophys. Res.*, vol. 61, pp. 251-263; June, 1956.

<sup>13</sup> E. T. Byram, T. A. Chubb, and H. Friedman, "The dissociation of oxygen at high altitudes," in "The threshold of space," *Proc. Conf. Chem. Aeronomy*, M. Zelickoff (ed.), Pergamon Press, New York, N. Y., pp. 211-216; 1957.

factor of about 3. Such a result is consistent with the low value of the pressure deduced by Horowitz and LaGow.<sup>11</sup>

The publication of Mikhnevitch<sup>14</sup> also indicates a relatively low pressure:  $1.8 \times 10^{-4}$  mm Hg. But, recent data obtained at Fort Churchill (58°N) show that the pressure is not less than  $3 \times 10^{-4}$  mm Hg and that density data<sup>15</sup> for molecular oxygen must lead to a total density not less than  $9 \times 10^{-10}$  gm cm<sup>-3</sup>. Thus, if there is a very broad range of a factor of 4 in the pressure and density data at 100 km, this cannot be attributed to a permanent latitudinal effect since too strong an easterly wind would be required permanently. In other words, pressure at 100 km is of the order of  $(3 \pm 1) \times 10^{-4}$  mm Hg, but it is not yet possible to determine the range of variation.

Such considerations show that any atmospheric model even at such low altitudes as 100 km is currently subject to uncertainty and very great precision is needed in the observational data before valid conclusions can be drawn. For example, a pressure of the order of  $4.5 \times 10^{-2}$  mm Hg at 70 km and a range between  $1 \times 10^{-4}$  and  $4 \times 10^{-4}$  mm Hg at 100 km require a variation of more than 70°K near the mesopause.

#### THE DISSOCIATION OF MOLECULAR OXYGEN

The mesopause can be considered as a border between two regions in which the behavior of atomic oxygen is different. In the mesosphere, atomic oxygen<sup>16</sup> is subject to photochemical and chemical actions leading to different aeronomic conditions between day and night;<sup>17</sup> but in the thermosphere, where the time of recombination of an oxygen atom is very long (several months at 100 km), its vertical distribution depends on a downward transport.<sup>18</sup> The balance between recombination and dissociation of oxygen must occur in the lower thermosphere. In fact, photoequilibrium conditions cannot exist; vertical transport carries molecular oxygen upward<sup>19</sup> while atomic oxygen is carried downward. In other words, one dissociated O<sub>2</sub> molecule is replaced by another through the upward diffusion process while oxygen atoms are forced downward until they reach a region of sufficiently high pressure to cause them to recombine. Thus, the mixing ratio

<sup>14</sup> V. V. Mikhnevitch, "Pressure measurements in the upper atmosphere," *Progr. Phys. Sci., Acad. Sci., USSR*, vol. 63, pp. 197-207; 1957.

<sup>15</sup> J. E. Kupperian, Jr., E. T. Byram, H. Friedman and A. Unzicker, "Molecular oxygen densities in the mesosphere over Ft. Churchill," *IGY Rocket Rep. Ser.*, Natl. Acad. Sci., Washington, D. C., no. 1, pp. 203-207; 1958.

<sup>16</sup> D. R. Bates, "The physics of the upper atmosphere," in "The Earth as a Planet," G. Kuiper (ed.), Univ. of Chicago Press, Chicago, Ill., ch. 12, pp. 576-643; 1954.

<sup>17</sup> D. R. Bates and M. Nicolet, "The photochemistry of the atmospheric water vapor," *J. Geophys. Res.*, vol. 55, pp. 301-327; September, 1950.

<sup>18</sup> M. Nicolet and P. Mange, "The dissociation of molecular oxygen in the high atmosphere," *J. Geophys. Res.*, vol. 59, pp. 15-45; January, 1954.

<sup>19</sup> M. Nicolet, "The aeronomic problem of oxygen dissociation," *J. Atmos. Terrest. Phys.*, vol. 4, pp. 132-140; 1954.

$$[2n(\text{O}_2) + n(\text{O})]/n(\text{N}_2) = 0.537 \quad (8)$$

cannot be kept constant in the thermosphere. It can be shown that the ratio  $n(\text{O})/n(\text{N}_2)$  may be as low as 1/10 near 100 km if the downward transport is important, while perfect photoequilibrium conditions will lead to  $n(\text{O}) = 2n(\text{N}_2)$ . Therefore, although it is certain that the oxygen/nitrogen ratio in the thermosphere cannot correspond to the mixing ratio (8), it is, however, impossible to determine exactly what the exact ratio  $n(\text{O})/n(\text{N}_2)$  is in the lower thermosphere below the diffusion region.

The fluctuations in the emission of the green line of atomic oxygen in the airglow show that there are considerable variations in the concentration of atomic oxygen in the lower thermosphere. Nevertheless, experimental evidence on the vertical distribution of atomic oxygen does not exist, and it is not possible to know what the percentage of dissociation of molecular oxygen in the thermosphere is. The rocket data of Byram, Chubb and Friedman<sup>13</sup> show that molecular oxygen still has a concentration of  $4 \times 10^8$  molecules  $\text{cm}^{-3}$  at 180 km, but it is difficult to determine the associated concentrations of atomic oxygen and molecular nitrogen.

#### THE DISSOCIATION OF MOLECULAR NITROGEN

If the dissociation of molecular nitrogen were due only to a predissociation mechanism, atomic nitrogen would be completely negligible above 100 km; but the effect of dissociative recombination of  $\text{N}_2^+$  (or the ion-atom interchange collision) must be considered in the ionosphere where there is a continuous production of molecular nitrogen ions by X rays and ultraviolet radiation.

Bates<sup>20</sup> has shown that  $\text{N}_2^+$  ions have a short lifetime in the F layer, for spectral observations of the twilight airglow spectrum require a rapid loss of these ions. Therefore, the following processes<sup>21</sup>



and (or)

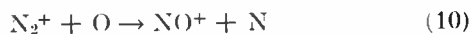

are important mechanisms in the ionosphere leading to nitrogen atoms.

Atomic nitrogen reacts with molecular oxygen according to the following process:

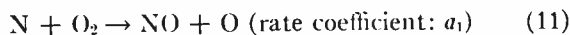

and subsequently with nitric oxide as follows:



An additional process for the production of atomic nitrogen is the ion-atom interchange collision:

<sup>20</sup> D. R. Bates, "The emission of the negative system of nitrogen from the upper atmosphere and the significance of the twilight flash in the theory of the ionosphere," *Proc. Roy. Soc. (London)*A, vol. 196, pp. 562-591; 1949.

<sup>21</sup> M. Nicolet, "Aeronomic chemical reactions," presented at 2nd Internatl. Symp. on Phys. and Med. of Atmos. and Space, San Antonio, Tex.; November 10-12; 1958. (Not yet published.)

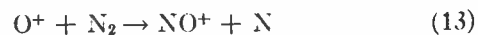

competing with

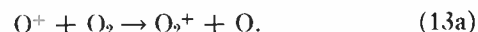

Simple expressions of atomic nitrogen and nitric oxide concentrations are obtained when equilibrium conditions are adopted. They are<sup>21</sup>

$$n(\text{NO}) = a_1 n(\text{O}_2)/a_2 \simeq 10^{-2} e^{-3120/T} \quad (14)$$

and

$$n(\text{N}) = \frac{n(\text{N}_2)I_{\text{N}_2} + Yn(\text{O})I_{\text{O}}}{a_1 n(\text{O}_2)}. \quad (15)$$

The numerator of (15) represents the photoionization of  $\text{N}_2$  with an ionization rate  $I_{\text{N}_2}$  and the photoionization of O with the effective ionization rate  $YI_{\text{O}}$  corresponding to (13).

Eq. (14) shows that nitric oxide is a minor constituent since its concentration is a small fraction of the concentration of molecular oxygen. In order to determine the concentration of atomic nitrogen, it is necessary to know at least the ionization rate of molecular nitrogen. In fact, an exact determination of the vertical distribution of atomic nitrogen requires the knowledge of  $n(\text{N}_2)$ ,  $n(\text{O})$ , and  $n(\text{O}_2)$ , as well as the temperature. For example, if we consider ionization by X rays of about 50 Å with an energy of 0.1 erg  $\text{cm}^{-2}$   $\text{second}^{-1}$ , the number of resulting nitrogen atoms at 100 km is of the order of  $5 \times 10^6$   $\text{cm}^{-3}$ . Atomic nitrogen is, therefore, a minor constituent in the lower thermosphere.

The maximum value of the atomic nitrogen concentration should be obtained in the  $F_1$  layer and would be of the same order as that of  $n(\text{O}_2)$  between 150 km and 180 km under certain temperature conditions. However, steady conditions cannot be assured for atomic nitrogen in the whole thermosphere since the lifetime of a nitrogen atom varies with height; in the  $F_1$  layer, its lifetime may be shorter than one night, and there is therefore a daily variation.

#### DIFFUSION IN THE THERMOSPHERE

In aeronomic problems<sup>1</sup> it is possible to find a criterion for the diffusion phenomenon by making a comparison between a mixing distribution corresponding to a constant mean molecular mass and a diffusion distribution in which each constituent behaves according to its own molecular mass: a diffusion time associated with a certain altitude. In that case, it is easy to determine diffusion times for minor constituents<sup>22</sup> to reach vertical distribution in diffusion equilibrium, but the absolute times must be deduced by using the continuity equation<sup>23</sup> since diffusion proceeds continuously. It is found that the percentage concentration change is always the

<sup>22</sup> P. Mange, "Diffusion processes in the thermosphere," *Ann. Geophys.*, vol. 11, pp. 153-168; 1955.

<sup>23</sup> P. Mange, "The theory of molecular diffusion in the atmosphere," *J. Geophys. Res.*, vol. 62, pp. 279-296; June, 1957.



same for all altitudes but corresponds to different diffusion times. This continuous action of diffusion is, however, limited by the mass exchange due to mixing which determines a boundary condition. If we compare the theoretical result for argon and the observational data obtained by Meadows and Townsend,<sup>24</sup> it is possible to deduce that mixing times for argon are not less than one day and not more than one week near 110 km.

Therefore, diffusion begins for minor constituents in the thermosphere above 100 km. As far as principal constituents are concerned, diffusion should begin at higher levels.

#### THE CONDUCTION OF HEAT

Ionospheric data, rocket results and more recently satellite observations have shown that the density cannot be less than  $10^{-16}$  gm  $\text{cm}^{-3}$  at 700 km. The temperature must increase continuously up to the greatest altitudes or its gradient must be very large in a certain part of the thermosphere.

Since the heat flux,  $E$ , by conduction is expressed by

$$E = \lambda_c \frac{dT}{dz} \text{ cm}^{-2} \text{ second}^{-1}, \quad (16)$$

where  $\lambda_c$ , the thermal conductivity, is for thermospheric temperatures

$$\lambda_c(\text{air}) = 1.8 \times 10^2 T^{1/2} \quad (17)$$

$$\lambda_c(O) = 3.6 \times 10^2 T^{1/2} \quad (18)$$

$$\lambda_c(H) = 2.1 \times 10^3 T^{1/2}, \quad (19)$$

it can be seen that large gradients of temperature require a high energy flow to maintain a steady state. Any gradient of the order of  $10^\circ\text{K}$  per km for temperatures higher than  $1000^\circ\text{K}$  requires a heat flow greater than  $1 \text{ erg cm}^{-2} \text{ second}^{-1}$ . Such an energy may be found in the chromospheric lines of helium. However, since this energy first goes into an ionization process, it is necessary that the most abundant constituent not be involved in the normal production of the electron concentration detected by radio electric methods.<sup>25</sup> In other words, the most important part of the ionizing radiation should go rapidly into recombination and heating.

Since LaGow, Horowitz and Ainsworth<sup>6</sup> have interpreted their density measurements at Fort Churchill ( $58^\circ\text{N}$ ) by a scale height of about 70 km at 155 km and a gradient of the scale height of the order  $dH/dz = 1.67$ , 4.5 to 5  $\text{ergs cm}^{-2} \text{ second}^{-1}$  are needed to maintain such a high temperature gradient, namely, between  $30^\circ\text{K}$  and  $50^\circ\text{K}$  per km.

In a molecular nitrogen atmosphere the preceding values correspond to about  $10^{11}$  photons  $\text{cm}^{-2} \text{ second}^{-1}$ , leading to an ionization rate of about 3000 electrons

$\text{cm}^{-3} \text{ second}^{-1}$  at the absorption peak. Since the peak of the  $F_1$  layer requires only an effective production of a few hundred electrons  $\text{cm}^{-3} \text{ second}^{-1}$ , it is necessary that about 90 per cent of the electronic production disappear immediately by a dissociative recombination process. Therefore, in the lower part of the  $F$  layer molecular nitrogen should be more abundant than atomic oxygen. In other words, the heat should be supplied mainly by unobserved ionization.

Another source of heating may be the particles entering the atmosphere in various forms. For example, protons of velocities of about  $1000 \text{ km second}^{-1}$  have charge-transfer cross sections greater than  $10^{-16} \text{ cm}^2$  in nitrogen.<sup>26</sup> A subsequent dissociative recombination would lead to some heating. However, more evidence on the properties of these particles is needed. In his analysis of the radio star scintillations as caused by interstellar particles entering the ionosphere, Harrower<sup>27</sup> has found that the atmosphere would receive about  $6.0 \times 10^{12}$  hydrogen atoms  $\text{cm}^{-2} \text{ second}^{-1}$  with a velocity of the order of  $3.3 \times 10^6 \text{ cm second}^{-1}$ . This infall of particles should lead to a source of heating.

There is also a possibility, according to Van Allen,<sup>28</sup> that the radiation belt is the source of a leakage of energetic particles contributing to the general heating of the atmosphere. Other suggestions have been made such as the effect of hydromagnetic waves,<sup>29</sup> indicating that arguments can be made for the existence of sources of heating of the thermosphere.

Finally, a temperature gradient in the thermosphere could be easily maintained<sup>30</sup> if a small fraction of the coronal energy were trapped in the upper thermosphere as Chapman<sup>31</sup> has proposed when he considered the conduction of heat in the ionized coronal gas to the terrestrial atmosphere.

#### CONCLUSION

The data obtained on atmospheric structure by means of rocket and satellites should be compared when enough information has been obtained. Present rocket information<sup>5,32</sup> on rocket densities at 200 km ( $59^\circ\text{N}$ ) indicates possible variations of more than a factor of 10 between a summer day ( $6 \times 10^{-13} \text{ gm cm}^{-3}$ ) and a winter night

<sup>26</sup> P. M. Stier and C. F. Barnett, "Charge exchange cross sections of hydrogen ions in gases," *Phys. Rev.*, vol. 103, pp. 896-907; August, 1956.

<sup>27</sup> G. A. Harrower, "A consideration of radio star scintillations as caused by interstellar particles entering the ionosphere," *Can. J. Phys.*, vol. 35, pp. 792-798; 1957.

<sup>28</sup> J. A. Van Allen, C. E. McIlwain and G. L. Ludwig, "Radiation observation with satellite 1958 epsilon," presented at the 2nd Internatl. Symp. on Phys. and Med. of Atmos. and Space, San Antonio, Tex.; November 10-12, 1958. (Not yet published.)

<sup>29</sup> A. J. Dessler, "Large amplitude hydromagnetic waves above the ionosphere," *J. Geophys. Res.*, vol. 63, pp. 507-511; September, 1958.

<sup>30</sup> M. Nicolet, "High atmosphere densities," *Science*, vol. 127, pp. 1317-1320; June, 1958.

<sup>31</sup> S. Chapman, "Notes on the solar corona and the terrestrial ionosphere," *Smithsonian Contributions to Astrophys.*, vol. 2, pp. 1-12; 1956.

<sup>32</sup> J. W. Townsend, Jr., "Atmospheric structure above Ft. Churchill," *IGY Rocket Rep. Ser.*, Natl. Acad. Sci., Washington, D. C., no. 1, pp. 11-13; 1958.

<sup>24</sup> E. B. Meadows and J. W. Townsend, Jr., "Diffusive separation in the winter nighttime arctic upper atmosphere," *Ann. Geophys.*, vol. 14, pp. 80-91; 1958.

<sup>25</sup> D. R. Bates, "The temperature of the upper atmosphere," *Proc. Phys. Soc. (London)*, vol. 64, pp. 805-821; 1951.

( $4 \times 10^{-14}$  gm cm $^{-3}$ ). Analyses of satellite observations such as those made by Sterne,<sup>33</sup> Harris and Jastrow,<sup>34</sup> and Siry<sup>35</sup> show that densities between 200 km and 800 km may have a vertical distribution as follows:

Altitude (km)	200	300	400	600	800
Density (gm cm $^{-3}$ )	$6 \times 10^{-13}$	$6 \times 10^{-14}$	$8 \times 10^{-15}$	$5 \times 10^{-16}$	$8 \times 10^{-17}$

Such a variation of thermospheric densities may be interpreted as an increase of the scale height with alti-

<sup>33</sup> T. E. Sterne, "Density of the upper atmosphere," *Science*, vol. 128, p. 420; January, 1958.

<sup>34</sup> I. Harris and R. Jastrow, "Densities determinations based on the Explorer and Vanguard satellites," *Science*, vol. 128, pp. 420-421; January, 1958.

<sup>35</sup> J. W. Siry, "The Vanguard IGY earth satellite program," presented at 5th CSAGI Assembly, Moscow, U.S.S.R.; August, 1958. (To be published in the *Ann. IGY*.)

tude. Nevertheless, the large variations in the rocket data do not yet permit one to use the satellite results in a single representation.

The heat flux is given<sup>30</sup> by:

$$E, \text{ erg cm}^{-2} \text{ second}^{-1} \simeq 9 \times 10^{-4} \beta H^{1/2} \quad (20)$$

where  $\beta = dII/dz$  denotes the gradient of the local scale height  $II$ . Formula (20) shows that scale heights of 40 km and 75 km at 160 km require about 1 and 3 erg cm $^{-2}$  second $^{-1}$ , respectively. On the other hand, a small increase of only 20 km in the scale height between 400 km and 800 km needs not less than 0.1 erg cm $^{-2}$  second $^{-1}$ . Therefore, it is thought that the thermosphere, besides the heating below 300 km by solar ultraviolet radiation, is also subject to a heat flux conducted from higher altitudes.

# The Normal F Region of the Ionosphere\*

D. F. MARTYN†

**Summary**—The global morphologies of the  $F_1$  and  $F_2$  regions at magnetically quiet times are reviewed, and attention also is given to the sunspot-cycle variations. The physical conditions, temperature, pressure, recombination coefficients, and collision frequencies are reassessed in the light of recent studies of rocket and satellite results and of diffusion. The theory of the F region is reviewed with special attention to Bradbury's hypothesis and to the effects of transport of ionization.

Also considered are the morphology of "spread-F" and radio star scintillation phenomena. A theory of the latter is outlined, and it is shown that the undersurface of the F region is unstable at times of upward drift, which appear to be the times when such phenomena are prominent.

## INTRODUCTION

THE F region may be defined as the part of the ionosphere which lies above a height of about 150 km. Ionosonde records tend to exaggerate the discreteness of the E,  $F_1$ , and  $F_2$  regions. The interpretation of such records in terms of true-ionization height-profiles ( $N-h$ ), presents analytical difficulties which have been satisfactorily overcome only recently, and leaves partially unresolved the important matter of the distribution in the troughs between each ionization peak. As long ago as 1935, Hollingworth<sup>1</sup> put forward the view that the ionization trough between the E and F regions was shallow, but his arguments appar-

ently did not win general acceptance. The matter finally has been resolved by rocket soundings, and it is known now<sup>2</sup> that, in general, only very shallow troughs exist between the E,  $F_1$ , and  $F_2$  peaks. It now is realized too that the  $F_1$  peak occurs some 50 km lower than had previously been supposed, *i.e.*, at a height of about 160 km at noon. The  $F_2$  ionization peak by day<sup>3</sup> averages around a height of about 250 km; thus the  $F_1$  region is closer to the E than it is to the  $F_2$  region. However, there is reason to believe, at least for sunspot minimum conditions, that both  $F_1$  and  $F_2$  are formed by the same solar ionizing radiation, so it is convenient to treat them together, as is done here.

The  $F_2$  region is subject to many anomalies, and is obviously perturbed by tidal influences, both solar and lunar, as well as by the conditions associated with magnetic storms. It is believed now<sup>1,5</sup> that these perturbations, as well as at least some of the anomalies, arise from electro-dynamical forces associated with the flow of

<sup>2</sup> J. E. Jackson and J. C. Seddon, "Ionosphere electron-density measurements with the Navy Aerobee-Hi rocket," *J. Geophys. Res.*, vol. 63, pp. 197-208; March, 1958.

<sup>3</sup> J. O. Thomas, J. Haselgrove, and A. Robbins, "The electron distribution in the ionosphere over Slough—1. Quiet days," *J. Atmos. Terrest. Phys.*, vol. 12, pp. 46-56; 1958.

<sup>4</sup> D. F. Martyn, "Atmospheric tides in the ionosphere: part 4—studies of the solar tide, and the location of the regions producing the diurnal magnetic variations," *Proc. Roy. Soc. (London) A*, vol. 194, pp. 445-463; November 9, 1948.

<sup>5</sup> D. F. Martyn, "The morphology of the ionospheric variations associated with magnetic disturbance. I. Variations at moderately low latitudes," *Proc. Roy. Soc. (London) A*, vol. 218, pp. 1-18; 1953.

\* Original manuscript received by the IRE, December 12, 1958.

† CSIRO Radio Res. Labs., Camden, Australia.

<sup>1</sup> J. Hollingworth, "The structure of the ionosphere," *Proc. Phys. Soc. (London)*, vol. 47, pp. 843-851; 1935.



electric currents in the ionosphere. This paper is confined to the magnetically quiet  $F$  region.

#### MORPHOLOGY OF THE $F$ REGION

The  $F_1$  region can be simply described as substantially a Chapman region, with a peak electron density ( $N_m$ ) of  $2.5 \times 10^5$  electrons per  $\text{cm}^3$  at noon at the equator at the equinoxes at sunspot minimum ( $R=0$ ). Typical global contours of  $N_m$  for such a region have been given by Millington.<sup>6</sup> Decay of ionization in the  $F_1$  region occurs according to a recombination law (*i.e.*, it is given by  $\alpha N^2$ ), with  $\alpha^7$  about  $8 \times 10^{-9}$ . The relaxation time of the ionization  $(2\alpha N)^{-1}$  is about four minutes, which means that the daily maximum of  $N_m$  is reached a few minutes after noon, and therefore is closely proportional to  $\cos^{1/2} \chi$ , where  $\chi$  is the noon zenith angular distance of the sun at the given location.

The variation of  $N_m F_1$  with sunspot number has been studied carefully by Allen,<sup>8</sup> from whose work it can be deduced that at the equator its noon equinoctial value, at an epoch of sunspot number  $R$ , is

$$N_m F_1 = 2.5 \times 10^5 (1 + 0.0062R).$$

Although at and below the level of peak ionization, the  $F_1$  region behaves substantially as a Chapman region, nevertheless, small deviations are found<sup>4,9</sup> when months or years of ionosonde measurements are examined statistically. It has been shown<sup>10</sup> that these perturbations are due to local electric currents associated with the solar and lunar magnetic variations.

The morphology of the  $F_2$  region is much more complex. Figs. 1 through 4 show<sup>11</sup> world contours of  $f_0 F_2$  for two epochs of maximum and minimum sunspot activity (1947 and 1943–1944, respectively) for equinoctial and solstitial months. (The peak electron density is given, per cubic cm, by the relation  $N_m = 1.24(f_0)^2$ , where  $f_0$  is expressed in mc/s.) These contours have been plotted on a grid of local time (horizontal) and *geomagnetic* latitude (vertical). (Had they been plotted in *geographic* latitude the equinoctial contours would have been unsymmetrical about the equator, and additional diagrams would have been needed to illustrate the "longitude effect" which then arises.) The contours in these figures have been derived from the data of 64

ionospheric observatories. For comparison purposes, Fig. 5 shows theoretical equinoctial contours of a Chapman region with a relaxation time of one and a half hours plotted on a grid similar to that of Figs. 1–4, except that geographic instead of geomagnetic latitude is used.

Figs. 1–4 show in compact fashion all the major anomalies of the  $F_2$  region. First, the symmetry of Figs. 1 and 2 about the geomagnetic equator is itself an anomaly. During World War II, it was recognized on both sides by those responsible for ionospheric predictions that the  $F_2$  region was unsymmetrical about the geographic equator. It appears to have gradually been realized, both in the U. S. and Japan, that this anomaly was associated in some way with magnetic latitude. The first published references to symmetry of the region about the magnetic equator appear to be due to Martyn<sup>12</sup> and Appleton.<sup>13</sup>

Second, Figs. 1–4 show further major departures from Chapman's theory in that there is a trough in  $f_0 F_2$  at or near the magnetic equator. This is the long-known noon "bite-out" first discovered at Huancayo, Peru. Figs. 1 and 2 show that at sunspot minimum this effect is pronounced, but confined to the daylight hours from midmorning onwards, whereas at sunspot maximum the effect, though smaller, persists until well after midnight. Apparently associated with this effect are two anomalously high peaks of  $N_m$  in the afternoon lying about  $10^\circ$ – $15^\circ$  on each side of the magnetic equator. In winter these two peaks appear to occur rather earlier, and to be centered about the noon meridian.

Third, comparison of Figs. 1 and 2 with Fig. 5 shows that the former contours display a meridional gradient much steeper, and a longitudinal gradient less steep than Chapman's theory predicts. The latter effect is especially pronounced in moderate to low latitudes.

Fourth, in moderate to high latitudes there is a gross seasonal anomaly in that winter daytime values of  $f_0 F_2$  are not smaller than the corresponding summer values; in moderate latitudes at sunspot maximum the winter noon values, in fact, are considerably greater than the summer ones. Because of these complexities it is not easy to express simply the variation of  $f_0 F_2$  with sunspot number. Obviously, this relationship varies with latitude, season, and the local time selected. The matter has been studied by Allen<sup>14</sup> who concludes that

$$N_{mR} = N_{mO}(1 + 0.02R)$$

where the additional subscripts  $R$  and  $O$  refer to epochs of sunspot numbers  $R$  and  $O$  respectively. Figs. 1–4

<sup>6</sup> G. Millington, "The relation between ionospheric transmission phenomena at oblique incidence and those at vertical incidence," *Proc. Phys. Soc. (London)*, vol. 50, pp. 801–825; 1938.

<sup>7</sup> C. M. Minnis, "The effective recombination coefficients in the  $E$  and  $F_1$  layers" in "Solar Eclipses and the Ionosphere," Pergamon Press, London, Eng.; pp. 204–211; 1956.

<sup>8</sup> C. W. Allen, "Variation of the sun's ultra-violet radiation as revealed by ionospheric and geomagnetic observations," *Terrest. Mag. and Atmos. Elec.*, vol. 51, pp. 1–18; March, 1946.

<sup>9</sup> D. F. Martyn, "Lunar variations in the principal ionospheric regions," *Nature*, vol. 163, p. 34; January, 1949.

<sup>10</sup> D. F. Martyn, "Atmospheric tides in the ionosphere: part 3—lunar tidal variations at Canberra," *Proc. Roy. Soc. (London) A*, vol. 194, pp. 429–444; November 9, 1948.

<sup>11</sup> D. F. Martyn, "Geomagnetic anomalies of the  $F_2$ -region and their interpretation" in "Physics of the ionosphere," The Physical Society, London, Eng., p. 260; 1955.

<sup>12</sup> D. F. Martyn, "Anomalous behavior of the  $F_2$ -region of the ionosphere," *Nature*, vol. 155, p. 363; 1945.

<sup>13</sup> E. V. Appleton, "Two anomalies in the ionosphere," *Nature*, vol. 157, p. 691; 1946.

<sup>14</sup> C. W. Allen, "Critical frequencies, sunspots, and the sun's ultra-violet radiation," *Terrest. Magnet. and Atmos. Elec.*, vol. 53, pp. 433–448; December, 1948.

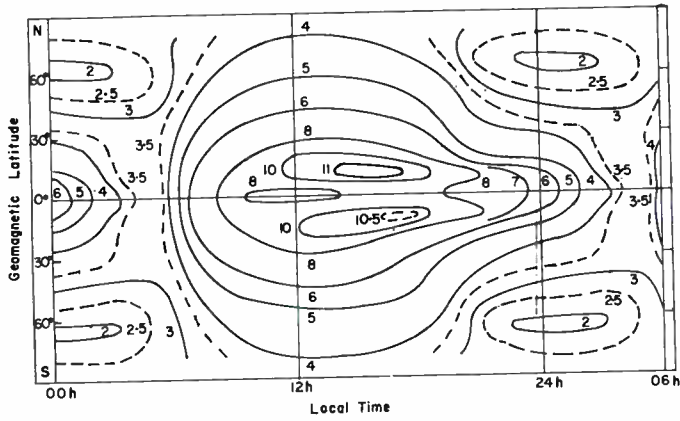

Fig. 1— $f_0F_2$  1943-1944. Equinox.

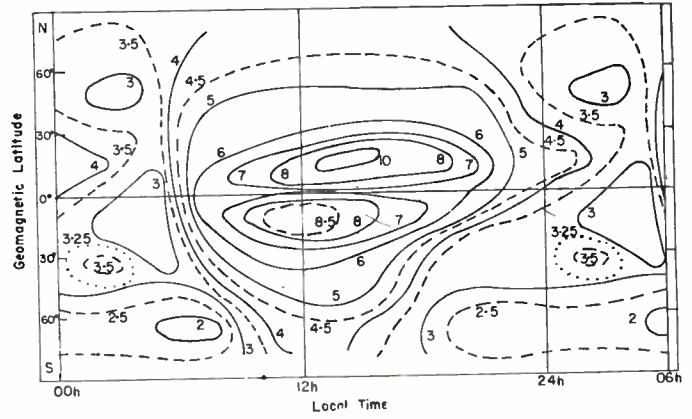

Fig. 3— $f_0F_2$  1943-1944. N. Solstice.

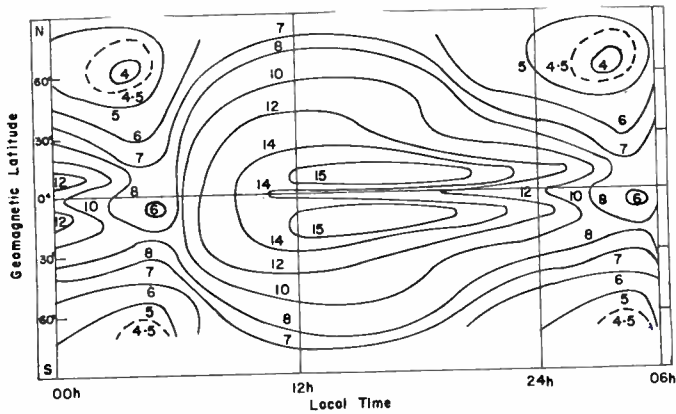

Fig. 2— $f_0F_2$  1947. Equinox.

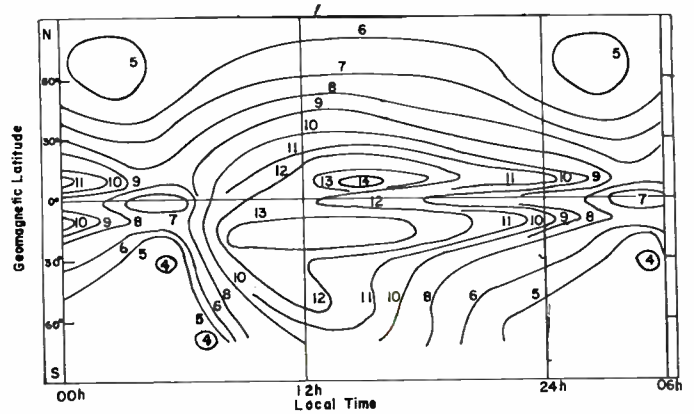

Fig. 4— $f_0F_2$  1947. N. Solstice.

show that this relationship is a useful guide for noon equinoctial conditions at moderately high latitudes, but that it breaks down in low latitudes in all seasons, and in higher latitudes in summer.

The morphology of  $h_m F_2$ , the height of  $N_m$  in the  $F_2$  region, is not yet fully known. The minimum equivalent height  $h' F_2$  is a sensitive index of height variations in the region, but it is difficult to accurately deduce  $h_m$  from ionograms without elaborate analysis. In particular,  $h' F_2$  can be much greater than  $h_m F_2$  at times when  $f_0 F_2$  is not much greater than  $f_0 F_1$ . Certain facts already are clearly established, however, by rocket ascents conducted by the U. S. Naval Research Laboratory, and by the ionogram analyses of Ratcliffe and his school.<sup>15</sup> At moderate to high latitudes, noon  $h_m F_2$  is about 220 km at the equinoxes at sunspot minimum on magnetically quiet days. For the same conditions in winter,  $h_m F_2$  is some 10 km lower, and in summer some 20 km higher. This seasonal variation constitutes yet another anomaly, in that it is opposite in sense to that predicted by Chapman's theory. The corresponding midnight values of  $h_m F_2$  are about 320 km, with no clear seasonal variation yet established. The latitude variation of noon  $h_m F_2$  is

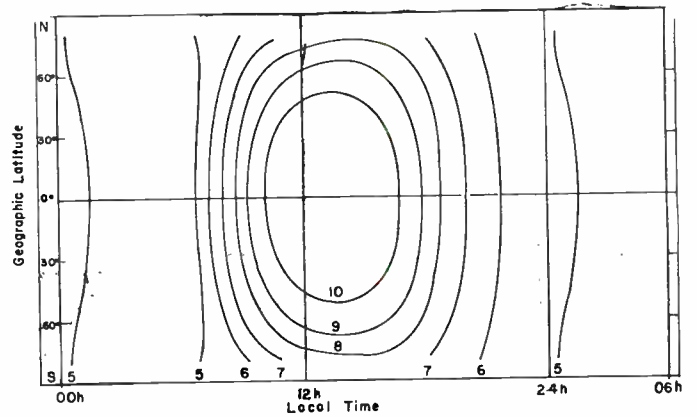

Fig. 5—Theoretical  $f_0 F_2$  contours for Chapman region.

not yet well known. At the magnetic equator, however, it is well established that the  $F_2$  region is substantially higher than at lower latitudes. Thus at Huancayo at sunspot minimum,  $h_m F_2$  is about 350 km at noon (and about 300 km at midnight). The fact that the height of peak ionization near the magnetic equator is greater by day than by night constitutes yet another  $F_2$ -region anomaly.

It has been pointed out<sup>4</sup> that  $h_m F_2$  appears to vary with the sunspot cycle, the height rising with increasing

<sup>15</sup> J. O. Thomas, J. Haselgrove, and A. R. Robbins, "Tables of Ionospheric Electron Density, Slough (England)," Cavendish Lab., Cambridge, Eng., Ser. B, No. 1.



sunspot number even on magnetically quiet days. At moderate latitudes daytime,  $h_m F_2$  at sunspot maximum is some 30 km higher than the heights given above; at Huancayo the corresponding rise is some 70 km.

#### SPREAD $F$ AND SCINTILLATION OF RADIO STARS

At certain times the ionogram traces of  $F$ -region reflections become diffuse and broad near the critical penetration frequencies, indicating that the region then cannot be considered uniformly stratified, but must contain embedded irregularities such as clouds, "blobs," or columns of electrons differing in density from their surroundings. This phenomenon has come to be known as "spread  $F$ " by reason of the characteristic appearance of the associated ionosonde traces. There is little doubt now that the inhomogeneities associated with this phenomenon are also a principal and probably the main cause of radio-star scintillations.

Spread  $F$  occurs mainly at night. At medium to high latitudes it shows a diurnal variation with maximum frequency of occurrence<sup>16</sup> soon after midnight. At low latitudes it appears to occur most frequently somewhat earlier in the evening; at Huancayo<sup>17</sup> around 21 hours.

The occurrence of these phenomena is closely associated with geomagnetic activity. At moderate to high latitudes the correlation is strong and positive, at low latitudes strong and negative.<sup>18</sup> At medium latitudes (c. 35° geomagnetic) there appears to be a minimum of occurrence of spread  $F$  at all times.

#### PARAMETERS OF THE $F$ REGION

In previous sections, an account has been given of the morphology of the peak electron density distribution of the  $F$  region. This section outlines the other known physical characteristics of the region, and of the part of the atmosphere in which it exists.

Many years ago it was suggested<sup>19</sup> that the turbulence and mixing due to upper-air winds would prevent diffusive separation of the atmospheric gases even at  $F$ -region levels, and that the air there consisted substantially of nitrogen and atomic oxygen. It was suggested also that interpretation of all available evidence tended rather strongly to show that the temperature at these levels must be very high, of the order of 1000°C, at all hours and seasons. The most recent results obtained by rockets and satellites<sup>20</sup> seem to substantiate these early findings. It now appears that the temperature at the

300-km level is of the order of 1400°K, and the particle density about  $2 \times 10^9$  cm<sup>-3</sup>.

It seems reasonably certain that the recombination coefficient in the  $F_2$  region is inversely proportional to  $N$ , so that the ionization there decays in linear proportion to  $N$ , i.e.,

$$\frac{\partial N}{\partial t} = \alpha - \beta N.$$

It also can be accepted<sup>14,21</sup> that  $\beta$  at 300 km is about  $10^{-4}$  sec<sup>-1</sup>, and that it varies with height according to the formula

$$\beta = 10^{-4} \exp \left\{ \frac{300 - h(\text{km})}{50} \right\}.$$

An important parameter of the region is the scale-height  $H_0$ , which determines the (exponential) rate of height decrease of the number density of un-ionized air particles. This is given by  $H_0 = kT/\bar{M}g$ , where  $k$  is Boltzmann's constant,  $T$  the absolute temperature,  $\bar{M}$  the mean molecular mass of the particles, and  $g$  the acceleration due to gravity at the height considered. It appears safe to take the mean molecular weight as 23.8 in the  $F$  region<sup>22</sup> corresponding to an atmosphere of nitrogen and oxygen in the same proportions as at the ground, but with the oxygen completely dissociated. This gives  $H_0 = 0.039 T$  (km) at 300 km, and  $0.037 T$  at 160 km ( $F_1$ ), so that  $H$  is 55 km at 300 km, in good agreement with recent<sup>23</sup> calculations from nighttime  $N-h$  profiles. No reliable measurements are available of the half thickness of the  $F_1$  region. However, it is well established that the temperature is about 300°K at 110 km, and if a nearly linear rise is assumed between 110 and 300 km (as is necessary to give the particle densities found at 300 km), then the temperature at 160 km is 560°K and the scale height is 21 km. It is readily calculated, then, that the neutral particle density at 160 km is  $1.8 \times 10^{11}$  per cm<sup>3</sup>.

For various purposes it is necessary to know the electron and ion collision frequencies. These are given<sup>21</sup> by

$$\nu_{ei} = \{34 + 4.18 \log_{10}(T^3/N_e)\} N_e T^{-3/2}$$

$$\nu_{en} = 5.4 \times 10^{-10} N_n T^{1/2}$$

$$\nu_{in} = 2.6 \times 10^{-9} (N_e + N_n) W^{-1/2}$$

where  $W$  is the molecular weight of the ions and neutral particles (assumed equal), and the subscripts  $e$ ,  $i$ , and  $n$

<sup>16</sup> R. W. Wright, J. R. Koster, and N. J. Skinner, "Spread  $F$ -layer echoes and radio-star scintillation," *J. Atmos. Terrest. Phys.*, vol. 8, pp. 240-246; May, 1956.

<sup>17</sup> R. W. Knecht and D. W. Schlitt, "Early Results from the Equatorial Close-Spaced Chain of Ionospheric Vertical Sounding Stations," NBS Rep. No. 5587; September 7, 1958.

<sup>18</sup> A. J. Lyon, N. J. Skinner, and R. W. Wright, "Equatorial spread- $F$  and magnetic activity," *Nature*, vol. 181, pp. 1724-1725; June, 1958.

<sup>19</sup> D. F. Martyn and O. O. Pulley, "The temperatures and constituents of the upper atmosphere," *Proc. Roy. Soc. (London) A*, vol. 154, pp. 455-486; April, 1936.

<sup>20</sup> G. F. Schilling and T. E. Sterne, "Densities of the Upper Atmosphere Derived from Satellite Observations," IGY World Data Center A Satellite Rep. No. 4, pp. 30-36; July, 1958.

<sup>21</sup> J. A. Ratcliffe, E. R. Schmerling, C. S. Setty, and J. O. Thomas, "The rates of production and loss of electrons in the  $F$ -region of the ionosphere," *Phil. Trans. Roy. Soc. (London) A*, vol. 248, pp. 621-642; 1955-1956.

<sup>22</sup> D. R. Bates, "The temperature of the upper atmosphere," *Proc. Phys. Soc. (London)*, vol. 64, pp. 805-821; September, 1951.

<sup>23</sup> R. A. Duncan, "Computations of electron density distributions in the ionosphere making full allowance for the geomagnetic field," *J. Geophys. Res.*, vol. 63, pp. 491-499; September, 1958.

<sup>24</sup> S. Chapman, "The electrical conductivity of the ionosphere; a review," *Nuovo cimento*, vol. 4, ser. 10, suppl. no. 4, pp. 1385-1412; 1956.

denote electrons, ions, and neutral particles, respectively. (It should be pointed out however that according to Dalgarno,<sup>25</sup> the diffusion of O<sup>+</sup> in O may be up to four times slower than is usually accepted. This may increase the numerical coefficient in the expression for  $\nu_{in}$  by a proportionate factor in cases where the ion moves in a gas containing substantial quantities of the parent particle.) Thus at the level  $h_m F_1$  we have, at sunspot minimum,

$$\nu_{ei} = 880; \quad \nu_{en} = 2300; \quad \nu_{in} = 96.$$

At 300 km, for  $N_e = 10^6 \text{ cm}^{-3}$ , we have

$$\nu_{ei} = 900; \quad \nu_{en} = 40; \quad \nu_{in} = 1.1 \text{ sec}^{-1}.$$

Thus in the  $F_1$  region the electron collisions are mainly with neutral particles; in the  $F_2$  region mainly with ions.

These electron collision frequencies are important for calculations of radio-wave absorption and of the electric conductivity; the ion collision frequencies are important for calculations of the diffusion of all ionization (electrons and ions) and of the absorption of hydromagnetic waves.

#### THEORY OF THE F REGION

Chapman<sup>26</sup> has shown that the absorption of monochromatic solar ionizing radiation in the atmosphere produces  $q$  electrons per  $\text{cm}^3$ , where

$$q = q_0 \exp(1 - z - \sec \chi e^{-z}), \quad (1)$$

and  $q_0$  is the maximum rate of electron (and ion) production for a vertically overhead sun,  $z$  is height above the level of this maximum production, measured in units of  $H_0$ , and  $\chi$  is the solar zenith distance at the given time.

The electron density at any time and height is given by the solution of

$$\frac{\partial N}{\partial t} = q - \alpha N^2, \quad (2)$$

where  $\alpha$  is the recombination coefficient and  $N$  the electron density.

Apart from minor perturbations,<sup>4</sup> this theory satisfactorily accounts for the global morphology of the  $F_1$  region; it is clear, however, that it gives only a crude approximation to that of the  $F_2$  region.

A first step towards a more adequate theory of the  $F_2$  region was taken by Bradbury,<sup>27</sup> who suggested that for this region,  $\alpha$  was inversely proportional to  $N$ , the rate of decay of ionization being  $\beta N$  where  $\beta$  was a coefficient (attachment-like) which decreased with height. On this theory, the  $F_2$  region was simply the part of the  $F_1$  re-

gion lying above the level  $z_m F_1$ , the increased observable  $N$  being due to substantial reduction of the effective coefficient of decay. The proposed "attachment law" of decay accounts better for the observed latitudinal distribution of  $N_m$  (which under equilibrium conditions varies as  $\cos \chi$  rather than as  $\cos^{1/2} \chi$  as required by a recombination law). Bradbury's suggestion is attractively simple, and has appealed especially to theoreticians who are attempting to determine the ionizable constituents of the regions and the part of the solar spectrum whose absorption is responsible for the observed ionization. However, it has been pointed out,<sup>4</sup> and should be emphasized again, that the observed sunspot cycle variation rate of  $N_m F_2$  is more than three times that of  $N_m F_1$ . Even allowing for the fact that the latter varies as  $q^{1/2}$  while the former varies as  $q$ , it still appears that the radiation responsible for  $F_2$  ionization differs to some extent in quality from that which produces  $F_1$ . The latter conclusion gains support from the fact that the  $F_2$  region is systematically higher at sunspot maximum than at minimum, though there is little change in  $h_m F_1$ . If it is supposed that increased temperature at sunspot maximum is responsible for the elevation of  $h_m F_2$ , the difficulty is only enhanced, because  $N_m F_2$  should be inversely proportional to the temperature (scale height) whereas at sunspot maximum it is already greater than can be reconciled with Bradbury's suggestion.

In attempting to account for the peculiar morphology of the  $F_2$  region, Martyn<sup>28</sup> has introduced the concept of ionization transport. He replaced (2) by

$$\frac{\partial N}{\partial t} = q - \beta N - \text{div}(vN), \quad (3)$$

where  $v$  is the transport velocity of the electrons (and ions).  $v$  can arise in several ways. First, the air in the region may be in motion, carrying the ionization with it. (At the air densities in the  $F_2$  region the effective component  $u$  of the air motion is that parallel, or antiparallel, to the geomagnetic field; the ionization cannot move transversely to this field.) Second, if an electric current is present, the ionization drifts with the velocity vector  $\mathbf{E} \wedge \mathbf{H} / H^2$  where  $\mathbf{E}$  is the electric and  $\mathbf{H}$  the magnetic field. (This drift is simply the manifestation of the Ampère force on the medium; it can be shown readily that the drifting ionization exerts precisely this force on the air through which it moves.) Third, the ionization diffuses under the influences of gravity and of its own partial-pressure gradient.

The second kind of transport is due mainly to currents produced by the polarization field<sup>29</sup> in the lower "dynamo" region ( $E$ ), which is communicated to the  $F$

<sup>25</sup> A. Dalgarno, "Ambipolar diffusion in the  $F_2$ -layer," *J. Atmos. Terrest. Phys.*, vol. 12, pp. 219-220; 1958.

<sup>26</sup> S. Chapman, "The absorption and dissociative or ionizing effect of monochromatic radiation in an atmosphere on a rotating earth," *Proc. Phys. Soc. (London)*, vol. 43, pp. 26-45; 1931.

<sup>27</sup> N. E. Bradbury, "Ionization, negative-ion formation, and recombination in the ionosphere," *Terrest. Magnet. and Atmos. Elec.*, vol. 43, pp. 55-66; March, 1938.

<sup>28</sup> D. F. Martyn, "Atmospheric tides in the ionosphere: part 1—solar tides in the  $F_2$  region," *Proc. Roy. Soc. (London) A*, vol. 189, pp. 241-260; April 17, 1947.

<sup>29</sup> W. G. Baker and D. F. Martyn, "Electric currents in the ionosphere 1. The conductivity," *Phil. Trans. Roy. Soc. (London) A*, vol. 246, pp. 281-294; December, 1953.



region along the highly conducting lines of the geomagnetic field. It has been shown by Duncan<sup>30</sup> that the velocity divergence arising from this field is small, so that the main contribution to  $\partial N/\partial t$  is  $w(\partial N/\partial z)$  where  $w$  is the vertical drift velocity arising from the current in the region.

Save at the magnetic equator, the main transport contribution due to diffusion is the vertical ionization drift<sup>31</sup> given by

$$w_D = -\frac{g}{v_i} \left( 1 + \frac{2}{N} \frac{\partial N}{\partial z} \right) \sin^2 I$$

where  $I$  is the angle of inclination of the lines of geomagnetic force. The contributions of all these kinds of transport may be expressed by

$$\begin{aligned} \frac{\partial N}{\partial t} = & q(z, t) - \beta(z)N + \frac{2g \sin^2 I}{H_0 v_i(z)} \left( \frac{\partial^2 N}{\partial z^2} + \frac{3}{2} \frac{\partial N}{\partial z} + \frac{N}{2} \right) \\ & - w \frac{\partial N}{\partial z} - \text{div}(uN). \end{aligned} \quad (4)$$

According to time and place the magnitude of each of the terms in this equation ranges from about 10 to 100 electrons per  $\text{cm}^3$ . The resulting value of  $N$  depends in general on at least seven terms, all of the same order of magnitude; it is hardly surprising that  $F_2$  morphology is complicated. So far, only beginnings have been made in the complex task of explaining it in detail. The procedure followed has been to examine conditions when one or more terms of (4) become negligible, thus permitting determination of the residual terms. For example, Martyn<sup>31</sup> has shown that the shape (and  $N_m$ ) of a Chapman region (recombinative,  $C_\alpha$  region)

$$N = N_m \exp \frac{1}{2}(1 - z - \sec \chi e^{-z})$$

is unaffected by diffusion; also, that an ionized region of arbitrary shape assumes by diffusion that of a  $C_\alpha$  region, in a time of order  $v_{in} H_0 / g \sin^2 I$ . In the  $F_2$  region at moderate latitudes this is about two hours. This appears to be the explanation of the long-known fact that the undersurface of the  $F$  region assumes a nearly parabolic form a few hours after sunset:  $N = N_m(1 - z^2/4)$  is a close approximation to a  $C_\alpha$  region. In fact, Duncan has shown just recently<sup>23</sup> that the undersurface of the region assumes the "tail" characteristic of a  $C_\alpha$  region soon after midnight.

Although a  $C_\alpha$  region does not change shape under the influence of diffusion, it moves *downwards* under the influence of gravity. This movement is countered by the downwards increase of  $\beta$ , which by eroding the undersurface of the region tends to make  $h_m$  rise. It has been shown<sup>31</sup> that the combined influences of diffusion and the height gradient of  $\beta$  cause the region to settle (in a

decaying condition), at a height given by  $\beta v_i = g \sin^2 I / 2H_0$ . Inserting the above-given values of the parameters, gives  $h_m = 314$  km, in good agreement with the observed<sup>15</sup> nighttime values of  $h_m F_2$  at sunspot minimum.

A general expression for the velocity  $W$  of vertical movement of  $h_m$  has been derived.<sup>32</sup> It is

$$-\left( \frac{\partial^2 N}{\partial z^2} \right)_{z_m} \cdot W = \left\{ \frac{\partial}{\partial z} \left( \frac{\partial N}{\partial t} \right) \right\}_{z_m}. \quad (5)$$

For a Chapman ( $C_\alpha$ ) region, under the combined influences of ion production, attachment-like decay, diffusion, and vertical drift, this becomes

$$W = \left\{ \frac{2}{N} \left( \frac{\partial q}{\partial z} \right) - 2 \frac{\partial \beta}{\partial z} - \frac{g \sin^2 I}{H_0 v_i} + v \right\}_{z_m}. \quad (6)$$

On the right-hand side of this equation, the first term is always negative in the  $F_2$  region (on Bradbury's hypothesis) and increases numerically downwards; the second term is positive, and increases numerically downwards; the third is negative and increases numerically *upwards*, while the fourth is unlikely to have a height gradient.

To a first approximation, (6) may be rewritten as

$$W = -ae^{-z} + be^{-z} - ce^z + v \quad (7)$$

where  $a, b, c$ , are all positive, and are given by

$$a = 2q_1/N_m; \quad b = 2\beta_1; \quad c = g \sin^2 I / H_0 v_1$$

the subscript 1 indicating that the value of the parameter is that appropriate to a height of 300 km;  $z$  is measured here from the same height. At night,  $a=0$  and the region takes up a height close to 320 km,  $v$  merely producing a perturbation to this equilibrium height. For example, for  $v=500, 1000$ , and  $3000$   $\text{cm sec}^{-1}$  the height perturbations are 18, 35, and 80 km, respectively. At sunrise, in all except a narrow range of equatorial latitudes,  $h_m$  decreases<sup>3</sup> rapidly by almost 100 km. Clearly, the first term in (7) dominates the equation in the postsunrise period. During the daytime  $z$  is about  $-1.4$  so that the relative influence of the third (diffusion) term is then negligible. The equilibrium level then is determined by a balance between the first two terms, which can be assessed only by expressing them to a higher degree of approximation than is attempted in (7). (For example, the gradient of the first term must diminish as the level of  $q_0$  is approached; it also will be less than  $e^{-z}$  if the ionizing radiation is not monochromatic.) Again,  $v$  produces only a perturbation in the equilibrium level.

Conditions become very different as the magnetic equator is approached. Here  $c$  rapidly decreases (as  $\sin^2 I$ ) and diffusion no longer stabilizes the region against upward drift. At the magnetic equator at night

<sup>30</sup> R. A. Duncan, "Lunar variations in the ionosphere," *Aust. J. Phys.*, vol. 9, pp. 112-132; March, 1956.

<sup>31</sup> D. F. Martyn, "Processes controlling ionization distribution in the  $F_2$  region of the ionosphere," *Aust. J. Phys.*, vol. 9, pp. 161-165; March, 1956.

<sup>32</sup> D. F. Martyn, "Theory of Height and Ionization Density Changes at the Maximum of a Chapman-Like Region, Taking Account of Ion Production, Decay, Diffusion, and Tidal Drift" in "The Physics of the Ionosphere," The Physical Society, London, Eng., p. 254; 1954.

the  $F$  region drifts downwards and the average value of  $W$  is about 19 km per hour. In the absence of diffusion, this downward drift must be due to  $v$ , and we have (expressing velocities in units of  $10^3 \text{ sec}^{-1}$ )

$$W = be^{-z} + v = 1.2 \times 10^{-4} + v = -9.5 \times 10^{-5}$$

so that

$$v = -2.15 \times 10^{-4}, \text{ or } -1180 \text{ cm sec}^{-1}.$$

This negative value of  $v$  is what would be anticipated at the equator at night according to the modern form<sup>29</sup> of the dynamo theory of the geomagnetic variations. During the daytime  $v$  reverses in sign. Thus we have (at about nine hours at sunspot minimum)

$$W = -ae^{-z} + 1.2 \times 10^{-4} + 2.15 \times 10^{-4}.$$

The observed value of  $W$  is about  $1.35 \times 10^{-4}$ , so that

$$ae^{-z} = 2 \times 10^{-4} \text{ and } q(300 \text{ km}) = 80.$$

These values are all acceptable. However, it should be noted that on Bradbury's hypotheses, since the neutral particle ratio  $nF_1/nF_2$  is about 100, it follows that  $h_m F_2$  is about four and a half scale heights above  $h_m F_1$ , so that  $q_0 F_1/q(300 \text{ km}) = 14$  and  $q_0 F_1 = 1100$  at nine hours at the equator at sunspot minimum. This value is about two to three times too large, and suggests that the radiation involved in producing the  $F$  region is not monochromatic, the absorption being spread over a greater thickness. As mentioned above, there is other evidence that this is the case, notably the fact that the height gradient of  $q$  appears to be substantially less than  $e^{-z}$  even at three scale heights above the level of  $q_0$ .

The above discussion neglects the effect of horizontal diffusion of ionization. This is important only near the magnetic equator where the geomagnetic lines of force are horizontal and the  $F_2$  region is raised by electrodynamic forces to great heights where diffusion is fast. There is little doubt that the daytime ionization trough at the magnetic equator, and the ionization peaks on each side of that equator, are due to horizontal divergence of ionization from the equator and convergence (down the lines of magnetic force) at neighboring low latitudes.<sup>32</sup> This view still lacks quantitative expression, however.

In summary, it may be said that the main features of the equinoctial morphology of the  $F_2$  region now have qualitative and in some cases quantitative explanation. In particular, the theory of electrodynamic drift, coupled with diffusion, seems to give a satisfactory explanation of the geomagnetic control of the region. Bradbury's hypothesis also seems acceptable as a first approximation, with due reservation regarding the non-monochromatic character of the solar ionizing radiation and the probable softening of this radiation as it becomes more intense towards sunspot maximum.

The pronounced seasonal changes in the morphology of the  $F_2$  region remain almost entirely unexplained. Martyn<sup>4</sup> has suggested that this may be due to seasonal

changes in the air tides and associated electrodynamic drifts, but his suggestion still lacks quantitative support. The suggestion has been made repeatedly that the  $F_2$  region is much hotter in summer than in winter, due to solar heating. This has the attractive merit of appearing to account for the increased height and reduced electron density of the  $F_2$  region in summer. However, this idea has failed to stand up to quantitative examination. It appears to ignore the fact that the summer reduction in  $N_m$  is confined to moderate and high latitudes; at the solstices the most intense peaks of ionization over the world lie at low latitudes in the summer hemisphere. If heating is involved, it must arise in some manner more sophisticated than by local absorption of solar radiation. One such possibility might be by absorption of hydromagnetic waves, in much the same way as has been studied<sup>33</sup> in attempts to explain the heating of the solar corona. The waves involved might come directly from the exosphere down the lines of geomagnetic force. It seems more probable, however, on energy considerations that semiacoustic waves generated in the lower regions of the ionosphere might pass upwards, being converted into hydromagnetic waves (and strongly absorbed) at the level where the gas pressure becomes comparable with the magnetic pressure  $H^2/8\pi$ . At the level of  $h_m F_1$ , the gas pressure is  $1.38 \times 10^{-2} \text{ dyne cm}^{-2}$ , while  $H^2/8\pi$  is  $1.16 \times 10^{-2} \text{ dyne cm}^{-2}$ . Thus the magnetic and gas-kinetic energy densities become equal just above  $h_m F_1$ , suggesting that the possibility of  $F_2$  heating in this way deserves closer examination. It is worthy of remark, too, that winds and wind gradients in the lower ionosphere at moderate latitudes are much stronger in summer than in winter, so that the conditions for generation of semiacoustic waves and pulses are much more favorable in summer. The energy contained in a sound wave comparatively weak at 100 km could cause considerable local heating if absorbed in the more rarefied  $F_2$  region.

#### THEORY OF SPREAD $F$ AND SCINTILLATIONS

Theories of these phenomena to date<sup>34-36</sup> have a common basis; they ascribe the necessary irregularities of  $N$  to the density changes associated with atmospheric turbulence. The earlier theories<sup>34,35</sup> consider the turbulence to be produced *in situ*, but do not appear to have considered the effect of electromagnetic damping, which is serious in the  $F_2$  region. This difficulty is avoided by Dagg,<sup>36</sup> who considers the effect of  $E$ -region turbulence

<sup>33</sup> J. H. Piddington, "Solar atmospheric heating by hydromagnetic waves," *Monthly Notices Roy. Astron. Soc.*, vol. 116, pp. 314-323; 1956.

<sup>34</sup> A. Maxwell, "Turbulence in the upper ionosphere," *Phil. Mag.*, vol. 45, p. 1247; 1954.

<sup>35</sup> H. G. Booker, "Turbulence in the ionosphere with applications to meteor-trails, radio-star scintillation, auroral radar echoes, and other phenomena," *J. Geophys. Res.*, vol. 61, pp. 673-705; December, 1956.

<sup>36</sup> M. Dagg, "The origin of the ionospheric irregularities responsible for radio-star scintillations and spread- $F$ . I. Review of existing theories," *J. Atmos. Terrest. Phys.*, vol. 11, pp. 133-138; 1957.



to be transferred to the ionization in the  $F$  region by currents along the lines of the geomagnetic field.

It is not easy to see how these proposals could account for the very large inhomogeneities necessary to explain spread  $F$ , or how they are specifically related to its very definite morphology.

The following considerations may throw light on these essential points.

The ionization on the undersurface of the  $F$  region is essentially unstable if it is moving upwards under the influence of electrodynamic drift. To understand this, consider a long circular cylinder of ionization whose axis is parallel to the geomagnetic field, and whose ionization density exceeds that of the surrounding medium ( $N$ ) by an amount  $\Delta N$ . (Cylindrical perturbations of this kind in the ionization contours of the  $F$  region could arise in several ways. For present purposes, however, it is sufficient to realize that they must arise whenever there are small inhomogeneities in the "dynamo" region ( $E$ ) due to any cause whatever as *e.g.*, meteors or turbulence; electric polarization inevitably develops<sup>37</sup> on the walls of the dynamo region "blobs," and the resulting additional electric field is communicated to the  $F$  region by the almost perfectly conducting geomagnetic field lines. In general, the consequent displacement of ionization has a vertical component, so "kinking" the horizontal contours and producing a cylinder of perturbed ionization.) Martyn<sup>37</sup> has shown that a cylinder of this type embedded in a medium of different ionization density moves through the medium. In the  $F_2$  region, where Hall conductivity is unimportant, such a cylinder moves as a solid without distortion, and with a velocity *relative to the surrounding ionization*, given by

$$v = -V\epsilon/(2 + \epsilon) \quad (8)$$

where  $V$  is the drift velocity of the surrounding medium and  $\epsilon = \Delta N/N$ .

It will be noted that an infinitely dense cylinder ( $\epsilon = \infty$ ) moves with velocity  $-V$  relative to the medium, while an empty cylinder ( $\epsilon = -1$ ) moves with velocity  $+V$  relative to the medium. When  $|\epsilon| \ll 1$ , we may write

$$v = -V\epsilon/2. \quad (9)$$

Consider for simplicity the magnetic equator, where  $H$  is horizontal and the cylinder lies horizontally along the meridian, in a medium which is drifting vertically upwards with velocity  $V$  due to the main polarization field communicated from the dynamo region at higher latitudes. If  $\epsilon$  is negative the cylinder (of reduced density) moves upwards through the region, thus moving into regions of greater  $N$ , where the inhomogeneity becomes more pronounced (Fig. 6). This in turn causes the cylinder to move continually faster into regions of denser ionization where the inhomogeneity becomes still

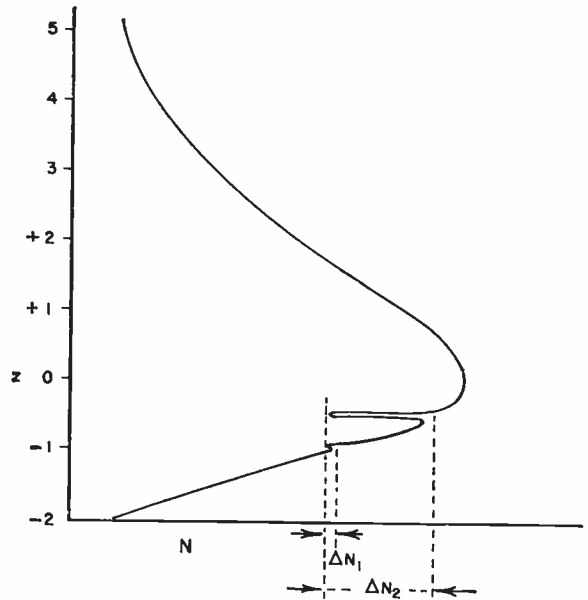

Fig. 6—Illustrates how a small negative perturbation ( $-\Delta N_1$ ) on the under surface of an upward drifting Chapman region becomes a large perturbation ( $-\Delta N_2$ ) because it drifts upwards faster than the region.

greater. Similarly, a cylinder of enhanced ionization moves downwards into regions where the surrounding density is lower. In other words the ionization is unstable, any inhomogeneity, either positive or negative, increasing with time. Matters are different for negative  $V$ ; inhomogeneities now are smoothed out, an overdense cylinder moving upwards into regions of increasing  $N$ , and an underdense cylinder downwards into regions of decreasing  $N$ . On the upper side of the region, the conditions for instability are reversed; the ionization is unstable when  $V$  is negative. This case is not likely to be of such practical importance, however, since on the upper side of the region the gas pressure is lower, and diffusion will smooth out inhomogeneities relatively quickly. These ideas can be given simple quantitative expression by writing  $N = N_m(1 - z^2/4)$ , which is a good approximation to the shape of the undersurface of the  $F$  region at night when it becomes a  $C_o$  region (see above). Then the relative velocity at  $z$  of a small perturbation  $\Delta N_1$  supposed initiated at  $z_1$  is

$$\begin{aligned} v &= \frac{dz}{dt} = -\frac{V}{2} \left( \frac{N_1 + \Delta N_1 - N}{N} \right) \\ &= \frac{V}{2} \left\{ 1 - \frac{4(N_1 + \Delta N_1)}{N_m(4 - z^2)} \right\}. \end{aligned} \quad (10)$$

Integrating this equation between  $z_1$  and  $z_2$  gives

$$\frac{Vt}{2} = z_2 - z_1 + (4 - A)A^{-1/2} \tanh^{-1} \left( \frac{A^{1/2}(z_2 - z_1)}{(A - z_1 z_2)} \right) \quad (11)$$

where

$$A = 4 \left( 1 - \frac{N_1 + \Delta N_1}{N_m} \right).$$

<sup>37</sup> D. F. Martyn, "Electric currents in the ionosphere. III. Ionization drift due to winds and electric fields," *Phil. Trans. Roy. Soc. (London)*, vol. 246, pp. 306-320; December, 1953.

The amplification  $\mu$  of the original inhomogeneity is

$$\mu = \epsilon_2/\epsilon_1 = \left(1 + \frac{N_1 - N_2}{\Delta N_1}\right) \frac{N_1}{N_2}. \quad (12)$$

If  $|\epsilon| \ll 1$ ,  $|z_2 - z_1| \ll 1$  for permissible values of  $Vt$ . For illustrative purposes we choose  $z_1 = -1$ , then

$$\mu = 1 - 2\Delta z/3\epsilon_1$$

and

$$Vt/2 \approx 3 \tanh^{-1} \left( \frac{\mu - 1}{\mu + 1} \right). \quad (13)$$

(Note that for  $V > 0$ , if  $\epsilon_1 < 0$ ,  $\Delta z > 0$  and  $\mu > 1$ ; while if  $\epsilon_1 > 0$ ,  $\Delta z < 0$ , and  $\mu > 1$ ; there is magnification in both cases; but if  $V < 0$ ,  $\mu < 1$  in both cases, and the perturbation decays.) The lifetime ( $t$ ) of the perturbation is the relaxation time of the region ( $\beta^{-1}$ ), or  $10^4$  sec. For  $V = +19$  m/sec,  $\mu = 5$ ; for  $V = +39$  m/sec,  $\mu = 10$ . Such values of  $V$  are common at higher latitudes in times of magnetic disturbance during the night hours around midnight, and at equatorial latitudes on magnetically quiet days in the early hours of the evening.<sup>17</sup> On the other hand, at the latter latitudes during magnetic

storms the  $F$  region moves downwards in the early evening, upwards in the morning hours, so that we may expect the normal occurrence of spread  $F$  at the equator to be inhibited by magnetic storms, and such occurrence as remains to be shifted to the early morning hours. This is observed to happen.<sup>17</sup>

Summing up the above ideas, spread  $F$  and radio scintillation phenomena should be expected to occur chiefly at the following times and places.

- 1) Mainly at night, because the ionization gradient of the undersurface of the  $F$  region then is much steeper than it is by day.
- 2) At moderate to high latitudes, at times of magnetic disturbance.
- 3) At equatorial latitudes in the early evening at magnetically quiet times (especially at the equinoxes), and in the early morning at magnetically disturbed times.

It is to be anticipated also that the main sources of radio scintillation phenomena will lie below  $h_m F_2$ . If subsidiary sources are found above this level, they should occur at quite different times, namely, when the  $F_2$  ionization is drifting *downwards*.

## The Normal E Region of the Ionosphere\*

SIR EDWARD V. APPLETON†

**Summary**—The  $E$  layer is situated in the middle ionosphere; its lower boundary is at a level of about 100 km when the sun is vertical. Its maximum ionization density is of the order of  $10^5$  electrons per cc but this varies by about 50 to 60 per cent in the course of the sunspot cycle. The production of ionization in the  $E$  layer is due to solar photons, most probably of X-ray character. The disappearance of electrons in the  $E$  layer is by way of dissociative recombination between electrons and positive molecular ions.  $E$ -layer morphology is influenced to a slight extent by horizontal currents flowing in it across the horizontal geomagnetic field; in other words, the  $E$  layer is a motor. It is generally considered that such currents are produced by dynamo action in the  $E$  layer due mainly to a diurnal horizontal tidal motion of the conducting medium across the earth's vertical magnetic force. The rough parallelism of the intensity of these horizontal currents with  $E$ -layer conductivity during the sunspot cycle suggests the simple result that the diurnal horizontal motion itself does not vary substantially with solar activity.

### INTRODUCTION

THE  $E$  layer is situated in the middle ionosphere. Its chief characteristic is the regularity of its formation and behavior. Nevertheless, even on

magnetically quiet days, its morphology is influenced, to a slight extent, by its being the seat of at least part of the  $Sq$  system of overhead horizontal currents. In considering the normal  $E$  layer we therefore must take into account the electron transport effects brought about by  $Sq$  currents, since these currents are never absent.

### FUNDAMENTAL IONOSPHERIC THEORY

In  $E$  layer studies it is customary to compare experimental results with the predictions of the classical theory of ionized layer production developed by Chapman.<sup>1,2</sup> This theory is based on two simple assumptions: the earth's atmosphere is considered to be of uniform temperature and composition, and the process by way of which electrons disappear is taken to be that of recombination with positive ions. The basic continuity equation for electrons, according to this theory, may

<sup>1</sup> S. Chapman, "Some phenomena of the upper atmosphere," *Proc. Roy. Soc. (London) A*, vol. 132, pp. 353-374; July/August, 1931.

<sup>2</sup> S. Chapman, "The absorption and dissociative or ionising effect of monochromatic radiation in an atmosphere on a rotating earth," *Proc. Phys. Soc.*, vol. 43, pp. 26-45; January, 1931.

\* Original manuscript received by the IRE, November 12, 1958.  
† University of Edinburgh, Edinburgh 8, Scotland.



therefore be written

$$\frac{\partial}{\partial t} N(h, t) = q(h, \chi) - \alpha [N(h, t)]^2 \quad (1)$$

where  $N(h, t)$  is the electron density at height  $h$  and time;  $q(h, \chi)$  is the rate of electron production per unit volume, and so is a function of both height and solar zenith distance  $\chi$ ; while  $\alpha$  is the recombination coefficient, assumed independent of  $h$  and  $t$ . In the isothermal atmosphere considered by Chapman,<sup>1,2</sup> it is found that the maximum value of  $q$  is given by

$$q_m = \left( \frac{S_\infty}{H \exp 1} \right) \cos \chi = q_0 \cos \chi \quad (2)$$

where  $S_\infty$  is the photon flux of the ionizing radiation outside the earth's atmosphere and  $H$  is the scale height of the atmospheric absorbing constituent.

However, in vertical radio sounding,  $Nm$  is measured directly, a quantity not given simply in Chapman's original investigation. This has led Appleton and Lyon<sup>3</sup> to provide an alternative version of simple ionospheric theory yielding explicit theoretical expressions for  $Nm$ . These authors have shown that, under sufficiently quasi-stationary conditions, we can write, instead of (1),

$$\frac{dNm}{dt} = q_0 \cos \chi - \alpha Nm^2. \quad (3)$$

The criterion for the validity of this approximation is that

$$\frac{a^2}{2} \ll 1 \quad (4)$$

where

$$a = \frac{\tan \chi \frac{d\chi}{dt}}{2\alpha Nm}, \quad (5)$$

a quantity, as will be seen, determined by the "time of relaxation" of the layer.

If, however, we make the further assumption that the layer conditions are completely stationary, we can write (3) as

$$Nm = \sqrt{\frac{q_0 \cos \chi}{\alpha}} \quad (6)$$

Expressing  $Nm$  now in terms of the critical penetration frequency,  $fE$  (in mc), we can derive the familiar relations

$$\frac{(fE)^4}{\cos \chi} = K = \frac{1}{(1.24 \times 10^4)^2} \frac{S_\infty}{\alpha H \exp 1}. \quad (7)$$

The literature, however, contains many instances where (7) is written, more generally,

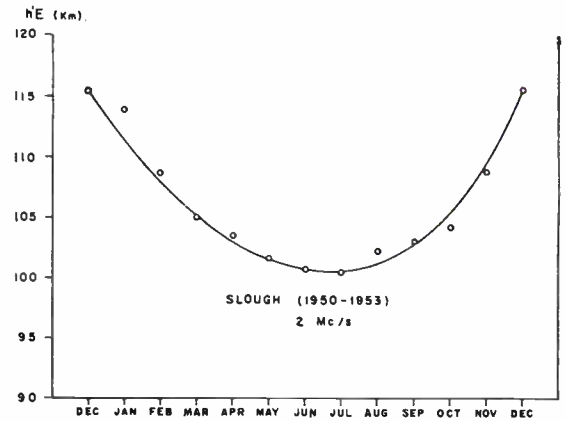

Fig. 1—Monthly means of noon  $h'E$ , measured on 2 mc at Slough, England for the years 1950-1953.

$$\frac{(fE)^n}{(\cos \chi)^n} = \frac{fE}{(\cos \chi)^p} = K. \quad (8)$$

We shall return to the experimental determinations of  $n$  (or  $p$ ) which have been made. Meanwhile, we may note the position of the  $E$  layer in the atmosphere.

#### POSITION AND ELECTRON PROFILE OF THE $E$ LAYER

The position of the  $E$  layer in the atmosphere varies, roughly, in accordance with the theoretical relation

$$h = h_0 - H \log \chi \quad (9)$$

where  $h$  may be either the height of the  $E$ -layer under-boundary  $h'E$ , or the height of its peak ionization density  $hm$ . From (9) it is seen that  $h'E$ , or  $hm$ , should be low when the sun is vertical and high when it is on the horizon; experience shows that such is the case. When the sun is vertical the height of the lower boundary  $h'E$  is situated at 100 km or just below, while the height of the peak electron density  $hm$  is, under the same conditions, about 125 km.

The fact that the height of the  $E$  layer varies much as we would expect [e.g., according to (9)] is illustrated in Fig. 1 where monthly means of noon  $h'E$ , measured on 2 mc at Slough, England, are shown for the months of the year.

Recent studies, by both rocket sounding and the determination of  $N(h)$  profiles, indicate that the stratum between the  $E$  and  $F_1$  layers is more strongly ionized than simple theory would suggest. Indeed, this stratum appears ionized roughly to the level of the  $E$ -layer peak maximum density, as was first demonstrated by Hollingworth<sup>4</sup> many years ago.

#### THE DEPENDENCE OF $Nm(E)$ ON $\cos \chi$

This is a subject which can be investigated by studying the relation between  $(fE)^2$ , a quantity proportional

<sup>3</sup> E. V. Appleton and A. J. Lyon, "Ionospheric Layer Formation under Quasi-Stationary Conditions" in "The Physics of the Ionosphere," The Physical Society, London, Eng., pp. 20-39; 1955.

<sup>4</sup> J. Hollingworth, "The structure of the ionosphere," *Proc. Phys. Soc. (London)*, vol. 47, p. 843; 1935.

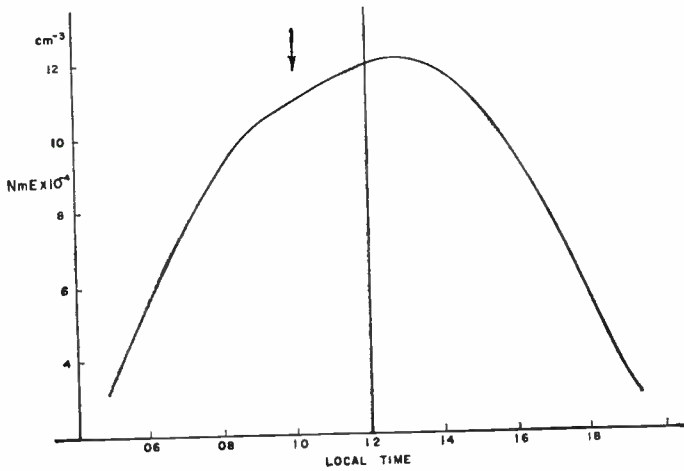

Fig. 2—Summer diurnal variation of  $Nm(E)$  at Slough.

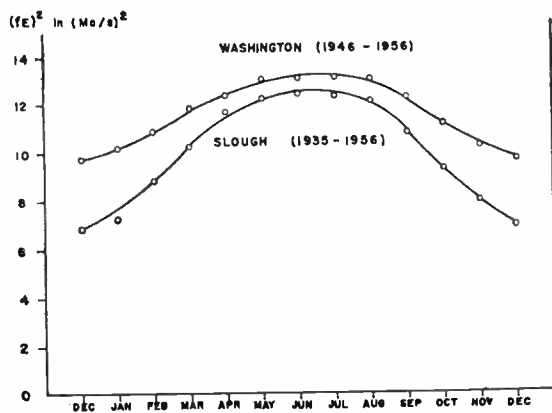

Fig. 3—Seasonal variation of monthly means of noon  $(fE)^2$ , in  $(mc)^2$ , for Washington, D. C., (upper curve) and Slough (lower curve). The values are averages over one, and two, sunspot cycles, respectively.

to  $Nm(E)$ , and  $\cos \chi$ . For this purpose diurnal, seasonal and latitudinal examinations can be made.

A diurnal curve of  $Nm(E)$  for summer at Slough is shown in Fig. 2. Here it is seen that  $Nm(E)$  responds to variations of  $\cos \chi$ , its value being higher round noon than in the morning and evening. However, a slight pre-noon depression in  $Nm(E)$  is evident, marked by an arrow, which Appleton, Lyon, and Turnbull<sup>5</sup> have interpreted as due to the influence of the  $Sq$  currents in the  $E$  layer. According to this interpretation, an east-to-west current of this type reduces the value of  $fE$ . This conclusion has been confirmed by Shimazaki<sup>6</sup> and provides the key to the general explanation of the effects of  $Sq$  and other currents on  $E$ -layer morphology.

Further illustration of the substantially regular behavior of the  $E$  layer is shown in Fig. 3, which exhibits the variations of noon  $(fE)^2$  over the months of the year for both Slough and Washington, D. C. These monthly

values of noon  $(fE)^2$  are averages for two sunspot cycles (1935–1956) in the case of Slough, and for one sunspot cycle (1946–1956) in the case of Washington.

However, if we wish to test the correspondence between theory and reality further, it is necessary to examine the quantitative relation between  $fE$  and  $\cos \chi$ . For this purpose, we can use either of the two forms of the relation (8) and find  $n$ , or its reciprocal  $p$ , from the experimental data. The most ambitious and exhaustive test of this kind is due to Menzel, Wolback, and Glazer.<sup>7</sup> Writing (8) as

$$\log fE = \log K + p \log \cos \chi, \quad (10)$$

these authors have made the best possible determinations of  $\log K$  and  $p$  for a wide range of stations in both the northern and southern hemispheres. For this purpose, data for the period 1944–1953 were used; each station was first investigated individually. Although the values of  $\log K$  and  $p$  were found to vary systematically with geographic latitude, no significant difference was found between the northern and southern hemispheres. It was possible therefore to use data for both hemispheres in compiling Table I, which summarizes the results of this exhaustive enquiry.

TABLE I

ESTIMATED VALUES FOR LOG K AND  $p$ . NORTHERN AND SOUTHERN HEMISPHERES COMBINED FOR THE PERIOD 1944–1953

Year	Geographic Latitude		
	0°	45°	90°
$\log K$			
1944	0.534	0.520	0.484
1945	0.564	0.550	0.514
1946	0.601	0.586	0.551
1947	0.624	0.609	0.574
1948	0.624	0.609	0.574
1949	0.607	0.592	0.557
1950	0.587	0.572	0.537
1951	0.570	0.550	0.520
1952	0.553	0.538	0.503
1953	0.535	0.521	0.485
$p$			
1944	0.284	0.266	0.216
1945	0.287	0.269	0.219
1946	0.294	0.276	0.226
1947	0.296	0.278	0.228
1948	0.291	0.273	0.223
1949	0.285	0.267	0.217
1950	0.287	0.269	0.219
1951	0.295	0.277	0.227
1952	0.301	0.284	0.233
1953	0.299	0.281	0.231

From Table I we note that the value of  $\log K$  varies from year to year; this is a reflection of the general variation of  $fE$  with sunspot activity, for the sunspots were more numerous in 1947 and 1949 than in 1944 and 1953. Also, we may note the definite falling off of the value of  $p$  as the latitude of the station increases. For

<sup>7</sup> D. H. Menzel, J. G. Wolback, and H. Glazer, "Solar Eclipses and the Ionosphere," Pergamon Press, London, Eng., p. 282; 1956.

<sup>5</sup> E. V. Appleton, A. J. Lyon, and A. G. Turnbull, "Distortion of the  $E$  layer of the ionosphere by electrical currents flowing in it," *Nature*, vol. 176, pp. 897–899; November 12, 1955.

<sup>6</sup> T. Shimazaki, "Effect of the  $Sq$  current system on the ionospheric  $E$  and  $F_1$  regions," *J. Radio Res. Labs., Japan*, vol. 4, pp. 37–48; January, 1957.



geographic latitude  $0^\circ$ , the value of  $p$  is greater than the theoretical value of 0.250, while for geographic latitude  $90^\circ$  the value of  $p$  is less than 0.250. An interesting, and possibly significant, fact further disclosed by the work of Menzel, Wolback, and Glazer is that when the magnetic dip is  $90^\circ$  the value of  $p$  is approximately equal to the theoretical value 0.250.

So far we have been considering an investigation in which no distinction has been made between diurnal and seasonal data in respect of the choice of  $fE$ . However, when such a distinction is made, further important results come to light. Let us take first diurnal data where it is usual to express the results in terms, not of  $p$ , but of  $n$ , its reciprocal. Here it is found that the value of  $n$  does not vary too markedly with latitude; an average value is about 3—corresponding to a value of 0.33 for  $p$ . On the other hand, when seasonal data (for example, of noon values of  $fE$ ) are considered, very different results are obtained. The seasonal variation of  $(fE)^2$  for Slough, exhibited in Fig. 3, indicates that  $n$  is about 4 for that particular latitude; while the data on the same curve for Washington indicate that  $n$  is approximately 5. In an extended study of the same subject on a global basis, Beynon and Brown<sup>8</sup> have found a remarkable systematic variation of the value of  $n$  with latitude; there are two sharp maxima of that quantity at middle latitudes in both the northern and southern hemispheres. The positions of these maxima are deemed to be associated in some way with the positions of the  $Sq$  current foci.

Further interesting features of  $E$ -layer morphology have been disclosed by an examination of the delineation of contours of constant  $fE$  over the whole world at a given season. For example, Appleton<sup>9</sup> has found that, at the equinoxes, although  $fE$  is a maximum at the subsolar point, the contours of constant  $fE$  are not circles as would be expected if  $fE$  depended uniquely on  $\cos \chi$ . They are, instead, of elliptical shape, the major axis lying along the equator. Again, in June and December at noon, the same author<sup>9</sup> has found that  $fE$  does not attain its maximum at the subsolar point, but at a latitude displaced therefrom by some  $10^\circ$  towards the equator. These results have been interpreted by Appleton, Lyon, and Turnbull<sup>5</sup> as an indication of the influence of west-to-east  $Sq$  currents which enhance the value of  $fE$  at the equator at all times of the year.

#### VERTICAL ELECTRON TRANSPORT IN THE $E$ LAYER

The results described in the preceding section suggest that the fundamental continuity equation (1), and its practical approximation (3), need revision in the case of the  $E$  layer. This is due to the fact that the  $E$  layer is found not to be a quiescent medium. The most general form of the basic continuity equation would be

<sup>8</sup> W. J. G. Beynon and G. M. Brown, "Region  $E$  and the  $Sq$  current system," *Nature*, vol. 177, pp. 583-584; March 24, 1956.

<sup>9</sup> E. V. Appleton, *Proc. Fourth Meeting Joint Commission on the Ionosphere*, pp. 14-15; 1955.

$$\frac{dN}{dt} = q(t) - d(N) - \text{div}(Nv), \quad (11)$$

where  $q(t)$  is the term relating to the rate of electron genesis,  $d(N)$  indicates the electron disappearance rate, while  $\text{div}(Nv)$  is the electron disappearance rate per unit volume, outward from the point in question.

A special case of electron transport is vertical drift which, Martyn<sup>10</sup> has suggested, plays an important part in perturbing the  $F_2$  layer. Appleton and Lyon<sup>3</sup> therefore have developed the Chapman theory so as to allow for the effects of such drift under conditions applicable to the  $E$  layer. As in the case of (3), the theory of Appleton and Lyon is formulated in terms of the practical quantity  $Nm$ . From a practical point of view, we are concerned with two effects of vertical drift, namely the alterations it provokes in the level of maximum electron density, that is,  $\delta h(Nm)$ , and in the magnitude of that ionization density itself, that is,  $\delta Nm$ . The appropriate expressions for these quantities are

$$\delta h(Nm) = \frac{v}{2\alpha Nm} \quad (12)$$

and

$$\frac{\delta Nm}{Nm} = \frac{-\left(\frac{\partial V}{\partial h}\right)}{2\alpha Nm} - \frac{1}{4H^2} \left(\frac{v}{2\alpha Nm}\right)^2. \quad (13)$$

It is in terms of these equations that explanations of the diurnal anomaly in  $Nm$ , shown in Fig. 1, and the many other anomalies described in the foregoing section, have been sought.

#### THE IONIZING AGENT RESPONSIBLE FOR THE $E$ LAYER

There seems little doubt that the ionizing radiation which produces the normal  $E$  layer is solar in origin and electromagnetic in character. This has been amply demonstrated by ionospheric radio soundings made on the occasion of solar eclipses. However, besides proving that the ionizing radiation travels with the velocity of light, such eclipse studies have yielded additional information of great value, showing that, although the bulk of the radiation comes from the sun's visible disk, additional radiation can come from active localized spots and possibly also from the corona. Such studies also give the best values available for the value of the

<sup>10</sup> D. F. Martyn, "Atmospheric tides in the ionosphere: Part 1—solar tides in the  $F_2$  region," *Proc. Roy. Soc. (London) A*, vol. 189, pp. 241-260; April 17, 1947.

———, "Atmospheric tides in the ionosphere: Part 2—lunar tidal variations in the  $F$  region near the magnetic equator," *Proc. Roy. Soc. (London) A*, vol. 190, pp. 273-288; July 8, 1947.

———, "Atmospheric tides in the ionosphere: Part 3—lunar tidal variations at Canberra," *Proc. Roy. Soc. (London) A*, vol. 194, pp. 429-444; November 9, 1948.

———, "Atmospheric tides in the ionosphere: Part 4—studies of the solar tide, and the location of the regions producing the diurnal magnetic variations," *Proc. Roy. Soc. (London) A*, vol. 194, pp. 445-463; November 9, 1948.

effective recombination coefficient  $\alpha'$ . These values range from  $1.5 \times 10^{-8}$  to  $4 \times 10^{-8} \text{ cm}^3 \text{ sec}^{-1}$ .

Rocket soundings have demonstrated the important result that the ionizing agency for the *E* layer consists of soft X rays.

As regards the process by way of which electrons disappear in the *E* layer, we may note that the experimental values of  $\alpha'$  quoted above are in flagrant disagreement with that predicted by quantum theory for the radiative recombination process, which is of the order of  $10^{-12} \text{ cm}^3 \text{ per sec}$ . However, it is likely that a reconciliation of experiment and theory may be effected by invoking the possibility of dissociative recombination, as first suggested by Bates and Massey.<sup>11</sup> Here we picture processes of the type indicated by

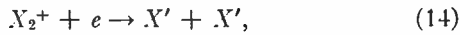

a positive molecular ion, of species *X*, combining with an electron to form two excited atoms. Laboratory experimental work on dissociative recombination confirms that recombination coefficients of the order of  $10^{-8} \text{ cm}^3 \text{ per sec}$  can be explained in this way.

#### THE SUNSPOT CYCLE VARIATION OF THE *E* LAYER

Long-term studies show a direct connection between  $Nm(E)$  and solar activity. This is best exhibited by a plot of  $(fE)^2$  with the Zurich sunspot number *R* which indicates a relation which is substantially linear. Taking for example, monthly mean noon values of  $(fE)^2$  for any one station, we can write

$$(fE)^2 = a_n(1 + b_n R). \quad (15)$$

Here the twelve values of  $a_n$  obtained express the general seasonal variation of  $(fE)^2$  over the months of the year, already illustrated for Washington and Slough in Fig. 3. On the other hand, the value of  $b_n$  varies but little with season; its value is approximately 0.004. In other words, the seasonal variation of  $(fE)^2$  [i.e.,  $Nm(E)$ ] remains of the same type throughout the sunspot cycle, but the general level of this quantity waxes and wanes with sunspot activity. To illustrate this, and the general dependence of  $(fE)^2$  on *R*, curves of average summer noon  $(fE)^2$  and average winter noon  $(fE)^2$ , with the appropriate average sunspot numbers, are plotted in Fig. 4 and Fig. 5, respectively.

It may be mentioned further that the daytime intensity of the overhead *Sq* current system varies with *R* in much the same way as does  $Nm(E)$ . We therefore arrive at the simple result that, if the *Sq* current is

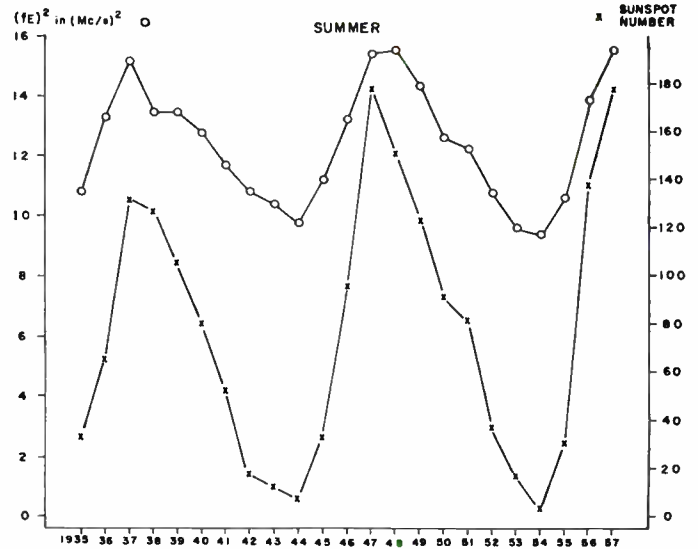

Fig. 4—Variation of average summer noon  $(fE)^2$  at Slough, and of *R* (sunspot number), over the years 1935–1957.

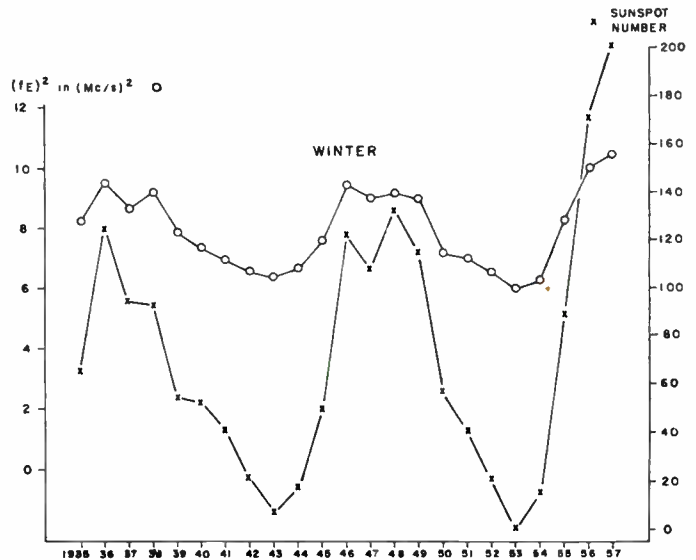

Fig. 5—Variation of average winter noon  $(fE)^2$  at Slough, and of *R* (sunspot number), over the years 1935–1957.

mainly localized in the *E* layer, as is now thought to be the case, its intensity variation over the sunspot cycle is an expression of the variation of the conductivity of the medium, the electromotive, prompting the current flow, remaining fairly independent of solar activity. Perhaps this result, in its turn, is a simple demonstration of the fundamental characteristic of a dynamo: that the electromotive force generated in a conductor moving in a magnetic field is independent of the electric conductivity of that conductor.

<sup>11</sup> D. R. Bates and H. S. W. Massey, "The basic reactions in the upper atmosphere. Part 2—the theory of recombination in the ionized layers," *Proc. Roy. Soc. (London) A*, vol. 192, pp. 1–16; December 23, 1947.



# The Normal $D$ Region of the Ionosphere\*

J. J. GIBBONS† AND A. H. WAYNICK†, FELLOW IRE

**Summary**—The general theory of low-frequency sounding in the lower ionosphere is discussed in order to indicate the radio transmission characteristics which a  $D$ -layer model must satisfy.  $D$  layers based on the fundamental physical processes from 60 to 90 km, which have been presented up to now, have not been completely satisfactory. There is indication that the more accurately determined values of fundamental parameters now available, such as reaction rates, will lead to a more satisfactory model.

## INTRODUCTION

AN understanding of the  $D$  region of the undisturbed ionosphere requires a knowledge of the distributions of the atmospheric constituents over the altitude range from about 60 km to 90 or 100 km, including minor constituents resulting from photochemical reactions of considerable complexity and which are not, at the present moment, completely understood.

Since the production of ionization, the dissociation of molecular constituents, and the various photochemical processes involved, are dependent on the solar radiation reaching these altitudes; one must have data available on the relevant solar spectral intensities above the earth's sensible atmosphere and on the absorption of this radiation in reaching  $D$ -layer heights, including the cross sections and reaction rate coefficients for all the possible processes involved.

Finally, dissipative processes must be considered since the layer formation depends on a balance between ionization production and loss. The loss rate of electrons may finally involve all the mechanisms of recombination, negative ion formation by attachment, mixing, and diffusion. The formation of negative ions by electron attachment effectively removes a negative charge insofar as its influence on electromagnetic propagation is concerned because of the much lower  $e/m$  value for the ion.

The validity of the final model thus obtained from basic physical considerations, using the available data, can then be judged by its agreement with the results of ionospheric experiments such as radio sounding and direct rocket measurements.

It is also possible to attempt the construction of a model of the lower ionosphere purely from vertical-incidence, radio-sounding data, with no regard to the physical origin of the ionization. In theory, if the complex reflection parameters were known for the whole frequency range below one mc/sec it would be possible to devise electron-density and collision-frequency profiles for the lower  $E$  and  $D$  regions. But data on a few

frequencies are not sufficient. Absorption, for example, is an integrated effect and a few frequencies cannot determine a unique model. The same is true of data arising from other integrated effects such as group height, phase height, and polarization.

## ELECTROMAGNETIC WAVE PROPAGATION IN THE LOWER IONOSPHERE

A plane radio-wave, incident normally on the lower ionosphere, may be investigated mathematically by resolving the electromagnetic field into the ordinary ( $O$ ) and extraordinary ( $E$ ) component as in the Appleton-Hartree theory. The different propagation characteristics of these two partial fields are a result of the motor force of the earth's magnetic field on the forced oscillations of the free electrons of the medium. These two components,  $O$  and  $E$ , are in general coupled to each other as a result of the variation with height of the electron density and the collision frequency; that is, ordinary generates extraordinary and vice-versa in propagating through an inhomogeneous medium in the presence of a magnetic field. This coupling effect is of particular importance for frequencies of a few hundred kilocycles, but may be practically negligible in the megacycle range for an undisturbed ionosphere.

For our purpose we may define the  $O$  and  $E$  waves by their respective reflection levels in the absence of collisions,

$$\omega_0^2 = \frac{4\pi N e^2}{m} = \omega^2 \text{ ("}N_c\text{ point," } O \text{ reflection)}$$

$$\omega_0^2 = \frac{4\pi N e^2}{m} = \omega^2 + \omega\omega_H \text{ ("}N_Y\text{ point," } E \text{ reflection).}$$

Here  $N$  is the number of electrons  $\text{cm}^{-3}$ ,  $e$  and  $m$  the electronic charge and mass,  $\omega_H = 2\pi \times$  the gyrofrequency, and  $\omega = 2\pi \times$  the wave frequency. For frequencies of a few hundred kilocycles, the general picture of the reflection of a probing signal is then as follows. A linearly polarized wave enters the lower ionosphere and is thought of as resolved into elliptical  $E$  and  $O$  components. For the frequencies and levels considered, the collision frequency is too high for the  $N_c$  level to cause reflection of the  $O$  component which therefore passes through and is absorbed. The higher  $N_Y$  level, however, is effective, and we picture an almost pure  $E$  wave starting back down from this level. On its way down it passes through the level of significant coupling in the neighborhood of  $N_c$ . The  $E$  wave here generates some of the  $O$  component, which then travels along with the  $E$ , superimposed on it. In general, the phase and amplitude in

\* Original manuscript received by the IRE, December 17, 1958. The preparation of this paper was supported by the Air Force Cambridge Research Center, Geophysical Research Directorate, under Contract AF 19(604)-4875 and, in part, by the National Science Foundation under Grant G-5939.

† Ionosphere Research Lab., Pennsylvania State University, University Park, Pa.

which the *O* wave is generated by coupling presents a laborious computation problem and the result is sensitive to the ionospheric electron-density and collision-frequency profiles used. The two components then travel on down together and out of the ionosphere, having suffered some further differential amplitude and phase change in passing through the lower *E* and *D* region. The resultant signal observed at the ground is the superposition of two oppositely rotating circles whose relative amplitudes and phase depend on their past history in traversing the lower ionosphere.

If the coupling is quite strong around some frequency, there may even be a separate, lower, back-scattered coupling-echo arising from a similar process as the probing wave passes the *N<sub>c</sub>* level on its upward passage.

Similarly in computing the group height and phase height, one finds that they also depend on the properties of the ionosphere below the actual reflection level. Thus not only the absorption but the complicated details of low frequency polarization, and of group and phase delay, must be correctly predicted by a satisfactory *D*-layer model.

The straightforward radio sounding of the *D* layer would seem to require quite low frequencies if the electron densities indicated by higher-frequency absorption are correct. For example, the *N<sub>y</sub>* value for 55 kc/sec is 1056 electrons cm<sup>-3</sup>; for 25 kc/sec, 471 electrons cm<sup>-3</sup>. Best, Ratcliffe and Wilkes,<sup>1</sup> using 16 kc/sec CW signals, found average reflection heights of 74 km in the daytime and 92 km at night. Brown and Watts<sup>2</sup> found the reflection heights of pulsed 50 kc/sec signals to be 74–81 km in the daytime and 80–82 km at night, but to be near 90 km at twilight. However, Gnanalingam and Weekes,<sup>3</sup> Dieminger and Hoffman-Heyden,<sup>4</sup> and Gardner and Pawsey,<sup>5</sup> have detected very weak echoes from *D*-region levels with frequencies in the 1–5-mc range.

<sup>1</sup> J. A. Best, J. A. Ratcliffe, and M. W. Wilkes, *Proc. Roy. Soc., A*, vol. 156, p. 614; 1936.

<sup>2</sup> J. N. Brown and J. N. Watts, *J. Geophys. Res.*, vol. 55, p. 179; 1950.

<sup>3</sup> S. Gnanalingam and K. Weekes, *Nature*, vol. 170, p. 113; 1952.

<sup>4</sup> W. Dieminger and A. E. Hoffman-Heyden, *Naturwiss.*, vol. 39, p. 84; 1952.

<sup>5</sup> F. F. Gardner and J. L. Pawsey, *J. Atmos. Terrest. Phys.*, vol. 3, p. 321; 1953.

This indicates a *D*-layer structure more complicated than a simple, monotonic tail below the *E* layer.

#### D-LAYER MODELS

Several *D*-layer models have been proposed purely on the basis of radio data. Gardner and Pawsey<sup>5</sup> on the basis of their data deduced a daytime maximum of 200 electrons cm<sup>-3</sup> at 73 km. Nertney,<sup>6</sup> in explaining the results at 150 kc/sec and at 16 kc/sec, was led to assume a summer noon maximum of 700 electrons cm<sup>-3</sup> at 80 km, with a minimum of 350 electrons cm<sup>-3</sup> at 86 km.

Clearly the desired position would be to have a satisfactory *D*-region model based on the basic physical reactions which occur between 60 and 90 km. Previous attempts to adduce oxygen or sodium as the ionized constituent have not been successful.<sup>7</sup> The most likely process is that proposed by Nicolet<sup>8</sup>

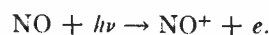

To investigate this process the atmospheric distribution of atomic nitrogen and nitric oxide must be determined. The complexity of the problem is indicated by the number of reactions which must be considered and for which the reaction rates must be known. All possible reactions involving N, O, NO, NO<sub>2</sub>, N<sub>2</sub>, O<sub>2</sub>, O<sub>3</sub>, and their ionization rates and recombination coefficients, must be examined. Mitra<sup>9</sup> obtained an NO concentration in the *D* region of 10<sup>12</sup> cm<sup>-3</sup>. Nicolet<sup>10</sup> obtained about 10<sup>8</sup> cm<sup>-3</sup> at 80 km. But these models, based on the information on reaction rates and flux densities then available, gave values for the low frequency absorption which were too high. Work now in progress,<sup>11</sup> which includes more recent information on the fundamental physical parameters, gives promise of coming to closer agreement with radio data.

<sup>6</sup> R. J. Nertney, *J. Atmos. Terrest. Phys.*, vol. 3, p. 92; 1953.

<sup>7</sup> K. Watanabe, F. F. Marmo, and J. Pressman, *J. Geophys. Res.*, vol. 60, p. 513; 1955.

<sup>8</sup> M. Nicolet, *Mem. Mus. Hist. Nat. Belg.*, vol. 19, p. 124; 1945.

<sup>9</sup> A. P. Mitra, *J. Atmos. Terrest. Phys.*, vol. 5, p. 28; 1954.

<sup>10</sup> M. Nicolet, *J. Atmos. Terrest. Phys.*, vol. 7, p. 152; 1955.

<sup>11</sup> — private communication.



# The Distribution of Electrons in the Ionosphere\*

J. O. THOMAS†

**Summary**—This paper describes the methods now available for calculating the distribution of electrons in the ionosphere from observed virtual height-frequency records. Particular emphasis is given to recently developed machine and manual methods which make it practicable to produce electron distributions on a rapid, routine basis.

Attention is drawn to the importance of these data for the physics of the ionosphere by quoting from the results of some existing surveys.

## 1. INTRODUCTION

ONE of the most powerful tools of ionospheric research is the well-known variable frequency pulse-sounder; the  $h'(f)$  records produced regularly by this machine at numerous observatories all over the world contain a mass of data of the greatest importance for upper-atmospheric physics. Unfortunately, this great store of information is, at present, only partially available to students of the ionosphere, for although the precise shapes of the  $h'(f)$  curves are of the greatest significance, it has become customary to publish only the barest summaries in the form of tables of critical frequencies and certain minimum equivalent heights known as  $h'F$ ,  $h'E$ , etc. It is strange that, although the  $h'(f)$  curve was from the earliest days of ionospheric research known to contain information about the height distribution of the ionospheric electrons, only a few sporadic attempts were made, until recently, to deduce that distribution. In the past two or three years, however, the situation has been fundamentally changed and now electron distributions are being deduced as a routine in a number of observatories and will soon be available for research workers.

It is the purpose of this paper to describe in outline, and to compare, the methods of computation which can be used in this reduction of the data, to show the limitations of the resulting figures, and to give some indication of their use for ionospheric research.

## 2. THE PROBLEM

The equivalent height of reflection,  $h'$ , for radio waves of frequency  $f$  incident on the ionosphere vertically is given by

$$h'(f) = \int_0^{h_0} \mu'(f, N) dh \quad (1)$$

where  $\mu'$  is the group refractive index,  $h$  is the height above the ground,  $h_0$  is the height of reflection, and

$N(h)$  is the electron density at height  $h$ . It is with the solution of this fundamental equation that we are concerned in the problem of calculating the variation of electron density with height from  $h'(f)$  records.  $\mu'$  is a complicated, but known, function of  $f$  and  $N$  and of the strength and direction of the earth's magnetic field. The solution of (1) may be effected in two ways:

- A) Model or comparison methods: The layer is assumed to have an  $N(h)$  profile (for example, parabolic or linear) such that substitution in (1) gives an integral which can be evaluated analytically. The calculated  $h'(f)$  curve is then compared with the one observed and the parameters of the assumed distribution obtained.
- B) Integral equation methods: The integral equation methods can be divided into two classes. In the first, the equation is inverted directly to give an analytical solution. This forms the basis of a rapid and accurate manual method developed recently (see Section 4). In the second, the integral is replaced by a discrete sum over a number of suitable frequency intervals. These we shall call "lamination" methods. Methods of this kind are widely used at the present time for calculating  $N(h)$  curves from  $h'(f)$  curves, both by manual and electronic digital computation. Their development represents the most important advance in this field.

The integral equation methods, when applied to the analysis of an Ordinary ray  $h'(f)$  curve, give a unique  $N(h)$  curve only when  $N$  increases monotonically with increasing  $h$ . The profiles calculated when the assumption of a monotonically increasing  $N(h)$  is not valid will be discussed later.

Table I gives a list of some of the investigations into the problem of converting  $h'(f)$  to  $N(h)$  curves; a complete bibliography is given at the end of the paper.

## 3. EARLY HISTORY

Historically, the distinction between group, phase, and true path was clearly made by Appleton [1], [21], who calculated these paths for simple assumed distributions of electron density, neglecting the effect of the earth's magnetic field.

At this time, Appleton [21] and de Groot [22] showed how the integral (1) could be inverted to give (when the earth's field was neglected) an exact solution for the true height for the case of a monotonically increasing  $N(h)$  curve.

In his Bakerian lecture [2], Appleton derived the well-known expression for the group height corresponding to

\* Original manuscript received by the IRE, November 10, 1958. The work described on ionospheric electron densities at the Cavendish Laboratory is supported by a grant from the Dept. of Scientific and Industrial Research (Britain).

† Cavendish Laboratory, Cambridge, Eng.

TABLE I

EXAMPLES OF METHODS OF CONVERTING  $h'(f)$  TO  $N(h)$  CURVES

Model Methods	Integral Equation Methods	
	Direct	Lamination
No Field <i>Parabolic N(h)</i> Appleton & Beynon (1940) Booker & Seaton (1940) Ratcliffe (1951) Beynon & Thomas (1956) <i>Chapman N(h)</i> Pierce (1947) Jaeger (1947) Guha (1949) <i>Other distributions</i> Appleton (1928; 1930) Ratcliffe (1951)	No Field Appleton (1950) de Groot (1930) Pekeris (1940) Rydbeck (1940) Manning (1947) Kelso (1952) Schmerling & Thomas (1956)	With Field <i>Manual</i> Murray & Hoag (1937) Budden (1954) King (1954; 1956) Jackson (1956) Titheridge (1959)
	With Field Rydbeck (1942) Whale (1951) Kelso (1954; 1957) Shinn (1954) Schmerling (1957; 1958) Ventrice & Schmerling (1958)	<i>Machine</i> Schmerling (1957) Thomas, Haselgrove, & Robbins (1958) Thomas & Vickers (1958) Duncan (1958)
With Field Shinn & Whale (1952) Shinn (1953) Becker (1956)		

a parabolic layer. This type of assumed distribution formed the basis of two methods [3], [7] which were widely used for the rapid calculation of approximate layer heights and thicknesses with particular application to the prediction of ionospheric maximum usable frequencies.

More recently, Ratcliffe [8] showed how the comparison method for linear, square law, and parabolic layers could, by the use of transparent gratitudes, be used in a rapid way for the routine analysis of large numbers of records. Ratcliffe also produced the first large-scale true height survey [72]. Beynon and Thomas [6] showed how the expression for the virtual heights for a composite ionosphere made up of truncated parabolas could be put in the form of simple expressions involving inverse hyperbolic sine and cosine functions (of which the formulas given by the various workers above were special cases) and used these expressions to calculate the  $N(h)$  curves for the  $E$ ,  $F_1$ , and  $F_2$  layers.

Although the comparison methods (A) were mainly used for parabolic layers, other assumed distributions have also been treated. The best known of these is the Chapman layer, for which the corresponding virtual heights were calculated by Jaeger [12], Pierce [13], and Guha [11].

The methods (A) have mainly been applied when the effect of the earth's magnetic field was neglected, but Shinn and Whale [20], Shinn [19], Argence and Mayot [14]–[16], and Becker [17] extended them to allow for its effect.

In general, methods (A) have the disadvantages that an *a priori* assumption is made about the shape of the layer, that it is difficult to allow for the effect of the earth's magnetic field, and that they are slow to use in comparison with methods (B). The former methods will, therefore, not be discussed further.

As already stated, the method for inverting the integral to give an analytical solution was known in the very early days of ionospheric research but was not applied until much later by Pekeris [28], Rydbeck [29],

and Manning [25], [26]. The analysis was, however, tedious and involved integrals which had to be evaluated graphically. It is interesting to note that Savitt [91] was one of the first to apply true height calculations to the physics of the ionosphere by his use of  $N(h)$  profiles in the study of ionospheric behavior during an eclipse of the sun.

Rydbeck [35], [36], Kelso [33], [34] and others later included the effects of the earth's magnetic field, but the methods were not quick and easy to apply.

In 1937, Murray and Hoag published a paper [45], the importance of which was not realized at the time. It was, in fact, the first announcement of a lamination method for obtaining true heights. Twenty years were to pass before this technique was independently discovered and very widely applied.

#### 4. RECENT WORK

##### 4.1. Integral Equation Methods (B)—Direct Inversion

It is well known that if the effect of the earth's magnetic field and of the collisions of electrons with heavy particles is neglected, the function  $\mu'$  is of a form such that (1) reduces to an Abelian integral equation which may be directly inverted to give an analytical solution. Thus, from (1) we may write [21], [22]

$$h(f_N) = \frac{2}{\pi} \int_0^{f_N} \frac{h'(f)df}{\sqrt{(f_N^2 - f^2)}} \tag{2}$$

where

$$f_N = \sqrt{\left(\frac{Ne^2}{\epsilon_0 \pi m}\right)}$$

is the plasma frequency corresponding to a number density  $N$  of electrons of charge  $e$  and mass  $m$ , and  $\epsilon_0$  is the permittivity of free space.  $h(f_N)$  is the height at which the plasma frequency is  $f_N$  and the electron density is  $N$ . Putting  $\theta = \sin^{-1}(f/f_N)$ , (2) becomes

$$h(f_N) = \frac{2}{\pi} \int_0^{\pi/2} h'(f_N \sin \theta) d\theta. \tag{3}$$

The integration may be performed numerically by dividing the curve  $h'(f_N \sin \theta)$  into a series of steps of equal width in  $\theta$  [23]. If five steps are taken, with equal increments in  $\theta$ , they then correspond to values of  $f/f_N$  given by

$$f/f_N = 0.156, 0.454, 0.707, 0.891, 0.988. \tag{4}$$

Eq. (3) then becomes

$$h(f_N) = \frac{2}{\pi} \left\{ \frac{1}{5} \cdot \frac{\pi}{2} \right\} \{ h'(0.156f_N) + h'(0.454f_N) + h'(0.707f_N) + h'(0.891f_N) + h'(0.988f_N) \}. \tag{5}$$



The five values of  $f/f_N$  are called the "five-point Kelso coefficients." If greater accuracy is required ten or twenty steps can be taken. The ten- and twenty-point (no field) Kelso coefficients are given in Table II(b).

In order to calculate the height  $h(f_N)$  at which the plasma frequency is  $f_N$ , it is merely necessary to read off from the experimental curve the values of  $h'(f)$  at the frequencies given by the series (4), to add them up and to divide by the number of steps.

To facilitate reduction, the  $h'(f)$  trace for the Ordinary ray may be replotted on a logarithmic frequency scale [30]. By marking a card with the frequency ratios (4) on the same scale, the five heights for each value of  $f_N$  can be read off immediately.

Shinn [38] has shown that it is possible to modify these coefficients to allow for the effect of the earth's magnetic field. The true height corresponding to the plasma frequency  $f_N$  is given by

$$h(f_N) = \frac{1}{n} \sum_{i=1}^{i=n} h'(f_i) \quad (6)$$

where  $n$  is the number of steps. The sampling frequencies have been given in terms of the ratios  $f_i/f_N$  which, for values of  $f_N$  in the ranges given, define the frequencies  $f_i$  at which the virtual height must be read to give  $h(f_N)$ . These ratios, called the Shinn-Kelso coefficients, are given in Table II(c) for a number of places. The values of  $\sec \phi/2$  (where  $\phi$  = dip angle) and of  $F$  (the value of the earth's total field) assumed in calculating the coefficients are also shown [Table II(a)].

The frequencies  $f_i$  depend on the plasma frequency  $f_N$ , but it is found in practice that sufficient accuracy can be obtained by using the same set of coefficients over a range of frequencies shown in the table. These modified coefficients may be used in the way described by Schmerling and Thomas [30], except that a card marked with the coefficients for the range of frequencies containing  $f_N$  must be selected from a set of cards covering the whole frequency range.

The coefficients given in Table II(c) may be used to compute the sampling frequencies for all values of the frequency  $f_N$  at intervals of 0.1 mc/s between 1.0 mc/s and 20 mc/s for the cases  $n = 10$  and  $n = 5$ . Such a set of tables [52] provides an extremely simple and rapid method of calculating the  $N(h)$  curve. To obtain the height at which the plasma frequency is, say, 15.0 mc/s,

it is merely necessary to add up the virtual heights at the ten (or five) frequencies given opposite the value  $f_N = 15.0$  mc/s and to divide by ten (or five). In practice the conversion of a single record takes about 20 minutes.

King [43] suggested that the modified Kelso coefficients might be obtained from the elements of the inverted matrix used in the lamination method (see Section 4.2). Schmerling [37], working independently, has produced these coefficients for Washington, D. C., in a similar way. Recently Ventrice and Schmerling [39] have extended this work and have given sets of coefficients which may be used for any station for which the magnetic dip angle does not exceed 80°.

4.2. Inversion of the Integral Equation by Lamination Methods

The lamination method seems to have been first thought of by Murray and Hoag [45], but the importance of the principle was not realized for almost twenty years. Recently, however, a large amount of attention has been given to lamination methods both for manual application [41]–[44], [47], [48] and machine application [50]–[52]. The method is described below.

4.2.1. Principle: Instead of making an assumption about the shape of the whole layer, as in methods (A) in the lamination methods an assumption is made only about the shape over a thin strip or lamination defined by a frequency interval  $\Delta f$ . In practice the desired accuracy may be achieved (subject to the limitations of Section 5) by making the interval  $\Delta f$  sufficiently small. The integral in (1) is replaced by a discrete sum over a number of suitable frequency intervals. The coefficients in the equations involved are, for convenience, written in matrix form. The method then involves inversion of the matrix or a step-by-step solution for each strip.

An example of a typical lamination method is outlined below.

Consider an  $N(h)$  curve which when replotted as an  $f_N(h)$  curve is as shown in Fig. 1(a). The  $f_N(h)$  curve may be considered to be made up of strips at heights  $h_1, h_2, \dots, h_n, \dots$  obtained by dividing the frequency axis into constant intervals  $\Delta f$ . The  $h'(f)$  curve with the corresponding values of virtual height is shown in Fig. 1(b). The strips are taken to be so narrow that the gradient  $dh/df_N$  may, with sufficient accuracy, be assumed constant inside each strip. Let the true and vir-

TABLE II

(a) MAGNETIC FIELD PARAMETERS FOR THE STATIONS SHOWN

Ionospheric observatory	Assumed sec $(\phi/2)$	Assumed $F$ (oersted)
Cheltenham, Maryland, U.S.A.	1.230	0.570
Slough	1.200	0.480
Watheroo and Canberra	1.182	0.575
Brisbane	1.140	0.550
Port Stanley	1.100	0.400
Maui	1.060	0.365

(b) 5-10, AND 20-POINT KELSO COEFFICIENTS (NO FIELD)\*

$n$	Sampling ratios (for all values of $f_N$ )									
20	.039	.118	.195	.271	.346	.419	.489	.556	.619	.679
	.734	.785	.832	.873	.908	.938	.962	.981	.993	.999
10	.079	.233	.383	.523	.649	.760	.853	.924	.972	.997
5	.156	.454	.707	.891	.988					

\* Applicable to places on the magnetic equator.

(c) 5- AND 10-POINT SHINN-KELSO COEFFICIENTS (WITH FIELD)

Cheltenham, Maryland, U.S.A.							
sampling ratios \ $f_N$ (mc/s)	<2.0	2.0 to 2.8	2.8 to 4.0	4.0 to 5.7	5.7 to 8.0	8.0 to 11.4	>11.4
	$n=10$						
1	.071	.075	.078	.079	.080	.080	.080
2	.209	.219	.226	.232	.235	.236	.236
3	.336	.350	.360	.370	.376	.381	.382
4	.452	.467	.480	.492	.502	.510	.514
5	.556	.572	.587	.601	.613	.624	.632
6	.653	.668	.683	.698	.711	.724	.733
7	.744	.757	.770	.784	.796	.809	.818
8	.829	.839	.849	.859	.870	.880	.889
9	.909	.914	.920	.926	.932	.938	.944
10	.979	.980	.981	.982	.983	.985	.986
$n=5$							
1	.119	.125	.129	.132	.133	.134	.133
2	.410	.424	.437	.447	.457	.464	.467
3	.606	.620	.635	.650	.664	.675	.684
4	.777	.788	.801	.813	.825	.837	.846
5	.952	.959	.962	.965	.968	.971	.973

Brisbane							
sampling ratios \ $f_N$ (mc/s)	<2.0	2.0 to 2.8	2.8 to 3.9	3.9 to 5.5	5.5 to 7.8	7.8 to 11.0	>11.0
	$n=10$						
1	.072	.074	.077	.078	.079	.080	.080
2	.211	.219	.225	.230	.233	.235	.236
3	.342	.352	.362	.369	.376	.380	.382
4	.461	.473	.485	.495	.503	.510	.515
5	.571	.583	.595	.607	.617	.626	.633
6	.672	.683	.695	.707	.718	.728	.736
7	.767	.776	.785	.795	.805	.815	.823
8	.854	.859	.866	.873	.880	.888	.894
9	.932	.934	.936	.939	.942	.946	.950
10	.990	.990	.990	.990	.990	.990	.991
$n=5$							
1	.119	.124	.128	.130	.132	.133	.133
2	.418	.430	.440	.450	.458	.463	.467
3	.623	.634	.646	.658	.669	.679	.687
4	.800	.808	.816	.826	.835	.844	.852
5	.975	.974	.974	.976	.977	.978	.979

Slough							
sampling ratios \ $f_N$ (mc/s)	<1.7	1.7 to 2.4	2.4 to 3.4	3.4 to 4.8	4.8 to 6.8	6.8 to 9.6	>9.6
	$n=10$						
1	.072	.075	.077	.079	.080	.080	.080
2	.209	.218	.226	.231	.234	.236	.236
3	.338	.350	.361	.370	.376	.380	.382
4	.454	.468	.481	.493	.503	.510	.515
5	.560	.574	.589	.602	.614	.624	.632
6	.658	.672	.686	.700	.713	.724	.734
7	.750	.762	.774	.787	.799	.810	.820
8	.836	.844	.854	.863	.873	.882	.890
9	.915	.919	.924	.930	.935	.940	.946
10	.983	.983	.984	.985	.986	.987	.988
$n=5$							
1	.119	.124	.128	.131	.133	.134	.134
2	.412	.426	.438	.449	.457	.464	.467
3	.610	.624	.639	.652	.665	.676	.685
4	.783	.793	.805	.816	.828	.838	.848
5	.962	.964	.965	.968	.970	.973	.975

Port Stanley							
sampling ratios \ $f_N$ (mc/s)	<1.4	1.4 to 2.0	2.0 to 2.8	2.8 to 4.0	4.0 to 5.6	5.6 to 8.0	>8.0
	$n=10$						
1	.072	.074	.076	.078	.079	.079	.079
2	.213	.220	.225	.229	.232	.234	.235
3	.347	.355	.363	.370	.375	.379	.381
4	.470	.479	.489	.498	.505	.511	.515
5	.583	.592	.602	.612	.621	.629	.635
6	.687	.696	.705	.714	.723	.732	.739
7	.784	.790	.797	.804	.812	.820	.827
8	.870	.874	.878	.882	.888	.893	.899
9	.944	.945	.946	.947	.949	.952	.955
10	.993	.993	.993	.993	.993	.993	.993
$n=5$							
1	.120	.124	.127	.130	.131	.132	.132
2	.425	.434	.443	.451	.458	.464	.467
3	.636	.645	.655	.665	.674	.682	.689
4	.817	.822	.828	.835	.842	.849	.856
5	.981	.981	.981	.981	.981	.982	.982

Watheroo and Canberra							
sampling ratios \ $f_N$ (mc/s)	<2.0	2.0 to 2.9	2.9 to 4.1	4.1 to 5.8	5.8 to 8.2	8.2 to 11.5	>11.5
	$n=10$						
1	.072	.075	.077	.079	.080	.080	.080
2	.210	.218	.225	.230	.234	.236	.236
3	.338	.350	.361	.369	.376	.380	.382
4	.456	.469	.482	.493	.503	.510	.515
5	.563	.576	.590	.603	.615	.625	.632
6	.661	.674	.688	.702	.714	.725	.734
7	.754	.765	.777	.789	.800	.811	.821
8	.841	.848	.857	.866	.874	.883	.891
9	.920	.923	.927	.932	.937	.942	.947
10	.985	.985	.986	.986	.987	.988	.990
$n=5$							
1	.119	.124	.128	.131	.133	.134	.134
2	.413	.427	.438	.449	.457	.463	.467
3	.613	.627	.640	.654	.666	.677	.685
4	.787	.797	.808	.819	.830	.840	.849
5	.967	.967	.968	.969	.972	.974	.976

Maui							
sampling ratios \ $f_N$ (mc/s)	<1.3	1.3 to 1.8	1.8 to 2.6	2.6 to 3.7	3.7 to 5.2	5.2 to 7.3	>7.3
	$n=10$						
1	.074	.075	.076	.077	.078	.079	.079
2	.218	.222	.226	.229	.232	.233	.234
3	.355	.361	.366	.372	.376	.379	.381
4	.484	.490	.496	.502	.508	.513	.516
5	.602	.607	.614	.620	.627	.633	.637
6	.710	.714	.720	.726	.732	.738	.743
7	.807	.810	.814	.818	.823	.828	.833
8	.891	.892	.894	.896	.899	.902	.906
9	.957	.957	.957	.958	.958	.959	.960
10	.995	.995	.995	.995	.995	.995	.995
$n=5$							
1	.123	.125	.127	.129	.131	.132	.132
2	.437	.443	.449	.455	.460	.464	.467
3	.657	.662	.668	.675	.681	.687	.692
4	.840	.842	.845	.849	.853	.858	.862
5	.986	.986	.986	.986	.986	.986	.986



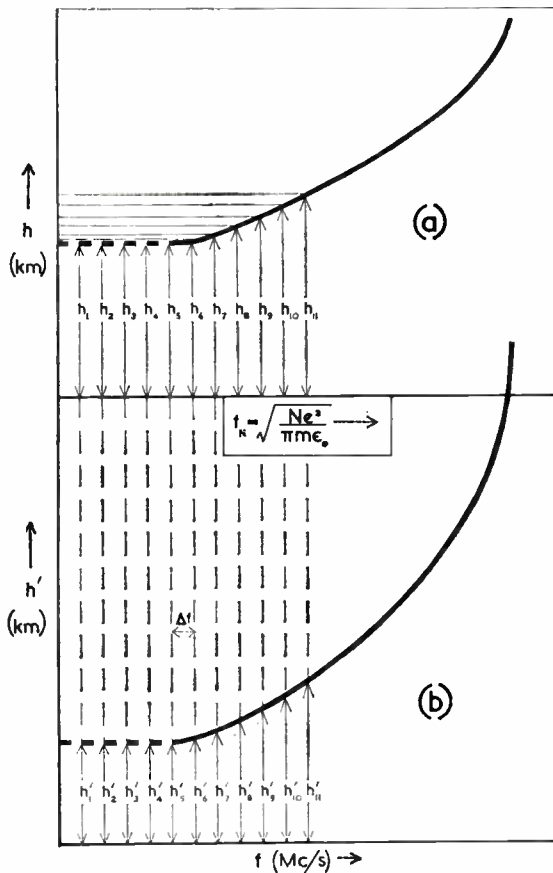

Fig. 1—(a) An  $N(h)$  profile replotted as an  $f_N(h)$  curve, showing laminations at a frequency interval  $\Delta f$  at heights  $h_1, h_2, \dots, h_n, \dots$ . (b) Corresponding values  $h'_1, h'_2, \dots, h'_n, \dots$  of virtual height are shown on the  $h'(f)$  curve. The continuous curves correspond to the parts of the  $h'(f)$  curve actually observed and the broken lines to the assumed form for frequencies below the limit of the apparatus.

tual heights be related by coefficients  $A$ . Then we may write

$$\left. \begin{aligned} h'_1 &= A_{11}h_1 \\ h'_2 &= A_{21}h_1 + A_{22}h_2 \\ h'_3 &= A_{31}h_1 + A_{32}h_2 + A_{33}h_3 \\ &\vdots \\ h'_n &= A_{n1}h_1 + A_{n2}h_2 + \dots + A_{nm}h_m + \dots \\ &\quad + A_{nn}h_n \dots \\ &\vdots \end{aligned} \right\} \quad (7)$$

Rearranging these equations, we have

$$\left. \begin{aligned} h_1 &= \frac{1}{A_{11}} h'_1 \\ h_2 &= -\frac{A_{21}}{A_{22}} h'_1 + \frac{1}{A_{22}} h'_2 \\ h_3 &= -\frac{A_{31}}{A_{33}} h'_1 - \frac{A_{32}}{A_{33}} h'_2 + \frac{1}{A_{33}} h'_3 \\ &\text{etc.} \end{aligned} \right\} \quad (8)$$

These equations give the true heights  $h_1, h_2, \dots$ , in terms of the observed virtual heights.

For convenience we define a matrix  $B$  for the coefficients of (8)

$$B = \begin{bmatrix} B_{11} & B_{12} & \dots & B_{1m} & \dots & \dots \\ & B_{21} & \dots & & \dots & \dots \\ & & & & & \vdots \\ B_{31} & \dots & & \dots & \dots & \dots \\ \vdots & & & & & \vdots \\ B_{n1} & B_{n2} & \dots & B_{nm} & \dots & B_{nn} \dots \\ \vdots & & & & & \vdots \end{bmatrix}$$

i.e.,

$$B_{nm} = -\frac{A_{nm}}{A_{nn}} \quad (m \neq n)$$

$$B_{nn} = \frac{1}{A_{nn}}$$

$$B_{nm} = 0 \quad (m > n).$$

The values of  $h_1, h_2, \dots, h_n, \dots$  can be found in succession, replacing each  $h'_n$  by the corresponding  $h_n$  as it is found and obtaining  $h_{n+1}$  from

$$h_{n+1} = \sum_{m=1}^n B_{n+1,m} h_m + B_{n+1,n+1} h_{n+1}'. \quad (9)$$

Thus the heights can be found, provided the coefficients  $A$  and therefore the elements of  $B$  are known.

This is the basis of the method used in the British program for the routine conversion of  $h'(f)$  records during the International Geophysical Year [51], [52].

The set of equations (7) may be written in matrix form:

$$\begin{bmatrix} h'_1 \\ h'_2 \\ h'_3 \\ \vdots \\ h'_n \\ \vdots \end{bmatrix} = \begin{bmatrix} A_{11} & 0 & 0 & 0 & \dots \\ A_{21} & A_{22} & 0 & 0 & \dots \\ A_{31} & A_{32} & A_{33} & 0 & \dots \\ \vdots & \vdots & \vdots & \vdots & \vdots \\ A_{n1} & A_{n2} & \dots & A_{nm} & \dots & A_{nn} \dots \end{bmatrix} \begin{bmatrix} h_1 \\ h_2 \\ h_3 \\ \vdots \\ h_n \\ \vdots \end{bmatrix} \quad (10)$$

or

$$h' = Ah$$

where the bold face letters denote a matrix, say,

$$\therefore h = A^{-1}h' = Lh'. \quad (11)$$

This again gives the required true heights and is the basis of the matrix inversion method suggested by Budden [41] and by King [43], [44], and used by Schmerling [50] for the routine reduction of records as part of the American IGY program, and by Wright, van Zandt, and Stonehocker [80] in connection with the U. S. satellite observation program.

4.2.2. Evaluation of the elements of  $A$ : To evaluate the coefficients  $A$ , i.e., the elements of  $A$ , we have [41]

$$h'(f) = \int_0^{h_0} \mu'(f, f_N) dh = \int_0^f \mu'(f, f_N) \left\{ \frac{dh(f_N)}{df_N} \right\} df_N \quad (12)$$

in which  $f_N(h)$  is unknown. We find  $h(f_N)$  so that  $f_N$  is the variable of integration. This transformation may be made only when the  $N(h)$  profile is monotonically increasing. We write

$$h'(n\Delta f) = h_n'; \quad h(n\Delta f) = h_n \quad \text{and} \quad n\Delta f = f_n, \text{ etc.,}$$

and assume

$$\frac{dh}{df_N} = \text{constant} = \frac{h_m - h_{m-1}}{\Delta f} \quad (13)$$

within each interval  $(m-1)\Delta f < f_N \leq m\Delta f$ , where  $m$  is an integer  $\leq n$ . The integral may be replaced by a summation over a finite number of strips,  $n$ . Then

$$h_n' = \sum_{m=1}^n (h_m - h_{m-1}) M_{nm} \quad (14)$$

where

$$M_{nm} = \int_{f_{m-1}}^{f_m} \frac{\mu'(f_n, f_N) df_N}{\Delta f} \quad \text{for } m \leq n; \quad M_{nm} = 1 \quad \text{for } m = 1;$$

$$M_{nm} = 0 \quad \text{for } m > n.$$

Writing this in the form of column and square matrices

$$h' = MDh = Ah \quad \text{where} \quad A = MD \quad (15)$$

and

$$h' = \begin{bmatrix} h_1' \\ h_2' \\ h_3' \\ \vdots \\ h_n' \\ \vdots \end{bmatrix} \quad M = \begin{bmatrix} M_{11} & 0 & 0 & 0 & 0 & \cdots \\ M_{21} & M_{22} & 0 & 0 & 0 & \cdots \\ M_{31} & M_{32} & M_{33} & 0 & 0 & \cdots \\ \vdots & \vdots & \vdots & \vdots & \vdots & \vdots \\ M_{n1} & M_{n2} & M_{n3} & M_{n4} & 0 & \cdots \\ \vdots & \vdots & \vdots & \vdots & \vdots & \vdots \end{bmatrix}$$

$$h = \begin{bmatrix} h_1 \\ h_2 \\ h_3 \\ \vdots \\ h_n \\ \vdots \end{bmatrix} \quad D = \begin{bmatrix} 1 & 0 & 0 & 0 & 0 & \cdots \\ -1 & 1 & 0 & 0 & 0 & \cdots \\ 0 & -1 & 1 & 0 & 0 & \cdots \\ 0 & 0 & -1 & 1 & 0 & \cdots \\ \vdots & \vdots & \vdots & \vdots & \vdots & \vdots \\ \vdots & \vdots & \vdots & \vdots & \vdots & \vdots \end{bmatrix}$$

The  $M$ 's may be obtained from the Appleton-Hartree magneto-ionic theory using the method of Shinn and Whale [20] or by the method [49] described by Thomas and Vickers [52]. From these, the elements of  $A$ , and hence those of  $B$ , are derived.

TABLE III  
 $N(h)$  DATA CALCULATED BY AN ELECTRONIC DIGITAL COMPUTER\*

Slough, September 1, 1957								
	Local Mean Time							
$h(\text{km})$	0000	0100	0200	0300	0400	0500	0600	0700
320						10.37		
310						9.98		5.66
300						9.52	4.02	5.57
290					10.80	8.94	3.96	5.42
280		5.79			10.42	8.33	3.89	5.18
270		5.49		7.77	9.84	7.67	3.78	4.92
260		5.07		7.25	9.10	7.00	3.67	4.58
250		4.52		6.44	8.17	6.34	3.55	4.19
240		3.84	14.74	5.36	7.25	5.75	3.42	3.76
230		3.04	14.11	4.24	6.34	5.18	3.29	3.35
220		2.12	13.28	3.24	5.48	4.65	3.17	2.99
210	4.26	1.02	12.19	2.48	4.73	4.19	3.05	2.67
200	3.74		10.82	1.96	4.15	3.84	2.92	2.36
190	2.84		9.10	1.60	3.68	3.51	2.77	2.08
180	1.54		7.17	1.34	3.29	3.10	2.59	1.83
170			5.00	1.14	2.92	2.74	2.37	1.62
160			2.69	0.99	2.55	2.37	2.12	1.42
150			0.12	0.88	2.11	2.01	1.87	1.26
140				0.80	1.81	1.69	1.66	1.13
130				0.74	1.66	1.51	1.52	1.04
120				0.32	1.27	1.35	1.12	0.98
110								0.66
$hmF_2$	219	285	248	279	296	324	301	319
$NmF_2$	4.47	5.91	15.01	8.14	10.96	10.50	4.03	5.74
$h_0$	174	201	150	120	120	115	120	110
$N_0$	0.12	0.06	0.12	0.32	1.27	0.78	1.12	0.66

\* Values of  $N \times 10^{-6}$  shown in  $\text{cm}^{-3}$ .

In practice, the calculation may be conveniently thought of as being in two parts:

- 1) The calculation of matrix elements for a particular station. This requires two constants, the dip and the gyrofrequency. These elements are computed once and for all and may then be used in 2) below.
- 2) A calculation to convert the given  $h'(f)$  data into  $N(h)$  data. It uses matrix elements previously computed in 1) above. Full details of such a calculation and its arrangement in a machine have been given by Thomas and Vickers [52].

The particular program referred to, [52], converts sixteen  $h'(f)$  curves to give the  $N(h)$  data with one reading of the matrix. The time taken for the output of the  $N(h)$  data is about six minutes for the sixteen  $h'(f)$  records, i.e., about twenty seconds per record. For the British IGY  $h'(f) - N(h)$  program, the digital computer is arranged to print the output as shown in Table III. Reading down a column at a given time gives the  $N(h)$  curve and reading across a horizontal row gives the variation of electron density with time at a fixed height, the  $N(t)$  curve. The values of electron density in Table III are in units of  $10^6$  electrons  $\text{cm}^{-3}$ . Additional parameters as shown are also automatically determined and printed.  $NmF_2$  and  $hmF_2$  are, respectively, the maximum  $F_2$ -layer electron density and the height at which it occurs.  $h_0$  and  $N_0$  are the values of the minimum virtual height and the electron density corresponding to the frequency below which  $h'$  is observed (or assumed) constant.



4.2.3. *Lamination methods—manual applications:* The elements of the matrix  $L$  (11), for conditions in south-eastern England, were published by Budden [41] for plasma frequencies up to 6.0 mc/s and for  $\Delta f = 0.2$  mc/s. This forms the basis of a useful manual method for the reduction of  $h'(f)$  records.

Lamination methods for manual application were developed independently by Murray and Hoag [45], Jackson [42] and Titheridge [47], [48].

The method given by Titheridge is very important because:

- 1) of all the manual methods it is the fastest to apply,
- 2) it is capable of extremely high accuracy and has been used for the determination of the fine structure of the  $E$  layer from  $h'(f)$  data obtained with sensitive equipment,
- 3) it can easily be applied both to the Ordinary and Extraordinary wave traces on the  $h'(f)$  record, with advantages discussed in the next section.

## 5. THE USE OF THE EXTRAORDINARY WAVE

The methods of calculation hitherto described suffer from the following two limitations:

- 1) there are no observations of  $h'$  below some limiting value,  $f_{lim}$ , of the observing frequency, and
- 2) it must be assumed that the  $N(h)$  curve is monotonic, so that there is no minimum of electron density between, for example, the peaks of the  $E$  and  $F$  layers.

Jackson [42] and Titheridge [47], [48] have shown how, by making use of observations on the Extraordinary and Ordinary waves simultaneously, it is possible to remove these limitations to a considerable extent.

The principle of the method is as follows. First it is assumed that if observations had been made at frequencies less than  $f_{lim}$ , the  $h'(f)$  curve would have indicated a constant value of  $h'$  equal to that actually observed at  $f_{lim}$ . An  $N(h)$  curve is then calculated from the Ordinary wave trace on the  $h'(f)$  record. From this  $N(h)$  curve, the shape of the Extraordinary wave  $h'(f)$  trace is deduced and compared with the observed shape. If the two curves are not the same, adjustment can be made in the  $N(h)$  curve to bring them into coincidence, without spoiling the agreement with the observed  $h'(f)$  trace for the Ordinary wave. These adjustments may be concerned either with low-lying electrons with plasma frequencies less than  $f_{lim}$ , or with minima in the electron-density profiles between peaks on the curve.

The estimate of low-lying electrons with plasma frequencies less than  $f_{lim}$  is of importance in the analysis of nighttime records, and particularly those made near sunrise and sunset. An example is shown in Fig. 2 where the upper curves show the  $N(h)$  profiles calculated from the Ordinary wave trace on the assumption that the  $h'(f)$  curve is horizontal for  $f < f_{lim}$ , and the lower,

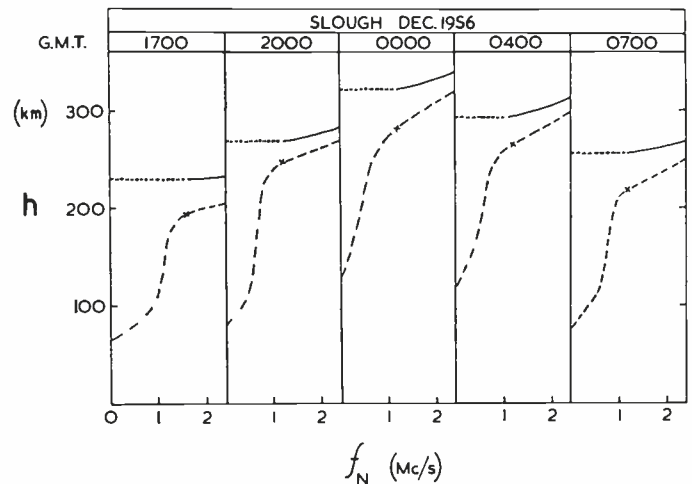

Fig. 2—Upper curves show the mean  $N(h)$  profiles calculated from the Ordinary wave traces averaged for International Quiet Days at Slough in December, 1956, at intervals between 1700 GMT (one hour after ground sunset) and 0700 GMT (one hour before ground sunrise), on the assumption that  $h'$  is constant for frequencies below  $f_{lim}$  (marked  $\times$ ). Lower, broken curves show profiles deduced by Titheridge's method from Ordinary and Extraordinary wave traces.

broken curves show the profiles deduced by Titheridge's method, taking into account both the Ordinary and Extraordinary wave traces. Examination of several nighttime  $h'(f)$  curves in the same way suggests that an  $N(h)$  curve deduced, as described above, from the Ordinary wave trace alone is not likely to be much in error near the peak of the layer, but that the values of  $h$  for the plasma frequency  $f_{lim}$  may be as much as 50 km too high. The error is particularly large near sunrise and sunset when the plasma frequency of low-lying electrons may be only just below the lower-frequency limit of the recorder.

When it was thought that there was a minimum in the  $N(h)$  curve between the top of the  $E$  layer and the bottom of the  $F$  layer, it was realized that there would be considerable inaccuracy in the calculated curves since the integral equation methods can be strictly applied only when the  $N(h)$  curve is monotonically increasing [54], [55], [82]. Calculations in which both wave traces were used have always shown that if this minimum exists it is very shallow. This result agrees with that derived from experiments with rockets [92] and with the conclusions of Hollingworth [53] and Landmark and Lied [90]. Thus it appears that the assumption of monotonically increasing  $N(h)$  is reasonable and that the "lower-limit"  $N(h)$  curve derived in the analysis described above is probably near the truth.

## 6. RESULTS

Table IV gives a brief summary of true height surveys which have been reported in the literature. Full references are given in the bibliography.

Fig. 3 shows some typical  $N(h)$  curves taken from some of the data for quiet days published in the refer-

TABLE IV  
SUMMARY OF TRUE HEIGHT SURVEYS REPORTED IN THE LITERATURE

Electron Density Distributions		
No Field	With Field	I.G.Y. Surveys with Field
<p><i>White &amp; Wachtel (1949)</i> Washington { Hourly records for one year</p> <p><i>Ratcliffe (1951)</i> Slough { Hourly records for a few days Watheroo { in summer, equinox and winter Huancayo { in years of high and low sunspot number</p> <p><i>Beynon &amp; Thomas (1956)</i> Swansea { Noon and midnight records over a period of one year</p> <p><i>Schmerling &amp; Thomas (1955; 1956)</i> Slough { Averages for International Quiet Watheroo { Days (I.Q.Ds.) in summer, Huancayo { equinox and winter in years of high and low sunspot number</p> <p><i>Thomas &amp; Robbins (1955)</i> Port Stanley { Averages for I.Q.Ds. in summer, Maui { equinox and winter in years of high and low sunspot number</p>	<p><i>Jackson (1956)</i> White Sands { <math>N(h)</math> curves deduced from <math>h'(f)</math> records taken during rocket flights, compared with rocket results.</p> <p><i>King &amp; Cummack (1956)</i> Christchurch { One quiet day per month in the years 1954-1957 also Raratonga and Maui</p> <p><i>Thomas, Haselgrove &amp; Robbins (1957; 1958)</i> Slough { Hourly records for every day of six months—summer, equinox and winter in a year of high and a year of low sunspot number</p> <p><i>Duncan (1958)</i> Brisbane { <math>N(h)</math> profiles, noon and mid- night for selected days</p> <p><i>Thomas &amp; Robbins (1958)</i> Slough { Results for disturbed days</p> <p><i>Croom, Robbins &amp; Thomas (1959)</i> Maui { Hourly records for 10 I.Q.Ds. Watheroo { for summer, equinox and win- ter in a year of high and of low Huancayo { sunspot number</p>	<p><i>Smith-Rose (1958)</i> <i>D.S.I.R. Bulletins of <math>N(h,t)</math> results</i> <i>Thomas &amp; Vickers (1958)</i> Slough Inverness { Hourly records for at least Ibadan { three R.W.Ds. per month Singapore { during the I.G.Y.</p> <p>Port Stanley 1958-59 Penn. State Univ. Tables of <math>N(h,t)</math> results</p> <p><i>Schmerling (1957)</i> Panama { Hourly records for I.Q.Ds. Talara { and R.W.Ds. for every month Huancayo { during the I.G.Y.</p> <p>Washington <i>Wright, van Zandt &amp; Stonehocker (1958)</i> Eleven stations { Various times during Oc- tober, 1957 <i>Knecht &amp; Schlitt (1958)</i> Talara Chiclayo { S. America—equatorial close- Chimbote { spaced stations. Results for Huancayo { October 15, 1957 La Paz</p>

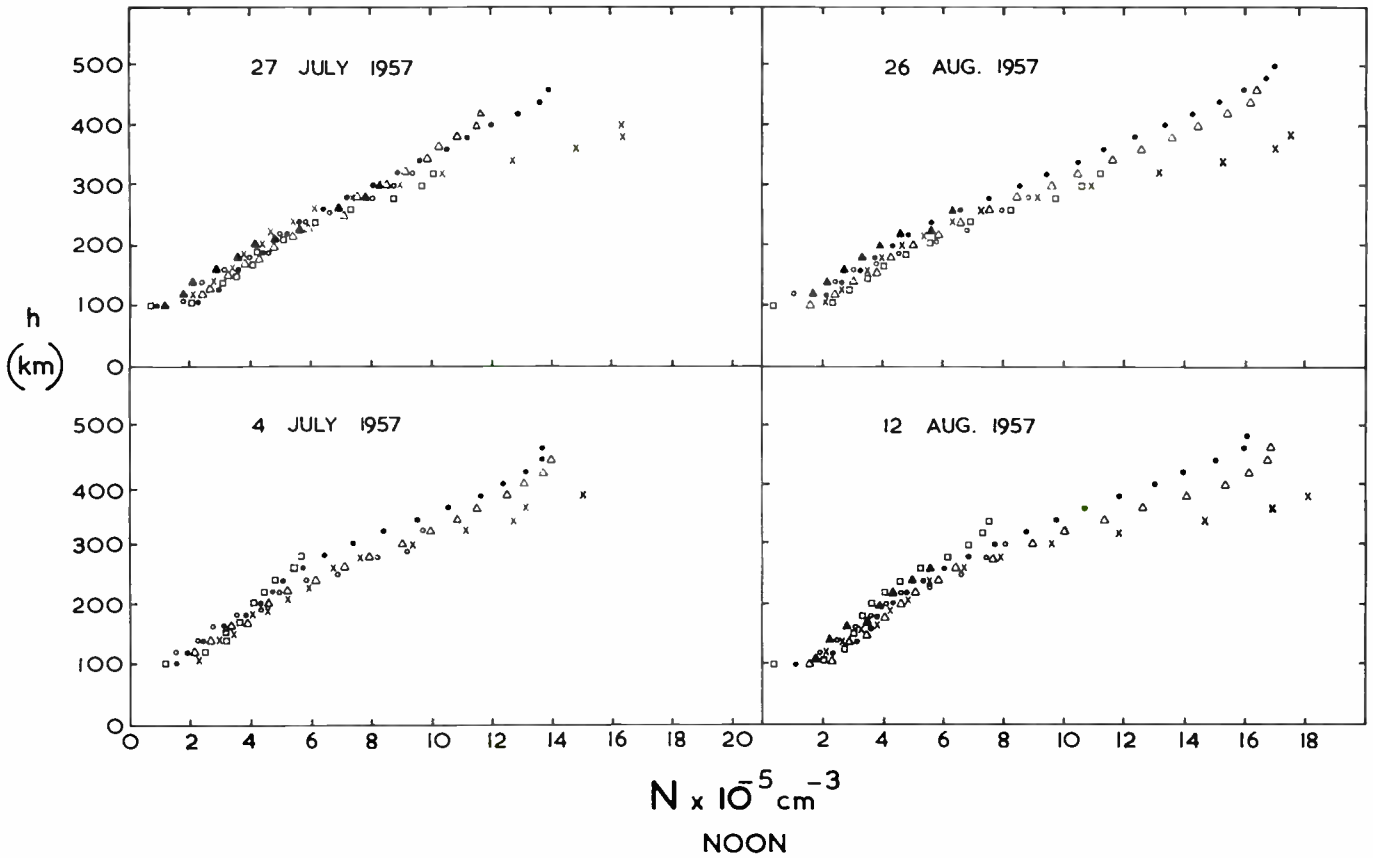

Fig. 3— $N(h)$  profiles for Regular World Days in July and August, 1957, at the places listed below. Geographic latitudes and longitudes are given.

- |            |                      |          |                      |
|------------|----------------------|----------|----------------------|
| Slough     | 51°30'N, 00°36'W (○) | Panama   | 09°24'N, 79°54'W (×) |
| Inverness  | 57°27'N, 04°15'W (▲) | Talara   | 04°00'S, 81°30'W (●) |
| Washington | 38°42'N, 77°00'W (□) | Huancayo | 12°00'S, 75°18'W (△) |



ences given in Table IV. Fig. 4 shows  $N(t)$  curves at fixed heights for a number of places. Fig. 5 shows the  $h'(f)$  and  $N(h)$  curves obtained on a disturbed and quiet day at Slough. Information of the kind shown in Figs. 3-5 is basic for the testing of ionosphere theories.

It may be useful to draw attention to some facts which are noticeable when  $N(h)$  tables are available, but which may be lost sight of when only the routine quantities ( $f_oF_2$ ,  $hmF_2$ ,  $h'F_2$ , etc.) are tabulated.

- 1) The minimum virtual height,  $h'F_2$ , depends so much on the group retardation lower in the ionosphere that it is quite unreliable as an index of the height, or of the changes in height, of the  $F_2$  layer (Fig. 6).
- 2) The true variation of the electron density at a given height is a quantity of importance for the continuity equation which, with the usual nomenclature, may be written

$$\frac{dN}{dt} = q - \left\{ \begin{array}{l} \beta N \\ \alpha N^2 \end{array} \right\} - \text{div}(Nv).$$

The time variation of the routine quantity  $f_oF_2$  (or  $NmF_2$ ) is much less valuable because it represents

the plasma frequency at a height which is continually changing. Figs. 7 and 8 show, for three widely separated places, the variations of  $NmF_2$ ,  $N_{260}$ , and  $N_{220}$  where  $N_{260}$  and  $N_{220}$  are the electron densities at 260 and 220 km, respectively. It is interesting to see how the electron density at a fixed height behaves quite differently from  $NmF_2$ .

- 3) The way in which the height of maximum electron density in the  $F_2$  layer varies with time and position is shown in Fig. 9. In general these heights are in agreement with rocket results and are lower than those previously deduced from  $h'(f)$  curves. Figs. 10 and 11 show the variation of  $hmF_2$  over the world obtained from some of the results referred to in Table IV.

It is clear that the publication of  $N(h,t)$  data in the form suggested (Table III) together with diagrams showing the mean  $N(t)$  curves at 20-km height intervals for International Quiet Days provides theoretical workers with the morphological data they require in a convenient and economical way. It may even prove possible to provide at a later date reliable world maps of electron density morphology, but results for many more stations are required before this becomes feasible.

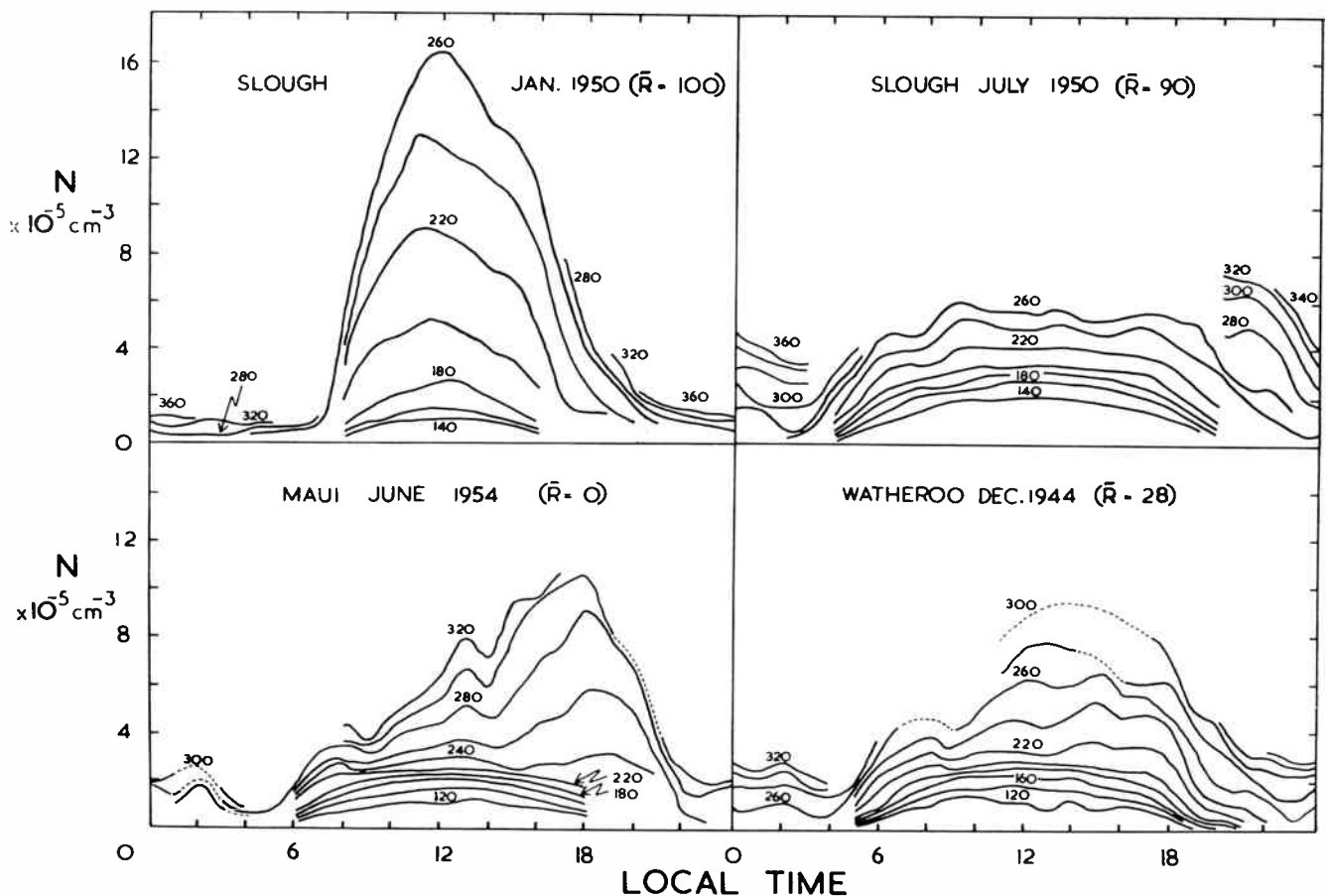

Fig. 4—Curves show average electron density variation with time at fixed heights [ $N(t)$  curves] for ten International Quiet Days at Slough ( $51^{\circ}30'N$ ,  $00^{\circ}36'W$ ), Maui ( $20^{\circ}48'N$ ,  $156^{\circ}30'W$ ), and Watheroo ( $30^{\circ}19'S$ ,  $115^{\circ}53'E$ ). The average relative Zürich sunspot number  $\bar{R}$  for each month is also shown.

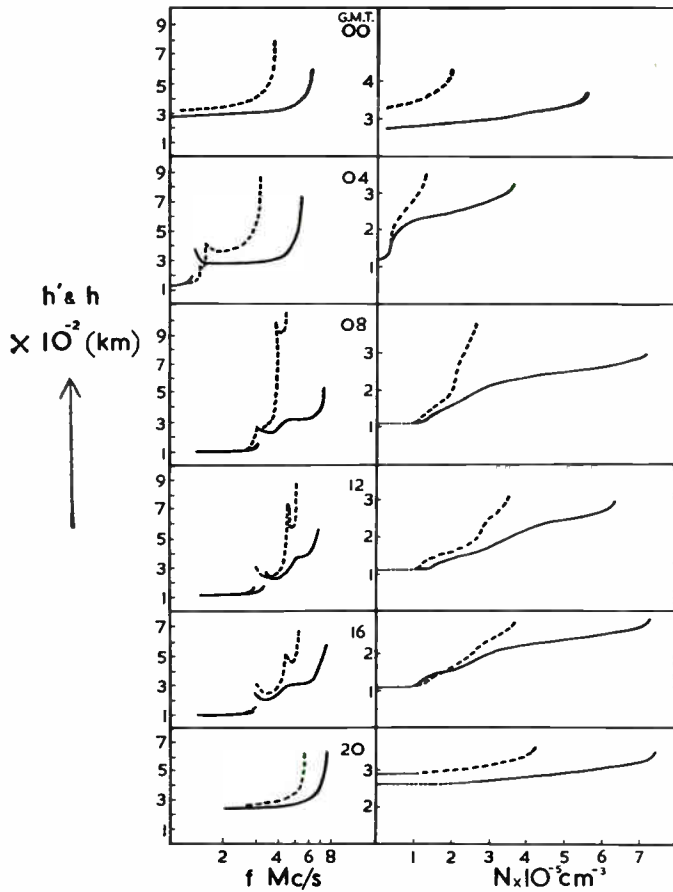

Fig. 5—The left-hand side of the diagram shows  $h'(f)$  curves for July 20, 1950, a quiet day (continuous lines), and for July 25, 1950, a disturbed day (broken lines), taken at Slough. The curves on the right are the corresponding  $N(h)$  profiles.

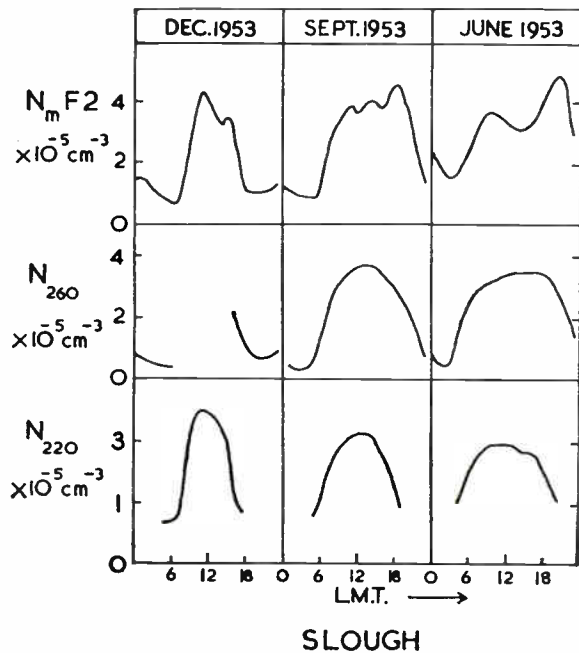

Fig. 7—For ten International Quiet Days in each month, the average variation at Slough of  $NmF_2$ , and of the electron density at 260 and 220 km ( $N_{260}$  and  $N_{220}$ ) in a year of low sunspot number.

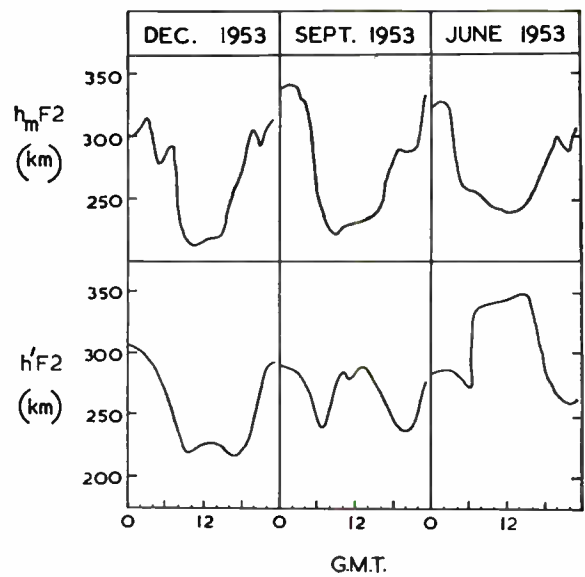

Fig. 6—Average variation of  $hmF_2$  and  $h'F_2$  for ten International Quiet Days in each month at Slough. It is clear that there is little relation between  $h'F_2$  and the height of the peak of the layer.

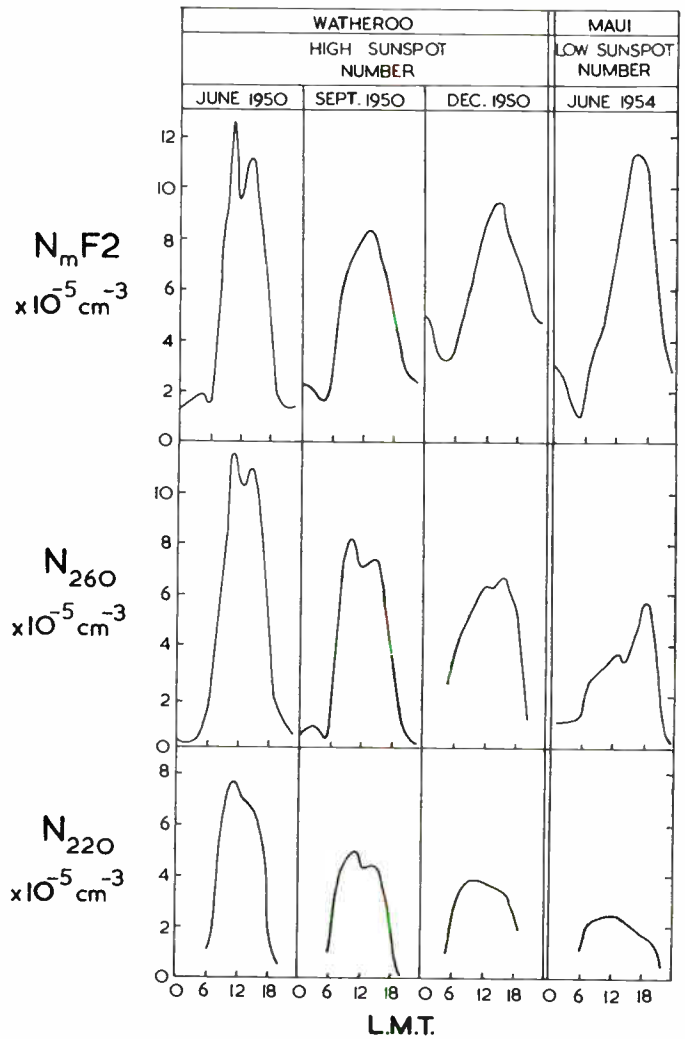

Fig. 8—For ten International Quiet Days in each month, the average variation of  $NmF_2$  and of the electron density at 260 and 220 km ( $N_{260}$  and  $N_{220}$ ). Results obtained for Watheroo in a year of high sunspot number and for Maui in a year of low sunspot number.



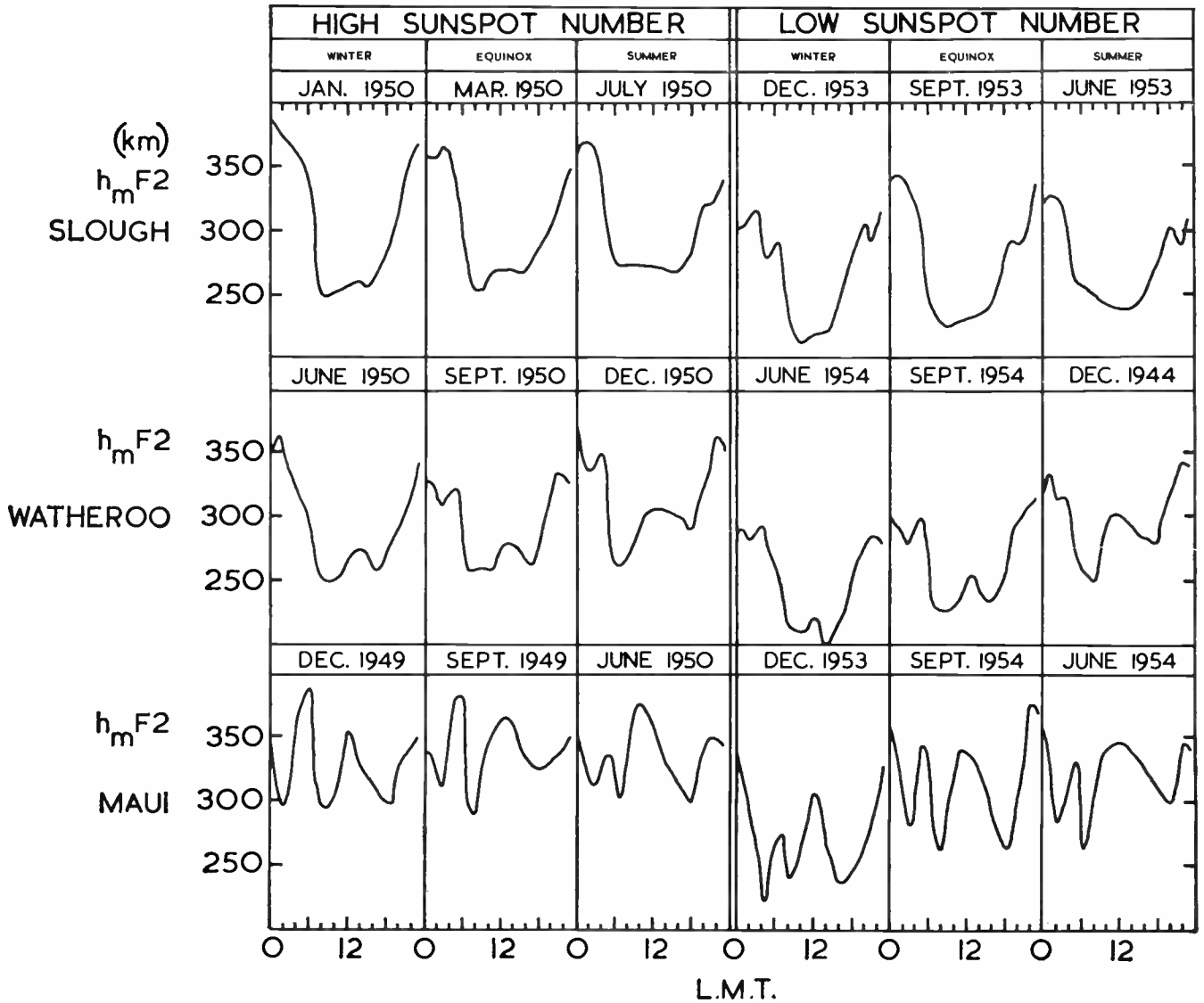

Fig. 9—The average variation of  $hmF_2$  for ten International Quiet Days in each month for three seasons in years of high and low sunspot number at Slough ( $51^{\circ}30'N$ ,  $00^{\circ}36'W$ ), Watheroo ( $30^{\circ}19'S$ ,  $115^{\circ}53'E$ ), and Maui ( $20^{\circ}48'N$ ,  $156^{\circ}30'W$ ).

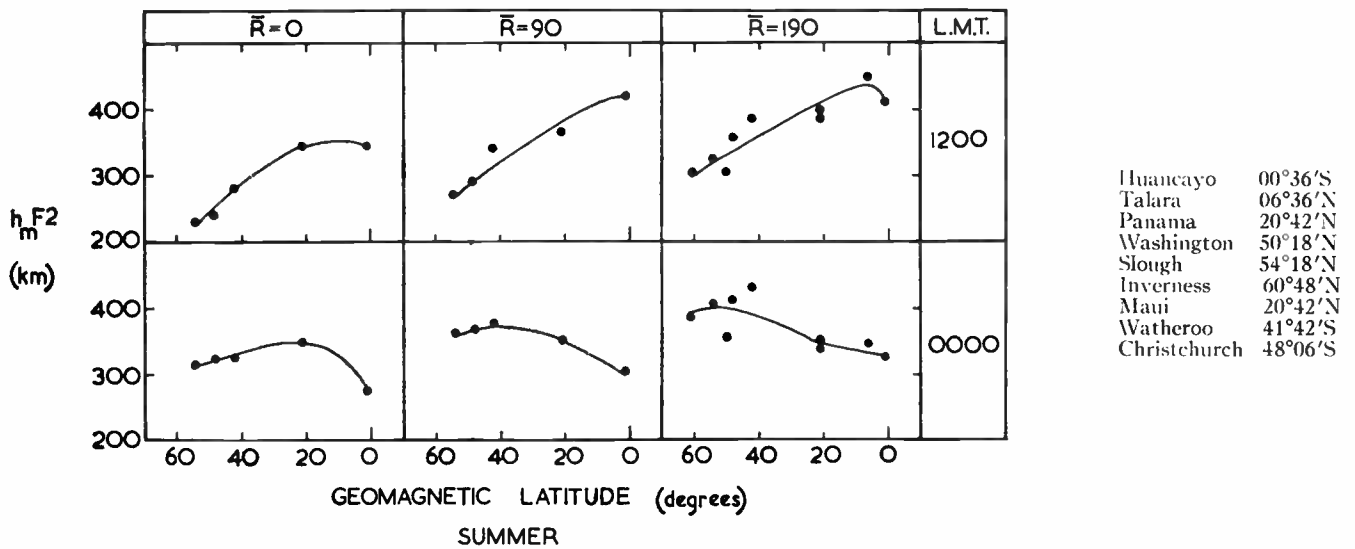

Fig. 10—The variation with geomagnetic latitude of  $hmF_2$  averaged for a summer month at three epochs of the solar cycle. Stations used are listed below. Geomagnetic latitudes are also given.

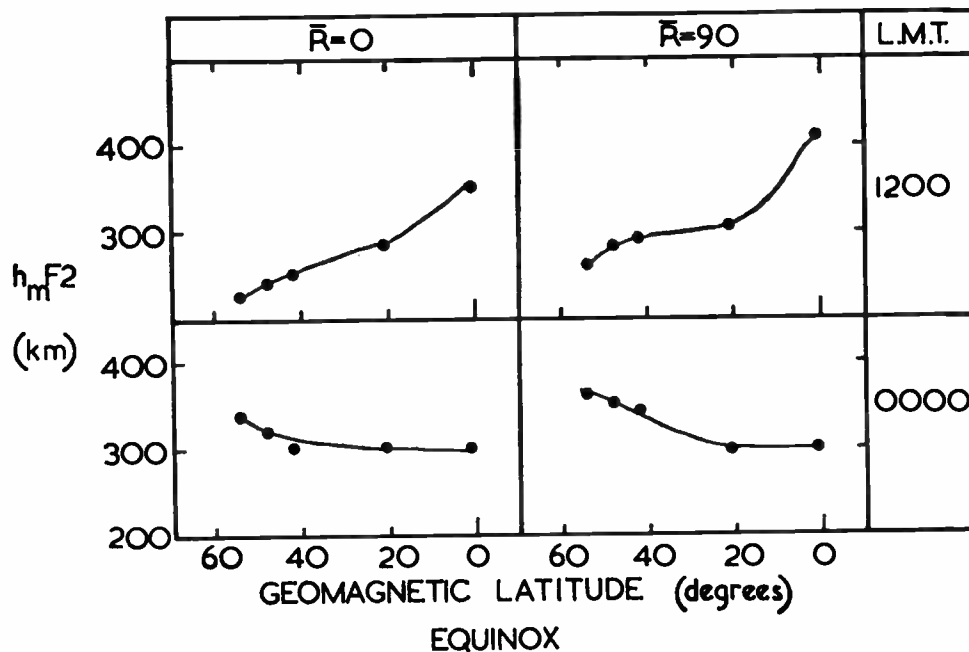

Fig. 11—The variation with geomagnetic latitude of  $h_m F_2$  averaged for an equinox month at two epochs of the solar cycle. Stations and geomagnetic latitudes are given in Fig. 10.

## 7. ACKNOWLEDGMENT

The author is indebted to J. A. Ratcliffe, of the Radio Group of the Cavendish Laboratory, for his help and advice with the writing of this paper.

He wishes to thank Dr. D. H. Shinn for permission to reproduce the coefficients given in Table II(c), and J. E. Titheridge for permission to reproduce the  $N(h)$  profiles of Fig. 2 from his paper [48]. He is grateful to Dr. R. L. Smith-Rose, Director of Radio Research, Department of Scientific and Industrial Research, Slough; Prof. A. H. Waynick and Dr. E. R. Schmerling, of the Pennsylvania State University; J. W. Beagley the Superintendent, G. A. M. King and C. H. Cummack, of the Geophysical Observatory, Christchurch, New Zealand, and A. H. Shapley and members of his group in the Central Radio Propagation Laboratory, National Bureau of Standards, Boulder, Colo., for tables of  $N(h)$  results.

He is also grateful to Mrs. S. A. Croom, J. R. Dumas, Miss D. Mills, and Miss A. R. Robbins of the Cavendish Laboratory for assistance in the preparation of the manuscript and diagrams.

## BIBLIOGRAPHY

### 1. MODEL OR COMPARISON METHODS (A)

#### 1.1. Model or Comparison Methods, No Field

##### 1.1.1. Parabolic, linear and square law layers:

- [1] E. V. Appleton, "Some notes on wireless methods of investigating the electrical structure of the upper atmosphere. I," *Proc. Phys. Soc.*, vol. 41, pp. 43-59; December, 1928.
- [2] ———, "Regularities and irregularities in the ionosphere. 1," Bakerian lecture, *Proc. Roy. Soc. (London) A*, vol. 162, pp. 451-479; October, 1937.
- [3] E. V. Appleton and W. J. G. Beynon, "The application of ionospheric data to radio communication problems," *Proc. Phys. Soc.*, vol. 52, pp. 518-533; July, 1940.

- [4] E. V. Appleton and R. Naismith, "Normal and abnormal region-E ionization," *Proc. Phys. Soc.*, vol. 52, pp. 402-415; May, 1940.
- [5] W. Becker, "The analysis of observations on the ionosphere," *A.E.U.*, vol. 4, pp. 391-400; October, 1950.
- [6] W. J. G. Beynon and J. O. Thomas, "The calculation of the true heights of reflection of radio waves in the ionosphere," *J. Atmos. Terrest. Phys.*, vol. 9, pp. 184-200; 1956.
- [7] H. G. Booker and S. L. Seaton, "Relation between actual and virtual ionospheric height," *Phys. Rev.*, vol. 57, pp. 87-94; January, 1940.
- [8] J. A. Ratcliffe, "A quick method for analysing ionospheric records," *J. Geophys. Res.*, vol. 56, pp. 463-485; December, 1951.
- [9] O. E. H. Rydbeck, "The reflection of electromagnetic waves from a parabolic friction free ionized layer," *J. Appl. Phys.*, vol. 13, pp. 577-581; September, 1942.
- [10] T. Shimazaki, "World-wide daily variations in the height of the maximum electron density in the ionospheric F2 layer," *J. Radio Res. Lab.*, vol. 2, pp. 85-97; January, 1955.

#### 1.1.2. Chapman layers:

- [11] U. C. Guha, "Analysis of virtual height-frequency records," *J. Geophys. Res.*, vol. 54, pp. 355-362; December, 1949.
- [12] J. C. Jaeger, "Equivalent path and absorption in an ionospheric region," *Proc. Phys. Soc.*, vol. 59, pp. 87-96; January, 1947.
- [13] J. A. Pierce, "The true height of an ionospheric layer," *Phys. Rev.*, vol. 71, pp. 698-706; May, 1947.

#### 1.2. Model or Comparison Methods, With Field

- [14] E. Argence and M. Mayot, "A method for the determination of the true heights of ionospheric layers, allowing for the effect of the earth's magnetic field. I. Using an approximation for the refractive index (Ordinary ray)," *J. Geophys. Res.*, vol. 58, pp. 147-165; June, 1953.
- [15] ———, "II. Using the exact value of the refractive index (Ordinary ray)," *J. Geophys. Res.*, vol. 58, pp. 493-496; December, 1953.
- [16] ———, "Determination of the height and semi-thickness of a regular ionospheric layer taking into account the effect of the earth's magnetic field (Ordinary and Extraordinary rays)," *Compt. Rend. (Paris)*, vol. 238, pp. 1721-1723; April, 1954.
- [17] W. Becker, "A method for the routine evaluation of the true distribution of the electron density in an ionospheric layer, from the ionograms of this layer," *A.E.U.*, vol. 10, pp. 207-214; February, 1956.
- [18] F. Mariani, "Electron density in the upper atmosphere and the interpretation of  $h'(f)$  curves," *Ann. Geofis.*, vol. 6, pp. 21-45; January, 1953.



- [19] D. H. Shinn, "The analysis of ionospheric records (Ordinary ray)—I," *J. Atmos. Terrest. Phys.*, vol. 4, pp. 240-254; 1953.
- [20] D. H. Shinn and H. A. Whale, "Group velocities and group heights from the magneto-ionic theory," *J. Atmos. Terrest. Phys.*, vol. 2, pp. 85-105; 1952.

## 2. INTEGRAL EQUATION METHODS (B)

### 2.1. Integral Equation Methods, Analytical Solutions

#### 2.1.1. Neglecting the effect of the earth's field:

- [21] E. V. Appleton, "Some notes on wireless methods of investigating the electrical structure of the upper atmosphere," *Proc. Phys. Soc.*, vol. 42, pp. 321-339; June 15, 1930.
- [22] W. de Groot, "Some remarks on the analogy of certain cases of propagation of electromagnetic waves and the motion of a particle in a potential field," *Phil. Mag.*, vol. 10, pp. 521-540; October, 1930.
- [23] J. M. Kelso, "A procedure for the determination of the vertical distribution of the electron density in the ionosphere," *J. Geophys. Res.*, vol. 57, pp. 357-367; September, 1952. Also, Penn. State Univ. Ionospheric Res. Sci. Rep. No. 19; 1952.
- [24] L. Kraus, "Further discussion of Kelso's paper: on a method for determination of the distribution of electron density in the ionosphere," *J. Geophys. Res.*, vol. 58, pp. 551-553; December, 1953.
- [25] L. A. Manning, "The determination of ionospheric electron distribution," *Proc. IRE*, vol. 35, pp. 1203-1207; November, 1947.
- [26] ———, "Discussion of Kelso's paper: on a procedure for the determination of the vertical distribution of the electron density in the ionosphere," *J. Geophys. Res.*, vol. 58, pp. 117-118; March, 1953.
- [27] Y. Nakata, *Rep. Jap. Res. Radio Wave Propagation*, 1, ref. 29E; 1946.
- [28] C. L. Pekeris, "The vertical distribution of ionization in the upper atmosphere," *Terrest. Mag. Atmos. Elec.*, vol. 45, pp. 205-211; June, 1940.
- [29] O. E. H. Rydbeck, "The propagation of electromagnetic waves in an ionized medium and the calculation of the true height of the ionized layers of the atmosphere," *Phil. Mag.*, vol. 30, pp. 282-293; October, 1940.
- [30] E. R. Schmerling and J. O. Thomas, "The distribution of electrons in the undisturbed  $F_2$  layer of the ionosphere," *Phil. Trans., A*, vol. 248, pp. 609-620; March, 1956.
- [31] D. H. Shinn, "Further remarks on Kelso's paper: a procedure for the determination of the vertical distribution of the electron density in the ionosphere," *J. Geophys. Res.*, vol. 58, pp. 416-418; September, 1953.

#### 2.1.2. Allowing for the effect of the earth's field:

- [32] E. Argence, "Methods of calculating the true heights of the layers of the ionosphere," *Zeit. für Geophys.*, vol. 20, pp. 91-103; 1954.
- [33] J. M. Kelso, "The determination of the electron density distribution of an ionosphere layer in the presence of an external magnetic field," *J. Atmos. Terrest. Phys.*, vol. 5, pp. 11-27; 1954.
- [34] ———, "The calculation of ionospheric electron density distributions," *J. Atmos. Terrest. Phys.*, vol. 10, pp. 103-109; 1957.
- [35] O. E. H. Rydbeck, "Further notes on the electron density distribution of the upper atmosphere," *Terrest. Mag. Atmos. Elec.*, vol. 47, pp. 219-226; September, 1942.
- [36] ———, "A theoretical survey of the possibilities of determining the distribution of the free electrons in the upper atmosphere," *Trans. Chalmers Tech.*, no. 3; 1942.
- [37] E. R. Schmerling, "An easily applied method for the reduction of  $h'(f)$  records to  $N(h)$  profiles including the effects of the earth's magnetic field," Penn. State Univ. Ionospheric Res. Rep. No. 96; August, 1957. Also, *J. Atmos. Terrest. Phys.*, vol. 12, pp. 8-16; August, 1958.
- [38] D. H. Shinn, private communication; 1954.
- [39] C. A. Ventrice and E. R. Schmerling, "Coefficients for the rapid reduction of  $h'(f)$  records to  $N(h)$  profiles without computing aids," to be published.
- [40] H. A. Whale, "Determination of electron densities in the ionosphere from experimental  $h'(f)$  curves," *J. Atmos. Terrest. Phys.*, vol. 1, pp. 244-253; 1951.

### 2.2. Integral Equation Methods, Numerical or Lamination Methods (With Field)

#### 2.2.1. Manual methods:

- [41] K. G. Budden, "A method for determining the variation of electron density with height ( $N(h)$  curves) from curves of equivalent height versus frequency  $h'(f)$ ," *Rep. Cambridge Conf. Ionospheric Phys. (Phys. Soc. London)*, pp. 332-339; 1954.

- [42] J. H. Jackson, "A new method of obtaining the electron density profiles from  $h'(f)$  records," *J. Geophys. Res.*, vol. 61, pp. 107-127; March, 1956.
- [43] G. A. M. King, "Electron distribution in the ionosphere," *J. Atmos. Terrest. Phys.*, vol. 5, pp. 245-246; 1954.
- [44] ———, "Electron distribution in the ionosphere," *J. Atmos. Terrest. Phys.*, vol. 8, pp. 184-185; 1956.
- [45] F. H. Murray and J. B. Hoag, "Heights of reflection of radio waves in the ionosphere," *Phys. Rev.*, vol. 51, pp. 333-341; March, 1937.
- [46] F. H. Murray, "Erratum: heights of reflection of radio waves in the ionosphere," *Phys. Rev.*, vol. 51, p. 779; May, 1937.
- [47] J. E. Titheridge, "The calculation of true and virtual heights of reflection in the ionosphere," 1959.
- [48] ———, "The use of the Extraordinary ray in the analysis of ionospheric records," (In press.)

#### 2.2.2. Machine methods:

- [49] J. Haselgrove, private communication; 1956.
- [50] E. R. Schmerling, "The reduction of  $h'(f)$  records to electron-density-height profiles," Penn. State Univ., Ionospheric Res. Sci. Rep. No. 94; June, 1957.
- [51] J. O. Thomas, J. Haselgrove, and A. R. Robbins, "The electron distribution in the ionosphere over Slough I. Quiet days," *J. Atmos. Terrest. Phys.*, vol. 12, pp. 46-56; 1958.
- [52] J. O. Thomas and M. D. Vickers, "The conversion of ionospheric virtual height-frequency curves to electron density-height profiles," *DSIR Radio Res. Spec. Rep. No. 28*; 1958.

## 3. "VALLEY" AMBIGUITY

- [53] J. Hollingworth, "The structure of the ionosphere," *Proc. Phys. Soc.*, vol. 47, pp. 843-851; September, 1935.
- [54] L. A. Manning, "The reliability of ionospheric height determination," *Proc. IRE*, vol. 37, pp. 599-603; June, 1949.
- [55] W. R. Piggott, "On the interpretation of the apparent ionization distribution in the ionosphere," *J. Atmos. Terrest. Phys.*, vol. 5, pp. 201-210; 1954.

## 4. GROUP REFRACTIVE INDEX CALCULATIONS, ETC.

- [56] E. V. Appleton, "Wireless studies of the ionosphere," *J. IEE*, vol. 71, pp. 642-650; October, 1932.
- [57] R. R. Bajpai and K. B. Mathur, "Group velocity curves for radio-wave propagation in the ionosphere," *Indian J. Phys.*, vol. 11, pp. 165-175; July, 1937.
- [58] W. Becker, "Tabulations of group velocities of Ordinary echoes at vertical incidence in the ionosphere," *A.E.U.*, vol. 11, pp. 166-172; December, 1957.
- [59] G. Goubau, "Connection between the apparent and the true height of the ionosphere allowing for magnetic bi-refringence," *Hochfreq. u. Elek.*, vol. 44, pp. 17-23; 1934.
- [60] ———, "The connection between virtual and true height in the ionosphere," *Hochfreq. u. Elek.*, vol. 44, pp. 138-139; 1934.
- [61] ———, "On the dispersion theory of the ionosphere," *Hochfreq. u. Elek.*, vol. 45, pp. 179-185; 1935.
- [62] G. Millington, "Attenuation and group retardation in the ionosphere," *Proc. Phys. Soc.*, vol. 50, pp. 561-580; July, 1938.
- [63] D. H. Shinn, "Tables of group refractive index in the ionosphere for the Ordinary ray," *Rep. Cambridge Conf. Ionospheric Phys. (Phys. Soc. London)*, pp. 402-406; 1954.
- [64] M. Taylor, "The Appleton-Hartree formula and dispersion curves for the propagation of electromagnetic waves through an ionized medium in the presence of an external magnetic field," *Proc. Phys. Soc.*, vol. 45, pp. 245-265; March, 1933.
- [65] A. H. de Voogt, "The analysis of ionospheric reflections," *Tijds. Nederland Radiogen.*, vol. 13, pp. 183-195; November, 1948, and vol. 14, pp. 73-85; May, 1949.
- [66] H. A. Whale and J. P. Stanley, "Group and phase velocities from the magneto-ionic theory," *J. Atmos. Terrest. Phys.*, vol. 1, pp. 82-94; 1950.

## 5. RESULTS OF TRUE HEIGHT ANALYSES

- [67] S. A. Croom, A. R. Robbins, and J. O. Thomas, "Tables of ionospheric electron density on International Quiet Days—Maui, Watheroo and Huancayo," Ser. B, Nos. 2-4, Radio Group, Cavendish Lab., Cambridge, Eng.; 1959. (In press.)
- [68] D.S.I.R. (Eng.) "Ionospheric  $N(h)$  profiles," Tables for selected days in each month during the I.G.Y. at Slough, Inverness, Singapore, Ibadan and Port Stanley, Bulletins issued by Radio Res. Sta., Slough, Eng.; 1958-1959.
- [69] R. A. Duncan, "Computations of electron density distributions in the ionosphere making full allowance for the geomagnetic field," *J. Geophys. Res.*, vol. 63, pp. 491-499; September, 1958.

- [70] G. A. M. King and C. H. Cummack, "Electron distribution in the ionosphere," *J. Atmos. Terrest. Phys.*, vol. 8, pp. 270-273; 1956.
- [71] R. W. Knecht and D. W. Schlitt, "Early results from the equatorial close-spaced chain of ionospheric vertical sounding stations," NBS Boulder Labs. Rep. No. 5587; 1958.
- [72] J. A. Ratcliffe, "Some regularities in the  $F_2$  region of the ionosphere," *J. Geophys. Res.*, vol. 56, pp. 487-507; December, 1951.
- [73] E. R. Schmerling, "Ionospheric electron densities for Washington, Panama, Talara and Huancayo" (tables for each month during the I.G.Y.), Penn. State Univ. Ionospheric Res. USNC-IGY-Project No. 6.9; 1958-1959.
- [74] E. R. Schmerling and J. O. Thomas, "Tables of  $F_2$  layer electron density on International Quiet Days—Slough, Watheroo, Huancayo," Ser. A, No. 1, Radio Group, Cavendish Lab., Cambridge, Eng.; 1955.
- [75] R. L. Smith-Rose, "Electron density profiles in the ionosphere during the I.G.Y.," *J. Geophys. Res.*, vol. 63, pp. 570-572; September, 1958.
- [76] J. O. Thomas and A. R. Robbins, "Tables of  $F_2$  layer electron density on International Quiet Days—Port Stanley, Maui," Ser. A, No. 2, Radio Group, Cavendish Lab., Cambridge, Eng.; 1955.
- [77] J. O. Thomas, J. Haselgrove, and A. R. Robbins, "Tables of ionospheric electron density, Slough (England)," Ser. B, No. 1, Radio Group, Cavendish Lab., Cambridge, Eng.; 1957.
- [78] J. O. Thomas and A. R. Robbins, "The electron distribution in the ionosphere over Slough. II—Disturbed days," *J. Atmos. Terrest. Phys.*; 1958. (In press.)
- [79] G. R. White and I. S. Wachtel, "True heights of the  $F_2$  layer," *J. Geophys. Res.*, vol. 54, pp. 239-242; September, 1949.
- [80] J. W. Wright, T. E. van Zaudt, and G. H. Stonehocker, "Data on ionospheric electron densities—I tables and isoionic maps for selected times in October 1957," NBS Boulder Labs. Rep. No. 5590; 1958.
- [81] W. Becker, "The calculation of the true distribution of the electron density in the ionosphere—I," *A.E.U.*, vol. 9, pp. 277-284; March, 1955.
- [82] G. Grawert and H. Lassen, "The interpretation of ionospheric observations," *Z. angew. Phys.*, vol. 6, pp. 136-143; 1954.
- [83] G. A. M. King, "Relation between virtual and actual heights in the ionosphere," *J. Atmos. Terrest. Phys.*, vol. 11, pp. 209-222; 1957.
- [84] A. K. Saha, "On the determination of electron density distribution in the ionospheric regions from  $h'(f)$  curves," *Ind. J. Phys.*, vol. 30, pp. 464-479; September, 1956.
- [85] J. W. Wright, R. W. Knecht, and K. Davies, "Methods of true-height analysis," *Ann. IGY*, vol. 3, pp. 62-68; 1957.

## 7. MISCELLANEOUS

- [86] A. J. Lyon and A. J. C. Moorat, "Accurate height measurements using an ionospheric recorder," *J. Atmos. Terrest. Phys.*, vol. 8, pp. 309-317; 1956.
- [87] G. H. Munro and L. H. Heisler, "Cusp type anomalies in variable frequency ionospheric records," *Aust. J. Phys.*, vol. 9, pp. 343-358; September, 1956.
- [88] J. C. Seddon, A. D. Pickar, and J. E. Jackson, "Continuous electron density measurements up to 200 km," *J. Geophys. Res.*, vol. 59, pp. 513-524; December, 1954.
- [89] J. M. Watts and J. S. Brown, "Some results of sweep-frequency investigation in the low frequency band," *J. Geophys. Res.*, vol. 59, pp. 71-86; March, 1954.

## OTHER REFERENCES USED IN THE TEXT

- [90] B. Landmark and F. Lied, "Note on a 'QL-QT' transition level in the ionosphere," *J. Atmos. Terrest. Phys.*, vol. 10, pp. 114-116; 1957.
- [91] J. Savitt, "Recombination and attachment in the  $F$ -region during the eclipse of May 20, 1947," *J. Geophys. Res.* vol. 55, pp. 385-394; December, 1950.
- [92] J. C. Seddon and J. E. Jackson, "Absence of bifurcation in the  $E$ -layer," *Phys. Rev.*, vol. 97, pp. 1182-1183; February, 1955.

## 6. SURVEY ARTICLES

- [81] W. Becker, "The calculation of the true distribution of the elec-



# Motions in the Ionosphere\*

C. O. HINEST†

**Summary**—The ionosphere, even in its “undisturbed” state, is constantly in motion. Its charged and uncharged constituents may travel together or independently, while irregularities in the distribution of charge may take a different course again. The pertinent observational data are extensive and, in some cases, conflicting; their interpretation is seldom direct. The theoretical factors affecting that interpretation are becoming clear, though in some cases their areas of relevance are still subject to divergent opinions.

An attempt is made here to bring into focus the theoretical factors themselves, to record their bearing on the observations wherever it has been established, and to suggest paths of future progress wherever it has not. Details of observational results and theoretical developments are largely suppressed, and with them the conflicts and discrepancies which, however real, would obscure the presentation of the principles involved.

## I. INTRODUCTION

MOTION was an essential feature of the ionosphere as first postulated, and even today it provides many of the challenging aspects of ionospheric study.<sup>1-5</sup> A wide variety of motions has now been revealed, and virtually all of these require examination on a world-wide basis to insure proper interpretation. The extensive supply of IGY data, if analyzed as assiduously as it has been accumulated, may be expected to resolve many of the problems which have so far been encountered.

The purpose of the present paper is to outline the state of the art at the moment: to describe, against a background of past successes, the points on which clarification is most urgently needed, and to indicate in some cases the paths by which it may be achieved. No attempt will be made to cover the extensive literature in its entirety nor to provide a detailed collation of the findings it contains; only the major features and broad aspects of the subject will be treated.

A background of conceptual thought on motions in the upper atmosphere undoubtedly exists in us all, stemming from our direct experience with the lower levels in which we dwell. However, it has become well-recognized in the past two decades that such an extrapolation is probably invalid when extended into ionospheric regions. Electromagnetic forces there begin to

dominate over the collisional forces which rule motion in the denser atmosphere below, and even the immediate sources of energy input tend to differ markedly. Indeed, with two important exceptions, there are no established causal connections between motions within the ionosphere and those beneath it. Caution has been advised<sup>6</sup> against the acceptance of this conclusion as final, however, and some studies suggest the possibility of closer links than had previously been supposed.<sup>7</sup>

Of the two known exceptions, the first will receive only brief attention. It is the motion of rotation about the earth's axis—a motion which is so commonplace as to be frequently overlooked. Some remarks on this subject are in order if only for the sake of completeness, and they will be presented in Section II. It will be noted there that important problems in the field still remain; but, since these are not obviously of direct consequence to the balance of the paper, they will be treated only superficially.

On the other hand, a fairly thorough outline must be given of the second exception: the atmospheric tides which daily sweep round the world and cyclically disturb all levels. Not only are they important in themselves, as global events, but evidence is accumulating which demonstrates their direct influence on more localized observations of motion. If a composite picture of the latter is to be achieved, then, it will probably require a proper understanding of the whole tidal process. Such an understanding now appears to be near, and on some points to have been reached. The varied history and present status of tidal theory will be outlined in Section III.

The observational detection of tidal motion is by no means straightforward. But three types of observation do exist which, if interpreted directly or with the aid of accepted theory, yield an apparently consistent picture of tides up to the 110–120 km level. That picture will be presented in Section IV. Other pertinent observations, and still others whose pertinence has been guessed but not yet established, will be discussed in Section V.

There remain two types of observed motion whose relation to the atmospheric tides is remote, and whose

\* Original manuscript received by the IRE, November 10, 1958. This work was performed under project PCC No. D 48-95-11-01.

† Radio Phys. Lab., Defence Res. Telecommun. Est., Defence Res. Board, Ottawa, Can.

<sup>1</sup> S. K. Mitra, “The Upper Atmosphere,” The Asiatic Society, Calcutta, India, 2nd ed.; 1952.

<sup>2</sup> Internatl. Union of Geodesy and Geophys. Info. Bull., No. 6, pp. 299–336; July, 1954.

<sup>3</sup> “The Physics of the Ionosphere,” The Physical Society, London, Eng., pp. 88–211; 1955.

<sup>4</sup> K. Weekes, ed., “Polar Atmosphere Symposium; Part II, Ionospheric Section,” Pergamon Press, London, Eng.; 1957.

<sup>5</sup> W. J. G. Beynon and G. M. Brown, eds., “The measurement of ionospheric drifts,” *Ann. IGY*, vol. 3, pt. 3, Pergamon Press, London, Eng.; 1957.

<sup>6</sup> S. Chapman, “Some Causes of Winds in the Ionosphere,” Internatl. Union of Geodesy and Geophys. Info. Bull., No. 6, pp. 303–311; July, 1954.

<sup>7</sup> That a continuous variation of wind occurs as the height increases has been well established, though the causes of the variation are yet unknown. Compare the results quoted by the following:

L. G. H. Huxley, “The measurement of ionospheric drifts,” *Ann. IGY*, vol. 3, pt. 3, Pergamon Press, London, Eng.; 1957.

W. W. Kellogg and G. F. Schilling, “A proposed model of the circulation in the upper stratosphere,” *J. Meteorol.*, vol. 8, pp. 222–230; August, 1951.

R. J. Murgatroyd, “Winds and temperatures between 20 km and 100 km—a review,” *Quart. J. Roy. Meteorol. Soc.*, vol. 83, pp. 417–458; October, 1957.

existence is probably dependent on quite different processes. They will be discussed in Sections VI and VII. Finally, in Section VIII, the principal conclusions of the present paper will be summarized.

## II. ATMOSPHERIC ROTATION

It seems to be generally agreed that the upper atmosphere rotates with the earth,<sup>1</sup> but the reason for this belief is not particularly clear. The usual arguments, based on viscosity, would lead to quite a different conclusion if extrapolated to heights where the atmosphere interacts with the interplanetary (coronal) gas. The atmosphere rotates with the earth (angular velocity  $\Omega$ ) at the earth's surface ( $r=r_0$ ), but if it were prevented from rotating at some greater distance ( $r=r_1$ ), then its steady-state velocity under a uniform viscous influence would be

$$\mathbf{u} = \Omega \times r(r^{-3} - r_1^{-3})(r_0^{-3} - r_1^{-3})^{-1}. \quad (1)$$

This differs markedly in form from the rigid-rotation result

$$\mathbf{u} = \Omega \times r \quad (2)$$

even when  $r_1 \rightarrow \infty$ , though the difference in magnitude is not very large if  $r \approx r_0 \ll r_1$ .

It may be objected that viscosity loses its formal meaning at great heights, but this would merely beg the question. Moreover, the high conductivity of the outer atmosphere introduces an intense inductive viscosity which cannot be argued away. The outer atmosphere would be held almost rigidly by the interplanetary gas, if the geomagnetic field should penetrate the latter, and the effective value of  $r_1$  might be reduced considerably as a result. Appreciable discrepancies between (1) and (2) might then be expected even at heights of 100 km.

In the absence of any recognized indication of such discrepancies, which would appear as a westward wind increasing with height in the ionosphere, an alternative description must be considered more acceptable. According to it,<sup>8,9</sup> the geomagnetic field is confined within the earth's outer atmosphere by the effects of strong currents induced in a transitional layer. The outer atmosphere is, then, dynamically separated from the external gas and free to partake of rigid rotation with the earth and lower atmosphere. The transitional layer, which probably lies within ten earth radii, is expected to be unstable, and a variety of disturbances may be thought to originate at it. Theoretical and experimental investigations of the regions concerned should be pursued.

One question arises immediately if the foregoing picture is adopted: why should it, rather than the preceding

one, be found in practice? The answer undoubtedly lies in the relative values of some effective cohesive force at the outer boundary and at the lower levels where shearing would otherwise occur, but the relevant criteria are not easy to imagine. When established, they should contain new information about the outer reaches of the atmosphere.

It may even be that the two descriptions will stand together. The second one, though by no means fully developed, implies the development of "horns" descending from the outer boundary along geomagnetic field lines to auroral regions,<sup>8</sup> analogous to the "horns" which have been pictured in one major study of geomagnetic storm effects.<sup>10</sup> If the analogy is complete, then field lines originating at latitudes above the auroral belt are in fact connected through to the interplanetary gas, and the upper atmosphere which they traverse may once again be held in place by inductive viscosity. Eq. (1) would apply, and the effective  $r_1$  might be only fractionally greater than  $r_0$ . Shearing across the auroral belt would then be expected, as would further effects related to the asymmetry of the auroral zone with respect to the axis of rotation.

Finally, it should be noted that any motion in the presence of the geomagnetic field, including rigid rotation, implies the existence of inductive electromotive forces (emf's). These emf's can be offset by an appropriate polarization field, but an extremely fine balancing must be established if residual effects are to be negligible.<sup>11</sup> It is only when such effects can be neglected that one is justified in ignoring the rotation upon adopting a rotating coordinate system in subsequent studies. It is difficult to see how the necessary space-charge distributions can be maintained, in view of the large diurnal variations which occur in the ionization densities, without the flow of strong currents and resultant winds. If an asymmetric nonrotating polar region exists the polarization fields established outside of it could have further important effects.

While these questions provide interesting material for speculation, in their present state they cannot be brought to bear directly on the major problems of the subsequent sections. Therefore they will be abandoned at this point, to be recalled only in passing reference at later stages.

## III. TIDAL MOTIONS

The history of atmospheric tidal studies extends over a period of two centuries and more.<sup>12</sup> Early interest centered on the pressure changes which might be expected, and on the regular oscillations which were in fact detected in barometric recordings. But modern in-

<sup>10</sup> S. Chapman and V. C. A. Ferraro, "A new theory of magnetic storms; part I, the initial phase (continued)," *Terrest. Mag. Atmos. Elec.*, vol. 36, pp. 171-186; September, 1931.

<sup>11</sup> H. Alfvén, "Cosmical Electrodynamics," Clarendon Press, Oxford, Eng.; 1950.

<sup>12</sup> M. V. Wilkes, "Oscillations of the Earth's Atmosphere," Cambridge University Press, Cambridge, Eng.; 1949.

<sup>8</sup> J. W. Dungey, "Electrodynamics of the Outer Atmosphere," *Ionospheric Res. Lab., Pennsylvania State Univ., State College, Pa., Sci. Rep.*, no. 69; September, 1954.

<sup>9</sup> J. W. Dungey, "Electrodynamics of the outer atmosphere," in "The Physics of the Ionosphere," The Physical Society, London, Eng., pp. 229-236; 1955.

terest in the tidal phenomenon received its greatest impetus from a suggestion put forward less than a century ago,<sup>13</sup> to the effect that certain magnetic variations which had been discovered were an indirect manifestation of the tidal motions. The connecting link was postulated to be an electrically conducting region of the upper atmosphere—a region now recognized as the ionosphere—in which electrical currents would be induced by a dynamo process involving the atmospheric tides and the main geomagnetic field.

This suggestion was developed into a fairly satisfactory mathematical theory some fifty years ago,<sup>14</sup> but it was subsequently confronted with a quantitative discrepancy when direct measurements of ionospheric parameters became available. The last few decades have seen important advances in the study of tidal oscillations and in the understanding of ionospheric behavior, which in combination appear to remove the major difficulties of the past. A comprehensive theory now seems to be close at hand.

It will be useful to review briefly the two principal developments which lead to this optimistic view, for the elements they contain are of direct concern to any further discussion of motions in the ionosphere.

To begin, it should be remarked that the solar semidiurnal component of pressure variation greatly exceeds the lunar semidiurnal component, although the tide-producing gravitational force of the moon is nearly twice that of the sun. This finding could be explained qualitatively if the solar variation were dominated by thermal rather than gravitational effects, but a further problem would then arise: the solar semidiurnal tide (so-called) exceeds the solar diurnal tide even though the diurnal component of the temperature variation is predominant.<sup>15</sup> A possible solution to this problem was proposed some seventy-five years ago<sup>16</sup> and was based on the postulate that the atmosphere has a natural mode of oscillation whose period is close to 12 hours. A resonant response to any exciting agency having that period could then be anticipated. Following an initial reverse,<sup>17</sup> and a subsequent reorientation of the theoretical approach,<sup>18,19</sup> a satisfactory "resonance theory" was finally

developed little more than a decade ago.<sup>20</sup>

The physical picture it provides is this. Tidal energy is supplied to the atmosphere in greatest quantity at the lowest, densest regions. The diurnal component propagates upwards as a modified pressure wave, until it reaches regions of relatively high kinematic, eddy, or inductive viscosity. There, at heights of 100–300 km, the tidal motion is damped to inappreciable magnitude. The semidiurnal components (lunar and solar) propagate similarly, but, with their shorter periods, they are strongly reflected at lower heights (55–100 km) by a region of diminishing, low temperature. The reflected disturbances return to the ground and suffer further reflection there. They are, in fact, effectively trapped and multiply reflected within the lowest 60 or 70 km of the atmosphere. Standing waves are established whose amplitudes depend markedly on the relative phases at successive reflections, and a resonant response can be achieved under suitable circumstances. It appears that such a response does in fact obtain in the case of the solar semidiurnal variation, and that the latter is accordingly magnified greatly in comparison with the other solar components and with the nonresonant lunar semidiurnal component.

This conclusion, which is based on a detailed analysis,<sup>20</sup> establishes with near certainty the validity of the resonance hypothesis. It also reopens the question of the origin of the solar semidiurnal variation, since the estimated amplification factor is comparable to that which the observations would demand of a purely gravitational theory. A final decision, if one is indeed possible, will most likely be reached by avoiding the complications of resonance entirely—by comparing the gravitational and the thermal semidiurnal tides which would have been expected in the absence of resonance, the estimates being determined from the lunar gravitational tides on the one hand and from the solar 24-hour (and perhaps 8-hour) tides on the other. The conversion coefficients required for this process would not be subject to the large sources of error which are implicit in the estimation of a resonant response. For the present, however, it will be sufficient to note that indirect arguments suggest strongly that the part played by thermal effects is quite significant, whether dominant or not.<sup>21</sup>

The development of the resonance theory to its present state produced an unexpected secondary result which is of major concern to the present review. It became apparent, contrary to previous belief, that the amplitude of the tidal oscillations would in general increase with height, at such a rate as to maintain a nearly constant flow of energy in spite of the decreasing density.<sup>19,20</sup> Amplifications of 50 or 100 (relative to ground) would be attained even before the reflecting regions

<sup>20</sup> K. Weekes and M. V. Wilkes, "Atmospheric oscillations and the resonance theory," *Proc. Roy. Soc. (London) A*, vol. 192, pp. 80–99; December, 1947.

<sup>21</sup> S. Chapman, "The semidiurnal oscillation of the atmosphere," *Quart. J. Roy. Meteorol. Soc.*, vol. 50, pp. 165–193; July, 1924.

<sup>13</sup> B. Stewart, "Terrestrial Magnetism," *Encyclopaedia Britannica*, Chicago, Ill., 9th ed.; 1882.

<sup>14</sup> A. Schuster, "The diurnal variation of terrestrial magnetism," *Phil. Trans. Roy. Soc. (London) A*, vol. 208, pp. 163–204; April, 1908.

<sup>15</sup> It is interesting to note that the diurnal thermal input, acting in conjunction with the semidiurnal motion, may actually control the period of the earth's rotation. See the following:

E. R. Holmberg, "A suggested explanation of the present value of the velocity of rotation of the earth," *Monthly Notices Roy. Astron. Soc. Geophys. Suppl.*, vol. 6, pp. 325–330; September, 1952.

<sup>16</sup> W. Thomson (Lord Kelvin), "On the thermodynamic acceleration of the earth's rotation," *Proc. Roy. Soc. Edinburgh*, vol. 11, pp. 396–405; January, 1882.

<sup>17</sup> G. I. Taylor, "Waves and tides in the atmosphere," *Proc. Roy. Soc. (London) A*, vol. 126, pp. 169–183; December, 1929 (printed 1930).

<sup>18</sup> G. I. Taylor, "The oscillation of the atmosphere," *Proc. Roy. Soc. (London) A*, vol. 156, pp. 318–326; August, 1937.

<sup>19</sup> C. L. Pekeris, "Atmospheric oscillations," *Proc. Roy. Soc. (London) A*, vol. 158, pp. 650–671; February, 1937.



were reached. The upwards flow of energy could not remain constant in those regions of course, but it would not diminish totally nor even abruptly. Some leakage would continue on through, with gradually diminishing strength, and would emerge finally into the freely propagating region above. In contrast to first expectations, the upwards flow of tidal energy there would require a downwards progression of phase,<sup>20,22</sup> so the phase angle<sup>23</sup> decreases with increasing heights. The amplitude of oscillation would resume its upwards increase, however, and so continue until dissipative effects set in. The height variation of amplitude and phase angle for a typical assumed temperature profile would, in the absence of dissipation, have the form depicted in Fig. 1.

It seems necessary to suppose that some type of damping does occur in the region below 120 km, at least in the case of the solar semidiurnal variations, for otherwise the "perturbation" pressure variations would tend towards 100 per cent. The actual mechanism of dissipation is important, for it may operate selectively against certain modes and so alter appreciably the relative magnitudes of the various tidal components.

But before absorption is discussed any further, it will be useful to review the second major development which was noted above. This is concerned with the absolute amplitude of the geomagnetic variations, and with the difficulty of reconciling that amplitude with estimated tidal velocities and ionospheric conductivities.

The magnetic effects were simply too strong. The discrepancy was extreme before the amplification of velocity with height was appreciated, and even with this amplification taken into account it appeared to exceed the limits of error.<sup>24</sup>

The difficulty can be discussed as an effect of the main geomagnetic field, which renders the conductivity of the ionosphere anisotropic above heights of 80 km or so.<sup>1</sup> The "longitudinal conductivity" ( $\sigma_0$ ), measured along the field, is unchanged by the presence of the field, and it would have been sufficient to provide the required currents in the lower *E* region. But much of the current flow was necessarily oblique and nearly perpendicular to the geomagnetic field, so it appeared that the transverse components—the "Pederson conductivity" ( $\sigma_1$ ) and the "Hall conductivity" ( $\sigma_2$ )—would be of more direct concern. Neither was sufficient.

Then it became apparent, in quite a different con-

<sup>22</sup> M. L. White, "Gravitational and thermal oscillations in the earth's upper atmosphere," *J. Geophys. Res.*, vol. 61, pp. 489-499; September, 1956.

<sup>23</sup> "Phase angle" is to be considered here as the angle  $\phi$  which appears in a variation of the form  $A \cos(\omega t - \phi)$ . It is therefore distinct from the "phase" proper,  $\omega t - \phi$ , and its variation with height is opposite in sense to the variation of the phase. It has the advantage, however, that it gives directly the "phase time,"  $\phi/\omega$ , when a maximum value of  $A \cos(\omega t - \phi)$  is attained. The term "phase" has been used variously in the literature for  $\omega t - \phi$ ,  $\phi$ ,  $-\phi$ ,  $\phi + \pi/2$ ,  $-\phi - \pi/2$ , and  $\phi/\omega$ , thereby making comparisons difficult. The adoption of some clear convention, perhaps that indicated here, would be of great value in further studies.

<sup>24</sup> W. G. Baker and D. F. Martyn, "Electric currents in the ionosphere; part I, the conductivity," *Phil. Trans. Roy. Soc. (London) A*, vol. 246, pp. 281-294; December, 1953.

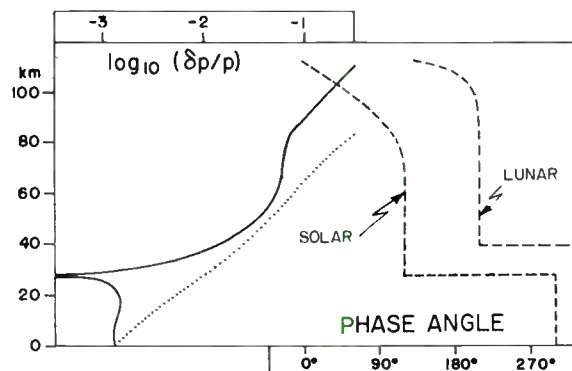

Fig. 1—Height variation of amplitude (solid line) and phase angle<sup>23</sup> (broken lines) in semidiurnal tides.<sup>12,20</sup> The amplitude scale shown applies to the solar component; the variation for the lunar component is similar, but the absolute value is diminished by a factor of 10 or more. The dotted curve represents the variation which would have occurred, had the energy flow been exactly constant in height for the assumed atmosphere. Zero phase angle corresponds to the time of (solar or lunar) transit; maximum pressure is taken to occur at 1000 and 2200 solar hours, 0100 and 1300 lunar hours, local time.<sup>29</sup>

text,<sup>25</sup> that intense polarization fields can be established by the currents in suitable circumstances, and that these fields can play a more important part than the original induction emf's in determining the ultimate pattern and strength of current flow. They can, in fact, lead to a substantial increase in the "effective conductivity" which relates the composite current to the primary emf, and values as high as the "Cowling conductivity" ( $\sigma_3 \equiv \sigma_1 + \sigma_2^2/\sigma_1$ ) could sometimes be produced. Such values, even if only partially achieved, would be sufficient for the dynamo theory. Their relevance to that theory was postulated a decade ago,<sup>26</sup> and established in essence by a number of subsequent investigations.<sup>21,27-29</sup>

These and related investigations<sup>30</sup> differ appreciably from one another in the types of complication they take into account, and they reveal a variety of interesting features worthy of further study, but they suffer from a common defect which also merits examination. They all treat the ionosphere as a thin spherical shell, or perhaps as a series of such shells, and not as the extended plasma which it is. The approximations involved are not always convincing, and those concerning vertical currents and vertical gradients are particularly suspect. It is unlikely

<sup>25</sup> T. G. Cowling, "The electrical conductivity of an ionised gas in the presence of a magnetic field," *Monthly Notices Roy. Astron. Soc.*, vol. 93, pp. 90-98; November, 1932 (printed 1933).

<sup>26</sup> D. F. Martyn, "Electrical conductivity of the ionospheric D-region," *Nature*, vol. 162, pp. 142-143; July, 1948.

<sup>27</sup> M. Hirono, "A theory of diurnal magnetic variations in equatorial regions and conductivity of the ionosphere E region," *J. Geomagnet. Geoelec.*, vol. 4, pp. 7-21; April, 1952.

<sup>28</sup> W. G. Baker, "Electric currents in the ionosphere; part II, the atmospheric dynamo," *Phil. Trans. Roy. Soc. (London) A*, vol. 246, pp. 295-305; December, 1953.

<sup>29</sup> J. A. Fejer, "Semidiurnal currents and electron drifts in the ionosphere," *J. Atmos. Terrest. Phys.*, vol. 4, pp. 184-203; December, 1953.

<sup>30</sup> An extensive series of papers by Japanese workers should be noted in this connection. Of most immediate interest here is the paper by:

H. Maeda, "Horizontal wind systems in the ionospheric E region deduced from the dynamo theory of the geomagnetic Sq variation; part III," *J. Geomagnet. Geoelec.*, vol. 9, no. 2, pp. 86-93; 1957.

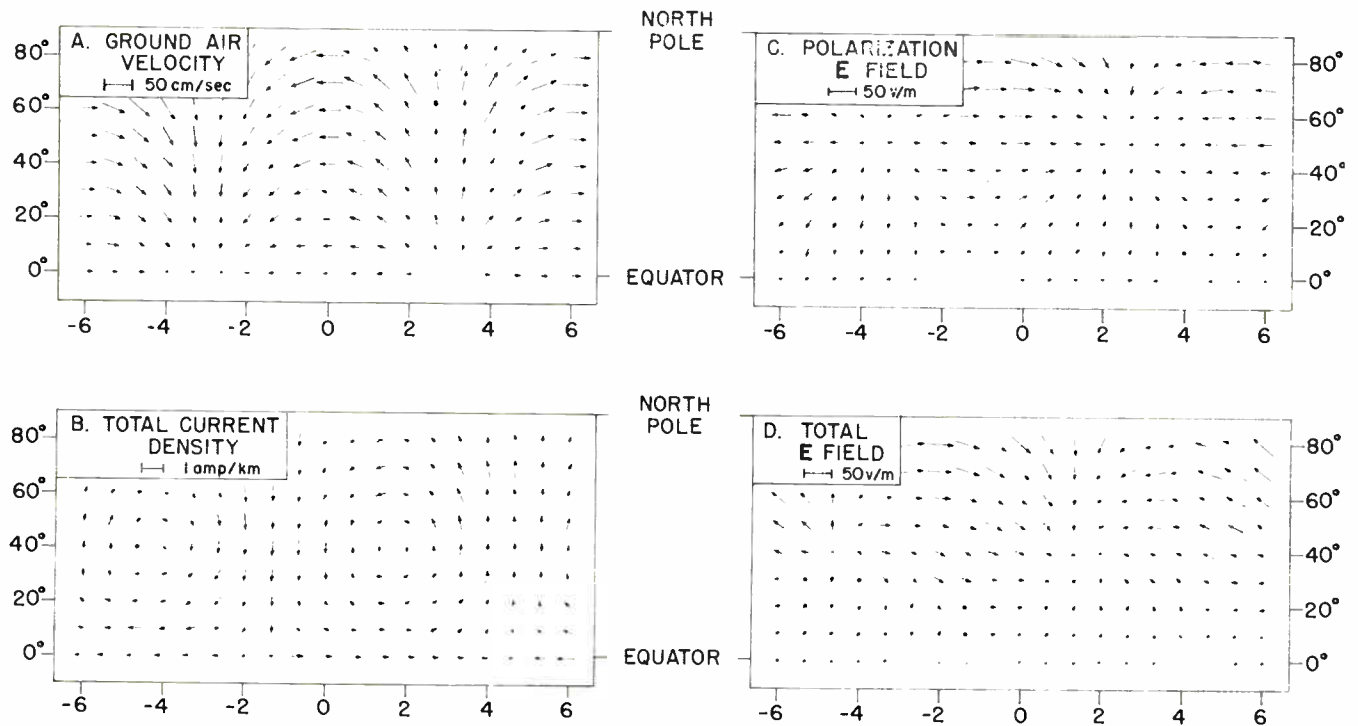

Fig. 2—Patterns of winds, currents, and horizontal electric fields in the dynamo theory of semidiurnal geomagnetic variations.<sup>29</sup> The winds shown, and the other vectors deduced, are based on the winds derived for the solar component at ground level. The horizontal scale measures hours after the times of maximum pressure—1000 and 2200 solar hours, 0100 and 1300 lunar hours, local time. This scale can be converted directly into longitude difference from the meridian of maximum pressure, using 1 hour = 15°. In this sense, only one quadrant of the globe is depicted; the others may be deduced from symmetry.

that an improved attack would alter the dynamo theory except in its details, but the point has been reached where the details are becoming important. A more thorough study of vertical variations is now called for.

The horizontal polarization fields are of considerable concern in other studies, as will be seen in a subsequent section. They are produced primarily by currents in the  $E$  region, but they are carried to other heights by virtue of space-charge accumulations. The high mobility of charge along the geomagnetic field lines tends to make the latter equipotential, and the polarization fields are effectively mapped by transport along these equipotentials.<sup>24</sup> The polarization and other vector fields deduced in one development of the dynamo theory are illustrated in Fig. 2.

If the  $E$  region does indeed dominate the polarization fields, then it also controls the movement of ionization at greater heights. This point will be taken up again, but it should be noted here that the premise is based in part on the assumption that the amplitude of the atmospheric motion decreases with increasing height through the  $E$  region. Such a decrease must be attributed to dissipative effects as already noted, and inductive viscosity seems to be the most likely source. This supposition appears the more probable in view of the increased effective conductivities which have now been found and which lead in turn to increased damping. The problem of dissipation is an exceedingly difficult one to treat in detail, but it must be taken into account from the start if a fully comprehensive theory is to be developed.

#### IV. DIRECT TIDAL OBSERVATIONS

It is appropriate at this point to bring experimental evidence to bear on the subjects which have been discussed. Care must be exercised in selecting the types of data to be employed, however, because of major complications which arise at ionospheric heights. These complications will be discussed more fully in the next section, while an arbitrary choice of "direct" tidal observations will be made for present purposes.

Meteor studies appear to be particularly pertinent. Atmospheric winds blow upon and distort the originally straight meteor trails, and the resultant motions can be detected both by optical<sup>31</sup> and by radio<sup>5,32</sup> means. These motions must, over most of the relevant height range, reproduce accurately the atmospheric movement which produces them.

Although prevailing winds, when deduced, are generally directed towards the east, there is little agreement as yet on their magnitudes or seasonal variations, or on the diurnal components that are superimposed.<sup>5</sup> A consistent picture of these motions has yet to be developed. The solar semidiurnal component has been more clearly established, however, and has provided sufficient data to warrant a thorough examination. Even in summary,

<sup>31</sup> W. Liller and F. L. Whipple, "High-Altitude Winds by Meteor-Train Photography," *Internat. Union of Geodesy and Geophys. Info. Bull.*, No. 6, pp. 329-330; July, 1954.

<sup>32</sup> J. S. Greenhow and E. L. Neufeld, "Diurnal and seasonal wind variations in the upper atmosphere," *Phil. Mag.*, vol. 46, pp. 549-562; May, 1955.

the pattern it reveals<sup>32</sup> is most interesting.

The velocity vector rotates clockwise in the northern hemisphere and counter-clockwise in the southern, when viewed from above, as would be expected. At the 85-km level it is directed eastwards at about 0830 and 2030 hours, with an amplitude (wind) of the order 10–30 m/sec. The times become earlier (by 10–25 min/km) and the amplitude greater (at an average rate of 2m/sec/km) as the height increases to 100 km.

These results are completely consistent with the resonance theory as set out above. They indicate a velocity at 85 km nearly antiphase to that at the ground,<sup>33</sup> and amplified by a factor of 50 relative to it, much as would be predicted from Fig. 1. Even the upwards decrease of phase angle and increase of amplitude are essentially the same as those derived theoretically.

Some discrepancies should be noted. Seasonal changes of phase and amplitude occur, as do random variations in the ratio of north-south to east-west winds, and both are unaccounted for in tidal theory as presently developed. One suggested explanation<sup>32</sup> for the systematic effects involves the incorporation of a second component of the solar semidiurnal tide which has been ignored so far in this paper. It has the nature of a standing wave oscillating between the poles and equator, with maximum amplitude at the higher latitudes. Its relevance should be determined by the correlation of measurements at separate longitudes, since its phase is dependent on universal rather than local time. (This phase dependence has always been difficult to explain, because simple considerations of symmetry would argue against it. A dynamically distinct and asymmetric polar region such as that proposed in Section II might provide an essential clue to the elucidation of this peculiar tidal component.)

Variations in the temperature profile of the atmosphere, and a possible thermal input at ionospheric heights, have also been cited<sup>32</sup> in explanation of the anomalous variations revealed by meteors. The former could alter the phase angle and amplitude at a given datum level, while the latter could alter the local rate of change of these quantities with height. The question of high altitude thermal effects has been raised independently in other contexts,<sup>34,35</sup> and the implications of such effects in tidal theory have received some consideration<sup>22</sup> but probably not enough.

The decrease of phase angle is itself of considerable importance in the development of a complete picture,

for it reappears at greater heights in a second type of observation and provides an urgently required link between the two.<sup>36,37</sup> The observations referred to, *E*-region "drifts," are not so certainly understood as are the meteor motions, and will not be examined further until the next section. But, if they do represent true atmospheric winds, then they become consistent with the tidal motions revealed by meteors only if the phase shift is included. This shift is sufficient to bring the atmospheric wind motion back into phase with the motion at the ground, somewhere in the 95–115 km region.

That it should be in phase, or nearly so, is a deduction from yet another type of observation. The geomagnetic variations, if explained by the dynamo theory, imply a maximum eastwards air velocity at about 0400 and 1600 hours<sup>29</sup> just as at the ground. (One analysis<sup>30</sup> indicates that the maximum occurs earlier than this in summer and later in winter, a variation which might well be explained by changes in local heating effects.)

Both the dynamo theory and the *E*-region drifts indicate winds of the order 20–30 m/sec for the solar semidiurnal component.<sup>29,38–40</sup> It is difficult to reconcile these values with those previously quoted for meteors, when the upwards increase of amplitude is taken into account, unless a rapid damping sets in above 100 km. The damping should be revealed, or the difficulty otherwise resolved, by further close coordination of meteor and drift measurements.

The conclusions which have been drawn here can be summarized by a "harmonic dial" display as in Fig. 3, which is intended to be representative only. Similar information deduced from combined studies at individual stations would be most valuable in consolidating or correcting the composite picture it provides. Accurate height determinations for all detected motions are obviously vital to success.

The lunar semi-diurnal geomagnetic variations appear to require a maximum eastwards wind at about 0130 and 1330 lunar hours, in phase opposition to the motion at ground level.<sup>29</sup> They differ from the solar variations in this respect, and have been attributed to a lower level in consequence.<sup>41</sup> It is possible that diurnal variations of ion density would play some part in causing a distinction of this sort, but the mechanism is not at all clear nor does the distinction itself appear to be required. Tidal theory indicates that the reversed phase angle of

<sup>36</sup> I. L. Jones, "The height-variation of horizontal drift velocities in the *E*-region," in "Polar Atmosphere Symposium; Part II, Ionospheric Section," Pergamon Press, London, Eng., pp. 20–22; 1957.

<sup>37</sup> I. L. Jones, "The height variation of drift in the *E* region," *J. Atmos. Terrest. Phys.*, vol. 12, no. 1, pp. 68–76; 1958.

<sup>38</sup> G. J. Phillips, "Measurement of winds in the ionosphere," *J. Atmos. Terrest. Phys.*, vol. 2, no. 3, pp. 141–154; 1952.

<sup>39</sup> J. H. Chapman, "A study of winds in the ionosphere by radio methods," *Can. J. Phys.*, vol. 31, pp. 120–131; January, 1953.

<sup>40</sup> B. H. Briggs and M. Spencer, "Horizontal movements in the ionosphere," *Rep. Prog. Phys.*, vol. 17, pp. 245–280; 1954.

<sup>41</sup> D. F. Martyn, chairman, "Tidal Phenomena in the Ionosphere," Internat. Sci. Radio Union Spec. Rep. No. 2, General Secretariat of URSI, Brussels, Belgium; publication approved 1950.

<sup>33</sup> In the solar semidiurnal tide at ground level, the wind velocity deduced from pressure variations has an amplitude of about 0.4 m/sec at middle latitudes and is directed eastwards (*i.e.*, towards the east) at about 0400 and 1600 hours. See Fejer, *loc. cit.*, or Fig. 2(a).

<sup>34</sup> L. R. Rakipova, "Possible effect of dust on vertical air movements and isothermy in the stratosphere," *Izv. Akad. Nauk SSR, Geograph. and Geophys. Ser.*, vol. 11, pp. 15–19; 1947. Translation by E. R. Hope, No. T 199 R, Directorate of Sci. Info. Serv., Defence Res. Board of Can., Ottawa; August, 1956.

<sup>35</sup> H. E. LaGow, R. Horowitz, and J. Ainsworth, "Rocket measurements of the arctic upper atmosphere," *IGY Rocket Rep. Ser.*, Natl. Acad. of Sci., Washington, D. C., no. 1; July, 1958.



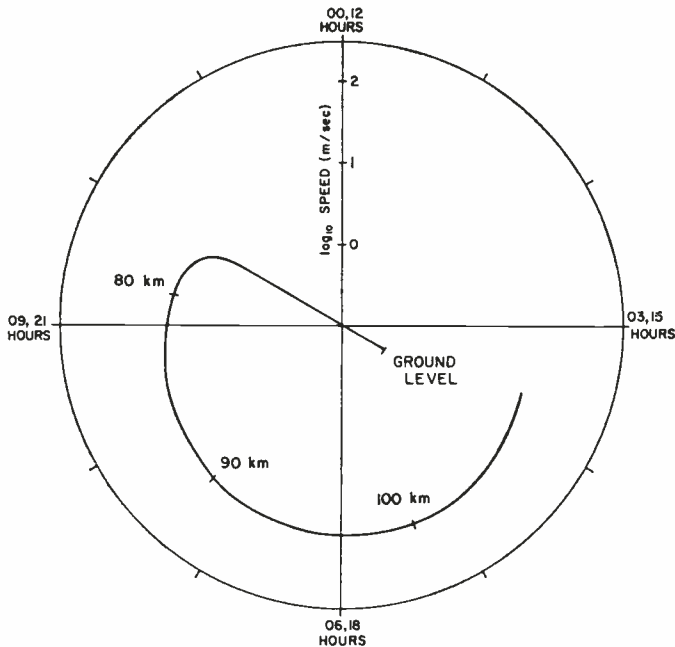

Fig. 3—Tentative representation of height variations in the amplitude and phase time<sup>38</sup> of the observed eastwards wind component in the solar semidiurnal tide.

the lunar semidiurnal component should persist up to heights of 100 or 105 km before any significant decrease sets in (Fig. 1), so both the solar and lunar variations might well originate in current sheets in the 95–110 km range. This includes the levels at which maximum effective conductivities are to be expected,<sup>21</sup> and at which intense currents have already been found.<sup>42</sup>

A rapid decrease of phase angle with height is predicted above 105 km (Fig. 1). This could provide consistency with *E*-region drift measurements of the lunar semidiurnal tide, which generally require eastwards winds at about 0600 and 1800 lunar hours,<sup>38,39</sup> and it suggests an explanation for wide variations which have been observed in such studies.<sup>40</sup>

#### V. INDIRECT TIDAL OBSERVATIONS

As has been indicated already, care must be exercised in the interpretation of apparent motions at ionospheric heights. It should be noted as a basic point that virtually all indications of motion depend on the existence of inhomogeneities in the medium observed, and that the motion revealed is really some composite of the motion and deformation of the inhomogeneities. It may be that the latter move with the atmosphere, as in the case of noctilucent and self-luminous clouds, but even these are complicated by growth and decay at the edges and sometimes by wave-like irregularities passing through. The motion of more complex structures, such as auroral forms, may be dominated by precipitation or excitation from regions entirely external to those observed.

<sup>42</sup> S. F. Singer, E. Maple, and W. A. Bowen, "Evidence for ionospheric currents from rocket experiments near the geomagnetic equator," *J. Geophys. Res.*, vol. 56, pp. 265–281; June, 1951.

The difficulty is compounded in radio studies, where electrons alone are important. Even when the movement of irregularities in the electron distribution can be interpreted in terms of the actual motion of electrons, the latter motion may be quite different from that of the surrounding atmosphere. Electric fields are important, and at least three types may be distinguished. The first two are the induced and polarization fields established on a very large scale by tidal action or by some other major process. These are becoming understood, as has been seen. The third consists of the local polarization fields established at the irregularities. Their scale is that of the irregularities, while their form depends on the form of the irregularities and on the pattern of motion of the charged particles. A feedback mechanism exists: the field and the motion must be determined simultaneously in any theoretical approach. This renders the interpretation exceedingly difficult, and only one rigorous analysis has succeeded as yet.<sup>43</sup> Its importance in the case it treats can scarcely be overemphasized, and its value as a more general guide is considerable.

A gross example of the various problems is provided by tidal oscillations in the heights of ionospheric layers. The solar variations are badly masked by variations in the rate of production of ionization, and indirect methods must be employed to separate out the small contribution of the tidal motion itself.<sup>44</sup> This difficulty is not so severe in the case of the lunar variations, particularly for the *F* layers, but an extensive reduction of data must be completed even for them.<sup>45</sup> Various characteristics have been deduced for the different layers, and all have found at least partial explanation on a theoretical basis.<sup>41</sup>

The direct vertical oscillation of the atmosphere plays only a minor part in the movement of the layers. The vertical velocities of the charged particles considerably exceed those of the atmosphere itself, in the *E* region and above, being dominated by the induced and polarization fields established by the tide. Although vertical currents may be suppressed, a vertical motion of

<sup>43</sup> P. C. Clemmow, M. A. Johnson, and K. Weekes, "A note on the motion of a cylindrical irregularity in an ionized medium," in "The Physics of the Ionosphere," The Physical Society, London, Eng., pp. 136–139; 1955. The expressions for  $V_z$  and  $V_u$  in (3) of this paper should be interchanged; at present they conflict with the illustrations, which are correctly marked (Clemmow, private communication).

<sup>44</sup> D. F. Martyn, "Atmospheric tides in the ionosphere; part IV: studies of the solar tide, and the location of the regions producing the diurnal magnetic variations," *Proc. Roy. Soc. (London) A*, vol. 194, pp. 445–463; November, 1948.

<sup>45</sup> The initial difficulty is one of extracting a cyclic variation from data which contain a wide scatter. This has been done successfully by a number of workers now. However, there remains the difficulty of establishing that a variation having the lunar semidiurnal period is in fact due to the influence of the moon. Seasonal or irregular variations in the dominant solar semidiurnal component could easily produce Fourier components at the lunar semidiurnal period. This same objection has been raised (Briggs and Spence, *loc. cit.*) in connection with drift measurements. The most satisfactory resolution of the difficulty would be provided by a complete Fourier analysis over periods from 11.5 to 13 solar hours, but this is seldom practicable. Certain apparent discrepancies between results for so-called lunar tides must remain suspect, however, until some such an analysis is applied.

the whole charge complex does persist, with a magnitude approximating that appropriate to the heavy ions alone. If recombination occurs only slowly, this motion carries the layer vertically with it; if recombination is rapid, the layer is merely distorted in the direction of motion. In the latter case the displacement of the layer is in phase with the vertical velocity of the charge, while in the former it is in phase quadrature. The motion of the layer may bring it into regions of the atmosphere where recombination times are sufficiently altered to produce distortion, and height variations of the motion may further complicate the net effect.

While various combinations of these details can be adduced to explain the observed tidal changes in the different layers,<sup>41</sup> a fully deductive theory has yet to be developed. Such a theory will probably emerge as our understanding of the horizontal motions and polarization fields at the lower levels improves.

The study of the horizontal motions will likely proceed along lines such as those followed in the previous section. Included there were results from *E*-region drift measurements.<sup>38-40</sup> These are studied as systematic motions in a changing diffraction pattern. The pattern is detected by the diversity reception of a fixed-frequency ionospheric sounder, and is imposed on the radio waves by irregularities in the *E*-region distribution of ionization.

The extraction of a meaningful systematic motion is sometimes difficult.<sup>46-48</sup> Its interpretation as a drift of *E*-region irregularities is fairly direct, but the interpretation of that drift is once again difficult and complicated by the effects discussed above. The assumption adopted in the preceding section, that the drifts reveal directly the atmospheric motion, has no sure theoretical grounding at the moment. It has the purely empirical support that it seems to provide agreement with both the meteor and the dynamo studies.

The drifts reveal a further interesting feature which has yet to be explained in any detail. Their speeds are independent of magnetic activity for a *K* index less than 5, but increase with the *K* index at higher values.<sup>39</sup> It seems reasonable to suppose that the atmospheric motion does indeed dominate the drifts in normal circumstances, and that increased polarization fields become more important and finally control as the magnetic activity rises.

This supposition is consistent with the behavior of *F*-region drifts, which are detected in the same way. The atmospheric motion is believed to be less than in the *E* region, whereas the tidal polarization fields are of the same order. The latter may be expected therefore to

come into prominence at lower values of the *K* index, and the *F*-region drift speed does in fact increase with magnetic activity even when the activity is low.<sup>39</sup>

The same behavior is found for the ionization irregularities which lead to radio star scintillations.<sup>49</sup> These appear to be in the *F* region, and to be extended as columns along lines of the geomagnetic field.<sup>50</sup> Their motion appears to be essentially east-west, at least on the average, even after spurious effects due to their elongated shape have been taken into account.<sup>51</sup> The reason for this is by no means obvious at the present stage of development, but the geometry of these irregularities is essentially the same as that which has been treated successfully by theory, and some elucidation of the motion may therefore be near.

The irregularities generally move westwards in the evening and eastwards in the morning hours.<sup>48</sup> This is a property they share with auroral structures,<sup>52-54</sup> and the two types of inhomogeneity may simply represent different degrees of the same phenomenon. The suggestion<sup>54</sup> is certainly quite reasonable, on the basis of what is now known, that the high speeds frequently attributed to auroral forms represent the upper extreme in an inherently continuous and magnetically-dominated spectrum.

These last few topics have been included under the heading of "indirect tidal effects" purely on conjecture. It seems probable that the higher velocities are indeed produced by electric fields, and polarization fields established by diurnal or semidiurnal tides provide a likely source. Certainly the reversal of direction near midnight, if it is an ionospheric effect, demands something on the scale of the tides as its causal agency. The confirmation of this conjecture or equally its invalidation would mark a further major step in the study of ionospheric motions.

## VI. TURBULENCE

Nothing has yet been said as to the nature of the irregularities detected in drift and scintillation measurements. Had their motion been attributed to wave propagation—and there are some arguments in favor of this interpretation—the irregularities would have been explained directly as the perturbation involved. But if, as here, the motions are attributed to (tidal) forces extending over very great spacial scales, then some small-

<sup>46</sup> J. A. Ratcliffe, "The analysis of fading records from spaced receivers," *J. Atmos. Terrest. Phys.*, vol. 5, pp. 173-181; July, 1954.

<sup>47</sup> G. J. Phillips and M. Spencer, "The effects of anisometric amplitude patterns in the measurement of ionospheric drifts," *Proc. Phys. Soc. (London) B*, vol. 68, pp. 481-492; August, 1955.

<sup>48</sup> I. L. Jones, "Theoretical views on drift measurements," in "Polar Atmosphere Symposium; Part II, Ionospheric Section," Pergamon Press, London, Eng., pp. 3-11; 1957.

<sup>49</sup> A. Maxwell, "Investigation of *F* region drift movements by observation of radio star fading," in "The Physics of the Ionosphere," The Physical Society, London, Eng., pp. 166-171; 1955.

<sup>50</sup> M. Spencer, "The shape of irregularities in the upper ionosphere," *Proc. Phys. Soc. (London) B*, vol. 68, pp. 493-503; August; 1955.

<sup>51</sup> G. C. Reid, "The variation with sidereal time of radio star scintillation rates," *Can. J. Phys.*, vol. 35, pp. 1004-1016; September, 1957.

<sup>52</sup> A. B. Meinel and D. H. Schulte, "A note on auroral motions," *Astrophys. J.*, vol. 117, pp. 454-455; May, 1953.

<sup>53</sup> K. Bullough and T. R. Kaiser, "Radio reflections from auroras—II," *J. Atmos. Terrest. Phys.*, vol. 6, pp. 198-214; April, 1955.

<sup>54</sup> B. Nichols, "Drift Motions of Auroral Ionization," Geophys. Inst., Univ. of Alaska, College, Alaska, Sci. Rep. No. 1, Contract AF 19(604)-1859; July, 1957.

ler-scale agency must be assumed. Turbulence has received the greatest attention.<sup>55-57</sup>

Turbulence, too, has been cited often as the cause of random motions in both drift and meteor studies. The latter undoubtedly reveal the existence of a strong vertical shearing of horizontal velocities,<sup>31</sup> of an amount which has been considered sufficient to produce turbulence at the heights concerned.<sup>56</sup> On this basis a theory of turbulent diffusion and deformation of meteor trails has been developed, and indeed extrapolated upwards to heights appropriate to *E* and *F*-region drifts and radio star scintillations.<sup>56</sup> The details and application<sup>58</sup> of the development have been criticized<sup>59</sup> and reaffirmed,<sup>60</sup> and the present status of the subject is very much a matter of opinion.

In any event, a study of turbulence at ionospheric heights now appears to be well launched, and early improvements in the theory may be anticipated. One modification is urgently required—the incorporation of anisotropies. The necessity for this at lower heights is borne out by the meteor observations themselves, for meteors reveal no vertical motions comparable in magnitude to the horizontal speeds and certainly no vertically-circulating isotropic eddies of observable scale size (>1 km). Indeed, the wind shears on which predictions of turbulence have been based could be explained entirely on the basis of a random spectrum of atmospheric waves,<sup>59</sup> which, on the pertinent scales, can be shown to propagate of necessity nearly vertically and to oscillate nearly horizontally. But the amplitudes involved (which would be the “winds” observed) are appreciable fractions of the phase speeds deduced, so the oscillation would at best be nonlinear. Some form of turbulence might be expected as a result, but probably not of an isotropic nature. It is certainly not clear that the usual criteria for turbulence would apply.

Anisotropies associated with the geomagnetic field will become more important at greater heights in radio studies. It should be noted, for example, that a simple vertical shear in a purely laminar horizontal motion of the atmosphere can produce ionization irregularities just as if the atmosphere itself were turbulent.<sup>61</sup> Shear-

ing of this type might therefore provide an explanation for short-lived layer effects and even for the “scatter” transmission of VHF waves, both of which have been suggested in the past as manifestations of isotropic (or nearly isotropic) turbulence.<sup>56</sup>

The geomagnetic anisotropy would appear to dominate in the *F* region, at least in the production of scintillation irregularities. It has been suggested that the control exists only on the charged particles, with the anisotropy of their irregularities being determined more or less by the anisotropy of their mobilities,<sup>56</sup> a number of ionization irregularities might then be horizontally spaced within the single atmospheric eddy which produces them. Such an assumption appears unwarranted, and a converse viewpoint might well be advanced—that variations of density in directions perpendicular to the field would be difficult to generate, and that the relatively small scale-sizes detected for those directions would argue against isotropy in the atmospheric turbulence. The required anisotropy might result from shearing at the geomagnetic field lines which rise from the auroral belt, as suggested in Section II, or it may be due to effects, such as precipitation from the outer atmosphere or interplanetary gas, which have nothing to do with *F*-region turbulence.

The future of turbulence theory in ionospheric studies can only be guessed at the moment. But, whatever the guess, the immense potential of the phenomenon cannot be ignored.

## VII. LARGE-SCALE TRAVELING DISTURBANCES

The final type of motion to be discussed is that revealed by very extensive irregularities in the *F* region, stretching over fronts hundreds of kilometers in length and progressing horizontally over similar distances.<sup>62</sup> Various techniques have been used for their study, but the simplest in principle is the correlation of vertical incidence ionograms obtained at separated stations. Typically, each station detects the appearance of an irregularity at the top of the *F* trace, and follows it down through the *F* and possibly into the *E* layer, but the times of occurrence at the different stations differ because of the horizontal component of motion. The irregularities can be of considerable amplitude, reaching 10 per cent or more in the fractional variation of electron density.

It has been argued on occasion that the horizontal movement revealed in these studies is basically that of an atmospheric wind, perhaps associated with a cellular wave,<sup>63</sup> or alternatively that of an ionization drift induced by an electric field.<sup>64</sup> It is difficult to reconcile

<sup>55</sup> A. Maxwell, “Turbulence in the upper ionosphere,” *Phil. Mag.*, vol. 45, pp. 1247-1254; December, 1954.

<sup>56</sup> H. G. Booker, “Turbulence in the ionosphere with applications to meteor trails, radio star scintillation, auroral radar echoes, and other phenomena,” in “Polar Atmosphere Symposium, Part II, Ionospheric Section,” Pergamon Press, London, Eng., pp. 52-81; 1957. Repeated in *J. Geophys. Res.*, vol. 61, pp. 673-705; December, 1956.

<sup>57</sup> H. G. Booker, “The use of radio stars to study irregular refraction of radio waves in the ionosphere,” *Proc. IRE*, vol. 46, pp. 298-314; January, 1958.

<sup>58</sup> H. G. Booker and R. Cohen, “A theory of long-duration meteor-echoes based on atmospheric turbulence with experimental confirmation,” *J. Geophys. Res.*, vol. 61, pp. 707-733; December, 1956.

<sup>59</sup> L. A. Manning and V. R. Eshleman, “Discussion of the Booker and Cohen paper, ‘A theory of long-duration meteor echoes based on atmospheric turbulence with experimental confirmation,’” *J. Geophys. Res.*, vol. 62, pp. 367-371; September, 1957.

<sup>60</sup> H. G. Booker, “Concerning ionospheric turbulence at the meteoric level,” *J. Geophys. Res.*, vol. 63, pp. 97-107; March, 1958.

<sup>61</sup> J. W. Dungey, “The influence of the geomagnetic field on turbulence in the ionosphere,” *J. Atmos. Terrest. Phys.*, vol. 8, pp. 39-42; February, 1956.

<sup>62</sup> G. H. Munro, “Travelling disturbances in the ionosphere,” *Proc. Roy. Soc. (London) A*, vol. 202, pp. 208-223; July, 1950.

<sup>63</sup> D. F. Martyn, “Cellular atmospheric waves in the ionosphere and troposphere,” *Proc. Roy. Soc. (London) A*, vol. 201, pp. 216-234; March, 1950.

<sup>64</sup> D. F. Martyn, “Interpretation of observed F2 ‘winds’ as ionization drifts associated with the magnetic variations,” in “The Physics of the Ionosphere,” The Physical Society, London, Eng., pp. 161-165; 1955.



these views with other features however. An atmospheric wind would tend to produce a vertical shift in the layer as a whole, amounting to some tens of kilometers in the course of a disturbance. None is seen. An irregularity would tend to diffuse rapidly away along geomagnetic field lines if a uniform wind or external field were acting, whereas in fact the observation of a single disturbance may last for more than an hour. Furthermore, the horizontal speeds deduced from nearby stations differ markedly from those deduced by combinations of distant results,<sup>65</sup> in contrast to the expectations of either a wind or a field process.

These features are, however, all consistent with the assumption of a propagating atmospheric wave as the source of the disturbance, and such a source is the one now most commonly accepted. The wavelength, on this basis, is typically of the order 100–200 km, and the period of the order 15–20 min. Atmospheric waves in this range would be strongly affected by gravitational forces as well as the restorative pressure gradients, while inertial forces associated with the oscillation would be relatively small. The phase speed would exhibit strong dispersion.

An oscillation of this type could propagate as a perturbation, leaving the height of the layer as a whole essentially unchanged. Moreover, such an oscillation creates its own inhomogeneities as it progresses, and so avoids the difficulty which would be inherent if diffusion were important. And finally, the speed detected by stations spaced over distances comparable to a wavelength would be the phase speed, while that detected from more widely-spaced stations would be the group speed; the two should not be the same.

Several aspects of the study of waves might be contemplated, and some of these have already been attacked. The energy source of the wave is an obvious topic to pursue, and various suggestions have been made: thermal effects within the atmosphere,<sup>66</sup> interactions between the interplanetary gas and the earth's outer atmosphere,<sup>8</sup> and shock waves emitted by the sun.<sup>67</sup> Only the last of these has received detailed theoretical analysis, and its possible correlation with the observed occurrences has yet to be effected.

In searching for likely energy sources, some weight has undoubtedly been given to the observed fact that the vertical component of propagation is invariably downwards. But this feature, and others which appear to be characteristic, may have only a relatively incidental relation to the actual source. For it should be noted that our only means of detection is dependent on the

ability of the disturbance to produce irregularities in the electron distribution, so an observational selection is implicit in the measurements. A disturbance which attempted to compress the electron plasma by differential motion along geomagnetic field lines, for example, would be more likely to succeed than one which required compression across those lines. The possibility exists, then, that waves propagating in many directions with many characteristics are actually generated, but only those having certain characteristics are observed.

This possibility has been explored along two lines only, both involving the concept of resonance—first in the electromagnetic field engendered by the moving charge,<sup>68</sup> and secondly in the oscillation of the electron plasma itself.<sup>69</sup> The theoretical development of the latter was faulty, and it will have to be converted in effect to a study of resonance in the ion plasma before further detailed comparisons with the observations can be pursued.<sup>70</sup> The principles involved are clear, however. Oscillations of the plasma alone are governed by a dispersion relation between the frequency and the (three-dimensional) spacial scales. For given spacial scales, a natural period of oscillation of the plasma may be deduced. The spacial scales may be considered as being set by the atmospheric disturbance, and that disturbance too has a specific associated period of oscillation determined by its own dispersion relation. The forced oscillation of the plasma will have an amplitude proportional to that of the forcing atmospheric oscillation, and the factor of proportionality will depend on the degree of matching that exists between the two periods. Large resonant motions can result if the two periods are equal. Mathematically, the relevant condition is that the two dispersion equations should be satisfied simultaneously.

Powerful selection principles can be deduced by this approach, and subsidiary conditions can be added. The latter might include, for example, a requirement that the disturbance not be damped out too rapidly by viscous or inductive effects.

The further elucidation of large-scale traveling disturbances must be left to the future. But it should be noted that, if they are produced by waves, their interpretation will probably be facilitated by noting their various characteristics (period, speed, direction, vertical tilt of wave front, etc.) separately for individual events. The more usual procedure in presentations at the moment is, instead, to summarize a large number of observations of isolated characteristics, thereby losing vital information on inter-relations. And further, the observation of these disturbances in depth, as they descend through the *F* layer, is probably as important to their understanding as is the detection of their hori-

<sup>65</sup> R. E. Price, "Traveling disturbances in the ionosphere," in "The Physics of the Ionosphere," The Physical Society, London, pp. 181–190; 1955.

<sup>66</sup> J. A. Pierce and H. R. Mimmo, "The reception of radio echoes from distant ionospheric irregularities," *Phys. Rev.*, vol. 57, pp. 95–105; January, 1940.

<sup>67</sup> S. Askasofu, "Dispersion relation of magneto-hydrodynamic waves in the ionosphere and its application to the shock wave," *Sci. Reps. of Tohoku University, Japan, Ser. 5, Geophys.*, vol. 8, pp. 24–40; November, 1956.

<sup>68</sup> C. O. Hines, "Hydromagnetic resonance in ionospheric waves," *J. Atmos. Terrest. Phys.*, vol. 7, pp. 14–30; August, 1955.

<sup>69</sup> C. O. Hines, "Electron resonance in ionospheric waves," *J. Atmos. Terrest. Phys.*, vol. 9, pp. 56–70; July, 1956.

<sup>70</sup> The conversion will be presented elsewhere shortly, but it may be noted here that the orders of magnitude involved in the phenomenon remain essentially the same, and these are certainly pertinent to the observed disturbances.

zontal motions; sweep frequency soundings are therefore to be encouraged in conjunction with any study of the horizontal motion.

### VIII. CONCLUSION

Perhaps the most immediate conclusion that can be drawn from all these remarks is that a very great deal has yet to be learned about motions in the ionosphere. It must also be clear, however, that much groundwork has already been laid on which to build.

Elementary problems associated with the earth's rotation have yet to be investigated in any detail. These include purely terrestrial effects of geomagnetic interaction with a rotating ionosphere, and coupling effects between the ionosphere and the interplanetary or coronal gas. Neither subject has been more than touched on insofar as "undisturbed" conditions are concerned.

Tidal theory has been more fortunate, both in the study given it and in the results achieved. Further observational effort is required, aimed primarily at the collation of measurements obtained by a succession of techniques leading, each in turn, to successively higher

levels. As many levels as possible should be investigated at any one station, in preference to a scattering of isolated investigations, but a distribution of such stations in both latitude and longitude is essential to the development of a final composite account. As the observations become available, the theory will undoubtedly advance to incorporate them.

In studies of the more localized phenomena, including drifts, scintillations, auroral forms, turbulence and large-scale traveling disturbances, the theory seems to lag well behind the observations. Until theoretical advances are made, leading to the deduction of crucial tests of conflicting hypotheses, the observations must proceed with little guidance. It is to be hoped that this phase will not continue long.

### ACKNOWLEDGMENT

The author would like to acknowledge the value of discussions with his colleagues at the Defence Research Telecommunications Establishment during the preparation of this paper, and the assistance of Miss C. A. May who computed the vector patterns of Fig. 2.

## Meteors in the Ionosphere\*

L. A. MANNING†, SENIOR MEMBER, IRE, AND V. R. ESHLEMAN†, SENIOR MEMBER, IRE

**Summary**—When meteors enter the lower *E* region of the ionosphere, they produce trails of ionization. Sensitive radio systems at frequencies of 3 to 300 mc can record echoes from these ionized trails at rates of thousands per hour. Study of these echoes has benefited astronomy, the physics of the upper atmosphere, and radio communication. This paper presents a review of the nature of meteoric echoes, and describes the principal uses of meteors as research tools. Some of the directions in which further meteoric research may prove profitable are suggested as well. When the results of the IGY programs are correlated, we may expect the knowledge gained from the study of meteors to play an important role.

### INTRODUCTION

SINCE the second world war, the radio study of meteors has received a vast amount of attention—perhaps more than has any other branch of ionospheric physics. At first little more was known than that certain transitory radio echoes were correlated in their occurrence with the sighting of visual meteors. However, as the outgrowth of vigorous research programs at a number of institutions, meteoric echoes are now important and well-understood tools in astronomical and upper atmospheric research; they are also the basis for

new techniques of radio communication. The knowledge gained from the study of meteors must be considered in virtually every other investigation of the lower ionosphere. Using meteors, detailed measurements of atmospheric density and temperature, scale height, diffusion coefficient, wind velocity, and turbulence have been made. Meteors are a source of sodium and other dilute atmospheric constituents, a tool for the study of tidal motions, and a means for determining the height of low-lying layers of absorption. This paper will review briefly the nature of meteoric radio echoes and some of their many applications. From the IGY programs, further results may be expected, notably from the coordinated observation of meteors by visual, photographic, and radio techniques.

### THE NATURE OF METEORS

A meteoric particle is a small solid body that normally revolves about the sun as a member of our solar system. Such particles describe elliptical orbits and travel with heliocentric velocities less than the solar escape velocity. Upon interception by the earth's atmosphere, the meteoric particle is heated by collision with air molecules, and produces phenomena of light and ionization. Occa-

\* Original manuscript received by the IRE, December 15, 1958.  
† Radio Propagation Lab., Stanford University, Stanford, Calif.

sionally an exceptionally large particle will penetrate to the ground whereupon it is called a meteorite. Most meteors cease to exist at heights of about 80 km, however, because of erosion by the air. During the incandescence and destruction of the particle, relatively little of its speed is lost. The meteor is destroyed through molecule by molecule disintegration with but small deceleration. To a very high degree of precision the path of the meteor while in the atmosphere is a straight line. Particles of decreasing size occur with increasing frequency so that, although meteors of visible size are seen perhaps eight times an hour, meteors of size detectable telescopically, or by radar, can be recorded on radio equipment at rates of better than one per second. As a rough guide, the total number of meteors  $n$ , of mass  $m$  or greater, incident upon the atmosphere at a given time is inversely proportional to  $m$ ;  $n = K/m$ . The constant  $K$  is then a measure of the rate, and depends upon the time of day, the season of the year, etc.

Meteors can be detected by radio means because of the ionization they produce. Apparently most of the ionization comes from atoms of the meteoric particle rather than of air. The total number of electron-ion pairs produced is within several factors of ten of the number of atoms in the meteoric particle but is influenced by such factors as the meteoric speed and composition. The ionization can be measured more directly by radio methods than can the mass. Hence it is convenient and useful to specify the number of trails having electron production per unit length of path (line density) greater than or equal to a given amount. A useful order of magnitude equation is<sup>1</sup>

$$n = \frac{160}{q} \quad (1)$$

where  $n$  is the number of trails per square meter per second for which the line density is greater or equal to  $q$  electrons per meter. Meteors at the limit of naked eye visibility (about 5th magnitude) have line densities of the order of  $10^{14}$  electrons per meter. Through coincidence, this same line density is also the division point between the "over-dense" and "under-dense" reflection characteristic, as will be shown.

It must be recognized in using (1) that the rate given is an average value and that seasonal and latitudinal variations occur. In addition, meteoric particles tend to have preferred orbits about the sun. Certain orbits that are used by whole streams of meteors have been plotted, and give rise to "showers" of meteors coming from definite directions at certain times of year. When meteors are detected that cannot be assigned to a known shower, they are said to be "sporadic."

The ionization produced by a meteor varies in intensity along the length of the trail. Very little is produced

at heights greater than about 110–120 km because the mass of intercepted air is unimportant at such heights. For the typical meteor the maximum rate of ionization production is at about 93 km, and the rate of production then decreases because of the subsequent loss of particle size. The mean length of trail may usually be taken as about 25 km in computing the effect on radar reflections.<sup>2,3</sup> It is influenced by the meteoric speed and inclination. Fast particles burn out more quickly and at a greater height. The length of trail also increases with increase of the zenith distance of the meteoric radiant (point of apparent origin in the sky).

It is not known at present to how low a line density (1) may be applied. Experiment has verified it to densities of about  $10^{10}$  electrons per meter.<sup>4</sup> However, if the meteoric mass corresponding to extrapolated line densities of the order of  $10^8$  electrons per meter is examined, it is found that the usual meteoric behavior is no longer obtained. Such "micro-meteorites" quickly lose their initial velocity upon striking high layers of the atmosphere, probably with the production of little, if any, ionization.<sup>5</sup> Rocket experiments show that the rate of arrival of such small particles may be higher than would be predicted by extrapolating the inverse mass law.<sup>6</sup> Thus it is dangerous to extrapolate the ionization rate law much beyond the measured region. The rapidity with which small meteors may be detected is suggested by Fig. 1, a plot of echo intensity in range-time coordinates.



Fig. 1—Display of meteor activity on 23.1 mc at Stanford, Calif., at 0310, January, 1956. An array of 48 Yagi antennas was beamed north. The vertical range scale covers 1000 km, and the time scale covers 40 seconds reading from left to right. The peak transmitted power was 35 kw.

## IONIZATION DISTRIBUTION

Although the trail of ionization formed by a meteor is of the order of 25 km in length, its initial radius is only a few centimeters. A typical meteoric particle, traveling

<sup>2</sup> L. A. Manning, O. G. Villard, Jr., and A. M. Peterson, "The length of ionized meteor trails," *Trans. Am. Geophys. Union*, vol. 43, pp. 16–21; February, 1953.

<sup>3</sup> V. R. Eshleman, "The theoretical length distribution of ionized meteor trails," *J. Atmos. Terrest. Phys.*, vol. 10, pp. 57–72; February, 1957.

<sup>4</sup> P. B. Gallagher, "An antenna array for studies in meteor and radio astronomy at 13 meters," *PROC. IRE*, vol. 46, pp. 89–92; January, 1958.

<sup>5</sup> F. L. Whipple, "The theory of micro-meteorites," *Proc. Natl. Acad. Sci. U. S. pt. I*, vol. 36, pp. 687–695; December, 1950; *pt. II*, vol. 37, pp. 19–30; January, 1951.

<sup>6</sup> O. E. Berg and L. H. Meredith, "Meteoric impacts to altitude of 103 kilometers," *J. Geophys. Res.*, vol. 61, pp. 751–754; December, 1956.

<sup>1</sup> V. R. Eshleman and L. A. Manning, "Radio communication by scattering from meteoric ionization," *PROC. IRE*, vol. 42, pp. 530–536; March, 1954.



with a velocity of 50 km/s, produces its maximum ionization at heights of 90 or 100 km where the thermal velocities of the air are of the order of 0.5 km/s. The meteoric molecules knocked from the meteoric body by collision with air molecules enter the air with the higher meteoric speed. They lose no more than a third of their speed upon each subsequent collision with air molecules. Only a fraction of a millisecond is needed to reduce the meteoric atoms or ions to thermal velocities, but because of the many collisions required to reach equilibrium, the meteoric matter is quickly distributed in a column whose radius is of the order of fourteen ionic mean-free-paths.<sup>7</sup> Since the mean-free-path for ions is less than that for neutral molecules, the equilibrium radius for ionization is smaller than that for the neutral molecules. To a first order, each distribution will be Gaussian.

Once the meteoric matter is in thermal equilibrium with the air molecules, the ionization trail will expand by ambi-polar diffusion; the electrons will follow the heavier positive ions because of electric attraction.<sup>8</sup> This second or diffusion phase is slower. For most purposes the distribution of ionization may be treated as if it were created instantaneously at an initial radius of  $r_0$  equal to fourteen ionic mean-free-paths, and thereafter was subject to ordinary diffusion. The electron density during diffusion is then given by the equation

$$N(r, t) = \frac{q}{4\pi Dt} \exp\left(\frac{-r^2}{4Dt + r_0^2}\right) \quad (2)$$

where  $N$  is the electron density in electrons per cubic meter,  $q$  is the line density in electrons per meter,  $r$  is the distance from the trail axis,  $t$  is time, and  $D$  is the diffusion coefficient in meters squared per second. A good value for  $D$  is about  $3 \text{ m}^2/\text{s}$  at 93 km, but it varies exponentially with height, the scale height being about 6 km. Because of such effects as heating it is likely that the Gaussian distribution is only approximately valid at the time of trail formation.

The duration of a meteoric radar echo at high frequencies is controlled by the distribution of electron density, but is largely independent of the processes of electronic recombination or attachment. This is so because the low rate of recombination produces an appreciable reduction in the total electron content of the trail only after the electron gradients have been effectively dispersed by diffusion. Although the effective coefficient of recombination for the  $E$  region of the ionosphere is about  $10^{-14} \text{ m}^3/\text{s}$  ( $10^{-8}$  cgs), that for meteoric ionization must be no greater than  $10^{-16} \text{ m}^3/\text{s}$ , and may be even less.<sup>9</sup> The recombination process if uninterrupted by dif-

fusion is hyperbolic, not exponential, but a time-constant of  $1/(2\alpha N)$  seconds may be used to judge the rate of recombination. If  $N=10^{13}$ , corresponding roughly to the critical density of a 30-mc wave, or alternatively to the density of ionization due to a fifth-magnitude meteor a third of a second after formation,  $1/(2\alpha N) > 10$  seconds. As the trail ages and  $N$  decreases due to diffusion, the time constant will continue to increase in direct proportion to the age of the trail. Thus if recombination is negligible at one part of the trail lifetime, it is so at other times too; an exception occurs when the ionization is limited in its decrease by approach to the ambient level.

Although meteoric ionization is first formed along a straight line path, with passage of time the trail is distorted by winds.<sup>10,11</sup> Thus in addition to diffusion of the ionization about the trail, a warping of the trail takes place, leading to eventual disorganization of the ionization distribution. The winds have significant eddies with a minimum scale of about a kilometer. A general failure of correlation is found between wind velocities separated by about seven kilometers of altitude. Thus a trail eventually attains the serpentine shape familiar in long enduring visual trains. The velocity of the winds is of the order of 70 m/s.

#### REFLECTIONS FROM METEORIC IONIZATION

In general, back-scatter radar echoes are easily obtained from meteoric ionization trails at frequencies anywhere within the range from 3.5 to 150 mc. Little exploration has been carried out beyond these limits. At a frequency of 6 mc, the duration of a radar-detected meteoric echo is of the order of five seconds or more. At 50 mc it is as short as the time taken to form the trail, since the echo from any one part of the trail may last only a few milliseconds. At the lower frequencies, part of the observational problem is the identification of the echoes; at very high frequencies, the initial radius (several molecular mean-free-paths) tends to become large compared with the wavelength, thereby subtracting a fixed interval from a decreasing duration.

The nature of meteoric echoes depends upon the radio frequency. We shall speak first of the properties of the received signals at the lower frequencies; that is, we assume the duration of the echo from the trail is large compared with the time taken by the meteoric particle to form the trail. Under these conditions an echo may be divided into two phases in time. The first phase is that of active trail formation during which the echo amplitude builds up; it ends when the meteor burns out. The second is the main echoing phase. The terms "meteor whistle," "head echo," and "diffraction fluctuations," are all descriptive of the formative phase, while

<sup>7</sup> L. A. Manning, "The initial radius of meteoric ionization trails," *J. Geophys. Res.*, vol. 63, pp. 181-196; March, 1958.

<sup>8</sup> L. G. Huxley, "The persistence of meteor trails," *Aust. J. Sci. Res.*, vol. 5, pp. 10-16; March, 1952.

<sup>9</sup> T. R. Kaiser and J. S. Greenhow, "On the decay of radio echoes from meteor trails," *Proc. Phys. Soc. B*, vol. 66, pp. 150-151; February, 1953.

<sup>10</sup> L. A. Manning, "Air motions at meteoric heights," *Proc. of the Mixed Commission of the Ionosphere*; August, 1957. (In press.)

<sup>11</sup> J. S. Greenhow, "A radio echo method for the investigation of atmospheric winds at altitudes of 80 to 100 km," *J. Atmos. Terrest. Phys.*, vol. 2, pp. 282-291; 1952.

the terms "body echo" or "burst" refer to the main phase.<sup>12</sup> In the development phase an echo is detected before the meteor has traversed the perpendicular reflection point (the point of intersection of a normal ray from the observatory to the trail) so that the range of the echo changes with time. The body echo, on the other hand, appears at a relatively fixed range, influenced mainly by winds. An echo of maximum strength is obtained only when the normal-reflection condition holds. Thus meteoric echoes are extremely aspect-sensitive, and most trails fail to produce detectable echoes because of their unfavorable orientations.<sup>1,13-16</sup>

Analysis of the reflection coefficient of body echoes in the general case is very difficult, even with our present restriction to the lower frequencies and with neglect also of the distortion of the trail by winds. However, excellent approximate analyses can be made when electron line density is either high or low. Laborious, exact calculations have been made in the bridging region where the line density is about  $10^{14}$  electrons per meter.<sup>17-19</sup>

The reflection conditions for a low density trail may be found by adding directly the field strengths that would be scattered by each electron individually were the others not present. Thus, each electron returns a signal

$$\frac{E_{sc}}{E_{inc}} = \frac{r_e}{R} = \frac{2.818 \times 10^{-15}}{R} \quad (3)$$

where  $E_{sc}$  is the signal in volts per meter scattered back to the ground,  $E_{inc}$  is the incident field strength measured at the electron,  $r_e$  is the classical electron radius in meters, and  $R$  is the range to the electron in meters. Thus for a diffuse collection of charge of electron density  $N$  per cubic meter,

$$\frac{E_{sc}}{E_{inc}} = r_e \int_V \frac{N \exp(4i\pi R/\lambda) dV}{R} \quad (4)$$

where the volume integral is taken to include all the charge, and  $\lambda$  is the wavelength in meters.

If the electron density in the cloud is represented by the Gaussian formula of (2), the received field strength

<sup>12</sup> L. A. Manning, O. G. Villard, Jr., and A. M. Peterson, "Double-Doppler study of meteoric echoes," *J. Geophys. Res.*, vol. 57, pp. 387-403; September, 1952.

<sup>13</sup> L. A. Manning, "The theory of the radio detection of meteors," *J. Appl. Phys.*, vol. 19, pp. 689-699; August, 1948.

<sup>14</sup> C. O. Hines and R. E. Pugh, "The spatial distribution of signal sources in meteoric forward-scattering," *Can. J. Phys.*, vol. 34, pp. 1005-1015; 1956.

<sup>15</sup> V. R. Eshleman and R. F. Mlodnosky, "Directional characteristics of meteor propagation derived from radar measurements," *Proc. IRE*, vol. 45, pp. 1715-1723; December, 1957.

<sup>16</sup> M. L. Meeks and J. C. James, "On the influence of meteor-radiant distributions in meteor-scatter communication," *Proc. IRE*, vol. 45, pp. 1724-1733; December, 1957.

<sup>17</sup> V. R. Eshleman, "The Mechanism of Radio Reflections from Meteoric Ionization," Stanford University Rep. No. 49, Contract N6onr-251; July, 1952.

<sup>18</sup> T. R. Kaiser and R. L. Closs, "Theory of radio reflections from meteor trails; I," *Phil. Mag.*, vol. 43, pp. 1-32; January, 1952.

<sup>19</sup> G. H. Keitel, "Certain mode solutions of forward scattering by meteor trails," *Proc. IRE*, vol. 43, pp. 1481-1487; October, 1955.

can be computed from (4). In expressing the results, it is convenient to define a "reflection coefficient" ( $\rho$ ) for scattering by the ionization column in response to a spherical wavefront.

$$\rho = \sqrt{\frac{2\pi^2 R}{\lambda} \frac{E_{sc}}{E_{inc}}} \quad (5)$$

The reflection coefficient so defined is independent of the range to the trail.

In giving formulas for reflection characteristics, we will be able to write them more simply if we first introduce three new normalized parameters. The first is the half-length  $F$  of the first Fresnel zone

$$F = \sqrt{\lambda R/2} \quad (6)$$

and is a measure of the length of trail scattering coherently to the receiver. The second is

$$Q = \pi r_e q = 0.885 \times 10^{-14} q \quad (7)$$

where  $q$  is the line density in electrons per meter; the value  $Q=1$  naturally separates the region of applicability of low-density and high-density theory and corresponds as well to the visual limit. Finally we introduce a third definition,

$$T = \lambda^2/(16\pi^2 D), \quad (8)$$

the characteristic time-constant of decay of under-dense echoes; the average diffusion coefficient  $D$  is roughly  $3 \text{ m}^2/\text{s}$ .

Then for the low density trail<sup>20-23</sup>

$$\rho_{ul}(t) = Q \exp(-t/T) \quad \text{for } Q < 1. \quad (9)$$

In (9) the initial radius of the trail has been assumed to be zero. The subscripts  $u$  and  $l$  of  $\rho$  refer to the restriction of (9) to the under-dense low-frequency case. A finite initial radius  $r_0$  can be taken into account by assuming the trail to be of initial age  $t_0$  where  $4Dt_0=r_0^2$ .

Other commonly used descriptions of the reflection process may be given in terms of  $\rho$ .

$$\frac{P_R}{P_T} = \frac{G^2 \lambda^2}{16\pi^4 R^4} F^2 \rho^2 \quad (10)$$

is the ratio of received to transmitted power  $P_R/P_T$  with  $G$  the antenna gain and  $R$  the range. Alternatively

$$\sigma = F^2 \rho^2 \quad (11)$$

is the radar cross section.

<sup>20</sup> N. Herlofson, "Plasma resonance in ionospheric irregularities," *Arkiv Fysik*, vol. 3, pp. 247-297; 1951.

<sup>21</sup> J. Feinstein, "The interpretation of radar echoes from meteor trails," *J. Geophys. Res.*, vol. 56, pp. 37-51; March, 1951.

<sup>22</sup> V. R. Eshleman, "Theory of radio reflections from electron-ion clouds," *IRE TRANS. ON ANTENNAS AND PROPAGATION*, vol. AP-3, pp. 32-39; January, 1955.

<sup>23</sup> J. S. Greenhow, "Characteristics of radio echoes from meteor trails. 111: The behavior of the electron trails after formation," *Proc. Phys. Soc. B*, vol. 65, pp. 169-181; March, 1952.

The formula for reflection coefficient given by (9) should not be used unless  $Q < 1$ , so the line-density  $q$  is less than about  $10^{14}$  electrons per meter. Thus it applies only to echoes from meteors too small to be seen by eye. Such echoes form the bulk of the echoes seen on sensitive radars. They are often called "exponential type" echoes because of their decay characteristics.

If the line density of a trail is much above  $10^{14}$  electrons per meter,  $Q > 1$ , and the preceding simple theory does not describe the characteristics of meteoric reflections. For these higher densities, secondary scattering from electron to electron becomes important, and the trail acquires a negative dielectric constant core that the incident wave cannot penetrate. A satisfactory approach is then to view the reflection process as being analogous to that from a metallic cylinder. The radius of the equivalent metallic cylinder that would produce the same reflection coefficient as the actual trail is usually taken to be that radius for which the dielectric constant of the trail is zero.

Assuming as before that the electron distribution in the trail is given by the Gaussian function of (2), that the trail is not distorted by wind motions, and that the initial radius is zero, the radius  $r$  for which the dielectric constant becomes zero is given by

$$r^2 = 4Dt \ln(4QT/\pi l) \quad (12)$$

where  $D$  is in meters squared per second, and  $Q$  and  $T$  are defined by (7) and (8).

The reflection coefficient of the instantaneously-formed high-density trail is then<sup>18, 22, 23</sup>

$$\rho_{ol} = \left[ \left( \frac{\pi}{4} \right)^2 \frac{l}{T} \ln \left( \frac{4QT}{\pi l} \right) \right]^{1/4} \quad \text{for } Q > 1 \quad (13)$$

where the subscripts  $ol$  on  $\rho$  indicate the *over-dense low-frequency* case, and the line density  $q$  should be well above  $10^{14}$  electrons per meter for the equation to apply.

Eq. (13) describes a type of signal strength - time behavior quite different from that of (9). For the low-density trail the reflected amplitude decays exponentially, and the time constant of the exponent is independent of the line density  $Q$ . The peak amplitude is proportional to  $Q$ . For the high-density trail the signal strength builds up quickly to a relatively constant maximum value proportional to the fourth root of the line density  $Q$ . The duration, however, is directly proportional to  $Q$  for the high density trail. The following expressions give the maximum reflection coefficients for the low- and high-density trails;

$$(\rho_{ol})_{\max} = Q \quad (14)$$

for  $q \ll 10^{14}$ , or  $Q \ll 1$ ; and

$$(\rho_{ol})_{\max} = (\pi Q/4\epsilon)^{1/4} \quad (15)$$

for  $q \gg 10^{14}$ , or  $Q \gg 1$ . Notice the change in the exponent of  $Q$ .

The durations of the echoes from undistorted low- and high-density trails follow; for low-density trails, the time constant  $T_{ul}$  of the exponential decay is

$$T_{ul} = T \quad (16)$$

where the subscripts  $u$  and  $l$  refer again to the *under-dense low-frequency* case. For high-density trails the duration, based upon time to loss of the over-dense negative dielectric-constant core, is

$$T_{ol} = \frac{4QT}{\pi} \quad (17)$$

seconds. A transition region exists for  $Q \cong 1$  showing intermediate behavior.

As might be expected of approximate analyses, these simple formulas do not quite tell the complete story. The assumption of reflection from an equivalent metallic cylinder in the high-density case fails to consider the refractive effects of ionization at greater radii.<sup>24</sup> As a result of this refraction, the back-scattered energy is defocused, and becomes considerably weaker than calculated above as the over-dense duration is approached. In the low-density case, no account was taken of polarization effects. Under certain conditions when the incident electric vector is perpendicular to the axis of the trail, a resonance may occur between the frequency of the applied wave and the frequency of the natural plasma oscillation of the ionization column.<sup>17-21, 25, 26</sup> For plasma resonance to occur the dielectric constant in the trail must be of the order of minus one, while the trail dimensions are small in terms of the wavelength. Thus, plasma oscillations are found only in the low-density or exponential type echoes. Their effect is to make the amplitude of reflection perhaps twice as great for perpendicular as for a parallel electric polarization early in the echo lifetime. After the trail diffuses and the required negative dielectric constant is no longer present, both components of polarization are of strength indicated by (9), while prior to the peak of the plasma resonance, the binding forces between the electron and positive ion plasmas reduce the electron motion, and so the perpendicular-field reflection. Plasma resonance is not observed for longitudinal field polarization because of the effective lack of boundaries at which polarization may be set up across the length of the trail. Fig. 2 is a typical recorded plot showing the dependence of echo strength on received polarization, using circularly polarized antennas.

In Table I are summarized some of the preceding reflection conditions; adequate duration in relation to the

<sup>24</sup> L. A. Manning, "The strength of meteoric echoes from dense columns," *J. Atmos. Terrest. Phys.*, vol. 4, pp. 219-225; October, 1953.

<sup>25</sup> M. E. Van Valkenburg, "The two-helix method for polarization measurements of meteoric radio echoes," *J. Geophys. Res.*, vol. 59, pp. 359-364; September, 1954.

<sup>26</sup> E. R. Billam and I. C. Browne, "Characteristics of radio echoes from meteor trails. IV: Polarization effects," *Proc. Phys. Soc. B*, vol. 69, pp. 98-113; 1956.



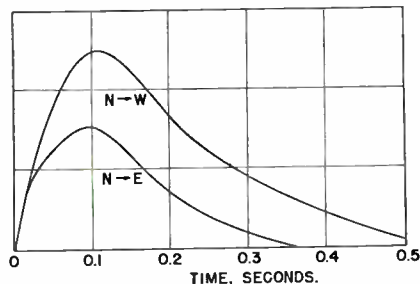

Fig. 2—Records taken by Van Valkenburg at Stanford illustrating the polarization effect.<sup>25</sup> The transmission was circularly polarized with a North to West rotation. Presence of a received echo with a North to East rotation results when the transverse reflection coefficient differs from the longitudinal. The frequency was 23.1 mc, the date June 3, 1950.

for the lower radio frequencies, but is shorter than this zone, being proportional to  $v$  times the low-frequency echo duration.<sup>29-32</sup> In terms of these effective lengths, if we denote the high-frequency case by the subscript  $h$ ,

$$\frac{(\rho_{uh})_{\max}}{(\rho_{ul})_{\max}} = \frac{L_{uh}}{L_{ul}} \tag{18}$$

and

$$\frac{(\rho_{oh})_{\max}}{(\rho_{ol})_{\max}} = \frac{L_{oh}}{L_{ol}} \tag{19}$$

where  $L_{ul} = L_{ol} = F$ , one-half of the length of the principal Fresnel zone for both under-dense and over-dense trails at low-frequencies; and  $L_{uh} = Tv$  and

TABLE I

APPROXIMATE BEHAVIOR OF METEORS OF VARIOUS SIZES

Line Density $q$ Meters <sup>-1</sup>	Average Flux $m^{-2}s^{-1}$	Average Interval Between Meteors	Maximum Reflection Coefficient	Radar Cross Section Meter <sup>2</sup>	Theoretical Duration at 30 mc	Comments
$10^{17}$	$1.6 \times 10^{-15}$	16 hours	4.2	$13 \times 10^7$	4 hours	fireball
$10^{16}$	$1.6 \times 10^{-14}$	100 minutes	2.4	$4.2 \times 10^6$	25 seconds	0th magnitude
$10^{15}$	$1.6 \times 10^{-13}$	10 minutes	1.3	$1.3 \times 10^6$	2.5 second	visual losing effect
$10^{11}$	$1.6 \times 10^{-12}$	60 seconds	$\sim 0.5$	$0.2 \times 10^6$	0.5 second	5th magnitude, visibility limited
$10^{13}$	$1.6 \times 10^{-11}$	6 seconds	0.089	$6 \times 10^3$	0.5 second	
$10^{12}$	$1.6 \times 10^{-10}$	0.6 second	0.0089	60	0.5 second	10th magnitude
$10^{11}$	$1.6 \times 10^{-9}$	0.06 second	0.00089	0.6	0.5 second	
$10^{10}$	$1.6 \times 10^{-8}$	0.006 second	0.000089	0.006	0.5 second	15th magnitude
$10^9$	?	?	0.0000089	0.00006	0.5 second	beyond present radio limit

Note: The average interval between meteors is computed for an observed area of sky of  $10^4$  km<sup>2</sup>; the reflection coefficient was computed for a range of 150 km at a frequency of 30 mc.

meteoric speed and Fresnel zone size is assumed, and polarization enhancement, recombination if present, and destructive effects of winds on long-lasting trails are neglected. In interpreting the table, one must remember that the rates given are averages for incident particles. True rates will be modified by diurnal and seasonal effects, showers, etc. Detectable rates will be reduced because of aspect sensitivity effects. The times of occurrence of the individual meteors are completely random.<sup>27,28</sup> The radar cross section was computed for a range of 150 km and a wavelength of 10 meters; it is directly proportional to both range and wavelength. The echo duration was likewise computed for  $\lambda = 10$  meters. It is proportional to  $\lambda^2$ , neglecting still the effect of wind-caused trail disorganization.

For radar frequencies above about 100 mc the echo durations ( $\sim \lambda^2$ ) given above may become less than the time required for the meteor particle, traveling at speed  $v$ , to traverse the length  $2F \sim \lambda^{1/2}$  of the principal Fresnel zone. Thus the "effective length" of the scattering region is not related to the principal Fresnel zone as is the case

$L_{oh} = (4/\pi)QTv$ . Since the definition of reflection coefficient  $\rho$  was made with cylindrical targets in mind, it is perhaps better to speak of radar cross section when discussing the high-frequency case, where the reflecting region is concentrated immediately behind the meteor particle. The maximum radar cross sections for the under-dense and over-dense trails at high frequencies, assuming zero initial trail radius, are then given by

$$(\sigma_{uh})_{\max} = (Tv)^2 Q^2 \tag{20}$$

and

$$(\sigma_{oh})_{\max} = (4QTv/\pi)^2 (\pi Q/4\epsilon)^{1/2} \tag{21}$$

which may be compared with

$$(\sigma_{ul})_{\max} = F^2 Q^2 \tag{22}$$

and

$$(\sigma_{ol})_{\max} = F^2 (\pi Q/4\epsilon)^{1/2} \tag{23}$$

<sup>29</sup> V. R. Eshleman, "The effect of radar wavelength on meteor echo rate," IRE TRANS. ON ANTENNAS AND PROPAGATION, vol. AP-1, pp. 37-42; October, 1953.

<sup>30</sup> W. A. Flood, "Meteor echoes at ultra-high frequencies," J. Geophys. Res., vol. 62, pp. 79-91; March, 1957.

<sup>31</sup> G. S. Hawkins, "Radar echoes from meteor trails under conditions of severe diffusion," PROC. IRE, vol. 44, p. 1192; September, 1956.

<sup>32</sup> M. Loewenthal, "On Meteor Echoes from Underdense Trails at Very High Frequencies," Lincoln Lab., M.I.T., Lexington, Mass., Rep. No. 132; December, 1956.

<sup>27</sup> B. H. Briggs, "Observations of short bursts of signal from a distant 50 mc/s transmitter," J. Atmos. Terrest. Phys., vol. 8, pp. 171-183; 1956.

<sup>28</sup> T. J. Keary and H. J. Wirth, "The random occurrence of meteors in the upper atmosphere," J. Geophys. Res., vol. 63, pp. 67-75; March, 1958.

for the low frequency echoes. The expressions for  $\sigma$  in (20) to (23) are in each case given by the square of a length (the effective scattering-length) times a dimensionless quantity which is related to the scattering per unit length.

Echo durations at the higher radar frequencies are dependent on this scattering-length (a length of the trail immediately behind the meteor particle, from which scattering still takes place). A strong echo is produced as long as the scattering-length is moving between the two Fresnel zones on either side of the principal zone, whose lengths are equal to this scattering-length. The length of each of the two portions of the  $n$ th Fresnel zone is  $[n^{1/2} - (n-1)^{1/2}]F$ , or approximately  $F/(2n^{1/2})$ . The time of travel between the two portions of the  $n$ th zone, which are equally spaced from the specular reflection point, is  $2n^{1/2}F/v$ . Thus echo durations at high frequencies are given by this last expression, with the  $n$  determined by equating the scattering-lengths to the  $n$ th Fresnel zone length. The durations are<sup>33</sup>

$$T_{uh} = \frac{F^2}{Tv^2} \quad (24)$$

and

$$T_{oh} = \frac{\pi}{4Q} \frac{F^2}{Tv^2} \quad (25)$$

The shapes of the high-frequency echoes are expected to be approximately symmetrical relative to the time the meteor particle crosses the specular point. For example, a more detailed (but still approximate) analysis<sup>33</sup> has shown that

$$\sigma_{uh}(t) = \frac{(T\tau Q)^2}{1 + \left(\frac{2\pi T\tau^2}{F^2}\right)^2 t^2} \quad (26)$$

Thus  $T_{uh}$  in (24) is the interval during which the echo intensity exceeds  $(1 + \pi^2)^{-1/2}$ , or 10 per cent of its maximum value, or the time the echo amplitude exceeds about 30 per cent of its maximum value. Recall again, however, that at these high frequencies a very large further reduction in echo strength usually results because of the finite initial radius of the trail. In the under-dense case, the reduction factor in  $\sigma$  is  $\exp(-8\pi^2 r_0^2/\lambda^2)$  where  $r_0$  is the initial trail radius of  $14 l_i$ , or about  $3l_n$  with  $l_i$  the ionic mean-free-path, and  $l_n$  the molecular mean-free-path. No more than 40 db of loss will occur in this way, however.<sup>7</sup>

To determine the radio frequency or wavelength that marks the division between the low- and high-frequency regimes, we need only equate the scattering-lengths.

From  $L_{ul} = L_{uh}$ , the transitional wavelength for low-density trails is found to be  $(128\pi^4 D^2 R/v^2)^{1/3}$  where  $R$  is the range,  $D$  the diffusion coefficient. From  $L_{ol} = L_{oh}$ , the transitional wavelength for high-density trails is  $(8\pi^6 D^2 R/Q^2 v^2)^{1/3}$ . For average values of the various parameters, the transitional wavelength is about 3 m (a frequency of 100 mc) for under-dense trails, and progressively less than this value (frequencies greater than 100 mc) for increasing density in the over-dense trails.<sup>33</sup>

The under- and over-dense formulas for echo strength and duration yield the same values (i.e.,  $\sigma_{ul} = \sigma_{ol}$ ,  $\sigma_{uh} = \sigma_{oh}$ ,  $T_{ul} = T_{ol}$ , and  $T_{uh} = T_{oh}$ ) when  $Q$  has a value near unity. Thus  $Q \cong 1$ , or  $q \cong 10^{14}$  electrons per meter, marks the division between under-dense and over-dense trails for both low and high frequencies.

It is interesting to note that the expression for echo energy, as given by the product of echo intensity and duration, is independent of whether the frequency is above or below the transitional value between low and high frequencies; that is,  $\sigma_{ul} T_{ul} = \sigma_{uh} T_{uh}$  and  $\sigma_{ol} T_{ol} = \sigma_{oh} T_{oh}$ .

#### ECHO FADING AND TRAIL DISTORTION

The echo amplitude vs time functions that have been discussed so far do not take trail distortion effects into account. Exponential type echoes are generally of such short duration that wind effects on amplitude may be neglected. For the longer enduring echoes, however, the trail may deviate from a straight line by distances of the order of many wavelengths during the echo duration. These deviations result in the creation of additional "glints," or normal reflection points on the trail.<sup>10,34</sup> Since the wind velocity is in general different at each of the reflecting points, the received signal consists of several components having different Doppler frequency shifts. The observed fading results from the beating of the signal components.

The nature of the observed trail distortion effects can only be explained if the winds acting on the trail have certain definite properties. The velocities must range up to 70 or 100 m/s, and must be directed predominantly horizontally. Velocity vectors separated in altitude by about 6 km must show slight correlation in speed and direction, and there can be very little motion in turbulence of scale less than about a kilometer. These properties are identical to those found from photographic meteor trains; an example of such a profile as given by Whipple<sup>35</sup> is shown in Fig. 3. Winds with these characteristics will not distort a trail enough to produce a second normal reflection point, and so fading, until an average of 0.4 second after formation.<sup>23</sup> This early fading is generally regular and characterized by deep cusps as would be expected of a signal of two com-

<sup>33</sup> V. R. Eshleman, "Short-Wavelength Radio Reflections from Meteoric Ionization. Part 1: Theory for Low-Density Trails," Stanford University, Stanford, Calif., Rep. No. 5, Contract AF19(604)-1081; August, 1956.

<sup>34</sup> L. A. Manning, "The Fading of Meteoric Radio Echoes," paper read at the 12th General Assembly of URSI, Boulder, Colo.; August, 1957.

<sup>35</sup> F. L. Whipple, "Evidence for winds in the outer atmosphere," *Proc. Natl. Acad. Sci. U. S. A.*, vol. 40, pp. 966-972; October, 1954.

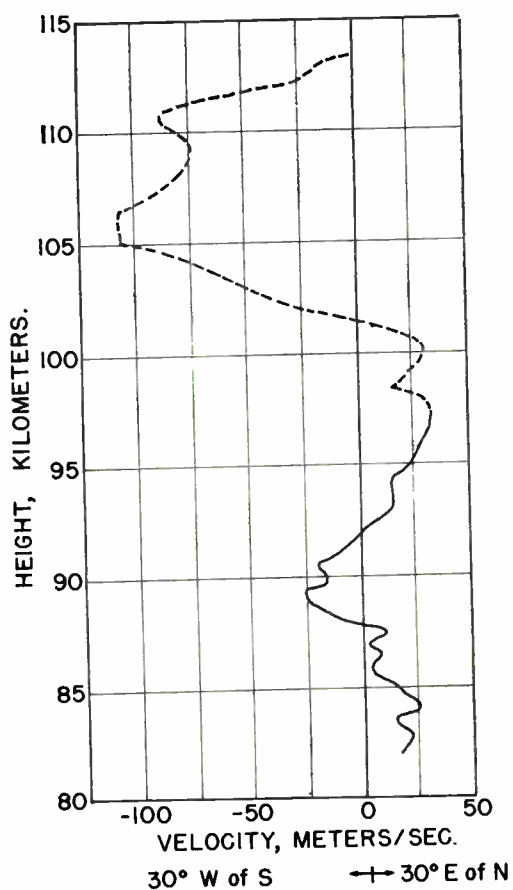

Fig. 3—A photographic wind profile recorded in New Mexico by Whipple<sup>36</sup> in March, 1953. Super-Schmidt meteor cameras were used to measure the wind drift and distortion of the glowing meteor trains.

ponent frequencies. As time advances, the number of glints on the trail increases because of the turning to the normal of sections of the trail at increasing distances from the original reflection point. As the number of glints goes up, so does the number of Doppler-shifted frequencies. The total bandwidth defined by the received components tends to go up with their number, since the Doppler shift at each glint is essentially a random sampling of wind velocity from a distribution of different velocities at different heights. Hence the fading speed, being proportional to the bandwidth, goes up on the average with the advance of time and the acquisition of new glints. It continues its rise until near the end of the echo duration. At that time, the effective length of trail becomes shorter and shorter, since the weaker ionization at the ends of the trail does not support an echo as long as does the stronger ionization near the center. This shortening of the trail quickly reduces the number of glints and so the fading frequency at the end of the echo. During the phase when the number of glints is increasing, however, the increased number of spectral components results in a change in the character of the fading. It becomes less similar to a rectified sinusoid and more Rayleigh in character. Because of the limited bandwidth, however, it generally continues to have a fairly well-defined apparent frequency.

It is a characteristic of the normal reflection geometry (consider, for example, the normals from a point to a sinusoidal curve as the amplitude of the sinusoid is gradually increased) that a glint first appears at a single point on a trail, but as the distortion of the trail becomes more pronounced, the glint divides into two adjacent glints. Since the two elements of such a pair of glints remain relatively close together in relation to the predominant wavelength of the trail distortion, the difference of velocity at two such points is relatively small. The two components of a split glint thus beat together and cause a resulting signal that may be looked upon as a single spectral component whose amplitude fades very slowly. The period of fading depends on the age of the glint, and may be as much as 30 times longer than that of the rapid fading. Since the echoes returned from long-enduring meteors are made up of a number of such slowly fading spectral components, it is often found that the typical rapid fading at, say, 5 or 10 cps, is modulated by a much more slowly varying fading envelope.

Before a meteor trail is distorted by winds, the whole of the echo appears to come from the single normal reflection point, or more correctly from the first Fresnel zone centered at that point. As the trail ages, additional glints appear. At first they are but a few kilometers from the original glint, but as time advances, they are found over an increasing length of trail. To the receiver, the ensemble-average trail looks like a randomly reradiating Gaussian aperture of steadily increasing length. When the trail reradiates as an aperture of some given width, the phase of the received fading pattern depends upon the position of the receiver on the ground. There is a diversity effect in reception. As time advances, and the width of the aperture increases, the required spacing between two receiving antennas to obtain a given degree of correlation between the fading patterns decreases. The minimum required spacing may be estimated from the trail length. The number and spacing of the glints have been determined in this way in conjunction with measurements of the change in fading rate.<sup>34,36</sup>

When a meteor first creates a trail, the echo can only be received if the geometry of specular reflection is met. Most meteors do not present the correct aspect for immediate detection at a given receiving site. As time advances, however, the wind shears and turbulence turn sections of the trail farther and farther from the initial orientation. As a result, the aspect sensitivity of detection is gradually lost. Usually 8 to 12 seconds are needed before the signal is scattered in all directions.<sup>37</sup> The interval after trail formation until the echo is detected ranges up to this limit for variations of the initial orien-

<sup>36</sup> B. Landmark, "The fading of long duration meteor bursts in forward scatter propagation," *J. Atmos. Terrest. Phys.*, vol. 12, pp. 341-342; July, 1958.

<sup>37</sup> D. W. R. McKinley and P. M. Millman, "A phenomenological theory of radar echoes from meteors," *Proc. IRE*, vol. 37, pp. 364-375; April, 1949.



tation of the trail from the specular condition of 0 to 90°. Because of this aspect sensitive behavior, most really long enduring echoes are detected, even though their aspect be arbitrary. They are relatively few in number compared with the brief specular echoes, however.

#### WIND MEASUREMENT

The initial location of the path of a meteor is quite independent of the conditions in the atmosphere. However, the ionization, once formed, is blown by winds, and its later motion is that of the air in which it is imbedded.<sup>38</sup> Most echoes of short duration give a signal only from the part of the trail near the point of initial normal reflection. Thus a simple Doppler frequency shift of the received echo is observed of magnitude

$$f = \frac{2u}{\lambda} \quad (27)$$

where  $f$  is the Doppler frequency shift, and  $u$  is the component of the wind drift velocity in the direction of the observing station. The velocity components are of magnitude up to 70 or more m/s, so that at a wavelength of 15 meters the typical Doppler frequency is between plus and minus 10 cps. Although a complete wind vector cannot be found from a single Doppler measurement, the average properties of the wind can be found by suitably combining the shifts from a sufficient number of meteors.

Suppose the radial velocity component of wind drift is measured for meteors observed over all azimuths and vertical angles of arrival. For those meteors observed in a given azimuthal direction  $\theta_m$ , the average observed velocity component  $[u]$  will be

$$[u] = [w][\sin i] \cos [\alpha] \cos (\theta_m - [\theta_w]) - [w][\cos i] \sin [\alpha] \quad (28)$$

where square brackets represent averages,  $[w]$  is the magnitude of the vector average wind speed,  $[\sin i]$  is the average of the sine of the angle of arrival of the meteor reflections, measured from the vertical,  $[\alpha]$  is the dip angle of the vector average wind, and  $[\theta_w]$  is the azimuth of the vector average wind.<sup>39</sup> It will be seen that the average radial velocity component varies sinusoidally with  $\theta_m$ , the azimuth of detection of the meteors. By plotting average Doppler shift vs the meteoric direction, the azimuthal direction, speed, and dip angle of the average wind at meteoric heights may be found. Height resolution may be achieved by measuring the height of the individual meteors going into the average. Typical vector average winds obtained in this way, averaged over the whole meteor region, are about 30

m/s with the vertical component being near zero. Diurnal and semidiurnal tidal components of wind velocity are found from measurements of this type.<sup>40,41</sup> In the northern hemisphere, the tidal components of the velocity vector rotate in a north to east sense, and have magnitudes in the range of 7 to 40 m/s. In the southern hemisphere the rotation is in the south to east sense. The number of meteors  $P$  that need to be used can be estimated from the approximate formula for the probable error,  $100/\sqrt{P}$  m/s for a sample containing mixed velocities. Thus several hundred meteors are required, unless the meteors can be selected to lie in a uniform velocity stratum.<sup>39</sup>

A somewhat different treatment of the radial velocity data may be used to estimate mean-square wind speeds. An average is taken over all azimuths, and the results plotted vs vertical arrival angle. For a fixed arrival angle, the mean-square radial velocity component is

$$[u^2] = \frac{1}{2}([\overline{w_h}]^2 + [\langle w_h \rangle]^2) - ([w_h]^2 + [\langle w_h \rangle]^2) - [w_v]^2 - [\langle w_v \rangle]^2 \cos^2 i \quad (29)$$

where square brackets indicate averages,  $[w_h] = [w][\sin i]$  is the mean horizontal wind component,  $[w_v] = [w][\cos i]$  is the mean vertical wind component,  $\langle w_h \rangle$  is the difference between the actual instantaneous horizontal wind speed and the mean wind  $[w_h]$ ,  $\langle w_v \rangle$  is the difference between actual and mean vertical winds, and  $i$  is the vertical arrival angle.<sup>39</sup> If  $[u^2]$  is plotted vs  $\cos^2 i$  a linear plot results. Its  $i=0$  and  $90^\circ$  ordinates lead to values of the vertical and horizontal mean-square winds. The chief problem in the application of this method is in obtaining accurate values of the arrival angle. Ideally, the angle of arrival should be measured. Since such measurements are difficult to make over all azimuths as well as over a considerable range in vertical angle, use has been made in practice of an approximate estimate of angle based upon range. If the reflection height  $h$  is assumed to be known,  $\cos i = h/R$ . Thus mean-square radial velocity as given by (29) may be plotted vs  $(h/R)^2$ , where  $h$  is assumed. The results contain some uncertainty with respect to the vertical wind component, but do show it to be much less than the root-mean-square horizontal velocity. In Fig. 4 is shown an experimental plot of this type.

#### TRAIL FORMATION AND FRESNEL EFFECTS

So far we have discussed the echo returned from a fully formed trail but have said little about the echo during trail formation, except with reference to VHF echoes. Consider now the situation at lower frequencies where the time taken for radial diffusion comparable to the wavelength is long compared to the times in-

<sup>38</sup> L. A. Manning, O. G. Villard, Jr., and A. M. Peterson, "Meteor echo study of upper atmosphere winds," *Proc. IRE*, vol. 38, pp. 877-883; August, 1950.

<sup>39</sup> L. A. Manning, A. M. Peterson, and O. G. Villard, Jr., "Ionospheric wind analysis by meteoric echo techniques," *J. Geophys. Res.*, vol. 59, pp. 47-62; March, 1954.

<sup>40</sup> J. S. Greenhow, "Systematic wind measurements at altitudes of 80-100 km using radio echoes from meteor trails," *Phil. Mag.*, vol. 45, pp. 471-490; May, 1954.

<sup>41</sup> W. G. Elford and D. S. Robertson, "Measurements of winds in the upper atmosphere by means of drifting meteor trails," *J. Atmos. Terrest. Phys.*, vol. 4, pp. 271-284; 1953.

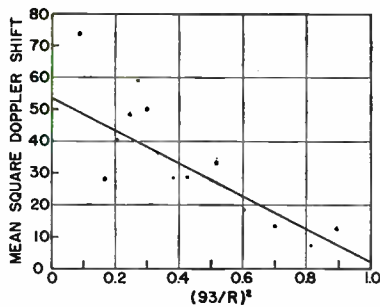

Fig. 4—Mean-square body-Doppler shift caused by wind motion vs  $(93/R)^2 = \sin^2 \alpha$ , where  $\alpha$  is the elevation angle of the ray to the meteor, and  $R$  is the slant range. The curve, based on 330 echoes recorded by Manning, Peterson, and Villard, on July 27, 1949, from 0230 to 0500 LST, demonstrates the wind velocities to be predominantly horizontal. The frequency was 23.1 mc.

involved in trail formation. The strength of the echo is then greatly influenced by phase addition effects. Because little radial diffusion need be considered, the dominant property of the ionization column is its rapidly increasing length. For an under-dense trail, the integration over the ionization containing volume  $V$  of (4) reduces to an integration of the trail length. Evaluation of this integral may be made with the time parameter taken as zero at the moment the meteor reaches the specular reflection point. With suitable neglect of second-order quantities, the signal strength is found to be expressible in terms of Fresnel integrals. In complex form the reflection coefficient of a weakly ionized trail during formation is found to be

$$\rho_{ul}(t) = \frac{Q}{\sqrt{2}} \left\{ \left[ \frac{1}{2} + C(\sqrt{2}vt/F) \right] + i \left[ \frac{1}{2} + S(\sqrt{2}vt/F) \right] \right\} \quad (30)$$

where  $C$  and  $S$  are the cosine and sine Fresnel integrals,  $v$  is the meteor speed,  $R$  is the perpendicular range, and  $Q$  and  $F$  are defined by (6) and (7).<sup>42</sup> When plotted with time as parameter, (30) takes the form of a Cornu spiral.<sup>12</sup> The arc length measured from  $t=0$  is equal to the argument of the integrals. The magnitude of the received signal varies with time as the radial coordinate of the Cornu spiral. At  $t=0$  the ratio  $d|\rho|/dt$  to  $|\rho|$ , the slope of the amplitude normalized by the amplitude, is  $v/\sqrt{2}F = V/\sqrt{\lambda R}$ ; it is a measure of the rate of echo build-up, and may also be used to estimate the velocity in a rough sort of way. Velocity may be more accurately estimated by noting the period of the fluctuations in phase or amplitude associated with the initial or final coil of the Cornu spiral. By beating the received echo with a wave of transmitted frequency, the phase oscillations of the initial spiral may be scaled as amplitude fluctuations. Except very near  $t=0$ , the frequency of amplitude fluctuations is given by  $f = 2v^2t/\lambda R$ , where  $v$  is the meteoric velocity, and  $R$  is the perpendicular

range to the trail. Thus velocity can be found if the rate of change of fluctuation-frequency and range are scaled. The observed fluctuation frequencies range up to several kilocycles for a 30-mc carrier. They are of largest amplitude when the trail is near specular aspect, so that the observations are weighted towards the lower frequencies. Since the fluctuations are at audio frequencies, they are often called "meteor whistles." They are also known as "diffraction fluctuations."

If Doppler beat records are made in two receiver channels with high-amplitude beating voltages in 90° phase-quadrature, the resulting amplitude waveforms are the rectangular components of the Cornu spiral. To obtain all the information in an echo, it is necessary to use such a "double Doppler" recording system or its equivalent.<sup>12,39</sup>

Measured meteor speeds fall within the limits imposed on meteors as members of the solar system. No meteor can strike the earth with a relative velocity greater than 72 km/s, since particles of higher energy would not be held to elliptical orbits by the sun's gravitational field. Nor can the speed of a meteor on entering the earth's atmosphere be less than the earth's escape velocity of about 11.3 km/s. The mean observed speeds are highest in the early morning, lowest in the late afternoon. Extensive measurements by McKinley<sup>42</sup> may be used to estimate the velocity distribution of the larger meteors vs time of day for each month of the year. A sample distribution, based on his results, is shown in Fig. 5. If a single figure is to be used for meteoric speeds, 40 km is probably a representative value. It should be noticed that the velocity distributions for the larger meteors are influenced heavily by the major meteor showers. The seasonal behavior of small meteors may be quite different.

The Fresnel integral theory of trail formation contains approximations that are valid when the meteor is near the point of perpendicular reflection but which yield incorrect answers if the trail is viewed more nearly end on. For example, the Fresnel formulas imply that the length of the higher order zones approach zero. In fact, the lengths approach  $\lambda/4$  as a limit. This difference is usually not important since the contributions of adjacent higher-order Fresnel-zones annul themselves. However, if a weakly ionized trail is viewed end-on during formation, the sudden discontinuity in line density at the point of formation leads to an unannulled signal whose reflection coefficient is

$$\rho_{ul} = Q\sqrt{\lambda/8\pi^2 R} \quad (31)$$

Thus some signal can be obtained from a weakly ionized trail during formation regardless of orientation, although the level may be down more than 60 db (if  $\lambda = 10$  meters,  $R$  about 100 km) compared with the normal reflection coefficient. Experimentally, it has been found for some meteors that a "head echo" varying in range with the position of the meteoric particle is observable at angles far from the normal reflection condition, but

<sup>42</sup> D. W. R. McKinley, "Meteor velocities determined by radio observations," *Astron. J.*, vol. 113, pp. 225-267; March, 1951.

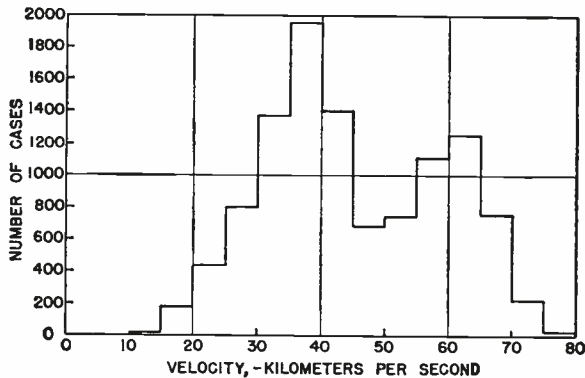

Fig. 5—Histogram showing the distribution of meteor velocities as measured by McKinley.<sup>42</sup> The plot shows the combined results for all hours, on selected days each month from December 10, 1948, through March 18, 1950.

with signals that are removed in strength from the burst value by *much* less than 60 db. These head echoes are found for meteors with line density above the scatter theory limit of  $q=10^{14}$  electrons per meter. As yet no exact analysis of the reflection mechanism has been made for these dense trails when viewed end-on. McKinley has suggested that the relatively high reflection coefficient that is observed is produced by an ultraviolet-light caused, moving ball of ionization surrounding the meteoric particle.<sup>37</sup> No conclusive evidence exists on this point.

#### RADIANTS AND THE NUMBER OF METEORS

Most of our present knowledge of the rate of meteoric incidence and of the orbits in which the particles travel about the sun has resulted from radio studies. In addition to its importance to astronomy, this information is useful in estimating the information capacity and directional characteristics of meteor-burst and ionospheric scatter communication circuits.

The basic method of studying the relation between rate and line density is to count the echoes on a radar as the system sensitivity is varied. It is then necessary to estimate line density from the system parameters using the formula appropriate to either the under-dense or over-dense case, depending upon whether the observed reflection coefficient  $\rho$  is less or greater than unity. In some of the early work the fact that echo amplitude varies with line density as  $q$  in the former case, but  $q^{1/4}$  in the latter, was overlooked. At present it appears, however, that a rate law  $n \sim 1/q$  applies to sporadic meteors over the range of  $q$  from about  $10^{10}$  to perhaps  $10^{16}$  electrons per meter, where  $n$  is the number of trails of line density  $q$  or greater. The upper limit of about  $q=10^{16}$  corresponds to 0th magnitude meteors, while the lower limit of  $q=10^{10}$  is at the limit of present measurements technique—about the 15th magnitude.<sup>4</sup>

In the case of meteors of magnitude greater than 15, nothing is known until the particle size decreases to that of the micro-meteorites,<sup>5</sup> of 20th magnitude and above. These particles have linear dimensions less than 10 microns, or thereabouts. Because of their high ratio of sur-

face to volume, they are quickly stopped by the atmosphere without being destroyed, and probably with the production of very little ionization; they then gradually drift down towards the earth. Micro-meteorites are most directly studied by noting their impingement on the surface of high flying rockets.

The distribution in size of shower meteors is not in accord with the inverse-line-density rate-law. Most of the well-known showers produce considerable increases in the rates for visual meteors, magnitude five and less, but little change in the rate of arrival of the smaller radar meteors.<sup>43</sup> A commonly held view is that the sporadic rate is a result of the superposition of many weak and unidentified showers. If this viewpoint is correct, these component showers do not share the restriction to large particle size characteristic of the known visual showers.

In (1) was given an average rate of meteoric incidence. Actually the rate of meteoric arrival varies with time of day and season of the year. The most important single factor controlling the diurnal and seasonal variations in numbers and apparent directions at a particular geographic location is the geometrical relationship between this location and the apex of the earth's way (the direction of the velocity of the earth in its orbit). During the morning hours an observer is on the leading side of the earth as it sweeps through the interplanetary dust at 30 km/s. The rate of influx of meteors is maximum at this time. During the evening hours the observer is on the trailing side of the earth and the meteor rate is at the diurnal minimum. The resulting diurnal variation in rate is evident in the plot of Fig. 6. There is a seasonal variation in rate (maximum near the autumnal equinox and minimum near the vernal equinox) because of the tilt of the earth's axis from the pole of its orbit. As the latitude of an observer increases, the amount of the diurnal variation decreases, and the amount of the seasonal variation increases. When the apex is overhead, the meteoric arrival rate tends to be about fifty times higher than when the anti-apex is overhead. In addition to the above variations there appears to be an increase in meteor rate during June and July because of a grouping in the number of meteor orbits crossing the corresponding parts of the earth's orbit.<sup>44</sup>

The variations in the rate of detection of meteor trails by radar depend upon the detailed radiant distribution as well as the changes in total influx rate. Because strong echoes are obtained only when the ray from the radar meets the trail at right angles, the echo rate may be strongly dependent upon the antenna beam direction. If the meteor radiants are concentrated toward the apex of the earth's way, a directional radar antenna in mid-

<sup>43</sup> L. C. Browne, K. Bullough, S. Evans, and T. R. Kaiser, "Characteristics of radio echoes from meteor trails. II: The distribution of meteor magnitudes and masses," *Proc. Phys. Soc. B*, vol. 69, pp. 83-97; 1956.

<sup>44</sup> G. S. Hawkins, "A radio echo survey of sporadic meteor radiants," *Monthly Notices Roy. Astron. Soc.*, vol. 116, pp. 92-104; 1956.



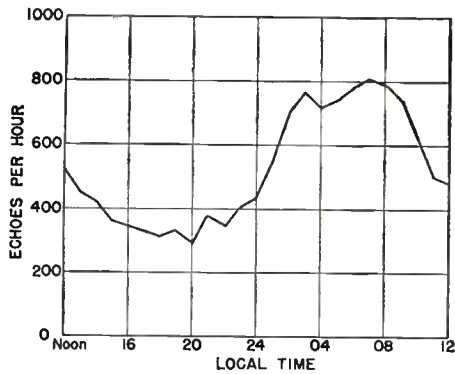

Fig. 6—Example of the diurnal variation of meteor arrival rate using an effectively nondirectional antenna. The observations were made at Stanford, Calif., with a 38-mc radar having 20-kw peak power, on September 12, 1956.

northern latitudes should be pointed north at 0600 local time, east at 1200, south at 1800, and west at 2400 for maximum echo detection rate;<sup>45</sup> in mid-southern latitudes, interchange north and south in the previous statement.

With a pencil-beam antenna as a part of a radar in mid-latitudes, the beam elevation angle for maximum total echo rate at any azimuth is about 20°, although the maximum rate per unit slant range would be obtained for an elevation angle of about 45°. Measurements confirm these predicted directional characteristics. The directional properties of meteor echoes are important in the application of meteor scatter to radio communications, as discussed in the next section.

While the apex concentration of meteor radiants accounts for the gross features of the directional characteristics of meteor detection, recent radio measurements at Jodrell Bank<sup>46</sup> show that there are also radiant concentrations along the ecliptic at about  $\pm 60^\circ$  from the apex. These radiants are grouped toward the ecliptic plane, while those near the apex show little concentration in the ecliptic. It now appears from these measurements that the more eccentric meteor orbits encountered by the earth are direct and confined near the ecliptic plane, while many of the smaller particles are in nearly circular orbits with inclinations grouped near 60° (direct orbits) and near 120° (retrograde orbits). Davies<sup>46</sup> suggests that the percentage of meteors in the tilted circular orbits increases for the smaller particles due to the Poynting-Robertson effect.

#### FORWARD-SCATTERING FROM METEOR TRAILS

Radio signals forward-scattered from meteor trails can be received at distances up to about 2200 km from the transmitting site. Studies of meteor echoes propagated over long paths have led to an understanding of

the sometimes dominant role played by meteoric ionization in ionospheric scatter communications.<sup>1,45,47-53</sup> In addition, these studies have led to the development of a new technique of radio communication based upon the intermittent bursts of received signal strength propagated by meteor trails.<sup>53</sup> Extremely interesting techniques for attaining reliable and relatively secure<sup>54-56</sup> extended-range communications at frequencies from about 30 to 300 mc have resulted from this work.

When the receiver is separated from the transmitter, the geometry of meteor reflection is changed. The condition for specular reflection is no longer that the ray from the radar site meet the trail at right angles—it is rather that the angle with the trail of the rays to the transmitter and receiver be supplementary. Thus a trail illuminated from a fixed direction scatters the incident radiation in a hollow cone-shaped beam; the axis of the cone is the trail axis.

For the radar geometry the center of the principal Fresnel zone is at the point of tangency of the trail axis and a sphere centered at the common transmitter and receiver. For forward scatter the principal Fresnel zone center is at the point of tangency of the trail and a prolate spheroid whose two foci are at the transmitter and distant receiver. The half-length of the first Fresnel zone for back-scatter is  $F = \sqrt{\lambda R/2}$ , while for forward-scatter it is

$$F_f = \left[ \frac{\lambda R_1 R_2}{(R_1 + R_2)(1 - \sin^2 \phi \cos^2 \beta)} \right]^{1/2} \quad (32)$$

where  $R_1$  and  $R_2$  are the ranges from the transmitter and receiver to the meteor trail,  $2\phi$  is the included angle between  $R_1$  and  $R_2$ , and  $\beta$  is the angle between the trail axis and the plane of propagation.<sup>1,17</sup> Note that if a meteor trail is aligned normal to the transmitter-receiver base-line ( $\beta = 90^\circ$ ) and is equidistant from these two

<sup>47</sup> D. K. Bailey, R. Bateman, L. V. Berkner, H. G. Booker, G. F. Montgomery, E. M. Purcell, W. W. Salisbury, and J. B. Wiesner, "A new kind of radio propagation at very high frequencies observable over long distances," *Phys. Rev.*, vol. 86, pp. 141-145; April, 1952.

<sup>48</sup> O. G. Villard, Jr., A. M. Peterson, L. A. Manning, and V. R. Eshleman, "Extended-range radio transmission by oblique reflection from meteoric ionization," *J. Geophys. Res.*, vol. 58, pp. 83-93; March, 1953.

<sup>49</sup> D. W. R. McKinley, "Dependence of integrated duration of meteor echoes on wavelength and sensitivity," *Can. J. Phys.*, vol. 32, pp. 450-467; July, 1954.

<sup>50</sup> W. J. Bray, J. A. Saxton, R. W. White, and G. W. Luscombe, "VHF propagation by ionospheric scattering and its application to long-distance communication," *Proc. IEE*, vol. 103, pt. B, pp. 236-260; March, 1956.

<sup>51</sup> D. K. Bailey, R. Bateman, and R. C. Kirby, "Radio transmission at VHF by scattering and other processes in the lower ionosphere," *Proc. IRE*, vol. 43, pp. 1181-1231; October, 1955.

<sup>52</sup> P. A. Forsyth and E. L. Vogan, "Forward-scattering of radio waves by meteor trails," *Can. J. Phys.*, vol. 33, pp. 176-188; May, 1955.

<sup>53</sup> Meteor Papers in *Proc. IRE*, vol. 45; December, 1957.

<sup>54</sup> P. A. Forsyth, E. L. Vogan, D. R. Hansen, and C. O. Hines, "The principles of Janet—a meteor-burst communication system," *Proc. IRE*, vol. 45, pp. 1642-1657; December, 1957.

<sup>55</sup> O. G. Villard, Jr., A. M. Peterson, L. A. Manning, and V. R. Eshleman, "Some properties of oblique radio reflections from meteor ionization trails," *J. Geophys. Res.*, vol. 61, pp. 233-249; June, 1956.

<sup>56</sup> J. P. Casey and J. A. Holladay, "Some airborne measurements of VHF reflections from meteor trails," *Proc. IRE*, vol. 45, pp. 1735-1736; December, 1957.

<sup>45</sup> O. G. Villard, Jr., V. R. Eshleman, L. A. Manning, and A. M. Peterson, "The role of meteors in extended-range VHF propagation," *Proc. IRE*, vol. 43, pp. 1473-1481; October, 1955.

<sup>46</sup> J. G. Davies, "Radio observation of meteors," *Advances in Electronics and Electron Physics*, Academic Press, New York, N. Y., vol. 9, pp. 95-128; 1957.

terminals ( $R_1 = R_2$ ), the Fresnel zone length is the same for the oblique path as for an equivalent radar path. If the meteor trail is aligned parallel to the base-line, however, the Fresnel zone length is augmented by  $\sec \phi$ , a factor which may be more than five for a long path. The increase in Fresnel zone length results in a proportional increase in echo amplitude for low frequencies, and in a rise in the transition frequency separating the low- and high-frequency formulas.

In addition to the possible lengthening of the Fresnel zone associated with oblique meteor reflection, the geometrical factors lead to a change in the effective wavelength in the formulas describing the reflection process. The formulas for the radar cross sections and echo durations of under-dense trails given in (16), (20), (22), (24), and (26) will apply to the forward-scatter case when  $F$  of (6) is changed to  $F_f$  of (32) and  $T$  of (8) is changed to  $T_{uf} = T \sec^2 \phi$ . The formulas for over-dense trails, (17), (21), (23), and (25) will apply to the forward-scatter geometry when  $F$  is changed to  $F_f$  and the  $T$  of (8) is changed to  $T_{of} = T \sec^m \phi$ , where  $m = 2$  for undistorted along-the-path trails, and  $m = 0.3$  for undistorted across-the-path trails.<sup>57,58</sup> In addition there is a new polarization factor in the expressions for echo cross section given by  $\sin^2 \alpha$ , where  $\alpha$  is the angle between the electric vector of the incident wave at the trail and the line  $R_2$ . When the above changes are made in the expression for the transitional wavelength between the low- and high-frequency formulas, it can be shown that the change-over in formulas for long paths and under-dense trails should be made at an average wavelength of 0.5 m for across-the-path trails ( $\beta = 90^\circ$ ) and 1.5 m for along-the-path trails ( $\beta = 0$ ).<sup>33</sup>

The most important effect of the oblique geometry on echo characteristics is the increase in duration of the low-frequency echoes from under-dense trails.<sup>1,17</sup> This multiplication of echo duration greatly increases the available information capacity of a long meteor propagation path in comparison with that apparent at back-scatter. While measured echo durations are greater for oblique paths than for the radar geometry, the actual increase may be less than the theoretical values of the factor  $\sec^2 \phi$ , which is as great as 25 for long paths.<sup>59</sup>

For over-dense trails the Fresnel zone length is increased as described above, with corresponding changes in echo amplitude and transition frequency. However, the average increase in echo duration for low-frequencies is less than for the under-dense trails as indicated by the values of  $m$  in  $\sec^m \phi$  listed above. A mean exponent  $m$  of 1.13 has been found experimentally by McKinley and McNamara.<sup>58</sup>

<sup>57</sup> L. A. Manning, "Oblique echoes from over-dense meteor trails," *J. Atmos. Terrest. Phys.* (In press.)

<sup>58</sup> D. W. R. McKinley and A. G. McNamara, "Meteoric echoes observed simultaneously by back-scatter and forward-scatter," *Can. J. Phys.*, vol. 34, pp. 625-637; July, 1956.

<sup>59</sup> V. R. Eshleman, P. B. Gallagher, and R. F. Młodnosky, "Meteor Rate and Radiant Studies," Stanford University, Stanford, Calif., Final Rep., Contract AF 19(604)-1031; February, 1957.

From the above discussion of the effects of oblique geometry on Fresnel zone length and equivalent wavelength, it follows that at high frequencies the radar cross sections are increased, and the average echo durations are decreased when going from the radar to the oblique geometry. The increase in echo intensity with obliquity is greater than for the low frequencies, and the decrease in echo duration averages less than the increase in duration at the low frequencies.

For applications of meteoric forward-scatter to long-range VHF communications, it is important to study not only the echo intensities and durations but also the echo rates. The rate of detection depends upon both the system parameters and the rate and radiant distributions of the incoming particles.<sup>1,14-16</sup> Of particular importance is a consideration of the product of the echo duration by the number of trails oriented to produce an echo for each area of the meteor region.

The duration increase factor for low frequencies is always highest at the path midpoint, and reaches its maximum possible value at the limiting path length. This suggests that the antenna beams at the transmitter and receiver should illuminate the meteor region (approximately 93 km high) somewhere near the path midpoint to maximize the received duty cycle. However, very few echoes can be obtained near the exact midpoint, since the specular reflection condition then requires the meteor to come in parallel to the earth's surface. Very few of the required horizontal trails are produced since the earth's surface presents a very small target when seen edge on. For a uniform radiant distribution over the celestial hemisphere, the maximum fraction of the produced trails which are oriented for detection over an oblique path occurs for positions in the meteor plane which lie near an ellipse. The major axis of the ellipse lies along the path and is slightly greater in length than the transmitter-receiver line; the length of the minor axis is twice the average meteor height. The product of number and duration for such a uniform radiant distribution is, thus, maximum in two regions or "hot spots" in the meteor plane whose centers lie equidistant from the transmitter and receiver and somewhat less than 100 km to either side of the path midpoint. The product of number and duration is minimum directly over the path midpoint.

When the diurnal variations in meteor rates and radiants discussed in the previous section are taken into account, the two lateral hot-spots of echo number-duration product change in strength, shape, and position.<sup>15</sup> These changes are such that for maximum meteoric scatter over an east-west path in mid-northern latitudes, the antenna beams at transmitter and receiver should be directed north of the great circle bearing for the hours centered on 0600 and south of the direct bearing for the hours centered on 1800 local time. For a north-south path, the favored bearing is west of the direct path at night and east of the direct path during the day. The optimum off-path bearing varies

from a few degrees to as much as  $30^\circ$ . For oblique paths in mid-southern latitudes, interchange north and south in the above statements.

The directional characteristics mentioned above are of obvious importance for optimizing the information capacity of meteor burst communication circuits. Measurements of arrival angle show that at times one side of the path may have as many as ten times more meteors oriented for specular reflections as does the other side.<sup>15,60,61</sup> Recent measurements<sup>62,63</sup> of the direction of arrival of continuous VHF ionospheric scatter circuits show diurnal off-path variations similar to those predicted from meteor burst studies (see Fig. 7). The results thus demonstrate that meteoric ionization supports this type of scatter propagation during most of diurnal period.

### CONCLUSIONS

Hundreds of papers have treated meteoric effects during the past decade, leading to a remarkably good understanding of the subject. Here it has only been possible to give a skeletal outline of the principal fields of study together with a very partial bibliography. Despite the great amount of work that has been done, there remain a number of relatively untouched problems.

Studies of the rates of arrival of the smaller meteors, and of their radiants, have only been made on a relatively coarse basis, and for short intervals of time. We do not know to what extent the day to day variations in meteor rates are repeated from year to year. Similarly, studies of trail distortion and turbulence now appear to explain satisfactorily the mechanics of echo production, but little has been done to learn about the seasonal or height variations in turbulent structure.

<sup>60</sup> W. R. Vincent, R. T. Wolfram, B. M. Sifford, W. E. Jaye, and A. M. Peterson, "Analysis of oblique path meteor-propagation data from the communications viewpoint," *Proc. IRE*, vol. 45, pp. 1701-1709; December, 1957.

<sup>61</sup> K. Enderson, T. Hagfors, B. Landmark, and J. Rödsrud, "Observations of angle of arrival of meteor echoes in VHF forward-scatter propagation," *J. Atmos. Terrest. Phys.*, vol. 12, pp. 329-384; July, 1958.

<sup>62</sup> V. C. Pineo, "Off-path propagation at VHF," *Proc. IRE*, vol. 46, p. 922; May, 1958.

<sup>63</sup> K. L. Bowles, "Ionospheric forward scatter," *Ann. IGY*, vol. 3, pt. 4, pp. 346-357; 1957.

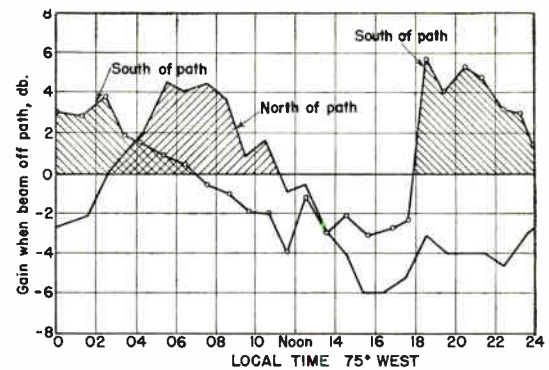

Fig. 7—The change in signal level when the Cedar Rapids–Sterling ionospheric-scatter transmission was received with the receivers located to utilize the hot spots for specular meteor reflection, rather than the path midpoint. During most of the day, the specular meteor signal dominated (cross-hatched area). Data by Pineo,<sup>62</sup> January, 1956.

Such studies hold great promise in attempts to understand the dynamics of the lower *E* region. Insufficient study has been given to the physics of trail formation, and the mechanism of ionization production. Studies are needed of the effect of the slowly recombining meteoric ions as a constituent of the *E* region, and of their distribution in the presence of wind shears.

Despite the observations of strong moving or "head" echoes associated with over-dense trails, no theory has been developed to explain the echoing process from such a trail, nor to assess the importance of rapidly recombining ultraviolet formed ionized air in the vicinity of the glowing particle. Meteoric theory and observations likewise fail to indicate in detail the effect of meteoric ionization at low and very low frequencies. More attention should be given to the effects of fragmentation<sup>64</sup> of meteoric particles on radio echoes and the relation between the rate of arrival of small meteors and the condensation nuclei important in the production of rainfall.<sup>65</sup> Until these and other similar problems are solved, meteoric studies must remain an active field of investigation.

<sup>64</sup> L. G. Jacchia, "Fragmentation as the cause of the faint-meteor anomaly," *Meteors* (Spec. Suppl.), *J. Atmos. Terrest. Phys.*, vol. 2, pp. 36-42; 1955.

<sup>65</sup> E. G. Bowen, "The influence of meteoritic dust on rainfall," *Aust. J. Phys.*, vol. 6, pp. 490-497; 1953.



# Atmospheric Whistlers\*

R. A. HELLIWELL†, SENIOR MEMBER, IRE, AND M. G. MORGAN‡, SENIOR MEMBER, IRE

**Summary**—A general description of atmospheric whistlers is given. Their discovery, and the development and proof of a theory to explain them, are reviewed. The IGY synoptic program of study is described and examples of results, both individual and statistical, are presented and discussed.

## INTRODUCTION

WHISTLERS result from the dispersive propagation over very long paths of very low frequency (a few thousand cycles) electromagnetic waves radiated by lightning impulses. Through the action of free electrons in the outer ionosphere they are believed to follow horseshoe-shaped paths defined by the earth's magnetic field. Traveling from one hemisphere to the other in times of the order of 1 second, whistlers can be heard to echo back and forth up to twenty times or more. With each successive bounce the whistler increases in duration because of the added dispersion. A typical path of propagation is shown by the dashed line in Fig. 1, which is a plot of the earth's dipole field. The idealized frequency-time behavior of whistlers produced by a single impulse, as observed at opposite ends of the path, is sketched in Fig. 2. In the hemisphere of the originating impulse the time delays at any given frequency are in the ratios 2:4:6: etc., while in the opposite hemisphere the ratios are 1:3:5: etc.

Since whistler time-delays depend on the integrated ionization density and earth's magnetic field strength encountered, they became a potentially powerful tool for investigating the outer ionosphere, or exosphere, which is inaccessible by conventional sounding techniques. This relatively enormous region of space around the earth, extending perhaps 5 to 10 earth radii beyond the earth's surface, is thought to play a vital role in the development of magnetic storms and auroras, the details of which still remain among the outstanding mysteries of the upper atmosphere.

It has been the purpose of the IGY synoptic program on whistlers and VLF emissions<sup>1</sup> to provide the data which will lead to a better understanding of these phenomena and eventually to new knowledge of the exosphere. Simultaneous and regular observations have been made at many stations scattered over the earth and the data stored on magnetic tape for future analysis. Firm conclusions from such a study cannot, of course, be reached until all the data have been reduced. Our

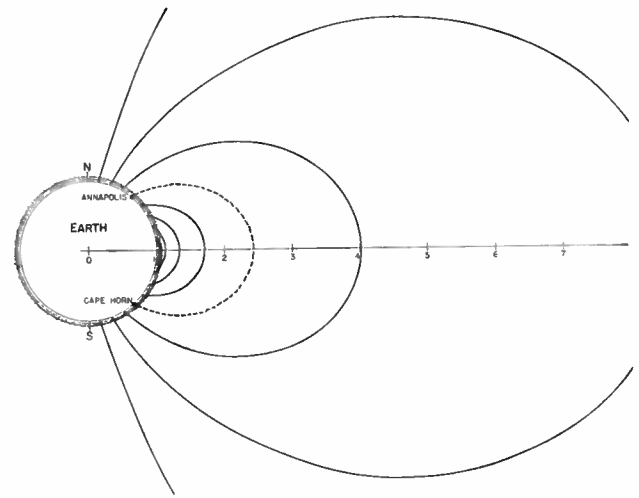

Fig. 1—Earth's dipole field showing postulated VLF propagation path between Annapolis and Cape Horn; shaded region near the earth represents known ionosphere.

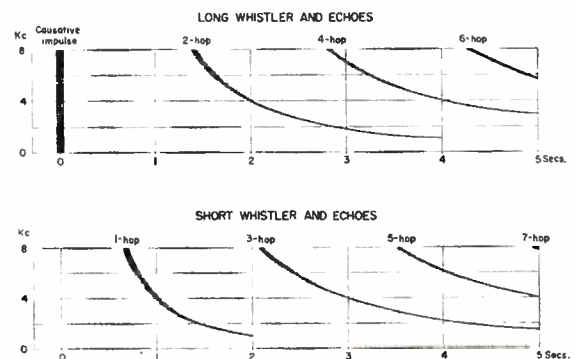

Fig. 2—Idealized whistler echo trains at opposite ends of a line of force.

purpose at this time therefore must be limited to illustrating the results which are being obtained and indicating the direction in which the work seems to be leading.

We shall review briefly the history of atmospheric whistlers, outline their elementary theory and possible applications, describe the IGY synoptic program, and present some illustrative results. It should be emphasized that one of the primary objectives of the whistler program is a better understanding of whistlers themselves, for only when the essential features of whistler phenomena are understood can they be used as a tool in the exploration of the outer ionosphere.

## HISTORICAL REVIEW

Whistlers were first reported by Barkhausen who ob-

\* Original manuscript received by the IRE, December 15, 1958.

† Stanford University, Stanford, Calif.

‡ Thayer School of Eng., Dartmouth College, Hanover, N. H.

<sup>1</sup> "VLF emissions" are very low frequency noises which are closely associated with magnetic disturbance and sometimes with whistlers. They are treated by R. M. Gallet, this issue, p. 211.

served them in 1919 while eavesdropping on Allied telephone conversations during World War I.<sup>2,3</sup> The association of whistlers with atmospheric clicks (sferics), the occurrence of echo trains, and a positive correlation between their rate of occurrence and solar activity were reported by Eckersley of the Marconi Co., in 1928.<sup>4</sup> In 1931 he reported an observation by Tremellen indicating association of whistlers with visible lightning.<sup>5</sup> The first quantitative measurement of the frequency-time relation in a whistler was made by Burton and Boardman, from a whistler recorded in Ireland.<sup>6</sup> From the magneto-ionic theory which had then just recently been developed, Eckersley obtained a dispersion law which explained the variation of whistler-frequency with time, and he demonstrated that Burton and Boardman's published analysis agreed closely with his new dispersion theory.<sup>7</sup>

Interest in whistlers then lagged for about 15 years until Storey began his doctoral studies at Cambridge University in 1951.<sup>8</sup> Storey made a detailed experimental study of whistlers and related sferics. He identified "short" whistlers which were not associated with loud clicks, and "long" whistlers which were always preceded by a loud click. The time delays for "short" and "long" whistlers were found to have the ratios 1:3:5: etc. and 2:4:6: etc., respectively, as illustrated in Fig. 2. From spectrum analysis, he was able to show that multiple whistlers were of two types. In the first, or multiple-flash type, each whistler appeared to originate in a distinct sferic. In the second, called multiple-path, each whistler appeared to originate in the same lightning discharge. Storey concluded that in the latter case they must have followed separate paths of propagation.

From a theoretical study of the ray paths, Storey discovered that whistler energy should be guided approximately by the lines of force of the earth's magnetic field. This led Storey to postulate that the path of propagation was indeed along the lines of force of the earth's magnetic field, a picture which was in complete accord with his experimental results even though it required a minimum electron density of 500/cc at the crest of the path in the exosphere, a value considerably higher than had been generally accepted. In addition, Storey showed a

positive correlation between the critical frequency of the F<sub>2</sub> layer and whistler dispersion, suggesting a common controlling factor.

The simultaneous observation of whistlers at spaced stations was begun by Helliwell in 1951 at Stanford and Seattle. About 25 per cent of the whistlers observed were coincident at the two stations, whose separation (1120 km) corresponded to the area coverage predicted by Storey.<sup>9</sup> His predicted relation between sferics in the southern hemisphere and short whistlers in the northern hemisphere was confirmed by Helliwell in 1954.<sup>10</sup> Simultaneous observations of whistler echo trains at Unalaska and at Wellington and Dunedin, New Zealand, near its geomagnetic conjugate point, were made in 1955 by Morgan and Allcock. Their results fully confirmed the predicted behavior sketched in Fig. 2.<sup>11</sup> Spectrograms from their original records are reproduced in Fig. 3. The predicted absence of whistlers on the geomagnetic equator was confirmed by Koster and Storey.<sup>12</sup> These several tests provided confirmation of Storey's remarkable postulation of the whistler path and established a firm basis for the present IGY program on whistlers.

Extension of whistler recording to frequencies above 10 kc and the observation of whistlers at College, Alaska, led to the discovery of nose whistlers by Helliwell, *et al.*, who presented, at the same time, an explanation based on a re-examination of the dispersion equation.<sup>13</sup> Nose whistlers were also reported by Dinger at Washington, D. C.,<sup>14</sup> and independently, both Ellis<sup>15</sup> and Gallet<sup>16</sup> predicted their existence.

The characteristics of multiple nose whistlers led to the hypothesis that propagation of individual component whistlers takes place along discrete paths spaced in latitude.<sup>13</sup> It has further been suggested that whistler energy might be guided in field-aligned columns of ionization which extend between the hemispheres and act like cylindrical waveguides.<sup>10</sup> With a sufficient enhancement of the ionization in such columns, the whistler energy would tend to be confined to the column and hence to the field line.

Other interesting features of whistler propagation

<sup>9</sup> J. H. Crary, R. A. Helliwell, and R. F. Chase, "Stanford-Seattle whistler observations," *J. Geophys. Res.*, vol. 61, pp. 35-44; March, 1956.

<sup>10</sup> R. A. Helliwell, "Low-Frequency Propagation Studies, Pt. 1, Whistlers and Related Phenomena," Final Rep. Contract AF 19(604)-795; June 15, 1953-September 30, 1956. (Revised May 28, 1958.)

<sup>11</sup> M. G. Morgan and G. M. Allcock, "Observations of whistling atmospherics at geomagnetically conjugate points," *Nature*, vol. 177, pp. 30-31; January 7, 1956.

<sup>12</sup> J. R. Koster and L. R. O. Storey, "An attempt to observe whistling atmospherics near the magnetic equator," *Nature*, vol. 175, pp. 36-37; January 1, 1955.

<sup>13</sup> R. A. Helliwell, J. H. Crary, J. H. Pope, and R. L. Smith, "The 'nose' whistler, a new high latitude phenomenon," *J. Geophys. Res.*, vol. 61, pp. 139-142; March, 1956.

<sup>14</sup> H. E. Dinger, "Whistling Atmospherics," Navy Res. Lab. Rep. No. 4825, September 14, 1956.

<sup>15</sup> G. R. Ellis, "On the propagation of whistling atmospherics," *J. Atmos. Terrest. Phys.*, vol. 8, pp. 338-344; June, 1956.

<sup>16</sup> R. M. Gallet, private communication.

<sup>2</sup> At the Conference on Atmospheric Electricity, Portsmouth, N. H., May 19-21, 1954, held by USAF Cambridge Res. Center (GRD), and at the 12th General Assembly of URSI, Boulder, Colo., August 22-September 5, 1957, Dr. J. Fuchs, of Vienna, Austria, reported observations of whistlers on a 22-km ground return telephone line at the Sonnblick High Altitude Observatory in Austria dating back to 1888.

<sup>3</sup> H. Barkhausen, "Zwei mit Hilfe der neuen Verstärker entdeckte Erscheinungen," *Phys. Z.*, vol. 20, pp. 401-403; September, 1919.

<sup>4</sup> T. L. Eckersley, "Letter to the editor," *Nature*, vol. 122, p. 768; November 17, 1928.

<sup>5</sup> T. L. Eckersley, *Marconi Rev.*, vol. 5, no. 31, p. 5; 1931.

<sup>6</sup> E. T. Burton and E. M. Boardman, "Audio-frequency atmospherics," *Proc. IRE*, vol. 21, pp. 1476-1494; October, 1933.

<sup>7</sup> T. L. Eckersley, "Musical atmospherics," *Nature*, vol. 135, pp. 104-105; January 19, 1935.

<sup>8</sup> L. R. O. Storey, "An investigation of whistling atmospherics," *Phil. Trans. Roy. Soc. A*, vol. 246, pp. 113-141; July 9, 1953.

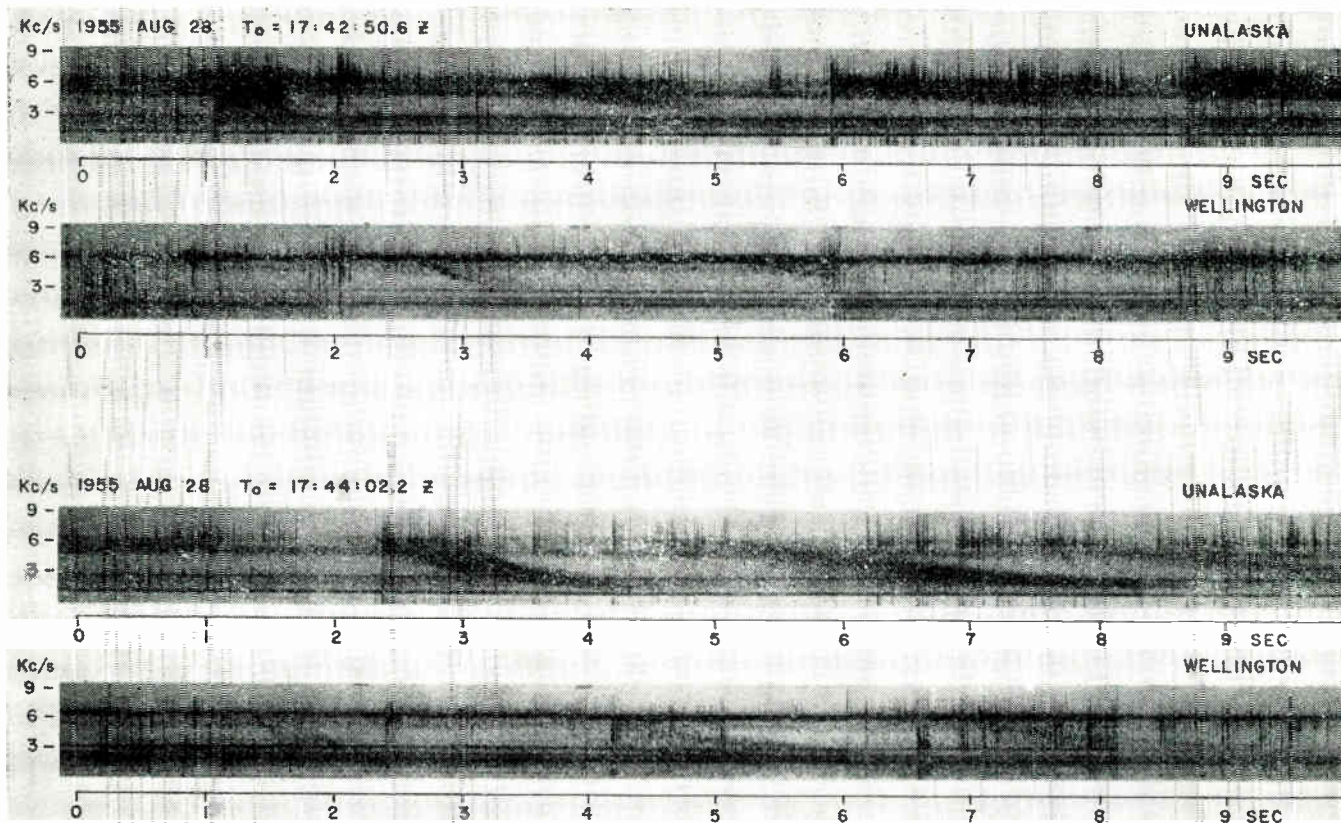

Fig. 3—First recordings confirming Storey's theory that whistlers echo back and forth along the flux lines of the earth's magnetic field between the northern and southern hemispheres. (From the original magnetic tapes of Morgan and Allcock.<sup>11</sup>)

have recently been reported. Storey has shown how the proton density along the path of propagation might be deduced from the low frequency ( $\sim 1$  kc) behavior of whistlers.<sup>17</sup> Maeda and Kimura have shown that whistler ray paths depart significantly from the lines of force for their chosen model of the ionization distribution.<sup>18</sup> Recently, Iwai and Otsu found a close correlation between low-latitude whistler dispersions at Toyokawa, Japan (geomagnetic latitude  $N24^\circ$ )<sup>19</sup> and local values of  $F_2$  critical frequency. Rivault has reported an interesting minimum in whistler occurrence near local sunrise.<sup>20</sup> Allcock and Morgan have found that whistler time delays (obtained aurally) correlate with sunspot numbers with a time lag of one to two months.<sup>21</sup>

Interpreting whistlers in terms of the distribution of ionization presents certain difficulties which are dis-

cussed in detail elsewhere.<sup>10,22-24</sup> Although results to date are highly tentative, they suggest electron densities in the outer ionosphere of the order of  $10^2$ – $10^3$  electrons per cc.

Some unique properties of whistler-producing discharges were found from simultaneous observations at Stanford and Boulder made in September, 1956.<sup>25</sup> Whistler-producing sferics constituted a small percentage of all sferics and were characterized by a peak in the energy spectrum near 5 kc. They exhibit a characteristic "sound" which has been described by Morgan and Dinger as a "bonk."<sup>24</sup> Most of the sferics, on the other hand, peaked in the vicinity of 10 kc. This unusual type of sferic appeared to occur more frequently over the sea than over the land. It should be remarked that whistlers are frequently produced by impulses which do not appear unusual.

Visible lightning has recently been related to whistlers

<sup>17</sup> L. R. O. Storey, "A method to detect the presence of ionized hydrogen in the outer atmosphere," *Can. J. Phys.*, vol. 34, pp. 1153–1163; November, 1956.

<sup>18</sup> K. Maeda and I. Kimura, "A theoretical investigation on the propagation path of the whistling atmospherics," *Reps. Ionosphere Res. Japan*, vol. 10, pp. 105–123; September, 1956.

<sup>19</sup> A. Iwai and J. Otsu, "On an investigation of the field intensity of whistling atmospherics," *Proc. Res. Inst. Atmos.*, Nagoya University, Toyokawa, Japan, vol. 5, pp. 50–52; March, 1958.

<sup>20</sup> R. Rivault, "Sifflements radioélectriques d'origine naturelle," Lab. National de Radioélectricité, *Note Préliminaire*, No. 191; February, 1956. (French PTT.)

<sup>21</sup> G. M. Allcock and M. G. Morgan, "Solar activity and whistler dispersion," *J. Geophys. Res.*, vol. 63, pp. 573–576; September, 1958.

<sup>22</sup> G. M. Allcock, "The electron density distribution in the outer ionosphere derived from whistler data," submitted to *J. Atmos. Terrest. Phys.*, 1958.

<sup>23</sup> L. R. O. Storey, "A method for interpreting the dispersion curves of whistlers," *Can. J. Phys.*, vol. 35, pp. 1107–1122; September, 1957.

<sup>24</sup> M. G. Morgan and H. E. Dinger, *Nature*, vol. 177, pp. 29–30; January 7, 1956.

<sup>25</sup> R. A. Helliwell, W. L. Taylor, and A. G. Jean, "Some properties of lightning impulses which produce whistlers," *Proc. IRE*, vol. 46, pp. 1760–1762; October, 1958.



by Jean<sup>25</sup> and Morgan,<sup>26</sup> confirming Tremellen's early observation.

The first man-made soundings of the outer ionosphere were made using pulses transmitted from Navy station NSS (15.5 kc) at Annapolis, Md.<sup>27</sup> Ordinary direct signals were received at all times at Cape Horn, South America. During most nighttime runs an echo was heard 10–30 db below the direct signal with an average delay of 0.7 second. Whistlers recorded at the same time showed similar delays at 15.5 kc, thus giving further support to Storey's theory. On several occasions man-made echoes were present but no whistlers could be detected, demonstrating that when whistlers are not heard the reason often is the absence of suitable sources. Since the mode of propagation is not restricted to whistlers, the term "magneto-ionic duct" was suggested as a substitute for "whistler-mode."

THEORY AND APPLICATIONS

Whistler propagation depends on interaction of the earth's magnetic field with free electrons excited by the passing wave. The principal features of whistlers can be explained in terms of the double-valued Appleton-Hartree formula for the refractive index. The energy travels approximately in the direction of the earth's field and is circularly polarized with right-handed sense when propagation is from south to north. This is called the longitudinal extraordinary mode,<sup>8</sup> for which the square of the refractive index for zero losses is

$$n^2 = 1 + \frac{f_p^2}{f(f_H - f)} \tag{1}$$

where

- $f_p$  = plasma frequency =  $9\sqrt{N}$  kc
- $N$  = number of electrons/cm<sup>3</sup>
- $f$  = wave frequency in kilocycles
- $f_H$  = electronic gyro-frequency =  $2800B$  kc.
- $B$  = flux density of earth's field in gauss.

The group velocity is related in general to the refractive index by

$$v_g = c \left( n + f \frac{dn}{df} \right)^{-1} \tag{2}$$

Performing the indicated operations on (1) and substituting in (2), the group velocity becomes<sup>13</sup>

$$v_g = 2c \frac{(f_H - f)^{3/2} [f^2(f_H - f) + ff_p^2]^{1/2}}{2f^3 - 4f^2f_H + 2ff_H^2 + f_H f_p^2} \tag{3}$$

<sup>25</sup> M. G. Morgan, "Correlation of whistlers and lightning flashes by direct aural and visual observation," *Nature*, vol. 182, pp. 332–333; August 2, 1958.

<sup>27</sup> R. A. Helliwell and E. Gehrels, "Observations of magneto-ionic duct propagation using man-made signals of very low frequency," *Proc. IRE*, vol. 46, pp. 785–787; April, 1958.

This is a cumbersome expression and can be simplified when  $f_p^2$  is large compared with the product  $ff_H$ . These conditions are thought to obtain in most cases. The resulting approximate expression for group velocity is then

$$v_g = 2c \frac{f^{1/2}(f_H - f)^{3/2}}{f_H f_p} \tag{4}$$

It is easily found that the group velocity in this case is a maximum at  $f = f_H/4$ . At frequencies above and below this the group velocity is reduced, becoming zero at  $f = 0$  and  $f = f_H$ .<sup>28</sup> The minimum gyro-frequency along a whistler path is therefore the upper cutoff frequency for propagation in the whistler mode. It is plotted for the dipole field of the earth as a function of geomagnetic latitude in Fig. 4. An impulse launched in such a medium is transformed into a whistler with simultaneous rising and falling components. Such a whistler is called a nose whistler because of the shape of its spectrographic trace. The frequency of minimum time delay is called the nose frequency. Examples are shown in the section on preliminary results.

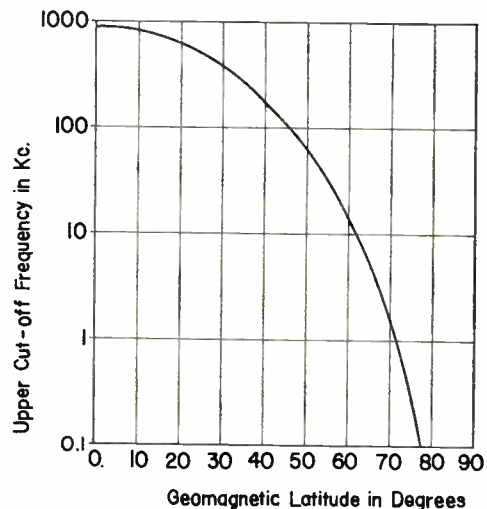

Fig. 4—Upper cutoff frequency as a function of geomagnetic latitude.

For medium and low latitudes and at frequencies below about 10 kc, it can usually be assumed that  $f$  is small compared with  $f_H$ , and (4) becomes

$$v_g = 2c \frac{\sqrt{ff_H}}{f_p} \tag{5}$$

which is the expression developed by Eckersley and used by Storey.

Eqs. (3)–(5) explain the frequency-time behavior of whistlers but do not account for the guiding effect

<sup>28</sup> A somewhat similar effect has been found by Garriott for the condition of low plasma frequency. See O. K. Garriott, "A note on whistler propagation in regions of very low electron density," accepted by the editor, *J. Geophys. Res.*; 1958.

of the earth's field. This is to be found in the anisotropic behavior of the medium in which the refractive index is a strong function of the angle between the wave normal and the earth's field. Storey demonstrated that when (5) applies, the direction of energy flow—the ray path—must lie within a cone about the earth's field of half angle  $19^\circ 29'$ .<sup>8</sup> The exact direction depends on the spatial variation of the magnetic field and the electron density. Marked deviations of the ray path from the field line are thus possible. Further discussion is beyond the scope of this paper.

Since the experimental data are in the form of curves of time delay vs frequency, we are interested in the time delay integral, which for the Eckersley law given by (5) is

$$T = \int_{\text{path}} \frac{ds}{v_g} = \frac{1}{2c} \int_{\text{path}} \frac{f_p}{\sqrt{f f_H}} ds = \frac{D}{\sqrt{f}} \quad (6)$$

where

$$D = \frac{1}{2c} \int_{\text{path}} \frac{f_p}{\sqrt{f_H}} ds,$$

and is called the "dispersion" path.

Thus a plot of  $1/\sqrt{f}$  vs  $T$  should be a straight line when (6) applies. The whistlers sketched in Fig. 2 were calculated from (6), with  $D = 63.25$  seconds<sup>1/2</sup>. Most low-frequency whistlers at medium and low latitudes fit this law very closely. Therefore, only the one parameter  $D$  can be determined. If the path of propagation and gyro-frequency variation are known and a form for the electron distribution is assumed, the electron density can be determined. It should be noted that the effect of a given electron density on the time delay becomes *greater* as the gyro-frequency is reduced. Thus the dispersion of a whistler is most sensitive to regions near the top of the path. Low latitude whistlers should be particularly useful for studying the top of the  $F_2$  layer over the equator when vertical soundings at the end points of the path are available.

In regions of low gyro-frequency, where (3) or (4) must be used to determine the time delay, it is clear that the relative effects of  $f_H$  and  $f_p$  are strongly dependent on the frequency. If the nose whistler is well defined, some three or four independent measurements of time delay can be made at different frequencies, leading to a corresponding number of independent parameters describing the path and electron distribution. One of these could be the latitude of an assumed dipole path of propagation, while the others could describe the variation of electron density along the path. A two-parameter method applicable at frequencies less than about one-tenth of the cutoff frequency has been developed.<sup>29</sup>

The location of the path presents an important prob-

lem. Recent ray path calculations obtained by Yabroff for smooth distributions of ionization show that the path depends significantly on the form of the electron distribution.<sup>30</sup> It is possible that iterative procedures might lead to a consistent path and distribution. The idea would be to assume a path and then calculate the distribution. Using the calculated distribution, a new path would be calculated, from which an improved distribution could be computed. Whether values obtained through such a procedure would converge to the correct result is not yet known. In any event, it depends on the assumption of a smooth distribution of ionization; the ionization may in fact be distributed in field-aligned columns acting like waveguides.<sup>10</sup> In the latter case, the path would be better defined, but the dispersion might be altered by the geometry of the guide.

The problem is further complicated by the fact that the path can vary with frequency except, as Storey has shown,<sup>8</sup> in regions where the Eckersley law of (5) applies. From the variation of whistler amplitude between IGY stations, it may be possible to determine at what location the energy emerges from the ionosphere and whether this point moves about with frequency. This is an example of the application of the synoptic data to the interpretation of results obtained at a single station.

#### IGY SYNOPTIC PROGRAM OF OBSERVATION

Whistler stations for the IGY are shown on the map of Fig. 5. Geomagnetic coordinates are superimposed (courtesy, Geophysical Institute, University of Alaska). Not shown on the map are the Antarctic stations at Ellsworth Station (geomagnetic latitude S  $67^\circ$ ), Byrd Station ( $70^\circ$ ), Scott Base ( $79^\circ$ ), and the South Pole ( $78^\circ$ ).

Several factors influenced the choice of locations. First, a series of stations extending from the geomagnetic equator to the pole was needed to define the latitude variation of whistler properties. Second, pairs of stations at conjugate points were needed to determine the relationship between the whistlers observed at opposite ends of a field line. Third, stations spaced in longitude were needed to define the significance of geomagnetic latitude on whistler properties as well as to determine which phenomena were local-time dependent and which were simultaneous. The exact choices were limited by such practical considerations as availability of facilities and personnel, and freedom from power-line noise.

Recording techniques and procedures have been standardized as much as possible; however, the actual field equipment is standard only within the network of each coordinating institution. In general, whistlers and VLF emissions are tape-recorded at all stations from 35 to 37 minutes after each hour together with time marks

<sup>29</sup> R. L. Smith and R. A. Helliwell, "Calculation of the Electron Density of the Outer Ionosphere Using Whistlers," Symp. Propagation of VLF Radio Waves, CRPL, NBS, Boulder, Colo., Paper 22; January 23-25, 1957.

<sup>30</sup> I. W. Yabroff, "Whistler Paths in the Outer Ionosphere," presented at joint URSI-IRE meeting, Washington, D. C.; April 25, 1958.





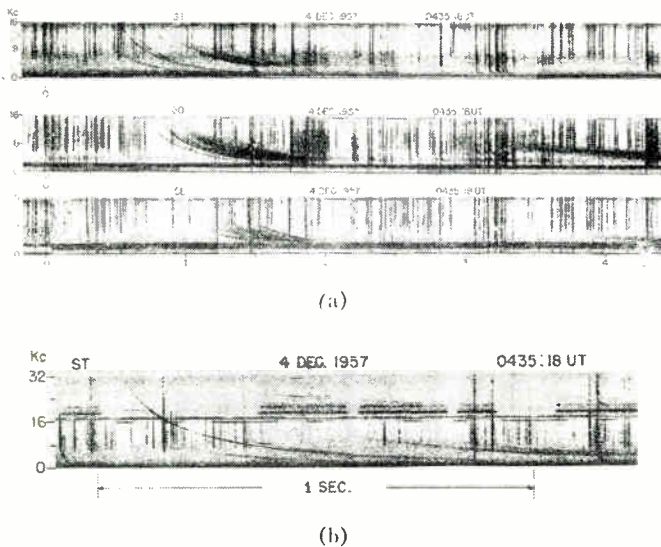

Fig. 6—(a) Short whistler recorded at Stanford (ST), Boulder (BO), and Seattle (SE). (b) Same whistler at Stanford with analysis extended to 32 kc.

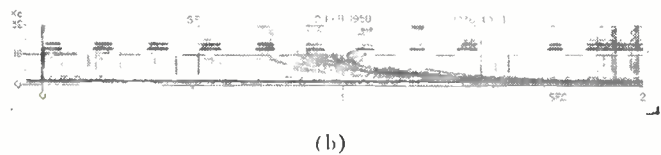
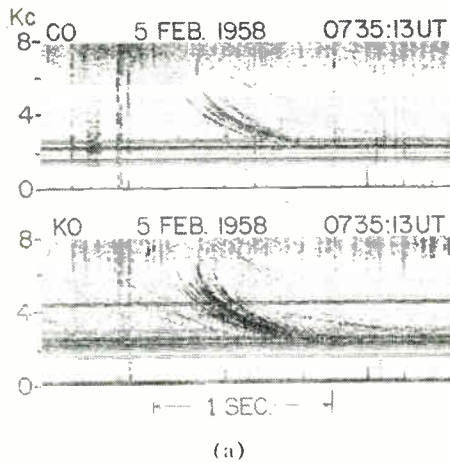

Fig. 7—(a) Nose whistler at College (CO) and Kotzebue (KO). Time of origin unknown. (b) Nose whistler at Seattle (SE).

percentage spread in frequency. (Examples: first two traces for Stamford whistler, Fig. 6.)

2) *Swishy*: Relatively broad band of frequencies to which no definite tone can be assigned by ear; it exhibits a hissing sound of descending mean frequency. [Examples: trailing components in Fig. 6(a), especially Seattle.]

3) *Multiple*: Separate component whistlers closely associated in time. In the *multiple-path* type, each component appears to originate with the same single sferic. In the *multiple-flash* type, each component relates to a separate sferic and usually has identical dispersion. (Examples: multiple-path—all figures; multiple-flash—none given.)

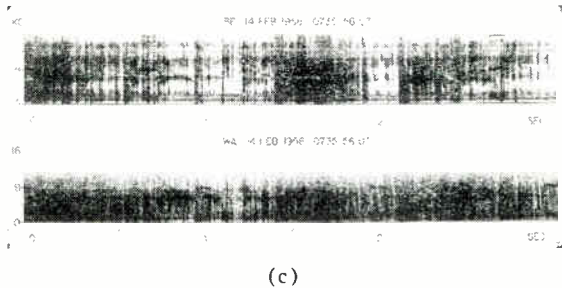
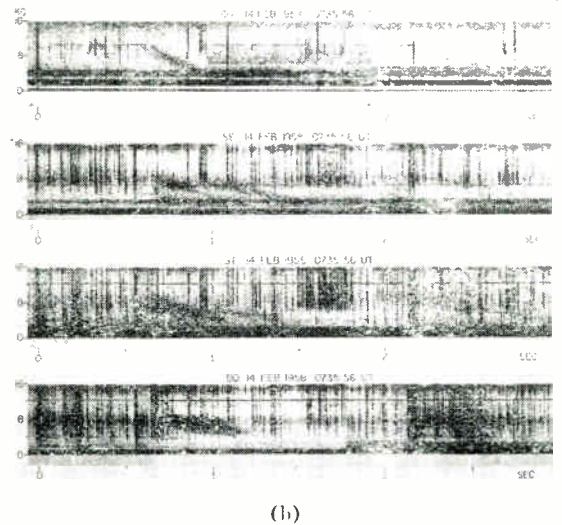
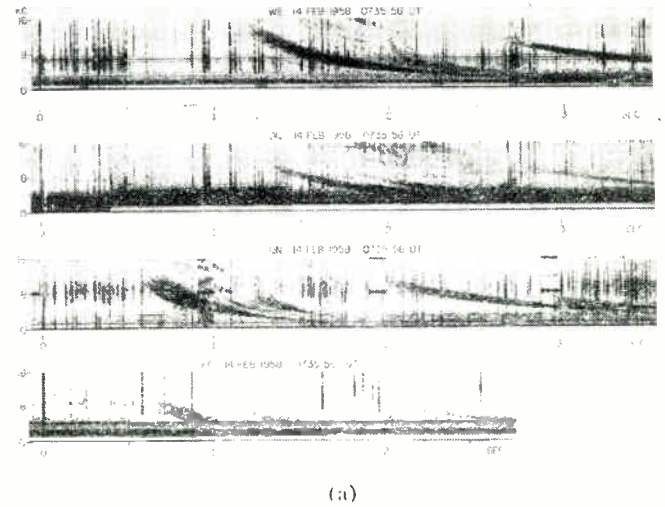

Fig. 8—Multistation whistler showing conjugate relationship. (a) Wellington (WE), Dunedin (DU), Unalaska (UN), and Kotzebue (KO). (b) College (CO), Seattle (SE), Stanford (ST), Boulder (BO). (c) Bermuda (BE), Washington (WA). Note: The whistlers at Bermuda and Washington were very weak but they are distinctly observable aurally on the magnetic tapes and can be identified on the original spectrograms just before the 1-second marks.

4) *Nose*: A whistler having both rising and falling components which join in a continuous manner at the nose frequency. (Examples: Fig. 7.)

5) *Short*: A one-hop whistler; whistler and echo dispersions in ratio 1:3:5: etc. Preceding sferic frequently cannot be identified. (Examples: Fig. 8, all northern hemisphere stations.)

6) *Long*: A two-hop (round trip) whistler which can

frequently, but not always, be identified by its dispersion; only certain method is to compare dispersions (or time delays) of echoes—2:4:6: etc. (Examples: Fig. 8, Wellington and Dunedin.)

7) *Echo*: A reflection of the first whistler. Time delay is equal to that of the first whistler multiplied by an integer. [Examples: Fig. 6(a), Fig. 8.]

8) *Tweek*: (not a whistler) Spectrogram shows a hook-shaped trace. Although the tweek is not a whistler, it often has a faintly musical sound resulting from the extended echoing of the original pulse between earth and lower ionosphere. The frequency falls very rapidly at first, approaching an asymptotic frequency of about 1700 cps. Most prevalent at night when ionospheric absorption is low. [Examples: Fig. 6(a), particularly the Stanford record, in the vicinity of 3.2 seconds.]

These illustrative spectrograms have been selected primarily to show how whistlers produced by a single source compare at different recording locations. Morgan and Dinger found in 1955 that whistlers observed simultaneously in Hanover, N. H., and Washington, D. C., apparently had the same dispersion.<sup>24</sup> However, consider the short whistler of Fig. 6, recorded simultaneously at Stanford, Boulder, and Seattle. Only at Stanford were strong pure-toned components observed, with one extending up to 28 kc [Fig. 6(b)]. The swishy components show greater time delays and are most prominent at Boulder and Seattle. From the time delays of all components at 4 kc, we find the range of the dispersion constant,  $D$ , to be roughly 44–110 at Stanford, 80–120 at Boulder, and 92–120 at Seattle. Thus the average time delay of the energy does tend to increase with geomagnetic latitude. This behavior was first observed in simultaneous records at Seattle and Stanford in 1956<sup>19</sup> and supports the hypothesis of multiple paths spaced in latitude.<sup>13</sup>

The separate traces in the multiple nose whistlers of Fig. 7 also illustrate this effect; *i.e.*, the nose frequency decreases with arrival time, corresponding to the decrease in gyro-frequency at the top of the path as its height increases with latitude. The principal traces at College and Kotzebue [Fig. 7(a)] both show the same nose frequency of 6.4 kc, while at Seattle [Fig. 7(b)] the nose frequency of the principal trace is 15 kc. The ratio of nose frequency to minimum gyro-frequency has been estimated to be 0.45.<sup>10</sup> Thus from Fig. 4 we find the effective dipole latitude of the Kotzebue and College nose whistlers to be roughly 60°, whereas the stations are located at 64° geomagnetic latitude. This result can be interpreted in two ways. It may mean that the strength of the earth's field drops off less rapidly than in the dipole model, or that the whistler emerged from the ionosphere at the calculated latitude of 60° and traveled to the receiver in the space between earth and ionosphere. Applying the same analysis to the principal Seattle nose whistler, we find the effective latitude to be 54°, very close to the station latitude of 53°. Here the agreement is better. Dinger found that the nose fre-

quency may be much lower than present theory would predict.<sup>14</sup> The reason might be a distortion of the earth's field, propagation to the receiver from a much higher latitude, or possibly a basically different mechanism.

The geographical extent of whistlers produced by a single source is illustrated in Fig. 8 by the records from ten stations, two of which lie in the Southern Hemisphere. The dispersion of the principal component is roughly 65 at all northern hemisphere stations and 130 in the southern hemisphere. The whistlers are therefore short in the northern hemisphere and long in the southern hemisphere. It is interesting to note that, as shown by this figure and Fig. 3, the causative sferic and other sferics are often identifiable in *both* hemispheres. Perhaps the most striking feature of this multistation whistler shown in Fig. 8 is the extent of its coverage. The maximum separation of stations in one hemisphere (Kotzebue to Bermuda) is 7000 km. This shows that the causative impulse need not be near the receiver or its conjugate point to produce a detectable whistler.

There is clearly less difference among the whistlers of Fig. 8 than those of Fig. 6. However the same tendency for the components with greater delay to be relatively stronger at higher latitudes is evident. This effect is especially marked between Stanford and Seattle. The dominance of one component with the same dispersion at all stations in one hemisphere is interesting. The explanation may be that there was only one good path of propagation from which all the observed whistlers came. If this is true, then the latitude of the recording station may have little relation to the latitude of the whistler path as Morgan and Dinger found.<sup>24</sup> Locating the path either experimentally or theoretically from component nose whistlers thus becomes one of the outstanding problems of analysis.

Whistler occurrence, as Storey pointed out quite clearly,<sup>8</sup> must be a function of *both* thunderstorm occurrence and propagation conditions through the ionosphere. This greatly complicates the interpretation of whistler occurrence data since the relevant world-wide lightning occurrence data which are available are meager. Certain well-defined occurrence variations can be interpreted simply. These are illustrated by the variation with local time of the average number of whistlers per minute at several stations for the two periods, December, 1957–January, 1958, and June–July, 1958, shown in Fig. 9. In all cases, the rate is higher at night than during the day, presumably because of the diurnal variation in D-region absorption. The other principal feature of the rate curves is the difference between local summer and winter, with winter generally showing a much higher rate than summer at Unalaska, Boulder, and Stanford. At Seattle and Norwich the summer rates are higher and suggest the influence of summer thunderstorms near the stations or their conjugate points. The southern hemisphere appears to be consistent, since the Wellington diurnal curve for December and January is similar to the Unalaska curve for June and July.

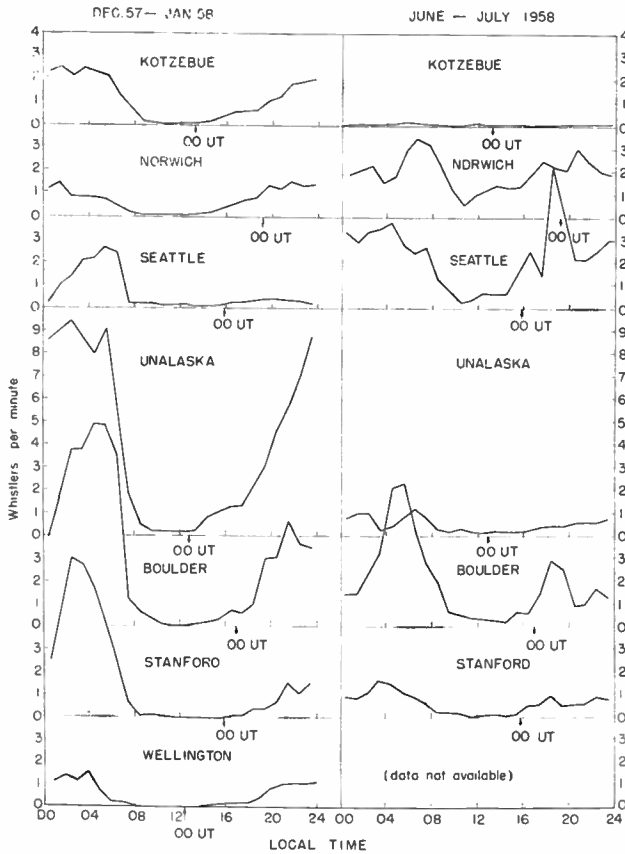

Fig. 9—Diurnal variation of whistler occurrence at various IGY stations. (Norwich, Vt., is adjacent to Hanover, N. H.)

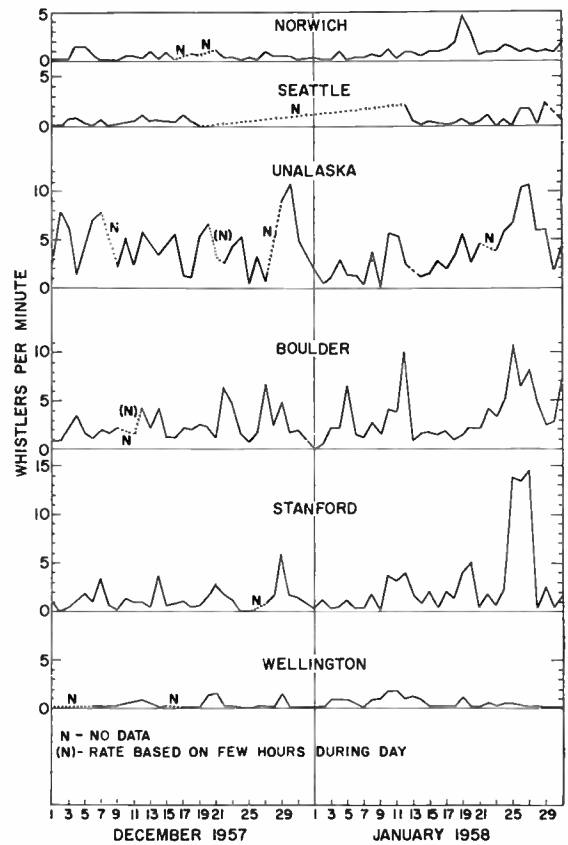

Fig. 10—Day-to-day variation in whistler rates for December, 1957 and January, 1958. (Norwich, Vt., is adjacent to Hanover, N. H.)

The correlation of day-to-day whistler activity between stations is apparent but poor, as illustrated for a number of stations during December, 1957–January, 1958 in Fig. 10. From the magneto-ionic duct propagation of man-made signals, Helliwell and Gehrels found that the absence of whistlers may often be attributed simply to an absence of sources.<sup>27</sup> Although it is at least plausible to attribute all of the differences to varying thunder-storm activity, including both the variation in the number of whistlers generated and the effect of the varying background noise on the observations, it seems plausible also that propagation conditions may vary widely between stations. An expanded program of observing man-made signals is needed to answer this.

CONCLUSIONS

It is clear that the mechanism of whistler propagation is quite complex. Thus particular whistler components can be restricted to a single station, while, on the other hand, it is possible to observe simultaneous whistlers over a large fraction of the earth's surface. Among the outstanding problems in the interpretation of whistlaspectra are 1) determining precisely the path of proper propagation, and 2) understanding the cause of the fine structure in multiple-path whistlers. The relation of whistler properties to geomagnetic phenomena is an interesting and largely untapped subject.

Although there are many implications in the few

samples of data presented here, it has not been possible to discuss them in any detail. Further study of such records is beyond the scope of this discussion and is properly the subject for individual research papers. With the development of new methods of analysis, we can look forward to a period of rapid progress, perhaps similar in many respects to the progress made following the development of the first vertical incidence recorder for the ionosphere. Research on whistlers should prove of great value in research on the physics of the outer ionosphere and in studies of the propagation of very low frequency radio waves through the ionosphere.

ACKNOWLEDGMENT

Synoptic programs of whistler observation and study under our direction, at our respective institutions, have been made possible through the support of the USA-IGY National Committee. The successful operation of these programs has been possible only with the cooperation of many individuals and institutions in the United States, Canada, the United Kingdom, Denmark, Peru, Argentina, Chile, New Zealand, and Australia. The United States Department of Defense has lent very important assistance to these programs through its several branches. Spectrograms from current data were prepared at Stanford by John Katsufakis, and from the 1955 Unalaska-Wellington records by W. C. Johnson at Dartmouth.



# Radiation and Particle Precipitation upon the Earth from Solar Flares\*

L. BIERMANN† AND R. LÜST†

**Summary**—A brief survey of the main features of solar emissions in connection with solar flares is given: ultraviolet and X-ray radiation, corpuscular emission, radio frequency radiation, and relativistic particles. For these different components of nonthermal emissions the energies are estimated and their effects in the ionosphere are briefly discussed.

THE transient radiative and corpuscular emissions connected with solar flares represent, from the solar physics point of view, the most pronounced form of nonthermal energy output. In the higher strata of the earth's atmosphere they are the cause of violent disturbances which are one of the most fruitful subjects of ionospheric research. It is the purpose of the present article to survey the main features of these solar emissions which form some of the numerous connections between solar physics and ionospheric research.

In ionospheric physics, ordinarily the main emphasis is given first, to ultraviolet radiation which extends into the X-ray range, and second, to the corpuscular emissions consisting of ionized but macroscopically neutral particle streams travelling with velocities of the order of 1000 km/s. For the deeper understanding of the physical problems involved, it seems, however, useful to start by presenting a brief survey of the whole range of the observed emissions before discussing in more detail those features of special interest in connection with the present issue.

The two other types of nonthermal emissions which are or may be connected with solar flares are: the emissions in the radio frequency range observable from some 10,000 mc/s down to about 20 mc/s, where they begin to be turned back by the ionosphere, and which are particularly intense in the range from some hundred mc/s downward; and the acceleration of charged particles to relativistic energies, which shows up sometimes by an increase of the "cosmic" radiation on earth, but more frequently by a special type of radio bursts (type IV), and which are probably due to relativistic electrons spiralling in magnetic fields.

The energies involved (expressed in erg/cm<sup>2</sup>/s) near the sun's surface may be seen in Table I.

These figures should be compared with the value of the radiative flux of thermal energy, 6 or 7 × 10<sup>10</sup> erg/cm<sup>2</sup>/s. For the more general questions of the mechanisms of these emissions and their relation to solar activity, the

TABLE I

	UV and X Rays	Radio Frequency	Ordinary Corpuscular Radiation	Relativistic Particles
Average in absence of special activity	10 <sup>8</sup> -10 <sup>6</sup>	10 <sup>-7</sup>	10 <sup>6</sup>	?
Flares	10 <sup>8</sup> -10 <sup>10</sup>	10 <sup>2</sup> -10 <sup>3</sup>	10 <sup>7</sup> -10 <sup>9</sup>	(10 <sup>5</sup> -)10 <sup>7</sup> -10 <sup>8</sup>

reader is referred to a discussion by the same authors given elsewhere.<sup>1</sup>

In direct spectroscopic observation a solar flare shows up by a sudden brightening of spectral lines, especially *H $\alpha$* , and strong continuum emissions which last a fraction of an hour may be so pronounced as to make the flare visible even in integral light. The increase of *L $\alpha$* , which must be connected with the *H $\alpha$*  emission, has, however, been observed until now to be much smaller than expected, possibly partly because the rocket observations<sup>2</sup> could only begin 10 to 12 minutes after the beginning of the flare itself. Relatively large increases have however been observed in the regions 1.5-8.Å. The energy radiated in this spectral region may, during an intense flare, increase to an amount comparable to the total X-ray emission which (referred to the sun's surface) is of the order of 10<sup>2</sup>-10<sup>3</sup> erg/cm<sup>2</sup>/s, depending on the general activity in the solar corona, or even to a multiple of the higher amount. This means that not only the quantity of light in the X-ray region, but also the mean energy per quantum is increased, thereby causing the variations in the structure of the ionosphere during flares.

Of the corpuscular emissions connected with flares, even the component consisting of relativistic charged particles reaches the earth with a delay of at least ten minutes, due to the scattering of the particles in the solar and the interplanetary magnetic fields. The influence on the ionosphere, according to the observations made on February 23, 1956, may be quite pronounced in large-scale solar events; on that date, during and after the big flare which was accompanied by the largest increase of the cosmic ray intensity recorded hitherto, the ionosphere was very much disturbed also on the night side of the earth, which was not reached directly by the ultraviolet light. As far as can be judged in the

<sup>1</sup> L. Biermann and R. Lüst, "Non-Thermal Phenomena in Stellar Atmospheres," *Compendium of Stellar Astronomy*, Vol. 6, ed. by G. P. Kuiper. (In press.)

<sup>2</sup> H. Friedman, "Astrophysical Measurements from Rockets," vol. 10, IAU Meeting, Moscow, U.S.S.R.; 1958.

\* Original manuscript received by the IRE, November 10, 1958.  
† Max-Planck-Institut für Physik und Astrophysik, Munich, West Germany.

absence of detailed discussions, the amount of energy released in the form of relativistic particles, which according to an estimate by Meyer, Parker and Simpson<sup>3</sup> amounted to  $\approx 10^{31}$  erg, might have been just sufficient to produce the observed increase of the ionization. In view of the recent observation<sup>4</sup> of solar  $L\alpha$  light in the night sky scattered backwards by atomic hydrogen in a large region around the earth, the possibility cannot be excluded that in this particular case  $L\alpha$  was sufficiently strong in the first minutes of the flare to affect the earth's atmosphere even in the night side.

The outburst of the so-called corpuscular radiation, which is often connected with a flare, reaches the earth only after about 20 hours or more, causing magnetic storms, aurorae and ionospheric disturbances. The mechanism of these phenomena is discussed elsewhere in this issue; but it should be mentioned that there exists no one-to-one correlation between a solar flare and a magnetic storm. We shall deal now with those data which may be derived from astronomical evidence, in particular with the value of the density in the particle streams.

There are several ways to estimate this figure<sup>5</sup> which cannot be discussed comprehensively here. The most reliable method available today appears to be an estimate based on certain observations in the comet tails and on the consideration that the appearance of ion structure, within a time scale of the order of an hour or

a fraction of an hour, is most probably due to exchange of charge between solar ions (mostly protons) and originally nonionized cometary molecules. Together with the cross sections known from laboratory experiments, these observations lead to a value of the particle flux near the earth of some  $10^{10}$  particles/cm<sup>2</sup>/s under quiet conditions, but up to  $10^{12}$  or possibly even  $10^{13}$  particles/cm<sup>2</sup>/s in magnetic storms. These last figures correspond to an energy flux near the earth of  $10^4$  or even  $10^5$  erg/cm<sup>2</sup>/s in very big magnetic storms. It should be mentioned at this point that certain observations, for instance the so-called Forbush decrease of the cosmic ray intensity, suggest that the corpuscular streams carry at least occasionally magnetic fields, the detailed features of which seem still very uncertain.

The recent rocket and satellite observations of very hard X rays which are probably secondaries to electrons in the 10–100 keV range indicate a component of corpuscular radiation somehow intermediate, both in speed and energy flux, between the "ordinary" corpuscular radiation and the solar "cosmic ray" component. It would seem premature, however, to say more about this component at the present time.

The energy of the radiations in the radio frequency range is too low, by several orders of magnitude, to affect the state of the earth, but their properties are of great interest in connection with the more general questions about the mechanisms on the sun which are operative in producing those emissions which have more direct influence. The radio radiation also recently directly confirmed the value of the velocity of the corpuscular streams derived hitherto only from the time difference between disturbances on the earth and solar phenomena assumed to be their cause.

<sup>3</sup> P. Meyer, E. N. Parker, and J. A. Simpson, "Solar cosmic rays of February, 1956, and their propagation through interplanetary space," *Phys. Rev.*, vol. 104, pp. 768–783; July, 1956.

<sup>4</sup> J. E. Kupperian, Jr., E. T. Byram, T. A. Chubb, and H. Friedman, *Ann. Geophys.* (In press.)

<sup>5</sup> L. Biermann, Letter to *Observatory*, vol. 77, pp. 109–110; March, 1957.

# The Very Low-Frequency Emissions Generated in the Earth's Exosphere\*

ROGER M. GALLET†

**Summary**—Naturally occurring, very low-frequency signals not associated with lightning discharges, and strongly correlated with solar activity, have been recognized nearly as long as the atmospheric whistlers which have their genesis in lightning discharges. Whereas whistlers have been satisfactorily explained, until recently these other phenomena have not.

From the examination of a large quantity of high resolution spectrograms, it has been deduced that a major fraction, if not all, of these other "noises" are excited in the exosphere by streams and bunches of high-speed ionized particles precipitating into the ionized atmosphere in the presence of the earth's magnetic field. The electromagnetic waves excited are then propagated in the manner of whistlers.

The excitation mechanism is similar to the operation of a traveling-wave tube. Two frequencies are simultaneously generated, and are given by:

$$\omega = \frac{\omega_H}{2} \left[ 1 \pm \left\{ 1 \pm \left( \frac{\omega_P}{\omega_H} - \frac{V}{c} \right)^2 \right\}^{1/2} \right].$$

Their values depend only on the three parameters: local electronic density in the exosphere, local magnetic field intensity, and particle velocity  $V$ . For a large range of conditions, corresponding to middle latitude observations, the low frequency explains many types of noise, and reduces to

$$\omega_1 = \left( \frac{V}{c} \right)^2 \frac{\omega_P^2}{\omega_H}.$$

Most of the observations require particle velocities of the order of 10,000 km/sec. The shape of the spectrum is also very sensitive to the ambient electronic density distribution. A model in which the ratio of electron density to magnetic field strength is almost constant, along a line force in most of the exosphere, seems indicated by several types of noise. Such a model satisfies also the whistler data.

The problem of the production of bunches and streams or particles is briefly discussed.

## INTRODUCTION

IN the same frequency range as whistlers, other types of natural electromagnetic signals not related to lightning are observed, although less frequently and less regularly. Like whistlers, they can be heard after the voltage which they induce in an antenna is amplified and applied, without frequency conversion or rectification, to a headphone. Their forms are not as regular and specific as those of whistlers, and very little progress in explaining them has been made until quite recently. Since the beginning of 1957, their true nature has been partially disclosed, as a result of systematic work using a large number of good quality spectrograms.

It has been deduced that at least a large fraction of these noises must arise from the emission of very low frequency electromagnetic waves in the earth's outer ionosphere, called the exosphere, under excitation by streams and bunches of high-speed ionized particles moving through the exosphere. This result has very im-

portant physical significance and discloses a new geophysical process. The mechanism of excitation itself is quite similar to that acting in a traveling-wave tube. After excitation of the waves, the mode of propagation is the same as for whistlers. A quantitative theory has been developed which can account in detail for several types within this class of VLF noises. However, it is possible that other excitation mechanisms are at play and are required for the explanation of other types.

It is important to understand that these VLF emissions have an origin and a source of energy completely different from those of whistlers. Until now, there has been a certain source of confusion arising from the lack of a well-established and accepted nomenclature with the use of such expressions as "odd shaped whistlers, rising whistlers, etc. . . ." in some publications. To contrast the respective roles, it can be said that the whistlers are significant mainly by their mode of propagation, the study of which reveals properties of the *static* exosphere such as the distribution of the electron density. For VLF emissions, it is the emission process which is the most significant and which reveals the *dynamic* properties of the exosphere such as the high-speed motions of charged particles. From a morphological point of view, they are somewhat like the botanical and animal kingdoms, respectively, for a biologist. In fact, the "fauna" of VLF emissions is quite rich and diversified compared to the "flora" of whistlers. Here, also, there are some species for which it is still difficult to decide in which kingdom they belong. Whistlers and VLF emissions have the same propagation mode, imposed by the frequency of the electromagnetic waves, the presence of an ionized exosphere and the magnetic field. At this point, the analogy ends.

## OBSERVATIONS—A SHORT SURVEY OF PROGRAM AND PROGRESS

At the beginning of 1956, whistlers were quite well understood. However, very few good quality spectrograms, amenable to precise quantitative measurements, were available, and still fewer for the other types of noises had been obtained. The resolution of the original whistler records by Storey was insufficient for further progress, and qualitative aural descriptions of the natural signals not related to lightning was very unsatisfactory. The need was realized for systematic observation programs, for high quality storage on magnetic tapes, and for graphical documents with good resolution. At first, the necessity was more apparent for whistlers if quantitative information on the exosphere was to be obtained from their propagation characteristics. It was

\* Original manuscript received by the IRE, December 24, 1958.

† National Bureau of Standards, Boulder, Colo.



necessary to measure precisely the dispersion and its time variation at a given station and to extend to higher frequencies the range of the dispersion law because theoretical work indicated interesting deviations relative to Storey's simple approximation. Also, the fine structure of the whistlers and the precise measurements of successive echoes in whistler echo-trains were important. Satisfactory spectrograms, marking a great improvement over any other previous methods, were obtained with the "sonagraph" machine or similar equipment. With care, experience, and some modifications, it was soon possible to obtain spectrograms of really high quality. Only with fundamentally different methods, such as Fourier analysis of the complete waveform of the signals, can further significant progress be achieved. However, this will be very laborious and, therefore, restricted to special works requiring a high degree of precision.

Almost simultaneously, several groups in the United States and one in Canada undertook regular observation programs of varying magnitude. They seriously approached the laborious task of obtaining high quality spectrograms. Sonagraph machines are somewhat temperamental, and much care is required to obtain regularly, pictures with optimum contrast, definition, etc. Having isolated a portion of magnetic tape, 2.3 seconds in length, about five minutes are required for producing a spectrogram. Therefore, the work is very time-consuming, and it is easy to see that it is very time-consuming to obtain by this method a spectrogram for a continuous time sequence covering 30 seconds or a minute. Generally the tapes are monitored aurally, and the interesting signals localized in time for the preparation of spectrograms. However, such a method is quite inadequate for VLF emission noises, because generally they are less intense and, at least in the first part of the studies, not so definite.

At the Boulder Laboratories of the National Bureau of Standards, a systematic program of study started early in 1956, has been almost continuous since May, 1956. The shortcomings of the analysis and particularly the need for a very extensive and inclusive spectrogram coverage of the "noises" on the tapes were realized during the latter part of 1956. Various types of VLF emission noises were recognized, and some essential observations were obtained more or less by chance. For example, trains of echoes from particularly strong noises, presenting similarities with echoes from whistlers, were recorded (see Fig. 1, p. 217). A parallel but separate study of whistlers was also undertaken. The analysis was rendered more regular with time, and in January, 1957, it became more intensive with the view to extending it over the IGY period. The recording program will cease in January, 1959. One of its aims has been to obtain homogeneous statistics for diurnal and seasonal variations as well as for correlation with magnetic and solar activity. Another objective has been the establishment of a systematic classification of VLF emissions and

types of whistlers and the production of a representative Atlas of spectrograms. A program of this nature is needed for supporting the theoretical investigations.

Since VLF emissions are generally quite weak, the improvement of signal-to-noise ratio is very important. A very high sensitivity was achieved by using the 1-mile loop antenna, built across the deep valley of a canyon near Boulder, for LF sweep frequency ionospheric soundings by Watts.<sup>1</sup> The vertical loop has a total area of 110,000 square meters. The equipment used to obtain the observations was largely designed and built by Watts, who has been responsible for very valuable achievements in the recording technique and improvements of the spectrogram quality. The effective range of frequencies is from about 500 cps to 32 kc. The observations are taken in agreement with IGY schedules, at 35 minutes past each hour for a period of 1.5 minutes. The timing is defined by automatic recordings of WWV time signals. Simultaneous observations at Anchorage, Alaska, have been available from the beginning of 1957, but it was only from the end of that year that real continuity and quality were achieved. The lack of a large antenna, which diminishes the sensitivity, is responsible for a very much smaller yield at Anchorage.

The observations for the year 1957 have been entirely reduced. In addition, a large amount of material is available for 1956, and the most remarkable events for 1958 are currently available in spectrograms. A collection of roughly 20,000 spectrograms is continually expanding. Detailed accounts of the results, such as whistler statistics, whistler dispersion laws, classes of VLF emissions, especially remarkable events, etc., will be presented in separate publications. In the present review only the most general properties of VLF emissions are treated.

It is impossible to do full justice to the work of other groups. The author is well aware of what he has learned and of the stimulation he has received from discussions with his colleagues. Several conferences, particularly a special meeting at the Boulder Laboratories in 1956, the VLF Symposium in February, 1957, and the URSI 12th General Assembly in August, 1957, have been real sources of progress. Sometimes these meetings somewhat resembled groups of naturalists presenting specimens of new animals to each other. Perhaps Dinger, from the Naval Research Laboratory, Washington, D. C., was the first to present good spectrograms of really weird shapes, almost incredible at first.<sup>2</sup> The interesting thing is that soon after, the same general shape

<sup>1</sup> J. M. Watts, Sunset Field Station, Natl. Bur. Standards, Boulder, Colo. No formal description of this equipment is published, but it is referred to in several publications, particularly in reference 7. For LF sweep frequency soundings see J. M. Watts and J. N. Brown, "Some results of sweep frequency investigation in the low frequency band," *J. Geophys. Res.* vol. 59, pp. 71-86; 1954. (Also references infra.)

<sup>2</sup> H. E. Dinger, "Whistling Atmospherics," Naval Res. Lab. Washington, D. C., 37 pp., Rep. 4825; September 14, 1956. (See p. 12.)

—, "Whistling atmospherics observed at Washington, D. C.," presented at URSI Spring Meeting, Washington, D. C.; May, 1955.

was observed at some other place and time, thus illustrating one important property of almost all the known VLF emissions: their *reproducibility*. Therefore, the way was opened to a classification or "systematics."

OBSERVATIONS—SYSTEMATICS AND SOME STATISTICAL PROPERTIES

In the following sections selected examples of different types of VLF emissions are reproduced. It is possible from *morphological* properties only, to organize almost all observations into types and classes, according to Tables I and II.

Such a system is useful for obtaining statistics of the different classes. It has been developed by Jones and the author at NBS and used to investigate the diurnal and seasonal occurrence of frequency variations.<sup>3</sup> It has been found, for example, from the statistics for the period January to June, 1957, at Boulder (geomagnetic latitude 48.9°) that for discrete VLF emissions (see Table II) the order by number of *occurrences* is: classes 2, 3 almost equal, then class 5, quasi-horizontal tones, half as abundant, followed by the "hooks" class 1, very recognizable but relatively rare, and classes 4, 7, 6, 8. The average diurnal distribution is markedly different for separate classes. Of the four most abundant classes, the risers (class 2) and the quasi-horizontal tones (class 5) are almost uniformly distributed over the 24 hours. In strong contrast, class 3, forming principally the so-called "dawn chorus," occurs almost only in the 9 hours from 08 to 17 Universal Time (01 to 10 Local Mean Time) with a strong peak between 13 to 15 UT (06 to 08 LMT) around local sunrise period. This distribution for class 3 is almost parallel to the diurnal distribution for the continuous type of VLF emissions or hiss. Finally the hooks class 1, occurs only within the 9 hours from 14 to 23 UT without any well-marked peak. Similar statistics, based on aural observations, have been presented by Alcock for New Zealand.<sup>4</sup>

Such properties as have been described, the details of which will be presented elsewhere, are indicated here just for emphasizing several important points.

Observational Questions

The distinction between types and classes of VLF emissions is important and physically significant. Such broad and pictorial terms as "dawn chorus," first introduced by Storey<sup>5</sup> and used in several publications<sup>6</sup> are insufficient and in some way misleading for characterizing the phenomena. An accepted terminology should be

<sup>3</sup> R. M. Gallet and D. L. Jones, "A systematic classification of natural VLF noises other than whistlers," presented at URSI Spring Meeting, Washington, D. C.; May, 1957.

<sup>4</sup> G. M. Alcock, "A study of the audio-frequency radio phenomenon known as dawn chorus," *Aust. J. Phys.*, vol. 10, pp. 286-298; 1957.

<sup>5</sup> L. R. O. Storey, "An investigation of whistling atmospherics," *Roy. Soc. Phil. Trans.*, vol. A246, pp. 113-151; July 9, 1953. See Appendix, pp. 139 and 140.

<sup>6</sup> Dinger, *op. cit.*, p. 14, reference 4; p. 205, reference 7a.

TABLE I  
SYSTEMATIC CLASSIFICATION OF OBSERVED VLF NOISES

2 Large Groups:









- I. WHISTLERS—Cause: Lightning Discharges.  
All frequencies emitted at once; shape due to dispersion along the path.
- II. VLF EMISSIONS—Not caused by lightning.  
Strongly associated to magnetic perturbations.  
TWO PRINCIPAL TYPES:
  1. Continuous in both time and frequency.  
Steady state situation. Hiss.
  2. Discrete, but often with repetition tendency.  
Transient situation. Many classes recognized.

A third group more complex and rarer exists:

- III. Interactions between Whistlers and VLF emissions.  
The interaction involves either the continuous or the discrete VLF emissions.

TABLE II

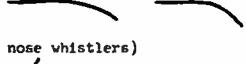
II. 2. CLASSES OF DISCRETE VLF EMISSIONS:

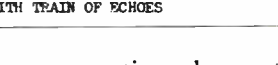
1. HOOKS	
2. RISERS	
2B. HOOK WITH EXTENDED RISING TAIL	
3. QUASI VERTICAL (Generally FUZZY. Typical Chorus)	
4. FALLING TONES	
4B. PSEUDO WHISTLERS	
5. QUASI HORIZONTAL	
5B. COMBINATION OF 4 AND 5	
6. PSEUDO NOSES (by analogy with nose whistlers)	
7. TOO COMPLEX FOR THE PRECEDING CLASSES	
8. EXCEPTIONAL STRONG NOISES WITH TRAIN OF ECHOES	

particularly useful for large cooperative observational programs such as the IGY.

However, the distinction between classes is not always clear cut and is sometimes somewhat arbitrary; the morphological transitions are gradual rather than sharp; the introduction of new classes or subclasses will perhaps be needed and some changes necessary. The aural observations alone are insufficient for recognizing most of the emissions. Laboratories engaging in this work need facilities for producing good quality visual records rapidly and in large quantities. To help the classification, particularly from the extensive archives of IGY records, only experience and sets of good examples, progressively arranged in each category, permit workers to obtain consistent results. For example, the distinction between risers (class 2) and the quasi-vertical, typical chorus

16 MAY 1956  
1335 UT



10 NOVEMBER 1956  
1235 UT

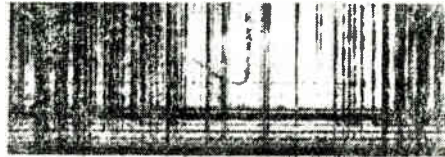

12 NOVEMBER 1956  
2335 UT



17 MAY 1956  
0135 UT

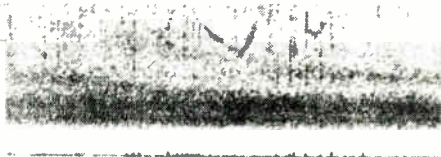

29 OCTOBER 1956  
1135 UT

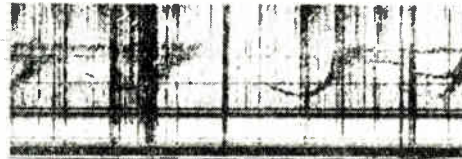

24 NOVEMBER 1956  
1135 UT

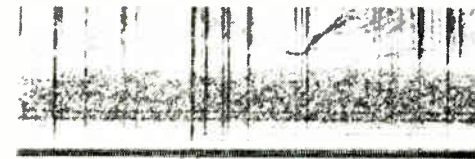

16 SEPTEMBER 1956  
1835 UT



16 SEPTEMBER 1956  
1835 UT

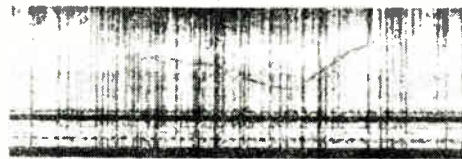

25 NOVEMBER 1956  
0435 UT



26 OCTOBER 1956  
2230 UT



26 OCTOBER 1956  
2230 UT



Fig. 1—Transition of the slopes in hooks.



(class 3) from isolated spectrograms only is often arbitrary. But the fuzziness and bunching of many noises for class 3, as opposed to the thin, isolated character of the risers, having generally a smaller slope along with other properties such as closer correlation with periods of magnetic activity for class 3 helps separation into classes. In order to facilitate the work, a provisional atlas of spectrograms has already been furnished to interested groups by the NBS group, and a more systematic new atlas is in production along these lines. No attempt is made in this paper to illustrate completely the different categories of noises.

#### *Physical Significance of Classification*

The fact that the different types and classes have different statistical properties may indicate that several mechanisms are at work. A strong diurnal variation in terms of local mean time indicates that the conditions prevailing for the production of the relevant class of noises have a strongly nonuniform longitudinal distribution. The knowledge of these properties is fundamental for the development of a detailed theory.

#### PHYSICAL PROPERTIES MOST SIGNIFICANT FOR THE ORIGIN OF THE EMISSIONS

##### *Definiteness of the Spectrum*

Many of the types have sharp and precise features, often as sharp or better than for the best whistlers. This is very well illustrated in many of the figures. Consider particularly the hooks (Fig. 1) on 0–8-kc spectrograms of standard length 2.3 seconds and the extended rising tails or risers (classes 2 and 2B) on 0–16-kc spectrograms of standard duration 1.15 second, in Figs. 2 and 3. The definition in time and frequency for a given point along the spectrum, as accurate as the equipment resolution will permit, is often excellent.

In terms of origin, if the shape is not due to a dispersion effect, this indicates that the producing mechanism is capable of emitting one or a few precisely defined frequencies at a given moment. These frequencies vary continuously in time in a well-defined manner.

##### *Reproducibility*

This property can be understood in several ways. For example, it is often easy to match two hooks almost exactly in time and frequency. This can occur at short intervals or after several months. There is a good tendency for the *repetition*, at short intervals of a few seconds or a few minutes, of the same type during an emission period. This can occur, for example, with hooks during some large magnetic storms. Generally, however, during a short interval of a few minutes, the *general character* or class will be conserved without exact reproduction of the spectrum. Three consecutive hooks will look very much alike, but the minimum frequency will differ by 2 or 3 kc and the duration will not be exactly the same.

The reproducibility in character, even for quite complex events, either at intervals of a few seconds or at

long intervals, is well illustrated by the rising tails (class 2B, or 2) in Fig. 2 and Fig. 3 (spectrograms: 0–16 kc). In Fig. 2, the three events on November 14, 1956, 2335 UT, follow at 33, 35, and 55 seconds. In Fig. 3, the five events on February 12, 1958, 1835 UT, follow at 30, 37, 40 second, 1 minute +19 and +45 seconds. Between these two figures, the interval is 15 months.

Almost all types, including rare shapes in classes 6 and 7, have been reobserved in the course of about two years. Even the rare event presented in Fig. 4 was duplicated almost exactly about one minute before.

The reproducibility indicates that the conditions of emission are far from being random. They correspond to a certain number of definite situations which can be repeated in the course of time.

##### *Propagation Mechanism*

Theoretically, for the range of frequencies considered here, the electromagnetic waves have only two general modes of propagation. Either they propagate along the earth's surface between ground and ionosphere, or they propagate according to the whistler mode, essentially along the lines of force of the geomagnetic field, in the exosphere.

From the observations, the mode of propagation is almost certainly the whistler mode. The best experimental proof is furnished by the observation of a train of successive echoes, following a particularly strong VLF emission. A beautiful example is shown in Fig. 4. By a remarkable chance, this important observation was obtained on February 27, 1956, 2102 UT, almost at the beginning of the NBS observing program. Two such trains have been recorded in an interval of two minutes, but in the first train the initial signal and the first two or three echoes were already gone when the automatic recording started. The second train, shown here, contains the initial signal and 11 echoes before the recording stopped automatically. Very few trains of echoes from ordinary whistlers have been observed having *at least* 11 echoes. The range of frequencies is narrow but the progressive dispersion of the successive echoes, according to the whistler laws, is very visible and quite accurately measurable. The dispersion constant can also be measured from the time interval between echoes at a given fixed frequency. In the present example at the frequency 3.25 kc, the average time interval is 2.18 seconds. The dispersion constant  $2D$  for one double path, including one reflexion in the southern hemisphere, is:

$$2D = \tau f^{1/2} = 124.3.$$

The value  $D = 62.1$  is consistent with the values of the dispersion constant for the whistlers observed at Boulder during the same period. This example shows several other features which deserve special attention. The frequency broadening between the initial signal and the following echoes, seems to indicate that some nonlinear mechanism spreads energy by transport or

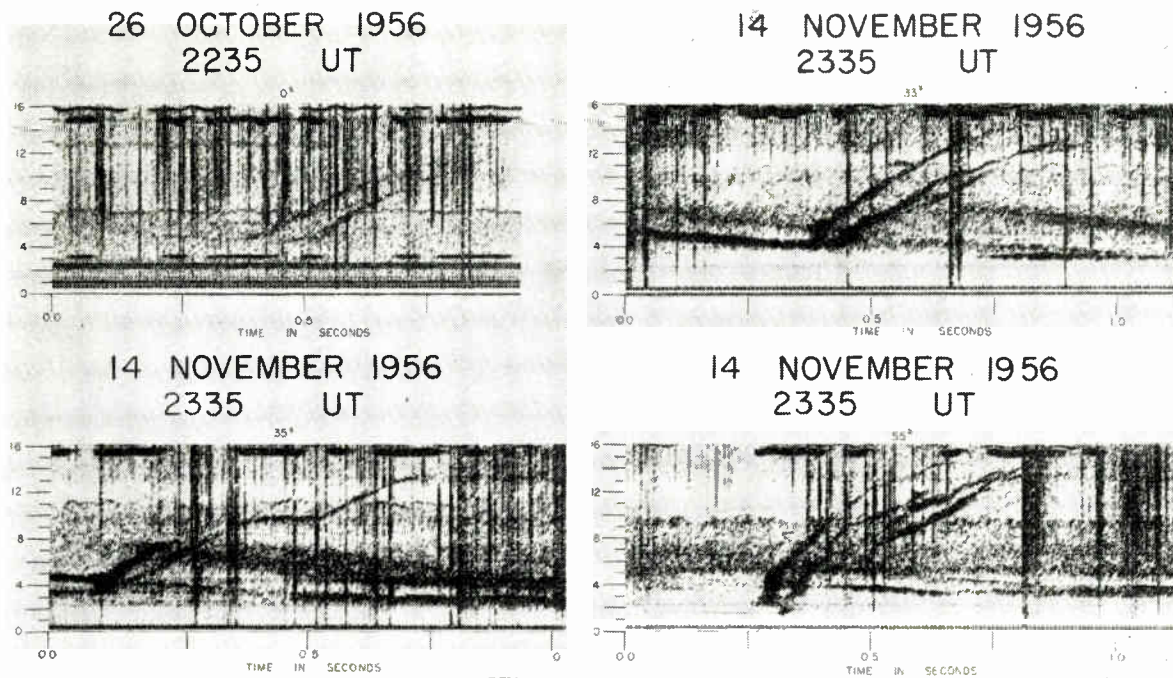

Fig. 2.

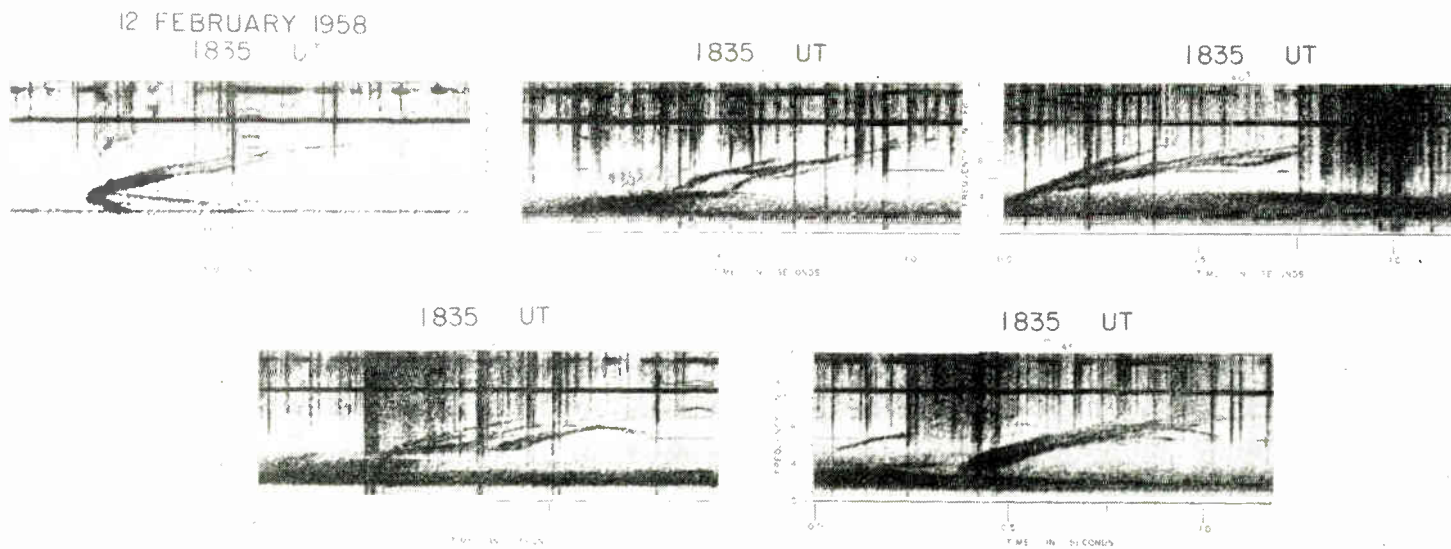

Fig. 3.

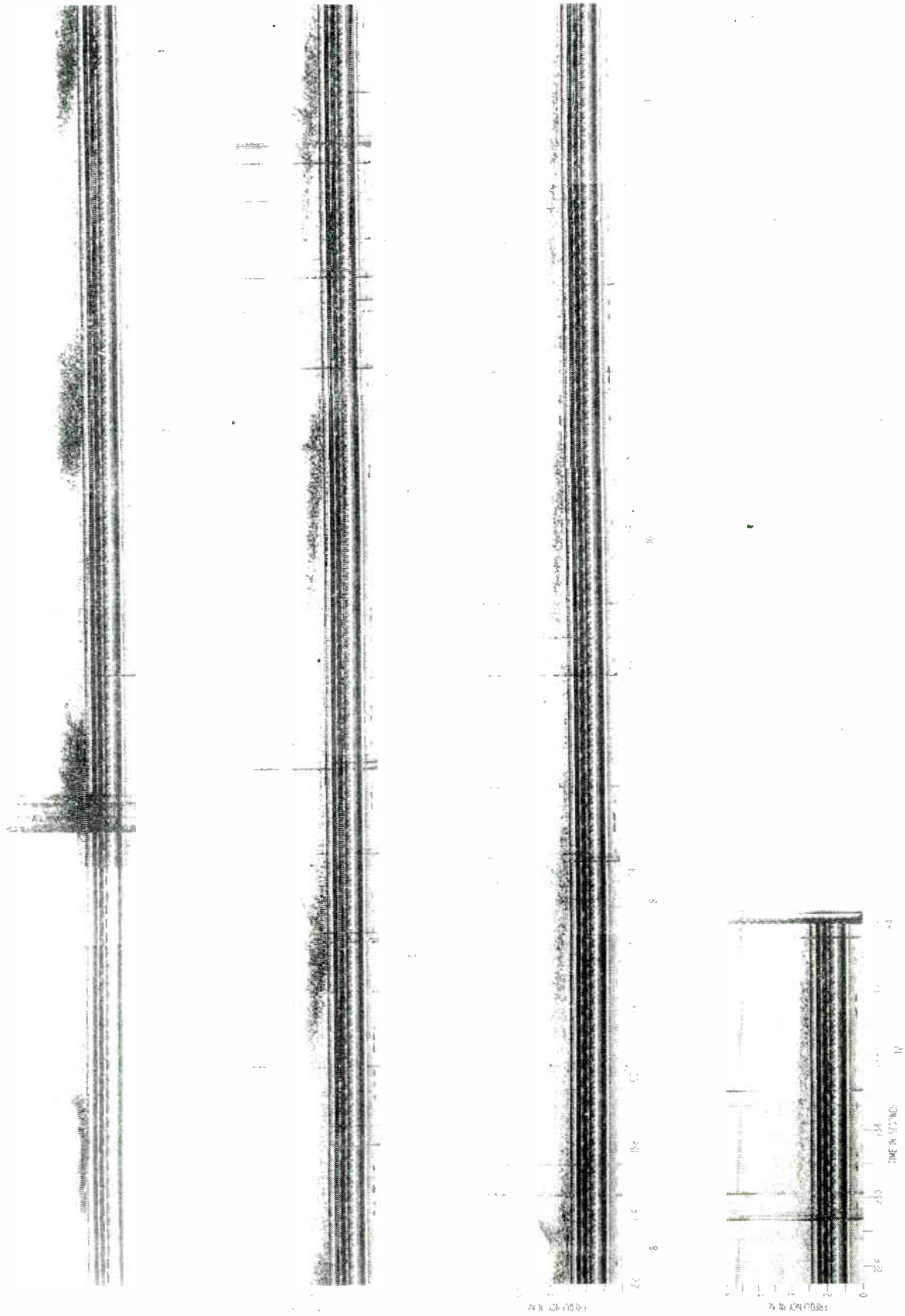

Fig. 4 Strange emission with train of echoes.



excitation from one frequency to neighboring frequencies. Also, the reinforcement of the short riser at the end of only certain echoes suggests an induced re-emission rather than a single echo.

Other good cases of such trains of echoes have been observed both at Boulder and Anchorage. When the interference level due to lightning strokes is strong and the VLF emission activity intense, it is not always simple to separate the echoes. An intermediate case in difficulty is presented in Fig. 5(a) and 5(b), for Boulder, June 30, 1957, 1735 UT. In Fig. 5(a), 4 echoes from an elongated hook can be distinguished from second 3 to second 9. The scale for Fig. 5(a) is 0–16-kc double spacing in time. Fig. 5(b) starts one minute, 10 seconds later; the scale is 0–8-kc normal spacing in time. From the initial signal at the top of Fig. 5(b) (this signal is partly cut, because an intermediate plate has been suppressed) five successive echoes can be seen at an average interval of 2.12 seconds at 4.5 kc, which give  $2D=142$  ( $D=71$ ).

This property, which is a basic one for any theoretical interpretation, will be further discussed with the help of Figs. 6 and 7. Fig. 6 illustrates the periodicity property at high latitudes. Four groups of first signal and several echoes can be separated, as shown by precise measurements; the easiest group to see is in the second and third band, and it has 5 “followers” after the first riser. The three other groups have only two observable followers each. The average time interval measured at 6 kc for all cases is 1.64 kc, which gives  $2D=127$ ;  $D=63.5$ . But the “echoes” in these series of risers (class 2) do not seem to become progressively more dispersed according to their order in the train. Further, some later “echoes” are apparently stronger than the initiating emission. Other similar examples at Anchorage, Alaska and at Boulder are recorded; the same property has been indicated above in discussing Fig. 4.

Fig. 7 shows a clear case of regular periodicity in “hiss” observed at Boulder, February 14, 1957, 0135 UT. These observations suggest that the propagation takes place by the whistler mode and is likely to produce several echoes for sufficiently strong signals. However, in certain cases a reinforcement of the emission can take place at some position along the path when the wave train passes this position.

#### *Tendency for Horizontal or Gliding Tones*

Classes 5 and 5B of discrete VLF emissions are illustrated in Fig. 8. Generally the signal is remarkably pure, occupying a very narrow-frequency band. A duration of one half to one second is common, but much longer signals are observed. A good example of very slowly decreasing frequency over about 2.5 seconds and around 12-kc average frequency is shown in Fig. 9.

The same tendency for almost constant frequency over a relatively long period can be observed in other types. [See the last three cases of long hooks in Fig. 1, the initial signals in Figs. 4, 5(a), and 5(b).]

Very often, within the bands of *hiss*, long slowly descending or almost horizontal tones are observed. A particularly good case is shown in Fig. 10. The gliding tones merge slowly within the hiss band, strongly suggesting that the hiss band is formed of many such tones fused together. This fine structure in the hiss has already been described by Watts.<sup>7</sup>

It is remarkable that such almost constant frequency can be emitted during a relatively long time, being as in the cases of hiss and hooks at least a part of a more general emission. There should be a quite simple and natural reason explaining this feature. The physical significance of this will appear in the theoretical discussion.

#### *Association with Magnetic Activity*

The occurrence of VLF emissions at a given place is very definitely correlated with magnetic activity. Almost each individual great magnetic storm shows a typical sequence of apparition of the different types and classes of VLF emissions. Several particularly remarkable and well-isolated periods have been studied in detail with the 1956 observations. Hiss has a tendency to appear during the recovery phase of a strong magnetic storm, but is sometimes present for short periods of one or two hours during the main phase. Hooks often occur in great numbers during certain hours in the middle of a magnetic storm.

Sometimes, however, strong activity is observed without any special magnetic disturbance. Also the  $K_p$  numbers do not seem to be statistically a very significant index for correlation. The main physical reason is that the  $K_p$  represents an average variability over a 3-hour period, while quite often active periods of strong VLF emissions are of duration less than one hour.

The detailed relationship between magnetic activity and the occurrence of the VLF emission is not simply characterized and deserves further study. Some aspects of this relationship have already been discussed in published literature.<sup>4–7</sup>

#### *Steady-State of Hiss vs Transients*

The discrete VLF emissions evidently represent transient effects, sharply defined in time and frequency. In contrast, the hiss appears as a solid band of noise, occupying a broad band of frequency, and is emitted over a long time. From the statistics of visual observations of the hiss spectra for the first 6 months of 1957, the average duration of the hiss emission was 1.6 hours for 122 distinct cases. The distribution of the duration falls off more slowly than for an exponential distribution; consequently, cases of continuous emission during more than 10 consecutive hours have been observed. The

<sup>7</sup> J. M. Watts, “An observation of audio frequency electromagnetic noise during a period of solar disturbance,” *J. Geophys. Res.*, vol. 62, pp. 199–206; 1957. (See pp. 202–203.)

<sup>4</sup> “Audio frequency electromagnetic hiss recorded at Boulder in 1956,” *Geofisica Pura e Applicata (Milano)*, vol. 37, pp. 169–173; 1957.

30 JUNE 1957  
1735 UT

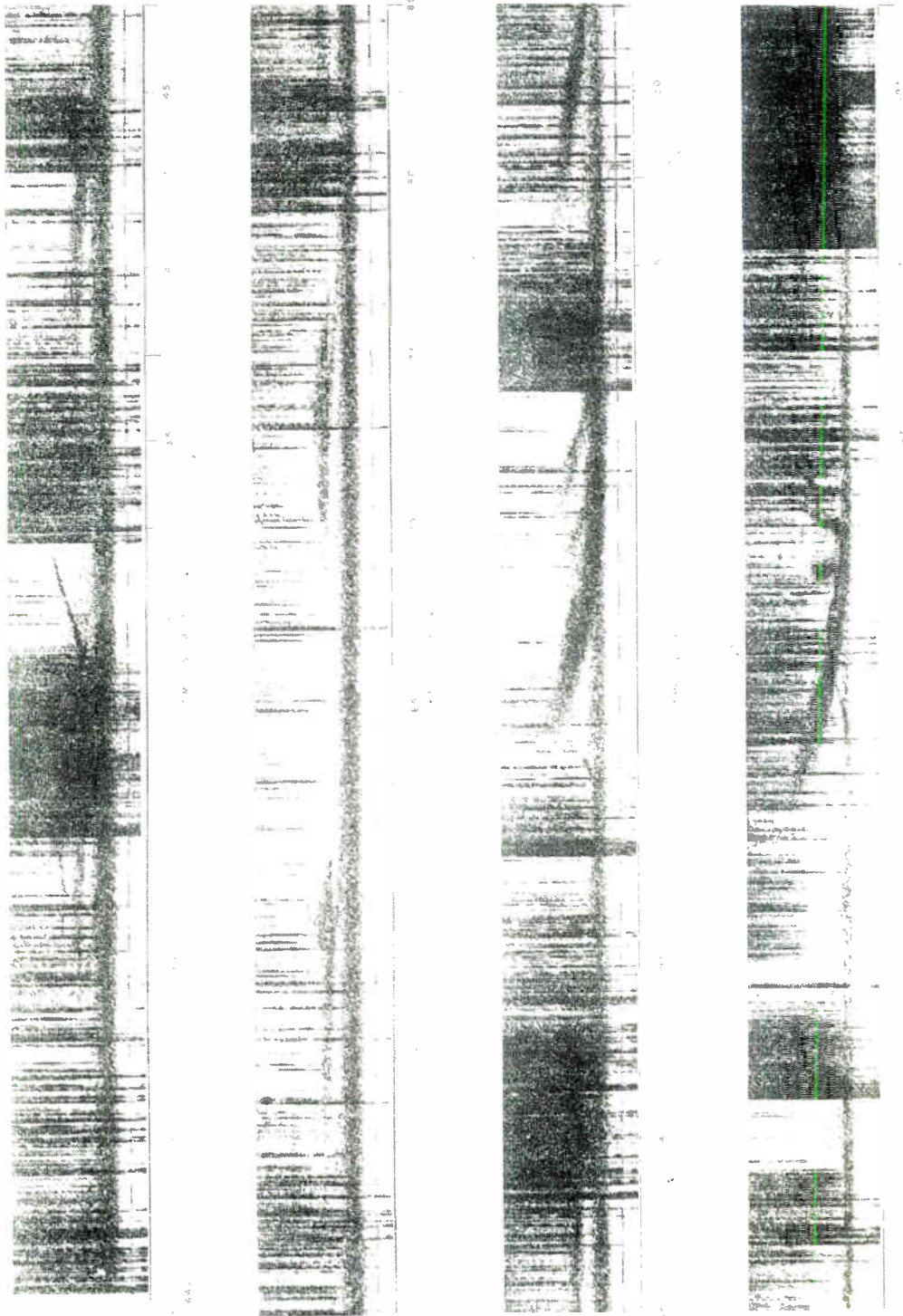

(a)

Fig. 5.





15 FEBRUARY 1958  
0635 UT

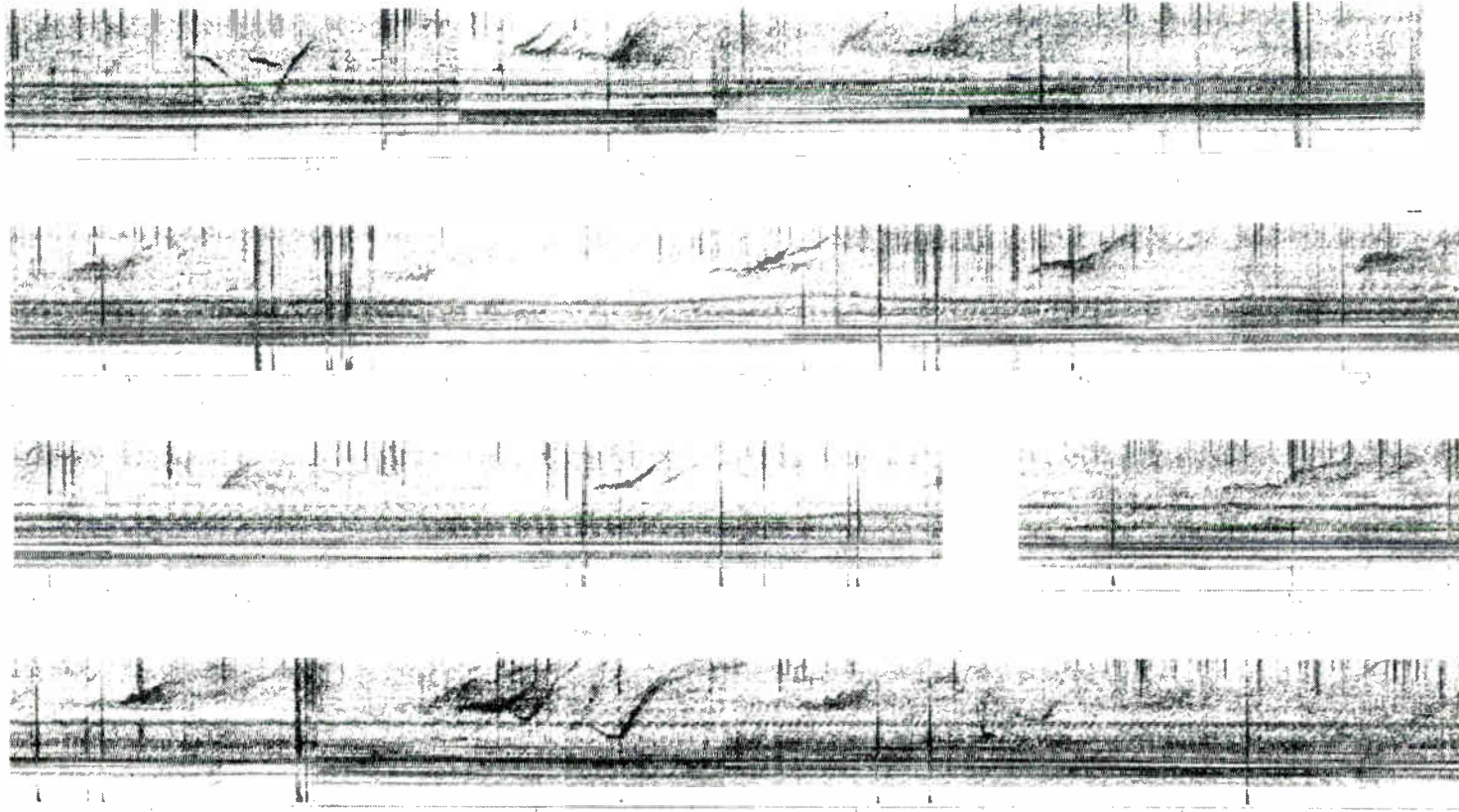

Fig. 6—Alaska.

14 FEBRUARY 1957  
0135 UT

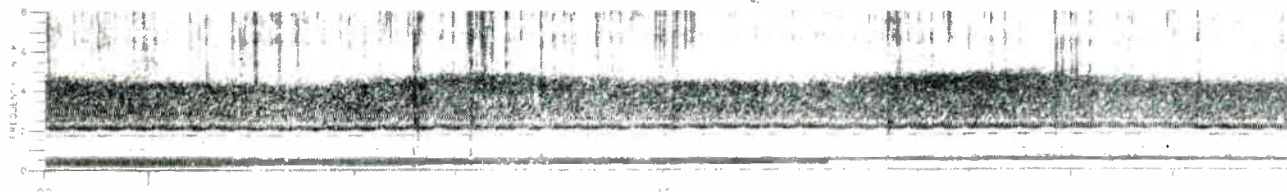

Fig. 7.

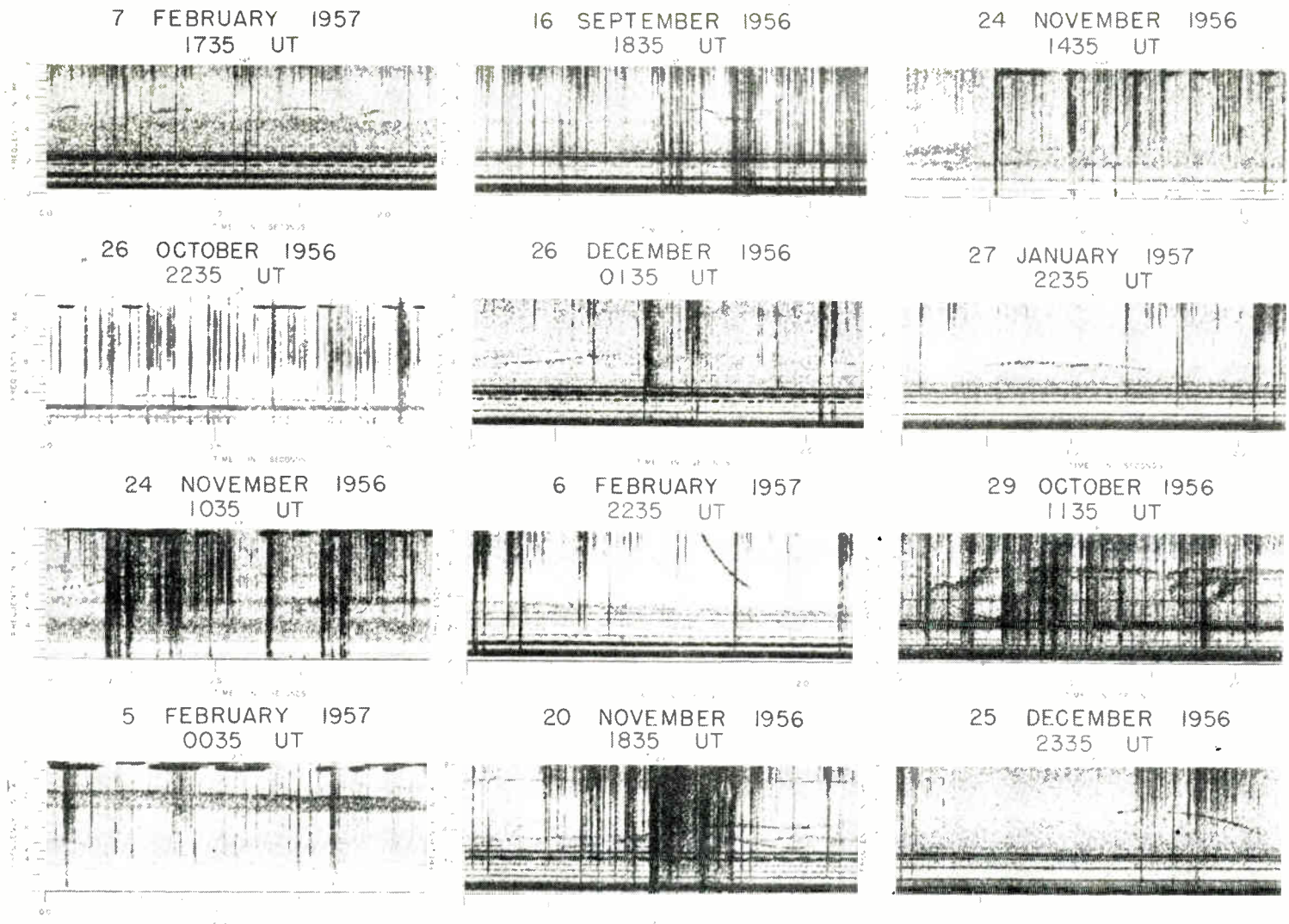

Fig. 8—Quasi-horizontal tones.

peak occurrence of the middle of the frequency band is about 3.5 kc. The bandwidth generally extends over 2 to 3 kc, but solid bands of noise extending to as much as 8 to 32 kc have been recorded. The simplest cases of hiss are shown in Fig. 11. In this figure, the first two rows of observations are with 0–8-kc spectrograms, the third row is with 0–16-kc spectrograms, and the fourth row is with 0–32-kc spectrograms.

More complex cases of hiss are recorded, such as two bands simultaneously present—one at low frequencies, the other at higher frequencies. Intensity fluctuations, gliding and quasi-horizontal tones, as illustrated in Fig. 10, and often some well-defined discrete VLF emissions which come down from or disappear into the upper limit of the frequency band are recorded.

Hiss evidently represents some steady-state condition for the emissions.

#### THE THEORY OF VLF EMISSIONS PHENOMENOLOGICAL THEORY

The principal properties outlined in the preceding sections permit the deduction of a certain number of conclusions, almost independently of any specific mechanism producing the electromagnetic waves.

For convenience, a short useful summary of observed properties most significant for the theory is presented: From discrete VLF emissions (transients):

- 1) spectrum, sharply defined in frequency and time,
- 2) reproducibility, indicating some definite processes,
- 3) a whistler mode of propagation,
- 4) tendency to "quasi-horizontal tones," separately or as part of other noises, as a capacity for generating almost constant frequency during an extended time, and
- 5) association with magnetic activity.

A *steady state* as indicated by the hiss is often present.

From the fact that the mode of propagation is the whistler mode, one can infer that the generation of the different frequencies is distributed as a function of time. If somewhere along the line of force, all frequencies were generated at once as they are by the electromagnetic impulse of a lightning discharge, the resulting spectrum due to dispersion will be exactly like a whistler. Only the dispersion constant will be diminished, according to the length of the propagation path from the place of emission to the earth's surface.

It is possible to invert the process. Suppose from theoretical assumptions that a model of the exosphere, *i.e.*, a law of distribution of the electronic density in space, has been accepted which satisfies the requirements for whistlers, including the dispersion constant, shape of nose whistlers, etc. Along a given line of force, the phase and group velocities at each point can be obtained for each frequency. By integration, one can compute the propagation time  $\tau_f(s)$  from the earth's surface to any point  $s$  along this line. An observed spectrum, a typical hook, for example, furnishes an empirical func-

tion: the time of arrival as a function of frequency  $t_f$ . If a frequency  $f_1$  has been generated at a certain arbitrary point  $s_1$  along the line of force, this generation will have taken place at the emission time

$$\theta_{f_1}(s_1) = t_{f_1} - \tau_{f_1}(s_1). \quad (1)$$

The other frequencies cannot have been generated at the same emission time at the same point, otherwise the observed function  $t_f$  will be a whistler. If they are generated at the same place  $s_1$ , the emission time  $\theta_f$  should be a function of frequency. In such a case, the emission mechanism should be fixed in space but with frequency variation in time. It is more likely, in general, that the frequency emitted will be a function of space position, excited at an emission time  $\theta$  by some agent moving through the exosphere.

So, an important concept is obtained: the observed time of arrival  $t$  is the sum of an emission time  $\theta$  and a propagation time  $\tau$  along the trajectory.

$$t = \theta + \tau.$$

The absolute values of times  $t$  for different frequencies are unknown; only the relative differences are observed.

The agent responsible for the excitation is inferred from the relationship with solar activity. The ionized solar corpuscular clouds, responsible for the production of magnetic storms and auroras, are likely to be the excitation agency by their motion through the earth's exosphere.

It is easy to see that if some high-speed cloud of ionized gas moves toward the earth, as is the case in the aurora, it will excite the radiation progressively as a function of time.

The sharpness of the spectra of many classes of discrete VLF emissions indicates that often these clouds are of very small dimensions and maintain their individuality during times of the order of seconds. If one (or a few) discrete frequencies are emitted at a given point in the exosphere under the excitation provided by the passage of a cloud, spatial extension of the cloud is limited by the frequency bandwidth observed at a given moment. The numerical developments of the theory, given below, indicate that the small clouds cannot be much larger than about 100 km. Such clouds of dimensions, very small when compared to the dimensions of the earth and the exosphere, are difficult to understand. It will be seen that they are very likely produced near the earth in the hydromagnetic interaction between the earth's magnetic field and the large solar corpuscular clouds.

The steady state, represented by the hiss phenomenon, will be interpreted along these views as the result of a steady stream of ionized gas through the exosphere. In each point in space a different frequency is constantly emitted. The differences of emission and propagation times are not observable, and the simultaneous arrival of all frequencies gives the aspect of a solid band of noise.



5 FEBRUARY 1957  
0035 UT



Fig. 9.

12 NOVEMBER 1956  
0235 UT

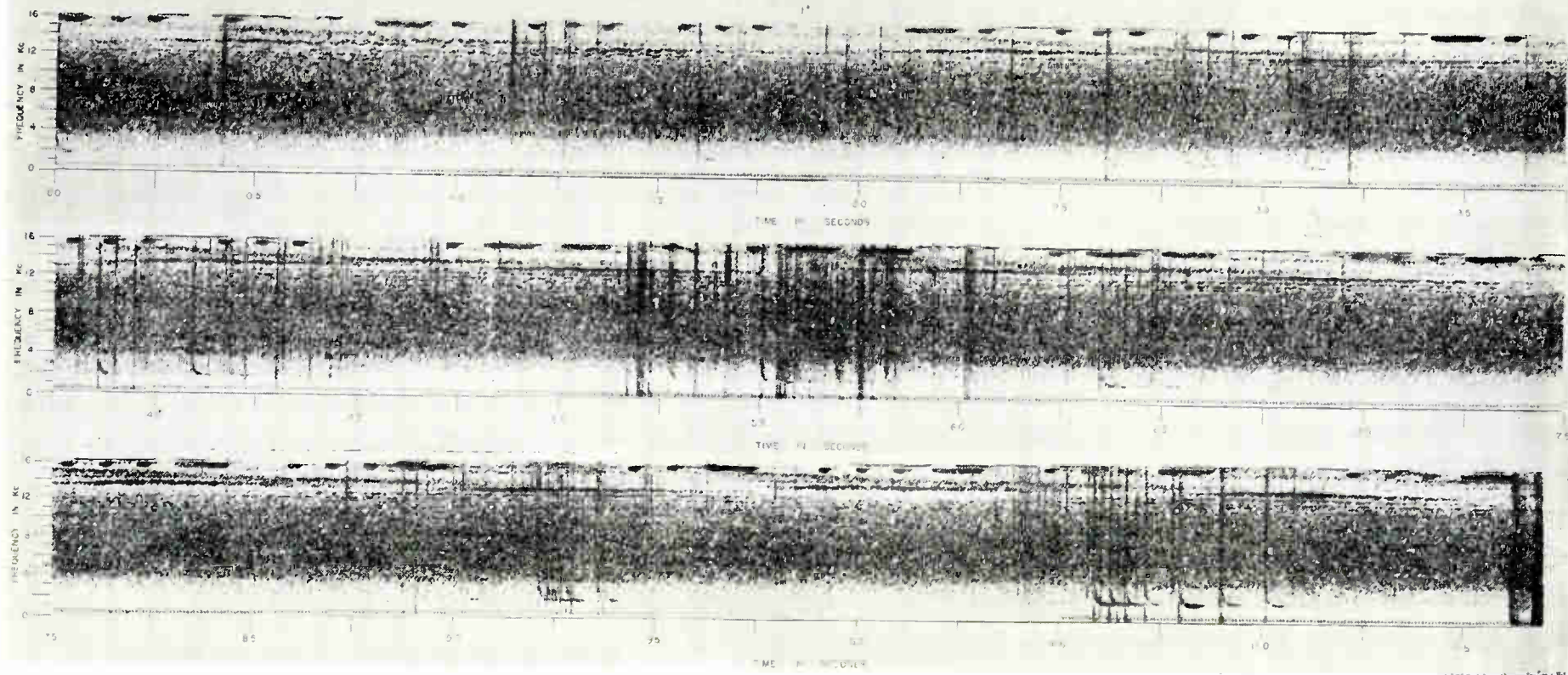

Fig. 10.

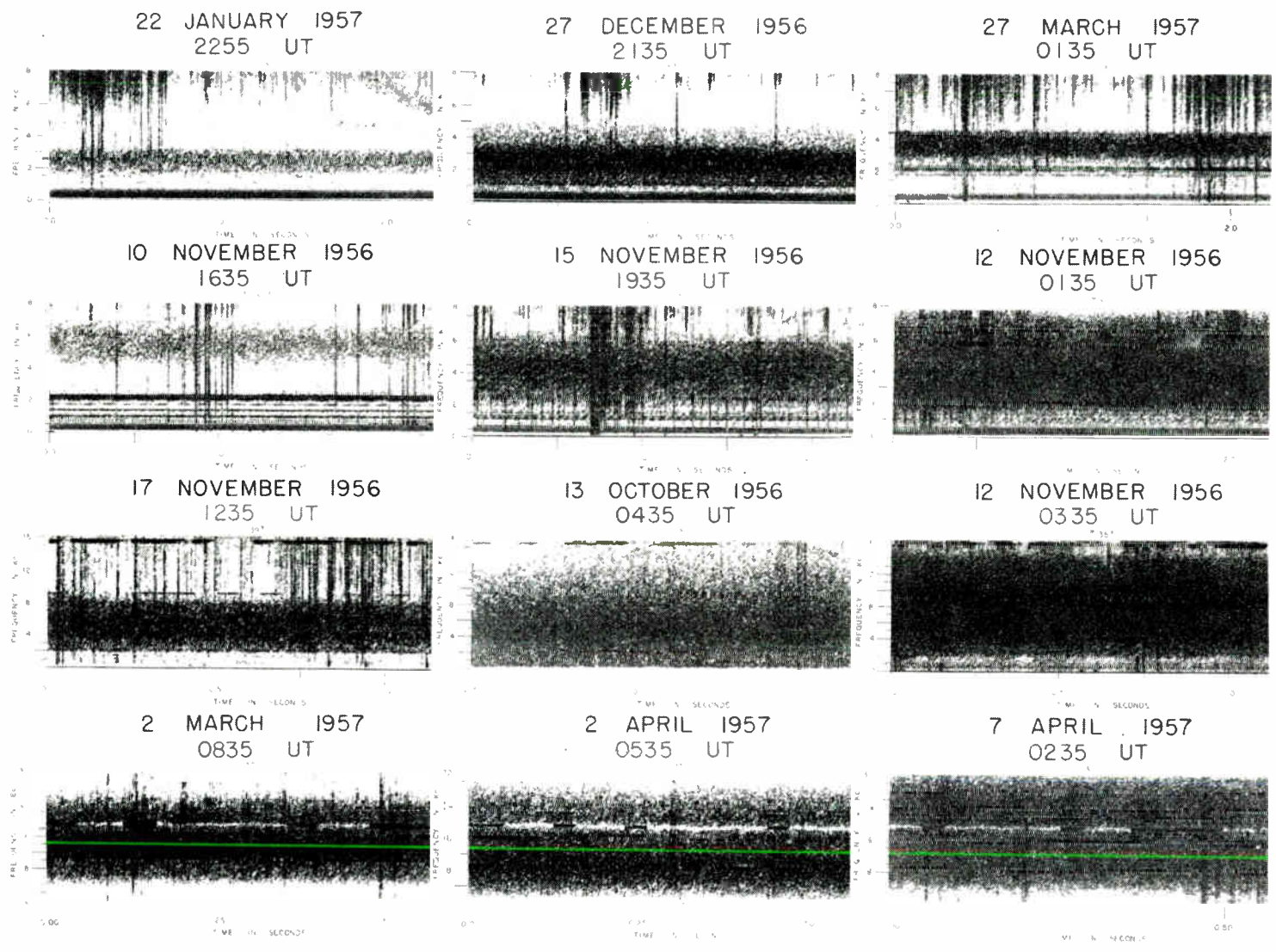

Fig. 11—Hiss.



It is difficult to go farther without finding the specific mechanism of emission, but it is also important to realize that the preceding conclusions are independent of any knowledge of it. Therefore, direct information on solar corpuscular radiation is obtained from time variations of VLF emission activity without any further assumptions.

#### THE THEORY OF VLF EMISSIONS THE TRAVELING-WAVE TUBE MECHANISM

##### *The Emission Mechanism*

Observations show that the emitted frequency is discrete and very well defined. The first hypothesis which presents itself is some sort of resonance excited by the incoming high-speed particles.

The natural resonance frequencies in the exosphere are the plasma frequency and the gyrofrequency, given by

$$\omega_p^2 = \frac{4\pi n_e e^2}{m} \quad (2)$$

$$\omega_H = \frac{eH}{mc} \quad (3)$$

and numerically

$$n_e = 1.24 \times 10^{-8} f_p^2 \text{ (electrons per cm}^3\text{)}$$

$$f_H = 2.800 \times 10^6 H \text{ (H in gauss).}$$

For any model of the exosphere, space distribution of  $n_e$  is such that the plasma frequency anywhere is of the order of hundreds of kilocycles and, therefore, too large. The gyrofrequency will have the right order of magnitude at sufficiently large distances, larger than about 4 times the radius of the earth. (*Note:* in what follows the distances in earth's radii are given from the earth's center.) At a distance greater than about 7 radii, however, the gyrofrequency becomes too small; the earth's magnetic field at these distances loses its dipolar character, being of the same order of magnitude as the magnetic perturbations produced by the interplanetary clouds of solar ionized material. The radiation at the gyrofrequency is an interesting possibility—with some difficulties, however. The magnetic field along lines of force, terminating at relatively low geomagnetic latitudes  $\lambda < 60^\circ$  at the earth's surface, is too large for explaining the emissions. Some work has been done by the author in this direction, but it will not be discussed further here.

In discussing these problems during the U. S. URSI Fall Meeting, December, 1956, in Florida, Helliwell and the author made an essential observation subsequently developed by them in the theory called "the traveling-wave tube mechanism of VLF emissions." The outline of this theory was presented first at the VLF

Symposium, Boulder, Colo., February, 1957, and later at several other meetings.<sup>8</sup>

Calculations for whistler propagation show that for relatively low frequencies the phase velocity can be as low as  $c/100$  in some parts of the trajectory. For those frequencies the combination of the exosphere plasma and the magnetic field plays the role of a very effective slow-wave structure. Now from solar-terrestrial relationship studies and from aural studies, particularly the recent spectrographic observations of  $H\alpha$  emissions in auroras by Meinel,<sup>9</sup> it is known that the velocities of the high-speed ionized clouds or streams are of the order of a few thousands of kilometers per second. When in a certain structure an ionized beam and an electromagnetic wave propagate at the same velocity over a sufficient length, an interaction and exchange of energy between the two take place. This interaction is used in many devices. In the *traveling-wave tube* energy is transferred from the kinetic energy of the electrons of the beam to the electromagnetic wave which is amplified in the manner discussed by Pierce<sup>10</sup> and in many other papers.

In other cases, a beam of ionized particles can be accelerated at the expense of the energy of the electromagnetic wave, as in the *linear accelerators* which are the large number of observations, mentioned as the third type of natural VLF noise in Table I, where this inverse case seems to take place. The energy is furnished either by a strong whistler, or by some strong VLF emission. The accelerated bunches or streams of particles in turn are susceptible to producing some radiation. This very interesting subject will not be further discussed in this paper because a proper discussion will be almost as extensive as the present one. It is hoped to present the observation material and its interpretation in the future.

The interaction requires that the propagating electromagnetic wave have a longitudinal component of electric field along the phase direction of propagation. With the propagation being highly anisotropic in the whistler mode, the directions of phase and energy propagation are generally different. This can produce the longitudinal component of electric field. There are also many indications that the electronic distribution in the exosphere is not homogeneous, but "modulated" in columns along the lines of force. These columns can organize a true dielectric guiding of the electromagnetic wave, which will have a longitudinal electric field.

<sup>8</sup> R. M. Gallet and R. A. Helliwell, "A theory of the production of VLF noise (so-called dawn chorus) by traveling-wave amplification in the exosphere of the earth," presented at VLF Symp., Boulder, Colo., Paper 20; January 23-25, 1957.

<sup>9</sup> "A theory of the generation of VLF hiss and so-called dawn chorus," *J. Geophys. Res.*, 1959. (To be published.)

<sup>10</sup> A. B. Meinel, "Doppler-shifted auroral hydrogen emission," *Astrophys. J.*, vol. 113, pp. 50-54; 1951.

<sup>11</sup> J. R. Pierce, "Traveling-Wave Tubes," D. Van Nostrand Co., Inc., New York, N. Y.; 1950.



A low level of electromagnetic wave, such as caused by the natural thermal noise in the exosphere, produces a slight density modulation along the fast beam. In turn, this density modulation produces an amplification of the wave which grows in time. The interaction ceases if the two velocities eventually become different.

Basic Formulas

In this mechanism, the condition of interaction is

$$v_p = V \tag{4}$$

where  $V$  = velocity of the ionized stream of particles and  $v_p$  = phase velocity of the electromagnetic wave. In this paper, only propagation along the direction of the magnetic field will be considered. For small angles of propagation this approximation is very good. In the whistler mode, the local refractive index is

$$n = \left[ 1 + \frac{\omega_p^2}{\omega\omega_H - \omega^2} \right]^{1/2} \tag{5}$$

and

$$v_p = \frac{c}{n} \tag{6}$$

Combining (4)-(6) and solving for  $\omega$  gives

$$\omega = \frac{\omega_H}{2} \left[ 1 \pm \left\{ 1 - \left[ 2 \frac{\omega_p}{\omega_H} \frac{V}{c} \frac{1}{\sqrt{1 - \frac{V^2}{c^2}}} \right]^2 \right\}^{1/2} \right] \tag{7}$$

Generally the value of the expression

$$\frac{1}{\sqrt{1 - \frac{V^2}{c^2}}}$$

will differ extremely little from 1. Thus, (7) can be simplified with great accuracy to

$$\omega = \frac{\omega_H}{2} \left[ 1 \pm \left\{ 1 - \left( 2 \frac{\omega_p}{\omega_H} \frac{V}{c} \right)^2 \right\}^{1/2} \right] \tag{8}$$

Eq. (8) is the basic expression of the theory.

Generally two frequencies are emitted simultaneously. Their values depend on the plasma parameters  $\omega_p$  and  $\omega_H$  and on the high-speed beam parameter  $V$ . When the inequality

$$2 \frac{\omega_p}{\omega_H} \frac{V}{c} > 1 \tag{9}$$

holds, no emission takes place. When this expression is equal to 1, the two distinct frequencies merge in one given by

$$\omega = \frac{\omega_H}{2} \tag{10}$$

One frequency, the low one,  $\omega_1$  is always  $\omega_1 < (\omega_H/2)$ ; the high frequency  $\omega_2$  is always  $\omega_2 > (\omega_H/2)$ .

Because  $V/c$  will generally be small (few times  $10^{-2}$ ), the condition (9) exists only at large distances when  $\omega_H$  becomes very small. In Fig. 12, several lines of force have been traced. The dashed one shows the line of force corresponding to geomagnetic latitude  $67^\circ$ , corresponding approximately to the center of the auroral zone. Along this auroral line of force, local values of the gyrofrequency in kilocycles have been indicated below the line. Above the line, the excited frequencies in kilocycles are indicated for a hypothetical case when

$$\frac{V}{c} f_p$$

is kept constant at the value 2 kc for a small cloud moving along the line of force. This figure is illustrative only.

For any given exosphere model, it is possible by numerical integration to calculate for a small cloud moving along a line of force, according to a velocity law  $V(s)$

- 1) at each place  $s$ , the emission time  $\theta$ ,
- 2) the frequencies  $f_1$  and  $f_2$  emitted,
- 3) from this point on to the earth's surface, the propagation times  $\tau_1$  and  $\tau_2$  with the group velocity along the line of force, and
- 4) the arrival times

$$t_1 = \theta(s) + \tau_1; \quad t_2 = \theta(s) + \tau_2.$$

A table of the results  $f_1$  and  $t_1$ ,  $f_2$  and  $t_2$  for each point  $s$  constitutes a theoretical spectrum. The group velocity in each point from  $s$  to the earth is given, as in whistler calculations, by

$$n^g = \frac{c}{n'} \quad \text{with} \quad n' = n + \omega \frac{dn}{d\omega} \tag{11}$$

$$n' = n \left[ 1 + \frac{1}{n^2} \frac{\omega\omega_p^2(2\omega - \omega_H)}{2(\omega^2 - \omega\omega_H)^2} \right] \tag{12}$$

Many such numerical calculations for applying the theory have been done at NBS by the author, using models suggested from parallel studies on whistlers and generally a constant velocity  $V$  for the cloud of particles along the line of force. The programming and numerical tabulations have been done on an IBM 650 computer by Hessing.<sup>11</sup>

Important Physical Implications

Relatively near the earth, less than about 4 radii from the center,

<sup>11</sup> R. M. Gallet and A. Hessing, "Numerical computations from the theory of VLF emissions and their comparison with observations," presented at URSI Spring Meeting, Washington, D. C.; May, 1957. (Companion paper to Gallet and Jones, *op. cit.*)



$$\left(2 \frac{\omega_p}{\omega_H} \frac{V}{c}\right)^2$$

in (9) will generally be very small compared to 1. Under such conditions, the two frequencies emitted reduce to

$$f_1 = \left(\frac{V}{c}\right)^2 \frac{f_p^2}{f_H} \tag{13}$$

and

$$f_2 = f_H \left[1 - \left(\frac{V}{c} \frac{f_p}{f_H}\right)^2\right]. \tag{14}$$

The high-frequency  $f_2$  is very near  $f_H$  and becomes very large; but if the model of the exosphere is such that  $f_{2p}/f_H$  is approximately constant along the line of force for a constant velocity  $V$ , the low-frequency emitted  $f_1$  stays almost constant. This model may look very artificial, but it is such that  $n_e/H$  stays constant along a line of force. Because  $H$  varies essentially like  $r^{-3}$ , the model is equivalent to an electronic density in the exosphere falling like  $r^{-3}$ . It would be too much to discuss here the theoretical models based on physical arguments, but it can be said, perhaps, that it is an acceptable approximation from a theoretical viewpoint. More empirically, the use of a family of models in  $r^{-n}$  and also a model departing very little from  $r^{-3}$  gives the best fit. The best model is made of one ionospheric model matching the F<sub>2</sub> region and falling off exponentially at large heights like a Chapman type of ionosphere, plus an exosphere in  $r^{-3}$  falling off more slowly at large distances, say, above 1000 km from the surface.

With such models and a constant velocity  $V$  along the line of force in the first approximation, the numerical applications have given a very natural explanation of several classes of VLF emissions, particularly the hooks.<sup>11</sup> Detailed calculations and results will be presented elsewhere.<sup>11</sup> See Appendix to be published.<sup>8</sup>

It is believed that the model indicated above and (12) are the natural explanation for the long "quasi-horizontal or gliding tones." The departures of the true distribution relative to the model

$$\frac{n_e}{H} = \text{constant}$$

is reflected immediately in variations of the frequency  $f_1$ . The hooks are explained very naturally along these lines. Calculations show that the slowly descending or almost horizontal part is explained as above. The turning point and the rapidly rising part are due to arrival of the cloud in the ionospheric part where  $n_e$  increases exponentially and the ratio  $n_e/H$  rises rapidly.

Examples of a model and some results are given in Figs. 13-15. For the exosphere, the model is characterized by

$$\frac{f_p^2}{f_H} = K$$

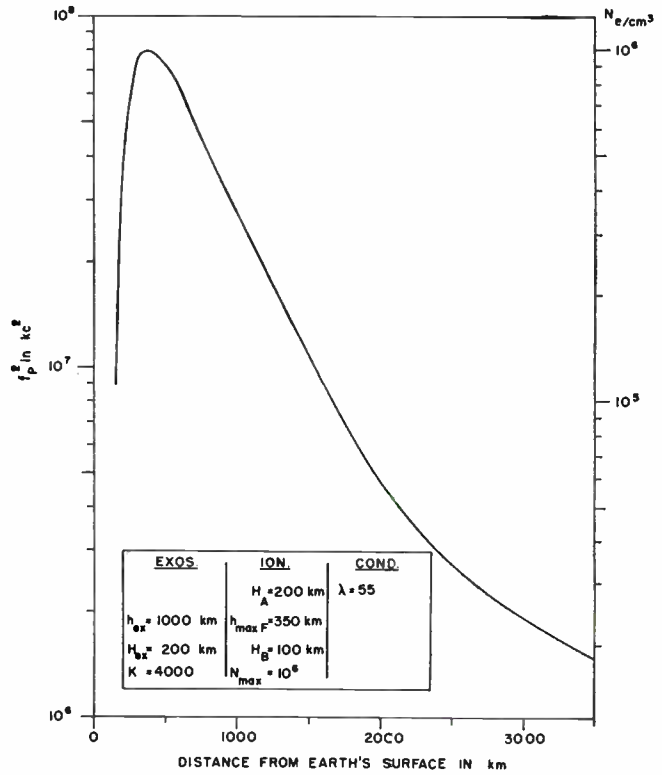

Fig. 13—VLF emissions theory. Model distribution of electronic density.

(in this example  $K = 4000 \text{ kc}$ ) where  $f_p$  and  $f_H$  are expressed in kilocycles. It is cut progressively below  $h_{ex}$ . The ionosphere is like a Chapman model with an electronic density maximum  $N_{max}$ , which can be varied a height of maximum  $h_{max}$  with scale heights  $H_A$  above the maximum and  $H_B$  below the maximum. A more detailed account with other examples are given in paper to be published.<sup>8</sup> It will be seen that very satisfactory theoretical spectra of hooks are obtained, both in frequency and duration. In general, the required velocities  $V$  are of the order of 10,000 km.

### CONCLUSION

VLF emissions are a very distinct group of phenomena. They are direct effects of the corpuscular solar radiation, amenable to precise numerical analysis when their theory becomes sufficiently developed. Quite a large amount of information can already be obtained in a purely phenomenological way. It requires a sufficiently comprehensive classification from good quality spectrograms. Homogeneous statistics, extending over a sufficiently long period, covering at least the maximum of solar activity as during the IGY, and the minimum are needed in several geographic positions.

It has been deduced that the corpuscular radiation, which propagates through the earth's exosphere and ionosphere, exists in two distinct forms. In one case, steady streams, more or less intense, are maintained for periods of hours at a time. In the other case, transient



EXOS.	ION.	COND.
$h_{ex} = 350$ km	$H_A = 500$ km	$\lambda = 55$
$H_{ex} = 100$ km	$h_{max F} = 350$ km	$v = 8,500$ km/sec
$K = 6000$	$H_B = 100$ km	
	$N_{max} = 2 \times 10^8$	

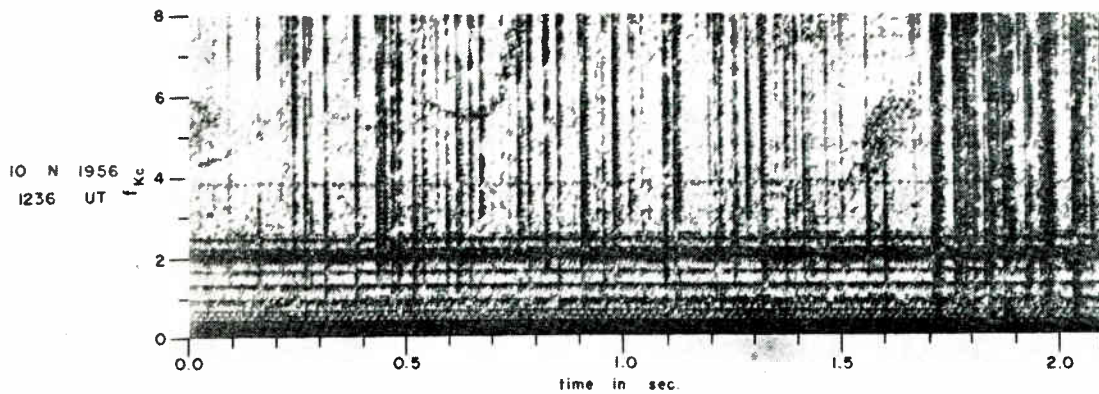
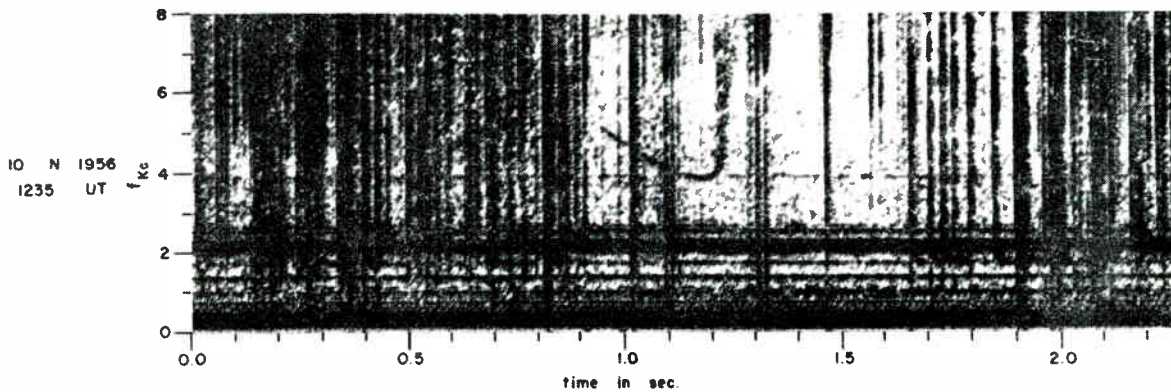
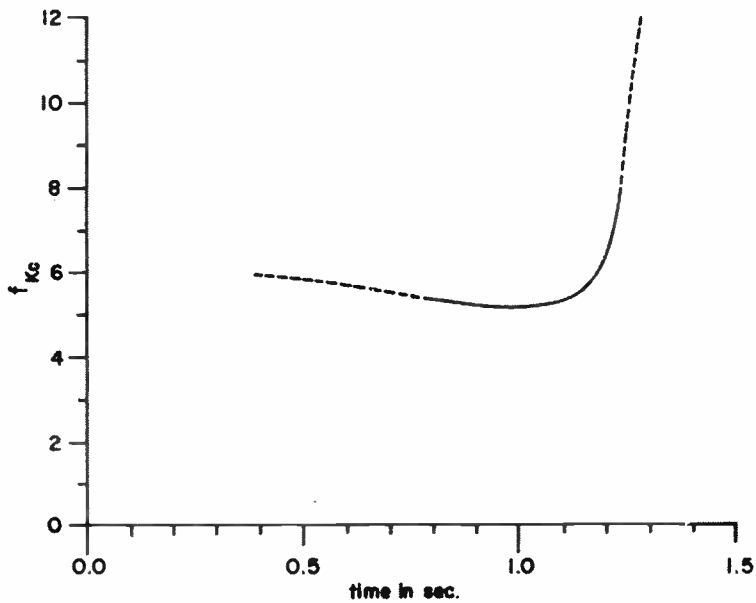

Fig. 14—VLF emissions. Comparison of theory and observation.

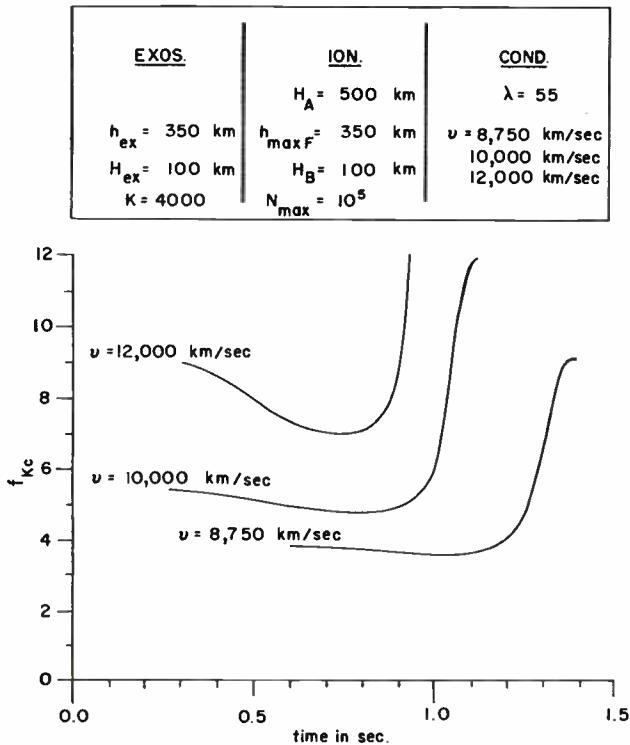

Fig. 15—VLF emissions theory. Example of influence of velocity.

bursts of particles move at high speed. These bursts are in very small lumps or clouds. The two cases are mutually exclusive and can often be observed simultaneously.

Probably several mechanisms are necessary to explain the diversity of all the types and classes observed. One mechanism, however, seems to dominate and to be able to explain a large fraction of the emissions. The mechanism of interaction between the ionized streams and the electromagnetic waves is the same as in traveling-wave tubes. Two discrete frequencies, given by (8), are emitted at the same time.

Numerical applications of the theory have shown that the general shape of the theoretical spectra is sensitive enough to give the model of the electronic density distribution in space. A model such that

$$\frac{f_p^2}{f_H}$$

is almost constant for a large part of the exosphere seems to be required.  $f_H$  is known by the geometry of the earth's magnetic field. A value of the constant of the order of 4000 to 6000 kc, when the frequencies are expressed in kilocycles, gives the best fit both from a numerical point of view for representing the properties of VLF emissions and whistlers and from the physical point of view for giving reasonable electronic densities

in the region of interest. For example,  $K = 4000$  kc gives 180 electrons per  $\text{cm}^3$  at 6 times the earth's radius (from the center of the earth), and  $5 \times 10^4$  electrons per  $\text{cm}^3$  near the earth's surface. *Departures* relative to this reference model are sensitively reflected in the value of the frequency  $f_1$  emitted.

The velocity of the corpuscular clouds is simply indicated by

$$f_1 = \left(\frac{V}{c}\right)^2 \frac{f_p^2}{f_H}$$

With the above model for  $K = 4000$  kc, an observed frequency of 4 kc for a quasi-horizontal tone gives  $V = 9500$  km. Because  $f_1$  is proportional to the square of  $V$ , it is seen that  $V$  cannot be very much smaller or larger. In general, an insufficiently large velocity will give too long a duration and much too low a frequency while the general character of the spectrum is conserved, being more a function of the exosphere model. Good matching for several classes of VLF emissions is obtained with velocities of the order of 10,000 km.

These velocities are one order of magnitude larger than the velocities deduced from solar-earth transit time. However, they are in agreement with the velocity required for auroral protons in order that they penetrate to the 100-km level as observed in auroras. Most likely, the formation and acceleration of these small fast clouds is due to a secondary process of hydromagnetic interaction between the large interplanetary solar clouds with velocities of the order of 1000 km and the geomagnetic field.<sup>12</sup>

It is likely that these fast clouds consist of neutral, ionized hydrogen. At 10,000 km, the kinetic energy of the electrons is 285 ev and the protons 522 kev. These energies are, thus, well below the energies of the particles, discovered by Van Allen and his collaborators from satellite measurements, which form a trapped belt in the exosphere.<sup>13</sup> Van Allen estimates that the electrons of this radiation have an energy of at least 6 mev and the protons at least 40 mev.

The theory of the traveling-wave tube mechanism can be developed still further by taking into account some plausible laws of variation of cloud velocities and by explaining the interactions between whistlers and VLF emissions by the acceleration of particles by trains of electromagnetic waves.

<sup>12</sup> E. N. Parker, "Interaction of the solar wind with the geomagnetic field," *Phys. of Fluids*, vol. 1, pp. 171-187; 1958. (See pp. 175-176.)

<sup>13</sup> J. A. Van Allen, C. E. Mellvain, and G. H. Ludwig, "IGY Satellite Report Series No. 3," Natl. Acad. Sci., Natl. Res. Council, Washington, D. C.; 1958.

"IGY Bulletin," *Trans. Am. Geophys. Union*, vol. 39, pp. 767-769; 1958.

"Radiation observations with satellite 1958 epsilon," *J. Geophys. Res.*; 1959. (To be published.)

# The $F$ Region During Magnetic Storms\*

K. I. MAEDA† AND T. SATO‡

**Summary**—The results are described of statistical investigations made in the  $F$  region during magnetic storms. The characteristics of the daily variation of the deviation from the mean critical frequency and of the height of the maximum electron density,  $\Delta f_0 F_2$  and  $\Delta h_p F_2$ , respectively, are shown over the wide range of latitude from the equator to the auroral zone and for the principal seasons of the year. After a brief survey of theories to interpret the observed results, it is shown that the ionization-drift theory, which is associated with the dynamo theory, is almost satisfactory for the consistent interpretation of the various facts observed.

## 1. STATISTICS OF THE OBSERVED RESULTS

### A. The Commencement of the $F$ Disturbance

IT WAS reported by Berkner, Seaton, and Wells<sup>1</sup> that the decrease of  $F_2$  electron densities at Kensington and Huancayo began at the same time as the sudden commencement (SC) of the severe magnetic storm of April 16th, 1938, and that the electron densities decreased to one-hundredth within an hour. Also, Berkner and Seaton<sup>2</sup> reported that outstanding changes in the  $F_2$  electron density and height at Watheroo and Huancayo took place within a few minutes after the SC of the magnetic storm of March 24th, 1940. These results indicate the important fact that the change in the  $F$  region starts almost at the time of SC of magnetic storms.

### B. Daily Variation of $\Delta f_0 F_2$ and its Latitudinal Distribution and Seasonal Variation

It was shown by Appleton, Ingram, and Naismith,<sup>3</sup> Berkner and Seaton,<sup>4</sup> Nagata, Fukushima, and Sugiura,<sup>5</sup> and Uyeda and Arima,<sup>6</sup> that the mean value of  $f_0 F_2$  during a magnetic storm varies with the season and the latitude. Thereafter it was revealed that the variation of  $\Delta f_0 F_2$  (disturbed time  $f_0 F_2$  minus quiet time  $f_0 F_2$ ) depends upon the local time of the station (that is, the daily variation), and that this daily variation differs with latitude and season.

\* Original manuscript received by the IRE, November 12, 1958.

† Kyoto University, Kyoto, Japan.

‡ Shiga University, Otsu, Japan.

<sup>1</sup> L. V. Berkner, S. L. Seaton, and H. W. Wells, "Ionospheric effects associated with magnetic disturbances," *Terrest. Mag.*, vol. 44, pp. 283-311; September, 1939.

<sup>2</sup> L. V. Berkner and S. L. Seaton, "Ionospheric changes associated with the magnetic storm of Mar. 24, 1940," *Terrest. Mag.*, vol. 45, pp. 393-418; December, 1940.

<sup>3</sup> E. V. Appleton, L. J. Ingram, and R. Naismith, "British radio observations during the Second International Polar Year 1932-1933," *Phil. Trans. Roy. Soc. (London) A*, vol. 236, pp. 191-259; 1937.

<sup>4</sup> L. V. Berkner and S. L. Seaton, "Systematic ionospheric changes associated with geomagnetic activity," *Terrest. Mag.*, vol. 45, pp. 419-423; December, 1940.

<sup>5</sup> T. Nagata, N. Fukushima, and M. Sugiura, "Geomagnetic disturbances and ionospheric storms," *Rep. Ionospheric Res., Japan*, vol. 3, pp. 41-73; December, 1949. (In Japanese.)

<sup>6</sup> H. Uyeda and Y. Arima, "Classification of  $F_2$  layer with respect to the world-wide distribution and characteristics of them," *Rep. Ionospheric Res., Japan*, vol. 6, pp. 7-12; March, 1952.

The daily variation has been analyzed over a wide range, from lower latitudes to the auroral zone. The methods of analysis have been:

- 1) plotting of  $\Delta f_0 F_2$  against local time for many individual disturbances, and so obtaining the average variation;<sup>7-9</sup>
- 2) Chapman's method of analysis for geomagnetic storms, that is, the analysis of  $S_D$  and  $D_{st}$  components from a number of disturbance data;<sup>10-15</sup>
- 3) difference or ratio of  $(f_0 F_2)^2$  on disturbed and quiet days;<sup>16,17</sup>
- 4) plotting of contour curve of  $\Delta f_0 F_2$  on local time-storm-time-coordinates;<sup>18,19</sup>
- 5) progressive aspect of map of  $f_0 F_2$  variation observed at various stations over the world during one particular disturbance.<sup>19,20</sup>

From the results of the above analyses, the following characteristics of the daily variation of  $\Delta f_0 F_2$  were made clear:

- 1) For higher latitudes, including the auroral zone, the great depression of  $f_0 F_2$  usually occurs at a time centered on local noon throughout the year. The duration of the depression undergoes a seasonal change<sup>9,18</sup> (Fig. 1). That is to say,  $f_0 F_2$  is depressed over the whole day in summer, while in winter the de-

<sup>7</sup> J. H. Meek, "Ionospheric disturbances in Canada," *J. Geophys. Res.*, vol. 57, pp. 177-190; June, 1952.

<sup>8</sup> T. Sato, "Disturbances in the ionospheric  $F_2$  region associated with geomagnetic storms. II. Middle latitudes," *J. Geomag. Geoelectricity*, vol. 9, pp. 1-21; March, 1957.

<sup>9</sup> T. Sato, "Disturbances in the ionospheric  $F_2$  region associated with geomagnetic storms. III. Auroral latitudes," *J. Geomag. Geoelectricity*, vol. 9, pp. 94-106; June, 1957.

<sup>10</sup> T. Obayashi, "Some characteristics of ionospheric storms," *Rep. Ionospheric Res., Japan*, vol. 6, pp. 79-84; June, 1952.

<sup>11</sup> K. Sinno, "On the variation of the  $F_2$  layer accompanying geomagnetic storms," *Rep. Ionospheric Res., Japan*, vol. 7, pp. 7-14; March, 1953.

<sup>12</sup> K. Sinno, "On the variation of the  $F_2$  layer accompanying geomagnetic storms. Second report; on the relation between the grade of geomagnetic activity and ionospheric disturbances," *Rep. Ionospheric Res., Japan*, vol. 8, pp. 127-133; September, 1954.

<sup>13</sup> D. F. Martyn, "Geo-morphology of  $F_2$  region ionospheric storms," *Nature*, vol. 171, pp. 14-16; January, 1953.

<sup>14</sup> D. F. Martyn, "The morphology of the ionospheric variations associated with magnetic disturbance. I. Variation at moderately low latitudes," *Proc. Roy. Soc. (London) A*, vol. 218, pp. 1-18; June, 1953.

<sup>15</sup> S. Matsushita, "Ionospheric variations associated with geomagnetic disturbances," *J. Geomag. Geoelectricity*, vol. 5, pp. 109-135; December, 1953.

<sup>16</sup> N. J. Skinner and R. W. Wright, "Some geomagnetic effects in the equatorial  $F_2$  region," *J. Atmos. Terrest. Phys.*, vol. 6, pp. 177-188; January-June, 1955.

<sup>17</sup> E. V. Appleton and W. R. Piggot, "The morphology of storms in the  $F_2$  layer of the ionosphere. I. Some statistical relationships," *J. Atmos. Terrest. Phys.*, vol. 2, pp. 236-252; 1952.

<sup>18</sup> T. Nagata and T. Oguchi, "Ionospheric storms in the auroral zone," *Rep. Ionospheric Res., Japan*, vol. 7, pp. 21-28; March, 1953.

<sup>19</sup> T. Obayashi, "On the development of ionospheric storms," *Rep. Ionospheric Res., Japan*, vol. 8, pp. 19-27; March, 1954.

<sup>20</sup> T. Obayashi, "On the world-wide disturbance of the ionosphere," *Rep. Ionospheric Res., Japan*, vol. 8, pp. 135-142; September, 1954.



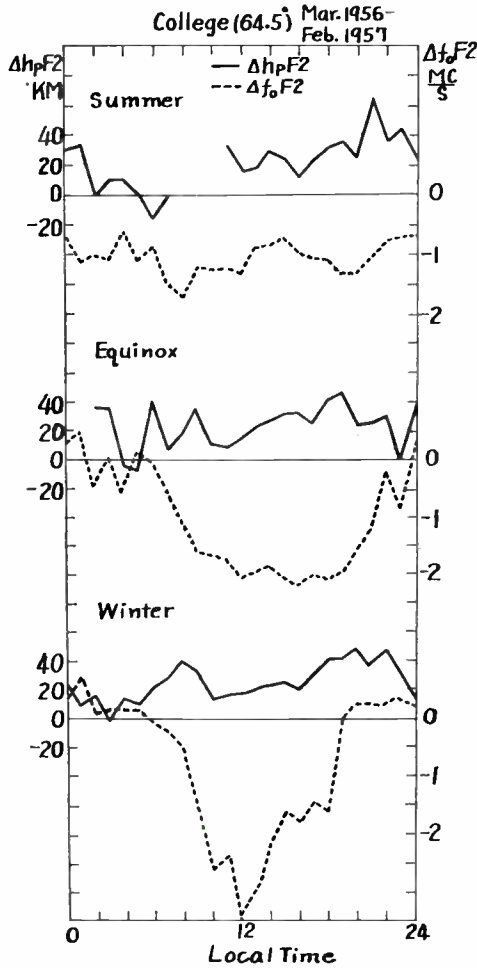

Fig. 1—Observed mean daily variations of  $\Delta f_0F_2$  (dotted line, right ordinate) and of  $\Delta h_pF_2$  (full line, left ordinate) at College (auroral zone) in three seasons. The variation is the mean of notable deviations during the years indicated in the figure. (After Sato.)

pression lasts for several hours around noon and  $f_0F_2$  increases during the night.

2) For lower latitudes, including the equator, increase of  $f_0F_2$  occurs in every season and depression is quite rare (Fig. 2).

3) For medium latitudes, there are two types of variation of  $\Delta f_0F_2$ . One is the depression type as in higher latitudes, and the other is the increase of  $f_0F_2$  from noon towards night, which is representative of the type found in lower latitudes (Fig. 2). The former type usually occurs in summer and the latter type in winter.

According to the theoretical study of Sato,<sup>8</sup> which is described in the next section, the depression-type representing the high latitude variation, and the increase-type representing the low latitude variation, can be said to be the two basic types. The former is called "negative disturbance" (N.D.) and the latter "positive disturbance" (P.D.). Some statistics of occurrence of N.D. and P.D. for each season are shown in Fig. 3. In medium latitudes, both N.D. and P.D. occur, and sometimes the type of disturbance cannot be clearly classified. This medium latitude zone comes across the boundary on

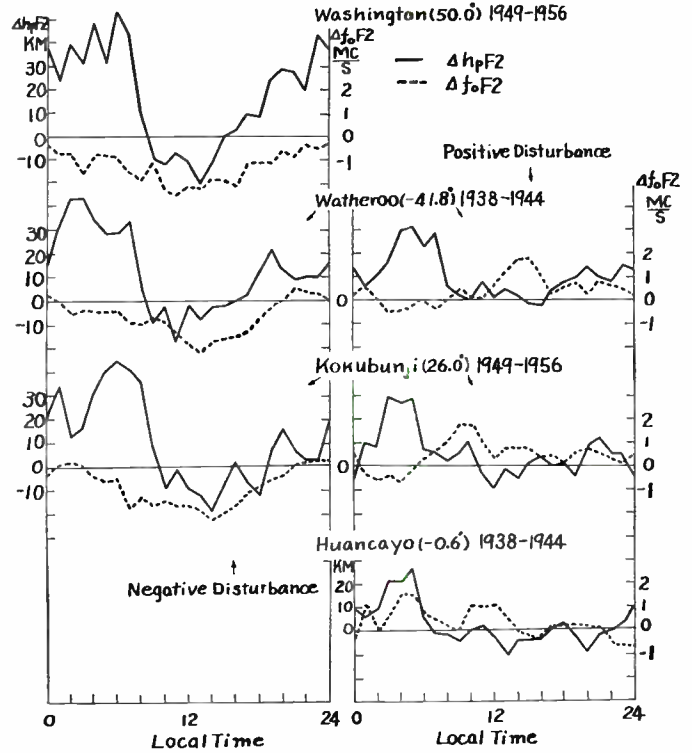

Fig. 2—Observed mean daily variations of  $\Delta f_0F_2$  (dotted line, right ordinate) and of  $\Delta h_pF_2$  (full line, left ordinate) in negative and positive disturbances for four stations below the auroral zone (number is geomagnetic latitude). The variation is the mean of notable deviations during the years indicated in the figure. (After Sato.)

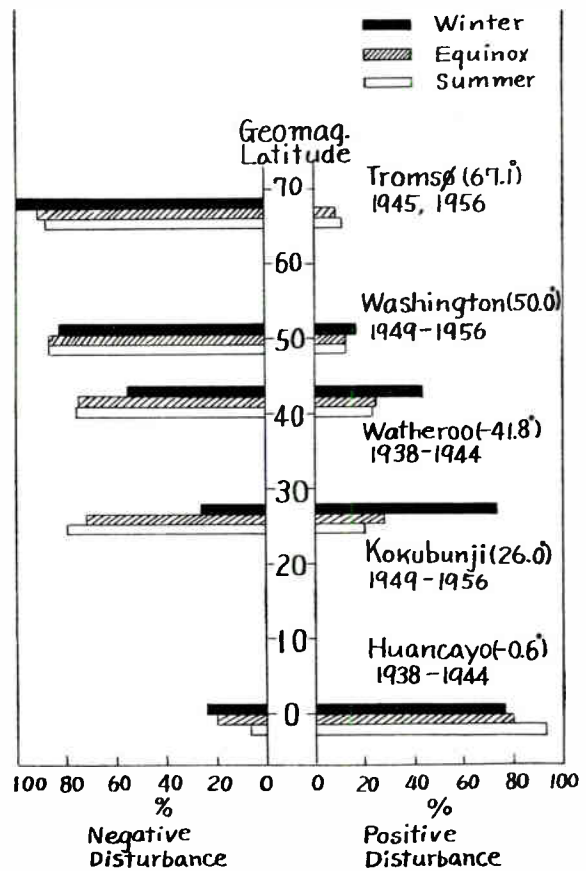

Fig. 3—The ratio (in per cent) of the number of the negative and positive ionospheric disturbances to the sum of them in three seasons. (After Sato.)

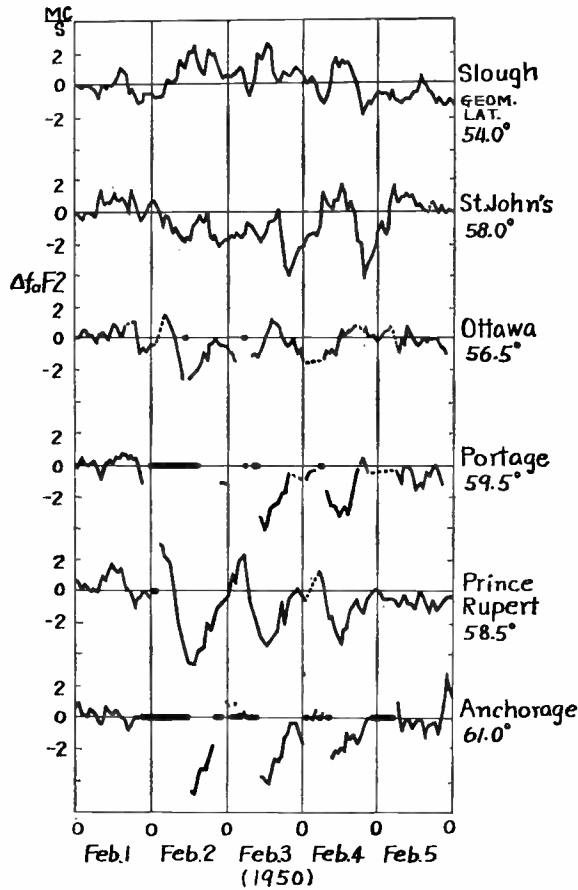

Fig. 4—Hourly plots of  $\Delta f_0 F_2$  at some stations for the ionospheric disturbance which occurred on February 2, 1950. (After Meek.)

which the vortex center of the  $S_q$  current system responsible for the geomagnetic variation falls. Type N.D. occurs north of the center and type P.D. south. This indicates that the  $F_2$  disturbance variation is closely connected with the  $S_q$  current system. In an intense storm, N.D. occurs all over the world;<sup>2,3</sup> this fact serves as a criterion for the theory of the  $F_2$  disturbance.

C. Day-to-Day Variation of  $\Delta f_0 F_2$

According to Meek,<sup>7</sup> Appleton and Piggot,<sup>17</sup> and Obayashi,<sup>19,20</sup> the value of  $\Delta f_0 F_2$  is greatest during the first day of the geomagnetic storm, and then decreases. However, the phase of daily variation is almost constant for the first few days. In Fig. 4 these tendencies can be seen.

D. Variations of  $\Delta f_0 F_2$  with the Solar and Geomagnetic Activities

The  $\Delta f_0 F_2$  variation is in general enhanced in proportion to the solar and geomagnetic activities in any season.<sup>4,3,9,12</sup> The only exception is at the equator at the time of intense geomagnetic activity, in which  $f_0 F_2$  rather decreases.

The value of  $f_0 F_2$  itself on quiet days increases with solar activity, as is well known; but the ratio of  $\Delta f_0 F_2$  to quiet  $f_0 F_2$  is nearly constant for any activity, although the value of  $\Delta f_0 F_2$  increases with activity.<sup>8</sup>

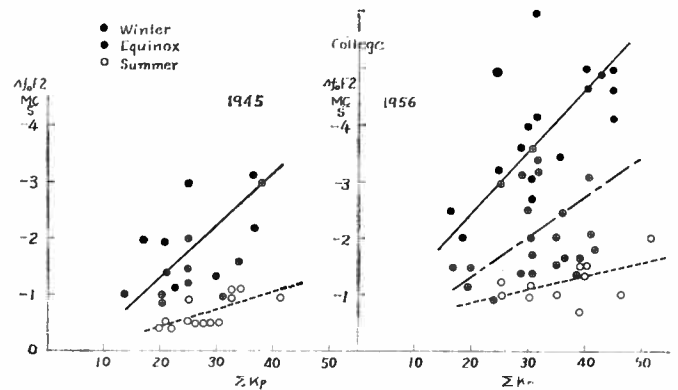

Fig. 5—Relation between the mean value of  $\Delta f_0 F_2$  during three hours centered on noon, and  $\Sigma K_p$  (a daily sum of  $K_p$  indexes) at College in 1945 (a year near sunspot minimum) and in 1956 (a year near sunspot maximum). (After Sato.)

As for the relationship with the geomagnetic activity, some examples are shown in Fig. 5, where  $\Delta f_0 F_2$  is plotted against  $\Sigma K_p$  (a measure of geomagnetic activity, the sum of geomagnetic  $K_p$  indices). These data were obtained at College, Alaska, in 1945 (small solar activity) and in 1956 (large solar activity).

For the same sunspot and the geomagnetic activity, the greatest  $\Delta f_0 F_2$  appears in the season in which the value of  $f_0 F_2$  on quiet days is the greatest. For instance,  $\Delta f_0 F_2$  is greater in winter or at the equinoxes for higher latitudes.<sup>8,9</sup>

E. Variation of the Height of Maximum Electron Density

Appleton, Ingram, and Naismith<sup>3</sup> and a number of other authors have reported that the deviation ( $\Delta h' F_2$ ) of apparent height from the mean greatly increases during the depression of  $f_0 F_2$ , and that the height of maximum electron density ( $h_p F_2$  or  $h_m F_2$ ), which is deduced from the data, also increases with disturbance time. However, according to Sato's investigation<sup>8,9</sup> of the data observed in auroral and high and medium latitudes, it is pointed out that  $\Delta h_p F_2$  (that is, the deviation from the mean of the height of maximum electron density) will be almost correct at night; however, the value during the daytime is quite questionable because the observed height is affected by a great retardation in the  $F_1$  region in the daytime. For instance, in the course of an ionospheric storm  $h' F_2$  increases suddenly at sunrise when the  $F_1$  region appears, and decreases abruptly at sunset when the  $F_1$  region disappears. As the retardation is great when  $f_0 F_2$  is near to  $f_0 F_1$ , the retardation effect is most remarkable in cases in which:

- 1) the solar activity is small and  $f_0 F_2$  is fairly close to  $f_0 F_1$ ,
- 2)  $f_0 F_2$  decreases greatly and comes close to  $f_0 F_1$ ,
- 3) the season is summer.

Such effects of retardation were eliminated by Sato. The variation of the height of maximum electron density shown in Figs. 1 and 2 is the result thus obtained.

As these figures show, the variation of  $\Delta h_p F_2$  is almost of the same type over the whole latitude range (from the

higher latitudes to the equatorial zone), regardless of the kind of disturbance and the season, although more or less difference is seen in the time-duration of the variation. The typical variation is an increase of height for several hours centering at midnight and a rather decreasing tendency during the daytime. For the auroral zone, in which it is difficult to eliminate the retardation effect, there is a general tendency of increase and  $\Delta h_p F_2$  is greatest near sunrise and 6 P.M.

### F. Disturbance Variation of the Electron Density of the $F_1$ Region

Berkner and Seaton<sup>2</sup> pointed out that in severe magnetic storms the electron density and height vary simultaneously in the  $F_1$  and  $F_2$  regions. Thereafter it was also shown by Sato<sup>21</sup> that  $f_0 F_1$  varies in the same manner as  $f_0 F_2$  during storms, and also that the daily variation (daytime only) and latitudinal and seasonal characteristics of  $f_0 F_1$  are similar to those in  $f_0 F_2$ , although the amplitude of the variation is much less than that of  $f_0 F_2$ . This simultaneous occurrence of disturbance in the  $F_1$  and  $F_2$  regions is important to theoretical considerations.

## II. THEORETICAL CONSIDERATIONS

### A. Brief Survey of the Existing Theories

1) *Thermal Expansion Theory*: This theory was advocated by Meek,<sup>22</sup> Nagata and Oguchi,<sup>18</sup> and Kamiyama.<sup>23</sup> According to Nagata and Meek, the variation of  $f_0 F_2$  in the auroral zone is generated by the heating effect of particles precipitating into the zone from the sun. The depression of  $f_0 F_2$  by this effect was calculated by Nagata and Kamiyama, but the accordance between the results of calculation and of observation is unsatisfactory. The weak points in this theory seem to be the difficulty of explaining the facts that

- 1) the clear daily variation repeats itself,
- 2) the depression occurs around noon,
- 3) the great variation of depression takes place south of the auroral zone, and
- 4) the disturbance occurs in medium and low latitudes.

2) *Recombination Theory*: This theory has been suggested by Seaton.<sup>24</sup> Electrons disappear by dissociative recombination with  $O_2^+$  ions, and  $O_2^+$  ions are produced by collision of  $O_2$  molecules and  $O^+$  ions. From the fact that intense spread-echoes are observed from the  $F$  region during magnetic storms, Seaton supposed that

<sup>21</sup> T. Sato, "Disturbances in the  $F_1$  and  $E$  regions of the ionosphere associated with geomagnetic storms," *J. Geomag. Geoelectricity*, vol. 9, pp. 57-60; March, 1957.

<sup>22</sup> J. H. Meek, "Correlation of magnetic, auroral, and ionospheric variation of Saskatoon," *J. Geophys. Res.*, vol. 58, pp. 445-456; December, 1953.

<sup>23</sup> H. Kamiyama, "Ionospheric changes associated with geomagnetic rays," *Sci. Rep. Tohoku Univ.*, vol. 7, pp. 125-135; March, 1956.

<sup>24</sup> M. J. Seaton, "A possible explanation of the drop in  $F$  region critical densities accompanying major ionospheric storms," *J. Atmos. Terrest. Phys.*, vol. 8, pp. 122-123; January-June, 1956.

during storms the mixing is greatly enhanced in this region and that plenty of  $O_2$  is provided by transportation from the lower ionospheric layer. However, this theory remains yet incomplete.

3) *Ionization Drift Theory*: Taking notice of the almost simultaneous occurrence of  $F_2$  disturbance over the world, Martyn<sup>13</sup> proposed the process that the  $S_D$  electric field set up in the auroral zone as the geomagnetic storm develops over the world, together with the permanent geomagnetic field, gives rise to a drift motion of electrons in the  $F_2$  region, and that this drift is the reason for the disturbance observed. Martyn<sup>14</sup> tried to work out the quantitative variation and to explain the seasonal variation. Maeda<sup>25</sup> also tried to explain the  $S_D$  and  $D_{st}$  components of  $F_2$  disturbance by the drift of electrons produced by  $S_D$  dynamo electric field and the induction field. Thereafter, Sato<sup>8,9,26,27</sup> performed a profound and detailed calculation of the effect of electron drift for the average of a number of storms and for individual storms. The results are fairly satisfactory in explaining the daily variation and its latitudinal and seasonal characteristics. At present this theory of electron drift is the most effective in interpreting the disturbance phenomena of the  $F$  region associated with geomagnetic storms.

### B. Interpretation of $F_2$ Region Disturbance by Ionization Drift Theory

1) *Outline of the Theory*: The theory of drift in the  $F_2$  region has been developed by Martyn,<sup>28</sup> Maeda,<sup>29</sup> and Hirono.<sup>30</sup> This theory was applied to the study of drift motion of the  $F_2$  region on quiet days. The ionospheric current density is denoted by  $I_x$  (southwards) and  $I_y$  (eastwards) and the variation field of geomagnetism by  $\Delta X$  and  $\Delta Y$ . Then we have

$$I_x = \frac{1}{2\pi} \Delta Y, \quad I_y = -\frac{1}{2\pi} \Delta X. \quad (1)$$

On the other hand, when we denote the electric field by  $E_x$  and  $E_y$ , we have

$$\begin{aligned} I_x &= k_x E_x + k_{xy} E_y, \\ I_y &= k_{yx} E_x + k_y E_y, \end{aligned} \quad (2)$$

<sup>25</sup> K. Maeda, "A theory of distribution and variation of the ionospheric  $F_2$  layer," *Rep. Ionospheric Res., Japan*, vol. 7, pp. 81-107; September, 1953.

<sup>26</sup> T. Sato, "Disturbances in the  $F_2$  region of the ionosphere associated with geomagnetic storms," *Rep. Ionospheric Res., Japan*, vol. 10, pp. 35-48; June, 1956.

<sup>27</sup> T. Sato, "Disturbances in the ionospheric  $F_2$  region associated with geomagnetic storms. I. Equatorial zone," *J. Geomag. Geoelectricity*, vol. 8, pp. 129-135; December, 1956.

<sup>28</sup> D. F. Martyn, "Electrical current in the ionosphere. III. Ionization drift due to winds and electric field," *Phil. Trans. Roy. Soc. (London) A*, vol. 246, pp. 306-320; December, 1953.

<sup>29</sup> K. Maeda, "Theoretical study on the geomagnetic distortion in the  $F_2$  layer," *Rep. Ionospheric Res., Japan*, vol. 9, pp. 71-85; September, 1955, and references therein.

<sup>30</sup> M. Hirono, "Effect of gravity and ionization pressure gradient on the vertical drift in the  $F_2$  region," *Rep. Ionospheric Res., Japan*, vol. 9, pp. 95-104; September, 1955, and references therein.



where

$$k_x = \int_{E+F} \sigma_{xx} dh$$

etc., and  $\sigma_{xx}$  is the element of conductivity tensor

$$\begin{pmatrix} \sigma_{xx} & \sigma_{xy} \\ \sigma_{yx} & \sigma_{yy} \end{pmatrix}.$$

From (2) and (1) we have

$$E_y = \frac{I_x}{K_{xy}} + \frac{I_y}{K_y} = \frac{1}{2\pi} \left( \frac{\Delta Y}{K_{xy}} - \frac{\Delta X}{K_y} \right), \quad (3)$$

where

$$K_{xy} = \frac{\Delta}{k_{xy}}, \quad K_y = \frac{\Delta}{k_x}, \quad \Delta = k_{xy}^2 + k_x k_y. \quad (4)$$

The vertical component of drift velocity is given by the next equation,

$$v = \frac{E_y}{F} \cos \phi = \frac{1}{F} \left( \frac{\Delta Y}{K_{xy}} - \frac{\Delta X}{K_y} \right) \frac{\cos \phi}{2\pi}. \quad (5)$$

$\phi$  is the dip angle and  $F$  is the total geomagnetic field. If  $\Delta X$  and  $\Delta Y$  are the variation fields in the  $S_q$  current system,  $v$  is the drift velocity ( $v_q$ ) on quiet days; and if  $\Delta X$  and  $\Delta Y$  are the values deduced from the disturbance daily variation of the geomagnetism,  $v$  is the drift velocity  $v_d$ , which is to be added to  $v_q$ . The electron density ( $n$ ) is given by the equation of continuity,

$$\frac{\partial n}{\partial t} = q - \beta n - v \frac{\partial n}{\partial h}. \quad (6)$$

$q$  is the rate of electron production,  $\beta$  is the attachment coefficient and  $h$  is the height. The disturbance component of  $n$  is obtained by taking the difference of the two values of  $n$ , which are obtained by solving (6) for the two cases of  $v = v_q + v_d$  and  $v = v_q$ .

2) *Calculated Results (Sato)*: From the observed results of the daily variation of the geomagnetic horizontal intensity ( $II$ ) and its declination ( $D$ ), the mean variations ( $II_q$  and  $D_q$ ) on quiet days before and after the storm days are first obtained. When  $II_q$  and  $D_q$  are subtracted from those quantities on disturbed days ( $II_d$  and  $D_d$ ),  $\Delta II$  and  $\Delta D$  are obtained. In  $\Delta II$  and  $\Delta D$  there are involved  $D_s$  and  $D_{st}$  components, but the  $D_{st}$  corresponds to the equatorial ring current far outside the ionosphere and does not mean any current flowing in the ionosphere. We need to extract the  $D_s$  component, which corresponds to the ionospheric current to produce the drift of electrons. In order to do this, the 24-hour overlapped means of  $\Delta H$  and  $\Delta D$  are calculated over the whole interval of disturbance ( $D_{st}$  is thus obtained). Then, by subtracting these overlapped means from  $\Delta II$  and  $\Delta D$ , the  $D_s$  components ( $\Delta II_d$  and  $\Delta D_d$ ) for  $\Delta II$  and  $\Delta D$  are obtained.

The quiet-day means of  $\Delta X$  and  $\Delta Y$  calculated from  $II_q$  and  $D_q$  are denoted by  $\Delta X_q$  and  $\Delta Y_q$ , and  $\Delta X$  and

$\Delta Y$  calculated from  $\Delta H_d$  and  $\Delta D_d$  are denoted by  $\Delta X_d$  and  $\Delta Y_d$ . In the calculation of  $v$  by means of (5),  $v_q$  for the quiet days is obtained by using  $\Delta X_q$  and  $\Delta Y_q$ ;  $v_d$  for the disturbed days is obtained by using  $\Delta X_d$  and  $\Delta Y_d$ . The mean variation of  $n_q$  and  $h_{pq}$  on quiet days is calculated from (6) by using  $v_q$ , and the variation of  $n$  and  $h_p$  over the whole interval (say two or three days) of the disturbance is calculated by using  $v_q + v_d$ . The ratio ( $n - n_q / n_q$ ) of the difference ( $n - n_q$ ) to the quiet time value ( $n_q$ ), and the value ( $h_p - h_{pq}$ ) of the height difference, are plotted against storm time. In Fig. 6 a few examples of such calculations are shown, and the observed results are added for comparison.

The value of  $\beta$  used in this calculation is shown in Fig. 7. The conductivities  $K_{xy}$  and  $K_y$  were taken to undergo daily variation. For instance, for the medium latitudes they are taken as follows (Maeda<sup>29</sup>):

$$K_{xy} = 1.6 \times 10^{-8} p(t) \text{ emu,}$$

$$K_y = 3.0 \times 10^{-8} p(t) \text{ emu,}$$

where  $p(t)$  represents the daily variation which in turn varies with the season.  $q$  is the rate of electron production in the theory of Chapman.

3. *Explanation of the types of disturbance*: From Fig. 6 good agreement can be seen of the observed and theoretical results; this indicates the validity of the drift theory. On the basis of this theoretical calculation, Sato<sup>8</sup> explained the variation types (N.D. and P.D.) of the  $F_2$  region disturbance and their latitudinal and seasonal characteristics.

On disturbed days the drift motion is the superposition of  $v_q$  (quiet days) and  $v_d$ . As  $v_q$  depends upon the  $S_q$  current system, the phase of  $v_q$  is different according as the station lies in the north of the center of current vortex or in the south. Therefore,  $v_q$  is downwards around noon and upwards during night for the higher latitude, and the phase is reversed for the lower latitude (see Fig. 8, dotted curves). The position of this vortex center lies in the geomagnetic latitudes  $15^\circ$  to  $20^\circ$  (or  $-15^\circ$  to  $-20^\circ$  for the southern hemisphere) in summer, and moves to higher latitudes in winter. Therefore, it is expected that in medium latitudes the phase of  $v_q$  has a tendency to reverse from summer to winter. On the other hand, the phase of  $v_d$  is almost constant from higher latitudes to the equator, with the exception of the auroral zone; that is,  $v_d$  is downwards around noon and upwards during the night, but the phase is reversed in Tromsø (auroral zone) (see Fig. 8).

When the electrons move with the velocity  $v_q$  in the daytime on quiet days, this motion acts as a hinderance to the concentration of electrons, regardless of whether the motion is upwards or downwards. As a consequence, the maximum electron density becomes less than that in the case of no motion. When the disturbance occurs and the phases of  $v_d$  and  $v_q$  coincide, the motion of electrons is enhanced and the maximum electron density is much decreased. This phenomenon corresponds to the case of N.D. (depression type) in the higher latitudes or in the

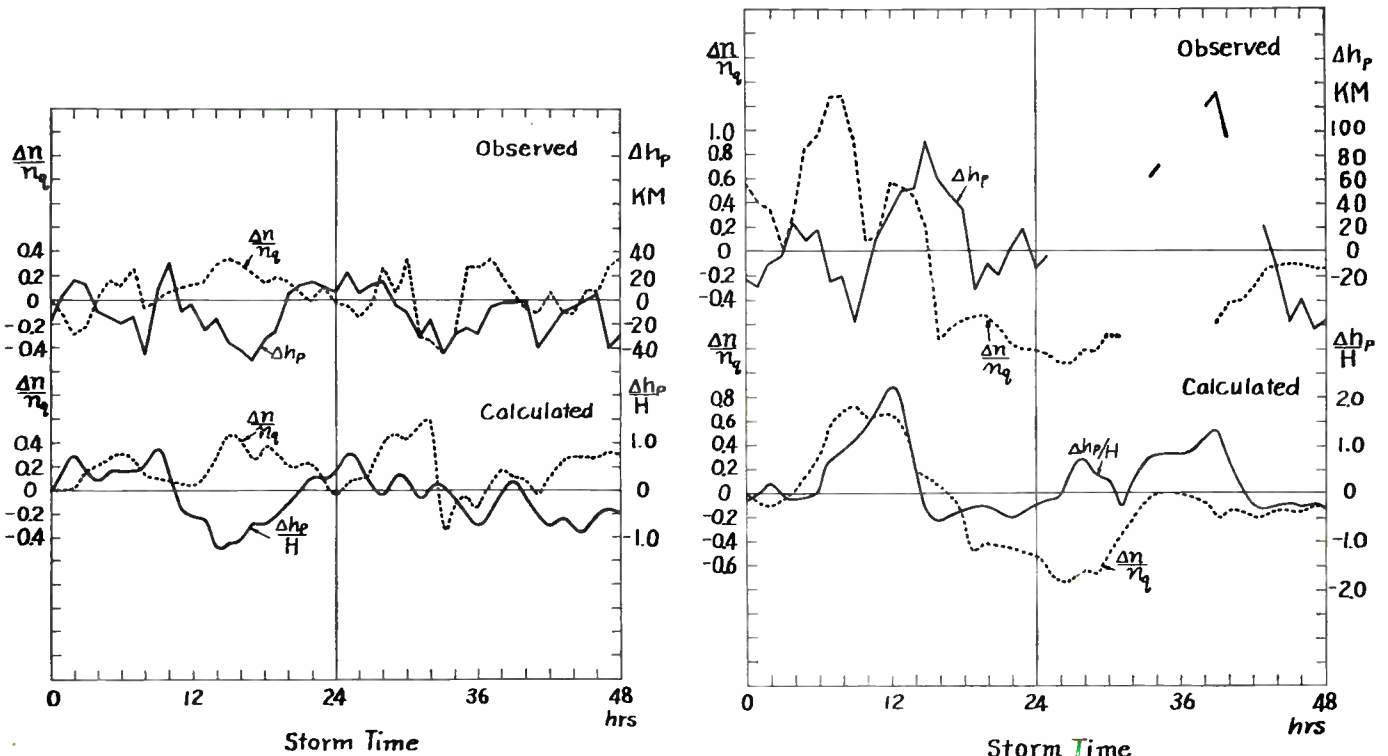

(a) Huancayo, 20h (Local Time), July 2, 1939.

(b) Watheroo, 16h (Local Time), November 12, 1940.

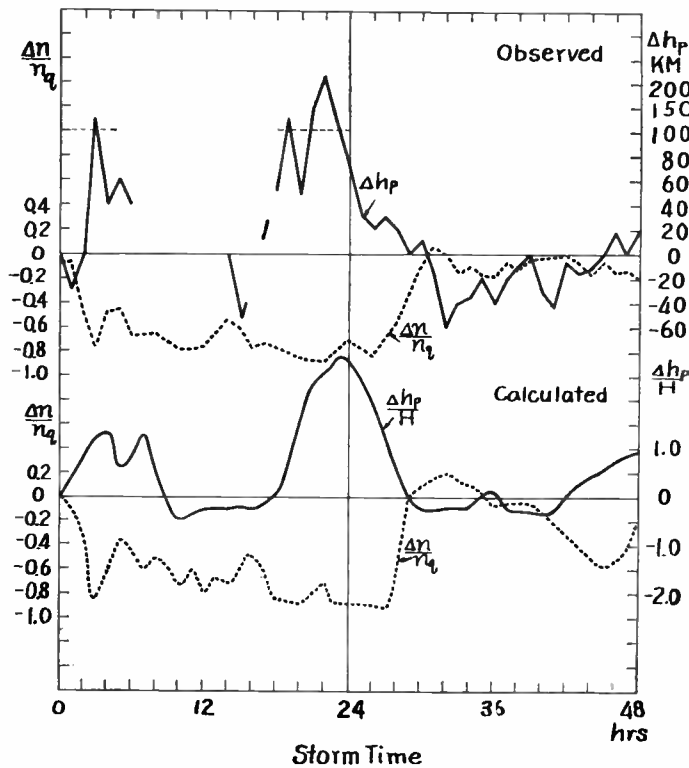

(c) Washington, 1h (Local Time) May 12, 1949.

Fig. 6—Observed and calculated variations of  $\Delta n/n_q$  ( $\Delta n = n - n_q$ , dotted line, left ordinate) and  $\Delta h_p$  (or  $\Delta h_p/H$ ) ( $\Delta h_p = h_p - h_{pq}$ , full line, right ordinate) for the  $F_2$  ionospheric disturbance which begins at the time indicated under the figure.  $H$  is the scale-height in the F region and is taken as 60 km. (After Sato).

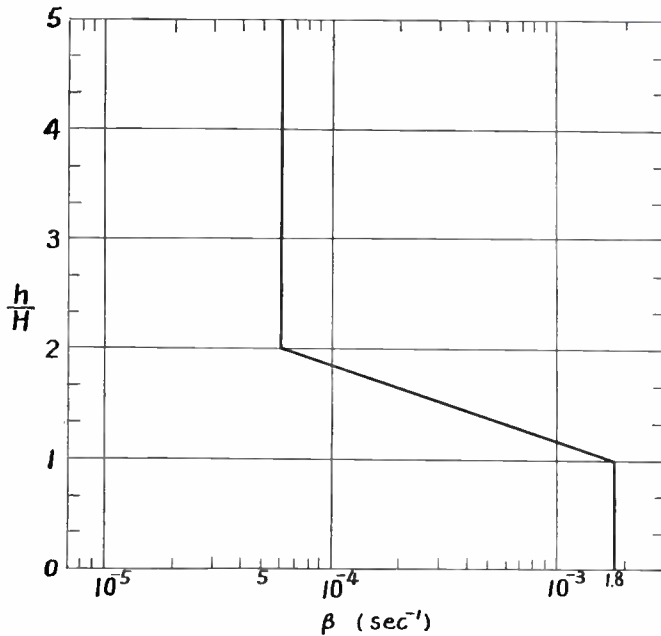

Fig. 7—Distribution of attachment coefficient  $\beta$  with the height  $h/H$ , where  $H$  is the scale-height in the  $F$  region. (After Sato.)

summer in medium latitudes. On the contrary, when the phase of  $v_d$  is opposite to  $v_q$ , the layer tends to no motion and the maximum electron density increases. This corresponds to the case of P.D. (increase type) in the lower latitudes and the equatorial zone, or to winter in medium latitudes. Thus the occurrence of N.D. and P.D. depends upon the  $S_q$  current system at the station.

In the auroral zone  $v_q$  is negligibly small in comparison with  $v_d$  and so the  $f_0F_2$  variation is controlled by  $v_d$ . The phase of  $v_d$  does not vary seasonally; therefore, the type of  $\Delta f_0F_2$  is N.D. However, the interval of depression of  $f_0F_2$  varies with the season. In the summer the depression continues over the whole day because the solar radiation is always present, while in winter the depression lasts for several hours around noon and, owing to the upward drift towards evening, the layer goes up to a height of smaller decay coefficient ( $\beta$ ); in addition, because of the early sunset in the afternoon, the maximum electron density becomes greater than that on quiet days during night.

In an intense storm  $v_d$  is much greater than  $v_q$  over the whole world. As the phase of  $v_d$  is almost the same, the depression of  $f_0F_2$  (N.D. type) occurs from high latitudes to the equator.

4) *Variation of the Height of Maximum Electron Density ( $h_p$ ):* At night, when there is no electron production, the deviation of height is nearly equal to the time integral of  $v_d$ . Therefore, the height increases during the night over the range from high latitudes to the equator. In these latitudes,  $v_d$  in the daytime is downwards and the height decreases, but the rate of attachment ( $\beta$ ) increases rapidly as the height goes down, so the maximum electron density does not appear below a certain level.

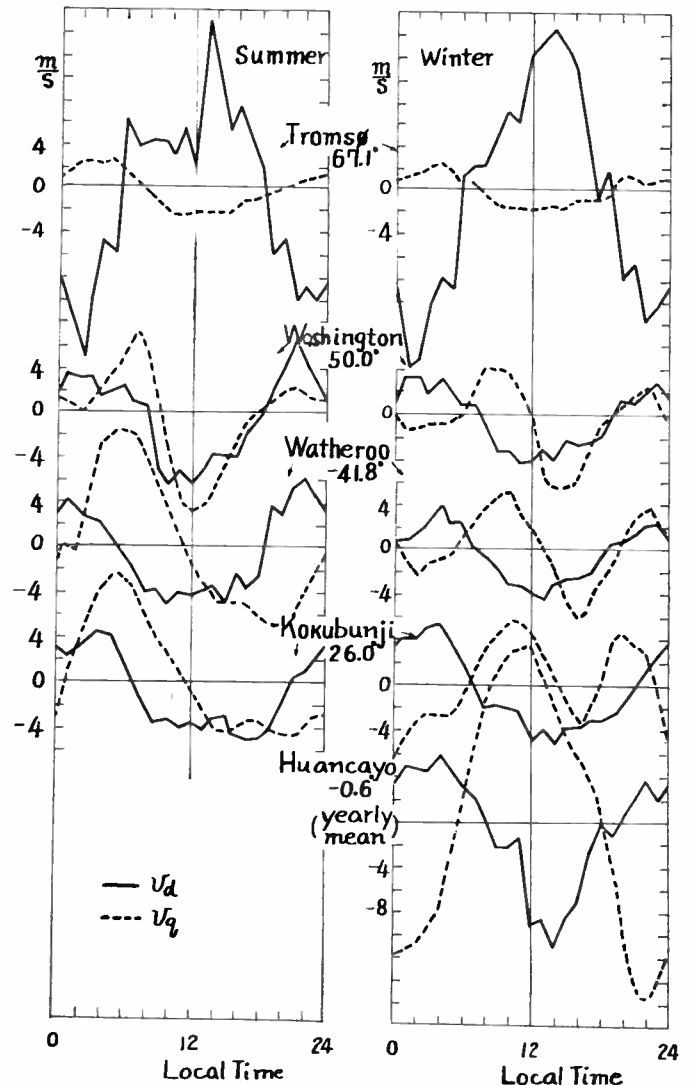

Fig. 8—Mean daily variations of the vertical drift velocities of the electron,  $v_q$  (dotted line) and  $v_d$  (full line), at stations from the auroral zone to the equator (number is geomagnetic latitude). The variation in summer is shown in the left-hand side and that in winter and yearly mean at Huancayo in the right-hand side. (After Sato.)

In the auroral zone  $v_d$  is upwards in the daytime, but the height of maximum electron density which had been located at higher levels because of the electron production at sunrise can hardly go higher due to the effect of electron production since electron production comes down in the daytime. After sunset, when the electron production disappears, the height increases rapidly, but as  $v_d$  reverses its direction into downward motion from about 6 P.M., the maximum deviation of height occurs around 6 P.M. This maximum is notable in winter. Another deviation of the maximum occurs at the time when the height jumps up to a newly produced level of maximum electron density just after sunrise. The time of this sunrise deviation changes with the season.

### III. DISCUSSION

It has been shown that the complicated disturbances of the  $F$  region during magnetic storms can be inter-



puted fairly satisfactorily by the theory of electron drift, but it must be pointed out that a few facts of importance remain to be explained.

1) The agreement of the observed and calculated results of the increase-type (P.D.) of  $f_0F_2$  is sometimes unsatisfactory for medium latitudes, although for the equatorial zone it is interpreted quite well by the theory.

We know of cases in which different disturbance variations occur for stations in nearly equal latitudes during a storm, and the disturbance activity of the ionosphere is quite large with very small magnetic activity. Also, there have been cases in which  $f_0F_2$  was depressed or increased alternatively only for a very short time interval, in the progress of a magnetic storm. It is unknown at present whether these examples are in contradiction to the drift theory. It seems that there remains the necessity of collecting much more data and of improving the treatment of the data in the calculations. For instance, the method of deduction of the  $D_s$  variation component is a problem of importance. In the calculations shown in the preceding section, the  $D_s$  vari-

ation ( $\Delta H_d$ ) of the horizontal component  $\Delta H$  for a geomagnetic storm was obtained by subtracting the 24-hour overlapped mean of  $\Delta H$  from  $\Delta H$  itself. But this method cannot be applied to a rapidly varying element. If we can make use of the data observed at stations distributed equidistantly along a certain geomagnetic latitude, the  $D_s$  variation will be found in more exact form. That is to say, arranging the observed values ( $\Delta H$ ) at each station according to storm time and averaging them, the  $D_{st}$  variation is at first obtained. By subtracting it from  $\Delta H$ , the  $D_s$  variation is found.

2) According to the vertical drift theory,  $f_0F_2$  in the zone of the polar cap must not vary much, but the data are insufficient to investigate this point. If this is true, the validity of the drift theory is enhanced.

In the International Geophysical Year, ionospheric and geomagnetic data have been obtained for many stations in the world. When these data become available, our knowledge of  $F_2$  disturbance will be greatly increased, and the important problems described above may be solved.

## Auroral Phenomena\*

E. N. PARKER†

**Summary**—The aurora is the visible excitation of the gases above the ionosphere by energetic electrons and protons. The auroral patterns are strongly influenced by the geomagnetic field, forming curtains and rays along the magnetic lines of force. The details of the optical excitation in the aurora are very complicated and not well understood. It is clear that both electrons and protons are necessary and that these exciting particles must be accelerated in the vicinity of Earth. We have only rough and untested ideas as to how the protons are accelerated, and why the auroras show a preference for latitude  $\pm 65^\circ$ . We do not understand how and where the electrons are accelerated, or why auroras should have a curtain and ray-like structure, or why the aurora is a night side phenomenon. We wonder to what extent the aurora is associated with the radiation belt around Earth.

### I. DESCRIPTION

THE visible aurora seems to be the result of the excitation of the upper terrestrial atmosphere (above 70 km) by high speed particles coming down along the geomagnetic lines of force. The variety of color visi-

ble to the naked eye suggests the complexity and variety of this excitation, and we refer the reader to the review article by Chamberlain and Meinel<sup>1</sup> for a discussion of the observed auroral spectra. The details of auroral excitation are not clearly understood. Incoming protons are observed in homogeneous auroral arcs at low latitude and are undoubtedly responsible for a large portion of the excitation. On the other hand, protons are not observed in auroral rays, where presumably electrons are the principal excitation mechanism. Intimately connected with the visible aurora is the bremsstrahlung observed from rockets and balloons. The bremsstrahlung suggests 50–100 keV electron fluxes of  $10^7/\text{cm}^2/\text{s}$ .

Now the homogeneous arcs seem to follow lines of geomagnetic latitude, and both arcs and rays seem to extend upward along geomagnetic lines of force. For an exhaustive description, see Störmer,<sup>2</sup> Stagg and Paton<sup>3</sup>

\* Original manuscript received by the IRE, November 10, 1958. The work performed for this paper was assisted in part by the Office of Sci. Res. and Geophys. Res. Directorate, AF Cambridge Res. Center, Air Res. and Dev. Com., USAF.

† Enrico Fermi Institute for Nuclear Studies, and Dept. of Physics, University of Chicago, Chicago, Ill.

<sup>1</sup> J. W. Chamberlain and A. B. Meinel, "The Earth as a Planet," G. P. Kuiper, ed., University of Chicago Press, Chicago, Ill., pp. 514–575; 1954.

<sup>2</sup> C. Störmer, "The Polar Aurora," Clarendon Press, Oxford, Eng.; 1955.

<sup>3</sup> J. M. Stagg and J. Paton, *Nature*, vol. 143, p. 941; 1939.

found that there is a close correlation between the position of a visible aurora and the equivalent ionospheric current filament ascribed to the observed local geomagnetic fluctuations.

Auroral activity is principally a night side phenomenon, never occurring earlier than about 4:00 in the afternoon, and vanishing completely shortly after dawn. The activity is most frequent in the auroral zones, 20–25° from each geomagnetic pole, where an auroral display is to be seen almost every clear night; there is, evidently, an auroral display almost every night. During the years of minimum activity in the 11-year solar cycle, the aurora shifts nearer the geomagnetic poles, giving an apparent decrease of activity in the nominal auroral zones. Unusual auroral activity appears to follow unusual solar activity within a day or two, at which times the aurora may be seen at low latitudes far beyond the auroral zones. In the northern hemisphere there is a tendency for the individual auroral structures to drift westward ( $\lesssim 1$  km/s) before midnight and eastward after; the direction of drift has not yet been established in the southern hemisphere.

A certain amount of information concerning the primary auroral particles has been established. Chamberlain<sup>4</sup> has been able to show, from an analysis of the Doppler shift<sup>5</sup> of  $H\alpha$  and the distribution of luminosity with height, that the energy  $E$  of the primary protons exciting low latitude homogeneous auroral arcs has a spectrum roughly proportional to  $E^{-1.5}$  in the range 5–500 keV ( $10^3$ – $10^4$  km/s). For such high energy protons he estimates<sup>6</sup> the total flux at  $10^7$ – $10^8$ /cm<sup>2</sup> sec, or  $\sim 0.1$  proton/cm<sup>3</sup>; if the majority were of lower energy, a larger flux would be required. The low velocity ( $10^3$  km/s) protons produce the excitation at the great heights (a few hundred kilometers) and the high velocity (up to  $10^4$  km/s) protons penetrate deep into the atmosphere to give excitation down to the lower edge of the arc at 100 km altitude.

It would seem that the observed visible auroral ray could follow as a consequence of an electron discharge in an electrostatic field which is essentially independent of height. Chamberlain<sup>7</sup> estimates that perhaps  $6 \times 10^{12}$  electrons/cm<sup>2</sup>/s can account for the auroral rays in this manner.

High altitude observations with ionization chambers and counters find 10–100 keV X rays to be associated with auroral activity. Presumably the X rays are bremsstrahlung from somewhat higher energy electrons in the atmosphere above. In particular, rocket measure-

ments<sup>8,9</sup> in the auroral zone during periods of essentially normal solar activity show that 10–40 keV X rays are common down to their limit of penetration of 50 km (1.05 gm/cm<sup>2</sup> depth). Harder X rays (up to 100 keV) are observed<sup>10</sup> penetrating deeper in the atmosphere to 8–10 gm/cm<sup>2</sup> (balloon altitudes) during periods of enhanced solar activity and particularly under a homogeneous auroral arc in the process of developing a strong ray structure.<sup>11,12</sup> The X-ray intensity under homogeneous auroral arcs suggests an electron intensity higher up amounting to  $3 \times 10^6$ /cm<sup>2</sup>/s in the 100 keV range. In the auroral zones the commonly occurring X-ray fluxes suggest  $10^6$ – $10^8$  electrons/cm<sup>2</sup>/s of somewhat lower mean energy.

One wonders what connection may exist between the intense electron streams coming down into the atmosphere to produce the observed auroral X rays and the region of high energy electrons recently observed above 1000 km by Van Allen with the Explorer satellites.

## II. THEORETICAL AURORAL MODELS

Störmer suggested<sup>2</sup> that the aurora is caused by large numbers of individual, mono-energetic, charged particles from the sun which are focused by the geomagnetic field into the observed sharp rays and curtains. He has been able to demonstrate some striking resemblances between the pattern of such charged particle trajectories and the observed auroral forms. Perhaps the most obvious difficulty with his basic idea is that the incident particles must all have energies falling within extremely narrow limits in order to produce the observed thin auroral curtains, and these energies are very much higher than the depth of penetration into the atmosphere would indicate.<sup>2</sup>

Chapman and Ferraro have been interested in the possibility that charges on the surface of the cavity about Earth, produced in their ring current theory of magnetic storms, might be responsible for the aurora,<sup>13–15</sup>

<sup>8</sup> L. H. Meredith, M. B. Gottlieb, and J. A. Van Allen, "Direct detection of soft radiation above 50 kilometers in the auroral zone," *Phys. Rev.*, vol. 97, pp. 201–205; January 1, 1955.

<sup>9</sup> J. A. Van Allen, "Interpretation of soft radiation observed at high altitudes in northern latitudes," *Phys. Rev.*, vol. 99, p. 609; July 15, 1955. See also "Direct detection of auroral radiation with rocket equipment," *Proc. Natl. Acad. Sci.*, vol. 43, pp. 57–62; 1957.

<sup>10</sup> K. A. Anderson, "Occurrence of soft radiation during the magnetic storm of 29 August 1957," *J. Geophys. Res.*, vol. 62, pp. 641–644; December, 1957.

<sup>11</sup> J. R. Winckler and L. Peterson, "Large auroral effect on cosmic-ray detectors observed at 8 g/cm<sup>2</sup> atmospheric depth," *Phys. Rev.*, vol. 108, pp. 903–904; November 1, 1957.

<sup>12</sup> J. R. Winckler, L. Peterson, R. Arnoldy, and R. Hoffman, "X-rays from visible aurorae at Minneapolis," *Phys. Rev.*, vol. 110, pp. 1221–1231; June 15, 1958.

<sup>13</sup> S. Chapman and V. C. A. Ferraro, *Terrest. Mag.*, vol. 36, pp. 77, 171; 1931.

<sup>14</sup> V. C. A. Ferraro, "On the theory of the first phase of a geomagnetic storm: a new illustrative calculation based on an idealized (plane not cylindrical) model field distribution," *J. Geophys. Res.*, vol. 57, pp. 15–49; March, 1952.

<sup>15</sup> S. Chapman and J. Bartels, "Geomagnetism," Oxford University Press, London, Eng.; 1951.

<sup>4</sup> J. W. Chamberlain, "On a possible velocity dispersion of auroral protons," *J. Astrophys.*, vol. 126, pp. 245–252; 1957.

<sup>5</sup> A. B. Meinel, "Doppler-shifted auroral hydrogen emission," *J. Astrophys.*, vol. 113, pp. 50–54; 1951.

<sup>6</sup> J. W. Chamberlain, "The excitation of hydrogen in aurorae," *J. Astrophys.*, vol. 120, pp. 360–366; 1954.

<sup>7</sup> J. W. Chamberlain, "Auroral rays as electric-discharge phenomena," *J. Astrophys.*, vol. 122, pp. 349–350; 1955. See also "Proceedings of the Belfast Symposium on the Aurora and Airglow," Pergamon Press, London, Eng.; 1955.

and Martyn<sup>16</sup> has discussed some interesting ideas for the origin of the aurora, although his model predicts the wrong direction of drift of the aurora.

Alfvén<sup>2,17</sup> has suggested an idea for the origin of the aurora which involves a beam of ionized gas with velocity  $v$  carrying a magnetic field  $B$  from the sun. Since the gas is a conductor of electricity, there can be no electric field in its own frame of reference. Hence in the fixed frame we find by a Lorentz transformation that there is the well known polarization field  $E = -v \times B/c$  first pointed out by Chapman and Ferraro. Alfvén suggests that this polarization field will produce an electric drift of the electrons arriving in the geomagnetic field such that a separation of electrons and ions will result. He suggests that the electrostatic potential of this charge separation will cause concentrated thread and sheet-like discharges along the geomagnetic lines of force, thereby yielding the aurora.

The basic difficulty with Alfvén's idea is that, for any portion of the beam hitting the geomagnetic field,  $v$ , and therefore  $E$ , drops to zero. Hence there is no basis for the charge separation, which in any case is contrary to the initial assumption of high electrical conductivity along the magnetic lines of force. We must keep in mind Alfvén's initial assertion that in the frame of reference moving with a highly conducting gas there can be no electric field; hence there can be no electrostatic discharge phenomena no matter how we may complicate the situation with solar and geomagnetic fields. Gradients in the magnetic field density<sup>18</sup> in no way alter this situation.<sup>19</sup> Thus the many interesting terrella experiments, in which an electrostatic field is *artificially* applied across the apparatus,<sup>17,20,21</sup> cannot be compared directly with Alfvén's polarization field model, and so are difficult to evaluate. Like Störmer's classical theory, they result in phenomena which bear striking superficial resemblance to the actual aurora. Yet they involve glaring discrepancies if we try to scale them to fit the real aurora.

To summarize the situation, we feel that there is not yet much understanding of the formation of the observed auroral structures. It would appear that the aurora is a much more complex phenomenon than any of our present theoretical models dream of, certainly involving the interplay of many dynamical effects. With our present vast experimental and theoretical ignorance of cooperative plasma dynamical processes, we are per-

haps somewhat in the same position as the old alchemist, patiently but futilely wishing to transform lead into gold. Only by giving up pursuit of the final goal and turning to nearer horizons is success finally to be achieved. Therefore, we confine our attention throughout the remainder of this paper to processes, both observational and theoretical, which seem to be not unrelated to the aurora, but which for the present cannot be assembled into a theoretical auroral model. We suggest that this more indirect approach may ultimately prove more fruitful than the continued frontal assault.

### III. ELEMENTARY THEORETICAL CONSIDERATIONS

Enhanced auroral activity is observed to follow one or two days after increased activity at the sun. This has long been recognized to imply that the aurora is produced by something from the sun which propagates with a velocity of 1000–2000 km/s, so that the transit time will account for the delay. The observation of auroral protons with 1000 km/s velocities<sup>4</sup> suggests that it is solar corpuscular emission which is basically responsible for the aurora.

Relevant to this view, then, is the observation by Biermann<sup>22</sup> that gas, presumably ionized hydrogen, is streaming outward from the sun in all directions at all times with velocities of  $\sim 500$  km/s and densities of  $\sim 100$  atoms/cm<sup>3</sup> at the orbit of Earth. When the sun is extremely active, the velocity evidently increases to  $\sim 1500$  km/s or more, and the density to perhaps  $10^4$  or  $10^5$ /cm<sup>3</sup>. It seems<sup>23</sup> that this solar wind may be the hydrodynamic expansion of the  $2 \times 10^6$  °K solar corona. In any case, the solar wind is an important line of communication of solar activity to Earth. Furthermore, its presence largely prevents any other solar material from reaching Earth except as individual particles such as cosmic rays. The slowing down time of a fast particle of mass  $M$ , velocity  $w$ , and charge  $e$  in the solar wind (ionized hydrogen of temperature  $T$  and density  $N$ /cm<sup>3</sup>) is<sup>24</sup>

$$t_s = M^2 w^3 / 8\pi e^4 N \ln \Lambda \quad (1)$$

where

$$\Lambda = (3/2e^3)(k^3 T^3 / \pi N)^{1/2} = 1.24 \times 10^4 T^{3/2} / N^{1/2}.$$

The mean free path  $w t_s$  proves to be of the order of 40 au (1 astronomical unit = Earth-sun distance,  $1.5 \times 10^{13}$  cm) for  $w = 500$  km/s,  $N = 10^3$ /cm<sup>3</sup>,  $T = 10^5$  °K. Thus an individual particle can easily penetrate from the sun to Earth. However, a stream of ions of density  $n$ /cm<sup>3</sup> and individual mass  $M$  will excite plasma oscillations in the solar wind,<sup>25</sup> with a characteristic time of growth of the

<sup>16</sup> D. F. Martyn, "The theory of magnetic storms and auroras," *Nature*, vol. 167, pp. 92–94; January 20, 1951. See also, "The theory of magnetic storms and auroras," *Nature*, vol. 167, pp. 984–985; June 16, 1951.

<sup>17</sup> H. Alfvén, "Cosmical Electrodynamics," Clarendon Press, Oxford, Eng.; 1950.

<sup>18</sup> H. Alfvén, *Tellus*, vol. 6, p. 232; 1954. See also "Magnetic storm effect on cosmic radiation," *Phys. Rev.*, vol. 94, p. 1092; May 15, 1954.

<sup>19</sup> E. N. Parker, "Origin and dynamics of cosmic rays," *Phys. Rev.*, vol. 109, pp. 1328–1344; February 15, 1958.

<sup>20</sup> K. G. Malmfors, *Ark. Mat. Astr. Fys.*, vol. 34, p. 3; 1946.

<sup>21</sup> See also the description and photographs in footnote, p. 371, Figs. 206, 207 of reference 2.

<sup>22</sup> L. Biermann, *Z. Astrophys.*, vol. 29, p. 274; 1951. See also, *Z. Naturforsch.*, vol. 7 (a), p. 127; 1952, and *Observatory*, vol. 77, p. 109; 1957.

<sup>23</sup> E. N. Parker, "Dynamics of the interplanetary gas and magnetic fields," *J. Astrophys.*, vol. 128, no. 3; November, 1958.

<sup>24</sup> L. Spitzer, "Physics of Fully Ionized Gases," Interscience Publishing Co., Inc., New York, N. Y., p. 79; 1956.

<sup>25</sup> E. N. Parker, "Suprathermal particles III: electrons," *Phys. Rev.*, vol. 112; December, 1958.



order of the plasma period  $(M/4\pi Ne^2)^{1/2}$ , as is well known for electron streams.<sup>26,27</sup> Thus any corpuscular streams from the sun are stopped by their plasma interaction with the solar wind within a very short time, and cannot penetrate to Earth. This is another way of saying that in spite of the long free path  $wt_s$ , the thickness of a shock front is very small ( $\lesssim 1$  km) because of the plasma interaction.<sup>28</sup>

The conclusion which we draw is, then, that the terrestrial phenomena (geomagnetic storms, the aurora, dawn chorus) produced by "solar" particles, are produced by the solar wind itself. The aurora arises, somehow, as a consequence of the solar wind streaming past Earth. This view is further supported by the fact that the aurora is *continuously* present in the auroral zones, so that it obviously cannot depend upon special solar events producing high speed particles, etc., as is usually supposed.

Now since a tenuous ionized gas, such as the solar wind, behaves essentially<sup>29</sup> like a highly conducting fluid, it is clear that the solar wind does not penetrate freely across the geomagnetic lines of force. The wind does not penetrate to Earth itself but sees only the outer geomagnetic dipole field. We would suppose that the solar wind can push its way into the geomagnetic field to a depth where the magnetic pressure  $B^2/8\pi$  becomes comparable to the impact pressure  $NMU^2$  of the solar wind of velocity  $U$  and of density  $N$  atoms (each of mass  $M$ ) per  $\text{cm}^3$ . It is doubtful that a smooth interface between the solar wind and the geomagnetic field is established where  $B^2/8\pi = NMU^2$  because it can be shown<sup>30</sup> that any such smooth interface will be unstable, much as is the surface of water unstable to a strong blast of air. Thus the intrusion of the solar wind into the geomagnetic field is probably a disordered affair, with tongues of ionized gas passing between and around flapping ropes of geomagnetic flux.

Since the geomagnetic field is roughly a dipole with a density  $B_0 \cong 0.35$  gauss on the geomagnetic equator, we have a field density

$$B = B_0(a/r)^3 \quad (2)$$

in the equatorial plane at a distance  $r$ ; we let  $a$  represent the radius of Earth (6400 km). Thus the maximum depth of penetration of the solar wind is  $r = R_1$  where

$$R_1 \cong a(B_0/8\pi NMU^2)^{1/6}. \quad (3)$$

<sup>26</sup> J. R. Pierce, "Possible fluctuations in electron streams due to ions," *J. Appl. Phys.*, vol. 19, pp. 231-236; 1948.

<sup>27</sup> O. Buneman, "Instability, turbulence, and conductivity in current carrying plasma," *Phys. Rev. Letters*, vol. 1, pp. 8-9; July, 1958.

<sup>28</sup> E. N. Parker, *J. Astrophys.*, vol. 129, no. 1; 1959.

<sup>29</sup> E. N. Parker, "Newtonian development of the dynamical properties of ionized gases of low density," *Phys. Rev.*, vol. 107, pp. 924-933; August 15, 1957.

<sup>30</sup> E. N. Parker, "Interaction of the solar wind with the geomagnetic field," *Phys. of Fluids*, vol. 1, pp. 171-187; May/June, 1958.

We find that the everyday solar wind may perhaps penetrate as far as  $4.8a$ , or to within about 25,000 km above the surface of Earth. The enhanced solar wind, with  $U = 1500$  km/s and  $N = 10^4/\text{cm}^3$  may penetrate to  $1.53a$ , or perhaps to within a distance of the order of 3500 km above the surface. These distances suggest the altitudes beyond which we might expect to observe the direct effects of the solar wind with rocket borne instruments.

The line of force of the geomagnetic dipole which crosses the equatorial plane at a distance  $R_1$  comes down to the surface of Earth at an angular distance  $\Theta_1$  from the geomagnetic poles, where

$$\sin \Theta_1 = (a/R_1)^{1/2} \quad (4)$$

$$= (8\pi NMU^2/B_0)^{1/12}. \quad (5)$$

Thus the everyday solar wind probably directly disturbs all those lines of force originating within  $27^\circ$  of the pole. This may explain why geomagnetic observing stations within about  $25^\circ$  of the pole record unceasing agitation of the magnetic field of Earth,<sup>31</sup> whereas agitation at lower latitudes, while not uncommon, does seem to depend more on a high level of solar activity and an enhanced solar wind.

Now the primary auroral particles, which are apparently protons and electrons, are more or less constrained to move along the geomagnetic lines of force. Therefore, if they are produced directly by the solar wind, we would not expect to see them farther from the geomagnetic pole than  $\Theta_1$ ; *i.e.*, we would expect the everyday aurora to appear within about  $27^\circ$  of the pole. In this way we might perhaps explain the auroral zone, within a maximum of auroral activity in the band  $20$ - $25^\circ$  from the pole. The enhanced solar wind following intense solar activity will, on the other hand, penetrate sufficiently deeply to account for the aurora observed at such times within  $20^\circ$  of the geomagnetic equator.

#### IV. AURORAL PARTICLE ACCELERATION

In the homogeneous auroral arc one observes protons with energies up to 500 kev. Beneath auroral arcs one observes X rays which imply electrons with energies up to 100 kev. Both the electrons and protons appear with intensities of  $10^7$ - $10^9/\text{cm}^2/\text{s}$ . Since the electron and proton velocities show a continuous distribution and are very much in excess of the velocity which their transit time from the sun would indicate, the conclusion is that they are accelerated in the vicinity of Earth.<sup>4</sup>

Now consider how the acceleration might take place. The solar wind is presumably ionized hydrogen. Furthermore, the region occupied by the geomagnetic field appears to be filled with ionized hydrogen of a comparable density<sup>32</sup> ( $10^2$ - $10^3/\text{cm}^3$ ). Thus the entire region

<sup>31</sup> S. Chapman, "The Earth's Magnetism," Methuen and Co., London, Eng.; 1951.

<sup>32</sup> L. R. O. Storey, *Phil. Trans. Roy. Soc. A*, vol. 246, p. 113; 1954.

around Earth will be an excellent conductor of electricity, given by the approximate expression<sup>33</sup>

$$\sigma \cong 2 \times 10^7 T^{3/2} \text{ esu.} \quad (6)$$

And as a first approximation we treat the gas using the hydromagnetic approximation, which regards the gas to be a highly conducting fluid. Then in the frame of reference moving with the fluid the electric field will be exceedingly weak. Transforming to the laboratory frame of reference, we find that for fluid velocities small compared to the speed of light, the electric, magnetic, and velocity fields are related by the well known condition<sup>34</sup>

$$\mathbf{E} = -\mathbf{v} \times \mathbf{B}/c. \quad (7)$$

It follows immediately that the equation of motion for a particle with mass  $M$ , charge  $q$ , and velocity  $\mathbf{w}$ ,

$$d\mathbf{w}/dt = (q/M)\{\mathbf{E} + \mathbf{w} \times \mathbf{B}/c\}$$

reduces to

$$d\mathbf{w}/dt = (q/M)(\mathbf{w} - \mathbf{v}) \times \mathbf{B}/c.$$

Since we are interested in increasing the energy of such a particle, we form the scalar product with  $\mathbf{w}$ , obtaining the energy equation

$$\begin{aligned} d(1/2Mw^2)/dt &= -(q/c)\mathbf{w} \cdot \mathbf{v} \times \mathbf{B} \\ &= + (q/c)\mathbf{v} \cdot \mathbf{w} \times \mathbf{B}. \end{aligned} \quad (8)$$

Thus we see that in hydromagnetic fields, defined by (7), we can accelerate a charged particle only when the fluid motion works against the Lorentz force  $(q/c)\mathbf{w} \times \mathbf{B}$ . We recognize this as the Fermi acceleration mechanism;<sup>9,35</sup> there is no other in hydromagnetic fields. Charged particles can be accelerated only by being bounced back and forth from the magnetic fields of relatively moving regions of gas. Consider, then, the effectiveness of this simplest particle accelerating mechanism. To illustrate its operation we consider a one-dimensional model in which a particle constrained to move only in the  $x$ -direction is repeatedly reflected from the magnetic fields carried by "eddies" in the gas with velocity  $\pm v$ . Elastic reflection from a magnetic field moving with velocity  $v$  changes the particle velocity by  $\pm 2v$  depending upon whether the collision is head-on or overtaking. Supposing equal numbers of regions moving in the positive and negative  $x$ -directions, the probability of a head-on collision is proportional to the relative velocity  $w+v$ , and the probability of an overtaking collision is proportional to  $w-v$ . If the mean free path for collision with the relatively moving regions is  $l$ , so that the mean collision rate is  $w/l/s$ , it is readily shown that the

mean, time rate of increase of  $w$ , which we denote by  $\alpha$ , is  $2v^2/l$ . The mean time rate of increase of  $w^2$ , which we denote by  $\beta$ , is  $8vw^2/l$ .

We shall further suppose that a particle may escape from the region (thickness  $L$ ) of relatively moving fields by a random walk with steps  $l$  for a distance  $L/2$  to the nearest boundary. The required number of steps are, therefore,  $n=L^2/4l^2$ . Hence a particle with velocity  $w$  has a mean life  $\tau = nl/w = L^2/4lw$  in the region of acceleration. The Fokker-Planck equation<sup>36</sup> for the particle velocity distribution function  $\psi$  becomes

$$\begin{aligned} \frac{\partial \psi}{\partial t} &= \frac{1}{2} \frac{\partial^2(\beta\psi)}{\partial w^2} - \frac{\partial(\alpha\psi)}{\partial w} - \frac{\psi}{\tau} \\ &= \frac{4v^2}{l} \left( w \frac{\partial^2 \psi}{\partial w^2} + \frac{3}{2} \frac{\partial \psi}{\partial w} - \frac{l^2}{v^2 L^2} w \psi \right). \end{aligned}$$

The steady state solution of this equation, subject to the boundary condition that  $\psi$  vanish at infinite velocity, is readily seen to be of the form

$$\psi(w) = C(Lx/lw)^{1/4} K_{1/4}(lw/Lx),$$

where  $C$  is a constant. Thus for high velocities

$$(lw/2Lv \gg 1)$$

we have

$$\psi(w) \sim C \left(\frac{\pi}{2}\right)^{1/2} \left(\frac{Lx}{lw}\right)^{3/4} \exp\left(-\frac{lw}{Lv}\right).$$

Now the velocity  $v$  will be at least as large as the mean shearing velocity  $lU/L$  across the thickness  $L$  of the transition layer between the geomagnetic field and the solar wind. Actually,  $v$  may be rather larger than this because the unstable nature of the interface suggests that irregular motions will be present, besides the smooth background shear. Therefore,  $v=lU/L$  represents a lower limit on  $v$ , and so will underestimate the amount of Fermi acceleration. We obtain

$$\psi(w) \sim C \left(\frac{\pi}{2}\right)^{1/2} \left(\frac{L}{w}\right)^{3/4} \exp\left(-\frac{w}{U}\right)$$

which, for an enhanced solar wind of  $U=2000$  km/s, is compared in Fig. 1 with the approximate proton velocity spectrum,  $l/w^2$ , deduced<sup>4</sup> from observations of homogenous auroral arcs. The calculated and the observed spectrum are not unlike. More elaborate calculations may be found elsewhere.<sup>30</sup>

Now the Fermi acceleration mechanism increases the velocity of a charged particle at a rate which is more or less independent of the mass of the particle (provided of course that the mass is not so small as to make it impossible for the particle to penetrate across the magnetic fields to regions of different relative velocity). Therefore, we expect that Fermi acceleration will not result in electrons which are any faster than the protons, and

<sup>36</sup> S. Chandrasekhar, "Stochastic problems in physics and astronomy," *Rev. Mod. Phys.*, vol. 15, pp. 1-89; January, 1943.

<sup>33</sup> T. G. Cowling, "The Sun," University of Chicago Press, Chicago, Ill., pp. 532-591; 1953.

<sup>34</sup> W. M. Elsasser, "Dimensional relations in magnetohydrodynamics," *Phys. Rev.*, vol. 95, pp. 1-5; July 1, 1955.

<sup>35</sup> E. Fermi, "On the origin of cosmic radiation," *Phys. Rev.*, vol. 75, pp. 1169-1174; April 15, 1949. See also "Galactic magnetic fields and the origin of cosmic radiation," *J. Astrophys.*, vol. 119, pp. 1-6; 1954.

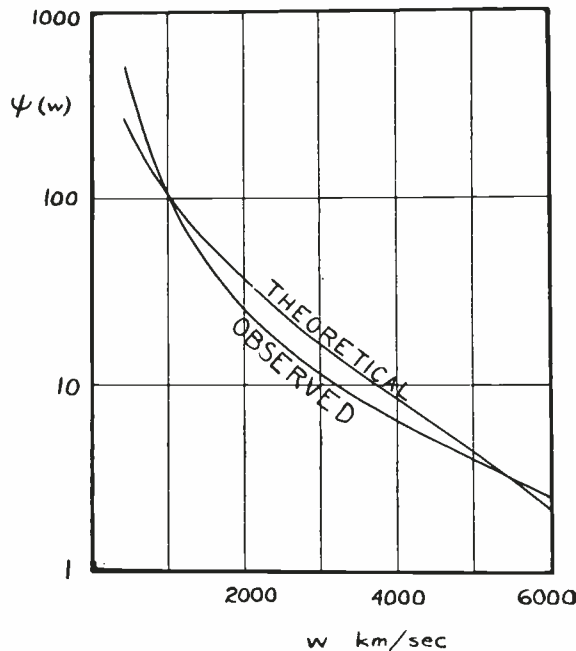

Fig. 1—A comparison of the form of the proton velocity distribution, produced by Fermi acceleration in the transition layer between an enhanced 2000 km/s solar wind and the geomagnetic field, with the approximate spectrum ( $I/w^2$ ) deduced by Chamberlain from observations of homogeneous auroral arcs.

this means trivial electron energies, 100 keV protons corresponding to 50 eV electrons. Whatever we may believe concerning the Fermi acceleration of protons, it is clear that we *cannot* account for the observed 100 keV electrons in this way.<sup>25, 37</sup>

Hence, if we are to account for the electrons, we must give up the simple hydromagnetic approximation and go to the more general, and unfortunately very much more complicated, dynamics of plasmas. In particular it should be interesting to understand what happens at the interface where the 1000 km/s solar wind collides with the ionized hydrogen of density<sup>32</sup>  $\sim 10^3/\text{cm}^3$  enmeshed in the geomagnetic field. The interaction of two interpenetrating electrically neutral streams of plasma<sup>25</sup> proves to be much like the well-known interaction of two electron streams, or of an electron stream with an ion cloud.<sup>26</sup> The kinetic energy of the relative motion of the two plasma streams is carried principally by the ions, and it is converted into plasma oscillations of the electrons with a characteristic time of the same order as

<sup>37</sup> E. N. Parker and D. A. Tidman, "Suprathermal particles," *Phys. Rev.*, vol. 111, pp. 1206-1211; September 1, 1958.

the ion plasma period  $(\pi M/Ne^2)^{1/2}$ . Thus the initial 20 keV energy of a 2000 km/s hydrogen ion is converted into 20 keV electrons in a time which is probably of the order of several times the plasma period of  $5 \times 10^{-5}/\text{s}$  for an enhanced solar wind of density  $10^4/\text{cm}^3$ .

Perhaps, then, it is the direct impact of the solar wind against the ionized gas embedded in the geomagnetic field which is the source of the observed 10-100 keV electrons.

This leaves entirely unanswered, of course, the question of the electron acceleration responsible for exciting the auroral rays. In order to fit the observed independence of luminosity with height, Chamberlain<sup>7</sup> finds that we need the equivalent of a uniform electrostatic field in the ray. But of course we cannot confine an electrostatic field to lie along, and entirely inside, a cylindrical ray without having a nonvanishing curl at the boundary. For Maxwell's equation  $\partial \mathbf{B} / \partial t = -c(\nabla \times \mathbf{E})$  would then require a rapidly changing magnetic field, which we could hardly reconcile with, among other things, the quasi-static appearance of the ray.

## V. CONCLUSION

We would like to re-emphasize our earlier contention that we know very little about the auroral phenomenon. There is a host of interesting and pertinent observations of the visible aurora, and there are a number of interesting theoretical suggestions whose pertinence we are not yet very well able to judge.

We have no consistent theory which can explain why the aurora is principally a night-side occurrence, and why the aurora assumes the form of arcs, rays, streamers, etc., or why it is sometimes remarkably stationary and at other times flits across the sky like a searchlight beam. We have only the vaguest ideas of acceleration and excitation processes which occur in visible auroral features.

It is clear only that the visible aurora is a complicated interplay of cooperative plasma processes, particle acceleration, and optical excitation, originating from the energies in solar activity, probably via the solar wind.

We speculate that the visible aurora may ultimately prove to be only an optically conspicuous, but dynamically superficial, aspect of the general plasma processes (such as the intense particle activity above 1500 km recently detected by Van Allen's satellite instruments) which occur in the ionized gas enmeshed in the geomagnetic field and bombarded by the solar wind.



# Auroral Ionization and Magnetic Disturbances\*

BENJAMIN NICHOLS†, SENIOR MEMBER, IRE

**Summary**—An examination of radio studies of auroral ionization shows that an average ionization density of about  $5 \times 10^6$  electrons per  $\text{cm}^3$  is sufficient to explain the normal radar echo. The magnetic disturbances produced by current systems in the ionosphere are closely related both to the ionization and the luminosity of the aurora. The magnetic variations are also associated with increases in the speeds of motion of the ionization.

The increased ionization manifest in the aurora, together with its increased speed of motion, brings about the magnetic changes observed at the ground. The rapid speeds of auroral motions observed both visually and by radio means are at the upper end of a continuous curve of drift motions that increase with increasing magnetic disturbance.

## I. INTRODUCTION

THE aurora is an extremely complex, rapidly changing geophysical phenomenon that occurs over broad regions of the earth. Whatever causes the visual luminosity in auroras also causes ionization, and that ionization can be detected by radio waves. Since 1940, and at a greatly accelerated pace since World War II, radio means have been used to investigate auroral ionization. The chief method has been the use of radars at meter wavelengths, but information also has been obtained from studies of the scintillations of the so-called radio stars and from the study of the absorption of radio waves at longer wavelengths.

The motions associated with auroras remain to be understood fully. As seen visually or photographically, the luminous auroral forms may move very rapidly across the sky. Even among experienced visual observers, there is not complete agreement on the character of these motions, much less on their interpretation. Radio measurements of the motions of auroral ionization have been made by observing the range variation of pulsed radar echoes and the Doppler shifts of continuous wave signals. All observers now agree that the rapidity of the fading of radar echoes and of radio star scintillations must be caused by motions in the aurora whose speed is about a power of ten faster than is normally measured in other ionospheric observations.

Auroral motions take place in the ionosphere, where in recent years evidence concerning the speed and direction of other motions has increased greatly. One striking feature of radio observation of ionospheric motions has been the association of increases in the speeds of motions with increases in magnetic activity. These magnetic disturbances can be explained in terms of current systems in the ionosphere, and in high latitudes are associated with auroras. Furthermore, there is a close relationship between the deduced current systems and

the morphology of the aurora. A study of the motions of auroral ionization should therefore consider general motions in the ionosphere, the motion of the visible aurora, and the disturbance current systems.

In Section II we shall review some of the knowledge of the aurora that has been derived from radio studies. The relevant parts of the extensive knowledge concerning magnetic storms and their ionospheric current systems will be discussed in Section III. Section IV will summarize the available information on motions of visual auroral forms. It will be shown that this information, while highly valuable, is still too incomplete to be conclusive.

In Section V we shall discuss those aspects of the various data on general motions in the ionosphere that relate to auroral motions. It will be necessary to consider the relationship of wind speeds to the motion of charged particles in order to determine the significance of the radio data.

Direct measurements of the drift motions of auroral ionization and the comparison of these results with magnetic observations will be described in Section VI. The drift motions will be shown to be of the same order of magnitude and direction as motion of the electrons in the ionospheric current systems required to explain the magnetic disturbances. They are a factor of ten greater than the normally measured ionospheric winds. The rapid fading of auroral radio echoes is thus shown to be associated with the increased electric fields which must drive the currents in the auroral regions.

## II. RADIO STUDIES OF THE AURORA

Since excellent summaries of most of the literature on auroral radio echoes are already available,<sup>1,2</sup> only the brief review necessary for the present purpose is given here. In addition, some more recent results are included.

While the aurora is undoubtedly effective in producing radio echoes at frequencies below 30 mc, the study of auroral echoes at these lower frequencies is complicated by severe absorption effects and reflections from the normal ionospheric layers. A recent study<sup>3</sup> showed that, in addition to the direct echoes, auroral radar echoes are obtained at 12 mc over paths that include at least one reflection from the  $F_2$  layer and one reflection from the ground.

<sup>1</sup> C. G. Little, W. M. Rayton, and R. B. Roof, "Review of ionospheric effects at VHF and UHF," *Proc. IRE*, vol. 44, pp. 992-1018; August, 1956.

<sup>2</sup> T. R. Kaiser, in "Proceedings of the Belfast Symposium on the Aurora and Airglow," Pergamon Press, London, Eng., pp. 156-173; 1955.

<sup>3</sup> L. Owren and R. Stark, *Quart. Prog. Rep. No. 3*, Contract No. DA 36-039-sc-71137, Geophys. Inst., Univ. of Alaska, College, Alaska; December 1, 1956.

\* Original manuscript received by the IRE, December 15, 1958.  
† School of Elec. Eng., Cornell University, Ithaca, N. Y.

It is not uncommon for the absorption of natural radiation from celestial sources at 30 mc to reach three decibels in auroral regions.<sup>4,5</sup> This figure refers to one-way passage through a broad zone centered on the zenith. If the absorbing region is traversed twice at an oblique angle, as for a radar echo, the absorption at 30 mc may typically be 12 db. Furthermore, since the nondeviative absorption in decibels is almost proportional to the wavelength squared, the corresponding figure at 10 mc for reasonable values of the collisional frequency may be of the order of 80 db.

At frequencies above 30 mc the situation is simpler. While absorption undoubtedly plays some role in the lower VHF range, its effect decreases rapidly as the frequency is increased. Thus 12 db of absorption at 30 mc would result in 6.4 db absorption at 41 mc (the frequency used in the US-IGY auroral radars) and less than one db at frequencies above 106 mc.

Auroral radar echoes have been observed recently at frequencies of about 400 mc<sup>6,7</sup> and 800 mc.<sup>8</sup> These experiments used narrow-beam steerable antennas which made it possible for the first time to determine directly the height of the reflecting region from measurements of the range and elevation angle. Peterson *et al.*<sup>6</sup> reported heights between 80 and 130 km, with an average height of 105 km. These heights agree well with the heights at which maximum luminosity is observed in the visible aurora.

The connection between the radio echoes and the visible aurora was obscured for some time by the fact that auroral ionization is effective in producing radar echoes only when the incident radar beam is nearly perpendicular to the earth's magnetic field in the auroral region. Since auroras are most frequently observed in high latitudes, where the earth's magnetic field is nearly vertical, radio echoes in the northern hemisphere are obtained only from regions near the northern horizon. Comparisons with visible aurora therefore must be made only in that region. When the analysis is restricted to these regions, fairly good correlations between visual and radar auroras are obtained,<sup>9</sup> although the intensity of the echoes is not always proportional to the brightness of the visual forms.

<sup>4</sup> S. Chapman and C. G. Little, "The nondeviative absorption of high-frequency radio waves in auroral latitudes," *J. Atmos. Terrest. Phys.*, vol. 10, no. 1, pp. 20-31; 1957.

<sup>5</sup> C. G. Little and H. Leinbach, "Some measurements of high-latitude absorption using extraterrestrial radio waves," *Proc. IRE*, vol. 46, pp. 334-348; January, 1958.

<sup>6</sup> R. L. Leadabrand, L. Dolphin, and A. M. Peterson, Final Rep., Contract No. AF 30 (602)-1462, Stanford Res. Inst., Menlo Park, Calif.; 1957.

<sup>7</sup> S. J. Fricker, S. M. Ingalls, M. L. Stone, and S. C. Wang, "UHF radar observations of aurora," *J. Geophys. Res.*, vol. 62, pp. 527-546; December, 1957.

<sup>8</sup> R. I. Presnell, R. L. Leadabrand, R. B. Dyce, L. T. Dolphin, and A. M. Peterson, paper presented at URSI Spring Meeting, Washington, D. C.; April 23-26, 1958.

<sup>9</sup> K. L. Bowles, Res. Rep. EE 248, School of Elec. Eng., Cornell Univ., Ithaca, N. Y.; June 1, 1955.

The aspect sensitivity of auroral radio echoes has been the subject of much investigation.<sup>6,9-11</sup> It is clear that the number and intensity of echoes decrease as the angle from perpendicularity with the geomagnetic field increases. The perpendicularity requirement becomes less critical as the frequency is decreased, varying from a few degrees tolerance at 400 mc to about 8° at 50 mc.

The reflecting ionization (like the visual luminosity) during an individual aurora is often closely confined to an arc along a parallel of magnetic latitude.<sup>9,12,13</sup> For ionization distributed along a parallel of latitude, the range spread measured will be a function of the antenna beamwidth in azimuth. Nevertheless, many workers have found that the echoes can be separated into two types in terms of the spread in range exhibited. Echoes showing great spread in range are called diffuse; those with narrow spread are called discrete. Bullough and Kaiser<sup>13</sup> pointed out that their diffuse echoes were generally observed before 2100 local time, and that their echoes showing discrete structure generally occurred after 2100 local time.

The use of the term "discrete" does not imply that auroral radio echoes have ever been found to have the characteristics of an echo arising from such a single source as an airplane. The signals received from aurora are always complex; they have the characteristics that would be expected of echoes arising from many randomly positioned, moving sources. The probability distribution of amplitude is approximately Rayleigh.

The best evidence<sup>5</sup> of the value of the ionization density under auroral conditions comes from the measurement of the absorption of extraterrestrial radio waves at 30 mc and these measurements correlate well with the minimum frequency at which *F*-region echoes are observed on an ionospheric sounder such as the model C-3. Also, if the auroral ionization density were high enough to lead to critical frequencies greater than about 6 mc, echoes from the aurora would be observed on the sounder. However, these echoes are not observed. Thus it is concluded that the average ionization density of most auroras does not exceed about  $5 \times 10^5$  electrons per cm<sup>3</sup>.

The character and strength of echoes from auroral ionization have been interpreted by Booker<sup>14</sup> in a theory of scattering by nonisotropic irregularities. According to Booker's theory, the irregularities of electron density are created by atmospheric turbulence and made non-

<sup>10</sup> R. B. Dyce, Res. Rep. EE 249, School of Elec. Eng., Cornell Univ., Ithaca, N. Y.; June 1, 1955.

<sup>11</sup> R. W. Unwin, "The geometry of auroral ionization," *J. Geophys. Res.*, vol. 63, pp. 501-506; September, 1958.

<sup>12</sup> K. Bullough and T. R. Kaiser, "Radio reflections from aurorae," *J. Atmos. Terrest. Phys.*, vol. 5, no. 4, pp. 189-200; 1954.

<sup>13</sup> K. Bullough and T. R. Kaiser, "Radio reflections from aurorae—II," *J. Atmos. Terrest. Phys.*, vol. 6, no. 4, pp. 198-214; 1955.

<sup>14</sup> H. G. Booker, "A theory of scattering by nonisotropic irregularities with application to radar reflections from the aurora," *J. Atmos. Terrest. Phys.*, vol. 8, nos. 4-5, pp. 204-221; 1956.

isotropic by the action of the earth's magnetic field. The irregularities mainly responsible for the VHF radar echoes would have dimensions of about 40 meters along the earth's magnetic field and one meter normal to the field. These dimensions, particularly the length, would explain the aspect sensitivity observed. It had been supposed that the effect of the aurora is to increase the electron density in the *E* region by a factor of about a hundred, that is, to a value of approximately  $10^6$  electrons per  $\text{cm}^3$  and Booker concluded that for this mean electron density  $N$ , and the dimensions stated above, a mean square deviation of electron density  $(\Delta N/N)^2$  of the order of  $3 \times 10^{-7}$  in the scattering region would explain the strength of the echoes.

A major shortcoming of the quantitative part of this approach was the assumption of a Gaussian spatial autocorrelation function to describe the statistical variation of electron density. Booker showed that the dimensions found were consistent with the scale of the small eddies at 100 km deduced from a turbulence theory. Turbulence theory, however, would lead to a quite different autocorrelation function and therefore to a different expression for the aspect sensitivity and scattered power. In addition, later measurements give much higher values of the mean-square deviation of electron density.

Nichols<sup>15</sup> has applied the scattering theory to auroral echoes measured at College, Alaska, at 41 mc and at 106 mc. Using a value of the mean ionization density consistent with the absorption results (critical frequency of 6 mc), the normal value of the mean square fractional deviation of ionization was deduced to be about  $6 \times 10^{-4}$ . This value, while considerably higher than that deduced by Booker, does not seem unreasonably great. Bailey *et al.*,<sup>16</sup> for example, used a value of  $10^{-4}$  for the same parameter in explaining the original VHF long-distance ionospheric observations. The concept that the normal auroral echoes arise through scattering from small irregularities in the ionization density would still seem to be valid.

The explanation for the strength of the strongest echoes observed by Nichols<sup>15</sup> is less certain. A value of  $(\Delta N/N)^2$  as high as  $2 \times 10^{-2}$  would be required. It is doubtful that values of  $(\Delta N/N)^2$  as high as  $10^{-2}$  could be produced by turbulence unless the turbulence model in auroral regions is modified to take into account the sharp gradients in luminosity, and presumably therefore in ionization density, seen in auroras.

Nichols<sup>15</sup> also compared the strength of the echoes observed at College during March, 1957 at 106 mc and

at 398 mc, and deduced that a twelfth-power wavelength dependence would fit the observations. Turbulence theory<sup>17</sup> leads to a wavelength dependence of this order of magnitude.

Because of the transient nature of auroral echoes, it has not been possible to measure the wavelength dependence accurately. However, observations of auroral radar echoes between 30 and 800 mc have shown no indication of the presence of a critical frequency in this range. A contrary viewpoint for frequencies less than 50 mc has been expressed by Forsyth and Vogan.<sup>18</sup>

It appears that a theory of scattering by anisotropic irregularities is capable of explaining the amplitude of VHF and UHF auroral echoes as well as their wavelength dependence. The average ionization density in auroras, deduced from radio measurements, is around  $5 \times 10^5$  electrons per  $\text{cm}^3$ .

### III. RELATIONSHIP BETWEEN AURORAS AND MAGNETIC STORMS

The statistical agreement between the degree of magnetic disturbance and the intensity of auroral activity has long been known. More recently, detailed comparisons of magnetic and auroral variations have been made, and even more striking relationships have been found. Meek<sup>19,20</sup> concluded that the maximum elevation of aurora above the northern horizon at Saskatoon was related closely to the magnetic variations. The absence of aurora always indicated the absence of magnetic disturbance (defined as a variation of greater than 200  $\gamma$  in the *H* component). The presence of aurora to the south of the zenith indicated large magnetic disturbances 95 per cent of the time. The aurora became brighter at the times of sharp deviation in the magnetic field.

Heppner<sup>21</sup> showed that for auroral arcs the disturbing current was located approximately in the same space as the auroral light. The most striking feature in demonstrating this spatial coincidence was the change in sign of the variation in the vertical component ( $\Delta Z$ ) when an auroral arc at the southern edge of the aurora moved south across the zenith.

Heppner also found that the magnetic disturbances and simultaneous auroral activity could be represented

<sup>17</sup> F. Villars and V. F. Weisskopf, "The scattering of electromagnetic waves by turbulent atmospheric fluctuations," *Phys. Rev.*, vol. 94, pp. 232-240; April 15, 1954.

<sup>18</sup> P. A. Forsyth and E. L. Vogan, "The frequency dependence of radio reflections from aurora," *J. Atmos. Terrest. Phys.*, vol. 10, no. 4, pp. 215-228; 1957.

<sup>19</sup> J. H. Meek, "Correlation of magnetic, auroral, and ionospheric variations at Saskatoon," *J. Geophys. Res.*, vol. 58, pp. 445-456; December, 1953.

<sup>20</sup> J. H. Meek, "Correlation of magnetic, auroral, and ionospheric variations at Saskatoon—part 2," *J. Geophys. Res.*, vol. 59, pp. 87-92; March, 1954.

<sup>21</sup> J. P. Heppner, "Time Sequences and Spatial Relations in Auroral Activity During Magnetic Bays at College, Alaska," Ph.D. Dissertation, Calif. Inst. of Tech., Pasadena, Calif.; June, 1954—*J. Geophys. Res.*, vol. 59, pp. 329-338; September, 1954.

<sup>15</sup> B. Nichols, "Drift Motions of Auroral Ionization," Sci. Rep. No. 1, Contract AF 19 (604)-1859, Geophys. Inst., Univ. of Alaska, College, Alaska; July, 1957.

<sup>16</sup> D. K. Bailey, R. Bateman, L. V. Berkner, H. G. Booker, G. F. Montgomery, E. M. Purcell, W. W. Salisbury, and J. B. Wiesner, "A new kind of radio propagation at very high frequencies observable over long distances," *Phys. Rev.*, vol. 86, pp. 141-145; April 15, 1952.



by two patterns in which the changes in the horizontal component ( $\Delta H$ ) are correlated with changes in the auroral forms. In both patterns, the disturbances consist essentially of a positive bay, that is, an increase in the horizontal component of the magnetic field lasting for several hours, followed by a negative bay, that is, a similar decrease in  $H$ , with a short interval of  $+\Delta H$  following the negative bay.

In the first pattern the transition from positive to negative bay occurs between 2300 and 0200 local time (College, Alaska) and is coincident with a transition of the aurora from quiet arcs and glow to rayed auroral forms that fluctuate greatly in intensity, shape, and location. The later  $+\Delta H$  period, which may last for about half an hour, occurs at the same time that pulsating forms are observed. The second pattern occurs less frequently and differs in the manner in which the positive bay ends and the negative bay begins. The positive bay starts as in the first pattern but ends when the aurora recedes northward and disappears. The negative bay begins with the reappearance of auroral arcs, and  $\Delta H$  continues to be negative when the arcs break into active rayed forms.

Both Meek<sup>19,20</sup> and Heppner<sup>21</sup> agreed that magnetic records on disturbed nights can be thought of as the resultant of a number of overlapping bays. On nights when the disturbance appeared to be exceedingly complex, Heppner was able to single out individual bays by recognizing the sequence of auroral forms. "The complexity is the consequence of the bays overlapping and the aurora simultaneously starting a new cycle of activity before the previous cycle is completed," he reported. Two other results of Heppner's study were as follows:

- (1) The negative bays were usually of greater magnitude than the positive bays; and
- (2) The late evening discontinuity between the eastward and westward currents responsible for the positive and negative bays, respectively, took place first in the north and progressed southward. The transition in the auroral forms also started in the north and proceeded southward with the current discontinuity.

The close association of auroras with polar magnetic storms makes it desirable to examine the magnetic disturbances themselves in more detail. Polar magnetic disturbances in general show very complicated variations of the geomagnetic field. Because of this complexity in the individual disturbances, many of the main studies of the world-wide morphology of the storms have been statistical. Such analyses have shown that the average disturbance field can be separated into two parts, one of which depends upon local time and the other of which depends upon the time measured from the world-wide commencement of the storm. In auroral regions the latter component is small compared to the

one which depends upon local time.<sup>22</sup> Since, for our purposes, however, we are chiefly interested in the character of individual storms, we shall not elaborate upon the statistical results.

A rather complete summary of the character of individual storms was presented by Fukushima.<sup>23</sup> In his analysis, Fukushima showed that the geomagnetic variations are composed of a number of elementary disturbances that take place intermittently or concurrently and last from several minutes to a few hours. These elementary disturbances can be linked with current systems which are similar to those responsible for magnetic bays. The similarity of Fukushima's conclusion, based on analyses of magnetograms taken by a world-wide chain of stations, with the statements of Meek and Heppner quoted above is obvious.

The average current system of a number of polar magnetic storms can be seen in Fig. 1. The current system of Fig. 1 has a number of characteristics that will prove important for later comparison with the motions of auroral ionization described in Section VI. For latitudes between 65 and 70°, the current is eastward until about 2100 local time, becoming westward after 2200. For stations at these latitudes, therefore, a positive bay would be expected before 2100, a negative bay after 2200. Since the westward currents are more intense than the eastward ones, the negative bay would be the stronger one.

Silsbee and Vestine<sup>24</sup> also noted in their fundamental study of the current systems of geomagnetic bays that the westward currents flowing along the auroral zone were much more intense than the eastward currents. In their average current system, the ratio of intensities was considerably greater than that shown in Fig. 1. The same is true for the elementary disturbances described by Fukushima.<sup>23</sup>

The intense auroral zone current of individual elementary disturbances of polar magnetic storms generally is more localized than the average storm in Fig. 1. The average storm is made up of a number of localized storms that take place around the auroral zone with their maximum number occurring around local midnight. Fukushima showed that the elementary disturbances can be represented by the current systems of electric doublets situated on the auroral zone. He gave additional quantitative arguments indicating that this doublet could be produced by a local increase in the ionization density, and therefore in the conductivity. The wind system, acting upon this region of increased conductivity, would produce an increased electric field

<sup>22</sup> S. Chapman and J. Bartels, "Geomagnetism," Clarendon Press, Oxford, Eng., vol. I, ch. 9; 1940.

<sup>23</sup> N. Fukushima, "Polar magnetic storms and geomagnetic bays," *J. Fac. Sci. Tokyo Univ.*, vol. 8, pt. 5, pp. 293-412; 1954.

<sup>24</sup> H. C. Silsbee and E. H. Vestine, "Geomagnetic bays, their frequency and current-systems," *Terrest. Mag.*, vol. 47, no. 3, pp. 195-208; 1942.

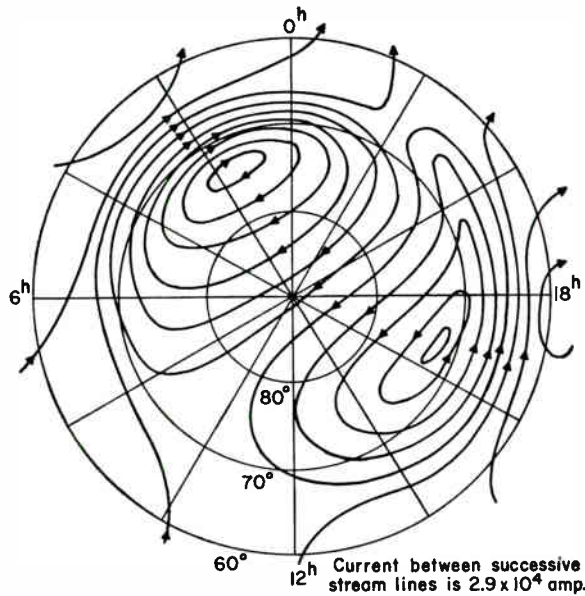

Fig. 1—Mean equivalent current system for polar magnetic storms during Second Polar Year (after T. Nagata). The world-wide current system for geomagnetic latitudes above  $60^\circ$  north is shown as a function of local time. The current between successive stream lines is  $2.9 \times 10^4$  amperes.

by dynamo action. The observed total auroral zone current of between  $5 \times 10^5$  and  $8 \times 10^5$  amps could be produced by increases in conductivity of 10 to 100 over regions whose extent is of the order of 200 km in latitude and 600 to 1000 km along the auroral zone. Such a zone of increased conductivity is not fixed, even for single storms. Nagata,<sup>25</sup> for example, computed the southward progression of the auroral zone currents as a magnetic storm became more intense.

The increases in ionization associated with magnetic disturbances have also been proved by measurements of increased absorption of radio waves and by observation of *Es* echoes on ionospheric sounders. Wells<sup>26</sup> found that at College high absorption of radio waves was coincident with each of 69 significant magnetic bays examined for the period January to September, 1942. The radio absorption was limited to the duration of the magnetic bay. More recent absorption measurements<sup>5</sup> using extraterrestrial radiation at 30 mc have lately suggested that the zone of anomalous absorption coincides in latitudinal extent with the zone of maximum auroral occurrence.

The increase of *Es* ionization at College was examined by Heppner, Byrne, and Belon,<sup>27</sup> who concluded that, in the presence of nonpulsating forms, the *Es* echoes varied in height and intensity in a manner similar to the changes in luminosity. From no aurora, to homo-

geneous arcs, to rayed bands, the maximum frequency of *Es* reflections changes approximately from 3, to 6, to 9 mc. Absorption was shown to be closely related to the forms with the minimum height of mean luminosity, namely, the pulsating forms.

On the basis of the close association of the visual, magnetic, and radio observations, the conclusion seems inescapable that the visual luminosity takes place in a region of increased ionization and increased currents. The intensity of the currents is directly related to the intensity of the aurora. Even the changes in the auroral forms correspond to changes in the current directions.

#### IV. MOTIONS OF VISIBLE AURORAL FORMS

The fact that visible auroral forms move is well known to all auroral observers and there is a well-recognized pattern of motions associated with the development and subsidence of an aurora. In many cases<sup>28</sup> the aurora first appears as a homogeneous arc which may be quiet for a time and then progress to the south. The arc may develop rayed forms and then break up into curtains and rays. Rapid motions and changes in the structure may be seen, followed by faint patches and pulsating forms. Finally the aurora may recede toward the north, leaving only a faint glow.

One could describe these sometimes regular and sometimes random changes in the auroral structure as "motions." In general, however, the motions to be discussed here are not those associated with the movement of arcs or the creation of new forms, but those of particular features of the aurora, for example, the drift of a group of rays or of a bend in an arc. Even in these cases, it is not at all certain that the apparent drift is in fact a mass motion. However, the use of the term "motion" leaves the question open.

The most general positive statement describing these motions was made by Meinel and Schulte.<sup>29</sup> On the basis of wide-angle photographic sequence records taken at Yerkes Observatory during June, 1952, they reported a general movement of auroral features that was westward in the evening and eastward in the morning. The drift speeds were maximum in the early evening, decreased to a minimum at local midnight, and increased again in the opposite direction in the early morning. The magnitude of the drifts varied between about 100 and 1300 meters per second.

The simple description by Meinel and Schulte was disputed by other experienced observers. Meek,<sup>30</sup> using similar equipment at Saskatoon, found that of 58 forms observed during a five-month period (December, 1953-April, 1954, inclusive), 19 exhibited a definite easterly motion and 14 a definite westerly motion. The 14 cases

<sup>25</sup> T. Nagata, "Development of a magnetic storm: the southward shifting of the auroral zone," *J. Geophys. Res.*, vol. 55, pp. 127-142; June, 1950.

<sup>26</sup> H. W. Wells, "Polar radio disturbances during magnetic bays," *Terrest. Mag.*, vol. 52, no. 3, pp. 315-320; 1947.

<sup>27</sup> J. P. Heppner, E. C. Byrne, and A. E. Belon, "The association of absorption and *E<sub>s</sub>* ionization with aurora at high latitudes," *J. Geophys. Res.*, vol. 57, pp. 121-134; March, 1952.

<sup>28</sup> C. Störmer, "The Polar Aurora," Clarendon Press, Oxford, Eng.; 1955.

<sup>29</sup> A. B. Meinel and D. H. Schulte, "A note on auroral motions," *Astrophys. J.*, vol. 117, pp. 454-455; May, 1953.

<sup>30</sup> J. H. Meek, "East-west motion of aurorae," *Astrophys. J.*, vol. 120, pp. 602-603; November, 1954.

of westerly motion all took place before 0200 local time. The remaining cases were scattered throughout the night. The estimated speeds of motion were about 200–500 meters per second.

On the basis of auroral movies taken at Ithaca, N.Y., since 1939, Bless, Gartlein, and Kimball<sup>31</sup> found that of 120 displays, 57 showed definite motion to the east or to the west. Of these 57 auroras, 45 showed a westward drift of rays, patches, and draperies and/or westward movement of bright patches and rays on arcs; and 22 showed similar motion to the east. In 8 displays a reversal of large-scale motion occurred between 2200 and 0200, and 39 displays showed complex motions, mostly short periods of alternating east-west motion. The steady motions, when seen, were westward early in the night and eastward late in the night, but either or both ways in the middle of the night. Random motions occurred at any hour, and nearly always after arcs broke into rays. The authors concluded that the motions are not sharply controlled by local time.

In reply to the authors just cited, Meinel<sup>32</sup> argued that the reversal from westward drift to eastward drift during the night is not an exact effect but a systematic one. He pointed out the similarity to the “reversal of ionospheric currents near midnight and noon during magnetic storms.” These do not exhibit an abrupt reversal, and the local time of reversal varies from storm to storm; but the phenomenon as a whole does show a systematic reversal during the night.

A recent series of measurements<sup>33</sup> of the directions of the motions of “180° bends” was made at College, Alaska, using sequence photographs taken with an all-sky camera. The 180° bend is formed when an arc, either homogeneous or rayed, is bent through an angle of 180°, forming two parallel arcs. Between January, 1954, and April, 1955, 105 of the 180° bends were found. Bends with open ends toward the west maximized at 2330 local time, while bends with open ends toward the east maximized at 0300 hours. Thirty of the bends were observed to move, 20 with westward drifts and 10 with eastward drifts. No systematic division of the westward and eastward drifts into evening and morning hours was found. The westward motions, however, were clustered around 2330.

Other descriptions of motions of auroras seem to be limited to specific instances rather than systematic variations, and of these only a few are based on actual measurements. Störmer<sup>28</sup> described the motion of two cloud-like auroras.<sup>34</sup> One, on January 3, 1940, was observed from 1700 to 1940 local time. The drift velocity of a portion of the cloud was measured to be from 690

to 780 m/s in a westward direction. In another instance on March 25, 1933, between 0334 and 0408 the aurora moved in an easterly direction with a speed of the order of 200 m/s.

An early measurement,<sup>35</sup> using parallactic photographs, studied the movement of “auroral clouds” seen at Halde Observatory. The height of the forms was determined to be between 106–110 km. Measurements were made on the night of March 8–9, 1915, from 2333 to 0105 local mean time. The speeds measured for different parts of the form varied between about 100 and 400 m/s. The direction of the drifts was mainly to the northeast. In geomagnetic coordinates the direction would have been quite close to geomagnetic east.

Other visual observations of aurora at College, Alaska, have referred to the directions of the motion. Fuller and Bramhall<sup>36</sup> concluded that “the movement of rays generally, but not always, was easterly rather than westerly.” Heppner<sup>21</sup> made extensive visual observations, which he correlated with magnetic records. He reported that the movements of discrete rayed forms during  $-\Delta I I$  disturbances, which generally occurred after midnight, were almost without exception eastward. The movements during  $+\Delta I I$  disturbances (generally earlier in the evening) were uncertain because of insufficient data.

Recent measurements<sup>37</sup> taken from US-IGY all-sky camera film records have given results of the same nature as those already quoted. The motions are generally observed near or after local midnight, and they are mainly eastward with speeds of from 300 to 500 m/s.

It is clear that the character of the motion of auroral forms has not yet been definitely established. Most of the observations seem to fit the general pattern of a westward drift in the early evening hours and an eastward drift in the early morning hours, but it is apparent that no rule for individual cases can be stated on the basis of evidence presently available. The change in the direction of motion appears to be associated more directly with the change in the character of the aurora (and of the magnetic disturbance) than with the local time. The speeds vary from several hundred to a thousand meters per second.

## V. GENERAL MOTIONS IN THE IONOSPHERE

It is shown in this section that the measured speeds of ionospheric motions constantly increase with the increase of magnetic disturbance. The high speeds of auroral motions are at the upper end of a continuous curve and are directly related to magnetic disturbances. At times, especially during auroras, the electric field in

<sup>31</sup> R. C. Bless, C. W. Gartlein, and D. S. Kimball, “East-west motions in the aurora,” *Astrophys. J.*, vol. 122, pp. 205–206; July, 1955.

<sup>32</sup> A. B. Meinel, “Systematic auroral motions,” *Astrophys. J.*, vol. 122, pp. 206–208; July, 1955.

<sup>33</sup> Interim Sci. Rep. No. 1, Contract AFCRC-TN-55-579, Geophys. Inst., Univ. of Alaska, College, Alaska; August 15, 1955.

<sup>34</sup> L. Harang, “The Aurorae,” John Wiley and Sons, Inc., New York, N. Y.; 1951.

<sup>35</sup> O. Krogness and E. Tönsberg, *Geofys. Publikasjoner*, vol. 11; 1934–1937.

<sup>36</sup> V. R. Fuller and E. H. Bramhall, “Auroral research at the university of Alaska, 1930–1934,” *Misc. Publs. Univ. of Alaska*, vol. 3; 1937.

<sup>37</sup> Private communication to B. Nichols from G. Sprague, IGY Auroral Data Center, Cornell Univ., Ithaca, N. Y.



the ionosphere seems to increase simultaneously with an increase in ionization density and produces the currents responsible for magnetic disturbances. Since radio techniques measure the motion of charges, principally electrons, we conclude that the observed rapid auroral motions are associated with the increased electric field.

The ionosphere differs fundamentally from the lower atmosphere by the simple fact of its ionization. Motions of the ions and electrons, taking place in the presence of the geomagnetic field, will be influenced not only by the mass motion of the neutral gas but also by electrostatic and electromagnetic forces. The motions of the charged particles in turn may react on the mass motions of the air. Since most of our information about ionospheric motions comes from radio studies, it is important to remember that radio observations indicate the presence and motion of the electrons, both of which may differ from that of the main air mass. Ratcliffe<sup>38</sup> in his summary of irregularities and movements in the ionosphere suggested the use of the term "drift" for the movement of irregularities of electron density to avoid confusion with the term "wind," which refers to the movement of the neutral air. Unfortunately, some authors have not avoided this confusion.

Measurements of ionospheric motions have been obtained from visual observations of meteor trails, noctilucent clouds, and sodium clouds injected into the ionosphere from a rocket. There is little doubt that the motions observed visually are directly caused by existing winds at the heights involved. Although the number of observations has been limited, it is useful to summarize briefly the velocities measured.

Sodium-cloud wind observations<sup>39</sup> were made in New Mexico at 1800 local time on October 12, 1955. By tracking the clouds with theodolites, the wind at the 85-km level was measured to be 80 m/s (180 mph) to the southeast; at the 100-km level, the wind was 45 m/s (100 mph) to the northwest. These shearing winds rapidly distorted the sodium trail.

Noctilucent clouds having heights between 74 and 92 km are observed at high latitudes in summer, some hours before sunrise and after sunset. The data on their motions have been summarized by Mitra.<sup>40</sup> Although early measurements gave higher speeds, the more recent information puts the average wind speed at around 50 m/s.

Many visual observations of long enduring meteor trails have been made over the years. Some 1600 cases were examined by Olivier.<sup>41</sup> The average speed deduced from these generally crude measurements was about 50

m/s. More recently, much more accurate measurements have been made using Super-Schmidt telescopes and photographic techniques.<sup>42</sup> The velocities of five persistent meteor trains were measured as a function of altitude in the range 81 to 113 km. The winds changed rapidly with altitude at the rate of about 20 m/s per km. Winds separated by five km in height seemed uncorrelated. The maximum wind component reached about 100 m/s; the mean wind speed was 38 m/s.

Although the visual measurements of wind speeds have been limited to more or less isolated instances, they have yielded consistent results as far as the magnitude and character of the winds in the *D* and *E* regions of the ionosphere are concerned. The speeds may be as high as 100 m/s; the mean value is about 50 m/s. All observations indicate that the lower regions of the ionosphere are turbulent, the wind speeds varying rapidly and irregularly with height.

In the past decade the limited visual observations have been supplemented by extensive radio measurements of ionospheric motions. The principal methods used have been as follows:

- 1) Measurement, at closely spaced points, of time shifts in the amplitude pattern at ground level produced by vertically incident radio waves reflected from the *E* or *F* layer;
- 2) Measurement, at widely spaced points, of time shifts of large-scale irregularities in the *F* region;
- 3) Measurement, at points separated by up to a few kilometers, of the time shifts in the scintillations of radio stars;
- 4) Measurement of the positions of meteor trails and the radial components of the velocity of drift of the ionized trails; and
- 5) Measurement of the motions of auroral ionization.

An extensive summary of the results of the measurements using methods (1–4) was compiled by Briggs and Spencer.<sup>43</sup> A few of their major conclusions will be mentioned here. They reported that the mean velocity of the drift in the *E* region varies from time to time, but that it has an average value of 80 m/s. It contains a semidiurnal component of about 30 m/s which has the general form expected from the theory of atmospheric oscillations produced by the thermal and tidal action of the sun. The velocities in the *F* region are somewhat higher, with directions toward the east by day and toward the west by night.

Of particular interest from the point of view of our study is the increase in the speeds measured during magnetic disturbances. Using method (1), Chapman<sup>44</sup> reported that for the *F* region at Ottawa the mean drift velocity was independent of the *K* index until *K* ex-

<sup>38</sup> J. A. Ratcliffe, "The physics of the ionosphere," Physical Society of London, London, Eng., pp. 88–99; 1955.

<sup>39</sup> H. D. Edwards, J. F. Bedinger, E. R. Manring, and C. D. Cooper, in "Proceedings of the Belfast Symposium on the Aurora and Airglow," Pergamon Press, London, Eng., pp. 122–134; 1955.

<sup>40</sup> S. K. Mitra, "The Upper Atmosphere," 2nd ed., The Asiatic Soc., Calcutta, India, pp. 334–335; 585; 1952.

<sup>41</sup> C. P. Olivier, "Long enduring meteor trains," *Proc. Am. Phil. Soc.*, vol. 91, pp. 315–327; October, 1947.

<sup>42</sup> W. Liller and F. L. Whipple, "Rocket Exploration of the Upper Atmosphere," Pergamon Press, London, Eng., and Interscience Publishing Co., Inc., New York, N. Y., p. 112; 1954.

<sup>43</sup> B. H. Briggs and M. Spencer, "Horizontal movements in the ionosphere," *Reps. Prog. Phys.*, vol. 17, pp. 245–280; 1954.

<sup>44</sup> J. H. Chapman, "A study of winds in the ionosphere by radio methods," *Can. J. Phys.*, vol. 31, pp. 120–131; January, 1953.

ceeded four. For a  $K$  index of five or greater, the higher absorption commonly made echoes too weak for recording. Occasionally, however, echoes were obtained that invariably indicated drift velocities ranging from 200 to 500 m/s. For the  $F$  region, Chapman reported a mean drift velocity that increased regularly with the  $K$  index.

Briggs and Spencer,<sup>43</sup> using the same technique at Cambridge, England, reported that for the  $E$  region the velocity was independent of the  $K$  index for values between one and five. High velocities of the order of 500 m/s were nevertheless recorded in the  $E$  region on one occasion during a severe magnetic storm. For the  $F$  region the velocity was independent of  $K$  index until the value reached five, after which the velocity increased steadily. For the particular case in which  $F$ -region motions were measured during a period of aurora, motions were observed first to the west and then to the east with speeds of up to 750 m/s. On one occasion a velocity of 1000 m/s was observed during a magnetic storm.

The most complete studies of the variation of the drift velocity with the degree of magnetic disturbance<sup>45-50</sup> have been made by using method (3). The results of all these studies showed that the increase in the drift speed is correlated with the increase in the  $K$  index. Speeds up to 1000 m/s were noted.

The radio star is a versatile tool for studying ionospheric motions, for as the elevation angle of the radio star under observation varies, its radiation penetrates the ionosphere at different latitudes. The radiation from different stars, observed at the same time, will traverse the ionosphere in different locations. By taking advantage of this versatility, Maxwell and Dagg<sup>48</sup> were able to determine that the drift motions near the auroral zone were twice as great as those overhead at Jodrell Bank and that, in general, the velocities in two areas separated by 800 km along the same geomagnetic latitude were substantially the same. Overhead motions at Jodrell Bank, particularly during magnetically disturbed conditions, were towards the west before midnight and the east after midnight. Near the auroral zone, the reversal took place at about 2100. The north-south components of velocity were generally small. Dagg<sup>50</sup> has also shown that the speeds measured by the drift of radio star scintillations are associated in detail

with magnetic records taken at the same time.

There are two other significant observations in connection with the scintillation measurements. The first is that the size of the irregularities responsible for the scintillations does not change as the degree of magnetic disturbance and the speed of motion vary. The second is that the amplitude of the scintillations does not usually correspond to the degree of magnetic disturbance. These facts lead directly to the conclusion that the character of the irregularities is not changed during magnetic disturbances but their speed is increased.

The chief difficulty in the interpretation of the radio star data concerning motions is that no firm conclusion has been reached as to the heights of the irregularities whose motions are being measured.<sup>51</sup> The only conclusion one can safely draw is that these measurements refer to heights above the  $E$  region. It is also possible that the measured direction of motions may be in error. Spencer<sup>52</sup> demonstrated that the ionospheric irregularities that produce the scintillations are elongated along the earth's magnetic lines of force. The elongated shapes of the amplitude patterns on the ground are therefore approximately elliptical, with axis ratios greater than five to one. Under these conditions the apparent direction of motion lies very close to the minor axis of the ellipse. Even in the face of the uncertainties, it is possible to conclude from the scintillation measurements that at heights above the  $E$  region the magnitude of the drift motions is correlated with the degree of magnetic disturbance.

To demonstrate the correlation of the speed of motions measured by various radio methods with the degree of magnetic disturbance, various authors have plotted curves as a function of  $K$  index. The nonlinear character of that index tends to obscure the direct relationship between the speeds of motion and the disturbance of the magnetic field. Accordingly, in Fig. 2 we have replotted several of the published curves to show the variation in  $\Delta\gamma$  as a function of the measured speeds. Since the  $K$  figure at the different stations corresponds to a different range of  $\Delta\gamma$ , the percentage of the  $\Delta\gamma$  corresponding to the highest  $K$  figure,  $K-9$ , has been used. Curves  $A$ ,  $B$ , and  $D$  refer to heights above the  $E$  region and show a smooth increase of  $\Delta\gamma$  as speed of motion increases. The change in the field is nearly proportional to the square of the speed. Since the strength of the currents responsible for the magnetic variations would depend upon the product of the ionization density and the speed, it appears that both the speed of motion and the ionization density increase during magnetic disturbances. For  $K$  figures less than four, the  $E$ -region speeds (curve  $C$ ) seem to be independent of the magnetic disturbance, but for higher  $K$  figures the shape of

<sup>45</sup> C. G. Little and A. Maxwell, "Scintillations of radio stars during aurorae and magnetic storms," *J. Atmos. Terrest. Phys.*, vol. 2, no. 6, pp. 356-360; 1952.

<sup>46</sup> A. Maxwell and C. G. Little, "A radio astronomical investigation of winds in the upper atmosphere," *Nature (London)*, vol. 169, pp. 746-747; May 3, 1952.

<sup>47</sup> A. Hewish, "The diffraction of galactic radio waves as a method of investigating the irregular structure of the ionosphere," *Proc. Roy. Soc. (London) A*, vol. 214, pp. 494-514; October 9, 1952.

<sup>48</sup> A. Maxwell and M. Dagg, "A radio astronomical investigation of drift movements in the upper atmosphere," *Phil. Mag.*, vol. 45, pp. 551-569; June, 1954.

<sup>49</sup> A. Maxwell, *Occasional Notes: Roy. Astron. Soc. London*, vol. 3, no. 16, pp. 65-70; 1954.

<sup>50</sup> M. Dagg, "The correlation of radio-star-scintillation phenomena with geomagnetic disturbances and the mechanism of motion of the ionospheric irregularities in the  $F$  region," *J. Atmos. Terrest. Phys.*, vol. 10, no. 4, pp. 194-203; 1957.

<sup>51</sup> H. G. Booker, "The use of radio stars to study irregular refraction of radio waves in the ionosphere," *Proc. IRE*, vol. 46, pp. 298-314; January, 1958.

<sup>52</sup> M. Spencer, "The shape of the irregularities in the upper atmosphere," *Proc. Phys. Soc. (London) B*, vol. 68, pp. 493-503; August, 1955.

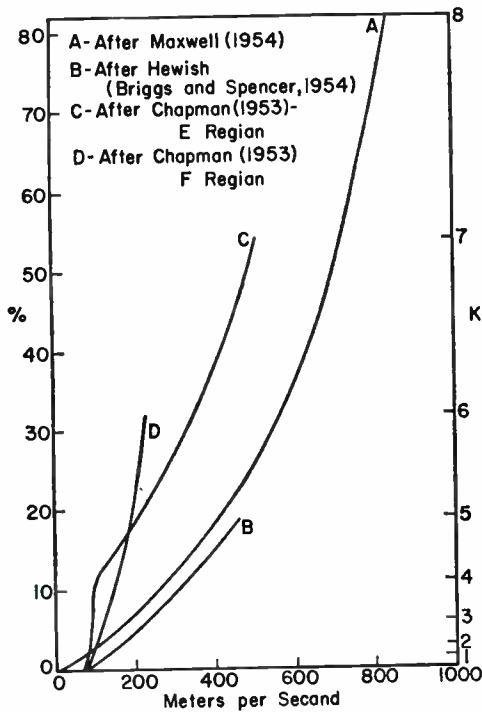

Fig. 2—Magnetic disturbance vs speed of motion. The degree of magnetic variation that establishes a magnetic  $K$  figure of 9 for the station involved is used as 100 per cent. The right-hand scale shows the appropriate  $K$  figure. Curves  $A$  and  $B$  show motions derived from radio star scintillation studies.<sup>43,49</sup> Curves  $C$  and  $D$  show the motions derived from three-station ionospheric sounder measurements<sup>44</sup> of the  $E$  and  $F$  regions, respectively.

the  $E$ -region curve is very similar to that for the  $F$  region. The  $E$ -region curve suggests that two mechanisms are involved and that, as the magnetic disturbance increases, the mechanism responsible for the increase in the currents predominates.

The possible mechanisms responsible for the motions of charges in the ionosphere are winds and electric fields. These are not independent, for winds moving charges in the presence of the earth's magnetic field will generate electromotive forces. The probable motions of charges resulting from the wind systems and electric field in the ionosphere have been described by Baker and Martyn,<sup>53</sup> who concluded that the dynamo theory is valid and that the region in which the currents flow is between 110–150 km in height. Their analysis showed that, in the lower  $E$  region, ionization moves horizontally with substantially local wind velocity. In the upper  $E$  region, the horizontal motion of ionization may differ substantially in magnitude and direction from that of the local wind. In the  $F$  region ionization cannot be moved by winds transverse to the earth's magnetic field. There, high east-west drift velocities can be produced only by north-south electric fields communicated from elsewhere. These electric fields might originate in the  $E$  region and reach the  $F$  region along the highly conducting lines of magnetic force.

The conclusions of Baker and Martyn seem to fit the measurements described in this section. The various visual measurements of  $E$ -region winds gave results of similar magnitude to the  $E$ -region drift motions measured by radio means under magnetically quiet conditions. For quiet conditions, the  $E$ -region radio measurements are probably measurements of wind speed.

The continuous variation of the  $F$ -region speeds of drift motion with magnetic disturbances, even for very small disturbances, confirms the conclusion that the  $F$ -region motions are linked to the electric fields which drive the currents at lower heights. In the  $E$  region, however, when the speeds measured are small, they refer to winds. The faster  $E$ -region drift motions are correlated with magnetic disturbances and undoubtedly are also associated with an increased electric field. It seems more than coincidental that during magnetic disturbances the  $E$ - and  $F$ -region drift motions have the same order of magnitude.

## VI. DRIFT MOTIONS OF AURORAL IONIZATION

The major studies of the drift motions of auroral ionization based on VHF radio echoes from aurora have been reported by Bowles,<sup>9,54</sup> Bullough and Kaiser,<sup>13</sup> and Nichols.<sup>15,55</sup> Bowles measured the Doppler shift of CW auroral echoes at College and Kenai, Alaska, and at Ithaca, N.Y. The measured radial components of velocity at College were typically about 600 to 1000 m/s. At Kenai and Ithaca the radial components were typically about 300–500 m/s. Bowles noticed that the Doppler shifts of the CW echoes had no correlation with the range changes of radar echoes. At times when the radar range showed no change, the CW echoes continued to show Doppler shifts. Upward shifts in frequency were correlated with homogeneous forms of the visible aurora; rayed forms were correlated with downward shifts in frequency. After ruling out east-west motions on the basis of several occasions when rotation of the antenna revealed "no large change in the shape of the spectrum," Bowles concluded that the drift motions were directed along the magnetic lines of force with speeds of 10 to 100 km/s. However, the measurements described later in this section appear to rule out this interpretation.

Bullough and Kaiser<sup>13</sup> deduced the speeds of motion of the reflecting regions from measurements of the change in range of radar echoes observed at Jodrell Bank, using an antenna directed 50° west of the geomagnetic meridian. From geometrical considerations they showed that the motions were along a parallel of geomagnetic latitude. The motions were toward the west in the evening and toward the east in the morning, the reversal occurring between 2100 and 2200. The mean speeds at 1800 and 0600 were about 600 m/s to

<sup>53</sup> W. G. Baker and D. F. Martyn, "Electric currents in the ionosphere," *Phil. Trans. Roy. Soc. (London) A*, vol. 246, pp. 281–320; December, 1953.

<sup>54</sup> K. L. Bowles, "Doppler shifted radio echoes from aurorae," *J. Geophys. Res.*, vol. 59, pp. 553–555; December, 1954.

<sup>55</sup> B. Nichols, "Drift motions of auroral ionization," *J. Atmos. Terrest. Phys.*, vol. 11, nos. 3–4, pp. 292–293; 1957.



the west and east, respectively. Speeds as high as three km/s were observed. On several occasions regular sequences of moving echoes were observed. In one case seven echoes with speeds of 500 m/s in the same direction passed through their antenna beam at intervals of 11 minutes.

Kaiser<sup>2</sup> reported that a detailed analysis of the magnetic variation during individual auroras showed that for positive and negative bays the auroral motions were toward the west and east, respectively. In addition, the time of reversal in direction of the motions corresponded to the time of reversal of the mean variation of the vertical component ( $\Delta Z$ ) of the magnetic disturbance at a station 10° east of the reflecting region. Bullough *et al.*<sup>56</sup> noted a close relationship between the auroral motions and the atmospheric electric current system. The change from a positive bay to a negative bay between 2100 and 2200 hours coincided with the minimum of echo occurrence that separated their "diffuse" westward moving echoes from their "discrete" eastward-moving echoes.

Nichols<sup>15,55</sup> also measured the frequency spectra of CW echoes from the aurora. By observing simultaneously to the east and west of geomagnetic north at College, Alaska, it was possible to determine the direction and approximate speeds of motion responsible for the measured Doppler shifts. Components of the motion symmetrical with respect to the meridian, *i.e.*, motions along the geomagnetic lines of force or in the north-south direction, would have identical radial components. East-west components, on the other hand, would have radial components that were opposite in sign. Whenever echoes were obtained simultaneously from both east and west of north, the frequency shifts were in opposite directions.

From measurements made during 33 auroral nights, Nichols deduced that the average speed of motion to east or west ranged from 360 to 1460 m/s, with a median speed of 725 m/s. The diurnal variation of the direction of motion is shown in Fig. 3. The number of occurrences of motion to the east or west observed during the hours indicated may be noted. Along the top border of Fig. 3 is given the number of times that observations were made during the hour specified. For example, between 2300 and 2400 Alaska Standard Time observations were made on 43 nights. Auroral echoes were obtained during that hour on 14 of the nights. Of these, 10 showed electron drift motion to the east and four to the west. It is apparent from Fig. 3 that westerly drift motions were observed chiefly in the evening hours. The transition from predominantly westerly motions to predominantly easterly motions occurred around 2200 local time.

It should be noted that the direction shown in Fig. 3

<sup>56</sup> K. Bullough, T. W. Davidson, T. R. Kaiser, and C. D. Watkins, "Radio reflections from aurorae—III. The association with geomagnetic phenomena," *J. Atmos. Terrest. Phys.*, vol. 11, nos. 3-4, pp. 237-254; 1957.

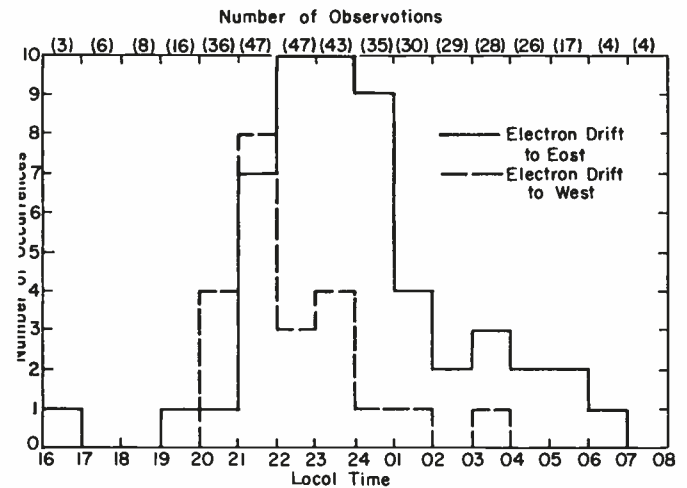

Fig. 3—Nocturnal variation of the direction of electron drift motions in auroral ionization. The number of occurrences of electron drift to the east (solid line) and to the west (broken line) is shown as a function of time at College, Alaska. The number of days when observations were made at each hour is listed along the top.

refers to the direction of motion of the electrons responsible for the echo and therefore responsible for the Doppler shifts. The directions thus check very well with the average current system shown in Fig. 1, where we saw that the transition from easterly currents (westerly motion of electrons) to westerly currents (easterly motion of electrons) also occurs around 2200. The result also agrees with the auroral zone scintillation motions of Maxwell and Dagg<sup>48</sup> described in the previous section and with the results of Bullough *et al.*<sup>56</sup> just mentioned. The predominance of easterly motions also corresponds with the same predominance in the motions of the visual forms described in Section IV.

Nichols also noted a close correspondence of the electron motions with simultaneous variations of the magnetic field. On some occasions the electron motions and the magnetic variations remained in the same direction for several hours. On these occasions the echoes were being received from both east and west of geomagnetic north and therefore from ionization distributed along a parallel of latitude. It seems clear that the electrons responsible for the auroral echoes are part of the current system that produces the magnetic disturbance. Both the increased ionization of auroras and the increased speed of motion bring about the magnetic changes measured at the ground.

The correspondence between the motions of electrons, measured by Doppler-shift methods, and the motions of the regions of ionization along parallels of latitude, measured by the pulse radar method, leads to the conclusion that the electric fields that drive the currents are also responsible for the motions of the regions of ionization. These electric fields, transmitted above the *E* region, also produce the motions measured by the radio star scintillation method. The directions and speeds of motion also correspond to those observed in the visual aurora.

# Abnormal Ionization in the Lower Ionosphere Associated with Cosmic-Ray Flux Enhancements\*

D. K. BAILEY†

**Summary**—Abnormal ionization in the lower ionosphere associated with cosmic-ray flux enhancements is discussed mostly in terms of the great solar event of February 23, 1956. Two kinds of abnormality were recognized: *early effects* observable in the dark hemisphere at the time of the sudden cosmic-ray enhancement, and *late effects* which began gradually and reached a maximum a few hours after the cosmic-ray enhancement. The late effects died away over a period of several days in geomagnetic latitudes above 70°, but more rapidly in lower latitudes. Both effects were more intense in higher geomagnetic latitudes. Early effects, though much the less intense of the two, appear to have been observable in lower geomagnetic latitudes than the late effects.

The early effects are explained as a consequence of a plausible difference in composition between streams of solar particles of cosmic-ray energies, and ordinary cosmic rays. The late effects are explained in terms of ionization produced in the lower ionosphere (the range of height from 30 to 110 km is studied) by the passage or stopping of solar particles—mostly protons. Such particles are shown, like the more energetic solar cosmic rays, to be arriving essentially isotropically after the maximum effects occur. A plausible extension of the observed magnetic-rigidity spectrum of the solar cosmic rays downward in rigidity by about a power of 10 would provide the protons necessary to account for the observations. The absence of auroral and significant magnetic activity accompanying the abnormal ionization is consistent with the explanations offered. Moreover, certain more recent high-latitude absorption events, unaccompanied by ground-level cosmic-ray flux enhancements, are explicable in similar terms.

An interesting by-product of the investigation is a provisional evaluation not only of the coefficient of collisional detachment of electrons from negative ions, probably mostly  $O_2^-$ , but also of the negative-ion-to-electron ratio and the effective recombination coefficient at night between 30 and 110 km.

## INTRODUCTION

THE number of sudden cosmic-ray flux enhancements observed up to the present is very small. Each such event is accompanied by, and is apparently directly related to, unusual activity on the sun—represented by a great flare and apparently also by significant emission of radiation at radio frequencies. The most recent of these events was associated with a great flare first observed near the western limb of the sun at about 0331 UT on February 23, 1956. The large cosmic-ray flux enhancement which followed the start of the flare by 15 to 20 minutes was exceptionally well observed all over the earth. This paper deals with the abnormal ionization in the lower ionosphere, first recognized in the dark hemisphere, which followed the flare and in its first manifestations accompanied the cosmic-ray flux enhancement. Similar ionospheric abnormalities

are known to have accompanied earlier cosmic-ray flux-enhancement events; but during these earlier events, the number of suitably situated observing stations was small, and the available techniques for observation could not reveal the more interesting and detailed features of such events. In any case the event of February 23, 1956 was the greatest and most interesting yet observed.

## SUDDEN COSMIC-RAY INCREASES

Stimulated by the cosmic-ray and solar observations, there is gradually evolving some understanding of the generation at the sun and propagation to the earth of high-speed charged particles having cosmic-ray energies (often termed solar cosmic rays). Briefly, it is thought that the high-energy charged-particle emission is representable as an impulse somewhat resembling and roughly coinciding in time with the light curve of the associated flare. Thus, most of the particle radiation is thought to be over by the end of the flare. Simultaneous observations at several frequencies of solar radio-frequency radiation provide valuable information on the generation and emission of the charged particles. The magnetic-rigidity (or momentum) spectrum of the particles as they escape from the sun is not known although it is clear that the emission drops off sharply with increasing rigidity. As for the extent of the radiation in the direction of low rigidities, cosmic-ray observations are of rather limited value. It is commonly assumed that the direction of maximum emission is normal to the sun's surface. This is supported by many years of observation of the relationships between activity on the sun's surface, viewed optically, and magnetic and ionospheric disturbances at the earth. Such evidence may be misleading since it involves corpuscular radiation at very much lower energies than cosmic-ray energies. The nature of the acceleration process at the sun remains a field for lively speculation.

What the continuously operating cosmic-ray recorders have to say about the propagation of the solar particles of cosmic-ray energies is most interesting. For example, the particles are received on both the light and dark sides of the earth, though the onset is observed some minutes later on the dark side. The intensity builds up, above the background of ordinary cosmic rays, to a sharp maximum in a time of the order of five to ten minutes, following which a slow decline sets in, lasting many hours before the intensities return to normal. Dur-

\* Original manuscript received by the IRE, December 23, 1958.

† Page Communications Engineers, Inc., Washington, D. C.

ing the period before the maximum intensities are recorded, there is evidence for preferred directions of arrival—anisotropy. In the much longer period following the occurrence of maximum intensity at a station, however, the evidence suggests that the solar cosmic rays may be considered as coming with approximately equal intensity from all directions. That is to say, the solar cosmic rays are, like ordinary cosmic rays, essentially isotropic, except for the local effect of the earth's magnetic field which excludes charged particles altogether or from certain directions, according to their rigidity.

The fact that solar cosmic rays continue to reach the earth hours after the associated solar activity has died away, though traveling at nearly the velocity of light, and the fact that by then they are arriving essentially isotropically indicate strongly that "storage" must occur in the inner solar system.

Much thought is being given to the cosmic implications of the solar cosmic-ray observations, and it may be assumed that the apparent isotropy and storage will eventually be accounted for in terms of magnetic fields associated with plasmas of solar origin which extend beyond the earth and are perhaps an ever-present, ever-changing feature of space around a star such as the sun.

Much fuller discussion of the solar and solar cosmic-ray observations and some first attempts at interpretation are given for example by Meyer, Parker, and Simpson [1] and Lüst and Simpson [2].

#### ASSOCIATED IONOSPHERIC EFFECTS

With the exception of the SID observed in the daylight hemisphere, the ionospheric abnormalities associated with the solar event of February 23, 1956 are attributable to the effects of the solar particles of cosmic-ray and lower energies. For one thing, ionospheric effects had beginnings virtually coincident with the cosmic-ray enhancement and were observed in the dark hemisphere. For another, the effects increased in magnitude with geomagnetic latitude. Two quite distinct kinds of ionospheric effects occurred. They are termed early and late effects and may be attributed to different causes. The early effects were apparently observable in lower geomagnetic latitudes than the late effects.

##### *Early Effects*

The early effects consisted of a sudden increase in the electron density at heights well below 100 km and probably mostly in the 70–90-km range. This increase was sufficient to transform the dark ionosphere at these heights from night characteristics to those of a sunlit ionosphere. The duration of the early effects cannot be well defined because the late effects tended to mask the early effects after two or three hours. The early effects were observed at LF and VLF as a sudden phase anomaly, indicating a decrease in the height of reflection,

and as a decrease in field strength of certain signals received from distant sources [3]–[6]. Most of the available observations were made in western and northern Europe and in the eastern United States and correspond to geomagnetic latitudes between 50 and 60°N. The coincident sudden decrease in the intensity of atmospherics observed at Churchill, Manitoba, at LF [7], and at VLF in Scotland [5] and southern England [4], but particularly in southern England, suggests that the early ionospheric effects extended to somewhat lower geomagnetic latitudes since it may be assumed that atmospherics in February originate almost entirely in the tropics and the Southern Hemisphere.

Early effects were observed at night in higher geomagnetic latitudes ranging from 61 to 83°N as rapid enhancements of the intensity of VHF signals propagated over paths ranging in length from 915 to 1575 km by means of scattering in the lower ionosphere [8]. The enhancements are interpreted as indicating a substantial increase in the ambient electron density in height regions of the ionosphere containing scatterers. Independent evidence puts the height regions mostly below 90 km.

##### *Late Effects*

The late effects may be described in necessary detail in terms of Figs. 1 and 2. Fig. 1 also illustrates the early effect—the initial enhancement of the signals propagated in high latitudes by means of ionospheric scattering, as described above. It is reproduced from a previous paper [8], which provides a discussion of the observing arrangement. Fig. 2 has been previously published by Little and Leinbach [9]. The observations represented by Fig. 2 should be compared with the cosmic-noise observations represented by the lower set of points in Fig. 1(a) and 1(b). What Figs. 1 and 2 show is a gradual increase in the nighttime ionospheric absorption observed at VHF beginning shortly after the cosmic-ray increase and reaching an approximately constant value in some three to five hours, followed by a slow recovery made evident by the observations on succeeding nights. During the intervening periods of daylight the absorption increased greatly to a maximum roughly at midday. The daytime absorption, like that occurring during darkness, decreased from day to day following a maximum at the midday period of the first day after the cosmic-ray increase. The remaining observational material relating to the late effects consists of recorded intensities of ionospherically scattered VHF signals for several additional paths without simultaneous observations of cosmic noise [8] and extensive observations in high latitudes with vertical-incidence ionosondes. Most of the latter simply give the time of beginning and approximate duration of complete blackout usually including day and night in geomagnetic latitudes much above 60°N [10]. In the general vicinity of 60°N the large absorption effects during the first daylight period were generally in-



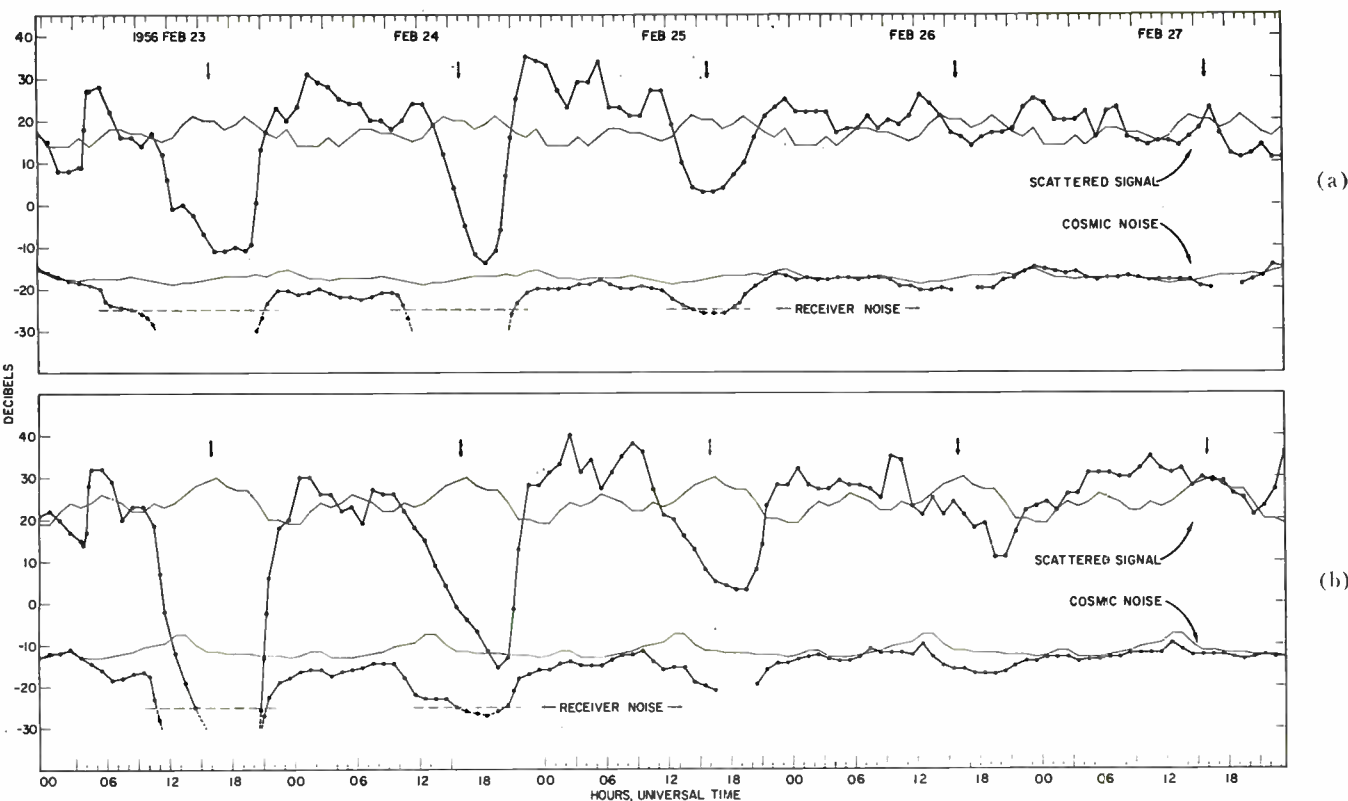

Fig. 1—Observed variations with time of intensity of signals and background cosmic noise at the same frequency with the same antenna. Normal variations indicated by the thin line. Vertical arrows indicate local apparent noon at path midpoint. (a) Observations at Søndre Strømfjord, Greenland, of signals from Thule, Greenland, and background cosmic noise, at 31.5 mc. (b) Observations at Søndre Strømfjord of signals from Goose Bay, Labrador, and background cosmic noise, at 32.2 mc.

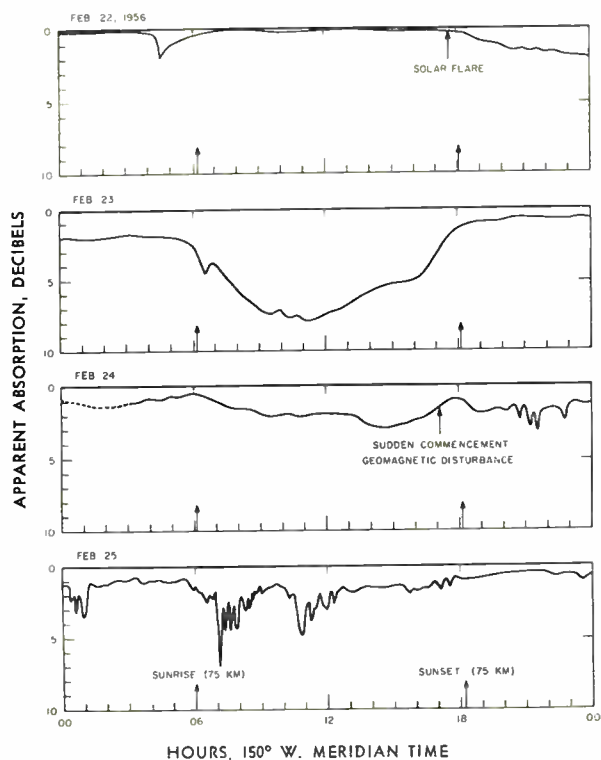

Fig. 2—Apparent absorption of cosmic noise at 30 mc recorded with a wide-beam antenna directed vertically at College, Alaska.

sufficient to produce a complete blackout [11], [12]. For ionosondes operating at geomagnetic latitudes less than about 51–53°N, no abnormal absorption effects were found even by day.

Without further elaboration at this point it may be stated that all the observations of late effects are apparently consistent with the following views:

- 1) The observed absorption effects took place entirely in the lower ionosphere (*i.e.*, mostly below 90 km). Furthermore the complete absence of reflections during the oblique-incidence VHF ionospheric-scatter observations at high geomagnetic latitudes clearly indicates that the electron density in the abnormal absorbing region never exceeded about  $4 \times 10^5$  per cubic centimeter.
- 2) The additional absorption observed during the daylight period is simply a photodetachment effect and is not related to any change in the ionizing agency.
- 3) After normalization the various absorption observations, extending as they do over a very large range of longitude and latitude, may be taken to indicate the presence of an ionizing agency which increases greatly in effectiveness between geomagnetic latitudes 60 and 70°N, but which is nearly constant in its effects north of 70°.

- 4) Unlike ordinary auroral-zone ionization, the ionization is remarkably uniform and, except for the photodetachment effect associated with local daylight, is remarkably constant at a particular instant of time and at a particular geomagnetic latitude, but is independent of longitude. There may have been some exceptions to this statement during the first hours after the cosmic-ray flux enhancement.
- 5) The return to normal in the ionosphere took place more rapidly in lower geomagnetic latitudes, as a result of a more rapid decay in the ionizing agency rather than simply as a threshold effect.

#### Other Geomagnetic Observations

Before attempting to account in detail for the extraordinary effects observed in the lower ionosphere it is necessary to take note of certain additional information.

*Magnetic Effects:* The usual sort of magnetic crochet was observed to accompany the flare in the daylight hemisphere. In low and middle geomagnetic latitudes in the dark hemisphere, magnetometer traces were exceptionally undisturbed through February 23, 24, and for the first three hours of the 25th [4]. This period corresponds to the most intense and general radio blackout at HF observed up to that time in high latitudes. Magnetometers in very high geomagnetic latitudes and well inside the auroral zone did show some disturbance of uncertain interpretation beginning about half an hour after the flare, but at stations along the auroral zone itself the magnetic records exhibited nothing unusual [13]. Shortly after 0300 UT on February 25, a sudden-commencement geomagnetic disturbance took place with characteristic auroral-zone effects. In absorption these effects show up well in Fig. 2 as irregular and rapid changes. There is no particularly strong reason to associate this magnetic disturbance with the great flare of February 23 [14].

*Auroral Effects:* No unusual auroral activity has been reported either at the time of the flare or for the two following days. This absence of auroral activity was confirmed by auroral radars operating near Ottawa [15]. Thus, by the usual criteria for ionospheric disturbance, it is apparent that the cosmic-ray increase and the very unusual ionospheric effects which followed took place at a time of exceptional magnetic and auroral quiet—in contrast with conditions usual during strong auroral-zone ionospheric absorption events.

#### IONIZATION RESULTING FROM PARTICLE BOMBARDMENT

The remainder of this paper summarizes the results of a preliminary investigation seeking to account for the early and late effects in the ionosphere as the result of a continuing bombardment, with slowly diminishing intensity, by charged particles of which the solar cosmic rays were the components of highest energy. Such an

explanation, even if quantitatively satisfactory, must also be consistent with the absence of significant magnetic and auroral activity.

#### Basic Assumptions

As a first step certain assumptions need to be made and justified.

*Composition of the Particle Flux:* The particles ejected by the sun are considered to have been accelerated at chromospheric levels or in a similar environment so that on their outward passage through the corona collisions may be neglected [16]. At chromospheric temperatures and pressures, ionization will not proceed far. A case can therefore be made for believing that the solar cosmic rays may differ somewhat in composition from ordinary cosmic rays. In ordinary cosmic rays it has been established that about 80 per cent of the primary particles are protons. Nearly all of the remainder are  $\alpha$  particles, but a few heavier stripped nuclei are found. In the case of the solar cosmic rays, most, perhaps also about 80 per cent, of the particles are protons, but the remainder may well contain singly ionized helium as well as  $\alpha$  particles and a few not fully stripped heavier ions. The possible ionospheric consequences of the presence of a small fraction of  $\text{He}^+$  ions will be examined since further ionization or stripping is not likely to occur during their passage between the sun and the atmosphere of the earth. It is considered that free electrons carried along to maintain space-charge neutrality possessed such low energies in comparison with the positively charged particles that their effects need not be considered.

*Vertical Penetration Depths and Magnetic Cut-Offs:* In discussing the collisional ionization produced by the passage through the lower ionosphere of charged particles, it is convenient to have some idea of what the range-vs-rigidity characteristics of typical particles are like when expressed as vertical penetration depths in the atmosphere. This information is presented in Fig. 3 which represents a replot, using a logarithmic scale of magnetic rigidity rather than kinetic energy as ordinate with some minor improvements and some extension at higher rigidities, of the information shown in Fig. 4 of a previous paper [8]. This reference should be consulted for a discussion of such matters as the atmospheric model used and the basic range information. The penetration depths for  $\text{He}^+$  ions are those for  $\alpha$  particles of the same velocity or energy since it may be assumed that the  $\text{He}^+$  ions are stripped of their remaining electron at an altitude well above the lower ionosphere.

As is well known, the cut-off magnetic rigidities for the indicated geomagnetic latitudes are given by

$$R = 14.7 \cos^4 \lambda, \quad (1)$$

where  $R$  represents the magnetic rigidity, in this particular relation in units of  $10^9$  volts, of the particles of lowest rigidity capable of reaching the lower ionosphere at geomagnetic latitude  $\lambda$ . In this and later considerations the geomagnetic theory for cosmic-ray particles,

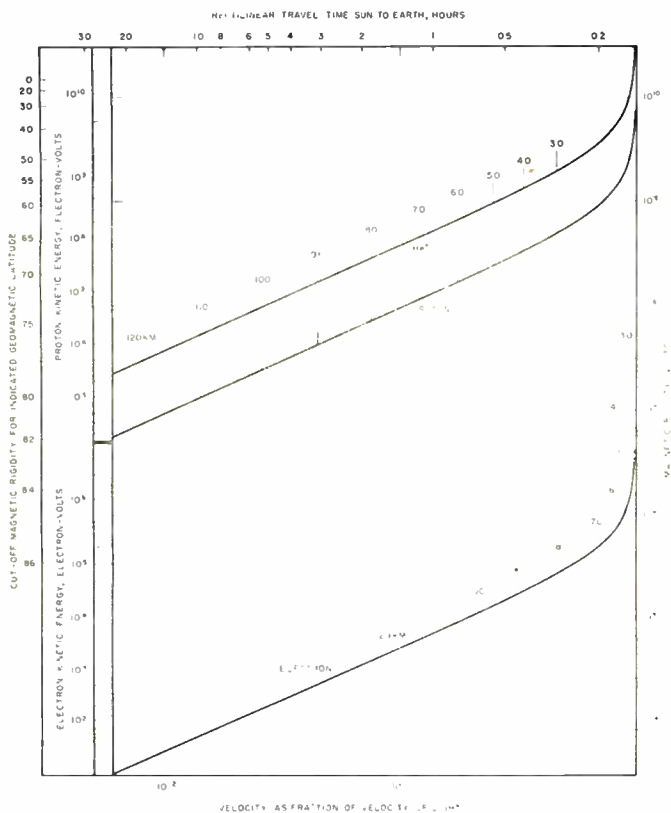

Fig. 3—Atmospheric depths of vertical penetration expressed as heights above ground for electrons, protons, and He<sup>+</sup> ions, as a function of their magnetic rigidities and velocities. The left-hand scale indicates the geomagnetic latitude below which single particles or particle fluxes of very low density cannot arrive as a result of the magnetic dipole field of the earth.

given originally by such people as Størmer, LeMaitre, and Vallarta, has been used in the conveniently restated form given by Alpher [17].

**Isotropy:** Meyer, Parker, and Simpson [1] have given convincing arguments for isotropy in the solar cosmic rays arriving by the time of and following the peak of the flux enhancement. As a rough guide it may be said that isotropy is well established when the particles being observed have had time to travel a distance of about 3 AU. From the preceding discussion it is seen that protons likely to contribute significantly to ionization in the lower ionosphere travel with velocities of the order of 0.1 *c*. Using the guide above, it would then be expected that isotropy of the less energetic particles capable of producing the late effects in the lower ionosphere would be established by perhaps 0745 UT on February 23, 1956—some four hours after the flare. As for the solar cosmic rays, the time established by such a criterion is about the time of maximum of the late effect.

The observations of the late effect support quite independently the occurrence of isotropy since, when allowance is made for the photodetachment by day, the observed absorption seems to be very uniform locally and independent of geomagnetic longitude. This could scarcely be true if any preferred directions of arrival existed in the vicinity of the earth.

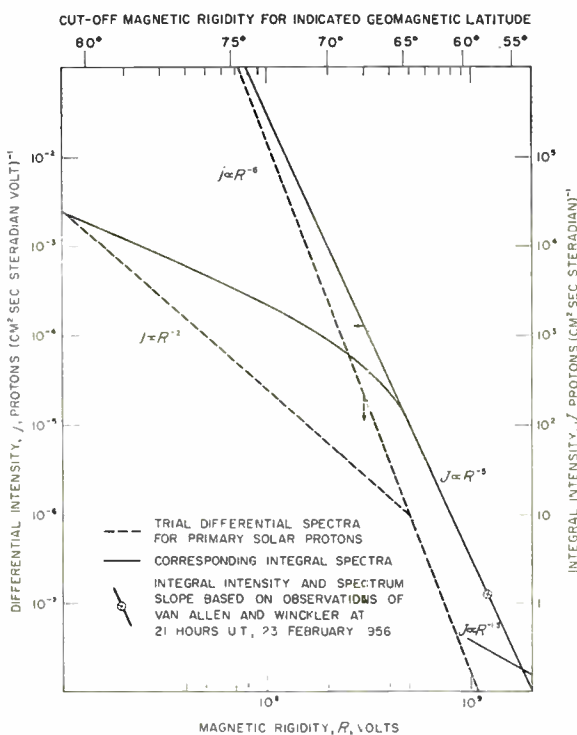

Fig. 4—Trial magnetic-rigidity spectra.

**Magnetic-Rigidity Spectrum:** In order to calculate the rate of electron production *q* as a function of height resulting from the collisions of fast solar protons, it is necessary to be able to specify their differential spectral distribution as a function of magnetic rigidity at each instant of time for which the calculations are to be made. The form of the spectrum of the solar cosmic rays of February 23, 1956 is not known for rigidities much below the 1 to 2 Bv region since this represents the lower limit for direct observation by cosmic-ray techniques. It is from the observed late ionospheric effects themselves that information about the spectrum much below 1 Bv must be derived.

Cosmic-ray intensities are often expressed as the number of particles having rigidities in excess of some specified value *R* (such as a cutoff value) crossing a unit area per unit time per unit solid angle in a direction normal to the unit area. Such an intensity is called an integral intensity, usually written as *J*. For normal cosmic-ray primaries (particles outside the atmosphere), it is found that the integral spectrum can be approximated over a considerable range of rigidity by a power law of the form

$$J = .1R^{-n}, \tag{2}$$

where *A* is a constant of proportionality and *n* > 1. For ordinary cosmic rays *n* ≈ 1.3. The differential intensity, usually written as *j*, is defined in the case of rigidity spectra as *dJ/dR*. Thus, for *n* > 1, the differential intensity spectrum is also expressible as a power law as follows:

$$j = -n.1R^{-(n+1)}, \tag{3}$$

or, substituting from (2) to eliminate *A*,



$$j = -nJR^{-1}. \quad (4)$$

In the discussion that follows,  $n$  will have different values, but will always be greater than unity. The units employed for  $J$  are protons per (cm<sup>2</sup> sec steradian) and for  $j$ , protons per (cm<sup>2</sup> sec steradian volt).

Power-law expressions have been used by cosmic-ray workers to describe the spectrum of solar cosmic rays. For example, Meyer, Parker, and Simpson [1] found for times after the peak of the cosmic-ray enhancement of February 23, 1956 that the primary integral intensity spectrum between about 2 and 15 Bv could be represented as proportional to  $R^{-7}$ . Within this rigidity range, however, the decline in intensity at the upper end appeared to be still steeper, while at the lower end it seemed to be less steep. The exponent did not seem to vary appreciably with time for many hours. Van Allen and Winckler [18] give results from balloon observations which indicate that at 21 UT on February 23, 1956, more than 17 hours after the onset of the cosmic-ray flux enhancement, the integral spectrum was varying as  $R^{-5}$  in the cut-off region for their observations, about 1.2 Bv. From the information given by these workers it is relatively simple to deduce that outside the atmosphere the integral primary cosmic-ray intensity at 21 UT was about 1.3 protons per (cm<sup>2</sup> sec steradian). This observation, though not very precise, has been used as a fixed reference point in the spectrum studies which follow. The corresponding differential intensity  $j$  at 1.2 Bv is found from (4) to be  $5.4 \times 10^{-9}$  protons per (cm<sup>2</sup> sec steradian volt).

Returning to some of the earlier discussion concerning isotropy and noting Fig. 3, it will be appreciated that trial expressions for the differential intensity spectrum extending down to rigidities of the order of  $2 \times 10^7$  volts will be needed if account is to be taken of all protons capable of causing ionization at heights below about 110 km. Such protons, if they traveled by the most direct possible path, would require about 10 hours to reach the earth. If the criterion previously given for the establishment of isotropy for solar cosmic rays continues to have meaning at such low rigidities, then some 30 hours would be required for  $2 \times 10^7$ -volt protons to achieve isotropy.

It is therefore clear that the differential intensity spectrum is a complicated function of time, particularly for the subrelativistic protons considered to produce the late effects. Furthermore, the proton flux responsible for the late effects in the ionosphere cannot be assumed to be isotropic for all rigidities until many hours have passed. In the light of this discussion, it is not surprising that the late effects in the ionosphere showed a growth and decay taking approximately ten times as long as the comparable growth and decay of the flux of solar cosmic rays. Moreover, it seems inescapable that the early effects in the ionosphere must in some way be directly associated with the flux of relativistic particles described as cosmic rays.

For purposes of trial calculations, various deliberately crude assumptions are made about the differential spectrum at one instant of time, 21 hours UT, and all trial spectra at this moment are required to fit the point deduced from the observations of Van Allen and Winckler [18], thus forcing the deduced ionospheric effects to be consistent with the cosmic-ray observations made at the same time. Fig. 4 shows three such trial spectral distributions in both their integral and differential forms. It also shows in the lower right-hand corner an approximation to the integral spectrum of ordinary cosmic rays. This latter spectrum is not extended much below  $10^9$  volts because of lack of knowledge. The first trial spectrum is simply a continuation to lower rigidities of the power law established by Van Allen and Winckler. Since the cosmic-ray evidence of Meyer, Parker, and Simpson suggested that the exponent  $n$  was decreasing with rigidity, such a spectrum can be thought of as representing an upper limit to the intensities. On the other hand, it would be unjustified to attempt to construct a trial spectrum in which the exponent  $n$  could be thought of as decreasing continuously with  $R$ . Some very simple spectra are all that are required for trial purposes. Therefore, noting that the late ionospheric effects increased rapidly in magnitude with geomagnetic latitude between 60 and 70°N, but were nearly constant above 70°N, it was decided for a second trial to alter the exponent of the differential spectrum from 6 to 2 discontinuously at  $R = 5 \times 10^8$  volts, which corresponds to a cut-off at about 65°N. The third trial consisted of continuing the sixth-power differential spectrum derived from Van Allen and Winckler down to  $3 \times 10^8$  volts, corresponding to a cut-off at  $\lambda = 67\frac{1}{2}^\circ\text{N}$  and arbitrarily assuming a total absence of particle radiation at lower rigidities. The effect of this trial assumption is indicated in Fig. 4 by small arrows. This particular trial-spectrum assumption simply assures that the late effect shall be nearly independent of latitude above  $67\frac{1}{2}^\circ\text{N}$ ; no special physical justification for it is claimed.

#### Early Effects

A tentative explanation of the early effects was offered in an earlier paper [8], but a more interesting and plausible one has been given by Elliot [19]. He suggests that the ionization represented by the early effects in the ionosphere may be the result of the stopping of electrons carried to the outer reaches of the earth's atmosphere as the orbital electron in He<sup>+</sup> ions of cosmic-ray rigidities. Such electrons as indicated earlier become detached by collision in the atmosphere at heights thought to be above the *E* region and continue their downward journey independently but with about the *same velocity*. No attempt is made at this time to test this suggestion by detailed calculations of the resulting ionization. Fig. 3, however, illustrates conveniently the attractiveness of the idea. Consider He<sup>+</sup> ions with rigidities between about 3 and 10 Bv. Such ions would consti-

tute quite convenient carrier vehicles for electrons to geomagnetic latitudes below  $50^\circ$ , latitudes quite inaccessible to any free electrons likely to be found in the flux of solar cosmic rays. With atmospheric stripping occurring at heights above the  $E$  region, the detached electrons of the same velocity as the parent  $\text{He}^+$  ions would, having energies between  $10^5$  and  $10^6$  ev, be capable of penetrating vertically to heights in the 60- to 80-km region. Remembering that most such electrons would have oblique and spiraling paths through the atmosphere, the production of abnormal ionization below about 90 km is seen to be a natural consequence. The ionization so produced at night might easily be sufficient to give the appearance of daytime conditions at such heights for LF and VLF radio signals without giving rise to any such excessive absorption for HF and VHF as characterized the late effects.

#### Late Effects

To investigate the late effects quantitatively, conditions at 21 UT on February 23, 1956 are isolated for study. The reasons for this and for the various trial differential spectra selected for this particular instant have already been discussed. Furthermore the principal results will be shown for a particle flux consisting solely of protons. The ultimate objective is to compute the resulting nondeviative ionospheric absorption at certain frequencies for comparison with absorption figures derived from observations.

*Rate of Electron Production:* As a first step, it is necessary to compute the rate of electron production  $q$  as a function of height and geomagnetic latitude. This involves a tedious process of numerical integration, of which a brief account is now given.

The height region investigated extended from 30 to 110 km and was divided into eight 10-km-thick slabs centered at 35, 45, . . . , 105 km. In using the differential rigidity spectra, the rigidity scale was divided into variable class intervals  $\Delta R$  for which  $\Delta R/R$  ranges from 0.11 to 0.29. The centers of adjacent rigidity class intervals thus corresponded to small enough changes in the geomagnetic cut-off latitude as given by (1) to result in reasonably smooth variation of the final curves with geomagnetic latitude. The zenith-centered hemisphere from which, except for excluded directions [17], the primary protons were assumed to come isotropically, was divided into three solid-angle zones centered about the zenith and separated by almucantars at zenith distances of 30 and  $60^\circ$ . Thus the arriving proton flux was considered as approaching the ionosphere at three discrete zenith angles,  $75^\circ$ ,  $45^\circ$ , and  $15^\circ$ . Albedo effects and certain other matters were ignored, so that all incident protons were considered to have given up all their kinetic energy by ionizing collisions on their first encounter with the atmosphere. Finally, detailed use of a Bragg curve was avoided by assuming that the protons lost their kinetic energy at a rate which could be expressed as the ratio of their incident kinetic energy divided by their

range in air at the density corresponding to each particular slab height for which  $q$  was being computed. In calculating the amount of energy dissipated per centimeter of path at a particular height it was, of course, necessary to terminate the ionization process at the stopping height corresponding to the incident rigidity and direction. To find the rate of electron production  $q$  per cubic centimeter per second, it was merely necessary to divide the total energy dissipated by all the protons passing through a cubic centimeter of the atmosphere per second at a particular height by the average energy required to produce one electron-ion pair. This figure for protons in air, having energies of interest, has been found to be about 36 ev [20].

The resulting curves of  $q$  vs height for the various trial spectra are shown in Fig. 5 for the geomagnetic latitudes indicated on the curves. The unbroken curves in Fig. 5(a) are based on the differential spectrum shown in Fig. 4 in which  $j \propto R^{-6}$ . Such a spectrum leads to values of  $q$  in excess of  $10^7$  electrons per ( $\text{cm}^3 \text{ sec}$ ) at heights of around 100 km and above in geomagnetic latitudes above about  $80^\circ$ . Such rates of electron production would result in strong luminescence at night and electron densities sufficient to support direct reflection at VHF on such an oblique path as that illustrated in Fig. 1(a). No evidence for direct reflection exists. Moreover, the observation that the late effect did not seem to increase significantly in intensity with geomagnetic latitude north of  $70^\circ$  would be impossible to explain with such a spectrum. If it is assumed that  $j \propto R^{-6}$  for  $R \geq 3 \times 10^8$  volts and  $j = 0$  for  $R < 3 \times 10^8$  volts, then the broken line curve at  $\lambda = 67\frac{1}{2}^\circ$  would approximately represent conditions at that and all higher latitudes. Finally, if the trial differential spectrum, also shown in Fig. 4, is taken in which  $j \propto R^{-6}$  for  $R \geq 5 \times 10^8$  volts and  $j \propto R^{-2}$  for  $R < 5 \times 10^8$  volts, the  $q$  curves shown in Fig. 5(b) result. This last trial spectrum is considered the most reasonable and is used for the computations in the succeeding sections. It leads to  $q$  curves which decrease with height in the  $E$  region at all geomagnetic latitudes of interest and show little further increase at any height for geomagnetic latitudes above  $70^\circ\text{N}$ . Furthermore, the maximum value for  $q$  is only slightly greater than  $10^3$  electrons per ( $\text{cm}^3 \text{ sec}$ ) and this value occurs at about 70 km. These various trials illustrate that late effects are not likely to shed much light on the form of the spectrum at rigidities below about  $10^8$  volts except that the exponent of an approximating power law for such particles, if present, must be much smaller than 6.

*Abnormal Ionospheric Layer Formation:* It is necessary at this point to draw attention to the unusual opportunity presented by the presence *at night* of very considerable electron production rates in a considerable height region below the  $E$  layer. Hitherto, most knowledge of electron production and electron-density distribution for this region has come from daytime observations since the ionization at night is normally too small

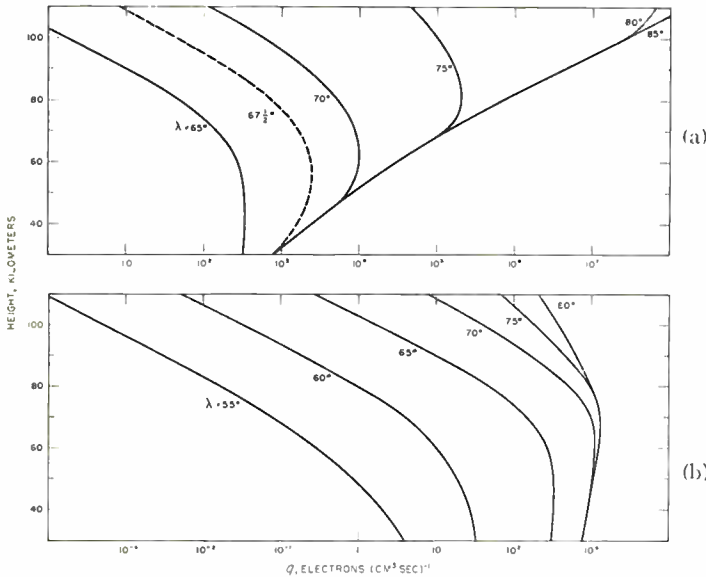

Fig. 5—Calculated electron production rates as a function of geomagnetic latitude for isotropic proton spectra as follows: (a)  $j \propto R^{-6}$ , and (b)  $j \propto R^{-6}$  for  $R \geq 5 \times 10^8$  volts and  $j \propto R^{-2}$  for  $R < 5 \times 10^8$  volts.

or too irregular for useful observation.

In arriving at a considered set of estimated values for the various rates and rate coefficients describing the processes which determine the electron density, frequent recourse of the cut-and-try kind was had to the observations of absorption termed the late effect. Not only must the proton-bombardment explanation, to be acceptable, account for the magnitude of the absorption at the given instant, but it must also be able to explain the difference between the absorption at local time conditions corresponding to midday and during periods of darkness when conditions of approximate equilibrium may be expected to exist. This difference is conveniently described as the ratio of the midday absorption expressed in decibels to the night absorption similarly expressed. This ratio may be roughly estimated from such observational material as that shown in Figs. 1 and 2. In the case of Fig. 1, as discussed elsewhere [8], the ratio may be as high as 10, though recent re-examination puts it somewhat lower. From Fig. 2 the ratio is at least 4 and probably greater.

Table I gives further information about the observational material used. In connection with these estimates, all the observational material has been adjusted to represent the absorption that would be observed for vertically incident plane waves.

Consider now the well-known differential equations which describe the variation of electron and ion densities in the lower ionosphere:

$$\frac{dN}{dt} = q - \alpha_d N^- N^+ - \eta n_1 N + \kappa n_2 N^- + \rho S N^- \quad (5)$$

$$\frac{dN^-}{dt} = -\alpha_i N^- N^+ + \eta n_1 N - \kappa n_2 N^- - \rho S N^- \quad (6)$$

In addition, the net space charge must be zero so that

$$N^+ = N + N^- \quad (7)$$

By adding (5) and (6) and noting (7), an additional useful equation is obtained:

$$\frac{dN^+}{dt} = q - \alpha_d N^- N^+ - \alpha_i N^- N^+ \quad (8)$$

The symbols used above have the following meanings:

$N$  = electron density.

$N^-$  = negative-ion density.

$N^+$  = positive-ion density.

$n_1$  = particle density of neutral particles of the kind to which electrons may become attached (mainly  $O_2$ ).

$n_2$  = particle density of neutral particles which may detach electrons from negative ions by collision. (This is taken to be  $5n_1$ , the total neutral particle density.)

$q$  = rate of electron production by flux of solar particles. (Photoionization by day is by comparison so small that it may be neglected.)

$\eta$  = coefficient of attachment of electrons to  $O_2$  molecules.

$\kappa$  = coefficient of collisional detachment of electrons from negative ions ( $O_2^-$ ).

$\rho S$  = photodetachment rate of electrons from negative ions ( $O_2^-$ ).

$S$  = intensity of solar radiation involved in the photodetachment process (zero at night).

$\alpha_d$  = dissociative recombination coefficient (effective value) for collisions between electrons and diatomic positive ions.

$\alpha_i$  = coefficient of mutual neutralization for collisions between negative and positive ions.

As may be later numerically verified, the time constants for the various collisional processes taking place in the height region of interest, 30 to 110 km, are all sufficiently short to justify the assumption, as long as  $q$  is not changing rapidly, that equilibrium exists at midday and is fairly rapidly established after sunset. Under equilibrium conditions the time derivatives in (5), (6), and (8) may be put equal to zero; thus from (8) it follows that

$$q = \alpha_d N^- N^+ + \alpha_i N^- N^+ \quad (9)$$

Next, introducing the negative-ion-to-electron ratio<sup>1</sup>

$$\lambda = \frac{N^-}{N} \quad (10)$$

so that the following relations may be used to eliminate  $N^-$  and  $N^+$ :

$$N^- = \lambda N$$

$$N^+ = (1 + \lambda) N$$

<sup>1</sup> Context will prevent confusion in the use of the same symbol for this quantity and for geomagnetic latitude.



TABLE I  
ADJUSTED ABSORPTION MEASUREMENTS—FEBRUARY 23, 1956

Location	Geographic		Geomagnetic Latitude	Type of Observation	Frequency, mc	Estimated total vertical incidence absorption at 32 mc at 21 UT*	
	Latitude	Longitude				Midday, db	Night, db
Midpoint of path between Thule and Søndre Strømfjord, Greenland	72.0°N	57.3°W	82.9°N	Absorption of cosmic noise received with highly directional antenna at Søndre Strømfjord, main lobe at elevation of 5.3°	31.5	10.3 (7.8-14.5)	1.2 (1.0-1.4)
Midpoint of path between Goose Bay, Labrador, and Søndre Strømfjord, Greenland	60.3°N	56.5°W	71.4°N	Absorption of cosmic noise received with highly directional antenna at Søndre Strømfjord, main lobe at elevation of 2.9°	32.2	10.3 (7.3-14.5)	1.0 (0.8-1.2)
College, Alaska	64.9°N	147.7°W	64.6°N	Absorption of cosmic noise received with Yagi antenna directed vertically upward	30	4.2 (3.8-4.7)	0.59 (0.49-0.70)
Kjeller, Norway	60.0°N	11.1°E	60.1°N	Absorption of vertical-incidence reflections received with ionosonde	Variable HF	0.66 (0.59-0.75)	0.12 (0.098-0.14)

\* Figures for "midday" and "night" conditions mostly obtained by interpolation or extrapolation based on observed trends. Estimated confidence limits given in parentheses.

The following well-known equation results:

$$q = (1 + \lambda)(\alpha_d + \lambda\alpha_i)N^2, \quad (11)$$

in which the effective recombination coefficient is defined as

$$\alpha = \alpha_d + \lambda\alpha_i. \quad (12)$$

It is from (11) that electron densities are obtainable, employing the previously computed values of  $q$ , if numerical values can be found for  $\lambda$  and  $\alpha$ .

Putting  $dN^-/dt=0$  in (6) and eliminating  $N^-$  and  $N^+$  by the introduction of  $\lambda$ , it follows that

$$\alpha_i\lambda(1 + \lambda)N = \eta n_1 - (\kappa n_2 + \rho S)\lambda. \quad (13)$$

It is found that for all combinations of plausible values for the various quantities contained in (13), the term containing  $\alpha_i$  is several powers of 10 smaller than the other terms, as may be later numerically verified. To a high degree of precision, therefore,  $\lambda$  is expressible as a characteristic of the atmosphere at a particular height and independent of  $q$  and  $N$ . It is given by

$$\lambda = \frac{\eta n_1}{\kappa n_2 + \rho S}. \quad (14)$$

Of the quantities required, only  $\rho S$  has been well determined in the laboratory [21], although progress is being made with  $\alpha_d$  [22]. Work now going on may shed further light on the attachment coefficient  $\eta$  for  $O_2$ , but at present about the best that can be done is to use the crude pressure-dependent extrapolation of laboratory data given by Bates and Massey [23]. Fortunately, the increasing dissociation of  $O_2$  above about 100 km with the consequent presence of some negative ions of atomic oxygen toward the top of the height region of interest can be disregarded with negligible error. The coefficient

of collisional detachment at the temperature of the lower ionosphere is not known and is regarded as a free parameter to be established from the observations after the adoption of values for the other coefficients. In view of the uncertainties and variations in the estimates of these constants by other workers such as Mitra and Jones [24] from other kinds of observations, the following values are adopted as independent of height:

$$\alpha_d = 3 \times 10^{-8} \text{ cm}^3 \text{ sec}^{-1}$$

$$\alpha_i = 3 \times 10^{-9} \text{ cm}^3 \text{ sec}^{-1}$$

$$\rho S = 0.44 \text{ sec}^{-1}$$

$$\kappa = 2.4 \times 10^{-17} \text{ cm}^3 \text{ sec}^{-1}, \text{ for } n_2 = 5n_1.$$

In Table II, the adopted values of  $\eta$  are shown as a function of height, together with the corresponding partial pressure of  $O_2$  and other atmospheric characteristics. Fig. 6 shows the resulting variations with height for midday and night of the negative-ion-to-electron ratio  $\lambda$  and the effective recombination coefficient  $\alpha$ . The values for night are noteworthy. With this information and making use of (11) and (12), the variation of electron density with height and geomagnetic latitude can now be obtained from the values of  $q$  shown in Fig. 5(b). The resulting abnormal ionospheric layers thus formed are shown for midday and night in Fig. 7(a) and 7(b) respectively.

*Specific and Total Absorption:* It is convenient to introduce the term specific absorption which will be understood to mean the nondeviative absorption loss per unit path length experienced by a plane wave of given frequency in traversing a medium having a given electron density and electron-collision frequency. As a matter of convenience in later obtaining the total absorption, the unit path length was selected as 10 km, corresponding to the thickness of each of the eight slabs into which the

TABLE II  
ADOPTED ATMOSPHERIC CHARACTERISTICS

Height, km	$n_1, \text{cm}^{-3}$	Total pressure, mb	Partial pressure of $\text{O}_2$ , mb	$\eta, \text{cm}^3 \text{sec}^{-1}$	$T, ^\circ\text{K}$	Electron collision frequency, $\text{sec}^{-1}$
35	$3.7 \times 10^{16}$	6.5	1.3	$2.0 \times 10^{-12}$	247	$1.6 \times 10^9$
45	$9.5 \times 10^{15}$	1.9	$3.7 \times 10^{-1}$	$5.7 \times 10^{-13}$	268	$4.5 \times 10^8$
55	$2.8 \times 10^{15}$	$5.4 \times 10^{-1}$	$1.1 \times 10^{-1}$	$1.7 \times 10^{-13}$	270	$1.3 \times 10^8$
65	$9.1 \times 10^{14}$	$1.4 \times 10^{-1}$	$2.9 \times 10^{-2}$	$5.3 \times 10^{-14}$	235	$3.7 \times 10^7$
75	$2.4 \times 10^{14}$	$3.2 \times 10^{-2}$	$6.4 \times 10^{-3}$	$2.0 \times 10^{-14}$	195	$9.3 \times 10^6$
85	$4.3 \times 10^{13}$	$6.0 \times 10^{-3}$	$1.2 \times 10^{-3}$	$1.2 \times 10^{-14}$	197	$1.7 \times 10^6$
95	$7.5 \times 10^{12}$	$1.2 \times 10^{-3}$	$2.3 \times 10^{-4}$	$1.0 \times 10^{-14}$	$\sim 205^*$	$\sim 2.9 \times 10^6^*$
105	$1.6 \times 10^{12}$	$\sim 3 \times 10^{-4}$	$\sim 5 \times 10^{-5}$	$1.0 \times 10^{-14}$	$\sim 230^*$	$\sim 6.1 \times 10^6^*$

\* Dissociation of  $\text{O}_2$  only partially allowed for owing to numerical unimportance in problem under study.

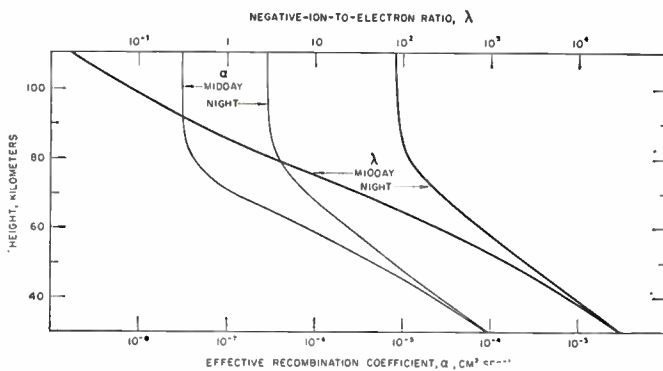

Fig. 6—Adopted values of negative-ion-to-electron ratios and effective recombination coefficients for midday and nighttime equilibrium conditions as a function of height.

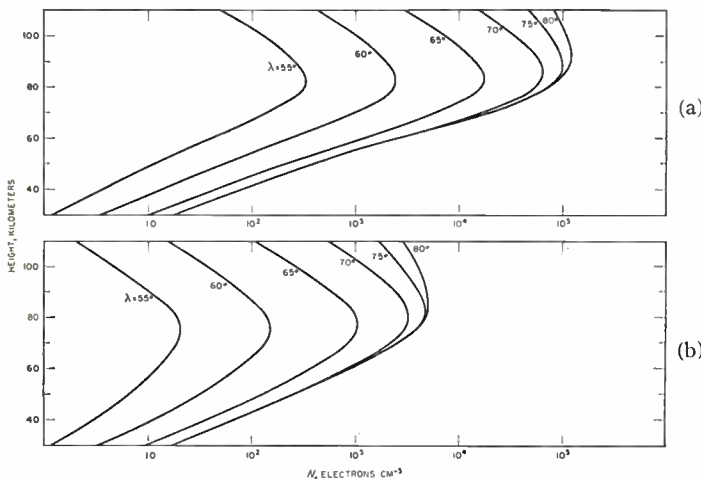

Fig. 7—Calculated electron-density distributions as a function of geomagnetic latitude for the abnormal ionospheric layers. (a) For midday equilibrium. (b) For nighttime equilibrium.

lower ionosphere was earlier divided. The electron-collision frequencies were calculated at heights corresponding to the slab centers according to Nicolet [25] and are shown in Table II along with the values of pressure, temperature, and other characteristics adopted for the atmosphere at these heights. The absorption calcu-

lations themselves are made for the ordinary wave according to classical magneto-ionic theory as conveniently formulated for some rather similar calculations by Chapman and Little [26]. Complete expressions involving the collision frequency are used. The results are shown in Fig. 8(a) and 8(b) for midday and night, respectively, as a function of height and geomagnetic latitude for a frequency of 32 mc. A single value, 1.6 mc, for the vertical component of the gyro-frequency has been employed throughout. The frequency of 32 mc was chosen to represent the observations of cosmic-noise absorption of Fig. 1.

The total absorption for a vertical plane wave of 32 mc is then simply obtained by a process of numerical integration consisting of summing the values of specific absorption for the eight center heights of the 10-km slabs at 35, 45, . . . , 105 km. The final result is shown in Fig. 9 for midday and night as a function of geomagnetic latitude. For the trial differential rigidity spectrum with exponent  $n$  changing discontinuously from 6 to 2 at  $R = 5 \times 10^8$  volts, the smooth curves are obtained. For the trial differential spectrum with  $n=6$  but with no particles with rigidities below  $3 \times 10^8$  volts, the curves become horizontal, as indicated by the arrows, at  $\lambda = 67\frac{1}{2}^\circ$ . The dashed curves with this latter type of trial spectrum indicate the effect of adding one  $\text{He}^+$  ion for every five protons in each rigidity interval of the differential spectrum. This figure is likely to be an upper limit, and it is seen that the resulting increase in total absorption is negligible except possibly in latitudes well below  $60^\circ$  where, in any case, the late-effect absorption was not large. The values of absorption deduced from the observations made at the locations and by the techniques indicated in Table I, together with a crude estimate of their probable errors, are also shown in Fig. 9. The general agreement is considered satisfactory.

*Some Energy Considerations:* Chapman [27] has given an estimate made by himself and Ferraro that the minimum density of a neutral ionized gas stream, sufficient upon encountering the earth and its magnetic field to

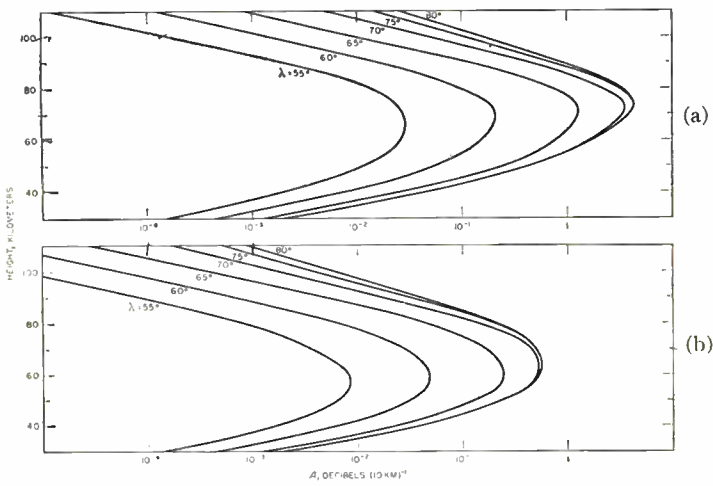

Fig. 8—Calculated specific absorption distribution at 32 mc as a function of geomagnetic latitude resulting from the abnormal ionospheric layers. (a) For midday equilibrium. (b) For nighttime equilibrium.

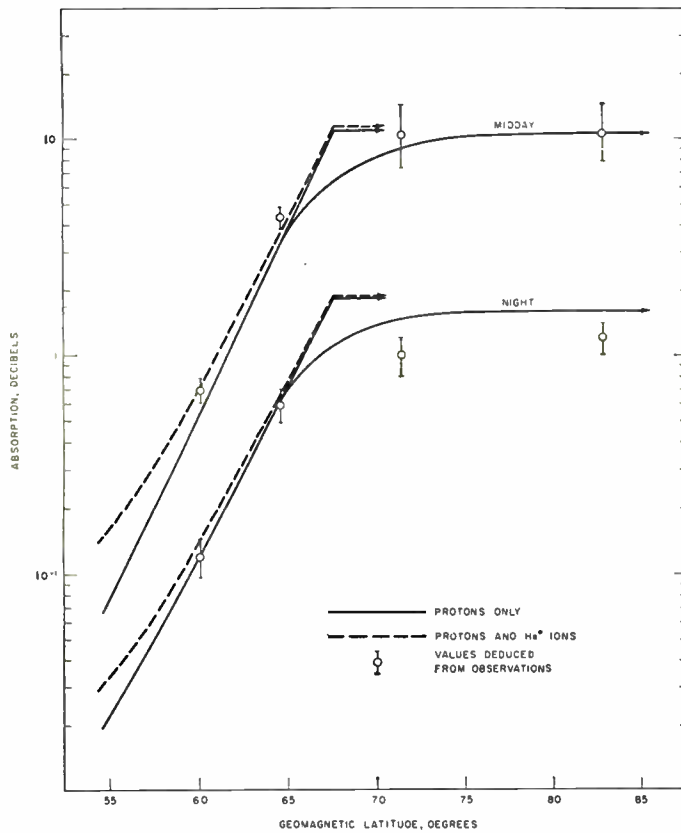

Fig. 9—Comparison of the calculated total vertical-incidence absorption at 32 mc as a function of geomagnetic latitude with values deduced from observations.

cause a moderate magnetic storm, is 100 protons (and 100 electrons) per cubic centimeter. This estimate refers to streams taking of the order of 20 hours (or longer) to reach the earth from the sun. For the purpose of rapid calculation, such proton streams are considered to contain monoenergetic protons of about  $2 \times 10^4$  ev traveling at about  $0.007 c$  or  $2.1 \times 10^8$  cm/sec. The energy density of such a stream before its interaction with the

TABLE III  
CHARACTERISTICS OF SOLAR PARTICLES AT 21 UT  
ON FEBRUARY 23, 1956

R, volts	Particle density,* protons/cm <sup>3</sup>	Energy density,* ev/cm <sup>3</sup>	Incident power,† ergs/cm <sup>2</sup> sec
10 <sup>7</sup>	$4.8 \times 10^{-4}$	$2.2 \times 10^2$	$3.0 \times 10^{-1}$
$2 \times 10^7$	$1.2 \times 10^{-4}$	$1.8 \times 10^2$	$2.9 \times 10^{-1}$
$5 \times 10^7$	$2.0 \times 10^{-5}$	$1.3 \times 10^2$	$2.7 \times 10^{-1}$
10 <sup>8</sup>	$4.9 \times 10^{-6}$	$9.8 \times 10$	$2.5 \times 10^{-1}$
$2 \times 10^8$	$1.1 \times 10^{-6}$	$6.3 \times 10$	$2.1 \times 10^{-1}$
$5 \times 10^8$	$8.0 \times 10^{-8}$	$1.4 \times 10$	$6.8 \times 10^{-2}$
10 <sup>9</sup>	$1.8 \times 10^{-8}$	1.0	$6.7 \times 10^{-3}$
$2 \times 10^9$	$3.5 \times 10^{-11}$	$7.2 \times 10^{-2}$	$5.6 \times 10^{-4}$

\* For all magnetic rigidities  $\geq R$  in the absence of the earth and its magnetic field.

† At the top of the atmosphere at a location having a cut-off magnetic rigidity  $R$ .

earth's magnetic field would therefore be about  $2 \times 10^6$  ev/cm<sup>3</sup> and the incident power would be about  $4.2 \times 10^{14}$  ev/cm<sup>2</sup> sec or  $6.7 \times 10^2$  ergs/cm<sup>2</sup> sec. These figures when compared with corresponding values in Table III make plausible the absence of significant magnetic disturbance in connection with the late effects in the ionosphere. Moreover, most of the abnormal ionization, according to the assumptions of this paper, occurred at ionospheric levels of comparatively low conductivity. Finally, it may be noted (again according to Chapman) that particle densities in Table III are far less than one per cubic centimeter so that the single-particle theories as given by Størmer, LeMaitre, and Vallarta may be expected to have validity as applied [17].

CONCLUSION

In the account of the ionospheric effects associated mostly with the particular cosmic-ray flux enhancement of February 23, 1956, a great many uncertainties remain which are represented by the many assumptions required in order to arrive at the final position summarized by Fig. 9. The account represents a cosmic-ray approach to an apparently very unusual and hitherto virtually unrecognized class of ionospheric phenomena. A by-product of the investigation is a crudely quantitative extension of the differential rigidity spectrum of the solar cosmic rays to considerably lower rigidities than can be observed by cosmic-ray techniques. The form of the extension of the differential spectrum is not uniquely determined, but it is quite certain that the exponent of its power-law approximation could be little if any greater than 2 for rigidities of the order of  $3 \times 10^8$  volts and below. Indeed, the observed ionospheric effects are rather insensitive to the differential spectrum below 2 or  $3 \times 10^8$  volts. With exponents this small, a low-rigidity cut-off in the solar particles could easily exist at these or lower rigidities without significant effect on the ionospheric observations.



It is sometimes remarked that solar cosmic-ray flux enhancements are an all-or-nothing effect since there seems to be an absence of more numerous but weaker events. This may be an illusion; the statistics are far from satisfactory. When all the evidence is in from the IGY program there may be an answer. In 1957 and 1958 several events have been observed in connection with high-latitude ionospheric-scatter communication systems which resemble the signal-intensity behavior shown in Fig. 1. As cosmic-noise observations are no longer generally available with these observations, the events have to be judged by their effect on the intensity of the scattered signals. Study is at present incomplete, but it is already certain that some of these more recent events have followed great solar flares by a few hours and have occurred during periods of comparatively undisturbed magnetic conditions. The effects have several times persisted for three or more days, indicating storage. The absence of accompanying cosmic-ray flux enhancements suggests therefore that the differential spectrum at these times dropped more steeply with increasing rigidity than was the case on February 23, 1956, but that the differential flux intensity was sufficient at rigidities of the order of  $2$  or  $3 \times 10^8$  volts to produce late effects such as those mentioned. Anderson [28] has recently published direct observations of a solar proton flux at an atmospheric depth of  $10 \text{ g/cm}^2$  associated with a solar radio noise storm on August 22, 1958. He was able to verify a low abundance of electrons and photons during this event and could rule out  $\alpha$  particles, X rays, and electrons as the source of the observed ionization. He was also able to verify that the event was not associated with visible aurora or magnetic disturbance.

#### ACKNOWLEDGMENT

Particular thanks are due to the U. S. Air Force and to Dr. C. Gordon Little of the Geophysical Institute of the University of Alaska for observational material. In addition thanks are due to Dr. J. A. Simpson, Dr. E. N. Parker, Dr. J. R. Winckler, Dr. H. Elliot, and Dr. F. Lied with whom valuable discussions were held.

#### REFERENCES

- [1] P. Meyer, E. N. Parker, and J. A. Simpson, "Solar cosmic rays of February, 1956 and their propagation through interplanetary space," *Phys. Rev.*, vol. 104, pp. 768-783; November 1, 1956.
- [2] R. Lüst and J. A. Simpson, "Initial stages in the propagation of cosmic rays produced by solar flares," *Phys. Rev.*, vol. 108, pp. 1563-1576; December 15, 1957.
- [3] J. S. Belrose, M. H. Devenport, and K. Weekes, "Some unusual radio observations made on 23 February 1956," *J. Atmos. Terrest. Phys.*, vol. 8, pp. 281-286; April-May, 1956.
- [4] T. Gold and D. R. Palmer, "The solar outburst, 23 February 1956. Observations by the Royal Greenwich Observatory," *J. Atmos. Terrest. Phys.*, vol. 8, pp. 287-291; April-May, 1956.
- [5] M. A. Ellison and J. H. Reid, "A long-wave anomaly associated with the arrival of cosmic-ray particles of solar origin on 23 February 1956," *J. Atmos. Terrest. Phys.*, vol. 8, pp. 291-293; April-May, 1956.
- [6] J. A. Pierce, "VLF phase shifts associated with the disturbance of February 23, 1956," *J. Geophys. Res.*, vol. 61, pp. 475-483; September, 1956.
- [7] C. A. McKerrow, "Sudden decrease in low-frequency atmospheric noise during the cosmic-radiation storm of February 23," *Nature*, vol. 177, pp. 1223-1224; June 30, 1956.
- [8] D. K. Bailey, "Disturbances in the lower ionosphere observed at VHF following the solar flare of 23 February 1956 with particular reference to auroral-zone absorption," *J. Geophys. Res.*, vol. 62, pp. 431-463; September, 1957.
- [9] C. G. Little and H. Leinbach, "Some measurements of high-latitude ionospheric absorption using extraterrestrial radio waves," *Proc. IRE*, vol. 46, pp. 334-348; January, 1958.
- [10] A. H. Shapley and R. W. Knecht, "Ionospheric effects of the great solar-cosmic ray event of February 23, 1956," presented at URSI-IRE Meeting, Washington, D. C.; May 25, 1957.
- [11] C. M. Minnis, G. H. Bazzard, and H. C. Bevan, "Ionospheric changes associated with the solar event of 23 February 1956," *J. Atmos. Terrest. Phys.*, vol. 9, pp. 233-234; October, 1956.
- [12] F. Lied, "Ionospheric absorption observed on the 23rd February 1956 at Kjeller and Tromsø," *J. Atmos. Terrest. Phys.*, vol. 10, p. 48; January, 1957.
- [13] S. Matsushita, "A Note on the Geomagnetic Variations Following the Solar Flare and Cosmic Ray Effects of 23 February 1956," High Altitude Observatory, Univ. of Colorado, Boulder, Colo., Solar Res. Memo. No. 77; September 14, 1956.
- [14] K. Kawabata, "On the magnetic storm on February 25, 1956," *Rep. Ionosphere Res., Japan*, vol. 10, p. 148; 1956.
- [15] A. G. McNamara, private communication; August, 1957.
- [16] K. O. Kiepenheuer, "Emission of corpuscles from the sun," *J. Geophys. Res.*, vol. 57, pp. 113-120; March, 1952.
- [17] R. A. Alpher, "Theoretical geomagnetic effects in cosmic radiation," *J. Geophys. Res.*, vol. 55, pp. 437-471; December, 1950.
- [18] J. A. Van Allen and J. R. Winckler, "Spectrum of low-rigidity cosmic rays during the solar flare of February 23, 1956," *Phys. Rev.*, vol. 106, pp. 1072-1073; June 1, 1957.
- [19] "Relations between the sun and the ionosphere," *Nature*, vol. 179, pp. 804-806; April 20, 1957.
- [20] B. Rossi, "High-Energy Particles," Prentice-Hall, Inc., Englewood Cliffs, N. J.; 1952.
- [21] S. J. Smith, D. S. Burch, and L. M. Branscomb, "Experimental photodetachment cross section and the ionospheric detachment rate for  $\text{O}_2^-$ ," *Ann. Geophys.*, vol. 14, pp. 225-231; April-June, 1958.
- [22] E. P. Bialecke and A. A. Dougal, "Pressure and temperature variation of the electron-ion recombination coefficient in nitrogen," *J. Geophys. Res.*, vol. 63, pp. 539-546; September, 1958.
- [23] D. R. Bates and H. S. W. Massey, "The negative ion concentration in the lower ionosphere," *J. Atmos. Terrest. Phys.*, vol. 2, pp. 1-13; January-February, 1952.
- [24] A. P. Mitra and R. E. Jones, "Recombination in the lower ionosphere," *J. Geophys. Res.*, vol. 59, pp. 391-406; September, 1954.
- [25] M. Nicolet, "The collision frequency of electrons in the ionosphere," *J. Atmos. Terrest. Phys.*, vol. 3, pp. 200-211; July-August, 1953.
- [26] S. Chapman and C. G. Little, "The non-deviative absorption of high-frequency radio waves in auroral latitudes," *J. Atmos. Terrest. Phys.*, vol. 10, pp. 20-31; January, 1957.
- [27] S. Chapman, "Corpuscular influences upon the upper atmosphere," *J. Geophys. Res.*, vol. 55, pp. 361-372; December, 1950.
- [28] K. A. Anderson, "Ionizing radiation associated with solar radio noise storm," *Phys. Rev. Lett.*, vol. 1, pp. 335-337; November 1, 1958.

# The Night Airglow\*

FRANKLIN E. ROACH†

**Summary**—A phenomenological description of the night airglow is presented, reviewing the historical background, and what is known about height, temporal and spatial variations in intensity, and movements. The very important relationship to aurora and evidence for latitude-seasonal effects are examined.

## HISTORICAL BACKGROUND

THE night airglow was discovered by astronomers who found a persistent radiation at a wavelength of 5577 Ångstroms on long-exposure spectrograms. They noted that the radiation becomes systematically brighter from the zenith toward the horizon, a fact which can be readily understood on the basis of an atmospheric origin. An atmospheric emitting layer which is uniform in brightness and thickness, as seen from the center of the Earth, produces a systematic increase of intensity toward the horizon for an observer who is on the surface of the Earth. An example of the change of intensity of airglow 5577 with zenith distance for the average of twelve nights at Fritz Peak, Colo., is shown in Fig. 1. That the early investigators were probably correct in attributing the phenomena to the Earth's upper atmosphere is indicated by the close agreement of the theoretical curve and the observational points in Fig. 1.

After the initial discovery, our knowledge of the airglow was augmented by:

- 1) the identification of the 5577 green radiation as a forbidden transition of atomic oxygen [OI],
- 2) the discovery and identification of the sodium D lines,
- 3) the discovery and identification of two red lines (6300 Å and 6363 Å) due to forbidden transitions of atomic oxygen, and
- 4) the discovery and identification of a complex system of molecular bands (chiefly in the near infrared) due to hydroxyl (OH).

The hydroxyl bands are intrinsically so strong that if they were concentrated in the visual region of the spectrum, they would be as bright as a prominent aurora and would constitute a permanent twilight.

Airglow brightness is measured in rayleighs, a unit defined as  $4\pi \times 10^6$  quanta/cm<sup>2</sup>/sec/steradian.

\* Original manuscript received by the IRE, December 23, 1958. Reprinted in part from "Geophysics and the IGY," Geophysical Monograph No. 2, American Geophysical Union, Washington, D. C.: July, 1958.

† Bureau of Standards, Boulder, Colo.

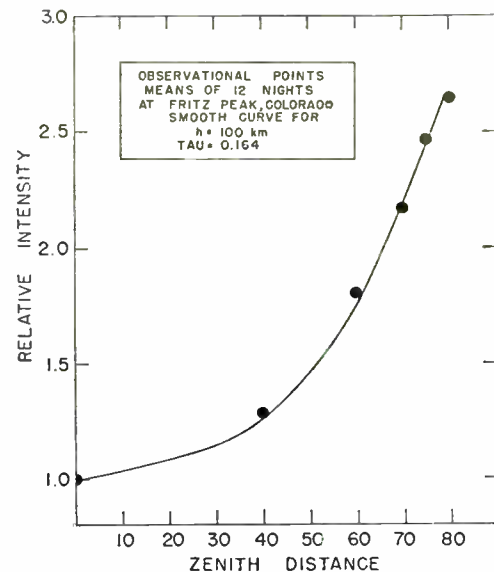

Fig. 1—Change in intensity of airglow 5577 with zenith distance; the smooth curve corresponds to an emission height of 100 km and an extinction coefficient, tau, of 0.164.

## THE HEIGHT OF THE AIRGLOW

There are three methods for estimating the effective height of the airglow:

- 1) by a night firing of a rocket through the emitting layer,
- 2) by triangulation between two ground stations, and
- 3) by the increase of intensity toward the horizon.

There have been concentrated attempts by all three methods in the case of 5577 and a height of about 100 km is consistent with all the data.

In Fig. 2 is reproduced a plot of 5577 and of sodium D nightglow intensity with height from a rocket firing reported by Koomen, Scolnik, and Tousey [2] showing a sharp drop-off between 90 and 100 km for 5577 and between 80 and 90 km for sodium D. This isolates the "layers" between these limits.

In Fig. 3 are shown some results on triangulation between Cactus Peak, Calif., and Palomar Mountain [3]. At each station photometers scanned the sky systematically during the night and recorded the changes of intensity. These intensity changes were correlated for a number of combinations of intersecting lines of sight at various heights above the Earth's surface. The correlation of the intensity changes is shown as  $\Sigma d^2/n$  in Fig. 3 from which it is seen that the best correlation occurs at a height near 100 km.

The third method of estimating airglow heights, the rate of increase of intensity toward the horizon, is difficult to apply. As a matter of fact, the deduced height is critically dependent on a nice knowledge of the extinction coefficient of the lower atmosphere. A current study of the problem [4] has analyzed the observations during twelve nights at Fritz Peak. We have found that, if we assume the extinction coefficient of the lower atmosphere is constant from night to night, the mean height is about 100 km but the range among the nights is between 51 and 136 km. We prefer the alternative possibility that the extinction coefficient is variable and the height is sensibly constant near 100 km.

In summary, the height of the night airglow 5577 now seems to be established. For the other radiations the case is not so clear. The sodium D layer was observed by a rocket flight near 85 km (Fig. 2). The OH layer is probably a little lower (near 70 km) but a rocket confirmation of this would be very useful. According to Heppner, Stolarik, and Meredith [5] a recent rocket flight indicates that 6300 originates higher than 163 km.

THE CHANGES OF INTENSITY WITH TIME

All airglow observers have noted the intensity variations of the airglow. In general, very fast variations of a minute or less have not been reported, probably because the observing techniques have been too sluggish to detect them. Sky coverages every ten or fifteen minutes are common and during a given night the intensity of 5577 may vary over a two-fold or three-fold range. Often the entire sky visible to a given observer goes through synchronous variations showing that the phenomenon is a large scale one of several hundred kilometers (Fig. 4). On occasion, however, the various regions of the sky go through quite different variations during a night as on October 1-2, 1956 (Fig. 5).

In order to visualize the photometric history of an entire night, it is convenient to make circular plots of the entire sky at intervals during the night. The outer circle (Fig. 6) corresponds to a distance along the Earth's surface of about 470 km from the observer who is in the center of the circle. In preparing these isophote maps the general increase of intensity toward the horizon has been eliminated.

On the night of October 1-2, 1956, the airglow was especially bright in the south during the early evening (20h and 21h MST), actually about the brightness of a faint aurora. Between 20h and 22h, one has the impression that a strong maximum region has moved southward outside the limits of our observing circle at Fritz Peak. By 23h and midnight, the general level of brightness is significantly lower but the south is still brighter than the north. At 01h, a new localized region of brightness appears in the north which develops significantly by 02h and is slightly weaker by 03h. The "activity"

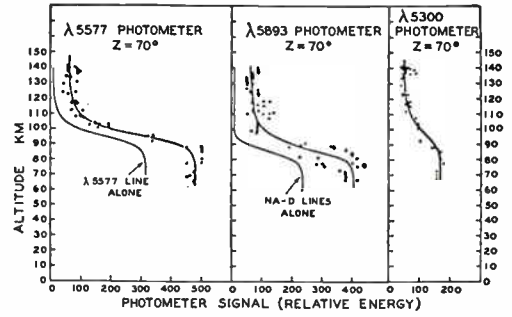

Fig. 2—Variation of airglow intensities with height from a rocket flight, according to Koomen, Scolnik, and Tousey [2].

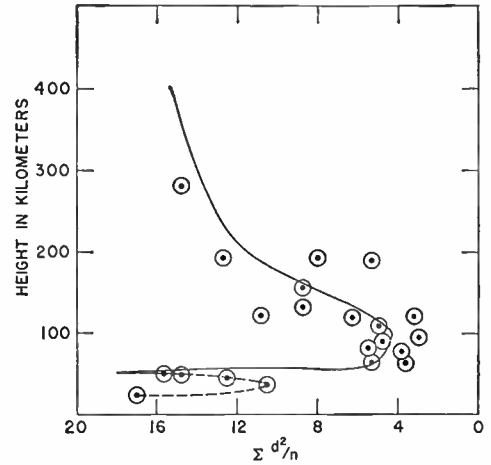

Fig. 3—Results of triangulation between Cactus Peak and Palomar Mountain according to St. Amant, Pettit, Roach, and Williams [3].

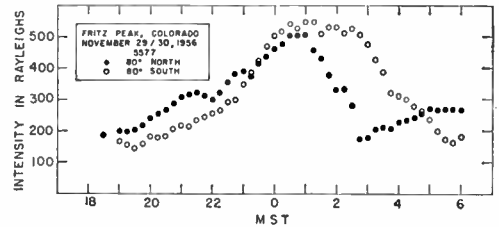

Fig. 4—Synchronous variations of 5577.

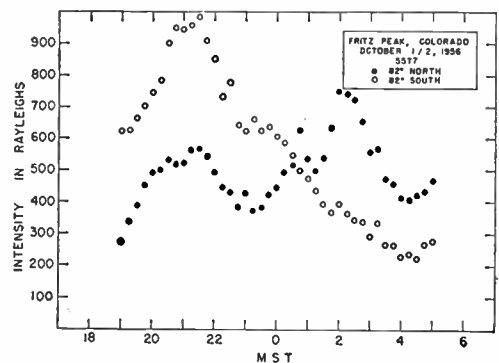

Fig. 5—Nonsynchronous variations of 5577.



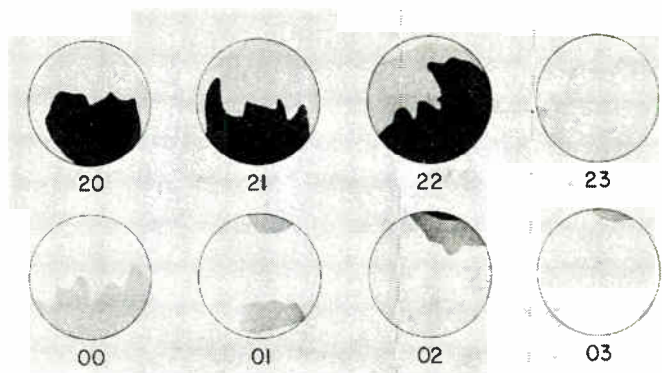

Fig. 6—Circular plots of the entire sky.

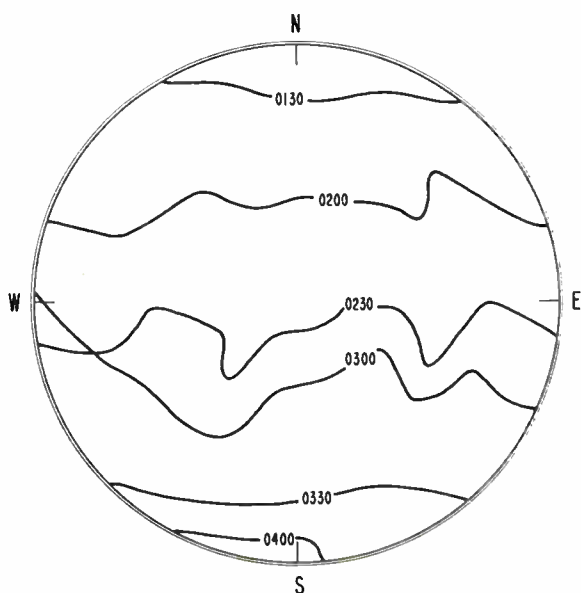

Fig. 7—Movement of 300 R isophote, Fritz Peak, October 31, 1956.

during this night illustrates the fact that the airglow is a dynamic phenomenon of the upper atmosphere.

#### THE SIZE OF AIRGLOW CELLS

An inspection of isophote maps, such as in Fig. 6, suggests the existence of discrete airglow cells. One gets the general impression that the cells are larger than the field of view which has a diameter of 940 km if the emission is at 100-km height. On rare occasions smaller airglow features have been noted.

Two methods have been used to approach the problem of determining the size of the cells: 1) a comparison of the diurnal changes of intensity in various parts of the sky, and 2) a measure of the gradients over the sky. In the first method, one assumes that regions associated with the same airglow cell tend to follow similar diurnal changes, as in Fig. 4, and that dissimilar changes, as in Fig. 5, imply a lack of association with a given pattern. In the second method, an estimate of the size of the air-

glow cells is made from the intensity gradients on each circular map.

In a recent analysis of twelve nights using both methods, Roach, Tandberg-Hanssen, and Megill [6] have found the typical size to be about 2500 km.

#### MOVEMENTS OF AIRGLOW CELLS

Roach, Tandberg-Hanssen, and Megill [7] have followed the movement of isophote lines, that is, lines of equal airglow intensity, as shown in Fig. 7. From twenty cases in which the movement could be followed long enough to establish a value for its speed, a mean value of 92 meters per second in substantial agreement with that deduced from the apparent movement of isophote lines.

Inasmuch as the diurnal intensity-variations in widely separated regions are sometimes similar, and sometimes dissimilar, there is no specific periodicity that can be assigned to all the observations at a given station. However, Roach, *et al.* have examined their records systematically for individual diurnal changes which can be interpreted as periodic, and they have found periods ranging from 5–16 hours with a mean of about 10 hours. If a cell which is 2500 km in size passes the observer in 10 hours, one deduces a speed of 70 meters per second.

As with the aurora, it remains to be shown whether these motions are due to transport of the emitting particles or to motion of the excitation.

#### RELATION TO AURORA

Radiation at 5577 Å is the principal emission from the aurora as well as from the night airglow in the visible region of the spectrum. In general, the light has been called aurora if it can be seen with the unaided eye, and airglow if it cannot. This threshold level is about 1000 rayleighs. Although the two phenomena are thus obviously linked, it is equally obvious that this criterion for classification can be only an expedient.

St. Amand and Ashburn [8] suggested that the statistical distribution of absolute 5577 intensities at a given location might yield information as to the common or separate origin of the airglow and the aurora. If there is a common origin, one might expect the distribution of intensities to be "unimodal" as in the right-hand side of Fig. 8. If, on the other hand, the origins are separate, one would expect the distributions to be "bimodal" as in the left-hand side of Fig. 8. Of course, in the bimodal case, there might be some overlapping of the curves. Following this approach, St. Amand and Ashburn examined the distributions of the nightly-mean intensities for 86 nights at Cactus Peak, Calif., and concluded tentatively that the aurora and airglow are completely separate phenomena.

Using the large amount of airglow data obtained at subauroral-zone stations during the first half of the

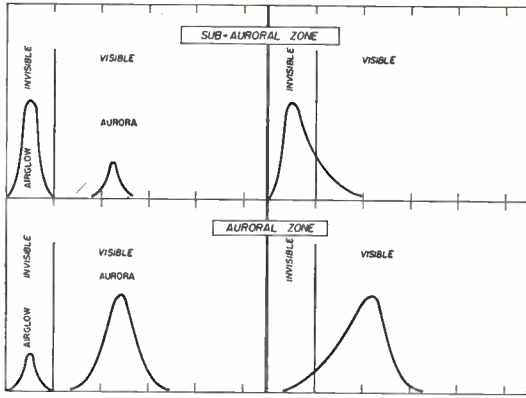

Fig. 8—Hypothetical intensity distributions for separate causes for airglow and aurora ("bimodal") on the left, and for a common cause ("unimodal") on the right.

IGY, Roach, McCaulley, and Marovich [9] have found that, without exception, the distributions are unimodal. They suggest that St. Amand's and Ashburn's opposite conclusion was due to the use of nightly means and to the improper interpretation of the distribution, as well as to the relatively small amount of data used.

Recent observations at Thule, Greenland, near the center of the auroral zone show: 1) a unimodal distribution of 5577 intensities, 2) a mode at about twice the average brightness observed at subauroral stations, and 3) a smooth distribution from the invisible across the threshold to the visible. These observations lend further support to the hypothesis of a common origin for the 5577 airglow and the fainter auroras.

EVIDENCE FOR A LATITUDE-SEASONAL EFFECT

Several years ago, Barbier, Dufay, and Williams [10] noted that, at the Haute Provence Observatory in southern France, there was a strong tendency for the airglow 5577 to be brightest near the southern horizon. Using published data from Sacramento Peak and Cactus Peak and accumulated unpublished data from Fritz Peak, we have made a comparison of the north vs south tendency for these three stations plus Haute Provence. When the results are plotted as histograms as shown in Fig. 9, it is seen that there is an indication of a region of maximum intensity at about 38° north latitude. It has been suggested that this might be a secondary, weak, auroral zone and in Fig. 10 the same histograms are shown against geomagnetic latitude where 44° geomagnetic latitude seems to be indicated as the maximum region. Is it just a coincidence that the co-latitude, in this case (46°), is exactly twice the co-latitude of the primary auroral zone (23°)?

This apparent latitude maximum turns out to be a complex matter. Fig. 11 shows a plot of the ratio of intensity at Fritz Peak of 5577 in the extreme north (80° north zenith distance) to the extreme south (80° south zenith distance) plotted against the day in the

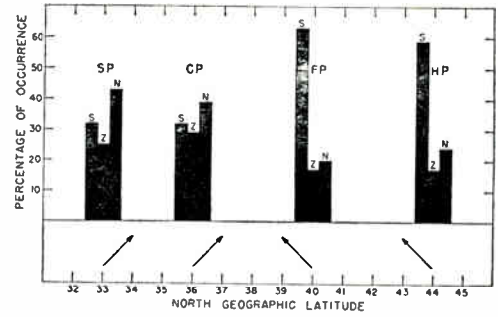

Fig. 9—Histogram of the relationship of the percentage of occurrence to the geographic latitude.

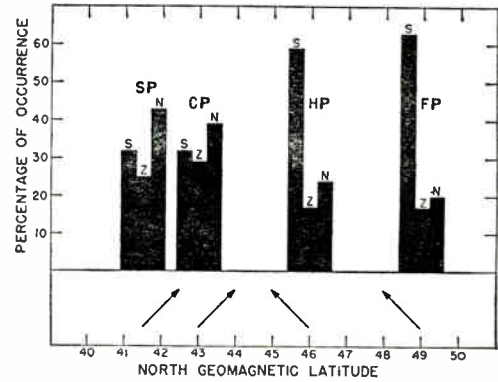

Fig. 10—Histogram of the relationship of the percentage of occurrence to the geomagnetic latitude.

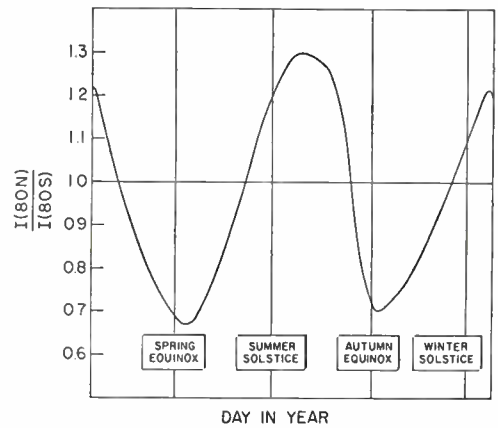

Fig. 11—Relationship of the ratio of intensity of 5577, north/south to season.

year. A definite seasonal variation is evident with the north brighter in the summer and winter, and the south brighter in spring and autumn. The explanation for the southern tendency at Fritz Peak lies in the fact that the spring and autumn southern tendency persists through a larger fraction of the year than the summer and winter northern tendency.

Fig. 12 shows a composite sketch of the seasonal effects at three of the four stations included in the present discussion. The evidence suggests the existence of a large-scale latitude-seasonal variation in airglow 5577.

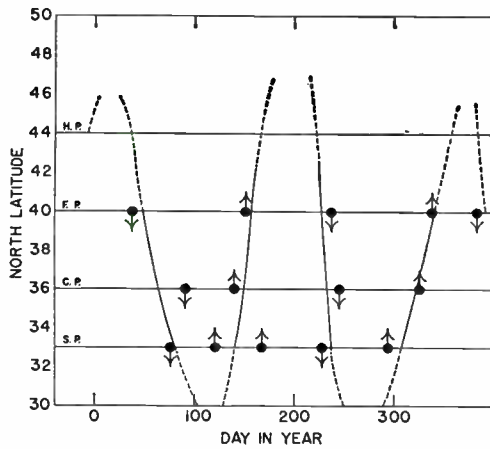

Fig. 12—Composite sketch of seasonal effects; the arrows indicate the dates on which the maximum brightness goes from north to south (arrows pointing downward) or from south to north (arrows pointing upward).

The existence of a half-year periodicity is puzzling. One speculative suggestion is that we are dealing actually with two phenomena which are schematically represented in Fig. 13. According to this picture each of the two phenomena goes through a single annual cycle, but an observer at a midlatitude sees a semiannual cycle as the two excitation waves appear, disappear, and reappear.

#### BIBLIOGRAPHY

- [1] D. M. Hunten, F. E. Roach, and J. W. Chamberlain, "A photometric unit for the airglow and aurora," *J. Atmos. Terrest. Phys.*, vol. 8, pp. 345-346; 1956.
- [2] M. Koomen, R. Scolnik, and R. Tousey, "Distribution of the night airglow (OI) 5577A and NaD layers measured from a rocket," *J. Geophys. Res.*, vol. 61, pp. 304-306; 1956.

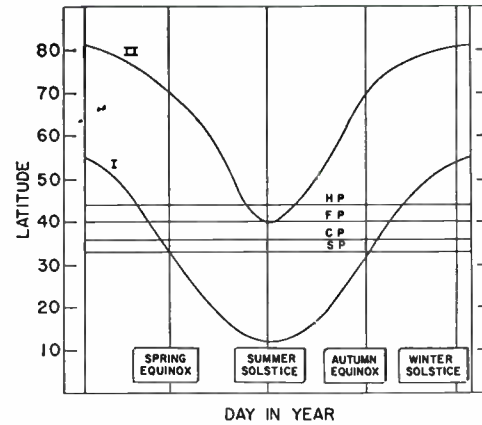

Fig. 13—Suggested double mechanism to explain the seasonal variation of 5577.

- [3] P. St. Amand, H. Pettit, F. E. Roach, and D. R. Williams, "On a new method of determining the height of the nightglow," *J. Atmos. Terrest. Phys.*, vol. 6, pp. 189-197; 1955.
- [4] F. E. Roach, L. R. Megill, M. H. Rees, and E. Marovich, "The height of nightglow 5577," *J. Atmos. Terrest. Phys.*, vol. 12, pp. 171-186; 1958.
- [5] J. P. Heppner, J. D. Stolarik, and L. H. Meredith, "Rocket measurements at WSPG, New Mexico, July 5, 1956; pt. A, altitude distribution of nightglow emissions (abstract)," *Trans. Amer. Geophys. Union*, vol. 38, pp. 394-395; 1957.
- [6] F. E. Roach, E. Tandberg-Hanssen, and L. R. Megill, "The characteristic size of airglow cells," *J. Atmos. Terrest. Phys.*, to be published.
- [7] F. E. Roach, E. Tandberg-Hanssen, and L. R. Megill, "Movements of airglow cells," *J. Atmos. Terrest. Phys.*, to be published.
- [8] P. St. Amand and E. V. Ashburn, "The frequency distribution of the intensity of aurorae and the night airglow for 5577 [OI]," *J. Geophys. Res.*, vol. 60, pp. 112-113; March, 1955.
- [9] F. E. Roach, J. W. McCauley, and E. Marovich, "The origin of [OI] 5577 in the airglow and the aurora," to be published.
- [10] D. Barbier, J. Dufay, and D. R. Williams, "Recherches sur l'émission de la raie verte de la lumière du ciel nocturne," *Ann. Astrophys.*, vol. 14, pp. 399-437; 1951.



# Rocket Observations of the Ionosphere\*

HERBERT FRIEDMAN†

**Summary**—Daytime electron density profiles measured at Fort Churchill have been found to be similar to those observed at White Sands. One winter nighttime flight showed very little ionization, less than 20,000 electrons per cc up to 165 km. Polar blackout produced strong enhancement of the *D*-region electron density down to 55 km.  $\text{NO}^+$  is the predominant ion below 200 km during the night, but  $\text{O}^+$  becomes the most abundant ion above 150 km during the day.

Solar flares are accompanied by X-ray bursts capable of penetrating to the 60-km level and sufficiently intense to account for sudden ionospheric disturbances. At night a diffuse glow of Lyman- $\alpha$  is visible over the entire sky. From the observed intensity it is possible to estimate the electron density of interplanetary space.

## INTRODUCTION

THE ambitious rocket program planned for the IGY, July, 1957 to December, 1958, has been carried through almost to completion at this time. In the first twelve months, scientists of the U.S.A. launched over one hundred instrumented rockets. At the Fifth CSAGI Assembly in Moscow, August, 1958, sixty launchings were reported by the U.S.S.R. The United Kingdom, a later starter in the rocket program, also had important results to present at the same meeting. A considerable number of the rocket experiments have been devoted to the study of ionospheric parameters and the ionizing solar radiations. Of particular interest from the standpoint of ionospheric physics have been the measurements of: 1) electron density distributions from the *D* to *F* regions during polar blackout; 2) ion composition up to 820 km; 3) the intensities of X rays and Lyman- $\alpha$  during solar flares; 4) the intensity of Lyman- $\alpha$  radiation scattered from interplanetary hydrogen; and 5) the particle and X-ray fluxes associated with auroras.

## METHODS OF MEASURING IONOSPHERIC ELECTRON DENSITY

From 1946 to 1956 numerous ionospheric measurements were reported by scientists associated with the United States Naval Research Laboratory (NRL), the Air Force Cambridge Research Center (AFCRC), and the Army Ballistic Research Laboratories (BRL). The NRL method, as developed by Seddon<sup>1</sup> involves the transmission of two harmonically related CW signals, 7.754 mc and 46.524 mc, from the rocket to the ground. The higher frequency is the sixth harmonic of the lower frequency and traverses the ionosphere essentially unaffected. The lower frequency, however, experiences a pronounced retardation. At the ground station, the

lower frequency is multiplied by a factor of six and combined with the higher frequency to produce a beat signal. The beat frequency recorded as the rocket traverses the ionosphere provides a measure of the refractive index at the rocket. Beat frequency,  $f_b$ , refractive index,  $n$ , and the fundamental frequency,  $f$ , are related according to

$$f_b = \frac{6fv}{c} (1 - n) \quad (1)$$

where  $v$  is the radial velocity of the rocket relative to the ground receiver, and  $c$  is the velocity of light in vacuo.

The AFCRC method, developed in collaboration with the University of Utah, utilizes a two-frequency pulse transmission. A pulse carrying a 200-mc frequency is closely followed by a pulse carrying a 10-mc frequency. The differential delay in traversing the ionosphere again provides the data for computing charge density.

DOVAP (Doppler velocity and position), developed at BRL, is still another radio propagation technique for determining electron density. Two RF signals are transmitted from one ground station to another, one directly, the other by way of the rocket. As the radiation is received by the rocket in flight, a transponder doubles the frequency and transmits it back to the ground. Because of the rocket's motion, the rebroadcast signal is altered by Doppler effect, dropping in frequency if the rocket is rising, or increasing in frequency if the rocket is falling. The signal from the rocket is received at three or more ground stations and is beat against the directly received ground wave. The resulting beat frequency is proportional to the rocket velocity in the plane containing the transmitter, rocket, and receiver. If propagation were taking place in a vacuum, the DOVAP data would give the true trajectory of the rocket, but because the DOVAP frequencies (38 and 76 mc) are low enough to suffer retardation by the ionospheric charge density, errors are introduced in the tracking data. A true vacuum trajectory may be computed from DOVAP data above the atmospheric drag region, but still below the ionosphere. Comparison with the apparent DOVAP trajectory then permits an evaluation of electron density in the ionosphere.

Besides the radio propagation methods described above, attempts are being made to use bipolar probes. The University of Michigan has developed a probe consisting of two identical six-inch spheres rigidly connected in the form of a "dumbbell" but electrically isolated. A repetitive sweep potential is programmed between the spheres, and the resulting current flow is used

\* Original manuscript received by the IRE, November 25, 1958.

† U.S. Naval Res. Lab., Washington 25, D. C.

<sup>1</sup> J. C. Seddon, "Propagation measurements in the ionosphere with the aid of rockets," *J. Geophys. Res.*, vol. 58, pp. 323-335; September, 1953.

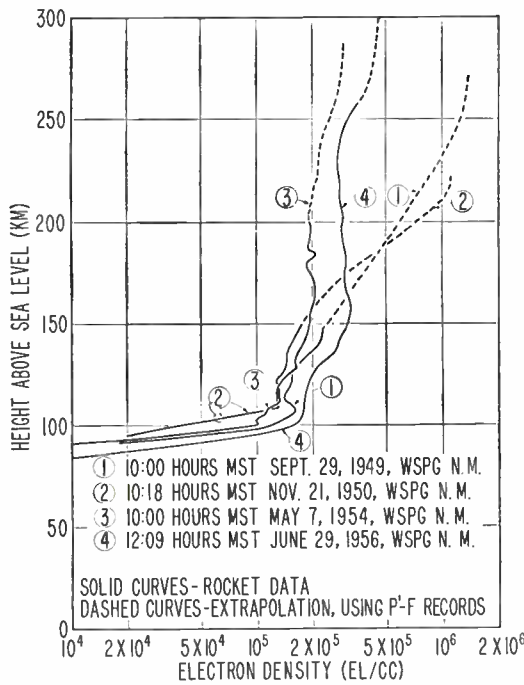

Fig. 1—Electron densities in the ionosphere. Results of NRL measurements using Seddon's propagation method.<sup>2</sup>

to derive the ambient density according to Langmuir probe theory. To evade the distorting influence of the rocket body, the probe unit is ejected at a height of fifty miles and carries its own telemetering transmitter. Another probe developed by Sayres was described by Massey at the Fifth CSAGI Assembly, in Moscow. The rocket nose cone is electrically insulated from the rocket cylinder. The nose cone is part of an LC oscillator whose frequency varies when it passes through a conductive region. The instrumentation was designed to study densities below the *E* layer, up to about 2000 electrons per cc.

RESULTS OF ELECTRON DENSITY MEASUREMENTS

The picture of the ionosphere as derived from rocket measurements is a continuum of charge density increasing with altitude. Critical frequencies identify changes in the gradient of the density distribution rather than discrete layers. Fig. 1 summarizes the highest altitude data obtained by Jackson, Kane, and Seddon<sup>2</sup> of NRL at White Sands, N. M. from 1949 to 1956. Influence of sunspot cycle on the *F* region seems pronounced although the *E* region is much less affected. *F*<sub>1</sub> is barely evident as a bank of slowly varying density. The curves of Fig. 1 are consistent with the ionization distribution to be expected in a static atmosphere under the influence of the solar radiation spectrum.

Figs. 2 and 3 show a series of ionospheric density measurements obtained by Russian scientists. These

<sup>2</sup> J. E. Jackson, J. A. Kane, and J. C. Seddon, "Ionosphere electron density measurements with the Navy Aerobee-Hi rocket," *J. Geophys. Res.*, vol. 61, pp. 749-751; 1956.

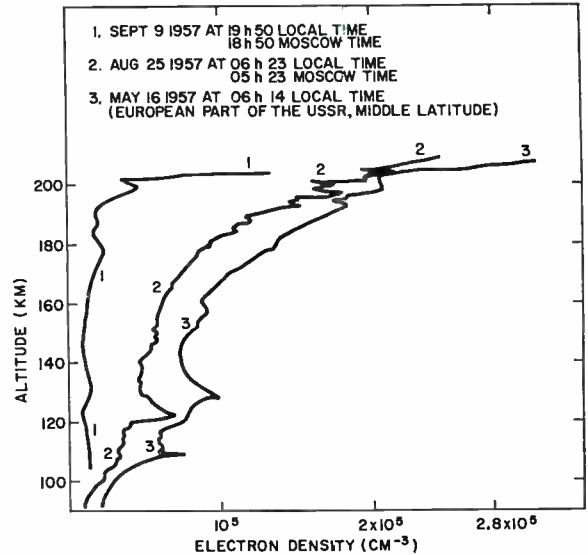

Fig. 2—Ionospheric electron density. Rocket data obtained in middle latitudes of U.S.S.R.

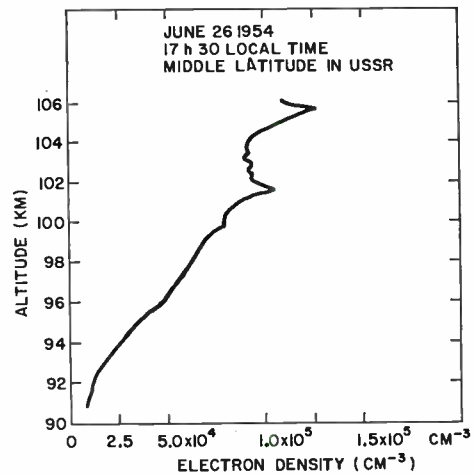

Fig. 3—Russian electron density measurement of base of *E* region.

data were exhibited at the 1958 Brussels Fair and no details of the experiments were offered other than that the principle was similar to Seddon's. The Russian results are not inconsistent with the NRL data shown in Fig. 1, although they appear to find evidence of sharper structure in the *E* region. In a flight carried out on February 21, 1958, the Russians obtained an ionospheric profile to a height of 470 km.<sup>3</sup> The maximum electron density was  $1.8 \times 10^6$  electrons per cc at 290 km. At 470 km the density had fallen back to  $1.0 \times 10^6$  per cc.

At Fort Churchill, Seddon and Jackson have obtained results for a summer day, a winter day, and a winter night.<sup>4</sup> The daytime electron density distributions shown in Fig. 4 were similar to those measured over

<sup>3</sup> "Preliminary Results of Scientific Researches on the First Artificial Earth Satellites and Rockets," Academy of Sciences of the U.S.S.R., Moscow, no. 1, pp. 40-108; 1958.

<sup>4</sup> J. C. Seddon and J. E. Jackson, "Rocket arctic ionospheric measurements," presented at Fifth CSAGI Assembly, Moscow, U.S.S.R.; August, 1958.

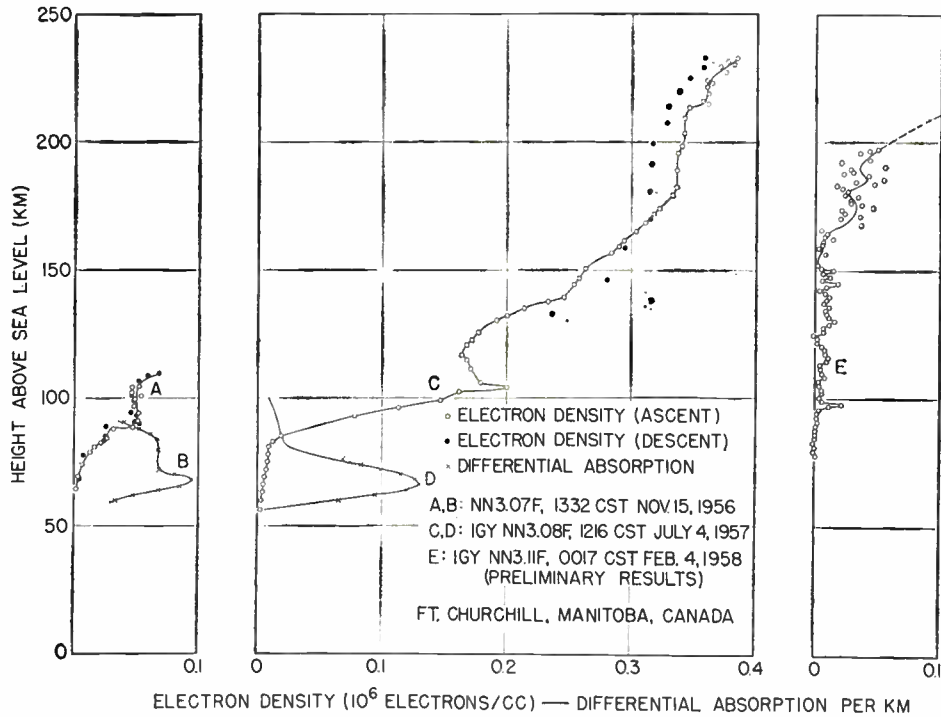

Fig. 4—Electron densities measured on a winter day, summer day, and winter night, above Fort Churchill. Differential absorption on 7.75 mc below E region is shown for both daytime flights.<sup>2</sup>

White Sands at 33° N latitude. The winter night flight reached 235 km. The bottom of the F region began at about 165 km and the region above that height was characterized by extreme turbulence and irregularity. This was corroborated by “spread F” on the ground-station ionograms.

POLAR BLACKOUT

Both daytime flights at Fort Churchill occurred during polar blackouts. An unusually high electron density was observed in the D region down to a level of 58 km. Fig. 5 compares the polar blackout conditions in the D region at Fort Churchill with the density distribution measured during undisturbed conditions at White Sands. Although the polar blackout produced a strong intensification of D-region ionization, the E region and F region were virtually unaffected.

Radio reflections from auroras are generally attributed to ionization produced by corpuscular streams. The mobility of the auroral patterns implies rapid movement of the ionizing streams, and the ionospheric soundings exhibit similar movements in the ionized clouds. Severe ionospheric absorption signifies a much more penetrating radiation than the primary corpuscular streams. X rays of wavelength shorter than 1 Å could account for the low-level ionization detected by Seddon and Jackson. Such X rays have, in fact, been observed by Van Allen and his co-workers<sup>5</sup> and attributed to the bremsstrahlung of 10-kev to 150-kev electrons. Chapman and

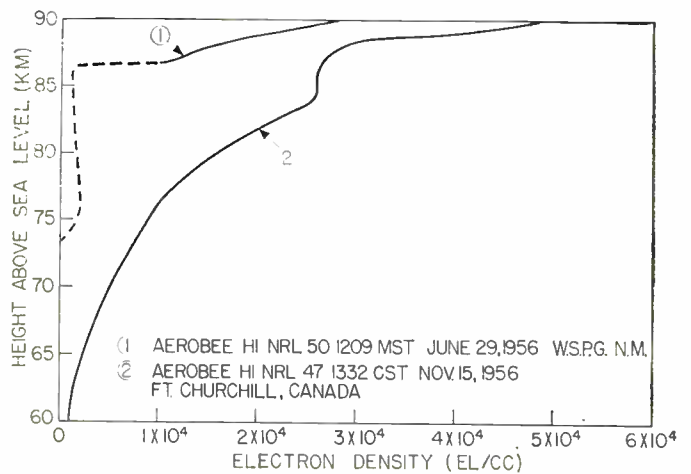

Fig. 5—Electron densities below E region under normal daytime conditions at White Sands, and during polar blackout at Fort Churchill.<sup>1</sup>

Little<sup>6</sup> pointed out that the absorption responsible for polar blackout may be produced by such X rays, which can penetrate much further than the electrons and spread over a much broader base. The presence of absorption both day and night, even though auroral activity is at a minimum near midday, would at first appear to contradict this theory. But Chapman and Little suggest that although the X-ray flux should be far weaker during the day, photodetachment of electrons from oxygen atoms irradiated by visible sunlight can

<sup>5</sup> J. A. Van Allen, “Direct detection of auroral radiation with rocket equipment,” *Proc. Natl. Acad. Sci.*, vol. 43, p. 57; January, 1957.

<sup>6</sup> S. Chapman and C. G. Little, “The nondeviative absorption of high frequency radio waves in auroral latitudes,” *J. Atmos. Terrest. Phys.*, vol. 10, pp. 20-31; January, 1957.



greatly retard the daytime electron loss process. At night, attachment proceeds rapidly without competition by the detachment process, and a much greater X-ray flux is required to produce the observed absorption.

### SPORADIC E

Seddon and Jackson observed evidence for the formation of sporadic-E regions extending over many square kilometers with little evidence of coarse patchiness. On one flight near noon, the electron density increased as much as 100 per cent at a height of 101 km producing a layer of thickness less than 2 km. Massey<sup>7</sup> reported a layer of similar sharpness at night in the range 99 to 101 km. In the winter night flight at Fort Churchill shown in Fig. 4, a thin layer with a maximum electron density of only  $2 \times 10^4$ /cc was obtained at 99 km and sporadic-E reflections were seen on the ground-station ionograms, evidently produced by the steep gradient. There was no significant difference between the "virtual" height of the radio reflection and the true height.

Helliwell reported in 1952<sup>8</sup> that sporadic-E traces seen on standard 1–20-mc ionograms at San Francisco show a strong preference for 100, 106, and 111 km, and that these are the same heights from which low-frequency echoes are obtained. In 1954<sup>8</sup> he reported that the preference for these heights persisted throughout the year, though the diurnal, seasonal, and latitude dependence of the occurrence rate was different at the different levels. Seddon and Jackson have found a preference for these same heights in their recent rocket results<sup>4</sup> and peaks at these heights were also apparent in the earlier rocket results reported by Seddon, Pickar, and Jackson.<sup>9</sup> Pfister and Ulwick, in a recently published<sup>10</sup> re-analysis of the data from Aerobee rocket no. 38 fired in New Mexico on June 3, 1953 near noon, found ionization peaks at 106, 111, 117, and 123 km. The data were missing between 119 and 123 km. Helliwell noted that the separation of the reflection levels appears even more constant than the absolute height. It has been suggested that this stratification, with a separation of about one scale-height, may be related to wind-shears.

### ION COMPOSITION OF THE IONOSPHERE

Measurements of the ion composition of the upper atmosphere at Fort Churchill have revealed the presence of positive ions of 32, 30 and 16 atomic mass units corresponding to  $O_2^+$ ,  $NO^+$  and  $O^+$ . The distribution vs altitude of these ions was determined in three separate

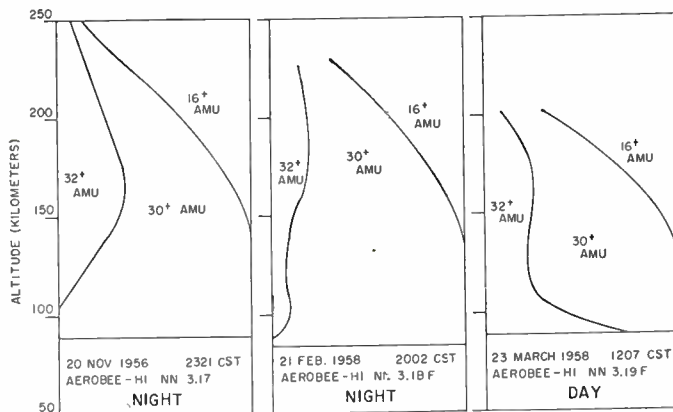
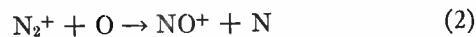

Fig. 6—Positive-ion composition of the ionosphere above Fort Churchill. The relative abundance of an ion at a particular altitude is represented by the horizontal width of the area assigned to the ion.<sup>11</sup>

experiments carried out by Johnson, Meadows and Holmes.<sup>11</sup> Their results are illustrated in Fig. 6. The rockets, which reached altitudes of 251, 225, and 202 km, carried radio frequency mass spectrometers. An over-cast prevented any visual observation of an aurora on the night of the November, 1956, flight. The flight of the night of February, 1958, entered an auroral display. The third flight in March, 1958, was launched at noon.

The relative abundance of an ion is represented by the horizontal width of the area assigned to it in Fig. 6. Below 130 km there is no indication of  $O^+$  night or day, but it becomes the dominant ion above 200 km. During the daytime, the relative abundance of  $O^+$  increases more rapidly with altitude than it does at night. Below 200 km, the positive ion of nitric oxide ( $30^+$ ) is most abundant at night. During the day, however,  $O_2^+$  is predominant below 100 km and  $O^+$  above 150 km.

It may appear surprising to find  $NO^+$  so abundant considering the fact that the molecule is only a trace-constituent of the atmosphere. We have no direct measurements of the abundance of  $NO$  but can infer its concentration from the intensity of the solar Lyman- $\alpha$  line and the electron density of the  $D$  region. It is generally believed that the  $D$  region is formed as a result of photoionization of  $NO$  under irradiation by Lyman- $\alpha$ . The measured flux of Lyman- $\alpha$  in recent years has been of the order of  $6 \text{ ergs cm}^{-2}\text{s}^{-1}$ . It can be shown that less than a part per million of  $NO$  is sufficient to produce the observed  $D$ -region electron density. Because the ionization potential of  $NO$  is only 9.4 ev, much less than the ionization potentials of the common atmospheric molecules, nitric oxide can charge exchange with any of the other atmospheric ions. Nicolet has also suggested<sup>12</sup> that



<sup>7</sup> H. S. W. Massey, "Report of progress of United Kingdom IGY rocket program," presented at Fifth CSAGI Assembly, Moscow, U.S.S.R.; August, 1958.

<sup>8</sup> R. A. Helliwell, paper presented at USA-URSI Spring Meeting, Washington, D. C.; 1952. Also, paper presented at USA-URSI Spring Meeting, Washington, D. C.; 1954.

<sup>9</sup> J. C. Seddon, A. D. Pickar, and J. E. Jackson, "Continuous electron density measurements up to 200 km," *J. Geophys. Res.*, vol. 59, pp. 513–524; December, 1954.

<sup>10</sup> W. Pfister and J. C. Ulwick, "The analysis of rocket experiments in terms of electron-density distributions," *J. Geophys. Res.*, vol. 63, pp. 315–334; June, 1958.

<sup>11</sup> C. Y. Johnson, E. B. Meadows, and J. C. Holmes, "Ion composition of the Arctic ionosphere," *J. Geophys. Res.*, vol. 63, p. 443; June, 1958.

<sup>12</sup> M. Nicolet, private communication. See also M. Nicolet, "The constitution and composition of the upper atmosphere," this issue, p. 142.



fective in the *F* region, X rays and Lyman- $\beta$  in the *E* region, and Lyman- $\alpha$  in the *D* region.

SOLAR FLARES

Sudden ionospheric disturbances develop simultaneously with the appearance of a visible flare. Radio fade-out, sudden cosmic noise absorption, sudden phase anomaly, and enhancement of atmospherics are all explainable in terms of increased ionization of the *D* region. As is evident from Fig. 8, X rays of wavelength 2.5 Å, and Lyman- $\alpha$ , have equivalent penetrating characteristics. When the sun is quiet, Lyman- $\alpha$  is always observed in the *D* region but X rays of wavelengths less than 6 Å are detected only infrequently. Accordingly, it was long supposed that an enhancement of Lyman- $\alpha$  was the most likely source of increased *D*-region ionization during a flare.

The NRL rocket flare experiments have shown that X rays are produced in flares in sufficient intensity and of short enough wavelength to account for the enhanced *D*-region ionization. The rockets were equipped with X-ray photon counters sensitive to wavelengths from 1 to 8 Å and with Lyman- $\alpha$  ion chambers. Table II summarizes the X-ray fluxes measured on four flights coincident with flares. In no case has any significant change in Lyman- $\alpha$  been observed. In each launching,

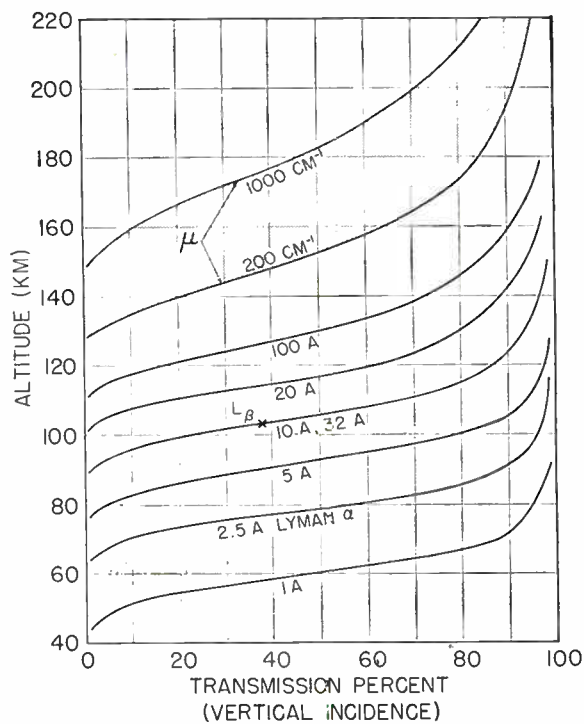

Fig. 8—Penetration of solar radiations into the earth's atmosphere. The limits of the shade band cover all wavelengths for which the absorption coefficients lie between 200 and 1000  $\text{cm}^{-1}$ . This includes almost the entire spectrum from 200 to 850 Å.

TABLE II  
X-RAY FLARES

Rocket	Launching Time (Z)	Class Flare	X-Ray Penetration km	X-Ray Wavelength Angstroms	X-Ray Flux $\text{erg cm}^{-2}\text{s}^{-1}$
Rockoon NN5.31	7/20/56 1217	1 No SWF	77	3-8	$5 \times 10^{-3}$
Nike-Deacon NN7.42F	8/20/57 0949	1+ weak SWF	70	2.5-?	$3 \times 10^{-3}$
Nike-Deacon NN7.45F	8/29/57 1412	2 $\frac{1}{2}$ hr SWF	77	3-8	$2 \times 10^{-2}$
Nike-ASp NN7.49F	9/18/57 1054	Class 3 2 hr SWF	63.5	1.5-?	$4 \times 10^{-6}$ at 63.5 km $1.2 \times 10^{-4}$ at 70 km

an attempt was made to time the rocket firing to coincide with the maximum phase of the flare so that the first few minutes of flare development were always bypassed. It is possible that Lyman- $\alpha$  could have flashed too early in the development of the flare to be detected by the rocket.

BALLOON MEASUREMENT OF SOLAR GAMMA-RAYS DURING A FLARE

Peterson and Winckler<sup>17</sup> have observed a short burst of penetrating radiation at balloon altitude (10 gm/cm<sup>2</sup> depth) near Cuba (30° geomagnetic latitude). The burst began approximately  $\frac{1}{2}$  minute before the reported

visual observation of a Class-2 flare and the beginning of a sudden ionospheric disturbance at 1305 Z on March 20, 1958. The balloon carried both a Geiger counter and a high-pressure ionization chamber. The duration of the burst could not have exceeded 18 seconds which was the resolution time of the data output from the counter-scaler apparatus. On the basis of the relative response of the Geiger counter and ion chamber, it is possible to discriminate between particles and X rays or gamma rays. Peterson and Winckler identified the burst as a flash of 0.5 mev gamma radiation. Furthermore, they concluded that the radiation did not appear to be bremsstrahlung and suggested a possible origin in nuclear processes associated with production of the flare. Assuming 0.5 mev gamma rays, the observed flux corre-

<sup>17</sup> L. Peterson and J. R. Winckler, private communication.



sponded to  $7.6 \times 10^{-5}$  erg  $\text{cm}^{-2}\text{s}^{-1}$ . Severny<sup>18</sup> has developed a theory of flare production based on a magnetic pinch effect. His theory predicts a bremsstrahlung capable of producing maximum energies of 10 to 100 electron rest masses. Such a process could produce the gamma rays observed by Peterson and Winckler.

#### X-RAY AND ULTRAVIOLET RADIATION IN THE NIGHT SKY

Attempts to detect X-ray radiation in the 50-Å region from the night sky have been unsuccessful. It is possible to set an experimental upper limit of  $10^{-8}$  erg  $\text{cm}^{-2}\text{s}^{-1}$  per Ångström on any influx from celestial sources in this soft X-ray range. At Lyman- $\alpha$  and neighboring ultraviolet wavelengths, however, the night-time flux is quite large.<sup>19</sup> The entire night sky is aglow with a diffuse Lyman- $\alpha$  emission amounting to about  $3 \times 10^{-3}$  erg  $\text{cm}^{-2}\text{s}^{-1}$  per steradian.

The measurement of Lyman- $\alpha$  at night was accomplished by means of ion chambers flown in an Aerobee rocket to a height of 146 km.<sup>19</sup> The detectors were collimated to restrict the angular field of view and were mounted on the skin of the rocket looking outward in directions normal to the rocket's long axis. A spatial scan of the sky was produced by the combined spin and yaw motions of the rocket.

At the peak of the flight the signals from the rolling rocket showed a maximum intensity when the windows looked out into space and a minimum, but not zero, when looking back toward the earth. The flux from above is believed to come from hydrogen atoms in space, and the radiation from below to originate in hydrogen atoms in the terrestrial atmosphere. It appears that the Lyman- $\alpha$  flux from space excites Lyman- $\alpha$  resonance radiation of hydrogen in the terrestrial atmosphere. The Lyman- $\alpha$  albedo of the earth's atmosphere was 42 per cent.

Fig. 9 is a plot of the measured distribution of Lyman- $\alpha$  radiation over the night sky. Whenever the detectors looked at the sky directly opposite the sun the intensity reached a shallow minimum. The zenith is at the center of the chart and the minimum isophote contour includes the antisolar point. It is quite striking that the isophotes are almost circular about the antisolar direction. This feature strongly suggests that the primary source of the night-sky Lyman- $\alpha$  is the sun and that solar Lyman- $\alpha$  radiation traveling out into space is resonantly scattered back to the dark side of the earth by neutral hydrogen atoms in interplanetary space. Furthermore, the circular symmetry of the isophotes shows that the hydrogen is symmetrically distributed about the sun rather than being concentrated toward the ecliptic plane.

<sup>18</sup> A. B. Severny, "Flares as a Pinch Effect," Tenth General Assembly of the IAV, Moscow, U.S.S.R.; 1958.

<sup>19</sup> J. E. Kupperian, Jr., E. T. Byran, T. A. Chubb, and H. Friedman, "Ultraviolet radiation in the night sky," *Ann. Geophys.*, (in press).

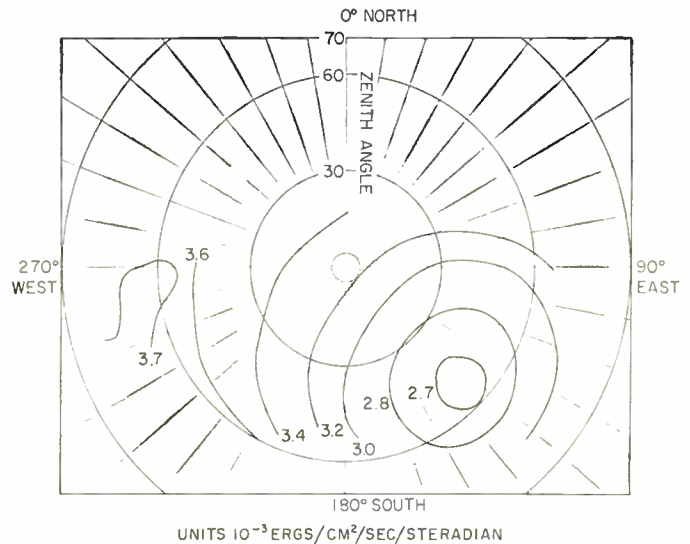

Fig. 9—Lyman- $\alpha$  intensity contours in the night sky. The smallest intensity contour loop contains the antisolar direction. No correction to the data was made for the contribution of discrete sources between 1225 and 1350 Å which appear in the West. (NRL Aerobee 31, March 28, 1957, 2200.<sup>19</sup>)

#### INTERPLANETARY HYDROGEN

During recent years evidence has accumulated that interplanetary space may be filled with an ionized gas-density of as much as a few hundred electrons and protons per cc. The associated high conductivity of interplanetary space must have important consequences for any theory of the transport of charged particles from Sun to Earth and the development of magnetic storms. The evidence for high particle densities comes from such diverse sources as observations of the intensity and polarization of zodiacal light, the intensity of auroras, whistling atmospherics, and the acceleration of comets' tails.

It is estimated that as much as  $10^{20}$  gm per yr of matter may be emitted by the Sun. If concentrated into streamers near the ecliptic, the density near the earth may be as great as 100 particles/cc. Chapman<sup>20</sup> has considered the extension of the solar corona to the vicinity of the earth and derives an equilibrium density of  $10^3$ /cc and a temperature of 200,000°K. The zodiacal light may be interpreted as due to scatter from both electrons and dust particles. From the observed intensity and polarization, the electron and atom density has been estimated as high as 500/cc.<sup>21</sup> To explain the acceleration of comets' tails away from the Sun, Bierman<sup>22</sup> requires solar particle streams carrying atom densities of  $10^3$  in quiet periods and as high as  $10^5$  in storms. In the vicinity of the earth, whistlers provide convincing

<sup>20</sup> S. Chapman, "Notes on the Solar Corona and the Terrestrial Ionosphere," *Smithsonian Contributions to Astrophys.* 2, No. 1; 1957. See also, S. Chapman, "The earth and its environment," this issue, p. 137.

<sup>21</sup> A. Behr and H. Siedentopf, "Untersuchungen über Zodiacallicht und Gegenschein Nach Lichtelektrischen Messungen auf dem Jungfrauoch," *Z. Astrophys.*, vol. 32, p. 19; 1953.

<sup>22</sup> L. Biermann, "Physics of Comets," Liège, Belgium, p. 251; 1953.

evidence of densities of the order of 400 to 600 per cc within a distance of several earth radii.<sup>23</sup> Furthermore, the frequency of whistler occurrence is much more regular than would be indicated if the gas density were derived entirely from corpuscular streams.

The rocket observations of Lyman- $\alpha$  at night provide another independent gauge of interplanetary hydrogen. If we knew the contour of the solar Lyman- $\alpha$  line we could estimate the density of neutral hydrogen,  $n_H$ , in interplanetary space, from the observed night sky flux. Each atom of hydrogen in space has an effective scattering cross section dependent on its temperature and the breadth of the solar line. Struve<sup>24</sup> assumes a line width of one Ångström and a cross section,  $\sigma$ , of  $10^{-14}$  cm<sup>2</sup>. Within a range of one-half Ångström on either side of the line center, a neutral hydrogen atom would absorb solar Lyman- $\alpha$  as though opaque within an area of  $10^{-14}$  cm<sup>2</sup>. If the solar Lyman- $\alpha$  flux is  $5 \text{ erg cm}^{-2}\text{s}^{-1}$  at one astronomical unit ( $1 \text{ AU} = 1.5 \times 10^{13} \text{ cm}$ ), each atom absorbs on the average  $5 \times 10^{-14} \text{ erg s}^{-1}$  from the primary flux. If  $n_H$  were 0.1 per cm<sup>3</sup>, each cubic centimeter of space would absorb  $5 \times 10^{-15} \text{ erg s}^{-1}$ . The excited atoms would then re-radiate Lyman- $\alpha$  quanta in all directions. Per unit solid angle, the scattered radiation would be  $(\frac{1}{4}\pi) \times 5 \times 10^{-15} \text{ erg s}^{-1}$  from each cm<sup>3</sup> of space, or approximately  $4 \times 10^{-16} \text{ erg s}^{-1}$ . Struve made the simplifying assumptions that both the hydrogen gas and the radiation density were uniform in space and that the scattered flux originated in a layer one astronomical unit thick. Such a layer would scatter  $(4 \times 10^{-16}) (1.5 \times 10^{13})$  or  $6 \times 10^{-3} \text{ erg cm}^{-2}\text{s}^{-1}$  per steradian. This compares well with the observed flux.

Shklovsky in a similar treatment<sup>25</sup> used a solar flux of only  $0.5 \text{ erg cm}^{-2}\text{s}^{-1}$  and a line width of  $0.2 \text{ Å}$  and arrived at a density of 0.5 neutral atom per cm<sup>3</sup>. It is very apparent that accurate knowledge of the contour of the solar line is essential to the solution of the problem. Kupperian<sup>26</sup> has pointed out that the presence of a deep core in the center of the line can be inferred from the weak albedo ( $< 2$  per cent) of the earth's atmosphere when directly irradiated by solar Lyman- $\alpha$  during the day. Such a deficiency in the center of the solar line seriously affects the value of  $\sigma$  and consequently the computation of  $n_H$ .

From the mere fact that the distribution shows a minimum about the anti-solar point when viewed from the earth, one may deduce that the mean free path of a Lyman- $\alpha$  quantum before scattering is at least one AU.<sup>26</sup> The requirement that the temperature of the interplanetary gas not exceed a few hundred degrees K implies that the scattering cross section in the center of

the line be about  $3 \times 10^{-13} \text{ cm}^2$ . If one AU is taken to represent unit optical depth, we can write

$$\sigma \delta n_H (1.5 \times 10^{13}) = 1.$$

The value of  $n_H$  turns out to be 0.2 per cm<sup>3</sup>.

#### THE ELECTRON DENSITY OF INTERPLANETARY SPACE

If the neutral hydrogen content and the solar flux below the Lyman limit are known, we can compute the number of protons and electrons per cm<sup>3</sup> in an ionization equilibrium. The ionizing radiations are comprised primarily of the Lyman continuum, the He-II resonance line at  $304 \text{ Å}$ , and the X-ray spectrum below  $100 \text{ Å}$ . At the Lyman limit the absorption cross section is of the order of  $10^{-17} \text{ cm}^2$ . As the wavelength decreases the cross section falls inversely as the wavelength cubed. At the He-II line ( $304 \text{ Å}$ ) the cross section is approximately  $10^{-18} \text{ cm}^2$ .

Although Rense's spectrogram<sup>14</sup> shows the importance of the He-II line, it is difficult to assign absolute intensities to it or to the Lyman continuum. Using the ionosphere as a gauge of the ionizing flux, it appears that about  $0.1 \text{ erg cm}^{-2}\text{s}^{-1}$  is sufficient to account for an equilibrium density of  $10^6$  electrons per cm<sup>3</sup> at the maximum of the  $F_2$  region. We may assume that the recombination of electrons and protons in space is controlled by the radiative recombination coefficient ( $\alpha = 1.5 \times 10^{-12} \text{ cm}^3\text{s}^{-1}$ ). Accordingly, if we adopt  $n_H = 0.2 \text{ cm}^{-3}$  and a flux of  $0.1 \text{ erg cm}^{-2}\text{s}^{-1}$ , the corresponding electron densities lie between 15 and 45 per cm<sup>3</sup> depending on where the appropriate cross section lies between the values of  $10^{-18}$  and  $10^{-17} \text{ cm}^2$ . If the true value of solar flux is higher than  $0.1 \text{ erg cm}^{-2}\text{s}^{-1}$  the computed electron density will be greater in proportion to the square root of the flux.

#### CONCLUSION

Upper-air research with rockets during the IGY progressed to the stage where both scientific instrumentation and rocketry achieved a high degree of reliability. Techniques are now adequate for synoptic measurements of solar radiations and atmospheric parameters and for "push-button" firings in synchronism with events such as auroras and solar flares. The bulk of the information derived from the IGY program still remains to be analyzed and reported. This brief report represents essentially a "half-way mark" summary of results and makes no mention of many areas of rocket investigation related to the ionosphere, such as the observations of pressure, temperature, density, composition, and atmospheric winds, and the first successful measurements of the composition of auroral particle streams.

*Note added in proof:* The October 12, 1958 solar eclipse was observed by an IGY expedition to the Danger Islands of the South Pacific. A group of scientists from

<sup>23</sup> L. R. O. Story, "A method to detect the presence of ionized hydrogen in the outer atmosphere," *Can. J. Phys.*, vol. 34, pp. 1153-1163; November, 1956.

<sup>24</sup> O. Struve, "Far-ultraviolet radiation of the night sky," *Sky & Telescope*, vol. 17, pp. 445-447; July, 1958.

<sup>25</sup> J. S. Shklovsky, "On hydrogen emission in the night sky," presented at Fifth CSAGI Assembly, Moscow, U.S.S.R.; 1958.

<sup>26</sup> J. E. Kupperian, Jr., private communication.

the United States Naval Research Laboratory, including T. A. Chubb, R. W. Kreplin, J. C. Lindsay, and H. Friedman, launched five rockets during the course of the eclipse to measure soft X rays and Lyman- $\alpha$ . The first four rockets flew to peak altitudes of 139, 148, 152, and 150 miles; the last performed poorly, reaching only 55 miles. In the sequence of four successful shoots, the first was launched 10 minutes before second contact and the last, 5 minutes after third contact. The intervening second and third rockets were launched 1 minute apart and were in the air during totality.

At the time this is being written the telemetering records have not yet been quantitatively interpreted, but certain general features are clearly apparent. The Lyman- $\alpha$  radiation appeared to follow the unclipped area of the disk very closely and almost disappeared within a few seconds after the rockets entered totality.

Measurements of the X-ray flux before second and after third contacts showed great limb-brightening in X rays, closely resembling the kind of intensity distribution observed in radio decimeter wave measurements. In X-ray emission the sun appears to be ringed by a bright halo. During totality the X-ray flux did not drop to zero but remained at an appreciable fraction of the unclipped level. A detailed analysis of the telemetering records should yield quantitative information on the residual flux of X rays at totality. At the time of the eclipse, there were a number of active sunspot groups and bright plage regions surrounding them on the east limb whereas the west limb was comparatively quiet. Any asymmetry in X-ray emission related to the sunspot distribution on the east limb as compared to the absence of sunspots on the west limb should be apparent in data recorded in the first and fourth shots.

## Earth Satellite Observations of the Ionosphere\*

WARREN W. BERNING†

*Summary*—A number of so-called "First Generation" experiments for exploring the ionosphere with artificial earth satellite vehicles has either been carried out or is planned by the United States and the Soviet Union. The theoretical and experimental bases of these experiments are outlined and discussed, and their limitations emphasized. The first available results are from the Soviet experiments and these are discussed. Finally, a brief consideration is given to the kinds of satellite orbits desirable for ionospheric experiments.

### INTRODUCTION

SINCE the early 1930's, systematic and ever growing studies of the ionosphere have been carried out by many educational and governmental research establishments. These studies have been directed not only to the collection of data for use in the prediction of radio wave propagation for communication purposes, but also for the solution of rather difficult and fundamental problems in geophysics. The IGY has seen the expansion of these studies on an unprecedented scale.

The principal tool for exploring the ionosphere is still the sweep-frequency, vertical incidence pulse transmitter. Recently, back-scatter and forward-scatter transmitter-receiver combinations have greatly increased the area coverage of ionospheric sounding and promise to become an important part of ground-based

survey equipments. Even more recently, studies of very low-frequency radiowaves propagated in the "whistler" mode have furnished data on ionospheric electron densities to distances of several earth radii.

Ground-based studies of the ionosphere suffer several limitations, however, and cannot give a complete picture of ionospheric structure. The determination of the true-height electron density profile, fine structure in the vertical profile, and the ionospheric structure above the  $F_2$  electron density maximum, is either very difficult or impossible using ground-based instrumentation alone.

With the advent of high altitude sounding rockets, it was possible to measure certain properties of the ionosphere within the immediate vicinity of the rocket carrier, as well as integrated ionospheric effects along a radio path from the rocket to the ground. An early attempt was made to study ionospheric properties with a Langmuir probe carried in the rocket,<sup>1</sup> but experimental difficulties limited the value of these observations. More recently, the Soviet satellite, Sputnik III, carried an ion trap as part of the research instrumentation, and for the first time quite definitive measurements of positive ion concentrations over a large altitude range were obtained.

<sup>1</sup> G. Hok and W. G. Dow, "Exploration of the ionosphere by means of a Langmuir-probe technique," in "Rocket Exploration of the Upper Atmosphere," Pergamon Press, London, Eng., pp. 240-246; 1954.

\* Original manuscript received by the IRE, November 25, 1958.

† Ballistic Research Labs., Aberdeen Proving Ground, Md.



Apart from the probe experiment mentioned above, rocket studies of the ionosphere have depended upon analyses of radio transmission either to or from the rocket in flight. This transmission may be continuous-wave or pulsed, but in either case the ionospheric measurements made are related to changes in group or phase propagation velocities produced by free electric charges in the high atmosphere. The continuous-wave method, characterized by the experiments of Seddon<sup>2</sup> and Berning,<sup>3</sup> is sensitive to the density of free charges in the immediate vicinity of the rocket, while the pulse method, described by Lien<sup>4</sup> and others, measures the total charge content below the rocket during flight. In Fig. 1 is

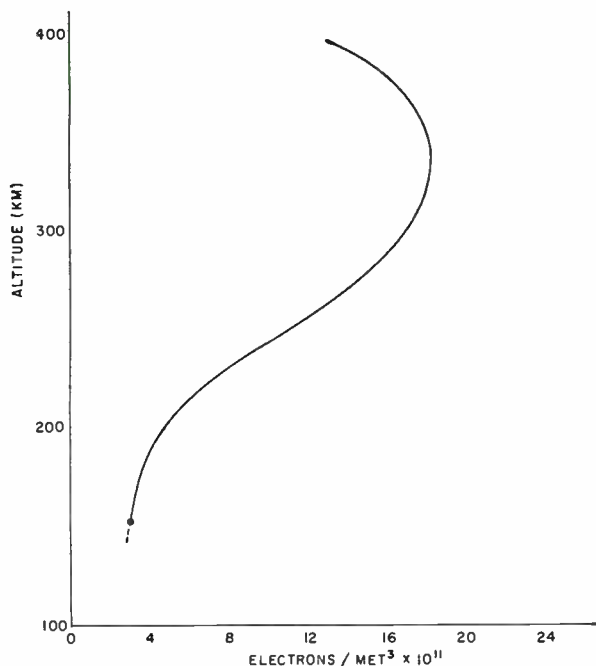

Fig. 1—Altitude profile of electron densities obtained from radio Doppler tracking of Bumper 5; fired February 24, 1949, 22.22 GCT, at White Sands Proving Ground, N. M.

shown a sample of the charge density-altitude profile obtainable with the CW transmission technique. The particular data shown were taken on the V-2 Wac-Corporal two-stage flight of February 24, 1949, (Bumper V) and show the decrease in charge density above the  $F_2$  layer maximum. These data represent a change from the profile given by Berning<sup>3</sup> arising from a reanalysis of the computed drag-free trajectory necessary for obtaining the data.

The study of ionospheric regions with rockets has a number of serious limitations, however, so that other techniques must be employed to extend the knowledge of ionospheric structure. The rocket, with its restricted temporal and spacial capabilities, is not amenable to the study of horizontal ionospheric structure, and lati-

tude, diurnal and seasonal variations with any reasonable expenditure of funds and manpower. It is necessary, then, to employ a direct measuring instrument complementary to the rocket; and this is, of course, the satellite research vehicle.

In the following sections, a variety of ionosphere exploration techniques utilizing satellite vehicles is described. Each is suitable for measuring some ionospheric characteristic such as total electron content below the satellite, electron densities at the satellite position and horizontal inhomogeneity. It will be recognized that satellite methods permit some study of diurnal, seasonal and latitude variations in ionospheric parameters. However, a later section will show that this is not an unmixed blessing when an interpretation of the measurements is attempted.

#### MEASUREMENTS OF INTEGRATED ELECTRON CONTENT BELOW THE SATELLITE

It was mentioned above that the majority of rocket techniques for exploring the ionosphere depended upon analyses of the effects of free electrons on radio wave transmissions. In the same fashion, studies of the ionosphere using satellite vehicles employ radio signals as the principal probing mechanism. As a consequence, the effects measured depend upon the characteristics of the ionosphere along the entire radio path from satellite to radio receiver. In addition, the mass of electrons when compared to ions leads to the result that free electrons are primarily responsible for producing the observed or predicted radio wave variations introduced by the ionosphere. Certain of the experimental techniques are more dependent than others upon integrated ionosphere effects along the radio path and these will be discussed first.

#### Faraday Rotation

For many years it has been recognized that the presence of the earth's magnetic field produces a bi-refracting medium in the ionosphere for the propagation of radio waves. This is similar but not analogous to the double refraction observed in certain crystals at visible wavelengths. However, the terminology of "ordinary" and "extraordinary" propagation modes has been applied to radio waves in the ionosphere to designate, respectively, ray paths unaffected (approximately) or affected by the magnetic field. The expression for the complex index of refraction for radio waves in the ionosphere was derived independently by Appleton and Hartree and is extensively discussed in the literature.<sup>5</sup> Because this expression forms the basis for all experiments designed to study ionospheric properties using radio waves transmitted from satellites and rockets, it is herewith included.

<sup>2</sup> *Ibid.*, pp. 214-222.

<sup>3</sup> *Ibid.*, pp. 261-273.

<sup>4</sup> *Ibid.*, pp. 223-239.

<sup>5</sup> S. K. Mitra, "The Upper Atmosphere," *The Asiatic Soc. Mono. Ser.*, vol. 5, 2nd ed., pp. 177-353; 1952.

$$M^2 = \left( \mu - \frac{jck}{p} \right)^2$$

$$M^2 = 1 + 2 \{ 2(\alpha + j\beta) - \alpha r^2 [1 + \alpha + j\beta]^{-1} \pm (\gamma r^4 [1 + \alpha + j\beta]^{-2} + 4\gamma L^2)^{1/2} \}^{-1}, \quad (1)$$

where

- $M$  = complex refractive index.
- $k$  = index of attenuation.
- $c$  = velocity of light in free space.
- $p$  = radian frequency of the radio wave signal.
- $N_e$  = electron density in electrons per meter<sup>3</sup>.
- $II$  = magnetic field in ampere turns per meter.
- $II_L$  = component of field along direction of propagation.
- $II_T$  = component of field normal to direction of propagation.
- $\nu$  = collisional frequency.
- $e, m$  = charge and mass of electron, respectively.
- $p_0^2 = N_e e^2 / m \epsilon_0$  (plasma frequency).
- $p_H = \mu_0 II_e / m$  (gyromagnetic frequency of electrons).
- $p_{L,T} = \mu_0 II_{L,T} e / m$ .
- $\alpha = p^2 / p_0^2$ .
- $\beta = p\nu / p_0^2$ .
- $\gamma = p p_H / p_0^2$ .
- $\gamma_{L,T} = p p_{L,T} / p_0^2$ .

The bi-refringence in the medium is expressed, of course, by the multivalued nature of the index of refraction formulated in (1). Examination of this expression reveals that if absorption is negligible (*i.e.*,  $\beta \ll \alpha$ ) and if  $p \gg p_H$ , it is possible to rewrite (1) in the forms.

$$n^2 = 1 + \{ \alpha \pm \gamma \cos \phi \}^{-1}; \quad |\phi| < 90^\circ \quad (2)$$

$$n^2 = 1 + 1/\alpha, \quad n^2 = 1 + (1 + \alpha)/(\alpha + \alpha^2 - \gamma); \quad \phi = 90^\circ, \quad (3)$$

where use has been made of the relationships,

$$\gamma_L = \gamma \cos \phi.$$

$$\gamma_T = \gamma \sin \phi.$$

$$n = \text{real index of refraction.}$$

If, now,  $\gamma \gg 1$ , (2) and (3) assume the still simpler forms,

$$n = 1 + (\alpha \pm \gamma \cos \phi)^{-1/2} \quad (2')$$

$$n = (2\alpha + 1)/(2\alpha), \quad n = 1 + (1 + \alpha)/2(\alpha + \alpha^2 - \gamma). \quad (3')$$

Eqs. (2') and (3') show quite clearly the absence of a true analogy between ionosphere and optical double refraction. Only for (3') can the terms "ordinary" and "extraordinary" propagation be properly descriptive. In (2'),  $\gamma$  must be considered as a vector quantity so that different results are obtained when the angle  $\phi$  is considered acute or obtuse.

Eq. (1) was derived from Maxwell's field equations under the assumption of plane-wave propagation and using a conventional solution of the wave equations. It

is possible to solve also for the state of polarization of the wave propagated in a magnetic field under the same assumptions with the result,

$$\frac{H_z}{H_y} = -j[(M^2 - 1)^{-1} - (\alpha + j\beta)]/\gamma_L. \quad (4)$$

If, now,  $\beta$  is negligible as before and propagation along the magnetic field is considered (*i.e.*,  $\gamma_T = 0$ ), (1) may be substituted into (4) to give the result,

$$\frac{H_z}{H_y} = \mp j. \quad (5)$$

The above indicates that under the assumptions made, the magnetic field results in two circularly polarized waves rotating in opposite directions. Each of these waves, however, is propagated at different velocities so that the vector amplitude of one wave changes with respect to the other in passage through the dispersive medium. This relative change is known as Faraday rotation. If, for the sake of simplicity, the incident wave is linearly polarized, Lorentz<sup>6</sup> has shown that the plane of polarization is shifted, per unit length, by an amount,

$$d\Omega = \frac{1}{2} p(n_1 - n_2)/c_0, \quad (6)$$

where  $n_1$  and  $n_2$  are the indexes of refraction for the two propagation modes,  $c_0$  is the velocity of light in vacuo and  $p$  is the radio wave frequency. Substituting (2') into (6), applying the definitions for  $\alpha$  and  $\gamma$  and maintaining the condition  $p_H \ll p$ , the Faraday rotation per unit length in the quasi-longitudinal mode is given by

$$d\Omega = - \frac{e^3 \mu_0 H N_e \cos \phi}{2 p^2 m^2 c_0 \epsilon_0} dr. \quad (7)$$

The algebraic sign of (7) is dependent upon the sign of  $II$  projected upon the positive direction of signal propagation as well as upon the sign of  $e$ . A positive value for  $\Omega$  states that the rotation is clockwise when viewed from behind the wavefront.

Eq. (7) must be modified, however, when consideration is given to the fact that the quantities  $N_e, II$  and  $\cos \phi$  are not constant along a transmission path from, say, a satellite to a ground observer. Under these conditions the expression takes the form,

$$\Omega = \frac{-e^3 \mu_0}{2 p^2 m^2 c_0 \epsilon_0} \int_0^r H N_e \cos \phi dr. \quad (7')$$

Referring to the sketch in Fig. 2, (7') can also be written,

$$\Omega = \frac{-e^3 \mu_0}{2 p^2 m^2 c_0 \epsilon_0} \int_{h_1}^h H N_e \cos \phi \sec \theta dh. \quad (7'')$$

Under certain but rather general conditions, the product  $II \cos \phi \sec \theta$  is quite insensitive to the coordinate  $h$ ,

<sup>6</sup> H. A. Lorentz, "The Theory of Electrons," Dover Publications Inc., New York, N. Y., p. 163; 1952.

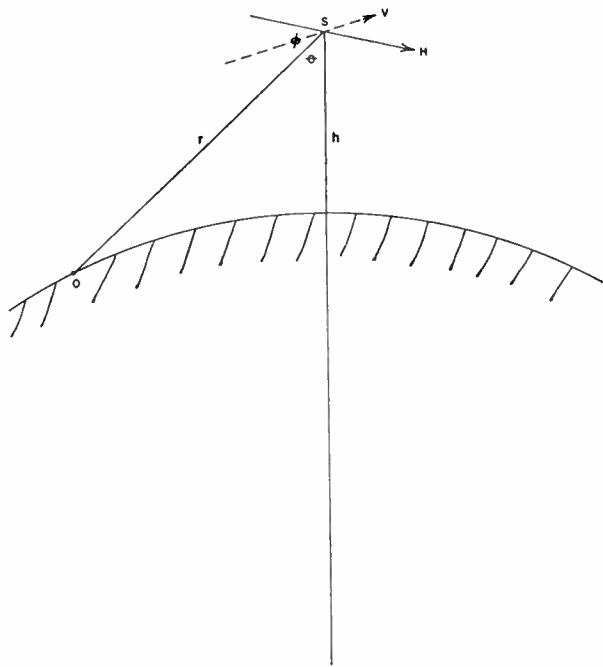

Fig. 2—Definition of angular quantities used in derivation of Faraday rotation effect.

and the Faraday rotation becomes a sensitive measure of the electron content,  $\int N_e dh$ , below the satellite altitude.

As the previous discussion indicates, a simple interpretation of Faraday rotation as a measure of the total electron content below a transmitting satellite depends on certain simplifying assumptions and is restricted to frequencies considerably greater than the plasma and electron gyromagnetic frequencies. Further, because a satellite will not reach the base of the ionosphere during its orbit, there will be an uncertainty of  $2\pi n$  radians in the measure of  $\Omega$  arising from the unknown rotation from electrons below perigee; the lower the frequency, the greater the value for  $n$ . An experiment specifically designed to study the total electron content below a transmitting satellite through Faraday rotation measurements should utilize two frequencies: one in the 50–100-mc region and the second either removed by a few megacycles or greater by a factor of perhaps ten. In this fashion, the ambiguity introduced by the lower ionosphere can be removed.

The presence of Faraday rotation has been detected by many observers in the reception of signals from Soviet satellites 1957- $\alpha$  and 1957- $\beta$ . Unfortunately, much of the data was taken at 20 mc and early instrumentation difficulties have made interpretation of these data quite difficult. In Fig. 3 is shown a section of an interferometer trace for 1957- $\alpha$ . The high-frequency oscillation appearing on the trace is almost certainly caused by the ionosphere and its regularity is most suggestive of Faraday rotation. However, the absence or erratic nature of similar oscillations during other transits of the satellite show that a simple explanation is probably erroneous.

### Radio Dawn and Radio Set of a Satellite

In a recently published paper by Al'pert, *et al.*,<sup>7</sup> a method is discussed for obtaining approximate total electron content below a transmitting satellite by noting the distance from observer to the sub-satellite point at the instant the radio signal is first received or last detected. A knowledge of the orbital parameters permits the computation of the theoretical distance to the sub-satellite points corresponding to radio dawn or radio set in the absence of a refracting medium. The method then attempts to reconcile the observed departure from in-vacuo computations by the process of constructing an ionospheric profile which will minimize the differences between observed times of radio dawn and radio set and those computed from known satellite positions using the assumed ionospheric structure. The cut-and-try process of fitting a profile to many observations is obviously tedious but is a problem quite suited to high-speed computers, and quite definitive results have been obtained by the authors. While application of this method results in an altitude profile of electron densities, the method is, in reality, sensitive to total electron content as well. This should become clear in the discussion below.

Following the method of Al'pert, reference is made to Fig. 4 which pictorially describes the various radio paths followed by a signal from a satellite to a ground observer under the special conditions of a circular orbit passing over the observer and a concentric, stratified ionosphere. The particular transmitting frequency used determines the maximum zenith angle,  $\theta_n$ , corresponding to radio dawn or radio set of the satellite. It can be seen that if the frequency is sufficiently great,  $\theta_0 = 90^\circ$  and the measurements become somewhat simpler since information on the angle of arrival is not then necessary. If the orbital parameters are reasonably well known, it is possible to determine the ground range,  $r_m$ , from observer to the sub-satellite point. An expression for  $r_m$  can be derived from the geometry of Fig. 4 and is

$$r_m = R_0 \theta_0 + \int_{Z_0}^{Z_c - Z_0} [1 - Z_0/R_0 - Z/R_0)(n^2(Z)[1 - Z_0/R_0 - Z/R_0]^2)^{1/2}]^{-1} dZ, \quad (8)$$

where  $n$  = index of refraction and use has been made of Snell's Law in spherical coordinates,

$$\begin{aligned} R_0 \sin \theta_0 &= (R_0 + Z_0) \sin \theta_H \\ &= n(Z)R(Z) \sin \theta(Z) = \text{constant.} \end{aligned}$$

Since  $r_m$  is the measured quantity, it is necessary to find  $Z_0$ ,  $Z_m$ , the critical frequency of the  $F_2$  layer,  $f_c$ , and the function  $n^2(Z)$ . Conventional ionospheric soundings may be used to obtain the first three unknowns, but an

<sup>7</sup> I. A. Al'pert, F. F. Dobriakova, E. F. Chudesenko, and B. S. Shapiro, "On the results of determining the electron concentration of the outer regions of the ionosphere by means of observations of the radio signals of the first satellite," *Doklady, Acad. Nauk USSR*, vol. 120, no. 4, pp. 743–746; 1958.



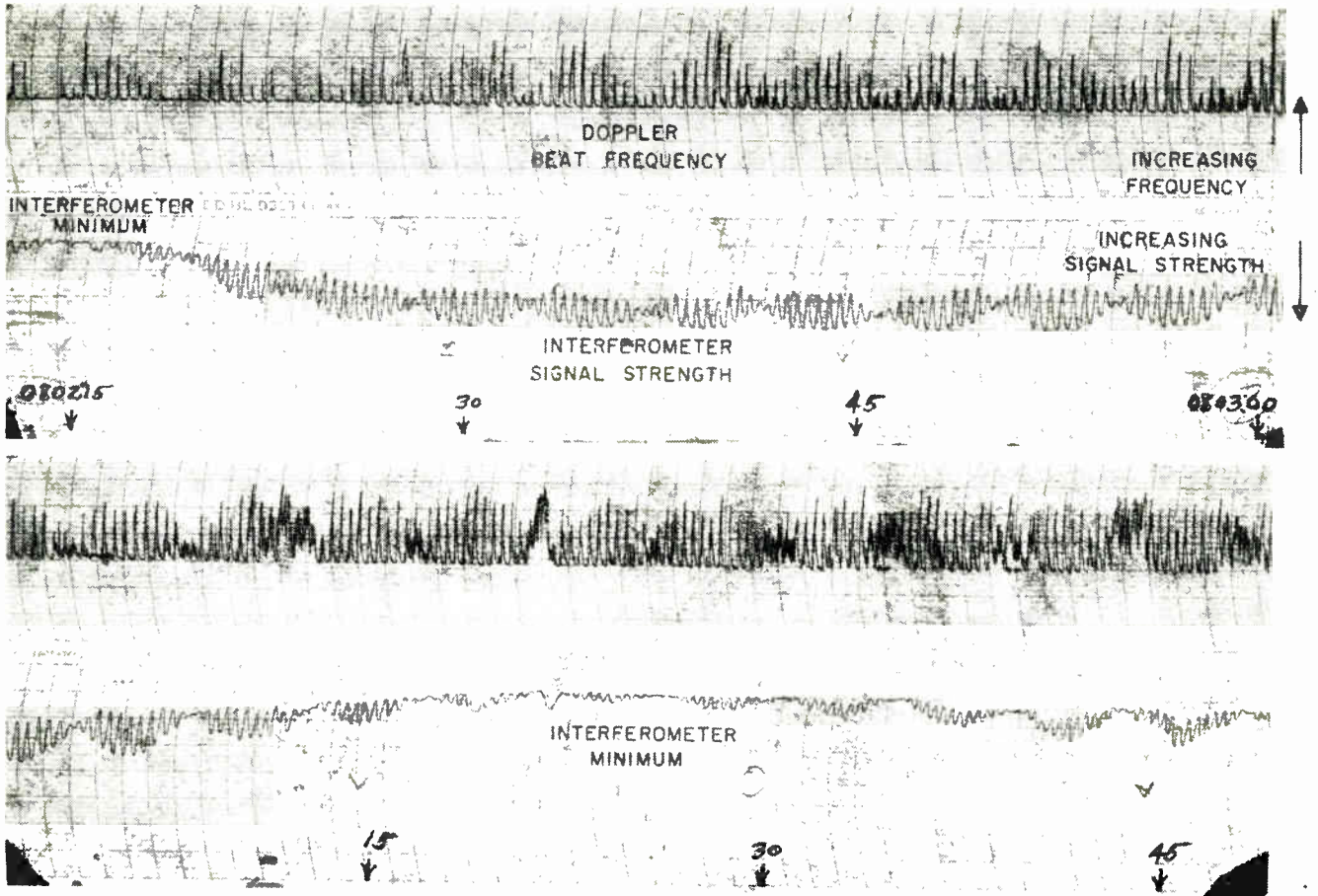

Fig. 3—Recorded radio interferometer and Doppler data for Soviet satellite 1957 Alpha-2 (October 13, 1957).

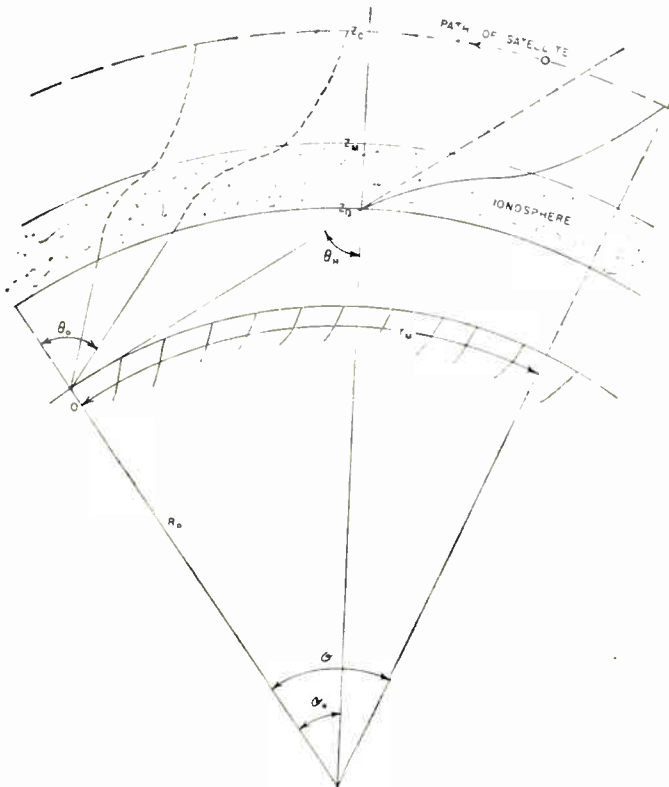

Fig. 4—Geometry of refraction paths for analyzing the radio down and radio set of satellite observations.

approximation of  $n^2(Z)$  must be made. To do this, Al'pert assumes a parabolic distribution extending to slightly above the  $F_2$  layer maximum and an exponential decrease in electron density above that point. Specifically the functions are

$$n_1^2(Z) = 1 - 2p_c^2 Z / Z_m b^2 - p_c^2 Z^2 / p^2 Z_m^2$$

$$n_2^2(Z) = 1 - 0.96(p_c^2 / p^2) \exp(-x[Z - 1.2Z_m]), \quad (9)$$

where  $p_c$  is the critical frequency of the  $F_2$  layer and  $p$  is the transmitted frequency, both in radians per second. It is the quantity  $x$ , of course, which is fitted to the measured values of  $r_m$ . From the observations on Sputnik I, Al'pert found that the value  $x = 3.5 \times 10^{-3} \text{ km}^{-1}$  was the best fit for all the experimental data in the 300 to 600-kilometer region.

The method of investigation described leads to a determination of an electron density profile. It is clear, however, that the presence of layers above the  $F_2$  layer would be undetected unless a layered structure were assumed *a priori*. The refraction of the radio wave which gives rise to the observed difference between the radio down and geometric down is, in fact, dependent upon both an idealized electron density profile and the total electron content along the radio path. Such a criticism in no way reflects, however, upon the work of Al'pert since results obtained are quite consistent with rocket measurements and defensible on theoretical grounds.

### Radio Wave Refraction Measurements

It can be seen from Fig. 4 that the presence of an ionized region between a transmitting satellite and a ground observer gives rise to refraction of the radio wave so that its angle of arrival differs from the geometric line of sight. If the radio wave frequency exceeds the plasma frequency by a factor of three or more, the difference in the angles of arrival gives a measure of the total electron content below the satellite. The input data for the measurements may be furnished by simultaneous sightings with optical and radio interferometer equipments. The formulation of this problem, as developed by Mester,<sup>8</sup> is outlined below.

Referring to the geometry in Fig. 5,

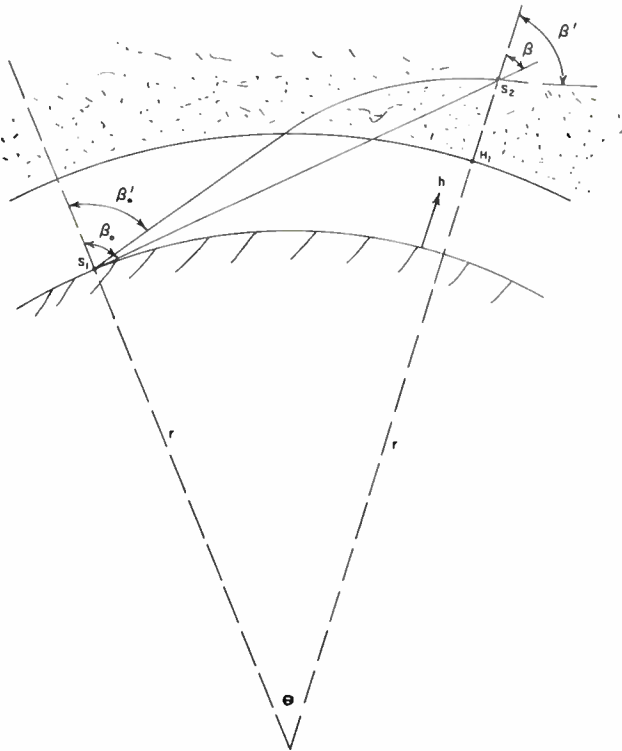

Fig. 5—Sketch of geometry used in relating refraction effects to measured angles of signal arrival.

$$\tan \beta = r d\theta / dr = r_e \sin \beta_0 (1 - r_e^2 \sin^2 \beta_0 / r^2)^{-1/2} / r \quad (10)$$

or,

$$\begin{aligned} d\theta &= r_e \sin \beta_0 dr (1 - r_e^2 \sin^2 \beta_0 / r^2)^{1/2} r^2 \\ \theta &= \beta_0 - \sin^{-1} (r_e \sin \beta_0 / r), \end{aligned} \quad (11)$$

in the absence of the ionosphere. In the presence of the ionosphere,

$$\tan \beta' = r d\theta' / dr = r_e \sin \beta_0' (1 - r_e^2 \sin^2 \beta_0' / r^2 n^2)^{-1/2} / r n \quad (12)$$

or,

$$d\theta = r_e \sin \beta_0' dr / (1 - r_e^2 \sin^2 \beta_0' / r^2 n^2)^{1/2} r^2 n$$

whence,

$$\theta = \int_{r_e}^r r_e \sin \beta_0' dr / (1 - r_e^2 \sin^2 \beta_0' / r^2 n^2)^{1/2} r^2 n. \quad (13)$$

The simultaneous solution of (10) and (13) give the relationship between the angles  $\beta_0$  and  $\beta_0'$  and some integral function of the index of refraction,  $n$ .

If, now, a flat-earth approximation and high-frequency transmission are assumed, (13) becomes,

$$X = \int_0^h \sin \beta_0' dh / (1 - \sin^2 \beta_0' / n^2)^{1/2} \quad (14)$$

in the presence of the ionosphere, and,

$$X = h \tan \beta_0 \quad (15)$$

in the absence of the ionosphere. Equating (14) and (15) and simplifying give the result,

$$\begin{aligned} h(\tan \beta_0 - \tan \beta_0') \\ = [e^2 \tan \beta_0' / 2 \cos^2 \beta_0' m p^2 \epsilon_0] \int_0^h N_e dh, \end{aligned} \quad (16)$$

where it has been assumed that

$$N_e e^2 / m p^2 \epsilon_0 \ll \cos^2 \beta_0'.$$

The assumptions of a flat earth and the limitation imposed on  $\beta_0$  obviously restricts the application of this method to small zenith angles. However, the combination of line-of-sight and radio Doppler measurements should yield information on both the total electron content below the ionosphere and electron densities at the satellite position.

### MEASUREMENTS OF ELECTRON DENSITIES AT SATELLITE ALTITUDES

The previous sections have discussed methods of measuring the total electron content below a satellite utilizing radio transmission to or from a ground observer. For many reasons, however, it is desirable to measure ionospheric characteristics in the immediate vicinity of a satellite. Such measurements can be made either with sensing equipments carried aboard the vehicle or by a careful study of the radio Doppler shift observed in radio tracking of a satellite.

#### Direct Measurements

In the early portion of this paper, reference was made to the ion-trap experiment carried aboard the Soviet satellite, Sputnik III. Recently Krassovsky<sup>9</sup> described the apparatus used and some of the results obtained. Because that paper is reproduced elsewhere in this issue, only the briefest summary will be given in the present context.

Two ion traps, one of which is shown schematically in Fig. 6, are mounted on opposite sides of the instrumented portion of Sputnik III at a distance of perhaps

<sup>9</sup> V. I. Krassovsky, "Exploration of the upper atmosphere with the help of the third Soviet Sputnik," this issue, p. 289.

<sup>8</sup> Private communication, Ballistic Res. Labs.

50 cm from the conical surface and supported by rods isolated electrically from the metallic surface of the satellite. The trap itself consists of a perforated spherical shell surrounding, but at some distance from, an inner collecting sphere. The inner sphere has a negative potential of approximately  $-150$  volts relative to the satellite surface, while the outer spherical grid has a variable potential relative to the satellite surface. This grid bias is varied in a sawtooth fashion at regular intervals. In operation, the inner sphere collects all the positive ions passing through the grid mesh, and the current measured in the circuit of this collector can be related to the density of positive ions in the surrounding plasma. Fortunately, the speed of the satellite is much greater than the average speed of thermal ions, and the relationship between collector current and plasma ion density is accordingly rather simple. The variable bias on the outer spherical grid permits a measurement of the satellite surface potential relative to the external plasma and a correction to the measured ion current; this correction is a consequence of the surface potential.

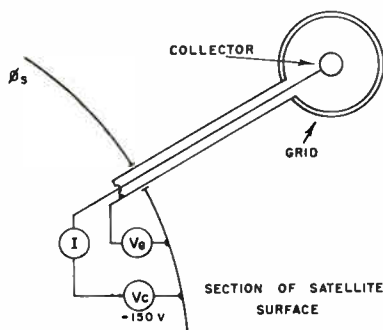

Fig. 6—Sketch of ion-trap detector used on Soviet satellite 1958- $\delta$  (Sputnik III).

The ion traps employed on Sputnik III (see Fig. 6) have given the first direct measurements of ion densities at extreme altitudes and, most significantly, at altitudes above the  $F_2$  layer maximum. The functional relationship between ion current and ion density may not be so simple as the one assumed; yet, the agreement of ion-trap data with electron densities derived by Al'pert and from an extension of rocket soundings is quite striking. The electron temperatures, however, derived from measured satellite potentials are subject to some question. A Maxwellian velocity distribution was assumed for electrons in relating kinetic temperature to the satellite surface potential. The presence of non-equilibrium high energy electrons in the atmosphere illuminated by the sun would lead to derived kinetic temperatures considerably higher than the temperature corresponding to the most probable velocity of the true distribution curve.

#### Measurements Derived from the Observed Radio Doppler Shift

All measurements of ionospheric characteristics which attempt to detect the effects of the ionosphere on radio

wave transmissions from or to a satellite in orbit are affected by the electron concentration at the satellite itself and the electron distribution along the radio path. Certain of the methods, however, are more sensitive to one or the other of these two disturbing factors. An experiment, designed to study in detail the frequency of the transmitted radio waves, is affected principally by the change in wavelength of the transmission. If the satellite is traveling in a region of high electron content, a frequency measurement is more sensitive to electron density at the satellite than to the electron content along the radio path. If, on the other hand, electron densities along the path are considerably greater than those at the satellite position, the reverse is true. The comparative magnitudes of the two effects are in turn quite dependent upon orbital characteristics and the zenith angles at which the particular measurements are made.

One method for measuring ionospheric characteristics by careful observation of the radio Doppler shift has been described in the literature<sup>3</sup> and will only be briefly outlined here. Again the assumption is made of a transmission frequency (large compared to the plasma frequency), and geometrical propagation is considered applicable. Referring to Fig. 7, it will be noted that the

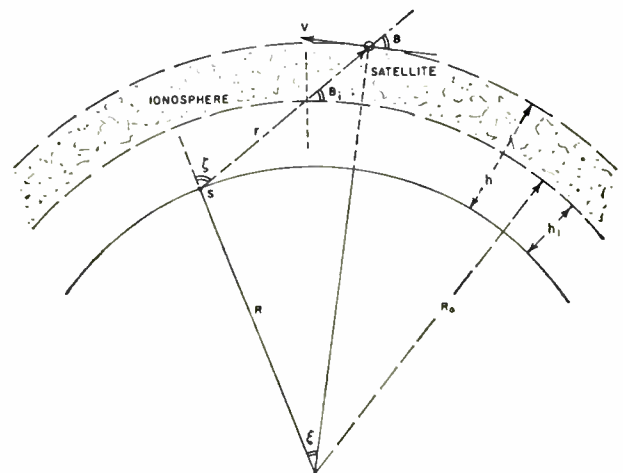

Fig. 7—Sketch of satellite passage used for derivation of ionospheric effects on Doppler tracking records.

satellite has velocity components normal to and along the radial vector  $r$ . If, now,  $\dot{r}$  is the time rate of change of  $r$ , the frequency received by a ground observer is given by

$$p' = p \left( 1 \pm \frac{\dot{r}}{c_1} - \frac{1}{2} \frac{\dot{r}^2}{c_1^2} \pm \dots \right), \quad (17)$$

where  $p$  is the transmitted frequency and  $c_1$  the velocity of radio propagation at the satellite. The algebraic sign depends on whether the satellite is approaching or receding. If  $\dot{r}$  is small compared to  $c_1$ , the Doppler frequency shift arising from the radial motion is given closely by



$$p_D = p' - p \doteq \pm p \frac{\dot{r}}{c_1} \quad (18)$$

If, now,  $p$  is known and  $\dot{r}$  can be obtained from precise orbital information, (18) can be expressed in the form,

$$c_1 = \left| \frac{p\dot{r}}{p_D} \right| \quad (19)$$

With  $n = c_0/c_1 \doteq 1 - e^2 N_e / 2p^2 m \epsilon_0$ , (19) may be solved for  $N_e$  in the form,

$$N_e = 2p^2 \epsilon_0 (p - p_D c_0 / \dot{r}) / e^2 \quad (20)$$

In general, the true frequency  $p$  is not a known frequency when the transmitter is in the satellite. It can be determined, however, that  $\dot{r} = 0$  since  $p' = p$  at that point (disregarding the relativistic transverse Doppler effect). This implies, in turn, that the stability of the transmitting frequency is very high ( $\sim 1:10^8$ ) if (20) is to be used at other points during the satellite passage. In practice, the quantity  $\dot{r}$  is quite difficult to determine with sufficient precision, and, to date, it has not been possible to determine  $N_e$  by this method using existing orbital data for the U. S. and Soviet satellites.

Referring again to Fig. 7, it is seen that the velocity of the satellite has a component normal to the radial vector,  $r$ , which changes the total path length of the radio wave through the ionosphere. As a consequence, other portions of the ionosphere contribute to changes in the observed Doppler frequency and must be considered. The phase path of the radio signal may be written,

$$\begin{aligned} \Phi &= p \int_0^r dr/c, \quad c = f(r) \\ &= (p/\sin B) \int_0^h dh/c, \quad c = f(h) \\ &= (p/c_0) \left\{ r_1 - \frac{1}{\sin B} \int_{h_1}^h dh \right\} + \frac{p}{\sin B} \int_{h_1}^h dh/c \\ \Phi &= (p/c_0) \left\{ r_1 - \frac{1}{\sin B} \int_{h_1}^h (n - 1) dh \right\}, \quad (21) \end{aligned}$$

where  $r$  is the radial distance to the satellite and  $h_1$ , the altitude of the ionosphere base. A flat-earth approximation has been made (*i.e.*,  $\sin B \neq f(h)$ ). Taking the time derivative of (21), setting  $\dot{r}_1 = 0$  since only the transverse motion is of interest and using the geometry of Fig. 7, the hitherto assumed approximation for  $n$  gives the result,

$$\begin{aligned} \dot{\Phi} &= - \frac{e^2}{p m c_0 \epsilon_0} \left[ \left( \frac{R}{r_1} \right)^2 \left\{ 1 - \left( \frac{R}{r_1} \right)^2 \sin^2 \xi \right\}^{-1/2} \right. \\ &\quad \left. \sin \xi \cos \xi \int_{h_1}^h N_e dh \right] \quad (22) \end{aligned}$$

The above expression may be considered an error frequency which must be added to the  $p_0$  of (20) to give the proper value for  $N_e$ . The algebraic sign of this correction

is always of such a nature as to reduce the ionospheric effects arising from radial motion. In Fig. 8 is shown the predicted ionospheric effects on the radio Doppler signal for a typical ionosphere, a circular orbit at 300-km altitude and a transmitting frequency of 74 mc.

It should be stressed that the expressions above are of a descriptive nature only. Under general conditions the flat-earth approximation cannot be used and refraction of the radio wave must be taken into account. However, this does give a method for extracting information on electron densities at the satellite position if an independent measure of the total electron content below the satellite is available, or if observations are restricted to points along the orbit where the transverse motion is small compared to the radial motion.

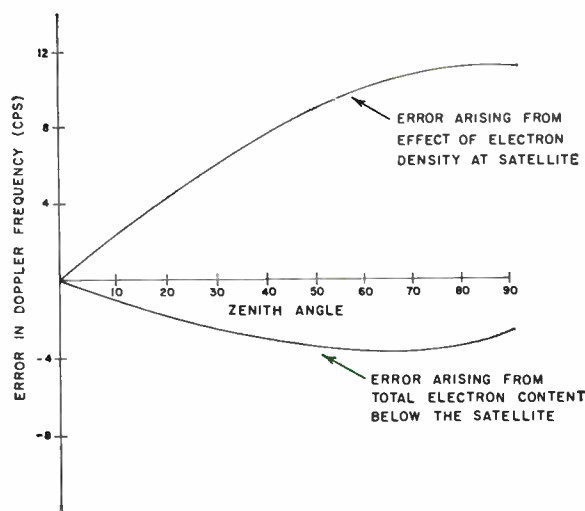

Fig. 8—Representative Doppler errors introduced by the ionosphere for a 300-km circular orbit and a transmitting frequency of 74 mc.

A second method for studying ionospheric characteristics with Doppler shift techniques might be one employing harmonically related two-frequency transmissions in a fashion analogous to Seddon's<sup>2</sup> rocket experiment. As in the rocket experiment, one of the frequencies must be relatively unaffected by the ionosphere. Use of this method eliminates the requirement for high stability in the transmitted frequencies but introduces a difficulty not easily susceptible to analysis. Unfortunately, the satellite velocity component along the two ray paths is slightly different because of the unequal refraction effects, and observed differences in Doppler frequency cannot be simply related to electron densities at the satellite. If, however, one of the frequencies is sufficiently high, geometric propagation may be assumed for one of the paths, and the analysis becomes similar to that described above.

#### STUDIES OF HORIZONTAL INHOMOGENEITIES

The large horizontal motions of an artificial transmitting satellite above and through the regions of high ionization permit a study of quite local variations in

electron density. In principle the observing equipment consists of multiple receivers spaced at intervals of a few to perhaps hundreds of miles. The quantities to be measured are principally the angle of arrival of the radio waves and the amplitude of the received signals. A rather fast time response is desirable in the recording equipment because of the high satellite speeds ( $\sim 8$  km) and the apparently small size ( $\sim 1$  km) of local scattering areas.

The general theory of scattering by local variations of the refractive index is rather complicated and will not be discussed here. Bergman<sup>10</sup> and Booker<sup>11</sup> have treated certain of the theoretical aspects of atmospheric scattering. Pfister<sup>12</sup> has discussed a specific proposal for utilizing a satellite for the study of ionospheric fine structure. Warwick<sup>13</sup> has published a preliminary analysis of radio observations on the first two Soviet satellites and presents a number of the interferometer and receiver records with qualitative comments. The above authors should serve as references for a more detailed consideration of this kind of ionospheric measurement.

#### ORBITAL CONSIDERATIONS

One of the great advantages of satellites as tools for geophysical research is the long duration of flight time through the regions of interest. If the orbit of a satellite passes over the geographical poles, the geographical area of coverage is maximized. This permits the very desirable study of latitude and diurnal variations of geophysical phenomena and, if the flight is of sufficient duration, the seasonal variations as well. For studies of the ionosphere, an eccentric orbit with perigee close to or below the level of  $F_2$  layer maximum gives the most sensitive measure of the vertical variations in electron and ion densities. This argument is particularly valid for

measurements based on the observed Doppler shift of radio transmissions.

At the present time, launching considerations for U. S. satellites limit the maximum orbital inclination possible so that the area coverage for ionospheric information is limited. Because the earth is ellipsoidal in shape, the line of apsides rotate with the rotational rate dependent on the orbital inclination. For the purposes of ionospheric and other geophysical exploration, this rotation is desirable since over a long period of time the atmospheric volume coverage at the various latitudes is maximized. However, this change in latitude of the orbital perigee is not desirable from the standpoint of transmission of information if the receiving points are in a restricted geographical area. For satellites which have already been launched, signal strength at the ground varies by a factor of 100 from perigee to apogee distance. As a consequence, this latter consideration may make it necessary to restrict the movement of perigee so that it occurs at approximately the same geographical latitude during each passage. A perusal of the orbital equations of motion for a small body above an oblate spheroid shows that the rotation of the line of apsides becomes zero for an inclination of approximately  $64^\circ$ . For greater and lesser inclinations, the rotation occurs. It is probable that the orbital inclination chosen by the Soviets arose from just this consideration.

#### POSTSCRIPT

The materials summarized in the foregoing sections should be considered as introductory remarks to the subject of ionospheric exploration using satellite vehicles. With the possible exception of the Soviets, the launching of the first satellites found the scientific community in a state of general unpreparedness for using this new tool efficiently in a systematic study of the ionosphere. As a result, the analyses of early tracking data are just now being completed and little information on the ionospheric structure inferred from these data is available. This situation has been remedied and a well-organized effort is in progress pointed toward the design of new experiments for direct "on-board" measurements and for full utilization of radio transmission in the less direct measurements.

<sup>10</sup> P. G. Bergman, "Propagation of radiation in a medium with random inhomogeneities," *Phys. Rev.*, vol. 70, pp. 486-492; October, 1946.

<sup>11</sup> H. G. Booker and W. E. Gordon, "A theory of radio scattering in the troposphere," *Proc. IRE*, vol. 38, pp. 401-412; April, 1950.

<sup>12</sup> W. Pfister, "Study of the fine structure and irregularities of the ionosphere with rockets and satellites," in "Scientific Uses of Earth Satellites," J. A. Van Allen, (ed.), University of Michigan Press, Ann Arbor, Mich., pp. 283-291; 1956.

<sup>13</sup> J. W. Warwick, "Radio Observations of Soviet Satellites 1957 Alpha 2 and 1957 Beta 1," *Natl. Acad. Sci.*, Washington, D. C., IGY Satellite Rep. Ser. No. 5; July, 1958.

# Exploration of the Upper Atmosphere with the Help of the Third Soviet Sputnik\*

V. I. KRASSOVSKY†

**Summary**—The creation of the Soviet artificial sputniks of the Earth, and the physical questions to be investigated by them are first discussed. The instruments used on the third sputnik and the problems solved with them are then described; the results obtained are presented simultaneously.

## INTRODUCTION

THE achievements of the Soviet Union in rocketry have laid the ground for important new explorations of the upper atmosphere. Soviet engineers and scientists started constructing gigantic artificial "sputniks" of the Earth. Geophysicists engaged in the study of the upper atmosphere thereby obtained the opportunity of installing instruments in the sputniks to investigate various properties of the upper atmosphere and its interaction with the agents lying beyond the Earth, such as hard electromagnetic and corpuscular emission from the Sun, interplanetary dust and gaseous medium, and magnetic fields related to it, as well as cosmic rays and other emissions of the Universe not reaching the Earth's surface. By that time, Soviet geophysicists were experienced in the investigation of the upper atmosphere by means of rockets.

The construction of the first Soviet artificial sputniks marked a new era, the era of an assault to master completely the secrets of the upper atmosphere and interplanetary space, to create continuously working laboratories above the dense layers of the Earth's atmosphere. Each sputnik enriched our knowledge of the upper atmosphere and cosmic space. Each new success went beyond its predecessor. With the first three Soviet sputniks of the Earth, extensive and valuable data were obtained and instruments such as a remembering system, radiotelemetry, and provision of the most complicated research equipment were mastered. Solar batteries were also tested; they will allow in the future the setting up of a sputnik-laboratory with a very long period of service. The problems connected with the temperature regime inside the sputnik as well as outside, together with other circumstances, were solved by means of these first artificial sputniks.

The purpose of the present paper is to describe the geophysical investigation recently carried out in the Soviet Union with the help of the third artificial sputnik. The scientific program and the instrumentation for the research were worked out by a large group of scientific

workers and engineers. Participating in the construction work of the sputniks was a wide circle of Soviet scientists, including large numbers of research workers, engineers, and workers of various research institutions, design offices, and industrial enterprises. All this accomplishment was due to the high level of Soviet economics and industry.

## THE QUESTIONS TO BE INVESTIGATED

Before coming to the description of the geophysical instruments installed in the third artificial sputnik and presenting some preliminary results of the investigations carried out with it, I shall reiterate the principal vague questions with which the research workers were faced at the very start of the work. It is impossible in the present paper to dwell on all the scientific investigations connected with the sputniks. Some, which might serve as the subjects of separate scientific contributions, will be omitted here. These include the investigation of cosmic rays and of radio-transmission from the sputniks, fields in which the Soviet Union has in its possession very extensive data.

Most essential seemed to be the question of the sources of energy and heating of the upper atmosphere. As is well known, the upper atmosphere is strongly cooled by microwave atomic oxygen emission. The greatest outflow of heat occurs in the zone of maximum concentration of atomic oxygen somewhat above the 100-km level. On the other hand, it has been recently concluded that the temperature increases continuously with height, the gradient being about  $5^{\circ}\text{K}/\text{km}$ . With such a gradient, there must exist, due to heat conductivity, a flow of heat estimated as  $0.5 \text{ erg sec}^{-1} \text{ cm}^{-2}$  down from the *F* region of the ionosphere at a height of 300 km. But hard electromagnetic solar radiation which could be absorbed in the earth's atmosphere above this level was proved to be essentially less than the indicated value. Different hypotheses have been set forth to explain the heating of the upper atmosphere. For example, it has been postulated that the heating is due to absorption of infrasonic waves from the troposphere, or that the upper atmosphere is heated by a hot interplanetary gas which is the continuation of the solar corona. The temperature of the interplanetary medium is postulated to reach some hundreds of thousand degrees K. It seems to me that in explaining the heating of the upper atmosphere, one should keep in mind the possibility of its being heated at the expense of electric currents in the ionosphere. As is known, one of the varieties of such currents can arise as a result of circulation of electroconductivity

\* Original manuscript received by the IRE, November 10, 1958. This paper was presented at the Ninth Congress of the International Astronautical Federation, Amsterdam, The Netherlands, August, 1958.

† Institute of Physics of the Atmosphere, Bolshaja Gruzinskajala, Moscow, U.S.S.R.



of the air in the magnetic field of the Earth. Important currents can be induced also due to the motion of the Earth through the interplanetary ionized gas and solar corpuscular fluxes with magnetic fields frozen into them. Such currents can arise in the electroconductive contours formed along the magnetic force lines in the outer atmosphere and in the lower layers of the ionosphere along the meridians. The boundaries of such electroconductive contours can lie at some Earth radii from its center and their cross section can be so large that they may give rise to large electromotive forces even during small short-period variations of the geomagnetic field. In this case, the electroconductivity in the direction perpendicular to the magnetic force lines will be of little significance, owing to high ionization and small density of the outer atmosphere. However, despite the hypotheses indicated above, a point of view completely neglecting the above-mentioned sources had been generally accepted. The temperature of the upper atmosphere at the level of approximately 200 km and higher was believed to be considerably less than 1000°K. This view had been confirmed by many primary rocket experiments. For the last year or two, the so-called "rocket-models" of a cold isothermal region of the atmosphere with small density were generally in use.

Numerous observations of the night sky emission, twilight emission, flares, aurorae, meteors, the ionosphere, and variable magnetic field of the earth, as well as recent investigations of the polar atmosphere with the help of rockets, have made it possible to assume that the Earth's atmosphere may be subjected to solar and lunar tides; it may extend while heating during the day-time and condense while cooling at night. All of these changes are more intensive in the polar regions. Latitudinal and seasonal variations have also been found, but in view of the absence of direct observations of all of the phenomena mentioned, it has not been possible to determine the regularity.

There has been much vagueness on the question of an allotropic structure of the upper atmosphere, a diffusion division of molecules and atoms in the gravitational field of the Earth. There has been no clarity of the nature of ions and distribution of ionization with altitude. The questions about the sources of the ionization of the upper atmosphere remain still unsolved.

Meteors intrude from interplanetary space into the upper atmosphere. Their penetration is connected with the formation of columns of ionized gas in the upper atmosphere which reflect radio waves. However, the so-called micrometeorites give rise to a feeble ionization propagating throughout extensive volumes of the upper atmosphere. Sporadic layers changing the conditions of radio wave propagation arise in the atmosphere as a result of their intrusion. In view of this, the investigation of micrometeorites is of great interest. Besides being of a purely geophysical interest, they are of importance for construction and flights of the artificial Earth-sputniks, because the sputniks might be destroyed by them.

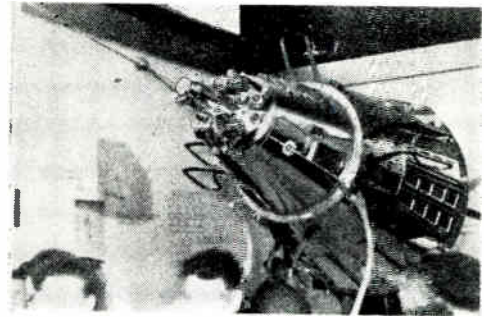

Fig. 1—The third Soviet sputnik.

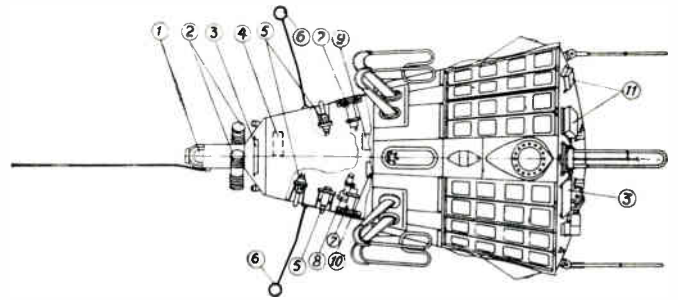

Fig. 2—Scientific equipment of Sputnik III. (1) Magnetometer. (2) Photomultipliers to register corpuscular radiation of the sun. (3) Solar batteries. (4) Instrument to register photons in cosmic rays. (5) Magnetic and ionization manometers to measure pressure in the upper atmosphere. (6) Ion traps. (7) Electrostatic fluxmeters to measure electrical charge and strength of electrostatic field. (8) Mass-spectrometric tube to register composition of ions at high altitudes. (9) Instrument to register heavy nuclei in cosmic rays. (10) Instrument to measure intensity of primary cosmic radiation. (11) Devices to register micrometeors. Electronic units of scientific equipment, radio measuring and radiotelemetering systems, time programming device, temperature regulating and measuring devices, and electrochemical batteries are inside the body of the sputnik and are not seen in the diagram.

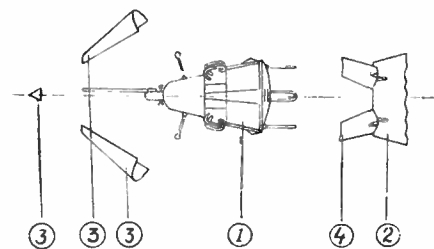

Fig. 3—Separation of Sputnik III from the carrier rocket. (1) Sputnik. (2) Carrier rocket. (3) Separable protective cone. (4) Separable shields.

### THE THIRD SOVIET SPUTNIK

The third Soviet sputnik is the first complex laboratory for research of various properties of the upper atmosphere. Fig. 1 is a picture of the third Soviet sputnik, and the captions of Fig. 2 describe the research instruments installed. Fig. 3 shows the separation of the sputnik from its carrier rocket.

By now, extensive observational material has been accumulated with the help of the third sputnik. These data are being processed, and as it will take much time to complete the work we have at our disposal only pre-

liminary information. To make the report more relevant, I shall simultaneously describe the instruments, the problems solved with their help, and the results obtained.

#### RETARDATION

Before the launching of the first Soviet sputnik, the aforementioned "rocket-model" of the atmosphere was expected to be confirmed. But the density data of nearly  $3 \times 10^{-13}$  gr  $\text{cm}^{-3}$  at the height of 220 km obtained with the help of the first Soviet sputniks from their retardation made an essential change in the accepted view of the density, temperature, and dynamics of the upper atmosphere. The retarding of the sputnik might give some indication of the fact that at a level of 220 km the density is greater during the day than during the night and is greater in the polar regions than in the equatorial regions. The upper atmosphere was previously expected to undergo thermal diurnal and tidal semidiurnal variations; the latter were thought to be more essential. The information obtained with the sputnik allows one to assume for the time being only a diurnal variation rhythm. It is quite difficult to assume that the main constituent of the atmosphere at 200 km is hydrogen, and one cannot explain the large height of the upper atmosphere by a small molecular weight. The observed small retardation of the sputniks can be explained as yet only by a higher temperature of the upper atmosphere than has been supposed in the "rocket-models." The observations of the retardation of the artificial sputniks confirm the former model of a hot and dense upper atmosphere imparting a more definite correspondence to the real value.

#### MANOMETERS

New information about the upper atmosphere obtained from the data of the first sputnik's retardation made the above-mentioned question of the sources of upper atmosphere heating even more urgent, since the temperature increase at 200 km is connected with that of the temperature gradient, and consequently, with the increase of a heat flux down from the upper layers of the atmosphere. Thus test work for a method to determine the density of the upper atmosphere by some other means was of particular interest. For this purpose the third sputnik was equipped with ionization and magnetic manometers. Determination of the density of the upper atmosphere with manometers is interesting not only for comparison of manometric data with the data obtained from the sputnik's retardation but also as a means of clarifying some indefinite results which were obtained at the primary determination of the upper atmosphere at the level of 200 km with the help of manometers in rockets. The main difficulty in processing the data obtained with ionization manometers is to gain absolute calibration of the manometers, for laboratory conditions are not equivalent to those at levels greater than 100 km. The atmospheric gases exist at these levels mostly in a dissociated atomic state. Besides that, the

relative composition of the elements of the upper atmosphere is not known. Dissociated atomic gases getting into a manometer can give rise to molecules such as nitric oxide which are missing in the ground layers of atmosphere. The comparison of the manometric data with data obtained from a sputnik's retardation can provide a more accurate calibration of ionization manometers. The absolute and relative composition of the atmosphere is not presumed to undergo any essential change with slight changes of altitude.

Ionization manometers can provide determination of scale-heights at different layers of the upper atmosphere, a thing that is difficult to do by observing a sputnik's retardation. Manometric investigations by the sputnik itself have value also in determining the degree of contamination of the manometers' volumes with gas excreted by the sputnik's body. Because the sputnik stays in the upper atmosphere for a far longer period than a rocket, it becomes possible to determine the velocity of gas excretion of the sputnik's outside surface and to determine the moment when the contamination stops influencing the manometers' readings and when they begin to reflect the actual properties of the upper atmosphere.

Valuable information about the density of the atmosphere inside the manometers has been obtained by the third sputnik. It makes possible a conclusion about the density of the outer atmosphere too. It may be considered established that after several revolutions of the sputnik around the earth, the excretion of gases from the sputnik's surface becomes insignificant, since by this time the manometric data seem to coincide with the data obtained from the observation of the sputnik's retardation. So it is established that scale-height increases with altitude. There is some information about atmospheric density obtained with the help of manometers on the third artificial sputnik. At a height of 260 km, the density is equal to  $10^{-13}$  gr  $\text{cm}^{-3}$ ; at the height of 355 km,  $9 \times 10^{-15}$  gr  $\text{cm}^{-3}$ .

#### MASS SPECTROMETER

The third Soviet sputnik was equipped with a Benet mass spectrometer for determining the nature of atmospheric ions with a mass-number of 6 to 50 units. Before being used in the sputnik this instrument was tested in rockets. Ions of nitric oxide are the principal constituent at a height of about 250 km. This does not mean, however, that this ion appears as a result of ionization of neutral molecules of nitric oxide. As a series of theoretical and laboratory investigations show, the ionized nitric oxide molecules arise as a result of a reaction of oxygen ions with neutral nitrogen molecules, or as a result of a reaction of oxygen atoms with ionized molecules of nitrogen. The observation of nitric oxide ions indicates the existence of nitrogen molecules at heights up to 250 km. However, as the investigations by the third sputnik show, atomic ions of oxygen and nitrogen are the principal constituents above 250 km,

the ions of atomic oxygen being predominant. This result indicates that the upper atmosphere at 250 km and higher is mainly of atomic composition.

The preponderance of oxygen ions over nitrogen ions points to the fact that the oxygen atom is easily ionized. This circumstance reduces the selection of possible sources of ionization of the upper atmosphere.

#### RADIO INTERFEROMETER

Even before the third Soviet sputnik was launched it was found with the help of a high altitude rocket that the electron concentration above the level of maximum ionization of the *F* region slowly decreases with the increasing height. An ultrashort wave dispersion interferometer was used for this purpose. This experiment showed that the electron density at the height of 475 km is  $1.0 \times 10^6$  e cm<sup>-3</sup> as compared to the density  $1.8 \times 10^6$  e cm<sup>-3</sup> at the height of 290 km. A detailed distribution of the electron density is shown in Fig. 4. The illustrated material shows that the scale height for the electrons in the upper atmosphere above the level of maximum electron concentration is very large.

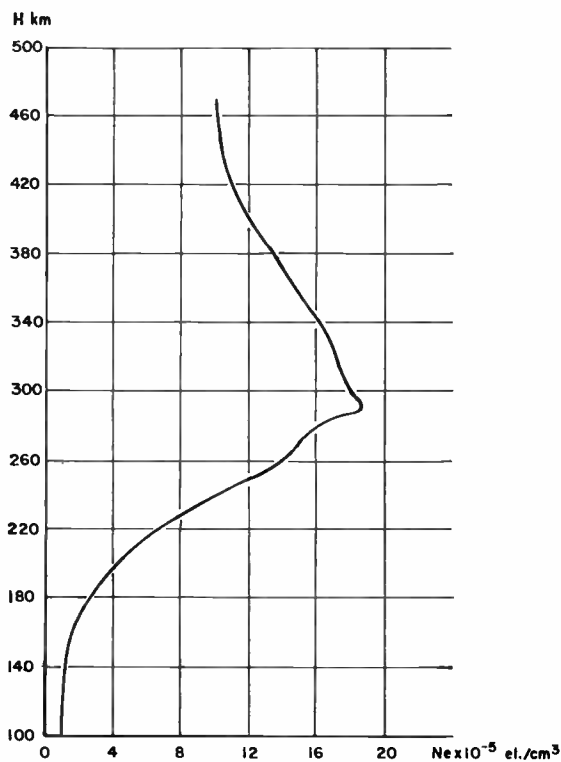

Fig. 4—Distribution of electron concentration with height as observed by means of a rocket during 1958.

#### ION TRAPS

For the purpose of furthering the investigation of ionization distribution with height, the third Soviet sputnik was equipped with an instrument for direct measurement of the concentration of charged particles in the ionosphere. The readings of the instrument were transmitted to the Earth with a radiotelemetering system. The uniqueness of experiments of this kind lies in

the fact that the results are independent of the characteristics of the integrated thickness of the atmosphere and the processes occurring within it. The instrument for measuring positive ions which was installed in the sputnik consists of two spherical-grid ion-traps attached to thin bars and mounted on diametrically opposite sides of the sputnik. There is also an electronic package of two amplifier-transformers and a generator of saw-tooth voltage impulses. Each of the ion traps represents a spherical grid, in the center of which there is a spherical collector. A negative voltage is applied to the collector with respect to the covering grid ( $\sim -150$  v). The electric field gathers to the collector all positive ions which are trapped and drives out all the negative ones.

The collector is connected through a resistance to the conductive surface of the sputnik. The current of the positive ions gathered on the collector flows to the sputnik's surface causing a corresponding increase in the electron current to the sputnik's surface from the surrounding medium. The voltage across the input resistance goes to the amplifier input; its output is switched to the radiotelemetric system. The details of the instrument are shown in Figs. 5 and 6. The concentration of positive ions can be determined according to the equation given in Appendix I.

Due to different causes, such as the different electron and ion velocities, electron photoemission from the sputnik's surface, etc., the sputnik can acquire an electrical charge and, consequently, the potential of the covering grid of the trap with regard to the medium around will differ from zero. For the purpose of estimating the effect of the sputnik's electrical charge on the observational results, the saw-tooth impulses are applied between the covering grid and the sputnik's surface.

At the moment of applying the saw-tooth impulses, simultaneous telemetric records of the trap collector currents and the voltage between the trap and the sputnik surface make it possible to get the volt-ampere characteristics of the collector current with regard to the voltage between the trap cover grid and the sputnik's surface. Their expected character is shown in Fig. 7. The point in which the collector current stops decreasing with the increase of the potential of the trap cover grid, with respect to the surrounding medium, corresponds to the retardation potential of the ions which can be determined on the basis of the well-known formula shown in Appendix II. The impulse voltage of the generator and the retardation potential of the ions being known, one can find a point in the curve indicated corresponding to the state when the potential of the covering grid of the trap with regard to the medium around is equal to zero. At that time the density of the ion flow will show the actual density in the ionosphere. This makes it possible to determine the actual ion current between two neighboring saw-tooth impulses. The current corresponding to the retardation potential is a residual or "dark" current created by parasitic processes if they occur. Every two seconds, two bipolar impulses



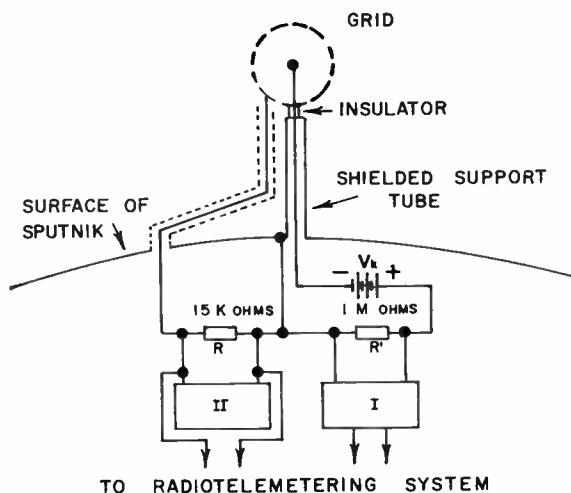

Fig. 5—Plan of the equipment for determination of positive ion concentration.

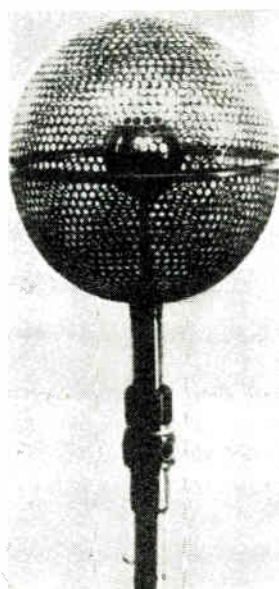

Fig. 6—The ion trap.

of voltage with respect to the sputnik's surface, of 0.2 sec duration, were given to the covering grids of the ion traps.

The recording of the collector currents while the voltage impulses are not on the traps makes it possible to measure the range of small-scale inhomogeneities of ionization.

For the time being, the processing of the experimental results is in its initial stage, and therefore only some preliminary information characterizing the measurements can be given. We confine ourselves to consideration of the measurements at two points of the sputnik's orbit made during the first day of flight. These values are typical although numerically smaller ones are also observed.

Fig. 8 shows the volt-ampere characteristics of the collector currents of the traps upon the voltage at the spherical grid-coverings of the traps at a height of 795 km on May 15, 1958, 5-6 hours after noon in middle

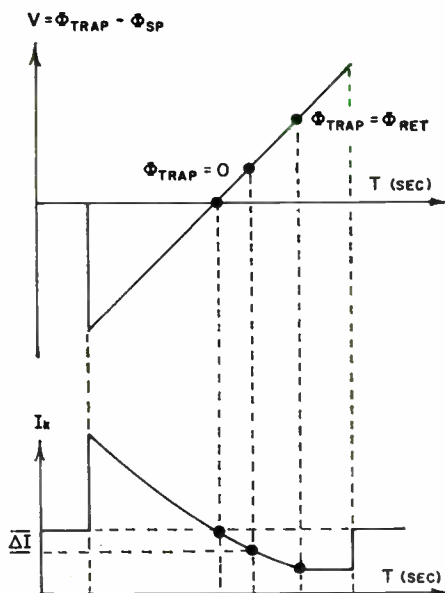

Fig. 7—Expected characteristics of the trap.

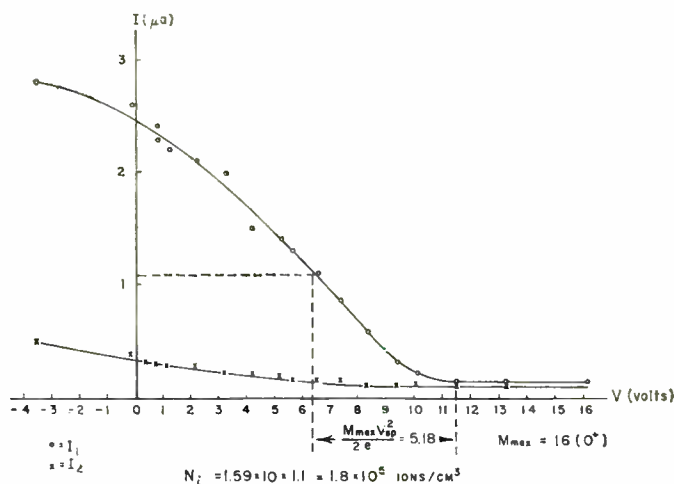

Fig. 8—Volt-ampere characteristic of the ion trap.

latitudes. The character of the dependence is that which was expected. One of the ion traps at the moment considered was within the rarefied region behind the sputnik and, due to that fact, the ion current was too small. The points of full retardation of the positive ions can be noted on the characteristics. Considering ions of the atmospheric oxygen to be the heaviest ones at a given height (atomic mass = 16) and considering consequently the ion kinetic energy at the moment of retardation to be 5.1 ev it becomes possible to determine that the potential of the trap cover is equal to the surrounding plasma potential, the voltage = 6.4 v with respect to the cover being given. Consequently, the negative potential of the sputnik's surface with respect to the plasma equals 6.4 v. This potential of the sputnik, without taking into account the photo-effect, can occur with the electron effective temperature not lower than 15,000°K. The concentration of the positive ions determined according to the current corresponding to zero potential

of the trap cover with respect to the plasma is equal to  $1.8 \times 10^5$  ions  $\text{cm}^{-3}$ . As another example, the volt-ampere characteristics which were obtained at a height of 242 km in middle latitudes 1–2 hours before noon on May 15, 1958, can be drawn. In this case, at a height of 242 km, the positive ion concentration proved to be equal to  $5.2 \times 10^5$  ions  $\text{cm}^{-3}$ . The negative potential of the sputnik is approximately equal to 2 v and the effective electron temperature is  $\sim 7000^\circ\text{K}$ . The information obtained is of great interest to the physics of the upper atmosphere. The large scale-height for electrons above the  $F_2$  layer, as well as the high electron effective temperature, agree well with a strongly heated upper atmosphere with a large scale-height which results from observations of the sputnik's retardation. One notes with much interest the absence of thermodynamical equilibrium between the electrons and ions of the upper atmosphere. It is quite probable that the electrons of the outer atmosphere are accelerated by the short-period, variable geomagnetic fields created by the circulation of the atmosphere or by motion of the inhomogeneously magnetized interplanetary medium. Extra energy of the electrons can cause general heating of the upper atmosphere. Here we observe phenomena very similar to those occurring in gaseous discharges. Since the mean free path length in the upper atmosphere is very large, even variable electromagnetic fields of small intensity are sufficient to give large energy to electrons.

#### CORPUSCULE DETECTOR

A series of observations of extraterrestrial agents was carried out by means of the third sputnik. For instance, hard electromagnetic solar, cosmic, X-ray, and  $\gamma$ -ray emission were investigated. The experiment was intended to work due to the absence of parasitic background created by cosmic rays in the low, dense layers of the atmosphere. And at the same time there was an experiment in the sputnik to look for electron corpuscule fluxes of large intensity. The existence of intensive electron fluxes causes great difficulties for the experiment previously described. However, some theoretical considerations arising in the processing of the observational material on aurorae point to their existence. This fact justifies an attempt to find the electron fluxes.

A new experiment was carried out in the third Soviet sputnik. The instruments used in the experiment are shown in Fig. 9. Two fluorescent screens made of ZnS (Ag) zinc sulfide activated by silver ( $2 \times 10^{-3}$  gr  $\text{cm}^{-2}$ ) covered with aluminum foils of different thickness ( $8 \times 10^{-4}$  gr  $\text{cm}^{-2}$  and  $4 \times 10^{-4}$  gr  $\text{cm}^{-2}$ ) were used as indicators of hard electrons. There were three aluminum diaphragms 5 mm thick in front of screens 5 cm in diameter. The diaphragms had an inlet providing the capture of corpuscules within a solid angle of  $\frac{1}{4}$  steradian. The emission of the fluorescent screens was recorded with the help of photomultipliers. The electrical signals produced by them were transmitted to the remembering device and then to the Earth by a radio telemetering system.

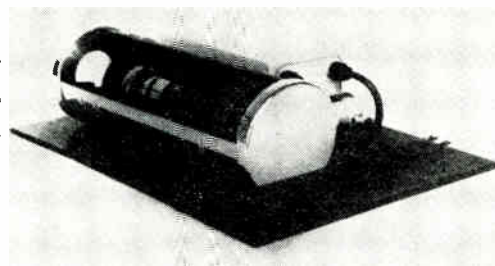

Fig. 9—The instrument used for corpuscule observations.

The characteristic of the amplifier system was made nonlinear so that the recording of electrons with energy of  $10^4$  ev and current of  $10^{-11}$  to  $10^{-8}$  a  $\text{cm}^{-2}$  falling perpendicular to the fluorescent screen might be accommodated, the indicators having a thick foil.

A thin foil had some micropores which let the sunlight pass through. For this reason, when an indicator with such a foil was directed to the Sun, it produced a mid-scale reading. As the sputnik rotated, the photocurrent due to the solar electromagnetic radiation had to be symmetrical with regard to its maximum. A knowledge of these circumstances is necessary for the estimation of the corpuscular effect on the fluorescent screen with a thin foil. The indicator with a thick foil directed to the Sun gave no signal currents.

Intensive signals were recorded by both indicators during the magnetic disturbances on May 15, 1958. The signals sometimes went off the scale and rarely were there no signals at all near the sensitivity threshold. The signal amplitude seems to be larger in the high latitudes than in the equatorial ones, and seems to be larger at greater height as compared with the lower ones. In many cases there appeared intensive signals with a sudden start or a sudden stop within a second. The signal intensity varied continuously.

The processing of the records obtained has not been completed nor have the records been compared with the other observations. In view of this, we have no final opinion.

In principle one can make an attempt to explain the signals recorded by irradiation of the screen, with ions (protons, for instance), or X rays, or electrons if all of these agents have energies of some kev to some hundred kev. Since it is difficult to imply a great intensity of protons or electrons, preference should be given to an agent which is associated with the least energy flow. That is why not very hard electrons seem to be most attractive.

In those cases when the emission intensity of the thin fluorescent screen was somewhat lower than the one with the thick foil, the electron energy might be supposed not to exceed  $10^4$  ev and it might be even less than this. However, it should be noted that the instruments used could not have discovered harder electrons if their fraction were less than  $\frac{1}{4}$  of softer electrons. Thus when the electron flux exceeded  $4 \times 10^3$  erg  $\text{sec}^{-1}$   $\text{cm}^{-2}$

steradian<sup>-1</sup>, the instrument was ineffective. The electron flux at that moment was at least a thousand times greater than the flux corresponding to the minimum sensitivity of the instrument. Such an intensive irradiation undoubtedly will make the investigation of solar X-ray radiation and cosmic  $\gamma$ -radiation more difficult. The X-ray radiation of electrons may be dangerous for living beings that have to travel in the upper atmosphere for a long time without special defense. On the other hand, powerful electron fluxes can strongly heat the upper atmosphere increasing its scale height. Many new data about the upper atmosphere are, undoubtedly, of great interest.

It is not yet time to put forward my definite hypothesis on the origin of the observed corpuscles. I confine myself to some short comments. The usual time delay of geomagnetic disturbances after the passage across the center of the Sun of any characteristic formation of solar activity, does not allow one to assume that the electrons with energy of some kev to some hundred kev might be solar corpuscles. It is also difficult to assume that these electrons were formed near the Earth due to the energy transformation of the primary corpuscles, protons having a speed of about  $2 \times 10^8$  cm sec<sup>-1</sup>. To explain the indicated energy fluxes of more than  $4 \times 10^3$  erg sec<sup>-1</sup> cm<sup>-2</sup> steradian<sup>-1</sup>, it is required that the proton density of the primary fluxes should be about  $4 \times 10^3$  cm<sup>-3</sup>, but this has not yet been found in studies of the auroral hydrogen emission.

It is of interest to point to the possibility of explaining the observed phenomena by acceleration of the electrons in the outer atmosphere (in the conductive chain formed along the Earth's magnetic force lines in the outer atmosphere as well as in the ionosphere) due to variable magnetic fields frozen into the solar corpuscular fluxes. The faster electrons are expected in this case to get into the polar regions rather than into low latitude regions, as the polar regions are related to a contour of a large area. The increase of the electron fluxes during the day-time might be explained by the increase of ionization on the exosphere's boundary. As a result of the increase of ionization, a great number of ionized particles may get into the outer atmosphere. It may also be due to magnetic pulsations, which are more intensive during the daytime. Acquiring some speed, the electrons may oscillate along the Earth's crooked magnetic force lines.

It is also of interest to note that these data are fully confirmed by the data obtained with the instrument intended for discovering extraterrestrial X-ray and  $\gamma$ -ray radiation. The parasitic X-ray emission arising from the bombardment of the sputnik's surface by fast electrons makes it impossible to observe the expected ambient radiation.

#### MICROMETEORITE DETECTOR

The third Soviet sputnik was equipped also with instruments for recording collisions with micrometeorites.

The instrument is shown in Fig. 10. It consists of a ballistic piezo-indicator made of ammonium phosphate and an amplifier-transformer. Piezo-indicators are used for measuring impulses of  $10^{-1}$  to  $10^3$  gr cm sec<sup>-1</sup>. The amplifier-transformer is used to distribute, according to the amplitude, the voltage coming from the piezoindicator as short-time, decreasing oscillations. It also counts the number of impulses in each amplitude range. The indicators used make it possible to measure particles with a mass of  $10^{-9}$  gr and larger.

When such instruments were installed on rockets, the results showed the number of collisions with micrometeorites is 50/m<sup>2</sup>/sec at heights of 150–300 km. The

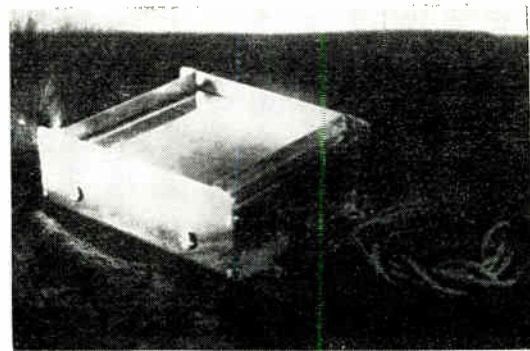

Fig. 10—The instruments used for micrometeorite observations.

third Soviet sputnik helped us to obtain for the first time extensive information about collisions with micrometeorites up to the height of 1000 km. The data are being processed and the results ready by now confirm those obtained with rocket investigations.

#### MAGNETOMETER

The third Soviet sputnik was equipped also with a magnetometer for measuring the magnetic field of the Earth at large heights. The instrument was also used to determine the orientation of the sputnik in the magnetic field of the Earth. Besides this, the instrument made it possible to find numerous irregularities in the intensity and direction of the magnetic field in the upper layers of the atmosphere. The data obtained are very extensive and are being processed now. No doubt, the results about the deviations of a magnetic field from the normal state will be valuable in the study of ionospheric current systems.

#### CONCLUSION

The third Soviet sputnik of the Earth has given valuable experience for the construction of artificial sputnik-laboratories for exploration of the upper atmosphere. Even preliminary results show that the data obtained are of great scientific value. We are looking forward to the fascinating perspectives of the exploration of the upper and outer atmosphere at ever-increasing heights with the help of more nearly perfect artificial sputniks.



## APPENDIX I

If the ion trap is in the ionized gas flow, the current measured is

$$I = N \cdot e \cdot \pi r^2 \cdot V \cdot \alpha \cdot f(\phi_{\text{trap}})$$

where  $e$  = electron charge,  $r$  = radius of the grid surface of the ion trap,  $\alpha$  = a transparency coefficient,  $V$  = sputnik's speed,  $\phi_{\text{trap}}$  = trap grid potential with regard to the surrounding medium.

## APPENDIX II

The retarding potential  $\phi_{\text{ret}}$  can be determined from the relation

$$e \cdot \phi_{\text{ret}} = \frac{m \cdot V^2}{2}$$

where  $e$  = electron charge,  $m$  = mass of ions which are trapped,  $V$  = sputnik's speed.

## Automatic Sweep-Frequency Ionosphere Recorder, Model C-4\*

J. N. BROWN†, MEMBER, IRE

**Summary**—An improved sweep-frequency ionosphere recorder was needed to carry out the expanded program of observation planned for the IGY. The resulting equipment included improvements in output power, receiver sensitivity, purity of output signal, and other details, over earlier equipments. The basic principles of operation are described and the transceiver-type of circuitry explained. The operating characteristics are: frequency range, 1–25 mc; output power, 10–30 kw peak pulse power; pulse length, 50  $\mu$ sec; repetition rate, variable from 10–70 pulses per second. An elaborate control and programming system is provided which can be used to operate the equipment on an unattended automatic basis. The “virtual height” of the ionospheric layers, as a function of frequency, is recorded on photographic film by two cameras—a 35-mm uniformly-moving-film unit, and a frame-by-frame 16-mm camera, which produces time-lapse motion pictures of the changes which occur. A brief history of the development of the sweep-frequency recorder technique is given.

### PURPOSE OF THE EQUIPMENT

THE Model C-4 ionosphere recorder is intended primarily to measure the “virtual height” of the layers of the ionosphere by means of pulse echoes at vertical incidence. As the operating frequency is swept, the records also yield the critical frequencies of the layers. The data are produced on photographically recorded graphs of virtual height of the ionospheric layers as a function of frequency, the frequency range covered being from 1–25 mc. The equipment is automatic in operation, requiring attention only for changing film and for routine maintenance.

With modification, this equipment has also been used to perform types of experiments other than vertical-incidence measurements. These experiments include oblique-incidence backscatter measurements and oblique-incidence, two-station, synchronized-pulse experi-

ments to examine the fine structure of pulse trains received from a distant station. In the latter case, the experiment requires the use of two Model C-4 recorders that are synchronized both in pulse repetition rate and in the radio frequency being swept.

### EARLIER EQUIPMENT

The pulse method of ionosphere sounding that is in common use in the medium and high-frequency spectrum dates back to the original experiments of Breit and Tuve<sup>1</sup> at the Carnegie Institution of Washington, D. C. These original experiments were performed on selected fixed frequencies and gave data in the form of ionospheric layer-height changes against time. Rapid changes of the layer height at a given frequency with changing time, and the obvious existence of more than one layer, pointed out the desirability of varying the transmitting and receiving frequencies simultaneously and of viewing the spectrum on a more revealing panoramic basis.

The early sweep-frequency equipments that probed the ionosphere were mechanically ganged units that tracked the various transmitter tank circuits as the frequency of operation was changed, and the receiver frequency had to be varied to correspond with that of the transmitter. Some very awkward and often ingenious methods were devised to accomplish the task. The first major improvement on this scheme was the use of the “transceiver” principle, wherein the transmitter and receiver tuning frequencies were derived from a common oscillator by a heterodyne method.<sup>2</sup> This basic scheme is

<sup>1</sup> G. Breit and M. A. Tuve, “A test for the existence of the conducting layer,” *Phys. Rev.*, vol. 28, pp. 554–575; September, 1926.

<sup>2</sup> T. R. Gilliland, “Field equipment for ionospheric measurements,” *J. Res. NBS*, vol. 26, pp. 377–381; May, 1941.

\* Original manuscript received by the IRE, November 14, 1958.

† Appl. Sci. Corp. of Princeton, Princeton, N. J.

still in use in the current equipment. However, when the system was first used, the transmitter tank circuits were still mechanically ganged and tracked to the driving frequency.

The next obvious step was to eliminate the necessity of tracking the various stages of the transmitter. Broadband amplifiers to cover the range of 1–25 mc were devised by Sulzer<sup>3</sup> and useful peak pulse power of 5–10 kw was obtained by this technique. It was the development of high-perveance pulse tubes which made this method practical. Various experimental models of the equipment were developed during the years following World War II. The Model C-1 recorder was built by the Central Radio Propagation Laboratory of the United States National Bureau of Standards and became the electrical prototype of the commercially produced Models C-2 and C-3.<sup>4</sup> The last of the Model C-3 recorders was manufactured in 1949. Since that time, these equipments have continued to be used extensively by the world-wide network of ionosphere sounding stations operated by the Bureau of Standards and the United States Army Signal Propagation Agency.

THE IGY PROGRAM

When plans were being formulated for the 1957–1958 International Geophysical Year program, it was desired that the world-wide ionosphere sounding program be extended and the program of observation be increased. The sounding equipment then in use was almost ten years old and was insufficient in quantity to equip the many additional stations planned. The Ionospheric Physics Panel of the United States IGY Committee, decided that a new, modernized version of the sweep-frequency sounder should be procured in sufficient numbers to equip properly the additional stations needed and to modernize some of the stations already in existence. The older equipment had certain undesirable features, including spurious emissions that needed to be eliminated. The Ionospheric Physics Panel drew up a set of specifications that were to be the requirements for the new equipment, and asked the National Bureau of Standards to undertake its procurement. Invitations to bid were sent out, and Barker and Williamson, Inc., of Bristol, Pa., was the successful bidder. Time was very short, but a successful schedule was met that yielded a preproduction model in one year and 21 additional units in the eight months that followed. The original order of 14 recorders for the United States IGY program was augmented by the requirements of various United States government and military research agencies as well as by foreign governments, including the USSR, which have taken part in the IGY. A second production run of 11 recorders brought the total to 33 Model C-4 recorders that were built by Barker and Williamson.

<sup>3</sup> P. G. Sulzer, "Ionosphere measuring equipment," *Electronics*, vol. 22, pp. 137-141; July, 1946.

<sup>4</sup> J. M. Carroll, "Automatic ionosphere recorder," *Electronics*, vol. 28, pp. 128-131; May, 1952.

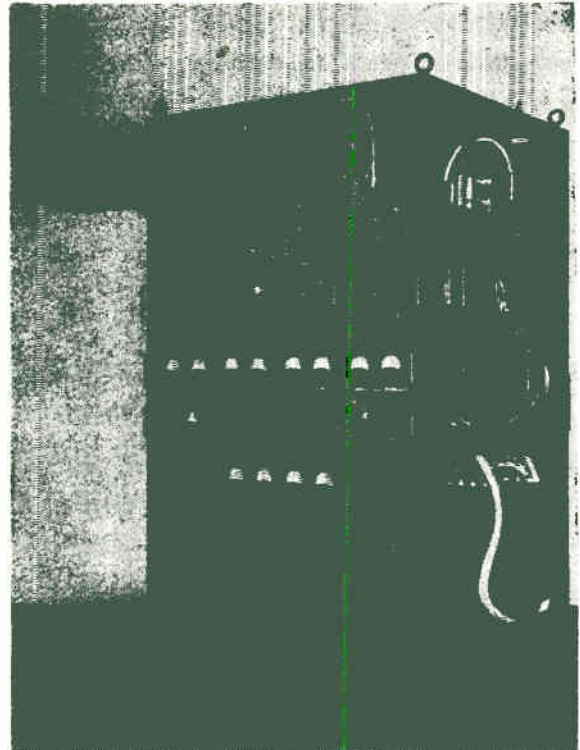

Fig. 1—Model C-4 ionosphere recorder.

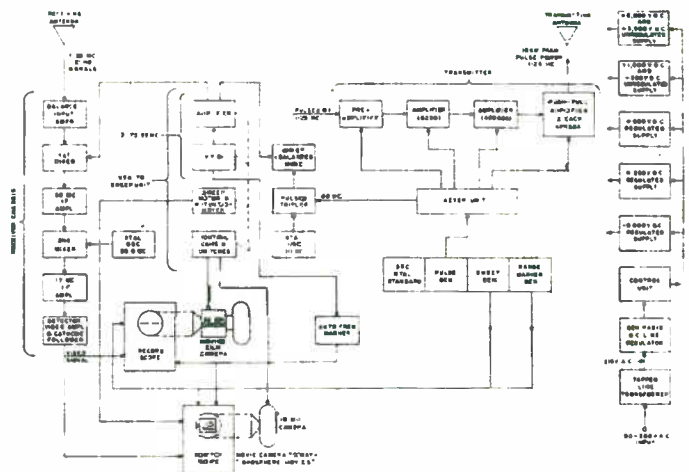

Fig. 2—Block diagram of Model C-4 transmitter and receiver circuits.

DESCRIPTION OF THE NEW EQUIPMENT

The Transmitter

Fig. 1 is a general view of the main rack of equipment that comprises the Model C-4 recorder. Not shown in the photograph is the large pendulum-actuated IBM master clock which controls the elaborate automatic programming system that is a part of the over-all equipment.

Fig. 2 is a block diagram of the complete transmitter-receiver system, and shows how it is associated with the film recording methods used. A brief description of the system follows. The basic frequency control circuit is the variable-frequency oscillator (VFO) which operates

between the frequencies of 31 and 55 mc. The VFO is followed by a buffer-amplifier which is tracked over the same frequency range. Considering first the transmitter signal generation, the variable 31–55-mc signal is heterodyned with a fixed-frequency pulsed signal at 30 mc. This 30-mc signal is derived from a 10-mc crystal oscillator and pulsed tripler and amplifier stages. Leakage of the 10-mc crystal signal is held to a very low level to prevent spurious receiver and transmitter signals. The heterodyne difference between the VFO signal and the 30-mc signal is extracted from the mixer (balanced modulator) stage thus producing a variable, pulsed 1–25-megacycle signal. This signal is then amplified in a chain of broad-band amplifiers. The higher level stages are all simultaneously gated on for the duration of the transmitted pulse and then turned off for the interval between pulses. This allows a very high duty factor to be used without exceeding the tube dissipations.

The actual transmitter circuitry following the crystal-diode balanced modulator and low-pass filter consists of a broad-band unkeyed amplifier and a second pulsed stage, both using 6AG7 tubes. This drives a parallel-connected type 3E29/829B stage which is also pulse-keyed. The following intermediate power amplifier (IPA) drives a push-pull connected power amplifier (PA). The IPA tube and both PA tubes are Eimac 41 PR60-A high-current, pulse amplifiers. The PA stage merits comment in that it is driven from an unbalanced source with resistance-capacitance coupling and produces balanced, push-pull output. Balanced output is attained by cathode coupling between the two tubes of the PA. The grid of one PA tube is driven from the plate of the preceding (IPA) stage, and the grid of the remaining PA tube is grounded for radio frequencies by means of a bypass capacitor. A choke, bifilar-wound to supply heater voltage, is the common cathode impedance for the two tubes. The voltage at the plate of the grid-driven PA tube is reversed in phase with respect to the driving signal, while the voltage at the grounded-grid, or cathode-driven tube plate, remains in phase. The resulting push-pull output is coupled to the transmitting antenna.

In operation, this circuit configuration has an excellent, natural, self-balancing action that is very tolerant of misadjustment of the keying pulses applied to the individual grids. The transmitter circuit is very stable and free of parasitic oscillations. The transmitter output power varies over the band, from a value of approximately 30 kw peak pulse power at the low frequency end to a value of 10 kw at the higher frequencies. The high output power at the low frequency end of the operating spectrum tends to compensate for the decreased radiation efficiency of the broad-band terminated delta antenna.

#### *The Receiver*

Again referring to Fig. 2, the receiver portion of the recorder gets its first-conversion-oscillator injection

signal from the same VFO that supplies the transmitter signal. The first receiver IF stage operates at 30 mc, which is always the difference between the 1–25-mc operating frequency and the varying 31–55-mc VFO frequency. The input circuit of the balanced mixer stage (a type 6J6 tube) is untuned and contains a carefully made broad-band transformer which excludes the in-phase component of nearby strong signals and passes only out-of-phase or push-pull signals. The 30 mc IF stage has a bandwidth of approximately 150 kc. Fundamental 30-mc signals that appear on the antenna are attenuated by a 25-mc low-pass filter in the antenna circuit plus a group of 30-mc trap circuits.

The final receiver selectivity is accomplished after a second conversion from 30 mc to 1.4 mc. The 28.6-mc crystal oscillator feeds the injection voltage into the second mixer stage (a type 6U8 for both oscillator and mixer). The 1.4-mc IF strip consists of two stages (a 6CL6 and a 6146) with three double-tuned IF transformers which were made of high-*Q* toroids with capacitive coupling. The IF bandwidth was adjusted for 25 kc to accommodate the 50-microsecond transmitter pulse length. Note that a small transmitting tube is used as the last IF amplifier so that large dynamic-range signals can be handled without serious overload. This prevents strong interfering signals from overloading the last IF stage and cutting off the pulse-echo signals. The video detector is conventional and is arranged so that it can furnish an automatic gain control voltage also to help prevent signal overload in the IF stages. Following detection, the video signals are severely limited and coupled to the oscilloscope indicating circuits through a cathode follower stage. The receiver has proven to be very satisfactory in design and has a pulse-signal sensitivity of better than one microvolt for an easily recognizable pulse in the background noise.

#### *Pulse and Time-Base Generator*

The specifications for the Model C-4 equipment imposed a very strict tolerance on the accuracy of the calibrating height markers placed on the film records. In the earlier C-2 and C-3 equipments, a gated, free-running oscillator was used as a source of height marks. A separate piece of crystal-controlled calibrating equipment was necessary to check the accuracy of the marker oscillator. It appeared to be an obvious solution to use a crystal oscillator as the marker generator source to insure the permanent accuracy of the system. A 3000-cps quartz crystal is used as a marker generator to furnish 50-km height markers and a binary counter furnishes 1500-cps signals for the 100-km marks. Since 3000-cps crystals cannot be gated at the start of each oscilloscope sweep, it is necessary to synchronize the basic transmitter pulse rate with some submultiple of the standard frequency. Thus the transmitter pulse rate and film-display height markers are derived from a very stable (0.01 per cent) temperature-controlled source. The necessary oscilloscope sweep and gate waveforms are de-



rived in a conventional manner. The transmitter delayed-trigger pulse is derived by use of a very stable phantastron circuit. This allows the transmitter signal to be delayed until after the start of the oscilloscope sweep and to be carefully aligned with a reference "zero" height marker. The transmitter pulse rate can be set at any frequency between 10 and 70 cps that is a subharmonic of the 1500-cps crystal-derived signal.

#### INDICATING AND RECORDING SYSTEM

Normally, the C-4 recorder operates with the 35-mm uniformly-moving-film camera photographing one of the two oscilloscope indicators. The other oscilloscope is used for monitoring the received signals as well as to check the various circuit functions. Fig. 3 shows a typical height vs frequency plot recorded on the 35-mm camera. The oscilloscope display for this method of recording is an intensity modulated horizontal line. The video pulse signals modulate the intensity downward so that a pulse echo signal will appear as a dark spot on the oscilloscope trace. The vertical motion of the film provides the frequency base on the record of Fig. 3. The height markers (100-km intervals) are also applied as intensity modulated information. The frequency markers appear as blanked oscilloscope sweeps and are applied automatically by generating blanking signals obtained by mixing the VFO signal with harmonics of a 1-mc crystal oscillator.

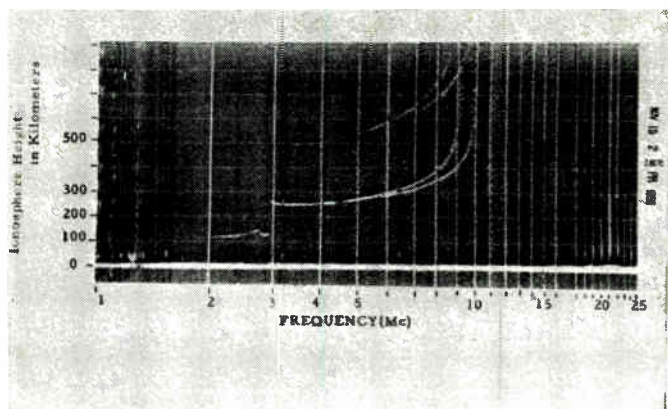

Fig. 3—Typical daytime height vs frequency recording made on Model C-4 ionosphere recorder.

The oscilloscope tube is an electrostatically deflected tube, a Dumont 5ATP-7 selected for its high light-output and high definition of trace. The C-2 and C-3 equipments used electromagnetically deflected indicators and had the usual nonlinear sweep problems.

The date-time information is recorded on the film by momentarily flashing a set of small lights which illuminates a modified IBM date-time printer unit.

Time-lapse 16-mm movies are also possible with the C-4. With this technique, a single frame of 16-mm film is exposed every 15 seconds. The 16-mm exposure is made by displaying the intensity-modulated A-scan pattern vertically on the face of the oscilloscope tube and moving the line horizontally as the frequency is

being swept throughout the 1–25-mc range. This is accomplished by deriving a sweep voltage from a linear potentiometer driven by the same shaft that sweeps the VFO frequency. At the end of the sweep, the oscilloscope trace is blanked and the 16-mm camera is advanced one frame in readiness for the next sweep exposure. Note that no shutter is used on the 16-mm camera since the camera is advanced during the oscilloscope blanking period. If a long series of these 16-mm pictures is taken, and then projected at the normal motion picture rate of 16 frames per second, a time-lapse motion picture is produced showing in the span of a few minutes the diurnal variations of the various ionospheric layers.

#### CONTROL AND PROGRAMMING SYSTEM

An elaborate control system is provided for unattended, automatic operation of the equipment. The specifications required that the equipment have provisions for quickly changing the methods of operation according to preset programs. As a result, an IBM master program clock mechanism is used to actuate the various receiver and transmitter circuits according to the desired operating program. The system permits the automatic selection of any one of three separate receiver-gain settings at any or every one-minute interval throughout a 24-hour day. Since the ionospheric absorption varies greatly from night to day, the variable-gain feature is a necessity for properly recording the echo patterns in the presence of noise and extraneous signals.

Program pins are placed in the master wheel of the IBM clock to control the operation. There are actually three pins for each minute throughout the 24-hour day. Each of the three pins represents one of the three possible receiver gain settings that can be adjusted from the front panel. Modifications to any elaborate preset program of operation may be made by switch selection from the front panel.

The IBM master clock has a manufacturer's guaranteed stability of  $\frac{1}{2}$  second per day. The spring mechanism, which drives the invar pendulum, is wound electrically to insure that a constant driving force is available. If the ac source of power should fail, the clock has a reserve of approximately 12 hours of operation in the fully wound condition. However, when the ac power fails, a changeover relay transfers the complete control system to a set of 24-volt batteries, which activate the clock and master program wheel until normal power is restored.

A selection of sweep times is available. The 1–25-mc spectrum can be swept in 15, 30, or 120 seconds. The motor-drive-gear ratios of both the VFO and 35-mm camera must be changed to give the desired sweep rate. The spectrum can be swept in either a linear or logarithmic manner. Selection of the properly shaped drive cam for the VFO determines the manner in which the spectrum will be covered. Special cam shapes may also be used to examine certain parts of the frequency spectrum in detail.

## MECHANICAL CONSIDERATIONS

The Model C-4 equipment was designed with ease of serviceability in mind. Each chassis unit can be removed from the main frame by unfastening the retaining screws holding its front panel to the frame, and sliding the unit out. Most of the units (where weight permits) are equipped with roller-type slides for ease of removal or partial withdrawal for examination and tube replacement. Each chassis unit is furnished with an extension cable which permits total removal and test operation on a work bench. The transmitter panel is the only part of the equipment which cannot be removed from the frame for service, and this is unnecessary since all the transmitter components are readily available from the rear of the main frame.

## OPERATION OF THE EQUIPMENT

Since operation of the equipment was, for the most part, to take place in isolated parts of the world, provisions were taken to furnish at least a 100 per cent complement of spare electrical parts. Complete film processing equipment was also shipped as part of the equipment.

There are several operational advantages of the new equipment over earlier equipments. One of the most noticeable is the reduction of interference to nearby communication facilities. Since it uses pulse transmission, there is inevitably a certain amount of interference, particularly at the time when the sweeping frequency passes through that in use by the other service. However, the signal purity is considerably improved by the absence of parasitic oscillation and spurious leakage

signals. The increased power and receiver sensitivity greatly increase the number of ionospheric phenomena that are observed. Physically, the new equipment is smaller than the C-2 or C-3 because the earlier units had a large separate cabinet of ac power-regulating equipment, which is now an integral part of the C-4 main frame unit. The regulator used is a servo-controlled, auto-transformer type manufactured by the General Radio Company.

Fig. 3 is a reproduction of a typical daytime 35-mm film record made on the C-4 equipment. In this record, frequency scale is logarithmic. From this form of data presentation, it is possible to extract not only vertical incidence information but oblique incidence information by the use of transparent drawings of transmission curves used as overlays.

## ACKNOWLEDGMENT

While most of the electrical and mechanical design of the Model C-4 equipment was that of the Barker and Williamson engineers, it should be acknowledged that a major portion of the transmitter and receiver circuitry was contributed by J. M. Watts, of the Central Radio Propagation Laboratory. The development of this equipment to such a strict delivery schedule was possible only through the closest cooperation of many people at both CRPL and B&W.

The author would like to express his appreciation to Barker and Williamson, Inc., for permission to publish this article and for their cooperation in furnishing photographic material.

## The IGY Three-Frequency Backscatter Sounder\*

A. M. PETERSON†, MEMBER, IRE, R. D. EGAN†, MEMBER, IRE, AND D. S. PRATT†

**Summary**—Design criteria and operating characteristics of the IGY Fixed-Frequency Backscatter Sounder are outlined. This three-frequency (12, 18, and 30 mc) rotating-antenna pulse sounder was designed at Stanford University for oblique-incidence ionosphere studies. During the IGY a network of these sounders has been operated at thirteen stations in polar, temperate, and equatorial regions. Data reduction and publication of data summaries have been carried out at Stanford using semiautomatic punch card methods. Preliminary analysis of data has yielded new information on sporadic-E, magnetic field aligned irregularities, large-scale traveling disturbances in the F region, and the effects of ionospheric tilts on long-distance propagation.

\* Original manuscript received by the IRE, December 19, 1958.

† Radio Propagation Lab., Stanford University, Stanford, Calif.

## INTRODUCTION

BACKSCATTER sounding of the ionosphere is an oblique-incidence, pulse radar method for the study of the regular layers, sporadic-E, and a variety of irregularities which occur. The method permits the surveillance of a large region of the ionosphere from a single location. A large percentage of the echoes obtained by a backscatter sounder are "ground backscatter echoes" which result from normal ionospheric propagation to remote points on the earth's surface and scattering by the ground of energy back over the ionospheric path to the transmitter. Other echoes observed in backscatter sounding arise by scattering from irregu-



larities occurring within the ionosphere and may be called "direct backscatter echoes." Among this latter class are echoes from meteor ionization trails, the aurora, and field-aligned irregularities occurring at low latitudes [6], [8].

The ground backscattered energy is detected as somewhat distorted echoes of the transmitted pulse. By measurement of the time delay of the returning echoes, and by using a directional antenna, the skip distance in the direction of the antenna beam may be deduced [2], [9], [12], [13]. It is often possible to detect backscattered echoes from each ground reflection in multi-hop propagation.

Historically, backscatter echoes were first observed while monitoring high-power transmissions at a short distance from the transmitters. Engineers of the early transoceanic short-wave stations made the discovery that in some way energy returned to the original location after considerable delay. Oscillographic observation, while transmitting a series of "dots," revealed the echo nature of the received energy. In this manner, scatter soundings were made in the United States and England as early as 1928–1930. In some cases a series of different fixed frequencies were monitored and differences in echo structure were noted.

Early sweep-frequency, vertical-incidence ionospheric sounders produced records which often showed oblique-incidence backscatter traces and, thus, constituted the first sweep-frequency backscatter sounders. These sounders utilized antennas which resulted in appreciable radiation at low angles as well as in the desired overhead direction, and thereby gave echoes which may now be identified as various forms of oblique-incidence backscatter echoes. The advent of the "delta" antenna for use with vertical sounders greatly reduced the occurrence of oblique-incidence backscatter traces on vertical-incidence sweep-frequency records.

In recent years, specialized equipment of both the fixed-frequency [1], [2], [3], [4], [8], [9] and sweep-frequency [10] variety has been developed to facilitate ionospheric research by the oblique-incidence backscatter methods. With fixed frequencies, rotatable, directional antennas can be used. While a simple range-time or *A*-scope presentation is satisfactory when one is measuring conditions in only one direction from the station, a plan position indication (PPI) can be used with a rotating antenna. As the directive antenna is rotated, a range-azimuth polar plot is traced out on the cathode-ray-tube screen which can then be photographed to provide a permanent record.

Fig. 1 is a sample series of PPI backscatter records obtained several years ago at Stanford University during one day's operation of a 14-mc fixed-frequency backscatter sounder. In these pictures, north is at the top, east is on the right-hand side, and so on. Range circles occur at 500-km intervals. The grey background of the pictures is the noise output of the receiver. Backscatter

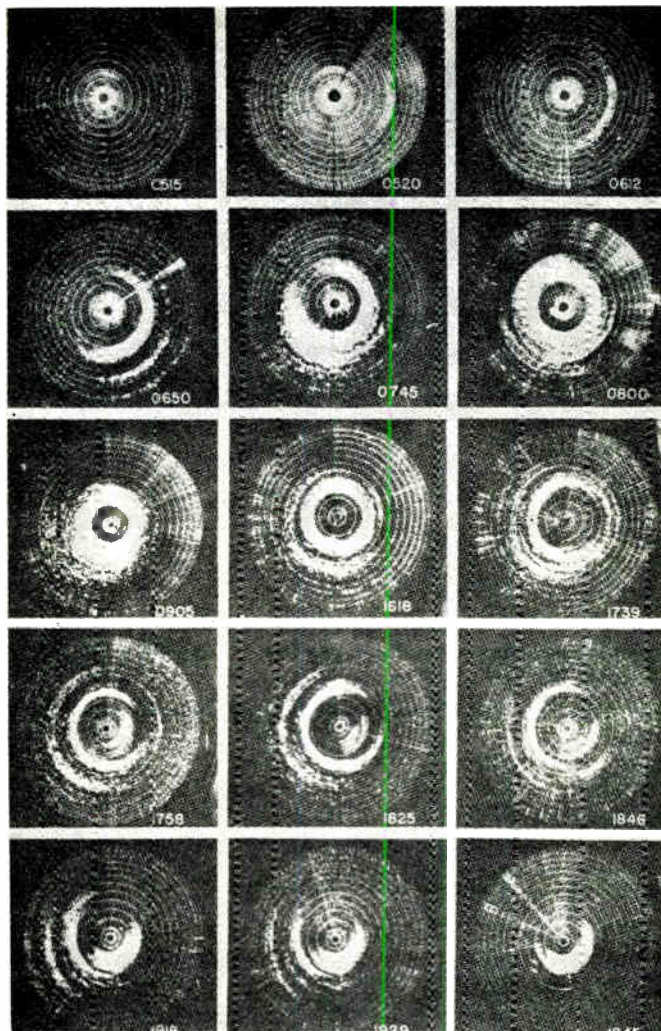

Fig. 1—PPI photographs showing scatter soundings throughout a 24-hour period.

echoes appear as bright spots or patches amid this noise.

The first picture, at 0515 local standard time, shows no noticeable *F*-layer propagated ground backscatter. The white splotches in the vicinity of the first range circle are transitory echoes caused by meteors. These echoes, which are quite frequent during the early morning hours, occur less frequently as the day progresses and are seen much less often in the evening. Also noticeable at 0515, and again at 0520, is a patch of echoes resulting from scattering from field-aligned irregularities occurring to the north of Stanford. Echoes of this type are seen most frequently near midnight, but often continue to be seen into the morning hours.

At 0520 the first sign of one-hop ground backscatter appears to the east and slightly south of east between the 3000 and 3500-km range circles. At this hour the *F*-layer electron density to the east has increased to the point that reflection can take place.

Shortly after 0612, two-hop transmission opens up, and by 0650 strong ground scatter extends from northeast to southwest. To the southeast may be seen two multiple echoes forming fragments of additional con-



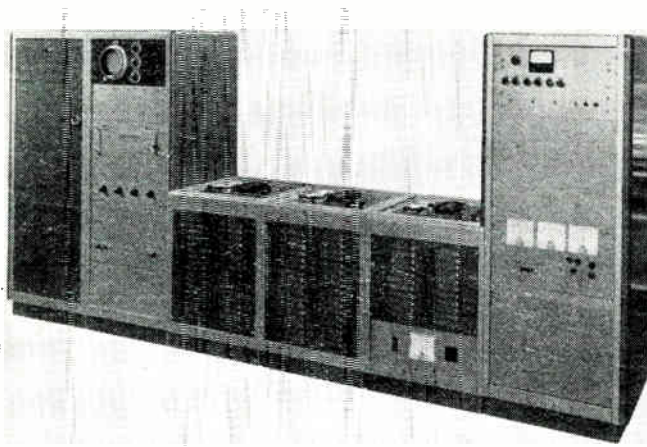

Fig. 2—Stanford IGY backscatter sounder.

centric scatter rings. By 0745 the main ground scatter ring has nearly encircled the station. The multiples to the southeast are now weaker, and by 0800 the third has disappeared, and the second coalesced with the first into one virtually solid mass. By 0905 the scatter ring is relatively thinner to the east, owing to absorption, than it is to the north, west, and south.

From 0905 on throughout the day, the ground scatter ring changes very little in appearance, its inner edge hovering close to the 1000-km range ring at this time of year. By 1618, however, the ring begins to move outward as the electron density decreases with the approach of evening. By 1739 the range to the eastern section of the ring is lengthening, and at the same time the echo is becoming weaker. At 1758 a definite gap in the ground scatter appears, but a sporadic-*E* patch has suddenly appeared to the SE, extending inward to about 750 km.

Sporadic-*E* patches occur rather frequently and may be readily tracked by backscatter sounding. This particular patch persisted and grew in size during the evening as the remaining pictures show. The *F*-layer ground backscatter echoes gradually decrease in extent and disappear completely to the southwest as the sun moves westward.

#### THE IGY FIXED-FREQUENCY BACKSCATTER SOUNDER

A three-frequency rotating-antenna, backscatter sounder has been specially designed and developed at Stanford University for use during the IGY. Each sounder consists of three separate ionospheric radars which operate simultaneously on frequencies near 12, 18, and 30 mc. A network of thirteen of these sounders has been established and operated as part of the United States program in ionospheric physics during the IGY.

Fig. 2 is a photograph of the complete sounder and the rotating antenna assembly is shown in Fig. 3. A block diagram showing the interconnection of the separate pieces is shown in Fig. 4.

As shown in Fig. 2, the sounder is housed in six racks which, from left to right contain: 1) PPI display and

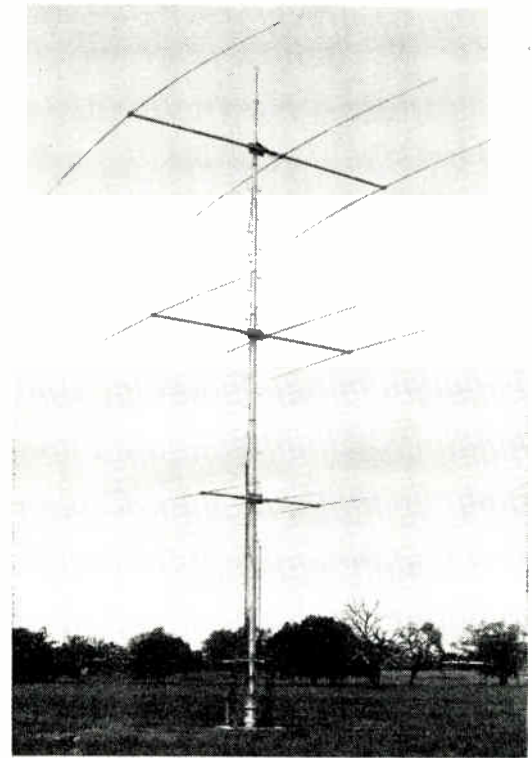

Fig. 3—Stanford IGY backscatter sounder antenna.

recording, 2) monitor oscilloscope, synchronizer, and receivers, 3) 12-mc final amplifier and TR switch, 4) 18-mc final amplifier and TR switch, 5) 30-mc final amplifier, TR switch, and the primary power input panel, 6) exciter and transmitter power supply. The following sections give a general description of the individual units and a discussion of the operating of the complete sounder.

#### Exciter

As shown in Fig. 5, the exciter for the sounder combines in a mixer the signal from the receiver-oscillator with an oscillator signal at the receiver first IF frequency (2.1 mc), thus producing the sum and difference frequencies. The transmitter output frequency is the sum of the two. This eliminates the need for elaborate shielding of an oscillator operating at a subharmonic of the operating frequency. Likewise, the mixer does not require shielding, as the 2.1-mc oscillator signal is gated on, by the long and short pulse, only when it is desired to transmit. The actual pulsing of the individual transmitter is done in the grid of the first stage following the mixer.

Another reason for the use of a beat frequency exciter is that it provides an RF phase interlock between the transmitter and receiver which is essential for certain special applications of the scatter sounder. One example is measurement of the changing phase path to detect small motions (less than a wavelength) in the ionosphere. In addition, the interlocked scheme insures that the transmitter and receiver operate on the same fre-

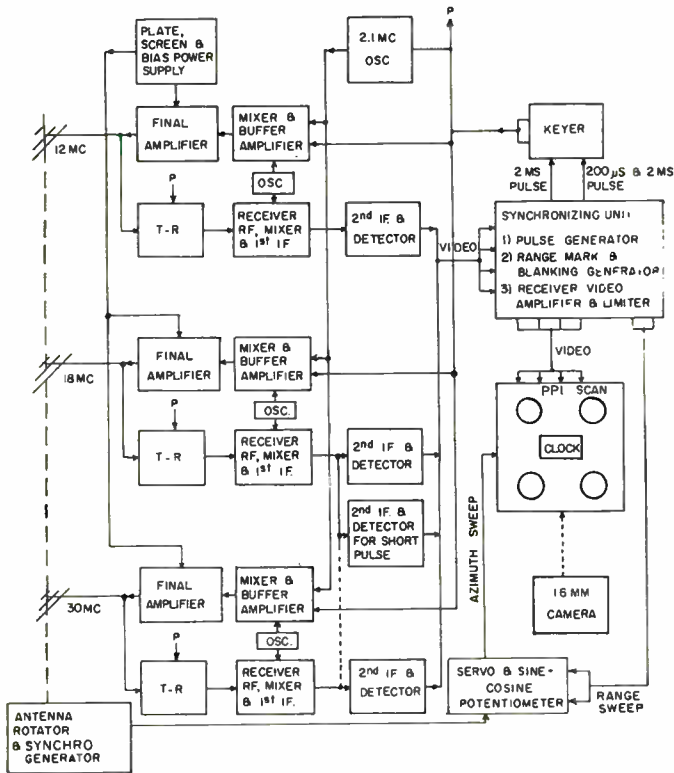

Fig. 4—Block diagram of backscatter sounder.

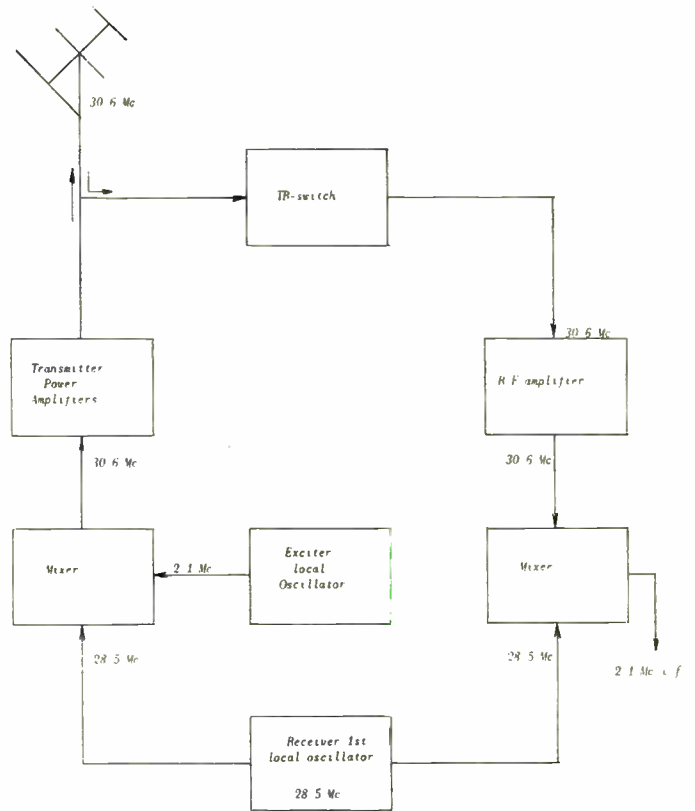

Fig. 5—Simplified illustration of transmitter-receiver frequency interlock scheme.

quency. Two front panel adjustments are provided for the normal operation of the radio frequency equipment. The first is the tuning for the plate circuit of the driver stage, and the second is a coupling adjustment to provide the correct amount of drive to the final amplifier. A single meter is provided along with a switch to indicate the grid and plate currents of the driver stages.

*Final Amplifiers*

The final amplifiers are modified Johnson Viking Kilowatt Amplifiers using a pair of 4-250A tubes in parallel. The output circuit is a pi network which feeds a 52-ohm load. The grid biasing scheme was altered to provide fixed bias only and the meters were replaced to provide more suitable ranges for pulse operation. While the manufacturer rates the amplifier at 1 kw input on CW or AM, it operates well within maximum ratings at 6 kw peak pulse input with a 4 per cent duty factor. The overall efficiency has been found to be from 65 to 70 per cent. The required driving power is approximately 50 watts peak on all frequencies.

*Transmitter Power Supply*

The final amplifiers receive their dc power from the transmitter power supply, which consists of three separate supplies with common control circuits assembled on a common chassis. The power supply outputs are:

- 1) 4200-volt voltage plate,
- 2) 900-volt screen voltage, and

3) -320 volts bias for the 4-250A amplifier tubes. The 900-volt screen supply is also used as plate voltage for the 6146 driver stages in the exciter unit. The power supply and the control circuits are mounted on one chassis, while the output capacitor bank is on a separate chassis. These two chassis are located at the bottom of rack number 6, as seen in Fig. 2.

*Antennas*

The antennas for 12, 18, and 30 mc are 3-element wide-spaced Yagis mounted horizontally at different heights on a single rotating mast. The half-power beamwidth of these antennas is approximately 60° on a one-way basis. Fig. 6 shows a representative field strength (voltage) pattern. Each antenna is 0.6 wavelength above the ground. This height was chosen as a compromise. It is desirable to place the antennas as high as possible to maximize the low angle radiation, while keeping the antenna sufficiently low to prevent a null in the vertical pattern below about 50°.

Fig. 7 shows a block diagram of the electrical connections, and Fig. 8, the mechanical construction of the rotating coupling transformers. The center element of each Yagi is fed at balanced 200-ohm points from 52-ohm cables through 4:1 baluns. Quarter-wave stubs are used at the rotary coupling links to prevent RF current from flowing on the outside of the coaxial cables. The rotary links and the fixed links are each tuned by series ca-



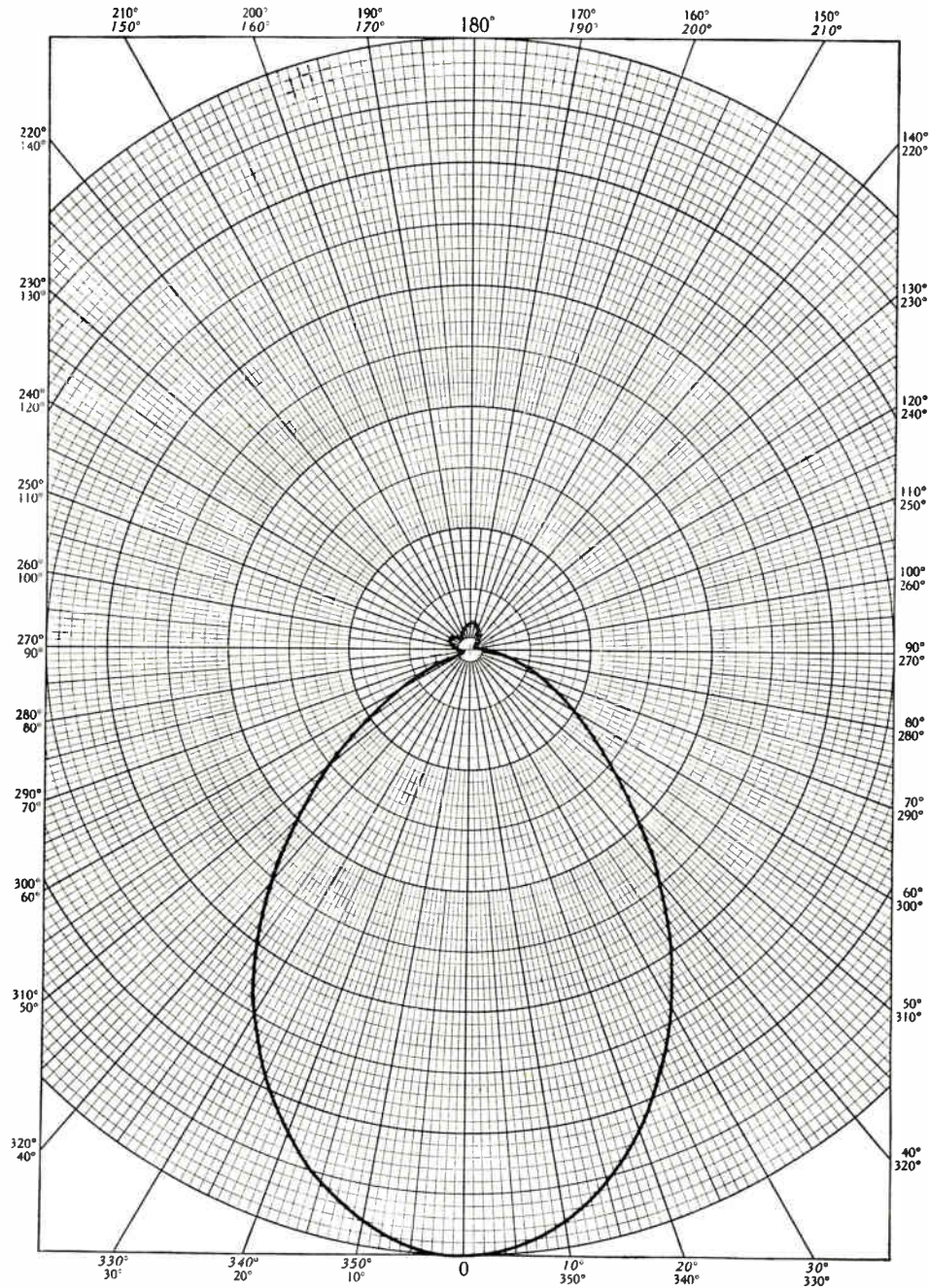

Fig. 6—Measured horizontal field strength pattern (voltage) of 18-mc antenna installed at Stanford.

capitors. Fifty-two-ohm coaxial cables connect the fixed links with the transmitters.

The tower is shipped in three sections which are bolted together in the field. Support is furnished by a foundation tube which is set in concrete. The bearing consist of a ball and socket at the bottom of the foundation tube and two sleeve bearings on the side. The entire foundation tube is filled with oil to provide lubrication.

Chain drive from a Boston "ratiomotor" is used to rotate the tower at approximately one revolution per minute. A synchro-transmitter is also driven by the ratiomotor and provides the control information for the servo used for PPI generation.

#### *T/R Switch*

The transmit-receive (T/R) switch must block the transmitter pulse from the receiver, and yet switch quickly afterwards to provide a low loss connection of the receiver to the common antenna. At higher frequencies, switches can be designed using suitable lengths of coaxial cable or waveguide, with or without cavities, and with the T/R tube placed at a high-impedance point.

However, at 30 mc and below, cavities become much too large, and the length of quarter-wave lines unwieldy. As a result, a lumped constant T/R switch was designed for this sounder.



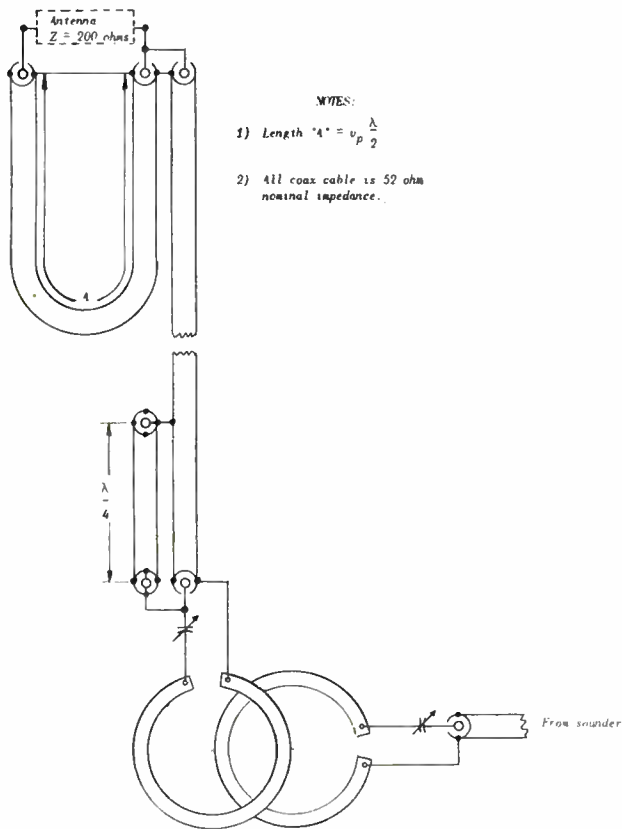

Fig. 7—Simplified diagram of the antenna coupling system for any one channel.

The circuit diagram for the switch is shown in Fig. 9, and a photograph of the interior of the unit in Fig. 10. A type 2D21 thyratron tube is used as the switching element. The input tuned circuit consisting of L-801 and C-801 is constructed in a separately shielded section along with the switching tube V-801 to prevent inductive coupling to the output tuned circuit L-802 and C-807.

In the "transmit mode" a positive trigger pulse is applied to the control grid of the thyratron at the same instant the RF pulse is initiated in the transmitter. When an RF voltage appears on the transmission line from the transmitter, the thyratron conducts. The conducting thyratron maintains a nearly constant plate to cathode voltage of about 12 volts, and thus appears as a low resistance shunting C-801, which destroys resonance in the tuned circuit. The impedance seen looking into the TR switch input is essentially the reactance of L-801. Thus, the effect of the TR switch on the transmission line during the transmitting period is similar to the effect of connecting an RF choke of approximately 1500 ohms in parallel with the 52-ohm transmission line. As a result, the transmitter sees a slightly inductive load (large inductive reactance in parallel with a resistive load of 52 ohms), but this inductive reactance can be cancelled by a small readjustment of the transmitter pi network output capacitor.

In the "receive mode," following the transmitted pulse the voltage on the transmission line quickly falls

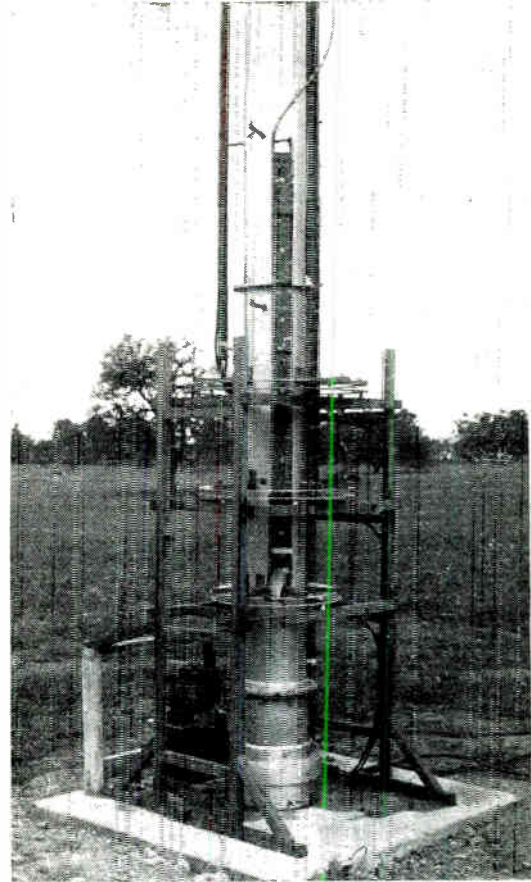

Fig. 8—Detail view of antenna support, rotary drive, and RF link coupling system.

below the minimum value required to keep the thyratron ionized. Battery B-801, which raises the cathode 1.5 volts positive with respect to the plate, provides the necessary bias to maintain the thyratron cut off during receiving periods. When cut off, the tube represents only a very small capacitance in the circuit. As a result, L-801, C-801, L-802, and C-807 form two series-tuned circuits resonated at the operating frequency. These circuits are critically coupled by capacitor C-806. Since both halves consist of identical resonant circuits which are critically coupled, a nearly lossless transfer of energy from input to output is obtained. The operating  $Q$  of each tuned circuit is the same (about 15) and hence, the input and output impedances are both 52 ohms.

Although the transmitter output is connected in parallel with the antenna at the TR-switch input, the effect is very small provided the transmitter is properly tuned. Under these circumstances, the impedance presented by the transmitter is several thousand ohms and has negligible effect when connected across the 52-ohm transmission line.

#### Receivers

The receiver unit consists of three similar, narrow bandwidth (6-kc), double conversion superheterodyne receivers plus a wider bandwidth (16-kc), second IF and

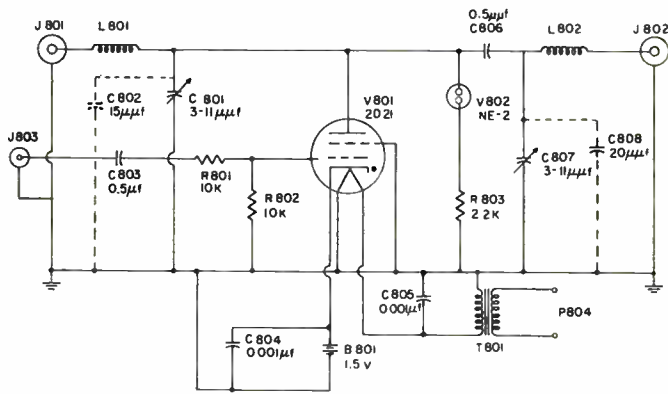

NOTE: C 802 & C 808 used only on 12mc T-R Switch.

LAST RESISTOR USED - R - 803  
CAPACITOR USED - C - 808

Fig. 9—Circuit diagram of lumped-constant TR switch.

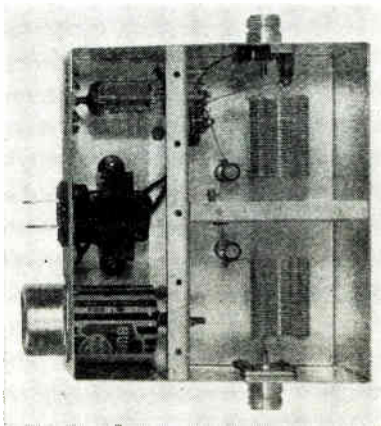

Fig. 10—Interior view of TR switch.

detector section, mounted on a single chassis. The long-range receivers are complete in themselves except for power supply and oscillators; that is, each consists of RF amplifier, first mixer, second mixer, second IF amplifier, and detector. The short-range receiver consists of the second IF amplifier and detector only. It may be plugged into the output of the second mixer of any of the long-range receivers, to permit operation of the short-range receiver on any one of the three operating frequencies. A block diagram of the receiver is shown in Fig. 11.

The receivers have nominal input impedance of 52 ohms unbalanced. An input signal of approximately 0.10  $\mu\text{v}$  will produce a signal-to-noise ratio of one at the output. Hence, the receiver noise (approximately  $10^{-16}$  watts at the input) is several orders of magnitude lower than the expected cosmic noise level at any of the three frequencies.

The receivers derive their selectivity from mechanical filters at the second IF frequency (455 kc). The filter bandwidths were chosen so as to minimize ringing effects while still maintaining excellent adjacent channel selectivity. The narrow-band receiver band-pass character-

istic is 6 kc, at 6 db down, and 12 kc at 60 db down. The corresponding wideband receiver frequencies are 16 and 27.5 kc. The skirt selectivity of the mechanical filters is greatly improved over conventional electrically-tuned circuit techniques.

Spurious signal (including image) rejection is better than 80 db, due to the selectivity of the input circuits and the use of double conversion with a 2.1-mc first IF frequency.

The usual method of operation of the scatter sounder receivers is to increase the receiver gain until the noise level is  $\frac{1}{3}$  to  $\frac{1}{2}$  of the clipping level. A manual gain control is provided to set the gain at a suitable level. The maximum over-all receiver gain is of the order of 120 db.

Crystal oscillators and the power supplies for the receivers are located on a second chassis. The high-frequency crystals for the first conversion are enclosed in ovens and provide a frequency stability better than 0.002 per cent. All of the voltages supplied to the receivers, with the exception of the filament voltage, are electronically regulated.

### Synchronizer Unit

The synchronizer unit is the central component of the sounder. The basic timing standard is a 1500-cps tuning-fork oscillator. All range marks, transmitter pulse rates, oscilloscope sweep timing, and blanking are derived from this standard. Fig. 12 is a simplified block diagram showing the various synchronizer stages grouped into six individual sections to illustrate the primary functions of this unit. These sections are:

- 1) Time-frequency reference section, which provides the basic timing or "synchronizing" of all other sections.
- 2) Frequency division circuits that divide or count down the basic timing frequency to other frequencies needed for sections 3-5.
- 3) Pulse generators which produce the necessary keying pulses for the transmitters.
- 4) Sweep generators that provide synchronized deflection waveforms for the PII display oscilloscopes.
- 5) Video amplifiers and range-mark generators that amplify the receiver video output and inject range markers.
- 6) Power supply section for producing necessary operating potentials for vacuum tubes used in above sections.

The basic pulse rate for the sounder was chosen as 18.75 pps. This gives an equivalent range interval between pulses of 8000 km. Stations located in the higher latitudes seldom will have echoes returning with equivalent time delays greater than 8000 km. However, at the lower latitudes, echoes are frequently seen at ranges greater than 8000 km. These echoes will appear on the time base as "second-time-around" echoes, if the

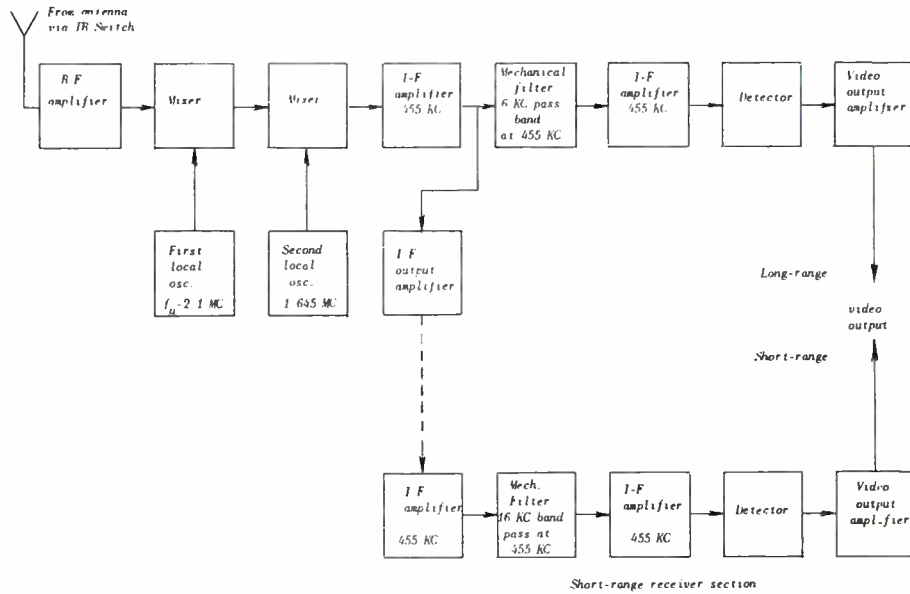

Fig. 11—Block diagram of long- and short-range receivers.

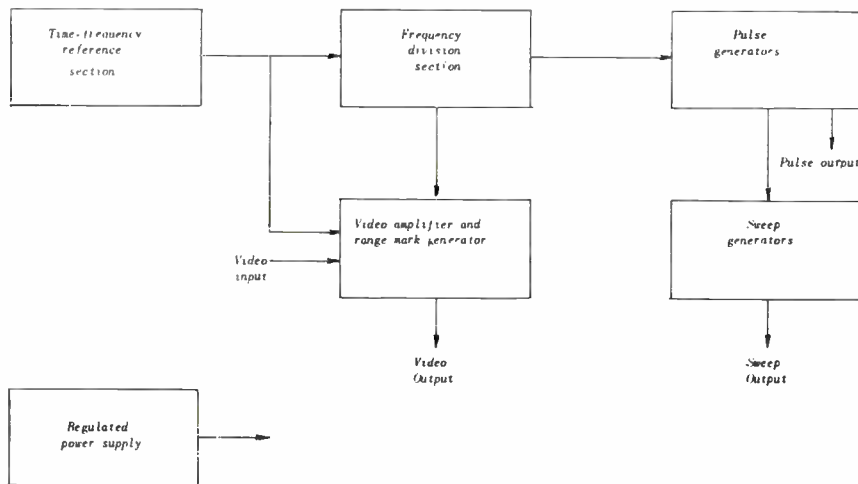

Fig. 12—Simplified block diagram of synchronizer.

sounder is operating at 18.75 pps. The ambiguity between “first-” and “second-time-around” echoes can be eliminated by reducing the pulse rate by one half and an optional plug-in stage is provided in the synchronizer to reduce the pulse rate to 9.375 pps. The range marks on the PPI’s are then changed from 500-km intervals to 1000-km intervals.

*PPI Display*

The output signal from each receiver is passed through the synchronizing unit where it is mixed with the range marks, amplified, and clipped. It is then used to modulate the intensity of the PPI for photographic recording. Fig. 13 is a block diagram of the PPI display unit.

The four PPI’s are arranged in a rectangle facing upward. Time, date, and station identification are located in the space between the PPI tubes.

The PPI sweep is generated by passing a linear sawtooth waveform obtained from the synchronizing unit, through the servo-driven sine-cosine potentiometer. Two outputs result, one the product of the cosine of the angle and the input waveform, and the other the product of the sine of the angle and the input waveform. When these two voltages are applied to the two sets of cathode-ray-tube deflection plates, the result is a PPI-type display.

Power supplies to operate the display unit are on a separate chassis. They supply filament voltage, regulated negative 1500 volts and unregulated positive 1500 volts.

*Servo*

The angular position of the antenna and the PPI trace are linked by the servo. A synchro-generator driven by the antenna rotator, supplies angle information to a



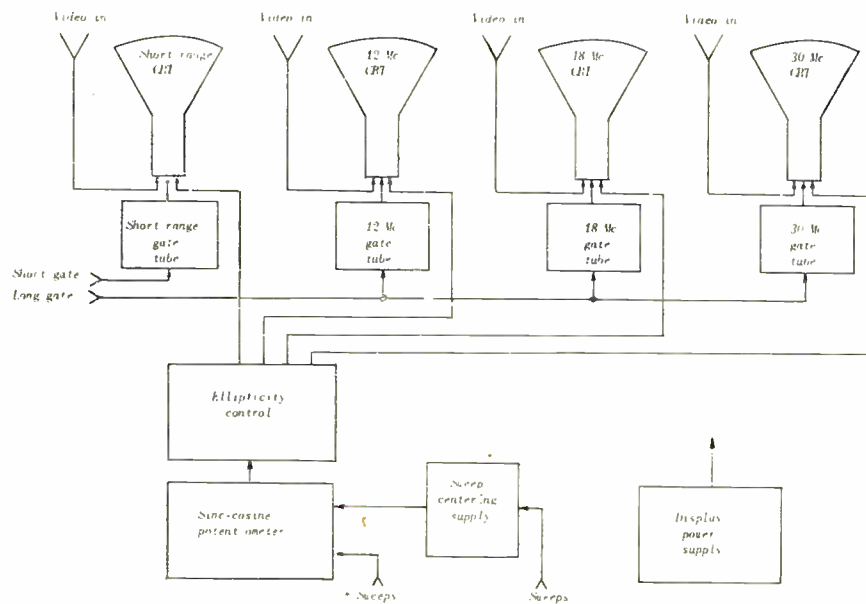

Fig. 13—Block diagram of display unit.

synchro control transformer in the servo. This in turn provides the servo input voltage. The output of the servo amplifier is connected to a servo motor, which drives the sine-cosine potentiometer and the control transformer.

#### Camera

The PPI's are photographed at one frame per minute by a modified Keystone 16-mm camera. This camera has its original spring motor and other related parts removed and is driven by a rotary solenoid, which advances it one frame at a time. To photograph the four PPI's (with the camera a reasonable distance away) a wide angle lens is used with the camera approximately 18 inches above the display face. The film is advanced at one-minute intervals by the camera indexer. This is a 1-rpm synchronous motor with a cam to operate the microswitches. One microswitch is used to index the camera and the other is used to illuminate the clock, date counter, and station identification card.

#### Keyer

Identification of the transmissions is accomplished by a call letter keyer in series with the pulse leads to the exciter. The keyer is timed to operate every 30 minutes and sends the call letters twice during each operating period. To permit the call letters to be readable at the relatively slow pulse repetition frequency, they are sent at about four words per minute.

#### Directional Power Monitor

A directional power monitor is provided to check the transmitter output and antenna system in peak power for the pulse width and rate involved; there is also a

D. F. Johnson Company directional coupler. The meter indicates absolute forward and reflected peak power and is also calibrated in voltage to facilitate the computation of VSWR.

#### Frequency-Stabilized Clock Drive

This is an optional feature for use in locations where the frequency of the primary power is not stable. The frequency-stabilized clock drive will supply sufficient power to operate the recording clock motor and the camera indexer motor. Input to the clock drive is from the synchronizer. Thus the 60-cycle output has the tuning-fork accuracy of about 0.01 per cent.

#### THE NETWORK OF IGY BACKSCATTER SOUNDERS

As a part of the United States IGY Program in Ionospheric Physics, these special backscatter sounders have been operated at the following thirteen locations:

Stanford, Calif., U. S. A.  
 Thule, Greenland  
 Knob Lake, Quebec, Canada  
 Fort Monmouth, N. J., U. S. A.  
 Grand Bahama Island  
 Panama Canal Zone  
 Huancayo, Peru  
 Boulder, Colo., U. S. A.  
 Meanook, Alberta, Canada  
 Pullman, Wash., U. S. A.  
 College, Alaska  
 Okinawa, Ryuku Islands  
 Camden, New South Wales, Australia.

The geographical arrangement provides several north-south and east-west chains of stations designed to sur-

vey large regions of the ionosphere. The most important feature of the program has been the simultaneous and continuous operation of the equipment, with operating characteristics maintained closely similar throughout the network, so as to insure that maximum information be obtained on short-lived or rapidly changing events such as auroral and meteor echoes, the growth and motion of sporadic-*E* patches, and the tracking of large-scale traveling disturbances in the *F* region.

#### DATA PROCESSING AND PUBLICATION OF DATA SUMMARIES

Approximately 3500 rolls of 16-mm film containing 10 million individual PPI photographs will result from the operation of the 13 IGY backscatter stations. The semiautomatic reduction of these film records and publication of data summaries are underway at Stanford University.

The film is read by an operator and the data are recorded on punched cards. A film reduction system consisting of a Benson-Lehner Boscar and Decimal Converter, and an IBM Type 026 Key Punch, is used.

The Boscar is a semiautomatic film reader which produces analog outputs representing the horizontal and vertical components of distances on the film. The analog outputs are fed into the decimal converter which performs the conversion to decimal digits. The converter also has a four-digit time (frame) counter and switches for ten digits of fixed data. The converter outputs are available to the key punch. The key punch punches numerical information into eighty-column IBM cards, either manually or automatically. It can be manually operated either from its own keyboard or from that on the Boscar, and automatically punches the information fed to it from the converter.

As the system is presently used, for each frequency one card is punched for each hour of *F*-layer echoes, one for each ten minutes of sporadic-*E* echoes, and one for each ten minutes of field-aligned echoes. On all of the cards, columns one through ten are punched with data recording the day, month, year, and station of the occurrence of the phenomenon which was observed. Columns fifteen and eighty are reserved for special code punches used in the subsequent processing of the cards.

The location of a point on the film is recorded in an eight-column word consisting of three digits and sign for each of the *x* and *y* coordinates of the point with respect to the reference (which is taken as the center of the PPI display). On the *F*-layer cards, eight such points are taken at the inner edge of the *F*-layer propagated echo in the four cardinal geomagnetic directions for both first and second hop. On the sporadic-*E* and field-aligned echo cards, only one point is recorded, and its coordinates are punched in columns sixteen through twenty-three. For sporadic-*E* the point recorded is the centroid of the echo patch; with field-aligned echoes the

center of the inner edge of the echo trace is scaled.

Once the data have been recorded on cards, it is in a convenient form for compilation and processing. Three pieces of semiautomatic equipment are used to facilitate this work. One is an IBM Type 101 Statistical Sorter. It will sort on one or more columns at the same time, recognize several digits or combinations of digits, and route cards to various pockets, depending on the wiring of the program board. In addition to its sorting capacity, the machine also contains fifteen counters, which will count cards in various categories as programmed. The counter outputs, together with four digits of identifying information and a crossfoot check of the totals, are read out through an automatic printer on the machine.

The other two machines used in the card processing are linked together to operate as a single unit. They are a Moseley Autograf XY Recorder with Card Translator, and an IBM Type 523 Summary Punch. The summary punch reads the data from the cards, and the XY recorder plots the data as a series of points on a graph.

As a result of the semiautomatic reduction methods just outlined, it has been possible to publish rapidly summaries of the backscatter data during the conduct of the IGY. The first summary was published in June, 1958 (140 pages), and the second in September, 1958 (110 pages). A third summary will be ready for publication in December, 1958. Three different kinds of data are presented in these data summaries:

- 1) Data on *F*-layer minimum range
- 2) Data on sporadic-*E* occurrences
- 3) Data on field-aligned irregularities in the ionosphere.

Examples of the summaries for the month of January, 1958, at Stanford and Camden are shown in Figs. 14–16.

Fig. 14 shows minimum echo range vs local time for *F*-layer propagated ground-backscatter echoes (minimum echo range is closely related to skip distance at the operating frequency). Each plot presents one station's data for one month for one frequency and geomagnetic direction. In addition to points representing echo ranges, the plots contain three "outage" symbols. These are for occasions during which an echo range could not be recorded because of interference, equipment failure, and skip distance less than 700 km. In this last situation, the echo range cannot be accurately recorded because the echo trace tends to merge with the transmitter pulse trace on the scope at short ranges. The Stanford and Camden stations are at almost the same geographic and geomagnetic latitudes, although one is in the northern hemisphere and the other in the southern hemisphere. As a result, for the records shown in Fig. 14, one is for a winter month (Stanford), and one is for a summer month (Camden). The marked differences in *F*-region behavior are clearly visible. The Stanford chart shows the pro-

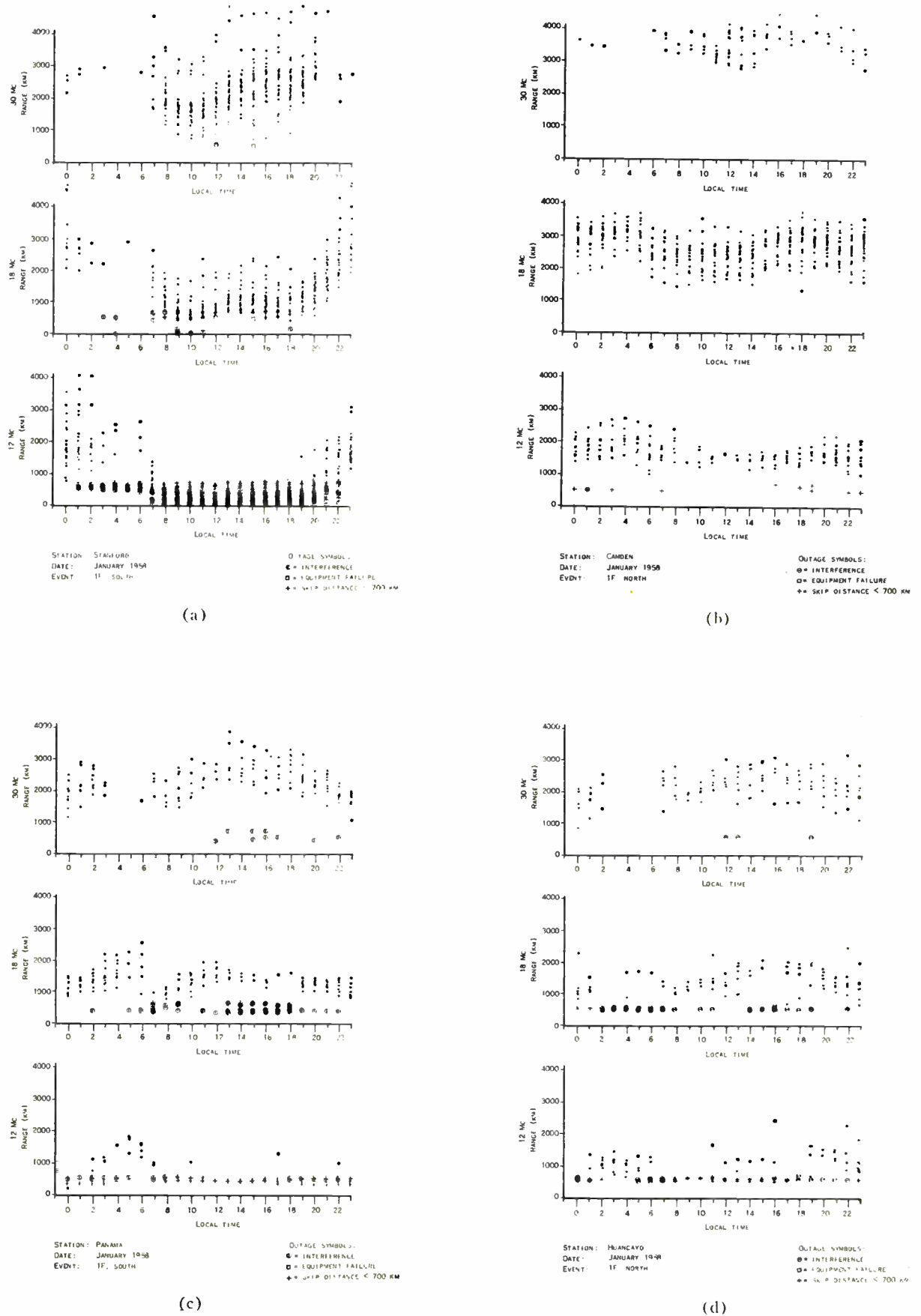
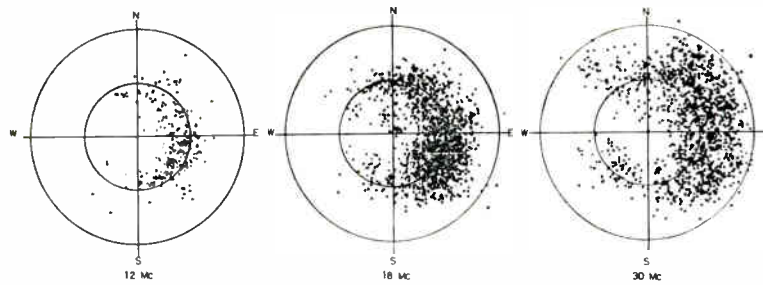

Fig. 14—IGY backscatter data summary showing minimum range of first-hop *F* layer propagated ground backscatter range throughout the month of February, 1958. (a) Stanford, Calif. (b) Camden, Australia. (c) Panama. (d) Huancayo, Peru.





STATION: CAMDEN  
 DATE: JANUARY 1958  
 EVENT: SPORADIC E  
 RANGE CIRCLES: 1000 KM 2000 KM

(a)

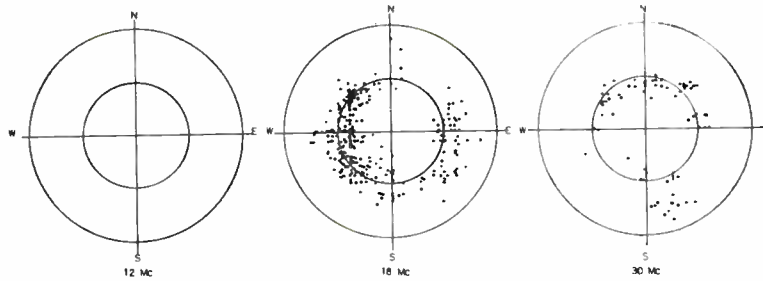

STATION: STANFORD  
 DATE: JANUARY 1958  
 EVENT: SPORADIC E  
 RANGE CIRCLES: 1000 KM 2000 KM

(b)

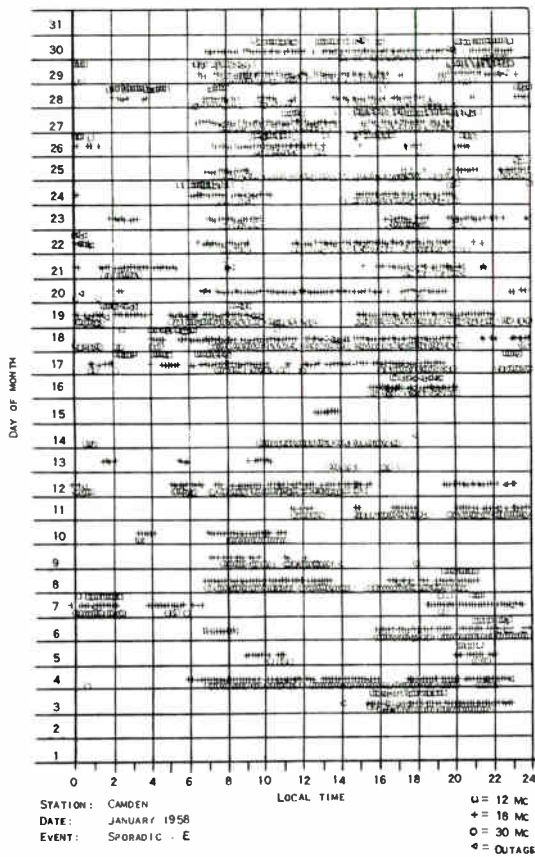

(c)

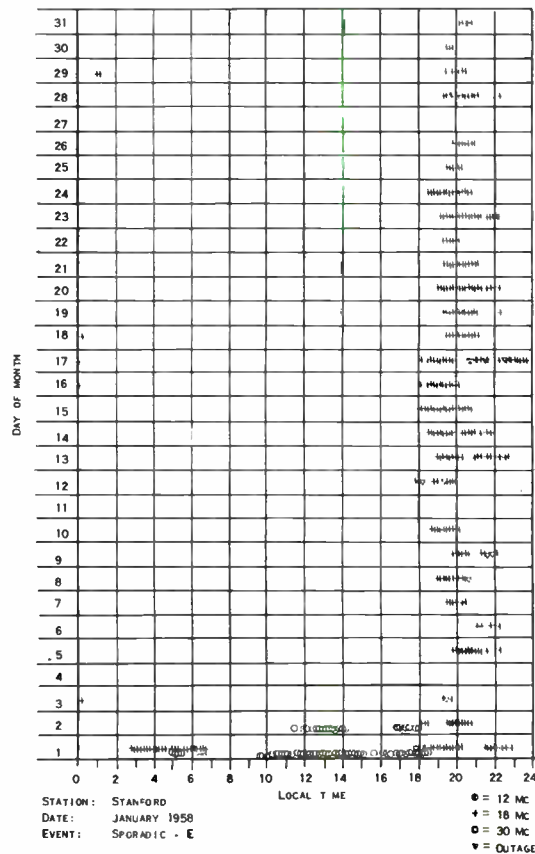

(d)

Fig. 15—IGY backscatter data summary showing sporadic-E occurrence at Camden, Australia and Stanford, Calif. for the month of January, 1958. (a) Range-azimuth plot of sporadic-E occurrence at Camden, Australia. (b) Range-azimuth plot of sporadic-E occurrence at Stanford, Calif. (c) Occurrence of sporadic-E at Camden during the 24-hour day throughout January, 1958. (d) Occurrence of sporadic-E at Stanford during the 24-hour day throughout January, 1958.

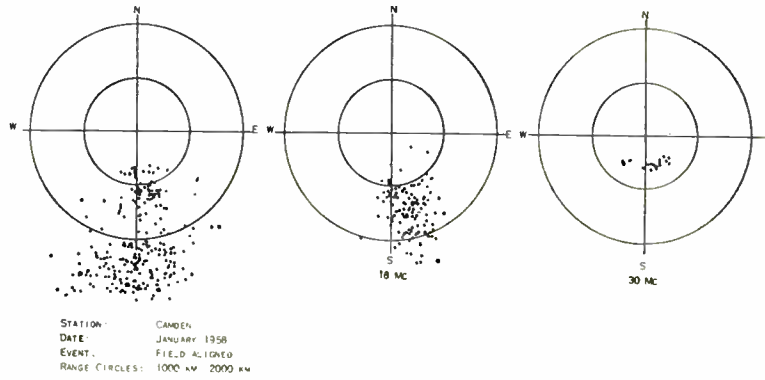

(a)

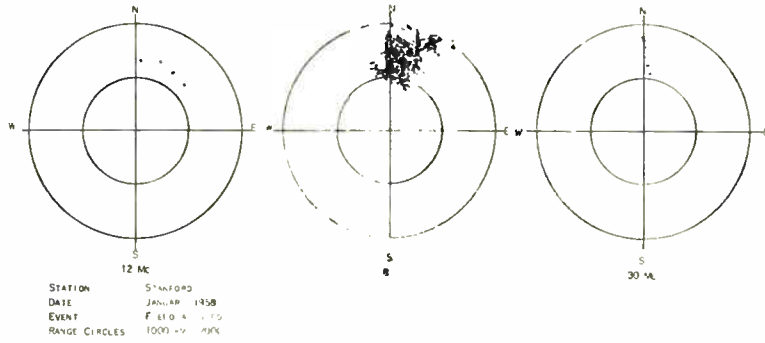

(b)

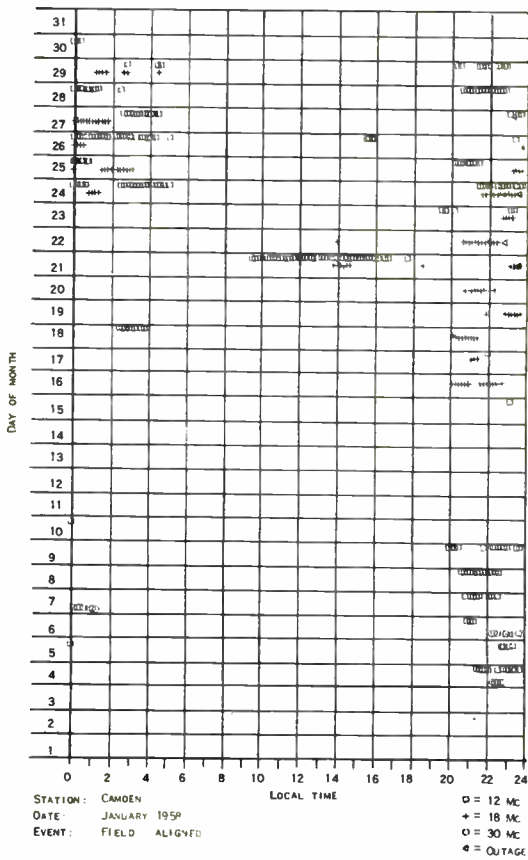

(c)

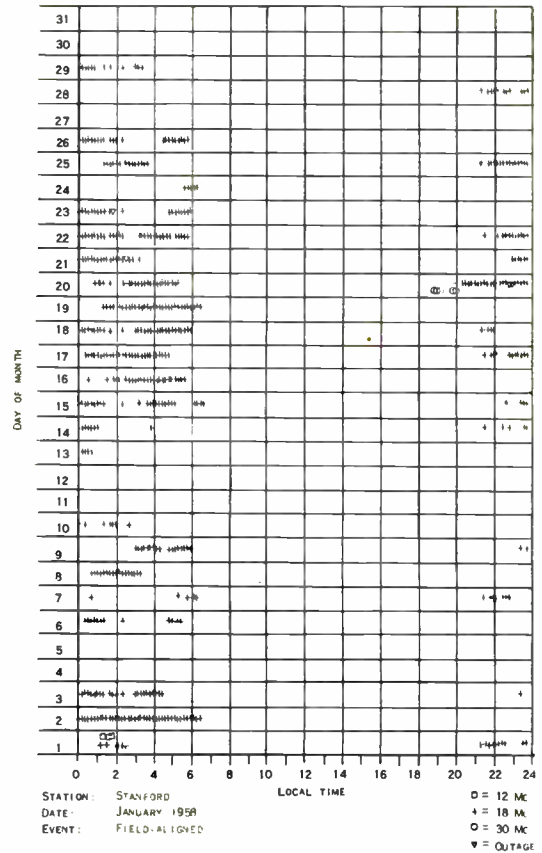

(d)

Fig. 16—IGY backscatter data summary showing occurrence of echoes from field-aligned scatterers at Camden, Australia and Stanford, Calif. (a) Range-azimuth plot of echo occurrence at Camden. (b) Range-azimuth plot of echo occurrence at Stanford. (c) Occurrence of echoes at Camden during the 24-hour day throughout January, 1958. (d) Occurrence of echoes at Stanford during the 24-hour day throughout January, 1958.

nounced variations in range from night to day, which are typical of winter, while the Camden chart shows only the slight variations from night to day which are typical for summer.

The sporadic-*E* summaries shown in Fig. 15 consist of a chart indicating the diurnal variations in occurrence of echoes throughout the month, and range-azimuth plots of these same echo points. On the day-of-month vs time-of-day charts a special symbol is used for each frequency, plus an outage symbol for interference and equipment failure. Echoes for each of the three frequencies are plotted separately on the range-azimuth plots. Geomagnetic azimuths and slant ranges are used with the sounder located at the center. The points plotted are the centroid of the recorded sporadic-*E* echo. Since for sporadic-*E* patches the scatter echo results from scattering back at the ground following a mirror-like reflection at the patch, the actual location of the patch may be determined by reducing the indicated range by one half. Scaling is done every ten minutes beginning on the hour.

Pronounced seasonal differences in sporadic-*E* occurrence are indicated in Fig. 15. There is a greatly increased rate at Camden (summer) over that at Stanford (winter). In addition, at Camden the sporadic-*E* occurs throughout the day, with a somewhat greater rate in the daytime; at Stanford sporadic-*E* occurred only in the evening during this period. The summer-winter characteristics shown here appear to be typical of sporadic-*E* occurrence at temperate latitudes such as Camden and Stanford. The summaries for June show reverse characteristics for the two stations.

Examples of summaries of echoes from ionization irregularities aligned with the earth's magnetic field (auroral and low latitude) are shown in Fig. 16. The format of the summaries of these echoes is identical to that of the sporadic-*E* summaries. The only difference is that the point recorded on the range-azimuth plot is the central angle and minimum range of the echo rather than the centroid of the echo. The occurrence of these echoes is primarily a nighttime phenomenon. The echoes occur under conditions in which a ray from the sounder can meet the earth's magnetic field lines at or near perpendicular incidence at ionospheric heights. As a result, for northern hemisphere stations such as Stanford, echoes are observed to the north, while at southern hemisphere stations such as Camden they are observed to the south.

#### PRELIMINARY RESULTS FROM THE IGY FIXED-FREQUENCY BACKSCATTER PROGRAM

The cause of sporadic-*E* ionization patches is still unknown, and their size, and time, and place of appearance are still relatively unpredictable. Some clouds move from place to place while the majority remain nearly stationary. It is not known whether the apparent motion is a consequence of true particle translation, such as might be due to winds, or due to some change in the

position or characteristics of the unknown agent which produces sporadic-*E*. At Stanford in a study of three years of backscatter sounding records (1952 to 1955) data on 2700 separate *E<sub>s</sub>* patches were obtained. The time duration of the individual patches varied from a few minutes to many hours, with a mean value of three hours. Of the total, 264 patches, approximately 10 per cent were found to move significant distances. The mean speed of patch motion was 300 km per hour, and the direction of motion was predominantly west. In 80 per cent of the cases the direction of motion was within  $\pm 45^\circ$  of due west.

Preliminary examination of the sporadic-*E* data from Camden, Australia, appears to show that at that southern hemisphere station, patch motion is predominantly westward as it is at Stanford in the northern hemisphere.

In pre-IGY studies at Stanford [8], sporadic-*E* occurring during the night was found to be rather closely correlated with the occurrence of field-aligned irregularities in the *E* region. A close relationship has also been noted in the auroral zone between the occurrence of visual auroras and sporadic-*E*. Examination of the IGY backscatter data from Huancayo, Peru, appears to show that the very prevalent "Huancayo sporadic-*E*" which has been observed for many years on the records of vertical incidence ionosonds is, in fact, a result of scattering from field-aligned irregularities. At the magnetic equator the magnetic field is horizontal and during the day, irregularities appear to develop in the *E* region parallel to the field and elongated along it in a north-south direction. Reflection at normal incidence from these irregularities is obtained over head by a vertical-incidence sounder, and when looking to the east or west with oblique-incidence backscatter sounders. The backscatter records from Huancayo, Peru, regularly show backscatter echoes extending outwards for a short range in the east-west directions. These data seem to confirm the existence, on a regular basis, of field-aligned irregularities in the *E* region over the magnetic equator during the day. Further analysis of the IGY backscatter data and comparison with geophysical data of other types will be required before the details of the phenomena can be understood.

Study of backscatter sounding records has revealed that layer tilts or horizontal gradients in the ionosphere can markedly modify the paths followed by radio waves in multihop ionospheric propagation [11]. In fact, equivalent layer tilts of only one or two degrees make possible the existence of completely new propagation modes. Low angle rays reflected from a properly oriented, slightly tilted *F* layer, will propagate beyond the bulge of the earth without striking the ground and illuminate the ionosphere again at a distance. In this manner a ray may be reflected several times by an ionospheric layer, without intervening ground reflection, before it strikes another properly oriented tilt and is returned to earth again. Backscatter observations at Stanford during the



spring and summer of 1957 showed that at a frequency near 12 mc, long-range tilt mode echoes occurred 23 per cent of the time during the hours between 1800 PST and 0600 PST. These observations appear to have been associated with layer tilts produced along the sunset line. Echoes were consistently returned at ranges between 6000 and 15,000 km, depending upon the number of intervening ionospheric reflections before the ray returned to earth. A particularly important feature of these tilt modes is the fact that the wave can travel great distances without passing repeatedly through the absorbing regions of the lower ionosphere.

Tilt modes appear to account for a major portion of the long-distance transequatorial propagation which has been observed at frequencies well above the normally accepted MUF and the characteristics of this mode of propagation across the magnetic equator are being studied by the backscatter sounders. The occurrence of a trough-like distribution of the equatorial  $F$  region, particularly prevalent in the afternoons and evenings, can be inferred from the appearance of the Huancayo ground backscatter echoes. The skip distance for  $F$ -region propagation along the magnetic east-west direction is often twice as great as in the north-south direction.

Long-range echoes (3000 to 5000 km) from ionization irregularities produced in the auroral zone during auroras are often observed on the records of temperate zone scatter sounders. Some of these observations appear to be associated with tilt mode propagation while others result from normal multihop ionosphere propagation. The possibility also exists that a portion of the observed echoes result from scattering by auroral ionization at relatively great heights above the auroral zone.

The backscatter method has been found to be particularly useful for the investigation of large, high-speed, traveling disturbances in the  $F$  region. The method is based on observing the variations of the minimum range of ground scatter echo pattern when the disturbance passes through the region in the  $F$  layer in which the radio wave is reflected. Using data from the IGY net-

work of scatter sounders, some of the disturbances have been identified as having wavefronts which stretch from the east coast to the west coast of North America, and to have traveled distances in excess of 4000 km. These disturbances have thus been shown to be far larger in extent than was previously supposed. The direction of travel has been primarily from north to south in the northern hemisphere and centered on geomagnetic coordinates. Speeds of travel typically range between 700 and 2000 km per hour. The available data suggest that these large disturbances may originate in or north of the auroral zone.

#### BIBLIOGRAPHY

- [1] W. G. Abel and L. C. Edwards, "The source of long distance back-scatter," *Proc. IRE*, vol. 39, pp. 1538-1541; December, 1951.
- [2] W. Dieminger, "The scattering of radio waves," *Proc. Phys. Soc. (London) B*, vol. 64, pp. 142-158; February, 1951.
- [3] W. L. Hartsfield and R. Silberstein, "A comparison of CW field intensity and backscatter delay," *Proc. IRE*, vol. 40, pp. 1700-1706; December, 1952.
- [4] T. Kono, "Experimental study on scattered echoes," in "Report of Ionosphere Research in Japan," Maruzen Publishing Co., Tokyo, Japan, vol. IV, no. 3; 1950.
- [5] A. M. Peterson and R. L. Leadabrand, "Long-range radio echoes from auroral ionization," *J. Geophys. Res.*, vol. 59, pp. 306-309; June, 1954.
- [6] A. M. Peterson, O. G. Villard, Jr., R. L. Leadabrand, and P. B. Gallagher, "Regularly-observed aspect-sensitive radio reflections from ionization aligned with the earth's magnetic field and located within the ionospheric layers at middle latitudes," *J. Geophys. Res.*, vol. 60, pp. 497-512; December, 1955.
- [7] A. M. Peterson, "The mechanism of  $F$ -layer propagated backscatter echoes," *J. Geophys. Res.*, vol. 56, pp. 221-237; 1951.
- [8] A. M. Peterson, "Ionospheric backscatter," in "Annals of the IGY," Pergamon Press, London, Eng., vol. 3, part 4; 1957.
- [9] E. D. R. Shearman, "A study of ionospheric propagation by means of ground back-scatter," *Proc. IEE*, vol. 103, pt. B, 1955.
- [10] R. Silberstein, "Sweep frequency back-scatter, some observations and deductions," *IRE TRANS. ON ANTENNAS AND PROPAGATION*, vol. AP-2, pp. 56-63; April, 1954.
- [11] S. Stein, "Role of ionospheric-layer tilts in long-range high-frequency radio propagation," *J. Geophys. Res.*, vol. 63, pp. 217-241; March, 1958.
- [12] O. G. Villard, Jr. and A. M. Peterson, "Instantaneous prediction of radio transmission paths," *QST*, vol. 36, pp. 11-20; March, 1952.
- [13] O. G. Villard, Jr. and A. M. Peterson, "Scatter-sounding: a technique for study of the ionosphere at a distance," *IRE TRANS. ON ANTENNAS AND PROPAGATION*, vol. AP-3, pp. 140-142; August, 1952.

# The Riometer—A Device for the Continuous Measurement of Ionospheric Absorption\*

C. G. LITTLE†, MEMBER, IRE, AND H. LEINBACH‡, MEMBER, IRE

**Summary**—A sensitive, self-balancing, noise-measuring equipment, known as the riometer, is described. This instrument has been designed for routine measurement of ionospheric absorption during the IGY, using the cosmic noise method. Application of this technique in the auroral zone has resulted in quantitative measurements of ionospheric absorption, even during polar blackouts.

The riometer has the advantages over a simple total-power cosmic noise receiving system of 1) linear response to changes of input noise power, 2) high accuracy in the presence of narrow-band RF interference, and 3) good long-term stability.

## INTRODUCTION

IONOSPHERIC absorption is often the controlling factor for MF and HF communications via the ionosphere. This is particularly true at high latitudes, where ionospheric storms frequently result in unreliable communications. These storms are often of sufficient intensity to result in "polar blackouts" or periods of complete absorption of MF and HF radio signals normally propagated via the ionosphere. The polar blackout phase of ionospheric storms may last for many hours, and over a period of a month may reduce the signal in-time by more than 20 per cent.<sup>1</sup> Studies of ionospheric absorption are thus of considerable interest to the communications engineer.

Of equal importance, however, is the information about the physical state of the lower ionosphere which can be gained from absorption measurements. This aspect of absorption studies has received considerable attention during the IGY.

Until quite recently, ionospheric absorption measurements have depended upon the study of man-made radio waves reflected back to the earth from the ionosphere. These techniques, although highly valuable, are laborious, and fail completely at high latitudes during polar blackouts. In 1953, Mitra and Shain<sup>2</sup> introduced the so-called cosmic noise method, in which ionospheric absorption is measured by comparing the signal strength of extraterrestrial radio waves actually received on a

fixed-receiving system with the signal strength received on the same system at the same sidereal time under conditions of negligible ionospheric absorption.

The cosmic noise technique is admirably suited for absorption work at high latitudes; by a suitable choice of observing frequency, absorption can be measured even during polar blackouts. Some pre-IGY absorption observations obtained at high latitudes using the cosmic noise method have been described elsewhere by the authors.<sup>3,4</sup> The cosmic noise method was an obvious choice for an IGY multistation investigation of high latitude ionospheric absorption and a special receiving equipment, described in detail in this paper, was therefore developed at the Geophysical Institute. Thirteen of the commercially built units, now called "riometers" (Relative Ionospheric Opacity Meters) are currently in use in Alaska, Canada, Greenland, Sweden, and the United States, as part of the U. S. IGY program. Others are being built by various agencies for a number of different radio wave propagation studies.

## PRINCIPLES OF OPERATION

The riometer is a self-balancing receiving system in which a local noise source is continuously made equal to the noise power from the antenna.<sup>4,5</sup> The mode of operation can be traced from the block diagram, Fig. 1.

The receiver input is switched alternately between the antenna and a local noise diode by means of a 340-cps RF switching unit. Any inequality between the strength of the antenna and noise diode signals results in a square-wave component at the switching frequency at the detector of the receiver. This square wave is amplified in an audio-frequency amplifier and then detected in a phase-sensitive detector. The amplitude of the dc output voltage of the phase-sensitive detector is proportional to the difference in noise power between the antenna signal and the signal from the noise diode, and its polarity is determined by which of the two signals is the stronger. This dc voltage is used to change the filament temperature, and hence the output noise power

\* Original manuscript received by the IRE, November 14, 1958. The development of the riometer was supported by a National Science Foundation grant and Signal Corps Contract No. DA-36-039-SC-71137.

† National Bureau of Standards, Boulder, Colo. Formerly at Geophys. Inst., University of Alaska, College, Alaska.

‡ Geophys. Inst., University of Alaska, College, Alaska.

<sup>1</sup> L. A. Ware and L. Owren, "Signal Outage Time on Short Paths and Black-outs Compared for Years of High and Low Solar Activity," Geophys. Inst., Univ. of Alaska, Final Rep., Task A, Contract DA-36-039-SC-71137; March, 1958.

<sup>2</sup> A. P. Mitra and C. A. Shain, "The measurement of ionospheric absorption using observations of 18.3 mc/s cosmic radio noise," *J. Atmos. Terrest. Phys.*, vol. 4, nos. 4-5, pp. 204-218; 1953.

<sup>3</sup> C. G. Little, "High latitude ionospheric observations using extraterrestrial radio waves," *Proc. IRE*, vol. 42, pp. 1700-1701; November, 1954.

<sup>4</sup> C. G. Little and H. Leinbach, "Some measurements of high-latitude ionospheric absorption using extraterrestrial radio waves," *Proc. IRE*, vol. 46, pp. 334-348; January, 1958.

<sup>5</sup> K. E. Machin, M. Ryle, and D. D. Vonberg, "The design of an equipment for measuring small radio-frequency noise powers," *Proc. IEE*, vol. 99, pts. 3-4, pp. 127-134; May, 1952.

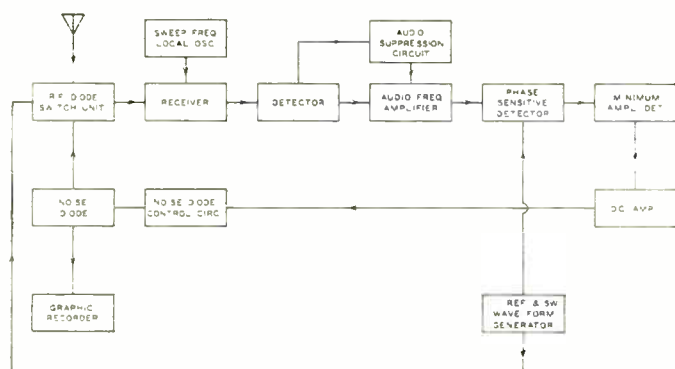

Fig. 1—Block diagram of IGY riometer.

of the temperature-limited noise diode, in such a direction as to reduce the inequality of antenna and noise diode powers to zero. In this way, the power from the noise diode is continuously made equal to the noise power from the antenna. The noise power from the noise diode is directly proportional to the dc current flowing through it, and therefore the antenna noise power can be measured on a linear scale by recording the noise diode current on a pen recorder.

A photograph of the commercially built riometer is seen in Fig. 2.

#### CIRCUIT DETAILS

##### *Interference Discrimination*

The choice of operating frequency of the riometer is limited by the desirability of using frequencies sufficiently low to obtain measurable absorption effects, yet sufficiently high to avoid an excessive amount of absorption during major disturbances. A frequency of 27.6 mc was chosen for the riometers, since they are operated primarily at high latitudes where strong absorption can be expected to occur. At lower latitudes, frequencies of 18 to 20 mc are commonly used.

Even at 27.6 mc, man-made radio waves propagated via the ionosphere often become a serious source of interference. The riometer therefore incorporates sweep-frequency and minimum-signal-detector circuits, which ensure that the riometer records the *minimum* signal strength received as a 6-kc exploring band is swept at about 2.5 kc/sec through a 100-kc search band. The mode of operation of the minimum detector circuit is as follows (see Fig. 3). When the receiver tunes through an RF signal, a positive-going pulse appears at the output of the phase-sensitive detector. This positive voltage biases the 1N270 minimum detector diode into the non-conducting state. The impedance of the diode is therefore very large, and in conjunction with the large capacitance of the 6AU6 capacity amplifier, presents a time constant of greater than 30 seconds for the increasing signal. Negative-going pulses, on the other hand, cause the diode to conduct, lowering its impedance and giving a resultant time constant of less than one second.

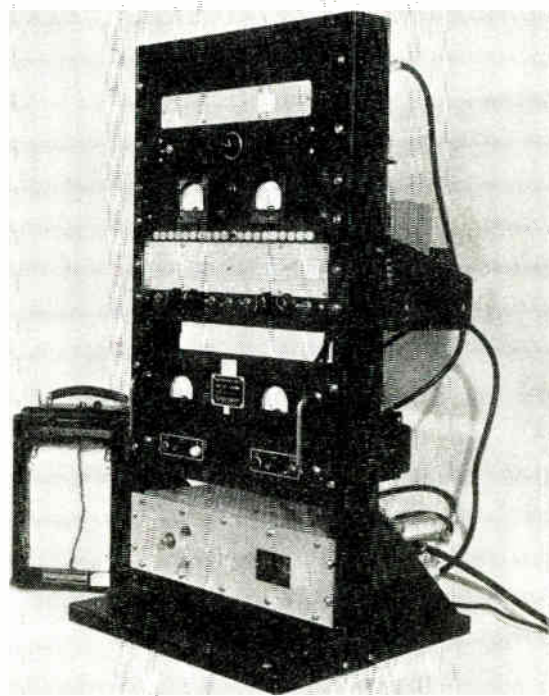

Fig. 2—The riometer.

The output of the minimum-detector circuit corresponds to the cosmic noise level, provided that at least one clear channel is present in each 100-kc sweep. The sweep-frequency, minimum-detector technique has been used previously by Lee<sup>5</sup> in a total-power cosmic noise receiver.

##### *Audio Suppression Circuit*

Due to the very low cosmic noise signal strength, the riometer requires a large voltage gain (approximately  $1 \times 10^{10}$ ) and therefore is subject to overloading in the presence of interfering signals. An audio-suppression circuit has been incorporated to minimize the effects of such overloading. The operation of the suppression circuit can be traced from Fig. 3. The detected output from the receiver is dc coupled to the grid of a 6AH6 suppression tube, and simultaneously ac coupled to the input grid of the 12AU7 audio amplifier. The plate of the 6AH6 is dc coupled to the same audio amplifier grid. The bias of the 6AH6 is set through a 5-kilo-ohm potentiometer in the cathode lead so that the 6AH6 is normally cut off. In the presence of an RF signal greater than a predetermined strength, the 6AH6 tube begins to conduct. This lowers the plate voltage of the 6AH6 and consequently the potential on the grid of the 12AU7, thereby cutting off the audio amplifier stage and reducing its gain to zero. This breaks the servo loop and prevents the servo diode from following the inter-

<sup>5</sup> R. H. Lee, "Solar-flare detection for IGY." *Electronics*, vol. 30, pp. 162-165; March 1, 1957.





fering signal. During the period when the servo loop is interrupted, the servo noise diode current rises to a "resting level" which is determined by the bias setting on the cathodes of the 6Y6 control tubes. This bias is adjustable, and in practice is set to give a resting level value just above the maximum of the cosmic noise signal received under quiet conditions. Normal operation of the servo loop is resumed as soon as the interfering signal disappears.

#### Noise Diode Control Circuit

The noise diode control circuit consists basically of a variable reactance load (transformer T2 in Fig. 3) in the noise diode filament circuit. The primary of T2 is in series (in the servo-controlled case) with the primary of the filament transformer T3. The secondary winding of the reactance transformer, T2, is connected to the plates of the 6Y6 servo-control tubes. The current through these tubes is controlled by the amplified dc signal from the phase-sensitive detector.

A positive-going output signal from the phase-sensitive detector, corresponding to a larger antenna signal than noise diode signal, decreases the grid bias of the 6AU6 dc amplifier, and increases the current flow through the tube. The positive potential on the plate of the 6AU6 therefore is decreased, and since the plate is dc coupled to the cathodes of the 6Y6 reactance tubes, the cathode bias of the 6Y6's is reduced accordingly. Consequently, the current flowing in the 6Y6's increases, reducing the reactance of the primary of transformer T2, and increasing the filament voltage of the servo noise diode. As a result the plate current of the noise diode increases, until the noise power output equals the noise power from the antenna. Under these conditions the positive dc signal from the phase-sensitive detector is approximately zero again. A negative dc signal from the phase-sensitive detector acts in a reverse manner to reduce the filament temperature and hence the noise power from the servo noise diode.

#### Diode Switches

The prime requirements of the switching unit are: 1) a large switching ratio between the on and off conditions, 2) a small feed-through loss in the on condition, 3) negligible noise generation, and 4) long-term stability. All of these requirements are met by a diode switching unit in which two diode switches, plus quarter-wave coaxial transformers, are used as shown schematically in Fig. 4. Three 1N270 crystal diodes are used in parallel in each switch to lower the forward resistance. The two diode switches are biased 180° out of phase by a sinusoidal switching voltage derived from the master oscillator, which also supplies the reference voltage to the phase-sensitive detector. Switching ratios of greater than 30 db are readily obtained with these diode switches.

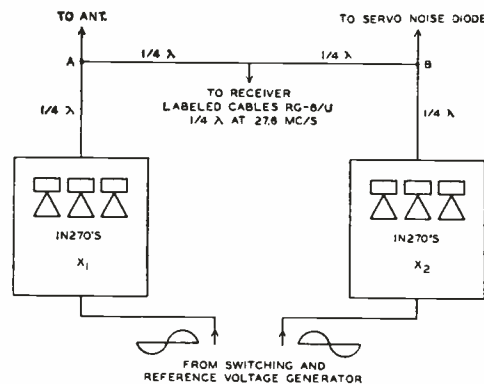

Fig. 4—Switching unit to switch the receiver input between the antenna and the servo-controlled noise diode at 340 cycles per second.

#### Noise Diodes

The two type-5722 diodes are operated in the temperature-limited condition, one as the servo noise diode, the other as a test noise diode for calibration and testing of the riometer. Plate resistors of 800 ohms are used in each diode, in order to obtain adequate noise power output within the current ratings of the tubes. Impedance matching to 52 ohms is accomplished by means of pi-network matching circuits.

#### Receiver

The receiver is a double-conversion superheterodyne receiver in which the first local oscillator is swept in frequency through approximately 100 kc every 40 seconds. The saw-tooth frequency sweep is accomplished mechanically by rotating a dielectric sector between the plates of a small capacitor in the frequency-determining tank circuit of the first local oscillator.

#### Antenna

A vertically-directed, three-element Yagi antenna is used at all of the riometer sites. This antenna was selected because it is easy to erect, mechanically sturdy, and easy to adjust electrically. The antenna pattern of a prototype Yagi was measured by flying a low-powered transmitter over the antenna; the measured beam-widths between the half-power points were 60° (*E* plane) and about 110° (*H* plane). The width of the beam is such that the scintillation of the stronger radio sources amounts to only a small percentage of the total cosmic noise level. Rotation of the sky through the antenna pattern each day results in a diurnal variation of signal strength amounting to about 1.5 db at the high latitude stations. This variation is removed automatically in the reduction of the data, since comparison is made between a given day and the quiet day cosmic noise strength at the same sidereal time.

The antenna is matched to the 52-ohm coaxial transmission line through a "T" match section on the driven element and a half-wave coaxial balun.

*Pen Recorder*

A 3-ma dc Esterline-Angus pen recorder, shunted to give a full scale reading of about 8 ma was used to record the current through the servo-controlled noise diode, and hence the noise power from the antenna. Since the riometers were, in general, to be installed at remote Arctic field sites, eight-day spring driven chart units were selected to eliminate timing uncertainties due to power failure or frequency variations.

*Test Points*

Provision was made for the examination, via pin-jacks on the front panel of the control unit, of the waveforms and voltages existing at some 20 critical points of the circuitry. The test points proved most valuable in facilitating the rapid setting-up of the equipment and the speedy diagnosis of equipment failures.

## OPERATING PARAMETERS

The main parameters of the receiver and the control unit of the riometer are listed below.

*Receiver*

Center frequency	27.6 mc
Input impedance	$R = 52 \pm 10$ ohms $X = 0 \pm 10$ ohms
Width of frequency sweep	100 kc nominal
Rate of frequency sweep	2.5 kc/sec
Shape of frequency sweep	Approximately saw-tooth
Over-all voltage gain to second detector	$3 \times 10^7$
Receiver noise factor	Less than 5
RF bandwidth	Approximately 0.5 mc
First IF frequency	4.7 mc
First IF bandwidth	20 kc
Second IF frequency	455 kc
Second IF bandwidth	6 kc (3 db); 30 kc (60 db)

*Control Unit and Diode Switches*

Feed-through ratio of RF switches	On:off ratio greater than 30 db
Feed-through loss in each diode switch when in "on" position	Less than 0.2 db
RF noise power generated in diode switches and fed into receiver	Less than $\frac{1}{2}$ KTB, <i>i.e.</i> , less than that produced by 0.5 ma of noise diode current flowing through 50 ohms
Output impedance of noise diodes	$R = 52 \pm 10$ ohms $X = 0 \pm 10$ ohms
Receiver input switching frequency	340 cps
Time constant of minimum detector circuit for increasing signal strength	30 to 100 seconds
Time constant of minimum detector circuit for decreasing signal strength	0.5 to 1.0 second
Audio voltage gain	Approximately 50
Audio suppression—reduction in audio gain produced by 1-volt increase in detector voltage (audio suppression bias optimized)	Greater than 20 db
DC amplifier voltage gain	Approximately 20
Over-all system voltage gain	Approximately $1 \times 10^{10}$
Dynamic range (fixed gain)	15 db
Dynamic range (variable gain)	30 db
Short-term stability	0.05 db
Long-term stability	0.5 db
Suppression of narrow-band transmitter interference	One transmission in frequency sweep, 60 db above sky noise, affects output by less than 0.1 db
Power input (electronically regulated)	250 v 190 ma dc 115 v 60 cps ac 6.3 v 12 amps ac



## ADVANTAGES OF THE RIOMETER

The riometer has three important advantages over a simple total power system: 1) It provides a linear input-output characteristic since the signal strength is recorded on a scale linear with power, 2) the equipment is capable of operating with high accuracy in the presence of narrow-band RF interference, and 3) the equipment possesses good long-term stability since the receiver acts as a null detector rather than as an amplifier. For example, one riometer, operated continuously under adverse field conditions, showed a variation of calibration of less than 6 per cent over a period of five months. A daily calibration of the equipment therefore is sufficient to assure accuracies limited primarily by uncertainties arising from the fundamental statistical fluctuations in the noise signal. These fluctuations limit the sensitivity of the present riometers to about 0.1 db-change in signal strength.

Although the riometer is a device designed for a specific purpose, it is clear that it could be readily adapted

for other types of noise measurements. By including such modifications as broader receiver bandwidth, AVC, and a careful redesign of the control circuit, it should be possible to design a system which would have a dynamic range in excess of 50 db, a limiting sensitivity to changes in noise power of better than 0.01 db, a long-term stability of the order of 0.1 db, and an absolute accuracy of the order  $\pm 10$  per cent of the scale reading, for noise powers in the range  $10^{-23}$  to  $10^{-18}$  watts per cycle per second of observing bandwidth.

## ACKNOWLEDGMENT

The authors are indebted to R. P. Merritt and Nate Warman of the Geophysical Institute staff, who contributed materially to the design and testing of the prototype riometer. They also are indebted to Robert Lee of the High Altitude Observatory of the University of Colorado for advance information on his use of the sweep-frequency, minimum-detector technique.

## A Low Power VHF Radar for Auroral Research\*

ROBERT S. LEONARD†, ASSOCIATE MEMBER, IRE

*Summary*—A 5-kw, 41-mc radar which was designed for use in the United States IGY program is described. The standard operating procedures are outlined and a sample of the records is shown. The design of a scaling machine is discussed and a method of utilizing the scaled data to produce an auroral echo activity index is described.

## INTRODUCTION

FOR the United States IGY Auroral Radar program, a simple, reliable, low power VHF radar was needed, and such a unit was developed at the Geophysical Institute of the University of Alaska. The requirements were for an instrument that would operate continuously at remote field stations with a minimum of service and maintenance under conditions of poor frequency and voltage regulation of ac power. The operating frequency was chosen by a compromise between the higher frequencies where the backscattering coefficient is less and higher powers are required, and the lower frequencies where absorption and normal *F*-layer backscatter are serious complications. An operating frequency between 40 and 42 mc was the final choice. The production units<sup>1</sup> have been in operation at field stations

in Alaska and the U. S. for more than one year with a minimum of outage time due to equipment failures.

## EQUIPMENT

The radar consists of the following sub-units: a pulsed, crystal controlled transmitter; a stable, low noise crystal controlled receiver; a transmit-receive switch to couple the receiver to the antenna; a time base generator; an oscilloscope; a camera drive unit; and the necessary power supplies. A block diagram is shown in Fig. 1 and a photograph of the production units in Fig. 2.

The transmitter follows closely the design of a conventional VHF communication transmitter. It has a well shielded crystal oscillator, followed by a gated buffer amplifier which is controlled by keying pulses from the time base generator. Following the buffer amplifier are two class-C doubler amplifiers, and a class-C final amplifier. All stages following the gated amplifier have special provisions to keep the operating potentials constant during the pulse as well as during the interval between pulses.

The receiver is a double-conversion superheterodyne with two crystal controlled local oscillators. A single-stage, dc-coupled, video amplifier is included in the receiver with a video signal clipping circuit to prevent blooming of intensity modulated oscilloscope display.

\* Original manuscript received by the IRE, November 14, 1958.

† Geophysical Inst., University of Alaska, College, Alaska.

<sup>1</sup> Copies of the prototype manufactured by Levinthal Electronics Products, Inc., Palo Alto, Calif.

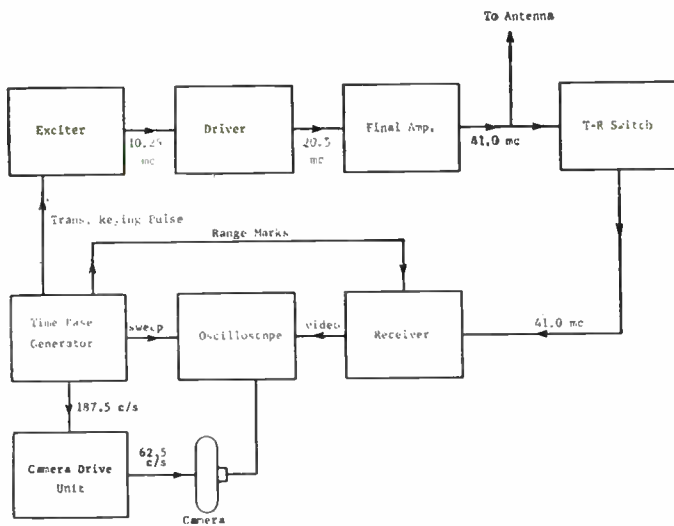

Fig. 1—Block diagram of the auroral radar.

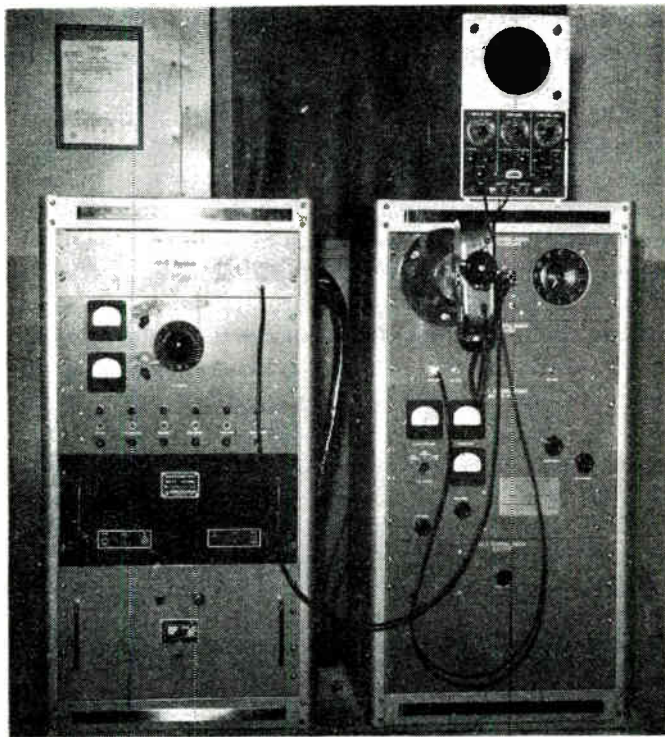

Fig. 2—Photograph of the radar in operation.

The transmit-receive switch consists of a pair of lumped-constant quarter-wave transformers, with a characteristic impedance of 1000 ohms, placed back-to-back. A type 1B32/532A gas diode is placed between these two transformers. During reception, the two transformers acting together produce no impedance transforming effect, and the 50-ohm receiver is connected to the 50-ohm antenna feed line. During the transmit period the gas diode conducts, producing nearly a short circuit between the two quarter-wave transformers. This very low impedance, when transformed by one quarter-wave transformer appears as an extremely high impedance in parallel with the 50-ohm antenna feed line, effectively disconnecting the receiver from the antenna

feed line. In practice, it is possible to realize more than 35 db of loss during transmit, with an insertion loss of 1 db. An anti-TR switch was not used because the transmitter impedance during standby was large compared to 50 ohms, so that almost all of the echo power was delivered to the receiver.

The time base generator is the control center of the entire radar. It consists of a 750-cycle tuning-fork controlled oscillator, binary frequency dividing chain, pulse generator and sweep generator. The 750-cycle signal produces the 200 km range marks directly; it is then divided by 8 to produce the transmitter keying frequency and saw-tooth sweep-triggering frequency. A pulse generator produces the transmitter pulse, and an identical pulse of opposite polarity to blank the oscilloscope during the transmit period.

In addition, 187.5 cycles per second square waves, derived from the divider chain, are supplied to the camera drive unit to provide a stable frequency to drive the camera motor.

The oscilloscope is intensity modulated by the video signal which is dc coupled from the video amplifier to the grid of the cathode ray tube. Two sweep plates are connected together to prevent any vertical deflection, and the others are connected to the sweep generator in the time base generator. A special 16-mm camera is employed, which has no shutter and drives the film through the focal plane continuously.

The camera drive unit divides the 187.5 cycles per second square waves to 62.5 cycles per second. This is then amplified and used to drive the camera motor which provides a constant film rate of 50 frames per hour independent of power line frequency. In addition, a special clock whose operation is independent of both the power line frequency and the camera drive unit, puts marks on the edge of the film every hour.

The antenna consists of a pair of horizontally polarized 4-element Yagis, located respectively one and two wavelengths above ground. It has been shown<sup>2</sup> that the auroral echoes at these observing frequencies occur almost entirely inside a sector centered on geomagnetic north. For this reason the antenna was not made steerable, but fixed with the center of the beam directed toward geomagnetic north.

#### OPERATING PROCEDURES

The daily operating procedure is designed to maintain the operating parameters as constant as possible, and identical to the other radars in the U. S. network. It is also necessary to identify positively each roll of film as to date and station. This is accomplished by photographing a coded identification daily.

The coded identification consists of three rows of four digits each. A typical example is:

\* R. B. Dyce, "Communication Aspects of VHF Auroral Reflections," Res. Rep. EE 249, School of Elec. Eng., Cornell University, Ithaca, N. Y.

0123  
C750  
0005

The first two digits in the top row are the month, and the second pair, the date. The first digit in the second row is a station code, according to the following plan:

B—Barrow, Alaska	M—Macquarie Island
C—College, Alaska	N—Ithaca, New York
D—Rapid City, S. Dak.	P—Pullman, Washington
F—Farewell, Alaska	S—King Salmon, Alaska
K—Kotzebue, Alaska	U—Unalaska, Alaska

The second digit in the second row is the year, 7 for 1957 and 8 for 1958. The last two digits in the second row are the tens of volts of RF at the output of the final amplifier. The four digits in the third row give the Universal Time when the camera was removed from operation. The example above would be January 23, 1957, College, Alaska, final amplifier output voltage = 500 volts, camera removed from operation at 0005 U.T. This daily identification provides the most frequently needed information for the analysis of the data, making it unnecessary to refer often to the more detailed daily operations log. A sample film is shown in Fig. 3.

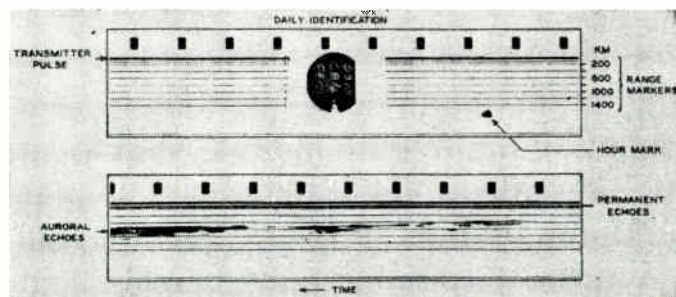

Fig. 3—Example of films taken at College, Alaska.

The gains of the receiving system are adjusted so that the range of signal strength between a minimum threshold signal and a signal which will produce the maximum intensity is small; this results in an appreciable darkening of the film for echoes just above the threshold. The minimum signal threshold is checked daily and corrected if necessary to a value of 0.6 microvolt at the 50-ohm input. The transmitter output power is calculated by measuring the RF voltage at the final amplifier output (antenna feed line input) and knowing the impedance of the antenna. This voltage is measured daily and corrected to be 500 volts across the 50-ohm antenna feed line. In addition to these fundamental operating parameters, the voltages and currents of many of the circuits are measured and logged daily.

#### SCALING EQUIPMENT

Each radar uses one 100-foot roll of 16-mm film in three days. Ten of these radars are in operation; this means that during the IGY there have been in excess of 100,000 feet of film exposed. With this tremendous

amount of film to be scaled and data reproduced in a form suitable for analysis, it was necessary to design a semi-automatic scaling machine. A statistical study of the distribution of auroral echoes in both time and location is the planned preliminary analysis. Another quantity which can be obtained from the auroral radar data is an index of auroral echo activity, applicable to a given region at a particular time. This index will be especially useful to single out of this mass of data special events for further detailed study.

For these purposes, it is planned to reduce the data into the fractions of each hour auroral echoes are present in each range interval. Since the film rate is 50 frames per hour, we can obtain a simple fractional echo-present time by simply counting the number of frames when auroral echoes are present in each range interval. Unfortunately, when interference is present, it will also produce darkening of the film, making it necessary for an operator to decide between spurious and real auroral echoes. Otherwise, it would be possible to scale the films photoelectrically.

The scaling machine designed for this purpose is built around an electrically driven, continuous motion, shutterless film viewer. The scaling machine produces one pulse for each frame as it moves across the viewing screen; these frame pulses are then routed to a bank of push switches, one for each range interval. The operator merely holds closed the switch corresponding to a range interval in which there is an auroral echo present, thus routing the frame pulses corresponding to the presence of an auroral echo into a mechanical counter that accumulates the number of one-fiftieths of an hour the auroral echo was present in that range interval. The frame pulses are also accumulated by a mechanical counter which stops the film transport mechanism on the 50th count, corresponding to one hour of the film. At this time, the bank of mechanical counters contains the total number of one-fiftieths of an hour an auroral echo was present in each range interval. By use of a suitable commutating device, the sums in these counters can be read out and punched directly into an I.B.M. card. Similar mechanical storage units are used to provide auxiliary information such as station, date, hour, etc.

From these cards the statistical distributions can be easily compiled. Similarly, by a simple process of sorting, and perhaps summing, an auroral echo activity index can be prepared directly.

#### ACKNOWLEDGMENT

The author wishes to express thanks for the invaluable assistance he received from the engineering staff of the Geophysical Institute in the design and construction of the prototype.

The production of the prototype was made possible by a National Science Foundation grant, number IGY 1.7, and the operation during the IGY by National Science Foundation grant, number IGY 1.14.



# The Day-to-Day Coordination of IGY Observations\*

A. H. SHAPLEY†

**Summary**—The IGY World Days and Communications program has four facets: 1) an IGY Calendar of selected days for experiments which cannot be carried on continuously; 2) a scheme for specifying periods when phenomena of unusual interest are anticipated a few hours in advance; 3) the prompt and wide distribution of summary observations of outstanding solar and geophysical events; and 4) the use of the world-wide scientific communications network for processing information of temporal interest. This is a cooperative effort including all the countries participating in the IGY.

The paper describes the plan and its execution, including the arrangements for rapid communications.

## INTRODUCTION

THE International Geophysical Year has been a period for greatly expanded and intensified observation in the sciences dealing with the earth, its atmosphere and nearby space. Many of the experiments are epochal, as for instance thickness of the Antarctic ice sheet at the South Pole; it matters little when during the IGY they are carried out. For a large number, however, the phenomena under study are known or suspected to vary significantly with time within a period as brief as the IGY. These are principally in the fields of meteorology and the high atmosphere in which seasonal effects or the influence of solar activity play a role. Thus, there has been an attempt to coordinate the timing of these observations, such that observing effort by the world networks of IGY stations is further concentrated on selected days, within the "year." This is the program for "World Days and Communications," which, although listed as one of the 14 IGY disciplines, is really a scientific service to the others.

The program has four facets: an IGY Calendar of selected days, a scheme for specifying periods when phenomena of unusual interest are anticipated a few hours in advance, the prompt and wide distribution of summary observations of outstanding solar and geophysical events, and the use of the worldwide scientific communications network for processing information of temporal interest. Also charged to the World Days program is the responsibility for compiling a brief summary of solar and geophysical events which actually took place during the IGY—an IGY Calendar Record, and the specification of periods for which intensive analysis may be expected to be particularly fruitful—IGY Analysis Intervals.

## THE IGY CALENDAR

A calendar of selected days was prepared long in advance for use in experiments which cannot be carried on continuously, but which do not depend strongly on

solar activity or geomagnetic disturbances. Marked on the IGY Calendar (Fig. 1) are *Regular World Days* (RWD) and *World Meteorological Intervals* (WMI). Also indicated are the days of important meteor showers and of solar eclipses. Thus, on these days, and in particular on the RWDs, the world-wide coverage of geophysical observations should be unusually complete.

There are three or four Regular World Days each month. Two of them are consecutive days at the time of new moon, when observing conditions for aurora and the airglow are most favorable. The others (one or two) are at times of unusual meteor showers or near one of the lunar quarter-phases. According to these criteria, each solar eclipse will occur on an RWD; the adjacent days are also designated as RWDs to insure a minimum of control observations. For geophysical phenomena which are insensitive to lunar phases or meteoric effects, the RWDs constitute a representative sample of the IGY period.

In meteorology, where measurements on adjacent days are strongly correlated, a longer series of consecutive days for intensified observations has advantage over the singlet and doublet RWD. Therefore, the World Meteorological Intervals last 10 days, with one WMI each season. They were selected to include the equinox or solstice (except December, 1958) and also at least two RWDs. They also are in phase with the "pentades" or series of 5-day intervals designated by the World Meteorological Organization for uniform reporting of surface meteorological observations.

Use has been made of the RWD in many of the IGY disciplines, in scheduling observations, in selecting periods for which detailed data will be sent to IGY World Data Centers, and in selecting periods for early or detailed reduction and analysis. Here are some examples, largely drawn from the field of ionospheric physics: The recommended schedule for vertical soundings of the ionosphere calls for observations every 5 minutes on RWDs while on ordinary days the work is on a 15-minute schedule. Ionospheric absorption measurements by the pulse reflection technique, which at most stations must be carried out by hand, are usually made only on RWDs because of manpower limitations, but measurements in different parts of the world can be better compared because observations were all made on the same days. Where possible, high altitude rocket launchings are scheduled for RWDs, both to provide the possibility for simultaneous launchings at widely separated points and because the quantity of control observations in selected IGY disciplines will be a maximum.

The RWDs are also being used as the basis for selection of periods for exchange and analysis of data. Iono-

\* Original manuscript received by the IRE, November 12, 1958.

† CSAGI Reporter for World Days and Communications, National Bureau of Standards, Boulder, Colo.

# Final Calendar of Regular World Days (RWD) and World Meteorological Intervals (WMI) during the International Geophysical Year 1957-1958

(Adopted by CSAGI, September 1956 and edited by)  
CSAGI SECRETARIAT - 3, AVENUE CIRCULAIRE, UCCLE-BELGIUM

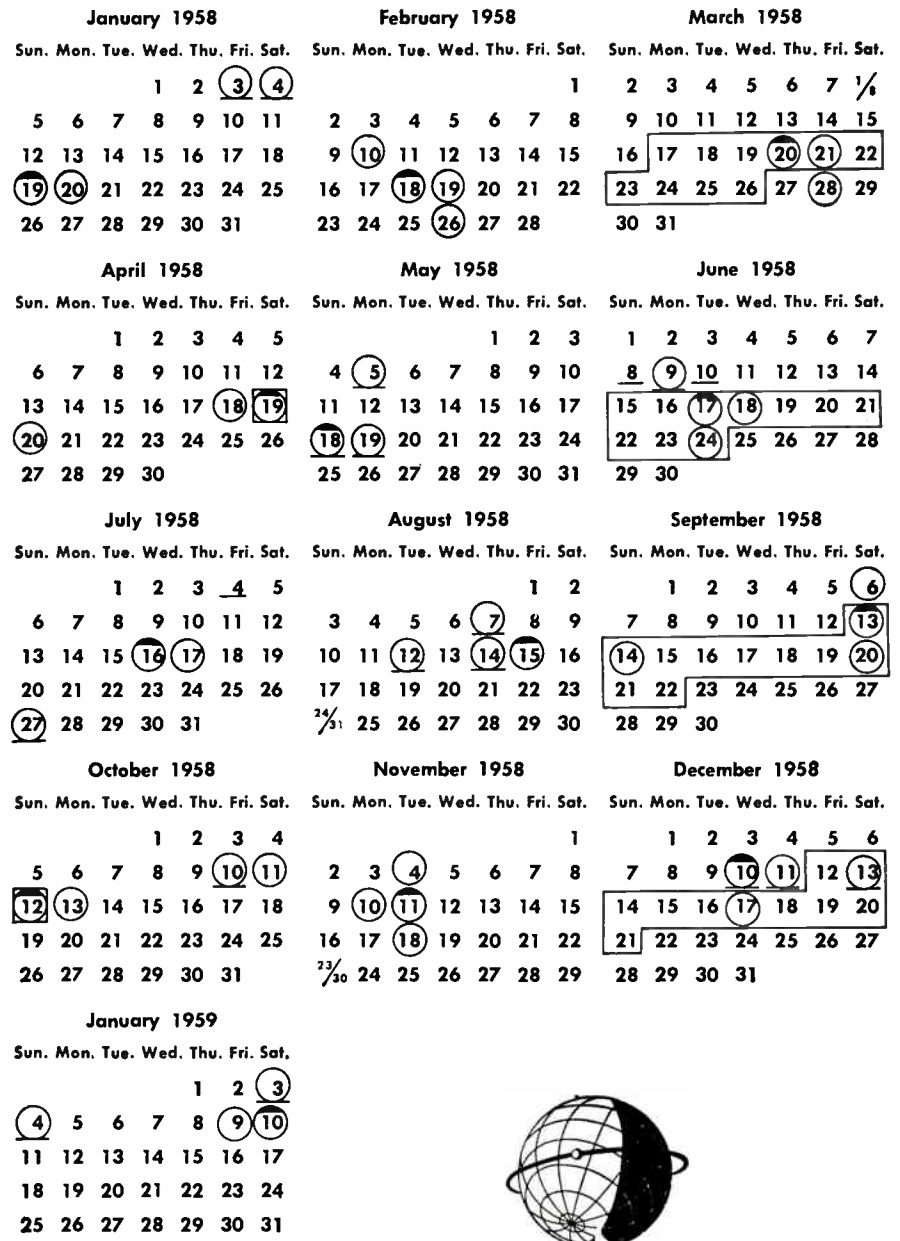
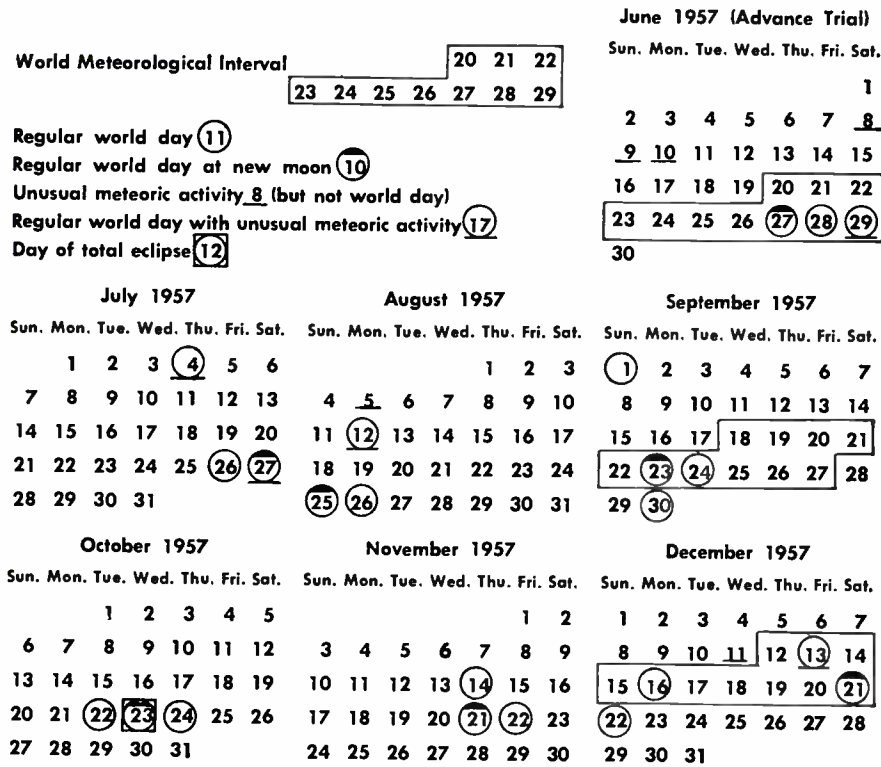

Fig. 1.

spheric soundings are systematically reduced by IGY stations in greatest detail for RWDs and, according to the data exchange plan, copies of the film records themselves for RWDs will be collected in the World Data Centers; it was decided at international IGY planning conferences that treating all days in such detail would be too expensive of money and effort for most laboratories but that the work would be warranted and of scientific importance for a few days, including the RWDs. Electron-density profiles, involving very laborious and costly calculation, are being done first for the observations on the RWDs.

Similarly, the WMI are being used in the IGY meteorology program both in scheduling observations and in analysis. Stations throughout the world are putting their best effort into the WMI, launching their best radiosonde balloons, or where there may be a shortage of equipment, making four launchings a day instead of two, or two instead of none. Thus the quantity of upper air data will be maximum during these intervals and the emphasis in analysis will naturally follow.

#### ALERTS AND SPECIAL WORLD INTERVALS

So many phenomena of the high atmosphere depend on solar activity and geomagnetic disturbance that world-wide coordination of IGY stations on a few hours notice was deemed to be necessary in order to achieve as large a return as possible from the IGY effort in these fields. It is, in fact, one of the major objectives of the IGY, to understand better the nature of solar influences on the earth. But solar activity, while generally at a very high level throughout the IGY, can vary over a wide range in the course of a few days or weeks; and there is no way yet known by which one can anticipate by more than a few minutes at most, the time a solar flare will occur. The class of high atmosphere disturbance marked by large geomagnetic fluctuations, brilliant auroral displays, radio blackouts and allied phenomena, evidently occurs in time-association with certain solar events, according to the many statistical relationships derived over half a century. Making useful forecasts of such disturbances was the problem posed to the IGY World Days program, for important studies in working out the mechanisms of solar influences on the high atmosphere depend greatly on worldwide, multidisciplinary observations, especially of the first minutes and hours of the disturbance.

Since the forecasts would be less than fully reliable, the plan evolved for this part of the coordination of IGY efforts, called for "Alerts" to be issued and quickly distributed to all IGY stations involved whenever solar activity reached a high level such that outstanding terrestrial effects might be expected to follow, judged by the statistical relationships. When solar events occur of the type and intensity which in the past have been most dependably in time-association with geomagnetic disturbance, a "Special World Interval" (SWI) is called to begin on eight hours notice. To make these decisions, it

is necessary to have prompt reporting of the significant solar observations for the time-lag between outstanding solar event and associated geomagnetic disturbance appears to be in the range 20 to 36 hours. The 24-hour patrol of solar activity, finally a reality in the IGY, obviously enhances the success of the scheme of IGY Alerts and SWIs.

The judging of the level of solar activity and the likelihood of ensuing geomagnetic disturbance has been shared by the expert groups in various parts of the world. Each formulates his opinion every day on the basis of telegraphic summaries of observations by the world network of solar observations. He then sends a telegram with advice on the declaration of Alerts or SWI to the IGY World Warning Agency, designated by international agreement as the North Atlantic Radio Warning Service of the CRPL, National Bureau of Standards, located on the grounds of Ft. Belvoir, near Washington. On the basis of advice received, the World Warning Agency makes the final decision at 16 o'clock, Universal Time, every day and issues the message which is distributed to IGY stations throughout the world to reach them, at the latest, in 8 hours. This is truly an international decision, for advice is regularly provided from France, Netherlands, Germany, USSR, Czechoslovakia, Japan, Australia, as well as Alaska, Colorado, and even Antarctica.

A typical series of events and the resulting IGY warning messages is as follows. There might be a few days of low solar activity—perhaps some sunspots, even large sunspots, but no or only a few minor flares or radio noise outbursts. The IGY message would be "No Alert." Then the next day a new solar activity region is noted on the visible disk, with large sunspots and perhaps a flare of intermediate importance but without intense radio frequency radiation. Probably the decision would again be "No Alert," but the forecasters—and the solar observers—would watch this region with special care. Perhaps the following day a flare of higher importance is observed and if the forecasters consider this solar region to be growing in activity—there are many clues—the message would read "Alert Begins." This means IGY stations should be on guard for possible, unusual, direct solar effects, and the likelihood of a geomagnetic storm with its associated effects is enhanced. For the next several days, unless no further flares or other activity occurred, the message could be "Alert Continues." If there then was a flare of highest importance, with a radio event of comparable significance, the consensus of the various Regional Warning Centers sending advice might be "Interval Starts" at 00 hours Universal Time the next day, 8 hours after the IGY warning message was issued. If the forecast is fully successful, a geomagnetic storm will start during the first day of the SWI. If one does start, or if the consensus of the forecasters is that there is still a strong probability one will come, the next warning message will read "SWI Continues." When the storm has run its course, usually 2 to 3 days, or when the fore-



casters give up hope for their forecast, usually in two days, the next warning message will be "SWI Finishes at 24 hours, Universal Time, Alert Continues" if the sun continues sufficiently active to warrant continuing the Alert; otherwise the Alert also will be concluded, and we revert to "No Alert" on the following days.

There are usually no organized, special observing programs during periods of Alert. The observers at an IGY station may monitor their experiment more closely and be more ready to take special observations if something unusual is noticed. For instance, the severest geomagnetic activity of the first 12 months of the IGY came February 11, 1958, during a period of Alert. The disturbance came sooner than expected so a Special World Interval had not been called. However, because of the Alert, observers were on guard and detailed observations were made of all but the first hours of the storm. Especially valuable was the fact that auroral observers in low latitudes were alerted to the possibility of a display, which was in fact observed at least as far south as Cuba.

The observing plans during Special World Intervals call for intensified observations even though at the beginning of the SWI, no unusual phenomena are occurring. Ionospheric soundings are taken at more frequent intervals, usually every five minutes, cosmic ray monitoring balloons are launched, and other programs proceed at an accelerated pace. In this way the full potential of the IGY high atmosphere program is in play at the time of onset of the disturbance—if the forecast is successful. Without such international coordination and forecasting, it would be impossible to obtain a worldwide picture of the very first hours of a disturbance by all the available techniques.

The selections of SWI have been more successful than anticipated. From the start of the IGY through October, 1958, there have been 19 SWIs declared (see Table I). In all but three cases there was significant geomagnetic activity during the SWI and in four instances a very severe storm started a few hours after the beginning of the SWI.

#### COMMUNICATIONS FOR THE IGY

The arrangements for the communications required for this program can only be summarized; more details are given in the IGY Manual for World Days and Communications,<sup>1</sup> but in such a dynamic and short-lived program as the IGY, many details are known and are of interest only to the centers and stations concerned. There is no IGY communications network as such; with a few exceptions, the work has relied on existing facilities and the cooperation of scores of communication agencies in the participating countries.

For distribution of the daily message regarding Alerts and SWIs, first reliance is placed on the meteorological

<sup>1</sup> "Annals of the IGY," vol. 7, Pergamon Press, London, Eng. (in press).

TABLE I  
LIST OF SPECIAL WORLD INTERVALS AND ACCOMPANYING  
GEOMAGNETIC STORMS

Special World Intervals	Outcome
1957	
*June 30–July 3	Storms June 30, 04XX UT and July 2, 0857 UT
Aug. 24	No storm
Aug. 29–Aug. 30	Storm Aug. 29, 1910 UT
*Sept. 2–Sept. 4	Storms Sept. 2, 0315 UT and Sept. 4, 1300 UT
*Sept. 12–Sept. 13	Storm Sept. 13, 0048 UT
Oct. 22–Oct. 23	No storm
Nov. 26–Nov. 27	Storm Nov. 26, 1455 UT
1958	
Mar. 5	Storm Mar. 5, 05XX UT
Mar. 15	Storm Mar. 14, 1212 UT
Mar. 23–Mar. 25	Storm Mar. 25, 1540 UT
Mar. 30–Mar. 31	Storm Mar. 30, 08XX UT
June 6–June 8	Storm June 6, 18XX UT
June 20–June 22	Storm June 21, 02XX UT
*July 8–July 9	Storm July 8, 0749 UT
July 30–July 31	No storm
Aug. 17–Aug. 18	Storm Aug. 17, 0623 UT
Aug. 24	Storm Aug. 24, 0140 UT
Aug. 27–Aug. 28	Storm Aug. 27, 02XX UT
Oct. 23–Oct. 25	Storm Oct. 24, 0730 UT

\* Very Severe Storm.

Note: When geomagnetic storm begins with a sudden commencement, the time of beginning is given to the minute; when a storm begins gradually, the time is given to the nearest hour, e.g. 04XX.

telecommunication networks, which cover most of the world by an interlocking schedule of teletype links or broadcasts. They are operated by the weather services of the various countries, with international coordination provided by the World Meteorological Organization, which is one of the organizations sponsoring the IGY. The program for Alerts and SWIs would be far less effective if these channels had not been available, for an IGY station need only make arrangements with its local or national meteorological station to receive the daily message, usually by telephone.

Important support is given to this network by broadcasting stations in many participating countries. The Alert and SWI message is broadcast repeatedly on four of the standard-frequency broadcasting stations: WWV, WWVH, JJY, LOL. In this case the message content is indicated by one of a set of standard symbols; in all other distribution channels, standard texts in plain language are used. Special arrangements for broadcasts were made for the Arctic and Antarctic regions and many countries also re-broadcast the message locally on a fixed schedule, either by voice or in code. In the Western Hemisphere region, many national centers in South America and many individual laboratories in the United States find it more efficient to receive direct telegrams from the Regional Warning Center at CRPL, Ft. Belvoir. In general, the supporting distribution is arranged in each region as best fits the available facilities.

Summaries of current observations follow by various channels from selected IGY stations to their Regional Warning Center. Radio links are used in Japan, teletype in Germany, telegrams in the United States. These centers interchange selection of the data received by

each directly, eliminating duplicate observations and observations of slowly varying phenomena or measurements of local interest. The interchange messages go once or twice a day on a fixed schedule, by telegram or teletype. The distribution of current data—summaries to IGY stations needing them for their own immediate programs is arranged by the Regional Center; France and Japan use radio broadcast, Germany and the U. S. use teletype or telegram.

This complex of communications has been surprisingly effective, when one realizes that the participants are usually not communication experts, and are principally interested and concerned with their IGY scientific programs. While the volume is small, the program strives for one- or two-hour performance with very high standards of accuracy and dependability. Standard synoptic codes are used for all messages, as specified in the IGY Manual, which has gone through a draft and five supplements to keep up with the progress of the program.<sup>1</sup> And in order to get the scheme into operation, there were trial weeks of the communications in each of the five months before the advance trial month of the whole IGY program in June, 1957. Even so there has had to be considerable trouble-shooting of the weak spots as shown by systematic reports from the National Warning Contacts designated by the participating committees to arrange for communications involving their IGY stations. The results are satisfying in that, with only one exception, no outstanding solar flares or outbursts have been unknown at least to the World Warning Agency at the time for a decision on Alerts and SWI. The IGY stations of the world have dependably known what to expect in the way of disturbance. Summaries of solar and geophysical observations usually not more than 36 hours old have been available to Regional Centers and IGY stations needing the information for specialized experiments or immediate data evaluation.

#### CURRENT OBSERVATION SUMMARIES

All of the Regional Warning Centers need to have prompt reports of solar observations in order to advise on the declarations of Alerts and Special World Intervals. They also need representative summaries of current geophysical observations for the purpose of assessing the outcome of the selections. To accomplish this the centers interchange data once or twice a day by telegram. The reports are put into standard abbreviating codes. The main categories of solar reports are:

flares, radio outbursts, radio flux levels, sunspots, active prominences, coronal intensities. Other reports interchanged deal with solar flare effects on the ionosphere, geomagnetic activity and typical ionospheric parameters.

In addition to the centers, many individual stations need, for their own work, to be aware of current solar and geomagnetic activity and this is provided by each of the centers. In Japan and France there are regular data broadcasts—called URSIgrams. From the U. S., Germany, Netherlands, and USSR, the summaries are made available usually by telegram or teletype directly to the stations which have requested them. These kinds of scientific services were provided on a smaller scale before the IGY, but have become much more efficient and comprehensive as a result of the IGY experience. Most of the centers also provide daily or weekly written summaries—maps of the sun and tables of measurements. These preliminary airmail reports have an even wider circulation than the telegrams and radio broadcasts.

The organization for data interchange developed for the IGY World Day program is also used to a certain extent for servicing individual IGY experiments. Thus special reports were provided for eclipse expeditions. Also these facilities have been much used for the international aspects of the Earth Satellite program. Predictions of satellite positions flow through the Warning Centers to observing stations in the participating countries. Reports of successful observations flow in the reverse direction back to computation centers to enable them to make improved future predictions.

#### CONCLUSION

The stations cooperating in the IGY have derived great benefit from being able to concentrate their observations simultaneously during outstanding solar and geophysical activity. Therefore, it has been found worthwhile to continue the international cooperation achieved during the IGY in this World Days and Communications program. Upon completion of the IGY, a similar but modified and simplified program will continue under the auspices of a new inter-union committee established by the International Council of Scientific Unions, through what is to be known as the "International Geophysical Cooperation 1959." In this way it is hoped to take advantage of IGY experience and continue the active coordination of geophysical observation at a level appropriate to a continuing program.

# Correspondence

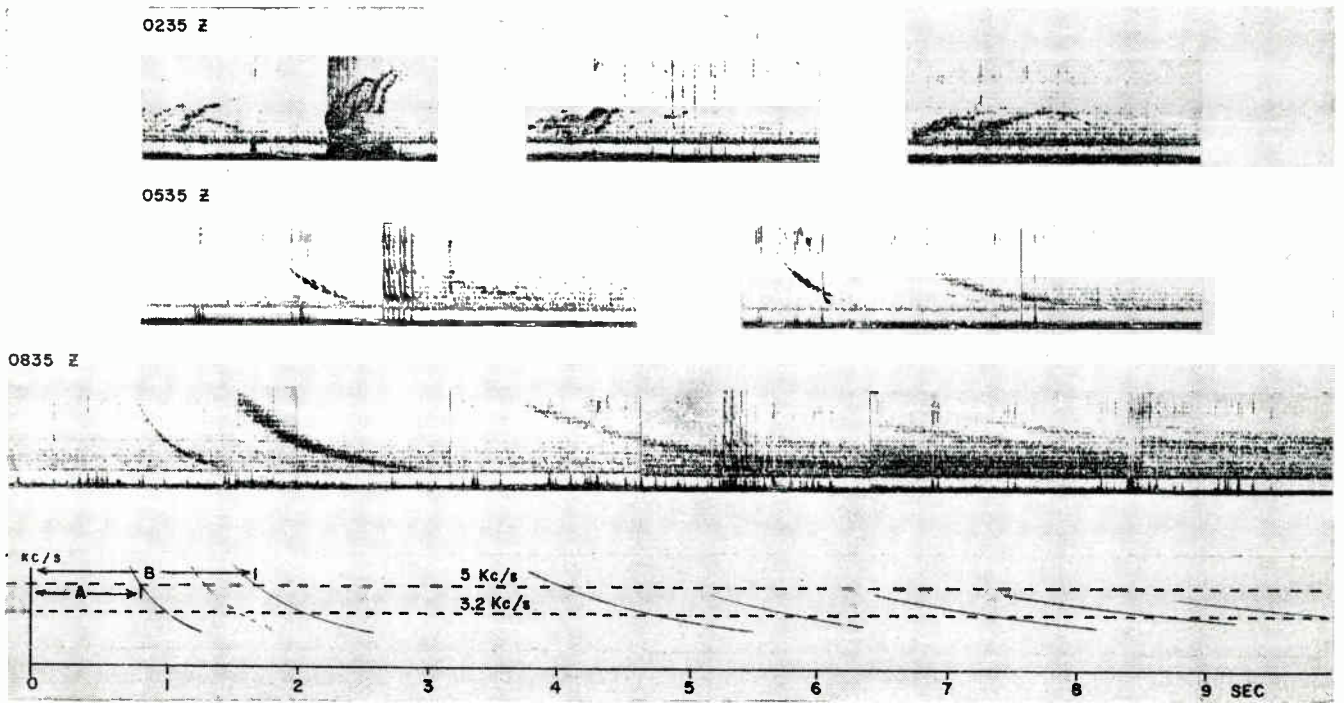

Fig. 1—Unalaska, November 11, 1956.

## Path Combinations in Whistler Echoes\*

The whistler<sup>1</sup> which results when the very-low-frequency electromagnetic radiation from a lightning flash is propagated dispersively along the flux of the earth's magnetic field, up into the exosphere and down again into the other hemisphere where the flux lines return to the earth's surface, may be heard, when amplified and applied to a headphone, as a descending musical tone. More often though, it is heard as a descending swish, or band of noise, because each frequency in the generating sferic has propagated over a range of dispersion. Spectrographic analysis reveals that not infrequently, several distinct, musical whistlers are produced within the range of dispersion, indicating that the electron density necessary to support the magneto-ionic duct propagation is disposed in multiple shells, or possibly filaments, conforming to the shape of the magnetic flux. The successively arriving whistlers have successively greater dispersion and lower noise-frequency, corresponding to longer and higher paths. The pattern of component whistlers is repeated in each occurrence during a period of whistler activity, changing relatively slowly, and this is consistent with the concept that it is produced by the structure of the propagation medium.

The increase in path-length from each component-whistler to the next, is usually

\* Received by the IRE, January 6, 1959.  
<sup>1</sup> See R. A. Helliwell and M. G. Morgan, "Atmospheric whistlers," *PROC. IRE*, this issue, p. 200.

TABLE I  
 UNALASKA, NOVEMBER 11, 1956, 05:35 Z

		5 kc/s			
		Computed T (given A, B)		Measured T	
one trip	A	0.78 sec	weak strong	0.78 sec	
	B	1.70		1.70	
three trip	3A	2.34	www wws wss sss	more probable	4.15 5.17
	2A+B	3.26			
	A+2B	4.18			
	3B	5.10			
five trip	5A	3.90	wwwwww wwwws wwwss wwsss wssss sssss	more probable	6.45 7.53 8.72
	4A+B	4.82			
	3A+2B	5.74			
	2A+3B	6.66			
	A+4B	7.58			
5B	8.50				

Data along the 3.2-kc/s line are similar. The same three and five trip combinations are clearly indicated.

small whether there are but two components or many. In the echoes, the range of dispersion of each component increases so that the components merge together to produce a swish.

We have found an occasion when there were but two, widely separated components as shown by the spectrograms in Fig. 1 of recordings made at Unalaska in the Aleutian Islands, November 11, 1956. During the recording which commenced at 02:35 Z, strong VLF emissions<sup>2</sup> occurred. The widely separated whistlers were first noted in the next recording, made at 05:35 Z. From the curva-

tures, one finds the dispersion of the first component to be about 60 and of the second to be about 120. An echo of a "long" whistler has twice the dispersion of the initial whistler but 60 is the typical "short" whistler dispersion for Unalaska (50° geomagnetic latitude) and there is no sferic at T=0. The echo of a short whistler has three-times the dispersion of the initial whistler. Thus it must be concluded that a second path having twice the dispersion of the normal path, was present. In the recording at 08:35 Z, the two widely separated components were still present, but were then followed by echoes. We were unable to explain the dispersions of the echoes until we realized that they embodied combinations of the two paths.

<sup>2</sup> See R. M. Gallet, "The very-low-frequency emissions generated in the earth's exosphere," *PROC. IRE*, this issue, p. 211.



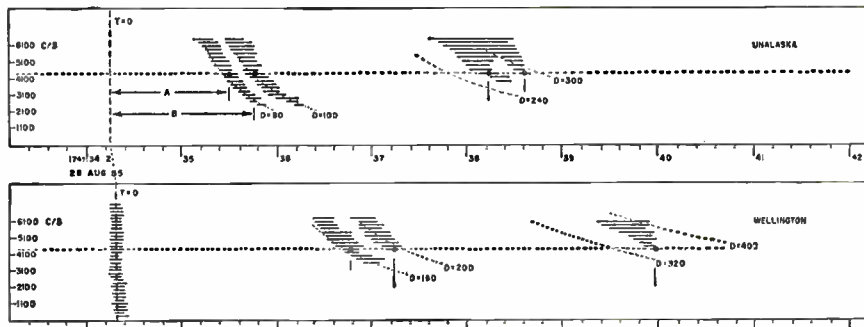

Fig. 2.

TABLE II  
UNALASKA—WELLINGTON, AUGUST 28, 1955, 17:40 Z

4.3 kc/s		
one trip	Computed T (given A, B)	Measured T
one trip	A	1.22 sec
	B	1.50
two trip	2A	2.44
	2B	3.00
three trip	3A	3.66
	2A+B	3.94
	A+2B	4.22
four trip	4A	4.88
	3A+B	5.16
	2A+2B	5.44
	A+3B	5.72

The first echoes must be produced by three one-way transits between the hemispheres. If we designate the shorter path, corresponding to the first whistler, as A and the longer path as B, then the first echoes can be produced by any of four combinations: 1) three trips over path A, 2) three trips over path B, 3) two trips over A and one over B, or 4) one trip over A and two over B. Because the whistler arriving over path B is seen to be stronger than that arriving over path A, echoes making the greatest use of path B are the ones most likely to be observed as indicated in Table I.

In the drawing below the spectrograms, the curved lines correspond to the whistlers, and echoes, of the spectrogram of the 08:35 Z recording. The horizontal, dashed lines are drawn at 5.0 and 3.2 kc/s. The origin of the time-scale corresponds to the time when the generating sferic must have occurred in the southern hemisphere. It has been chosen to give the best resulting fit to the echoes and it is seen in Table I that the echoes are all found at 5.0 kc/s at the most probable times, that is making the greatest use of the longer but lower-attenuation path. The times at 3.2 kc/s yield the same results.

We have applied the concept of path combination in the echoes to one of the spectrograms published by Morgan and Allcock<sup>3</sup> from the simultaneous observations in the Aleutian Islands and New Zealand which first confirmed Storey's deduction that whistlers echo back and forth between

the hemispheres. Their spectrogram no. 3 is reproduced in Fig. 2. Horizontal, dashed lines have been drawn at 4.3 kc/s, and T = 0 has been taken at the generating sferic in the southern hemisphere. The time-scale of the northern hemisphere spectrogram has been retarded very slightly—less than 0.1 second, whereas the published uncertainty was ±0.5 second. Choosing times A and B at the circles on the dashed line through the initial whistler pair, the times shown by the circles in the echoes are predicted by Table II. It is seen that the discrepancies have been corrected.

M. G. MORGAN  
H. W. CURTIS  
W. C. JOHNSON  
Thayer School of Engineering  
Dartmouth College  
Hanover, N. H.

### WWV Standard Frequency Transmissions\*

Since October 9, 1957, the National Bureau of Standards radio stations WWV and WWVH have been maintained as constant as possible with respect to atomic frequency standards maintained and operated by the Boulder Laboratories, National Bureau of Standards. On October 9, 1957, the USA Frequency Standard was 1.4 parts in 10<sup>9</sup> high with respect to the frequency derived from the UT 2 second (provisional value) as determined by the U. S. Naval Observatory. The atomic frequency standards remain constant and are known to be constant to 1 part in 10<sup>9</sup> or better. The broadcast frequency can be further corrected with respect to the USA Frequency Standard as indicated in the table below. This correction is *not* with respect to the current value of frequency based on UT 2. A minus sign indicates that the broadcast frequency was low.

The WWV and WWVH time signals are synchronized; however, they may gradually depart from UT 2 (mean solar time corrected for polar variation and annual fluctuation in the rotation of the earth). Correc-

tions are determined and published by the U.S. Naval Observatory.

WWV and WWVH time signals are maintained in close agreement with UT 2 by making step adjustments in time of precisely plus or minus twenty milliseconds on Wednesdays at 1900 UT when necessary; one minus step adjustment was made during this month at WWV and WWVH on November 26, 1958.

### WWV FREQUENCY\*

November 1958 1500 UT	Thirty-Day Moving Average, Seconds Pulses on 15 MC, Parts in 10 <sup>10</sup> †
1	-2.1
2	-2.0
3	-2.0
4	-2.0
5	-1.9
6	-1.9
7	-1.9
8	-1.9
9	-1.9
10	-1.8
11	-1.7
12	-1.6
13	-1.5
14	-1.4
15	-1.3
16	-1.3
17	-1.2
18	-1.2
19	-1.3
20	-1.3
21	-1.4
22	-1.4
23	-1.5
24	-1.7
25	-1.8
26	-1.9
27	-2.0
28	-2.0
29	-2.0
30	-2.0

\* WWVH frequency is synchronized with that of WWV.

† No adjustment was made in the control oscillator at WWV this month.

NATIONAL BUREAU OF STANDARDS  
Boulder, Colo.

### Optimum Coupled-Resonator Band-Pass Filter\*

The partial results reported here apply to three-resonator lossy narrow-band filters; the extension to more resonators is anticipated although not yet proved. Dishal,<sup>1</sup> Gordon-Wagner,<sup>2</sup> Taub and Bogner,<sup>3</sup> Fubini,<sup>4</sup> and others, have pointed out that a lossy filter whose resonators have equal unloaded Q's must be physically asymmetrical

\* Received by the IRE, October 29, 1958.

<sup>1</sup> M. Dishal, "Design of dissipative band-pass filters producing desired exact amplitude-frequency characteristics," *Proc. IRE*, vol. 37, pp. 1050-1069; September, 1949. Contains references to discussions of previous papers by same author.

<sup>2</sup> T. C. Gordon-Wagner, "The general design of triple- and quadruple-tuned circuits," *Proc. IRE*, vol. 39, pp. 279-285; March, 1951.

<sup>3</sup> J. J. Taub and B. F. Bogner, "Design of three-resonator dissipative band-pass filters having minimum insertion loss," *Proc. IRE*, vol. 45, pp. 681-687; May, 1957.

<sup>4</sup> E. G. Fubini and E. A. Guillemin, "Minimum insertion loss filters," presented at 1958 IRE National Convention. Pertinent remarks at end of lecture are not recorded in the IRE NATIONAL CONVENTION RECORD.

\* Received by the IRE, December 19, 1958.

<sup>3</sup> M. G. Morgan and G. M. Allcock, "Observations of whistling atmospherics at geomagnetically conjugate points," *Nature*, vol. 177, pp. 30-31; January 7, 1956.

in order to obtain maximally-flat (Butterworth) or equi-ripple (Tchebycheff) pass-band amplitude response vs frequency. From this, the inference is drawn that a lossy filter should be asymmetrical.

The purpose of this note is to point out that such a conclusion is not generally applicable and arises only because the frequency response is constrained in an arbitrary fashion. To see that this is true, a different, but (in some cases) more practical, constraint is imposed on the performance as follows:

An accept band is defined as the frequency range between two band edges, and the filter gain curve is assumed to be symmetrical about the center of the pass band when plotted on a linear frequency scale. (Narrow-band approximations are assumed.) The gain is a complex function of frequency and is defined as the ratio of the filter output to the output of an ideal matching transformer replacing the filter. A resistive generator and load are assumed.

The gain everywhere in the pass band is assumed to be equal to or greater than the gain at band edge. The band-edge gain is compared with the gain at any frequency far from the pass band, *i.e.*, a point on the asymptote or skirt.

The coupling coefficients between resonators and the end-resonator decrements are adjusted to maximize the band-edge gain while maintaining a constant ratio of band-edge gain to asymptote reference point gain (accept-reject ratio). This criterion corresponds to the frequently-encountered design problem in which a selective filter is to be designed to favor certain frequencies by a certain number of decibels over certain other frequencies (accept-reject ratio). The filter is supposed to minimize loss of desired frequencies while maintaining the specified accept-reject ratio. In the case to be discussed the reject frequencies are located for simplicity on the skirts of the response curve.

The three-resonator case has been studied by means of an extension of a simple graphical procedure<sup>5</sup> which, for lack of space, cannot be described here. After making narrow-band approximations the gain expression consists of a constant numerator divided by a third-order polynomial whose roots are  $P_a$ ,  $P_b$ , and  $P_c$ . These three complex (upper-half plane) poles of the gain function are placed symmetrically about center frequency as shown in Fig. 1. For a given accept-reject ratio the product of the lengths of the three vectors shown is fixed and a choice of  $P_a$  fixes  $P_b$  and  $P_c$ . Maintenance of a constant accept-reject ratio is equivalent to maintaining a constant denominator at pass band edge.

For any given set of poles there is an infinity of sets of filter parameters. By means of the graphical procedure the set of parameters which maximizes the numerator may be found. Different values of  $P_a$  are tried and that value yielding the greatest maximized numerator describes the "optimum" filter.

When the poles are located on the isosceles triangles of Fig. 2, the optimum parameters yield physical symmetry. That

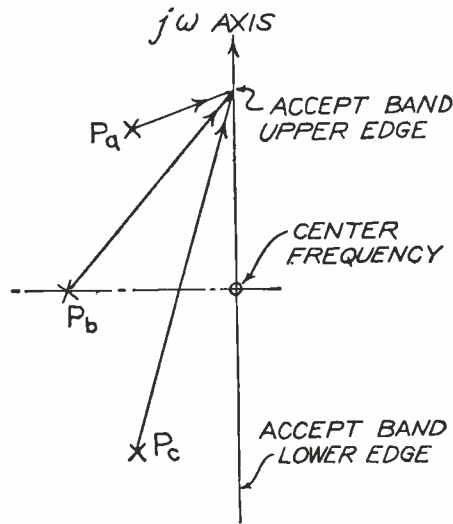

Fig. 1—Portion of the  $P = \sigma + j\omega$  plane.

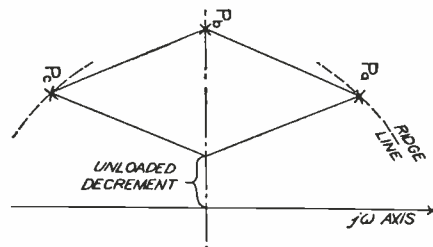

Fig. 2—Pole locations of a symmetrical filter.

is, the end resonator loaded decrements are equal and the coupling coefficients between resonators are equal. There is a certain curved line (called the "ridge line" for reasons which will appear presently) along which the  $P_a$  of a symmetrical filter may be moved while still maintaining the same accept-reject ratio. The numerator will vary continuously with the location of  $P_a$  on this line and will have a true maximum (zero derivative) at one particular point.

If  $P_a$  departs from the ridge line, the specified accept-reject ratio requires a value of  $P_b$  which does not form an isosceles triangle. This means that the filter is asymmetrical. Sample graphical-numerical calculations have shown that the numerator decreases linearly for small displacements of  $P_a$  from the ridge line, at least in the vicinity of the optimum symmetrical filter's  $P_a$ . If a three-dimensional surface is created by plotting the numerator value perpendicular to the  $P$  plane as a function of  $P_a$ , the surface near the optimum point will consist of two planes intersecting at values of  $P_a$  along the ridge line.

The slopes of the two surfaces are generally unequal because the laws governing parameter choice on one side of the ridge are different from those governing behavior on the other side.

From these observations the conclusion is drawn that departure from symmetry reduces the pass band-edge gain if the specified accept-reject ratio is maintained. This gives a simple rule for designing filters: make them symmetrical.

The gain curves of optimum three-resonator filters designed according to this note

are peaked in the center because  $P_b$  lies quite close to the  $j\omega$  axis. It appears that the optimum three-resonator filter may not be improved further by exchanging gain at the center of the pass band for more gain at the edges.

This result is at variance with inferences drawn from the familiar fact that Butterworth and Tchebycheff gain curves are impossible with lossy symmetrical filters. When we change the design criteria, the symmetrical filter turns out to be the optimum design rather than the impossible one. This indicates that Fubini's conclusion<sup>4</sup> should be extended to discourage maximally-flat filters where insertion loss is important.

This short note has not attempted to describe the calculations nor to define the limits of superiority of the symmetrical filter in terms of resonator dissipation and accept-reject ratio. Much of the actual work was carried out by graphical-numerical procedures so that it is difficult to generalize the results. Improvements in analysis, extension of conclusions, and careful definition of limits of validity are ideal subjects for individual study such as academic theses. It is also necessary to extend the analysis to filters having four or more resonators.

RICHARD LA ROSA

Hazeltine Corp.

Little Neck 62, N. Y.

and Polytechnic Inst. of Brooklyn,  
Brooklyn, N. Y.

## A Small Mind, Normal for Its Size\*

Several years ago, I built an electronic pet—not to coddle it, but because I wanted to see how a simple, wholly known brain behaves. Its design was largely based upon reports on *Machina Speculatrix*,<sup>1</sup> the imaginative design of Dr. W. Grey Walter which seemed to be just about right for my purpose. It had the shape of a turtle, about eight inches long, on a three-wheel chassis, could move forward and back and turn; it had two sense organs, a photocell looking around for a light source, and a touch response to objects it ran into. The brain comprised two hearing-aid tubes controlled by the sense organs and in turn controlling, via two relays, one motor to drive and one to turn. Filaments and motors were fed from a storage battery, the tube anode circuits from dry cells. Grey Walter's beast must look for, and find, the light in its home where it must recharge its battery, or die; when fully charged it will run off again.

My model also had a drive, and a turn motor on an eight-inch long three-wheeled chassis, and for senses a photocell and a touch contact in a bumper around the front. I decided on some improvements, for instance by saving the need for recharging. The main power consumption is that for locomotion. On wheels of optimal diameter and width my model could run about on smooth wood flooring for a very long time on four

\* Received by the IRE, November 24, 1958.

<sup>1</sup> Later described in his book, "The Living Brain," Norton Publishing Co., New York, N. Y., p. 289; 1953.

<sup>5</sup> R. La Rosa, "Pole migration in coupled-resonator filters," to be published in IRE TRANSACTIONS ON CIRCUIT THEORY.

flashlight *D* cells. It could even—if barely—move on a carpet. The steering motor could turn the front wheel up to  $\pm 90^\circ$  from straight forward. Its brain consisted of two junction transistors (then new) also fed from the six-volt supply but using no current to speak of. The photocell mounted on the front-wheel column looked around for light; there the beast went until it touched an obstacle; then it backed, turned, and tried again. As distinct from Grey Walter's, my model, by means of a trick relay, turned left when it had no success turning right; but this is not necessarily an advantage, and unimportant for the point I want to make.

When completed as planned, the beast was turned loose and raced around. It did what it could—and was an utter bore. I put it aside to consider where I might have slipped up technically, found nothing wrong and gave it another try; the result was the same. I put it out of sight where it has remained ever since.

But not out of mind. Because, being its sole god and creator, I have only myself to blame for the disappointment. After a year's reflection the matter turned out to be quite simple: the beast had nothing to do. Having improved it to need no recharging I had removed the suspense of whether it would find its charger in time to survive, and the vicarious satisfaction whenever it did. This insight brought out a dilemma, either to leave it with no aim in life, or to retrogress by giving it a need not needed. Another year's cogitation, and a way out, copied from life: if ever I go back to the pet, first thing, I shall give it a—suitably simple—TV set to watch.

And while I write I begin to wonder: it may still be a bore!

H. E. KALLMANN  
New York, N. Y.

### Resonance Isolator at 70 KMC\*

The use of oriented ferrite materials for ferrite devices at high frequencies has been suggested by various authors.<sup>1,2</sup> Here we describe a resonance isolator using Indox V, an oriented barium ferrite having an effective internal magnetization of approximately 17,000 gauss. This isolator has a reverse loss greater than 12 db, an insertion loss of about 1 db, and input VSWR is less than 1.1 over the band from 68–72 kmc.

The isolator is constructed from RG-98 waveguide and slabs of Indox V held in a section of teflon which completely fills the guide and which is tapered to prevent reflections as shown in Fig. 1. The ferrite material is cut so that the oriented effective internal field is perpendicular to the wide

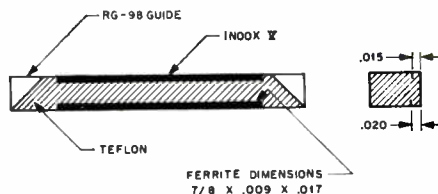

Fig. 1—Design of isolator for 68–72 kmc.

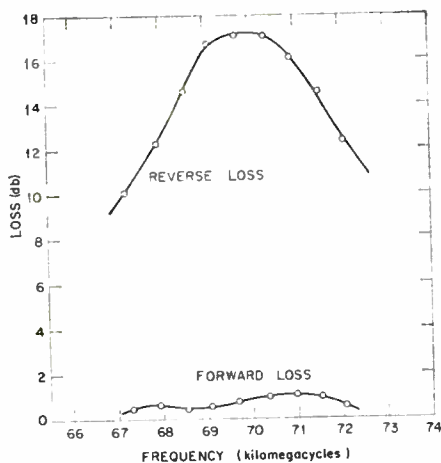

Fig. 2—Reverse and forward loss of isolator as a function of frequency.

dimension of the waveguide. With this orientation an additional external magnetic field of about 8000 gauss is required for resonance at 70 kmc. To achieve the required bandwidth, two slabs, displaced so that their individual resonant fields are slightly different, are used. No shaping of the magnetic field was found necessary.

The reverse and forward loss for this particular design is given in Fig. 2.

L. C. KRAVITZ  
G. S. HELLER  
Lincoln Lab., M.I.T.  
Lexington, Mass.

### Wavelength Dependence in Transhorizon Propagation\*

The matter of wavelength dependence in transhorizon propagation has elicited much experimental and theoretical effort over the past few years, both because of its practical importance to the communications engineer and because of its implicit connection with the structure of refractive index variations in the atmosphere and with the meteorological phenomena responsible therefore. The original Booker-Gordon theory<sup>1</sup> of scatter propagation predicted the scattering coefficient and, therefore, the median basic trans-

mission loss (above that of free space), to be independent of frequency. Much of the early data, on the other hand, have shown a mean dependence proportional to  $\lambda^2$ . Subsequent theoretical descriptions<sup>3</sup> have led to functional forms varying from  $\lambda^{-1/3}$  to  $\lambda$ . At least one attempt at the performance of an approximately scaled two-frequency experiment,<sup>4</sup> while not conclusive, has indicated a dependence of  $\lambda^{-2/3}$  for a short (60-mile) path during summer months. It is the purpose of this note to bring to the reader's attention the results of an accurately scaled two-frequency experiment,<sup>5</sup> which was recently performed, and to discuss the significance of these results briefly.

During the winter, spring and early summer of 1957 the Lincoln Laboratory of the Massachusetts Institute of Technology conducted simultaneous tests on 417.05 mc and 2290 mc. These were carried out on its transhorizon path from Round Hill, Mass., to Crawford's Hill, N. J., along the east coast of the United States. For intervals ranging in duration from 12 hours to 72 hours, distributed throughout the period February 11 to July 11, data were gathered continuously, or in alternate hours, using antennas that were closely scaled in accordance with the radio wavelength. Twenty-eight-foot parabolooids were employed on the lower frequency, ones five feet in diameter on the higher frequency. With the two channels geometrically similar, and operated simultaneously, the wavelength dependence of the propagation mechanism remained the sole important variable. Under such circumstances the ratio of average received powers (corrected for differences in transmitted powers, antenna gains, line losses, and free-space attenuation) should be indicative of this wavelength factor.

Continuous signals were radiated of 3.5 kw on 417 mc and 10 kw on 2290 mc. Cumulative distributions were plotted of the signal level received on each channel during each hour. From these distributions the hourly median received power levels were extracted, expressed in dbm.  $\Delta L$ , the difference in these hourly medians corrected as mentioned above (*i.e.*, the corrected difference in observed values of hourly median basic transmission loss), constitutes a measure of the ratio of received powers.

\* K. A. Norton, P. L. Rice, and L. E. Vogler. "Use of angular distance in estimating transmission loss." *Proc. IRE*, vol. 43, pp. 1488–1526; October, 1955.

<sup>2</sup> E. C. S. Megaw. "Scattering of electromagnetic waves by atmospheric turbulence." *Nature*, vol. 166, p. 1100; December, 1950.

F. Villars and V. F. Weisskopf. "Scattering of radio waves by turbulent fluctuations of the atmosphere." *Proc. IRE*, vol. 43, pp. 1232–1239; October, 1955.

R. A. Silverman. "Turbulent mixing theory applied to radio scattering." *J. Appl. Phys.*, vol. 27, pp. 699–705; July, 1956.

K. A. Norton. "Point-to-Point Radio Relaying via the Scatter Mode of Tropospheric Propagation." CRPL/NBS, Boulder, Colo., Rep. 3562. See in particular the note added July 28, 1956.

A. D. Wheelon. "Radio frequency and scattering angle dependence of ionospheric scatter propagation at vhf." *J. Geophys. Res.*, vol. 62, pp. 93–112; March, 1957.

H. T. Friis, A. B. Crawford, and D. C. Hogg. "A reflection theory for propagation beyond the horizon." *Bell Sys. Tech. J.*, vol. 36, pp. 627–644; May, 1957.

<sup>4</sup> "Microwave Transhorizon Propagation." School of Elec. Eng., Cornell University, Ithaca, N. Y., Res. Rep. EE 307; September, 1956.

<sup>5</sup> J. H. Chisholm, J. F. Roche, and W. J. Jones. "Experimental Investigations of Angular Scattering and Multipath Delays," paper presented at Combined Tech. Session, UKSI-IRE Joint Meeting, Washington, D. C.; May, 1957.

\* Received by the IRE, September 29, 1958. The work reported here was supported jointly by the Army, Navy, and Air Force under contract with the Mass. Inst. of Tech.

<sup>1</sup> A. G. Fox. "Notes on microwave ferromagnetics research." *Proc. IEE*, vol. 104B, p. 371; October, 1957.

<sup>2</sup> F. K. du Pre, D. J. DeBitetto, and F. G. Brockman. "Magnetic materials for use at high microwave frequencies." *J. Appl. Phys.*, vol. 29, p. 1127; July, 1958.

\* Received by the IRE, October 14, 1958. The research reported here was supported by the U. S. Air Force.

<sup>1</sup> H. G. Booker and W. E. Gordon. "Theory of radio scattering in the troposphere." *Proc. IRE*, vol. 43, pp. 401–412; April, 1950.



A total of 241 cases (hours) were recorded in all, the over-all distribution being that shown in Fig. 1. It is not only apparent that the experimental results fail to support any one of the theoretical predictions regarding wavelength dependence but also that this dependence is a widely distributed variable.

This latter statement (*viz.*, that  $\Delta L$  varies widely) deserves a more precise interpretation inasmuch as each hourly median is itself a statistical quantity, subject to random fluctuation. This, of course, arises in the rapidly fading character of the signals. One must ask, therefore, whether the distribution of differences in hourly medians is statistically significant; that is, is it indicative of an actual variation in the mean transmission loss values or simply of the random variations from one observation to the next.

One method of evaluating the degree of variation of the wavelength dependence or, equivalently, of  $\Delta L$  is to determine the distribution of  $\Delta L$  on the basis of statistical fluctuations alone and compare this with the actual data. If the latter show markedly greater variation, some consistent process must be at work.

Writing  $x_{1/2}$  and  $z_{1/2}$  for the hourly sample medians observed on the 417-mc and 2290-mc channels, respectively, and  $a_{1/2}$  and  $b_{1/2}$  for the corresponding true medians, the recorded radio data are  $20 \log_{10} x_{1/2}$  and  $20 \log_{10} z_{1/2}$ , the power levels (in dbm) equivalent to the sample median signals.  $\Delta L$  is computed from this information according to

$$\Delta L = 20[\log_{10} x_{1/2} - \log_{10} z_{1/2} - C] \quad (1)$$

in which  $C$  is a correction factor to account for fixed differences between the two channels of the nature noted previously.

There is a well-known derivation in statistics<sup>6</sup> which demonstrates that the sample median  $x_{1/2}$  of the random variable  $X$  is asymptotically normally distributed about the median of the parent population with standard deviation given by

$$\text{std dev } (x_{1/2}) = 1/[2\sqrt{n_x}f(a_{1/2})]. \quad (2)$$

$n_x$  is here the number of independent values in the sample and  $f(a_{1/2})$  is the density function of the parent population evaluated at the true median. Letting

$$x_{1/2} = a_{1/2}(1 - \epsilon_X), \quad (3)$$

it follows that  $\epsilon_X$  is asymptotically normally distributed with zero mean and standard deviation,

$$\begin{aligned} \text{std dev } (\epsilon_X) &= 1/[a_{1/2}2\sqrt{n_x}f(a_{1/2})] \\ &= 1/[1.386\sqrt{n_x}], \end{aligned} \quad (4)$$

if it is assumed  $X$  is Rayleigh distributed. For large  $n_x$ ,  $\epsilon_X$  is very small compared to unity with high probability. Applying this formulation to (1),  $\Delta L$  may be expressed

$$\begin{aligned} \Delta L &\approx 20[\log_{10} a_{1/2} - \log_{10} b_{1/2} - C] \\ &\quad - 8.686(\epsilon_X - \epsilon_Z). \end{aligned} \quad (5)$$

The statistical fluctuations in the 417-mc and 2290-mc sample medians surely are in-

<sup>6</sup> H. Cramer, "Mathematical Methods of Statistics," University Press, Princeton, N. J.; 1946.

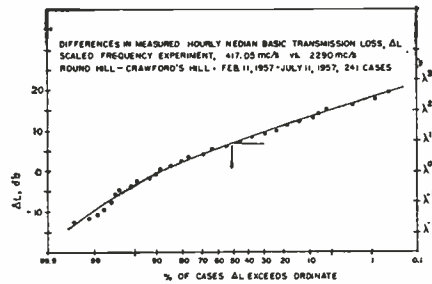

Fig. 1—Empirical distribution of wavelength dependence.

dependent and the fading rate on 2290 mc should be approximately the frequency ratio times that on 417 mc (making  $n_z \approx 5.5n_x$ ). Consequently,  $\Delta L$  is also asymptotically normally distributed with mean equal to

$$\begin{aligned} \text{mean } (\Delta L) \\ &= 20[\log_{10} a_{1/2} - \log_{10} b_{1/2} - C], \end{aligned} \quad (6)$$

*i.e.*, the difference in the true median values of basic transmission loss, and with standard deviation given by

$$\text{std dev } (\Delta L) \approx 6.8/\sqrt{n_x}. \quad (7)$$

If  $n_x$  is taken as 240 on the basis of a minimum typical fading rate at 417 mc of two cycles per minute, the standard deviation of  $\Delta L$ , due to statistical fluctuations alone, is less than 0.5 db.

Fig. 1 shows that the experimentally determined values of  $\Delta L$  also are approximately normally distributed but with a standard deviation of the order of 5 db. Since the experimental measurements have been reported to be accurate to within 1 db, there can be no doubt as to the statistical significance of the observed distribution. Applying the usual chi-square test,<sup>6</sup> the variation of the data is significant at substantially better than the 0.001 level.

Little uncertainty can remain, therefore, as to the fact that the wavelength dependence is not characterized by a unique form but varies from season to season, from day to day, and even from morning to evening. It would seem such variation must be linked to the meteorological phenomena that control refractive index structure. A strong suggestion that this is the case has been found<sup>7</sup> in the high correlation between values of  $\Delta L$  and Richardson's number for the 1 to 3 km layer, an index of dynamic stability of the atmosphere in the common volume.

The author would like to express his sincere gratitude to J. H. Chisholm and J. F. Roche, of the M.I.T. Lincoln Laboratory, for their kind invitation to visit the laboratory in order to analyze some of the data from their experiment and for their valuable assistance in interpreting these data.

RALPH BOLGIANO, JR.  
School of Elec. Eng.  
Cornell University  
Ithaca, N. Y.

<sup>7</sup> R. Bolgiano Jr., "A Meteorological Interpretation of Wavelength Dependence in Transhorizon Propagation," paper presented at Combined Tech. Session, URST-IRE Joint Meeting, Washington, D. C.; April 1958. Also presented as a dissertation to Graduate Faculty, Cornell University, in partial fulfillment of requirements for the Ph.D. degree (to be published).

## On Monotonic Response Filters\*

In a recent issue of PROCEEDINGS [1], a class of filters was developed with a monotonic response and maximum cutoff rate; the results were limited to odd values of the network order  $n$ . In the following the analysis is extended to even  $n$ .

With

$$A(\omega) = \frac{A_0}{\sqrt{1 + f(\omega^2)}} \quad (1)$$

the amplitude characteristic of our filter, the problem is to determine among all positive monotonic polynomials  $f(\omega^2)$  of degree

$$n = 2k + 2 \quad (2)$$

such that  $f(1) = 1$ , the one whose slope at  $\omega = 1$  is maximum. In the Appendix it will be shown that the optimum polynomials are given by

$$L_n(\omega^2) = \int_{-1}^{2\omega^2-1} \phi(\xi) d\xi \quad (3)$$

where

$$\phi(x) = B(x+1) \left( \frac{dP_{k+1}(x)}{dx} \right)^2; \quad (4)$$

$B$  is such as to make  $L_n(1) = 1$  and  $P_{k+1}$  is the Legendre polynomial of the first kind.

$L_n$  is readily obtained from (3) and (4); the corresponding network function  $H_n(p)$  and the resulting ladder network can be evaluated with well-known methods.

### SPECIAL CASES

$$L_4(\omega^2) = 6\omega^8 - 8\omega^6 + 3\omega^4$$

$$L_6(\omega^2) = 50\omega^{12} - 120\omega^{10} + 105\omega^8 - 40\omega^6 + 6\omega^4$$

$$L_8(\omega^2) = 490\omega^{16} - 1680\omega^{14} + 2310\omega^{12} - 1624\omega^{10} + 615\omega^8 - 120\omega^6 + 10\omega^4.$$

With

$$H_n(p) = \frac{\text{Constant}}{D_n(p)}$$

the denominator  $D_n(p)$  is given by

$$\begin{aligned} D_4(p) &= p^4 + 1.563p^3 + 1.888p^2 \\ &\quad + 1.242p + 0.408. \end{aligned}$$

Its roots:

$$-0.232 \pm j0.946, \quad -0.550 \pm j0.359$$

$$\begin{aligned} D_6(p) &= p^6 + 1.726p^5 + 2.690p^4 + 2.434p^3 \\ &\quad + 1.633p^2 + 0.680p + 0.141 \end{aligned}$$

its roots:

$$\begin{aligned} -0.115 \pm j0.978, \quad -0.309 \pm j0.698, \\ -0.439 \pm j0.240 \end{aligned}$$

$$\begin{aligned} D_8(p) &= p^8 + 1.866p^7 + 3.454p^6 + 3.734p^5 \\ &\quad + 3.556p^4 + 2.124p^3 + 0.996p^2 \\ &\quad + 0.300p + 0.045 \end{aligned}$$

its roots:

$$\begin{aligned} -0.071 \pm j0.988, \quad -194 \pm j0.825 \\ -0.300 \pm j0.541, \quad -0.367 \pm j0.181. \end{aligned}$$

\* Received by the IRE, October 16, 1958.

In Fig. 1 the upper half-plane poles of  $H_n(p)$  for  $n=4, 6, 8$  are shown and in Fig. 2 their realization as ladders is seen.

APPENDIX

We shall first determine a polynomial  $F(x)$  of degree  $n=2k+2$  such that its derivative  $dF/dx=\phi$  satisfies

$$\int_{-1}^{+1} \phi(\xi)d\xi = 1, \phi(x) \geq 0 \text{ for } x \geq -1 \quad (5)$$

and has the greatest possible value  $\phi(1)$  at  $x=1$ [2]. Since the degree of  $\phi$  is  $2k+1$  it must have a simple root; hence

$$\phi(x) = (x+r)\omega(x) \quad r \geq 1 \quad (6)$$

since [see (5)] the simple root cannot be greater than  $-1$ . We must have  $r=1$ ; indeed if  $r>1$ , then with

$$\phi_1(x) = A(x+1)\omega(x)$$

and  $A$  such that

$$\int_{-1}^{+1} \phi_1(\xi)d\xi = 1,$$

we have

$$1 = A \int_{-1}^{+1} (x+1)\omega(x)dx < \frac{2A}{1+r} \int_{-1}^{+1} (x+r)\omega(x)dx = \frac{2A}{1+r}$$

since

$$\frac{x+1}{x+r} < \frac{1+1}{1+r} \quad \text{for } -1 \leq x < 1.$$

Hence

$$A > \frac{1+r}{2}$$

and

$$\phi_1(1) = 2A\omega(1) > (1+r)\omega(1) = \phi(1),$$

impossible since  $\phi(1)$  was maximum. We shall next show that  $\omega(x)$  is an even polynomial in  $x$ ; indeed with

$$\omega = m + n$$

its even and odd parts, we have

$$\phi(1) = \int_{-1}^{+1} (x+1)(m+n)dx = \int_{-1}^{+1} (m+xn)dx, \quad (7)$$

$$\phi(1) = 2[m(1) + n(1)].$$

The polynomial

$$\phi_2(x) = (x+1)[m+xn]$$

is of the same degree as  $\phi_1$  and it satisfies (5) [see (7)] with

$$\phi_2(1) = 2[m(1) + n(1)] = \phi(1);$$

therefore,  $\phi_2$  is also optimum and since  $n+xn$  is even we can assume that

$$\omega = m = \text{even.}$$

Eq. (5) can now be written in the form

$$\int_{-1}^{+1} mx = 1 \quad m(x) \geq 0, \quad (8)$$

and our problem is reduced to that of determining an even polynomial  $m$  of degree

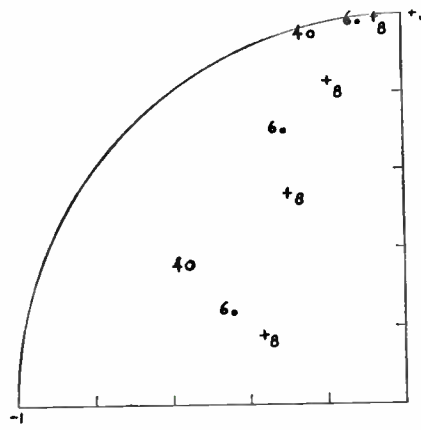

Fig. 1.

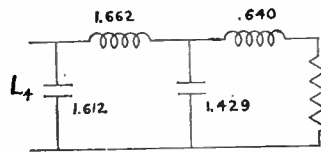
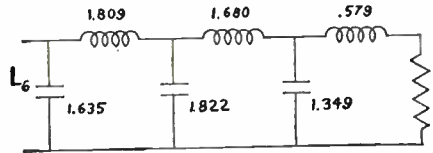
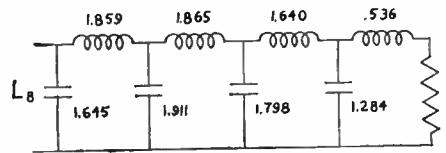

Fig. 2.

$2k$  satisfying (8) and having the greatest possible value at  $x=1$ [3]. Reasoning as in [1], we can show that  $m$  is a perfect square

$$\omega = u^2 \quad (9)$$

where clearly  $u$  is odd or even of degree  $k$ . To determine  $u$  we write it in the form

$$u = a_k P_k + a_{k-2} P_{k-2} + \dots \quad (10)$$

where the  $P$ 's are the Legendre polynomials; the last term is  $a_1 P_1$  if  $k$  is odd,  $a_0 P_0$  if  $k$  is even. From (8), (9) and (10) and the orthogonality properties of the  $P_k$ 's we obtain

$$\frac{2}{2k+1} a_k^2 + \frac{2}{2k-3} a_{k-2}^2 + \dots = 1; \quad (11)$$

to maximize

$$u(1) = a_k + a_{k-2} + \dots$$

subject to (11) we must have

$$\frac{a_k}{2k+1} = \frac{a_{k-2}}{2k-3} = \dots \quad (12)$$

But

$$\frac{dP_{k+1}}{dx} = (2k+1)P_k + (2k-3)P_{k-2} + \dots \quad (13)$$

From (10), (12) and (13) we conclude that

$$u = b \frac{dP_{k+1}}{dx}$$

$b$  is determined from (8); hence

$$\phi(x) = B(x+1) \left( \frac{dP_{k+1}}{dx} \right)^2$$

where  $B=b^2$ . Clearly

$$F(x) = \int_{-1}^x \phi(\xi)d\xi$$

and with  $2\omega^2-1=x$  eq. (3) follows.

A. PAPOULIS  
Polytechnic Inst. of Brooklyn  
Brooklyn, N. Y.

BIBLIOGRAPHY

- [1] A. Papoulis, "Optimum filters with monotonic response," *PROC. IRE*, vol. 46, pp. 606-609; March, 1958.
- [2] Prof. I. J. Schoenberg brought to the attention of the author the fact that the optimum polynomials  $L_n$  can be simply derived using the Gauss-Radau quadrature method; see also I. J. Schoenberg, "Some polynomial extremal problems and mechanical quadratures," *Amer. Math. Soc. meeting*, Princeton, N. J., October 25, 1958.
- [3] These polynomials were used in the solution of the delay line problem: A. Papoulis, "The approximation problem in lumped delay lines," 1958 IRE NATIONAL CONVENTION RECORD, pt. 2, pp. 102-108.
- [4] W. Magnus and F. Oberhettinger, "Special Functions of Mathematical Physics," Chelsea Publishing Co., New York, N. Y., 1949.

Theoretical Error Rates of "Differentially Coherent" Binary and "Kineplex" Data Transmission Systems\*

It is well established that reception of a high-frequency signal in the presence of additive noise is best accomplished by means of coherent detection.<sup>1</sup> When a local phase reference is not available to the receiver, incoherent or envelope detection is usually employed.

When incoherent detection is used for the reception of digital data, the error rate is increased above the minimum attainable because of the following reasons:

- 1) Incoherent detection is always less effective than coherent detection, regardless of the form of modulation used.
- 2) The modulation must be such as to allow the data to be recovered by incoherent detection. The most effective modulation for the transmissions of binary data is by means of phase-shift keying, which cannot be demodulated by an incoherent detector.

When a local phase reference is not available, the performance of an optimum binary data system can be approached by transmitting a phase reference in a suitable man-

\* Received by the IRE, October 10, 1958.

<sup>1</sup> P. M. Woodward, "Probability and Information Theory," Pergamon Press, New York, N. Y., pp. 62-77; 1957.

ner. The results of analysis—as well as experiments with a system in which each received signal waveform serves as a phase reference for “coherent” detection of the succeeding signal—are discussed below.

One can easily show that the minimum attainable error rate  $P_e$  of a binary data transmission system operating in the presence of additive, white, Gaussian noise is given by<sup>2</sup>

$$P_e = \frac{1}{2} \left( 1 - \operatorname{erf} \sqrt{\frac{E}{N_0}} \right) \quad (1)$$

where  $E$  is the energy per received symbol, and  $N_0$  is the noise power density per unit bandwidth. This minimum error rate is achievable only with a phase-shift keyed system which requires an absolute local phase reference for coherent detection. However, by a simple modification, a practical system approaching the performance of the ideal binary system results. An example of a system employing this technique is the Collins Kineplex System, which is discussed later. The modification consists solely of a change in the manner by which the two transmitted waveforms are selected at the transmitter. In the ideal or coherent PSK system a mark always corresponds to a  $0^\circ$  phase signal and a space always corresponds to a  $180^\circ$  phase signal; in the modified or “differentially coherent” PSK system a mark always corresponds to  $0^\circ$  change between successive signals and a space always corresponds to  $180^\circ$  change between successive signals. At the receiver the phase of a received signal is stored and may then be used as a reference in differentially coherent reception of the succeeding signal.

Aside from the minor operating requirement of one extra pulse to start the process, a differentially coherent system differs from the ideal system in the following respects:

- 1) Since the reference as well as the current signal is perturbed by noise, a higher ratio of  $E/N_0$  is required in order to achieve the same error rate.
- 2) The error probabilities of adjacent symbols are not independent. This dependence results in a tendency for a very large proportion of the errors to occur in pairs at high signal-to-noise ratios.

Analysis of a differentially coherent PSK<sup>2,3</sup> system as described above<sup>4</sup> shows the error probability for this system to be given by

$$P_e = \frac{1}{2} e^{-E/N_0} \quad (2)$$

This expression and the expression for the error probability of the coherent phase-shift keyed (ideal) system are plotted in Fig. 1. It will be noted that the  $E/N_0$  disadvantage of the differentially coherent phase-shift keyed system approaches zero at large  $E/N_0$ ; in fact, for  $E/N_0 = 10$  db this

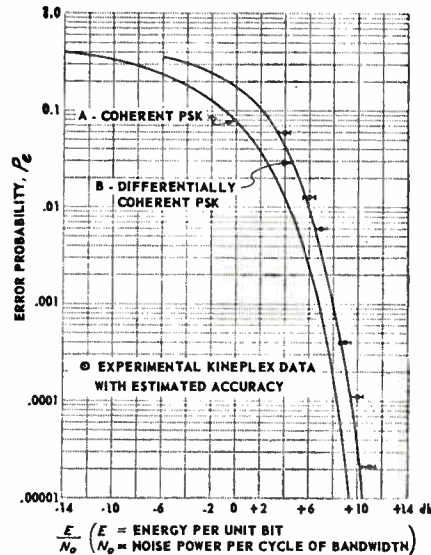

Fig. 1—Error probability of phase-shift keyed systems.

disadvantage is less than 1 db. The above results should allay the intuitive feeling, (which is unfortunately supported by approximate analyses<sup>5,6</sup>) that a differentially coherent PSK system has at least a 3-db signal-to-noise disadvantage relative to the optimum binary system, since both reference and current signal are perturbed by noise.

The Kineplex system<sup>5,7</sup> is a frequency division multiplex data transmission system in which each subcarrier (tone) carries two differentially coherent PSK channels in phase quadrature. The analysis of the differentially coherent PSK channel is directly applicable to the Kineplex system. One must note, however, that because of the combination of two PSK subchannels on each tone, only half of the transmitted energy is ascribable to each PSK subchannel.

Doelz, *et al.*<sup>7</sup> show a plot of “Error Rate (per cent of Bits Transmitted) versus Received Signal Power for One Bit per Second Capacity, divided by Receiver Noise Power in One Cycle Band-db,” while Fig. 1 plots “Probability of Error versus Received Signal Energy/Noise Power Density—db.” The scale of ordinates obviously differ by a factor of 100, while the scales of the abscissas are identical (as the following analysis makes clear). If the one bit per second capacity is interpreted not as channel capacity in the information theory sense,<sup>8</sup> but as signaling rate, then

$$\begin{aligned} \text{signal energy} &= (\text{average signal power}) \times (\text{sig-} \\ &\quad \text{nal duration}) \\ &= \frac{\text{average signal power}}{\text{signaling rate}} \\ &= \text{average signal power for one} \\ &\quad \text{bit per second capacity.} \end{aligned}$$

<sup>2</sup> R. R. Mosier, “Kineplex, a bandwidth-efficient binary transmission system,” *Trans. AIEE (Commun. and Electronics)*, vol. 34, pp. 723-727; January, 1958.

<sup>3</sup> “Performance of Predicted Wave Systems in the Presence of Additive, White Gaussian Noise,” Collins Eng. Rep. CER-W592; January 29, 1958.

<sup>4</sup> M. L. Doelz, E. T. Heald, and D. L. Martin, “Binary data transmission techniques for linear systems,” *Proc. IRE*, vol. 45, pp. 656-661; May, 1957.

<sup>5</sup> C. E. Shannon and W. Weaver, “The Mathematical Theory of Communications,” Univ. of Illinois Press, Urbana, Ill., p. 67; 1949.

Received noise power in a one-cycle bandwidth corresponds directly to our noise power density number. Therefore

$$\begin{aligned} &\frac{\text{received signal energy}}{\text{noise power density}} \\ &= \frac{\text{received signal power}}{\text{receiver noise power in a one-cycle band}} \end{aligned}$$

As a result of the analysis,<sup>2,3</sup> the theoretical performance of the Kineplex System at high signal-to-noise ratios is seen to be 3 db better than had hitherto been believed. Recent measurements performed by the Collins Radio Company<sup>9</sup> yielded the experimental points plotted in Fig. 1. They are seen to be in very good agreement with the theoretical curve (2) which was first derived in a previous report.

JOHN G. LAWTON  
Cornell Aeronautical Lab., Inc.  
Buffalo, N. Y.

<sup>9</sup> Letter from Collins Radio Co. to Cornell Aeronautical Lab., August 25, 1958.

## Reduction of Electron Beam Noisiness by Means of a Low-Potential Drift Region\*

Recent theoretical and experimental work on noise in electron beams carried out by the authors has suggested a mechanism for appreciable noise reduction in traveling-wave and backward-wave tubes. The new noise-reduction mechanism comes about when an electron beam is passed through a low-potential region for a certain prescribed distance as determined by the theory. That such a mechanism might be present was suggested by numerical calculations on an accelerated stream carried out by Siegman, Watkins, and Hsieh.<sup>1</sup>

Recent calculations carried out for a beam drifting at a dc potential of the same order of magnitude as the thermal voltage spread in the beam have indicated that noise figures as low as 1.5 db are theoretically possible. The calculations use the density-function method with the following assumptions:

- 1) One-dimensional model.
- 2) Full uncorrelated shot noise in each velocity class at the input plane (*i.e.*, cathode followed immediately by a velocity jump to the drift potential).
- 3) No short range collisions.
- 4) Linearized equations.
- 5) Rectangular dc velocity distribution.

\* Received by the IRE, October 14, 1958. This work was supported by Joint Services Contract administered by the Office of Naval Research and presented at the June, 1958, Conference on Electron Tube Research, Quebec, Can.

<sup>1</sup> A. E. Siegman, D. A. Watkins, and H. C. Hsieh, “Density-function calculations of noise propagation on an accelerated multiveLOCITY electron beam,” *J. Appl. Phys.*, vol. 28, pp. 1138-1148; October, 1957.

<sup>2</sup> J. G. Lawton, “Comparison of binary data transmission systems,” *Proc. Second Natl. Conf. on Military Electronics*, pp. 54-61; 1958.

<sup>3</sup> J. T. Fleck, “Alternate Derivation of the Error Rate of a Differentially Coherent PSK System,” Cornell Aero. Lab. Memo; June 9, 1958.

<sup>4</sup> With a stable transmission medium, the performance of a differentially coherent system can be further improved by deriving the reference phase from more than one previously received signal.



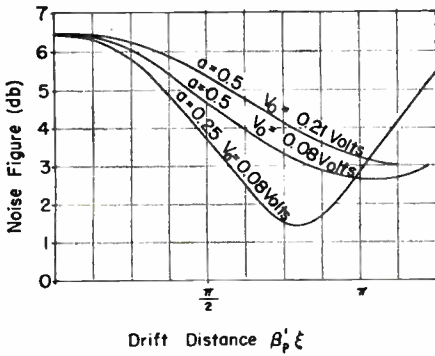

Fig. 1—Noise figure of a traveling-wave tube as a function of the length of the low-potential drift region according to the calculations.

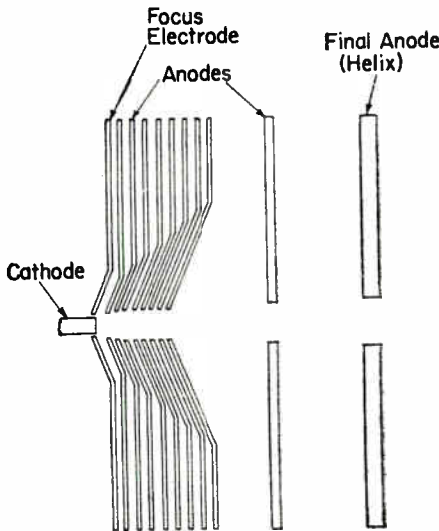

Fig. 2—Electrode configuration of the gun capable of providing a low-potential drift region of the proper length for low-potential drift-region noise reduction.

With these assumptions it is possible to obtain closed expressions for  $\bar{i}^2$ ,  $\bar{V}^2$ , and  $\bar{i}^*V$  and hence  $S$  and  $\pi$ , which involve definite integrals requiring numerical integration, in terms of normalized beam potential  $w_s$  and normalized frequency  $a$  as a function of normalized drift distance  $\beta_p' \xi$ . Where

$$w_s = \frac{eV_0}{KT_c} \quad (1)$$

$$a = \frac{\omega}{2\omega_p(V_0 = 0)} \quad (2)$$

$$\beta_p' \xi = \beta_p z, \quad (3)$$

and  $\beta_p$  is the plasma propagation constant with a correction for velocity spread. Fig. 1 shows noise figure as a function of drift distance assuming  $T_c/T = 3.5$  for various values of voltage and frequency.

The 3.5-db noise figure obtained by Currie<sup>2</sup> in S-band backward-wave amplifiers and by Caulton and St. John<sup>3</sup> can be at-

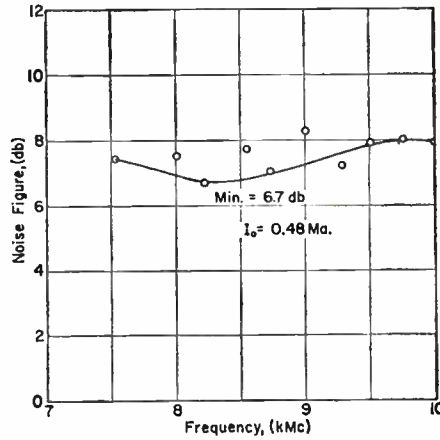

Fig. 3—Noise figure vs frequency of the experimental low-noise traveling-wave tube employing the gun of Fig. 2. The noise figure at X band is higher than would be obtained in a scaled S-band tube because of the higher skin-effect loss in the helix.

tributed to a utilization of this low-potential drift effect.

An X-band low-noise tube has been modified to utilize this effect with some success. The tube, previously designed by Buchmiller and Wade at Stanford utilizing a conventional velocity-jump gun, was modified to include a stack of eight closely-spaced electrodes immediately following the cathode, as shown in Fig. 2. By means of these electrodes, it has been possible to control the potential profile for a considerable distance out from the cathode and to emphasize the low-potential drift region effect. By this means a noise figure of 6.7 db has been obtained at 8300 mc in a tube employing a high-temperature Philips cathode. Fig. 3 shows the variation of noise figure with frequency for all electrode voltages fixed and shows also that the effect is quite independent of frequency. The noise figure would no doubt be further reduced by the use of a lower temperature oxide cathode. A tube embodying this modification is now being constructed.

A. W. SHAW  
A. E. SIEGMAN  
D. A. WATKINS  
Stanford University  
Stanford, Calif.

### Receivers with Zero Intermediate Frequency\*

A zero intermediate-frequency receiver uses a low-pass video amplifier (usually with a low cutoff-frequency of zero) instead of the high center-frequency, band-pass, IF amplifier used in ordinary superheterodyne receivers. Consequently, RF signals, appearing in the two bandwidths extending immediately above and below the local oscillator frequency by an amount equal to the band-

width of the video amplifier, are simultaneously converted into the pass band of the video amplifier. Whether this characteristic of simultaneously converting what are usually considered the signal and image frequencies is desirable depends entirely upon the nature of the received signal. For broadband noise signals, and for certain types of communication signals, this characteristic is extremely desirable. However, in spite of such properties and its inherent simplicity the zero intermediate-frequency receiver has not been widely used because of the high-noise figures expected from this type of receiver.

The expected high-noise figures are attributed to local oscillator sideband noise and mixer crystal noise temperature containing a component which varies inversely with frequency (which should introduce increasing noise amplitude into the IF amplifier as its center frequency is lowered).

Local oscillator contributions to receiver noise figure result from the mixing of the local oscillator signal and its sideband noise signals. The use of a well-balanced mixer will minimize the magnitude of the resulting IF noise components, but if a very noisy local oscillator (such as a klystron) is used, the resulting IF noise amplitude will still be quite high. Furthermore, the amplitude of the IF noise signals produced in this manner will vary approximately as the inverse of the intermediate frequency because of the  $Q$  of the oscillator cavity. (Measurements made on a typical X-band klystron show that the sideband noise level varies more nearly as the inverse square of the intermediate frequency.) Thus, a low-noise oscillator is absolutely necessary for optimum noise figure performance in this application, since it is usually impossible to filter the local oscillator signal sufficiently to remove the large-noise components close to the oscillator frequency.

The component of crystal mixer noise temperature which varies inversely with frequency generally is believed to be the relative excess portion of the noise temperature,<sup>4</sup> although McCoy<sup>5</sup> has recently pointed out that the experimental data on this topic are "not conclusive because of measurement problems and continual improvement of mixer diodes."

Recently, in designing a swept receiving system for solar spectrum analysis, a zero intermediate-frequency receiver was developed which swept over the 500 to 950-mc band at a 10-cps sweep rate. Noise figure measurements made on this receiver, a block diagram of which is shown in Fig. 1, indicated an average noise figure over the entire tuning range of 8 db. These measurements were made with both an argon discharge noise lamp and a CW signal generator, with good agreement between the two methods of measurement. Because of these unexpectedly low-noise figures, measure-

<sup>1</sup> G. C. Dalman and A. S. Rhoads, Jr., "Microwave oscillator noise spectrum measurements," IRE TRANS. ON ELECTRON DEVICES, vol. ED-1, pp. 51-55; December, 1954.

<sup>2</sup> P. D. Strum, "Some aspects of mixer crystal performance," PROC. IRE, vol. 41, pp. 875-889; July, 1953.

<sup>3</sup> C. T. McCoy, "Present and future capabilities of microwave crystal receivers," PROC. IRE, vol. 46, pp. 61-66; January, 1958.

\* Received by the IRE, October 27, 1958.

<sup>2</sup> M. R. Currie, "A new type of low-noise electron gun for microwave tubes," PROC. IRE, vol. 46, p. 911; May, 1958.

<sup>3</sup> M. Caulton and G. E. St. John, "S-band traveling wave tube with noise figure below 4 db," PROC. IRE, vol. 46, pp. 911-912; May, 1958.

ments were made on the video noise spectrum, which extended from 0.1 to 2.5 mc, and showed no significant component which increased inversely with frequency. These data were taken with several sets of both silicon and germanium mixer diodes.

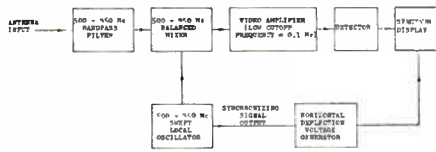

Fig. 1.

Furthermore, all measurable spurious responses in this receiver were down at least 60 db relative to the signal response. The major spurious responses come from signals beating with harmonics of the local oscillator and from the mixing of two strong input signals separated in frequency by less than the video bandwidth. By restricting the signal bandwidth to slightly less than an octave, the former spurious response is minimized, and the use of a well-balanced mixer minimizes the amplitude of the latter spurious response.

The local oscillator used in the receiver was a low-noise microwave triode with a high-*Q* cylindrical butterfly tank circuit.

Thus, it appears that with modern manufacturing techniques the noise temperature of present mixer diodes is substantially independent of intermediate frequency for frequencies as low as 0.1 mc. Also, with present low-noise microwave triodes, it appears quite feasible to design oscillators with remarkably low sideband noise levels. Consequently, it is hoped that the zero intermediate-frequency receiver will receive increased consideration in the future.

J. C. GREENE

J. F. LYONS

Airborne Instruments Lab.  
Mineola, N. Y.

### Corrections of Davisson-Calbick Aperture-Lens Formula for Space Charge and Magnetic Field\*

Electron-optical focal length  $f_0$  of a circular aperture (Fig. 1) separating two regions with electric fields  $E_1$  and  $E_2$ , and acting on a thin electron beam accelerated by a potential  $V$  and containing a negligible amount of space charge, is given by the well-known Davisson-Calbick formula

$$1/f_0 = (E_2 - E_1)/4V. \quad (1)$$

\* Received by the IRE, October 27, 1958. This work was first performed in connection with research carried on under the sponsorship of the U. S. Air Force Cambridge Res. Center, as described by V. Bevc, "Injection of Space-Charge-Balanced Beams for Microwave Tubes," Electronics Res. Lab., University of California, Berkeley, Calif., Sci. Rep., Issue 204, Ser. 60; June 15, 1958. Submitted under Contract AF19(604)-2270.

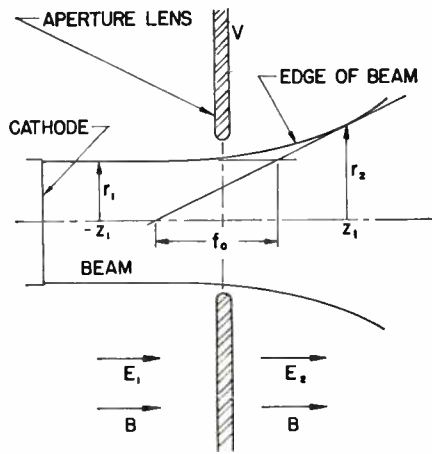

Fig. 1—Aperture-lens configuration.

Birdsall<sup>1</sup> has derived a correction that takes the first-order effect of space charge into account. For a beam of finite radius  $r$  and perveance  $P$ , the corrected focal length  $f$  is given by

$$\frac{1}{f} = \frac{1}{f_0} \left[ 1 + \frac{P}{2\sqrt{2}\eta\epsilon_0\pi} \frac{z_1 |f_0|}{r^2} \right] \quad (2)$$

where  $\eta = e/m$  and  $z_1$  denotes the axial distance over which the influence of the aperture is assumed to extend.

An additional correction, which also takes the size of the aperture into account (by a more exact definition of  $z_1$ ), has been derived by Pöschl and Veith.<sup>2</sup> Their formula, obtained by a procedure that involves the integration of the expression for slope by the infinite-series method, is

$$\frac{1}{f} = \frac{1}{f_0} \left\{ 1 + \frac{P}{2\sqrt{2}\eta\epsilon_0\pi} \frac{z_1}{r^2} \left[ |f_0| + z_1 \left( 1 + \frac{z_1}{2|f_0|} \right) + \frac{z_1}{|f_0|} \right] \right\} \quad (3)$$

The first correction in (3) is thus identical with Birdsall's correction of (2); the remaining terms serve to increase the correction (*i.e.*, further to decrease the focal length below the value predicted by the Davisson-Calbick formula), typically from a 20 to a 30 per cent correction for a microperveance of 1 and from a 26 to a 38 per cent correction for a microperveance of 2.

Pöschl and Veith also point out that the presence of an axial magnetic field serves to diminish the correction for space charge and finite aperture size. They illustrate this fact by a consideration of the case of a magnetic field that is constant in the region of the aperture and acts upon a beam originating from a magnetically shielded cathode.

It is of interest to estimate the value of this offsetting correction in a case of considerable interest in the design of gridless beam-type devices such as klystrons or traveling-wave tubes—the case of an electron gun immersed in a magnetic field  $B$  of the order of magnitude of the field  $B_0$  asso-

ciated with Brillouin flow.<sup>3</sup> It is shown that a magnetic field of the order of  $B_0$  just cancels Birdsall's correction, and that a somewhat larger field may therefore offset (or more than offset) even the additional correction suggested by Pöschl and Veith.

The equation of motion for this case is

$$\frac{d^2r}{dz^2} + \frac{|\eta| B^2}{8V} r - \frac{|\eta| B^2 r_1^4}{8V r^3} - \frac{|\eta|}{v^2} E_r = 0 \quad (4)$$

where  $r_1$  is the initial radius,  $v$  is the axial velocity, and  $E_r$  is the radial electric field in the vicinity of the aperture (*i.e.*, in the region between  $-z_1$  and  $z_1$ ). Integration yields

$$\frac{dr}{dz} \Big|_{z=z_1} = \int_{-z_1}^{z_1} \frac{|\eta|}{v^2} E_r dz - \int_{-z_1}^{z_1} \frac{|\eta| B^2}{8V} (r - \frac{r_1^4}{r^3}) dz. \quad (5)$$

The first integral is evaluated by Birdsall:<sup>1</sup>

$$\int_{-z_1}^{z_1} \frac{|\eta|}{v^2} E_r dz = \frac{r_1(E_1 - E_2)}{4V} + \frac{P}{2\sqrt{2}\eta\epsilon_0\pi} \frac{z_1}{r}. \quad (6)$$

The second integral will now be estimated, with the help of an assumption about the trajectory in the region of the aperture. According to the beam-spread nomogram given by Spangenberg<sup>4</sup> the radius of electron beams of microperveances up to 3 microperv accelerated by voltages of the order of 1000 volts does not exceed twice the initial value over a length of drift region less than ten times the initial radius. Therefore, a reasonable assumption is that  $r$  varies from  $r_1$  at  $-z_1$  to  $2r_1$  at  $z_1$ , an assumption that also proves to be justified by the result of the present analysis. A linear variation is assumed; the actual trajectory probably comes nearer to varying as some power of  $r$ , but the above assumption leads to a conservative estimate of the upper limit of the second integral. It should be noted that the first integral is, of course, evaluated on the basis of a beam whose radius remains constant throughout the aperture region; however, no inconsistency appears to be involved, since the more rigorous approach of Pöschl and Veith, which does assume a curved trajectory, leads to a result of which Birdsall's correction proves to be the first term, and the additional terms have the same sign as the first, as mentioned above.

We first note that in the present case,

$$\int_{-z_1}^{z_1} \left( r - \frac{r_1^4}{r^3} \right) dz = \int_{-z_1}^{z_1} (r - r_1) \left( 1 + \frac{r_1}{r} + \frac{r_1^2}{r^2} + \frac{r_1^3}{r^3} \right) dz < \int_{-z_1}^{z_1} 2(r - r_1) dz \quad (7)$$

since for  $r_1 < r < 2r_1$ ,

$$1 + \frac{r_1}{r} + \frac{r_1^2}{r^2} + \frac{r_1^3}{r^3} < 2. \quad (8)$$

<sup>1</sup> C. K. Birdsall, "Aperture lens formula corrected for space charge in the electron stream," IRE TRANS. ON ELECTRON DEVICES, vol. ED-4, pp. 132-134; April, 1957.

<sup>2</sup> K. Pöschl and W. Veith, "Die Brennweite einer Lochblende von endlicher Öffnung für Elektronenstrahlen endlicher Raumladung," Arch. elek. Übertr., vol. 12, pp. 45-48; January, 1958.

<sup>3</sup> See, for instance, J. R. Pierce, "Theory and Design of Electron Beams," D. Van Nostrand Co., Inc., New York, N. Y., 2nd ed., p. 152; 1954.

<sup>4</sup> K. R. Spangenberg, "Vacuum Tubes," McGraw-Hill Book Co., Inc., New York, N. Y., p. 445, Fig. 15.22; 1948.

Moreover, for a linear variation of  $r$  from  $r_1$  at  $-z_1$  to  $2r_1$  at  $z_1$ , we have  $r = (r_1 z / 2z_1) + (3r_1/2)$  and

$$\int_{-z_1}^{z_1} 2(r - r_1) dz = 2r_1 z_1 \quad (9)$$

so that we obtain the following maximum value for the second integral of (5):

$$\frac{|\eta| B^2}{8V} \int_{-z_1}^{z_1} \left( r - \frac{r_1^4}{r^3} \right) dz < \frac{|\eta| B^2}{4V} r_1 z_1. \quad (10)$$

Keeping these assumptions in mind, we may say that the effect of the magnetic field in counteracting the space-charge correction can be stated by amending (2) to

$$\frac{1}{f} = \frac{1}{f_0} \left[ 1 + \frac{P}{2\sqrt{2}\eta\epsilon_0\pi} \frac{z_1 |f_0|}{r_1^2} - \frac{|\eta| B^2}{4V} z_1 |f_0| \right] \quad (11)$$

since the slope at  $z_1$  is given by  $(dr/dz)_{z=z_1} = r_1/f$ . The last term in the brackets may be evaluated for magnetic fields expressed in terms of the field  $B_b$  required for Brillouin flow, given by<sup>3</sup>

$$\frac{B_b^2}{V} = \frac{\sqrt{2}P}{\pi\epsilon_0\eta^{3/2}r_m^2}. \quad (12)$$

Let

$$\beta \equiv \frac{B}{B_b} > 1 \quad (13)$$

where  $\beta$  is the proportionality factor that describes the ratio of actual magnetic field to Brillouin field. Then

$$\frac{1}{f} = \frac{1}{f_0} \left[ 1 + \frac{P}{2\sqrt{2}\eta\epsilon_0\pi} \frac{z_1 |f_0|}{r_1^2} - \frac{\beta^2 P}{2\sqrt{2}\eta\epsilon_0\pi} \frac{z_1 |f_0|}{r_m^2} \right]. \quad (14)$$

It is quite obvious that the two corrections are of the same order of magnitude; in fact for  $\beta^2=1$  (a magnetic field equal to the Brillouin-flow value), they cancel exactly, if the Brillouin-flow minimum radius  $r_m$  is taken to be equal to the initial radius  $r_1$ .

In practice, the value of  $B$  required to offset the space-charge correction may be larger, even though usually  $r_m < r_1$ ; it must

be remembered that the derivation is, after all, based on the conservative estimates represented by the linear-variation assumption and the inequality (8).

It appears, therefore, that in the presence of a magnetic field, second-order corrections of the expression for focal length that account for space-charge effects need not be, in general, considered as critical design factors. Nor does it appear to be necessary to follow the common practice of using the largest value of  $B$  that can be made conveniently available. To be sure, maximizing  $B$  reduces the magnitude of the periodic deviations of the electrons from their initial trajectory in the interaction region of a beam-type tube; but it should be kept in mind that these deviations would be largely absent in the first instance if the beam were correctly injected—a requirement over which the designer may perhaps exercise a greater degree of control than has been hitherto suspected.

VLADISLAV BEVC  
CHARLES SÜSSKIND  
University of California  
Berkeley, Calif.

## Contributors

Edward V. Appleton was born in 1892, in Bradford, England. He was a pupil of both of Sir J. J. Thomson and Lord Rutherford at Cambridge University. After participation in World War I, he continued studies, research, and teaching at Cambridge and later at London University where he earned the D.Sc. degree and became the Wheatstone professor of physics. In 1936, he returned to Cambridge to become the Jacksonian professor of natural philosophy.



E. V. APPLETON

During World War II, he joined the government as secretary of the Department of Scientific and Industrial Research and was created Knight Commander of the Bath in 1941 (and GBE in 1946). Dr. Appleton was awarded the Nobel Prize for physics in 1947 and went to the University of Edinburgh as its principal and vice-chancellor in 1949, where he has remained until now.

With the cooperation of the BBC in 1924, Dr. Appleton applied FM to the Bournemouth transmitter and observed a beat between the signal reflected from what he later called the  $E$  layer and the outgoing signal, thus proving conclusively the existence of the ionosphere as well as measuring

its height. In 1926, he discovered an upper layer which he subsequently called the  $F$  layer. In a famous publication in 1932, he set forth the now classical magneto-ionic theory which quantitatively describes radio-wave propagation in the ionosphere.

Sir Robert Watson-Watt has stated that, but for the early scientific work of Dr. Appleton in the field of radio-wave reflection, the development of radar would have come too late to have been the decisive factor it was in the Battle of Britain.

Even through the administrative phase of his life, Sir Edward has continued to perform ionospheric research and to publish frequent accounts of new work. He has now produced more than a hundred contributions to the literature on the ionosphere, not to mention numerous contributions in other fields, and is editor of the *Journal of Atmospheric and Terrestrial Physics*.

Learned societies, universities, and governments in many countries have accorded Sir Edward prizes, awards, and honors; and he has, above all, been a faithful worker for the cause of international science. As a former president of URSI and as chairman of its committee for the IGY, he has been instrumental in shaping the course of the IGY ionospheric program.



D. K. Bailey was born in Clarendon Hills, Ill., on November 22, 1916. After receiving the B.S. degree in astronomy at the

University of Arizona, Tucson, in 1937, he attended Oxford University, England, as a Rhodes scholar. He received the B.A. degree in physics in 1940, and the M.A. degree in 1943. From 1940 to 1941, he was in Antarctica as a physicist with the U. S. Antarctic Expedition to make cosmic-ray observations.



D. K. BAILEY

Mr. Bailey served on active duty with the Signal Corps from 1941 to 1946. From 1941 to 1943, he was attached to the Royal Air Force and acted as the Air Ministry representative in the Inter-Services Ionosphere Bureau (ISIB). For the next twenty months, he was assigned to the War Department where he established the Radio Propagation Unit (now the Radio Propagation Agency). From April, 1945 to June, 1946, he served in Manila, Leyte, and Tokyo in connection with Signal Corps ionosphere stations. In Tokyo, he assisted the Japanese in re-establishing a radio research program.

In December, 1946, Mr. Bailey joined the RAND project at the Douglas Aircraft Company where he worked in the communication and electronics field. In 1948, he joined the National Bureau of Standards (CRPL) and from 1948 to 1950, he was a member of the U. S. delegation in Geneva,



Switzerland, serving as chairman of the propagation working group of the Provisional Frequency Board. Since then, he has been a member of numerous U. S. delegations to international conferences and now serves as the International Chairman of Study Group VI (Ionospheric Propagation) of the International Radio Consultative Committee (CCIR). From 1951 to 1955, as a consultant to his division chief, he was actively engaged in a senior capacity in a research group investigating regular long-distance VHF ionospheric propagation and related communication matters. In 1955, he joined the firm of Page Communications Engineers, Inc. as scientific director.

Mr. Bailey holds the Legion of Merit and is a member of Phi Beta Kappa. He received the 1951 Arthur S. Flemming Government Award and has received U. S. Department of Commerce awards for both meritorious and exceptional service. He is a member of the American Astronomical and Physical Societies and a Fellow of the Royal Geographical and the Royal Astronomical Societies.



Lloyd V. Berkner (A'26-M'34-SM'43-F'47) was born in Milwaukee, Wis., on February 1, 1905. He received the B.S.



L. V. BERKNER

degree in electrical engineering in 1927 from the University of Minnesota, which honored him with the Distinguished Alumni Award in 1952, and studied physics for two years, 1933-1935, at George Washington University. He has been awarded honorary Doctorate degrees by Brooklyn Polytechnic Institute, 1955; Uppsala University, Sweden, 1956; University of Calcutta, India, 1957; Dartmouth College, 1958; University of Notre Dame, 1958.

While still an undergraduate, he was engineer-in-charge at radio station WLB-WGMS, Minneapolis. For one year after graduation, he worked as an electrical engineer for the Airway Division of the U. S. Bureau of Lighthouses. He was an engineer with the first Byrd Expedition to the Antarctic in 1928-1930, and was awarded the U. S. Special Congressional Gold Medal, the Silver Medal of the Aeronautical Institute, and the Gold Medal of the City of New York for his services. For three years thereafter, he was on the staff of the National Bureau of Standards. From 1933 to 1941, he was a physicist with the Department of Terrestrial Magnetism of Carnegie Institution of Washington, and during 1940-1941, he was a consultant to the National Defense Research Committee.

An aviator in the Naval Reserve since 1926, Dr. Berkner was called to active duty as head of the Radar Section, Bureau of Aeronautics in 1941. He directed the Bureau's Electronics Materiel Branch from 1943-1945, and served on the *U.S.S. Enterprise* in 1945. He has held the rank of

Rear Admiral, USNR, since 1955.

During 1946-1947, he was Executive Secretary of the Research and Development Board and remained a consultant to the Board until 1951. He was head of the Section on Exploratory Geophysics of the Atmosphere, Department of Terrestrial Magnetism, Carnegie Institution from 1947 to 1951. Since 1951 he has been President of Associated Universities, Inc., New York, N. Y., an educational institution which operates such research facilities as Brookhaven National Laboratory under contract with the Atomic Energy Commission and the National Radio Astronomy Observatory under contract with the National Science Foundation.

Dr. Berkner has held various offices in government, industry, and education. In the State Department, he served as Special Assistant to the Secretary of State, and Director of the Foreign Military Assistance Program in 1949, and Chairman of the International Science Steering Committee and author of the document "Science and Foreign Relations," in 1949-1950. He was a consultant on special projects at M.I.T. during 1950-1952, and a consultant to the National Security Resources Board during 1952-1953. At present, he is on the Board of Directors of the Long Island Biological Association and of Texas Instruments, Inc., and is a member of the Honorary Board of Judges of Fisher Body Craftsman's Guild, the Committee on Rockefeller Public Service Awards, and the President's Science Advisory Committee.

He received the Science Award of the Washington Academy of Sciences in 1941; Commendation Ribbon, Secretary of the Navy, in 1944; Honorary Officer, Order of the British Empire in 1945; U. S. Legion of Merit in 1946; and Alumni Recognition Award of Acacia Fraternity in 1954.

Dr. Berkner is Chairman of the Space Science Board of the National Academy of Sciences, Vice-President of the Special Committee on the IGY of the International Joint Commission on the Ionosphere, and a member of the Executive Committee of the U. S. National Committee for the IGY.

He is also President of URSI, Past President of the International Council of Scientific Unions, and a former member of the Executive Committee of the International Union of Geodesy and Geophysics.

He is Vice-President of the American Geophysical Union, and a Fellow of the American Academy of Arts and Sciences, AIEE, the American Physical Society, the Arctic Institute of North America, and the New York Academy of Sciences. He is a member of the International Policy Committee of the National Research Council, the AAAS, the American Philosophical Society, the Council on Foreign Relations, the Philosophical Society of Washington, the Washington Academy of Sciences, Acacia, Eta Kappa Nu, Plumb Bob, Scabbard and Blade, Theta Tau, the Cosmos Club, Explorers Club, and Century Association.

Abroad, he holds membership in the Royal Swedish Academy of Sciences, the Swedish Academy of Arts and Sciences, the Physical Society of India, the New Zealand Electronics Institute, and the Royal Society of Arts (England).

Warren W. Berning was born in Cincinnati, Ohio, in 1920. He graduated from the University of Cincinnati in 1942 with the



W. W. BERNING

B.A. degree in physics. From 1942-46 he served in the United States Army as a meteorologist, working principally in England, and in 1946 he received the M.Sc. degree in meteorology from the California Institute of Technology. Since 1949, he has been a physicist at the U. S.

Army Ballistics Research Laboratory, Aberdeen, Md. He is a candidate for the Ph.D. degree in physics at The Johns Hopkins University, where he conducted resident studies from 1950-1955.

He was employed as an aerodynamicist by the McDonnell Aircraft Corp. in St. Louis, Mo. in 1946, and by the Curtiss-Wright Aircraft Corp. in Columbus, Ohio, in 1947. He joined the Army Ballistics Research Laboratory in 1947 where he first worked on the effects of meteorology on the propagation of blast-waves, and then on the development of the DOVAP (Doppler velocity and position) missile tracking system. His activities have since ranged over many related fields and include the development of one of the basic experiments for the U. S. "Vanguard" satellite program.

Mr. Berning is a member of the American Meteorological Society and the American Geophysical Union, and a Fellow of the American Physical Society. He is a member of the U.S. IGY Technical Panel on Rocketry and serves as an Army representative to the Technical Panel on Earth Satellites



Ludwig F. B. Biermann was born in 1907 in Hamm, Westphalia, Germany. He received the Ph.D. degree from the University of Göttingen in 1932, and spent part of the next two years as an exchange scholar at the University of Edinburgh, Scotland.



L. F. B. BIERMANN

Returning to Germany, he worked and taught at several universities between 1934 and 1947. In the latter year he was made head of the astrophysics section of the Max Planck Institute for Physics in Göttingen, a position he held until 1958, when his section was reorganized as the Institute for Astrophysics. In addition to his earlier work in connection with astrophysics, plasma physics and cosmic radiation, he is now working on problems of controlled thermonuclear fusion. In 1955, he was visiting professor in Pasadena, Calif., Haverford, Pa., and Princeton, N. J.

Dr. Biermann is presently director of the Max Planck Institute for Physics and Astrophysics which has recently moved from Göttingen to Munich.

He is a member of the International Astronomical Union and the German Committee for URSI.



Jack N. Brown (S'48-A'49-M'55) was born in Franklin, Pa. in 1922. After graduation from high school, he worked as a ship-board radio operator. In 1941 he entered the Pennsylvania State University in the electrical engineering curriculum. From 1943 to 1946, he was on active duty with the U. S. Army Signal Corps. He received the B.S. degree in electrical engineering in 1948, graduating cum laude.



J. N. BROWN

While attending Penn State, he worked part time doing low-frequency ionosphere investigations on a research contract for the Air Force. He then joined the National Bureau of Standards as an electronic scientist in the Central Radio Propagation Laboratory. While there he was involved with various low-frequency ionosphere pulse investigations and also with high-frequency phenomena. In 1953 he took a position with Barker & Williamson, Inc., Bristol, Pa., where he served as chief design and development engineer until 1958. Since March of 1958, he has been with the Applied Science Corporation of Princeton, N. J.

Mr. Brown has been an active radio amateur for 20 years and is a member of Eta Kappa Nu.



Sydney Chapman was born in Manchester, Eng., in 1888. He received degrees in engineering and mathematics from the University of Manchester, Eng. (D.Sc., 1912).



S. CHAPMAN

Before 1919, he studied mathematics at Cambridge University, Eng. and became an astronomer at Greenwich Observatory. He later was fellow and lecturer in mathematics at Trinity College, Cambridge, Eng. From 1919 to 1924, Dr. Chapman was a professor of mathematics at the University of Manchester. He was also a professor of mathematics at the University of London for twenty-two years and a professor at Oxford University for seven years. Before and since his retirement from Oxford, he has studied or taught at universities in Egypt, Yugoslavia, Turkey, Germany, and America including California Institute of Technology, Pasadena, the Geophysical Institute of the University of Alaska, the High Altitude Observatory of the University of Colorado, the Aeronautical Engineering Department of the University of Michigan, New

York University, and the State University of Iowa.

His researches have been in the fields of gas theory, geomagnetism, astronomy, and meteorology, especially of the upper atmosphere. He has held the presidency of many scientific societies including the ICSU Union for Geodesy and Geophysics and the ICSU Special Committee for the International Geophysical Year. He is a Fellow of the Royal Society of London, and is also a foreign member of other national scientific academies, including the U. S. National Academy of Sciences. His extensive publications include (with Prof. J. Bartels) a two-volume treatise on geomagnetism and (with Prof. T. G. Cowling) a treatise on gas theory.



Raymond D. Egan (S'50-M'57) was born in Honolulu, T. H., on August 22, 1931. After attending Stanford University, Stan-



R. D. EGAN

ford, Calif., for two years, he served from 1951 to 1953, in the U.S. Air Force. He then returned to Stanford to receive the B.S. and M.S. degrees in electrical engineering in 1955 and 1956, respectively. Since 1955, he has been a research assistant with the Radio Propagation Laboratory at Stanford University and has been actively engaged in the design and implementation of the IGY fixed-frequency ionospheric backscatter program.

Mr. Egan is a member of Sigma Xi and the American Geophysical Union.



Von R. Eshleman (S'48-A'53-SM'55) was born in Darke County, Ohio, on September 17, 1924. After serving three years in the United States Navy, he attended George Washington University, Washington, D. C., where he received the B.E.E. degree in 1949. He received the M.S. and Ph.D. degrees in electrical engineering from Stanford University, Calif., in 1950 and 1952, respectively. From 1951



V. R. ESHLEMAN

to 1952, he held an Atomic Energy Commission Fellowship in the physical sciences. He was appointed research associate in 1952, lecturer in 1956, and assistant professor in 1957, in the Electrical Engineering Department at Stanford University. He also holds the position of Consultant at Boulder Laboratories, National Bureau of Standards, Colo., and at the Stanford Research Institute, Menlo Park, Calif.

Dr. Eshleman is a member of Sigma Tau, Sigma Xi, and the U.S.A. Commission III of URSI.



Herbert Friedman was born in New York, N. Y., in 1916. He graduated from Brooklyn College, Brooklyn, N. Y., with the B.Sc. degree in 1936 and from The Johns Hopkins University with the Ph.D. in physics in 1940. He recently was appointed superintendent of the Atmosphere and Astrophysics Division of the U. S. Naval Research Laboratory.



H. FRIEDMAN

He was an instructor in physics at Johns Hopkins in 1940 and a physical metallurgist at the Naval Research Laboratory during 1941-1942. He acceded to his new position at NRL after serving as head of the Electron Optics Branch from 1942 to 1958.

Dr. Friedman is a fellow of the American Physical Society and of the American Rocket Society. He is a member of the Rocket and Satellite Panel of the U. S. Academy of Sciences and of the Astronomy and Radio Astronomy Committee of the Academy's Space Science Board. He is also a member of the Working Group on Internal Instrumentation of the U.S. IGY Earth Satellite Panel and a member of the Committee on Cosmic-Terrestrial Relations of the American Geophysical Union.



R. M. Gallet was born in Paris, France, on January 1, 1923. He received degrees in philosophy, physics, and mathematics, with specialized certificates in astronomy and theory of atomic and molecular spectra, from the University of the Sorbonne in 1942 and 1943.



R. M. GALLET

During the German occupation, he worked for two years in the laboratories of St. Française Radio-electrique and, in 1943, in the laboratory of the School of Physics and Industrial Chemistry of Paris. He entered active duty in the French navy and was attached to the Scientific Research Organization. He was in Germany on intelligence work at the end of the war.

In 1946, he took an active part in the creation of SPIM (French Ionospheric Military Service) and was a civilian scientist attached to the French Navy Scientific Research Group until 1954. His work was principally connected with ionospheric and



solar physics. He took part in expeditions to Brazil in 1947, and Indochina in 1950, where he was in charge of building an ionospheric field station. In 1950, he was responsible for the development of computing automatic machine methods for radio propagation and ionospheric data processing. His group was the only one using electronic computing methods for regular ionospheric computing.

In 1955, he joined the Boulder Laboratories of the National Bureau of Standards in the field of upper atmosphere physics. His most recent work was on absorption by cosmic noise measurements, absorption during the solar eclipse of June 20, 1955, in the Philippines, and on the theory of sporadic *E* and turbulence. At present he is directing plans for computing facility for radio propagation studies.

Mr. Gallet is a member of the French Physical Society, the French Astronomical Society, and the American Astronomical Society.

❖

John J. Gibbons was born in Chicago, Ill., on April 8, 1906. He attended the University of Illinois, Urbana, from which he received the B.A. degree in 1928, the M.S. degree in 1930, and the Ph.D. degree in physics in 1933. Since 1937 he has been a member of the staff of the Physics Department of Pennsylvania State University, University Park, Pa., and since 1950, a part-time member of the



J. J. GIBBONS

University's Ionosphere Research Laboratory. Dr. Gibbons is a member of Commission 3 of URSI.

❖

Robert A. Helliwell (S'41-A'45-SM'50) was born in Redwing, Minn., on September 2, 1920. He received the A.B. degree in electrical engineering in 1942 from Stanford University, Stanford, Calif., and then took charge of Stanford's program of ionospheric measurements and research aimed at improving wartime communications. This was later augmented by studies of high-frequency direction finder errors over long-range paths. During this period he continued with part-time graduate work, receiving the A.M. and E.E. degrees in 1943 and 1944, respectively. Following the war he began studies of low-frequency



R. A. HELLIWELL

propagation including development of a new technique for making high-resolution soundings of the ionosphere at 100 kc. With this technique new virtual height and polarization data were obtained which formed the basis of a dissertation for which he received the Ph.D. degree from Stanford in 1948. In 1951, he began a program of research into the nature of "whistlers" and related low-frequency phenomena which is yielding new results of importance to wave propagation and ionospheric physics. He is in charge of a program of synoptic whistler measurements for the IGY and is author or co-author of several technical papers dealing with ionospheric wave propagation.

Since his graduation he has participated in both graduate and undergraduate teaching programs at Stanford where he is now a professor of electrical engineering. He has recently been named head of an international commission of scientists to work on problems of radio noise in the earth's atmosphere. He was elected chairman of the Commission for Terrestrial Radio Noise at the recent Twelfth Assembly of the International Scientific Radio Union held in Boulder, Colo.

He is a member of Phi Beta Kappa, Sigma Xi, Tau Beta Pi, The American Geophysical Union, Commissions 3 and 4 of the U. S. National Committee of URSI, and is a registered professional engineer in California. He serves on the Administrative Committee of the IRE Professional Group on Antennas and Propagation, is a member of the Panel on Ionospheric Physics of the U. S. National Committee for the IGY, and was delegate-at-large to the URSI General Assemblies held in Zurich, Switzerland, (1950), Sydney, Australia, (1952), and the Hague, The Netherlands (1954).

❖

Colin O. Hines was born on June 4, 1927, in Toronto, Ontario, Can. He received the B.A. degree in physics and the M.A. degree in applied mathematics from the University of Toronto in 1949 and 1950, respectively. After a year with the Defence Research Telecommunications Establishment of Canada's Defence Research Board, he studied at the University of Cambridge, Eng., where he received the Ph.D. degree in mathematics in 1953, and then at the University of London, Eng. He returned to the Radio Physics Laboratory of DRTE in 1954, and continued research in the fields of electromagnetic and hydromagnetic wave propagation and meteoric forward scatter. After a short period as Acting Superintendent, he was appointed Superintendent of the Radio Physics Laboratory in August, 1958.



C. O. HINES

Dr. Hines is a member of the Canadian Association of Physicists.

Valeryan I. Krassovsky was born in Russia in 1907. He received the Ph.D. degree in the physical and mathematical sciences.



V. I. KRASSOVSKY

From 1948 to 1949, he was a member of the Crimean Astrophysics Observatory and from 1954 to 1955, served with the Geophysics Institute of the Academy of Sciences, U.S.S.R.

At present, Dr. Krassovsky is the chief of the Upper Atmosphere Division of the Institute of Physics of the Atmosphere Academy of Sciences, U.S.S.R. His interests lie in the branch of physics of the upper atmosphere, astrophysics and spectroscopy.

During 1955, Dr. Krassovsky served on the U.S.S.R. National IGY Committee on Polar Lights and Night Sky Radiation. He is a recipient of the Stalin Prize and the Labor Valor Medal and has published widely.

❖

Harold Leinbach (M'57) was born in Fort Collins, Colo., on January 7, 1929. He received the B.S. degree from South Dakota State College in 1949, and the M.S. degree in astronomy from California Institute of Technology, Pasadena, in 1950.



H. LEINBACH

Prior to serving with the U. S. Army, he spent three years in auroral studies at the Geophysical Institute of the University of Alaska, College, Alaska. Since his return in 1956, he has been active in the study of high-latitude radio wave absorption. He participated in the development of the "riometer," a device for the routine measurement of ionospheric absorption, and was in charge of the installation and operation of the six Alaskan stations using this method during the IGY.

❖

Robert S. Leonard (A'54) was born in Berkeley, Calif., on January 20, 1930. He received the B.Sc. and M.Sc. degrees in physics from the University of Nevada, Reno, Nev., in 1952 and 1953, respectively, and he has been performing graduate studies at the University of Alaska, College, Alaska, since 1955.



R. S. LEONARD

Mr. Leonard was a teaching assistant in the Physics De-



partment at the University of Nevada, 1952-1953, and was employed as a researcher at the Geophysical Institute of the University of Alaska from 1953-1955, concentrating on the auroral reflection of radio signals.

Mr. Leonard is a member of the American Physical Society and the American Association of Physics Teachers.



C. Gordon Little (M'56) was born in Liu Yang', Hunan Province, China, on November 4, 1924. Before graduating from the University of Manchester, Eng., in 1948 with the B.S. degree in Honors Physics, he worked in industrial research laboratories for three years on the design of high-voltage rectifiers and electrometer tubes.



C. G. LITTLE

After graduate studies at the Jodrell Bank Radio Astronomy Research Center of the University of Manchester, he was awarded the Ph.D. degree in 1952. In January, 1954, he took up an appointment as visiting professor of geophysics and senior research scientist at the Geophysical Institute of the University of Alaska. From July, 1954, to June, 1958, he was deputy director of the Geophysical Institute, in charge of the research programs in ionospheric physics and arctic radio-wave propagation. In July, 1958, he joined the Central Radio Propagation Laboratories of the National Bureau of Standards, Boulder, Colo., as a consultant to the Radio Propagation Physics Division.

Dr. Little is a Fellow of the Royal Astronomical Society, London, a member of USA Commissions III and V of URSI, and an associate member of the Arctic Institute of North America. He has served as a member of or consultant to U. S. IGY committees on the Ionosphere, Aurora and Airglow, and Earth Satellites.



Reimar Lüst was born in Barmen, Germany, in 1923. He studied physics, astrophysics and mathematics at the Universities of Frankfurt and Göttingen. At Göttingen he received the Ph.D. degree in 1951.



R. LÜST

Since 1949, he has worked at the Max Planck Institute for Physics where he belonged to the astrophysics section since 1951. There he is working on different problems in connection with plasma physics and cosmic radiation. From 1955 to 1956, he was a Fulbright

fellow at the Enrico Fermi Institute for Nuclear Studies of the University of Chicago, Chicago, Ill., and at the Princeton University Observatory, Princeton, N. J.

Dr. Lüst is now heading a group for astrophysics at the Max Planck Institute for Astrophysics, located now in Munich.

He is a member of the International Astronomical Union.



Ken-Ichi Maeda was born in Osaka, Japan, on August 1, 1909. He was graduated from Kyoto University in 1932, and received the degree of Doctor of Engineering from the University in 1941.



K. I. MAEDA

He was engaged in research on the ionosphere and radio-wave propagation at the Electrotechnical Laboratory, Ministry of Communications, from 1932 to 1942, and at the Physical Institute for Radio Waves, Ministry of Education, from 1942 to 1948, serving as Director of the Institute from 1946. From 1948 to 1953, he was Director of Research at the Electrical Communication Laboratory, and from 1947 to 1953 lectured part time on ionospheric physics on the Faculty of Science of the University of Tokyo. Since February, 1953, when he became a professor in the Department of Electronics at Kyoto University, he has been conducting research in ionospheric physics and telecommunication. He has been a consultant of the Electrical Communication Laboratory since 1956.

He was awarded the prize of the Japan Radio Society in April, 1941, for his research work on ionosphere and radio wave propagation; the prize of the Institute of Electrical Engineers (IEE) of Japan in January, 1942, for the publication of "Radio Wave Propagation"; and the prize of the Institute of Electrical Communication Engineers (IECE) of Japan in May, 1955, for distinguished service in telecommunication science.

Dr. Maeda is a member of the IEE of Japan, the Society of Terrestrial Magnetism and Electricity and the IECE of Japan. He served as Vice-President of the latter from May, 1955 to May, 1957.



L. A. Manning (S'43-A'45-SM'54) for a photograph and biography, please see page 1432 of the July, 1958 issue of PROCEEDINGS.



D. F. Martyn was born in Cambuslang, Scotland, on June 27, 1906. He received the B.Sc. and A.R.C.Sc. degrees from the Royal College of Science, London, England, in 1926 and the Ph.D. degree and the D.Sc. degree in 1929 and 1936, respectively, from

the University of London. He joined the staff of the Radio Research Board in Australia in 1930. He visited the United Kingdom in 1939 on a mission in behalf of the Commonwealth Government which resulted in the founding of the Radiophysics Laboratory, Sydney, Australia, of which he was the first chief.

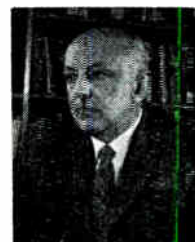

D. F. MARTYN

After initiating a program of radar research and development in Australia, he joined the services as director of operational research during the remainder of the war years. Returning to fundamental research after the war, he visited the Commonwealth Observatory and initiated various developments in radio astronomy. His most recent work has been in connection with the theory of the F region of the ionosphere, tidal oscillations, and the geomagnetic variations originating in the ionosphere.

Dr. Martyn was elected a Fellow of the Royal Society in 1950, and was first president of the Radio Astronomy Commission of the International Union of Scientific Radio. He is currently President of the Ionosphere Commission of URSI. He is a Foundation Fellow, and was the first secretary of the Australian Academy of Science, and is currently chairman of its Upper Atmosphere Research Committee.



Millett G. Morgan (S'42-A'43-SM'58) was born in Hanover, N. H., in 1915. He attended Cornell University as a George W. Lefevre scholar, earning the B.A. degree with honors in physics in 1937, and the M.S. degree in electrical engineering in 1938. He then attended Stanford University where he earned the degree of engineer in 1939, and the Ph.D. degree in 1946, both in electrical engineering. He



M. G. MORGAN

was an instructor in electrical engineering at Dartmouth College in 1941, and at the Massachusetts Institute of Technology in 1942. From 1942-1946, he was employed by the Submarine Signal Co. of Boston and was resident at the California Institute of Technology during the last two years of that period. He was a staff engineer and lecturer in electrical engineering at the University of California at Berkeley in 1946.

Dr. Morgan returned to the Thayer School of Engineering in 1947 as an assistant professor, and has been full professor since 1953. He served as assistant dean from 1947 to 1949, and has been director of research since 1949.

Dr. Morgan has been an active researcher in ionospheric radio for many years and dur-

ing the IGY has served as chairman of the Ionospheric Physics Panel of the U.S. IGY Committee. He has been an active participant in the affairs of the International Scientific Radio Union, serving during 1955-1958, as chairman of the U.S. Commission on the ionosphere and now as the U.S. associate editor. He has also been active in IRE affairs, having been a member of the Wave Propagation Committee and the Institute representative at Dartmouth College for many years. He was chairman of the Wave Propagation Committee during the period 1955-1957.



Benjamin Nichols (A'49, SM'54) was born in Staten Island, N.Y., on September 20, 1920. He received the B.E.E. degree in 1946 and the M.E.E. degree in 1949, both from Cornell University, Ithaca, N.Y., and the Ph.D. degree in geophysics from the University of Alaska, College, Alaska, in 1958.



B. NICHOLS

He has been teaching at Cornell since 1946, and has been an associate professor since 1953. He is chairman of the radio and communications courses in the School of Electrical Engineering. In 1951-1952, he was a faculty fellow of the Fund for the Advancement of Education, and in 1956-1957, was a research associate at the Geophysical Institute of the University of Alaska. He is the author of several papers on auroral radio echoes and auroral drift motions. Presently, he is directing a research program on radio star scintillation and acting as the scientific representative of Cornell University to the University Corporation on Atmospheric Research.

In 1955-1956, Dr. Nichols served as chairman of the Ithaca section of the IRE. He is a member of U.S.A. Commission 3 of URSI and was a delegate to its Eleventh and Twelfth General Assemblies. He is also a member of the American Society for Engineering Education and Sigma Xi.



Marcel Nicolet was born in Basse-Bodeux, Belgium, on February 26, 1912. He received the M.S. degree in physics in 1934, and the Ph.D. degree in 1937, from the University of Liège in Belgium. In 1935, he joined the scientific staff of the Royal Meteorological Institute of Belgium at Brussels where he is now head of the Department of Radiation. In 1947, he became associated with



M. NICOLET

the University of Brussels and since 1951, has also been a consultant to the Ionosphere Research Laboratory of the Pennsylvania State University.

Dr. Nicolet is the author of numerous papers in aeronomy, physical meteorology, and astrophysics. He is a member of the International Unions of Astronomy, of Geodesy and Geophysics, and of Radio Science. He is the chairman of the Committee on Aeronomy of the Geodesy and Geophysics Union. He is also a member of the Mixed Commission on the Ionosphere and on Solar and Terrestrial Relationships.

Since 1953, Dr. Nicolet has been the Secretary General of the ICSU Special Committee for the IGY.



E. N. Parker received the B.S. degree in physics in 1948, from Michigan State University, and the Ph.D. degree in 1951, from the California Institute of Technology.



E. N. PARKER

He was an instructor in the department of mathematics and astronomy at the University of Utah from 1951 to 1953. From 1953 to 1955, he served as assistant professor at that University in the Department of Physics. From 1955 to 1957, he was a research associate at the Enrico Fermi Institute for Nuclear Studies, University of Chicago, where he is at present an assistant professor in physics.

Dr. Parker was originally interested in hydromagnetic theory, particularly the problem of hydromagnetic dynamos and worked with Elsasser on the production of the geomagnetic field. More recently he has been concerned with the acceleration of charged particle in hydromagnetic fields as a part of the general problem of suprathermal particles: auroras, geomagnetic storms, origin and modulation of cosmic rays. He is currently working on the dynamics of violently agitated plasmas and the resulting "shock" fronts which are produced; applications are in astrophysics, space technology, and thermonuclear problems.



Allen M. Peterson (M'56) was born in Santa Clara, Calif., on May 22, 1922. He attended San Jose State College from 1939 to 1942. From 1942 to 1944, he was associated with the Electronics Group of Sacramento Air Service Command. He received the B.S., M.S., and Ph.D. degrees, all in electrical engineering from Stanford University in 1948, 1949, and 1952, respectively. Since



A. M. PETERSON

1957, Dr. Peterson has been a staff member of the Radio Propagation Laboratory at Stanford and at present is an associate professor in the electrical engineering department. He is also a member of the staff of Stanford Research Institute since 1953, where he is manager of the Communication and Propagation Laboratory.

Dr. Peterson is a member of the Scientific Research Society of America, Sigma Xi, the Society for Industrial and Applied Mathematics, Commission 3 of the U. S. Committee of URSI and the Aurora and Airglow Panel of the USNC, IGY.



David S. Pratt was born in Hollywood, Calif., on June 2, 1934. He attended Purdue University, Lafayette, Ind., from 1952 to 1954, and then transferred to Stanford University, Stanford, Calif., where he received the B.S. degree in electrical engineering in 1957.



D. S. PRATT

In 1956, he joined the Stanford Radio Propagation Laboratory and received an appointment as research assistant in 1957. He has been engaged in the design and field operations of the IGY fixed-frequency backscatter program and instrumentation for other radio propagation research projects.



Franklyn E. Roach was born on September 23, 1905, in Jamestown, Mich. He received the B.S. degree from the University of Michigan in 1927, and the M.S. and the Ph.D. degrees in astrophysics in 1930 and 1934, respectively, from the University of Chicago.



F. E. ROACH

Early in his career, he served as an assistant at various observatories and was a research scientist with the Naval Ordnance Test Station at Pasadena and China Lake, Calif., for nine years. During this time he was on a year's leave of absence as a Fulbright research scholar studying at the Institute of Astrophysics in Paris, France.

He has been a physicist with the A. O. Smith Corp., Milwaukee, Wis.; assistant and associate professor of physics and astronomy at the University of Arizona; and physicist with the Office of Scientific Research and Development at the California Institute of Technology. At present, Dr. Roach is an astrophysicist at the NBS Boulder Laboratories, engaged in making studies of faint color emissions in the sky that originate in



the upper atmosphere and are suspected to have an effect on radio transmission.

Dr. Roach is a member of the Astronomical Society, the Geophysical Union, the International Union of Radio Scientists, and the International Union of Geodesy and Geophysics.



Teruo Sato was born on November 19, 1923, in Kyoto, Japan. He received the B.S. degree in geophysics from Kyoto University in 1949.



T. SATO

Since 1949 Mr. Sato has been engaged in investigations of ionospheric physics at the Geophysical Institute, Kyoto University. He received the Tanakadate prize for the investigation of ionospheric storms from the Society of Terrestrial Magnet-

ism and Electricity of Japan in 1956. In 1958 he received the D.Sc. degree from Kyoto University. He is at present on the Faculty of Liberal Arts and Education, Shiga University.

Dr. Sato is a member of the Society of Terrestrial Magnetism and Electricity of Japan and the Ionosphere Research Committee of the Science Council of Japan.



Alan H. Shapley was born March 23, 1919 in Pasadena, Calif. In 1940, he was graduated from Harvard University, Cambridge, Mass., with the A.B. degree in astronomy. In 1947, he joined the National Bureau of Standards, where he now heads the work of solar-terrestrial relationships. During World War II, he was at the Carnegie Institution of Washington doing work for the Office of Scientific Research and Development.

As vice-chairman of the United States National Committee for the IGY, he has participated actively in plans for the major

IGY projects which the U. S. has undertaken. He is a member of the U. S. IGY technical panel on ionospheric physics and



A. H. SHAPLEY

has been active in planning ionospheric measurements by means of earth satellites. He is a member of the newly created Space Science Board and Polar Research Committee of the National Academy of Sciences, both of which have been established to guide United States policy

in these areas after the IGY.

He is a member of the URSI International Committee for the IGY and he has been responsible for the work of establishing new standards for the world-wide net of ionospheric sounding stations. He is the international IGY reporter for World Days and Communications.

Mr. Shapley is a Fellow of the AAAS, a member of the USA National Committee of URSI; a member of the American Geophysical Union, the American Astronomical Society, the American Physical Society, the Federation of American Scientists, Washington Academy of Sciences, Research Society of America, Sigma Xi, and the New York Academy of Sciences.



J. O. Thomas was born on May 31, 1926 in Swansea, Wales. He received the Ph.D. degree in physics from the University



J. O. THOMAS

College of Swansea, University of Wales in 1953, and the M.A. degree from the University of Cambridge, England, in 1954.

Dr. Thomas is presently a University Teaching Officer and a member of Sidney Sussex College in the University of Cambridge. For the

past five years he has been engaged in research on the ionosphere at the Cavendish Laboratory in the University of Cambridge.

He is chairman of the international working party in Commission 3 of URSI on ionosphere electron density distribution. He is secretary of the General Arrangements Committee and of the Executive Committee for the Twelfth General Assembly of URSI which is scheduled to be held in London in 1960.



Arthur H. Waynick (F'57) was born in Spokane, Wash., on November 9, 1905. He attended Wayne University, Detroit, Mich.,



A. H. WAYNICK

from which he received the B.Sc. degree and the M.Sc. degree in physics in 1935 and 1936, respectively. During the period 1937-1939 he attended Cambridge University, England. In 1943, he received the Sc.D. degree in communications engineering from Harvard Uni-

versity. He also served as a Guggenheim Fellow at Cambridge during 1954-1955.

At present he is employed by the Pennsylvania State University as a professor, head of the electrical engineering department, and director of the Ionosphere Research Laboratory. He is a member of the United States National Committee-International Geophysical Year, Technical Panel on Ionospheric Physics. His recent experience includes service as past chairman of the IRE Professional Group on Antennas and Propagation, past chairman of the U. S. National Committee of URSI, and the head of the U. S. delegation to the General Assembly of URSI at The Hague, The Netherlands in 1954.

Dr. Waynick is a member of the Institute of Electrical Engineers, the American Geophysical Union, the American Society for Engineering Education, and Sigma Xi.



## Scanning the Transactions

**Communication by use of sound, light, heat, nuclear and other forms of radiation** are being seriously examined in an effort to find new means of communication to supplement our present overcrowded conventional radio facilities. Of particular interest are those phenomena which can take advantage of certain propagation ducts that exist in the atmosphere, in the sea, and under the ground. Transmission through these natural ducts is very desirable because of the great ranges which may be obtained with low powered transmitters.

One of the most promising possibilities is offered by VLF radio waves (below 30 kc), which can be transmitted several thousand miles by means of a duct between the ionosphere and the earth's surface. Another VLF duct has been recently discovered which follows the earth's magnetic field between the Northern and Southern Hemispheres, forming a giant arching tube over 1000 miles in diameter.

Audible sound also offers exciting possibilities because of the existence of two natural sound ducts, one in the troposphere at an altitude of about 10 miles, and the other a half mile below the surface of the sea. Underground rock strata may also prove to be a useful transmission medium, both for sound and radio waves.

Of the remaining forms of radiation, ultraviolet looks the most interesting. Although it would be limited to line-of-sight distances, it has a good potential because background noise at low altitudes is very low due to the almost complete absorption of ultraviolet radiation from the sun by a layer of ozone in the stratosphere. It is not inconceivable that with a substantial improvement in the sensitivity of photocells, ultraviolet could some day become competitive with microwaves. (J. L. Ryerson, "Exploitation of physical phenomena for communications," 1958 IRE NATIONAL CONVENTION RECORD, Part 8.)

**How fast do you read?** About 250 words per minutes, if you are average. Moreover, you probably spend five hours a day reading—almost a third of your waking life. And yet experience shows that most average readers could learn to read from 400 to 500 words per minute and do this without loss of comprehension. This means most of us could read up to twice as much as we now do—or could have about two extra hours a day for other activities. In reading a line of print, the eye pauses to take in a group of words, jumps to the next group and pauses again, and so on. The average reader will read a line 10 or 12 words in length in six jumps, the rapid reader in only three because his eye is trained to perceive words in larger groups. You can train yourself by setting aside 15 to 20 minutes a day and practicing reading as fast as you can. After 10 or 12 days begin to push your speed in all your regular reading as well. Within three or four weeks you should be a habitual fast reader and will enjoy the rewards for the rest of your life. (J. B. Stroud, "The professional man and his reading," IRE TRANS. ON EDUCATION, December, 1958.)

**For a timely review of space technology** we heartily recommend the December issue of Military Electronics TRANSACTIONS, which in five absorbing articles summarizes present knowledge and points to problems which must yet be solved in man's endeavor to extend his world to encompass the solar system and beyond. The fact that the issue was mailed to its readers four days before the Soviets launched Lunik showed an uncanny sense of timing on the part of the editors. Indeed, one article on astronautics includes an enlightening discussion of the launching accuracies required to "shoot the moon." Other papers discuss the solar system, space communication requirements and guidance systems, providing an issue that is in every sense out of this world.

**The inefficiency of speech** as a means of communication, a fact long appreciated by natives of New England, wives of senators, and husbands in general, is becoming more and more apparent to the radio engineer. To transmit a speech signal he must provide a system with a channel capacity of the order of 50,000 bits per second. Yet the basic information content of the signal theoretically requires no more than 60 bits per second. The difference is taken up by redundancies, inefficient use of the audio spectrum, and those characteristics of speech which give the voice an identity and emotional quality. The need for more efficient use of the radio spectrum has led to a number of ingenious schemes for compressing the bandwidth of speech signals by as much as 20 to 1 by means of techniques involving frequency or time compression, sampling, and coding. Thus it is no longer sufficient that engineers design the circuits for transmitting messages; they must also devise more efficient "languages" as well. (S. J. Campanella, "A survey of speech bandwidth compression techniques," IRE TRANS. ON AUDIO, September-October, 1958.)

**The Professional Group on Nuclear Science** has published the *Proceedings of the Scintillation Counter Symposium* held in Washington, D. C., January 27-28, 1958. This Symposium, held biennially, covers all phases of this important field of nuclear instrumentation. The entire proceedings are published in the December issue. Papers cover the recent work on the types of scintillators, including crystalline, plastic, liquid, and gas. Other papers describe modern developments on photomultipliers both in the United States and in England and France. The application of scintillation counting to nuclear experimentation is described in other papers. These include the experiments on high energy particles and the famous experiments on the conservation of parity. In the high energy field, one of the more interesting developments is the application of scintillation detectors to the resolution of time intervals between nuclear events of the order of millimicroseconds. At the other end of the scale, scintillation detectors utilizing hundreds of pounds of scintillator solution and dozens of detectors are used to measure increases in radioactivity of human beings, animals, and plants resulting from fallout. Scintillation detectors, together with pulse height analyzers, are a powerful tool for resolving the energy spectra of nuclear radiations. Methods for spectrum resolution and the problems are discussed in detail.

**Costly flood damage**, amounting to millions of dollars annually, is expected to be saved by a novel radio warning and forecasting system. Water level conditions throughout the entire Susquehanna River basin will be continually "watched" by a communications and alarm system now being constructed. Information will be relayed by radio daily, or as often as required, from these remote sites to U. S. Weather Bureau Office at Harrisburg Airport in Pennsylvania. The radio system uses a wide variety of facilities, including automatic equipment for transmitting coded signals and manually operated stations for reporting by voice. The main system uses 960 megacycle equipment, over which speech, teletypewriter, and telemetering information is sent. At each of the repeater sites, a 170 or 400 megacycle base station is used for communication with the many outlying reporting stations. The system, built for the Pennsylvania Department of Forests and Waters, is also equipped with failure alarm protection so that failures can be corrected within a short time. (W. C. Wray, "A unique radio system for flood forecasting," 1958 IRE NATIONAL CONVENTION RECORD, Part 8.)

# Books

## The Junction Transistor and Its Applications, edited by E. Wolfendale

Published (1958) by The Macmillan Co., 60 Fifth Ave., N. Y. 11, N. Y. 377 pages+8 appendix pages+4 index pages+viii pages. Illus. 6½×9½. \$7.50.

This is another book on the basics of junction transistors and representative transistor circuits. The authors are from the British firm Mullar Radio Valve Co., Ltd. The purpose of the book is "... to give a comprehensive introduction to the junction transistor, its equivalent circuit and its application. . . ." The level of the book is suitable for electrical engineering seniors and practicing electronic circuit engineers. The topics chosen and the order of presentation are about what one expects. About one quarter of the book is devoted to semiconductor and transistor electronics (chapter 1: Transistor Physics), the second quarter to basic transistor and amplifier characteristics and properties (Chapters 2, 3, 4: Characteristics, General Four Terminal Networks and Transistor Equivalent Circuits, Biasing and Audio Amplification), the third quarter to band-pass amplifiers, oscillators, and modulators (chapters 5, 6, 7, 8: High Frequency Amplification, Class C Amplification, Sinusoidal Oscillators, Amplitude Modulation and Demodulation) and a final quarter to nonlinear operation and circuits (chapters 9, 10: Non-linear Circuits, D.C. Converters). Throughout the book the following sequence is used: a) a simple physical discussion of the topic, b) a straight forward and often elementary analysis, and c) a specific numerical example with element values for circuits, e.g., the design of an IF amplifier or a flip-flop.

If one accepts the book as being primarily addressed to the practicing circuit engineer with no experience or study in transistor circuits, it can serve as a competent vehicle to bring the reader quickly into the field. It will be useful both for individual study and for in- or out-of-hours professional courses. However, it does not seem appropriate as an undergraduate textbook. The general criticism can be made that the explanations and discussions are too tailor-made for the moment. Of greatest importance seems to be a plausible and acceptable explanation of the specific device, process, or circuit at hand. The emphasis is not on the general problems of device description or circuit operation and analysis.

The first chapter, Transistor Physics, by T. B. Watkins, is very well done. Here in 70 pages is a chapter easy to read and to understand, starting with an historical sketch and ending with equivalent circuits and noise properties. In this chapter, as throughout the book, use is made of RC transmission lines to represent the diffusion flow of minority carriers and to develop equivalent circuits. Simplifications and modifications are smoothly incorporated. However, a major omission here and elsewhere in the book is the presentation and discussion of the basic transistor V-I equations (the so-called Ebers and Moll equations).

The usual material on 2-port parameters is included, but this reviewer was pleased to see that material presented briefly, in less than 6 pages. The dazzling display of manipulation of one set of parameters to another, etc., etc., was omitted. How far off is the day when we can assume that the circuit engineer has a knowledge of 2-port characterization?

The last chapter on dc converters is a long one, and this reviewer wonders why this topic was given so much emphasis. It would have been more consistent to include only a brief description and maybe include a short section on power supply regulators.

DONALD O. PEDERSON  
Department of Electrical Engineering  
University of California  
Berkeley 4, Calif.

## Control System Components, by John E. Gibson and Franz B. Tuteur

Published (1958) by McGraw-Hill Book Co., Inc., 330 W. 42 St., N. Y. 36, N. Y. 480 pages+13 index pages+ix pages. Illus. 6½×9½. \$12.00.

The text comprises a review of electronic, electromechanical, magnetic, mechanical, hydraulic, and pneumatic components which, as the title indicates, are frequently used in control systems. The authors discuss control components that are contained within the system controller rather than the process under control, or the associated sensors or communication. Nonetheless, the area delineated is extremely broad in scope, and the authors' treatment amply demonstrates their depth of experience with a wide range of "hardware."

The reader seeking a handbook will be somewhat disappointed, because the text attempts no exhaustive compilations which comprise the state of the art. Nor do the references lead to the complete picture in most cases. Further, the arrangement of text and the abbreviated index are not those of a handbook. The reader seeking a college textbook will also be disappointed in the small number of examples and the lack of emphasis on principles necessary to extrapolate new or optimum designs. The reader seeking something between these two extremes, however, will most certainly find it here.

To illustrate the above comments by example, the section on dc transistor amplifiers contains a highly efficient and condensed treatment of basic circuits together with all major design factors stated and related to manufacturing data sheets. Thus, in minimum time, the neophyte reader may design his own amplifier. However, this design will most probably not be an optimum one, nor will the reader have learned much about solid-state physics, nor will he learn explicitly whether a magnetic amplifier would have been better for his application.

Inevitably in treating such a broad subject, omissions will occur. The seriousness of these omissions is of course a function of the individual reader's needs. Sections treating digital control components would have been welcomed by an increasing number of engi-

neers. Similarly, a discussion of nonlinear compensator components—both mechanical and electronic, transistor switching circuitry, and the use of poppet valves in modulating control would have been useful additions.

On the other hand, of special value is the inclusion of material on pulse operated hydraulic valves and the dynamics of fluid flow delay lines. The treatment of 2-phase motors, choppers, and magnetic amplifiers is particularly complete.

In summary, a text on this subject cannot provide all things for all people. This one, however, appears to be a useful addition to the majority of control engineering libraries. It is up-to-date, clearly written, and generally well organized.

DON LEBELL  
15366 West Longbow Drive  
Sherman Oaks, Calif.

## Electronic Components Handbook, Vol. 2, edited by Keith Henney and Craig Walsh

Published (1958) by McGraw-Hill Book Co., Inc., 330 W. 42 St., N. Y. 36, N. Y. 329 pages+17 appendix pages+9 index pages. Illus. 8½×11½. \$12.50.

"Electronic Components Handbook," Volume II, covers the following subjects: Active Parts—power sources and converters, choppers, blowers, drive motors, and filters, instruments; Passive Parts—printed wiring boards, solder and fluxes, fuses and circuit breakers; and Special Parts—RF transmission lines and wave guides.

Each chapter covers its subject with current information and data which can be used without a strong engineering background.

The book covers a wide variety of subjects, from RF components to dc and passive as well as active components. It is definitely a companion to Volume I. Some of the descriptive sketches showing application and mounting techniques to improve reliability are excellently presented. It is recommended reading and reference for designers as well as quick summary information for any engineer.

There is a consistent approach to the coverage of subject matter, and in general each chapter includes: definitions, general theory and/or background, descriptions and type (families), construction details, environmental considerations, applicable MIL specifications, application notes, and references.

The descriptive material is well presented. The book does not design circuits, but stresses how to apply parts in circuit applications. By selective use and application of the material in this text, the reliability of electrical and electronic designs can be improved. The book lacks summaries of modes-of-failure of the part under discussion in each chapter. These data can be valuable tools in designing equipment.

In general, the text is a worthy asset to technical book libraries.

F. A. PAUL  
Radioplane  
Van Nuys, Calif.



### Switching Circuits: with Computer Applications, by Watts S. Humphrey, Jr.

Published (1958) by McGraw-Hill Book Co., Inc., 330 W. 42 St., N. Y. 36, N. Y. 257 pages + 2 bibliography pages + 4 index pages + viii pages. Illus. 9½ X 6½. \$8.50.

Mr. Humphrey's stated objectives are first, "to present those techniques which can be of most use to a computer designer," and second, "to present enough theoretical material to enable the student to understand and apply new methods as they become available."

His first two chapters are devoted to number systems and Boolean algebra. The third chapter contains an introductory discussion of relay contact networks and their simplification by means of Boolean algebra, and some rather special circuit techniques. Chapter four is on the subject of codes, with emphasis on the reduction of undetected errors in digital computing machines.

The next four chapters alternate between methods for minimizing combinational circuits and applications to particular types of logic circuits. Chapter five gives a presentation of the map method with some added material on factoring Boolean expressions beyond the two level form. Chapter six contains a discussion of the properties of diode and transistor logic circuits, with some mention of load limitations and delay. Boolean matrix methods for circuit analysis and synthesis are covered in chapter seven, while relay circuits and a very special kind of magnetic core circuitry are discussed in chapter eight, with the emphasis here on bridge and multiterminal networks.

Chapter nine deals with cascaded networks, which form something of a link between combinational and sequential circuits. This chapter is heavily weighted with illustrative examples of relay, transistor, and diode cascaded networks. Chapter ten, which is the last, covers the subject of synchronous sequential circuits.

The textual material in this book is rather terse, making it in many places more of a handbook than a textbook. Fortunately, it is liberally supported by examples and problems. This reviewer is inclined to feel that the book ought not to be used as a graduate text unless supported by other sources which contain much more basic theory and by a teacher well qualified to serve as an interpreter in this field.

In general, Mr. Humphrey appears to have realized his first objective. Although his book omits discussion of asynchronous circuits and computational design techniques, he does about all that can be expected in covering the basic logical design technology in a fairly small number of pages.

The second objective, to teach theory, is met very feebly indeed. Boolean algebra is introduced in a purely intuitive fashion, using Venn diagrams and illustrations from the algebra of classes. Propositional logic and Boolean algebra as an axiomatic system are omitted. Truth tables are not discussed, nor are Boolean functions defined. This omission is likely to cause the reader confusion between functions and their algebraic representations, a condition not helped by the author when he writes of "the process by which functions are simplified" in chapter two. The subject of graph theory is avoided

religiously, with a consequent failure to give a very lucid and significant discussion of nonseries parallel networks and their duals. Another important omission is the subject of transformation symmetries of functions and the related equivalence classes of functions.

A less significant, but irritating, defect of the book is the lack of enough circuit schematics to make transistor logic circuits, as illustrated by the author, understandable to the novice. Fortunately, these things are simple enough so that most students can, with some effort, reinvent them.

M. KARNAUGH  
Bell Telephone Labs.  
Murray Hill, N. J.

### Electronic Digital Computers, by Franz L. Alt

Published (1958) by Academic Press Inc., 111 Fifth Ave. N. Y. 3, N. Y. 310 pages + 12 index pages + 12 bibliography pages + x pages. 8 Figs. 6½ X 9½. \$10.00.

This book was written as an introduction to digital computers for potential users of such equipment. In addition, it should prove very useful reading to many working in the field, since its broad coverage is sure to bring them new light.

The book is divided into five parts. To organize the many interconnected aspects of the subject, they must be separated in a way that causes trouble on first reading. Part 1 is an introduction, in which the author tries to cover enough to make the first reading of the rest understandable. To be really useful, however, the book must be read once and then reread or used as a reference.

Part 2, Automatic Digital Computers, covers the machine hardware. The basic parts of a computer and the different types of equipment used to perform their functions are dealt with.

Part 3, Coding and Programming, is notable in that the multi-address systems are considered as fully as one-address systems. Here the reader is introduced to simple machine codes so that examples of coding techniques can be illustrated. Examples in four, two, and one address coding are given to illustrate the salient points of each. A brief section on "automatic coding" concludes this part. This reviewer was sorry to see that vague overworked term "automatic coding" used here, and feels that the subjects covered by this umbrella deserve slightly better mention. Symbolic programming and automatic operator systems, for instance, are not even mentioned, although they are finding widespread use. The author does mention here or elsewhere the present and potential value of some of these efforts. Current work being done in the theory and use of computer languages is perhaps too new to appear in this book, but would be a worthwhile addition.

Part 4, Problem Analysis, is twice as long as any other part. It will probably prove the most useful part of the book, especially for reference use. It should be read by all who are learning to program. Problems of error control, checking, machine overflow, etc., are clearly dealt with. There follow more than 100 pages which might be called Numerical Analysis Made Easy or What Every Programmer Should Know. For instance,

this writer was glad to see explained the fact that many integration schemes are just end corrections to the trapezoidal rule. This is a fact which many programmers have been known to dispute.

Part 5 is called Matching Problems and Machines. Most types of problems that have occupied appreciable computer time are covered, with evaluations of numerical methods and machine capabilities. Then comes a short section on the organization of a computing laboratory. The book concludes with a fairly safe prediction, namely, that the computing field will continue its rapid expansion for some time, creating a need for progress in hardware, programming, and numerical analysis.

C. J. SWIFT  
Convair Div.  
General Dynamics  
San Diego, Calif.

### Engineering Electromagnetics, by W. H. Hayt, Jr.

Published (1958) by McGraw-Hill Book Co., Inc., 330 W. 42 St., N. Y. 36, N. Y. 311 pages + 9 appendix pages + 6 index pages + xi pages. Illus. 9½ X 6½. \$8.75.

The scientific basis of electrical engineering is electromagnetism. However, it has always been recognized that it is not practicable for the electrical engineering student to acquire complete competence in that science before proceeding to his engineering studies. This book is written in this context as suitable for advanced undergraduate electrical engineers.

The book is a well written, modern presentation of the classical development of Maxwell's equations, with an introduction to radiation and other manifestations. It is orderly, lucid, and well illustrated. **E** and **H** are treated as fields and **D** and **B** as fluxes. MKSC rationalized units are used. Adequate problems, references, and appended material on units, dimensions, and physical constants are provided. The discussion of units is particularly lucid.

M. G. MORGAN  
Thayer School of Engineering  
Dartmouth College  
Hanover, N. H.

### Introduction to the Design of Servomechanisms, by John L. Bower and Peter M. Schultheiss

Published (1958) by John Wiley and Sons, Inc., 440 Fourth Ave., N. Y. 16, N. Y. 469 pages + 36 appendix pages + 4 index pages + xi pages. Illus. 6 X 9½. \$13.00.

To encounter once more a newly published beginning text on the theory of servomechanisms may be disappointing to the experienced reader. But, as this book is one of the best organized and written, it is highly recommended to the student and practicing engineer alike who seek their first contact with the field.

Chapters 1 through 5 present the basic material, including concepts, background mathematics, analytical manipulations, and stability criteria. Good definitions, orderly progression, and concise coverage characterize the material. On the other hand, the mathematically inclined student might wish for a little more rigor and depth.

Chapters 6 through 9 introduce the notion of performance adjustment through



equalization. Criteria for steady-state and dynamic performance are established. These chapters also cover the various popular methods of charting system behavior. The root-locus technique is particularly well done.

The remaining two chapters introduce statistical and nonlinear considerations. The authors carefully restrict their material to fundamental notions sufficiently developed to expose the approach to the solution of many problems encountered by the designing engineer. The student will find many points of departure for further study in the more advanced literature. The problems offered at the end of each chapter are undoubtedly well developed under the fire of the hard-worked graduate students at Yale University.

This is a good book for IRE members desiring a good starting point for the theory of servomechanisms.

WILLIAM M. PEASE  
RCA  
Burlington, Mass.

### Propriétés et Applications des Transistors, by Jean Pierre Vasseur

Published (1958) by Société Française de Documentation Electronique, 12, rue Carducci, Paris 19ème, France. 458 pages+11 index pages+8 bibliography pages+viii pages+2 pages tables. Illus. 6½×9½.

Here is a well conceived book which will complement those of Shea and Hunter. Unfortunately, at this time it is available only in French. This is a pity because of its potential value to a large number of French radio engineers utilizing transistors.

This book not only gives a keen insight into the physical phenomena involved in the various types of transistors, but also teaches the analytical manipulations necessary to arrive at intelligent circuit designs. It is useful mostly to students and circuit engineers who, already acquainted with circuit theory, wish to "transistorize" their concepts of device representation.

The author starts with a concise and lucid description of the physical principles of transistors, and points out those physical factors which affect the design of devices. Very little is said about technology. Then Dr. Vasseur gives a general treatment of the linear four-pole theory. He simplifies the application of this theory to transistors by providing many conversion tables which represent all the parameters in either of the useful four-terminal equivalent circuits. The stress on the physical significance of the various parameters is noteworthy. The author presents methods for calculating the performance of transistor amplifiers of the grounded emitter, grounded base, and grounded collector configurations, and he studies carefully the neutralization of internal feedback to prevent oscillations. Biasing considerations lead to the discussion of the problem of stability and temperature drifts—for which compensating means are indicated.

The study of the maximum power handling capability of transistors receives profound attention and constitutes one of the original contributions of the author. The final chapter is a detailed treatment of the difficult problem of noise.

This work provides an adequate foundation for the analytical study of most transistor circuits and offers many graphs and tables for quick calculation of device performance. The many numerical examples use the most typical data that one is likely to encounter.

JACQUES I. PANKOVE  
RCA Laboratories  
Princeton, N. J.

### Single Sideband for the Radio Amateur, A Digest, 2nd ed.

Published (1958) by American Radio Relay League, West Hartford 7, Conn. 204 pages+2 index pages. Illus. 6½×9½. \$1.50 in U. S. \$1.75 elsewhere.

The dramatic contributions of radio amateurs as a communications corps in time of emergency, or in transmitting messages from men overseas to their families at home, or in other services to the public, are well known. Their contributions to radio techniques are not so widely appreciated.

Here, however, is good evidence of what the amateur does in the way of reducing rather esoteric matters to everyday practice. Here is a 200-page book, by and for amateurs, most of which deals with the single subject of single sideband equipment, how to design, build and operate it—a subject that is not little-boy stuff.

A few years ago such matters as single sideband, suppressed carrier or lattice filters were matters that existed only as mathematical equations to most communications engineers, or as something they had read about. In this book there is scarcely a single equation and yet there is no doubt that the amateur, engineer, or scientist can use it effectively to design single sideband equipment.

The book tells why single sideband works, how it works, how to make it work. It is an immensely practical, down-to-earth book (are not all ARRL books of this excellent nature?) useful to working men as well as to armchair engineers who merely want to know the how and why, and who never intend to design anything.

It is easy to see why so many thousand amateurs are becoming experienced in this subject; it is difficult and technical enough to satisfy them, even if they have little to say once they get on the air! And one would judge from reading between the lines of this book that there is still plenty of scope for inventive effort and imaginative engineering in single sideband.

KEITH HENNEY  
McGraw-Hill Book Co.  
New York, N. Y.

### Theory of A-C Circuits, by Sylvan Fich and James L. Potter

Published (1958) by Prentice-Hall, Inc., 70 Fifth Ave., N. Y. 11, N. Y. 436 pages+9 appendix pages+7 index pages+xii pages. Illus. 9½×6. \$11.35.

The major part of this textbook covers the body of material commonly associated with a first course in ac circuit analysis: single-element responses, complex number (phasor) algebra, series and parallel circuits (including resonance), mesh and node equations, network theorems, magnetically coupled circuits, polyphase circuits (including symmetrical components), and Fourier

series. The final two chapters treat the Laplace transformation and the synthesis of two-terminal reactive networks.

An interesting feature of the treatment in this book is the careful selection of advanced material at the ends of the chapters, such as, for example, electromechanical analogs, hyperbolic functions and complex frequencies, ac bridge circuits, the *Q*-meter, harmonics in three-phase systems, and correlation functions. Omitting such topics permits variations to fit curricular requirements, and the student can still see the directions further work will take.

The last two chapters on the Laplace transformation and network synthesis set this text apart. There is no reason why students at the junior level, with careful leading by the instructor, cannot assimilate the basic ideas involved. And this text provides good preparation by carefully used notation and seemingly incidental references to ideas such as complex frequency and poles and zeros.

Because of the conscious effort to establish a broad foundation for the study of modern network theory, much ground is covered, and since this is done within 436 pages, at places the pace is a fast one. Add a liberal dash of instructor, and the stew is an excellent choice for the main course.

R. R. SHANK  
Yale University  
New Haven, Conn.

### Electronics of Microwave Tubes, by W. J. Kleen, translated by P. A. Lindsay, A. Reddish, and C. R. Russell

Published (1958) by Academic Press, Inc., 111 Fifth Ave., N. Y. 3, N. Y. 339 pages+10 index pages+xxi pages. Illus. 6½×9½. \$9.00.

This book first appeared in a German edition in 1952. The present edition represents a complete revision, including subsequent developments in the microwave electronics field. Its scope is, in general, limited to "those effects which at present are basic to microwave tubes and seem likely to continue to be so in the future," and the emphasis is on analysis. Very little space is devoted to the details of specific devices, and no problems or illustrative examples are given.

The analyses are, in general, quite sophisticated, and the reader should approach the book well armed with the fundamentals of electromagnetic theory and perhaps a previous introduction to electron-field interaction processes.

Approximately the first half is devoted to electron dynamics and the interaction of electrons with electromagnetic fields. Some of the topics treated are electron motion in static fields, microwave currents, the Llewellyn-Peterson equations, exchange of power between electron streams and periodic electric fields, velocity modulation in stationary fields, ballistic treatment of electron bunching in regions free from radio frequency fields, use of stationary fields for extracting power from electron beams, diodes, and grid controlled tubes, phase selection, modulation of electron streams by traveling waves, free space-charge waves, and interaction between electron beams and traveling waves in crossed electric and magnetic fields.

Two short chapters in the middle of the book discuss the general classes of microwave tubes and practical applications.

The latter half of the book treats such topics as the tube as a circuit element, physical sources of noise in tubes, noise figure, microwave resonant circuits, slow-wave circuits for microwave tubes, electron beam focussing, and electron guns.

In general, the analyses are quite thorough and include extensive references to both American and European literature for additional material.

In summary, this is a book of analysis; the technical level is high and the material is concentrated. If it is used as a textbook, there will be plenty of fill-in work left for the instructor. In any case, it represents a valuable addition to the reference shelf of the microwave tube engineer.

C. W. BARNES  
Stanford Research Institute  
Menlo Park, Calif.

### Network Synthesis, by Norman Balbian

Published (1958) by Prentice-Hall, Inc., 70 Fifth Ave., N. Y. 11. N. Y. 421 pages+8 bibliography pages+3 index pages+xi pages. Illus. 61 X91. \$12.00.

In this book, the author has presented a clear and concise treatment of network realization. It is a graduate level text on network synthesis. The reader is assumed to be familiar with complex variable theory and elementary properties of matrices.

The book begins with a review of network analysis and the important concept of energy functions. The properties and realization procedures of the driving point impedances are given in the next two chapters. In chapter 4, the properties of 2-port networks with and without transformers are described. The next four chapters, which form the main body of the text, discuss the realization of 2-port networks and various types of transfer functions. Many important techniques, especially in the RC realization, are included for the first time in a textbook. Finally, a chapter on the approximation problem is presented. Subjects consist of the three conventional type filter approximations. In contrast to the realization problem, the treatment on the approximation problem is rather brief.

The main virtue of this book is in its order of presentation. The author has undoubtedly spent a considerable amount of effort in organizing the text. Most topics are rendered in a logical way to illustrate basic concepts. The derivations throughout depend more on mathematical than physical principles. Consequently, the ladder realization and the Bott-Duffin method will strike readers as being completely mechanistic rather than physical. The author could have stressed more fully the common removal technique. Other topics, such as the scattering matrix and equivalent network, might very well have been included to bring out the physical insights of network synthesis.

In chapters 5 and 6, statements are made without proof. The reviewer believes that some of them are incorrect. First, in the parallel ladder realization for the lossless 2-port, although the idea of using surplus factors could sometimes convert all coefficients in the numerator of  $-Y_{21}$  to be posi-

tive, yet the method is still invalid since the surplus factors cancel out when  $y_{22}$  is formed. Secondly, in the Cauer realization of a 2-port network from a specified set of  $y$  parameters, ideal transformers rather than perfect coupled coils are always needed.

On the whole, the book is well written, self-contained, and has an adequate number of examples. It is easy to read and should prove to be a good textbook. It is also valuable to engineers who wish to learn network realization through self-study.

E. S. KUH  
University of California  
Berkeley 4, Calif.

### Transistor Technology, Vol. I, edited by H. E. Bridgers, J. H. Scaff, and J. N. Schive

Published (1958) by D. Van Nostrand Co., Inc., 257 Fourth Ave., N. Y. 10. N. Y. 622 pages+26 index pages+10 appendix pages+xxvii pages. Illus. 91 X61. \$7.50.

Material covered in the Bell Telephone Laboratories and Western Electric Company symposium on transistor technology in April, 1952, was printed in two classified volumes. Material of this nature is now declassified; brought up-to-date, it forms the basis for "Transistor Technology," Vol. I. This book emphasizes principles, but is well illustrated by specific techniques, some of which are in use today and others are important more as background material. Diagrams and photographs of materials, devices, and equipment are plentiful. Germanium grown junction and point contact transistors, and grown junction photo transistors, are treated, but much of the technology is applicable to other devices and to other materials. Vol. I lays the groundwork for Vols. II and III, which will treat other techniques, structures, and materials.

"Transistor Technology," Vol. I, is divided into five parts. Part I, Technology of Germanium Materials, treats germanium from the oxide state in which it is received, through reduction, purification by directional solidification and zone-refining, and chemical methods for the reclamation of scrap germanium. Zone-levelling is included in this part of the book because of its similarity to zone-refining, even though it is used primarily to produce single crystals. Methods of testing the germanium at various stages of processing are discussed.

Part II, Preparation of Single Crystals, covers single crystals of germanium produced by the pulling method without junctions, with  $n-p$  junctions, and with  $n-p-n$  junctions. Included are discussions of equilibrium distribution coefficients and some methods to measure them, effects of growth conditions and how to vary them to get constant resistivity crystals, transient effects on the growth and properties of uniform crystals and those containing junctions, the pulling of single conductivity,  $n-p$  junction and  $n-p-n$  junction crystals by the impurity addition method, and the problems, equipment, controls, measurements and evaluations involved in the growth of these crystals.

Part III, Principles of Device Fabrication, is the largest section and is very well illustrated. It starts out with a good descriptive summary of the design theory of  $p-n$

junctions and point contact triodes. This includes properties of  $p-n$  junctions, and the principal effects of junctions, surfaces and end contacts on the operation of transistors. Selection of germanium for junction and point contact devices is discussed in terms of how the material parameters affect the device properties. Methods are described for measuring resistivity and lifetime in single conductivity germanium, locating junctions, and evaluating junction properties in multiple conductivity crystals. Sawing, magnetrostrictive cutting, abrasive blasting, and abrasive lapping are applied to the mechanical shaping of germanium wafers. Preliminary surface cleaning and plating in preparation for bonding or soldering contacts are discussed. Large area ohmic soldered contacts to plated and unplated germanium surfaces, and acid and electrolytic etching techniques prior to final lead attachment, are described. This is followed by a section detailing the attachment of whisker contacts to the point-contact transistor, and junction location and base contact bonding to the grown junction transistor. A brief description is given of surface effects, final surface treatment, and encapsulation in hermetically sealed or plastic filled containers. The electrical forming of sealed point-contact transistors is treated, followed by an all-too-brief section on pre-aging of point-contact and junction devices. Part III is concluded by a detailed discussion of advanced development on point-contact transistors.

Part IV, Principles of Transistor Performance Characterization, starts with a discussion of the different methods of performance characterization, *viz.*, small signal, families of curves, large signal, figure-of-merit and statistical reproducibility. Small signal representations for transistors with alpha greater and less than unity, and large signal characterization of transistors, are discussed in detail. This includes measurement of the four-pole  $r$ 's and alpha at low frequency, junction and point-contact capacitance, cutoff frequency, noise, distortion, and efficiency of class-A operation. Also included is the measurement of photo-transistor characteristics. A chapter on pulse and large signal measurements concludes Part IV. This includes dc and low frequency measurements, made by breaking the operating range into three regions, in each of which characteristics are assumed linear. Alpha vs emitter current, negative resistance characteristics, and transient behavior measurements are treated for point-contact transistors. Breakdown diode characteristics are also discussed.

Part V, Transistor Reliability, discusses briefly how to measure transistor reliability, with an example for the case of an  $n-p-n$  alloy device.

Appendixes present the IRE Definitions of Semiconductor Terms (1954) and the IRE Standards on Letter Symbols for Semiconductor Devices (1956).

A book of this sort, one in a series, is somewhat difficult to rate by itself because the contents represent only part of the material included in the series. "Transistor Technology," Vol. I, is written in a clear manner, with lots of illustrations, and thorough explanations of many concepts fundamental to semiconductor materials and de-



vice technology. For the devices treated (germanium grown junction and point-contact transistors, and grown junction phototransistors) there is presented a complete technology from raw materials through device testing. The book is well referenced, and has a complete list of illustrations following the table of contents.

"Transistor Technology," Vol. I will be of great use as an accumulation of information both to those who have been working in the semiconductor device field and to those who are just entering it. It brings together the many fields of technology that contributed to the successful production and use of transistors. However, for a more complete coverage of the field, (including the newer methods for making bar-type junction transistors, and advanced surface treatments, both of which might have been included in Vol. 1), the reader will have to refer to Vols. II and III.

I. A. LESK  
General Electric Co.  
Syracuse, N. Y.

### Transistor Technology, Vol. II, edited by F. J. Biondi

Published (1958) by D. Van Nostrand Co., Inc., 257 Fourth Ave., N. Y. 10, N. Y. 659 pages+28 index pages+11 appendix pages+ix pages. Illus. 61 X 9 1/2. \$17.50.

"Transistor Technology," Vol. II, builds upon many of the more fundamental concepts treated in Volume I a more up-to-date picture of the technology of semiconductor materials, techniques, and  $p-n$  junction devices. It is a collection of papers published between 1952 and 1957, mostly by authors affiliated with Bell Telephone Laboratories, but contributions of several authors with other affiliations are also included.

The first section, Technology of Materials (112 pages), treats germanium and silicon with brief reference to some semiconducting Compounds. Chapter 1, Recent Advances in Silicon, gives a thorough and concise review of silicon, including preparation, crystal growing, physical chemistry of impurities, bulk properties, electrical and optical properties associated with impurity levels, and silicon devices. Chapter 2, Imperfections in Germanium and Silicon, starts with a general discussion of the effects of impurities and imperfections on the electrical properties of semiconductors with illustrations for germanium, silicon, and several compounds, followed by sections dealing with removal and exclusion of the most troublesome impurities in germanium (copper) and silicon (boron). The work on germanium deals primarily with resistivity and lifetime changes experienced upon heating to elevated temperatures. Boron removal from silicon is accomplished by water vapor in a floating zone apparatus. The quenching in and annealing out of recombination centers in silicon is also discussed. A thorough discussion is presented of silicon floating zone refining. Chapter 3, Crystalline Perfection, applies the zone levelling process to the production of germanium single crystals with a uniform impurity concentration, high lifetime, and good lattice perfection. This chapter concludes with the presentation of

an acid etching procedure for visibly showing dislocations in silicon.

The second section, Technology of Materials (546 pages), treats many semiconductor devices as well as junction and surface phenomena. Chapter 4, Diode Design Principles, deals with the following: forward characteristics of  $p-i-n$  diodes up to very high current densities, including a derivation of the  $p-n$  junction carrier concentration boundary conditions good to high levels of injection, and consideration of linear and nonlinear recombination; electron multiplication in the high fields of reverse-biased  $p-n$  junctions; avalanche multiplication breakdown and breakdown instability in silicon junctions (with a short addendum presenting more up-to-date information and references); analyses of forward to reverse bias switching times for planar, hemispherical, and narrow base diodes; the design and use of nonlinear effects in diodes for frequency conversion and amplification; and an analysis of negative resistance produced by transit time effects in junction structures under bipolar or unipolar operation, and the mobility decrease at high electric fields.

The papers included in Chapter 5, Design on Junction Triodes, deal with switching, high-frequency, and high-power transistor design, as well as with the design of specific performance parameters of such transistors. Most of the papers are considered today classics in their respective fields, and accomplish their objective by establishing relationships between physical processes and material and structural parameters on the one hand and electrical terminal properties on the other. The first two papers deal with the theory of large-signal behavior and of transient response; the third applies the theory to specific design. The next paper deals with design of small-signal transistors in general, and is followed by one discussing high-frequency  $p-n-i-p$  and  $n-p-i-n$  transistors. The high-frequency power gain of transistors is then discussed in terms of device parameters, with an addendum dealing with stability and unilateralization. A paper on optimum design of power transistors defines figures of merit, expresses these in terms of electrical device parameters, and these, in turn, in terms of material and structural parameters. The last three papers of this chapter deal with important special design considerations, the effect of junction shape and surface recombination on current amplification, the variation of current amplification with emitter current, and the dependence of transistor parameters on the distribution of base-layer resistivity. Chapter 6, Switching Devices, treats the switching characteristics of avalanche transistors and  $p-n-p-n$  diodes. The first paper shows how a germanium alloy transistor can be made to exhibit a negative resistance region by employing avalanche breakdown of one junction. The second paper analyzes the  $p-n-p-n$  switch in terms of the two component transistor sections. Construction details and characteristics for silicon devices are also presented.

Chapter 7, Tetrodes, discusses the effect of a suitably biased fourth electrode on the performance of junction transistors and summarizes early investigations of the properties of tetrodes, as well as their first applications.

An addendum contains the results of more recent developments based on rate-grown devices. Chapter 8, Radiation Sensitive Device Design, treats  $p-n$  junction energy sources activated by radioactive decay products (atomic battery) or sunlight (solar cell). General design theories and results are given, and the effects of radiation damage to the semiconductor in an atomic battery are treated. Chapter 9, Field Effect Devices, includes a brief description of the analog transistor and the theory, design, fabrication methods, and measurement techniques applicable to the field-effect (unipolar) transistor, together with some experimental results at low and high frequencies. Chapter 10, Behavior of Noise Figure in Junction Transistors, summarizes the noise properties of junction transistors, based on a simplified version of the noise equivalent circuit developed by van der Ziel. A method of calculating noise figure (in terms of source resistance, emitter current, base resistance, low-frequency alpha, and alpha cutoff frequency) and minimizing it is presented. The frequency variation of the noise figure is also discussed. Chapter 11, Design Implications of Surface Phenomena, starts with a review of germanium surface phenomena, including such effects as surface conductance and channels, and recombination velocity. The relations between surface structure and electrical properties are discussed, and applied to surface leakage, and excess noise. In the next section, germanium and silicon grown junctions are used to explore the effects of water vapor on surface recombination velocity, channel formation, and ionic conduction. Effects of a channel on junction leakage current and surface breakdown are analyzed and related to experimental results. The effects of ambient atmosphere on the magnitudes and stabilities of junction breakdown voltage and leakage current, and current gain are discussed in terms of channel formation for germanium  $n-p-n$  and  $p-n-p$  alloy transistors. Ambient atmosphere controls necessary for the stable operation of these transistors are presented.

Also included in Vol. II are Appendix I, IRE Definitions of Semiconductor Terms (1954), and Appendix II, IRE Standards on Letter Symbols for Semiconductor Devices (1956).

The book gives a detailed coverage of germanium and silicon materials. It treats devices of a more conventional nature (i.e., diodes, conventional transistors, and tetrodes), those that are becoming prominent at the present time (i.e., avalanche transistors,  $p-n-p-n$  switches, solar cells, and diodes for parametric operation), and those that have a more future interest (i.e., transit time negative resistance diodes and analog transistors). The papers chosen to cover these areas are certainly among the most-referred-to publications in the field, and are well referenced and illustrated.

"Transistor Technology," Vol. II, will serve as a compact source of important publications for both the experienced worker in the field and the novice. It contains material of importance to those working in materials, devices, and circuits, and many of the articles tie together two, or all three, of these areas. A more smoothly running text would have resulted had the material been com-



pletely rewritten with the view to publishing a book along more conventional lines. However, in a field changing as rapidly as semiconductor technology, this would have limited advantage over the present form and would undoubtedly involve a huge effort.

I. A. LESK  
A. P. STERN  
General Electric Co.  
Syracuse, N. Y.

### Transistor Technology, Vol. III, edited by F. J. Biondi

Published (1958) by D. Van Nostrand Co., Inc. 257 Fourth Ave., N. Y. 10, N. Y. 389 pages + 10 index pages + 11 appendix pages + xiii pages. Illus. 9 1/2 x 6 1/2. \$12.50.

The third and final volume of the Bell Telephone Laboratories, series on Transistor Technology brings together 17 papers from the literature and 10 new articles on methods of *p-n* junction formation, device fabrication techniques, new (1956-1957) devices, measurements, characterization, and reliability. All but 2 of the 34 authors represented are or were associated with Bell Labs.

The reprinted papers are from Proc. IRE (5, including the IRE Standards on Methods of Testing Transistors 1956, Definitions of Semiconductor Terms 1954, and Letter Symbols for Semiconductor Devices 1956), *J. Electrochem. Soc.* or the meetings of that society (4), *J. Metals* (2), *J. Appl. Phys.* (1), and IRE TRANS. ON ELECTRON DEVICES (1). Most of the reprinted papers date from 1956 or 1957, but a few are earlier.

The level of detail varies. Some of the articles are packed with experimental information. Others give introductory perspectives. Some summarize relevant theory.

The most rewarding items to this reader were the articles and papers on *p-n* junction formation by Thurmond, Bridgers, Pfann, Fuller, and Frosch, covering the theory and practice of rate growth, remelting, and diffusion techniques. This material is new, or from *J. Appl. Phys.* and *J. Metals*.

The sections on chemical processing, etching techniques, ohmic contacts, and alloying are full of assorted detailed experimental results. Alloy-junction transistor and diode fabrication receives 70 pages of attention, including a concise summary of relevant theory. Four well-known papers on diffused devices (Prince, Veloric and Smith, Lee, and Tanenbaum and Thomas) are conveniently brought together here. A review chapter is supplied by Van Roosbroeck and Buck on methods for determining volume lifetimes and surface recombination velocities.

The comparatively slight chapters on measurement and reliability include Alsberg's paper, the IRE Standards, and very brief new articles by Waltz on reliability tests and field-use results.

Careful attention has been paid to bibliography throughout the volume. Hence it will serve admirably as a handbook from which to start a study of the pre-1957 literature in any of the diverse areas mentioned.

All in all this volume, and indeed the entire series of three Transistor Technology volumes, in spite of occasional galloping

heterogeneity and a relatively high price, should in this reader's opinion be available to anyone seriously concerned with teaching or practicing the arts of designing, fabricating, or making optimum use of semiconductor devices, vintage late 1950's.

HOWARD E. TOMPKINS  
The Moore School of Electrical Engineering  
University of Pennsylvania  
Philadelphia, Pa.

### Network Synthesis, Vol. I, by D. F. Tuttle, Jr.

Published (1958) by John Wiley and Sons, Inc., 440 Fourth Ave., N. Y. 16, N. Y. 1101 pages + 60 appendix pages + 10 index pages + xv pages. Illus. 9 1/2 x 6 1/2. \$23.50.

One of the few topics on which engineers interested in the broad area of linear system analysis have been able to agree is that H. W. Bode's "Network Analysis and Feedback Amplifier Design," published in 1945, is one of the very few "Great Books" of electrical engineering, for this book stood alone for more than a decade as the primary work in English in the theoretical aspects of modern network theory, servomechanisms and control theory, active circuit and feedback theory, and those areas which relate to the study of linear systems. In the area of network theory and synthesis, and the properties of network functions, the past year has witnessed the appearance of two books—Guillemin's and Tuttle's. Long awaited by engineers, the two works unquestionably establish an entirely new frame of reference for future research and application of modern network theory. With the publication of these two works, we can finally say, with perhaps only a reasonable hesitation, that textbook literature has caught up with Bode, at least in the area of network synthesis.

Tuttle's "Network Synthesis, Vol. I," is truly a monumental work in several important respects and, in the opinion of this reviewer, justifies the description as an outstanding work. This volume is devoted to the properties of network functions (in a broad sense, as in the presentation of the relation between complex function theory and network theory, or in the emphatically lucid discussion of duality), the synthesis of driving-point functions (with a coverage of the breadth of important specific techniques), and the approximation problem (with emphasis on the potential analogy, in which area Dr. Tuttle and his students have contributed so notably to the development over the past decade). The second volume will be concerned with two-port networks.

One aspect of the book should be mentioned: there are 1160 pages. The unfortunate length is, to a considerable extent, an inevitable result of several features which are in themselves highly desirable. First, an enormous number of problems are included (over 1100) which unquestionably constitute an important contribution of the book in that they are comprehensive and carefully prepared, and they illustrate, in terms of actual examples, the important concepts, and are utilized to present secondary or special aspects of the primary topics.

Second, there is excellent coverage of the subject, with inclusion of descriptions of important, diverse schemes. Third, and perhaps most significantly, the author presents each important topic in a carefully developed manner, in which he adroitly guides the reader from the core of the topic through the maze of secondary difficulties and questions to the final demonstration of general validity. Furthermore, the author exploits fully the advantages inherent in presenting simple numerical examples—at the outset when the topic is difficult, at the conclusion for simpler subjects, and to circumscribe a broad topic.

For example, the Bott-Duffin procedure is presented in the sequence of a simple numerical example in which the network is developed on an intuitive basis, with a discussion of the requirements to establish generality, a demonstration of generality, and finally a presentation of the essence of the latter, related work of Pantell and others. The chapter concludes with a clear exposition of the current status of knowledge and an indication of the general problem of the minimum number of R, L, and C elements.

Furthermore, and (in the mind of the reviewer) more than compensating for the length, the author possesses and fully utilizes a creative writing ability which is dismally rare among engineers. As a consequence, when the author subtitled Chapter 10 with the biblical quotation "... and the end is not yet," the reader is not dismayed, but rather anticipates the delights of future travels—as for example, in Chapter 12 when "we descend from the ivory tower to examine briefly some of these (practical) matters."

Notably and unusually sound technically, the book is a unified and diverting presentation of the essential elements of the modern theory of one-port networks, a textbook with a rare appreciation of the need for the careful development of key concepts and a unique sympathy for the reader's need for enjoyment as well as knowledge, and a reference book which is a necessity for every serious student of network theory and linear system analysis.

JOHN G. TRUXAL  
Polytechnic Inst. of Brooklyn  
Brooklyn, N. Y.

### RECENT BOOKS

- Automation Systems, Proceedings of the EIA Conference on Automation Systems for Business and Industry, 1958.* Engineering Publishers, Inc., GPO Box 1151, N. Y. 1, N. Y. \$5.00.
- Bellman, Richard. *Dynamic Programming.* Princeton University Press, Princeton, N. J. \$6.75.
- Conti, Theodore. *Metallic Rectifiers and Crystal Diodes.* John F. Rider, Inc., 116 W. 14 St., N. Y. 11, N. Y. \$2.95.
- Goode, H. H., and R. E. Machol. *System Engineering.* McGraw-Hill Book Co., Inc., 330 W. 42 St., N. Y. 36, N. Y. \$10.00.
- Hohn, Franz E. *Elementary Matrix Algebra.* The Macmillan Co., 60 Fifth Ave., N. Y.

11, N. Y. \$10.00.  
 Hughes, L. E. C., Ed. *Electronic Engineer's Reference Book*. The Macmillan Co., 50 Fifth Ave., N. Y. 11, N. Y. \$18.00.  
 Meyler, D. S., and O. G. Sutton. *A Compendium of Mathematics and Physics*. D. Van Nostrand Co., Inc., 120 Alexander St., Princeton, N. J. \$5.00.

Sokolnikoff, I. S., and R. M. Redheffer. *Mathematics of Physics and Modern Engineering*. McGraw-Hill Book Co., Inc., 330 W. 42 St., N. Y. 36, N. Y. \$9.50.  
 Taylor, E. Openshaw, Ed. *Nuclear Reactors for Power Generation*. Philosophical Library Inc., 15 E. 40 St., N. Y. 16, N. Y. \$7.50.

Zbar, Paul B., and Sid Schildkraut. *Basic Electricity. Second Edition*. McGraw-Hill Book Co., Inc., 330 W. 42 St., N. Y. 36, N. Y. \$2.25.  
 Zbar, Paul B., and Sid Schildkraut. *Basic Electronics. Second Edition*. McGraw-Hill Book Co., Inc., 330 W. 42 St., N. Y. 36, N. Y. \$2.25.

## Abstracts of IRE Transactions

The following issues of TRANSACTIONS have recently been published and are now available from the Institute of Radio Engineers, Inc., 1 East 79th Street, New York 21, N. Y. at the following prices. The contents of each issue and, where available, abstracts of technical papers are given below.

Sponsoring Group	Publication	Group Members	IRE Members	Non-Members*
Audio	Vol. AU-6, No. 5	\$1.50	\$2.25	\$4.50
Education	Vol. E-1, No. 4	1.10	1.65	3.30
Military Electronics	Vol. MIL-2, No. 1	1.15	1.75	3.45
Nuclear Science	Vol. NS-5, No. 3	2.50	3.75	7.50

\* Libraries and colleges may purchase copies at IRE Member rates.

### Audio

VOL. AU-6, No. 5,  
 SEPTEMBER-OCTOBER, 1958

PGA News (p. 91)

With Other Acoustical and Audio Societies

—Benjamin B. Bauer (p. 95)

Research and Development on the Piano—  
 J. P. Quitter (p. 96)

Applications of scientific methods and electronic instrumentation techniques to the study of a nonelectronic musical instrument are discussed. It is shown how findings obtained have resulted in better understanding of the physical basis for tone generation and modification, leading to improvements and evaluations based upon engineering principles rather than upon empirical methods of the past.

Physical and psychological aspects are presented in terms of communication engineering concepts. The nature and characteristics of piano tone are described, as well as other phases of this unique field of "musical engineering."

A Survey of Speech Bandwidth Compression Techniques—S. J. Campanella (p. 104)

Application of speech bandwidth compression techniques to voice communications provides the promise of more efficient utilization of the available radio spectrum and the possibility of improved performance of noisy, long distance communications links. That significant potential gain exists is evident from the fact that the information rate required for transmission of the conventional speech signal is approximately

24,000 bits per second, whereas that for transmission of the equivalent word-intelligence content by means of teletype is 75 bits per second. The paper presents brief descriptions of several speech bandwidth compression techniques which are currently being employed or investigated to achieve varying degrees of compression. Also a method of estimating the influence of signal-to-noise ratio on a communications link employing such compression techniques is presented.

Contributors (p. 116)

### Education

VOL. E-1, No. 4, DECEMBER, 1958

The Freedom to Choose—K. V. Newton (p. 93)

The Professional Man and His Reading—  
 James B. Stroud (p. 94)

The mean reading rate of the average educated adult is about 250 words per minute. Perhaps the top 5 per cent read twice this fast. Slow readers read no better than fast ones. Slow reading is a bad habit, and a needless waste of time. Most educated adults, in a few weeks' time, could achieve rates of four to five hundred words per minute, in their ordinary reading, and do so without loss in comprehension. The reading rate of a given person varies, of course, with a number of conditions; but the person who reads a given selection rapidly tends to read other selections at a proportional rate. Readers tend to maintain their relative ranks

as material and purpose vary.

Foreign Languages and the Ph.D. Degree—  
 Ronald King (p. 96)

The need for a knowledge of foreign languages by the leaders in scientific research is discussed. It is argued that if one language is started in school and a second one in college, fluency in both may be achieved before entering graduate school. This avoids the waste of valuable time by Ph.D. candidates who are far beyond the age when languages are easily learned. Engineering colleges are urged to adjust their requirements and curricula to implement this proposal.

Education is the "Core" Problem That  
 Industry Must Face—Beril Edelman (p. 99)

The question of formulating an educational policy has secured limited attention since 1951. The acute engineering shortage of 1955-1956 gave industry food for thought. Disclosures of the progress made by the U.S.S.R. alarmed our military and congressional personnel. The launching of Sputnik I awakened large segments of the public to the inadequacies of the national treatment of educational matters.

There is need to look ahead. Responsible scientists have foreseen tripling of world population by next midcentury; food production, resource utilization, and energy production must be brought to levels to permit life at desired standards. The most critical element necessary for all this is adequate technical manpower. There is a need for about three times the number available at present rates of growth.

The solutions require such magnitude of effort and support that joint endeavors by government, industry, and educators must be found.

Educational Castles in the Air—J. D. Ryder (p. 104)

Improving the abilities of our future engineers seems to call for enhanced study of the natural sciences as against continued study of applications of current hardware; however, we find that today's engineering college was built and designed along hardware lines.

A new form of engineering college organization is proposed in which the departmental and divisional responsibilities cover areas of scientific subject matter rather than areas leading to specific degrees. Realignment of conventional departmental areas will lead to an engineering program which will carry some of the aspects of liberal arts but with technical course subject matter. It should provide the freedom of choice and the mathematical depth required for the engineer of tomorrow.

**New Directions in Electrical Engineering Education**—T. L. Martin, Jr. and G. M. Rusel (p. 107)

Virtually all of us believe in the great importance of physics in engineering curricula and have fought for years to develop a strong and modern physical basis for instruction in engineering. From our observations, the basic question is no longer seriously disputed; the idea is generally accepted and only the details of local implementation seem to remain.

If this is so, why does discussion continue on what should be a dead issue? Why do we continue to beat an academic "dead horse"? In searching for the answer, we have come to some disturbing conclusions which, theoretically, place the entire issue in a different perspective, establishing new directions in electrical engineering education.

**Science and Engineering Education: Europe—U.S.A.**—Victor A. Babits (p. 110)

A definition of basic philosophy for our future education is given, and the implications with regard to our future teaching system are analyzed. Then the European primary and secondary education, and automatic selection in the precollege year are discussed. The teaching system in a European engineering school is explained, and a discussion of the main results of the 1957 International Conference on Engineering Education and Training, in Paris, is included. Finally, it is explained why, in many fields of science and engineering, the European university education appears superior to ours.

**New Demands on Engineering Education**—Glenn Murphy (p. 116)

Rapid changes in the professional activities of engineers are taking place as a result of revolutionary developments in sciences and industry. Inevitably, these changes must be reflected in all aspects of the training and education of engineers. Engineering curricula and other phases of college programs are being modified in several respects to provide the present-day graduate with the knowledge and the understanding of fundamentals that he requires. In recognition of the fact that the education of an engineer is far from complete when he graduates, industry is assuming increasing responsibility for parts of the educational program. Further cooperation between the colleges and industry is natural and desirable.

**Letter to the Editor** (p. 120)

**Contributors** (p. 121)

**Annual Index 1958** (follows p. 122)

## Military Electronics

VOL. MIL-2, NO. 1,

DECEMBER, 1958

**Frontispiece** (p. 1)

**Guest Editorial** (p. 2)

**Our Interest in Space and Its Technology**—H. Guyford Stever (p. 3)

The urge to learn more about the space surrounding the earth has been strong throughout mankind's recorded history, the incentive coming sometimes from primitive religion, sometimes from scientific curiosity, and oftentimes from a love of natural beauty. Today we can add to these the incentive of our newly acquired capability of penetrating into this space with instrumented and manned vehicles. We already know much about the solar system and a little about the universe beyond. We have some knowledge of the physical existence and the motion of the planets and their satellites, the asteroids, the comets and the meteors; the composition of these bodies is also somewhat known. The nature of the electromagnetic and particle radiations from the sun and extra solar system sources are less completely known and will be the continuing objective of some of our early

scientific explorations of solar space.

**Some Aspects of Astronautics**—R. W. Buchheim, S. Herrick, E. H. Vestine, and A. G. Wilson, edited by Peter Swerling (p. 8)

This paper is mainly concerned with four general topics of importance in astronautics:

1) Basic laws of celestial mechanics. The subjects covered are: Kepler's laws and their Newtonian redevelopment, the orbital elements and perturbations.

2) Lunar and interplanetary flights. A typical earth-moon transit trajectory, computed by automatic machine, is discussed. Guidance accuracies required for lunar impact are illustrated. Circumlunar flights, lunar satellites, and interplanetary flights are also briefly discussed.

3) The space environment. Among the subjects covered are: the distribution and characteristics of dust and meteoric material in the solar system; asteroids; comets; molecular, atomic, and sub-atomic particles in space; the possible lunar atmosphere and ionosphere; extraterrestrial radio noise; and the magnetic fields of the earth and sun.

4) Scientific experimentation in space. Useful subjects for experimentation are: refinement of our knowledge of basic constants such as the value of the astronomical unit; observation of the atmospheric and surface conditions of the moon and of our neighbor planets; increased observation of matter and radiation in space.

**Space Communications**—Peter Swerling (p. 20)

Preliminary design parameters for space communications can be estimated by standard application of the radiation range equation and of communication-theoretic equations relating channel capacity to bandwidth and signal-to-noise ratio. An example is given for a hypothetical situation involving communication between a space vehicle and a receiver located on the earth's surface, for various communication ranges.

Preliminary estimates of this type also serve to indicate areas of research and development which will be of importance in space communications. Some of the areas briefly mentioned are: components (vehicle and surface antennas, sensitive receivers, highly reliable circuit components, and electrical power sources); signal storage, encoding, and processing techniques; tracking and acquisition techniques; and studies of the physical environment (extraterrestrial noise, component environment, and electromagnetic propagation environment in space).

**Self-Contained Guidance Systems**—Charles S. Draper (p. 25)

Inertial guidance is based on the use of reference coordinates established by applications of Newton's Laws of Motion to self-contained systems. Gyro units carried by servo-powered gimbals give accurate information on preset angular positions that may be used to supply the function of the celestial sphere in conventional navigation. Changes in position are indicated by integration of acceleration components along axes fixed to the gyro-stabilized member. When vehicles moving over or near the earth's surface are involved, the use of Schuler tuning to give vertical indications unaffected by linear acceleration makes accurate long-range inertial guidance possible. Because in all cases only the laws of gravity and classical mechanics are involved, inertial guidance systems are generally free from interference, short of actual physical damage. Systems based on gyro units and accelerometers are made possible only by modern developments in mechanical design, materials, electronics, and servo-mechanism techniques. Illustrative examples are given and discussed to bring out the nature of the problems involved. Beyond question, the future holds many applications of inertial prin-

ciples to a wide range of guidance problems.

**Baseline Guidance Systems**—R. S. Grisetti and E. B. Mullen (p. 36)

This paper surveys the principles underlying the radio guidance and tracking of space vehicles. The various techniques which can be used for obtaining position and/or velocity information are described and their relative merits are assessed. The limitations imposed by tropospheric and ionospheric noise on radio systems are also discussed. Finally, two specific examples are worked out, illustrating the translation of radar guidance errors into flight uncertainties in the trajectories of ICBM's and satellites.

**Contributors** (p. 45)

## Nuclear Science

VOL. NS-5, NO. 3,

DECEMBER, 1958

**Introduction** (p. 76)

**Cerenkov Counters in High Energy Physics**—Clyde E. Wiegand (p. 77)

Cerenkov counters as particle detectors in high energy physics experiments are discussed with emphasis on the practical design of velocity-sensitive devices. The performance and problems associated with three types of detectors are considered: simple velocity threshold counters and wide-band and narrow-band velocity selectors. The limitation in resolution of practical velocity-sensitive counters in high energy experiments arises mainly from the characteristics of the beams which must pass through their radiators. These limitations include divergences in the direction of the beam particles, multiple coulomb scattering, and changes in velocity of particles as they pass through the Cerenkov radiator. Methods of coupling radiators to multiplier phototubes include direct optical contact, specular reflection, and diffuse reflection. Magnesium oxide is an excellent diffuse reflector and methods of its application are given. Statistical fluctuations in the small numbers of photo-electrons produced from Cerenkov radiators limit the accuracy with which the times of passage of individual particles are determined.

**Further Work with Noble Element Scintillators**—J. A. Northrop, J. M. Gursky, and A. E. Johnsrud (p. 81)

An investigation of the relative scintillation efficiencies of the various noble gas mixtures has been made in an attempt to find a combination that would yield either more light than any of the pure gases or allow a more economical use of the heavier gases without substantial loss of light. Data on the efficiency of all binary mixtures of Xe, Kr, Ar, Ne, and He are presented. They show a characteristic large drop in the light for mixtures containing a small proportion of the heavier gas in a major fraction of the lighter. However, a 10 per cent Xe-90 per cent He mixture has a relatively large output and could be useful in constructing a high-efficiency neutron counter using the  $\text{He}^3(n, p)\text{H}^3$  reaction. Data are also presented on the relative conversion efficiencies of several commonly used organic wafershifters. Of those tested, the best are diphenyl stilbene, tetraphenylbutadiene, and quaterphenyl having relative efficiencies of 1.0, 0.7, and 0.4, respectively. A survey investigation was also made of the relative efficiencies of solid and liquid xenon, krypton, and argon for ordinary glass and for quartz-faced photomultipliers. Although these data are not as accurate or reproducible as the corresponding work on gases, they indicate several of the combinations may approach NaI(Tl) in light output.

**Heavy Elements in Plastic Scintillators**—M. Hyman, Jr. and J. J. Ryan (p. 87)

The objective of this work is to study the



possibilities of incorporating into plastic scintillators substantial quantities of heavy element compounds without the introduction of appreciable color or haze. Factors governing the quenching of the light output are considered, and a practical balance is struck between lowered pulse height and the quantity of heavy element introduced.

The various components required in a heavy-element-loaded plastic scintillator are outlined, with a discussion of the effects of variations in their chemical character and proportion.

Specific approaches to the problem are outlined as follows: 1) the inclusion in the plastic scintillator of organo-metallic compounds, 2) inclusion of essentially non-ionic metal salts, 3) inclusion of chelated metal compounds, 4) use of a base plastic material in which a variety of metal compounds are more soluble than in the standard vinyl-aromatic type of base plastic, and 5) inclusion of a metal compound that is also a monomer.

Possible applications to detection of low energy radiation and of thermal neutrons are discussed.

**Fundamental Studies of Scintillation Phenomena in NaI**—W. J. Van Sciver and L. Bogart (p. 90)

Work on pure NaI reported at the Fifth Scintillation Counter Symposium (1956) has been extended using crystals of higher purity at temperatures down to 4°K. Decay of the light pulse from unactivated NaI is not a simple exponential but exhibits a rising component superimposed on an exponential decay. In other measurements, the absolute conversion efficiency (emitted useful light divided by exciting particle energy) was found to be as high as 25 per cent for unactivated NaI at liquid nitrogen temperature (compared with 13 per cent for NaI(Tl) at room temperature). Theoretical and practical implications of the results are discussed.

**Glass Scintillators**—R. J. Ginther and J. H. Schulman (p. 92)

The preparation of scintillating glasses is currently being studied with principal emphasis on the use of cerium as an activator. The most efficient material investigated to date is a cerium activated high silica glass prepared originally by the Corning Glass Company. The pulse height of this material has been found to be as high as 10 per cent that of NaI(Tl), but its efficiency is dependent upon the purity of the high silica glass from which it is prepared. Conventional meltable glasses activated with cerium have been prepared which have a pulse height of 7 per cent of NaI(Tl). The pulse height of these meltable glasses is dependent upon their composition. Alkaline earths have been found to be deleterious, whereas the presence of aluminum has been found to be beneficial. The most efficient composition to date has been found to be  $1.0\text{Na}_2\text{O}$ ,  $0.30\text{Ce}_2\text{O}_3$ ,  $3.0\text{--}4.0(\text{B}_2\text{O}_3 + \text{SiO}_2)$ ,  $1.0\text{--}1.3\text{Al}_2\text{O}_3$ . Methods of preparation of both meltable and high silica glass type glasses as well as their optical properties are described.

**Inelastic Nuclear Reactions of Protons in Scintillators**—L. H. Johnston, D. H. Service, and D. A. Swenson (p. 95)

When a scintillation counter is used as a spectrometer for energetic protons, corrections must be made for the fact that ( $p, n$ ) and other nuclear reactions may occur in the scintillator, causing some of the protons to register substandard pulse heights. These corrections have been measured for thalliated sodium iodide, and for plastic scintillators at proton energies between 10 and 40 mev, by measuring the pulse-height spectrum produced by a proton beam of homogeneous energy striking the crystal. The homogeneous beam is obtained by collimating a linear accelerator beam to one-eighth inch diameter, then magnetically

analyzing to get rid of the slit-scattered protons.

**Design of Photomultipliers for the Sub-Millimicrosecond Region**—G. A. Morton, R. M. Matheson, and M. H. Greenblatt (p. 98)

In considering the design of a photomultiplier with good time resolution characteristics, it is convenient to divide the problem into two parts, one dealing with the photo-cathode-to-first dynode region, the other with the secondary emission multiplier structure. The two principal causes of poor time resolution in both of these parts are: 1) the different path lengths of electrons originating from separated points on a second, and 2) the effect of initial velocities of the emitted electrons on transit times.

The electron optical approach to the alleviation of the transit time spread due to path differences is discussed for both the cathode region and the structure. The focusing spiral method of analyzing the performance of a structure is of considerable value. The effects of initial velocities can be reduced by insuring that the electron velocities within the photomultiplier are very high. It is not practical to obtain these high velocities simply by applying a high over-all voltage to the tube because of the loss of secondary emission gain and because of internal and external insulation difficulties. However, the necessary high velocities can be obtained by the use of high voltage field electrodes between successive dynodes, so arranged that electrons are rapidly accelerated to a high velocity and then decelerated just before they reach the next dynode.

A photomultiplier is described whose design is based upon these two principles. A high voltage central electrode system between successive dynodes serves to give electrons the high velocity required to minimize transit time spread. Calculated and measured characteristics of this structure are given. When operated in conjunction with suitable circuitry, resolutions of a few micromicroseconds should be obtainable.

**New Techniques in Low Level Fluoroscopy**—Bernard R. Linden (p. 104)

In recent years a great deal of attention has been paid to the dangers of high X-ray dosage during fluoroscopic examination of a patient. A number of electronic devices have been put forth in an attempt to allow fluoroscopic image intensification and a consequent decrease in the required dosage. The purpose of this paper is to outline briefly the principles on which these devices work.

The discussion begins with a general consideration of the requirements and limitations of fluorescent screen intensification. The devices which are then explained can be divided into four main categories: 1) solid-state intensifiers, 2) image-converter tube intensifiers, 3) television camera tubes directly sensitive to X radiation, 4) television camera systems with enhanced light sensitivity.

Some general conclusions are drawn concerning the present state of the art in these devices.

**Fatigue in Photomultipliers**—L. Cathey (p. 109)

The change of gain with time of two types of dynodes used in photomultipliers has been studied at several current levels and under repeated fatigue cycles. The fatigue of the photomultiplier takes place predominantly in the last few dynodes. The magnitudes and time dependence of the fatigue vary with dynode current, temperature, construction, and past history.

**Status of Multiplier-Phototube Development for Scintillation Counters**—William Widmaier (p. 114)

A number of recent developments have contributed to the design of multiplier phototubes having improved time discrimination, as well as improved pulse-height resolution. In the 6810-A, a modified version of the first commer-

cial high-gain, high-speed tube, a curved faceplate (flat on the outside) is used to reduce transit-time variations in the region between the photocathode and the first dynode. Special geometrical construction is used to minimize transit-time spread in the 7046, a five-inch tube developed under an AEC contract. Curvature of the inner faceplate is also used to improve pulse-height resolution and time discrimination of developmental versions of the 6342 and the 6655. In a new developmental tube, RCA Dev. No. C-7251, cathode curvature is combined with a new electrode structure between the cathode and the multiplier structure to reduce transit-time spread to less than a few tenths of a millimicrosecond.

**Special Purpose Multiplier Phototubes for Scintillation Counting**—Frederick W. Schenkel (p. 117)

A discussion on linear and box type multiplier phototubes is presented. Various aspects of dynode geometry and front end design of the DuMont linear type multiplier structure in regard to transit time and transit-time spread are discussed. Several methods of operation of the front end of a multiplier phototube are considered in order to determine the optimum conditions for collection efficiency and transit-time spread. The mechanical requirements of various linear multiplier phototube types are discussed briefly. The development of linear tube types has come about as a result of an increasing demand for fast tubes capable of delivering high peak pulse output currents.

**Recent Work on Photoemission and Dark Emission Problems**—R. W. Engstrom, R. G. Stoudenheimer, H. L. Palmer, and D. A. Bly (p. 120)

Recent developments have resulted in multiplier phototubes having wider spectral responses from the ultraviolet to the infrared, having higher absolute sensitivity, and having lower dark emission. The multialkali photocathode discovered by Sommer is now being used in the development type multiplier phototube, C7237. Despite the very high red sensitivity of this cathode, the dark emission is a factor 10 lower than that of antimony-cesium cathodes used in typical scintillation counters. Output dark current is basically due to the photocathode dark emission, but this is sometimes increased by regenerative processes. In a special sixteen-stage developmental type with a sealed-in optical shield, the dark current was kept to a minimum for gains as high as  $10^8$  to  $10^{10}$ . Photocathodes of very high quantum efficiency have been achieved on the 7029 multiplier phototube type of means of an internally evaporated-front-surface photocathode of the antimony-cesium type. Absolute comparisons of special characteristics are presented for the photocathodes mentioned above, as well as for the ultraviolet-sensitive 6903 and for the 7102 multiplier phototube which has red and infrared sensitivity.

**A High Current Coaxial Photomultiplier**—N. W. Glass and P. Rudnick (p. 124)

A photomultiplier structure capable of high current output and relatively fast rise time has been developed and several prototypes have been built. The design incorporates eight separate photocathode elements spaced around the cylindrical structure. A five or six-stage multiplier focuses the electrons onto a central coaxial collector-output structure matched directly to a coaxial line. Each stage of the multiplier consists of a ring of eight dynodes, giving effectively eight parallel current channels from photocathode to collector. The structure is approximately two and one-half inches in diameter by four and one-half inches long.

Saturated pulse output currents of nine amperes have been obtained in initial tests. Linearity within approximately 10 per cent has been obtained with output currents of four amperes. Calculations and measurements indicate a

transit time of approximately 5 millimicroseconds with a spread of the order of 1  $\mu$ sec. Current gains of 4000 at 2500 volts over all have been obtained with a five-stage multiplier with antimony-cesium dynodes.

The geometry of this structure and the operating characteristics are discussed. A pseudo-logarithmic response capability, inherent in this design of tube, is expected to be useful for covering an extended dynamic input range.

**A Sodium Iodide (Tl) Total Absorption Spectrometer for High Energies**—A. W. Knudson and R. Hofstadter (p. 152)

A scintillation counter employing a 70 lb NaI(Tl) crystal and a Swiss (AfiF) multiplier phototube has been tested with electrons of energy up to 600 mev. The plot of pulse height vs energy of incident electrons is found to be linear up to the highest energy tested (600 mev). Energy resolution of 16 per cent has been obtained at 350 mev. The crystal is  $9\frac{1}{2}$  inches both in diameter and length. The incident radiation, which can be either electrons or gamma rays, induces a cascade electromagnetic shower within the mass of the crystal giving rise to light which enters the photomultiplier tube. Graphs showing linearity in energy response are presented as well as plots of line shape at constant energy of the incident particle. The procedure for obtaining line breadth semi-theoretically is described, and the breadth so derived compared with the value obtained in actual practice. Details of the airtight crystal enclosure and of the crystal-photomultiplier optical coupling system are shown.

**Unscrambling of Gamma-Ray Scintillation Spectrometer Pulse-Height Distributions**—J. H. Hubbell and N. E. Scofield (p. 155)

This paper describes the construction of a matrix expressing the response of a large sodium iodide crystal to axially incident 0.01 to 8-mev gamma rays. Interpolation from measured and calculated pulse-height distributions due to monoenergetic sources yield a series of distributions at source-energy intervals uniform in the square root of energy. Each distribution was normalized to the total detection efficiency of the crystal and divided into "bins" whose centers were spaced at the above source-energy intervals. Integrated values of the contents of all such bins were written as a triangular matrix. Inversion of this matrix was performed on an automatic computer. Reduction of an experimental pulse-height distribution to a spectrum is effected by first expressing the distribution as a series of bin contents as above, then multiplying this series by the inverse response matrix, and finally dividing by bin widths to give photons per mev.

**Use of  $\text{Li}^6(\text{Eu})$  as a Fast-Neutron Detector and Spectrometer**—R. B. Murray (p. 159)

A review is given of experiments carried out in an investigation of the scintillation response of  $\text{Li}^6(\text{Eu})$  to fast neutrons. A considerable improvement in fast-neutron resolution is realized by operation of the crystal at low temperatures. Pulse-height spectra have been recorded for neutrons from various sources providing both line spectra and continuous spectra. These experiments indicate possible applications of  $\text{Li}^6(\text{Eu})$  as a fast-neutron detector and spectrometer.

**Response Functions of Total-Absorption Spectrometers**—H. W. Koch and J. M. Wyckoff (p. 127)

The characteristic shapes of the response functions of a sodium iodide scintillation spectrometer determine the potential of the spectrometer for X or gamma-ray spectroscopy. The present report reviews the evaluation of these functions for monoenergetic X rays and the limitations placed by this evaluation on the quality of the results for various applications. Emphasis is given to theoretical and experimental methods at X-ray energies between 1

and 100 mev. The theoretical methods available up to 4.5 mev are either of the analytical or Monte Carlo types. Above 4.5 mev, no satisfactory theoretical approaches have been developed. Experimental methods using gamma ray sources, monoenergetic electron data to synthesize X-ray responses, and synchrotron bremsstrahlung are reviewed in detail.

**Analysis of Gamma Ray Scintillation Spectra for Quantitative Photon Intensities**—N. H. Lazar (p. 138)

The various considerations necessary for conversion of the pulse height spectrum from NaI(Tl) spectrometers to photon intensity distributions are discussed. Some of these are: 1) resolution and efficiency of the crystal; 2) summing of cascade gamma rays; 3) source geometry and self-absorption; and 4) handling of positron emitters. A straightforward empirical method for subtracting the Compton distributions associated with the various gamma rays in a complex spectrum is indicated and the logical extension to continuous photon distributions is discussed.

**Measurement of Time of Flight in the Millimicrosecond Region**—H. W. Lefevre and J. T. Russell (p. 146)

The Hanford system for measurement of neutron time of flight differs from conventional techniques only in the use of a vernier chronotron for time interval measurements. The chronotron consists of two circulating transmission lines with a single fast coincidence circuit between them. The line lengths are adjusted to give slightly different circulation periods. By counting the number of circulations necessary to bring two noncoincident pulses into coincidence a number is obtained which is a measure of the time interval in terms of the difference in circulation periods. This number is used as the channel address for storage in a Radiation Counter Laboratories 256 channel analyzer.

Discussion of the vernier chronotron includes: 1) The factors determining channel width, stability and uniformity, 2) use of the RCA 6810 for starting circulation directly, 3) performance of the system as determined with prompt gamma ray cascades, and 4) performance of the instrument in conjunction with the other components of the time of flight system.

**Scintillation Counting in Experiments on Parity Conservation**—R. W. Hayward and D. D. Hoppes (p. 161)

The scintillation counter has played a key role in many of the recent experiments pertaining to the conservation of parity and other symmetry principles in weak interactions. Although in many instances the development of the techniques of scintillation counting, *per se*, has been limited, the applications to which these techniques have been put are sufficiently novel to warrant a general review of these applications to the measurement of certain dynamical quantities in weak interactions. These quantities include the momentum and angular distribution of emission with respect to nuclear polarization direction of beta particles from polarized nuclei, the longitudinal polarization of these beta particles, the circular polarization and angular distribution of gamma rays following the beta decay process, and any correlations of these quantities with one another or with the nuclear recoil.

Particular emphasis is placed on the scintillation spectroscopy of beta particles performed within the vacuum space of a cryostat where the temperature of the detector is of the order of 1°K and that of the source is below 0.01°K and where high magnetic fields are present.

**Applications of Liquid Scintillation Counters**—F. Newton Hayes (p. 166)

The liquid scintillator, in just a few years of development, has shown itself to be an extremely versatile chemical system for radiation

detection. Its evolution has been characterized by penetration into almost every phase of experimental science.

A survey of the most notable applications of liquid scintillation counting is presented.

**Application of Scintillation Counters to Reactors**—William W. Managan (p. 171)

Gamma sensitive scintillators may be applied to low power training reactors and reactor critical experiments where the residual fission fragment gamma activity is kept low. Some results of applying gamma sensitive scintillators with linear and log- $\pi$ -period circuits to reactor critical experiments are compared to results obtained with conventional neutron sensitive counters and ion chambers. Relative performances and reliability are discussed. One advantage found is a reduction in the time required to sense an unsafe condition. Power reactor problems of monitoring for excessive exhaust stack gas activity and for fission fragment leakage from defective fuel elements are also discussed.

**A Differential Cerenkov Counter**—D. E. Baldwin, C. Burrows, D. O. Caldwell, S. G. Hamilton, D. Hill, L. S. Osborne, and D. M. Ritson (p. 177)

A beam of parallel particles of given velocity traversing a transparent radiator gives off Cerenkov radiation at a unique angle with respect to the beam direction independently of the point of traversal. Such light can be brought to a ring focus.

A Cerenkov counter has been built using this principle. Velocity definition is obtained by using a ring diaphragm on the face of a photomultiplier. The greatest velocity definition is obtained for small angle Cerenkov light; we have chosen 10 degrees. To change the velocity selection without changing the optics the index of refraction of the radiator is varied. The index of refraction may be varied by changing the pressure of a gas near its critical point. The working fluid is Fluorochemical FC-75. The index of refraction of FC-75 can be varied continuously from  $n = 1.15$  to  $n = 1.01$  at a temperature of 250°C by changing the pressure. The counter has been tested using 1.8 beV/c  $\pi$  mesons from the Brookhaven Cosmotron; the counting rate vs pressure of the FC-75 has a full width corresponding to less than  $\Delta\beta = 0.01$ .

**Pulse Amplifiers Using Transistor Circuits**—R. T. Graveson and H. Sadowski (p. 179)

Transistor circuits simplify the design of pulse amplifiers because of their essentially linear gain characteristics. The low heat dissipation of such circuits permits small packages. The variations in transistor gain and leakage can be minimized by converting the high single stage gain to stability through the use of emitter feedback. Linearity and response to fast-rise pulses is shown for specific scintillation amplifier circuits.

**Decay Times of Scintillators**—R. K. Swank, H. B. Phillips, W. L. Buck, and L. J. Basile (p. 183)

The rate of decay of luminescence following excitation by a high energy particle is an important parameter both in application and interpretation of scintillation phenomena. Two of the present authors developed a more accurate method of measuring scintillation decay, using a pulsed X-ray tube. However, the intensity and time resolution of that apparatus was not adequate for the measurement of all interesting scintillators. A new apparatus has been constructed in which cathode rays are used to excite the scintillator. Cathode-ray pulses as short as  $10^{-10}$  sec are generated by sweeping a cathode-ray beam across a narrow slit. The emergent electrons in the pulse are accelerated to  $\sim 80$  kev and pass through a thin window to strike the scintillator. The latter may be a crystal, plastic or liquid. The light from the scintillator is detected and amplified



by a multiplier phototube, type 1P28. The currents from the anode and last dynode are fed through 120-ohm transmission lines to a traveling-wave oscilloscope.

A value of  $2.15 \times 10^{-9}$  sec is obtained for the decay time of scintillations from a solution of 5 g/l of terphenyl in toluene, in agreement with previous measurements.

The apparatus is currently being used to study the dependence of the decay time on solute concentration in liquid and plastic scintillators. The decay time is found to increase with decreasing concentration, as predicted by the current theories of energy transfer. Further investigations of the nature of the process of energy transfer in plastics are being carried out by measurements of the shape of the decay curve.

A description of the apparatus and some of the more interesting results are presented.

**A High Stability Gamma-Ray Spectrometer for Use at High Counting Rates**—W. B. Nelligan and J. Tittman (p. 187)

A spectrometer has been developed for rapid quantitative determination of nitrogen content in bulk media using neutron capture gamma-ray analysis. Four Na(Tl) scintillation detectors, each operated at counting rates of the order of  $10^5$  per second, are utilized to permit rapid measurement. Resolution loss due to pile-up is minimized by the use of a 40-microsecond pulse width at the photomultiplier anode followed directly by a low level biased silicon diode preselector. Those portions of pulses exceeding the diode bias are stretched and the four stretcher outputs are fed to a common amplifier of the nonoverloading type which has been modified to improve stability. The preselector reduces by almost two orders of magnitude the effective pulse rate which must be handled by the amplifier. Since pulse-height stability requirements are stringent, temperature regulation of the scintillation detectors and preselector units is used. Detailed measurements indicate that the NaI crystal-plus-photomultiplier combination contributes more instability than all the other spectrometer components combined.

**Multichannel Spectrometer Detector**—H. W. Kendall (p. 190)

The use of a multichannel detector in the focal plane of a magnetic spectrometer effectively decouples the well-known reciprocal relation between spectrometer resolution and transmission applicable to single-channel detection.

The Stanford 36-inch magnetic spectrometer is used in electron-scattering experiments in conjunction with the Mark III linear electron accelerator. In order to utilize the full momentum acceptance of the spectrometer ( $\Delta p/p \approx 0.05$ ), we have constructed a 10-channel prototype of a 50-channel scintillation-Cerenkov detection system which will possess a resolution ( $p/\Delta p \sim 1000$ ) close to the maximum obtainable from the spectrometer.

The momentum channels are defined by small scintillation counters which detect ionizing particles, consisting primarily of high-energy pions and electrons. Electrons are distinguished from mesons by Cerenkov counters which back up blocks of 10 scintillators. A coincidence is required ( $2\tau \approx 3 + 10^{-8}$   $\mu$ sec) between a scintillation detector and the associated Cerenkov counter.

A 256-channel computer-type ferrite core memory (Radiation Counter Laboratories Mark 20), divided into four manually or electronically-selected blocks of 64 channels, is used to store the information from the counter array. The use of this large memory allows storage of correlated information in matrix form from two arrays of counters.

**Low-Level Gamma Ray Detection in Humans**—E. C. Anderson and M. A. Van Dilla (p. 194)

The problem of measuring gamma activity at the natural levels, particularly in people and foodstuffs, is an extremely important one because of the necessity of monitoring both fallout from nuclear weapons tests and the disposal of reactor wastes. This problem will also be encountered because of the necessity for minimizing radiation in clinical and industrial tracer applications. Two principal techniques have been developed for this purpose which are applicable to *in vivo* studies: the NaI crystal spectrometer in a special, low-activity shield, and the large  $4\pi$  liquid scintillation counter. Both have sensitivities which permit the detection of gamma activity in the human body at levels a factor of 10 to 100 below the natural K-40 concentration. The choice between the two systems depends largely on the particular application, since they are comparable in terms of ultimate sensitivity and cost.

The liquid scintillator is the method of choice used for routine studies involving large numbers of samples in which the identity of the activity is known. This is the case, for example, in studies of the gamma activity of people and foodstuffs due to fallout because of the large discrimination factors in biological systems against elements not closely resembling nutritional essentials. Natural K-40 and Cs-137 are normally the only gamma activities present, and the energy resolution of the liquid scintillator permits their simultaneous determination. Because of the constancy and predictability of the K-40 level, additional hard gamma activity (e.g., Ba-140) can be easily detected and identification (in foodstuffs) is often possible on the basis of half-life. The extremely short counting times (2 to 4 minutes per sample) permit the processing of thousands of samples per year. Simple electronics and independence of background rate are very important for routine operation by technicians of limited experience.

For complex samples (such as soils), the superior energy resolution of NaI crystal is essential. Ability of the crystal to scan the subject and localize activity is very useful in distinguishing between internal and external contamination and between ingestion and inhalation. It is also important in clinical applications where physiological localization may occur. For the study of complex industrial or natural phenomena, possibility of simultaneous determination of two or more tracers is very useful. Finally, for extremely soft X or gamma rays (e.g. the Pu-239 17-keV X ray) or for bremsstrahlung counting, the crystal is the method of choice.

**The Decay Times of Organic Scintillators and Their Application to the Discrimination Between Particles of Differing Specific Ionization**—R. B. Owen (p. 198)

Studies of the differences in the decay time of organic phosphors have shown that, while most of the light is emitted with a short-period fluorescence decay, differences in specific ionization affect the long-term components.

It is consequently possible to distinguish between gamma ray and neutron excitation of many phosphors (including scintillating liquids) by using multiplier photocells having relatively slow response characteristics. Photomultipliers with large-area photocathodes can therefore be used.

**A Review of the EMI Development of Photomultiplier Tubes**—J. Sharpe (p. 202)

The structures of both production and developmental type photomultiplier tubes made by EMI are described and their characteristics presented. A departure from previous EMI tubes which has taken place in the past two years has been the development of a small box and grid structure system and recently a focused dynode system. The dark current characteristics of the EMI tubes are discussed particularly from the point of view of low energy counting.

In the limit, a single beta particle of low

energy in a scintillating phosphor may cause the emission of only 1 or 2 or 3 photoelectrons, and these are difficult to distinguish from the thermionic electrons emitted from the cathode. The problem is, therefore, to design and use photomultipliers so that as few thermionic electrons as possible are emitted from the cathode, and to reduce the collection of unwanted electrons from other parts of the cathode-D1 space. The results of development along these lines are presented.

**A Review of the 20th Century Photomultipliers**—A. E. Jennings (p. 208)

The work at 20th Century has been directed primarily at production of replacement units for photomultiplier types presently being produced in the United Kingdom. The tube type selected for study has been the venetian-blind type. A simplified dynode structure made of a single sheet of metal has been developed. Experiments have been conducted on the light utilization by a transparent cathode and results are presented. The collection characteristics of dynodes also have been investigated and the results are presented. Some general principles in tube design are outlined.

**Present Status of Scintillation Counter Development in France**—J. Labeyrie (p. 212)

Some properties of different types of photomultipliers which are now in commercial use in France, such as background linearity at high currents, transit time fluctuations, and stability for  $\beta$  counting, are discussed. In addition, some properties of different types of scintillators in commercial use or under development are presented. These include amplitude, light spectrum and decay time temperature for various mineral or organic (solid and liquid) scintillators, and of several gaseous mixtures.

The latter part of this paper describes briefly two new French applications of scintillation techniques: gamma spectrometer for aerial prospecting and the use of scintillation counters for measuring thermal neutron fluxes in reactors.

**Instrumentation at the ETH**—D. G. Maeder (p. 214)

After a brief outline of applications of scintillation counters to nuclear studies at ETII (Eidgenössische Technische Hochschule), some topics in electronic circuit developments are selected for a more detailed discussion.

1) A linear overload-protected amplifier is described in which pulse shape parameters can be adjusted independently.

2) In the linear amplifier double rectangular pulse shaping is produced by a ferrite core delay line of novel design. Higher order phase corrections are obtained by a combination of inductive and capacitive couplings.

3) Fast timing signals are derived from slow scintillation pulses using a nonlinear amplifier circuit. Amplitude-dependent time jitter is reduced by a special design of interstage couplings.

4) Requirements to be met by pulse stretchers are listed, and a corresponding circuit diagram is presented.

5) Ultrasonic delay lines can be used for the storage of channel counts in a pulse spectrometer. A new type of magnetostrictive transducer has been developed in order to improve the reliability of such a memory. Increased signal amplitude is obtained along with a suppression of unwanted reflections.

6) Straightforward decimal coding, as used in ultrasonic storage and in electrostatic storage type pulse spectrometers, will be explained briefly. Automatic data recording from the CRT display of the ultrasonic memory spectrometer is demonstrated. The electrostatic memory spectrometer is presently operative with four decimals on each of 32 columns in the storage tube.

7) A possible way of using a pulse spectrometer for automatic computing in the analysis of complex scintillation spectra is suggested.



# Abstracts and References

Compiled by the Radio Research Organization of the Department of Scientific and Industrial Research, London, England, and Published by Arrangement with that Department and the *Electronic and Radio Engineer*, incorporating *Wireless Engineer*, London, England

NOTE: The Institute of Radio Engineers does not have available copies of the publications mentioned in these pages, nor does it have reprints of the articles abstracted. Correspondence regarding these articles and requests for their procurement should be addressed to the individual publications, not to the IRE.

Acoustics and Audio Frequencies.....	356
Antennas and Transmission Lines.....	356
Automatic Computers.....	357
Circuits and Circuit Element.....	357
General Physics.....	359
Geophysical and Extraterrestrial Phenomena.....	359
Location and Aids to Navigation.....	361
Materials and Subsidiary Techniques.....	362
Mathematics.....	364
Measurements and Test Gear.....	364
Other Applications of Radio and Electronics.....	365
Propagation of Waves.....	365
Reception.....	365
Stations and Communication Systems.....	366
Subsidiary Apparatus.....	366
Television and Phototelegraphy.....	366
Tubes and Thermionics.....	367
Miscellaneous.....	368

The number in heavy type at the upper left of each Abstract is its Universal Decimal Classification number and is not to be confused with the Decimal Classification used by the United States National Bureau of Standards. The number in heavy type at the top right is the serial number of the Abstract. DC numbers marked with a dagger (†) must be regarded as provisional.

## ACOUSTICS AND AUDIO FREQUENCIES

534.2-8-14 1

**Measurement of Ultrasonic Velocity in Fluids under Pressure by the Pulse Method**—A. V. J. Martin. (*J. recherches centre nat. recherche sci.*, no. 41, pp. 251-272; December, 1957.)

534.23 + 621.396.677.3 2

**The Signal/Noise Performance of Electroacoustic Strip Arrays**—D. G. Tucker. (*Acustica*, vol. 8, pp. 53-62; 1958.) The directivity curves and signal/noise performance of 14 different arrangements of a strip array are discussed and tabulated. See also 994 of 1958.

534.641:621.395.92 3

**An Artificial Ear for Insert Earphones**—J. Y. Morton. (*Acustica*, vol. 8, pp. 33-36; 1958.) "The artificial ear is designed to have the mean acoustical impedance of 19 normal ears. It includes an ear-mould simulator, physical representation of the ear-canal, and acoustical elements to represent the ear-drum impedance. One of these elements is a series acoustical resistance." See also 1001 of 1958 (Morton and Jones).

534.78 4

**The "Characterization" of Speech and Diction**—A. Moles. (*Ann. Télécommun.*, vol. 12, pp. 21-32; January, 1957.) Problems of voice identification and typification are examined theoretically and discussed on a statistical basis with particular reference to the use of visual representation of speech.

534.78:534.844 5

**The Subjective Masking of Short-Time-Delayed Echoes by their Primary Sounds and**

The Index to the Abstracts and References published in the PROC. IRE from February, 1957 through January, 1958 is published by the PROC. IRE, May, 1958, Part II. It is also published by *Electronic and Radio Engineer*, incorporating *Wireless Engineer*, and included in the March, 1957 issue of that journal. Included with the Index is a selected list of journals scanned for abstracting with publishers' addresses.

**their Contribution to the Intelligibility of Speech**—J. P. A. Lochner and J. F. Burger. (*Acustica*, vol. 8, pp. 1-10; 1958.) Experiments are described on the masking of single echoes under nonreverberant conditions using speech and pulsed tones as signals. Results of articulation tests are given which were carried out to determine the integration characteristics of the hearing mechanism for speech.

534.839 6

**Techniques for Measuring and Evaluating Noise**—J. J. Hamrick. (*J. Audio Eng. Soc.*, vol. 6, pp. 19-25; January, 1958.) Measuring techniques and equipment for listening tests are described.

621.395.612.45.1:395.625 7

**The Application of Velocity Microphones to Stereophonic Recording**—E. R. Madsen. (*J. Audio Eng. Soc.*, vol. 5, pp. 79-85; April, 1957.) Single and two-channel reproduction systems are discussed. Suitable ribbon microphones are described.

621.395.623.743 8

**The Electrostatic Loudspeaker**—D. T. N. Williamson. (*J. IEE*, vol. 3, pp. 460-463; August, 1957.) A survey is made of progress in the field, concluding with an appraisal of the technique of constant-charge operation [see e.g. 2825 of 1955 (Walker)].

## ANTENNAS AND TRANSMISSION LINES

621.315.212.029.62 9

**Mutually Coupled CR-Type Directional Coupler**—S. Kurokawa, T. Takahashi, and M. Arai. (*J. Radio Res. Labs. Japan*, vol. 5, pp. 127-133; April, 1958.) Principles and construction are given of a directional coupler having a nearly constant coupling coefficient over the range 30-100 mc without frequency compensation. Performance details are presented.

621.372.2 10

**Investigations with a Model Surface-Wave Transmission Line**—G. Goubau and C. E. Sharp. (IRE TRANS. ON ANTENNAS AND PROPAGATION, vol. AP-5, pp. 222-227; April, 1957. Abstract, PROC. IRE, vol. 45, p. 895; June, 1957.)

621.372.2:621.318.134:621.385.029.6 11

**Designing with Ferrite Isolators**—W. A. Hughes. (*Canad. Electronics Eng.*, vol. 2, pp. 28-31; February, 1958.) An example is given of the method of selection of an isolator for a particular magnetron on the basis of maximum permissible frequency pulling. The magnetron Rieke diagram is used in conjunction with a nomogram for unilateral isolation.

621.372.2:621.396.11 12

**Return Loss: Part 3**—T. Roddam. (*Wireless World*, vol. 64, pp. 539-540; November, 1958.) Application of a transmission-line concept to problems of multipath propagation [see e.g. 2257 of 1958 (Bernath and Brand)]. Part 2: 346 of 1958.

621.372.8 13

**Guided Wave Propagation in Submillimetric Region**—A. E. Karbowiak. (PROC. IRE, vol. 46, pp. 1706-1711; October, 1958.) An analysis of em wave propagation in waveguides in the range 30-300 kmc and above. In the case of metallic waveguides at frequencies  $f$  well above cutoff the attenuation of  $TE_n$  modes is always proportional to  $f^{-3/2}$ , but for TII waves the proportionality changes from  $f^{1/2}$  to  $f^{-3/2}$  as the frequency increases.

621.372.8 14

**Step Discontinuities in Waveguides**—W. E. Williams. (IRE TRANS. ON ANTENNAS AND PROPAGATION, vol. AP-5, pp. 191-198; April, 1957. Abstract, PROC. IRE, vol. 45, p. 894; June, 1957.)

621.372.832.8:537.311.33 15

**The Semiconductor Hall-Effect Circulator**—(*Electronics*, vol. 31, pp. 118-122; October 10, 1958.) A magnetic field is applied perpendicular to a circular slice of semiconductor to give circulator action between six equally spaced contacts at the edge. The effect of load changes on forward and reverse loss is discussed and construction methods and practical limitations are described.

621.396.67 16

**Medium-Wave Antennas for Simultaneous Transmission of Broadcast Programmes**—L. Leng. (*Brown Boveri Rev.*, vol. 45, pp. 218-223; May, 1958.) The simultaneous operation of two transmitters over a single antenna is considered with reference to existing installations.

621.396.674.3 17

**The Exact Solution of the Field Intensities from a Linear Radiating Source**—R. N. Ghose. (IRE TRANS. ON ANTENNAS AND PROPAGATION, vol. AP-5, pp. 237-238; April, 1957.)

621.396.677.3 + 534.23 18

**The Signal/Noise Performance of Electroacoustic Strip Arrays**—Tucker. (See 2.)

621.396.677.43 19

**Studies on a Rhombic Antenna with Cylindrical Helices as the Arms**—A. K. Sen. (*Indian J. Phys.*, vol. 32, pp. 303-316; July, 1958.) The

use of helices is intended to reduce the area required for the erection of a rhombic antenna. Theoretical expressions are derived for the input impedance and directivity, and the results are compared with observed data using an antenna operating between 300 and 900 mc.

**621.396.677.5** 20  
Radiation Field of an Elliptic Loop Antenna with a Constant Current—S. C. Loh and J. Y. Wong. (*Can. J. Phys.*, vol. 36, pp. 672-676; June, 1958.)

**621.396.677.1** 21  
Radiation from a Fine Slot Traversed by a Travelling Wave—J. Ernest. (*Compt. rend. Acad. Sci., Paris*, vol. 246, pp. 2113-2116; April 9, 1958.) The conditions for radiation from a rectangular slot in a filled and unfilled waveguide are calculated.

**621.396.677.71** 22  
Experimental Investigation of Radiation from a Fine Slot Traversed by a Travelling Wave—J. Ernest. (*Compt. rend. Acad. Sci., Paris*, vol. 246, pp. 2236-2239; April 14, 1958.) Radiation diagrams for a slot in a filled and unfilled waveguide are given. See 21 above.

**621.396.677.833** 23  
A Simple Solution to the Problem of the Cylindrical Antenna—J. G. Chaney. (IRE TRANS. ON ANTENNAS AND PROPAGATION, vol. AP-5, pp. 217-221; April, 1957. Abstract, PROC. IRE, vol. 45, p. 895; June, 1957.)

**621.396.677.85** 24  
General Solution of the Luneberg Lens Problem—S. P. Morgan. (*J. Appl. Phys.*, vol. 29, pp. 1358-1368; September, 1958.) "The general solution is obtained for the index of refraction of a variable-index spherical lens which will form perfect geometrical images of the points of two given concentric spheres on each other."

#### AUTOMATIC COMPUTERS

**681.142** 25  
Electronic Computers and the Engineer—(*Electronic Radio Engr.*, vol. 35, pp. 420-423; November, 1958.) An outline of the form and function of the main units of a digital computer is given. The basic techniques of programming are described.

**681.142** 26  
The Physical Realization of an Electronic Digital Computer: Input and Output—A. D. Booth. (*Electronic Eng.*, vol. 30, pp. 570-574; October, 1958.) Continuation of a series of papers (447 of 1953 and back references). Electromechanical input-output equipment is described.

**681.142** 27  
Universal Tape Amplifiers for Digital Data Systems—R. F. Shaw. (*Electronics*, vol. 31, pp. 91-93; October 10, 1958.) Read- and write-amplifiers covering a wide range of input characteristics can be used with both return-to-zero and nonreturn-to-zero pulse techniques at rates up to 22 kc.

**681.142** 28  
Designing Ultrasonic Delay Lines—I. C. Miller and C. W. Sharek. (*Electronic Ind.*, vol. 17, pp. 72-76, 118; July, 1958.) The significant operational characteristics of delay lines and their influence on design are examined.

**681.142** 29  
The Minimality of Rectifier Nets with Multiple Outputs Incompletely Specified—R. McNaughton and B. Mitchell. (*J. Franklin Inst.*, vol. 264, pp. 457-480; December, 1957.)

**681.142** 30  
A Computer Oriented toward Spatial Problems—S. H. Unger. (Proc. IRE, vol. 46, pp. 1744-1750; October, 1958.) A stored-program computer is described which can handle spatial problems by operating directly on information in planar form without scanning or other methods for transforming the problem into some other domain.

**681.142** 31  
Analogue Computation—E. L. Thomas. (*Brit. Commun. Electronics*, vol. 5, pp. 348-358; May, 1958.) A survey of the principles, practice and current applications of computers, together with a tabulated analysis of British models.

**681.142** 32  
New Job for an Old Method: Capacitor Storage used in Analogue Memory—W. S. Kozak. (*Can. Electronics Eng.*, vol. 2, pp. 38-42; February, 1958.) A delay of 10 s for signals of frequency up to 10 cps with negligible attenuation and an error of 1 per cent can be obtained by the unit described.

**681.142:517.512.2** 33  
Fourier Analysis by a General Purpose Electronic Analogue Computer—N. S. Nagaraja. (*J. Inst. Telecommun. Eng., India*, vol. 4, pp. 130-136; June, 1958.) A method for use with a high-speed differential analyzer is described in which the period of the harmonic function, generated by the computer, is kept constant, and the period of the arbitrary function made variable.

**621.142:621.3.087.9** 34  
Electron Gun operates High-Speed Printer—J. T. McNaney. (*Electronics*, vol. 31, pp. 74-77; September 26, 1958.) A method of converting pulse-code data from a shaped-beam crt into printed records on untreated paper at a rate of  $10^6$  characters per minute is described.

**681.142:621.316.82** 35  
Resistance Potentiometers as Function Generators—R. W. Williams and H. Marchant. (*Electronic Eng.*, vol. 30, pp. 579-585; October, 1958.) "The generation of functions of a single variable by means of resistance potentiometers is reviewed." See also 37 of 1958 (Shen).

**681.142:621.318.57:621.318.134** 36  
End-Fired Memory uses Ferrite Plates—V. L. Newhouse, N. R. Kornfield, and M. M. Kaufman. (*Electronics*, vol. 31, pp. 100-103; October 10, 1958.) Magnetic flux is induced around corresponding holes in two adjacent plates and in this way irregularities in the material from hole to hole do not affect the accuracy. Storing and switching systems using plates are described and suitable transistor drive and regeneration circuits are given.

#### CIRCUITS AND CIRCUIT ELEMENTS

**621.3.011.21** 37  
Impedance—Matched or Optimum?—W. B. Snow. (*J. Audio Eng. Soc.*, vol. 5, pp. 66-70; April, 1957.) Examples are given of situations, where matched impedance is the ideal condition, and of cases in which other impedance relations prove to be better.

**621.3.049.75** 38  
Through-Connections for Printed Wiring—J. W. Buckelew and E. D. Knob. (*Bell. Lab. Record*, vol. 36, pp. 368-370; October, 1958.) In the process described a metal eyelet is passed through the printed-circuit board, staked and soldered in one operation.

**621.316.549** 39  
A Voltage-Sensitive Switch—K. O. Otley, R. F. Shoemaker, and P. J. Franklin. (Proc.

IRE, vol. 46, pp. 1723-1730; October, 1958.) The controlled dielectric breakdown of oxide films has been investigated. A small, shock-resistant device requiring no additional power supply has been developed which consists of an oxide layer between an Al base and a Ag film. Before breakdown the device has a resistance of at least  $10^7\Omega$ ; on switching the resistance drops to about  $1\Omega$ . Some circuit applications are described.

**621.316.825** 40  
Solving Thermistor Problems—R. S. Goodyear. (*Electronic Ind.*, vol. 17, pp. 51-55, 118; July, 1958.) The methods of designing circuits incorporating thermistors are illustrated by three particular cases.

**621.316.86** 41  
Nonlinear Properties of Carbon Resistors—C. E. Mulders. (*Tijdschr. Ned. Radiogenoot.*, vol. 22, pp. 337-347; November, 1957. In English.) A method of determining the nonlinear characteristics is proposed which is based on the measurement of harmonics produced when a pure sinusoidal current flows through the resistor.

**621.316.89** 42  
The Versatile Vamistor—R. C. Langford. (*Can. Electronics Eng.*, vol. 2, pp. 19-23; February, 1958.) Construction, specification and performance data of a resistor incorporating the best features of wire-wound and carbon types.

**621.318.57:621.314.7** 43  
Designing Transistor Circuits—Switching Stations—R. B. Hurley. (*Electronic Equip. Eng.*, vol. 6, pp. 42-56; June, 1958.) The basic switching properties of junction transistors are examined, and examples of single and multiple switches are given.

**621.318.57:621.396.669** 44  
An Electronic Transmit-Receiver Switch—A. S. McNicol. (*RSGB Bull.*, vol. 34, pp. 22-23; July, 1958.) Incoming signals are fed via the tank circuit to an RF pentode which is cut off by grid bias when the transmitter is on. See also 1347 of 1953.

**621.319.4:621.3.082.6** 45  
A Temperature-Sensitive Ceramic Reactance Element—C. V. Ganapathy, C. S. Rangan, R. Krishnan, and T. V. Ramamurti. (*J. Inst. Telecommun. Eng., India*, vol. 4, pp. 168-174; June, 1958.) A sintered mixture of  $BaTiO_3$  and CeO gives, within the range  $-50^\circ\text{C}$  to  $100^\circ\text{C}$ , a nearly linear, repeatable capacitance/temperature curve with a 50 per cent change of capacitance. The effects of different percentages of CeO are examined and applications are mentioned.

**621.319.43:621.314.63** 46  
A Voltage-Variable Capacitor—G. F. Straube. (*Electronic Ind.*, vol. 17, pp. 69-73 and 77-80; May and July, 1958.) Details of a subminiature Si junction device with a variable capacitance controllable by bias voltage are given. Applications of the "varicap" to an FM transmitter, an amplifier and a variable filter are described. See also 1677 of 1958 (Keizer).

**621.372.5** 47  
Response of a Capacitance-Resistance Divider to the Step Function, Exponential Function and Ramp Function—S. Turk. (*Electronic Eng.*, vol. 30, pp. 608-611; October, 1958.)

**621.372.5:621.314.7** 48  
A Four-Pole Analysis for Transistors—B. J. Alcock. (*Electronic Eng.*, vol. 30, pp. 592-594; October, 1958.) "An algebraically con-



venient analysis for four-pole networks is presented, based upon determinant techniques; it is applied to transistor circuits and introduces two new comprehensive parameters for the transistor."

- 621.372.54 49  
**Additional Tables for Design of Optimum Ladder Networks**—L. Weinberg. (*J. Franklin Inst.*, vol. 264, pp. 7-23 and 127-138; July and August, 1957.) Tables for networks with characteristics given by Butterworth, Tchebycheff and Bessel polynomials are presented; they are classified on the basis of the conductance ratio. See also *Proc. Nat. Electronics Conf.*, Chicago, vol. 12, pp. 794-817; 1956; and 702 of 1958.
- 621.372.54 50  
**Estimation of Dissipative Effects in Tchebycheff Symmetrical Filters**—D. C. Pawsey. (*Proc. IRE*, vol. 46, pp. 1763-1764; October, 1958.) Comment on 2053 of 1957 (Grossman).
- 621.372.542.2 51  
**Low-Pass RC Filter with Optimum Response**—D. D. Nye, Jr. (*Electronics*, vol. 31, pp. 104-105; October 10, 1958.) Formulas and graphs for one- and two-section filters are given.
- 621.372.543.2:538.652 52  
**Narrow-Band Magnetostrictive Filters**—A. P. Thiele. (*Electronic Radio Eng.*, vol. 35, pp. 402-411; November, 1958.) 20 filters, each with a 3-db bandwidth of 7 cps, are arranged with inputs in series and outputs isolated from one another, to form a bank with a center frequency of about 40 kc. Design and construction are described and applications of single resonators and arrays are considered. Temperature effects are reduced by using cobalt-substituted ferrites.
- 621.372.543.2:621.372.852.1 53  
**A Waveguide Filter Theory**—M. van Sliedregt. (*Tijdschr. Ned. Radiogenoot.*, vol. 22, pp. 375-389; November, 1957. In English.) On the basis of the matrix theory used by Hessel *et al.* (3374 of 1949) formulae are derived giving insertion loss and envelope delay for multistage filters having as parameters the ratios of the bandwidth of the stages to the bandwidth of the total filter.
- 621.373 54  
**Wide-Range RC Oscillator**—C. G. Mayo and J. W. Head. (*Electronic Radio Engr.*, vol. 35, pp. 412-416; November, 1958.) A frequency range exceeding 1000:1 in a single sweep can be obtained with the tone source described. Elements having continuously distributed series resistance and shunt capacitance are used, which can be made from standard high-stability resistors.
- 621.373.431.1 55  
**Negatively-Biased Multivibrator**—A. Bar-Lev. (*Electronic Radio Eng.*, vol. 35, pp. 436-440; November, 1958.) Description of a multivibrator which has its grids returned to a negative bias. It has high frequency stability and is suitable for use as a variable frequency source or a source of special wave shapes, and can be frequency modulated. The frequency varies linearly with bias voltage.
- 621.373.431.2:621.314.7 56  
**Transistor Blocking-Oscillator Circuits**—A. S. Daddario. (*Electronic Equip. Eng.*, vol. 6, pp. 55-58; June, 1958.) Circuit characteristics are examined and methods for varying the output waveform are discussed.
- 621.374.3:621.318.57 57  
**Increased Sensitivity of Trigger Circuits**—M. M. Vojinović. (*Bull. Inst. Nuclear Sci. "Boris Kidrich"* (Belgrade), vol. 8, pp. 123-131; March, 1958.) In the cathode-coupled monostable multivibrator described, the use of a crystal diode in the feedback loop allows one tube to amplify the trigger pulse before it is applied to the other tube. The circuit is sensitive to a few millivolts.
- 621.374.32 58  
**Latching Counters**—W. P. Anderson and N. A. Godel. (*Electronic Radio Eng.*, vol. 35, pp. 362-367 and 425-436; October and November, 1958.) The causes of low reliability of single-pulse counter chains are examined. A circuit with a multiphase output is described, which has a frequency range from dc to 500 kc and eliminates spurious pulses. Reset facilities and general design features including the use of transistor circuits are discussed.
- 621.374.32 59  
**Sensitive Single Channel Pulse-Height Analyser**—M. Simli and M. Birk. (*Rev. Sci. Instr.*, vol. 29, pp. 766-768; September, 1958.) The analyzer operates with input pulses of amplitude 4-40 mv and a dead time of about 6  $\mu$ s. The stability over a period of several days is better than 1 per cent.
- 621.374.4:621.314.6 60  
**Harmonic Generation with Ideal Rectifiers**—C. H. Page. (*Proc. IRE*, vol. 46, pp. 1738-1740; October, 1958.) The  $n$ th harmonic cannot be generated with an efficiency exceeding  $\pi^2$ . At least 75 per cent of the power converted to dc and harmonics is dc dissipation; this cannot be reduced by an arrangement of selective circuits.
- 621.374.4:621.372.44 61  
**Harmonic Generation with Nonlinear Reactances**—K. K. N. Chang. (*RCA Rev.*, vol. 19, pp. 455-464; September, 1958.) A simple theory of frequency multiplication using nonlinear reactances is derived and compared with the results obtained with the nonlinear capacitance of a Ge point-contact diode. The theory and the experimental results are in agreement at low input powers. Possible reasons for the discrepancies at high powers are mentioned.
- 621.375.2.018.756 62  
**Linear Amplifier for Negative Pulses**—A. S. Penfold. (*Rev. Sci. Instr.*, vol. 29, pp. 765-766; September, 1958.) A two-tube amplifier is described which has a gain of 100 and a rise time of 50  $\mu$ sec for outputs up to 125 v.
- 621.375.2.029.3 63  
**Three-Valve Preamplifier**—C. Hardcastle. (*Mullard Tech. Commun.*, vol. 4, pp. 39-42; August, 1958.) A description and performance specification of a circuit with inputs for magnetic and crystal pickups, tape recorder and radio receiver. Simultaneous outputs for tape recording and for a power amplifier are provided. See also 2023 of 1958.
- 621.375.221.029.6 64  
**Broad-Band Amplifier for Radar and Scatter**—J. H. Phillips and E. Maxwell. (*Electronics*, vol. 31, pp. 81-83; September 26, 1958.) The design of a low-noise two-stage amplifier and mixer for the range 400-450 mc is described. Over-all power gain in 29 db with noise figures varying from 3.6 to 5.5 db over the frequency band.
- 621.375.4 65  
**Design Considerations for Direct-Coupled Transistor Amplifiers**—J. E. Lindsay and H. J. Woll. (*RCA Rev.*, vol. 19, pp. 433-454; September, 1958.) It is shown that: a) the maximum obtainable signal/drift ratio of an amplifier is achieved by choosing the optimum source resistance, b) the signal/drift capability of a transistor and the optimum source resistance are nearly the same for the three configurations: common emitter, common collector and common base, c) negative feedback can change the optimum source resistance and generally degrades the signal/drift ratio, and d) improved signal/drift ratio can be obtained at reduced emitter currents.
- 621.375.4 66  
**Circuit Designed for High Voltage Gain from Transistors**—M. Price. (*Can. Electronics Eng.*, vol. 2, pp. 20-21; March, 1958.) In the circuit described, a common-emitter stage feeds into a modified common-collector stage with low output impedance.
- 621.375.4.029.3 67  
**Transistor Audio Amplifier**—F. Butler. (*Wireless World*, vol. 64, pp. 529-535; November, 1958.) Design principles are outlined for using multiple push-pull stages in series. The construction of a 10-w amplifier for battery operation and of a low-noise preamplifier is described.
- 621.375.4.029.3 68  
**15-W Public-Address Amplifiers using OC16 Transistors**—P. Tharma. (*Mullard Tech. Commun.*, vol. 4, pp. 30-32; August, 1958.) The amplifiers work from 14-v or 28-v supplies and may be fully driven by a low-impedance microphone.
- 621.375.4.029.33 69  
**A Transistor Video Amplifier having 80 Volts Output**—V. H. Grinich. (*IRE TRANS. ON BROADCAST TRANSMISSION SYSTEMS*, vol. BTS-5, pp. 32-37; September, 1956. Abstract, *Proc. IRE*, vol. 44, p. 1898; December, 1956.)
- 621.375.4.029.5 70  
**Transistorized I.F.-Strip Design**—R. E. Murphy and R. S. Mautner. (*Electronic Equip. Eng.*, vol. 6, pp. 51-53; June, 1958.) The performance of tetrodes in grounded-emitter and grounded-base circuits is compared. A nine-stage 30-mc IF amplifier using grounded-emitter tetrodes is described, with transformer coupling between stages providing for neutralizing and matching.
- 621.375.4.078 71  
**Temperature-Stable Transistor Circuit based on the Half-Supply-Voltage Principle**—B. G. Dammers, A. G. W. Uitjens, and W. Ebbinge. (*Electronic Applic. Bull.*, vol. 18, pp. 1-11; January, 1958.) The principle is applied to the design of a transformerless AF output stage and is used in each stage of a six-transistor superheterodyne receiver. (See also 628 of 1958 (Johnson and Verines).)
- 621.375.9:538.569.4.029.6 72  
**Masers and Related Quantum-Mechanical Devices: Parts 1 and 2**—G. E. Weibel. (*Sylvania Technologist*, vol. 10, pp. 90-97, October, 1957; and vol. 11, pp. 26-43; January, 1958.) Theoretical aspects are considered leading to the computation of the dielectric constant of a gaseous medium in a form which can be directly applied to the solution of problems in waveguides and cavities.
- 621.375.9:538.569.4.029.6 73  
**Behaviour of a Two-Level Solid-State Maser**—I. R. Senitzky. (*Phys. Rev. Lett.*, vol. 1, pp. 167-168; September 1, 1958.) It is shown, under simplifying assumptions, that when a system of spins is in resonance with the cavity, and when damping effects caused by relaxation phenomena and cavity losses are not excessive, modulation of the cavity power output is exactly what is to be expected on the basis of a dynamical analysis. See also 2677 of 1958 (Chester *et al.*).
- 621.375.9:538.569.4.029.6 74  
**Proposed Method for Tuning a Maser Cavity**—F. O. Vonbun. (*Rev. Sci. Instr.*, vol.



29, pp. 792-793; September, 1958.) A method is described for determining the small difference between the cavity resonance frequency and the frequency of the microwave spectral line.

**621.375.9:621.3.011.23** 75  
**Circuit Conditions for Parametric Amplification**—L. B. Valdes. (*J. Electronics Control*, vol. 5, pp. 129-141; August, 1958.) It is shown that signals may be amplified in a circuit which consists exclusively of passive elements, if a nonlinear or time-varying reactance is present. The circuit conditions which must be satisfied are established and the differences between parametric amplifiers and mixers or modulators are discussed.

**621.375.9:621.3.011.23** 76  
**Parametric Amplification and Frequency Mixing in Propagating Circuits**—P. K. Tien. (*J. Appl. Phys.*, vol. 29, pp. 1347-1357; September, 1958.) An analysis is given of the properties of time-varying distributed reactance in propagating structures which may have positive or negative phase and group velocities. Power at different frequencies may be converted from one frequency to the others, and the amplitudes of the waves may vary exponentially or periodically, depending on the relation of the frequencies and of the phase constants between the propagating waves and the variable coupling reactance. Applications to wide-band frequency converters, frequency channel selectors, wide-band amplifiers tunable narrow-band amplifiers, and oscillators are described.

**621.375.9:621.3.011.23** 77  
**Gain, Bandwidth, and Noise Characteristics of the Variable-Parameter Amplifier**—H. Heffner and G. Wade. (*J. Appl. Phys.*, vol. 29, pp. 1321-1331; September, 1958.) Increased gain is achieved by raising the  $Q$  of the idling resonant circuit or the amount of variation in the variable coupling reactance. The bandwidth is inversely proportional to  $Q$  and to the voltage gain, and directly proportional to the ratio of idling resonant frequency to amplifying frequency. Very low noise figures should be attained by artificially cooling the idling resonant circuit. The use of the parametric principle as applied to frequency conversion is discussed.

**621.375.9:621.385.029.63:537.533** 78  
**A Low-Noise Electron-Beam Parametric Amplifier**—Adler and Hrbek. (See 327.)

**621.375.9.029.6:621.3.011.23** 79  
**The Mavar: A Low-Noise Microwave Amplifier**—S. Weber. (*Electronics*, vol. 31, pp. 65-71; September 26, 1958.) The operation of the mavar (mixer amplification by variable reactance) requires a lossless nonlinear reactance exhibiting negative resistance under certain conditions. Low-noise amplification is achieved at room temperature. The performance and the operation of the main types of parametric amplifier are outlined.

#### GENERAL PHYSICS

**534.1+538.56** 80  
**Strongly Nonlinear Oscillations**—A. Papoulis. (*J. Math. Phys.*, vol. 37, pp. 147-156; July, 1958.) Mathematical analysis of a special class of nonlinear oscillations in systems without or with losses.

**536.7:530.17:621.372** 81  
**A Note on Thermodynamics of the Harmonic Oscillator with Radiation Damping**—N. Saitô and J. Hori. (*J. Phys. Soc. Japan*, vol. 13, pp. 717-721; July, 1958.) It is shown that the impedance of an irreversible thermodynamical system must be positive and real; the argument is based on representation of the sys-

tem by Langevin equations of the second order, corresponding to the construction of any passive network from elementary  $RLC$  circuits. The conclusion is illustrated by an examination of the properties of the harmonic oscillator.

**537.525** 82  
**Theory of the Cathode Sheath in a Low-Density Gas Discharge**—P. L. Auer, H. Hurlwitz, Jr., and S. Tamor. (*Phys. Rev.*, vol. 111, pp. 1017-1028; August 15, 1958.) The space-charge equations of a low-density gas discharge are derived and applied to the study of potential distributions in the cathode sheath. One conclusion is that a positive column will begin to evolve when the number of ionization mean free paths in the discharge gap is of the same order as the square root of the ratio of electron to positive-ion mass.

**537.525:538.69** 83  
**The Effect of a Uniform Magnetic Field on Electrodeless Discharge in a Tube and Measurement of Electronic Mobility: Part I—Air**—S. N. Goswami. (*Indian J. Phys.*, vol. 32, pp. 35-41; January, 1958.)

**537.533** 84  
**Perveance and the Bennett Pinch Relation in Partially Neutralized Electron Beams**—J. D. Lawson. (*J. Electronics Control*, vol. 5, pp. 146-151; August, 1958.) The concept of perveance is extended to take account of relativistic conditions and the effects of space-charge neutralization. See also 1919 of 1958.

**537.533:538.63** 85  
**Magnetic Forces and Relativistic Speeds in Stationary Electron Beams**—J. M. Winwood. (*J. Electronics Control*, vol. 5, pp. 161-162; August, 1958.) Comment on 3037 of 1958 (Meltzer).

**537.56** 86  
**A Variational Calculation of the Equilibrium Properties of a Classical Plasma**—S. F. Edwards. (*Phil. Mag.*, vol. 3, pp. 119-124; February, 1958.)

**537.56** 87  
**Correlations in the Charge Density of a Classical Plasma**—S. F. Edwards. (*Phil. Mag.*, vol. 3, pp. 302-306; March, 1958.)

**537.56** 88  
**Nonlinear Theory of Plasma Oscillations and Waves**—S. Amer. (*J. Electronics Control*, vol. 5, pp. 105-113; August, 1958.) An exact differential equation for density oscillations is found considering only Coulomb interactions between electrons. A number of properties of plasma oscillations are then derived including the form of stationary spherical waves in an isotropic plasma. See also 2707 of 1958 (Gold).

**537.56** 89  
**Thermal Diffusion in Ionized Gases**—S. Chapman. (*Proc. Phys. Soc. (London)*, vol. 72, pp. 353-362; September 1, 1958.) The "thermal diffusion factor"  $\alpha$ , which is less than unity in a neutral gas mixture, is of order  $Z+1$  in an ionized gas, where  $Ze$  is the ionic charge. In a mixed ionized gas containing also a small proportion of heavy ions the factor can be much greater and give increased heavy ion density in the hotter regions. This effect may be of importance in the solar corona.

**538.122** 90  
**Experimental Determination of the Field of a Permeable Alloy Cylinder, Placed in a Uniform Magnetic Field Parallel to its Axis of Revolution**—E. Selzer. *Ann. Geophys.*, vol. 12, pp. 144-146; April-June, 1956.)

**538.22** 91  
**Effective Parameters in Ferrimagnetic**

**Resonance**—R. K. Wangsness. (*Phys. Rev.*, vol. 111, pp. 813-816; August 1, 1958.) The steady-state solution for the susceptibility tensor of a two-sublattice system has been found by using sublattice equations of motion which include complete Landau-Lifschitz relaxation terms with individual relaxation parameters and which describe relaxation toward the instantaneous total field acting on the sublattice.

**538.3:52** 92  
**Spherical Vortices in Magnetohydrodynamics**—C. Agostinelli. (*Rend. acad. naz. Lincei*, vol. 24, pp. 35-42; January, 1958.)

**538.566:535.43** 93  
**Propagation of Waves through a Sheet of the Medium with a Cubic Periodic Structure**—P. Gosar. (*Nuovo Cim.*, vol. 7, pp. 742-763; March 16, 1958. In English.) An approximate solution to the wave equation is obtained for the case of normal and oblique incidence of the ingoing wave, and a detailed investigation is made of the case for which the wave equation is separable.

**538.566:621.396.677.85** 94  
**Some Electromagnetic Transmission and Reflection Properties of a Strip Grating**—R. I. Primich. (*IRE TRANS. ON ANTENNAS AND PROPAGATION*, vol. AP-5, pp. 176-182; April, 1957. Abstract, *PROC. IRE*, vol. 45, p. 894; June, 1957.) See also 1119 of 1958.

**538.569.4** 95  
**A General Theory of Magnetic Resonance Saturation**—K. Tomita. (*Prog. Theor. Phys. (Kyoto)*, vol. 19, pp. 541-580; May, 1958.) A general theory for describing a spin assembly due to a nearly resonant rotating magnetic field of arbitrary strength is given. Two different cases are treated dependent on the relation between the static field and the frequency of fluctuation of the environment.

**538.569.4.029.6** 96  
**A Microwave Electron-Spin-Resonance Spectrometer**—M. B. Palma-Vittorelli and M. U. Palma. (*Nuovo Cim.*, vol. 7, Supplement No. 1, pp. 139-154; 1958.) A general description is given of equipment which operates in the  $X$  and  $K$  bands and has highly stable magnetic and microwave frequency systems.

**538.569.4.029.6:621.375.9** 97  
**Masers and Related Quantum-Mechanical Devices: Parts 1 and 2**—Weibel (See 72.)

**538.569.4.029.64** 98  
**Paramagnetic Resonance in Copper Propionate Monohydrate**—H. Abe. (*J. Phys. Soc. Japan*, vol. 13, pp. 987-997; September, 1958.) Results of an investigation at  $cm \lambda$  of absorption in single crystals.

**538.691** 99  
**The Influence of the Anomalous Magnetic Moment on the Spin Kinematics of Electrons in a Uniform Magnetic Field**—M. Carrassi. (*Nuovo Cim.*, vol. 7, pp. 524-535; February 16, 1958. In English.) High-energy particles in a beam are considered.

#### GEOPHYSICAL AND EXTRATERRESTRIAL PHENOMENA

**521.03:061.3** 100  
**Proceedings of the Third Symposium on Cosmical Gas Dynamics held at the Smithsonian Astrophysical Observatory, Cambridge, Massachusetts, June 24th-29th, 1957**—(*Rev. Mod. Phys.*, vol. 30, pp. 905-1108; July, 1958.) 41 papers presented deal with velocity fields in the interstellar medium, cooling and condensation of interstellar matter, conditions at the ionization and shock fronts in collisions of gas clouds, and related problems.

- 523.164.32 101  
Polarization Measurements of the Three Spectral Types of Solar Radio Burst—M. Komisaroff. (*Aust. J. Phys.*, vol. 11, pp. 201-214; June, 1958.) A frequency-sweep technique was used in the range 40-240 mc, most data being obtained between 40 and 140 mc. Data for the type-I and type-III bursts cover the period January-October, 1955, and for type-II the years 1955 and 1956. Many type-III bursts were highly polarized, and there were strong indications that the polarization was due to the radiation source.
- 523.164.32 102  
Evidence of Echoes in the Solar Corona from a New Type of Radio Burst—J. A. Roberts. (*Aust. J. Phys.*, vol. 11, pp. 215-234; June, 1958.) The bursts contain two elements spaced by  $1\frac{1}{2}$ -2 seconds, the second being a repetition of the first with a frequency increase with time of 2-8 mc per second. An explanation is derived in terms of echoes from lower levels of the solar corona.
- 523.164.4 103  
Evidence on the Spatial Distribution of Radio Sources Derived from a Survey at a Frequency of 159 Mc/s—D. O. Edge, P. A. G. Scheuer, and J. R. Shakeshaft. (*Mon. Not. R. Astr. Soc.*, vol. 118, pp. 183-196; 1958.) Some results from a survey of radio sources at 159 mc are available for limited regions of the sky. These are discussed in relation to the spatial distribution of sources.
- 523.165:523.75 104  
Short  $\gamma$ -Ray Burst from a Solar Flare—L. Peterson and J. R. Winckler. (*Phys. Rev. Lett.*, vol. 1, pp. 205-206; September 15, 1958.) Observations of a burst of  $\gamma$  radiation are compared with simultaneous records of solar radio emission at 3 and 27 cm  $\lambda$ .
- 523.5 105  
A Suggested Improvement to the C.W. Technique for Measurement of Meteor Velocities—J. S. Mainstone, W. G. Elford, and A. A. Weiss. (*Aust. J. Phys.*, vol. 11, pp. 277-278; June, 1958.)
- 523.5:538.082.74 106  
A Search for Magnetic Effects from Meteors—G. S. Hawkins. (*J. Geophys. Res.*, vol. 63, pp. 467-475; September, 1958.) No magnetic pulses could be detected as a result of meteors having visual magnitudes between +5 and -3. The sensitivity of the magnetometer used allowed pulses of  $5 \times 10^{-3}$  and later  $3 \times 10^{-3}$   $\gamma$  to be recorded. See also 3797 of 1958.
- 523.746 107  
Behaviour of the Present Sunspot Cycle—S. W. Visser. (*Nature (London)*, vol. 182, pp. 253-254; July 26, 1958.)
- 550.37/.38 108  
Geomagnetic Dynamos—A. Herzenberg. (*Phil. Trans. Ser. A.*, vol. 250, pp. 543-583; August 21, 1958.) A rigorous proof is given of the dynamo theory of geomagnetism by postulating a velocity pattern in a sphere filled with conducting fluid so that the arrangement acts as a dynamo producing an external magnetic field.
- 550.38 109  
A Method for Analysing Values of the Scalar Magnetic Intensity—A. J. Zmuda. (*J. Geophys. Res.*, vol. 63, pp. 477-490; September, 1958.) The method uses a series for the square of the scalar intensity, the terms of which are obtained from the spherical harmonics generally applied to each component of the intensity. Those magnetic characteristics normally given by analysis of the vector intensity are obtained.
- 550.38:551.510.536 110  
Large-Amplitude Hydromagnetic Waves above the Ionosphere—A. J. Dessler. (*J. Geophys. Res.*, vol. 63, pp. 507-511; September, 1958.) Arguments are presented for the existence of waves of amplitude about 100 times that of geomagnetic fluctuations at the earth's surface; it is assumed that the latter are generated at six to ten earth radii and carried to earth by the waves. It is suggested that the waves produce irregularities in electron density which cause radio-star scintillation and that they are also responsible for high intensity particle radiation above about 1000 km.
- 550.38(98+99) 111  
Scientific Reports of the French Polar Expeditions S IV 2: Magnetic Activity in the Polar Regions—P. N. Mayaud. (*Ann. Géophys.*, vol. 12, pp. 84-101; January-March, 1956.)
- 550.380.8:538.569.4 112  
Measurement of the Earth's Magnetic Field with a Rubidium Vapour Magnetometer—T. L. Skillman and P. L. Bender. (*J. Geophys. Res.*, vol. 63, pp. 513-515; September, 1958.) The instrument described makes use of the relationship between the earth's field and the absorption lines in Rb vapour caused by ground-state Zeeman transitions. An absolute accuracy of 2 $\mu$  is quoted. See also 760 of 1958 (Bell and Bloom).
- 550.385:523.75 113  
Geomagnetic Activity and Eruptions—P. Simon. (*Ann. Géophys.*, vol. 12, pp. 167-182; July-September, 1956.) Statistical analysis of observational data to determine the relation between various types of solar flare and increases in geomagnetic activity.
- 550.389.2 114  
I.G.Y. Progress Report—G. M. C. Stone. (*RSGB Bull.*, vol. 34, pp. 15-17; July, 1958.) A general report of contributions made by members of the R.S.G.B. to the IGY program.
- 550.389.2 115  
I.G.Y. V.H.F. Programme—Progress to Date—C. E. Newton and G. M. C. Stone. (*RSGB Bull.*, vol. 34, pp. 13-15; July, 1958.) The report, compiled from observations made by members of the R.S.G.B., deals with a) an analysis of the origin of different air masses in relation to tropospheric propagation conditions, b) fading, c) auroral reflection propagation, and d) solar noise.
- 550.389.2:621.396.11 116  
Hit Rates of Radio Propagation Disturbance Warnings and S.W.I. Warnings—K. Sinno. (*J. Radio Res. Labs., Japan*, vol. 5, pp. 109-116; April, 1958.) In order to improve the hit rate, defined as the number of hits divided by the number of issued forecasts, it is suggested that long-distance propagation characteristics should be studied to account for the fall in hit rate in winter, that forecasting should be reduced to three or four days ahead, and that although S.W.I. warnings are fairly good, there should be a further study of solar radio noise.
- 550.389.2:629.19 117  
Gravitational Torque on a Satellite Vehicle—R. E. Roberson. (*J. Franklin Inst.*, vol. 265, pp. 13-22; January, 1958.) See also 3803 of 1958.
- 550.389.2:629.19 118  
Motion of the Nodal Line of the Second Russian Earth Satellite (1957B) and Flattening of the Earth—E. Buchar. (*Nature (London)*, vol. 182, pp. 198-199; July 19, 1958.)
- 550.389.2:629.19 119  
Air Drag Effect on a Satellite Orbit de-
- scribed by Difference Equations in the Revolution Number—R. E. Roberson. (*Quart. Appl. Math.*, vol. 16, pp. 131-136; July, 1958.) Difference equations are derived whose solutions express changes in orbital size and shape, and give the satellite's time behavior as functions of the revolution number. The results are obtained from a first-order perturbation theory using a small air-drag parameter and assuming the air density function to be locally exponential. See also 3803 of 1958.
- 550.389.2:629.19 120  
On the Reception of Radio Waves from Russian Earth Satellite I—H. Uyeda, T. Ishida, H. Shibata, and M. Mambo. (*J. Radio Res. Labs., Japan*, vol. 5, pp. 135-141; April, 1958.) Observations of bearing and field strength are used to determine the orbit and to estimate regions of reception, taking into account the various modes of ionospheric propagation.
- 550.389.2:629.19 121  
Radio Reflections from Satellite-Produced Ion Columns—C. D. Hendricks, Jr., G. W. Swenson, Jr., and R. A. Schorn. (*Proc. IRE*, vol. 46, p. 1763; October, 1958.) The records of signal strength of WWV transmission on 20 mc measured at the University of Illinois were examined for periodic variations due to reflection from ion columns. The results do not indicate the presence of such columns for extremely high satellites. See also 1725 of 1958 (Kraus).
- 550.389.2:629.19 122  
Satellite Tracking: Its Methods and Purpose—E. G. C. Burt. (*Endeavour*, vol. 17, pp. 216-222; October, 1958.) Radio, radar and optical techniques are discussed.
- 550.389.2:629.19 123  
Keeping Track of Earth Satellites—C. J. Sletten, G. R. Forbes, Jr., and L. F. Shodin. (*Electronics*, vol. 31, pp. 81-83; October 10, 1958.) Details are given of an interferometer-type antenna array having 22 dipoles proximity coupled to a two-wire transmission line. A receiver with inputs switched at 100 cps is used to detect signals below receiver noise level. Calibration methods are described and some transit passage records, accurate to within 1 second, are shown.
- 550.389.2:629.19 124  
Telemetering Information from Satellites—N. G. Hyde. (*RSGB Bull.*, vol. 34, pp. 8-12; July, 1958.) The data given cover both U.S.S.R. and U. S. satellites. Channel assignments for the Lyman- $\alpha$  environmental satellites are tabulated and general notes on recording technique are included.
- 551.510.535 125  
Pressure and Temperature Variation of the Electron-Ion Recombination Coefficient in Nitrogen—E. P. Bialecke and A. A. Dougal. (*J. Geophys. Res.*, vol. 63, pp. 539-546; September, 1958.) The variations have been investigated in the pressure range 0.2-2 mm Hg and for electron temperatures between 92° and 300°K. At 1.3 mm,  $\alpha_{ei}$  varies from  $8.5 \times 10^{-7}$  cm<sup>3</sup> sec<sup>-1</sup> at 300°K to  $6.7 \times 10^{-6}$  cm<sup>3</sup> sec<sup>-1</sup> at 92°K. Dissociative recombination is the most probable mechanism.
- 551.510.535 126  
Computations of Electron Density Distributions in the Ionosphere making Full Allowance for the Geomagnetic Field—R. A. Duncan. (*J. Geophys. Res.*, vol. 63, pp. 491-499; September, 1958.) Jackson's method (2381 of Jackson's method (2381 of 1956) for computing the distributions from  $h'(f)$  records has been slightly modified for use on an electronic computer. Each reduction takes about 20 seconds. It is assumed that the electron density between



two layers falls to 90 per cent of the lower layer value. Night time distributions for Brisbane, Australia, are found to be nearer to the Chapman than to the parabolic form.

**551.510.535** 127  
**Long Term Variations of the Sporadic E Layer in Japan**—I. Kasuya. (*J. Radio Res. Labs., Japan*, vol. 5, pp. 117-125; April, 1958.) Statistical analysis of E<sub>s</sub>-layer reflections at four observatories during 1947-1955 shows marked diurnal and seasonal variations in fE<sub>s</sub>. No annual variation is observed nor any correlation with sunspot number. An analysis of the occurrence of reflections above certain limiting frequencies at one observatory yields similar results.

**551.510.535** 128  
**On the Influence of Electron-Ion Diffusion Exerted upon the Formation of the F<sub>2</sub> Layer**—T. Yonezawa. (*J. Radio Res. Labs., Japan*, vol. 5, pp. 165-187; July, 1958.) The maximum electron density of the F<sub>2</sub> layer, and its height, h<sub>m</sub>F<sub>2</sub>, are obtained theoretically as functions of latitude and solar zenith distance. The theoretical height distributions derived are thinner than Chapman distributions and the effective recombination coefficient decreases with height at low altitudes but becomes constant at high altitudes. No better agreement between theory and observation is obtained when a vertical electron-ion drift velocity is considered. See also 3473 of 1957.

**551.510.535** 129  
**On the World Wide Distribution of f<sub>o</sub>F<sub>2</sub>**—H. Shibata. (*J. Radio Res. Labs., Japan*, vol. 5, pp. 235-256; July, 1958.) The coefficients *a* and *b* in the relation f<sub>o</sub>F<sub>2</sub> = *aR* + *b*, where *R* = sunspot number, are separated into components which are constant and those which vary diurnally and annually (see 2410 of 1958). Examination of these components for 47 stations shows a geomagnetic latitude control of the constant component while there is no significant difference between control by geomagnetic or geographic latitude for the varying components.

**551.510.535:523.7:621.396.11** 130  
**Solar-Cycle Influence on the Lower Ionosphere and on VHF Forward Scatter**—C. Ellyett and H. Leighton. (*Proc. IRE*, vol. 46, pp. 1711-1716; October, 1958.) Seven years' results at 49.8 mc for the Cedar Rapids-Sterling path (1243 km) have been analysed to determine the effect of the solar cycle. The monthly median signal intensity for the noon and afternoon period is found to follow the same trend as the sunspot number and the magnetic disturbance index.

**551.510.535:523.78** 131  
**Ionospheric Observations made at Freiberg during the Solar Eclipse of 30th June 1954**—R. Busch, E. Harnishmacher, and K. Rawer. (*Ann. Géophys.*, vol. 12, pp. 1-15; January-March, 1956.)

**551.510.535:525.624** 132  
**Lunar Tides in E<sub>s</sub> at Brisbane**—A. D. Gazard. (*Aust. J. Phys.*, vol. 11, p. 272; June, 1958.) See also 1717 of 1956 (Thomas and Svenson).

**551.510.535:550.38** 133  
**The Magnetic Field in the F<sub>2</sub> Layer at Dakar**—K. Suchy and P. Vila. (*Ann. Géophys.*, vol. 12, pp. 277-282; October-December, 1956.) The gyrofrequency is calculated from observed values of f<sub>o</sub> and f<sub>x</sub>, and its variations as a function of reflection height and time are analyzed.

**551.510.535:550.385** 134  
**Anomalous Changes in the Ionosphere Related to a Severe Magnetic Storm, Oct. 28,**

1951—T. Obayashi. (*J. Radio Res. Labs., Japan*, vol. 5, pp. 213-225; July, 1958.) Examination of world-wide geomagnetic and ionospheric data shows the existence of a short-lived electrojet stream with associated anomalous changes in F<sub>2</sub>-layer electron density. Two possible mechanisms are suggested: a) the formation of a new F<sub>2</sub> layer due to corpuscular streams, and b) the vertical drift of electrons resulting from interaction of the geomagnetic field with currents in the F<sub>2</sub> layer returning from the main electrojet in the E region. See also 3139 of 1957 (Sato).

**551.510.535:621.396.11** 135  
**F<sub>2</sub> Layer Deduced from the "Frequency Spectrum" of Radio-Propagation Q Figures at Long-Distance Routes**—T. Obayashi. (*J. Radio Res. Labs., Japan*, vol. 5, pp. 227-234; July, 1958.) The hourly radio-propagation quality figures for WWV, received at many stations in Canada, were used as basic data. Assuming a suitable height for the F<sub>2</sub> layer, its critical frequency at the reflection point of a transmission path could be obtained. The values calculated compared fairly well with those obtained from vertical incidence soundings provided the correct mode of propagation had been used for the transmission path. This analysis was also carried out during magnetic storms where no vertical-incidence observations were obtainable.

**551.524.1** 136  
**Thermal Structures in the Lowest Layers of the Atmosphere**—R. J. Taylor. (*Aust. J. Phys.*, vol. 11, pp. 168-176; June, 1958.) Temperature variations recorded simultaneously at heights of 1.5, 4, 16, and 30 m were examined statistically; correlation between a pair of such records was greatest at a time-displacement depending on wind speed difference between the two heights. The evidence suggests organized thermal structures of great vertical extent.

**551.594.5** 137  
**The Geometry of Auroral Ionization**—R. S. Unwin. (*J. Geophys. Res.*, vol. 63, pp. 501-506; September, 1958.) "New evidence is presented which shows that VHF radio echoes from auroral ionization are reflections from aspect-sensitive columns aligned with the earth's magnetic field."

**551.594.5** 138  
**Displacements of the Radiant Point during the Auroral Disturbance of September 22, 1957**—W. N. Abbott. (*Can. J. Phys.*, vol. 36, pp. 643-648; June, 1958.) Photographs of auroral corona enabled the position of the radiant point and its motion to be determined accurately. The motion was unrelated to the displacement of the magnetic zenith as determined from measurements on the ground.

**551.594.5:523.164.3** 139  
**Auroral Radiation at 500 Mc/s**—T. R. Hartz. (*Can. J. Phys.*, vol. 36, pp. 677-682; June, 1958.) Observations of RF-noise emissions from aurorae were made during a type-A red auroral display on October 21-22, 1957. This unusual display was linked to a large flare on the sun some 30h earlier. Theoretical considerations indicate that a large particle flux would produce such auroral radio emission.

**551.594.5:621.396.11** 140  
**A Comparison of Radio Echoes from the Aurora Australis and Aurora Borealis**—D. P. Harrison and C. D. Watkins. (*Nature (London)*, vol. 182, pp. 43-44; July 5, 1958.) Observations of echoes on 4 m λ made at Halley Bay, Antarctica, for the period May-October, 1957 are compared with contemporary observations made at Jodrell Bank. The great aurorae of the northern hemisphere are probably accompanied by greatly enhanced simultaneous activity of aurora australis.

**551.594.5:621.396.11.029.6** 141  
**V.H.F. Observations on the Aurora Australis**—T. J. Seed. (*J. Geophys. Res.*, vol. 63, pp. 517-526; September, 1958.) An investigation of radar echoes at 69 mc is reported. The range exponent in the radar equation is calculated as 2.15 ± 0.22, and a maximum value of reflection coefficient was 1.7 ± 10<sup>-7</sup>. Mechanisms of reflection are discussed, and only those involving column models are substantiated. See also 3466 of 1958 (Seed and Ellyett).

**551.594.6** 142  
**Some Properties of Lightning Impulses which Produce Whistlers**—R. A. Helliwell. (*Proc. IRE*, vol. 46, pp. 1760-1762; October, 1958.) Results obtained at Stanford, Calif., and Boulder, Colo., show that a characteristic waveform, having an intense energy peak near 5 kc, is frequently associated with the impulse which produces a whistler. Whistler-producing discharges appear to be more frequent over sea than over land. Identification of the causative impulse should be based on waveform analysis as well as the time of occurrence.

**551.594.6** 143  
**Polarization of Atmospheric Pulses due to Successive Reflections from the Ionosphere**—B. A. P. Tantry and R. S. Srivastava. (*J. Geophys. Res.*, vol. 63, pp. 527-538; September, 1958.) Explanations are offered of the more complex patterns observed on a crossed-loop crt direction finder for atmospheric. In addition to the normal straight-line display of an atmospheric pulse, elliptic traces or groups of straight lines within a small angle are produced. Elliptic traces are explained by polarization at ionospheric reflection, and groups by radiation from branch points in a nearly horizontal cloud-to-cloud lightning flash. See also 2420 of 1958 (Khashtgir) and 3822 of 1958 (Hornder and Khashtgir).

**551.594.6:523.746** 144  
**Solar Activity and Whistler Dispersion**—G. McK. Allcock and M. G. Morgan. (*J. Geophys. Res.*, vol. 63, pp. 573-576; September, 1958.) The time delay between the occurrence of a local lightning flash and the beginning of the associated whistler is correlated with the monthly mean sunspot number. The correlation coefficient is greatest when the sunspot number is related to whistler measurements made 1.5 months later.

#### LOCATION AND AIDS TO NAVIGATION

**621.396.93(94)** 145  
**A New Receiver for the Australian D.M.E. Beacon**—B. R. Johnson. (*Proc. IRE, Aust.*, vol. 18, pp. 423-430; November, 1957.) The receiver described operates at 206 mc, has a triggering sensitivity of 3 μV and echo suppression by instantaneous AGC. Performance figures and the results of field trials are given. See also 3470 of 1958 (Stern).

**621.396.933** 146  
**Modified Transceivers Compute Distance**—H. Vantine, Jr., and E. C. Johnson. (*Electronics*, vol. 31, pp. 94-98; September 12, 1958.) Two communications transceivers operating on a common frequency form an interrogator-responder system between an aircraft and the ground. The time delay between the transmitted and received pulses allows distances to be measured to within ±0.1 mile. Circuit details are given.

**621.396.96:551.501.8** 147  
**Commercial Airborne Weather Radar**—Al W. Vose and F. V. Wilson. (*RAA Rev.*, vol. 19, pp. 187-207; June, 1958.) Factors relating to the detection and penetration of atmospheric precipitation at microwave frequencies are discussed. Technical design features of both 5.6-cm weather penetration and 3.2-cm weather



avoidance radars in present-day commercial aircraft are described.

621.396.96:621.396.822 148

**A Proposed Technique for the Improvement of Range Determination with Noise Radar**—G. L. Turin. (PROC. IRE, vol. 46, pp. 1757–1758; October, 1958.) A proposal by Bourret [see 3833 of 1958 (Hochstadt)] is discussed and it is suggested that the true range cannot be marked unequivocally owing to the infinite average power in the processed noise component.

#### MATERIALS AND SUBSIDIARY TECHNIQUES

535.37 149

**The Identification of Luminescent Complexes of Cadmium Iodide and Lead Iodide**—G. Monod-Herzen and Nguyen Chung-Tu. (Compt. rend. Acad. Sci., Paris, vol. 246, pp. 2247–2250; April 14, 1958.)

535.37:537.58 150

**Cathodoluminescence of Strontium Oxide, Barium-Strontium Oxide, and Magnesium Oxide**—H. W. Gandy. (Phys. Rev., vol. 111, pp. 764–771; August 1, 1958.) A study of the spectral and time decay properties of the cathode-luminescence of samples in the spectral range 220–600 m $\mu$ , for temperatures from 90°K to above room temperature.

535.376 151

**Electroluminescence and its Applications**—J. N. Bowtell. (J. IEE, vol. 3, pp. 454–459; August, 1957.) Characteristics of the more important colored phosphors are given and the limitations in their application are discussed.

535.376:546.472.21 152

**Effects of Impurities and Temperature on the Spectra of Electroluminescence**—R. Huzimura and T. Sidei. (J. Phys. Soc. Japan, vol. 13, pp. 1064–1065; September, 1958.) Results are given of measurements on ZnS with impurities of Cu and Pb. See also 781 of 1956 (Alfrey and Taylor).

537.226/.228.1 153

**Ferroelectric Crystals and Ceramics**—J. M. Herbert. (J. Electronics Control, vol. 5, pp. 168–192; August, 1958.) A comprehensive review of the structure, properties and applications, particularly of BaTiO<sub>3</sub>. Over 30 references.

537.226/.228.1 154

**Properties, Appraisal and Selection of Ferroelectric Materials**—B. Lewis. (Brit. Commun. Electronics, vol. 5, pp. 332–337; May, 1958.)

537.226/.227:546.431.824–31 155

**Some Experiments on the Motion of 180° Domain Walls in BaTiO<sub>3</sub>**—R. C. Miller. (Phys. Rev., vol. 111, pp. 736–739; August 1, 1958.)

537.227/.228.1:546.431.824–31 156

**Primary Pyroelectricity in Barium Titanate Ceramics**—T. A. Perls, T. J. Diesel, and W. I. Dobrov. (J. Appl. Phys., vol. 29, pp. 1297–1302; September, 1958.) It is established experimentally that the total pyroelectric effect in polycrystalline BaTiO<sub>3</sub> ceramic is opposite in direction to the piezoelectric contribution arising from volumetric changes caused by thermal expansion and contraction. There must therefore exist a primary pyroelectric effect which, at room temperature, is about twice the piezoelectric contribution.

537.227 157

**Study of the Second-Order Ferroelectric Transition in Triglycine Sulphate**—S. Triebwasser. (IBM J. Research Develop., vol. 2, pp. 212–217; July, 1958.) See also 1105 of 1957 (Matthias et al.).

537.227:546.431.825–31 158

**Some Features of the Domain Structure of Ferroelectrics Shown by Electron-Microscope Observation**—G. V. Spivak, E. Igras, and I. S. Zheludev. (Dokl. Ak. Nauk S.S.S.R., vol. 122, pp. 54–57; September 1, 1958.) Investigation of BaTiO<sub>3</sub> single crystals, based on the different etch rates at the positive and negative ends of the electric dipole [see 2990 of 1955 (Hooten and Merz)]. Electron-microscope patterns obtained at magnifications up to 25,000 are shown.

537.227:546.431.824–31 159

**Phenomenological Theory of Polarization Reversal in BaTiO<sub>3</sub> Single Crystals**—C. F. Pulvari and W. Kuebler. (J. Appl. Phys., vol. 29, pp. 1315–1321; September, 1958.) The theory, based on a study of polarization reversal relates polarization  $P$ , switching field  $E$ , and switching time  $t$ , by an equation  $P=f(E, t)$ . The switching resistance, the time and field dependence of the switching current at constant temperature, and the dependence of coercive field on applied field and frequency are readily obtained.

537.227:546.431.824–31. 160

**Ultra-Low-Velocity Component of Spontaneous Polarization in BaTiO<sub>3</sub> Single Crystal**—K. Husimi. (J. Appl. Phys., vol. 29, pp. 1379–1380; September, 1958.) The spontaneous polarization of BaTiO<sub>3</sub> consists of two components: the high-velocity component of 26  $\mu\text{C}/\text{cm}^2$  and the ultra-low-velocity component of 18  $\mu\text{C}/\text{cm}^2$ . See also 3857 of 1958 (Husimi and Kataoka).

537.311.3:[537.32+538.6 161

**On the Galvanomagnetic, Thermomagnetic, and Thermoelectric Effects in Isotropic Metals and Semiconductors**—E. J. Moore. (Aust. J. Phys., vol. 11, pp. 235–254; June, 1958.) General expressions are obtained for metals and semiconductors which can be represented by the two-band model; the effects involve time-independent electric fields, magnetic fields, and thermal gradients. Emphasis is placed on experimentally and theoretically important coefficients. Formulas are given for isothermal galvanomagnetic effects in the presence of an HF electric field and a time-independent magnetic field.

537.311.31:539.23 162

**Development of Electrical Resistance in Thin Films of Cobalt**—F. Savornin. (Compt. rend. Acad. Sci., Paris, vol. 246, pp. 2230–2233; April 14, 1958.)

537.311.33 163

**Intermetallic Semiconductors**—H. T. Minden. (Sylvania Technologist, vol. 11, pp. 13–25; January, 1958.) Methods of synthesis, purification and growth of compounds are described, properties are tabulated and some applications indicated.

537.311.33 164

**Low-Field Mobility of Carriers in Non-degenerate Semiconductors**—M. S. Sodha and D. B. Agrawal. (Can. J. Phys., vol. 36, pp. 707–710; June, 1958.) The theory of the low-field variation of carrier mobility is extended to include the effect of scattering by a single optical mode of lattice vibration. Numerical results obtained for  $n$ -type Ge indicate serious disagreement between theory and experiment.

537.311.33 165

**Diffusion across a Semiconductor-Vapour Interface**—R. Bullough, R. C. Newman, and J. Wakefield. (Proc. Phys. Soc., (London), vol. 72, pp. 369–379; September 1, 1958.) Theoretical solutions are derived for: a) diffusion outwards of an impurity into a finite volume with or without simultaneous pumping, and b) dif-

fusion inwards from a limited source of impurity, initially in the vapor phase, in a closed system. These results are discussed with reference to the diffusion of Groups III and V elements across germanium and silicon surfaces.

537.311.33:[546.28+546.289 166

**Routine Crystal Orientation of Germanium and Silicon by High-Intensity Reflectograms**—G. H. Schwuttke. (Sylvania Technologist, vol. 11, pp. 2–5; January, 1958.) The equipment described measures tilt angle quickly with an accuracy of  $\pm 0.5$  degrees of arc.

537.311.33:546.28 167

**Infrared Spectra of Heat Treatment Centres in Silicon**—H. J. Hrostowski and R. H. Kaiser. (Phys. Rev. Lett., vol. 1, pp. 199–200; September 15, 1958.)

537.311.33:546.28 168

**The Preparation of Single-Crystal Ingots of Silicon by the Pulling Technique**—E. Billig and D. B. Gasson. (J. Sci. Inst., vol. 35, pp. 360–365; October, 1958.) A description of the construction and operation of a laboratory furnace for preparing monocrystals of Si by a method which allows close observation of the growth front of the ingot during its preparation.

537.311.33:546.28:621.317.331 169

**An Apparatus for Measuring the Electrical Resistivity of Silicon**—Heasell, Howard, and Timmins. (See 214.)

537.311.33:546.289 170

**Effect of Crystal Growth Variables on Electrical and Structural Properties of Germanium**—F. D. Rosi. (RCA Rev., vol. 19, pp. 349–387; September, 1958.) Examination of dislocation etch-pit distribution revealed plastic deformation by octahedral slip in crystals grown by the Czochralski technique. The conditions affecting the dislocation density are thoroughly investigated. Additions of  $n$ - and  $p$ -type impurities within their limits of solid solubility had no significant effect on the dislocation density.

537.311.33:546.289 171

**Surface States on Germanium**—G. Wallis. (Sylvania Technologist, vol. 11, pp. 6–12; January, 1958.) The properties of slow and fast surface states on etched Ge are reviewed and some methods of investigating the states are presented.

537.311.33:546.289 172

**Experiment Showing the Influence of Surfaces on 1/f Noise in Germanium**—J. J. Brophy. (J. Appl. Phys., vol. 29, pp. 1377–1378; September, 1958.) An attempt to measure the effect of changing the surface/volume ratio on 1/f noise was unsuccessful because of other surface effects. It was shown that etched surfaces are noisier than sanded surfaces by a factor of about 40.

537.311.33:546.289 173

**Normal Modes of Germanium by Neutron Spectrometry**—B. N. Brockhouse and P. K. Iyengar. (Phys. Rev., vol. 111, pp. 747–754; August 1, 1958.) The frequency wave-number of the lattice vibrations in Ge which propagate in the symmetric [100] and [111] directions were obtained by studying energy distributions of neutrons scattered by a Ge single crystal. A description of the methods of ascertaining the character of the phonons is given together with a discussion of the results.

537.311.33:546.289 174

**Piezoresistance in Heavily Doped  $n$ -Type Germanium**—M. Pollak. (Phys. Rev., vol. 111, pp. 798–802; August 1, 1958.) Piezoresistance has been measured as a function of temperature

- in *n*-type Ge specimens with donor concentrations between  $6 \times 10^{15} \text{ cm}^{-3}$  and  $3 \times 10^{19} \text{ cm}^{-3}$ . The results obtained are explained on the basis of the accepted multivalley model, provided that statistical degeneracy is taken into account. An analysis of the degeneracy observed in the data provides strong evidence for the four-ellipsoid model of the conduction band.
- 537.311.33:546.289** 175  
**On the Hot-Electron Effect in *n*-Type Germanium**—R. Stratton. (*J. Electronics Control*, vol. 5, pp. 157–161; August, 1958.) The variation of the mobility with an applied electric field is calculated, assuming that inter-electronic collisions are predominant. The scattering of electrons by acoustic and by non-polar optical modes of lattice vibrations is considered without restricting the treatment to cases where the mean electron energy is greater than the phonon energy. Good agreement is obtained between the theory and experimental data. See also 1768 of 1958.
- 537.311.33:546.289** 176  
**Infrared Absorption of Photogenerated Free Carriers in Germanium**—L. Huldt and T. Staffin. (*Phys. Rev. Lett.*, vol. 1, pp. 236–237; October 1, 1958.) Preliminary account of a study of surface recombination and hole concentration in Ge produced by the absorption of radiation of different wavelength ranges.
- 537.311.33:546.289** 177  
**Effect of Chemical Impurities on X-Ray Integrated Intensities in nearly Perfect Germanium**—B. W. Batterman. (*Phys. Rev. Lett.*, vol. 1, pp. 228–229; October 1, 1958.)
- 537.311.33:546.289:537.322.4** 178  
**Seebeck Effect Fluctuations in Germanium**—J. J. Brophy. (*Phys. Rev.*, vol. 111, pp. 1050–1052; August 15, 1958.) Fluctuations in the thermoelectric power of Ge single crystals have been observed. The Seebeck noise-power spectrum varies inversely with frequency and may be quantitatively predicted from current-noise measurements. The results indicate that carrier fluctuations having a  $1/f$  spectrum persist even in the absence of net dc flow.
- 537.311.33:546.682.86** 179  
**Electrical Conductivity in *p*-Type InSb under Strong Electric Field**—Y. Kanai. (*J. Phys. Soc. Japan*, vol. 13, pp. 1065–1066; September, 1958.) Results indicate the presence of holes with mobilities ten times greater than that of electrons.
- 537.311.33:546.682.86:537.228.1** 180  
**Piezoelectric Effect in Indium Antimonide**—J. H. Wasilik and R. B. Flippen. (*Phys. Rev. Lett.*, vol. 1, pp. 233–234; October 1, 1958.) Note on qualitative observations of piezoelectric resonances at the first and third harmonics of thickness vibrations in two InSb plates, the measurements being taken at 78°K and 4.2°K where the resistances of the samples were large.
- 537.311.33:546.817.221** 181  
**Mobility of Electrons and Holes in PbS, PbSe, and PbTe between Room Temperature and 4.2°K**—R. S. Allgaier and W. W. Scanlon. (*Phys. Rev.*, vol. 111, pp. 1029–1037; August 15, 1958.) Hall coefficient and resistivity measurements were made on 29 single crystals between room temperature and 4.2°K. Hall mobilities were calculated from the Hall coefficients and resistivity data and were found to increase rapidly with decreasing temperature. Between room temperature and about 50°K the mobility behavior was essentially intrinsic and varied approximately as  $T^{-2.2}$ . A possible explanation of the large mobilities at low temperatures is discussed.
- 537.331.33:546.873.241** 182  
**Magnetothermal Resistance and Magneto-thermoelectric Effect in Bismuth Telluride**—A. E. Bowley, R. Delves, and H. J. Goldsmid. (*Proc. Phys. Soc.*, vol. 72, pp. 401–410; September 1, 1958.) These effects have been measured in *p*-type and *n*-type  $\text{Bi}_2\text{Te}_3$  at 77°K. Scattering laws for the charge carriers have been derived from the results for *p*-type material, but no simple law fits the results from the magnetothermal resistance effect in *n*-type material.
- 537.311.33:546.873.241** 183  
**Galvanomagnetic Effects in *p*-Type Bismuth Telluride**—J. R. Drabble. (*Proc. Phys. Soc.*, vol. 72, pp. 380–390; September 1, 1958.) The resistivity components, Hall coefficients, and low-field magnetoresistance coefficients have been measured on single-crystal specimens at 77°K. The results are consistent with a many-valley form of the valence band. See also 2151 of 1958 (Drabble *et al.*).
- 537.311.33:621.314.63** 184  
**Solid-State Diffusion applied to Semiconductor Devices**—M. Darmony and B. Dreyfus-Alain. (*Rev. tech. Comp. franç. Thomson-Houston*, No. 27, pp. 37–49; December, 1957.) Theoretical and practical aspects of diffusion are considered and three techniques described. Some data of a prototype Si solar battery are given.
- 537.311.33:621.314.632** 185  
**On Electron-Hole Transition in Point-Contact Solid Rectifiers**—V. G. Mel'nik, I. G. Mel'nik, and S. S. Gutin. (*Dokl. Ak. Nauk. S.S.S.R.*, vol. 121, pp. 852–854; August 11, 1958.) Investigation of physical phenomena occurring in Ge and Si point-contact diodes under pulse conditions. Oscillograms of the thermo-EMF on heating to 500–600°C and  $V/I$  characteristics indicate the presence of two regions of different types of conductivity forming a *p-n* junction.
- 537.311.33:621.314.7** 186  
**On Avalanche Multiplication in Semiconductor Devices**—H. L. Armstrong. (*J. Electronics Control*, vol. 5, pp. 97–104; August, 1958.) The current multiplication and resulting characteristics are derived in general terms for the depletion region, and the conclusions applied to an intrinsic depletion region, an abrupt junction and a linear junction. Avalanche multiplication in an undepleted semiconductor carrying heavy currents should be similar to that observed for depletion regions.
- 537.311.33:621.314.7** 187  
**Metallographic Aspects of Alloy Junctions**—A. S. Rose. (*RCA Rev.*, vol. 19, pp. 423–432; September, 1958.) The presence of oxide films on the Ge and In surfaces of large-area junctions leads to nonplanar alloying, irregular Ge regrowth and unwetted areas. These effects can be minimized by using Ge crystals having very low dislocation densities, and by thermal deoxidation.
- 538.22** 188  
**Multispin Axis Structures for Antiferromagnets**—W. L. Roth. (*Phys. Rev.*, vol. 111, pp. 772–781; August 1, 1958.) Neutron diffraction intensities have been computed for antiferromagnetic spin arrangements in the rock-salt type structure. By assuming the crystal consists of domains with a common magnetic axis the experimental results can be accounted for quantitatively. See also 3541 of 1958.
- 538.22** 189  
**Nonmagnetic Ions in an Antiferromagnetic**—K. F. Niessen. (*Philips Res. Rep.*, vol. 13, pp. 327–334; August, 1958.) An experimental method is described for determining the distribution of a relatively small number of foreign nonmagnetic ions between the two sublattices of an antiferromagnetic.
- 538.22** 190  
**Magnetic Susceptibility of Copper-Nickel and Silver-Palladium Alloys at Low Temperatures**—E. W. Pugh and F. M. Ryan. (*Phys. Rev.*, vol. 111, pp. 1038–1042; August 15, 1958.)
- 538.221** 191  
**Direct Observation of Spin-Wave Resonance**—M. H. Seavey, Jr. and P. E. Tannenwald. (*Phys. Rev. Lett.*, vol. 1, pp. 168–169; September 1, 1958.) The direct observation of spin-wave resonances in a 5600 Å film of permalloy is described, the exchange constant being determined from the location of the spin-wave peaks. See also 3544 of 1958 (Kittel).
- 538.221** 192  
**Ferromagnetic Domain Structure as Affected by the Uniaxial Anisotropy Induced in a 40 Percent Co-Ni Single Crystal**—M. Yamamoto, S. Taniguchi, and K. Aoyagi. (*Sci. Rep. Res. Inst. Tohoku Univ., Ser. A.*, vol. 10, pp. 20–33; February, 1958.) Changes in structure which occur after quenching lead to the conclusion that the perminvar-type magnetic properties are due to the stabilization of domain walls by the induced uniaxial anisotropy in face-centered cubic solid solutions with cubic anisotropy constants of any sign and body-centered cubic solid solutions with negative cubic anisotropy constants.
- 538.221** 193  
**Temperature Dependence of Magnetic Properties of Silicon-Iron**—C. W. Chen. (*J. Appl. Phys.*, vol. 29, pp. 1337–1343; September, 1958.) Permeability, coercive force, remanence, hysteresis and core losses of 3 per cent singly oriented Si-Fe alloy were measured within the temperature range 30–700°C.
- 538.221:537.222.4** 194  
**Direct Measurement of the Velocity of Propagation of a Ferromagnetic Domain Boundary in "Perminvar"**—E. W. Lee and D. R. Callaby. (*Nature (London)*, vol. 182, pp. 254–255; July 26, 1958.) Report of measurements made on thin rings of magnetically annealed perminvar, using the magneto-optic Kerr-effect technique described earlier [3415 of 1958 (Lee *et al.*)] with a double-slit light source.
- 538.221:537.312.62** 195  
**On the Absence of Superconductivity in Ferromagnetics**—S. V. Vonsovskii and M. S. Svirskii. (*Dokl. Ak. Nauk. S.S.S.R.*, vol. 122, pp. 204–207; September 11, 1958.) Theoretical investigation showing that superconductivity can only occur in ferromagnetic metals where electron interaction is very weak.
- 538.221:[621.318.12+621.318.13]:539.169** 196  
**Radiation Effects in Magnetic Materials**—D. I. Gordon, R. S. Sery, and R. E. Fischell. (*Nucleonics*, vol. 16, pp. 73–77; June, 1958.) Percentage changes in magnetic properties are tabulated for seven commercial-type materials which had been irradiated.
- 538.221:621.318.13** 197  
**Analytical Theory of the Behaviour of Ferromagnetic Materials**—G. Biorci and D. Pescetti. (*Nuovo Cim.*, vol. 7, pp. 829–842; March, 16, 1958. In English.) Using a procedure based on the Preisach model of hysteresis [see *e.g.* 842 of 1957 (Fel'dtkeller and Wilde)], it is shown that every transformation in the *J-H* plane can be computed from the magnetization curve and saturation loop of the material. Experimental and theoretical results are in close agreement.



- 538.221:621.318.134 198  
**Microwave and Low-Frequency Oscillation due to Resonance Instabilities in Ferrites**—M. T. Weiss. (*Phys. Rev. Lett.*, vol. 1, pp. 239-241; October 1, 1958.) Microwave and LF oscillations were observed in single-crystal yttrium iron garnet discs. An explanation of the effect is given.
- 538.221:621.318.134 199  
**Crystal Structure and Ferrimagnetism in NiMnO<sub>3</sub> and CoMnO<sub>3</sub>**—W. H. Cloud. (*Phys. Rev.*, vol. 111, pp. 1046-1049; August 15, 1958.) The position of the atoms in the unit cell has been determined and it is shown that there are two Ni-O-Mn configurations favorable to magnetic superexchange interactions.
- 538.221:621.318.134 200  
**Observation of Domains in the Ferrimagnetic Garnets by Transmitted Light**—J. F. Dillon, Jr. (*J. Appl. Phys.*, vol. 29, pp. 1286-1291; September, 1958.) Light transmitted through sections of ferrimagnetic garnets about 0.005 cm thick undergoes a Faraday non-reciprocal rotation of the plane of polarization. This property enables the magnetic domain structure, at temperatures below the Curie point, to be studied with a polarizing microscope.
- 538.221:621.318.134 201  
**Magnetoacoustic Resonance in Yttrium Iron Garnet**—E. G. Spencer and R. C. LeCraw. (*Phys. Rev. Lett.*, vol. 1, pp. 241-243; October, 1958.)
- 538.221:621.385.833 202  
**The Variation with Temperature of the Magnetic Leakage Field in Cobalt**—M. Blackman and F. Grünbaum. (*Proc. Roy. Soc. Ser. A*, vol. 245, pp. 408-416; June 24, 1958.) Both the prism and hexagonal faces of an unmagnetized crystal were examined in the temperature range 20°-380°C by a new method using a divergent electron beam. The prism face was also studied from +20°C to -170°C. See also 1483 of 1958.
- 538.23:538.221 203  
**On the Effect of Coupling between Grains of Ferromagnetic Material having Hysteresis Properties**—L. Néel. (*Compt. rend. Acad. Sci., Paris*, vol. 246, pp. 2313-2319; April 21, 1958.) The properties of an assembly of couples, each formed by two interacting ferromagnetic grains, are examined. It is shown that in such a system two successive cycles of a field  $H$  do not necessarily give rise to the same magnetization.
- 538.23:538.221 204  
**Creep of Asymmetric Hysteresis Cycles as a Function of the Number of Cycles Described**—Nguyen Van Dang. (*Compt. rend. Acad. Sci., Paris*, vol. 246, pp. 2357-2359; April 21, 1958.) It is shown experimentally that whatever the initial condition, creep is approximately proportional to  $(\log n)^{1/2}$  provided the number of cycles  $n$  is greater than 20. This confirms Néel's theoretical work (see 3109 and 3110 of 1957).
- 548.0:[549.514.51+546.289-31 205  
**Infrared Studies on Polymorphs of Silicon Dioxide and Germanium Dioxide**—E. R. Lippincott, A. Van Valkenburg, C. E. Weir, and E. N. Bunting. (*J. Res. NBS*, vol. 61, RP 2885, pp. 61-70; July, 1958.)
- 549.514.51:621.372.412 206  
**Thermoelastic Loss in Quartz Vibrators**—H. Iwasaki. (*J. Radio Res. Labs., Japan*, vol. 5, pp. 257-279; July, 1958.)
- 537.311.33:[537.32+536.21 207  
**Semiconductor Thermoelements and Thermolectric Cooling. [Book Review]**—A. F. Ioffe. (Translated from the Russian.) Publishers: Infosearch, London, 1957, 184 pp., 42s. (*Nature (London)*, vol. 182, pp. 72-73; July 12, 1958.) A combination of two earlier works, on the basic theory of thermojunctions and their application to refrigeration, including examples of practical units for power supply.
- MATHEMATICS**
- 517.5:53.087 208  
**Experiments in the Smoothing of Data**—M. Lotkin. (*Quart. Appl. Math.*, vol. 16, pp. 169-173; July, 1958.) The effects of function smoothing and argument smoothing, and a combination of the two, are investigated for a few particular simple functions.
- 517.948.34 209  
**Errors in the Solution of Integral Equations**—P. Moon and D. E. Spencer. (*J. Franklin Inst.*, vol. 264, pp. 29-41; July, 1957.) A novel method of solving integral equations is presented. An analytic solution is obtained by exponential approximation of the kernel, and to this solution is added the solution of an auxiliary integral equation.
- 519.2:621.396.822 210  
**Generalized Rayleigh Processes**—K. S. Miller, R. I. Bernstein, and L. E. Blumenson. (*Quart. Appl. Math.*, vol. 16, pp. 137-145; July, 1958.) The generalized Rayleigh process  $R$  is defined by  $R = (X_1^2 + X_2^2 + \dots + X_N^2)^{1/2}$ , where  $X_1, X_2, \dots, X_N$  are  $N$  independent Gaussian processes. The following properties of  $R$  are calculated: the first order distribution function, the joint probability density, the correlation function, and the three-dimensional distribution.
- MEASUREMENTS AND TEST GEAR**
- 537.228.1:548.0].001.4 211  
**Methods of Measurement of the Parameters of Piezoelectric Vibrators**—E. A. Gerber and L. F. Koerner. (*Proc. IRE*, vol. 46, pp. 1731-1737; October, 1958.) The theory underlying the measurements specified in Standard 57 IRE 14.S1 (1788 of 1957) is discussed. See also 1437 of 1951 (Koerner).
- 621.3.018.41(083.74):529.786 212  
**Comparison of Caesium Frequency Standards of Different Construction**—L. Essen, J. V. L. Parry, J. I. Holloway, W. A. Mainberger, F. H. Reder, and G. M. R. Winkler. (*Nature (London)*, vol. 182, pp. 41-42; July 5, 1958.) The frequency of two "atomichrons," Nos. 111 and 117, and one experimental tube No. 857X1 operated with the electronics and servo system of No. 111, have been compared at Teddington with the NPL standard. Final results of the comparison, with corrections applied for errors in the servo and electronics system and for asymmetry of resonance, show the mean frequency difference to be respectively,  $(2.2 \pm 1.4)$ ,  $(3.2 \pm 1.4)$  and  $(1.5 \pm 1.4)$  in  $10^{-10}$ .
- 621.317.3:538.632:549.351.12 213  
**Measurement of the Hall Effect in Anisotropic Media by the Point Method**—M. Wintemberger. (*Compt. rend. Acad. Sci., Paris*, vol. 246, pp. 2366-2369; April 21, 1958.) Valdes' four-probe method may be applied to the measurement of Hall effect, e.g., in CuFeS<sub>2</sub>. See also 2827 of 1957.
- 621.317.331:537.311.33:546.28 214  
**An Apparatus for Measuring the Electrical Resistivity of Silicon**—E. L. Heasell, N. R. Howard, and E. W. Timmins. (*B.T.H. Activ.*, vol. 29, pp. 147-149; July/August, 1958.) Equipment based on the four-point probe method [1502 of 1954 (Valdes)] is described.
- 621.317.335:621.391 216  
**Uniform Transient Error**—E. L. R. Corliss. (*J. Res. NBS*, vol. 61, RP 2879, pp. 25-30; July, 1958.) "Equations describing error in power-level measurements of transients can be used to compute the design of analysers so as to distribute transient error in a way compatible with experimental requirements. In addition, consideration of a limiting power-discrimination factor provides a measure of the largest number of band-pass filters that can be overlapped on adjacent channels to yield meaningful information about a rapidly changing signal." See also 3168 of 1954 (Chang).
- 621.317.373 217  
**Coincident Slicer Measures Phase Directly**—Y. P. Yu. (*Electronics*, vol. 31, pp. 99-101; September 12, 1958.) The phase angle between two voltages can be read with an absolute accuracy of 1 degree and a relative accuracy of  $\frac{1}{4}$  degree. The output meter reading is independent of signal amplitudes in the range 0.3-70 V and of supply voltage variations of  $\pm 20$  per cent.
- 621.317.42 218  
**An Electrodynamic Magnetic Field Gradiometer employing a Microvibration Technique**—Y. L. Yousef and H. Mikhail. (*J. Sci. Instr.*, vol. 35, pp. 375-377; October, 1958.) The instrument utilizes the alternating electrodynamic forces experienced by a small probe coil fed by a low-frequency voltage. Magnetic field inhomogeneity can be measured to an accuracy of at least  $10^{-3}$  G/cm.
- 621.317.616 219  
**An Amplitude/Frequency Response Display using a Radio Method**—H. L. Mansford, K. M. I. Khan, and D. T. A. Margetts. (*Electronic Eng.*, vol. 30, pp. 541-544 and 595-597; September and October, 1958.) A method is outlined for balancing out the errors due to amplitude variations of the test signal from a frequency-sweep signal generator operating over a wide video-frequency range. A domestic television receiver is modified by turning the deflection coils through 90 degrees to show a vertical raster. Brightness modulation from 0.5  $\mu$ s pulses gives spots on the raster which trace the curves to be displayed. Full circuit details are given.
- 621.317.73.029.6:621.372.8 220  
**An Automatic Swept-Frequency Impedance Meter**—J. A. C. Kinnear. (*Brit. Commun. Electronics*, vol. 5, pp. 359-361; May, 1958.) The instrument measures the waveguide impedance in an appropriate reference plane and displays it on a crt screen.
- 621.317.74:621.372.8 221  
**A Production Testing Equipment for Microwave Components and Systems**—J. Welsh. (*Brit. Commun. Electronics*, vol. 5, pp. 438-439; June, 1958.) The equipment described is based on the rotary standing-wave indicator [203 of 1955 (Cohn)], but has no moving parts. The frequency band is 3.2 cm  $\pm 5$  per cent and the indicated SWR is within  $\pm 0.02$  of that measured using a slotted-line indicator.
- 621.317.74:621.396.65:621.376.3 222  
**A Portable Instrument for Measurements on Intermediate-Frequency Level on Fre-**



**quency-Modulated Microwave Radio Links**—J. W. A. van der Scheer. (*Tijdschr. ned. Radio-geenot.*, vol. 22, pp. 359-373; November, 1957. In English.) Measurements are carried out in the IF band in the ranges 60-80 or 95-115 mc and cover amplitude and group-delay variations as a function of frequency, discriminator linearity, and reflection coefficients.

**621.317.784.029.64** 223  
**A Double-Vane Torque-Operated Wattmeter for 7000 Mc/s**—S. Okamura, S. Kanzaki, S. Kurokawa, and G. Kondo. (*J. Radio Res. Labs., Japan*, vol. 5, pp. 157-163; July, 1958.) An instrument developed from the basic design of Cullen [1082 of 1953 (Cullen & Stephenson)] is described and compared with a barretter-type wattmeter.

#### OTHER APPLICATIONS OF RADIO AND ELECTRONICS

**535.376** 224  
**The Sylvatron: A New Application of Electroluminescence**—K. H. Butler and F. Koury. (*Sylvania Technologist*, vol. 10, pp. 98-101; October, 1957.) Three types of display device are described which incorporate a ceramic type of electroluminescent lamp [see 3636 of 1954 (Butler *et al.*)].

**535.376.07** 225  
**ELF—a New Electroluminescent Display**—E. A. Sack. (*Proc. IRE*, vol. 46, pp. 1694-1699; October, 1958.) A flat-screen display unit is described which uses ferroelectric ceramics with an electroluminescent layer to provide high brightness, flexible storage and fast writing speeds. Luminances greater than 25 foot-lamberts and contrast ratios of 50:1 have been obtained. Model screens with ten elements per inch and a scanning system for  $\mu$ s switching rates have been constructed.

**551.508.822** 226  
**Methods for the Calculation of Radiation Errors of Radiosondes**—W. D. Reshetov. (*Z. Met.*, vol. 12, pp. 46-50; January/February, 1958.)

**621.362:621.385.2** 227  
**Thermionic Diodes as Energy Converters: an Addendum**—Feaster. (See 324.)

**621.362:621.385.2** 228  
**Thermionic Energy Converter**—Hernqvist, Kanefsky and Norman. (See 325.)

**621.373.44:615.475** 229  
**A Versatile Stimulator**—R. H. Kay, C. G. Phillips, and R. H. Teal. (*Electronic Eng.*, vol. 30, pp. 575-578; October, 1958.) Conventional techniques are used to obtain various delayed positive- or negative-going pulse trains primarily intended for neuro-physiological research. The pulse width is variable from 0.1 to 100 ms and the train duration from 10 ms to 10 s. Full circuit diagrams are given. See also 1206 of 1950 (Attree).

**621.375.2.029.4:612.014.421** 230  
**The Sensitivity of Low-Frequency Valve Amplifiers for Electromyography**—A. Nightingale. (*J. Sci. Instr.*, vol. 35, pp. 366-371; October, 1958.) The sources of noise in LF amplifiers are discussed and experimental results are given for various valve types for the frequency range 2 cps-16 kc.

**621.383.4:612.84** 231  
**Photovoltaic Pile**—I. Levin. (*Nature (London)*, vol. 182, pp. 44-45; July 5, 1958.) A multiple-point voltaic cell in which all the individual electrodes are connected in series has been made by modifying the retinal type of cell described earlier (2846 of 1958).

**621.387.464** 232  
**Scintillation Counting—1958**—(*Nucleonics*, vol. 16, pp. 54-62; June, 1958.) Review based on papers presented at the 6th Scintillation Counter Symposium, Washington, D. C., January 27-28, 1958.

#### PROPAGATION OF WAVES

**621.396.11:550.372** 233  
**Further Studies of the Influence of a Ridge on the Low-Frequency Ground Wave**—J. R. Walt and A. Murphy. (*J. Res. NBS*, vol. 61, RP 2884, pp. 57-60; July, 1958.) "Computations are presented in graphical form for the perturbation of a plane wave by a semicylindrical boss on an otherwise flat ground plane of perfect conductivity. The height of the ridge is comparable to the wavelength. This is an extension of earlier work [2571 of 1957] on the semi-elliptical boss."

**621.396.11:551.510.52** 234  
**Some Aspects of Tropospheric Radio Wave Propagation**—A. P. Barsis. (*IRE TRANS. ON BROADCAST TRANSMISSION SYSTEMS*, vol. BTS-6, pp. 1-10; October, 1956. Abstract, *Proc. IRE*, vol. 45, p. 112; January, 1957.)

**621.396.11:551.510.52** 235  
**Antenna-to-Medium Coupling Loss**—H. Staras. (*IRE TRANS. ON ANTENNAS AND PROPAGATION*, vol. AP-5, pp. 228-231; April, 1957.) Abstract, *Proc. IRE*, vol. 45, p. 895; June, 1957.)

**621.396.11:551.510.535** 236  
**Radio Scattering Expressed in Terms of the Spectrum of Turbulent Fluctuation in the Ionosphere**—K. Tao. (*J. Radio Res. Labs., Japan*, vol. 5, pp. 95-103; April, 1958.) A theoretical expression for the scattering cross section is compared with the results of Bailey's experiment (2581 of 1952), and a cross section  $\sigma = 2 \times 10^{-15} \text{ cm}^2$ , is obtained, taking the size of large eddies to be 1000 m and their velocity to be 30 m/sec. The frequency dependence of the scattering power is given. See also 3626 of 1957.

**621.396.11:551.510.535:523.7** 237  
**Solar-Cycle Influence on the Lower Ionosphere and on VHF Forward Scatter**—Ellyett and Leighton. (See 130.)

**621.396.11:621.372.2** 238  
**Return Loss: Part 3**—Roddam. (See 12.)

**621.396.11:621.396.674.3** 239  
**The Transient Behaviour of the Electromagnetic Ground Wave on a Spherical Earth**—J. R. Wait. (*IRE TRANS. ON ANTENNAS AND PROPAGATION*, vol. AP-5, pp. 198-202; April, 1957. Abstract, *Proc. IRE*, vol. 45, p. 894; June, 1957.)

**621.396.11.029.55** 240  
**A Long-Distance Pulse-Propagation Experiment on 20.1 Megacycles**—R. Silberstein. (*J. Geophys. Res.*, vol. 63, pp. 445-446; September, 1958.) The experiment was performed in October 1956 between Sterling, Va., and Maui, Hawaii (7647 km) to study MUF determination and mode structure. Oblique-incidence records were made at Boulder, Colo., (2370 km) as well as back-scatter measurements at the transmitter and vertical-incidence records along the route. Results showed greatly differing mode structures from day to day;  $M$  and  $N$  reflections and layer tilts were important. The long path was very sensitive to ionospheric conditions.

**621.396.11.029.6** 241  
**An Experimental Investigation of the Diffraction of Electromagnetic Waves by a Dominating Ridge**—J. H. Crysdale, J. W. B. Day, W. S. Cook, M. E. Psutka, and P. E. Robillard. (*IRE TRANS. ON ANTENNAS AND*

*PROPAGATION*, vol. AP-5, pp. 203-210; April, 1957. Abstract, *Proc. IRE*, vol. 45, pp. 894-895; June, 1957.)

**621.396.11.029.6** 242  
**The Dependence of Microwave Radio Signal Spectra on Ocean Roughness and Wave Spectra**—C. I. Beard and I. Katz. (*IRE TRANS. ON ANTENNAS AND PROPAGATION*, vol. APS-5, pp. 183-191; April, 1957. Abstract, *Proc. IRE*, vol. 45, p. 894; June, 1957.)

**621.396.11.029.62/63** 243  
**An Experimental Investigation of the Diffraction at V.H.F. and U.H.F. by Mountain Ridges**—M. Hirai, Y. Fujii, and H. Saito. (*J. Radio Res. Labs., Japan*, vol. 5, pp. 189-211; July, 1958.) Field-strength measurements have been made simultaneously at frequencies of 159 mc and 600 mc over a distance of 280 km for a period of a few weeks. The results are analyzed in terms of variations in time, and spatial variation of transmission loss at right angles to the great circle. Diffraction losses over mountain ridges are also measured and compared with theoretical losses due to ideal knife edges.

**621.396.11.029.62/63** 244  
**Results of Experiment of Long-Distance Overland Propagation of Ultra Short Waves**—N. Onoe, M. Hirai, and S. Niwa. (*J. Radio Res. Labs., Japan*, vol. 5, no. 79-94; April, 1958.) Results of a path loss test over 364 km at frequencies of 160 and 600 mc are discussed. The observed annual median basic transmission loss is about 13 db greater than the estimated value for atmospheric scattering. The difference in loss between VHF and UHF is about 18 db, indicating a third-power frequency law. The loss is about 12 db larger in winter than in summer. There is a negative correlation between loss and atmospheric temperature. When the path traverses an anticyclone the loss is small and fading rate is small.

**621.396.11.029.63:551.510.52** 245  
**A Study of 468-Megacycle Tropospheric Scatter Propagation over a 289-Mile Path**—J. B. Atwood, G. B. MacKimmie, D. G. Shipley and G. S. Wickizer. (*RCR Rev.*, vol. 19, pp. 321-333; September, 1958.) Hourly distributions of field strength at the receiver were of Rayleigh type while the monthly cumulative distributions of the hourly medians followed a log-normal curve. The typical fading rate varied from 5 to 30 fades per minute. A comparison between two receiving sites showed that the site which had better foreground clearance had an 8.8 db stronger field.

**621.396.11.029.65** 246  
**Experimental Measurement of the Absorption of Millimetre Radio Waves over Extended Ranges**—C. W. Tolbert and A. W. Straiton. (*IRE TRANS. ON ANTENNAS AND PROPAGATION*, vol. AP-5, pp. 239-241; April, 1957.) Measurements were made using path lengths up to 61 miles at 8.6 mm  $\lambda$ , and up to 7.2 miles at 4.3 mm  $\lambda$ .

#### RECEPTION

**621.376.23:621.396.822** 247  
**Optimum Filter Functions for the Detection of Pulsed Signals in Noise**—H. S. Heaps. (*Can. J. Phys.*, vol. 36, pp. 692-703; June, 1958.) The filter characteristic which yields the optimum ratio of integrated signal power to noise power over a number of pulses is derived. The transfer function is shown to be realizable, and for a rectangular pulse is closely approximated by a third-order low-pass Butterworth filter. See also 3729 of 1958 (Heaps and McKay).

**621.376.23:621.396.822** 248  
**Detection of Asymmetric-Sideband Signals in the Presence of Noise**—T. Murakami and

R. W. Sonnenfeldt. (*RCA Rev.*, vol. 19, pp. 388-417; September, 1958.) A "video-to-noise error ratio" is proposed for a more adequate quantitative evaluation of detector performance. Theoretical curves of carrier-to-noise ratio prior to detection, against this ratio after detection, are derived and their validity proved by experimental results. These curves indicate that the video-to-noise error ratio can be improved by about 11 db if a product or synchronous detector is substituted for the normal envelope detector. The effect of impulse noise on detected noise is considered for asymmetric sideband signals. Product detectors eliminate the rectified noise envelope produced by envelope detectors. The use of the asymmetric-sideband system means that the impulse noise output can be at a high frequency relative to the signal frequency and may be separated from that signal.

**621.376.232.2 249**

**Analysis of Diode-Detector Circuits for Signals with Asymmetrical Sidebands**—A. van Weel. (*Philips Res. Rep.*, vol. 13, pp. 301-326; August, 1958.) "A theoretical analysis is given of a diode detector stage, for a modulated signal with asymmetrical sidebands, of which the carrier is detuned with respect to the resonance frequency of the IF circuit. The equivalent circuit is found to be a three-port consisting of the impedances for upper- and lower-sideband frequencies and video frequency in series. Measurements show different over-all characteristics in the case of equal positive or negative detuning of the carrier frequency, which effect is caused by the asymmetrical shape of the diode-current peak."

**621.396.62 250**

**Instability in Radio Receivers**—D. R. Bowman. (*Wireless World*, vol. 64, pp. 514-519; November, 1958.) Methods of locating and eliminating self-oscillation due to various forms of coupling in RF and IF amplifiers are given.

**621.396.62:621.376.3 251**

**F. M. Tuner uses Four Transistors**—H. Cooke. (*Electronics*, vol. 31, pp. 72-73; August 1, 1958. Only one variable tuning element is used in the single-transistor frequency changer. The ratio detector has 700 kc peak separation, and an emitter-follower circuit provides audio amplification.

**621.396.62:629.113 252**

**Car Radio Design**—F. Grimm. (*Wireless World*, vol. 64, pp. 541-543; November, 1958.)

**621.396.62.004.6 253**

**What Goes Wrong?**—W. Oliver. (*Wireless World*, vol. 64, pp. 522-523; November, 1958.) A classified analysis of 600 sound-broadcast receiver repairs.

**621.396.62.029.62 254**

**The ARR3 Sonobuoy Receiver**—R. V. Taylor. (*Wireless World*, vol. 64, pp. 544-549; November, 1958.) Conversion details for VHF/FM broadcast reception.

**621.396.812.029.63 255**

**Diurnal Variation of Hourly Median Field Strength of 1940 Mc/s Signal in the Foothills of Central Himalayas**—R. Vikramsingh, M. N. Rao, S. Singh, and S. Uda. (*J. Inst. Telecommun. Eng. India*, vol. 4, pp. 147-156; June, 1958.) Typical chart records of field strength, with corresponding ground level meteorological data for the period April, 1957-March, 1958, are presented.

**621.396.812.3.029.6 256**

**Diurnal Variation in Intensity of Fading of V.H.F. Wave**—K. Hirao. (*J. Radio Res. Labs., Japan*, vol. 5, pp. 105-107; April, 1958.) The day/night ratio of fading intensity decreases with the height of the point of intersection of the lines of sight from both the transmitter and receiver according to a  $\frac{1}{2}$ -to- $\frac{1}{3}$ -power law. The ratio is unity at about 1000 m

which appears to be the limiting height for atmospheric turbulence. See also 924 of 1957.

**STATIONS AND COMMUNICATION SYSTEMS**

**621.391 257**

**An Error-Correcting Encoder and Decoder of High Efficiency**—J. H. Green, Jr. and R. L. San Soucie. (*Proc. IRE*, vol. 46, pp. 1741-1744; October, 1958.) The applicability of regenerative shift-register sequences to error-correcting codes is demonstrated.

**621.391:621.396.82 258**

**On the "Minimum Loss Operation Time" for Short-Wave Communication: Part 1**—H. Shibata. (*J. Radio Res. Labs., Japan*, vol. 5, pp. 143-151; April, 1958.) Theoretical treatment for the determination of optimum operation time on a statistical basis.

**621.395.4:621.318.5 259**

**A High-Speed Data Signalling System**—E. A. Irland. (*Bell Lab. Rec.*, vol. 36, pp. 376-380; October, 1958.) In the system described, which is used in the SAGE (semi-automatic air-ground environment) project, binary digits are transmitted over voice-bandwidth telephone channels at rates of up to 1600 bits per second. See also 3973 of 1958 (Michael).

**621.396.2:551.510.52 260**

**Tropospheric Scatter Tests in Great Britain**—A. J. Wheelton. (*Brit. Commun. Electronics*, vol. 5, pp. 428-431; June, 1958.) An outline is given of the equipment used in the circuit operating between Start Point and Chelmsford. The performance of the system is assessed and future plans are discussed.

**621.396.2:621.396.11 261**

**Difficulties Facing Long-Distance H.F. Communications in the Approaching Years**—R. J. Hitchcock. (*Brit. Commun. Electronics*, vol. 5, pp. 340-344; May, 1958.) With several decades of low sunspot maxima, combined with high interference levels, circuit performance will deteriorate. By installing a cable link from Great Britain to the equatorial belt, and subsequent radio transmission, a good performance index is obtainable, taking advantage of high ionization levels in the equatorial region.

**621.396.41 262**

**Mobile Radio System Provides 920 Channels**—F. Brauer and D. Kammer. (*Electronics*, vol. 31, pp. 96-99; October 10, 1958.) Channels are spaced 50 kc apart in the frequency range 30-76 mc. Local-oscillator frequencies are controlled by reference to crystals using three successive interpolations. Transmitter frequency is derived from the receiver local oscillator.

**621.396.41:621.396.933.42 263**

**Single-Sideband, Present and Future**—R. Jeremy. (*Proc. IRE, Aust.*, vol. 18, pp. 363-371; October, 1957.) SSB and independent-sideband systems are described, and problems regarding the use of such techniques for ground/air communications are discussed. See also 3983 of 1958 (Gridale).

**621.396.65:621.396.43 264**

**Radio Relay Systems and the C.C.I.F.**—W. A. E. Quilter. (*Point to Point Telecommun.*, vol. 1, pp. 20-31; October, 1956.) CCIF recommendations for international trunk cable systems are examined. They cannot always be economically applied to radio relay systems, particularly with respect to noise levels. The hypothetical reference circuit recommended by the 1956 CCIF Conference in Warsaw is described. See also 2232 of 1958 (Mansfield).

**621.396.71(492) 265**

**Brief Survey of 30 Years' Activity in Short-wave Broadcasting in the Netherlands**—A. J.

Duivenstijn. (*Philips Telecommun. Rev.*, vol. 19, pp. 97-103; April, 1958.)

**621.396.712(492) 266**

**The New Netherlands World Broadcasting Centre at Lopik-Radio**—G. Radstake. (*Philips Telecommun. Rev.*, vol. 19, pp. 104-111; April, 1958.) Transmitters and directional aerial arrays covering the frequency range 5.9-26.1 mc are briefly described. See also 293 below.

**SUBSIDIARY APPARATUS**

**621.314.5:621.314.7 267**

**Designing Transistor D.C. to A.C. Converters**—S. Schenkerman. (*Electronics*, vol. 31, pp. 78-80; September 26, 1958.) Nomograms are presented for the design of the basic two-transistor saturable-core symmetrical circuit.

**621.314.63 268**

**Silicon Power Rectifiers**—M. Sassier. (*Rev. tech. Comp. franç. Thomson-Houston*, No. 27, pp. 139-151; December, 1957.) A technique is described for the construction of alloy-junction rectifiers.

**621.314.63 269**

**Germanium and Silicon Industrial Rectifiers**—J. Lecorguillier. (*Rev. tech. Compt. franç. Thomas-Houston*, No. 27, pp. 153-170; December, 1957.) A review of methods of construction and applications.

**621.316.72:621.316.8 270**

**The Theory of Ballast Tubes or Barretters**—R. O. Jenkins. (*Brit. J. Appl. Phys.*, vol. 9, pp. 391-394; October, 1958.) Results are given which explain the observed behavior of various low-voltage barretters. A better combination than iron wire in hydrogen is unlikely to be found.

**621.316.722.078.3:621.385.2 271**

**Stabilization by Zener Diodes**—J. Pereli. (*Wireless World*, vol. 64, pp. 537-538; November, 1958.) Elementary design principles are discussed.

**TELEVISION AND PHOTOTELEGRAPHY**

**621.397.24 272**

**Closed-Circuit Television**—(*Overseas Eng.*, vol. 32, pp. 116-118; November, 1958.) Industrial applications are reviewed.

**621.397.24 273**

**Some Problems concerning the Choice of Cable Circuits for Television Transmission**—A. P. Bolle. (*Tijdschr. ned. Radiogenoot.*, vol. 22, pp. 321-327; November, 1957. In English.)

**621.397.24 274**

**Experiments in Television over Telephone Cable Facilities**—C. R. Kraus. (*J. Franklin Inst.*, vol. 265, pp. 1-12; January, 1958.) The limitations of telephone line systems are examined generally and two short-distance demonstration circuits, using 250 kc bandwidths, are described.

**621.397.24:621.396.65 275**

**Long Cable Links for Television**—D. W. Harling. (*Brit. Commun. Electronics*, vol. 5, pp. 416-421; June, 1958.) A survey of techniques used for the transmission of video signals to switching, control and transmitting centers.

**621.397.33 276**

**A New Narrow-Band Image Transmission System: Parts 1 & 2**—C. MacDonald. (*QST*, vol. 42, pp. 11-15, 142, and 31-36, 148; August and September, 1958.) In the system described a crt flying-spot scanner and a photomultiplier are used to develop a 120-line picture once every six seconds from a photographic negative. No special equipment is needed for transmission or reception.



- 621.397.33 277  
**Stop-Go Scanning Saves Spectrum Space**—H. E. Haynes and D. T. Heger. (*Electronics*, vol. 31, pp. 84-88; September 26, 1958.) A method is described for increasing spectrum utilization for facsimile-type transmission, where graduations between white and black are not important, by using scanning that is halted at black to white transitions. Scanning velocity over the nontransition portions is determined by available signal to noise ratio of the channel.
- 621.397.5:535.623 278  
**Technical Standards for Colour Television**—J. W. Wentworth. (IRE TRANS. ON BROADCAST TRANSMISSION SYSTEMS, vol. BTS-5, pp. 25-31; September, 1956.) A discussion of desirable characteristics with reference to FCC standards.
- 621.397.61:535.623 279  
**The Vitascan Live Flying-Spot Colour Scanner**—J. H. Haines and G. R. Tingley. (IRE TRANS. ON BROADCAST TRANSMISSION SYSTEMS, vol. BTS-6, pp. 11-25; October, 1956. Abstract, Proc. IRE, vol. 45, p. 112; January, 1957.) See also 1926 of 1957 (Mate).
- 621.397.62:535.623:621.385.832 280  
**Design and Development of the 21CYP22 21-Inch Glass Colour Picture Tube**—C. P. Smith, A. M. Morrell and R. C. Demmy. (*RCA Rev.*, vol. 19, pp. 334-348; September, 1958.) The tube gives a brighter and more contrasted picture than its metal predecessor. Improvements are obtained by the use of a graded-hole shadow mask, an improved gun and pole-piece assembly, and increased filtering in the faceplate glass.
- 621.397.62:621.385.004.6 281  
**Unusual Tube Effects cause Circuit Troubles**—Babcock. (See 311.)
- 621.397.621.2:621.316.92 282  
**Protection Device for Stabilized Line Time-base Circuit**—B. G. Dammers, A. G. W. Uijtens, and H. Heyligers. (*Electronic Applic. Bull.*, vol. 18, pp. 12-14; January, 1958.) A positive-going pulse, applied to the line output valve control-grid during fly-back period, prevents excessive rise of elt upon failure of the stabilizing circuit. See 3316 of 1957.
- 621.397.621.2:621.385.032.263 283  
**A New High-Transconductance Electron Gun for Kinescopes**—Schwartz. (See 322.)
- 621.397.621.2:621.385.832 284  
**TV Picture Tubes employing 110-Degree Deflection**—W. A. Dickinson and W. D. Schuster. (*Sylvania Technologist*, vol. 10, pp. 111-114; October, 1957.) Development problems concerning both crt design and associated scanning circuits are outlined.
- 621.397.7 285  
**Remote-Control Carrier Systems in Two-Way Closed-Circuit Educational TV**—J. R. Martin, G. W. Warnick, and R. N. Vandeland. (*Elec. Eng., N. Y.*, vol. 77, pp. 304-306; April, 1958.)
- 621.397.7:621.376.79 286  
**Design Improvements in High-Wattage Tungsten Filament Lamps for Motion-Picture and Television Studios**—L. G. Leighton and A. Makulec. (*J. Soc. Mot. Pict. Telev. Engrs.*, vol. 67, pp. 520-533; August, 1958.) The life of high-wattage tungsten filament lamps is improved by the introduction into the bulb of a collector grid which reduces lamp blackening so that light output is maintained until filament failure occurs.
- 621.397.8 287  
**Measurement of Service Area for Television Broadcasting**—R. S. Kirby. (IRE TRANS. ON BROADCAST TRANSMISSION SYSTEMS, vol. BTS-7, pp. 23-30; February, 1957. Abstract, Proc. IRE, vol. 45, p. 573; April, 1957.)
- 621.397.8:621.317.328 288  
**Measurement of Television Field Strength**—H. T. Head. (*Elect. Eng., N. Y.*, vol. 77, pp. 298-302; April, 1958.) The preparation by TASO [see e.g. 3277 of 1958 (Bowie)] of new propagation curves and data on the basis of extensive field-strength measurements is outlined.
- 621.397.826 289  
**The Use of Vertical Polarization to Solve U.H.F. Television "Ghosting" Problems in a Shadowed Valley**—D. W. Peterson. (*RCA Rev.*, vol. 19, pp. 208-215; June, 1958.) Field tests were made at a frequency of 640 mc.
- TRANSMISSION**
- 621.396.61:621.375.2.026.445 290  
**A 60-kW Radio-Frequency Power Amplifier**—J. A. Gassner. (*Philips Telecommun. Rev.*, vol. 19, pp. 130-134; April, 1958.) A grounded-grid push-pull circuit is used in the equipment described, which is designed for class-B operation in the frequency range 6-27 mc.
- 621.396.61:621.396.4 291  
**Linear-Amplifier Transmitters**—W. J. Morcom. (*Point to Point Telecommun.*, vol. 1, pp. 7-19; October, 1956.) The transmitters described are used for independent-sideband operation in the frequency range 4-27.5 mc.
- 621.396.61:621.396.664 292  
**Automatic Supervision of F.M. Transmitters**—J. A. van der Vorm Lucardie. (*Philips Telecommun. Rev.*, vol. 19, pp. 135-141; April, 1958.) Remote control and automatic change-over equipment is described.
- 621.396.712 293  
**Type SOZ 294/00 High-Efficiency, 100-kW Short-Wave Broadcast Transmitter**—H. E. Eckhardt and A. G. Robeer. (*Philips Telecommun. Rev.*, vol. 19, pp. 113-129; April, 1958.) Description of the equipment, with particular reference to the RF power stage which is of the grounded-cathode type with anode modulation. Spot frequencies cover the range 5.9-26.1 mcs and all valves are air cooled.
- TUBES AND THERMIONICS**
- 621.314.63+621.314.7 294  
**Some General Remarks on the Development of Techniques of Producing Semiconductor Devices and on the Improvement of their Characteristics**—J. M. Mercier. (*Rev. tech. Comp. franç. Thomson-Houston*, No. 27, pp. 7-13; December, 1957.)
- 621.314.63 295  
**Theoretical Study of the Temperature Reached by a p-n Junction Operating as a Rectifier Element: Practical Consequences**—R. M. Henry. (*Rev. tech. Comp. franç. Thomson-Houston*, No. 27, pp. 15-35; December, 1957.) Methods of measuring two essential constants in the formulas derived are given, from which the working limits of Ge and Si diodes can be calculated.
- 621.314.63 296  
**Point-Contact Germanium and Silicon Diodes**—R. M. Henry. (*Rev. tech. Comp. franç. Thomson-Houston*, No. 27, pp. 63-81; December, 1957.) Parameters, characteristics and the manufacturing procedure are described.
- 621.314.63 297  
**Silicon Junction Diodes**—F. Provost. (*Rev. tech. Comp. franç. Thomson-Houston*, No. 27, pp. 83-94; December, 1957.) A general report on the construction and properties of Si diodes including a note on Zener diodes.
- 621.314.63 298  
**Study on Annealing of Radiation-Induced 1/f Noise in Ge p-n Junction**—K. Komatsubara and U. Hashimoto. (*J. Phys. Soc. Japan*, vol. 13, p. 1062; September, 1958.) A rapid variation of noise level and common-emitter current gain is observed, followed by a slow variation of reverse saturation current.
- 621.314.7 299  
**Evaluating the Effects of Temperature on Junction Transistors**—W. Bye. (*Brit. Commun. Electronics*, vol. 5, pp. 440-442; June, 1958.) Methods of evaluating junction temperature, and its correlation with the  $\alpha$  cut-off frequency are outlined, and test equipment is described.
- 621.314.7 300  
**Silicon Transistors**—R. M. Henry. (*Rev. tech. Comp. franç. Thomson-Houston*, No. 27, pp. 115-125; December, 1957.) Alloy and grown-junction Si transistors are compared theoretically. The preparation and mounting of the latter type is described and characteristics are given.
- 621.314.7 301  
**Silicon Transistors by means of Alternate Doping**—B. Dreyfus-Alain and M. Darmony. (*Rev. tech. Comp. franç. Thomson-Houston*, No. 27, pp. 51-62; December, 1957.) The construction of n-p-n type Si transistors, using the "grown junction" principle, is described, and theoretical aspects of the problem are discussed.
- 621.314.7 302  
**Germanium Power Transistors**—R. Dubois. (*Rev. tech. Comp. franç. Thomson-Houston*, No. 27, pp. 127-137; December, 1957.) Applications and performance limits are discussed.
- 621.314.7 303  
**The Tetratron Principle**—(*Electronic Ind.*, vol. 17, pp. 120-122; July, 1958.) Simple explanations with diagrams of the principles and application of the device are given. See also 3657 of 1958 (Aisberg) and 4005 of 1958 (Teszner).
- 621.314.7:621.372.5 304  
**A Four-Pole Analysis for Transistors**—Alcock. (See 48.)
- 621.314.7:621.375.4 305  
**Design of a Transistor for an I.F. Amplifier**—E. Martin. (*Rev. tech. Comp. franç. Thomson-Houston*, No. 27, pp. 95-113; December, 1957.) The development and manufacture of a transistor for use at 500 kc. in receiver IF stages is described.
- 621.314.7:621.397.62 306  
**Bilateral Conductivity in Power Transistors**—I. G. Maloff. (*Electronic Ind.*, vol. 17, pp. 82, 122; July, 1958.) Positive and negative portions of collector current curves at constant base voltage are similar in most junction p-n-p power transistors, which are therefore useful in horizontal-deflection output stages in television receivers.
- 621.314.7.002.2 307  
**Precision Evaporation and Alloying**—R. J. Gnaedinger, Jr. (*Bell Lab. Rec.*, vol. 36, pp. 364-367; October, 1958.) The production of diffused-base p-n-p transistors depends on alloying by precision evaporation. The technique of evaporating at very low pressure is described.
- 621.383:546.289 308  
**The Germanium Photo-tetrode**—F. A. Stahl and G. Dermit. (*Electronic Ind.*, vol.



17, pp. 64-66; July, 1958.) Details are given of the response of a particular *p-n-p* Ge transistor to light incident on the base region.

**621.383.5:621.314.63** 309  
**The Use of Germanium Junction Cells for Photoelectric Control Circuits**—R. F. Peart, T. B. Rymer, and D. H. Tomlin. (*J. Sci. Instr.*, vol. 35, p. 383; October, 1958.)

**621.385.001.2:623.451.8-519** 310  
**Tube Developments for Guided-Missile Applications**—R. W. Slinkman. (*Sylvania Technologist*, vol. 10, pp. 102-105; October, 1957.) Design problems and their solution are discussed.

**621.385.004.6:621.397.62** 311  
**Unusual Tube Effects cause Circuit Troubles**—W. E. Babcock. (*Electronics*, vol. 31, pp. 90-93; September 12, 1958.) A shot survey of some less familiar faults in electronic tubes and their effect on television receivers. Methods of eliminating the faults are described.

**621.385.029.6** 312  
**Water-Cooling of Low-Power Klystrons used in the Laboratory**—E. Niesen, R. W. Beatty, and W. J. Anson. (*Rev. Sci. Instr.*, vol. 29, pp. 791-792; September, 1958.)

**621.385.029.6** 313  
**Beam Noise in Crossed Electric and Magnetic Fields**—R. P. Little, H. M. Ruppel, and S. T. Smith. (*J. Appl. Phys.*, vol. 29, pp. 1376-1377; September, 1958.) The large amount of noise which originates in the gun region may be reduced by operating the cathode under temperature-limited rather than space-charge-limited conditions, or by injecting the electrons into the crossed-field region with a substantial velocity. An explanation of the effect is put forward.

**621.385.029.6** 314  
**Effect of Collector Potential on the Efficiency of Travelling-Wave Tubes**—H. J. Wolkstein. (*RCA Rev.*, vol. 19, pp. 259-282; June, 1958.) Methods are described for increasing the overall efficiencies of traveling-wave tubes. These methods allow the collector voltage to be reduced, reducing the collector dissipation, without spoiling the RF performance. Secondary electron emission is increased but this effect can be minimized. A method for estimating the minimum potential to which an axially symmetric collector electrode can be depressed without reduction of beam current.

**621.385.029.6** 315  
**Distribution of Leakage Flux around a TWT—Focusing Magnet—a Graphic Analysis**—M. S. Glass. (*Proc. IRE*, vol. 46, pp. 1751-1756; October, 1958.)

**621.385.029.6** 316  
**Dispersion of Electron Velocities and Pass Band in Travelling-Wave Amplifiers**—R. Warnecke, O. Doehler, and B. Epsztein. (*Compt. rend. Acad. Sci., Paris*, vol. 246, pp. 2239-2242; April 14, 1958.) Experiment shows that the bandwidth of M-type tubes is increased above the value predicted from simple theory because of dispersion in the electron beam. It is hoped to obtain similar results in high-power O-type tubes by artificial means, notably using two electron beams from cathodes at different potentials.

**621.385.029.6** 317  
**On the Increase of Bandwidth in O-Type Travelling-Wave Valves**—J. Arnaud and R. Warnecke. (*Compt. rend. Acad. Sci., Paris*, vol. 246, pp. 2359-2362; April 21, 1958.) Calculations are made of the increase in bandwidth obtained at the expense of gain in an O-type tube using two-coupled or noncoupled beams. See 316 above.

**621.385.029.6** 318  
**Electron Trajectories in the Gun of an M-Type Carcinotron**—D. H. Davies and K. F. Sander. (*J. Electronics Control*, vol. 5, pp. 114-128; August, 1958.) The method uses a modified version of the automatic tracer described by Pizer *et al.* (3833 of 1956). The beam shape is investigated and optimum operating voltages suggested for the given geometry.

**621.385.029.6** 319  
**The Helitron Oscillator**—D. A. Watkins. (*Proc. IRE*, vol. 46, pp. 1700-1705; October, 1958.) A new type of voltage-tuned microwave oscillator requiring no magnetic field is described. Electron focusing is accomplished by balancing centrifugal force against a radial electric force and RF field interaction is both radial and angular. The electron beam travels in a helical path interacting with the RF field which is provided by an internal circuit structure. Experimental results show continuous voltage tuning from 1.2 to 2.4 kmc with a low starting current. Power outputs up to 10 mw have been obtained with low harmonic content. Theoretical studies to explain the operation of the device are not yet completely successful. See also 3436 of 1955 (Heffner and Watkins).

**621.385.029.6:537.58** 320  
**Current and Velocity Fluctuations at the Potential Minimum**—F. N. H. Robinson. (*J. Electronics Control*, vol. 5, pp. 152-156; August, 1958.) "The fluctuations in temperature limited emission are shown to be uncorrelated. Space-charge smoothing leaves the velocity fluctuations unchanged but at low frequencies even moderate degrees of smoothing lead to complete correlation of the two fluctuations."

**621.385.029.63:537.533:621.375.9** 321  
**A Low-Noise Electron-Beam Parametric**

**Amplifier**—R. Adler and G. Hrbek. (*Proc. IRE*, vol. 46, pp. 1756-1757; October, 1958.) A new electrode structure is described which provides parametric amplification of the fast wave on an electron beam. A noise figure of 1.3 db was obtained. See also 2934 of 1958 (Adler).

**621.385.032.263:621.397.621.2** 322  
**A New High-Transconductance Electron Gun for Kinescopes**—J. W. Schwartz. (*RCA Rev.*, vol. 19, pp. 232-243; June, 1958.) The characteristics of a gun employing two mesh-covered apertures, which act as space-charge grid and control grid, are presented. Peak currents of 800-1600  $\mu$ A for 2-5 v drive are obtained, and resolution is equivalent to conventional guns.

**621.385.032.269** 323  
**On the Determination of the Electrodes Required to Produce a Given Electric Field Distribution along a Prescribed Curve**—P. T. Kirstein. (*Proc. IRE*, vol. 46, pp. 1716-1722; October, 1958.)

**621.385.2:621.362** 324  
**Thermionic Diodes as Energy Converters: an Addendum**—G. R. Feaster. (*J. Electronics Control*, vol. 5, pp. 142-145; August, 1958.) The work of Moss (1983 of 1957) is extended to include diodes whose anode work function is less than their cathode work function, the space charge being negligible or neutralized. Output potentials of the order of 1 v may be obtained when the diodes are loaded for maximum power output.

**621.385.2:621.362** 325  
**Thermionic Energy Converter**—K. G. Hernqvist, M. Kanefsky, and F. H. Norman. (*RCA Rev.*, vol. 19, pp. 244-258; June, 1958.) The operation of a thermionic diode with Cs vapour is analysed and experimental results are given. Conversion efficiencies of about 10 per cent have been measured. See also 4024 of 1958 (Hatsopoulos and Kaye).

**621.385.832:621.397.621.2** 326  
**TV Picture Tubes Employing 110-Degree Deflection**—Dickinson and Schuster. (See 284.)

#### MISCELLANEOUS

**621.3:537.55** 327  
**Advances in Electronics and Electron Physics, Vol. 9. [Book Review]**—L. Marton (Ed.). Publishers: Academic Press, New York, N. Y., and Academic Books, London, 1957, 347 pp., \$9. (*Nature (London)*, vol. 181, pp. 1688-1689; June 21, 1958.) This volume is devoted to geophysics and includes chapters on the aurora borealis, negative ions, meteors, cosmic rays and radio wave propagation.

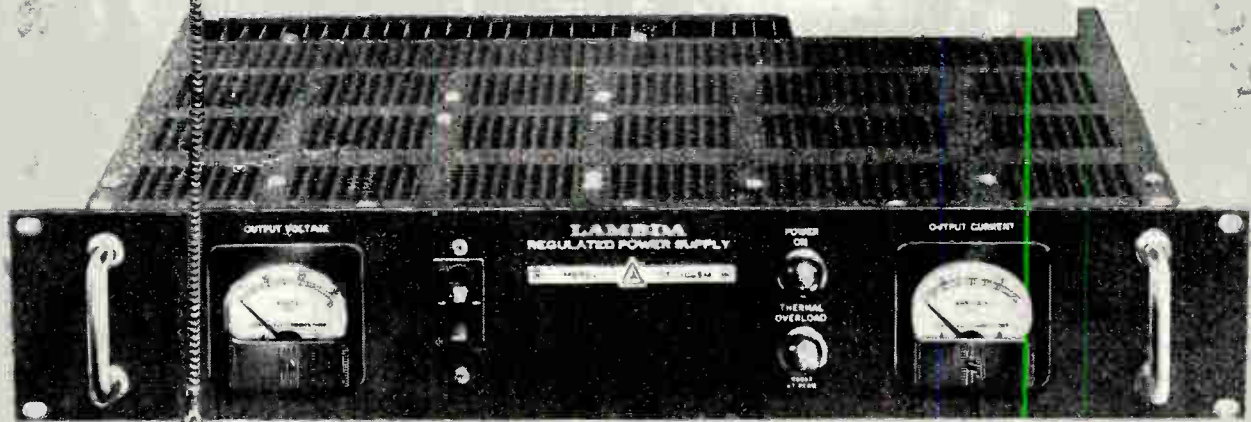

**Guaranteed: around-the-clock performance for five years**

Freedom from worry about major maintenance or extensive replacement for *five full years*. That's the guarantee given with every Lambda power supply—the first such guarantee in the electronics industry. It proves the point engineers keep making in preference studies: When operating conditions make dependability a “must,” they specify Lambda...

# LAMBDA POWER SUPPLIES

LAMBDA ELECTRONICS CORP., 11-11 131 STREET, COLLEGE POINT 56, N. Y.

World Radio History

Send  
for New  
1959 Catalog





## One-million unit-hours without failure

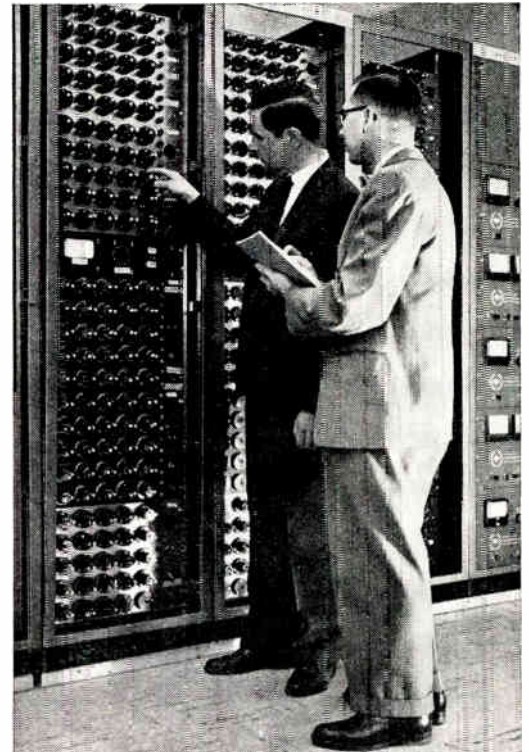
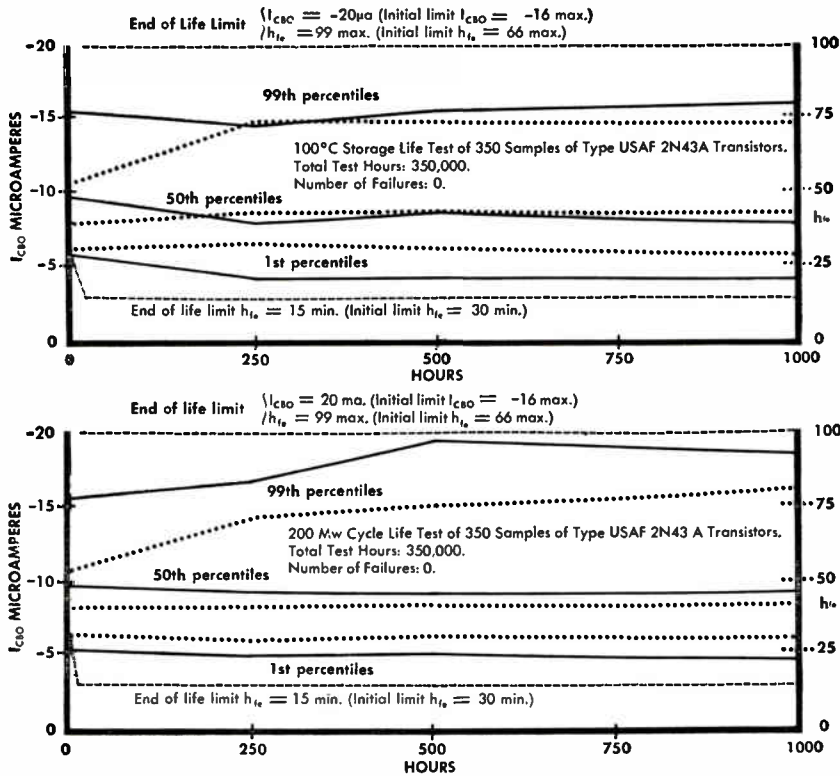

Dick Welch (left), Transistor Evaluation Engineering, and Lee Leinweber, Transistor Production Engineering, take readings at cycled-life-test rack. In addition to electrical testing, G-E 2N43A transistors are subjected to all mechanical-test requirements specified in MIL-T-19500/18.

**G-E 2N43A LIFE-TEST DATA OBTAINED AT 1000-HOUR POINTS.** Upper chart shows results of 100°C storage test (25°C storage test not shown). Lower chart shows results of 200 mw operating test. Broken lines in each chart indicate  $h_{FE}$ . Solid lines indicate  $I_{CEO}$  in microamperes. After 1000 hours of testing, there were no failures. The 2N43A transistor's high standard of quality is inherent in all G-E germanium PNP audio and switching transistors.

## 20% Safety Factor for silicon rectifiers aids designers

Designers who now apply their own safety factor to the published peak inverse voltage rating may avoid this step by using G-E low-current silicon rectifiers.

General Electric's PIV figures are set by allowing a 20% safety margin at  $-65^{\circ}\text{C}$ . This margin is applied at the point of sharp breakdown voltage and increases with temperature until a maximum safety factor of 33% is reached at  $150^{\circ}\text{C}$ .

If you are derating published PIV figures to provide over-voltage protection, you may be buying costlier cells than you need, or, in series applications, more cells than necessary. Thus the built-in safety margin of G-E low-current silicon rectifiers could save you money. Note: This safety factor is provided for over-voltage protection only. Designs should, in all cases, be maintained within published maximum ratings.

This is only one reason why you should consider G-E low-current silicon rectifiers for all your power requirements. You'll find these devices more attractive to use than ever before—both in quality and price—with equally fine values in low-current silicon stacks. Stud-mounted units are also available. Ask your G-E semiconductor representative for the "big news" on low-current silicon rectifiers.

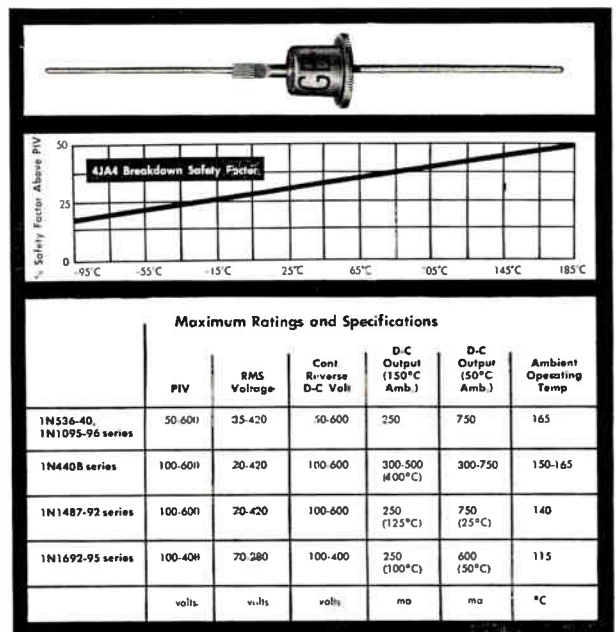



# for General Electric audio transistors

General Electric's 1958 process and quality-control advances were reflected in recent life-test results exhibited by G.E.'s line of germanium PNP audio transistors. Random samples of Type-2N43A transistors were subjected to rigorous mechanical testing . . . drop-shock, detergent-bomb, lead-fatigue (i.e., all the MIL-T-19500/18 mechanical test requirements). Then a total of 1050 Type 2N43A transistors were put on Life Test, with the following results:

350 (10 lots, 35 units each) were given a 100°C storage test for 1000 hours. No failures.

350 (10 lots, 35 units each) were given a 25°C storage test for 1000 hours. No failures.

350 (10 lots, 35 units each) were given a 200 mw cycled-life test for 1000 hours. No failures.

Engineering test data indicate that, without exception, parameters remained stable (see curves at left).

The G-E 2N43A transistor is representative of the outstanding quality built into General Electric's entire line of germanium PNP audio and switching transistors.

RATINGS: AUDIO AND LOW-FREQUENCY SWITCHING TRANSISTORS								
		2N43	2N43A	2N44	2N44A	2N1056	2N1057	
Collector-to-base Voltage (25°C)	V <sub>CB</sub>	-45	-45	-45	-45	-60	-45	volts
Collector-to-emitter V. (25°C)	V <sub>CE</sub>	-30	-30	-30	-30	-75	-45	volts
Total Dissipation (25°C)	P <sub>C</sub>	240	240	240	240	240	240	mw
Forward D-c Current Gain, Common Emitter I <sub>c</sub> /I <sub>b</sub> (V <sub>CE</sub> =-1v; I <sub>c</sub> =-20 ma)	h <sub>FE</sub>	53	53	31	31	32	58	
	(V <sub>CE</sub> =-1v; I <sub>c</sub> =-100 ma)	48	48	25	25		52	
Collector Cutoff Current (V <sub>CB0</sub> =-45v) (V <sub>CS</sub> =75v; I <sub>E</sub> =0)	I <sub>CO</sub>	-8	-8	-8	-8		-18	μa
	I <sub>CO</sub>					-18		μa

NOTE: All figures represent design-center ratings.

## High frequency transistors modified for higher Beta

Recent design improvements in high frequency switching transistors (Types 2N123 and 2N150) have improved their d-c beta at higher collector currents. The result is higher gain and improved saturation characteristics at these high currents.

Refinements in quality control tests have also been put into practice on the production line. These units are affected: Types 2N123, 2N450 and the 2N396 series. Units are aged at 100°C for 96 hours to stabilize characteristics. All transistors are subjected to a high-pressure detergent test for hermetic sealing. D-C characteristics are warranted to be within the limits shown on specification sheets. As a result, these transistors are now widely accepted in missile computer work and other rigorous applications.

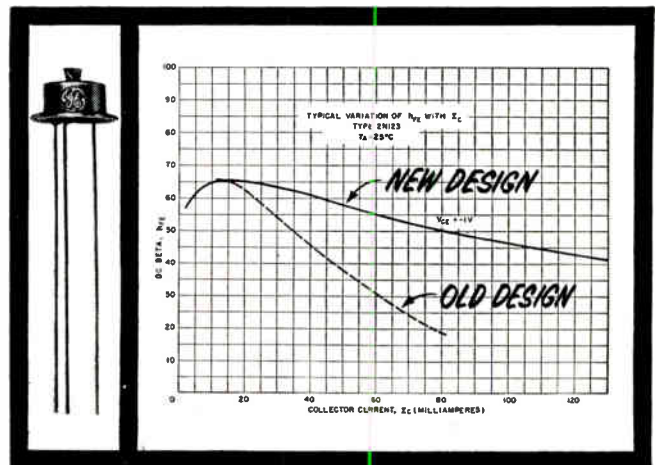

General Electric Company, Semiconductor Products Dept., Section 554259, Electronics Park, Syracuse, N. Y.

**GENERAL**  **ELECTRIC**

# NOW 0.1 to 525 KC

in **one** compact  
reliable **ultrasonic**  
**spectrum analyzer**



## PANORAMIC'S NEW SB-15

... designed for maximum application utility, reliability and automaticity for

- Ultrasonic Spectrum Analyses
- Harmonic and Cross Modulation Investigations
- Ultrasonic Vibration and Noise Measurements
- Telemetering
- Monitoring
- Attenuation Measurements of Filters and Transmission Lines

In the all-new, precisely developed SB-15, you get expanded frequency coverage ... all the way to 525kc! With a single, complete unit, only 8 3/4" high.

For a low-cost, highly stable Spectrum Analyzer 1-300kc for the 300kc range,



PANORAMIC'S SB-7bZ is the proven pace-setter

the pioneer  
is the leader



522 South Fulton Ave. • Mount Vernon, N.Y.  
Phone: OWens 9-4600 Cables: Panoramic, Mount Vernon, N.Y.

Check these specifications for the SB-15:

- Continuously calibrated sweep width from 200 KC to 1 KC
- Exceptional stability at reduced sweep widths
- 100cps resolution capability
- Independently variable resolution or automatically optimized resolution to suit your needs.
- Continuously variable sweep rate from 1cps to 60cps

For Single Line Frequency Response Curve Tracing



just add the  
PANORAMIC  
G-15

... highly selective ... discriminates against noise and hum ... virtually unlimited dynamic range. Valuable for analyzing telemetering and carrier current system components, transformers, filters, transducers, amplifiers, receivers and various networks and devices.

GET the full story on the many other uses of the SB-15. WRITE, WIRE, OR PHONE for detailed specification bulletin; and ask to be put on our regular mailing list for The PANORAMIC ANALYZER featuring application data.



**Membership**

(Continued from page 98A)

Miller, L. E., Laureldale, Pa.  
Ontiveros, P. C., Whittier, Calif.  
Redheffer, R. M., Los Angeles, Calif.  
Rowlands, R. O., State College, Pa.  
Schaffert, R. M., Vestal, N. Y.  
Sekiguchi, T., Urbana, Ill.  
van Vessel, J. C., Nymegen, Holland  
Williamson, C. N., Ft. Lauderdale, Fla.  
Willoner, G., North Vancouver, B. C., Canada

### Transfer to Member

Adams, R. E., Albuquerque, M. N.  
Alls, C. R., Albuquerque, N. M.  
Amemiya, H., Haddonfield, N. J.  
Andrews, J. V., Liverpool, N. Y.  
Arrison, C. R., Jr., North Tonawanda, N. Y.  
Bacon, R. A., Anchorage, Alaska  
Balash, F. J., Whippany, N. J.  
Balikov, M. H., Chicago, Ill.  
Baumann, R. H., New York, N. Y.  
Beans, J. B., Burbank, Calif.  
Beeby, P. A., Rhinebeck, N. Y.  
Berly, E., Jackson Heights, L. I., N. Y.  
Berry, J. D., Camp Hill, Pa.  
Blodgett, W. G., Santa Monica, Calif.  
Bodin, M., New York, N. Y.  
Bowen, J. R., Cantonsville, Md.  
Brodheim, E., New York, N. Y.  
Brown, N. J., Beverly, Mass.  
Brown, R. J., Scranton, Pa.  
Bugnolo, D. S., New York, N. Y.  
Carson, J. W., Los Angeles, Calif.  
Charmatz, A. W., Los Alamos, N. M.  
Daniel, D. B., Edmond, Okla.

(Continued on page 106A)

## NEW SEMICONDUCTOR DEVICE



The HS-51 HALLTRON is based upon the Hall effect. Its output characteristics are related to the product of the input current and magnetic field, hence are useful in many new applications. The HS-51 HALLTRON is a fully developed production unit utilizing indium antimonide and is designed to work in the customer's magnetic circuit.

Applications of the HS-51 HALLTRON

- DC to AC converters
- Magnetic field measurement
- Computer applications
- Control applications
- Gytrators
- Circulators
- Power meters
- Transducers

Typical Room Temperature Characteristics

Typical open-circuit Hall output voltage of an HS-51 HALLTRON vs. magnetic field strength for various values of control current, I<sub>c</sub>.

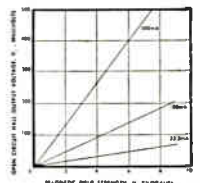

**OHIO SEMICONDUCTORS, INC.**  
1035 W. THIRD AVENUE, COLUMBUS 8, OHIO

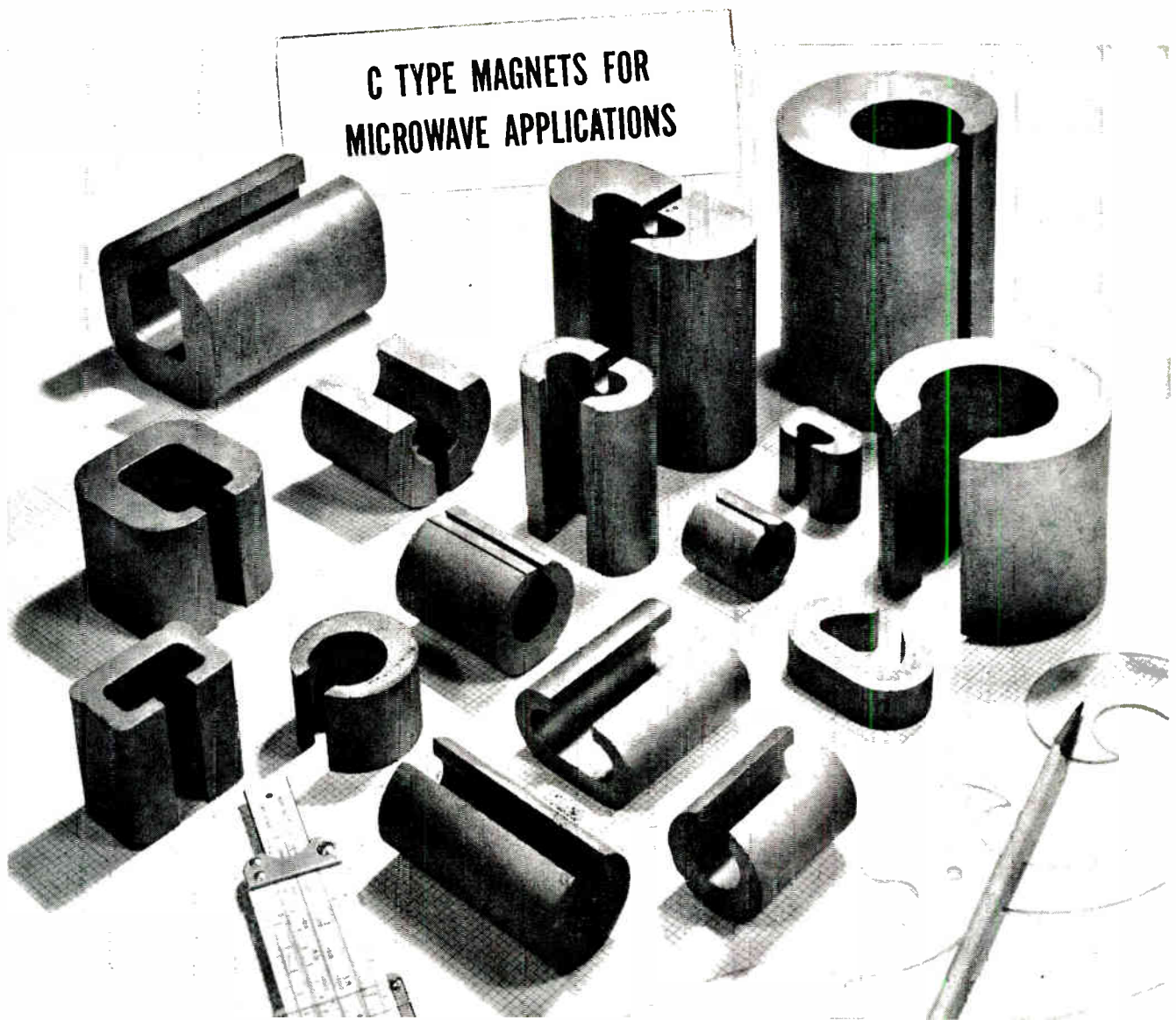

## C TYPE MAGNETS in a wide range of sizes to meet your design needs in ★TRANSVERSE FIELD ISOLATORS★ DIFFERENTIAL PHASE SHIFTERS★ DUPLEXERS

Arnold C-type Alnico Magnets are available in a wide selection of gap densities ranging from 1,000 to over 7,500 gauss. There are six different basic configurations with a wide range of stock sizes in each group.

The over-all size and gap density requirements of many prototype designs can be met with stock sizes of Arnold C Magnets, or readily supplied in production quantities.

When used in transverse field isolators, Arnold C Magnets supply the magnetizing field to bias the ferrite into the region of resonance, thus preventing interaction between microwave networks and isolating the receiver from the transmitter. These magnets are also used in differential phase shifters and duplexers, and Arnold is prepared to design and supply tubular magnets to provide axial fields in circular wave guides.

A feature of all Arnold C Magnets is the excellent field uniformity along the length of the magnet. Versatility in design may be realized by using multiple lengths of the same size magnet stacked to accomplish the needs of your magnetic structure.

Let us work with you on any requirement for permanent magnets, tape cores or powder cores. ● For information on Arnold C Magnets, write for Bulletin PM-115. Address *The Arnold Engineering Company, Main Offices and Plant, Marengo, Illinois.*

WSW 7428



# ARNOLD

**SPECIALISTS in MAGNETIC MATERIALS**

BRANCH OFFICES and DISTRIBUTORS in PRINCIPAL CITIES  
Find them FAST in the YELLOW PAGES





*when only the best is good enough*

## NORTH AMERICAN ELECTRONICS, INC.

212 Broad Street, Lynn, Massachusetts

# BOESCH

BOESCH

★ improved  
★ faster  
★ completely automatic



### BW2 BOBBIN winder

*rugged, versatile, high speed winder for bobbins, solenoids, resistors, relays and other random-wound coils.*

**Boesch Manufacturing Co., Inc. Danbury, Conn.**

# CAPITOL RADIO ENGINEERING INSTITUTE

Advanced Home Study and Residence  
Courses in Practical Electronics, Automation,  
and Industrial Engineering Technology

Pioneer in Electronics Engineering Instruction  
Since 1927

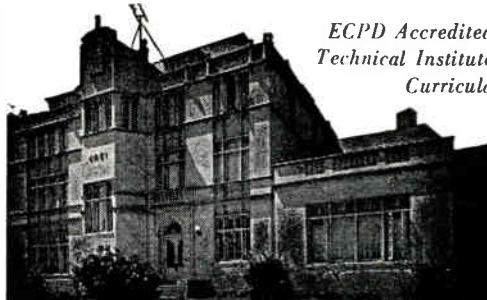

ECPD Accredited  
Technical Institute  
Curricula

Request your free Home Study or  
Resident School Catalog by writing to: Dept. 262F

3224 16th St., N. W. Washington 10, D. C.

Approved for Veteran Training



## Membership

(Continued from page 104A)

Davis, C. B., Indianapolis, Ind.  
Davis, C. C., Burlington, Ont., Canada  
Davis, F. W., Altadena, Calif.  
Dautremont, J. L., Jr., Los Angeles, Calif.  
Day, P. F., Auburndale, Mass.  
Devito, M. F., Kew Gardens, L. I., N. Y.  
Dokas, J., Jr., Randallstown, Md.  
Dunn, R. A., Newburgh, N. Y.  
Eltrman, L., Albuquerque, N. M.  
Ess, A. J., Saint Paul, Minn.  
Flowers, W. P., Detroit, Mich.  
Forte, M. P., Rome, N.Y.  
Fox, S., New York, N. Y.  
Fradly, W. E., Santa Ana, Calif.  
Ginaille, R. A., Winston-Salem, N. C.  
Giardina, J. F., Grand Rapids, Mich.  
Glist, S., Brooklyn, N. Y.  
Hagen, A. A., Queens Village, N. Y.  
Johnson, S., Jr., San Diego, Calif.  
Kaye, R. S., Brooklyn, N. Y.  
Labitt, B. H., Allston, Mass.  
Levasseur, J. R. A., Windsor, Ont., Canada  
McAdams, E. E., Jr., Nashville, Tenn.  
Morewood, H. W., Quebec, Canada  
Nuss, H. C. E., Vestal, N. Y.  
Pasquariello, C. J., Mt. Marion, N. Y.  
Rebeck, C. S., East Williston, L. I., N. Y.  
Silberberg, R. W., Dorchester, Mass.  
Sirel, M., Paris, France  
Stebbins, M. D., Cresskill, N. J.  
Smith, L. A., Springfield, Ohio  
Terrell, D. S., Aylmer East, Que., Canada  
Tillstrand, C. O., New York, N. Y.  
Trest, L. S., Jr., Vestal, N. Y.  
Wack, C. B., Anaheim, Calif.

(Continued on page 110A)

the transformer you need  
is probably among the

# 1100+

listed in these  
CHICAGO STANDARD catalogs  
and available for immediate delivery\*



### WRITE FOR YOUR FREE COPIES

\*If it isn't, our 48-man engineering department can design and produce "specials." Ask us to quote.

*the largest, most complete line—  
from the industry leader*

CHICAGO STANDARD TRANSFORMER CORPORATION  
3504 ADDISON STREET • CHICAGO 18, ILLINOIS

Model QS173 (.6 to 5.5 pf.)



actual size

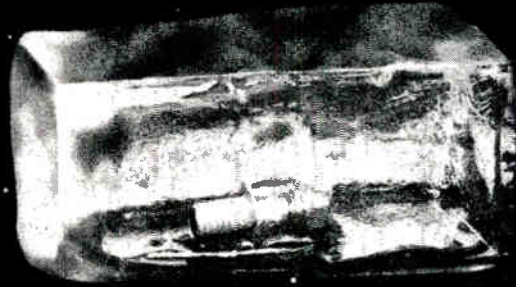

Patent Pending



# NEW FROM

## COMPLETELY SEALED

# MINIATURE QUARTZ SEALCAPS

Moving upstairs? Then you'll welcome the new JFD precision Miniature Quartz Sealcaps that seal out moisture, seal in reliability and accuracy, regardless of atmosphere.

These new JFD variable trimmer piston capacitors combine the unique characteristics of Sealcap construction and miniature quartz capacitor design. Each is filled with dry nitrogen under pressure and then sealed to maintain the compression, prevent corona and voltage breakdown at high altitude. Linear tuning with fine resolution is assured permanently, without breaking of seal.

Sealcap design also blocks the formation of moisture inside the unit, increases insulation resistance and dielectric strength. The use of quartz dielectric results in high Q, ultra low loss high frequency operation, greater stability, and approximately zero temperature coefficient.

JFD Standard Sealcaps are available unpotted or encapsulated in epoxy resin for higher dielectric strength. Our engineering staff will welcome the

opportunity to relate the advantages of Sealcaps to your specific application. In the meantime, why not write for Bulletin No. 215? Also available in glass dielectric, Bulletin No. 207A.

### FEATURES

1. Sealed interior construction lacks out all atmospheric effects.
2. High Q.
3. Anti-backlash design assures excellent tuning resolution — no capacitance reversal while tuning.
4. Extreme stability at high and low temperatures.
5. Ultra linear tuning for accurate alignment.
6. Low temperature coefficient of capacitance.
7. Low-loss low inductance coaxial tuning for high frequency use.
8. Special alloy plating protects metal parts against corrosion.
9. Fused Quartz dielectric with excellent electrical properties offers no derating at 150° Centigrade.
10. Rugged construction for shock and vibration resistance.
11. Miniaturized construction supplies maximum capacity in minimum space.
12. Positive mechanical stops at both ends of adjustment.
13. Available in panel and printed circuit type mountings — unpotted or encapsulated for complete imperviousness to humidity and moisture.

Ranges from .6 to 1.8 pf. to .8 to 16 pf. in 12 standard models.

PHONE DEWEY 1-1000



## ELECTRONICS CORPORATION

JFD Canada Ltd.  
51 McCormack St.  
Toronto, Ontario, Canada

1462 62nd Street, Brooklyn, New York  
Pioneers in electronics since 1929

JFD International  
15 Moore Street  
New York, New York

look what **\$24<sup>50</sup>** buys  
in test equipment!



**HEATHKITS  
GIVE YOU  
TWICE AS MUCH  
equipment for  
every dollar  
invested**

The famous model V-7A Vacuum-Tube-Voltmeter is a perfect example of the high-quality instruments available from Heath at 1/2 the price you would expect to pay! Complete, only **\$24<sup>50</sup>**

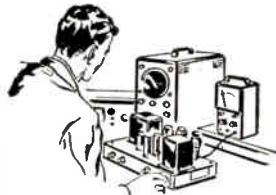

Get the most out of your test equipment budget by utilizing HEATHKIT instruments in your laboratory or on your production line. Get high quality equipment, without paying the usual premium price, by dealing directly with the manufacturer, and by letting engineers or technicians assemble Heathkits between rush periods. Comprehensive instructions insure minimum construction time. You'll get more equipment for the same investment, and be able to fill your needs by choosing from the more than 100 different electronic kits by Heath. These are the most popular "do-it-yourself" kits in the world, so why not investigate their possibilities in your particular area of activity! Write for the free Heathkit catalog now!



Contains detailed descriptions of Heathkit models available, including VTVM's, scopes, generators, testers, bridges, power supplies, etc.



Also describes Heathkit ham gear and hi-fi equipment in kit form. 100 interesting and profitable "do-it-yourself" projects!

**FREE catalog**

Mail coupon below for your copy—Now!

**HEATH COMPANY**  
A SUBSIDIARY OF DAYSTROM, INC.,  
BENTON HARBOR 4, MICHIGAN

Name \_\_\_\_\_

Address \_\_\_\_\_

City & Zone \_\_\_\_\_

State \_\_\_\_\_

THE PLACE...

"Institute of  
Radio Engineers  
New York City,  
March 23-26, 1959".



THE WAY TO GO...

**UNITED  
AIR  
LINES**



**Enjoy extra care at no extra fare!**

Choose luxurious First Class, or economical Air Coach. Radar on every plane. Fast, dependable scheduled times to suit your convenience on the convention route of the nation. Ask your travel agent to give you full details along with his suggestions for combining your convention along with one of the many vacations available on United Air Lines. Or call your nearest United Air Lines office.







- Radio Telescopes  
28', 60', 84', 140'
- Mobile Antennas 28'
- Scatter Antennas  
28', 60', 120'
- Trackers 28', 60', 84'
- Rotating Radar Antennas  
up to 20' x 120'
- Fixed Radar Antennas  
to 110' x 165' and up

## THE WORLD'S LARGEST ANTENNAS

## ARE COMING FROM KENNEDY

Kennedy builds them big — to meet the expanding needs of electronics. And Kennedy builds them rugged — to withstand the most demanding conditions of climate. Kennedy's facilities and engineering skills are devoted to serving the electronics trade in the development, design, manufacture and installation of all types of antenna systems.

### KENNEDY WAVE GUIDE COMPONENTS...

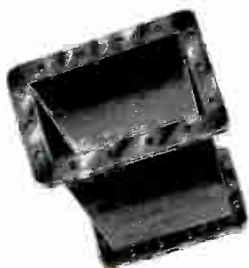

achieve highest transmitted power  
lowest standing wave ratio, trouble  
free operation.

- Complete feed systems — designed and installed
- Dual and linear polarization horns
- Transitions
- Duplexers
- Straight sections and bends
- Complete hardware

World Radio History

*For more complete information, send for your free copy of the handy file-size Kennedy Antenna Equipment folder.*



ANTENNA EQUIPMENT

**D. S. KENNEDY & CO.**

COHASSET, MASS. EVERGREEN 3-1200

West Coast Affiliate

SATELLITE-KENNEDY, INC. 51 CALIFORNIA  
P.O. Box 1711, Monterey, California - Frontler 3-2461

# Are you SAVING through ENGRAVING?

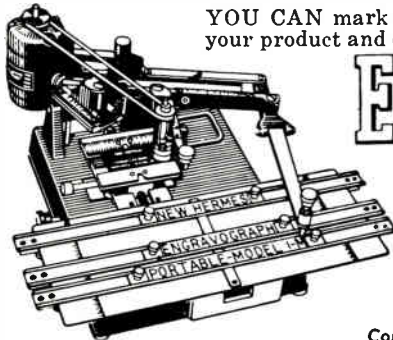

YOU CAN mark parts, make signs and nameplates, improve your product and cut your costs in 1001 ways with the portable

## Engravograph

It's tracer-guided for unskilled labor. Every plant needs one, wherever permanent lettering or numbering has to be done. There is a complete line of models to meet your application, from \$298.00 up.

Consult our engineers on how ENGRAVOGRAPH can help your operation, or write on your letterhead for our 28-page fully illustrated catalog YM-2

**new hermes ENGRAVING MACHINE CORP.**  
13-19 UNIVERSITY PLACE, NEW YORK 3, N. Y.

# BEEDE

INDICATING  
INSTRUMENTS

## the PANORAMA

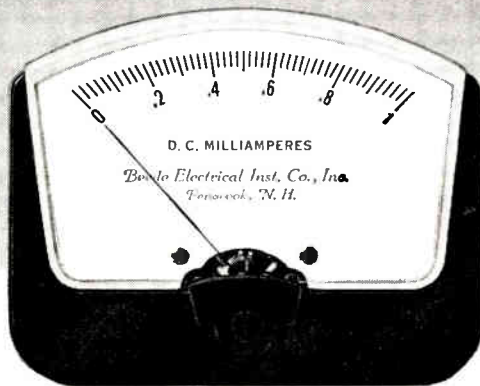

AVAILABLE IN  
**3**  
SIZES

Model 70	Model 230	Model 140
Width 7"	Width 4 1/2"	Width 3 1/2"
Height 5 1/4"	Height 3 3/8"	Height 2 3/8"

The PANORAMA gives you better, clearer vision longer scales, easier readability. The plastic panel provides excellent natural illumination; top, sides and front.

Available with frosted portion or color of your choice.

The ultra modern beauty of the PANORAMA will add much to your product.

Send for Complete Information

**BEEDE ELECTRICAL INSTRUMENT CO., INC.**  
**PENACOOK, NEW HAMPSHIRE**



## Membership



(Continued from page 106A)

Walls, A. B., Baltimore, Md.  
Watson, C. D., Jr., Dallas, Tex.  
Weinman, M., New York, N. Y.  
Weinstein, G. E., Holloman AFB, N. M.  
Wennerberg, A. L., St. Joseph, Mich.  
White, R. J., Somerville, Mass.  
Willert, A. F., St. Petersburg, Fla.  
Wysocki, J. J., Cranbury, N. J.

### Admission to Member

Ahearne, J. F., Inglewood, Calif.  
Ake, N. E., Reading, Pa.  
Allen, G. W., Fishkill, N. Y.  
Angehrn, T. W., Binghamton, N. Y.  
Armstrong, F. O., Murray Hill, N. J.  
Baker, B. R., Fort Worth, Tex.  
Baldock, R., Dorval, Que., Canada  
Barber, P. F., London, England  
Basista, J. Jr., East Pittsburgh, Pa.  
Baum, R. H., Escondido, Calif.  
Baxter, D. D., St. Louis, Mo.  
Bazzy, W., Norwood, Mass.  
Becchina, J. A., Metuchen, N. J.  
Berilla, D., Washington, D. C.  
Bertan, H. S., New York, N. Y.  
Beyer, F. J., West Caldwell, N. J.  
Bierman, H., Brooklyn, N. Y.  
Bijl, A., Amsterdam-N., The Netherlands  
Boland, L. J., Poughkeepsie, N. Y.  
Bonestroo, K. G., Minneapolis, Minn.  
Bosinox, I., Lexington, Mass.  
Boudreau, J. M. C., Medford, Mass.  
Brink, E. W., North Hollywood, Calif.  
Brown, R. K., Ottawa, Ont., Canada  
Carey, P. M., Belleville, Ont., Canada  
Carlson, R. L., Fullerton, Calif.  
Catalino, F. M., Buffalo, N. Y.  
Chandler, C. E., Washington, D. C.  
Christiansen, G. H., New Castle, Del.  
Cochrane, D. O., Dorchester, Mass.  
Cook, P. D., Cocoa Beach, Fla.  
Couvillion, A. J., Jr., Dallas, Tex.  
Damon, N. E., Venice, Calif.  
DeWolf, J. L., Los Angeles, Calif.  
Dickerman, J. J., Northport, L. I., N. Y.  
Dorsey, J. T., Barberton, Ohio  
Dupree, F. F., Jr., Washington, D. C.  
du Toit, J. P., Ft. Worth, Tex.  
Dyer, E. F., Baltimore, Md.  
Egler, G. A., Little Neck, L. I., N. Y.  
Eichelberger, R. P., Huntsville, Ala.  
Eklund, K. E., Hempstead, L. I., N. Y.  
Euler, J. R., Hamburg, N. Y.  
Fisher, B. W., Cincinnati, Ohio  
Fleeman, P. J., Gardena, Calif.  
Frankovich, J. M., Lexington, Mass.  
Frederick, D. E., Dayton, Ohio  
Freiberger, H., New York, N. Y.  
Friest, D. T., Los Gatos, Calif.  
Gaal, I. G., Southgate, Calif.  
Gladkowski, E. R., Alamogordo, N. M.  
Goldman, G., Valley Stream, N. Y.  
Gott, A. H., Arlington, Va.  
Graul, G. D., Jersey City, N. J.  
Green, J. E., Dayton, Ohio  
Grimes, W. P., Klamath Falls, Ore.  
Gulbrandsen, F. O., San Diego, Calif.  
Gupta, M. P., Boston, Mass.  
Gustafson, W. G., New York, N. Y.  
Haeblerlin, R. O. W., Montreal, Que., Canada  
Hager, K. F., Anchorage, Alaska  
Hagopian, N. D., Medford, Mass.  
Haid, H. R., Columbus, Ohio  
Hammack, G. W., Dallas, Tex.  
Harbourt, C. O., Syracuse, N. Y.  
Harris, G. G., Jr., Huntsville, Ala.  
Hauck, H. G., Hamilton, Ont., Canada  
Hiatt, H. E., Valparaiso, Ind.  
Hlavin, J. M., East Syracuse, N. Y.  
Hofmanis, I. A., Brooklyn, N. Y.

(Continued on page 112A)



# I-T-E CAN SUPPLY ALL YOUR LARGE WAVEGUIDE TEST EQUIPMENT

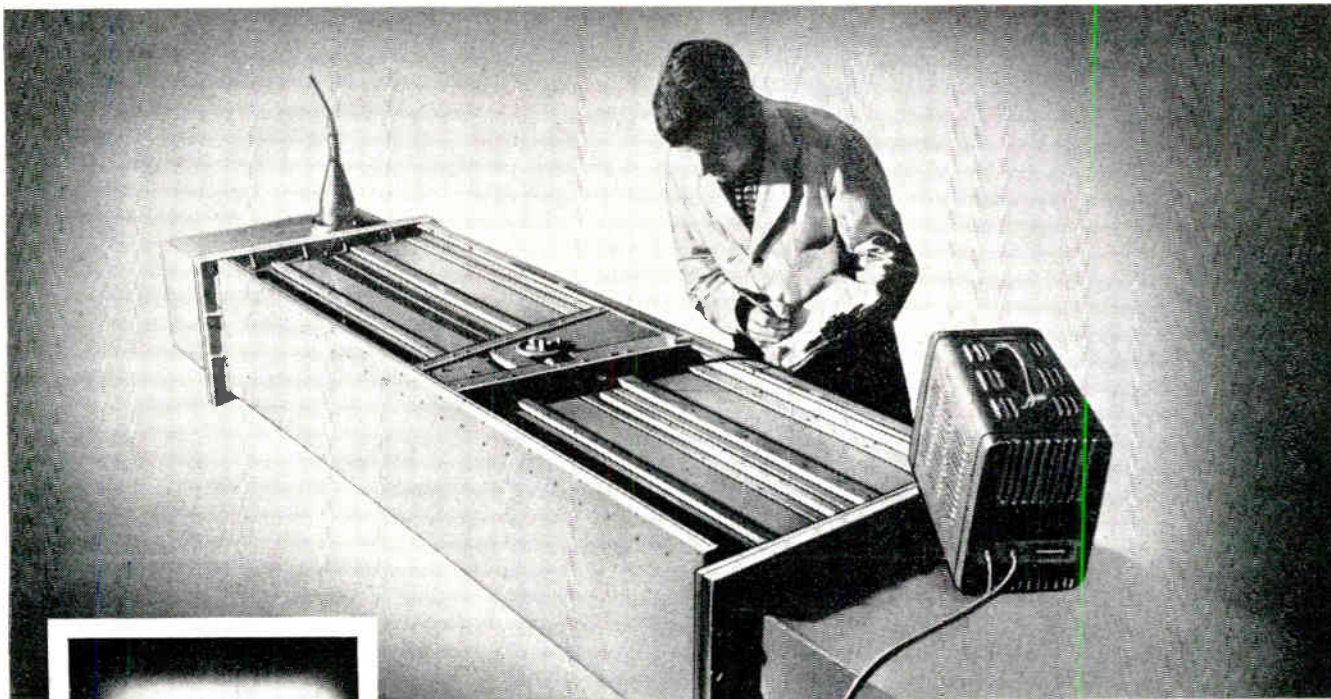

**Slotted lines** are supplied complete with probe and carriage. Residual SWR is less than 1.02:1 over the frequency band. Available in sizes WR770 through WR2300.

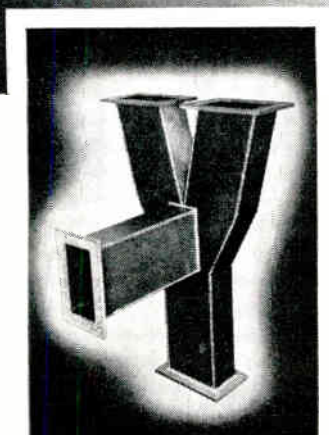

**Folded hybrid tee**

Here are a few examples of the waveguide test equipment and components currently available from I-T-E to meet the testing and operating requirements of multi-megawatt radar and scatter communications systems. This equipment reflects I-T-E's broad experience in all phases of large waveguide design and manufacture.

Take advantage of I-T-E's specialized knowledge of waveguide testing and the precision fabrication capabilities of a specially equipped waveguide shop. Facilities such as these assure you of the highest standards of quality, maximum economy, and excellent delivery—in single or production quantities.

If you have a requirement or problem relating to waveguide test equipment, write I-T-E Special Products Division, 601 E. Erie Ave., Philadelphia 34, Pa. And ask for your copy of free-space wave length vs. guide wave length conversion tables for large waveguide.

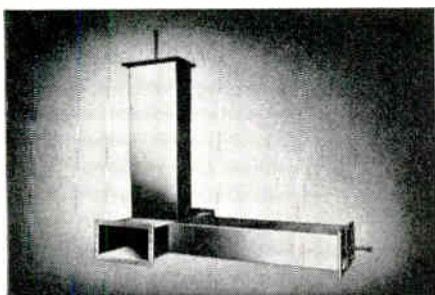

**E-H plane tuner**

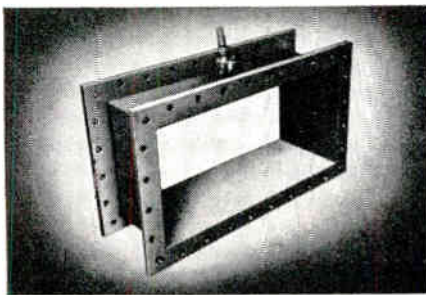

**Close-loop directional coupler**

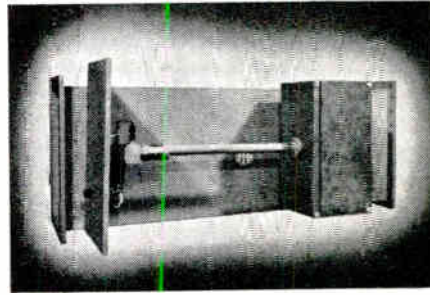

**Motorized short circuit section**



**I-T-E CIRCUIT BREAKER COMPANY**

Special Products Division • 601 E. Erie Avenue • Philadelphia 34, Pa.



# FIRST 1,040 Mile

Pulse Doppler Radar uses

## HYCON EASTERN CRYSTAL FILTERS

IRE SHOW  
Booth Nos. 3038 & 3039



**Membership**  
(Continued from page 110A)

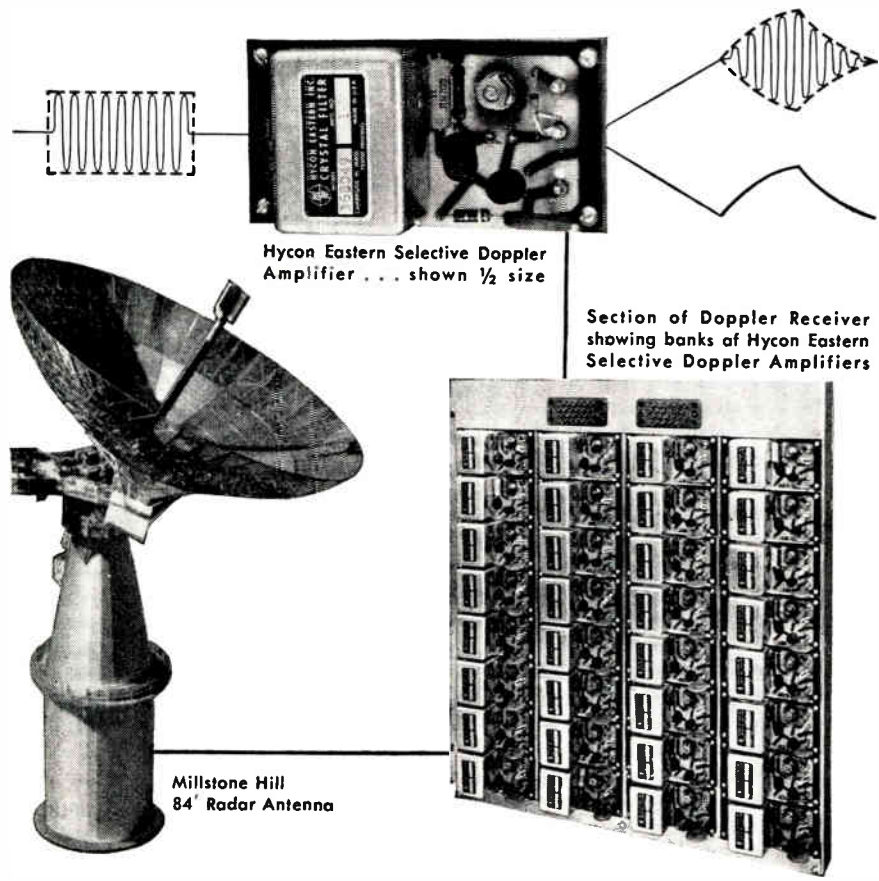

Hycon Eastern Selective Doppler Amplifier . . . shown 1/2 size

Section of Doppler Receiver showing banks of Hycon Eastern Selective Doppler Amplifiers

Millstone Hill  
84' Radar Antenna

The problems in long range radar for today's ballistic missile defense systems require solutions that are unique yet reliable. Meeting these criteria is the Lincoln Laboratory's "Millstone Hill System". Working closely with Lincoln Laboratory on the transient response problems, Hycon Eastern provided "comb set" crystal filters and associated circuitry forming complete networks termed Selective Doppler Amplifiers.

Hycon Eastern offers a unique customer service by assuming total responsibility for exact pulse output. All crystal filters are tested and aligned under simulated operating conditions, using a pulsed input. Transistor amplification, active impedance transformation, and detector circuitry are provided for complete compatibility with the total system. These integrated units are delivered ready for immediate use.

Hycon Eastern is presently supplying crystal filter banks for airborne intercept, bomber defense, shipborne and land based detection and tracking systems. Write for Crystal Filter Bulletin.



**HYCON EASTERN, INC.**  
75 Cambridge Parkway Dept. B Cambridge 42, Mass.

- Hoglund, J. B., Molndal, Sweden
  - Hosono, T., Tokyo, Japan
  - Howland, R. S., San Francisco, Calif.
  - Isaac, M. G., Utica, N. Y.
  - Joshi, M. G., Mahal, Nagpur, India
  - Juncker, J. R., Wayne, N. J.
  - Kemp, C. J., Dallas, Tex.
  - Kempf, R. F., Scottsdale, Ariz.
  - King, B. G., Bellevue, Wash.
  - Kirk, W. J., Jr., Kansas City, Mo.
  - Kjerulff, E. R., Placentia, Calif.
  - Kobayashi, H. K., Ann Arbor, Mich.
  - Kriegsman, B. A., Lexington, Mass.
  - Krivohlavek, G. M., Richmond, Calif.
  - Kuo, B. C. I., Urbana, Ill.
  - Kyle, H. C., Williamsburg, Va.
  - Lacker, H. F., Huntsville, Ala.
  - Lawton, B., St. John's Nfld., Canada
  - Leonard, H. Q., Jr., Dayton, Ohio
  - Lewis, R. E., Irving, Tex.
  - Lewison, G. L., Redondo Beach, Calif.
  - Limburg, M. A., Jr., Tonawanda, N. Y.
  - Linn, S. S., Garden City, L. I., N. Y.
  - Lund, V. M., Chicago, Ill.
  - Lutz, M. W., West Concord, Mass.
  - MacLachlan, D. T., Montreal, Que., Canada
  - Mann, G. A., Lawndale, Calif.
  - Marcellini, R. P., Los Angeles, Calif.
  - Marren, B. T., Cincinnati, Ohio
  - Martensson, I., Stockholm-Lidingo, Sweden
  - Marusich, E. A., East Pittsburgh, Pa.
  - Mason, W. F., Gahanna, Ohio
  - McCabe, F. C., Minneapolis, Minn.
  - McKean, G. A., Moscow, Idaho
  - Medoff, H., Hartsdale, N. Y.
  - Mercker, A. J., Chicago, Ill.
- (Continued on page 114A)

**LOW NOISE PREAMPLIFIER**  
UHF  
20 DB GAIN  
4.5 DB NOISE  
7077 Tube Predicted  
Measured performance when optimized at 400 MC

**TECHNICAL DATA**

Frequency Range	400 to 500 mc
Noise Figure	3.5 db to 5.5 db*
Gain & Bandwidth	21 to 23 db—2 mc
Input & Output Impedance	50 ohms
Max. Input Level	100 mv
Panel Size & Wt.	3 1/2 of 19-in Rack Space—9 3/4 lb.
RF Connectors	Type 'N'
Power	115 vac, 50-60 cps, 15 watts
Tube Type	7077 Ceramic Triode
Circuit	Grounded-grid, 2 stages
Tuned Circuits	Three continuously tunable coaxial cavities of rigid brass tubing. Simple peaking adjustment only.

\*Depending on tube selection

**RIXON Electronics**  
2414 Reedie Dr.  
Silver Spring, Md.

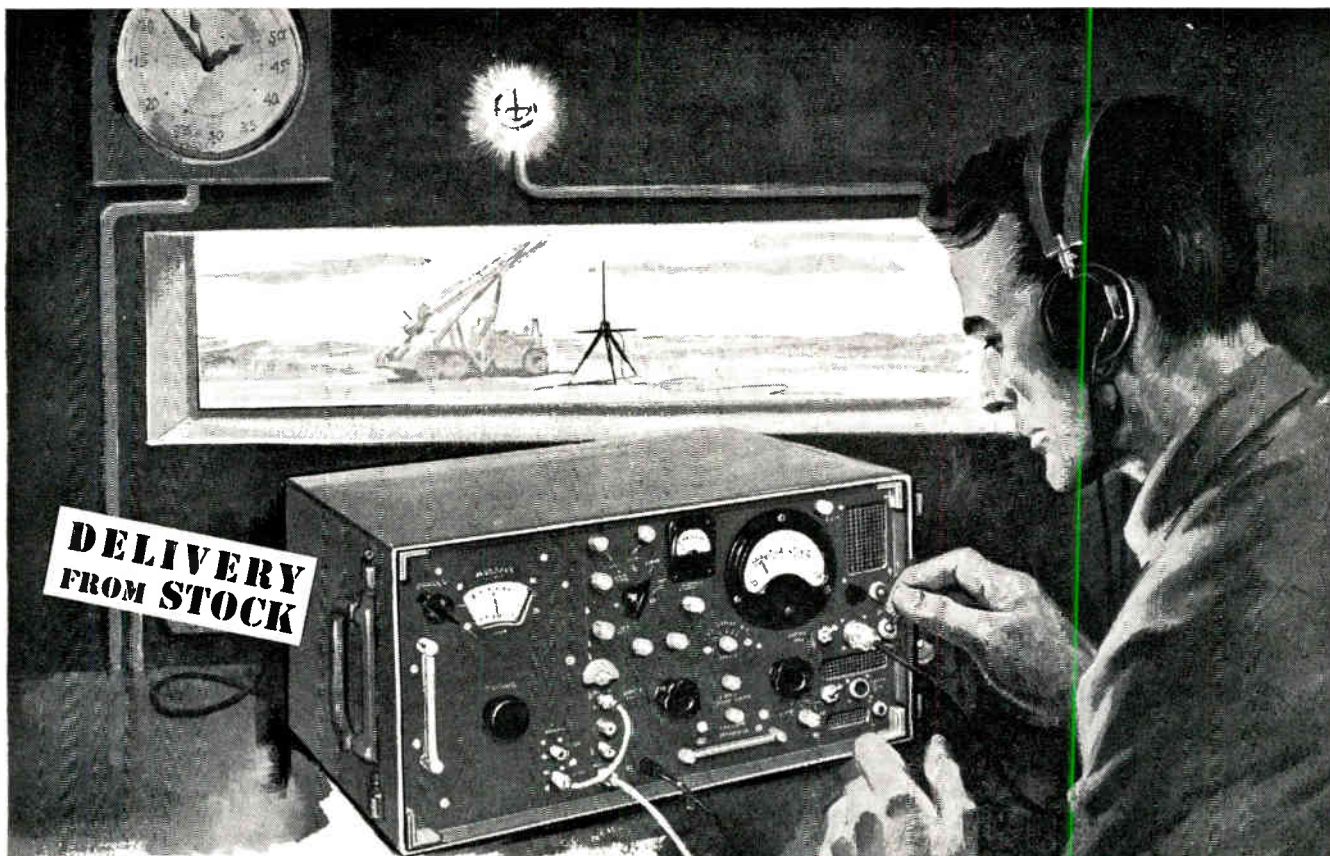

## FLEXIBILITY IN THE FIELD...

just one of the many useful features of

# EMPIRE'S NOISE & FIELD INTENSITY METER MODEL NF-105

Model NF-105 remotely located from its antenna, for personnel safety.

- Measures 150 kilocycles to 1000 megacycles accurately and quickly with only one meter.
- Approval status: MIL-I-6181B, Class I; MIL-I-6181C, Category A; MIL-I-26600 (USAF).
- Direct substitution measurements by means of broad-band impulse calibrator, without charts, assure repeatability.
- Self-calibrating, for reliability and speed of operation.
- True peak indication by direct meter reading or aural slideback.
- Four interchangeable plug-in tuning units, for extreme flexibility.
- Economical... avoids duplication.
- Safeguards personnel... ALL antennas can be remotely located from the instrument without affecting performance.
- Compact built-in regulated A and B power supply, for stability.
- Minimum of maintenance required, proven by years of field experience.



Only the Model NF-105 is so simple to operate that one technician can take readings over the entire frequency range in less time than required by three engineers manning any other three separate instruments.

Send for our Catalog No. N-357



**EMPIRE DEVICES PRODUCTS CORP.**  
AMSTERDAM, NEW YORK VICTOR 2-8400

MANUFACTURERS OF:

FIELD INTENSITY METERS • DISTORTION ANALYZERS • IMPULSE GENERATORS • COAXIAL ATTENUATORS • CRYSTAL MIXERS



# HIGH Voltage Quality Reliability

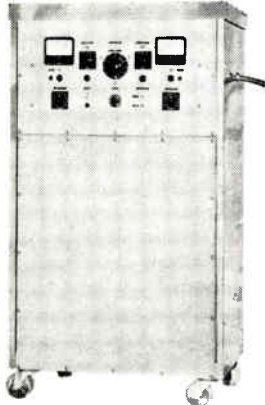

**HIGH VOLTAGE POWER SUPPLY MODEL 120-5-1**

- 5 MA at 120 KV D.C.
- Reversible Polarity
- Input 115V-60 cycle • Safety Interlock
- Overload Relays provide full range protection
- Automatic stored energy discharge switch
- No exposed high voltage components

Completely instrumented supplies are available from 30 KV to 250 KV D.C. up to 50 KVA.

## Compact High Voltage Power Supplies

- Selenium Rectifiers
- Low Ripple
- Reversible Polarity
- Shielded Output Cables
- Hermetically Sealed Can
- Epoxy Filled
- INPUT: 115 Volts—60 to 400 Cycles



Model No.	Output	Dimension W D H
2.5-2-1	2.5 KV-2MA	3 x 2 1/2 x 4 1/2
5-2-1	5KV-2MA	3 x 3 1/2 x 4 1/2
10-1-1	10KV-1.25MA	3 x 3 1/2 x 5 1/2
15-1-1	15KV-1.25MA	4 1/4 x 5 1/8 x 6 3/4
20-1-1	20KV-1.25MA	4 1/4 x 5 1/8 x 6 3/4
25-1-1	25KV-1.25MA	4 1/4 x 6 x 7 1/4
30-1-1	30KV-1.25MA	5 x 6 1/2 x 7 1/4

ALL DEL products represent the ultimate in quality. Their design and manufacture incorporate only the finest materials and workmanship to assure thoroughly dependable operation in industrial and research applications.

Standard Power Supplies and Transformers are available from stock. Others can be built to your specific requirements from stock components.

For additional information write to Department P.

**DEL ELECTRONICS CORP.**

OWens 9-3232

521 Homestead Ave., Mt. Vernon, N.Y.



## Membership

(Continued from page 112A)

Miasnick, J. D., Swampscott, Mass.  
 Milliken, M. P., State College, Pa.  
 Mitchell, J. H., Jr., Washington, D. C.  
 Mohler, R. R., Los Alamos, N. M.  
 Moore, K. A., Silver Spring, Md.  
 Morrison, R. E., Chicago, Ill.  
 Morrow, R. S., Kansas City, Mo.  
 Morse, F. L., Kalamazoo, Mich.  
 Munro, J. R., Glen Burnie, Md.  
 Nestor, R. P., New York, N. Y.  
 O'Brien, B., Jr., Fabyan, Conn.  
 Orbach, S., Jerusalem, Israel  
 Pacifico, E. M., White Plains, N. Y.  
 Paul, L. E., Ann Arbor, Mich.  
 Paul, V. L., Cedar Rapids, Iowa



Pazer, J., Little Neck, N. Y.  
 Pellegrinelli, A., Murray Hill, N. J.  
 Priest, W. G., Maynard, Mass.  
 Prouty, G. S., Jr., Stowe, Vermont  
 Rabinowitz, C. M., Stamford, Conn.  
 Ribaczek, A. W., El Paso, Tex.  
 Robertson, J. L., Sr., New Orleans, La.  
 Scheihing, F. A., State College, Pa.  
 Selkirk, W. J., Hempstead, L. I., N. Y.  
 Semmelhaack, C. F., Brooklyn, N. Y.  
 Sessel, R., Dallas, Tex.  
 Sherer, P. N., Pasadena, Calif.  
 Shoub, B., Montreal, Que., Canada  
 Smith, C. J., College Park, Md.  
 Smith, J. D., Costa Mesa, Calif.  
 Sourial, R. S., Orman, Giza, Egypt, U.A.R.  
 Spence, R. E., Jr., Midwest City, Okla.  
 Spicer, W. H., Cocoa, Fla.  
 Standley, R. D., Ft. Monmouth, N. J.  
 Stieglitz, C. B., Endicott, N. Y.  
 Thompson, M. W., Anaheim, Calif.

(Continued on page 128A)

For Your DC Measurements . . .

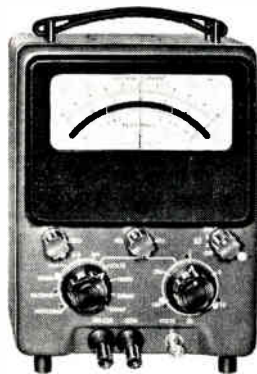

## The Belleville-Hexem Model 110 a versatile battery-powered EIR Meter

- E** • 100 millivolts to 1000 volts full scale in 9 ranges, 111 megohms input resistance
- I** • 1 millimicroampere to 300 milliamperere full scale in 18 ranges, 100 millivolt voltage drop
- R** • 10 ohms to 100 megohms center scale in 6 ranges

PRICE: \$315, standard, \$350, rack

Your B-H engineering representative will be happy to arrange a demonstration. For his name and complete technical data, write The Belleville-Hexem Corporation, 638 University Avenue, Los Gatos, California.

## UNITED MINERAL & CHEMICAL CORPORATION

Specialists in insulation-, conductor-, semi-conductor—materials

### SEMICONDUCTOR MATERIALS

Germanium Antimonides Selenides Tellurides  
 Bismuth Telluride Arsenides Sulphides and other Intermetallic Compounds

### HIGH PURITY METALS

Aluminum	Chromium	Magnesium	Rhodium	Thallium
Antimony	Cobalt	Manganese	Rubidium	Thorium
Arsenic	Copper	Mercury	Ruthenium	Tin
Barium	Gallium	Molybdenum	Scandium	Titanium
Beryllium	Germanium	Nickel	Selenium	Tungsten
Bismuth	Hafnium	Osmium	Silver	Vanadium
Cadmium	Indium	Palladium	Sulphur	Zinc
Calcium	Iridium	Platinum	Tantalum	Zirconium
Cerium	Iron	Rare Earth Metals	Tellurium and their oxides and salts	
Cesium	Lead	Rhenium		

## UNITED MINERAL & CHEMICAL CORP., Metals Division

16 Hudson Street; New York 13, New York  
 Beekman 3-8870

See us at booth 4119, March 23 thru 26th, at the 1959 Radio Engineering Show.

## MEET Oskar Giesecke...

...Vice-President in charge of Engineering at Air-Marine Motors.

Oskar, a senior member of the I.R.E., is responsible for the design and engineering of Air-Marine's products. He has written articles on the design and application of their A.C. motors, blowers and fans.

Born in Germany, he came to the U.S. in 1925 and received his B.A. in Physics from Pacific University. After doing graduate work at Illinois Institute of Technology and the University of Berlin, he became an electrical engineer for Lorenz A.G. Returning to the U.S. in 1941, he was Chief Design Engineer at Russell Electrical Company before joining Air-Marine in 1951.



VISIT OUR BOOTH 2315 AT THE I.R.E. SHOW



**air · marine motors, inc.**

AMITYVILLE, NEW YORK · LOS ANGELES, CALIF.



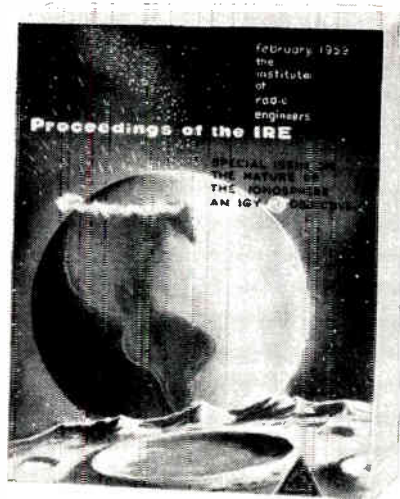

# KNOW YOUR

# NEW WORLD

*by reserving your copy of THE NATURE OF THE IONOSPHERE—AN IGY OBJECTIVE, special February issue of PROCEEDINGS OF THE IRE. On these pages you will find a distillation of 18 months of an intensive international effort. Set against a background of earlier work, here is a new compendium of engineering knowledge edited to your special interests. Here is your new frontier.*



## PARTIAL CONTENTS OF IONOSPHERE-IGY ISSUE

"The Earth and its Environment" by S. Chapman, U of Colorado

"The Constitution and Composition of the Upper Atmosphere" by M. Nicolet, Radio and Meteorology Institute, Belgium

"The Normal F-Region of the Ionosphere" by D. F. Martyn, Radio Research Labs. CSIRO, Australia

"The Normal E-Region of the Ionosphere" by E. V. Appieton, U of Edinburgh, Scotland

"The D-Region of the Undisturbed Ionosphere" by J. J. Gibbons & A. H. Waynick, Penn State U

"The Distribution of Electrons in the Ionosphere" by J. O. Thomas, U of Cambridge, England

"Motions in the Ionosphere" by C. O. Hines, Defense Research Board, Canada

"Meteors in the Ionosphere" by L. A. Manning & V. R. Eshleman, Stanford U

"Atmospheric Whistlers" by R. A. Helliwell, Stanford U & M. G. Morgan, Dartmouth U

"Radiation and Particle Precipitation upon the Earth from Solar Flares" by L. G. B. Biermann & R. Lust, Max Planck Institute for Physics and Astrophysics, Germany

"The Very-Low-Frequency Emissions Generated In The Earth's Atmosphere" by R. M. Gallet, National Bureau of Standards

"The F-Region During Magnetic Storms" by K. Maeda, Kyoto U & T. Sato, Shiga U, Japan

"Aurora Phenomena" by E. N. Parker, U of Chicago

"Rocket Observations of the Ionosphere" by H. Friedman, U. S. Naval Research Lab.

"Earth Satellite Observations of the Ionosphere" by W. W. Berning, Aberdeen Proving Grounds

"Exploration of the Upper Atmosphere with the help of the 3rd Soviet Sputnik" by V. I. Krassovsky, Institute for Atmospheric Physics, Moscow

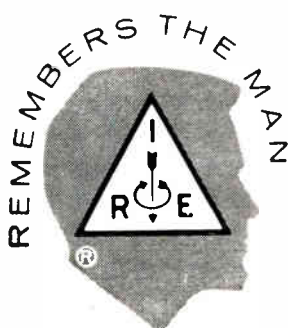

## THE INSTITUTE OF RADIO ENGINEERS

1 East 79th St., New York 21, N. Y.

△ Enclosed is \$3.00

△ Enclosed is company purchase order for the February 1959 issue on I.G.Y. and Ionosphere.

Send this special issue of THE NATURE OF THE IONOSPHERE—AN IGY OBJECTIVE to:

NAME \_\_\_\_\_

COMPANY \_\_\_\_\_

ADDRESS \_\_\_\_\_

CITY & STATE \_\_\_\_\_

All IRE members will receive this February issue as usual.

Extra copies to members, \$1.25 each (only one to a member)



**MISSILES  
ARE BIG  
IN THE  
MIDDLE  
WEST,  
TOO!**

**... and there's big opportunity  
at BENDIX—prime contractor  
for the TALOS MISSILE**

If you have the qualifications, you can build yourself an enviable engineering career with Bendix—and enjoy living in one of America's fine residential and recreational areas.

Bendix Missiles has opportunities now for engineers of exceptional ability. You'll be in the technical forefront of your profession at Bendix, working with men who have sparked some of the most important technological achievements of our

time. You'll have the use of facilities and equipment that are unmatched.

You'll enjoy a pleasant four-season climate, have excellent educational facilities available to you and your family, and have easy access to Chicago. Most of all, you'll find satisfaction in doing important work alongside men who are professional engineers. Mail the coupon today for a copy of "Opportunities Abound at Bendix Missiles".

**Bendix** PRODUCTS DIVISION **Missiles**



**Bendix Products Division—Missiles**  
402A So. Beiger St., Mishawaka, Ind.  
Gentlemen: I would like more information concerning opportunities in guided missiles. Please send me the booklet "Opportunities Abound at Bendix Missiles".

NAME \_\_\_\_\_  
ADDRESS \_\_\_\_\_  
CITY \_\_\_\_\_ STATE \_\_\_\_\_



**By Armed Forces Veterans**

In order to give a reasonably equal opportunity to all applicants and to avoid overcrowding of the corresponding column, the following rules have been adopted:

The IRE publishes free of charge notices of positions wanted by IRE members who are now in the Service or have received an honorable discharge. Such notices should not have more than five lines. They may be inserted only after a lapse of one month or more following a previous insertion and the maximum number of insertions is three per year. The IRE necessarily reserves the right to decline any announcement without assignment of reason.

Address replies to box number indicated, c/o IRE, 1 East 79th St., New York 21, N.Y.

**ELECTRONIC ENGINEER**

Age 26. BSEE. 1954; MSEE. 1956. TBTI, KME, HAM license. Lt. (j.g.) USNR. Three years with missiles and radar. Release from active duty Feb. 1, 1959. Desires position where graduate work may be done, double option, communication and industrial electronics analog computers. Box 1075 W.

**TELECOMMUNICATIONS ENGINEER**

B.Sc. (Eng.) 1st class honors London University, telecommunications. Age 33. Seven years experience in design and construction of every type of electronic equipment. Recent research on semiconductors. A.M.I.E.E., Member IRE. Several publications on circuits. Available in U.S. this year. Box 1077 W.

**SENIOR ELECTRONIC TECHNICIAN**

Experienced Senior Electronic Technician. Presently Chief Technician. Thirteen years electronics background; amateur license; 3 years as Radar Theory Instructor; data handling background; digital techniques; magnetic perforated tape handlers. Leadership abilities in supervisory capacities proven by minimum of last 5 years. Desires challenge with opportunity. Box 1078 W.

**ENGINEER—PILOT**

B.S.E.E., Princeton University. Age 31, married, 2 children. Desires position combining engineering talents and Beechcraft Pilot qualifications in engineering administration, application, liaison, sales or project supervision. Seven years diversified experience encompassing project engineering, flight test and instrumentation, electro-mechanical and electro-hydraulic design, application and sales engineering. Present responsibilities include hydraulics, radar drives and control systems, antenna selection and RF feed assemblies. Considerable experience in cost estimating and preparation of technical proposals. Prefer New Jersey or other eastern location. Box 1079 W.

*(Continued on page 118A)*

**Use your  
IRE DIRECTORY  
It's valuable!**

# ENGINEERS—

Another Example of Diversified Work **SPERRY** Engineers Do...

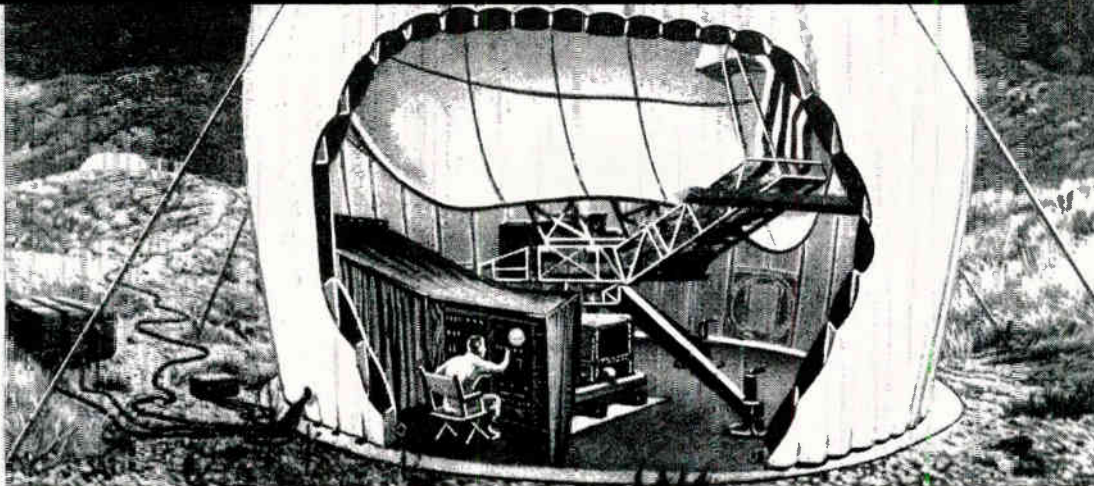

As fast on the move as a fighting Marine is the new "TEW" (tactical early warning) radar system being developed by Sperry for the Marine Corps. Only one-fourth the size and weight of conventional radars, TEW is easily carried to battle areas by helicopter, cargo plane, truck or amphibious vehicle. Within two hours, an 18-man crew can erect the TEW system and place it in operation.

With its very long range and portable construction, TEW provides the Marines with the means to extend the nation's defense perimeter and insure added protection for key installations and outposts.

*If you're interested,  
not in an engineering job,  
but in an engineering CAREER,  
check Sperry—*

Sperry Gyroscope also stands for steady growth. Not just for the company—but for its engineers. Sperry engineers are career engineers, working on projects—like TEW—that are creative, interesting, important. They stay, and grow, with us. That's why over 2,600 Sperry employees are 15-year men. And—today we're expanding, diversifying more than ever. If engineering is your life's work—check Sperry.

*Openings in many specializations  
including the following:*

INERTIAL NAVIGATION SYSTEMS  
DOPPLER NAVIGATION • RADAR RECEIVERS  
RADAR TRANSMITTERS • INFRARED SYSTEMS  
PULSE CIRCUITS • TIMING CIRCUITS  
ELECTRONIC PACKAGING  
TRANSISTOR CIRCUITS  
*For Pulse & Video Applications*  
MICROWAVE ANTENNA DESIGN

## Confidential Interviews

Contact Mr.  
J. W. Dwyer  
Employment Manager

•

Saturday Interviews  
8 A.M.-1 P.M.  
Arranged by Appointment

# SPERRY

## GYROSCOPE COMPANY

Division of Sperry Rand Corp.  
Great Neck, Long Island, N. Y.  
Fieldstone 7-3665





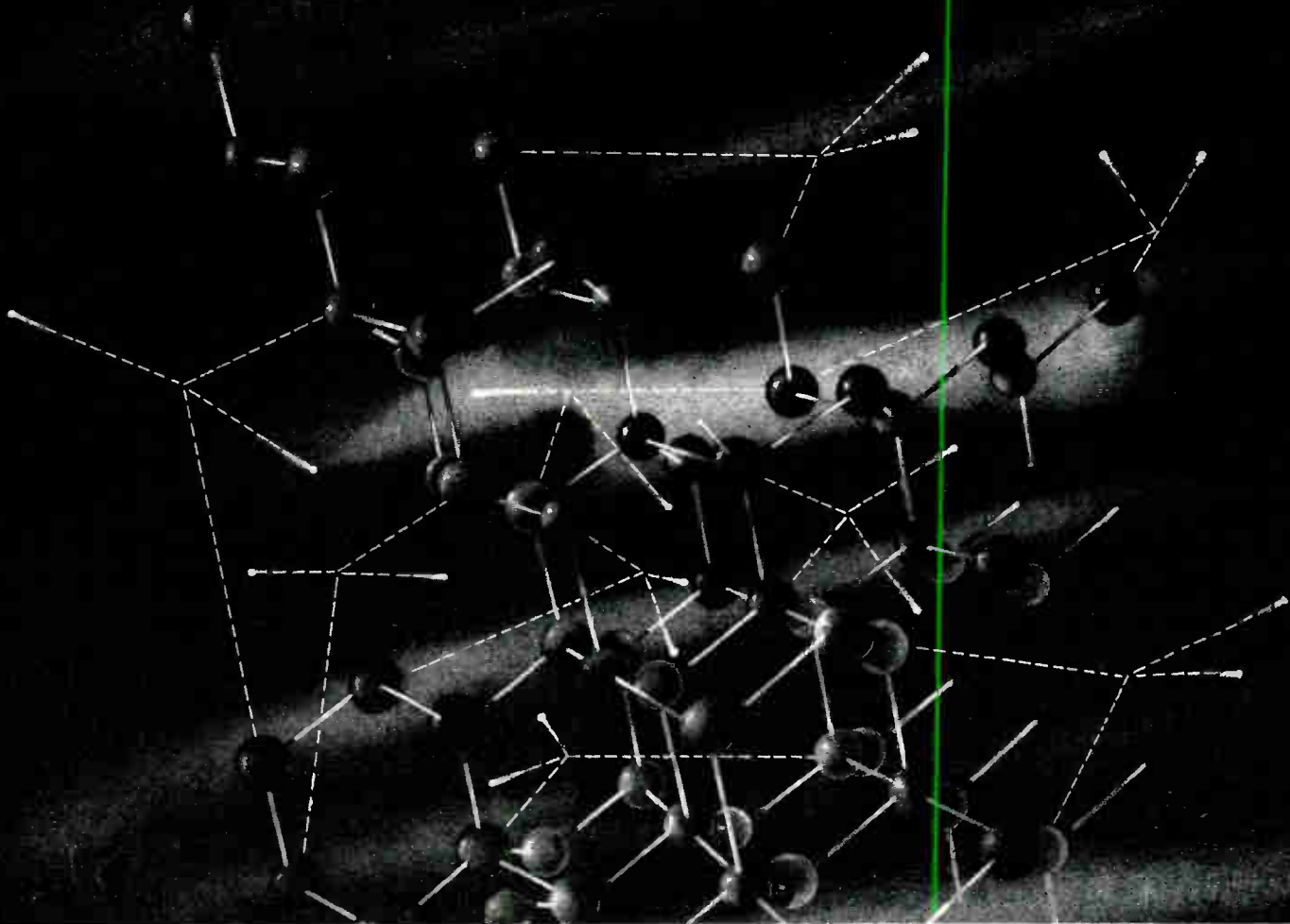

## The nature of electron transport in a solid

An active program is under way at IBM to investigate various mechanisms that influence the conduction of electrons in solids. One project of interest is the work being done by Dr. Seymour H. Koenig of the Watson Research Laboratory at Columbia University, involving the behavior of electrons when their mean energy is greater than would be indicated by the temperature of the solid.

At a few degrees above absolute zero, the application of even a small electric field to a sample of germanium will grossly affect equilibrium of the conduction electrons and increase their average energy by a factor of twenty-five or more. The characteristics of these "hot" electrons

are being studied to determine the processes that occur as they move through the lattice. "cool," and return to equilibrium. By measuring the detailed behavior of the electrical conductivity, often in time intervals measured in milli-microseconds, important information relating to the interaction of electrons with the germanium lattice can be obtained.

These investigations at the Watson Research Laboratory in New York City are adding to our understanding of basic solid state phenomena at low temperatures as well as yielding some interesting and unexpected device possibilities.

*Investigate the many career opportunities available in exciting new fields at IBM.*

**IBM**

RESEARCH

*International Business Machines Corporation, Dept. 645-B, 590 Madison Avenue, New York 22, New York*

# The new long look

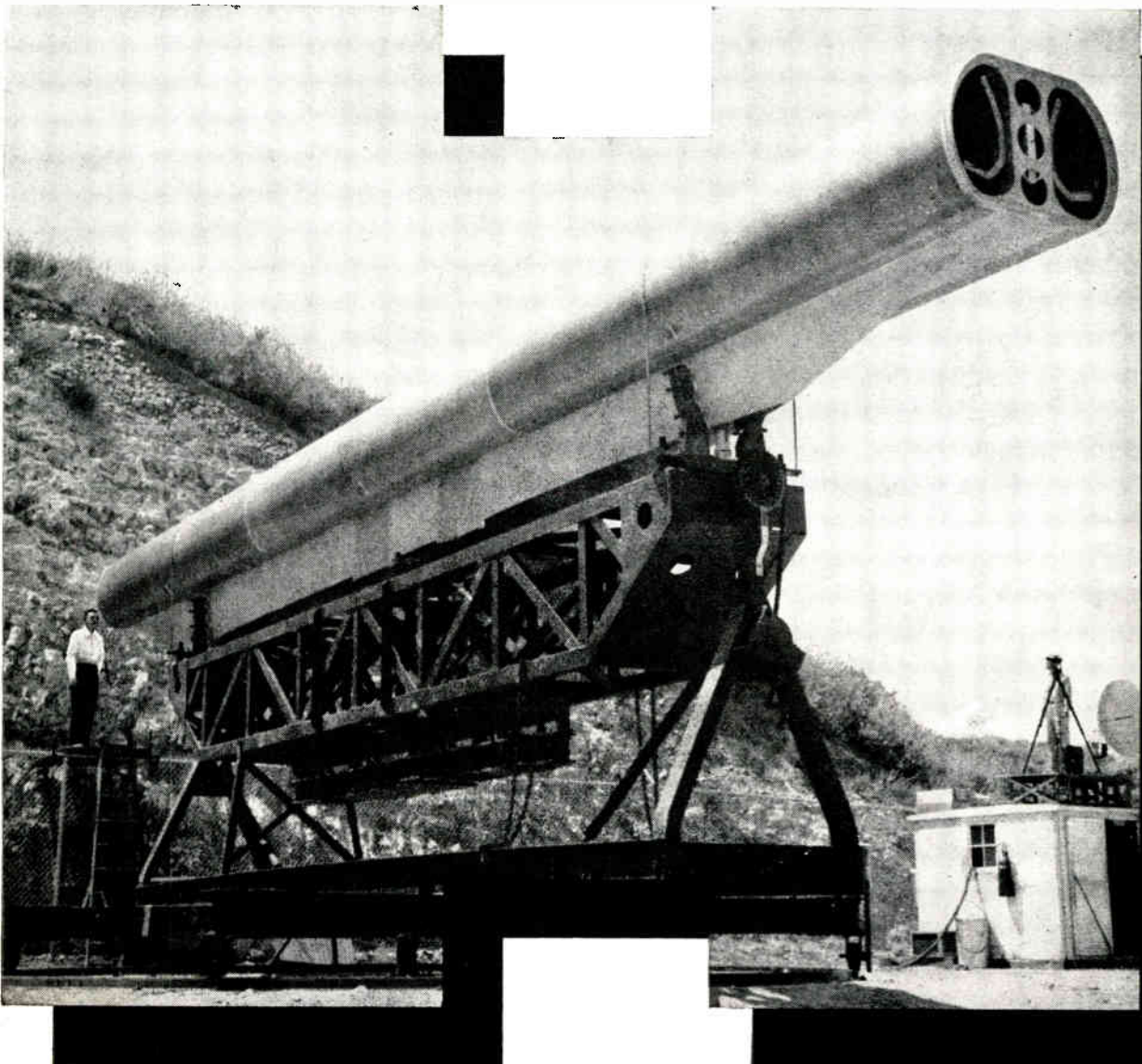



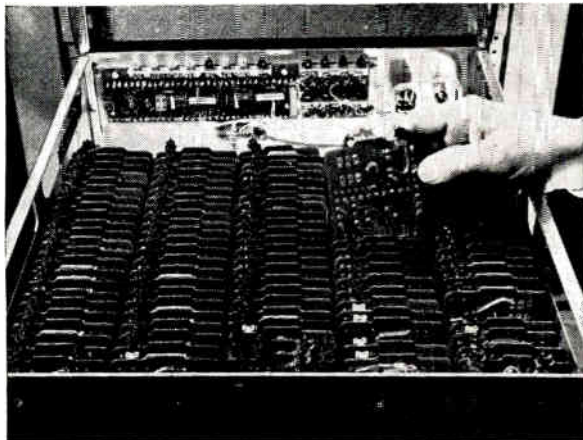

**Test Equipment** designed and built by Hughes El Segundo is as sophisticated as the Hughes Electronic Armament Systems which it tests.



**His lab is the cockpit.** Wherever Hughes systems and missiles are employed, Hughes Field Engineers are on hand to work directly with squadron personnel.

## in sky scanning

A totally new idea in reconnaissance radar, **SIGHTSEER** (*at left*) is a side-looking, microwave search antenna within a completely self-contained detachable pod. Carried under the Convair B-58 Supersonic Bomber as a 58-foot package, **SIGHTSEER** has all hardware and black boxes built-in. It is roll stabilized—when the aircraft changes flight attitude, the antenna maintains its normal axis.

**SIGHTSEER** was designed and developed by the Microwave Laboratory of Hughes. This Microwave Laboratory is presently engaged in every field of electronics for airborne, missile, communication, and ground and ship-based radar systems—with operational ranges from 50 to 70,000 megacycles.

The “systems orientation” represented by the new **SIGHTSEER** reflects Hughes philosophy of integration. The Microwave Laboratories, for example, support the Systems Development Laboratories as well as the Hughes Ground Systems Group in Fullerton.

Advanced Research and Development at Hughes creates stimulating opportunities for creative engi-

neers in Airborne Electronics Systems. Space Vehicles, Plastics, Nuclear Electronics, Global and Spatial Communications, Ballistic Missiles and many others.

Similar opportunities exist at Hughes Products, where basic Hughes developments are translated into commercial products—semiconductors, specialized electron tubes, and industrial systems and controls.

From basic research through final application, Hughes offers a unique opportunity for personal and professional growth.

*Newly instituted programs at Hughes have created immediate openings for engineers experienced in the following areas:*

Digital Computer Engr.	Communications
Microwaves	Radar
Semiconductors	Circuit Design
Field Engineering	Systems Analysis
Microwave & Storage Tubes	Reliability Engineering

*Write in confidence, to Mr. Tom Stewart,  
Hughes General Offices, Bldg. 6-E2, Culver City, California.*

© 1959. H. A. C.

*The West's leader in advanced ELECTRONICS*

**HUGHES**

HUGHES AIRCRAFT COMPANY  
Culver City, El Segundo,  
Fullerton and Los Angeles, California  
Tucson, Arizona

*This is one of a series of informative messages to acquaint engineers and scientists with the projects of RCA Moorestown.*

## **RCA MOORESTOWN AND ATLAS**

Responsibility for the development, design and production of an advanced launch control system for the Atlas missile is one of the charters of RCA Moorestown. The system is designed to perform two primary functions: To determine the operational readiness of the missile and to control the actual launching of the ICBM into space.

The Atlas launch control system complex requires over 200 cabinets of relay logic and newly developed transistorized digital and analog computer circuitry. Of critical significance in the development of the complex are the problems of reliability and accuracy, necessitating the use of advanced transistorized techniques. The challenge of the project is increased by the need for obtaining and integrating information from many associate contractors and by the problems of concurrent research, development and production. The breadth and complexity of the Atlas launch control system are creating stimulating assignments in systems, projects and development engineering.

Engineers, scientists and managers interested in contributing to this program—or to other challenging weapon system projects—are invited to address inquiries to Mr. W. J. Henry, Box V-17B.



**RADIO CORPORATION of AMERICA**

MISSILE AND SURFACE RADAR DEPARTMENT  
MOORESTOWN, N. J.



**Positions  
Open**



The following positions of interest to IRE members have been reported as open. Apply in writing, addressing reply to company mentioned or to Box No. . . .

The Institute reserves the right to refuse any announcement without giving a reason for the refusal.

Proceedings of the IRE  
1 East 79th St., New York 21, N.Y.

### **SCIENCE AND ENGINEERING**

Opportunities at Robert College, Istanbul, Turkey, for qualified men in engineering, mathematics, physics and chemistry interested in combining teaching and consulting with the opportunity to live and travel in a vital part of the world. Development program is in effect to strengthen staff, modernize undergraduate curricula, inaugurate graduate program, construct new science and engineering building, prepare engineers for the industrial and technological development of Turkey and the Middle East. Address inquiries to Dr. Duncan S. Ballantine, Pres. or Dean Howard P. Hall, College of Engineering, Robert College, Bebek, P.K. 8, Istanbul, Turkey with copy to Near East College Assoc., 40 Worth St., New York 13, N.Y.

### **PHYSICIST**

Magnetics: Theoretical physicist with MS. or Ph.D. degree and experienced in magnetics. Position involves aid to both ceramic and electrodeposition groups, developing new magnetic materials and applications. Send complete resume to K. B. Ross, National Cash Register Co., Dayton 9, Ohio.

### **TEACHERS**

Excellent opportunity is available in new expanding department. Location is at medium sized university in the midwest devoted primarily to undergraduate teaching. Rank and salary commensurate with qualifications. Appointment is available beginning February or September. Send complete resume to Box 1084.

### **ELECTRONIC ENGINEER**

Electronic engineer to teach lecture and laboratory courses. Up-to-date knowledge of the field required. Working and living conditions excellent; salary and opportunity very attractive. Write to Dean of Engineering, California State Polytechnic College, San Luis Obispo, California.

### **PROFESSORS**

Teaching positions—Assistant, Associate, or full professor of electrical engineering, MS. or Ph.D. required. 9 month salary range \$5000-\$9000 presently. Full year appointments available. Salaries are increasing rapidly. Candidate should be well prepared to teach in new undergraduate program with strong engineering science emphasis and E.E. graduate (MS) program. Apply to A. T. Murphy, Head, Dept. of E.E., University of Wichita, Wichita 14, Kansas.

### **ELECTRONIC ENGINEERS—PHYSICISTS**

Intermediate and senior positions open in long range program in each of the following projects: satellite, space, electronic test equip-

*(Continued on page 125A)*

# Able-One... a new apogee in scientific teamwork!

Preparation and execution of an undertaking such as the United States' IGY space probe demanded the participation and exceptional efforts of 52 scientific and industrial firms and the Armed Forces. The Advanced Research Projects Agency and the AFBMD assigned Space Technology Laboratories the responsibility for the project which was carried out under the overall direction of the National Aeronautics and Space Agency. One measure of this teamwork is the spectacular success of the Able-One flight into outer space.

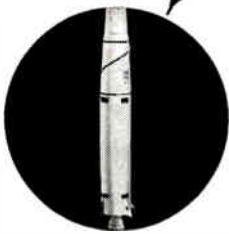
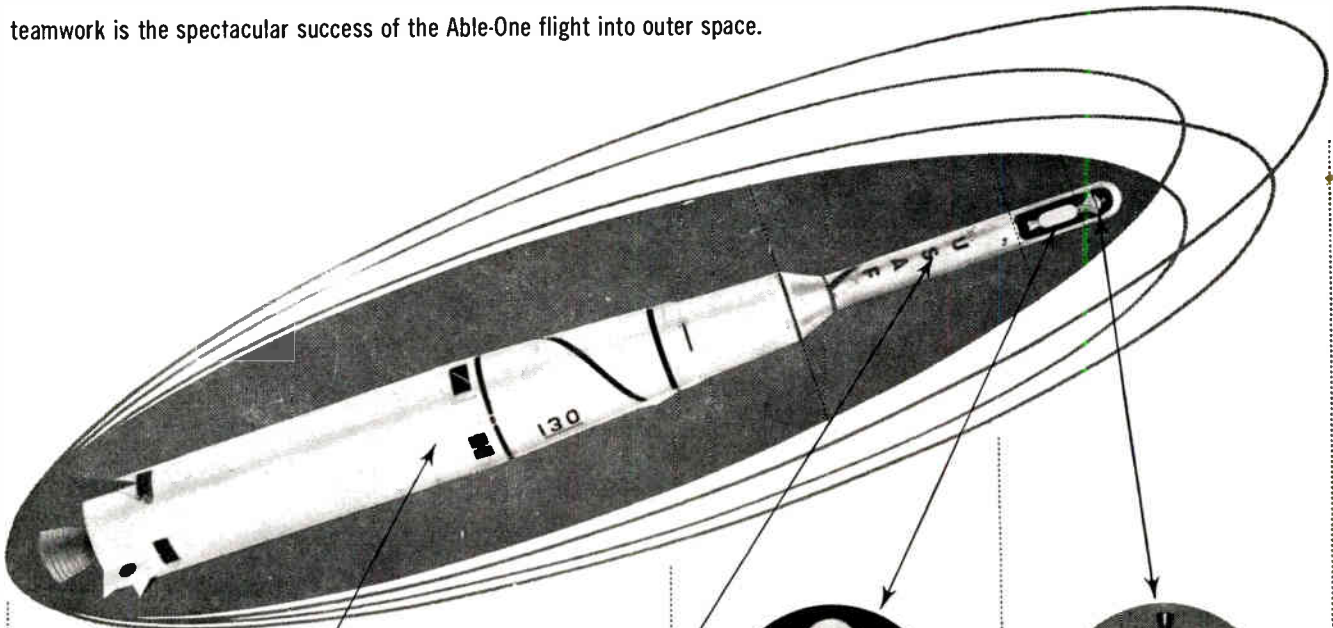

**1st stage:** Vehicle, Douglas Aircraft Thor IRBM; propulsion, Rocketdyne; airframe, control, electrical and instrumentation, Douglas Aircraft; assembly, integration, and checkout, Douglas Aircraft.



**2nd stage:** Propulsion system and tanks, Aerojet-General; control, electrical, instrumentation, accelerometer shutoff, and spin rocket systems, STL; assembly, integration, and checkout, STL.



**3rd stage:** Rocket motor, U. S. Navy Bureau of Ordnance and Allegheny Ballistic Laboratory; structure and electrical, STL; assembly, integration, and checkout, STL; ground testing, USAF's Arnold Engineering Development Center.

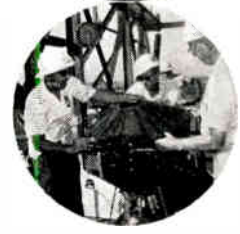

**Payload:** Design and production of Pioneer, the payload of the Able-One vehicle, was conducted by STL in addition to its overall technical direction and systems engineering responsibility of the Air Force Ballistic Missile Division project. This highly sophisticated package included a NOTS TV camera and transmitter and Thiokol rocket motor.

Inquiries concerning openings on our staff will be welcomed by

**Space Technology Laboratories, Inc.**

5730 Arbor Vitae Street, Los Angeles 45, California.



work in the fields of the future at NAA



## COUNTER-MEASURES ENGINEERS

Work on America's most advanced weapon systems.

At North American Aviation, such top-level projects as the B-70 and F-108 weapon systems have created unique careers with a tremendous engineering potential.

We have immediate openings for specialists and systems engineers in the field of electromagnetic and infrared countermeasures. Specialized areas include high power traveling wave tube analysis, receiver techniques, system logic, infrared systems design, and antenna and radome development. Experienced engineers are needed to establish requirements for countermeasures systems and to evaluate new components and techniques and their application to advanced systems.

Minimum requirements are actual experience in countermeasures plus B.S. degree in EE or Physics.

For more information please write to: Mr. B. B. Stevenson, Engineering Personnel, North American Aviation, Inc., Los Angeles 45, California.

THE LOS ANGELES DIVISION OF

**NORTH AMERICAN AVIATION, INC.**



## ENGINEERS AND PHYSICISTS

Armour Research Foundation, one of the nation's foremost independent research organizations, has appropriate positions available for experienced engineers, as well as recent graduates, to work on its many diversified research programs. As a member of our Electrical Engineering Research staff, you will have an opportunity to fully utilize your technical ability while enjoying excellent facilities, working conditions, and stimulating staff associations.

Applicants should have at least a B.S. degree and be experienced or interested in one of the following areas:

**ELECTRONIC COMPONENTS  
COMMUNICATIONS  
INSTRUMENTATION  
CONTROL SYSTEMS**

The Foundation is located on the campus of the Illinois Institute of Technology and encourages graduate engineering study through its education program providing tuition free graduate study, in addition to offering competitive salaries and liberal employee benefits.

If you are interested in this challenging opportunity to advance professionally, please send a complete resume to:

A. J. Paneral

**ARMOUR RESEARCH FOUNDATION**

Of Illinois Institute of Technology

10 West 35th St.

Chicago 16, Ill.

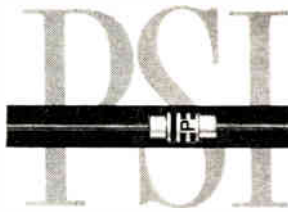

## Opportunities in Solid State Electronics

Pacific Semiconductors, Inc., a subsidiary of the Thompson-Ramo-Wooldridge Corporation, has several excellent Technical Staff opportunities as a result of the rapid expansion of its development programs on Very High Frequency and Very High Power Silicon transistors. We invite inquiries from Solid State Physicists and Engineers with experience in transistor development; mechanical engineers engaged in transistor package and manufacturing equipment development; and electrical engineers experienced in semiconductor device applications and test equipment development.

If you have a B.S., M.S., or Ph.D. degree in physics or engineering, applicable experience, and are interested in the future of semiconductor electronics with a young, dynamic organization where resourcefulness and original thinking are both recognized and encouraged, write:

Technical Staff Employment

**Pacific Semiconductors, Inc.**

10451 W. JEFFERSON BOULEVARD, CULVER CITY, CALIFORNIA





## Positions Open



(Continued from page 122A)

ment, instrumentation. Opportunity for advance degree, 4 weeks vacation, excellent working conditions. Submit resume and college transcript to Mr. J. Prager, New York University, Research Div., 401 West 205th St., New York 34, N.Y.

### SYSTEMS PROJECT ENGINEER

Manage full program pertaining to research and development of complex airborne navigational systems for application in aircraft, missiles, and space vehicles. Responsible for project administration as well as technical guidance of group. Send resume to Charles J. Weinpel, Kearfott Company, Inc., 1500 Main Ave., Clifton, New Jersey.

### ELECTRONICS ENGINEER

Opportunity for young electronic engineer (8 to 12 years experience) for export operation with well-established, well-financed and forward looking export organization. Position as assistant to senior service engineer, requires thorough familiarity with television receivers circuits, quality control and the specific problems concerned with the manufacture abroad of electronics components and television receivers. Eventual travel abroad makes knowledge of one or more foreign languages extremely desirable. Many benefits as well as company-paid pension plan. Salary open. Send complete resume to Ad. Auriema, Inc., 85 Broad St., New York 4, N.Y.

### INSTRUCTORS—EVENING

Increases in registration have created several additional positions for part-time instructors in the Electrical Technology Dept. Most subjects are taught on a 2 hour per night, 2 nights per week basis (6:15 to 7:55 and 8:10 to 9:50). Two subjects can be combined if a 4 hour load is desired. Degree in E.E. and industrial experience required. Address inquiry to Prof. J. De France, Head, Dept. of Elec. Tech., New York City Community College, 300 Pearl St., Brooklyn 1, N.Y.

### COMMUNICATIONS RESEARCH

RCA Laboratories invites you to investigate opportunities in communications research at its Rocky Point, L.I. and Princeton, N.J. locations. Positions open in digital communications systems, coding theory, modulation and detection techniques, statistical decision methods and propagation studies. Send resume to D. D. Holmes, Mgr. Radio Research Laboratory, Dept. PE-4, RCA Laboratories, Rocky Point, L.I. New York or telephone Shoreham 4-9974.

### TECHNICAL TRANSLATORS

World renowned firm in the field of communication engineering requires free-lance technical translators to translate German literature on communication systems into English. Applicants must be qualified communication engineers with an excellent knowledge of German. Send resume to Siemens New York Inc., 350 Fifth Ave., New York, N.Y.

### ELECTRONICS ENGINEER

Electronics Engineer (E.E.) about 35 years of age for research and development work in the high and medium frequency heating field. Location: New York City. Please send resume to Box No. 1086.

(Continued on page 126A)

# ENGINEERS

**NOW—CHOOSE YOUR ASSIGNMENT  
AND LOCATION THROUGH OUR  
NATION-WIDE PLACEMENT SERVICE  
SALARIES \$7,500 TO \$18,000**

**We can offer you a large selection of diversified positions with America's foremost electronic organizations WITH NO COST TO YOU.**

**SOME POSITIONS FOR RESIDENT NON-CITIZENS AND CANADIANS**

## WHAT WE DO FOR YOU—

Take all the work from you—no need for you to write to five or six companies, fill out applications for each one, only to find there is no job that interests you. We do all that for you, find the job that you want—in the location you want—we work with over 250 companies all over the country.

## ALL WE ASK YOU TO DO—

Send us 3 complete resumes, telling us your present and desired salary; the kind of work you want and where you would like to live. That is all you have to do!

## THEN YOU—

Wait to hear from us or our clients. There is *no need* to write directly to any companies, as we do all that for you and at absolutely **NO COST TO YOU!**

Just indicate where you would like to relocate and what you would like to do. We handle everything for you without cost or obligation.

### LOCATION DESIRED

- New England
- Northern East Coast
- Southern East Coast
- Midwest
- Southwest
- West Coast

### POSITION DESIRED

- Systems
- Radar
- Transistors
- Tubes
- TV Receivers
- Microwave
- Anal. Computers
- Dig. Computers
- Servo-Mechanisms
- Navigation
- Counter Measures
- Telemetry
- Nucleonics
- Ind'l. Instruments
- Components
- Circuit Design

A National Electronic Placement Service Established in 1937.  
You are assured of prompt and completely confidential service by forwarding three resumes to HARRY L. ERISK, (Member IRE)



# Accredited Personnel Service

Employment Counselors Since 1937  
Department A

12 South 12th Street, Philadelphia 7, Penna. WALnut 2-4460



# ORBIS SCIENTIARUM\*



The Westinghouse symbol represents a select circle of scientists and engineers dedicated to the betterment of man through the advancement of science. At Westinghouse-Baltimore, your engineering skill and creative abilities would be developed to their fullest capacity to further the attainment of this ideal. Write for details on the Westinghouse-Baltimore operation and the opportunities it offers you.

## CAREER OPPORTUNITIES EXIST IN THE FIELDS OF:

### TO APPLY:

Please send a resume of your education and experience to Dr. J. A. Medwin, Dept. 880, Westinghouse Electric Corporation, P. O. Box 746, Baltimore 3, Maryland.

ADVANCED FILTER DESIGN  
COMMUNICATION SYSTEMS  
ELECTRONICS INSTRUCTOR  
ENGINEERING WRITING  
INSULATION  
MICROWAVE COMPONENTS  
SOLID STATE SYSTEMS  
TEST ENGINEERING

# Westinghouse

## BALTIMORE

\*The Circle of the Sciences



(Continued from page 125A)

### PUBLICATIONS ENGINEERS

Present expansion is creating attractive opportunities with one of the foremost technical publications firms in the country. Vacancies at all levels for personnel experienced in the preparation of manuals on complex electronic equipments. Handbook III. Spec knowledge important. Permanent positions only. All replies in confidence. Send resume to Mr. Sidney Platt, Chief Engineer, Warner, Inc., 522 Fifth Ave., New York 36, N.Y.

### ELECTRONIC ENGINEER

Electronic Engineer with combined physics or geophysics background to develop measurement systems and study low frequency electromagnetic phenomena. Please write to Arthur A. Brant, Newmont Exploration Limited, R.F.D. 1, Briar Ridge Road, Danbury, Conn.

### ELECTRONIC TECHNICIAN

Research division of large mining company requires Electronic Technician for maintaining and assisting in the development of electronic equipment to be used in electrical prospecting for ore deposits (involves audio frequencies). This work can frequently involve traveling to remote locations for as much as 3 months of the year. Prefer man with either military or technical school training or both. Write Box 1087.

### ELECTRONIC REPRESENTATIVES

Electronic representatives wanted in all areas of the U.S. excepting the states of New York, Pennsylvania, New Jersey, Maryland, Delaware, Washington, D.C., Virginia and the territory of New England, to handle a complete line of klystrons, magnetrons, cathode ray tubes, orthicons, vidicons and storage tubes. State territory covered, number of personnel, lines represented and facilities. Write or contact H. L. Hoffman & Co., Inc., 35 Old Country Road, Westbury, L.I., N.Y., Edgewood 4-5600. Att: Mr. Howard Hoffman, Executive Vice-Pres.

### VOA ENGINEERS

The Voice of America is interested in obtaining experienced professional engineers qualified in electronics, electrical, civil or mechanical engineering fields to supervise engineering phases of construction and installation of high power broadcasting facilities both in the U.S. and overseas. Basic qualifications consist of degree from recognized college or university, professional engineering license or equivalent experience. Corresponding requirement for the various types of engineers on the Washington headquarters supporting staff. Address inquiries to Director of Personnel, U.S. Information Agency, Washington 25, D.C.

### ELECTRONICS ENGINEER

For R&D on an entirely new class of components employing thin metal films. Some experience required in microwave components or deposition of thin metal or inorganic films. Write Vice-Pres., Engineering, Box 1088.

### FACULTY POSITIONS

Assistant Professor positions open for persons with Ph.D. degree or equivalent in solid-state electronics, computers, networks, control,

(Continued on page 128A)



Engineering  
careers  
grow  
better  
at Link-  
Palo Alto

The climate is right for achievement at Link - Palo Alto... for your career, and for your enjoyment of life.

Among the burgeoning projects at Link's attractive new laboratory are those requiring cultivation by engineers who have a green thumb with *digital computers*. If you have such talents, you will want to investigate a career at Link - Palo Alto.

The professional atmosphere at Link is based on a recognition of technical competence and accomplishment. For those interested in advanced university study, Link will arrange tuition.

Salaries are excellent. The Link health, medical, and retirement plans are outstanding.

Palo Alto, a charming suburban community, offers an ideal location for career advancement and for raising a family.

In addition to digital computer engineers, Link has staff openings for people with capabilities in electronic packaging, automatic checkout equipment, optical systems, and radar simulators.

Your engineering career can grow better at Link - Palo Alto. Contact us at once. Write to Mr. M. A. Larko, Link Aviation, Inc., P. O. Box 1318, Palo Alto, California



A subsidiary of  
General Precision  
Equipment  
Corporation

LINK AVIATION, INC.

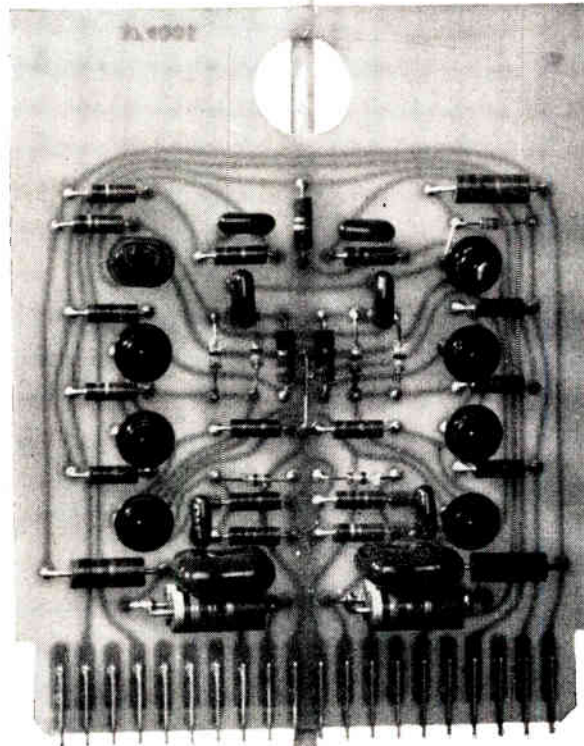
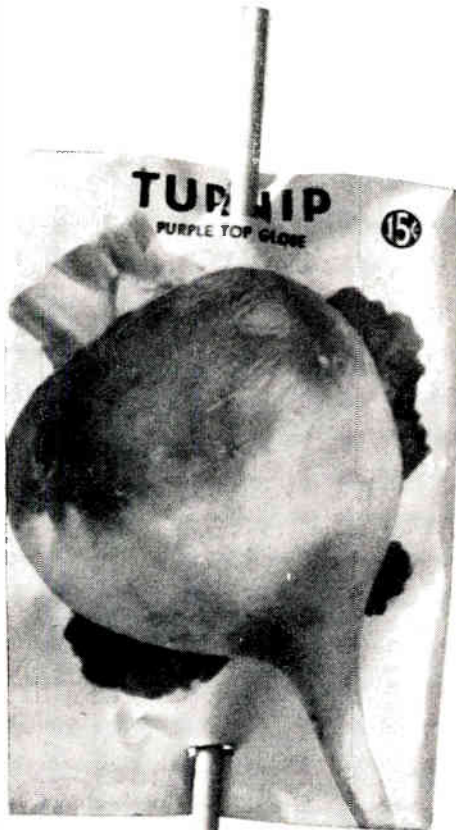

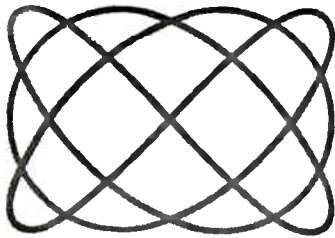

## ELECTRICAL ENGINEERS

are invited to join the Lincoln Laboratory scientists and engineers whose ideas have contributed to new concepts in the field of electronic air defense.

A brochure describing the following Laboratory programs will be forwarded upon request.

- HEAVY RADARS
- MEMORY DEVICES
- TRANSISTORIZED DIGITAL COMPUTERS
- SCATTER COMMUNICATIONS
- SOLID STATE
- AEW (air-borne early warning)
- SAGE (semi-automatic ground environment)
- SYSTEMS ANALYSIS

In certain of these programs, positions of significant professional scope and responsibility are open to men and women with superior qualifications.

### Research and Development



# MIT

LINCOLN LABORATORY  
BOX 16  
LEXINGTON 73, MASSACHUSETTS



## Positions Open



(Continued from page 126A)

microwaves, and others. Part-time Teaching Associate positions also available for persons with MS. degree or equivalent industrial experience who wish to work for Ph.D. degree. Research and Teaching Assistantships available for other graduate students. Write to Chairman, Dept. of E.E., University of California, Berkeley 4, California.

### ELECTRONIC CIRCUIT DESIGN ENGINEERS

Several years experience and graduate training desirable (but not required) for challenging circuit design problems. Ability to work in small, outstanding group on varied high caliber design projects e.g. computer techniques application, data accumulation and reduction, pulse amplifier and discriminator design. Phillips Petroleum Company, Atomic Energy Div., P.O. Box 2067-DK, Idaho Falls, Idaho.

### ASSOCIATE PROFESSORSHIP

Associate Professorship. \$8810. Mathematics Dept. of Air Force Institute of Technology, Dayton, Ohio. Most of the work is at advanced undergraduate and graduate level. One quarter out of four free of teaching duties for research or other academic pursuits, plus vacation. Working conditions comparable to those in leading universities. If interested, contact Dr. Albert B. Carson, Head, Mathematics Dept. AF Institute of Technology, Wright Patterson AF Base, Ohio.

### TECHNICAL STAFF ASSISTANT

Well qualified electronic systems engineer with supervisory and administrative experience for top level staff position. Must have broad technical background plus sound knowledge of R&D proposal and budget preparation. Must be capable of consulting with project engineers, Director of R&D and government agencies on advanced electronic techniques including digital, R.F., pulse, C.W., special waveform, video, microwave, etc. Attractive salary and bonus. Send resume to W. H. Hammer, Director of Research & Development, Land-Air, Inc., P.O. Box 394, Holloman, New Mexico.



## Membership



(Continued from page 114A)

- Tunis, I. L., New Orleans, La.
- Wade, W. T., Albany, N. Y.
- Walenga, J. Jr., Mishawaka, Ind.
- Webb, P. P., Montreal, Que., Canada
- Whitaker, N. A., Hudson, N. H.
- Wiemeis, E. L., Cleveland, Ohio
- Willey, J. C., Sudbury, Mass.
- Williamson, R. S., Billerica, Mass.
- Wiszwatay, C. B., Park Ridge, Ill.
- Wyllie, W. W., Culver City, Calif.
- Young, N. C., Jr., Boalsburg, Pa.
- Young, R. J., Las Cruces, N. M.

### Admission to Associate

- Agarwal, V. M., Jullundur City, Ind.
- Albin, N. E., Gardena, Calif.
- Bailey, A. W., Silver Spring, Md.
- Barnes, W. H., Utica, N. Y.

(Continued on page 130A)

## ELECTRICAL ENGINEERS FOR WORK WITH DIGITAL COMPUTERS

Expanding program in a progressive independent research organization has created several new career openings for electrical engineers with a strong math background, plus 4 to 5 years' experience with digital computers. The work involves the application of general-purpose digital computers to engineering and applied research problems. These positions offer excellent professional advancement and merit promotional opportunities in a research-oriented organization.

Please write today for prompt, confidential consideration to:

*The Personnel Manager*

**BATTELLE MEMORIAL INSTITUTE**

505 King Avenue  
COLUMBUS 1, OHIO

# PHILCO

P A L O A L T O

*on the beautiful  
San Francisco Peninsula*

•  
*urgently needs senior  
and project engineers*

•  
*for expanding operations*

## MISSILE TRACKING SYSTEMS

Pulse Tracking Radar  
C W Tracking Systems  
Conical Scan Tracking  
Interferometers  
Doppler Receivers

## GROUND-SPACE COMMUNICATIONS

Airborne Data Transmitters  
Ground Data Receivers  
Airborne Command Receivers  
Data Receiving Antennas  
Telemetry  
Microwave Relay System

## DATA PROCESSING

PHILCO S-2000 Transac digital  
computer entirely transistorized  
central computer facility.

Data Recording Devices  
Computer input, output  
equipment design

*U. S. citizenship required.  
Your inquiry confidential.*

Send resume to  
Mr. H. C. Horsley,  
Dept. R

# PHILCO

Government & Industrial Div.  
Western Development  
Laboratories  
3875 Fabian Way  
Palo Alto, California

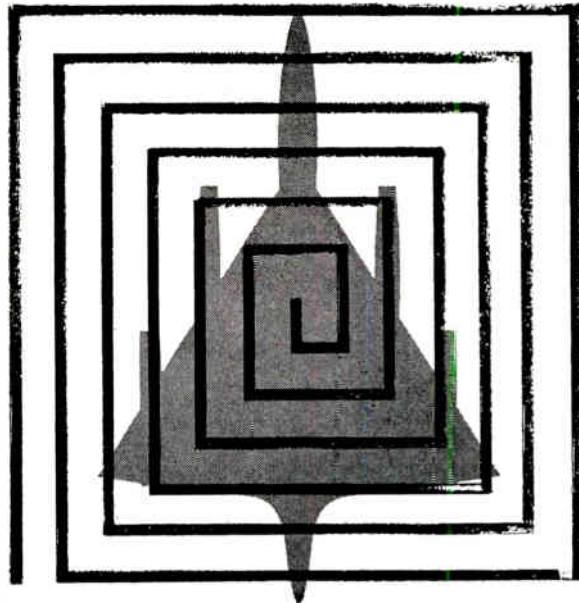

*For Engineers & Scientists:*

### THE PROBLEM:

# Detection... Resolution... Identification

Today we rely on devices hardly dreamed of a few short years ago. The limits of man's theoretical knowledge are being pushed farther almost daily. Between the theory and the device lies the exciting zone of applied research and development—the application of new concepts, and the development of new products. This is the fascinating challenge of creative engineering.

Radar Ambiguity is just one example, but typical, of the problems under intensive examination at Melpar. Important as the problems of radar are, they comprise but one part of the 110 different electronic research, development and production projects at Melpar.

**Rewarding positions are presently available in the following areas of Melpar's activities:**

Reconnaissance Systems Engineering  
Department  
Airborne Equipment  
Ground Data Handling Equipment  
Ground Support Equipment  
Simulation & Training Systems

Communication & Navigation  
Systems  
Detection & Identification Systems  
Chemistry Laboratory  
Antenna & Radiation Systems  
Applied Physics Laboratory  
Analysis & Computation Laboratory

Positions are also available in our Production Division and our Quality Control Department.

*For details about opportunities at Melpar,  
address your inquiry to:*

**TECHNICAL PERSONNEL REPRESENTATIVE**



**MELPAR** *Incorporated*

A Subsidiary of Westinghouse Air Brake Company  
3375 Arlington Boulevard, Falls Church, Virginia  
10 miles from Washington, D.C.





REPORT ON

# Plasma Propulsion at Republic Aviation

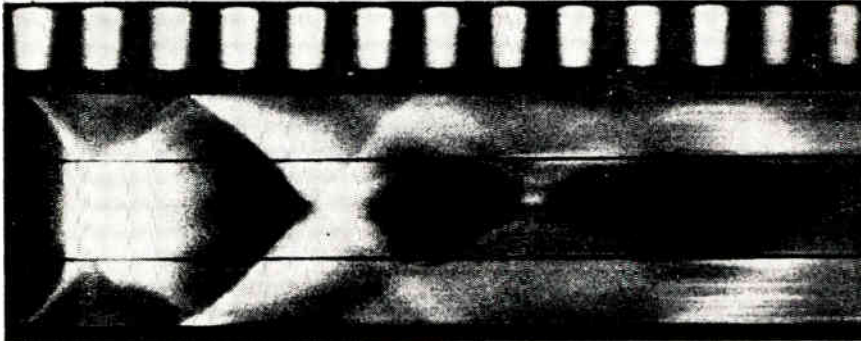

Space-Time Trace: With space as ordinate and time as abscissa, photograph shows development of pinch effect in plasma, followed by shock waves. Picture was obtained with special streak camera—part of the instrumentation devised for Republic's experimental Plasma Propulsion program. Each space at top measures an interval of 10 microseconds.

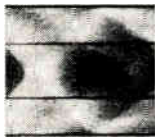

An experimental Plasma Propulsion System under test at Republic Aviation gives promise of a power plant ideally suited to space vehicles. The system generates plasma from a heavy gas and subjects it to magnetic acceleration to produce thrust at high exhaust velocity.

Research and Development in Plasma Propulsion and in a number of branches of Hydromagnetics and Plasma Physics is being sharply expanded as part of Republic's new \$35,000,000 Research and Development Program. Investigations currently in progress include studies of plasma generation of electricity and the application of Hydromagnetics to Hypersonics.

### Opportunities to Lead Theoretical and Experimental Research

The Scientific Research Staff welcomes the affiliation of scientists and engineers of stature in the following fields:

<b>HYDROMAGNETICS</b>	<b>PLASMA PHYSICS</b>
<b>GASEOUS ELECTRONICS</b>	<b>COMBUSTION AND DETONATION</b>
<b>HYPERSONICS AND SHOCK PHENOMENA</b>	<b>INSTRUMENTATION</b>
<b>PHYSICAL CHEMISTRY</b>	<b>HIGH POWER PULSE ELECTRONICS</b>

Salaries commensurate with the high degree of talent and creativity required. You work with stimulating associates in a laboratory atmosphere. \$14,000,000 of additional facilities now being built for Republic's new Research Center in suburban Long Island.

Write in confidence directly to:

**DR. THEODORE THEODORSEN, Director of Scientific Research**



**REPUBLIC AVIATION**  
FARMINGDALE, LONG ISLAND, NEW YORK



**Membership**



(Continued from page 128A)

- Beaver, V. H., Waimanalo, Oahu, Hawaii
- Bonghi, G., The Hague, Netherlands
- Boyd, C. S., Houston, Tex.
- Brader, G. F., Reading, Pa.
- Brosal, J., Torrance, Calif.
- Brown, A. L., New York, N. Y.
- Brown, W. C., Portland, Ore.
- Bryant, J. D., Fort Canaveral, Fla.
- Butcher, J. H., Quincy, Ill.
- Butzman, L. E., Jr., Elgin, Ill.
- Cannon, H. E., Los Angeles, Calif.
- Carballal, J. L., Buenos Aires, Argentina
- Carswell, J. D., Nanaimo, B. C., Canada
- Cegelski, R. M., Queens Village, L. I., N. Y.
- Clarke, J. W., Toronto, Ont., Canada
- Claydon, E. C., Montreal, Que., Canada
- Cone, R. M., New York, N. Y.
- Corwin, T. L., Dallas, Tex.
- Cotter, W. L., Danvers, Mass.
- Day, D. H., Kansas City, Mo.
- De Long, H. C., Tucson, Ariz.
- Desposito, G. J., Palo Alto, Calif.
- Fackenthal, D. F., Villa Park, Ill.
- Fant, J. P., Shreveport, La.
- Frederick, C. L., Jr., Bethesda, Md.
- Gharis, W. J., Tucson, Ariz.
- Gorman, H., St. Eutache Sur-Le-Lac, Que., Canada
- Grasselli, A., Berkeley, Calif.
- Griender, E. A., St. Petersburg, Fla.
- Grimsley, J. E., Kansas City, Mo.
- Haas, J. K., Melrose Park, Ill.
- Hagan, F. R., Jr., Baltimore, Md.
- Hall, S. C., Los Altos, Calif.
- Halliday, R. E., Montreal, Que., Canada
- Hamilton, W., Winnipeg, Man., Canada
- Hanna, P. D., Elberon, N. J.
- Hedger, R., Jr., Falls Church, Va.
- Hoelle, H. J., Lynchburg, Va.
- Isaacs, H. A. J., Saint John's, N.B., Canada
- Jones, W. R., Timonium, Md.
- Joseph, D. L., Endicott, N. Y.
- Kahn, B., Chicago, Ill.
- Kroehs, A. R., Lincroft, N. J.
- Kuberry, R. W., Philadelphia, Pa.
- Kuperstein, M. S., Hyde Park, Mass.
- La Master, F. S., Seattle, Wash.
- Lodge, A., Erie, Pa.
- Luskow, A. A., Rallett, Hert., England
- Lynch, J. T., Jamaica, L. I., N. Y.
- Mac Neil, G. E., Needham Heights, Mass.
- Manning, G. C., Jr., Fort Wayne, Ind.
- Marcus, M. S., East Northport, L. I., N. Y.
- Markussen, R. L., Council Bluffs, Iowa
- Martin, A. R., Potsdam, N. Y.
- Matthews, C. M., Exeter, N. H.
- Matthews, J. A., Galveston, Tex.
- McAteer, J., Toronto, Ont., Canada
- Moore, D. G., Cranberry Portage, Man., Canada
- La Munyon, R., 11, Houston, Tex.
- Neilly, C. E., Sunnyvale, Calif.
- Nelson, F. R., Palmdale, Calif.
- Nixon, W. A., Toledo, Ohio
- O'Connor, E. J., Morgan, N. J.
- Orwig, E. O., Worthington, Ohio
- Patenaude, N. H., North Tiverton, R. I.
- Post, B. S., Brooklyn, N. Y.
- Radtke, J. F., Chicago, Ill.
- Regan, W. T., Waltham, Mass.
- Reilly, W. B., Montreal, Que., Canada
- Rennie, M., Hicksville, L. I., N. Y.
- Roundy, G. H., Andover, Mass.
- Ryan, J. W., Manhattan Beach, Calif.
- Sardo, R. L., Beverly Hills, Calif.
- Seally, P. J., Dayton, Ohio
- Scott, E. W., Yucaipa, Calif.
- Seidl, R. H., Baltimore, Md.
- Simechik, R. J., Oneida, N. Y.
- Smith, E. E., Chicago, Ill.
- Sonder, E., New York, N. Y.

(Continued on page 133A)

# are you a Bendix Stockholder?

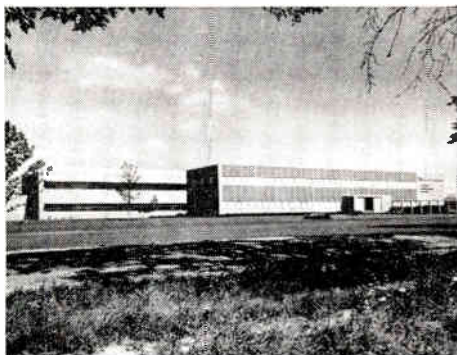

This new laboratory is located on a forty-six acre plot in the suburban area of Detroit. This building houses an extensive array of various types of research and testing equipment that has made Bendix Aviation Corporation's Research Laboratories a byword for scientific achievement in the mechanical engineering, physics, and electronics fields.

**RESEARCH LABORATORIES DIVISION**

*One of America's  
Foremost  
Scientific Development  
Centers*

**P. O. BOX 5115—DETROIT 35, MICH.**

**If so, you saw the accompanying photograph and this statement by President Malcolm Ferguson in his September 30, 1958, report to stockholders.**

“Research and engineering have been the life blood of your corporation since its inception. Because we attach even greater importance to this work today we have continuously strengthened our engineering and research staffs.

“The Research Laboratories is competent in all of the fields in which our divisions are engaged and supports the divisional engineering staffs on specialized problems. It is staffed with highly skilled engineers, scientists and technicians and is equipped with the most modern laboratory facilities and engineering test equipment.”

If you are seeking a career in research in a corporation known for its reliability, its sound policies, and its widespread fields of interest, write

**FRED A. BARRY, DIRECTOR OF PERSONNEL  
P. O. BOX 5115, DETROIT 35, MICH.**

Nuclear • Solid State • General Physics  
Microwaves • Acoustics • Mechanics • Electronics  
Radar • Missiles

**Bendix Research Laboratories Division**



## ENGINEERS

# Which Facts About **SANDERS ASSOCIATES, INC.** Are Important to You in a Career?

### THE WORK:

Diversified systems and components. Missile, space vehicle, radar, Panar, surveillance, ECM, computer, servo systems and circuitry development and study. Gyro, hydraulic servo valves, vacuum tube and microwave components development.

### SALARIES:

Open. More than competitive nationally, based on the individual.

### COST-OF-LIVING:

Low. No state income tax, no sales tax; low housing and living costs.

### THE COMPANY:

Growth based on technical excellence—from 12 to 900 employees on own capital in only 7 years.

### LOCATION:

Ideal. Less than an hour from downtown Boston, mountains and ocean beaches. Nashua, New Hampshire is an attractive city of 40,000 surrounded by picturesque small communities. Shopping facilities, schools and residential districts are excellent, and Nashua provides a safe, wholesome and friendly environment for your family.

### Continued Growth Creates Immediate Openings:

1. **STUDY & SYSTEMS.** Senior & Doctorate. Weapons Systems.
2. **RELIABILITY.** Junior thru Senior. Circuitry Background.
3. **SPECIFICATION & STANDARDS.** Section Head. Circuitry Background.
4. **SYSTEMS.** Senior. Countermeasures, Radar, Missile Electronics.
5. **SALES.** Senior. Rate gyros, hydraulic components and systems.
6. **GYROS.** Senior. Theoretical analysis & development.
7. **RECEIVERS.** Senior. Front ends, IF's.
8. **ELECTRONIC PACKAGING.** Senior Mechanical.
9. **MICROWAVE.** Junior thru Section Head. Systems or Components.
10. **CIRCUIT DESIGN.** Junior thru Senior. Transistor or Tube.
11. **QUALITY CONTROL.** Junior thru senior. ME & EE.
12. **TEST EQUIPMENT (Circuits).** Junior thru Senior. Transistor or Tube.

Please Send Resume  
Including Salary  
Desired  
To Lloyd R. Ware

**SANDERS ASSOCIATES**  
INCORPORATED  
Nashua, New Hampshire

# SEMICONDUCTORS

America's fastest growing industrial field needs

# SCIENTISTS & ENGINEERS

Hoffman's strong position in this fast-moving industry is characterized by an aptitude for getting to the market first with advanced products. To do this requires creative engineering; we are continually on the lookout for idea men (both theoretical and practical men). We have openings now for:

- Physicists
- Chemists
- Electrical Engineers
- Electronic Engineers
- Mechanical Engineers
- Production Engineers

If you are interested in our company, please send resume or write to Dr. M. B. Prince, Director of Research and Development, for more information.



**Hoffman Electronics**

CORPORATION

SEMICONDUCTOR DIVISION

930 PITNER AVENUE, EVANSTON, ILLINOIS

UNIVERSITY 9-9850

"World's foremost producers of silicon semiconductor devices and solar cells."

Get important information  
about

## EXECUTIVE OPPORTUNITIES

If you are in the \$16 to \$30,000 bracket, be sure to visit our interviewers at the

## IRE SHOW

Sunday through Thursday,

March 22-26, 1959.

Belmont Plaza Hotel,

New York. PLaza 5-1233

### Challenging Positions

... now available for E.E.'s, M.E.'s, A.E.'s, Mathematicians and Physicists. Consultations held in complete confidence with experienced placement specialists. Visit us at the Show.

### ALL EXPENSES PAID

Mail us your resume now.

## Guilford Personnel

Management Consultants

Seven Saint Paul St., Baltimore 2, Md.

MUlberry 5-4340





## Membership

(Continued from page 130A)

Stanghellini, E., Milano, Italy  
 Storm, A. C., Streator, Ill.  
 Swavely, R. S., Shillington, Pa.  
 Tsui, Y. T., Minneapolis, Minn.  
 Tuck, C. A., Jr., Rockville Centre, L. I., N. Y.  
 Tucker, F. R., Baltimore, Md.  
 Valle, L. J., Yonkers, N. Y.  
 Vanderford, W. H., Sylmar, Calif.  
 Vigh, M. E., Roslags, Nasby, Sweden  
 Vik, L. M., Kennewick, Wash.  
 Voigt, E. H., Toledo, Ohio  
 Vrzau, S. J., Chicago, Ill.  
 Welling, R. L., Claremont, Calif.  
 Wenk, R. L., Holloman AFB, N. M.  
 Wernick, D. H., Milton, Mass.  
 Whiteside, F. S., Boston, Mass.  
 Wilkinson, H. E., Montreal West, Que., Canada  
 Wilson, A. E., Toronto, Ont., Canada  
 Winters, H., Big Rapids, Mich.  
 Wolin, S., Brooklyn, N. Y.  
 Zebrowski, M. S., Detroit, Mich.  
 Zike, W. L., Anaheim, Calif.

**1959 Radio  
 Engineering Show**  
 March 23-26, 1959  
 New York Coliseum



## NEWS New Products



These manufacturers have invited PROCEEDINGS readers to write for literature and further technical information. Please mention your IRE affiliation.

(Continued from page 26A)

## Fan & Blower Catalog

Initial copies of their 1959 catalog are now available from **McLean Engineering Laboratories**, P.O. Box 228, Princeton, N. J. Featured are packaged fans, blowers, and accessory equipment used in conjunction with the cooling of electronic or electrical apparatus. The 36 page catalog contains many new and improved models and information, construction features and specifications of the entire McLean line.

The catalog shows ready-to-use cabinet cooling units available in panel heights ranging from a space saving 1 3/4 up to 10 1/2 inches and with air deliveries ranging from 100 to 1200 cfm.

A section on housing variations provides engineering assistance in the design of units with air flow patterns to meet specific requirements.

Prices, quantity discounts and terms on all models are included as well as complete price information on accessory items.

## Limiting Amplifier

**Fairchild Recording Equipment Corp.**, 10-40 45th Ave., Long Island City 1, N. Y., announces the availability of its new Model 660 limiting amplifier developed for use in recording studios and broadcasting stations.

(Continued on page 136A)

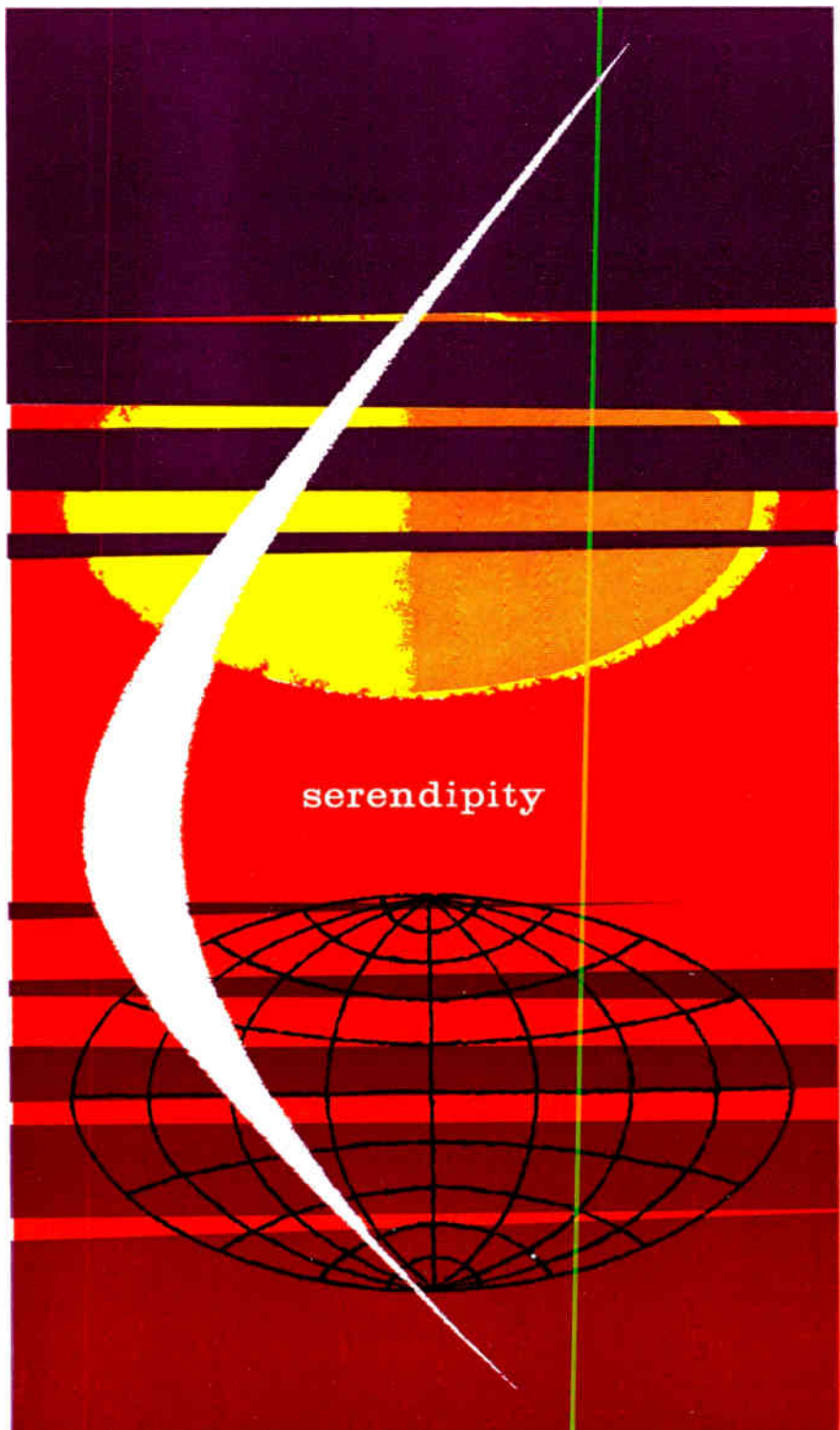

**probing beyond present knowledge . . . seeking to improve the bases for tomorrow's space concepts . . . It is this exciting opportunity for serendipity that confronts the professional minds at Martin-Denver. Possibly you, too, would enjoy this stimulus for greater personal and scientific recognition. If so, we invite you to write or call N. M. Pagan, Director of Technical and Scientific Staffing, The Martin Co., P. O. Box 179, (D-2), Denver 1, Colorado.**

**MARTIN**  
DENVER DIVISION

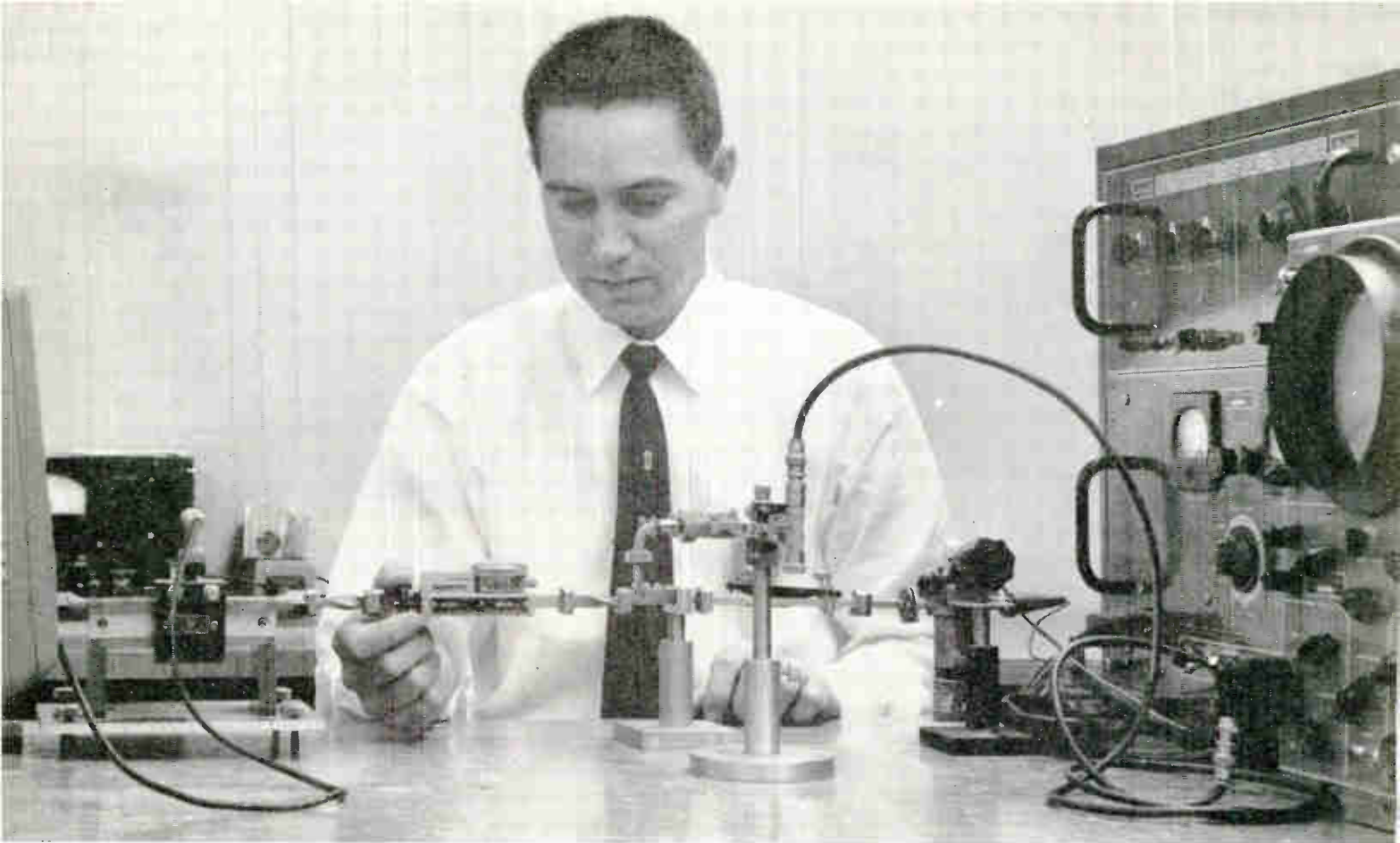

Deep in Space Age technology, TI has systems in 11 missiles; components in all missiles.

# You'll grow faster with a growing

*\*At TI in the past decade: Personnel has increased*

Leader in solid state electronics.

Leader in design and development of seismic instrumentation.

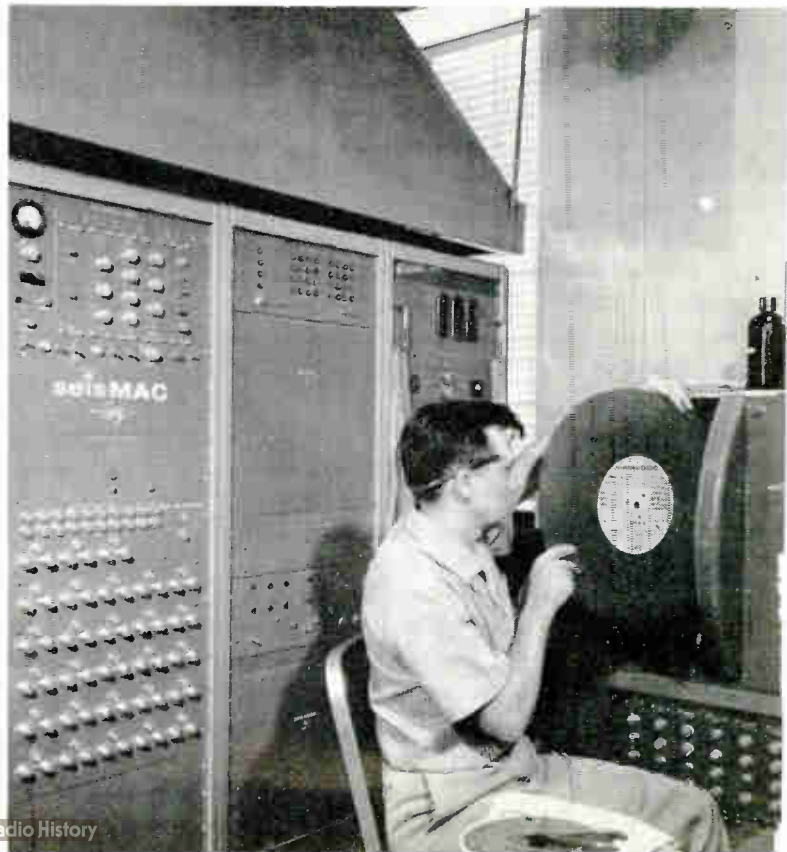
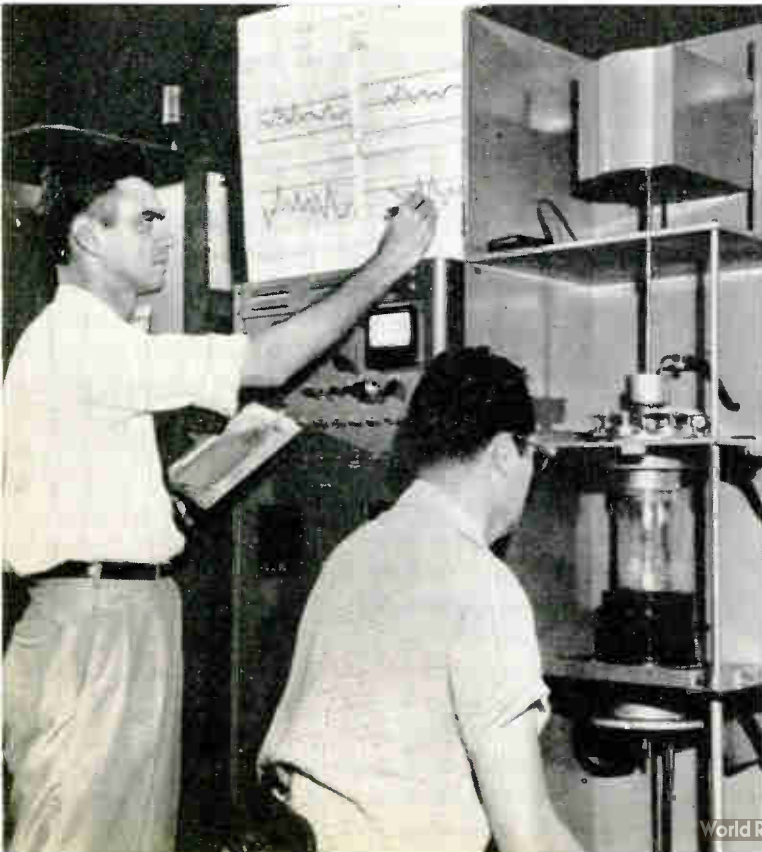



# TEXAS INSTRUMENTS INCORPORATED

6000 LEMMON AVENUE

DALLAS 9, TEXAS

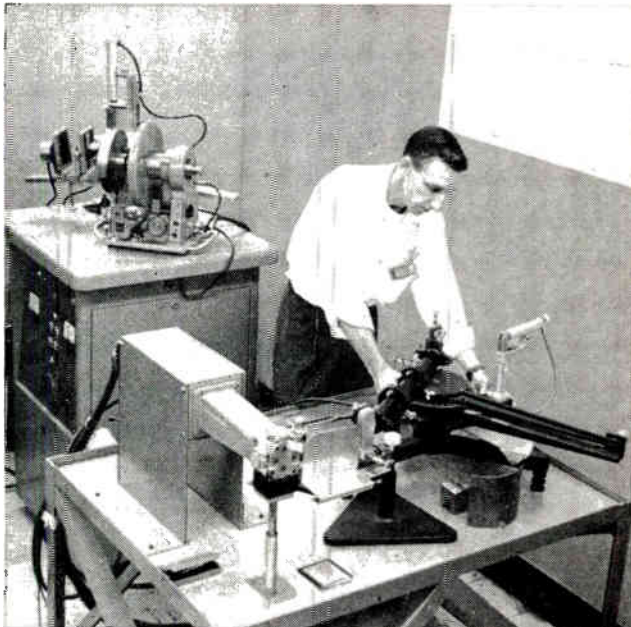

Advanced facilities permit work of highest caliber.

**company\***

*from over 800  
to almost 8,000  
and Sales  
have increased  
from under \$5,000,000  
to over \$91,000,000.*



Six major resorts and fishing lakes are within one hour of Dallas. Dallasites own 38,700 outboards; are served by a dozen boat manufacturers and 40 boat retailers. Houston, of course, is "next door" to Galveston, nationally known seaside resort.

Expand your professional potential where you and your work are recognized as vital. Enjoy a favorable engineering climate, major factor in the swift, steady growth of this dynamic company now in its 29th year *and still expanding!*

If you have a high order of ingenuity, technical skill and engineering ability, you can hit your stride at Texas Instruments — now one of the 500 largest industrial companies in the country. In association with outstanding colleagues, you can explore new horizons in any of a wide choice of fields:

**apparatus division** Design, development and manufacture of systems — reconnaissance, airways control, antisubmarine warfare, missile and anti-missile, countermeasures, airborne early warning, navigation, attack control, and engine control. Equipments, including: radar, infrared, sonar, magnetics, digital circuits, timers, telemetering, intercom, microwave, optics, detector cells, engine instruments, transformers, time standards, and other precision devices.

Please write J. R. Pinkston, Dept. A

**semiconductor-components division** Design, development and manufacture of semiconductors — transistors, diodes, rectifiers — and other electronic components including capacitors and resistors. Special studies in materials purification and analysis, surface treatment, circuit design, and circuit applications. Design of mechanized production and test equipment. Supervisory positions in manufacturing engineering and production management.

Please write H. C. Laur, Dept. B

**central research laboratory** Basic and applied research in solid state physics, materials, devices, data systems, and earth sciences with particular emphasis on semiconductors, electroluminescence, ferromagnetics, resonance, low temperature phenomena, dielectrics, infrared, geophysics, digital techniques, masers, memories, and transistors; physico-chemical studies of diffusion, alloying, crystal growth, and crystalline structure.

Please write A. E. Prescott, Dept. C

**industrial instrumentation division** Design, development and manufacture of commercial electronic and geophysical instrumentation including data gathering, recording and processing; circuit and instrument packaging; meter movements and transducer elements; remote measurement and control systems. (NOTE: This division is located in Houston.)

Please write D. G. Turner, Dept. D

Come grow with us in the pleasant climate of highly sophisticated Southwestern cities, Dallas or Houston — each large enough to be urbane, small enough to be neighborly. Modern plants are within the city but away from downtown traffic... near fine residential areas. You will live within minutes of year-around recreational, amusement and cultural activities.



Sailing on White Rock Lake; within Dallas.



# ENGINEERS

- RESEARCH
- DESIGN
- DEVELOPMENT

for

## CREATIVE ASSIGNMENTS WITH ADVANCED DEVELOPMENT GROUPS

Here at Daystrom Instrument qualified engineers will find an atmosphere of technical challenge with interesting programs to stimulate your professional growth. You will enjoy working in our air-conditioned offices and well-equipped laboratories in association with others of equal professional standing.

### MANAGEMENT ENGINEERS

7-12 years experience in Section or Project management. Applicants must be technically competent in one or more fields of interest listed below and be capable of handling proposal work or rendering technical assistance to Sales.

### NUCLEAR INSTRUMENTATION ENGINEER

3-5 years experience in design and development of reactor control circuits, protection and alarm systems, control rod drives, and position sensing devices.

### MECHANICAL ENGINEERS

5-10 years experience in directing design of electro-mechanical devices, modular packaging, printed wiring cards, MIL spec. type cabinetry and consoles.

### TRANSISTOR CIRCUIT ENGINEERS

3-5 years experience in pulse circuitry, stable oscillators multitar, multivibrators, timing and linear sweep circuits or switching circuits, memory circuits, and digital logic circuits.

### DIGITAL COMPUTER ENGINEERS

3-5 years experience in digital systems, logical circuitry, transistor and tube type switching circuits, magnetic storage, data logging, data handling and reduction systems.

### RADAR ENGINEERS

5-7 years experience in development of RF and IF circuits, modulators, microwave components, antennas or indicators. Previous work with beacons, pulse doppler or monopulse techniques desirable.

### COMMUNICATIONS ENGINEERS

5-7 years experience in communications systems. Previous work with transmitters, receivers, frequency synthesizers, direction finders or telemetering essential.

### APPLICATIONS ENGINEERS SENIOR DEVELOPMENT ENGINEERS

5-10 years experience in contacting the Military concerning present and future requirements in any of the above fields.

Living conditions in the area are ideal. Numerous lakes for swimming, boating, and fishing. Winter sports abound in the Pocono Mountain resorts. Small town or country living and the advantages of being 10 minutes away from a medium sized city are contrasted to the usual bumper-to-bumper conditions of metropolitan areas.

Send complete resume in confidence to

John E. Thomas, Director of Research & Development

## DAYSTROM INSTRUMENT

Division of Daystrom Incorporated  
Archbald, Penna.

These manufacturers have invited PROCEEDINGS readers to write for literature and further technical information. Please mention your IRE affiliation.

(Continued from page 133A)



Designed specifically to overcome many of the common problems encountered in automatically controlling program level, the Model 660 has extremely fast attack time to catch short transients without audible or observable thumps.

Release time is made adjustable from  $\frac{1}{2}$  second to 40 seconds in 6 steps. Three of these positions make the release time the automatic function of the nature of program material, thus providing fast recovery for short duration peaks and automatic reduction of overall level should the program level remain high.

The basic unit consists of three parts, all mounted on a single  $10\frac{1}{2}$  inch rack-mounted chassis. Audible thumps are eliminated by the use of a single push-pull stage of audio amplification and an extremely high control voltage.

Contrary to most limiting amplifiers, the Model 660 has extremely low distortion and noise under all conditions, either as a straight-through amplifier or under maximum limiting conditions. The unit may be placed into any normal line level circuit and can be set to have unity gain at no limiting.

Complete specifications may be obtained from Department 660.

## Dial Equipment for Mobile Radio

An eight page, illustrated brochure describing dial equipment for private radio dispatch and common carrier radio telephone systems has been released by Secode Corp., 555 Minnesota St., San Francisco 7, Calif.

The new bulletin clarifies the similarities and differences between dial signaling on private mobile radio systems and radio telephone systems. Topics discussed include requirements for selective or dial signaling, selective or dial signaling requirements for both private and common carrier systems, equipment required, and system operation. A key portion of the discussion centers about Secode dial signaling equipment for use with both automatic and manual telephone exchanges.

For your free copy please write the firm.

(Continued on page 138A)

# ENGINEERS

for expanding  
Electronics Division

(located in Carlstadt, N. J. 5 miles south of Hackensack on Newark-Hackensack line)

## PROJECT ENGINEERS

**Industrial TV:** Two or more years in industrial television, design and development of TV cameras, projectors, monitors. To design video equipment that requires familiarity with image orthicon and vidicon TV cameras.

**Electrical Systems:** M.S. in E.E. or equivalent. Minimum 5 years experience. Heavy background in circuit theory and design, servo mechanisms, pulse and switch circuits. Proven record of supervision in systems design, test and calibration.

**Digital Computer:** Minimum 5 years technical experience beyond engineering or allied degree. Minimum 3 years in digital computer techniques with special ability in systems design.

**Electronic Components:** Minimum 10 years experience. Must have a heavy background in components, reliability, quality production. Prefer experience in radiation and/or instruments.

**Radar Systems:** To design and develop unique circuitry for simulating radar signals from stationary and moving targets, including cultural and geographic features. Design circuitry for utilizing these radar returns in the same manner as in airborne tactical radar and/or fire control systems or ground based radar. Knowledge of pulse and sweep circuitry techniques, video amplifiers, servo mechanisms, analog computers, and military specifications.

Send detailed resume including salary requirements to: **T. W. Cozine, Mgr., Executive & Technical Placement, Curtiss-Wright Corporation, Dept. ED-36, Wood-Ridge, N. J.**

*All replies confidential*

**CURTISS-WRIGHT**  
CORPORATION • WOOD-RIDGE, N. J.

M · I · T

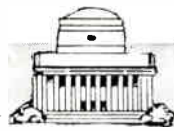

INSTRUMENTATION LABORATORY

*An Invitation to Engineers...*

*Work on*

## INERTIAL GUIDANCE

for

## MISSILES & SPACE VEHICLES

Work in association with our staff of 850 which is famous for outstanding contributions and leadership in the research and development of advanced navigation systems.

*Opportunities for:*

### MECHANICAL ENGINEERS

Plan and conduct performance tests on a variety of electro-mechanical components. Some knowledge desirable in strength of materials. B.S. plus minimum of one year experience in design of small fixtures.

### E.E.'s, M.E.'s or PHYSICISTS

Inertial components and systems. Plan and conduct experimental program. Ability to analyze and interpret results. Requires good general physics knowledge. Some servo, electronics, and/or optics experience desirable. B.S. or M.S.

Analysis of electrical and mechanical designs for reliability. Knowledge of statistics desirable but not required. B.S. and 2 to 5 years experience.

### ELECTRONICS ENGINEERS

*—openings at all levels*

DIGITAL DEVELOPMENT  
TRANSISTOR CIRCUITRY  
PULSE CIRCUITRY  
RELIABILITY

LOGICAL DESIGN  
SERVO MECHANISMS  
SYSTEMS ANALYSIS  
GYRO RESEARCH

**WRITE:**



IVAN SAMUELS  
*Director of Personnel*  
INSTRUMENTATION LABORATORY  
MASSACHUSETTS INSTITUTE  
OF TECHNOLOGY  
45 Osborne Street  
Cambridge 39, Massachusetts

\* Graduate courses may be taken for credit while earning full pay.

# WHAT SQUARES CAN YOU FILL IN THIS R & D MATRIX?

	RESEARCH	ANALYSIS	DESIGN AND TEST
	Physical Theory		
	Mathematical Theory		
	Experimental Systems		
	Numerical Simulation		
	Network		
	Radar Performance Information		
	Overall Systems		
	Pulse & Logic Circuit		
	R.F. & Microwave System		
	Feedback System		
Radar Systems			
Radar Data Processing			
Radar Techniques			
Electronic Displays			
Control Systems			
Navigation Systems			
Computer Systems			
Air Traffic Control			
Computer Application			
Information Storage			
Cognitive Systems			

## YOUR OPPORTUNITY IN ELECTRONICS AT CORNELL AERONAUTICAL LABORATORY

The ever expanding breadth of C.A.L.'s research program staffed by 400 engineers and scientists opens outstanding opportunities for capable, imaginative, electronics men. Whether a systems engineer or a specialist, you will find our unique combination of academic and industrial research atmosphere refreshing and rewarding. You will find welcome freedom from production-line pressures that hinder creative accomplishment. We invite you to match your skills and interests against our needs.

**CORNELL AERONAUTICAL LABORATORY, INC. of Cornell University**



### WRITE FOR FREE REPORT

The story behind Cornell Aeronautical Laboratory and its contributions to aeronautical progress is told in a 68-page report, "A Decade of Research." Whether you are interested in C.A.L. as a

place to work or as a place to watch, you will find "A Decade of Research" both useful and pertinent. Mail the coupon now for your free copy.

J. P. Ruch

**CORNELL AERONAUTICAL LABORATORY, INC.**

Buffalo 21, New York

EM

Please send me "A Decade of Research."

Name \_\_\_\_\_

Street \_\_\_\_\_

City \_\_\_\_\_

Zone \_\_\_\_\_

State \_\_\_\_\_

Please include employment information.

These manufacturers have invited PROCEEDINGS readers to write for literature and further technical information. Please mention your IRE affiliation.

(Continued from page 136A)

### Multiple Preset Counter

Freed Transformer Company, Inc., 1713 Weirfield St., Brooklyn 27, N. Y., is now making delivery on their new Multiple Preset Counter, Type 2020-4-6, designed and developed for counting and sequential predetermining control applications. This counter is suited for applications when a machine is started manually and stops automatically at several preset counts in one operation. For example, one of the industrial operations which this can be applied to is the winding of tapped toroidal or transformer coils. Type 2020-4-6 performs this and scores of similar complex operations accurately and at great speed.

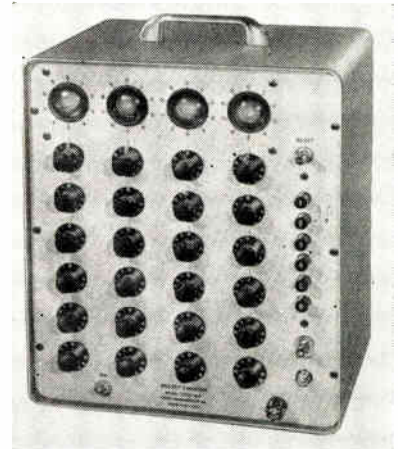

Specifications include a maximum 4 digit count of 9,999, operated at counting speeds of 4,000 per second, and presets one through six. Various inputs supplied include photocell, switch closure and pulse. Output is a relay dpdt-5 ampere contacts, with a 105-125, 50-60 cps power supply. Dimensions for Type 2020-4-6 counters are 11 x 13 x 8 1/2 inches deep. Complete unit weighs 19 1/2 lbs.

### Two New Shake Tables

Two wide-band electrodynamic shakers of improved new design have just been placed on the market by Ling Electronics, Inc., Culver City, Calif.

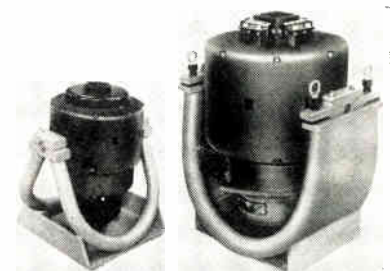

(Continued on page 140A)



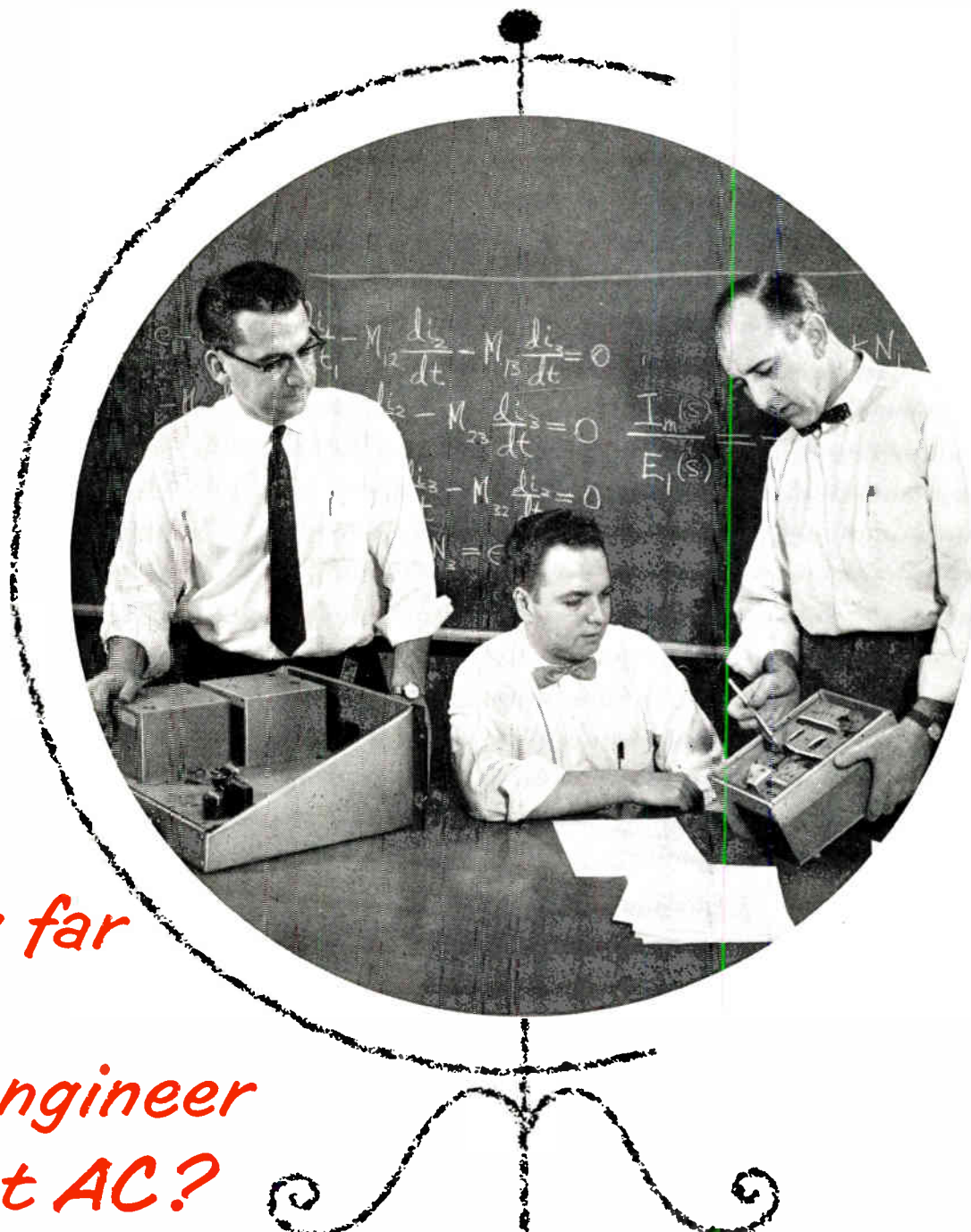

*How far  
can  
an engineer  
go at AC?*

Across the country or around the globe. You will find opportunity in any one of AC's bustling plants or installations. Your future is bright here. If you are a graduate engineer in the electronics, electrical or mechanical fields—you can go places at AC, because AC is going places.

Today you can help AC turn out AChiever inertial guidance systems, plus a wide variety of other electro-mechanical, optical and infra-red devices. Tomorrow you can work on instrumentation needs for the "space age".

What's more, at AC you'll enjoy highest professional status, advance in proportion to your ability, and find the long-range security of working for the leader in the field—General Motors.

This merits your attention. For details, just write the Director of Scientific and Professional Employment: Mr. Robert Allen, Dept. E, Oak Creek Plant, Box 746, South Milwaukee, Wisconsin; or Mr. M. Levett, Dept. E, 1300 N. Dort Highway, Flint 2, Michigan.



Inertial Guidance Systems • Afterburner Fuel Controls • Bombing Navigational Computers • Gun-Bomb-Rocket Sights Gyro-Accelerometers • Gyroscopes • Speed Sensitive Switches • Speed Sensors • Torquemeters • Vibacall • Skyphone

# TUBE ENGINEERS

NEW FLORIDA  
ELECTRONIC TUBE PLANT  
OF SPERRY  
ELECTRONIC TUBE  
DIVISION

UNUSUAL OPPORTUNITIES  
ON NEW PROJECTS  
In The Microwave Tube Field  
for RESEARCH, DEVELOPMENT  
and  
PRODUCTION ENGINEERS

B.S., M.S., or Ph.D's or equivalent,  
with previous experience or training  
on magnetrons, klystrons, and traveling  
wave tubes, etc.

Here you will find a unique, perfect  
combination for maximum profes-  
sional development, expression and  
recognition... a new division, recently  
started production, offering excep-  
tional growth potential... yet possess-  
ing the stability and "Know How" of  
Sperry's 50 year history of engineer-  
ing accomplishments.

ENJOY PLEASANT  
FAMILY LIVING IN FLORIDA

Our plant is located in the University  
City of Gainesville, Florida, noted for  
excellent all year round climate, un-  
excelled fishing, boating and swim-  
ming at nearby lake and gulf beaches,  
uncrowded living conditions with ex-  
cellent housing available.

PLEASE SUBMIT RESUME TO  
EMPLOYMENT DEPT.

**SPERRY**  
ELECTRONIC TUBE DIVISION  
*of Sperry Rand Corp.*  
Gainesville, Florida

## NEWS New Products

These manufacturers have invited PROCEEDINGS  
readers to write for literature and further technical  
information. Please mention your IRE affiliation.

(Continued from page 138A)

The shakers are the Model 219, rated  
at 500 pounds force output, and the  
Model 227, rated at 150 pounds force out-  
put. The new shaker designs are the first  
to be perfected and put into production  
since Ling Electronics acquired the Cali-  
dyne Company, Inc., of Winchester,  
Massachusetts, last August.

A feature of these new wide-band  
shakers is the elimination of all secondary  
structural resonances, so that the arma-  
ture behaves as a simple single degree of  
freedom system over an extended fre-  
quency range.

Another exclusive feature of the two  
new shakers is the dual magnetic field  
structure which yields maximum force at  
low power input with low stray magnetic  
field and improved force/current linearity.

The Model 219 has a 7.5-pound arma-  
ture of extruded, webbed aluminum con-  
struction for maximum rigidity. The arma-  
ture allows a high first bare table reso-  
nance of 6000 cps, or 4000 cps with a 14-  
pound load. The shaker design provides  
simplicity and ease of compensation over  
wide-band widths to 6000 cps and with no  
compensation required below 3000 cps.

(Continued on page 146A)

in the rough?



A snowstorm is a pretty big handicap even  
for a pro. Join Radiation, Inc. in Florida  
where you can play golf all winter long.  
The entire family will enjoy outdoor recrea-  
tion and the efficient, open architecture of  
Florida homes.

We have many openings for challenging  
and rewarding work in electronic design  
and development. Radiation is well known  
in DATA PROCESSING, TELEMETRY, AN-  
TENNAS, INSTRUMENTATION, and other  
areas of MISSILE ELECTRONICS. Our stable  
growth indicates a secure future with pro-  
fessional advancement for qualified elec-  
tronic engineers with ideas and energy.  
Write today for complete details on oppor-  
tunities available.

Technical Personnel Dept. 25



**RADIATION, Inc.**  
MELBOURNE, FLORIDA

## ENGINEERS

Senior Project & Staff Positions in Development of  
**ADVANCED CELESTIAL NAVIGATION SYSTEMS**

Qualifications should include previous responsible ex-  
perience in analog and digital computers, advanced elec-  
tronic techniques and navigation concepts.

### FIELD ENGINEERS

*For Development and Flight Evaluation Work.*

### PRODUCT ENGINEERS

*For Design of Field Test Equipment for  
Electromechanical Systems.*

Enjoy unusual opportunity for growth . . . a stimulating  
professional environment . . . with one of America's finest  
developers and manufacturers of flight instrumentation.

Send resume, in confidence, to T. A. DeLuca.



**kollsman** INSTRUMENT CORPORATION

80-08 45th AVENUE, ELMHURST, NEW YORK • SUBSIDIARY OF *Standard* COIL PRODUCTS CO. INC.



## It's great to be proud of the place you work

A MAN misses a lot if his job means only a paycheck. He ought to be excited about the work he's doing. He ought to feel proud of his company—of its past achievements, its current projects, its future.

That's the way our engineers and scientists feel at Autonetics. They're young men. Most of them got their BS since 1948. In ten memorable years they have made their company a leader in *electronics* and *electromechanics*.

Today there is room for engineers and scientists who want to share the unusual creative problems that lie ahead—in inertial navigation, digital computers, armament control, flight control, and a host of special military and commercial products.

If you'd like to join Autonetics, please send your resume to Mr. G. B. Benning, 9150 East Imperial Highway, Downey, California.

**Autonetics** 

A DIVISION OF NORTH AMERICAN AVIATION, INC.  
Downey, California

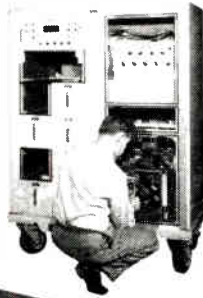

Among the achievements of Autonetics' young men: the first successful airborne all-inertial navigation system . . . first navigation system accurate enough to guide the USS Nautilus and Skate on their historic voyages beneath Arctic ice . . . first successful automatic star tracking by an inertial navigation system during daylight flight . . . first completely maneuverable, inertially stabilized gyro platform . . . first successful completely automatic landing system for supersonic missiles and aircraft . . . first transistorized portable digital computer with "big computer" capabilities.





In the lonely immensity of Space where there is neither "north" nor "up" nor "down" . . .

## which way is home?

It may have been in the gloom of a trackless, primeval forest that man first devised a system for answering the question "which way is home?" Since then nearly every basic advance in propulsion techniques has required him to find a correspondingly more complex method of solving this eternal question.

Today at Midwest Research Institute we are undertaking research which may help provide the basis for tomorrow's more sophisticated systems. In an analysis, for example, of guidance and position-finding systems we are investigating inherent system errors, errors due to electromagnetic scattering, and errors due to the nonhomogeneity of the medium between the vehicle and its position-finding reference points. In an instrumentation program we are investigating novel methods for measuring and indicating the velocity, temperature, and homogeneity of the media surrounding the vehicle.

Your having read to this point in our message might indicate that you would enjoy working on such projects. Our requirements are high . . . an advanced degree in EE, physics, or mathematics, a minimum of 5 years' broad, yet applicable experience with emphasis on one of the following activities:

1. **ELECTROMAGNETIC PROPAGATION.** Experience in scattering from atmospheric anomalies, in antenna pattern measurements, in antenna design, in radio telescope, or in infrared systems.
2. **MICROWAVE EQUIPMENT.** Design and instrumentation experience in CW and pulse radar systems, including wave guide components, mixers and detectors, traveling wave amplifiers, or master and parametric amplifiers.
3. **AIRBORNE INSTRUMENTATION.** System design experience for inertial, celestial, or radar guidance systems, for altimeters, or for direction-finding systems.

(If your field of interest is not listed here we invite you to inquire about our other numerous, equally-interesting activities in engineering, applied mechanics, and physics.)

It is generally conceded that an independent research organization such as Midwest Research Institute offers an unparalleled opportunity for a progressive, creative thinker to gain professional recognition and to enjoy an invigorating independence of thought and action.

Here you will find relative freedom in selecting projects that interest you most, and here you may have as much or as little management responsibility as you wish. Compensation is based on technical competence and is realistically scaled.

If you don't already know that Kansas City is a delightful place to live, a personal visit will demonstrate this more convincingly than anything we might say. Or if you are an errant midwesterner—as many of our present staff members once were—we should like to show you "which way is home."

Your brief resume, sent airmail, will receive our thorough, confidential attention, and we shall contact you promptly.



Attention: Dr. Warren Snyder,  
Manager Engineering Division

**MIDWEST RESEARCH INSTITUTE**  
433 Volker Blvd., Kansas City, Missouri

ENGINEERS (EE, ME) • PHYSICISTS

## To Design and Develop a New Generation of Microwave Magnetrons

Exploiting new knowledge gained from broad research programs, General Electric's Power Tube Dept. is beginning a program aimed at substantial breakthroughs in magnetron technology. An example of the scope of the work is the current design and development of voltage tunable magnetrons that will cover a frequency spectrum from 300 to 6,000 megacycles.

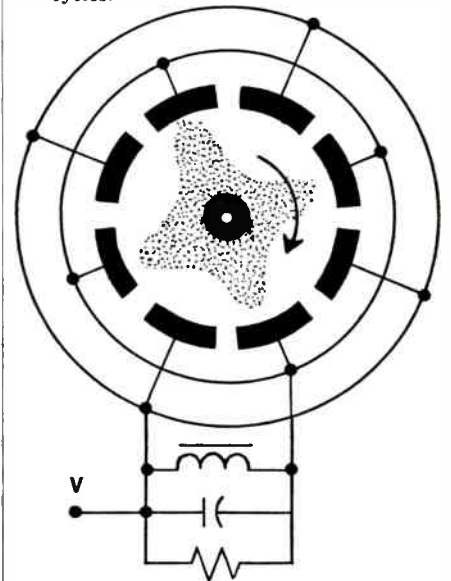

One of the many challenges facing engineers and scientists on this program is how to determine the shape and composition of the electrodes to optimize bunching of electrons for maximum power over the desired frequency range with minimum noise.

### Positions Open At All Levels

**REQUIREMENTS:** General background in tubes with specific experience in one or more of the following fields: electron dynamics, design and development of tube elements & circuits, conducting and evaluating "package" tests, cross field device theory, tube construction, behavior of materials in tubes, tube manufacture.

If you qualify and are interested in contributing to advanced programs, write:  
**Dr. Myron Weinstein, Mgr., Room 53 MB**

POWER TUBE DEPARTMENT

**GENERAL ELECTRIC**

1 River Road, Schenectady 5, N. Y.

## ENGINEERS AND SCIENTISTS RETURN TO THE MIDWEST

... where there's time and opportunity to enjoy yourself while climbing to the top in the field you like best.

Your friends in Minnesota are going sleigh riding! You remember what it's like—the smell of burning pine and birch. The sound of heavy runners and hoofs biting into the snow. Remember how bright the stars are in this winter wonderland and how the Northern lights whip across the sky. You should be here—with your wife and children—to enjoy Minnesota as you did before. And you can be . . .

The Research and Engineering Laboratories at the Mechanical Division of General Mills—in Minneapolis—need senior level staff members for creative design, research and development work in the following fields:

- Electronic Circuit Design
- Micro-wave Development
- Atmospheric Physics
- Field Engineering
- Advanced Digital Computer Systems Design
- Advanced Digital Computer Circuit Development
- Advanced Pulse and Video Circuit Development
- Advanced Inertial Navigational System Development
- Aerodynamics
- Applied Mechanics
- Optical and Infra-Red Equipment Engineering
- Research Physics
- Telemetering Systems Engineering
- Test and Evaluation of Basic Electronic and Electromechanical Components

Positions available are for purely technical and technical-supervisory work—job titles and salary provide equal opportunity for advancement in both. Our people enjoy their associates, liberal company benefits and non-routine projects, as evidenced by our extremely low turnover rate.

If you have from three to five years experience in any of the above fields we'd like to tell you more about opportunities at General Mills. Send today for all the facts. We'll keep your inquiry in strict confidence.

G. P. Lambert, Manager  
Professional Employment

MECHANICAL DIVISION



Personnel Department

2003 E. Hennepin, Minneapolis 13, Minnesota

# ENGINEERING UNLIMITED

AT ONE OF THE WORLD'S MOST  
SUCCESSFUL CORPORATIONS

Select Openings at *National's*  
**NEW Engineering-Research Center**  
at Dayton, Ohio

**Long-range non-military projects  
with exceptional stability**

## COMPUTER ENGINEERS

**Senior Systems Analysts**—Require Senior Systems Analysts with strong theoretical and design knowledge in the electronic engineering field including familiarity with electronic and electro-mechanical digital machines. Should possess minimum of 3 years' experience with commercial application digital data processing equipment, however, would consider experience with scientific or defense application systems. Operational experience with a large data processing system is a distinct asset. Will be required to analyse and direct product improvement on large general purpose computer or small special purpose desk computer series. Advanced degree desired.

**Senior Circuit Designers**—Experienced in the design, development and analysis of transistorized computer circuits. Familiar with the application of magnetic cores to computer high-speed memory design. Growth opportunities involving decision making, concerning reliability, cost and component selection are offered. Advanced degree desired.

**Senior Circuit and Logical Designers**—Similar experience and duties as noted for Senior Circuit Designer, plus evaluation and de-bugging arithmetic and control areas of computer systems. Advanced degree desired.

## DATA PROCESSING ENGINEERS

**Senior Electronic Design Engineers**—Experienced in development of logical design using standard computer elements, must also evaluate and design transistorized circuits including voltage regulated power supplies and circuitry related to decimal to binary coding. This data processing system is concerned with bank automation.

## SEND RÉSUMÉ TO:

Mr. K. N. Ross  
Professional Personnel Section J,  
The National Cash Register Co.  
Dayton 9, Ohio

TRADE MARK REG. U. S. PAT. OFF.

*National*  
ACCOUNTING MACHINES  
ADDING MACHINES - CASH REGISTERS  
NCR PAPER (NO CARBON REQUIRED)



# SOLAR SAILING



EXPANDING THE FRONTIERS OF SPACE





## TECHNOLOGY

**SOLAR SAILING:** Space travel with the aid of solar radiation pressure — an area of advanced research at Lockheed. Vehicle would employ a sail that would be raised and lowered in flight. The artist has depicted Magellan's ship "Trinidad" to symbolize man's great voyages of discovery.

**Lockheed Missile Systems Division** is engaged in all fields of missile and space technology — from concept to operation. Advanced research and development programs include — man in space; space communications; electronics; ionic propulsion; nuclear and solar propulsion; magnetohydrodynamics; computer development; oceanography; flight sciences; materials and processes; human engineering; electromagnetic wave propagation and radiation; and operations research and analysis.

The successful completion of programs such as these not only encompasses the sum of man's knowledge in many fields, but requires a bold and imaginative approach in areas where only theory now exists.

The Missile Systems Division programs reach far into the future. It is a rewarding future which men of outstanding talent and inquiring mind are invited to share. Write: Research and Development Staff, Dept. B-33, 962 W. El Camino Real, Sunnyvale, California, or 7701 Woodley Avenue, Van Nuys, California. For the convenience of those living in the East or Midwest, offices are maintained at Suite 745, 405 Lexington Avenue, New York 17, and at Suite 300, 840 N. Michigan Avenue, Chicago 11.

*"The organization that contributed most in the past year to the advancement of the art of missiles and astronautics."*

NATIONAL MISSILE INDUSTRY CONFERENCE AWARD

**Lockheed** / **MISSILES AND SPACE DIVISION**

SUNNYVALE, PALO ALTO, VAN NUYS, SANTA CRUZ, SANTA MARIA, CALIFORNIA  
CAPE CANAVERAL, FLORIDA • ALAMOGORDO, NEW MEXICO

are  
you



using  
only  
**HALF**  
your  
potential

**in your present job?**

Because of the diversity and rapidly increasing demands for our products, you have the challenging opportunity here at Bendix-Pacific to constructively apply all your talents.

There are important career positions open NOW at all levels in our small, independent engineering groups in these fields —

**MISSILE GUIDANCE • TELEMETERING  
AIRBORNE RADAR • MISSILE HY-  
DRAULICS & MARINE HYDRAULICS  
SONAR & ANTI-SUBMARINE WARFARE**

Please write W. C. Walker your qualifications or fill in the coupon and mail it today.

W. C. Walker, Engineering Employ'mt Mgr.  
Bendix-Pacific, Bendix Aviation Corp.  
11606 Sherman Way, No. Hollywood, Calif.

I am interested in (check one)

Electrical  Mechanical Engineering

I am a graduate engineer with \_\_\_\_\_

\_\_\_\_\_ degree.

I am not a graduate engineer but have \_\_\_\_\_

\_\_\_\_\_ years experience.

Name \_\_\_\_\_

Address \_\_\_\_\_

City \_\_\_\_\_

Zone \_\_\_\_\_ State \_\_\_\_\_

**NEWS**  
**New Products**



These manufacturers have invited PROCEEDINGS readers to write for literature and further technical information. Please mention your IRE affiliation.

(Continued from page 140A)

**Socket Assembly**

Augat Bros., Inc., 33 Perry Ave., Attleboro, Mass., have developed a new crystal holder socket assembly specifically designed for military-type HC-6/U and HC-13/U standard size crystal cans. It features compact unit construction that eliminates use of separate socket holder, thus reducing overall package size and weight.

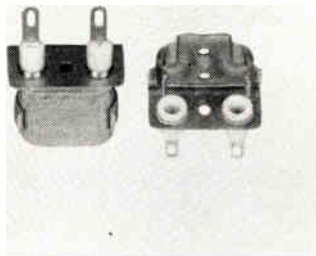

The clip is fabricated of beryllium copper, alloy 25 per QQ-C-533, and cadmium-plated per QQ-P-416A, type II, class 2. Two teflon insulated jacks with phosphor bronze, silverplated, gold flashed contacts

are press fitted into the assembly to receive the crystal pins. The assembly is designed for horizontal or vertical mounting and is available with extra long contact tails formed at right angles for use on  $\frac{3}{32}$ -inch maximum printed circuit boards. Also obtainable with anti-rotate tab.

**Silicon Rectifiers**

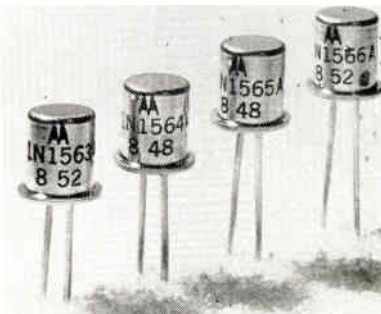

A new series of high-quality silicon rectifiers for military and industrial applications has been announced by Motorola, Inc., Semiconductor Products Div., 5005 E. McDowell Rd., Phoenix, Ariz. Types 1N1563A through 1N1566A offer peak inverse voltages of 100 through 400. One cycle average reverse current is limited to 150  $\mu$ a maximum when rectified output is 250 ma and ambient temperature is 150°C. Forward rectified currents are 1.5 amps and 250 ma at 25°C and 150°C ambient temperatures. Especially useful in magnetic amplifiers, these diffused-junction

(Continued on page 148A)

**Valuable  
service to  
executives**

We specialize in recruiting executives, engineers and scientists.

To reduce costly job hopping, the employers who pay for our service want us to help each candidate make his decision permanent. In complete confidence, therefore, we offer the candidates we select, enough different job opportunities for an intelligent choice. We welcome your inquiry.

*Charles A. Binswanger* ASSOCIATES

EXECUTIVE SEARCH SPECIALISTS

407 AMERICAN BUILDING • BALTIMORE 2, MD. • PLAZA 2-5013

**CHALLENGING OPPORTUNITIES IN  
RESEARCH AND DEVELOPMENT**

**ELECTRONIC ENGINEERS  
SYSTEMS ENGINEERS**

Design of electronic instrumentation for underwater ordnance. Analytical and experimental treatment of scientific research problems in the fields of hydrodynamics, acoustics, electronics, network theory, servomechanisms, mechanics, information theory and noise analysis including analogue and digital computations. Statistical signal detection and processing theory, random processes, analogue and digital instrumentation utilizing transistors.

THE PENNSYLVANIA STATE UNIVERSITY

ORDNANCE RESEARCH LABORATORY

P.O. Box 30, University Park, Pennsylvania

Opportunities for Graduate Study—Faculty Appointments for Qualified Applicants  
Excellent Working and Living Conditions

**SEND RESUME TO: ARNOLD ADDISON, PERSONNEL DIRECTOR**



complete systems

**missile tracking**  
**ground-space communications**  
**airborne instrumentation**  
**range design and operations**  
**data processing**

these are the pursuits of

PHILCO

# WESTERN DEVELOPMENT LABORATORIES

PALO ALTO



For industry, for the military . . . for ground, air or space . . .  
electronic and electromechanical systems designed and developed in superb new Palo Alto facilities . . . by the world's finest new team of senior specialists.

A rewarding share in this can be yours; your confidential inquiry is invited. Urgently needed:

*Ph.D., MS, BS in*

ELECTRONIC ENGINEERING    ENGINEERING PHYSICS  
MECHANICAL ENGINEERING    MATHEMATICS

experienced in any of our basic pursuits in military electronic systems. Please write H. C. Horsley, Dept. R

## PHILCO WESTERN DEVELOPMENT LABORATORIES

3875 Fabian Way, Palo Alto, California

A part of the Government and Industrial Division of Philco Corporation

5184



Measuring phase stability vs. temperature during prototype equipment development



Developmental helical antenna, part of sophisticated new direction-finder system



Pattern measurements—vital to development of microwave dish antennas



60' parabolic receiving antenna for missile telemetry and tracking



# MICROWAVE ENGINEERS

We have appropriate positions for both recent graduates and experienced engineers in our expanding Microwave, Antennas and Propagation Section. Exceptional opportunities exist for doing interesting research and advanced development under ideal working conditions in the following microwave fields:

- MICROWAVE COMPONENTS
- PROPAGATION STUDIES
- SPECIAL TEST EQUIPMENT
- INTERFERENCE EVALUATION
- ANTENNA DEVELOPMENT

Excellent salaries are offered to suit your individual experience and educational background. Benefits include insurance, and retirement programs, plus an unusual vacation policy which allows up to four weeks vacation per year. Tuition free graduate study may be taken at the Illinois Institute of Technology, which is also located at Technology Center. In addition generous relocation and interview allowances are provided. Further information concerning these positions may be obtained by sending a resume of your qualifications to:

A. J. Paneral

## ARMOUR RESEARCH FOUNDATION

of Illinois Institute of Technology

10 West 35th St.

Chicago 16, Ill.

# SPACE

Cape Canaveral is the site of the nation's major terminus to space. This terminus is managed by Pan Am. Our Guided Missiles Range Division has prime responsibility for management, operation and maintenance of the 5000-mile Atlantic Missile Range extending from Florida through the Bahamas to Ascension Island and beyond.

Because of these operations and the division's dynamic growth, we can offer high level physicists, mathematicians and electronic engineers truly unique opportunities in missile test and space probe engineering.

For an investigation of your future in the space age with Pan Am, please address a confidential resume to Mr. C. R. Borders, Assistant Division Technical Manager, Pan American World Airways, Inc., Patrick Air Force Base, Cocoa, Fla., Dept. C-3.



GUIDED MISSILES RANGE DIVISION

PATRICK AIR FORCE BASE, FLORIDA

These manufacturers have invited PROCEEDINGS readers to write for literature and further technical information. Please mention your IRE affiliation.

(Continued from page 146A)

units are intended for applications where efficiency is of prime importance. The welded, hermetically sealed single-ended package is designed for use with both printed circuit and chassis construction.

## Current Pulse Generator

Rese Engineering, Inc., 731 Arch St., Philadelphia 6, Pa., announces the latest in their line of specialized pulse equipment. Model 1051 Millimicrosecond Current Pulse Generator (Fig. 1) produces high amplitude, ultra short duration current pulses for development and design applications in high speed logic and memory problems, solid state research, and high speed transistor switching operation.

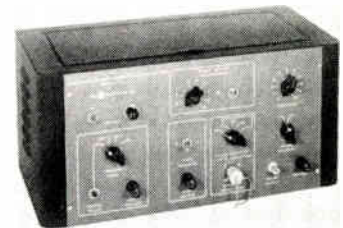

Fig. 1 - Rese Model 1051 Millimicrosecond Current Pulse Generator.

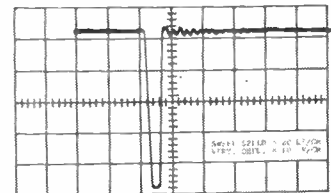

Fig. 2 - Output wave across 50 ohm load.

Featuring jitter-free pulses with rise times as fast as 5 millimicroseconds, the 1051 generates positive or negative pulses at ground level with durations of 10, 20, 50 and 100 Light Feet. (1 LF-1 millimicrosecond). Pulse amplitudes are continuously variable from 0 to more than 2 amperes, and pulse repetition frequency is continuously variable from 100 to 10,000 pps. The very fast rise time, less than 5 lf for pulse widths of 10 lf, makes the instrument invaluable for thin magnetic film studies, diode and transistor switching and recovery studies, and basic magnetics switching research. The combination of fast rise time and high current output is especially effective for high speed ferrite core and multi-apertured ferrite device studies.

## Adjustable-Speed Drives

The progress made in the engineering and production of silicon rectifiers has made possible a new series of adjustable-speed drives just announced by Servo-Tek

(Continued on page 150A)

# The further you have advanced in your career the more significant you will find the growth picture at STROMBERG-CARLSON

ELECTRONICS ARM OF  
GENERAL DYNAMICS CORPORATION

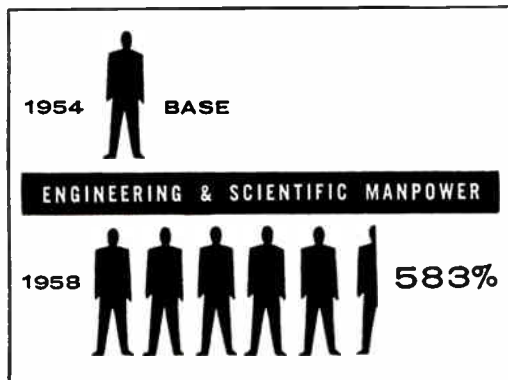

Moving heavily into electronics research and development only 5 years ago, Stromberg-Carlson has recorded the striking growth symbolized above. An engineer or scientist of proven superiority is not delayed in his advance by a slow-changing or static situation.

And a continuing growth story is projected by management—another 50% increase in engineering and scientific staff is scheduled between now and 1963.

Equally important, growth at Stromberg-Carlson is built on engineering achievement of a high order. The well-known quality of its work, and the caliber of the programs it handles (Prime Contractor and Systems Manager for an Electronic Reconnaissance System and recent developer of an electronic telecommunications switching system), make Stromberg-Carlson a natural choice for men who wish to advance as far in professional reputation as they do in position and income.

*Immediate Openings in  
a Diversity of Projects*

**TELECOMMUNICATIONS**

**PRINCIPAL SCIENTIST**

To consult on semi-conductor problems. To maintain technical knowledge and engineering capability at the highest level possible in the broad field of telecommunications.

**STAFF ENGINEERS**

Responsible for state of the art studies. To maintain technical knowledge and engineering capability at the highest level possible in the broad field of telecommunications.

**SENIOR ENGINEERS**

1. For telephone network design including modern synthesis filters, delay equalizers, discriminator networks, loss and phase equalizers, transistor switching circuitry etc.
2. For R&D of electronic switching systems involving solid state devices and new relay switching circuits.
3. General communications equipment design and development.

**EE's or EQUIVALENT**

1. Experience in carrier engineering; knowledge of dial and manual telephone systems.
2. For systems engineering work required by telephone central office equipment.

**RESEARCH &  
ADVANCED DEVELOPMENT**

**LABORATORY MANAGER**

Radio Communications. To direct R&D involving information theory, modulation techniques, propagation phenomena, microwave techniques.

**SENIOR MATHEMATICIAN**

PhD or outstanding MS in Math, Physics or EE. Specialist in information theory applied to communications and data systems.

**ENGINEERING WRITING**

EE degree or equivalent; technical writing experience. To work on military publications. Must be capable of working with schematics, electronic equipment and specifications to derive theory and maintenance information.

**ELECTRONICS ENGINEERING**

**SENIOR STAFF ENGINEERS**

To Become Recognized Authority in 1:

1. Automatic Test Equipment.
2. Undersea Warfare (airborne and submarine sonar systems).
3. Digital Computer Systems (airborne navigation and missile guidance).
4. Advanced Communications Systems.

**PRINCIPAL ENGINEER**

To develop and investigate new ideas in automatic control, including digital computer problems.

**SENIOR EE's,  
PHYSICISTS or EE's**

1. Transistorized industrial process control equipment.
2. Advanced automatic test equipment.
3. Advanced communications systems.

**APPLICATIONS ENGINEERING**

Engineering or technical background, 5 to 7 years experience including contractual requirements, sales or purchasing of complex electronic equipment.

**ELECTRONIC SYSTEMS**

**SECTION HEADS**

1. PhD or MS in EE or Physics. To supervise and act as consultant and liaison specialist in systems design work — both theoretical and equipment — in broad communications projects.
2. To supervise integration of antennas (emphasis on broadband ECM receiver types) into an ECM reconnaissance system.

**SENIOR ENGINEERS**

Experience in systems theoretical design and/or equipment design. Requires knowledge of entire electromagnetic spectrum; working knowledge of propagation methods.

**PRODUCTION ENGINEERING**

1. IE's to establish processes, methods and fixtures for manufacture of electrical and electronic assemblies.
2. EE's to design test equipment and develop procedures.

Rochester, New York, home of Stromberg-Carlson, is a professional community of approximately 500,000, located in New York's famous upstate vacationland, noted for its cultural advantages: advanced study opportunities at the University of Rochester with its

famed Eastman School of Music and Symphony; unrivaled park and school systems, modern hospitals.

If you qualify for one of the positions listed above, write immediately to Fred E. Lee, Manager of Technical Personnel.



**STROMBERG-CARLSON**

A DIVISION OF GENERAL DYNAMICS CORPORATION

1416 N. GOOMAN STREET • ROCHESTER 3, N. Y.



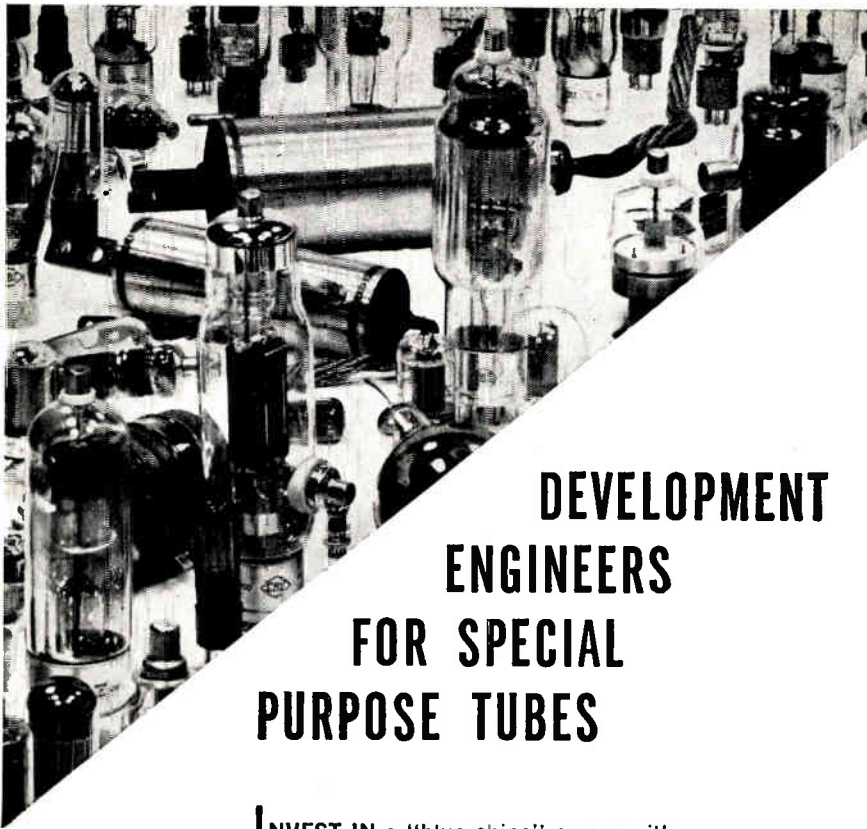

## DEVELOPMENT ENGINEERS FOR SPECIAL PURPOSE TUBES

**INVEST** in a "blue chips" career with CBS-Hytron. With CBS-Hytron, you not only join a well established company . . . you will also be joining an expanding, progressive organization that recognizes individual achievements and rewards all efforts.

**YOU WILL** be working for development and laboratory production of special purpose tubes. Your experience should be from 3 to 5 years, preferably on gas type tubes.

**IN ADDITION**, you'll be offered an attractive salary — a complete employee benefit program — and a company sponsored educational plan in an area boasting unsurpassed educational facilities.

► Send your resume, indicating salary desired, to Mr. Nicholas Bradley, Placement Administrator. It will be accorded absolute confidence and you will receive a prompt answer.

**ELECTRON TUBES**



**SEMICONDUCTORS**

## CBS-HYTRON

**DANVERS PLANT**  
A Division of  
Columbia Broadcasting System, Inc.  
100 Endicott Street  
**DANVERS, MASSACHUSETTS**  
Danvers is a suburb of Boston

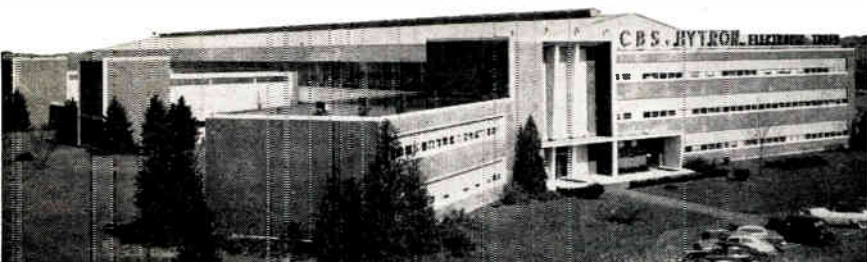

(Continued from page 148A)

Products Co., 1086 Goffle Rd., Hawthorne, N. J. The new series is available in 17 different models ranging from 1/20 to 3/4 horsepower.

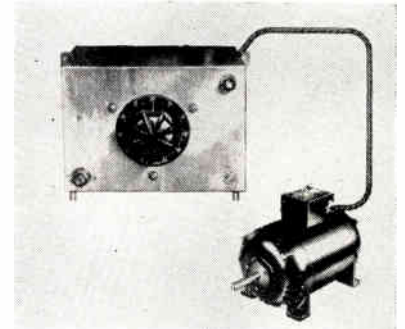

All models feature exceptionally smooth control from zero to maximum rated speed. Conservative rating of rectifiers and motors assures continuous operation at any speed. The entire controlled rectifier is contained in a compact enclosure that is designed for either bench use or wall mounting.

Prices start at \$117.00 complete with motor and include a 1/2 horsepower model selling for \$239.00 with an ungeared motor. For complete data and prices contact firm.

(Continued on page 153A)

**SCIENTISTS  
ENGINEERS**

## CALIFORNIA

*offers you and your Family*

- A world center of the electronic industry for CAREER ADVANCEMENT
- The High Sierras and the Pacific Ocean for RECREATION
- Some of the nation's finest public schools for your CHILDREN
- World Famous Universities for ADVANCED STUDY
- MAJOR CULTURAL CENTERS

while living in such places as  
Exciting San Francisco  
Fabulous Southern California  
Cultural Palo Alto

companies pay interview, relocation and agency expenses

submit resume in confidence to:

**PROFESSIONAL & TECHNICAL**

Recruiting Div. of  
Permanent Employment Agency  
825 San Antonio Rd.  
Palo Alto, Calif.



# Operations Research

Mathematicians, Physicists and Engineers with experience or strong interest in Operations Research on large-scale automated systems will be interested in the major expansion program at System Development Corporation.

SDC's projects constitute one of the largest Operations Research efforts in the history of this growing field. The projects are concerned primarily with man-machine relationships in automated systems in a number of fields, including air operations. The application of new and advanced digital computer techniques is particularly important in optimizing these man-machine relationships.

Senior positions are among those open. Areas of activity include: Mathematics, System Analysis, Forecasts, Cost Analysis, Operational Gaming, Design Analysis, Performance Evaluation.

Those who have professional questions or desire additional information are invited to write Dr. William Karush, Head of the System Development Corporation Operations Research Group at 2418 Colorado Avenue, Santa Monica, California.

---

## **"Method for First-Stage Evaluation of Complex Man-Machine Systems"**

*A paper by I. M. Garfunkel and John E. Walsh of SDC's Operations Research Group is available upon request. Address inquiries to Dr. William Karush at System Development Corporation.*

---

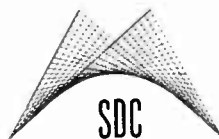

**SYSTEM DEVELOPMENT CORPORATION**

*Santa Monica, California*

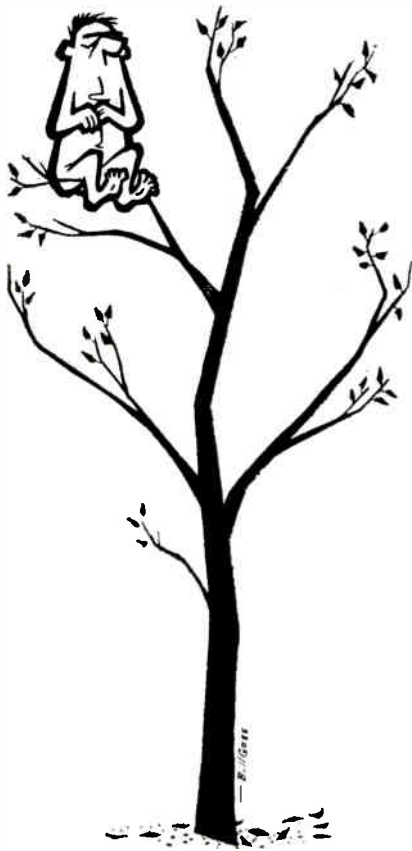

## up a tree?

Are you isolated from challenging engineering assignments? Gilfillan provides this challenge plus a friendly, informal atmosphere that is conducive to scientific achievement. Diversified technical opportunities are being offered to electronic engineers with a minimum of 3 years experience in missile systems, microwave, radar receivers, digital computers, pulse circuitry, and countermeasures.

You Owe It to  
Yourself to Write to



DIR. SCIENTIFIC PERSONNEL  
DEPT. 13  
1815 VENICE BOULEVARD  
LOS ANGELES 6, CALIFORNIA

## ELECTRONICS ENGINEERS and PHYSICISTS

Aeronutronic is expanding military and commercial programs involving the most advanced research, development, experimentation and prototype production at plants in Glendale and at modern, new facilities overlooking the Pacific Ocean at Newport Beach, California.

Career opportunities are open for scientists and engineers of high calibre in the fields of space technology, range instrumentation, missiles electronics, automatic controls, and display systems. Advanced degree and three to five years' experience in telemetry, radio propagation, atmospheric physics, servomechanisms, electronic and/or mechanical design, or plasma physics desirable. U.S. citizenship necessary. Qualified applicants are invited to send resume to Mr. K. A. Dunn, Aeronutronic Systems, Inc.

### AERONUTRONIC

*a subsidiary of Ford Motor Company*

1284 Air Way, Bldg. 29, Glendale California · CHapman 5-6651  
NEWPORT BEACH • GLENDALE • SANTA ANA • MAYWOOD, CALIF.

## STANFORD RESEARCH INSTITUTE

*Has Responsible Professional Opportunities in  
Electronic Engineering Fields for*

### ELECTRONIC ENGINEERS PHYSICISTS MATHEMATICIANS



*Opportunities in the Following Research Activities:*

PROPAGATION  
CONTROL SYSTEMS  
COMPUTER LOGIC DESIGN  
COMPUTER MAGNETIC DEVICES  
MICROWAVE COMPONENTS  
SYSTEMS ANALYSIS  
ANTENNAS  
COMMUNICATION TECHNIQUES  
MATHEMATICAL RESEARCH  
DISPLAY DEVICES

The continuing growth of activities at SRI offers excellent opportunities for qualified personnel on the MS and PhD levels with at least 5 years of experience in Electronic Engineering or Applied Physics.

Projects are varied and professionally challenging, offering unique opportunities to develop personal competence and broad experience.

Stimulating association, good research facilities and responsible assignments, coupled with living and working in one of the most desirable areas of the San Francisco Bay Area, complement an atmosphere conducive to professional growth and development.

*Write to...*

PROFESSIONAL EMPLOYMENT MANAGER  
STANFORD RESEARCH INSTITUTE  
MENLO PARK, CALIFORNIA

*Advanced study opportunities  
are available in the area*

These manufacturers have invited PROCEEDINGS readers to write for literature and further technical information. Please mention your IRE affiliation.

(Continued from page 150A)

### Digital Indicator and Printer

A new Digital Indicator and Printer, Model 176, has just been announced by Gilmore Industries, Inc., 13015 Woodland Ave., Cleveland 20, Ohio. Designed for high accuracy and resolution indication, the Model 176 permanently records weight, strain, temperature, pressure, and other variables which can be measured by sensitive bridge-type transducers.



The unit gives continuous monitoring and permanent periodic recording of the variable (in printed tape form for later analysis) at rates up to two readings per second. Controls are provided for run and calibration selection. Automatic readout-time-interval selection is optional. Load cells or other strain gage inputs are utilized. Data appears on a digital indicator and printed tape, providing a record of events with relation to time.

According to the manufacturer, the Model 176 has a high accuracy, high resolution, and is simple to operate.

### Resistor Ratio Set

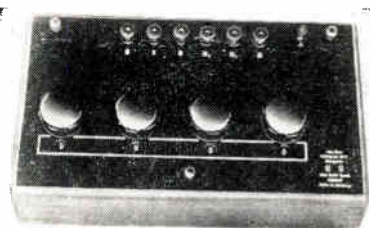

Physics Research Laboratories, Inc., P.O. Box 555, Hempstead, N. Y., announces the new Otto Wolff 4-Dial Direct Reading Ratio Set. This Ratio Set with a precision of 1 ppm affords the easiest, quickest and most precise method of comparing high precision resistors against known standards. It is encased in a polished mahogany box with removable cover. For complete details request PRL Technical Note No. 323 RS.

(Continued on page 156A)

# An Invitation To Join ORO...Pioneer In Operations Research

Operations Research is a young science, earning recognition rapidly as a significant aid to decision-making. It employs the services of mathematicians, physicists, economists, engineers, political scientists, psychologists, and others working on teams to synthesize all phases of a problem.

At ORO, a civilian and non-governmental organization, you will become one of a team assigned to vital military problems in the area of tactics, strategy, logistics, weapons systems analysis and communications.

No other Operations Research organization has the broad experience of ORO. Founded in 1948 by Dr. Ellis A. Johnson, pioneer of U. S. Opsearch, ORO's research findings have influenced decision-making on the highest military levels.

ORO's professional atmosphere encourages those with initiative and imagination to broaden their scientific capabilities. For example, staff members are taught to "program" their own material for the Univac computer so that they can use its services at any time they so desire.

ORO starting salaries are competitive with those of industry and other private research organizations. Promotions are based solely on merit. The "fringe" benefits offered are ahead of those given by many companies.

The cultural and historical features which attract visitors to Washington, D. C. are but a short drive from the pleasant Bethesda suburb in which ORO is located. Attractive homes and apartments are within walking distance and readily available in all price ranges. Schools are excellent.

**For further information write:  
Professional Appointments**

## OPERATIONS RESEARCH OFFICE

**ORO The Johns Hopkins University**

6935 ARLINGTON ROAD  
BETHESDA 14, MARYLAND



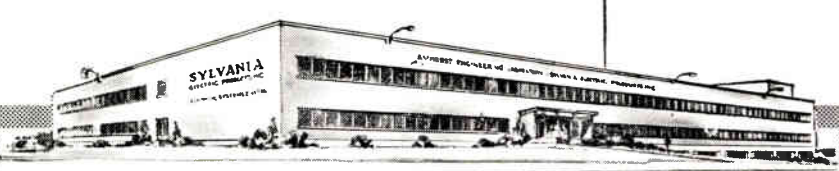

# THE AMHERST LABORATORY

## SYLVANIA'S CENTER FOR COMMUNICATIONS RESEARCH AND DEVELOPMENT

Whether your interests are in basic or applied research, the chances are that some area of interest to the Amherst Laboratory will coincide with your own. If you have demonstrated a capability for original research, Sylvania Amherst permits a considerable latitude in your choice of research problems, provides the facilities so essential for a successful research program, and encourages the publication of research results in appropriate journals and regular attendance at professional meetings. The guide lines that have been established are that the research program should be related in some way to communications. Typical examples of acceptable areas would be magneto hydro dynamics, finite group theory, statistical communication theory, difference sets and projective geometry, and wave propagation. A PhD degree or equivalent experience is required.

If your interests are more along applied lines, a number of attractive alternatives present themselves. The long-range objective of the Amherst Laboratory is to advance the state of the communication art. There is a need for scientists who will work with this objective in mind, who will keep abreast with the scientific developments in related fields, and who will determine whether applications in the communication field can be made. There is also a need to examine the other face of the coin, to take a customer's communications problems and attempt to find acceptable solutions. The requirements for such positions are imagination, initiative, and a sound scientific background. An advanced degree or equivalent experience is highly desirable.

The analysis and evaluation of proposed communication systems by analytical methods can be carried only so far. At some point it becomes necessary to translate basic system concepts into specific circuit designs, to fabricate feasibility or developmental models, and to test the system under actual field conditions for the purpose of obtaining an operational evaluation. This type of work requires training at the BS level and experience in pulse and digital techniques is desirable.

The scope of the work being carried out at the Amherst Laboratory is extremely broad. If you feel you might be interested and would like further details, please write to DR. ROBERT MALM.

AMHERST LABORATORY • SYLVANIA ELECTRONIC SYSTEMS

A Division of



1114 Wehrle Drive • Amherst 21, New York

IMPORTANT ANNOUNCEMENT TO  
ALL ENGINEERS—EE, ME, AE, CE:

## A New Organization Now Forming at General Electric to Integrate and Direct Systems Management of Prime Defense Programs

From within General Electric, and from industry at large, talented scientists and engineers from diverse disciplines are coming together to form the nucleus of the new Defense Systems Department.

The responsibilities of this new group encompass management of theoretical and applied research as well as advanced development on major terrestrial and space-age systems.

Engineers and scientists interested in exploring the broad new possibilities in the Defense Systems Department are invited to investigate current openings.

Direct your inquiry  
in confidence to Mr. E. A. Smith  
Section 2-F



ENGINEERS



A **FINER** **CLIMATE** TO WORK IN...

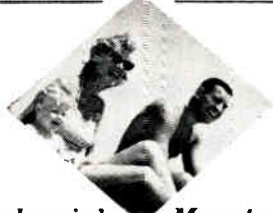

**THE** CLIMATE TO LIVE IN...

At Sylvania's *Mountain View Laboratories in California* (SAN FRANCISCO PENINSULA)

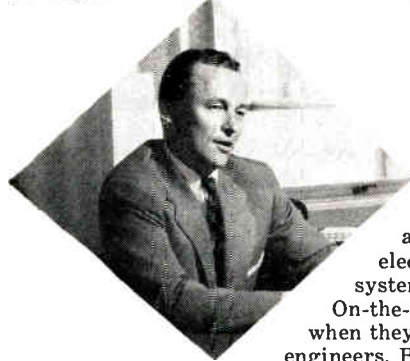

You'll discover more than just one kind of climate when you join Sylvania's Mountain View Laboratories.

**PROFESSIONAL CLIMATE** There's a professional climate that will speed your personal development. Advanced programs now under way will excite your professional imagination and challenge your technical creativity. You'll be making major contributions in the fields of electronic defense, radar, communications and data processing systems as well as related subsystems, equipments and components. On-the-spot, forward-looking engineer management makes decisions when they need to be made and knows the complex problems that face engineers. Because Sylvania is one of the nation's fastest growing electronics organizations, there are an unusual number of professional growth opportunities with commensurate reward.

**LIVING CLIMATE** You and your family will enjoy the healthful atmosphere, sunny climate and the happy way of life that goes with living in the heart of the beautiful San Francisco Peninsula. You'll find plentiful housing, excellent shops, fine schools and year-round recreation that the whole family can participate in.

---

**RECONNAISSANCE SYSTEMS LABORATORY** *Research & Development and fabrication of reconnaissance systems and equipment. Openings in: System Studies • Circuit Design • Computers & Data Handling • Electronic Packaging • Development Engineering*

---

**ELECTRONIC DEFENSE LABORATORY** *Research & Development and fabrication of electronic countermeasures systems and equipment. Openings in: Systems Concept & Planning • Advanced ECM Circuitry • Equipment Development • Product Engineering*

---

**MICROWAVE COMPONENTS LABORATORIES** *Research & Development and production of special purpose microwave tubes. Openings in: Tube Engineering • Tube Application Engineering • Mechanical Engineering • Tube Production Engineering*

---

**MICROWAVE PHYSICS LABORATORY** *Research & advanced development in the areas of microwave ferrites, gaseous electron physics, parametric amplifiers, solid state microwave control devices and propagation in ion plasmas. Openings for: Theoretical Physicists • Experimental Physicists • Mathematicians • Microwave Engineers*

---

Please send your resume to Mr. W. L. Pearson

**MOUNTAIN VIEW LABORATORIES**



SYLVANIA ELECTRIC PRODUCTS INC.

P. O. Box 188 — Mountain View, California

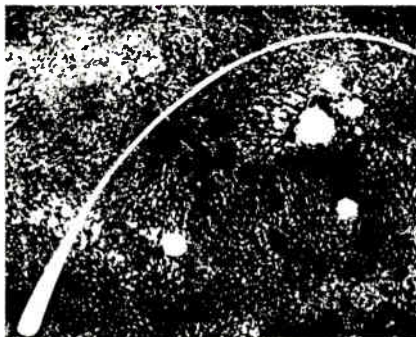

**Bendix YORK**

*offers the opportunity  
and the challenge of  
key assignments in...*

## GUIDED MISSILE ELECTRONICS

**ELECTRONIC  
ENGINEERS  
MECHANICAL  
ENGINEERS**

Here is your chance to prove your ability doing *important* work on missile fuzing, beacons, guidance, packaging and related test equipment. We have key openings that offer you the opportunity to move ahead rapidly in your profession. At Bendix York, you benefit from the advantages of a small company atmosphere in a growing division of one of the nation's largest engineering and manufacturing corporations. Also, you'll enjoy the "good life" in our beautiful suburban community. Good salaries, all employee benefits.

Drop us a card, briefly stating your education & experience. We'll act immediately to get together with you and talk it over.

ADDRESS:  
PROFESSIONAL  
PLACEMENT  
DEPT. P

**Bendix**  
AVIATION CORPORATION  
**York Division**  
York, Penna. York 47-2611

## NEWS New Products

These manufacturers have invited PROCEEDINGS readers to write for literature and further technical information. Please mention your IRE affiliation.

(Continued from page 153A)

### Antenna Multicoupler

A new antenna multicoupler, developed by Resdel Engineering Corp., 330 S. Fair Oaks, Pasadena, Calif., will pass the frequency range between 200 and 400 mc from a single wideband antenna to four separate-channel receivers. By cascading multicouplers, the same antenna will feed additional receivers. This one-antenna opera-

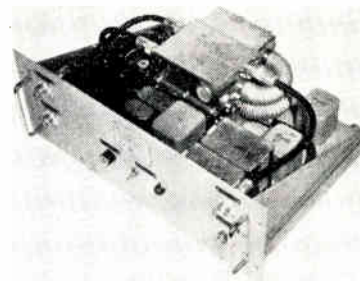

tion eliminates the difficulties common to multi-antenna installations.

Used as a laboratory wideband amplifier, the multicoupler will feed signals of

(Continued on page 158A)



### Control Systems Research

Creative scientific personnel required for research on control circuitry, servomechanisms and d-c to a-c power inversion systems for high frequency power sources.

Candidate should have a thorough understanding of circuit design by synthesis and transistor techniques. Some experience in electric rotating machinery design is also desirable.

PLEASE ADDRESS YOUR RESUME TO:

Dr. D. J. Sandell, Director of Research, Carrier Corporation  
Syracuse, New York  
All Replies Handled Confidentially.

**ELECTRONIC AND ACOUSTICAL ENGINEERS** wanted by **ELECTRO-VOICE, INC.** for research, development and design. Excellent opportunity for advancement and interesting work in rapidly expanding company.

Write: Vice President for Engineering  
**ELECTRO-VOICE, INC.**  
Buchanan, Michigan



*has attractive  
opportunities for*  
**MICROWAVE TUBE  
and  
CIRCUIT ENGINEERS**

At Chicago, Illinois and  
Redwood City, California Laboratories

You have read about the technical breakthrough represented by Zenith's New Low Noise Electron Beam Parametric Amplifier Tube. The further development of this Tube and its associated circuitry provides an opportunity to take part in a development which for the first time makes possible a really low noise vacuum tube amplifier for UHF and microwave frequencies.

write

Dr. Alexander Ellett,  
Vice President, Research  
Zenith Radio Corporation  
6001 W. Dickens Ave., Chicago 39, Ill.  
Telephone: BE 7-7500



work in the fields of the future at NAA

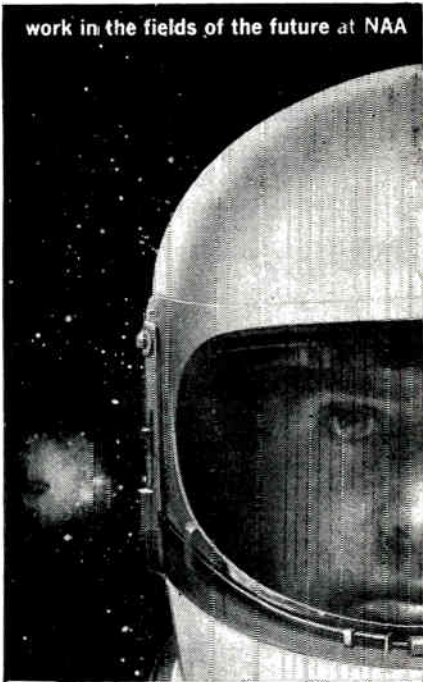

## ELECTRO-MECHANICAL ELECTRONIC ENGINEERS

A BS or advanced degrees in EE, ME, or Physics, may qualify you for a career at NAA, home of the advanced B-70, F-108, and X-15.

**Flight Control Analysis, Reliability Analysis, Flight Simulation, Systems Analysis.**

**Electrical Systems Analysis and Design, Mission and Traffic Control, Fire Control, Bombing Systems, Electronics Systems Integration, Flight Controls, Ground Support Equipment, Airborne and Electronic Test Equipment.**

**Applied Research in Radar Development, Antenna Development, Infrared, and Acoustics.**

Please write to: Mr. B. B. Stevenson, Engineering Personnel, North American Aviation, Los Angeles 45, California.

THE LOS ANGELES DIVISION OF

**NORTH AMERICAN AVIATION, INC.**



**B.S.(E.E.)**  
**M.S.(Phys.)**  
**B.S.(M.E.)**  
**Ph.D.**  
**D.Sc.**  
**M.S.(E.E.)**  
**... etc.**

## AT MOTOROLA in PHOENIX... Engineers are given a NEW DEGREE

Engineers who join our staff are given the *Degree of Responsibility* that every idea-sparking engineer wants, but so few receive. Our men follow through on their ideas—from first inspiration through final field test evaluation. This mature approach results in sound designs that have helped Motorola attain world-recognized leadership in military and industrial electronics. At Motorola, you will be granted authority commensurate with your responsibilities. Your working environment will provide the best opportunity for your growth; Arizona's sunny climate the best opportunity for healthy, pleasant living. Write today to Mr. Kel Rowan, Dept. C-2.

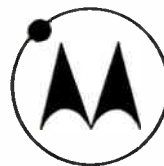

**MOTOROLA**

**Western Military Electronics Center** 8201 E. McDowell Rd. Phoenix, Arizona

### OPPORTUNITIES



**Electronic Engineers, Mechanical Engineers, Physicists—SYSTEM ANALYSIS, DESIGN AND TEST—Radar • Missile Guidance • Navigation • Combat Surveillance • Communications • Field Engineering • Data Processing and Display—CIRCUIT DESIGN, DEVELOPMENT AND PACKAGING—Microwave • Pulse and Video • Antenna • Transistor • R-F and I-F • Servos • Digital and Analog TECHNICAL WRITERS AND ILLUSTRATORS, QUALITY CONTROL ENGINEERS, RELIABILITY ENGINEERS**

Motorola also offers opportunities at Riverside, California and Chicago, Illinois

# Electronic Systems Scientists

FOR INTEGRATION OF THEORY, ENVIRONMENT  
AND EQUIPMENT . . . TO CREATE AND  
OPTIMIZE MAJOR CONCEPTS ASSOCIATED WITH:

Missile Guidance  
Navigation  
Communications  
Fire Control  
E.C.M. Systems

*Significant advanced education  
and experience are required*

Litton offers rewarding careers and salaries  
to scientists with proficiency and potential.

- Unique, Modern Facilities
- Professional Environment
- Attractive Benefits
- Interview And Relocation Assistance

Gracious Maryland living in the Northern  
suburbs of Washington, D. C.

*Résumé or collect phone call (UNion 4-5678)  
to Mr. C. A. Robinson*



**LITTON INDUSTRIES**  
MARYLAND DIVISION

4910 CALVERT ROAD, COLLEGE PARK, MARYLAND

*(Continued from page 156A)*

one signal generator to four independent rf  
amplifiers or receivers.

Isolation between outputs is 45 db  
minimum. Gain is 10db for each channel  
uniformity of response is  $\pm 2$  db. The unit  
has an integral power supply and is pack-  
aged for standard rack mounting.

## Nuclear Control Unit

A new nuclear magnetic resonance field  
control unit, the model FC-501, has just  
been added to the line of nuclear magnetic  
products available from **Harvey-Wells  
Electronics Inc.**, 5168 Washington St.,  
West Roxbury 32, Mass.



This new instrument is designed to pro-  
vide a means of precise regulation of elec-  
tromagnets by producing an error signal,  
derived from the field under control, suit-  
able for closed loop regulation of the mag-  
net power supply.

*(Continued on page 160A)*

## CIRCUIT DESIGN Engineers

World famous manufacturer of  
business machines offers exceptional  
career opportunities to creative and  
imaginative Circuit Design Engi-  
neers.

Assignments at our Research Center  
in Southern Connecticut are prin-  
cipally concerned with the creation  
of computer circuits working from  
computer logic.

Should hold Degree in Electrical  
Engineering, plus 2-5 years ex-  
perience in the design of Solid State  
pulse circuits.

Salary is open. Superior company benefits are  
offered. Send your resume, in confidence to

**Box 1091**

**Institute of Radio Engineers**  
1 East 79th St.  
New York 21, N.Y.

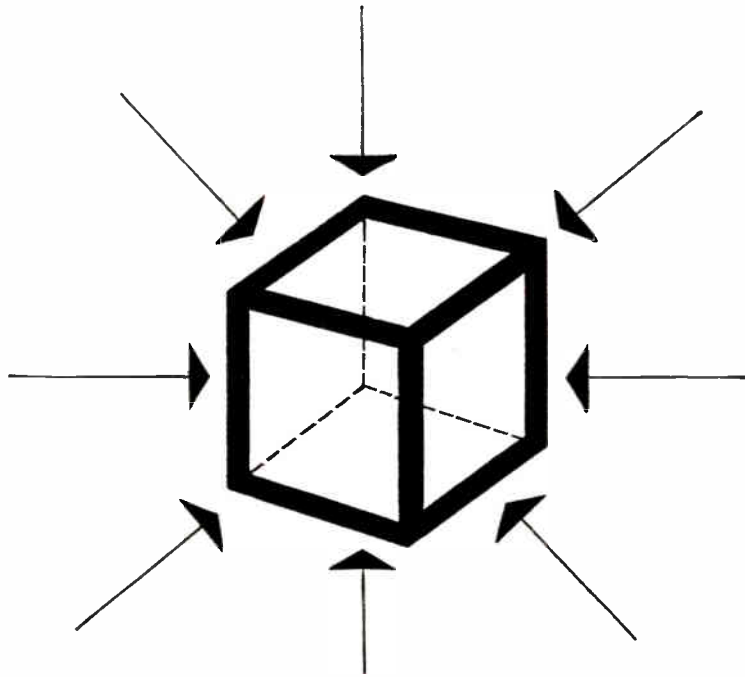

## YOU MAY BE JUST THE MAN TO HELP BURROUGHS SQUEEZE A MILLION TRANSISTORS INTO A CUBIC INCH

### OR EXPLORE FIELDS LIKE THESE:

- Statistical approaches to physiological processes
- Electro-chemical phenomena
- Radiation effects
- Plasma physics
- Magneto hydro-dynamics
- Electro-luminescence
- Cryogenics
- Superconductivity
- Semi-conductors
- And a lot of others

Right now—today at Burroughs: plenty of room for exceptional engineers to help create the *successors* to Burroughs' big line of advanced electronic and electro-mechanical data processing equipment. Equipment that ranges from giant electronic computer systems to automatic accounting machines and more.

We need men who can help us put the functional equivalent of a million transistors into a cubic inch of material. Or men who can help us produce equally advanced results in fields like those mentioned at the left.

Men who can thrive on working without strait jackets.

Men who can get the most out of our heavily budgeted research facilities.

Men who can welcome the security of our *cohesive* research programs. How cohesive? Because their common aim is to improve information processing for both commercial and military use. How do the programs offer security? Because their cohesiveness allows you to shift readily from one to another without learning a new technology.

We want men whose creativity will help us double our \$300 million yearly sales rate fast—and then redouble it even faster.

Men who are frankly interested in increased responsibility. In swift promotion in careers that offer a wide choice of location. And, yes, in money.

Are you as outstanding as these opportunities? Then outline your education and experience as briefly or fully as you wish, name the field you'd like to help us explore, and get that information to A. I. Suzio, Administrator, Corporate Placement Services, Dept. 103, Burroughs Corporation, Detroit 32, Mich.



## Burroughs Corporation

"NEW DIMENSIONS / IN ELECTRONICS AND DATA PROCESSING SYSTEMS"



## Immediate Openings at ELECTRIC BOAT DIVISION OF GENERAL DYNAMICS CORPORATION



# Birthplace of the Atomic Submarine

## Now Building first 2 Ballistic Missile POLARIS Subs

### RESEARCH & DEVELOPMENT DEPARTMENT

**ELECTRICAL SYSTEMS** EE, ME or Physics degree required. Responsible for conceptual engineering and system analysis of large complex devices employing a combination of electrical, electronic, electro-mechanical, hydraulic and pneumatic systems. Should be familiar with servomechanisms theory, experienced in use of analog or digital computers as a design tool, and have a good grasp of mathematics. Will work on proposal preparation, feasibility studies and execution of hardware contracts.

**CIRCUITS**—BSEE or Physics. Responsible for conceptual and production engineering of electronic equipment. Familiar with servomechanisms and analog computer theory. Experienced in use of semiconductors, magnetic amplifiers, and vacuum tube circuit elements; good grasp of mathematics.

**SERVOMECHANISMS** For engineering design of servomechanisms in both the instrument and multiple horsepower class. Will interpret performance specifications and be responsible for design of a system including stability studies and the calculation of other performance criteria.

### ENGINEERING SECTION-DESIGN DEPARTMENT

Circuit Development and Systems Installation assignments concerning application of missile fire control and shipboard navigation systems. Requires EE degree and minimum of 2 years missile or navigation system experience.

Development of Circuits and Equipment in conjunction with missile and navigation systems installations aboard submarines. Requires EE degree with advanced courses and experience in servomechanisms.

*The professional development offered engineers at Electric Boat—largest and most highly trained engineering and design staff of any private shipyard in the United States—is outstanding in every way.*

*Electric Boat's location, in the New England community of Groton on the Connecticut shore near New London, provides excellent living and working conditions—just half way between New York and Boston. To arrange interview appointment, send resume to James P. O'Brien, Technical Employment Supervisor.*

## GENERAL DYNAMICS CORPORATION

### ELECTRIC BOAT DIVISION

Groton, Connecticut

## RESEARCH & DEVELOPMENT

# ELECTRONIC ENGINEERS

UNUSUAL CAREER OPENINGS  
in RAPIDLY growing company  
for  
**PROJECT ENGINEERS**  
**SR. ENGINEERS & ENGRS.**  
**BS-EE or PHYSICS**

Several years or more experience in circuitry and equipment design or applicable background—to work on UHF and VHF systems. Wide band knowledge desirable for challenging assignments on electronic countermeasures systems for military application and electronic instruments for commercial use.

Excellent salary range at all levels. Close association with acknowledged leaders who will aid your professional growth and develop your engineering abilities.

Profit Sharing Retirement Plan  
Many other Benefits.



Call for interview  
J. V. Hicks  
O'Verbrook 1-7100  
or send resume  
in confidence to:

**INSTRUMENTS FOR  
INDUSTRY, INC.**

101 New South Rd. Hicksville, L.I.



## NEWS New Products



These manufacturers have invited PROCEEDINGS readers to write for literature and further technical information. Please mention your IRE affiliation.

(Continued from page 158A)

The range of the FC-501 is 310 to 20,000 gauss with standard probes. For control of fields out of this range, special probes are available.

The unit consists of three interconnected parts: (1) probe, (2) oscillator, (3) field control unit. This latter part consists of a power supply, lock-in amplifier and modulator. The oscillator is stable to greater than ten parts in a million. Even greater stability can be obtained by cohering it to an external frequency standard.

The modulation sweep range is zero to 20 gauss. Increased modulation facilitates the location of resonance and a modulation control allows decrease of modulation to optimize field control action.

The unit operates at 115 volts, 60 cycles at 2.5 amperes. Both the oscillator and field control unit are compactly designed and weigh 45 lbs.

Added versatility of the field control unit permits it to be used as a high gain null detector for precise control of temperature, pressure, and impedance by the addition of an external bridge.

For additional product data and specifications contact Robert G. Vance, at the firm.

(Continued on page 162A)

## An Occasion Of Note For Engineers And Scientists

Make Abbott's your PERSONAL AGENT with the nation's foremost employers of engineering and scientific talent. You'll soon find your abilities being utilized right up to the maximum, with rewards and satisfactions on the same high level.

**Salaries—\$10,000-\$30,000**

**CHIEF ENGINEERS:** (Research & Development only)—radar, communications, infrared, sonar

**ASSOCIATE DIRECTOR OF RESEARCH:** PhD—research & administration military electronics

**STAFF ENGINEERS:** radar, sonar, systems, communications

**PROJECT ENGINEERS:** synchros, fractional hp motors

**SECTION HEADS:** navigation systems, computers, radar

**SENIOR ENGINEERS:** electromagnetics, microwave, antennas, transmitters, and receivers

**PRODUCT DEVELOPMENT ENGINEERS:** gyros, instruments

**DESIGN & DEVELOPMENT ENGINEERS:** circuitry, diodes, tubes, systems, radar, communications, military electronic equipment

In our thirty-six years of confidential service, we have attained national recognition by leading companies as the personnel representative for engineering, scientific and administrative people. Our company clients will assume all expenses and our service charges. Please send detailed resume to Mr. Arthur R. Joyce.



EMPLOYMENT SPECIALISTS

101 Tremont Street, Boston 11, Massachusetts  
H Ancock 6-8400

# Physicists and Engineers

## FOR ADVANCED RESEARCH AND DEVELOPMENT OF HIGH QUALITY SEMICONDUCTOR DEVICES

Openings involving an unusually high degree of professional challenge are available in our congenial group of Scientists and Engineers. Inquiries are invited from qualified personnel at all levels of experience and education.

### **MICROWAVE PHYSICISTS**

### **SOLID STATE PHYSICISTS**

### **TRANSISTOR ENGINEERS**

### **ELECTRICAL ENGINEERS**

Sperry Semiconductor Division offers a desirable scientific atmosphere plus growth opportunity available only in a small group, yet enjoying the stability of its parent, Sperry Rand Corp. — a famous name in scientific accomplishment for almost 50 years. Our technical facilities are unsurpassed and located in a beautiful Connecticut suburban area, approximately 1 hour from New York City's cultural and educational activities. Standards are the highest, with remuneration and professional recognition commensurate. Liberal benefits. Please contact our Professional Personnel Administrator: Mr. B. F. Gandrup.



SEMICONDUCTOR DIVISION

OF SPERRY RAND CORPORATION

Wilson Avenue  
South Norwalk, Connecticut  
VOLunteer 6-1641

# ENGINEERS SCIENTISTS ERCO

A pioneer and one of the leading producers of electronic flight simulators, is increasing its engineering activity to include volume engineering programs in the fields of analog & digital computer techniques, telemetry, transistor applications and light/optical scanners. It is also rapidly expanding its research and development operations in the fields of ionospheric propagation & UHF communications.

Challenging and diversified assignments in product design & research & development are offered by this constantly growing organization to the career minded engineer or scientist who wishes to combine stability with the latitude necessary for rapid professional & financial growth.

Immediate openings exist for qualified, professional personnel whose areas of experience coincide with the following requirements:

## DESIGN & DEVELOPMENT PROGRAMS

### CIRCUIT DESIGN (ALL LEVELS)

BSEE, for transistor circuitry, application analog and digital computer techniques, DC amplifiers, simulation, telemetry and design of systems and components.

BS in Physics, plus experience in one or more of the following: optics, hydraulic instrumentation, human engineering, numerical analysis, computer techniques.

### AERODYNAMICISTS

BS in Aero E, plus 3 years' experience in aerodynamics, preferably in airplane stability, control, power plants, performance or simulation.

### TECHNICAL WRITERS

BS in EE or Physics, or equivalent, plus 2 years' experience in the preparation of operational and maintenance manuals & engineering reports concerning electronic systems & components.

## RESEARCH & DEVELOPMENT PROGRAMS

### IONOSPHERE PHYSICISTS

BS degree plus 3 to 5 years' experience in the study of ionospheric phenomena. Familiar with present state-of-the-art of upper atmosphere and have an understanding of present programs using rockets and satellites for studies in E & F regions and beyond. Will work with radiation problems spanning VLF to VHF region of spectrum with emphasis on HF backscatter techniques and their applications to communications. Will design and conduct field experiments.

### GLOBAL COMMUNICATIONS SPECIALISTS

BS degree plus 5 to 10 years' experience embracing theoretical as well as practical knowledge of communications systems design involving F-layer ionospheric propagation techniques. Working knowledge of modern high-power HF transmitters and HF receiving Systems.

### ELECTRONIC PHYSICISTS

BS degree with 3 to 5 years' experience in diffusion pump high-vacuum techniques and have an understanding of classical gas discharge physical phenomena. Will conduct laboratory investigations of simulated upper atmosphere experiments.

**EXCELLENT SALARIES**  
*commensurate with education & experience*

**MODERN COMPANY BENEFITS**  
*including educational assistance plan*

**IDEAL LIVING CONDITIONS**  
*in suburban Washington, D.C.*

**RELOCATION ASSISTANCE**

**EXPENSE-PAID INTERVIEWS WITH SELECTED APPLICANTS**

*Send Resume Stating Education & Experience to:*

**Mr. R. J. REID, Technical Employment Manager**

**ERCO PLANT**  
NUCLEAR PRODUCTS—ERCO  
DIVISION OF ACF INDUSTRIES INCORPORATED  
RIVERDALE, MARYLAND WARFIELD 7-4444



These manufacturers have invited PROCEEDINGS readers to write for literature and further technical information. Please mention your IRE affiliation.

(Continued from page 160A)

## Barometric Switch

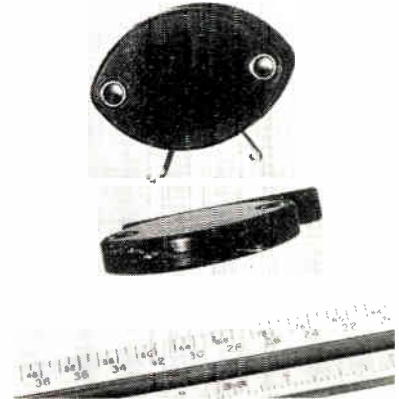

An aneroid or altitude type of barometric switch which is actuated by the ambient air pressure is announced by Erickson Specialties, 1219 Dulany Valley Rd., Towson 4, Md. This switch is normally open, SPST, snap action, closing and remaining closed above the "make" value with increasing altitude. Model ES-4 opens with decrease of altitude below the "make" value by a differential value. Rated at 0.5 ampere, 28 volts, inductive load, it has a plastic case for easy stacking and weighs 0.04 pound. Factory-calibrated and having fixed operating values from 3,000 to 70,000 feet, this component withstands severe conditions of humidity, temperature and vibration, is dependable and has a high degree of repeatability. It is not intended as a precision altitude measuring instrument but, for use in applications where rather loose manufacturing tolerances are acceptable. For additional data and prices contact Paul B. Gebhardt at the firm.

## Magnetic Amplifier Regulator

Kato Engineering Co., Mankato, Minn., has developed static exciter and magnetic amplifier type voltage regulator units.

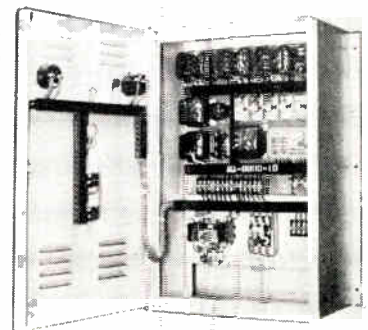

The line of Kato electrical machinery for which these control units are manufactured includes 60 cps brushless and brush type ac revolving field generators from 5

(Continued on page 164A)



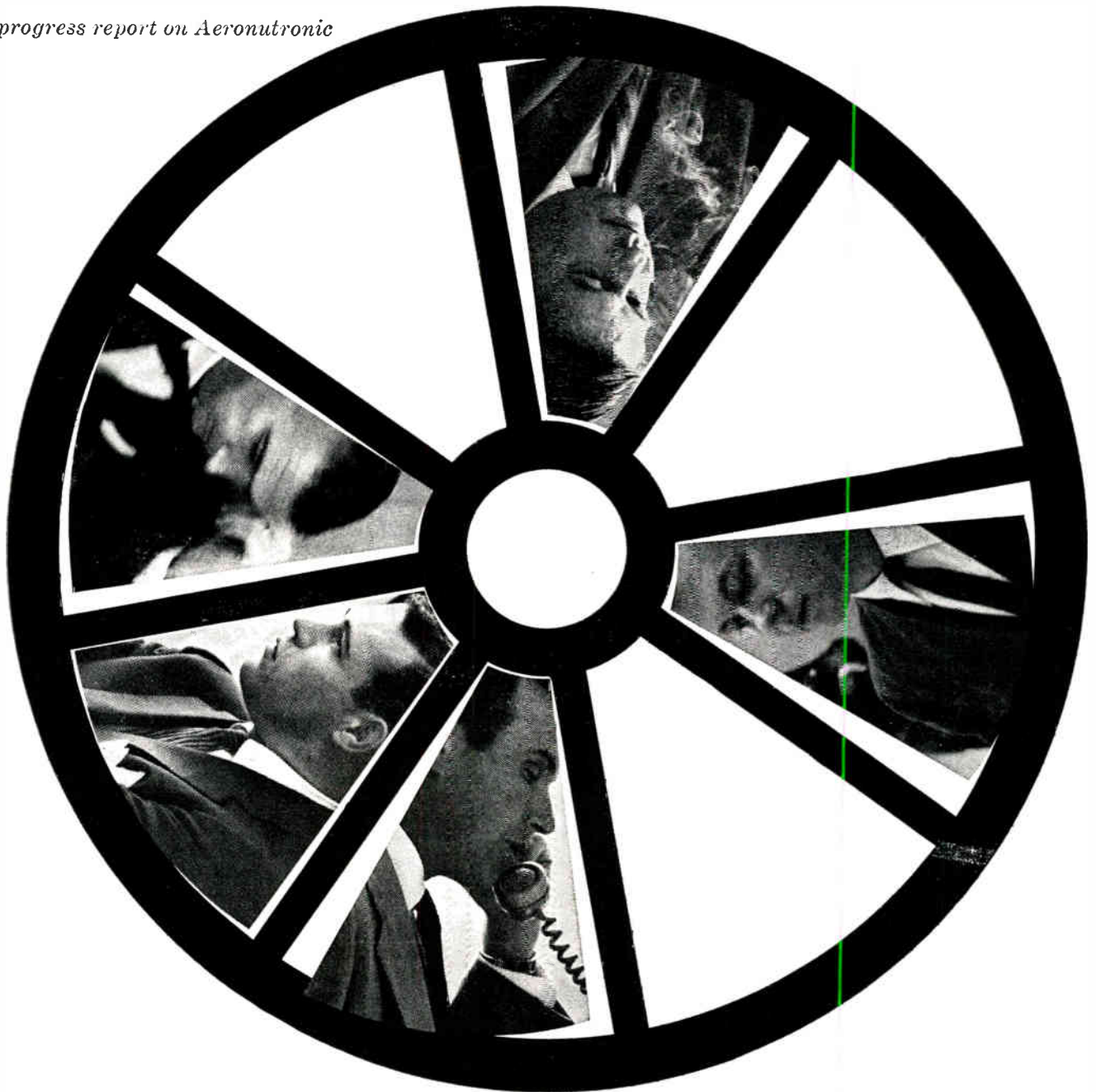

## MEN AND IDEAS IN MOTION: AERONUTRONIC

This is Aeronutronic — men, ideas, and the tools for research. Aeronutronic — a dynamic new name in science — created by the Ford Motor Company to meet the demanding technological needs of a nation on the move.

Aeronutronic is moving into the future and moving fast. Space sciences, missile technology and space vehicles...computers, electronics...tactical weapon systems... these are major research,

development and manufacturing activities conducted at ASI's modern 200-acre Research Center under construction at Newport Beach, California.

Exceptional engineers and scientists are needed now. If you are forward-looking and want to be an important part of a forward-moving organization, you'll find a new challenge and rewarding future at Aeronutronic — *where men set ideas in motion.*

*For information regarding positions, interests, facilities or products, write to Mr. K. A. Dunn, Aeronutronic Systems, Inc., Bldg. 29, 1234 Air Way, Glendale, California, or call CHapman 5-6651.*

## AERONUTRONIC

a subsidiary of FORD MOTOR COMPANY

NEWPORT BEACH, GLENDALE, SANTA ANA AND MAYWOOD, CALIFORNIA

OFFICE OF ADVANCED RESEARCH • SPACE TECHNOLOGY DIVISION • COMPUTER DIVISION • TACTICAL WEAPON SYSTEMS DIVISION

(Continued from page 162A)

kw to 400 kw; 60 to 400 cps frequency changers and 400 cps ac generators from 1 kw to 200 kw; synchronous and induction motors; variable frequency motor generator sets; dc generators and other ac generators in many different frequencies, speeds and voltages.

The units consist of a power magnetic amplifier, a transistorized dc amplifier and a sensing circuit with a Zener diode reference. It is energized from the same 60 cps source that drives the motor of the MG set. Separate Kato magnetic amplifier type regulators are utilized when other means of generator or synchronous motor excitation is desirable. Because of the nature of "brushless" generator design, rotating exciters must be used exclusively with these machines. Literature available on request.

### Miniature Pulse Transformer Kit

A new, miniature, pulse transformer kit for the design engineer is announced by the **New York Transformer Co.,** Alpha, N. J. Known as the NYT Miniature Pulse Transformer Laboratory Kit, the offering consists of 10, three-winding pulse transformers.



Part of the NYT standard line, the transformers in the kit provide a range of pulse widths from 0.1 to 10 microseconds. The range can be extended to 40  $\mu$ s by wiring the third winding of two transformers in series.

The first two windings of all transformers in the kit are in a one-to-one ratio. On six of the transformers the third winding is in a one-to-one ratio with three taps, and on four of the transformers the third winding is in a one-to-five ratio with 3 taps. A combination of 20 different ratios is possible, using the pulse transformers in the kit, from 1:1:0.1 to 1:1:5.0 and so forth.

These transformers are designed for blocking oscillator circuits, computer circuits, and interstage coupling. High permeability, low-loss cores are used, providing maximum inductance, minimum droop, high efficiency, and permit high repetition rates. Winding configurations are arranged for best high frequency performance. For laboratory and breadboard convenience, the units are designed to plug into a standard miniature nine pin tube socket.

Literature describing the kit is available from the firm.

(Continued on page 170A)

## PROFESSIONAL PERSONNEL REQUISITION

### ELECTRONIC ENGINEERS

Two excellent openings on long term, expanding projects. Marquardt is growing steadily in many diversified areas, which means real "ground floor" opportunities for qualified engineers.

### ELECTRONIC SYSTEMS TEST ANALYST

Group leader for analysis and definition of test requirements applied to automatic checkout of weapon systems. Requires six to fifteen years experience in systems design, development and circuitry. Able to perform preliminary design of test systems, programming requirements, accuracy requirements, specification preparation, system evaluation.

### ELECTRONIC CONTROLS ANALYST

Experience in circuit design, and in electronic controls using analog methods. Will generate specifications for systems and components. Will direct systems test programs. Will analyze closed loop systems in electronic and mechanical components. Familiar with servos and analog computer.

Contact: **Floyd E. Hargiss, Manager**  
Professional Personnel  
16540 Saticoy Street  
Van Nuys, California

Advanced power and weapons support systems for air and space   
VAN NUYS AND POMONA, CALIFORNIA · OGDEN, UTAH AIRCRAFT CO.

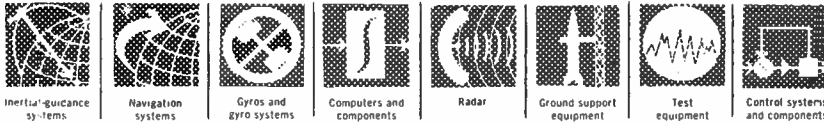

## SENIOR POSITIONS WITH SMALL DESIGN GROUP PIONEERING SPACE AGE COMPUTERS

... Five-Figure Salaries

Kearfott's advanced engineering organization is rapidly opening up a major area for digital techniques in space age guidance and navigation.

Programs under way at the Inertial Guidance, Electronics, and Astronautics Laboratories cover every major aspect of computer applications in guidance technology.

The complex problems entailed generate "start-to-finish" project responsibilities and correspondingly broad opportunity for achievement. Immediate openings exist for:

### SENIOR DIGITAL COMPUTER ENGINEER

Over-all computer logical structure synthesis and hardware instrumentation.

### SENIOR DIGITAL ELECTRONIC ENGINEER

Basic design and transistorized circuitry for digital computers and data processing systems.

### DIGITAL SYSTEMS AND CIRCUITRY

Adapt digital techniques to navigational problems, logical design, read-in/read-out devices, converters and memory devices.

Write in confidence to: Mr. C. Weinfeld, Engineering Division



1500 Main Avenue Clifton, New Jersey  
Subsidiary of General Precision Equipment Corp.

News about

## RAYTHEON'S

# SEMICONDUCTOR DIVISION — the place for the man

## who is growing faster

## than his associates

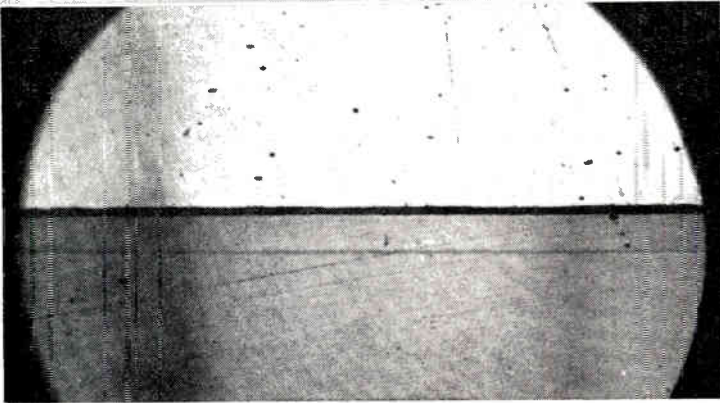

Bright Field ↑

↓ Interference

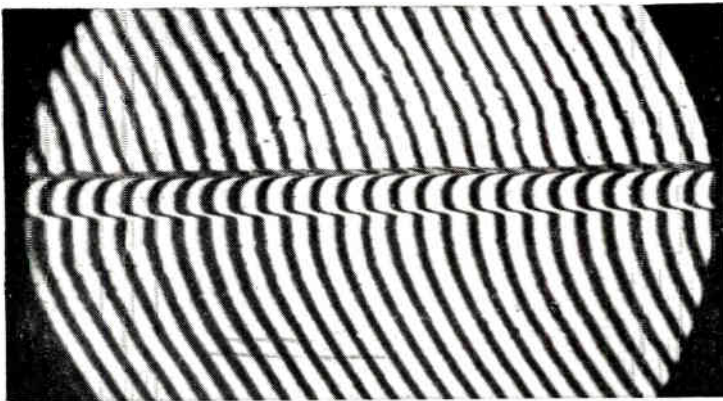

INTERFERENCE FRINGES are useful in determining slight changes in elevation and measurement of thin coatings such as those that might be laid down by vacuum evaporation. The above photomicrographs (112x) show gallium diffused silicon used in making Raytheon diffused base NPN silicon high frequency transistors. The silicon is at the bottom of each picture. The depth of the gallium penetration is .0007". The height of the junction step after etching is .0000088". The bright field picture shows how the junction looks normally under a metallurgical microscope. The interference picture shows how this same junction looks under an interference microscope.

### STRICTLY IN CONFIDENCE...

If you would like to explore the growth possibilities for yourself, please send your resume to Mr. Allen Moorhead, RAYTHEON MANUFACTURING COMPANY, Semiconductor Division, 150 California Street, Newton 58, Mass.

Here is where transistors were first mass-produced to open up the fast-growing semiconductor industry... where a major "all-out push" is under way... where 1,008 new people were added in the last half of 1958... where 220,000 sq. ft. of new modern facilities are being added... where management says: "Here are the tools you asked for!"... where men with growth potential play a *recognized* role.

In the major league now with a broad line, Raytheon's Semiconductor Division will continue to be a leader in the research, engineering and manufacture of semiconductors.

For the man who is growing faster than his present associates and who seeks diversified assignments, there are exciting growth opportunities in:

- Device Design and Development
- Material Development
- Product Design
- Product Evaluation
- Mechanization
- Automatic Electronic Testing
- Application Engineering

If you are looking for a place to grow faster, there's plenty of elbow-room for you at Raytheon's Semiconductor Division.

"The place for the man who is growing faster..."  
**SEMICONDUCTOR DIVISION of**



*Excellence in Electronics*



*Of prime career importance*

# COMPATIBILITY

*between you and the Company where  
you choose to exercise your talents*

A creative man finds the plane of transmittance at Norden Laboratories coinciding with his own

An engineer needs an environment that is professionally congenial — in order to live up to his creative potential. So—before you come up to visit us at Norden Laboratories, we'd like to give you a brief outline of what we're like and how we operate:

- *we're mainly R&D and we work on a diversity of projects in forward areas*
- *we're organized on a Departmental-Project basis to take full advantage of the special skills of our professional people. Versatility is encouraged*
- *we cut down on formality and red tape wherever we can*
- *our technically-minded management is in close touch with the staff, making it possible to give individual recognition where due*

If this brief sketch of Norden Labs sounds "compatible" with your aims and interests, inquire about these immediate openings at our White Plains, NY and Stamford, Connecticut locations:

#### TELEVISION & PASSIVE DETECTION

- Transistor Circuit Development
- High & Low Light Level TV Camera Design
- Video Information Processing
- TV Monitors & Contact Analog Displays
- Military Transistorized TV Systems  
(Also openings for recent EE grads)

#### RADAR & COMMUNICATIONS

*Design & Development of:*

- Antennas
- Microwave Systems & Components
- Receivers
- Transmitter Modulators
- Displays
- Pulse Circuitry (VT & Transistors)
- AMTI
- Data Transmission
- ECM

#### DIGITAL

- Digital (Senior) Design: Logical, Circuit, Magnetic Storage

#### PROJECT ENGINEERING

- Senior Engineers — Engineering Program Mgt.

#### SYSTEMS ENGINEERING

- Synthesis, analysis & integration of electronic & electro-mechanical systems

#### QUALITY ASSURANCE

- Systems Reliability Analyses
- Component Reliability & Evaluation
- Vibration, Shock & Environmental Test
- Standards

#### ENGINEERING DESIGN

- Electronic Packaging

#### FUTURE PROGRAMS

- Systems Engineer (SR) — Broad creative background, ability to communicate — experience in radar, TV systems — supervise R&D proposals
- Senior Engineer — Cost development for R&D proposals. Require broad technical experience in electro-mechanical and electronics systems

#### STABILIZATION & NAVIGATION

- Servo Loops for gyro stabilization, antenna stabilization, accelerometer force balance, antenna scanning
- Repeater Servos
- Transistorized Integrator, DC Amplifier, Servo Amplifier
- Magnetic Amplifiers
- Transistorized DC & AC power supplies
- Gyros & Accelerometers

Descriptive Brochure Available Upon Request

TECHNICAL EMPLOYMENT MANAGER

## NORDEN LABORATORIES

NORDEN DIVISION — UNITED AIRCRAFT CORPORATION  
121 WESTMORELAND AVENUE • WHITE PLAINS, NEW YORK

*I am interested in obtaining further information on opportunities at Norden Laboratories.*

NAME \_\_\_\_\_

ADDRESS \_\_\_\_\_

CITY \_\_\_\_\_ ZONE \_\_\_\_\_ STATE \_\_\_\_\_

DEGREE \_\_\_\_\_ YEAR \_\_\_\_\_

(United States Citizenship Required)

## OPPORTUNITIES for Electrical Engineers and Physicists in Industrial Electronics

FMC Central Engineering's current expansion into automatic measurement and control field provides unusual opportunities for technical accomplishment on important company sponsored long range programs. Both systems engineers and specialists are needed.

BS required and advanced degrees desirable. Experienced applicants and recent graduates should write to:

Manager of Central Engineering

### FOOD MACHINERY AND CHEMICAL CORPORATION

San Jose, Calif. • 1105 Coleman Ave.

Phone CYpress 4-8124

## Mr. Electronic Engineer

### You May Have

the qualifications which could make you a vital part of our expanding R/D staff.

Your choice with one of the nation's leading electronic manufacturers in any one of these fields.

- Transistor Circuits
- Phasor and RF Network
- High Power Transmitters
- Electro-mechanical
- Fatigue Amplifiers
- SSB

We Have

the advantages of a smaller mid-west city.

- Outstanding school system
- New public and parochial high schools
- On Mississippi River
- Only 125 miles north of St. Louis
- Complete recreational and cultural programs
- Negligible commuting time and expenses

Contact

N. L. Jochem, Director of Engineering  
Box P-4

GATES RADIO COMPANY

Quincy, Illinois

A subsidiary of

Harris-Intertype Corporation

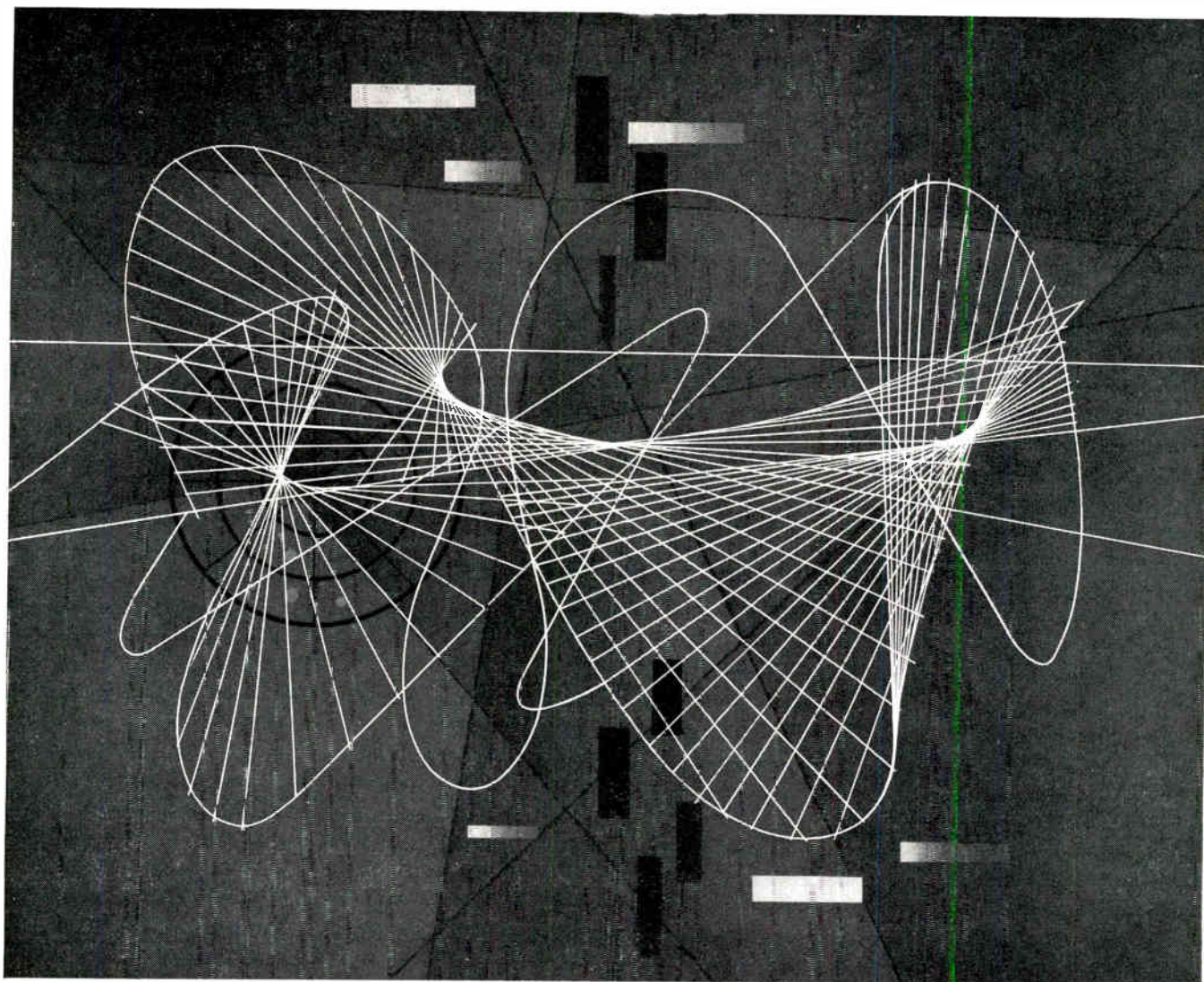

## WHEN A COMPANY OUTGROWS ITS NAME

As the domestic research organization of the world-wide International Telephone and Telegraph Corporation, we are carrying on our tradition of pioneering in electronics. As our engineering responsibilities have increased so our organization has grown. Today, in addition to our main laboratories in New Jersey, laboratories in Ft. Wayne, Chicago and in California are pursuing projects of great magnitude and importance.

You will find in our staff the same fine creative thinking and engineering imagination which brought distinction to our old names. Formerly Federal Telecommunication Laboratories and Farnsworth Electronics research laboratories, our names have been changed to identify us clearly with our parent company, and to reflect our expanded responsibilities and growth.

Electronic engineers will find here opportunity to express initiative and competence in such areas as long range radar systems, digital computer applications to data processing and communications, space technology, microwave tube research and missile systems instrumentation. We are continuing our work in air navigation and control, and in electronic systems . . . and making new contributions to electronic theory and techniques. In fact, it would be hard to find another research organization that offers the engineer such a wide scope of activities.

*Engineers interested in discussing professional positions with our staff are invited to write Mr. T. C. Allen, Manager, Professional Staff Relations.*

## ITT LABORATORIES

*A Division of International Telephone and Telegraph Corporation*  
500 Washington Avenue, Nutley, New Jersey  
Ft. Wayne, Indiana • Chicago, Illinois • Palo Alto, California • San Fernando, California





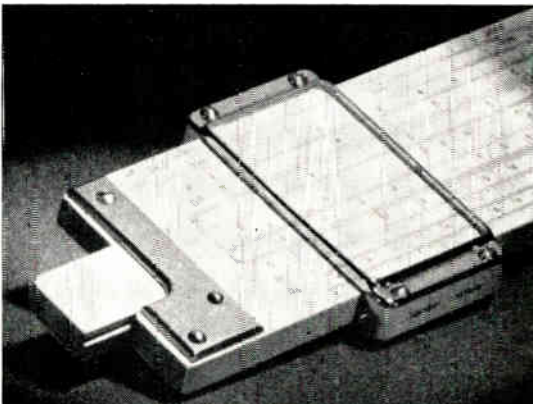
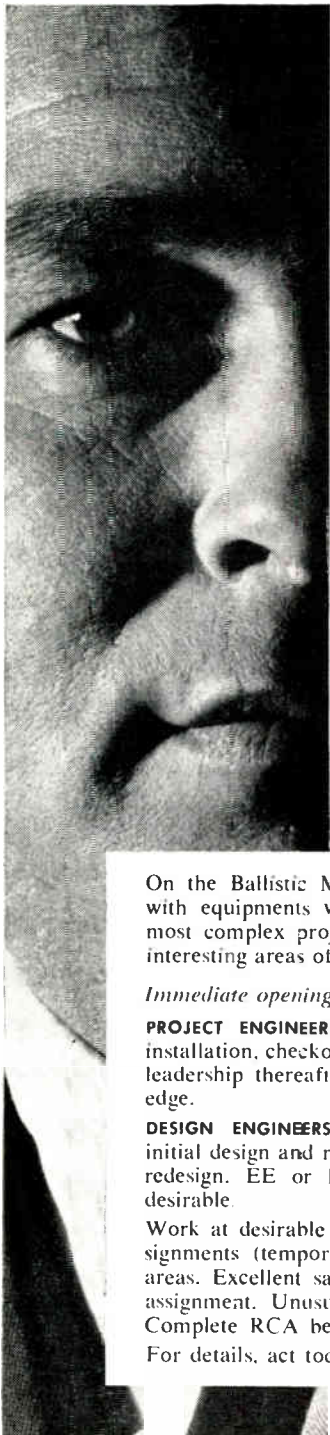

## Scope and adventure in RCA BMEWS engineering positions

On the Ballistic Missile Early Warning System, you work with equipments which are largest in their fields . . . the most complex project in military electronics . . . exploring interesting areas of scientific unknowns.

*Immediate openings include positions for:*

**PROJECT ENGINEERS**—assume systems responsibility during installation, checkout and integration and provide engineering leadership thereafter. EE, plus advanced theoretical knowledge.

**DESIGN ENGINEERS**—association with equipments through initial design and responsibility for checkout, integration and redesign. EE or ME, circuit design and field experience desirable.

Work at desirable New Jersey locations . . . or on field assignments (temporary or permanent) in Alaska and other areas. Excellent salaries, plus added compensation for field assignment. Unusual opportunities for rapid advancement. Complete RCA benefit program for you and your family. For details, act today!

Mr. Robert Vincent  
RCA, Dept. BM-2B  
1809 Bannard St., Riverton, N. J.



Have  Project Engineer  Design Engineer  
experience you need on BMEWS.

NAME \_\_\_\_\_

ADDRESS \_\_\_\_\_

CITY \_\_\_\_\_ ZONE \_\_\_\_\_ STATE \_\_\_\_\_



**RCA SERVICE COMPANY**  
A DIVISION OF RADIO CORPORATION OF AMERICA

## TECHNICAL EXCHANGE

THE LARGEST & OLDEST  
EXCLUSIVELY EMPLOYER  
RETAINED TECHNICAL  
AGENCY IN THE WEST

### ENGINEERS

COUNTER MEASURES  
SPACE PLATFORMS  
AERODYNAMICS  
SOLID STATE  
SYSTEMS  
ANTENNAS  
CELESTIAL MECHANICS  
COMPUTER DESIGN  
CIRCUITRY  
RADIATION  
TELEMETRY  
RESEARCH

**SALARY AREA**  
**\$6,000-\$30,000**

THERE IS ABSOLUTELY  
NO CHARGE TO YOU  
OUR CLIENT COMPANIES  
PAY ALL FEES

### SCIENTISTS

SHOCK TUBES  
BALLISTICS  
INFRA-RED  
COUNTER MEASURE  
OPERATIONS RESEARCH  
INERTIAL NAVIG.  
CIRCUITRY

**SALARY AREA**  
**\$11,000-\$30,000**

### SALES

TRONIC OR  
MECHANICAL  
E.E. B.S.-M.E.  
REQUIRED  
CONTACT OR  
EXPERIENCE  
NECESSARY

**SALARY AREA**  
**\$6,000-\$18,000**

All Inquiries Confidential  
Applications Mailed on Request

## TECHNICAL EXCHANGE

SUITE 302 AGENCY DU. 8-1237  
3850 WILSHIRE BLVD.  
Los Angeles 5



# To Electronic Engineers, Mechanical Engineers and Physicists who are looking for frontier projects in electronics

Permanent openings are available in Collins Radio Company's expanding engineering staffs in Cedar Rapids, Dallas and Burbank. You may join one of the closely knit research teams contributing significant advances in the areas of: Communication Systems - Single Sideband, Transhorizon, Microwave • Space and Missile Electronics • Aircraft Systems - Communication, Navigation, Instrumentation, Control • Antennas • High Speed Data Transmission. Opportunities exist in research and development, systems engineering, reliability engineering, field service and sales. Write for more information, or submit complete resume of education and experience to: G. G. Johnson, Collins Radio Company, 855-C 35th Street N.E., Cedar Rapids, Iowa; J. D. Mitchell, Collins Radio Company, 1930-C Hi-Line Drive, Dallas, Texas or F. W. Salyer, Collins Radio Company, 5700-C West Olive Avenue, Burbank, California.



COLLINS RADIO COMPANY • CEDAR RAPIDS • DALLAS • BURBANK

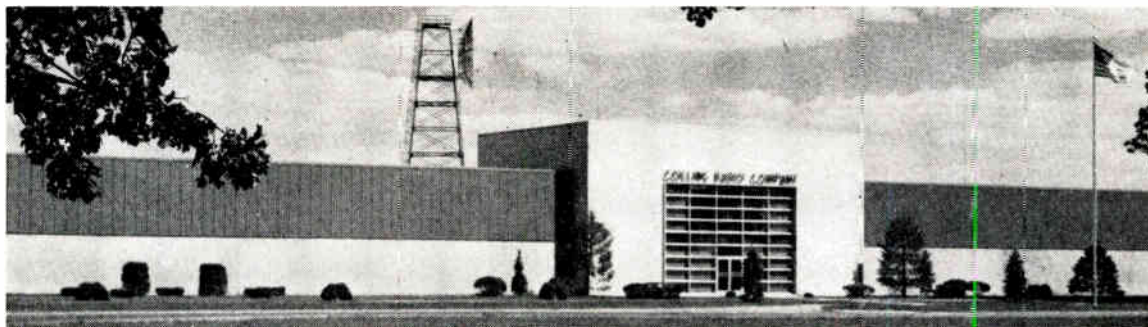

# HOW TO ANALYZE COMPLEX WAVEFORMS



At first blush, the analysis itself may seem rather complicated. But when you have the right kind of equipment, it is really quite simple.

The equipment we have in mind is a Raytheon RAYSPAN Spectrum Analyzer. Complex waveforms are separated into their frequency components by 420 narrow-band magnetostriction filters. Rapid successive sampling provides spectrum analysis rates of up to 100 times per second. A wide range of signals is handled with a 0.7% resolution over the entire band. RAYSPAN can be used with a scope or high-speed helix recorder for a permanent record of frequency versus real time.

Models available analyze any 3.36 Kc or 10.475 Kc band between 20 cps and 50,000 cps. Typical applications include vibration analysis, telemetered-data analysis, acoustical studies, coded-frequencies

analysis, detection of high-speed transients (while occurring), etc.



For consultation, or a detailed description of our models, simply contact:

RAYSPAN, Department 7322  
Raytheon Manufacturing Company  
520 Winter Street  
Waltham 54, Massachusetts

A complete line of magnetostriction filters is also available. Write for specifications and price list.



*Excellence in Electronics*

These manufacturers have invited PROCEEDINGS readers to write for literature and further technical information. Please mention your IRE affiliation.

(Continued from page 164A)

## Trimming Potentiometer

Radically different in design, this wire wound linear trimming potentiometer designed by Eastern Precision Resistor Corp., 675 Barbey St., Brooklyn 7, N. Y., features an internally positioned wiper contact, a completely encapsulated unit, zero per cent and resistance, one piece aluminum housing, positive end stops and 25 per cent greater winding area than comparable units.

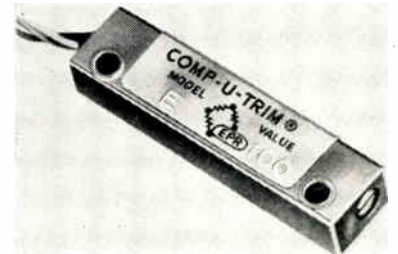

Designed to operate at 1.0 Watt at temperatures up to 125°C, Comp-U-Trim Model "E" can be mounted singularly or stacked. Measuring  $\frac{5}{16} \times \frac{1}{2} \times 1\frac{1}{4}$  inches, Model "E" is available in standard resistance values from 10 ohms to 30,000 ohms with a temperature coefficient of 20 parts per million. A 12-page technical brochure is available upon request.

## Precision Resistors

Close tolerance matched resistor sets and networks are now being manufactured by Ultronic, Inc., 116 South Bayshore Blvd., San Mateo, Calif., maker of precision wirewound resistors.

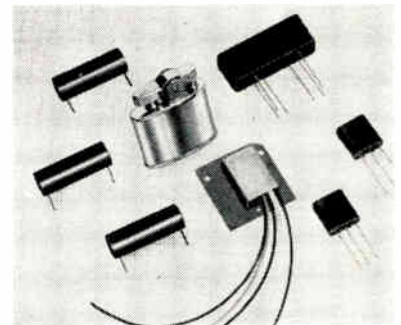

Available in a wide range of values, networks and sets are made with ratios matched as closely as 0.001 per cent and absolute values within 0.01 per cent. An example of current production is a ratio set of thirteen resistors each matched to the master resistor within ten parts per million with absolute resistance values held to within 0.01 per cent.

Because the resistors are encapsulated in an alkylid resin whose coefficient of linear

(Continued on page 172A)

# FREQUENCY STANDARDS

## PRECISION FORK UNIT

TYPE 50

Size 1" dia. x 3 3/4" H.\* Wght., 4 oz.

Frequencies: 240 to 1000 cycles

Accuracies:—

Type 50 ( $\pm .02\%$  at  $-65^{\circ}$  to  $85^{\circ}\text{C}$ )

Type R50 ( $\pm .002\%$  at  $15^{\circ}$  to  $35^{\circ}\text{C}$ )

Double triode and 5 pigtail parts required

Input, Tube heater voltage and B voltage

Output, approx. 5V into 200,000 ohms



\*3 1/2" high  
400 - 1000 cy.

## FREQUENCY STANDARD

TYPE 50L

Size 3 3/4" x 4 1/2" x 5 1/2" High

Weight, 2 lbs.

Frequencies: 50, 60, 75 or 100 cycles

Accuracies:—

Type 50L ( $\pm .02\%$  at  $-65^{\circ}$  to  $85^{\circ}\text{C}$ )

Type R50L ( $\pm .002\%$  at  $15^{\circ}$  to  $35^{\circ}\text{C}$ )

Output, 3V into 200,000 ohms

Input, 150 to 300V, B (6V at .6 amps.)



## PRECISION FORK UNIT

TYPE 2003

Size 1 1/2" dia. x 4 1/2" H.\* Wght. 8 oz.

Frequencies: 200 to 4000 cycles

Accuracies:—

Type 2003 ( $\pm .02\%$  at  $-65^{\circ}$  to  $85^{\circ}\text{C}$ )

Type R2003 ( $\pm .002\%$  at  $15^{\circ}$  to  $35^{\circ}\text{C}$ )

Type W2003 ( $\pm .005\%$  at  $-65^{\circ}$  to  $85^{\circ}\text{C}$ )

Double triode and 5 pigtail parts required

Input and output same as Type 50, above



\*3 1/2" high  
400 to 500 cy.  
optional

## FREQUENCY STANDARD

TYPE 2005

Size, 8" x 8" x 7 1/4" High

Weight, 14 lbs.

Frequencies: 50 to 400 cycles

(Specify)

Accuracy:  $\pm .001\%$  from  $20^{\circ}$  to  $30^{\circ}\text{C}$

Output, 10 Watts at 115 Volts

Input, 115V. (50 to 400 cycles)

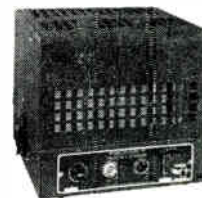

## FREQUENCY STANDARD

TYPE 2007-6

TRANSISTORIZED, Silicon Type

Size 1 1/2" dia. x 3 1/2" H. Wght. 7 ozs.

Frequencies: 400 — 500 or 1000 cycles

Accuracies:

2007-6 ( $\pm .02\%$  at  $-50^{\circ}$  to  $+85^{\circ}\text{C}$ )

R2007-6 ( $\pm .002\%$  at  $+15^{\circ}$  to  $+35^{\circ}\text{C}$ )

W2007-6 ( $\pm .005\%$  at  $-65^{\circ}$  to  $+125^{\circ}\text{C}$ )

Input: 10 to 30 Volts, D. C., at 6 ma.

Output: Multitap, 75 to 100,000 ohms



**NEW**

## FREQUENCY STANDARD

TYPE 2121A

Size

8 3/4" x 19" panel

Weight, 25 lbs.

Output: 115V

60 cycles, 10 Watt

Accuracy:

$\pm .001\%$  from  $20^{\circ}$  to  $30^{\circ}\text{C}$

Input, 115V (50 to 400 cycles)

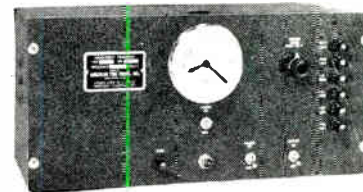

## FREQUENCY STANDARD

TYPE 2001-2

Size 3 3/4" x 4 1/2" x 6" H., Wght. 26 oz.

Frequencies: 200 to 3000 cycles

Accuracy:  $\pm .001\%$  at  $20^{\circ}$  to  $30^{\circ}\text{C}$

Output: 5V. at 250,000 ohms

Input: Heater voltage, 6.3 - 12 - 28

B voltage, 100 to 300 V., at 5 to 10 ma.

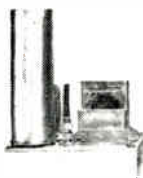

## FREQUENCY STANDARD

TYPE 2111C

Size, with cover

10" x 17" x 9" H.

Panel model

10" x 19" x 8 3/4" H.

Weight, 25 lbs.

Frequencies: 50 to 1000 cycles

Accuracy: ( $\pm .002\%$  at  $15^{\circ}$  to  $35^{\circ}\text{C}$ )

Output: 115V, 75W. Input: 115V, 50 to 75 cycles.

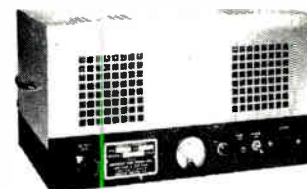

## ACCESSORY UNITS

for TYPE 2001-2

L—For low frequencies  
multi-vibrator type, 40-200 cy.

D—For low frequencies  
counter type, 40-200 cy.

H—For high freqs, up to 20 KC.

M—Power Amplifier, 2W output.

P—Power supply.

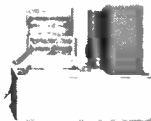

*This organization makes frequency standards within a range of 30 to 30,000 cycles. They are used extensively by aviation, industry, government departments, armed forces—where maximum accuracy and durability are required.*

WHEN REQUESTING INFORMATION  
PLEASE SPECIFY TYPE NUMBER

# American Time Products, Inc.

Watch  Master  
Timing Systems

Telephone: PLaza 7-1430

580 Fifth Ave., New York 36, N.Y.



(Continued from page 170A)

expansion is the same as the resistance wire, temperature coefficients can be closely held. In the matched set of thirteen resistors described above, the temperature coefficient is held to zero  $\pm$  one part per million.

For technical data on matched sets and networks, please write to the firm.

### Remote Controls

Gates Radio Co., subsidiary of Harris Intertype Corp., Quincy, Ill., has introduced a new Remote Control system to the market.

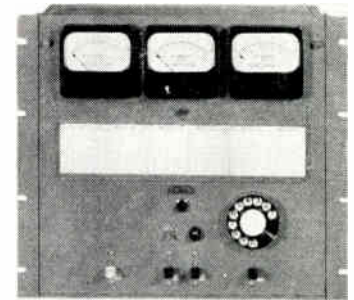

Designed for unattended operation, this system has many advantages: directional and multiple transmitting; 38 switching circuits with in-built facilities for expansion to 78; will operate on loop resistance up to 5000 ohms; large illuminated numbers to indicate circuit dialed; pulse, reset, and switching functions able to be controlled from transmitter for local operation; no simplex, phantom, or ground return with straight wire system; supplies 19 wired meter circuits and 20 additional unwired if needed; no problem with 60 miles of cable; standardization of all equipment.

Panel size of the studio and transmitter units is 19 x 15 3/4 inches. Each of these units has a self-contained power supply and operates independently. Contact Frank Grasett at the firm for details.

### Magnetic Amplifier Book

**Magnetic Amplifier Engineering.** By George M. Attura, Chief Engineer, Industrial Control Co. 304 pages, 6 x 9, 200 illustrations. McGraw-Hill. \$7.50.

Now available is an authoritative guide to the theory, operating principles, and practical application of all types of magnetic amplifiers.

The book describes the interrelation of the electric and magnetic variables through the equations of Faraday and Oersted and contrasts the special characteristics of the magnetic amplifier reactor with the performance of the linear inductor. It also discusses the special core materials, and the manufacture and test of these special reactors.

Against this background the various

(Continued on page 174A)

# best news yet...

for all coil winder users

Carl Hirschmann Co., Inc. now provides complete sales and service for all MICA-FIL Coil Winding Equipment.

Carl Hirschmann Co., Inc. maintains offices from coast to coast for Sales and Service on their line of high precision machine tools for the electronic and missile industry. Factory trained specialists are available for engineering consultation, sales and service on our entire line of high precision machine tools and coil winding equipment.



**CARL HIRSCHMANN COMPANY, INC.**  
30 PARK AVENUE MANHASSET, N. Y.

Branches: 6015 N. Cicero Ave., Chicago 46, Ill.  
• 5124 Pacific Blvd., Los Angeles 58, Calif. • Carl Hirschmann Co. of Canada Ltd., 5122 Dundas St. West, Toronto, Canada.

# hirschmann

Swiss precision with American service

See us at the I.R.E. SHOW, BOOTH 4023.  
See the MICA-FIL Coil Winding Equipment in operation.

## Stability .. 4 PARTS IN 10 MILLION WITH TRANSISTORIZED CRYSTAL CONTROL



Bliley Model  
CCO-7

A complete packaged assembly, the new Bliley CCO-7 oscillator is first in a series of transistorized plug-in units for precision frequency control and reference.

Outstanding stability of  $4 \times 10^7$ , under adverse conditions, is assured by such design features as glass sealed crystal units, printed circuitry and built-in temperature control. The entire unit is hermetically sealed.

For complete details request Bulletin 516.



**BLILEY ELECTRIC CO.**  
UNION STATION BUILDING  
ERIE, PENNSYLVANIA

# Electrical Indicating Instruments by SENSITIVE RESEARCH INSTRUMENT CORPORATION

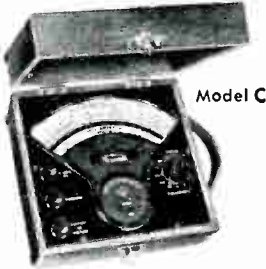

Model C

## POLYRANGERS

Multirange DC Reference Standard .25% accurate current and voltage measuring instrument. 14 ranges from 1.5 ma. and 3 V. to 3 amps. and 750 V. 6.3" scale length. Other Polyranges with as many as 88 ranges self-contained available for AC or AC-DC use.

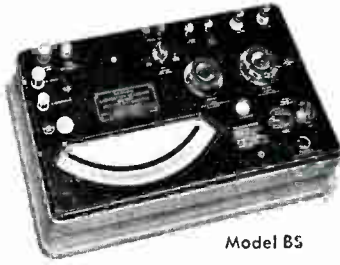

Model BS

## LABORATORY STANDARDS

"Self Checking" DC Volt-Amp-Milliammeter. .05% accurate. 12" vernier scale. 25 full scale ranges from 1.5 ma. and 3 V. to 15 amps. and 1500 V. Internal standard cell. Other DC laboratory standards available with an accuracy of .1% and full scale ranges starting from 30 microamps or 50 mv.



Model THACH

"Self Checking" Volt-Amp-Milliammeter. Accuracy .2% DC and AC 7 cps - 4 kcps. 6.3" scale length. 19 full scale ranges from 10 ma. and 1 volt to 5 amps. and 1000 V. Internal standard cell. Other AC standards available with an accuracy of .1% with full scale ranges from 10 ma. and 10V.



Model INCRE

## INCREMENTER

Direct reading DC electrical indicating instrument. Effective scale length of 63". Accuracy .05%. Each 10% of the instrument's range is expanded over its actual 6.3" full scale length. Single or multirange from 200 mv. to 1000 v. and 200 microamps. to 10 amps., in either portable or panel mounted models.



Model FM

## FLUXMETERS

Single or multirange. Basic sensitivity 10,000 maxwells per division using a single turn search coil. Accuracy .5%. 5.2" scale length. Available with general purpose 10 turn search coil with a mean area of 8 square centimeters.



Model CRV

## CREST VOLTMETERS

Measures RMS, positive and negative peaks of 10 per second or faster. Basic instrument is electrostatic voltmeter with accuracy of 1%. Ranges up to 100 KV, full scale. Input impedance 10,000 megohms. For AC or repetitive pulsed DC.



Model SCAMA

## SCALE MACHINE

For the accurate drawing or re-drawing of any laboratory standard electrical indicating instrument's scale whose arc is no greater than 110 degrees. Adapter to 270 degrees available for circular-scale instruments.



Model RFV

## VOLTMETERS

True RMS responding. Full scale ranges from 1 V. to 300 V. Accuracy .5% on DC to 1 megacycle. Usable up to 10 megacycles. Other thermocouple instruments available for all current and voltage measurements.

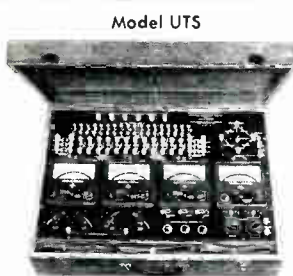

Model UTS

## TEST SETS

Replaces over 200 individual DC current, voltage and resistance measuring instruments. Accuracy .5%. Contains 3 instruments that may either be a millivoltmeter, voltmeter, milliammeter, or ammeter, and 1 microammeter. Portable. Other test sets available for AC and magnetic testing.

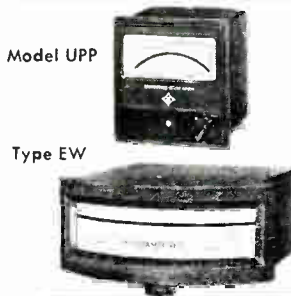

Model UPP

Type EW

## PANEL INSTRUMENTS

AC and/or DC edgewise panel instruments with the same electrical specifications as Reference Standard portable models. Accuracies to .25%. Scale lengths to 7". Up to eight ranges switch controlled and self-contained. Full scale ranges start from 1 microamp or 1 mv. DC and 1 ma. or 200 mv. AC.

**TRADITIONAL DEPENDABILITY**

Laboratory Standard and Reference Standard Portable and Panel Instruments that have earned Sensitive Research the reputation of "Those Standards People." All instruments have individually calibrated, hand-drawn mirrored scales. Available with the now world famous SRC "Diamond Pivot" and "Shock Mounted Jewel." Not pictured above, but available, are a complete line of: Wattmeters • Thermocouple Instruments • Electrostatic Voltmeters • Differential Galvanometers • Ratiometers • Corrosion Instruments. Write for Catalog No. 70.

**SENSITIVE  
INSTRUMENT**



**RESEARCH  
CORPORATION**

NEW ROCHELLE, N. Y.

Symbol of Quality  
World Radio History

ELECTRICAL INSTRUMENTS OF PRECISION SINCE 1927



**FOR PRECISION LABORATORY  
OR PRODUCTION TESTING**

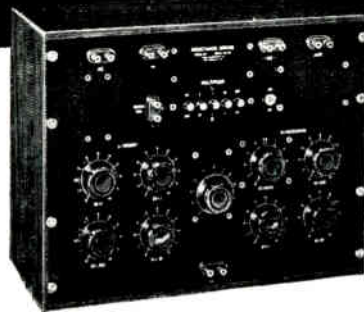

## FREED 1110-AB INCREMENTAL INDUCTANCE BRIDGE

**AND ACCESSORIES**

Accurate inductance measurement with or without superimposed D.C., for all types of iron core components.

- **INDUCTANCE** — 1 Millihenry to 1000 Henry
- **FREQUENCY** — 20 to 10,000 Cycles
- **ACCURACY** — 1% to 1000 Cycle, 2% to 10KC
- **CONDUCTANCE** — 1 Micromho to 1 MHO
- **"Q"** — 0.5 to 100
- **SUPERIMPOSED D.C.** — Up to 1 Ampere
- **DIRECT READING** — For use by unskilled operators.

**ACCESSORIES AVAILABLE:**

- 1140-A Null Detector
- 1210-A Null Detector - V.T.V.M.
- 1170 D.C. Supply and 1180 A.C. Supply.

## FREED VARIABLE TEST VOLTAGE MEGOHMMETER NO. 1620

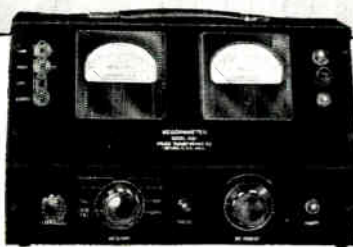

The Freed Type 1620 Megohmmeter is a versatile insulation resistance measurement instrument with a continuously variable DC test potential from 50 to 1000 volts.

Components such as transformers, motors, printed circuits, cables and insulation material can be tested at their rated voltage and above, for safety factor.

- **Resistance** — 0.1 megohms to 4,000,000 megohms.
- **Voltage** — variable, 50 - 1000 volts.
- **Accurate** — plus or minus 5% on all ranges.
- **Simple** — for use by unskilled operators.
- **Safe** — high voltage relay controlled.
- **Self contained** — AC operated.

**OTHER MEGOHMMETERS AVAILABLE**

- Type 1620C MEGOHMMETER** — a type 1620 with additional circuitry for testing capacitors.
- Type 1020B MEGOHMMETER** — a 500 volt fixed test potential. Range 1 megohm to 2 million megohms.
- Type 2030 PORTABLE MEGOHMMETER** — battery operated 500 volt test potential. Range 1 megohm to 10 million megohms.

Send for **NEW 48 page transformer catalog.** Also ask for complete laboratory test instrument catalog.

**FREED TRANSFORMER CO., INC.**  
1720 WEIRFIELD ST., BROOKLYN (RIDGWOOD) 27, N.Y.



## NEWS New Products



(Continued from page 172A)

types of amplifiers are analyzed—the saturable reactor, the reactor-rectifier amplifier, and the reversible, single-core amplifier—and several chapters are devoted to typical circuits and applications.

A consistent analytical method applicable to all types of magnetic amplifiers is presented. Specific types are treated from the same general basis, so that each is discussed without the need for prior reference to an earlier circuit.

Special topics not covered before in a work of this kind include: Hybrid circuits, bi-directional output amplifier, volt-second analysis of saturable reactors, winding and test specifications for toroidal reactors, experimental testing of reactors, and detailed mathematical analysis of the load action of the reactor-rectifier amplifier.

Further details are available through McGraw-Hill's Book Information Service, 327 West 41st St., New York 36, N. Y.

### 100 Channel Recorder

A 100 channel Operation Monitor for military (MIL-E4158B) and rigorous industrial applications is being manufactured by **Brush Instruments, division of Clevite Corp.**, 37th and Perkins, Cleveland 14, Ohio.

(Continued on page 176A)

### RADIO RESEARCH INSTRUMENT CO.

550  
FIFTH AVE.  
NEW YORK  
JUDSON  
6-4691

#### AN/APS-10 RF HEAD

3em. 10kw output, hydrogen thyatron mod. .8 microsec. revr 30 mc HF 5.5 mc bandwidth. Uses 30 tubes (katsals plus 2442 magnetron, \$275 ea. Full desc. MIT. Rad. lab. series Vol. 1 pg 616-625.

#### AN/APS-31A RF HEAD

4452 Magnetron, 100kw x band—complete RF Plumbing, beacon reference cavity 6AK5 1F Strip, sweeper. New with all tubes, \$285.  
**RT39/APG-5 10CM RADAR.** 500 watts. Complete S band RF package. Lighthouse 2C40 xmtr, 2C43 revr. TR, 829B pulser, miniature 6AK5 1F strip. Press. 12" dia., 24" lg. All brand new tubes \$275

#### X BAND KLYSTRON MOUNT

PRD type for 2K25 with variable attenuator. Completely shielded. 1"x1/2" output. Brand new \$45.00

**SCR 584—SKYSWEEP ANTENNA PEDESTAL** Full azimuth and elevation sweeps, 360 degree azimuth, 205 degree elevation. Accuracy ± one mill or better in angle, 6 ft. dish, fully desc MIT. Radiation Lab series Vol. 1 pg 284 and 209, Vol. 26, pg. 233. For full tracking response. Includes pedestal drives systems, etc. Excellent used condition. First time these pedestals have been available for purchase. Control consoles also in stock.

#### F-28/APN-19 FILTER CAVITY

Jan. spec. Tuneable 2700-2900mc, 1.5db max. loss at ctr. freq. over band. New, \$37.50 each. Sperry Klystron SMC-32. 9-10.5 KMC. 2 watts, \$425.  
Sperry Klystron SMC-11A. 4640-4670 mc. 1 watt, \$4.95.

#### FOR SALE: IN STOCK—COMPLETE RADAR SYSTEMS

**SCR-584** 30 ft. trailer Skysweep antenna system. PPI indicator, RIII 10 cm. High power for airway control missile-satellite tracking, radio astronomy R & D. As new Complete.

**SCR 784** Complete 10 cm. Sky Sweep System.

**AN/APS-10** Complete airborne Radar Mig. by G.E. 3em. using 2442 Magnetron for Navigation, Mapping, Weather, Collision Avoidance. Like New

**AM/MPN-1A** (GCA) Ground Control Approach Radar, 30 ft trailer with 3em precision and 10cm Search Radars as used by CAA. Full desc. Vol. 11 MIT Rad Lab Series Sec. 8.1E.

**WEATHER RADAR** 275 kw. 10 cm. Compact wt. 488 lbs. rotating yoke PPI 4, 20, 80 mile ranges, ideal for weather forecasting. Lab. Brand new. FCC approved \$950.



## "A" BATTERY ELIMINATORS



For  
**Demonstrating and  
Testing Auto Radios**

**TRANSISTOR OR VIBRATOR OPERATED**  
6 Volt or 12 Volt!  
New Models . . . Designed for testing D.C.  
Electrical Apparatus on Regular A.C. Lines.  
Equipped with Full-Wave Dry Disc Type —  
Rectifier, Assuring Noiseless, Interference-  
Free Operation and Extreme Long  
Life and Reliability.

TYPE	INPUT A.C. Volts 60 Cycles	D.C. OUTPUT		SHIP. WT.	USER PRICE
		VOLTS	AMPERES Cont. Int.		
610C-ELIF	110	6	10 20	22	\$42.95
		12	6 12		
620C-ELIT	110	6	20 40	33	59.95
		12	10 20		

**SEE YOUR JOBBER OR WRITE FACTORY**

- ✓NEW MODELS ✓NEW DESIGNS ✓NEW LITERATURE
- "A" Battery Eliminators • DC-AC Inverters • Auto Radio Vibrators



**AMERICAN TELEVISION & RADIO CO.**  
Quality Products Since 1931  
SAINT PAUL 1, MINNESOTA, U. S. A.





## Electronic Wire for Every Application

Service Rated—Quality Controlled  
Every Electronic Wire you need  
in easy-to-use packages.

- |                              |                          |
|------------------------------|--------------------------|
| Aircraft and Auto Radio Wire | Magnet Wire              |
| Antenna Rotor Cables         | Microphone Cables        |
| Broadcast Audio Cables       | Mil-Spec Hook-Up Wires   |
| Bus Bar Wire                 | RG/U Cables              |
| Community TV Cables          | Shielded Power Cables    |
| Cords                        | Shielding                |
| Hi-Fi and Phono Cables       | Sound and PA Cables      |
| Hook-Up Wires                | Strain Gauge Cables      |
| Intercom Cables              | Transmission Line Cables |
| TV Camera Cables             |                          |

**Ask Your Belden Jobber**

One Wire Source for Everything  
Electrical and Electronic



**Belden**  
WIREMAKER FOR INDUSTRY  
SINCE 1902  
CHICAGO

Magnet Wire • Lead Wire • Power Supply Cards,  
Cord Sets and Portable Cord • Aircraft Wires  
Electrical Household Cords • Electronic Wires  
Welding Cable • Automotive Wire and Cable

08A03J8

# PROFESSIONAL CONSULTING SERVICES

## Advertising rates

### Professional Consulting Service Cards.

1 insertion \$ 15.00  
12 insertions \$120.00  
50% discount to IRE members on 3 or more consecutive insertions.

In IRE DIRECTORY \$15.00 flat rate.  
1 inch only, no cuts or display type.

Advertising restricted to professional engineering and consulting services by individuals only. No product may be offered for sale, and firm names may not be mentioned in cards.

## PRINTED CIRCUITS

Arthur C. Ansley and staff

CONSULTATION—DESIGN—PROTOTYPES  
Circuit "Packaging"

Modularization—Miniaturization

New Hope, Pa. AXtel 7-2711

## Transistor Circuits ALBERT J. BARACKET MS IN EE & Staff

Development, and design of transistorized and standard regulated power supplies; broadcast and closed circuit TV camera and synchronizing circuitry both military and commercial.  
36 Commerce Road Cedar Grove, N.J.  
CEnter 9-6100

## RICHARD L. BICKEL & associates

Semiconductor Automatic Testing Specialists  
Production Test Equipment  
System Automation and Control  
Analog and Digital Circuitry  
Data Handling—Transistor Applications  
P.O. Box 451—Garland, Texas—BR 6-6859

## TECHNICAL MARKETING RESEARCH

A. D. EHRENFRIED and associates

Specialists in the planning, distribution, and promotion of electronic components, instruments, and systems.

CONCORD, Massachusetts EMerson 9-5500

## APPLIED MATHEMATICS CONSULTATION—RESEARCH

Joel L. Ekstrom, M.Sc., and Staff

Specialize in Filter Synthesis, Modulation and Demodulation Theory, and Allied Problems.  
Literature Research in Major Languages.  
Preparation of Bibliographies.

2006 Swansea Rd., Baltimore 14, Md. ID 5-2267

## CLYDE E. HALLMARK and associates

30 years experience specializing in Instrumentation—Automatic Control—Television—General Electronics—Semiconductor & Magnetics Application—Systems Research—Project Evaluation.

ENGINEERING SERVICE—CONTRACT R&D  
New Haven Indiana

## LEONARD R. KAHN

Consultant in Communications and Electronics

Single-Sideband and Frequency-Shift Systems  
Diversity Reception - Modulation Theory  
Television Systems

22 Pine St., Freeport, L.I., N.Y.  
Freeport 9-8800

## LEN MAYBERRY

ELECTRONICS CONSULTING ENGINEER  
Laboratories and Staff

• Test Equipment Design • Proposal Writing  
• Product Design • Engineering Assistance  
111 South Oak Street ORegon 8-4847  
Inglewood, California

## TRANSISTOR ENGINEERING

S. Moskowitz D. D. Grieg

Product Transistorization. Complete service in consulting, research, development, and production on transistor circuitry, products and instrumentation.

67 Factory Place, Cedar Grove, N.J.  
CEnter 9-3000



## NEWS New Products



These manufacturers have invited PROCEEDINGS readers to write for literature and further technical information. Please mention your IRE affiliation.

(Continued from page 174A)

The instrument will record, simultaneously, up to 100 separate and distinct operations and events on a moving chart 12 inches wide. It provides a permanent record of operations and events, indicating their duration and time relationship to each other.

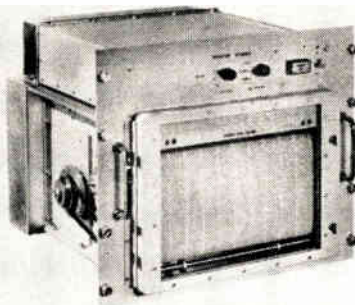

The monitor has been designed to meet the requirements of such military applications as the checkout of missiles, rockets, and other instrumentation involving complex circuitry. Industrial and commercial applications include the monitoring of control processing equipment, checking automated production lines, traffic monitoring, and the testing of telephone switching equipment.

Among Operations Monitor features are electric writing—which provides unattended operation, a response of up to 500 signal changes per second, instantaneous selection of eight chart speeds by local or remote control, preprinted chart paper and a paper roll capacity of 500 feet.

Dimensions of the monitor are 19 × 15½ (panel) × 17½ inches (deep). It may be mounted in a standard 19 inch rack and weighs 100 pounds net. Shipping weight is 175 pounds.

Power requirements are 105-125 volts, 60 cps, 250 watts.

Additional information may be obtained from the firm.

## Telecommunications Consulting Engineers "Worldwide Experience"

V. J. Nexon S. K. Wolf M. Westheimer  
WIRE, CARRIER, RADIO, MICROWAVE,  
TROPO SCATTER  
Feasibility Studies, Terrain Surveys, System Design, Job Supervision, Government Proposals, Market Research, Product Planning.  
1475 Broadway, New York 36, N.Y., BRyant 9-8517

## E. M. OSTLUND & associates

Electronic Engineers

Radio—Microwave—Carrier—  
Communication—Control—  
Systems and Equipment

Consulting—Research—Development  
ANDOVER, NEW JERSEY

Tel: Parkway 9-6635 P.E.N.J.

## NATHAN GRIER PARKE and staff

Consulting Applied Mathematicians  
Research • Analysis • Computation  
Bedford Road • Carlisle, Massachusetts  
Telephone EMerson 9-3818

## PAUL ROSENBERG & associates

Established 1945  
Consultation, Research & Development  
in Applied Physics

100 Stevens Ave., Mt. Vernon, New York  
MOunt vernon 7-8040 Cable: PHYSICIST

## WILLIAM R. SPITAL & staff

Specialize in Design and Development of  
Transformers, Chokes, etc.

for the  
Electronic, Industrial and Allied Fields.  
90 Magnolia Street  
Westbury, L.I., N.Y. EDgewood 3-2933

## DON C. WALLACE

Screen Room Engineering  
Line Filter Engineering  
Transmitting and Traveling Wave  
Tube Engineering  
Nuclear Application Engineering  
Bendix Building  
1206 Maple Ave., Los Angeles 15, Calif.  
Richmond 7-0401

## HAROLD A. WHEELER

Laboratories and Engineering Staff

Consultation — Research — Development  
Microwaves — UHF — VHF — VLF  
Antennas and Components

HUNter 2-7876 Great Neck, N. Y.  
Antenna Laboratory: Smithtown, N. Y.

## LEWIS WINNER

Market Research-Consultant

Communications—Broadcasting—Electronics  
Technical Conferences Staging . . . Lectures  
. . . Audio-Visual Aids and Demonstrations  
152 West 42d Street, BRyant 9-3125/3126  
N.Y. 36, N.Y.

## DELAY LINE ENGINEERING

Y. P. Yu, MSEE, PhD,  
and staff

Specialize in design and development of networks for continuously variable time delay, step variable time delay and fixed delay.  
249 Terhune Avenue, Passaic, N.J.  
GRegory 2-5622



## Advertising Index



IRE News and Radio Notes	14A
IRE People	30A
Industrial Engineering Notes	36A
Meetings with Exhibits	8A
Membership	98A
News—New Products	26A
Positions Open	122A
Positions Wanted by Armed Forces Veterans	116A
Professional Group Meetings	80A
Section Meetings	56A
Shows and Conferences— Western Joint Computer Conference	70A
Table of Contents	1A-2A

## DISPLAY ADVERTISERS

A C Spark Plug Div., General Motors Corp.	179A
ACF Industries, Inc., Erco Div.	162A
Abbott's Employment Specialists	160A
Accredited Personnel Service	125A
Aeronutronic Div. of Ford Motor Co.	152A, 163A
Ainslie Corporation	94A
Air-Marine Motors, Inc.	114A
Airborne Instruments Lab., Inc.	4A
Aircraft Radio Corporation	118A
Allen-Bradley Company	33A-34A
American Television & Radio Co.	174A
American Time Products, Inc.	171A
Amperex Electronic Corp.	79A
Amphenol Connector Div., Amphenol-Borg Electronics Corp.	32A
Ansley, Arthur C.	176A
Armour Research Foundation, Illinois Institute of Technology	124A, 148A
Arnold Engineering Co.	105A
Autonetics Div., North American Aviation, Inc.	141A
Ballantine Laboratories, Inc.	98A
Baracket, Albert J.	176A
Battelle Memorial Institute	128A
Beede Electrical Instrument Co., Inc.	110A
Belden Manufacturing Co.	175A
Bell Telephone Laboratories	6A
Belleville-Hexam Corporation	114A
Bendix Aviation Corp., Bendix-Pacific Div.	146A
Bendix Aviation Corp., Bendix Products Div.	116A
Bendix Aviation Corp., Research Labs. Div.	131A
Bendix Aviation Corp., York Div.	156A
Bickel, Richard L.	176A
Binswanger Associates, Charles A.	146A
Bliley Electric Company	172A
Boesch Mfg. Co., Inc.	106A
Bomac Laboratories, Inc.	17A
Buckbee Mears Company	58A
Burlingame Associates	78A
Burdny Corporation	80A
Burrroughs Corporation	159A
Bussmann Mfg. Div., McGraw Edison Co.	12A
CBS—Hytron Div.	55A, 150A
Cannon Electric Company	71A
Capitol Radio Engineering Institute	106A
Carad Corporation	70A
Carborundum Company	10A
Carrier Corporation	156A

# REDUCE BREAKDOWN FAILURES

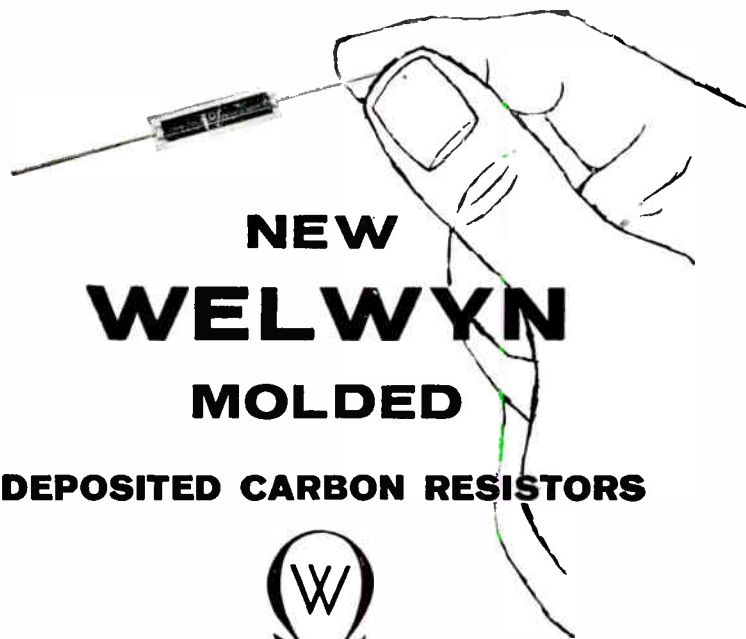

## NEW WELWYN MOLDED DEPOSITED CARBON RESISTORS



The use of a thermo-plastic insulation material has resulted in an economically priced molded carbon resistor of markedly improved endurance and long term stability.

Type N resistors subjected to several one-hour cycles of immersion in boiling water — while DC polarized — have revealed only negligible changes in resistance. Continuous operations at 150°C caused no damage to the component.

The new Type N resistor, a deposited carbon film fired onto a porcelain rod, is first tropicalized with multiple coatings of panclimatic lacquers to give it long term moisture resistance, and is then molded in a thermo-plastic material.

This molded insulation has an effective resistance in the order of  $10^{13}$  ohms. Its inherent thermal conductivity is approximately ten times that of air, resulting in substantially improved load life under conditions involving excessive or high wattage dissipation. Similarly, Type N resistors may be soldered as close to the insulation as desired without fear of melting or deforming the cover.

One added advantage of the Type N is that the original markings on the resistor body remain visible and legible through the transparent molded material.

Welwyn Type N carbon resistors meet the requirements specified by MIL-R-10509B, and are available in all values, ranging from 10 ohms through 1 megohm. For complete data and specifications write to Welwyn International, Inc., 3355 Edgecliff Terrace, Cleveland 11, Ohio.

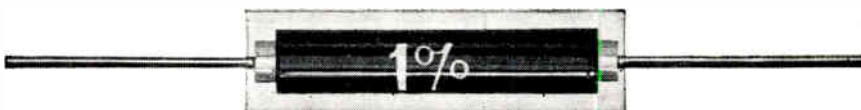

**SAMPLES AVAILABLE ON REQUEST.**



# INCREMAG

*precision counter with a memory*



## INCREMAG

...for systems

## INCREMAG

...as components

- COUNTING RATE: 100,000 pps Max.
- COUNTS PER STAGE: 16 Max.
- RELIABILITY RANGE:  $\pm 15\%$  Voltage;  $\pm 50$  C.
- APPLICATIONS: Counting, Dividing, Storing, Timing, Control, and Programming.

*For further information on components or systems, write to us*

*"Keeping Time*



*With Progress"*

## GENERAL TIME CORPORATION

109 Lafayette St., New York 13, N. Y.

### OPERATING DIVISIONS AND SUBSIDIARIES:

Westclox Division, LaSalle, Ill.	Athens Division, Athens, Georgia
Haydon Division, Torrington, Conn.	Stromberg Time Corp., Thomaston, Conn.
Seth Thomas Division, Thomaston, Conn.	Western Clock Co. Ltd., Peterborough, Ont.
Relogios Brazil, São Paulo, Brazil	Westclox Ltd., Strathleven, Scotland

### RESEARCH LABORATORIES

General Time Laboratory, Chicago, Ill. Central Research Laboratory, N. Y., N. Y.

**Timing Mechanically, Electrically and Electronically**



Chicago Standard Transformer Corp. ....	106A
Christie Electric Corp. ....	36A
Cohn Corporation, Sigmund ....	50A
Collins Radio Company ....	169A
Computer-Measurements Corp. ....	80A
Cornell Aeronautical Lab., Inc. ....	138A
Cornell-Dubilier Electric Corp. ....	Cover 3
Corning Glass Works ....	95A
Curtiss-Wright Corporation ....	137A

Dale Products, Inc. ....	56A-57A
Daystrom Instrument Div., Daystrom, Inc. ....	136A
Del Electronics Corp. ....	114A
Delco Radio Div., General Motors Corp. ....	60A
DeMornay-Bonardi ....	88A

EICO ....	54A
ESC Corporation ....	63A
Eastern Industries, Inc. ....	91A
Ehrenfried, A. D. ....	176A
Eitel-McCullough, Inc. ....	53A
Ekstrom, Joel L. ....	176A
Electric Boat Div., General Dynamics Corp. ....	160A
Electro-Voice, Inc. ....	156A
Electronic Research Associates, Inc. ....	8A
Elgin National Watch Company ....	25A
Empire Devices Products Corp. ....	113A

Food Machinery & Chemical Corp. ....	166A
Freed Transformer Co., Inc. ....	174A

Gates Radio Company ....	166A
General Aniline & Film Corp., Antara Chemicals Div. ....	69A
General Ceramics Corp. ....	83A
General Electric Co., Defense Systems Dept. ....	154A
General Electric Co., Power Tube Dept. ....	142A
General Electric Co., Semiconductor Products Dept. ....	102A-103A
General Magnetics, Inc. ....	31A
General Mills, Inc., Mechanical Div. ....	96A, 143A
General Radio Company ....	Cover 4
General Time Corporation ....	178A
General Transistor Corp. ....	89A
Giffillan Brothers, Inc. ....	152A
Goodyear Aircraft Corp. ....	118A
Guilford Personnel Service ....	132A

Hallicrafters Company ....	46A
Hallmark, Clyde E. ....	176A
Heath Company ....	108A
Hewlett-Packard Company ....	22A-23A
Hirschmann Company, Inc., Carl ....	172A
Hoffman Electronics Corp., Semiconductor Div. ....	132A
Huggins Laboratories ....	82A
Hughes Aircraft Company ....	120A-121A
Hughes Products, Electron Tube Div. ....	73A
Hughes-Treitler Mfg. Corp. ....	80A
Hycon Eastern, Inc. ....	112A
Hydro-Aire, Inc. ....	61A

I-T-E Circuit Breaker Company ....	111A
Institute of Radio Engineers ....	76A, 115A
Instruments for Industry, Inc. ....	160A
International Business Machines Corp. ....	119A
International Telephone & Telegraph Corp. ....	167A

J F D Electronics Corp. ....	107A
Johns Hopkins Univ., Applied Physics Lab. ....	40A
Johns Hopkins Univ., Operations Research Office ....	153A
Jones Div., Howard 8., Cinch Mfg. Corp. ....	90A



**Advertising  
Index**



Kahn, Leonard R. ....176A  
 Kay Electric Company .....9A  
 Kearfott Company, Inc. ....72A, 164A  
 Kennedy & Company, D. S. ....109A  
 Kepco Laboratories, Inc. ....62A  
 Knights Company, James .....80A  
 Kollsman Instrument Corp. ....140A

Lambda Electronics Corp. ....101A  
 Lapp Insulator Co., Inc. ....66A  
 Link Aviation, Inc. ....127A  
 Litton Industries, Inc., Electron Tube Div. ....7A  
 Litton Industries, Inc., Maryland Div. ....158A  
 Lockheed Aircraft Corporation ....144A-145A

Magnavox Company .....99A  
 Magnetics, Inc. ....64A  
 Mallory & Co., Inc., P. R. ....29A  
 Marconi's Wireless Telegraph Co., Ltd. ....62A  
 Marquardt Aircraft Company ....164A  
 Martin Company, Baltimore Div. ....94A  
 Martin Company, Denver Div. ....133A  
 Massachusetts Institute of Technology, Instrumentation Lab. ....137A  
 Massachusetts Institute of Technology, Lincoln Lab. ....128A  
 Mayberry, Len .....176A  
 Measurements, A McGraw Edison Div. ....180A  
 Melpar, Inc. ....129A  
 Menlo Park Engineering .....90A  
 Microdot, Inc. ....179A  
 Microtran Company, Inc. ....42A  
 Microwave Associates, Inc. ....37A  
 Midwest Research Institute ....142A  
 Millen Mfg. Co., Inc., James .....48A  
 Moskowitz, S., D. D. Grieg .....176A  
 Motorola, Inc., Semiconductor Products Div. ....97A  
 Motorola, Inc., Western Military Electronics Center .....157A  
 Mucon Corporation .....85A

Narda Microwave Corp. ....49A  
 National Aeronautics and Space Administration .....52A  
 National Cash Register Co. ....143A  
 National Tel-Tronics Corp. ....74A  
 New Hermes Engraving Machine Corp. ....110A  
 Nexon, V. J., S. K. Wolf, M. Westheimer .....176A  
 Norden Labs., Norden Div., United Aircraft Corp. ....166A  
 North American Aviation, Inc. ....124A, 141A, 157A  
 North American Electronics, Inc. ....106A  
 Northern Radio Co., Inc .....38A

Ohio Semiconductors, Inc. ....104A  
 Ohmite Manufacturing Co. ....51A, 59A  
 Ordnance Research Lab., Pennsylvania State Univ. ....146A  
 Ostlund, Evert M. ....176A

Pacific Semiconductors, Inc. ....124A  
 Pan American World Airways, Inc. ....148A  
 Panoramic Radio Products, Inc. ....104A  
 Parke, Nathan Grier .....176A  
 Perkin Engineering Corp. ....11A  
 Permanent Employment Agency .....150A  
 Phelps Dodge Copper Products Corp. ....19A  
 Philco Corp., Lansdale Tube Co. Div. ....35A  
 Philco Corp., Western Development Labs. ....129A, 147A  
 Polarad Electronics Corp. ....67A-68A  
 Polytechnic Research & Dev. Co., Inc. ....45A  
 Potter Instrument Co., Inc. ....38A



**microdot**  
*micro-miniature coaxial cables*

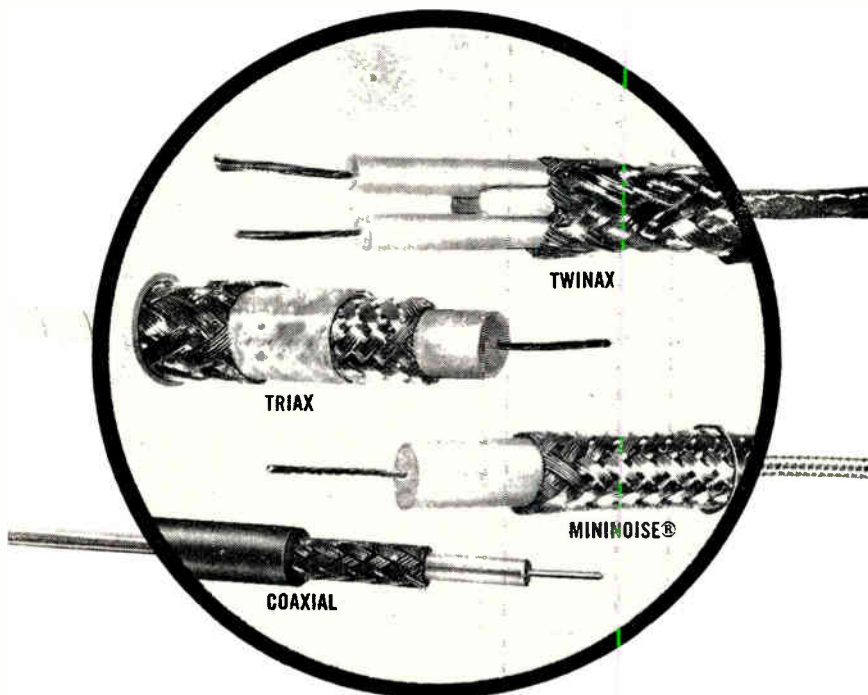

Microdot now offers you the most complete line of micro-miniature cables for design application and solution. More than 50 cables to choose from. Immediate delivery from our two plant locations.

COAXIAL CABLES IMPEDANCE	TRIAxIAL IMPEDANCE	TWINAX IMPEDANCE
50 ohm	50 ohm	120 ohm
70 ohm	93 ohm	160 ohm
75 ohm	_____	_____
93 ohm	_____	_____
95 ohm	_____	_____

OPERATING TEMPERATURES 165°F TO 450°F

Certain cables constructed to MIL. STD. 17-B. "Mininoise"® 50 ohm low noise coaxial cable treated to nearly eliminate self-generated cable noise.

**microdot, inc.**

220 PASADENA AVENUE, SO. PASADENA, CALIFORNIA

MICRODOT MICRO-MINIATURE  
 CONNECTORS FIT ALL MICRODOT CABLES

*send for free cable brochure*

**2 CABLE LOCATIONS TO SERVE YOU**

MICRODOT, INC. 220 Pasadena Ave. So. Pasadena, California  
 MICRODOT, INC. Microdot Cable Division Elm City, North Carolina

*Announcing  
another outstanding  
development  
in Electronics  
Instrumentation from  
the Measurements  
Laboratories.*

**NEW  
MEASUREMENTS  
Standard Signal  
Generator  
for mobile communications . . .**

The Model 560-FM  
Standard Signal  
Generator  
is specifically  
designed to meet  
the exacting  
requirements  
of the Mobile  
Communications  
industry.

Model 560-FM  
Price - \$640.00



- Frequency ranges 25-54, 140-175, 400-470, 890-960 Mc.
- Fine tuning control shifts carrier  $\pm 8$  Kc.
- Peak deviation to  $\pm 16$  Kc. read directly on meter.
- Residual FM less than 100 cycles at 460 Mc.
- Output 0.1 to 100,000 microvolts accurate  $\pm 10\%$  across 50 ohm termination.
- Excellent stability.
- Modulation by 1000 cycle internal or by external source.

*Laboratory Standards*



WRITE FOR BULLETIN

**MEASUREMENTS**  
A McGraw-Edison Division  
**BOONTON, NEW JERSEY**



Radiation, Inc. ....	140A
Radio Corp. of America, Defense Electronic Products .....	39A
Radio Corp. of America, Electron Tube Div. ....	65A, 100A
Radio Corp. of America, Missile & Surface Radar Dept. ....	122A
Radio Corp. of America, RCA Service Co., Govt. Service Dept. ....	168A
Radio Corp. of America, Semiconductor & Materials Div. ....	24A
Radio Research Instrument Co. ....	174A
Raytheon Mfg. Co., Industrial Dept., Commercial Equipment Div. ....	170A
Raytheon Mfg. Co., Microwave & Power Tube Div. ....	27A
Raytheon Mfg. Co., Semiconductor Div. ....	13A, 165A
Reeves-Hoffman Div., Dynamics Corp. of America .....	58A
Republic Aviation Corp. ....	130A
Rider, Publisher, Inc., John F. ....	30A
Rixon Electronics, Inc. ....	112A
Rosenberg, Paul .....	176A
Sanborn Company .....	93A
Sanders Associates, Inc. ....	132A
Sensitive Research Instrument Corp. ....	173A
Sola Electric Co., Div. Basic Products Corp. ....	81A
Sorensen & Co., Inc. ....	54A
Space Technology Labs. ....	123A
Specific Products .....	78A
Sperry Electronic Tube Div., Sperry Rand Corp. ....	140A
Sperry Gyroscope Co., Div., Sperry Rand Corp. ....	117A
Sperry Semiconductor Div., Sperry Rand Corp. ....	161A
Spittal, William R. ....	176A
Sprague Electric Company .....	3A, 5A
Stanford Research Institute .....	152A
Stoddart Aircraft Radio Co., Inc. ....	25A
Stromberg-Carlson Company .....	84A-85A, 149A
Switchcraft, Inc. ....	50A
Sylvania Electric Products, Inc. ....	28A, 86A-87A, 154A-155A
System Development Corp. ....	151A
Tarzian, Inc., Sarks, Rectifier Div. ....	42A
Technical Exchange Agency .....	168A
Tektronix, Inc. ....	21A
Texas Instruments Incorporated 20A, 47A, 134A-135A .....	
Thompson-Ramo-Wooldridge, Inc. ....	92A
Times Facsimile Corporation .....	74A
Trancoa Chemical Corp. ....	75A
Tung-Sol Electric, Inc. ....	41A
United Air Lines .....	108A
United Mineral & Chemical Corp. ....	114A
United Transformer Corp. ....	Cover 2
Varian Associates .....	43A
Wallace Don C. ....	176A
Welwyn International, Inc. ....	177A
Westinghouse Electric Corp., Baltimore Div. ....	126A
Westinghouse Electric Corp., Semiconductor Div. ....	77A
Weston Instruments, Div. Daystrom, Inc. ....	44A
Wheeler, Harold A. ....	176A
Winner, Lewis .....	176A
Yu, Y. P. ....	176A
Zenith Radio Corporation .....	156A



# COMPLETE, ACCURATE, WIDE RANGE

## Time Measurements and Pulse-Waveform Synthesis

One Instrument for...ECHO RANGING, TELEMETERING, COMPUTER DESIGN, TELEVISION,  
RADIO NAVIGATION, AND PHYSIOLOGICAL RESEARCH.

### Type 1391-B PULSE, SWEEP and TIME-DELAY GENERATOR, \$1975

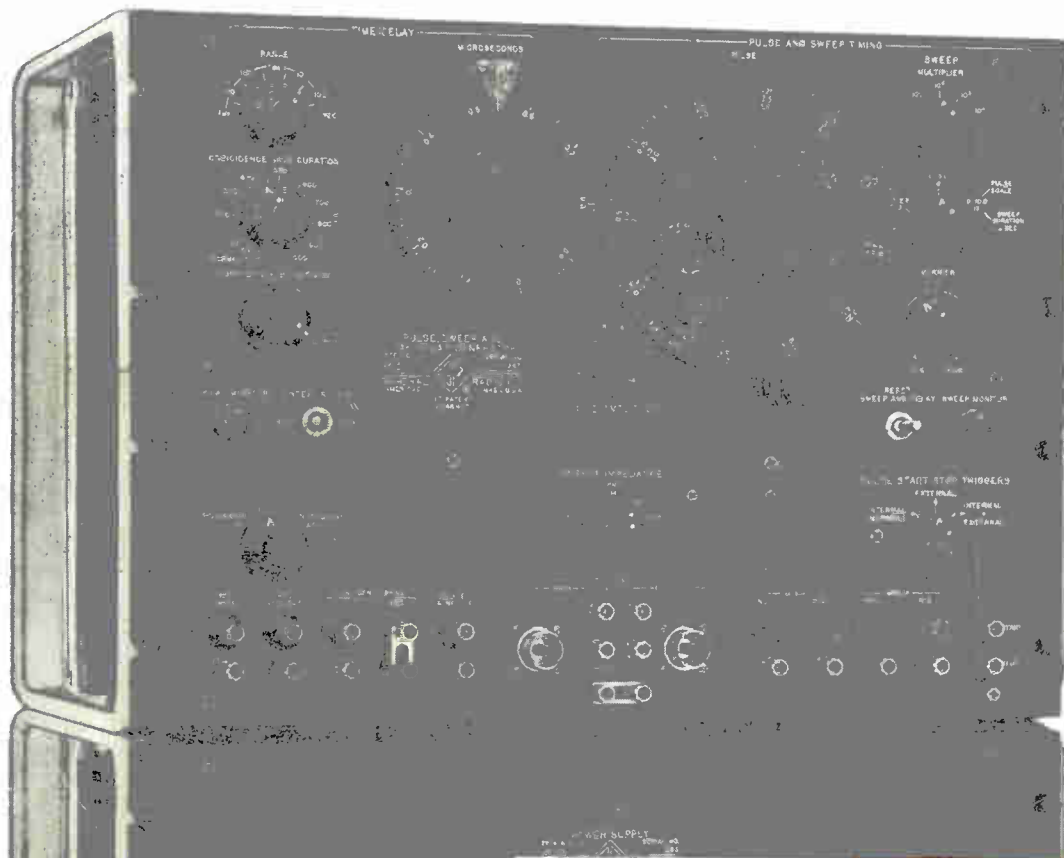

- ★ **Fast Rise and Decay Times** — Better than  $0.015 \mu\text{sec}$
- ★ **Push-Pull Pulses with Durations** from  $0.025 \mu\text{sec}$  to  $1.1 \text{ sec}$ .
- ★ **Time Delays** from  $1 \mu\text{sec}$  to  $1.1 \text{ sec}$ .
- ★ **Linear Sweep Voltage** from  $3 \mu\text{sec}$  to  $0.12 \text{ sec}$ .
- ★ **NO Duty Ratio Restrictions.**
- ★ **Very Small Jitter and Overshoot**
- ★ **High Accuracy and High Resolution** Throughout.
- ★ **Circuits Stable Against Hum and Line Transients.**
- ★ **Coincidence Circuitry For Multiple Pulsing and Time Selection.**
- ★ **Variable Output Impedance for Correct Termination with Variety of Transmission Lines.**
- ★ **Extreme Versatility** — Panel Controls for Important Pulse Characteristics. Binding Posts Provide Ready Access to Sync Pulses, Gates, Delayed Signals, Pulses, and Internal Sweeps.

Direct synchronizing pulse timed by the input signal.

Delayed synchronizing pulse accurately adjustable in time by delay generator. Built-in coincidence circuit for timing the delayed synchronizing pulse by externally generated pulses fed into the instrument.

Push-pull sawtooth voltage of sufficient amplitude to be applied to the deflection plates of oscilloscope for examining the generator's output pulses, or for use in driving auxiliary equipment.

Push-pull gating pulses with same duration as the sweep.

Positive or negative pulses with excellent shape characteristics, continuously adjustable in duration, amplitude, impedance level, and delay with respect to (a) the direct sync pulse and (b) the sweep.

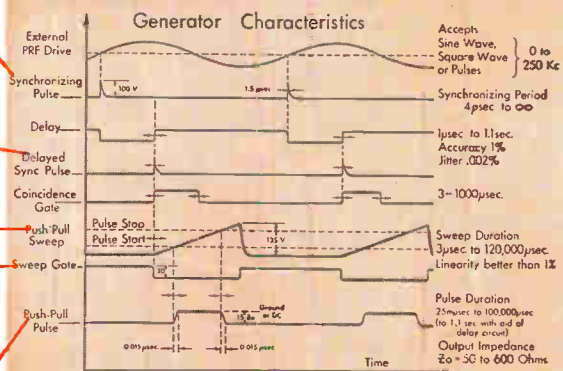

Write for Complete Information

## GENERAL RADIO COMPANY

275 MASSACHUSETTS AVENUE, CAMBRIDGE 39, MASSACHUSETTS

NEW YORK AREA  
Broad Ave. at Linden  
Ridgefield, N. J.  
N. Y. WOrth 4-2722  
N. J. WHimey 3-3140

CHICAGO  
6605 W. North Ave.  
Oak Park, Ill.  
Village 8-9400

PHILADELPHIA  
1150 York Rd.  
Abington, Pa.  
HAncock 4-7419

WASHINGTON, D.C.  
8055 Thirteenth St.  
Silver Spring, Md.  
JUniper 5-1088

SAN FRANCISCO  
1182 Los Altos Ave.  
Los Altos, Cal.  
WHitecliff 8-8233

LOS ANGELES  
1000 N. Seward St.  
Los Angeles 38, Cal.  
HOLlywood 9-6201

IN CANADA  
99 Floral Pkwy.  
Toronto 15, Ontario  
CHerry 6-2171



# now...capacitors as dependable as the time and tides

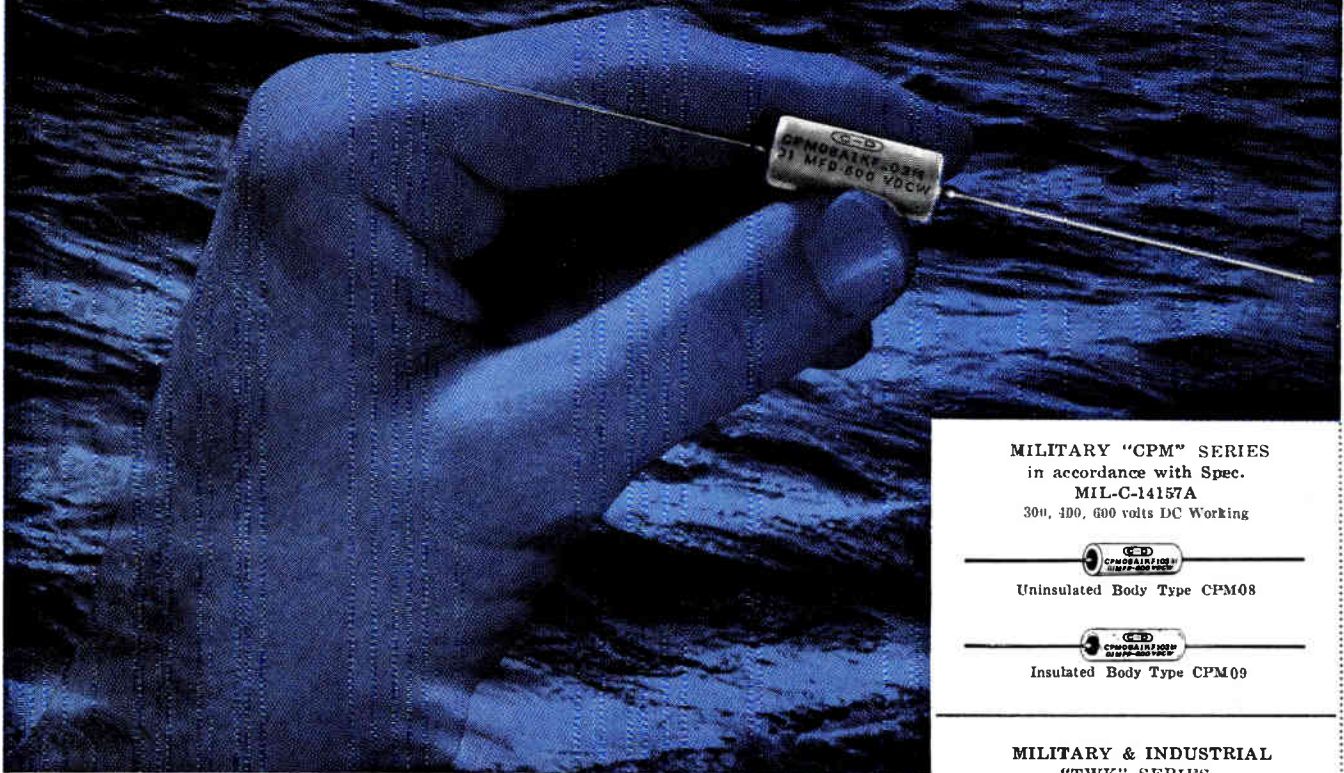

**Cornell-Dubilier Certified High-Reliability Capacitors** meet performance expectations for new environments and new complex military and industrial electronic equipment. These capacitors meet or surpass the exacting requirements of MIL-C-14157A and MIL-C-26244 (USAF). Each production lot is furnished with certified test data covering the stringent test program detailed in the specification.

When designing electronic equipment where *failure can't be tolerated* specify Cornell-Dubilier High-Reliability Capacitors. Write on your company letterhead for High-Reliability Bulletins 188A-1 and 188A-2 to Dept. IR-2, Cornell-Dubilier Electric Corporation, South Plainfield, New Jersey.

MILITARY "CPM" SERIES  
in accordance with Spec.  
MIL-C-14157A  
300, 300, 600 volts DC Working



Uninsulated Body Type CPM08



Insulated Body Type CPM09

MILITARY & INDUSTRIAL  
"TWK" SERIES  
in accordance with  
MIL-C-26244 (USAF)  
200, 300, 400, 600 volts DC Working



Uninsulated Body Type TWKN  
(equivalent to MIL-CPV09)



Insulated Body Type TWKP  
(equivalent to MIL-CPV09)

**CAPACITANCE:**  
001 mfd. to 1.0 mfd.  
**TEMPERATURE RANGE:**  
-55°C to +125°C.



Consistently Dependable  
**CORNELL-DUBILIER**  
CAPACITORS