

Proceedings



of the I·R·E

A Journal of Communications and Electronic Engineering

February, 1951

Volume 39

Number 2



Radioactive Products, Inc.

ELECTRONIC SENTINEL

The health of workers in the neighborhood of radioactive materials is safeguarded by electronic instruments, such as the above Radiation Hazard Survey Meter.

PROCEEDINGS OF THE I.R.E.

Television Broadcasting in the U.S.

Synchronizing Systems for Dot-Interlaced Color TV

Control Chart for Analyzing Experimental Data

Life Expectancy of Vacuum Tubes

Magnetic Recording with AC Bias

Representations of Speech Sounds

Traveling-Wave Amplifier for Medium Powers

Gain of Electromagnetic Horns

Slotted-Line Impedance Measurements

Feedback Oscillator Analysis

Spectrum Analysis of Transient Response Curves

Ionosphere Absorption at 150 Kc

Secondary-Emitting Surfaces

Poisoning of Oxide Cathodes by Sulfur (Abstract)

Abstracts and References

TABLE OF CONTENTS, INDICATED BY BLACK-AND-WHITE MARGIN, FOLLOWS PAGE 32A

The Institute of Radio Engineers



FILTER SPECIALISTS

PRODUCERS OF PERMALLOY DUST TOROID COILS AND FILTERS FOR OVER A DECADE



FOR FILTERS

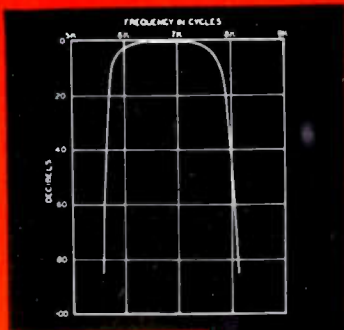

BROAD BAND SHARP CUTOFF FILTER

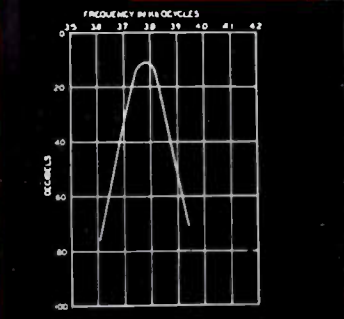

NARROW BAND SHARP CUTOFF FILTER

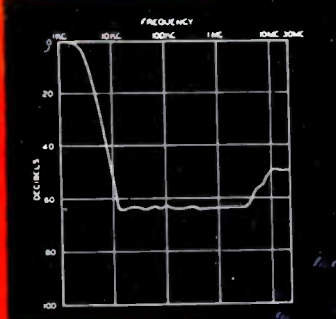

ATTENUATES 10KC TO 30 MEGACYCLES

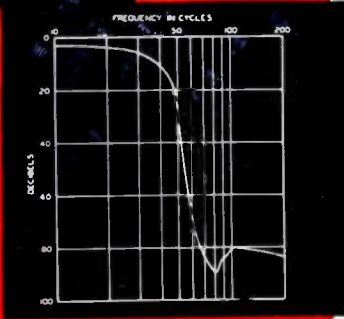

LOW FREQUENCY - LOW PASS FILTER

SUB-OUNCER TOROID FILTERS

Filters employing SUB-OUNCER toroids and special condensers represent the optimum in miniaturized filter performance. The band pass filter shown weighs 6 ounces.

FOR HIGH Q COILS



HQA, C, D TOROID COILS
1 1/8" Dia. x 1 1/8" High.

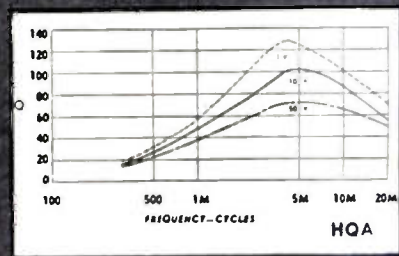

HQB TOROID COIL
2 5/8" L. x 1 5/8" W. x 2 1/2" H.

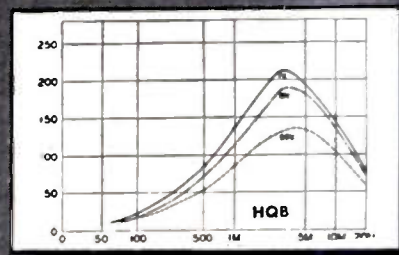

UNCASED TOROIDS

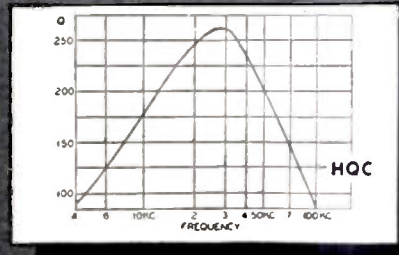

VIC VARIABLE INDUCTOR

1 3/8" L. x 1 1/4" W. x 1 1/2" H.

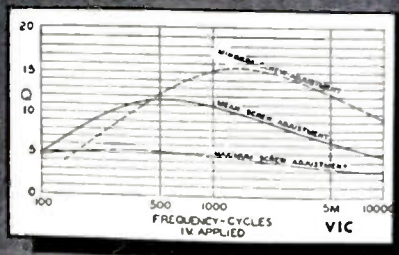
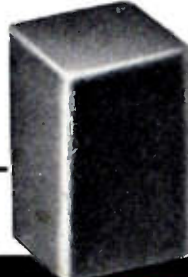
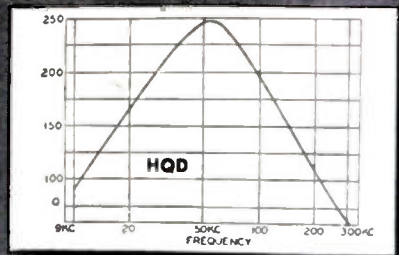

write for catalog PS-409

United Transformer Co.

150 VARICK STREET NEW YORK 13, N. Y.
EXPORT DIVISION: 13 EAST 40th STREET, NEW YORK 16, N. Y. CABLES: "ARLAB"

ADVANCE with Radio-Electronics in the National Emergency!

The 1951 IRE Convention

In pace with the rapid and widespread advances of the engineering and science of radio-television-and-electronics are the plans for the IRE Convention. 210 vitally important technical papers will be presented in 29 technical sessions, and 14 comprehensive symposia organized by nine of the IRE professional groups.

The entire industry, and every engineer attending will be helped to advance by these four days of meetings!

Engineering is accomplished by men! The humanly interesting contacts of the Convention help further the advances of the field. To know your fellow engineers is to help get things done, by exchange of information and finding "who knows

how"! A Banquet that this year is truly different from menu to program—a President's Luncheon with special tables for the Professional Groups—a "get-together" Cocktail Party all further these ends.

The Radio Engineering Show

267 Manufacturers will bring their 1951 Advances in better products, components and apparatus to a single meeting place, Grand Central Palace in New York City. Thousands of IRE members and visiting engineers may see them. Such a "show" saves time and spreads information. In no other way can you see and learn so much in four days!

The exhibit method is the finest form of product presentation. Here the manufacturer can properly prepare his demonstration—and adequately man his exhibit with his own competent engineers to answer your questions—doing much for you and himself, economically. Come and see these great 1951 Advances.

Remember these days, March 19-22, Monday through Thursday, and these places: Grand Central Palace; and the Waldorf-Astoria, our new hotel headquarters.



"IRE Meetings and Shows Accelerate Electronic Progress"

PROCEEDINGS OF THE I.R.E. February, 1951, Vol. 39, No. 2. Published monthly by The Institute of Radio Engineers, Inc., at 1 East 79 Street, New York 21, N.Y. Price per copy: members of the Institute of Radio Engineers \$1.00; non-members \$2.25. Yearly subscription price: to members \$9.00; to non-members in United States, Canada and U.S. Possessions \$18.00; to non-members in foreign countries \$19.00. Entered as second class matter, October 26, 1927, at the post office at Menasha, Wisconsin, under the act of March 3, 1879. Acceptance for mailing at a special rate of postage is provided for in the act of February 28, 1925, embodied in Paragraph 4, Section 412, P. L. and R., authorized October 26, 1927.

Table of Contents will be found following page 32A

TINY • DEPENDABLE • SPACE- SAVING *Cera-mite* Capacitors

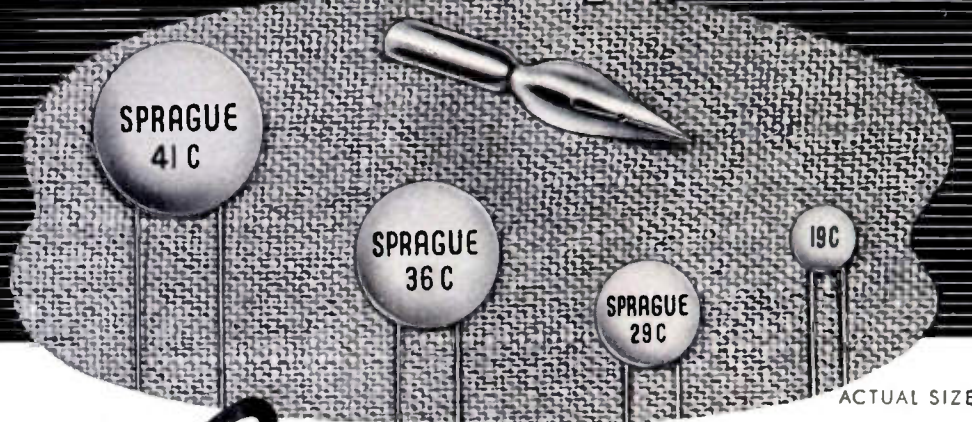

THE *First* COMPLETE DISC CERAMIC LINE

Sprague-Herlec Cera-mite Capacitors are a “must” for modern television circuits.

Now available in both temperature-compensating (TC) and general application (GA) types, Cera-mites meet most application needs in the 10 mmf to 15,000 mmf capacitance range.

These miniature capacitors offer set designers maximum space economy, ease of mounting, and improved very-high-frequency performance.

The flat disc with uni-directional lead construction has minimum self-inductance and a higher self-resonant frequency than a tubular design; hence improved v-h-f bypass efficiency.

Sprague-Herlec Engineering Bulletin 601B gives the complete list of standard ratings as well as performance specifications. Write for your copy today!

*Trademark

SPRAGUE

PIONEERS IN

SPRAGUE ELECTRIC COMPANY
North Adams, Massachusetts

ELECTRIC AND ELECTRONIC DEVELOPMENT

THE HERLEC CORPORATION • Milwaukee 3, Wisconsin
(Wholly owned Sprague Subsidiary)

How
to be sure
you get

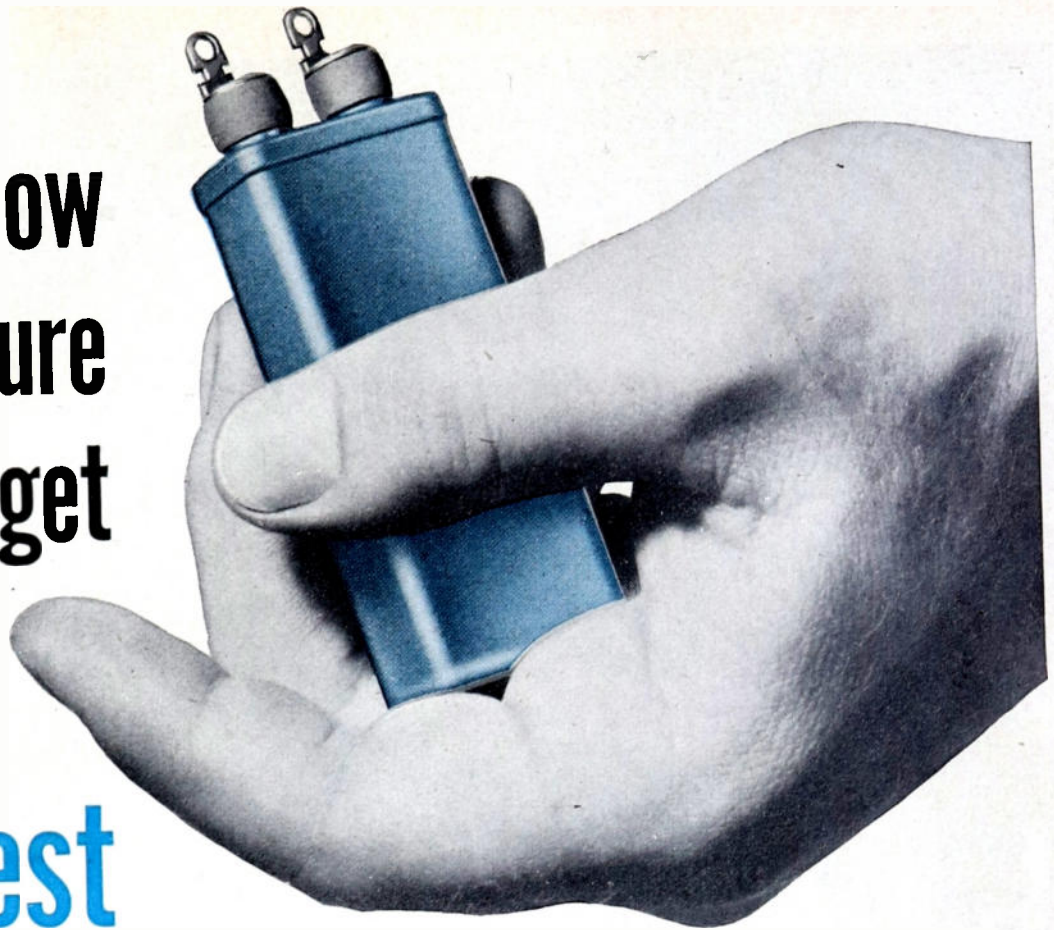

the Best Capacitor

YOU CAN test the paper for density . . . thickness . . . porosity . . . power factor . . . chloride content . . . dielectric constant . . . dielectric strength.

And then test the foil for thickness . . . purity . . . softness of the anneal . . . freedom from oil . . . cleanliness of surface . . . absolute smoothness.

And then test the liquid dielectric for specific gravity . . . viscosity . . . power factor . . . color . . . acidity . . . flash point . . . dielectric strength . . . dielectric constant . . . insulation resistance . . . water content.

And after that, test every single finished capacitor for shorts, grounds, and opens at overvoltage between terminals and between terminals and case . . . and measure the capacitance of every single unit . . . and then check every single capacitor to see that it has a leak-proof hermetic seal.

OR YOU CAN buy General Electric capacitors . . . product of outstanding research and know-how . . . which have already passed every one of these tests

- . . . on the materials when they were made.
- . . . and again before they were used.
- . . . and on the capacitors during manufacture.
- . . . and then, finally, on every single capacitor before shipment.

For full information on types, ratings, dimensions, types of mounting, and prices of capacitors, address the nearest *General Electric Sales Office or Apparatus Department, General Electric Company, Schenectady 5, N. Y.*

GENERAL  **ELECTRIC**

407-170

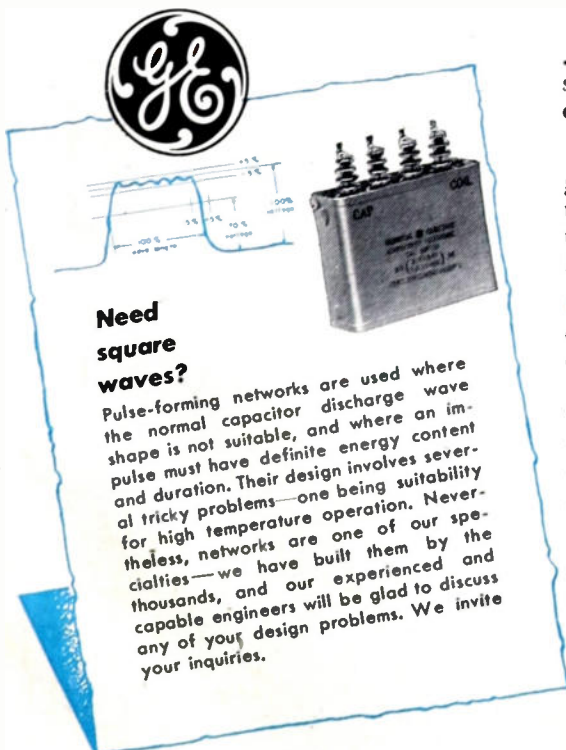

Need square waves?

Pulse-forming networks are used where the normal capacitor discharge wave shape is not suitable, and where an impulse must have definite energy content and duration. Their design involves several tricky problems—one being suitability for high temperature operation. Nevertheless, networks are one of our specialties—we have built them by the thousands, and our experienced and capable engineers will be glad to discuss any of your design problems. We invite your inquiries.

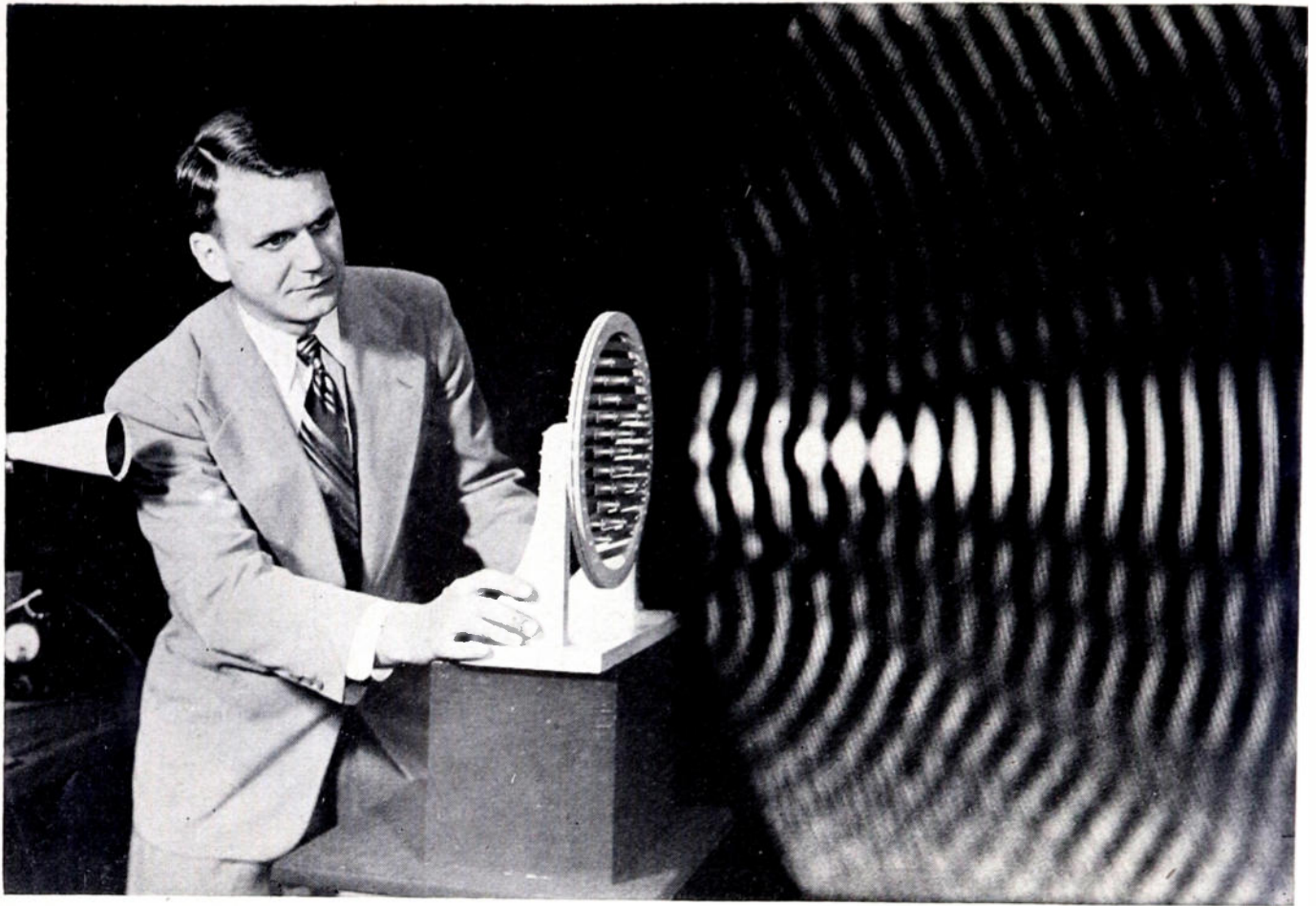

WAVE MAKING

*—for better
telephone
service*

Waves from the sound source at left are focused by the lens at center. In front of the lens, a moving arm (not shown) scans the wave field with a tiny microphone and neon lamp. The microphone picks up sound energy and sends it through amplifiers to the lamp. The lamp glows brightly where sound level is high, dims where it is low. This new technique pictures accurately the focusing effect of the lens. Similar lenses efficiently focus microwaves in radio relay transmission.

At Bell Telephone Laboratories, radio scientists devised their latest microwave lens by copying the molecular action of optical lenses in focusing light. The result was a radically new type of lens — the array of metal strips shown in the illustration. Giant metal strip lenses are used in the new microwave link for telephone and television between New York and Chicago.

The scientists went on to discover that the very same

type of lens could also focus sound . . . thus help, too, in the study of sound radiation . . . another field of great importance to your telephone system.

The study of the basic laws of waves and vibrations is just another example of research which turns into practical telephone equipment at Bell Telephone Laboratories . . . helping to bring you high value for your telephone dollar.

BELL TELEPHONE LABORATORIES



• WORKING CONTINUALLY TO KEEP YOUR TELEPHONE SERVICE ONE OF TODAY'S GREATEST VALUES

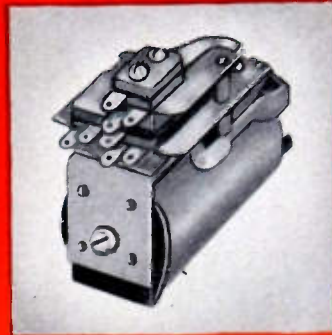

SERIES 695 D.C.

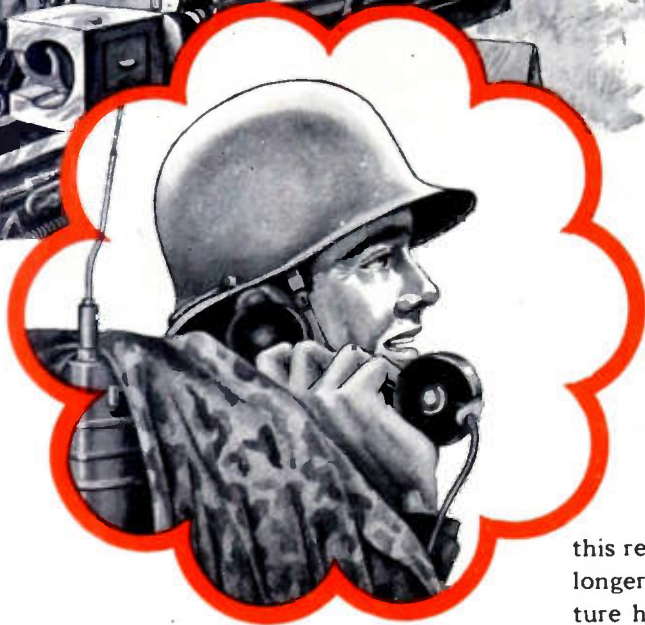

The
GUARDIAN
 SERIES 695 D.C.
RELAY

ONE OF A LINE

A tiny telephone type—the Guardian Series 695 D.C. Relay has distinguished itself in wartime communications equipment. For inter-plane—intra plane—ground to plane—ship to shore radio—walkie talkie—field telephone equipment—the Guardian Series 695 D.C. is unexcelled. Contrary to conventional design, armature on this relay is formed outward, away from coil, permitting use of a longer coil without increasing overall length of the unit. Armature hinges on a frictionless bearing which requires no lubrication. Proper balance of copper winding and volume of iron on field piece result in maximum flux density without oversaturation of iron. Series 695 D.C. Relay is capable of carrying up to 6 single pole, single throw contact combinations. Can be hermetically sealed as a standard unit in Lug Header type housing or, to specification, in A. N. Connector, Screw Terminal, or Lug Header type housings.



Series 30 A.C.



Series 210 A.C.—215 D.C.



Series 220 A.C.



Series 595 D.C.



Series 610 A.C.—615 D.C.

WRITE OR WIRE... FREE CATALOG, SPECIFIC RECOMMENDATIONS, NO OBLIGATION.

GUARDIAN  **ELECTRIC**
 1628-B W. WALNUT STREET CHICAGO 12, ILLINOIS

A COMPLETE LINE OF RELAYS SERVING AMERICAN INDUSTRY

TRUSCON... a name you can build on



WOW, Omaha, Nebr., Truscon Self-Supporting Radio Tower, 500 feet high overall.



WHDH, Boston, Mass. Three Truscon Guyed Towers; 565 feet, 605 feet, and 645 feet high.



WSAM AM-FM, Saginaw, Mich. Truscon Self-Supporting Tower, 386 feet high.

world leader in better radio tower engineering



KAA-284, Owatonna, Minnesota, Northern Natural Gas Co. Truscon Self-Supporting Tower, 260 feet high.

Truscon experience in radio tower engineering is world wide... meeting all types of topographical and meteorological conditions... and supplying many different tower types—guyed or self-supporting... tapered or uniform in cross-section... for AM, FM or TV transmission.

Your phone call or letter to any convenient Truscon district office, or to our home office in Youngstown, will bring you immediate, capable engineering assistance. Call or write today.



WXEL-TV Cleveland, Ohio. Truscon Self-Supporting Tower, 437 feet high.



WTCH, Shawano, Wisconsin. Truscon Self-Supporting Tower, 230 feet high.



WMRI-FM, Marion, Indiana. Truscon Self-Supporting Tower, 336 feet high.



WEMP-FM, Milwaukee, Wisconsin. Truscon Self-Supporting Tower, 456 feet high.

TRUSCON® STEEL COMPANY Youngstown 1, Ohio
 Subsidiary of Republic Steel Corporation

COMPLETE, WIDE-BAND INSTRUMENTATION FOR DISTORTION-FREE, FAST-PULSE MEASUREMENT!



New -hp- 460B Fast-Pulse Amplifier



-hp- 46A Connectors and Accessories



-hp- 460A Wide-Band Amplifier

SPECIFICATIONS

-hp- 460B PAST PULSE AMPLIFIER

FREQUENCY RESPONSE: Closely matches Gaussian curve. Hf 3 db point is approx. 140 mc. Lf 3 db point is approx. 50 kc into 200-ohm load.

MAXIMUM OUTPUT VOLTAGE: High bias, approx. 125 v. negative open circuit. Normal bias (linear amplification) approx. 8 v. peak into 200-ohm load or 16 v. peak open circuit, pos. or neg. pulses.

GAIN: Approx. 15 db into 200-ohm load.

INPUT IMPEDANCE: Approx. 200 ohms.

RISE TIME: Approx. 0.0026 μ sec.

DELAY: Approx. 0.016 μ sec.

DUTY CYCLE: 0.10 max. for 125 v. output pulse.

LINEARITY PULSE OPERATION: See Figure 1.

MOUNTING: Relay rack. 5 1/4" x 19", 6" deep.

POWER SUPPLY: 115 v. 50/60 cps. 35 watts.

PRICE: \$225.00 f.o.b. factory.

-hp- 460A WIDE-BAND AMPLIFIER

(Specifications same as Model 460B except:)

MAXIMUM OUTPUT VOLTAGE: Approx. 8 v. peak open circuit; 4.75 v. peak into 200-ohm load.

GAIN: Approx. 20 db with 200-ohm load.

DELAY: Approx. 0.012 μ sec.

PRICE: \$185.00 f.o.b. factory.

-hp- 46A ACCESSORIES

-hp- 46A-16A PATCH CORD - 200-ohms, 2' long. \$18.50.

-hp- 46A-16B PATCH CORD - 200-ohms, 6' long. \$25.50.

-hp- 46A-95A PANEL JACK - For 200-ohm cables, low capacitance. 1 1/8" dia. \$7.50.

-hp- 46A-95B CABLE PLUG - For 200-ohm cables, low capacitance. \$7.50.

-hp- 812-52 CABLE - 200-ohm cable in lengths to specification. Per foot \$1.75.

-hp- 46A-95C 50-OHM ADAPTOR - Type N connector for coupling 50-ohm line into -hp- amplifiers. \$15.00.

-hp- 46A-95D ADAPTOR - Bayonet sleeve for connecting -hp- 410A VTVM to output of 460A/B amplifiers. \$15.00.

-hp- 46A-95E CONNECTOR SLEEVE - Joins two 46A-95B CABLE PLUGS. \$7.50.

-hp- 46A-95F ADAPTOR - For connecting to 5XP CRT. \$10.00.

-hp- 46A-95G ADAPTOR - For connecting to Tektronix type 511 oscilloscope. \$12.50. Data subject to change without notice.

UP TO 90 DB GAIN IN CASCADE! AMPLIFIES MILLI-MICROSECOND PULSES! RISE TIME .0026 μ SEC! 125-VOLT OPEN-CIRCUIT OUTPUT! GIVES OVER 100 MC BANDWIDTH TO YOUR STANDARD OSCILLOSCOPE!

Here at last is complete instrumentation for true amplification of fast pulses at high power levels sufficient to operate scalars or counting meters, cathode ray tubes, or to give more than 100 mc band-width to your present oscilloscope. New -hp- 460B Fast-Pulse Amplifiers, in cascade with -hp- 460A Wide-Band Amplifiers, amplify up to 125 volts, open circuit (limited duty cycle). This permits full deflection of 5XP cathode ray tubes, or 2-inch deflection of 0.0026 μ sec, combined with zero overshoot, insures distortion-free amplification of pulses faster than 0.01 μ sec.

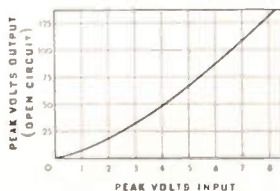

Fig. 1: Linearity of -hp- 460B Fast-Pulse Amplifier

New -hp- 460B Amplifier, cascaded with -hp- 460A provides linear amplification of 16 volts peak output and pulse amplification of 125 volts output (slight non-linearity). This combination provides maximum usefulness in fast-pulse study for nuclear radiation work, television or VHF research; for increasing frequency range of your oscilloscope, or general wide-band laboratory amplification. In addition to the above instrumentation, -hp- also offers series 46A accessories—a complete set of 200 ohm cables, adapters and fittings for inter-connecting amplifiers or patching to oscilloscopes.

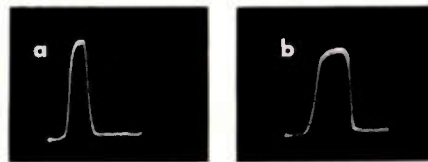

Fig. 2: (a) 0.01 μ sec pulse through -hp- 460B Amplifier (b) 0.02 μ sec pulse through 3 amplifiers in cascade

Get complete details. Write direct or see your -hp- sales representative.

HEWLETT-PACKARD COMPANY

2177D Page Mill Road • Palo Alto, California, U. S. A.

Sales Representatives in all principal cities.

Export: Frazar & Hansen, Ltd., San Francisco, New York, Los Angeles

HEWLETT-PACKARD



INSTRUMENTS

Exploration

for resistors too!



Specialization in resistors lets IRC concentrate on research and quality control to a greater degree than any other supplier.

Result:—IRC exploration anticipates future resistor needs—improves existing products—and controls quality and uniformity in every IRC unit. Largest resistor manufacturer in the world, IRC attracts the finest of engineering talent. We're using more of such talent than ever, now, to keep step with today's electronic requirements—while we plan for tomorrow's advances.



FLAT POWER WIRE WOUND RESISTORS

For high-wattage dissipation in limited-space applications, IRC Type FRW Flat Wire Wound Resistors have higher space-power ratios than standard tubular units. FRW's can be mounted vertically or horizontally—singly or in stacks. Non-magnetic mounting brackets permit easy, economical mounting, aid in heat distribution along the entire length, and transfer internal heat to the chassis. Available in 9 sizes—fixed and adjustable. Send for full details in Bulletin C-1.

is important

HIGH OHMIC RESISTORS

Engineered for high voltage applications where high resistance and power are required, IRC Type MVX Resistors are particularly suited to many types of television and electronic circuits. Unique application of IRC's proven filament resistance coating in helical turns on a ceramic tube provides a conducting path of long, effective length. Result: A unit of high resistance value with resistance materials having relatively low specific resistance. Type MVX's have 2 watt rating, are exceptionally stable—permit the use of high voltage on the resistor while keeping voltage per unit length of path comparatively low. Send coupon for complete details in Bulletin G-2.

DEPOSITED CARBON PRECISTORS

A unique combination of accuracy, stability and economy makes IRC Deposited Carbon PRECISTORS ideal for applications where carbon compositions are unsuitable or wire-wound precisions too expensive. Instrumentation, advanced electronics and critical television circuits also benefit from their wide range of values, low voltage coefficient, excellent frequency characteristics, predictable temperature characteristics, high voltage rating, low noise level and small size. Coupon brings full particulars in Bulletin B-4.

VOLTMETER MULTIPLIERS Sealed-precision IRC Type MF Resistors are completely impervious to moisture—have proved themselves dependable voltmeter multipliers for use under the most severe humidity conditions. Each multiplier consists of a number of IRC Precision Resistors, mounted, interconnected, and encased in a glazed, hermetically sealed ceramic tube. MF's are compact, rugged, stable, easy to install, and may be used with very little drain on the power supply. Individual precision resistors may be either inductive or noninductive, so that they may be used on AC as well as DC. Mail coupon for full data in Bulletin D-2.



Wherever the Circuit Says 

Power Resistors • Voltmeter Multipliers
 • Insulated Composition Resistors • Low
 Wattage Wire Wounds • Volume
 Controls • Voltage Dividers • Precision
 Wire Wounds • Deposited Carbon
 Precistors • Ultra-HF and High
 Voltage Resistors • Insulated Chokes

**INTERNATIONAL
 RESISTANCE COMPANY**

401 N. Broad Street, Philadelphia 8, Pa.

In Canada: International Resistance Co., Ltd., Toronto, Ontario

INTERNATIONAL RESISTANCE CO.
 405 N. BROAD ST., PHILADELPHIA 8, PA.

Please send me complete information on the items checked below:—

- Flat Wire Wound Resistors (C-1) Deposited Carbon PRECISTORS (B-4)
- High Voltage Resistors (G-2) Voltmeter Multipliers (D-2)
- Name and address of local IRC Distributor

NAME.....

TITLE.....

COMPANY.....

ADDRESS.....

CITY..... ZONE..... STATE.....

J. P. ARNDT & CO., ADV. AGENCY

THE CERAMIC CORES THAT
PAVED THE WAY TO BETTER

TV



STACKPOLE
Ceramag[®]

- ✓ Lower losses with higher efficiency and lower operating temperatures
- ✓ Lighter weight, smaller sizes for more compact construction, lower costs of finished equipment
- ✓ Much higher permeability
- ✓ Less corona effect
- ✓ Lower cost

Technically, Stackpole Ceramag Cores are molded from a metallic oxide powder mixture which, when properly handled during processing, promotes cubic crystal growth. This results in a non-metallic material having low eddy current loss and exceptionally high permeability.

Practically, Stackpole's skill in the highly critical fabrication of these cores in production quantities has resulted in lower costs and higher standards of performance and dependability for the nation's leading television receivers.

Besides the more popular standard Ceramag core types illustrated above, many specials are regularly supplied.

Electronic Components Division

STACKPOLE CARBON COMPANY, St. Marys, Pa.



Let's Put the Chill on a Hot Subject . . .

As you read this message engineers the country over are hard at work planning, experimenting on fused hermetic sealing for their company's electrical product.

When the subject of a so-called glass terminal comes up (and it's bound to) they're apt to talk in terms of thermal shock. That's where Fusite Hermetic Terminals come in.

Take the interfusion of steel and inorganic glass that is a Fusite terminal. Apply the sizzling heat of a soldering or welding operation. And if you want to be ornery, shove it right out on the shipping dock on a zero day.

What happens?

Absolutely nothing. Your seal remains as tight as your production skill made it. All Terminals remain as smooth, as rugged, and uniform as only Fusite makes them.

Would you like to know more, or see samples? Write to Dept. E.

TERMINAL ILLUSTRATED 908HTO—For plug-in to standard "Octal" sockets. Available with two to eight hollow tube electrodes.



THE FUSITE CORPORATION

CARTHAGE AT HANNAFORD, NORWOOD, CINCINNATI 12, OHIO

and now-- the magic link for closed circuit tv



Camera Signal

The Dumitter

Standard TV Receiver

the dumitter

Actually a miniature closed-circuit television transmitter. Takes signal directly from any standard camera chain, modulates a carrier frequency of either Channel 2 or 3, and feeds via cable directly through the antenna posts of standard TV receivers. Receivers operate exactly as though tuned to a telecast on that Channel.

Performance superior to other forms of transmission. Audio and video reception absolutely free from outside interference. Truly, the MAGIC LINK for closed-circuit television.

Ideal for use in industrial television applications, for field demonstrations of TV receivers, for studio use, for sales meetings, and countless other uses. Does away with expensive, bulky equipment and circuitry modification of receivers.

- Feeds up to 125 standard TV receivers.
- Distributes signals on standard TV Channel 2 or 3 via cable through regular antenna posts at receivers. No modification of receivers necessary. Receivers may be switched to regular telecast reception at any time.
- Feeds receivers both video and audio through single coaxial cable up to several thousand feet.
- No terminal equalization necessary as attenuation is only at carrier frequency.
- Uses signal from any standard camera chain without interim equipment.
- Completely stable — requires no operator.
- Light, compact, completely stable.
- No license required.

DUMONT

First with the Finest in Television

ALLEN B. DU MONT LABORATORIES, INC.
Television Transmitter Division, Clifton, N.J.

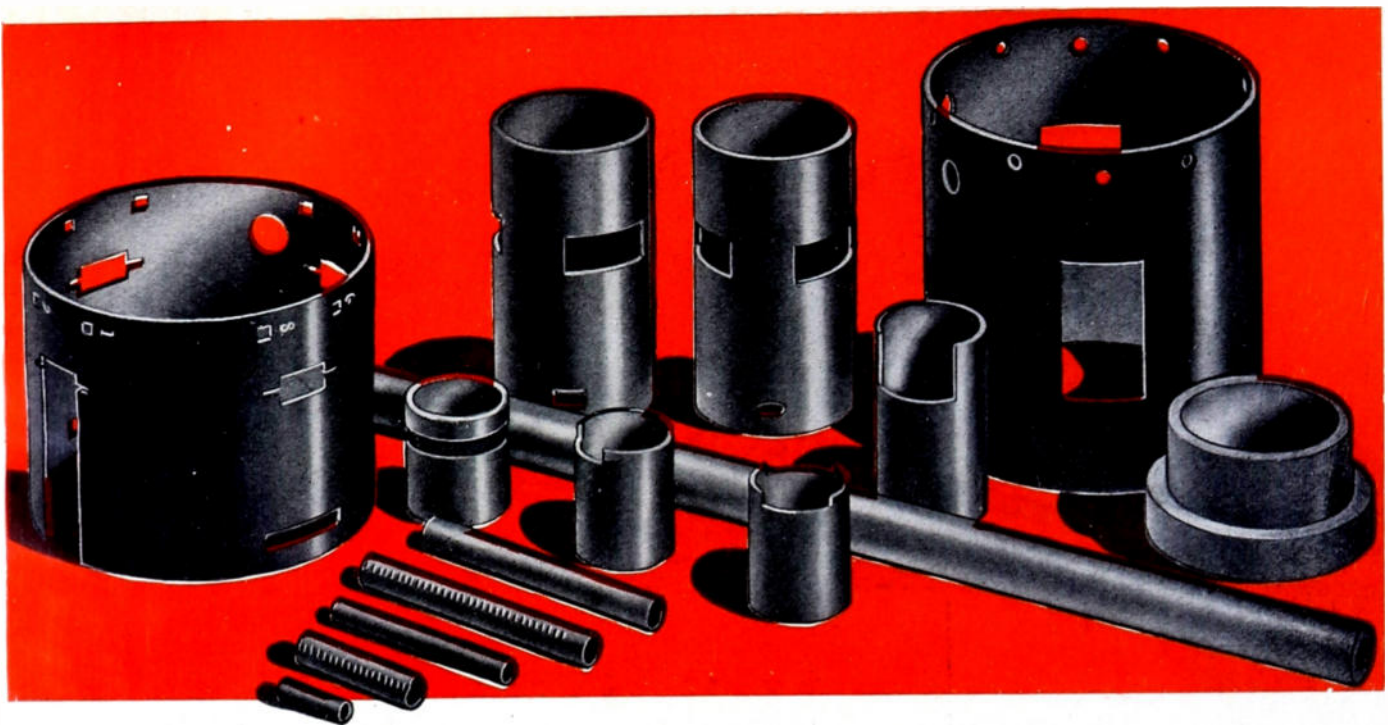

CLEVELITE* and COSMALITE* PHENOLIC TUBING

Meets the Most Exacting Specifications!

A Grade for Every Need:

Why Pay More?

ALSO USED WIDELY
BY MANUFACTURERS
OF ELECTRICAL
EQUIPMENT . . .
FOR ITS HIGH
DIELECTRIC STRENGTH
. . . LOW MOISTURE
ABSORPTION . . .
STRENGTH, LOW LOSS
AND GOOD
MACHINEABILITY.

AVAILABLE IN
DIAMETERS,
WALL THICKNESSES
AND LENGTHS TO
MEET ENDLESS
SPECIAL OR NEW
ADAPTATIONS.

INQUIRIES
ARE GIVEN
IMMEDIATE
ATTENTION.

ASK FOR SAMPLES

CLEVELITE

- Grade E Improved post cure fabrication and stapling.
- Grade EX Special grade for TV deflection yoke sleeve.
- Grade EE Improved general purpose.
- Grade EEX Superior electrical and moisture absorption properties.
- Grade EEE Critical electrical and high voltage applications.
- Grade XAX Special grade for government phenolic specifications.

COSMALITE

- Grade SP Post cure fabrication and stapling.
- Grade SS General purpose.
- Grade SSP General purpose—punching grade.
- Grade SLF Thin wall tubing—high dielectric and compression strength.

CLEVELAND PHENOLIC TUBING

THE FIRST CHOICE OF THE RADIO AND TELEVISION INDUSTRIES.
EXCELLENT SERVICE AND PROMPT DELIVERIES ASSURED.

* Trade Marks

The CLEVELAND CONTAINER Co.

6201 BARBERTON AVE. CLEVELAND 2, OHIO

PLANTS AND SALES OFFICES at Plymouth, Wisc., Chicago, Detroit, Ogdensburg, N. Y., Jamesburg, N. J.
ABRASIVE DIVISION at Cleveland, Ohio

CANADIAN PLANT: The Cleveland Container, Canada, Ltd., Prescott, Ontario

REPRESENTATIVES

- | | |
|---------------|--|
| NEW YORK AREA | R. T. MURRAY, 614 CENTRAL AVE., EAST ORANGE, N. J. |
| NEW ENGLAND | R. S. PETTIGREW & CO., 968 FARMINGTON AVE.
WEST HARTFORD, CONN. |
| CANADA | WM. T. BARRON, EIGHTH LINE, RR #1, OAKVILLE, ONTARIO |



**Service
Beyond
The Sale!**

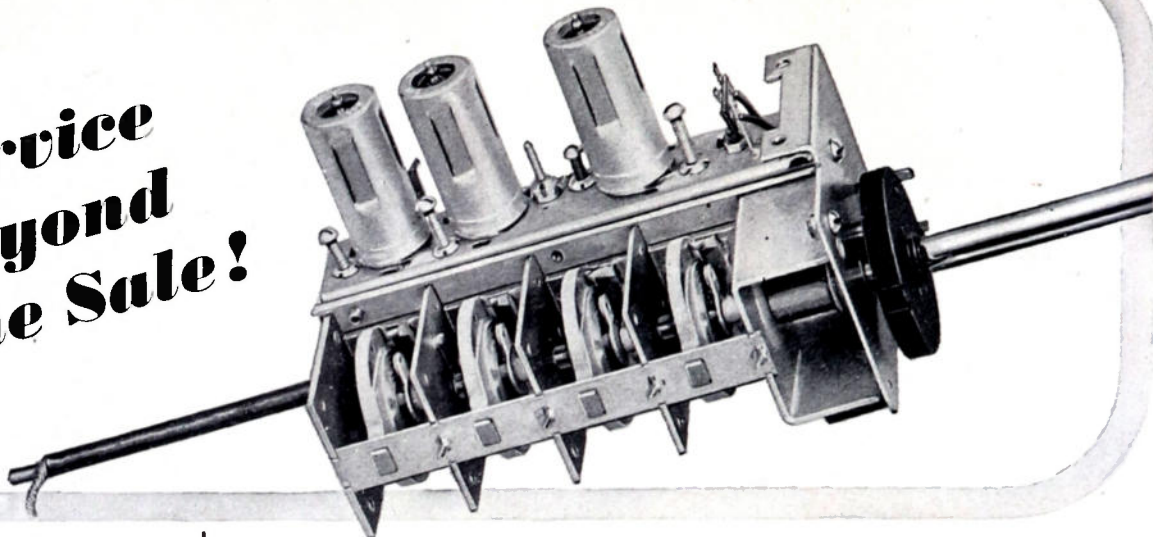

Mallory TV Front End Limits Oscillator Radiation

Outstanding Advantages of the new Mallory Spiral Inductuner

1. A single control for easy selection and fine tuning of any television or FM channel.
2. Easily adapted to UHF converter use.
3. Excellent stability eliminates frequency drift.
4. Supplied in two-, three- or four-section designs.
5. Far more quiet operation; permits high signal-to-noise ratio in front end designs.
6. Free from microphonics.
7. Greater selectivity on high frequency channels.
8. Eliminates "bunching" of high band channels.
9. Simplifies front end design and production.
10. Reduces assembly costs.
11. Choice of: 6 turn unit continuously tunes from channels 2 to 13; 4 turn unit tunes only channels 2 to 6, FM, 7 to 13; 3 turn unit tunes only the 12 television channels.

Mallory engineering has accomplished the development of a TV Front End Assembly which avoids interference by the receiver with nearby sets and other electronic equipment.

Built around the four-tuned circuit Spiral Inductuner*, this new front end is designed to restrict radiation from the oscillator. In addition, the oscillator and converter are shielded from the RF amplifier. And, each section of the Inductuner is provided with its own special shielding. Thus, Mallory now offers TV manufacturers a front end that is ready to perform within the strict standards contemplated for oscillator radiation.

That's service beyond the sale!

The Mallory Front End is universally adaptable. It features higher gain, and lower signal-to-noise ratio. Designed around the Inductuner, it is available with or without indexing provisions, in 3 and 4 revolution designs. Also available in 6 turns without the indexing feature.

*Reg. trade mark of P. R. Mallory & Co., Inc. for inductance tuning devices covered by Mallory-Ware patents.

Television Tuners, Special Switches, Controls and Resistors

SERVING INDUSTRY WITH

Electromechanical Products
Resistors Switches
TV Tuners Vibrators

Electrochemical Products
Capacitors Rectifiers
Mercury Dry Batteries

Metallurgical Products
Contacts Special Metals
Welding Materials

P. R. MALLORY & CO., Inc.
MALLORY

P. R. MALLORY & CO., Inc., INDIANAPOLIS 6, INDIANA

A New Concept in Precision Potentiometers . . .

THE MODEL J

Helipot

Precise Mechanical Concentricity

High Electrical Accuracy

Ball Bearing Construction

Independent Phasing

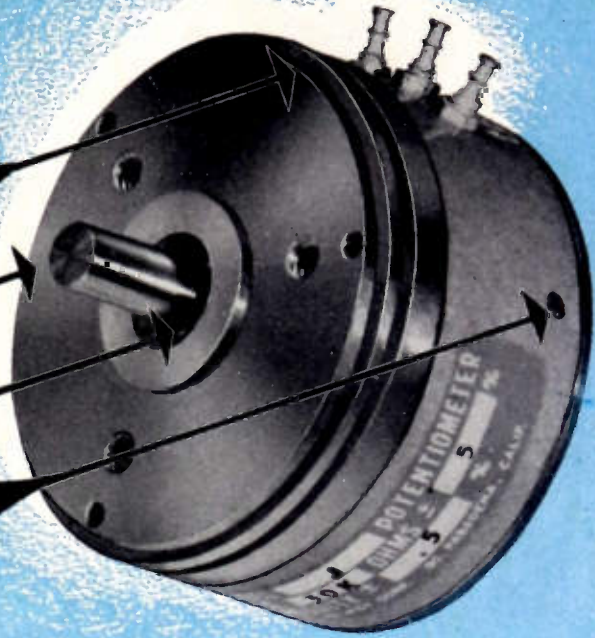

. . . combined with mass-production economies!



TYPICAL 6 GANG
MULTIPLE ASSEMBLY

If it's a tough potentiometer problem, bring it to Helipot

—for Helipot has facilities and know-how unequalled in the industry for mass-producing precision potentiometers with advanced operating and electrical features.

This recently-developed Model J Helipot, for example, combines several revolutionary advancements never before available in the potentiometer field . . .

Precise Mechanical Concentricity

Modern servo mechanisms and computer hook-ups require high mechanical precision to insure uniform accuracy when connected to servo motors through close-tolerance gears and couplings.

In the "Model J," close concentricity between mounting surface and shaft is assured by a unique mounting arrangement. The unit can be aligned on either of two wide-base flange registers and secured with three screws from the front of the panel . . . or it can be secured with adjustable clamps from the rear of the panel to permit angular phasing. Or if preferred, it can be equipped with the conventional single-hole bushing type of mounting.

In addition to accurate mounting alignment, exact rotational alignment is assured by the long-life, precision-type ball bearings upon which the shaft rotates. Precise initial alignment coupled with negligible wear mean high sustained accuracy.

High Electrical Accuracy

Helipot products have long been noted for their unusually high electrical accuracy and the "Model J" embodies the latest advancements of Helipot engineering in this field.

For example, tap connections are made by a new Helipot welding technique whereby

the tap is connected to only ONE turn of the resistance winding. This unique process eliminates "shorted section" problems!

High linearity is also assured by Helipot's advanced production methods. Standard "Model J" linearity accuracies are guaranteed within $\pm 0.5\%$. On special order, accuracies to $\pm 0.15\%$ (capacities of 5000 ohms and up) have been obtained.

Ball Bearing Construction

The shaft of each "Model J" is carefully mounted on precision-type ball bearings that not only assure sustained rotational accuracy, but also provide the constant low-torque operation so essential for servo and computer applications. Starting torque is only $\frac{3}{4}$ of an inch-ounce ($\pm .25$ in.-oz.)—running torque, of course, is even less.

Independent Phasing

When using the "Model J" in ganged multiple assemblies, each section can be independently phased electrically or mechanically—even after installation on the panel—by means of hidden internal clamps controlled from outside the housing. Phasing is simple, quick, accurate!

Mass-Production Economies

In addition to its many other unique features, Helipot engineers have developed unusual techniques that permit mass-production economies in manufacturing the "Model J". Actual price depends upon the number of taps required, special features, etc. . . . but with all its unique features, you will find the "Model J" very moderate in cost.*

Wide Choice of Designs

The "Model J" Helipot is available in a wide selection of standard resistance ranges—50, 100, 1,000, 5,000, 10,000, 20,000, 30,000 and 50,000 ohms . . . in single- or double-shaft designs . . . with choice of many special features to meet virtually any requirement within its operating field.

*Write for Bulletin 107 which gives complete data and price information on the versatile "Model J" Helipot!

THE Helipot CORPORATION
South Pasadena, California

Field Offices: Boston, New York, Philadelphia, Rochester, Cleveland, Detroit, Chicago, St. Louis, Los Angeles and Fort Myers, Florida. Export Agents: Frotham Co., New York 18, New York.

A New Tube For HIGH-POWER VHF TV

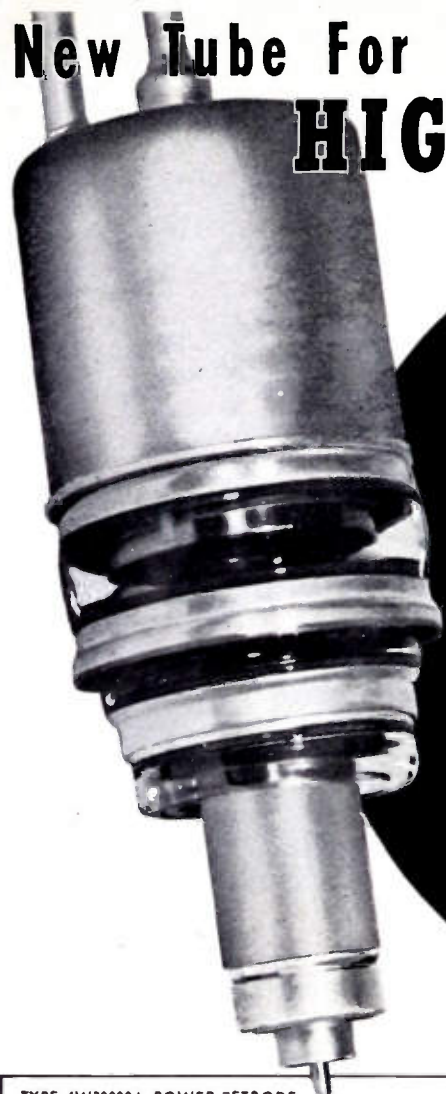

Eimac

4W20000A
Water-Cooled Power Tetrode

- ★ 20 Kw Peak Sync. Output
- ★ 5 Mc. Bandwidth
- ★ 216 Mc. Operation
- ★ LOW COST

TYPE 4W20000A POWER TETRODE	
CLASS-B LINEAR AMPLIFIER—TELEVISION SERVICE	
TYPICAL OPERATION (Per tube, 5-Mc. Bandwidth, 216 Mc.)	
Peak Synchronizing Level	
Load Impedance	400 Ohms
Effective Length of Plate Line	Quarter Wave
D-C Plate Voltage	5500 Volts
D-C Plate Current	7.1 Amps
D-C Screen Voltage	1000 Volts
D-C Screen Current	600 Ma.
D-C Grid Voltage	-310 Volts
Peak R-F Grid Input Voltage (approx.)	485 Volts
Plate Power Input	39 Kw.
Plate Dissipation	19 Kw.
Plate Power Output	20 Kw.

For the practical approach to high-power TV through channel 13, here is the tube . . . the new Eimac 4W20000A power tetrode.

Among the features of the 4W20000A are a unipotential cathode of thoriated tungsten heated by electron bombardment, a water-cooled anode rated at 20 kw dissipation, and coaxially arranged terminals.

This new tube's potential applications are not limited to TV service. Data on typical operation in class-C telegraphy or FM telephony as well as class-B linear TV amplifier service are included in a comprehensive data sheet . . . available for the asking.

Eitel-McCullough, Inc.
San Bruno, California
Export Agents: Frazar & Hansen, 301 Clay St., San Francisco, California

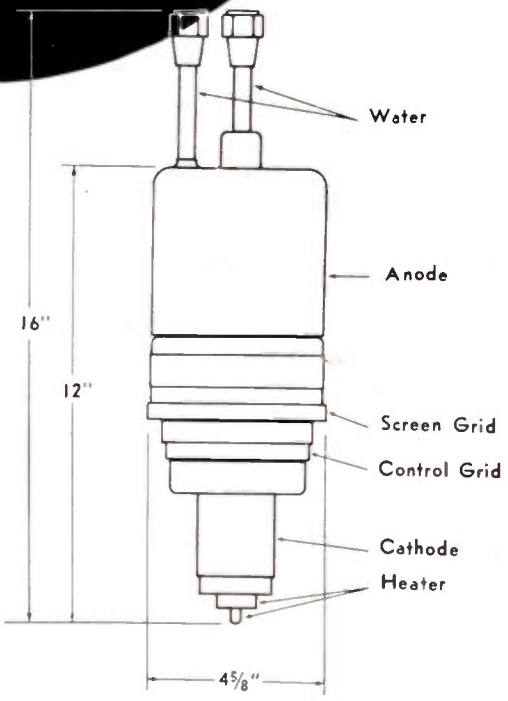

**SEE THE 4W20000A
at the March IRE Show, Booth 36**

PRODUCED BY THE MILLIONS

- by the top specialists in the ceramic field

Hi-Q

CERAMIC DISK CAPACITORS

Hi-Q Ceramic Disk Capacitors for by-passing, blocking, or coupling are being used by the millions by television receiver manufacturers who demand the utmost in performance.

Unit cost, time and labor may be saved by using several of the multiple capacity Hi-Q Disks where applicable in your television circuit. Multiple capacities having a common ground are available in standard units as shown in the chart below. Hi-Q Disks are coated with a non-hydroscopic phenolic to insure protection against moisture and high humidities. Hi-Q Disks like all other Hi-Q components assure you of the highest quality workmanship at the lowest possible cost.

Our Engineers are ready and willing to discuss the application of these highly efficient, dependable capacitors in your circuits. Write today for your FREE copy of the new Hi-Q Datalog.

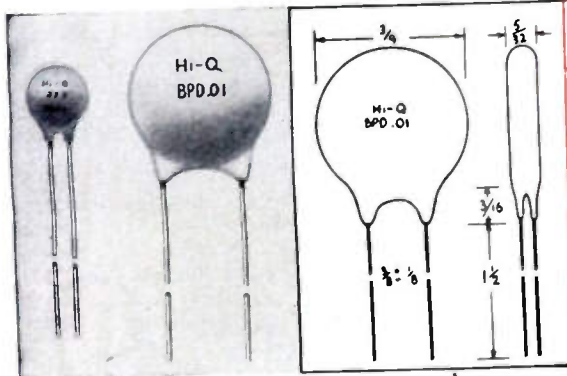

Hi-Q
COMPONENTS

Capacitors
Trimmers • Choke Coils
Wire Wound Resistors

BETTER 4 WAYS

✓ UNIFORMITY ✓ DEPENDABILITY
✓ PRECISION ✓ MINIATURIZATION

Type	A Diameter	B Lead Width	C Thickness
B.P.D. .00047	5/16" max.	3/16" + 1/16"	5/32" max.
B.P.D. .0008	5/16" max.	3/16" + 1/16"	5/32" max.
B.P.D. .001	3/8" max.	1/4" + 1/16"	5/32" max.
B.P.D. .0015	3/8" max.	1/4" + 1/16"	5/32" max.
B.P.D. .002	7/16" max.	1/4" + 3/8"	5/32" max.
B.P.D. .004	19/32" max.	1/4" + 3/8"	5/32" max.
B.P.D. .005	19/32" max.	1/4" + 3/8"	5/32" max.
B.P.D. .01	3/4" max.	3/8" + 1/8"	5/32" max.
B.P.D. 2x.001	19/32" max.	3/8" + 1/8"	5/32" max.
B.P.D. 2x.0015	19/32" max.	3/8" + 1/8"	5/32" max.
B.P.D. 2x.002	19/32" max.	3/8" + 1/8"	5/32" max.
B.P.D. 2x.003	3/4" max.	3/8" + 1/8"	5/32" max.
B.P.D. 2x.004	3/4" max.	3/8" + 1/8"	5/32" max.
B.P.D. 3x.0015	3/4" max.	3/8" + 1/8"	5/32" max.
B.P.D. 3x.002	3/4" max.	3/8" + 1/8"	5/32" max.

Insulation: Durez and Wax impregnated.
Leads: 22 gauge pure tinned dead soft copper.
Capacity: Guaranteed minimum as stamped.
All capacitance measurements made at 25°C at 1 KC at a test voltage not over 5 volts RMS.

Insulation Resistance: 7500 megohms min.
Power Factor: Max. 2.5% at 1 KC at not over 5 volts RMS.
Test Voltage: 1500 volts D. C.

JOBBERS — ADDRESS: 740 Belleville Ave., New Bedford, Mass.

Hi-Q

Electrical Reactance Corp.

OLEAN, N. Y.

SALES OFFICES: New York, Philadelphia
Detroit, Chicago, Los Angeles

PLANTS: Olean, N. Y., Franklinville, N. Y.
Jessup, Pa., Myrtle Beach, S. C.

60

now! a laminated plastic
designed especially for
60 cycle work!

FORMICA'S

new

Z-80

combining 3 important properties
in one grade:

- 1 High arc resistance
- 2 Good dimensional stability
- 3 Low power loss at 60 cycles

Made of a coarse weave fabric, bonded with arc resistant resin. Has good punching and excellent machining qualities. Can be laminated-molded to a wide variety of shapes. Available in sheet form from 1/32" to 1" thick, natural color, semi-gloss finish. You'll find plenty of uses for this useful new Formica grade . . . so send for your free Z-80 sample and complete engineering data today.

THE FORMICA COMPANY
4698 SPRING GROVE AVENUE
CINCINNATI 32, OHIO



News—New Products

These manufacturers have invited PROCEEDINGS readers to write for literature and further technical information. Please mention your I.R.E. affiliation.

Aircraft Signal Generator

A signal generator for complete testing of airborne omnirange and localizer receivers in aircraft or on the bench has been introduced by the Aircraft Radio Corp., Boonton, N. J.

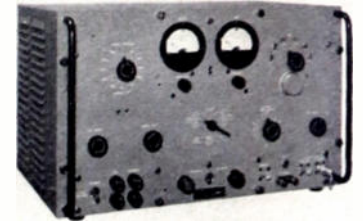

The unit, designated as Type H-14, has a frequency range of 108 to 118 Mc, and can be used for all necessary quantitative bench tests. It provides facilities for testing 24 omni courses, plus left-center-right checks on both amplitude and phase localizers. The output for outside checks is 1 volt into 52 ohm line, and for bench checks, 0 to 10,000 μ v.

New Tape Recorder

A high-fidelity magnetic tape recorder, with a range of 15,000 cps on half-track tape recorded at 7 1/2 inches per second is in production at Ampex Electric Corp., 131 Howard Ave., San Carlos, Calif.



The capacity of this Model 400 is 132 minutes on a single 10-inch reel.

Other features include three magnetic heads shielded in a single housing, a built-in vu meter, and a single control switch for forward, rewind, and record. The machine also provides 15 inches per second tape speed by simply turning a switch. At 7 1/2 inches per second flutter and wow is less than 0.25 per cent; frequency response is ± 4 db, 30 to 15,000 cps. At 15 inches per second flutter and wow is less than 0.2 per cent; frequency response is ± 2 db, 50 to 15,000 cps.

(Continued on page 22A)

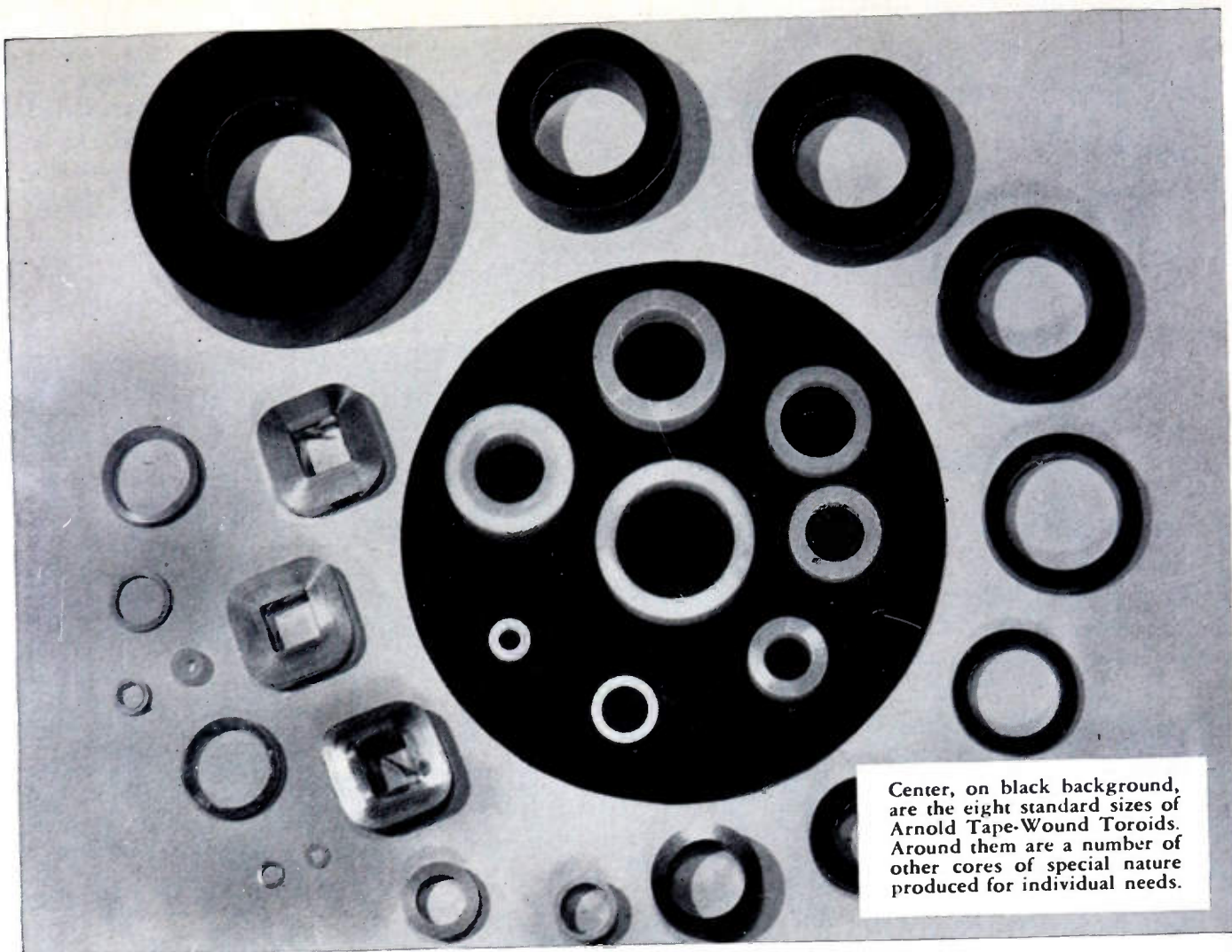

Center, on black background, are the eight standard sizes of Arnold Tape-Wound Toroids. Around them are a number of other cores of special nature produced for individual needs.

ARNOLD TAPE-WOUND TOROIDAL CORES

of DELTAMAX
4-79 MO-PERMALLOY
SUPERMALLOY*

APPLICATIONS

MAGNETIC AMPLIFIERS
PULSE TRANSFORMERS
NON-LINEAR RETARD COILS
and TRANSFORMERS
PEAKING STRIPS, and many other
specialized applications.

RANGE OF SIZES

Arnold Tape-Wound Toroids are available in eight sizes of standard cores—all furnished encased in molded nylon containers, and ranging in size from 1/2" to 2 1/2" I.D., 3/4" to 3" O.D., and 1/8" to 1/2" high.

RANGE OF TYPES

These standard core sizes are available in each of the three magnetic materials named, made from either .004", .002" or .001" tape, as required.

In addition to the standard toroids described at left, Arnold Tape-Wound Cores are available in special sizes manufactured to meet your requirements—toroidal, rectangular or square. Toroidal cores are supplied in protective cases.

* Manufactured under licensing arrangements with Western Electric Company.

W&D 3182

THE ARNOLD ENGINEERING COMPANY



SUBSIDIARY OF ALLEGHENY LUDLUM STEEL CORPORATION

General Office & Plant: Marengo, Illinois

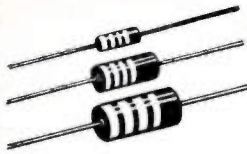

LITTLE DEVIL COMPOSITION RESISTORS

Resistance and wattage are clearly marked on every one of these tiny, rugged insulated composition resistors. Three sizes: 1/2, 1 and 2-watt in all RMA resistances. Tolerance $\pm 5\%$ and $\pm 10\%$.



CLOSE CONTROL RHEOSTATS

Insure permanently smooth, close control. Widely used in industry. All ceramic, vitreous enameled; 25, 50, 75, 100, 150, 225, 300, 500, 750, and 1000-watt sizes.



DUMMY ANTENNA RESISTORS

For loading transmitters or other r.f. sources. New, rugged, vitreous-enameled units are practically non-reactive within their recommended frequency range. 100 And 250-watt sizes, 52 to 600 ohms, $\pm 5\%$.

TYPE AB POTENTIOMETER



It's quiet! This Type AB Potentiometer has a resistance unit that's solid molded. As a result, the noise level often becomes less with use. Has a 2-watt rating, good safety factor.



BROWN DEVIL WIREWOUND RESISTORS

Dependable vitreous-enameled units, in a size small enough to fit most installations. Easily mounted by 1 1/2" tinned wire leads. Three sizes: 5, 10, and 20 watts. Tolerance $\pm 10\%$.



DIVIDOHM ADJUSTABLE RESISTORS

These wirewound resistors, with one or more adjustable lugs, provide a convenient means of obtaining odd resistance values. Stock units made in 10, 25, 50, 75, 100, 160, and 200-watt sizes, in many resistance values.

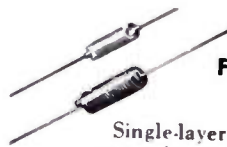

RADIO FREQUENCY CHOKES

Single-layer wound on low power-factor steatite or bakelite cores, with moistureproof coating. Seven stock sizes for all frequencies. 3 to 520 mc. Two units rated 600 ma, others rated 1000 ma.

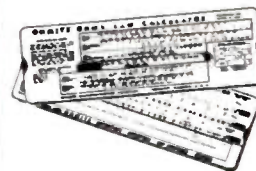

OHM'S LAW CALCULATOR

25¢

Favorite of engineers everywhere! Solves Ohm's Law problems with one setting of the slide. Also has parallel resistance and slide rule scales.

To countless thousands of technical men all over the world—engineers, designers, and servicemen—the name OHMITE has become synonymous with *dependability*. There is good reason for this overwhelming opinion. Every OHMITE product is carefully designed and constructed to give *extra* performance and long life under severe service conditions. When you need dependable resistance components, play safe and specify OHMITE.

Write on Company letterhead for CATALOG 40



OHMITE MANUFACTURING CO., 4861 Flournoy St., Chicago 44, Ill.

Be Right with **OHMITE** RHEOSTATS RESISTORS TAP SWITCHES

Only **A SMALL PIECE OF**
the pie ...



In the price of the El-Menco CM-15 capacitor, the cost of materials is small — for few materials are used. It's the know-how of putting these minute quantities of materials together that really counts.

Tiny as it is, the El-Menco CM-15 high-capacity fixed mica condenser exceeds the strict requirements of the Army and Navy. It is tested for dielectric strength at double its working voltage *before* leaving the factory — for insulation resistance and capacity value. You can *always* depend on this mighty midget — even under the most critical operating conditions and climate extremes.

**ALWAYS SPECIFY
EL-MENCO CAPACITORS**

COST OF
PRODUCTION

MATERIALS

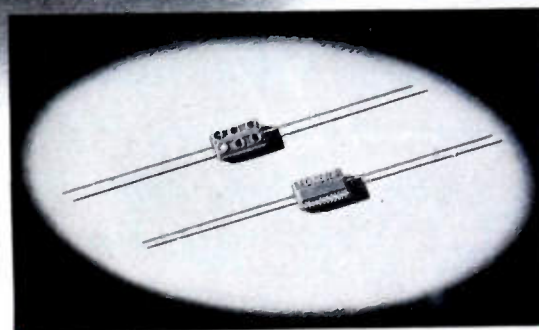

CM-15 MINIATURE CAPACITOR

Actual Size 9/32" x 1/2" x 3/16"
For Television, Radio and other Electronic Applications.
2 mmf. to 420 mmf. cap. at 500v DCw.
2 mmf. to 525 mmf. cap. at 300v DCw.
Temp. Co-efficient \pm 50 parts per million per degree C for most capacity values.
6-dot color coded.

THE ELECTRO MOTIVE MFG. CO., Inc.
WILLIMANTIC CONNECTICUT

Write on your firm letterhead for
Catalog and Samples.



MOLDED MICA **El-Menco** **MICA TRIMMER**
CAPACITORS

FOREIGN RADIO AND ELECTRONIC MANUFACTURERS COMMUNICATE DIRECT WITH OUR EXPORT DEPT. AT WILLIMANTIC, CONN. FOR INFORMATION.
ARCO ELECTRONICS, INC. 103 Lafayette St., New York, N. Y.—Sole Agent for Jobbers and Distributors in U.S. and Canada

A Better Product through "Sound" Research

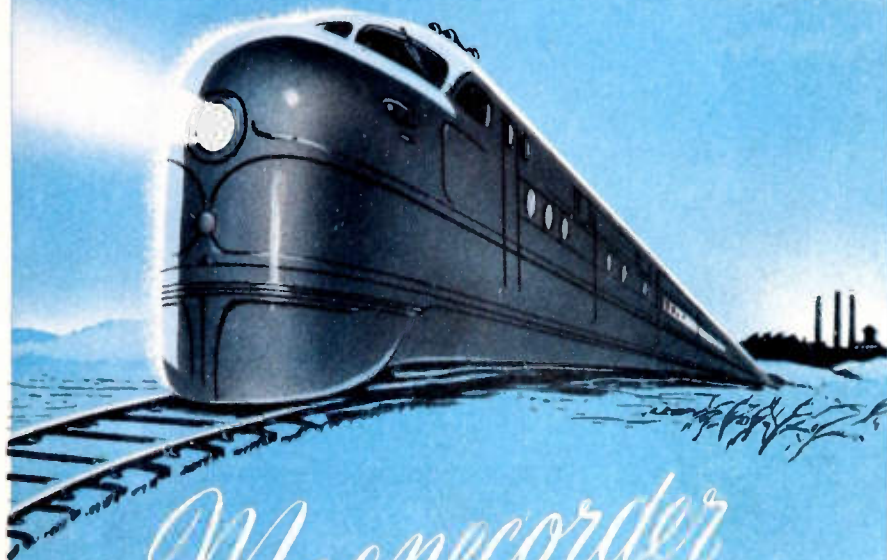

Magnecorder
High Fidelity Tape Recorders For Industry



**NOISE ANALYSIS • PROCESS CONTROL
VIBRATION TESTS • TELEMETERING**

Used by more engineers
than all other professional
tape recorders combined

Magnecord, INC.

360 NORTH MICHIGAN AVENUE
CHICAGO 1, ILLINOIS

Write for NEW CATALOG

Magnecord, Inc., Dept. P-2
360 N. Michigan Ave., Chicago 1, Ill.
Send me further information on Magnecord
tape recordings for industrial "Sound" Research.

Name.....
Company.....
Address.....
City..... Zone..... State.....

News—New Products

These manufacturers have invited PROCEEDINGS readers to write for literature and further technical information. Please mention your I.R.E. affiliation.

(Continued from page 18A)

New Amplifier

A new wide-range, low-distortion amplifier system A-20-5 is available from The Electronic Workshop, 351 Bleecker St., New York 14, N. Y.

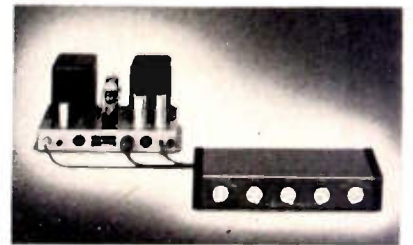

The four input channels, including an equalizer-preamplifier for any of the available magnetic phono cartridges, have independent level adjustments. A four-position treble cut-off filter reduces high-frequency noise and distortion. A loudness-compensated volume control is provided, as well as separate bass and treble controls giving 18-db boost or cut. The treble control equalizes for high-frequency recording characteristics.

A noise suppressor can be conveniently connected into the system to be effective on all channels. A recorder output which is unaffected by settings of the tone and volume controls is included.

The 18 db of feedback in the amplifier affords excellent loudspeaker damping and long tube life. Distortion at 20 watts is less than 1 per cent. Full power is delivered over the entire audio range.

A somewhat simplified system, the S-20 is also available.

Television Deflector Yoke Core

A high-permeability core for deflection of wide-angle, large-screen, kinescopes is available from Westinghouse Electric Corp., P. O. Box 2099, Pittsburgh 30, Pa.

Made of Hipersil, a cold-rolled, grain-oriented electrical steel, the core has low reluctance at all flux densities.

The core is wound and bonded in circular form from a continuous strip of 5-mil material. It is then cut into two "C" shaped pieces for assembly around the deflection coils. The firm claims that the extremely thin laminations plus superior magnetic characteristics of the steel result in improved linearity and sharper pictures. The cores are rugged and completely free from magnetic instability due to change in temperature.

The core is available in sizes to suit the application.

(Continued on page 23A)

News—New Products

These manufacturers have invited PROCEEDINGS readers to write for literature and further technical information. Please mention your I.R.E. affiliation.

(Continued from page 22A)

Plug-In Electronic Chassis

To meet a variety of requirements for compact, lightweight electronic assemblies, Avion Instrument Corp., 121 E. 24 St., New York 10, N. Y. has designed a universal electronic chassis for use in servo-mechanisms, pulse and flip-flop circuits, analog computers, and similar devices. Up to eight subminiature tubes can be mounted and wired.

The assembly mounts in a metal case, filled with a potting compound, which provides mechanical support for the components. Input and output leads are brought to a standard octal tube base, for connection to associated equipment. Operating weight is 12 ounces.



The chassis is designed to operate in temperatures ranging from -50°C to $+80^{\circ}\text{C}$. It meets specification AN-E-19 with respect to condition of altitude, humidity, and vibration.

Typical assembly is a direct-coupled basic amplifier having closed-loop characteristics as follows: output, with no load, -125 to 275 volts and, with 10^4 ohm load, -40 to 40 volts; output impedance, looking into amplifier, 1 ohm (approx.); linearity, variation over entire output range, less than 10 mv; gain is determined by choice of external resistors, maximum useful gain, limited by drift, 25 , (approx.); drift, referred to input, 20 mv (approx.); frequency response 3 db down at 100 cps; operating voltages must be regulated to ± 1 per cent.

Video Distribution Amplifier

The Type 1311 video distribution amplifier which consists of five separate isolation amplifiers and an electronically regu-

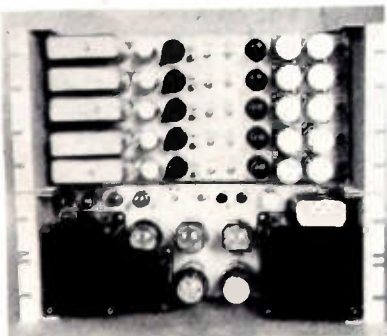

lated power supply is in production at Tel-Instrument Co., Inc., 50 Paterson Ave., East Rutherford, N. J.

(Continued on page 74A)

TEFLON

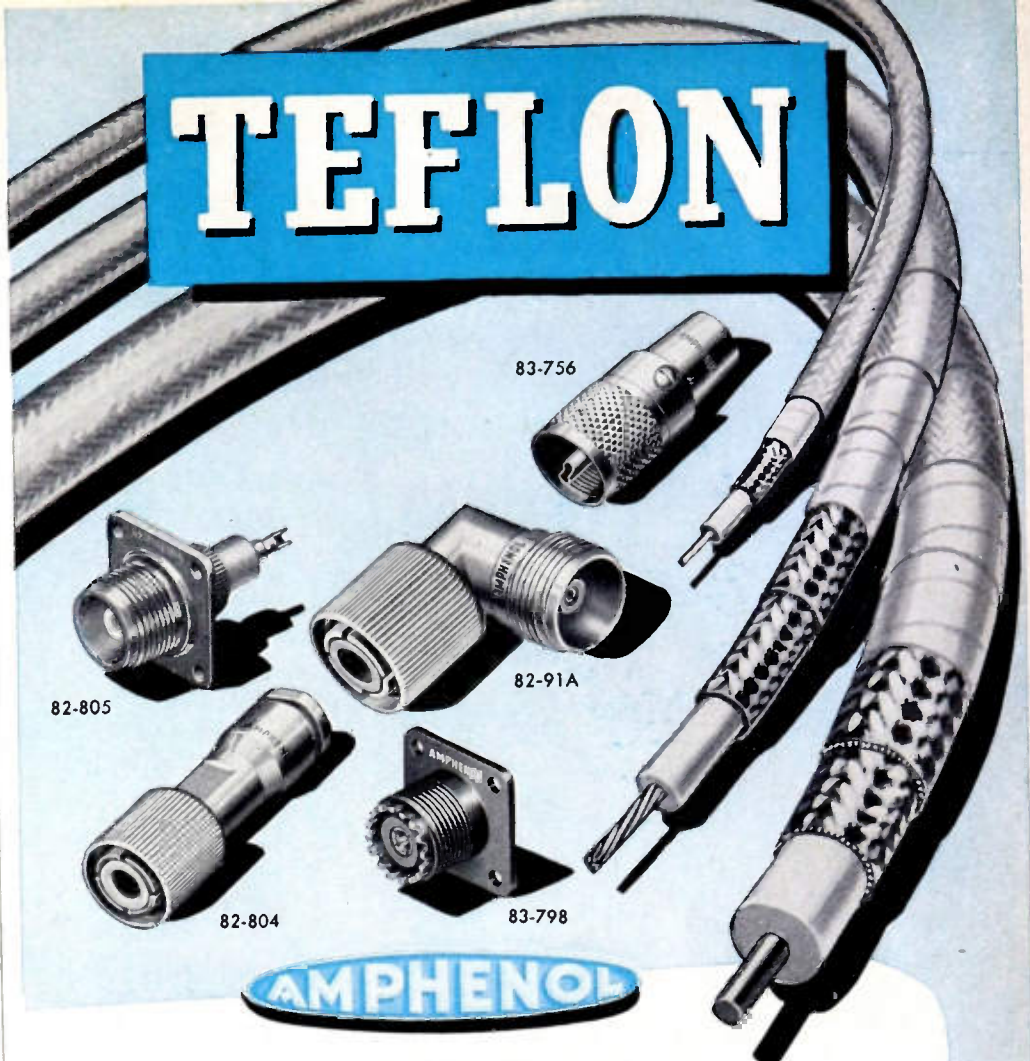

CABLES

AMPHENOL coaxial cables made with Teflon dielectric have low loss and perform satisfactorily at temperatures as high as 500°F . Covering the Teflon dielectric are two silver coated shields and two wrappings of Teflon tape. The jacket consists of two fibre glass braids impregnated with silicone varnish which is oven baked to provide maximum moisture and abrasion resistance.

CONNECTORS

Because impedance specifications of Amphenol RF Connectors can be depended on, no line unbalance is inserted, nor is the standing-wave ratio increased. Amphenol RF Connectors meet the exacting requirements of laboratory applications—have longer leakage paths, lower loss.

The 82 series connectors illustrated are weather-proof type HN connectors for use with 50 ohm cable. These connectors have full 4Kv . rating when used with Silicone Compound and may be used with 70 ohm cables when impedance is not critical.

The 83 series UHF connectors illustrated are low cost general purpose connectors ideal for laboratory applications. Not constant impedance, but suitable for general RF transmission below 160 megacycles.

Teflon inserts are standard on the connectors illustrated and will be supplied with any AMPHENOL RF connector on special order.



AMERICAN PHENOLIC CORPORATION

1834 SOUTH 54th AVENUE

CHICAGO 50, ILLINOIS

SHALLCROSS MATCHES YOUR Precision Resistor Requirements!

Something New

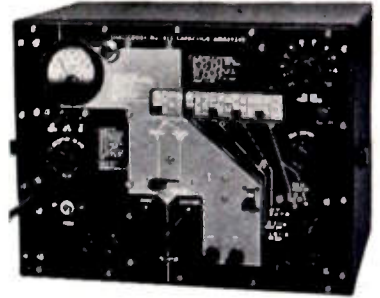

WIDE-RANGE, DIRECT READING CAPACITOR ANALYZER

A laboratory-type Capacitor Analyzer meeting the need for a highly accurate, wide-range, direct-reading measuring instrument capable of determining the essential characteristics of capacitors has been announced by the Shallcross Manufacturing Co. This versatile instrument will determine capacitance values between 5mmf. and 12,000 mfd.; insulation resistance from 1.1 to 12,000 megohms; also leakage current, dielectric strength, and percentage power factor. A divided panel carrying an outline of the operating instructions makes it readily possible to use the instrument without reference to an instruction book. The Shallcross analyzer operates on 110 volt, 60-cycle alternating current. Literature giving full details will gladly be sent on request to the Shallcross Manufacturing Company, Collingdale, Pa.

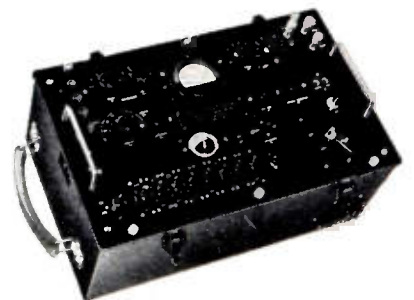

MULTI-PURPOSE TRANSMISSION TEST SET

In addition to measuring the electrical characteristics of telephone lines and equipment the new Shallcross multi-purpose transmission test set may be used for efficiency tests on local and common battery telephone lines and sets, carbon microphones, receivers, and magnetic microphones. It also provides a fast, efficient means of testing capacitors, generators, ringers, insulation resistance, dials, and continuity. Key switches and dials are used to select and control the test circuits. The 693 Transmission Test Set is powered by external batteries. It features compact, substantial construction and is fully portable, thus making it ideal for either field or laboratory use. Details may be obtained from the Shallcross Manufacturing Company, Collingdale, Pennsylvania.

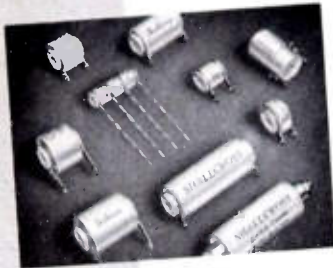

... for real dependability on STANDARD INDUSTRIAL USES

...over 40 economical standard types and sizes, each available in numerous mechanical and electrical adaptations. Write for Shallcross Data Bulletin R3A.



... for MINIATURIZATION PROGRAMS

For years, Shallcross has led the way in the production of truly dependable close-tolerance, high-stability resistors in miniature sizes. Standard and hermetically sealed types are available.



... for SPECIAL ASSEMBLIES

Shallcross regularly produces hundreds of special precision resistor types including precision power resistors, resistors with axial or radial leads and multi-unit strip resistors (illustrated) with either inductive or non-inductive windings.

... for JAN EQUIPMENT

Shallcross is in constant touch with the latest military precision resistor requirements. The present line includes 13 types designed for JAN characteristic "B" and 4 types for characteristic "A".

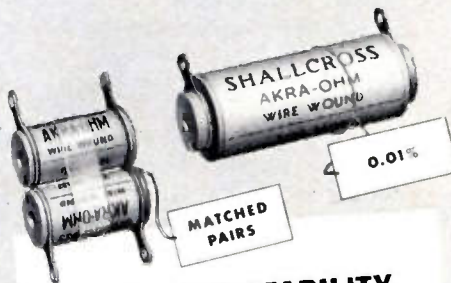

... for HIGH-STABILITY APPLICATIONS

Many Shallcross Akra-Ohm resistors are available with guaranteed tolerance to 0.01% and stability to 0.003%. Matched pairs and sets are supplied to close tolerances.

SHALLCROSS

SHALLCROSS MANUFACTURING COMPANY
COLLINGDALE, PA.

INCREASED ALSiMAG[®] PRODUCTION

PLANT NO. 4

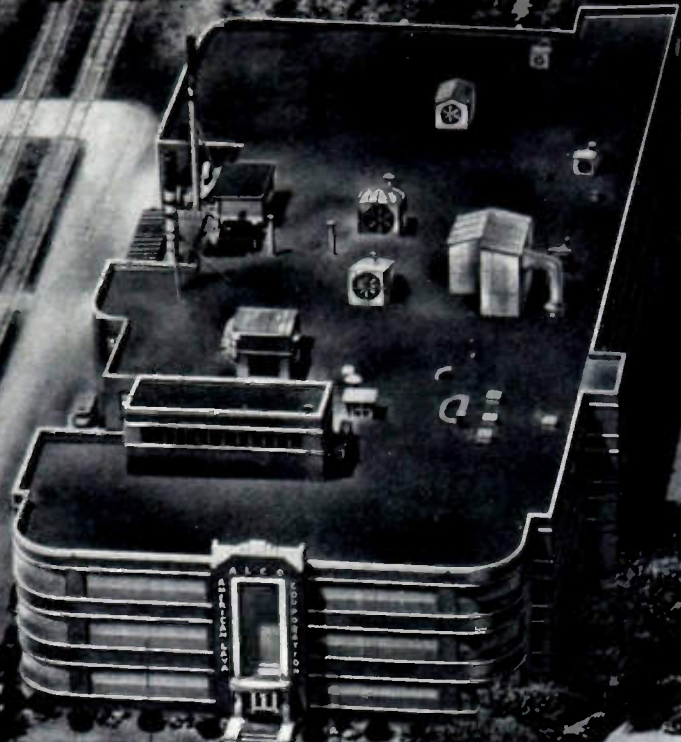

MAIN OFFICE AND
PLANT NO. 1



PLANT NO. 2
WILLIAMS ST.



PLANT NO. 3

Production facilities, already the largest in the steatite industry, are being rapidly expanded to take care of your needs. Plant No. 3 is just going into production. All plants are running 24 hours a day, 7 days a week. Plant No. 5 is on the way.

Current deliveries are not satisfactory to you or to us. We were swamped with rearmament orders for the last quarter of 1950. But great strides are being made toward taking care of your requirements for ALSiMag custom made technical ceramics.

Every effort is being made to keep American Lava Corporation your most dependable source for quality and for delivery according to promise.

AMERICAN LAVA CORPORATION

49TH YEAR OF CERAMIC LEADERSHIP

CHATTANOOGA 5, TENNESSEE

OFFICES: METROPOLITAN AREA: 671 Broad St., Newark, N. J., Mitchell 2-8159 • CHICAGO, 228 North LaSalle St., Central 6-1771
PHILADELPHIA, 1649 North Broad St., Stevenson 4-2823 • LOS ANGELES, 232 South Hill St., Mutual 9076
NEW ENGLAND, 28-B Brattle St., Cambridge, Mass., Kirkland 7-4498 • ST. LOUIS, 1123 Washington Ave., Garfield 4959



HEAVY, LESS EFFICIENT, and slower to assemble, was the original Weller Soldering Gun composed of the parts shown. Compare these with the fewer parts at right in the new Gun, and you'll readily see why the new streamlined Weller is so popular.



THE NEW WELLER SOLDERING GUN handles 250 watts; heats, ready for use, in five seconds; has longer range to get into the tight spots, and is equipped with spot light. Uses current only when trigger is operated. It is assembled faster. Requires no bolts or nuts. The $\frac{3}{8}$ " Revere Copper Rod that replaces the secondary coil in the transformer is sheared, flattened, and bent at right angles in a 200-ton press in a single operation.



COPPER TREATS YOUR PRODUCT BETTER WHEN YOU

Control Your Temper

Revere Copper Rod replaces Secondary Coil in Soldering Gun Transformer... reduces number of parts, makes for a speedier, more efficient assembly... also makes possible a lighter, more compact unit of increased capacity.

WHEN the Weller Manufacturing Company, Easton, Pa., was completing the development of its new electric soldering gun, they were confronted with this problem: The $\frac{3}{8}$ " Revere Copper Rod used to replace the secondary coil in the transformer had to maintain its rigidity yet be sufficiently soft so that during the shearing, coining, and bending operations there would be no breaking or splitting of the rod.

Revere's Technical Advisory Service recommended a certain temper copper rod. It was discovered that Weller was getting a twist in the rod when it was installed in the assembled gun. Other tempers were tried

and tested. Then a copper rod of a slightly harder temper than the first was recommended. That was it! Proper temper was the key. Proper temper was also the key to the .291 dia. copper rod used for the Soldering tip itself. For this, too, had to retain its rigidity and yet remain soft enough to be coined, punched, and formed without fracture.

"In addition to being extremely helpful in arriving at the proper tempers, Revere also recommended that we specify our rod in multiple lengths, and thus save considerably on scrap. They were also helpful in solving the problem of attaching the brass sleeve to the secondary rod in

our Soldering Gun," the Weller Manufacturing Company tells us.

So you see, Revere's interest in your problem does not stop with the recommendation of its products. Perhaps Revere can help you. Why not take your current problem to the nearest Revere Sales Office and see?

REVERE

COPPER AND BRASS INCORPORATED

Founded by Paul Revere in 1801
230 Park Avenue, New York 17, New York

Mills: Baltimore, Md.; Chicago, Ill.; Detroit, Mich.; Los Angeles and Riverside, Calif.; New Bedford, Mass.; Rome, N. Y.
Sales Offices in Principal Cities, Distributors Everywhere.

THIS IS THE REASON CLARE SEALED RELAYS

Can't Leak!

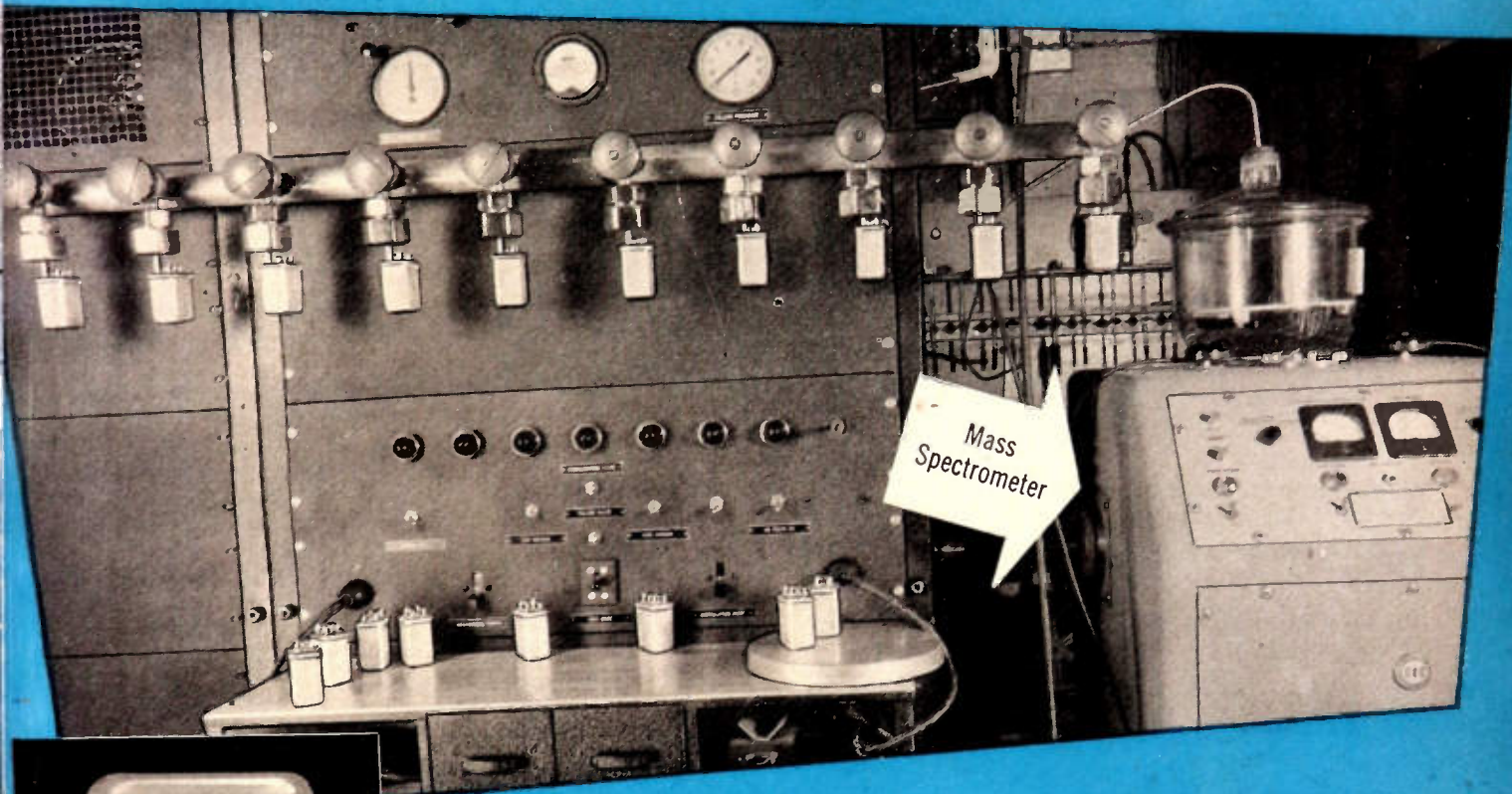

Cut-away View
CLARE Type "K"
Hermetically Sealed Relay

● Pictured here are ten CLARE Sealed Relays from which every trace of moisture and gas is being removed by a high vacuum pump.

After the first pumping, the enclosures are flushed with dry nitrogen and again pumped down to a few microns pressure. While under this extreme vacuum, enclosures and seals are tested for leaks by means of the mass spectrometer (right). This device can detect a leak so small that it would take 31 years for one cubic centimeter of air to pass through it.

Containers are next filled with dry nitrogen to a pressure of at least one atmosphere. When the evacuating tubes are pinched off,

the enclosures are hermetically sealed.

More than forty different series of CLARE hermetically sealed relays . . . immune to every type of climatic or environmental conditions . . . are now available to relay users. Innumerable variations of coil and contact specifications are possible.

If your relay requirement calls for the utmost in relay dependability under difficult operating conditions, get in touch with the CLARE sales engineer nearest you or C. P. CLARE & CO., 4719 West Sunnyside Avenue, Chicago 30, Illinois. In Canada: Canadian Line Materials Ltd., Toronto 13. Cable address: CLARELAY.

Write for 36-page Clare Bulletin No. 114

CLARE RELAYS...

First in the Industrial Field

SIGNAL GENERATORS by

AIRCRAFT RADIO CORPORATION

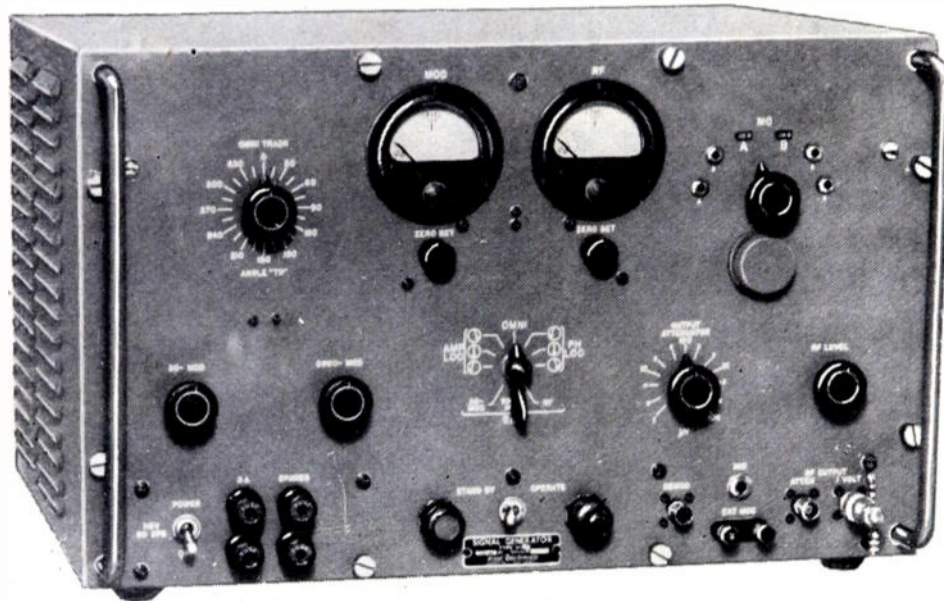

TYPE H-14

108-118 MEGACYCLES

Tests OMNI Receiving Units
in Aircraft or on the Bench

Checks on:

- 24 Omni courses
- Left-center-right on Phase-localizer
- Left-center-right on Amplitude-localizer
- Omni course sensitivity
- To-From and Flag-alarm operation
- All necessary quantitative bench tests

The Type H-14 Signal Generator, 108-118 megacycles, provides a standard signal source for the complete testing of VHF airborne omnirange and localizer receivers in aircraft or on the bench. It provides for testing 24 omni courses, plus left-center-right checks on both amplitude and phase localizers. Aircraft may be checked out

quickly and accurately just before take-off. RF output for ramp checks, 1 volt into 52 ohm line and for bench checks, 0-10,000 microvolts. Provision for external voice or other modulation. AF output available for bench maintenance and trouble shooting.

Price: \$885.00 net, f.a.b. Banton, N. J.

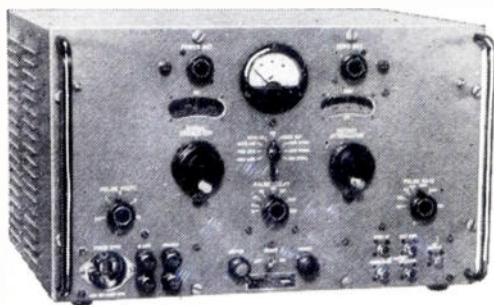
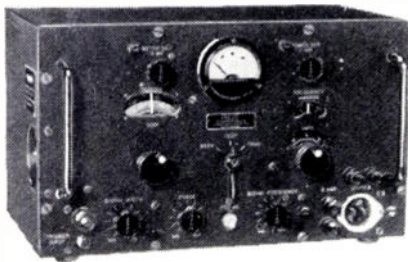

ARC Communication and Navigation Equipment



Aircraft Radio Corporation also manufactures LF and VHF airborne communication and navigation equipments—all CAA-Type-Certificated for scheduled air-carrier use or for those whose type of flying requires a high degree of reliability and performance. Equipment consists of light, small units which can be combined to provide the required operation, whether it be the 1 Receiver/1 Transmitter (15 pound) installation in a 2-place helicopter, or a 3 Receiver/2 Transmitter/ VHF Omni installation (70 pounds) in larger 2-engine aircraft.

TYPE H-10—Microwave Test Set; 23,500-24,500 Megacycles

Provides source of cw or pulse frequency-modulated RF, power level -37 to -90 dbm. RF power meter measures levels from +7 to +30 dbm. Frequency meter for measuring output or input RF accurate to better than 20 mc. Primary purpose of the H-10 is to

measure receiver sensitivity, bandwidth, frequency, recovery time, and overload characteristics, plus transmitter power and frequency. Recommended as a standard source of RF for research or production testing. Equal to military TS-223/AP.

Price: \$1692.00 net, f.a.b. Banton, N. J.

TYPE H-12—VHF Signal Generator; 900-2100 Megacycles

Provides source of cw or pulse amplitude-modulated RF, power level 0 to -120 dbm. Internal pulse circuits with controls for width, delay, and rate, and provision for external pulsing. Single

dial tuning, frequency calibration accurate to better than 1%. Built to Navy specifications for research and production testing. Equal to military TS-419/U.

Price: \$1950.00 net, f.a.b. Banton, N. J.



WRITE TODAY for descriptive literature on A.R.C. Signal Generators or airborne LF and VHF communication and navigation equipments, CAA Type Certificated for transport or private use.

Aircraft Radio Corporation

Bonton, N. J.

Dependable Electronic Equipment Since 1928

Look into this **PROFESSIONAL Telecast Projector**

*and see years of
Dependable Service*

The GPL Model PA-100 — a 16-mm Studio Projector with the basic features and performance reliability of the famous Simplex 35-mm Theatre Projectors.

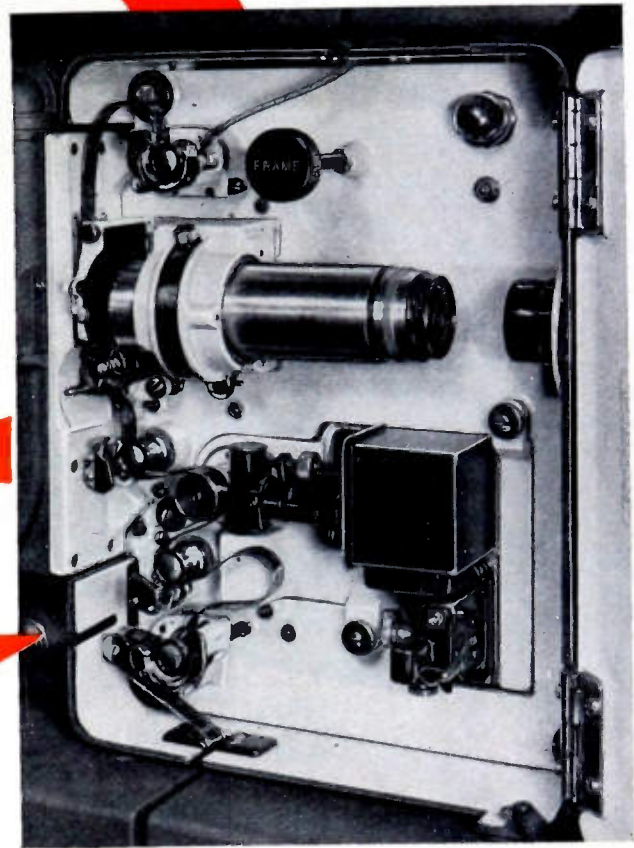

Sharper Pictures . . . Finer Sound From Any Film in Your Studio

The importance of 16-mm film in television programming has called for new standards of projection quality and dependability. The GPL Model PA-100 is the first projector designed and built specifically for television studio use. It is a heavy-duty film chain projector for operation with any full-storage type film pick-up.

The professional, sprocket-type intermittent, similar to that used in the finest 35-mm equipment, is quiet and trouble-free. It provides a vertical stability of better than 0.2% over years of service. Film is protected — tests show more than 4,000

passages without noticeable film wear.

The high quality optical system resolves better than 90 lines per mm, with illumination so uniform that corner brightness is at least 90% of center. With a 1,000 watt light source, the projector delivers 100 foot-candles to the camera tube. The sound system provides a frequency response truly flat to 7,000 cps, with flutter less than 0.2%.

The Model PA-100 is one of a complete line of GPL 16-mm television studio and theatre projectors built to highest 35-mm standards.

WRITE, WIRE OR PHONE FOR DETAILS

General Precision Laboratory

INCORPORATED

PLEASANTVILLE NEW YORK

TV Camera Chains • TV Film Chains • TV Field and Studio Equipment • Theatre TV Equipment

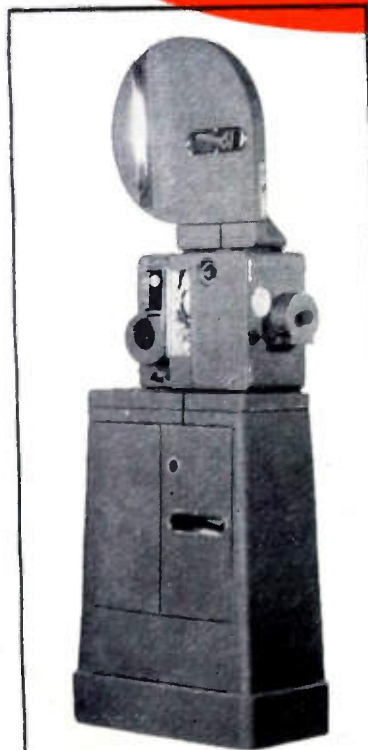

The Model PA-100 is a 16-mm projector consistent with the professional character of television station operation. Its enclosed 4,000 foot film magazine provides for 110 minutes of projection — an entire feature.



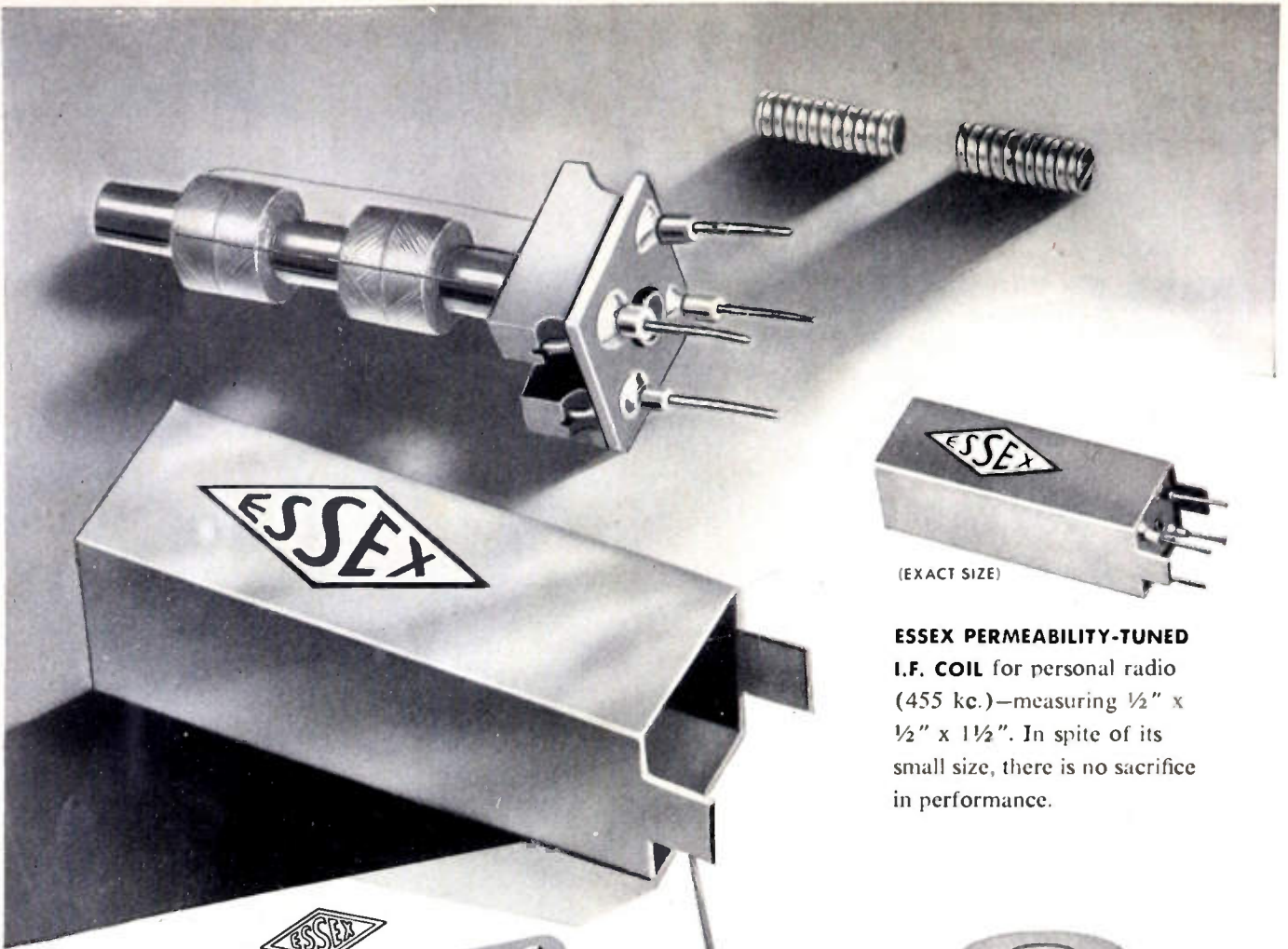

ESSEX ELECTRONICS
 Manufacturers of coils, chokes and transformers
 STATION STREET AND SPRINGFIELD AVENUE
 BERKELEY HEIGHTS, N. J. — SUMMIT 6-5432

Antara Products Division
 General Dyestuff Corporation
 435 Hudson Street
 New York 14, N. Y.

Gentlemen:

Miniaturization is a word that has become ever more important in our business. Over the past four years we have received one assignment after another of this type. The solutions to these problems do not always go by formula; they are not exactly simple. But -- on each and every occasion -- G A & F Carbonyl Iron Powders have been one of our major tools in the successful completion of these assignments.

A typical application was for the translation receivers which permit a United Nations delegate to select the language in which he wishes to hear any talk....Another was for the tuning coils on a hearing-aid, radio-receiving attachment. Another was for I.F. coils for a tiny personal receiver. And the nation's armament program -- to which we hope we are making full contribution -- calls for sub-miniature coils. These, too, we are developing with the help of your product.

At all times, our design work is aimed at top quantity production of top quality items. In every assignment of this type, we rely on the fully dependable properties of Carbonyl Iron Powders.

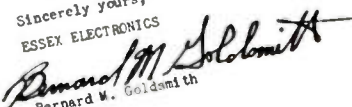
Sincerely yours,
 ESSEX ELECTRONICS

 Bernard M. Goldsmith
 President



(EXACT SIZE)

ESSEX PERMEABILITY-TUNED I.F. COIL for personal radio (455 kc.)—measuring 1/2" x 1/2" x 1 1/2". In spite of its small size, there is no sacrifice in performance.



ESSEX PERMEABILITY-TUNED R.F. TRANSFORMER for United Nations translation receiver—measuring 7/8" in diameter and 5/8" in height. Same type of construction has been made in 262 kc. I.F. Transformer—measuring 1/2" x 1/2".

G A & F Carbonyl

Each and every problem of **MINIATURIZATION** solved with the help of **CARBONYL IRON POWDERS**

Essex Electronics ranks today as one of the major suppliers of coils to the leading makers of receiving sets. Their reputation is based upon sound engineering and efficient production. With ten years of experience in this field, Essex Electronics testifies that G A & F Carbonyl Iron Powders have been one of the major tools in the successful completion of their many assignments.

Other makers—of both cores and coils—have testified that *it costs less* to work with these top quality materials and that major gains are effected in both weight reduction and increased efficiency. We urge you to ask your core maker, your coil winder, your industrial designer, how G A & F Carbonyl Iron Powders can improve the performance of the equipment you manufacture. It will cost you nothing to get the facts.

THIS FREE BOOK — fully illustrated, with performance charts and application data — will help any radio engineer or electronics manufacturer to step up quality, while saving real money. Kindly address your request to Department 22.



ANTARA® PRODUCTS
DIVISION OF
GENERAL DYESTUFF CORPORATION
435 HUDSON STREET • NEW YORK 14, NEW YORK

Iron Powders . . .



RCA PREFERRED-TYPE RECEIVING TUBES
Miniature types are shown in italics

RECTIFIERS and DIODE DETECTORS	CONVERTERS	AMPLIFIERS, OSCILLATORS & MIXERS						OUTPUT AMPLIFIERS
		Triodes			Pentodes			
		Single	Twin	With Diodes	Sharp Cutoff	Remote Cutoff	With Diode	
1B3-GT	1R5	6C4	6J6 6SC7 6SN7-GT	6AQ6 6AV6 6BF6	104	6AU6 6CB6 6SJ7	174 6BA6 6BJ6	354 3V4 6AQ5 6AU6-GT 6BG6-G 6K6-GT 6L6-G 6V6-GT
5U4-G 5Y3-GT	6BA7 6BE6		12AU7 12AX7	12AV6		12AU6	12BA6	
6AL5 6W4-GT 6X4	12BA7 12BE6							35CS 50CS
12AL5 35W4 117Z3								



THE FOUNTAINHEAD OF MODERN TUBE DEVELOPMENT IS RCA

Performance-Proved in active duty

For civilian and military electronic designs . . . RCA preferred-type receiving tubes offer these important advantages . . .

FLEXIBILITY—RCA *preferred-type* receiving tubes are chosen for the advantages they offer from engineering and equipment production viewpoints. They cover an extremely wide variety of tube applications in civilian and military equipment...and offer the engineer flexibility in circuit design.

PERFORMANCE—These types have demonstrated their reliability in equip-

ment of widely divergent designs. Proved in service, they are the logical types for future designs.

ECONOMY—This group of 44 tube types represents *more than half* of RCA's current receiving tube volume. By concentrating production on these few types having wide application, substantial savings are realized in manufacturing costs which are passed on to

customers . . . and quality and performance capability are sustained at a high level.

STANDARDIZATION—By concentrating on RCA preferred receiving-tube types, the equipment manufacturer also benefits by his ability to standardize on component parts . . . resulting in substantial purchasing and stocking economies.



RADIO CORPORATION of AMERICA
ELECTRON TUBES

HARRISON, N. J.

I. S. Coggeshall
President

Jorgen Rybner
Vice-President

W. R. G. Baker
Treasurer

Haraden Pratt
Secretary

Alfred N. Goldsmith
Editor

S. L. Bailey
Senior Past President

R. F. Guy
Junior Past President

1951

A. V. Eastman (7)
W. L. Everitt
D. G. Fink
F. Hamburger (3)
E. R. Piore
H. J. Reich (1)
J. D. Reid (5)
D. B. Sinclair
J. A. Stratton

1951-1952

H. F. Dart (2)
W. R. Hewlett
P. L. Hoover (4)
J. W. McRae
W. M. Rust (6)
A. B. Oxley (8)

1952-1953

W. H. Doherty
G. R. Town

Harold R. Zeamans
General Counsel

George W. Bailey
Executive Secretary

Laurence G. Cumming
Technical Secretary

PROCEEDINGS OF THE I.R.E.

Published Monthly by

The Institute of Radio Engineers, Inc.

VOLUME 39

February, 1951

NUMBER 2

PROCEEDINGS OF THE I.R.E.

Jorgen Rybner, Vice-President—1951	114
Preferred Numbers	115
3828. Television Broadcasting in the United States, 1927-1950	116
3829. Analysis of Synchronizing Systems for Dot-Interlaced Color Television	124
3830. The Control Chart as a Tool for Analyzing Experimental Data	132
3831. Statistical Evaluation of Life Expectancy of Vacuum Tubes Designed for Long-Life Operation	137
3832. Magnetic Recording with AC Bias	141
3833. Representations of Speech Sounds and Some of Their Statistical Properties	147
3834. Periodic-Waveguide Traveling-Wave Amplifier for Medium Powers	153
3835. Gain of Electromagnetic Horns	160
3836. Evaluation of Coaxial Slotted-Line Impedance Measurements	162
3837. Alternate Ways in the Analysis of a Feedback Oscillator and its Application	169
3714. Correction to "Two Standard Field-Strength Meters for Very-High Frequencies"	174
3838. Spectrum Analysis of Transient Response Curves	175
3839. Vertical Incidence Ionosphere Absorption at 150 Kc	186
3840. Secondary-Emitting Surfaces in the Presence of Oxide-Coated Cathodes	191
3841. On Poisoning of Oxide Cathodes by Atmospheric Sulfur	193
Correspondence:	
3842. Amplification by Acceleration and Deceleration of a Single-Velocity Stream	194
3735. The Traveling-Wave Cathode-Ray Tube	194
3608. Representation on Circuit Diagrams of Conductors in Contact	195
Contributors to THE PROCEEDINGS OF THE I.R.E.	196

INSTITUTE NEWS AND RADIO NOTES SECTION

Technical Committee Notes	199
The Expansion of the IRE Professional Group System	201
Professional Group Notes	202
Industrial Engineering Notes	203
IRE People	204
Books:	
3843. "Electrical Communications," by Arthur L. Albert	206
3844. "Principles and Applications of Waveguide Transmission," by George C. Southworth	206
3845. "Frequency Modulated Radar," by David G. C. Luck	206
3846. "Super-Regenerative Receivers," by J. R. Whitehead	206
3847. "Mobile Radio Handbook, First Edition," edited by Milton B. Sleeper	207
3848. "Short-Wave Radio and the Ionosphere," by T. W. Bennington	207
3849. "Radio Engineering Handbook," by Keith Henney	207
Conference on High-Frequency Measurements, Washington, D. C.—January 10-12, 1951—Summaries of Technical Papers	208
Books: (cont'd)	
3850. "Television Installation Techniques," by Samuel L. Marshall	211
3851. Abstracts and References	212
News—New Products	18A
Section Meetings	36A
Student Branch Meetings	42A
Advertising Index	94A
Membership	48A
Positions Open	50A
Positions Wanted	63A

EDITORIAL DEPARTMENT

Alfred N. Goldsmith
Editor

E. K. Gannett
Technical Editor

Mary L. Diamond
Assistant Editor

ADVERTISING DEPARTMENT

William C. Copp
Advertising Manager

Lillian Petranek
Assistant Advertising Manager

BOARD OF EDITORS

Alfred N. Goldsmith
Chairman

PAPERS REVIEW COMMITTEE

George F. Metcalf
Chairman

ADMINISTRATIVE COMMITTEE OF THE BOARD OF EDITORS

Alfred N. Goldsmith
Chairman

Responsibility for the contents of papers published in the PROCEEDINGS OF THE I.R.E. rests upon the authors. Statements made in papers are not binding on the Institute or its members.



Changes of address (with advance notice of fifteen days) and communications regarding subscriptions and payments should be mailed to the Secretary of the Institute, at 450 Ahnaip St., Menasha, Wisconsin, or 1 East 79 Street, New York 21, N. Y.

All rights of republication, including translation into foreign languages, are reserved by the Institute. Abstracts of papers with mention of their source, may be printed. Requests for republication privileges should be addressed to The Institute of Radio Engineers.

* Numerals in parenthesis following Directors' names designate Region number.



Jorgen Rybner

VICE-PRESIDENT, 1951

Jorgen Rybner was born at Frederiksberg, Denmark, on November 26, 1902. He was graduated as an electrical engineer, specializing in telecommunications, from the Royal Technical University of Denmark in 1926, and worked as a private assistant to Professor P. O. Pedersen at the university for 18 months, carrying out most of the computation work for Professor Pedersen's famous book, "The Propagation of Radio Waves."

During 1927-1928, Mr. Rybner spent a year in the United States, studying radio techniques with Professor Morecroft at Columbia University. He did part-time work in the propagation department of the Bell Laboratories, Inc. He also worked in the laboratory of the General Electric Company at Schenectady, N. Y.

He was associated with the Geodetic Institute of Denmark until 1939, serving as chief of the technical department, and he took part in the longitude determination of the Baltic Geodetic Commission 1929, carrying out extensive studies of the theory of seismographs, on which he published several papers.

In 1939, the chair of telecommunications at the Royal Technical University of Denmark held by Professor Pedersen since 1907, was doubled, and Mr. Rybner obtained the new professorship.

He has published, besides a number of scientific papers, a series of textbooks in Danish, covering tele-

graph and telephone techniques, including switching and application of probability, radio techniques, electronic amplifiers, network and transmission lines, and advanced books on filter theory and on the general theory of circle diagrams. Publications with English and Danish text include his "Nomograms of Complex Hyperbolic Functions," 1947, as well as "Table for Use in the Addition of Complex Numbers," 1949.

In 1948-1949, Professor Rybner paid another visit to the United States to study communication theory and advanced network theory at Massachusetts Institute of Technology, Boston, Mass., during the fall term. He also spent three weeks at Bell Telephone Laboratories, Murray Hill, N. J., and Holmdel, N. Y., with visits to the Watson Scientific Computing Laboratory, New York, N. Y., and Cornell University, Ithaca, N. Y.

Since 1933, he has been a teacher of telecommunications for signal officers at the Army Officers' School.

He was elected a member of the Danish Academy of Technical Sciences in 1937, and was president of the Danish National Committee of the International Scientific Radio Union (URSI) in 1948. He has been a chairman of the board of directors of the Radio Receiver Laboratory of the Academy since 1944. He was decorated with the Knight's order of Dannebrog in 1948. Mr. Rybner has been a member of the IRE since 1926.

The dimensions—or certain other characteristics—of physical things may have chosen values. But if such values are selected from an orderly and adequate list of "preferred numbers" a certain degree of simplification, interchangeability, uniformity, convenience, and economy will result.

The writer of the following guest editorial is particularly well qualified to discuss this subject analytically. He has served as the IRE representative on the ASA Sectional Committee Z17 on Preferred Numbers, and also on the ASA Sectional Committee C67 on Standardization of Voltages—Preferred Voltages—100 Volts and Under. He is a Past President of The Institute of Radio Engineers, and an engineer of long, diverse, and constructive experience.—*The Editor.*

Preferred Numbers

ARTHUR VAN DYCK

"Preferred Numbers" is the title given to a list of numbers standardized by the American Standards Association. The intention is that designers, and others who have discretion in design choices, will use the standard numbers, wherever practicable to do so, for dimensions, weights, ratings, and other requirements for which numerical values must be specified. Of course, there may be cases where it is impracticable to use the standard numbers, for technical or economic reasons. In such cases they should not be attempted. However, by adopting standard values whenever practicable, it will be found, as time goes on, that the impracticable cases will become rarer, and the benefits will increase.

As Preferred Numbers and their advantages have been described at length elsewhere,¹⁻³ it will suffice here to say that use of the system by even one manufacturer will improve his efficiency of operation, and that wider use by a whole industry, or many industries, brings benefits in geometric proportion to the extent of use. The subject has had active study for about thirty years, but in spite of this lengthy period, has not made great progress toward adoption by American industry.

The Preferred Numbers activity began just after World War I, in a period when high ideals inspired the thinking elements of mankind. Even the ultimate in human relations, international amity, seemed within reach. In the thirty years that have passed—enough to have brought impressive results, it would seem—progress has been disappointingly small. The League of Nations, expected to bring peace to the world, instead saw a second World War, and its successor, the United Nations is dallying with a third. Similarly, Preferred Numbers has not made the progress which its obvious advantages make it reasonable to expect.

It seems to me that the factors which have determined the amount of progress toward world peace, or lack of it, are much the same ones which have limited the degree of accomplishment in standardization, and that it is easier to see some of these factors in the broad field of international relations than in the narrow field of product design, in spite of the vastly greater scope of the former. The greatest obstacle to international peace agreement is the unwillingness of nations to limit "national sovereignty" to even the slightest extent. Each nation insists upon full rights to have and to do whatever it wants. Little attention is paid to the long term benefits which would accrue to each and to all by the establishment of unselfish, co-operative practices. Few realize that large, permanent benefits will result from small temporary sacrifices, and that such benefits are obtainable only in that way. Most want to eat the cake and have it, too. Consequently, petty bickering continues and so do the resulting wars.

The same attitude has existed in the design field in relation to Preferred Numbers. It is clear that the same numbers must be used by everyone. If each company, or industry, has its own private list of numbers, the benefits will be greatly limited. Nevertheless, various organizations have seen fit not to adopt the ASA Preferred Numbers, but instead have set up their own lists of numbers. They have done this because their own practices of the moment seemed to be accommodated better by lists different from the ASA Standard. I emphasize "of the moment" because that is the heart of the matter, the seat of the trouble, the crux of the situation. For example, some years ago, the Radio-Television Manufacturers Association found it desirable to standardize the values of resistors. The ASA Preferred Numbers Standard was considered, but judged not to suit the manufacturing conditions and the buying practices of the resistor field at the moment, whereas a special series of numbers suited better. The special series was adopted and, since it was an official RTMA list, it has been utilized by later RTMA committees for other applications than resistors, although adopted originally because of seeming advantages for resistors. Ironically, the original advantages have largely disappeared through changes in resistor manufacturing conditions. But the irregular standard remains, and in fact is now being proposed for universal application in the radio-electronic industry. We in the industry, of course, feel that radio-electronics is the outstanding element in the American industrial scene, but it is at least a wee bit unfortunate that electronics, just now entering into increasingly important and intimate relationships with all other elements of industry, exercises its "sovereignty," sets its own Standard, and exchanges the greater good for the appeal of the immediate.

Another point which seems to be overlooked by most standardization committees is that a standard must have much of the aspect of an ideal if it is to be worth while, and that if it cannot be used immediately for some practical reason, *it need not be used immediately*. As time goes on, with effort to use the standard wherever conveniently possible, the first practical objections lessen, and the standard becomes more and more universally usable. After five, ten, or twenty years, the standard is wholly acceptable and its benefits are had. A good standard is a goal to shoot at, not a ratification of old or existing practice. On the other hand, if standardization work operates on the basis of setting up standards with primary attention to the operating practices of the moment—so that everything every manufacturer is doing will be "standard" immediately—little is accomplished toward the proper objective of maximum simplification. It is not simplification of current practice to standardize all of current practice. The extreme to which overlooking this basic principle naturally leads, is exemplified by the proposals now active in the work to establish a Standard for Preferred Voltages, 100 volts and under. The proposals call for standardizing more than ninety values between zero and one hundred! The original committee "ideal" list called for twenty-three values, which is big enough, but as each industry element added the values it is using currently, the list grew until nearly every number up to one hundred is proposed as standard. That surely is the height of something or other, and one might ask "How absurd can we get?" The answer to that one is easy, however. It is found in the list of current television picture tube sizes!

In the long, difficult period ahead of us, when our industrial economy will have to bear strains greater than ever before experienced, the benefits to be obtained by standardization and simplification will be needed. Preferred Numbers can help much, if they are attempted with understanding, unselfishness, and co-operation. It must be realized that there is only one list of Preferred Numbers and that one must be the national standard. Individual industry lists are not Preferred Numbers and should not be so called—they are private numbers affording a limited amount of benefit or temporary advantage, but little of the large scale benefits which will result from national, widespread, inter-industry use of one list. The production capability of this country, great as it is, is finite, not infinite, and the tough task before us demands maximum efficiency to assure success.

¹ ASA American Standard Z 17.1—1936.

² John Gaillard, "Preferred numbers—an international tool for standardizers," *Standardization*, vol. 20, pp. 296-297, 299; November, 1949.

³ Arthur Van Dyck, "Preferred numbers," *Proc. I.R.E.*, vol. 24, pp. 159-179; February, 1936.

Television Broadcasting in the United States, 1927-1950*

DONALD G. FINK†, FELLOW, IRE

A study of the wishes of representative portions of the membership of The Institute of Radio Engineers has led to a plan to present to the readers of these PROCEEDINGS a series of tutorial papers on a wide variety of topics of both present and historical interest. These papers are to be educational in nature, of exceptional clarity, and prepared in each case by an authority in the corresponding field. It is believed that they will as well be appealing and interesting to others than experts in that field.

The procurement of these tutorial papers, and their individual recommended approval for publication, are carried out by the Subcommittee on Tutorial Papers (under the Chairmanship of Professor Ernst Weber) of the IRE Committee on Education (under the Chairmanship of Professor Herbert J. Reich). The first tutorial paper of what is hoped to be an extensive series is here presented.—*The Editor.*

TELEVISION broadcasting in America began in 1927, when the Federal Radio Commission issued the first television license to Charles F. Jenkins authorizing broadcast transmissions from a station in the suburbs of Washington, D. C. Prior to that time, development of television techniques was not open to public participation. V. K. Zworykin applied for a patent on his iconoscope, which may fairly be called the cornerstone of modern television, in 1925. In 1923, Jenkins in America and John Baird in England had demonstrated the transmission of crude images over wires. Early in 1927 the Bell Telephone Laboratories demonstrated a low-definition picture over wire circuits, between New York and Washington. But the concept of providing broadcast emissions, available to experimenters not otherwise connected with the transmitting organization, did not gain wide currency in America until 1929. In that year some 22 stations were authorized by the Federal Radio Commission to broadcast visual images.

The earliest stations had wide latitude in choice of frequency, almost any frequency above 1,500 kc being permitted if no interference was caused to other services. But this latitude was soon withdrawn, as the short-wave region became crowded with other, more vital services. In 1929, emissions were limited to a bandwidth of 100 kc, within the regions of 2.0–2.3 Mc and 2.75–2.95 Mc. The powers employed varied from 100 w to 20 kw, the majority of stations operating at 5 kw.

The quality of the early images were primitive, judged by any standard. The pictures were commonly transmitted at a rate of 20 per second. At this rate the number of picture elements capable of being transmitted by double sidebands in a 100-kc band is limited to 5,000. Equal resolution in vertical and horizontal dimensions was achieved within the band limits by employing a square image of about 70 lines, but the preferred figure was 60 lines.

* Decimal classification: R583. Original manuscript received by the Institute, November 15, 1950.

† *Electronics Magazine*, New York, N. Y.

Many of the major American television stations of the present day can trace their origin to this early period. The National Broadcasting Company's station in New York was first licensed as W2XBS in July, 1928, and has since evolved from the 2,000 to 2,100-kc band to the 66 to 72-Mc band, from 60-line pictures to 525-line pictures. In 1942 the call letters W2XBS were withdrawn in favor of the "commercial" call letters WNBC. Similarly, the Columbia Broadcasting System station in New York, now WCBS-TV, started in July, 1931, as W2XAX. This station operated with 60-line pictures, 20 per second, for a total of 2,500 hours in the period ending February, 1933. The General Electric station in Schenectady operated on similar standards, with 20-kw power from 1929 to 1932.

In 1931 it was evident that progress could not be made on the restricted channels of the 2-Mc band, and the trend toward higher frequencies began. One of the earliest to apply for permission to use frequencies above 40 Mc was the Don Lee Broadcasting System in Los Angeles, Calif. In December, 1931, the license of station W6XAO was granted to this organization, authorizing the use of the bands 43–46, 48.5–50.3, and 60–80 Mc. In 1941 this station became a commercial station with the call letters KTSL, operating on 54–60-Mc with a regular public program service.

Permission to use the 43–80-Mc bands was granted to several other stations, including NBC's W2XF and W2XBT in New York, Jenkin's W3XC in Wheaton, Md., W1XG in Boston, and W8XF in Pontiac, Mich. In 1933 and 1934 several additional vhf stations were licensed to use the bands 42–56 and 60–86 Mc. In 1936, all activity in the 2-Mc band ceased and all vhf stations were placed in the bands 42–56 and 60–86 Mc.

In 1937, the frequency allocation was set up for the first time on the basis of channels 6 Mc wide. Nineteen such channels were set up between 44 and 294 Mc. The present allocation comprises 12 channels, each 6 Mc wide, in two groups 54–88 Mc and 174–216 Mc.

EVOLUTION OF HIGH-DEFINITION STANDARDS

Shortly after permission to operate in the vhf bands was given, attention was focused on purely electronic methods of scanning and cathode-ray tubes for reproduction. Dr. Zworykin had demonstrated a cathode-ray receiver before The Institute of Radio Engineers in Rochester, N. Y., in November, 1929. In 1932, an "all-electronic" system was demonstrated by RCA, transmitting 240-line images from New York to Camden, near Philadelphia, over an air-line distance of about 80 miles, with one intermediate relay point at Arney's Mount, N. J. This was one of the earliest demonstrations of cathode-ray equipment, but the term "all-electronic" was something of a misnomer, since no satisfactory electronic synchronizing circuits had been developed, and the synchronizing pulses were derived by passing light to a photocell through apertures in a whirling disk. In 1934 P. T. Farnsworth announced a new electronic camera tube, the image dissector.

In 1934, the march toward higher definition got properly under way. Each transmitter was free to employ any scanning method, but between 1932 and 1934 agreement was reached that interlaced transmission, based on the "odd-line" principle, was the simplest and most satisfactory method of avoiding flicker in the reproduced images. The first "odd-line" value chosen was 343, an odd number composed of odd factors ($343=7\times7\times7$). From this root sprang many other choices, all tending toward greater definition in the pictures, all odd numbers, composed of odd factors. The majority opinion was that no more than 441 lines could be accommodated in a picture sent by double-sideband methods within the limits of a 6-Mc channel. The dissenting opinion was that it would be better to err on the high side in the number of lines, with consequent excessive definition in the vertical dimension, in the hope that better utilization of bandwidth would be possible as time went on. This dissenting opinion was in fact justified in 1939, when vestigial-sideband transmission was proved feasible and adopted as standard. The 441-line figure then proved too small for a 6-Mc channel and the standard was eventually changed (in 1941) to 525 lines, the value presently specified in the FCC regulations.

The foregoing paragraphs may indicate that the adoption of standards in the United States was accompanied by not a little dissension in the ranks. This must be admitted. In fact, the five-year period from 1936, when official sanction for public programs was given in the United Kingdom, to 1941, when similar sanction was granted in America, was characterized by a very vigorous debate on standards.

The debate finally came to an end in the meetings of the nine panels of the National Television System Committee (NTSC). This group of 168 television specialists, in the period from August, 1940, to March, 1941, devoted 4,000 man-hours to meetings, witnessed 25 demonstrations of the comparative merits of different

proposals, and finally left behind them a record of reports and minutes some 600,000 words in length. Out of this monumental effort came virtually complete agreement on a set of 22 standards which were presented to the Federal Communications Commission for approval and adoption. This approval was granted, and commercial operation of television broadcast stations was authorized, to be effective July 1, 1941. The stage was set for a rapid advance. On December 7, 1941, the United States entered the war and the state of the art was frozen by lack of man-power and materials. Thereafter, until 1945, commercial broadcasting continued, but at a "bare-subsistence" level. The FCC required a minimum of 15 hours per week of public programs from each station before the war; after Pearl Harbor this was reduced to four hours per week.

In 1944-1945 a thorough review of the standards was conducted by the Television Panel of the Radio Technical Planning Board (RTPB). The standards were reaffirmed by this group, and no change has since occurred.

EVOLUTION OF PROGRAM SERVICE

Prior to 1936, the American public was an incidental partner to the television enterprise. But in that year, the broadcasting of programs especially designed for public consumption began, although no regular source of receivers was available and no official sanction had been given for other than experimental transmissions. The occasion was one of considerable international competition between England and the United States. The first move came from the British Broadcasting Corporation. Plans for the opening of the London station in Alexandra Palace were announced early in 1936. This was the cue for the RCA-NBC transmitter to "get busy." On June 29, 1936, RCA started a field test of its television system with 100 of its engineers in and around New York as the observers. The images were transmitted by double sideband, at 343 lines, 30 frames per second. Film was used copiously in the early stages. But by November 6 of that year, the *New York Times* announced "the first complete program of entertainment over the NBC system," viewed enthusiastically by the press. Four days before, on November 2, the Alexandra Palace station had begun a regular public service. The American service was not public in the same sense, and did not become so for five years.

By 1938 the RCA field test had progressed to the point where its directors were ready to take a step in the direction of inviting the public to participate actively. It was announced in October, 1938, that, coincidentally with the opening of the New York World's Fair in May, 1939, regular public service would be offered.

In the meantime, vestigial-sideband transmission had been adopted as standard by the Television Committee of the Radio Manufacturers' Association and had been incorporated in the NBC transmitter. The scanning

pattern had been increased to 441 lines, and the effective video band to 4 Mc. In February, 1940, the Federal Communications Commission adopted rules permitting "limited" commercial operation of stations.

The stage seemed set. The NBC transmitter was offering 10 to 15 hours of program a week, including elaborate dramatic presentations from the studios, regular outside rebroadcasts of sporting events of every description, educational programs and films. But in April, 1940, the FCC retracted the offer of limited commercialization, following an announcement by RCA that receivers would be offered to the public in greater volume and at reduced prices. The FCC stated that this action by RCA tended to freeze the then accepted standards, those formulated by the Radio Manufacturers Association, without official sanction from the Government. This action effectively held up further progress until the standards had been studied and essentially reaffirmed by the National Television System Committee. In July, 1941, the impasse was cleared, and television broadcasting for the public officially began.

THE AMERICAN TELEVISION CHANNEL

The standard 6-Mc channel assigned to television broadcast stations in the United States is intended for vestigial-sideband transmission. At the lower frequency limit of the channel, the emission is required to be substantially zero, actually no more than one per cent of the picture-carrier amplitude. At a point 0.5 Mc higher in frequency, the sideband emission has full amplitude. The picture carrier itself is located 1.25 Mc above the lower channel edge, and occupies an asymmetrical position with respect to the channel limits. Thus only a portion of the lower sideband is transmitted, hence the term "vestigial-sideband transmission." The upper sideband is transmitted fully over a region 4 Mc wide, i.e., it maintains maximum amplitude to a point 5.25 Mc above the lower channel edge. At this point the sideband energy is attenuated with increasing frequency until, at a point 5.75 Mc above the lower channel edge, it is attenuated to one per cent of the carrier amplitude. The carrier of the associated sound transmission is placed at this point. The remaining 0.25 Mc of the channel is reserved as a guard band.

This arrangement of carriers and sidebands was originally devised in 1938 and has persisted substantially without change through the deliberations of the National Television System Committee and those of the Radio Technical Planning Board. The vestigial-sideband principle permits a maximum unattenuated vision frequency of 4 Mc and permits attenuated transmission of vision signals up to a maximum of 4.5 Mc. In comparison, the double-sideband system permits a maximum vision frequency of 2.5 Mc. The vestigial-sideband transmission thus offers an increase in pictorial detail of 80 per cent, with substantial improvement in picture quality.

The wide spacing between carriers (4.5 Mc) was

chosen in preference to the alternative narrow spacing (1.25 Mc) which would be possible if the sound carrier were transferred from the high frequency edge of the channel to the low frequency edge. The wide spacing produces a high-frequency beat frequency which is outside the limits of the vision frequency band and hence has little or no visible effect. The narrow spacing would produce a beat note within the video band.

The vestigial-sideband system is intended to operate with a receiver whose response characteristic increases linearly with frequency from 0.5 to 2.0 Mc above the lower edge of the channel. This "slope" region corresponds to the portion of the transmitter spectrum where both sidebands are transmitted. By virtue of the sloping receiver response the picture carrier is attenuated to one half, and the sum of the two sideband voltages is constant throughout the region, and equal to the value of sideband voltage at higher frequencies outside the "slope" region. Thus the video-frequency voltage developed at the output of the demodulator is the same for all sideband frequencies.

The ratio of sound-carrier power (radiated by the sound radiator) to picture-carrier power (radiated by the picture radiator) has been set up within the limits 0.5 and 1.50. The general range has been chosen to provide approximately equal areas of coverage of the sound and picture signals. The sound power is lower than the picture power because the sound transmission employs frequency modulation, with an inherent signal-to-noise ratio superior to that of amplitude modulation. Account has been taken, in setting up this ratio, of the fact that interference (particularly impulsive noise) in the sound channel is usually more objectionable than interference arising from the same noise source in the picture channel.

THE SCANNING SPECIFICATIONS

The standard American television picture is scanned in 525 lines from the beginning of one frame to the beginning of the next. Each frame is broken up into two fields of 262.5 lines each. The half-line portion at the end of a field causes the lines of one field to fall between the lines of the previous field. Hence an odd number of lines was chosen to give this half-line relationship between fields. The value 525 consists of odd integral factors ($525 = 7 \times 5 \times 5 \times 3$). This permits multivibrators or counting circuits in the synchronization generator (used to divide from the line frequency of 15,750 cps to the frame frequency of 30 cps) to operate in the most stable condition.

The frame frequency is 30 per second interlaced two-to-one. The aspect ratio of the scanning pattern (ratio of width to height) is 4/3, to agree with the ratio previously adopted as standard for motion-picture projection. The FCC standards specify that the active scanning of the picture shall occur at uniform velocity from left to right horizontally and top to bottom vertically.

The choice of 525 lines was made from among several proposed values, including 495 and 507 lines. Assuming 4.25 Mc as the maximum usable video frequency, equal vertical and horizontal resolution at 30 frames per second is obtained with a scanning pattern of about 500 lines, which would indicate that all the proposed values are equally suitable. The number 507 has the disadvantage of two large integral factors which require two of the frequency-dividing circuits in the synchronizing signal generator to count by a factor of 13. The choice between 495 and 525 was finally made on the basis of fineness of line structure, which indicates a slight preference for the higher number of lines. The value of 441 lines was discarded as it did not make full use of the maximum available video frequency.

SOUND SIGNAL STANDARDS

A major difference between British and American television practice lies in the method of modulation employed for the sound transmission. The American standard specifies frequency modulation with a maximum frequency deviation, corresponding to the maximum audio level, of 25 kc either side of the unmodulated carrier frequency. Frequency modulation, employing a spectrum considerably wider than that required for the corresponding amplitude-modulated signal, has been shown to offer a substantially higher signal-to-noise ratio than that offered by amplitude modulation. This advantage obtains over all types of noise, provided only that the peak signal voltage is at least twice the peak noise voltage. Since natural atmospheric noise is rarely present in the vhf spectrum, the principal advantage of frequency-modulated transmission is the mitigation of impulse noises such as is generated by automobile ignition systems, and noise generated in tubes and circuit elements of the receiver.

To assist in the reproduction of the upper register of the audible spectrum, it has been customary in frequency-modulated sound transmissions to introduce audio pre-emphasis at the transmitter. The standard pre-emphasis characteristic is that of a series resistive-inductive impedance whose time-constant (resistance times inductance) is 75 microseconds. The converse de-emphasis is inserted in the receiver (usually by a resistive-capacitive impedance of the same time-constant). The advantage of such pre-emphasis lies in the fact that the sound power associated with the higher register is generally lower than that of the lower register and hence is less efficiently transmitted with respect to the noise level. Artificial emphasis and de-emphasis thus add to the over-all signal-noise ratio, by reducing the noise level in the upper register.

The remaining standard is the direction of polarization of the electric vector of the radiated wave. This was chosen as horizontal as early as 1938, and although polarization has been the subject of intensive investigation by the NTSC and the RTPB the advantage of the horizontal direction has been consistently upheld.

RULES GOVERNING ALLOCATION OF TELEVISION BROADCASTING FACILITIES

As the demand for broadcasting facilities has consistently exceeded the supply, it has been necessary for the FCC to set up equitable rules whereby the available portions of the spectrum may be allocated to serve the public interest.

A conflict in allocation arises, by definition, when interference occurs among stations. The interference is defined in terms of (1) the signal level required to give satisfactory service in an area from the station serving that area, and (2) the level of signal which creates interference in that area, arising from another station on the same channel in an adjacent area. The problem of interference between stations in the same area but assigned to adjacent channels must also be considered.

The basic level of service is defined as a field strength which must be equalled or exceeded over 50 per cent of the distance along a radial line from the transmitter. The field strength thus specified for built-up city areas and business districts is 5 millivolts per meter. For residential and rural areas the specified field strength is one-tenth as great, or 500 microvolts per meter. These figures properly surpass the figure of 50 microvolts per meter commonly regarded by engineers as the lower limit for "marginal service," in the absence of man-made sources of noise.

The applicant for a television construction permit or license must show that his proposed transmitter will offer service in accordance with the above rules, and must estimate the population lying within the 5-mv/m and 0.5-mv/m contours.

The interference ratio (ratio of desired signal to undesired signal) which must be equalled or exceeded within the service area has been set at 100:1 for stations on the same channel and 2:1 for stations on adjacent channels. This is in keeping with the commonly-held engineering opinion that an interfering signal must be at least 40 db below the desired signal if it is to have negligible effect. For adjacent-channel interference, the selectivity of the receiver circuits will introduce sufficient additional rejection if the interfering signal voltage does not exceed one-half the desired signal voltage. It is the practice of the FCC to avoid assigning adjacent channels in the same metropolitan area; otherwise the 2:1 ratio would be met in but a small portion of the normal service area.

The problem of finding sufficient facilities for television without interference is most critical in the highly populated areas along the eastern seaboard. In general an allocation plan to provide sufficient service to the cities of Boston, Providence, Hartford, New York, Philadelphia, Baltimore, and Washington will take care of all other population centers in North America.

POSTWAR ACTIVITY

The postwar period has been marked by a very substantial expansion of the television service. At present

(December, 1950) the areas covered by television signals include 63 major population centers, in which 107 stations offer service to a potential audience in excess of 50,000,000. The expansion has emphasized the shortage of spectrum space for television stations and has brought into sharp focus the problem of interference between stations.

In 1945, at the close of the war, about 10,000 receivers had been produced and sold to the public. Nine stations were operating in five cities, four of them on a fully commercial basis. Postwar production did not get under way, owing to shortages of materials and components, until the spring of 1946. In that year, 6,500 receivers were produced by the six manufacturers then in the business. Three years later (1949), the production was 2,400,000 sets, according to figures compiled by members of the Radio Manufacturers Association. Production by non-RMA companies accounted for approximately 450,000 additional receivers in that year. Over 100 companies participated in the 1949 production. Production in 1950 was approximately 6,000,000 receivers.

The trends in receiver design have been toward larger pictures, fewer tubes and simplification of controls. The smallest screen size is $2\frac{1}{2}$ inches in diameter, offered in a 1948 model no longer in production. The largest direct-view tube was an all-glass tube of 20 inches diameter, now replaced by a 19-inch metal-cone tube. From 1946 to 1948 the most popular model was the 10-inch set, but in 1949 this model gave way to the $12\frac{1}{2}$ -inch size. The 16-inch tube took first place in 1950.

Projection pictures ranging from 9 by 12 inches to 18 by 24 inches have been offered in domestic receivers, although production of this type of receiver has been small compared with the direct-view type. Projection equipment for large audiences, ranging in screen size from 6 by 8 feet to the full theater screen of 18 by 24 feet has also been produced.

Reduction in the tube complement of receivers has averaged about 25 per cent since 1946. The first large-scale-production chassis was a 10-inch model employing 30 tubes. In 1948, a 7-inch model was offered with 16 tubes. Current models employ from 22 to 24 tubes. Substantially all receivers having screen diameter greater than 7 inches employ magnetic deflection of the picture tube.

Simplification of controls has resulted from improvement in the stability of circuits and components, particularly those used for tuning and for synchronization of scanning. The majority of receivers currently in production employ the intercarrier circuit, in which a sound intermediate frequency of 4.5 Mc is developed by frequency conversion at the picture second detector. The most popular value of picture intermediate frequency is 25.75 Mc, but plans for changing this to 45.75 Mc have been announced by many manufacturers and the latter value may eventually be adopted as standard by all manufacturers.

EXPANSION OF BROADCAST FACILITIES

By the end of 1946, 10 stations were in operation, and in that year 38 construction permits for additional stations were granted by the FCC. By the fall of 1948, 54 stations were operating, construction of an additional 70 stations had been authorized, and 310 applications for construction permits had been filed.

Beginning in the spring of 1948, the FCC received complaints that excessive interference was occurring between stations on the same channel, as well as between stations occupying adjacent channels. The co-channel interference takes the form of horizontal bars, which move upward or downward through the image of the desired station. These bars, known as "venetian-blind" interference, are caused by the heterodyne beat between the carriers of the stations. The beat frequency can have values from a few cycles per second to several thousand cycles per second, under the frequency tolerances permitted by the FCC regulations.

The interference extends over an appreciable portion of the service area of each station, for a majority of the operating hours, when the stations were separated by less than approximately 200 miles. It is explained by tropospheric propagation which produces signal strengths much higher than had been anticipated when the allocation plan was devised. Since the then-existing allocation plan called for a minimum spacing of 150 miles, and exceptions to the rule as small as 95 miles had been allowed, the FCC decided to call a halt on further expansion of broadcasting facilities until the cause and extent of the interference could be studied. Accordingly, in September, 1948, the Commission issued a "freeze" order, prohibiting construction of new stations for an indefinite period. The order did not prohibit completion of the 70 stations then under construction, but held up any further action on the 310 applications for construction permits. The freeze order was still on the books, as of December, 1950. At present nearly 400 applications for new stations are on the books of the FCC.

Meanwhile, the means of accommodating this large number of stations, while minimizing interference, have been under almost continuous study in a series of conferences and hearings before the FCC, from September, 1948, to the present. Two approaches have been investigated: (1) the reduction of co-channel interference by control of the interfering carriers, and (2) the extension of the television spectrum into the ultra-high frequencies.

Two techniques of interference reduction have been developed, carrier synchronization and carrier-offset operation. The second of these is now in wide use among co-channel stations in the east and midwest sections of the country.

In the carrier synchronization scheme, the two carriers are received in a monitor station approximately midway between the stations, and their frequencies compared

in a frequency discriminator. A signal representative of the frequency difference is sent over a telephone line to one of the stations, where it actuates a control circuit connected to the quartz-crystal frequency control. By this means, the carriers of the two stations are kept rigidly locked together in precise phase relationship. Since the beat frequency between the carriers is thereby reduced to zero, the venetian-blind interference is removed. The strength of the interfering signal may then be allowed to increase by about 17 db on the average before the image content of the undesired signal becomes objectionably apparent. This reduction in interference would permit co-channel stations to be located at a distance of separation of about 150 miles, compared to about 210 miles for the same degree of interference with carriers unsynchronized.

The cost of the monitoring station and the telephone lines necessary in the carrier synchronization method led to the development of a simpler system known as carrier offset. In this method, the carrier of one co-channel station is purposely separated from that of the others by 10.5 Kc, plus or minus the 0.002 per cent tolerance allowed by the FCC regulations. The average beat frequency of 10.5 Kc produces a large number of venetian-blind bars, each occupying about three adjacent scanning lines. Since each interference bar is thereby confined to the space occupied by two successive lines in a single field scanning, the average tone produced tends toward a neutral gray, and the effect is subjectively much less annoying than if the carriers were within a few hundred cycles of one another, as is usually the case between unsynchronized carriers.

Actually, the greatest reduction of interference is obtained when the offset frequency is 7.875 kc, that is, one-half the line scanning frequency, and no improvement is noted when the offset is 15.750 kc, the line scanning frequency. The half-line frequency would be used in the offset system, were it not for the fact that three or more co-channel stations are often involved in a single interference area. The insertion of 7.875 kc offset between all stations would then result in nearly zero or 15.750 kc offset (no interference reduction) between certain pairs in the group. The 10.5-kc figure was chosen as a compromise, permitting several stations to operate with carrier offset in the same area. The average interference reduction, relative to the unsynchronized case, is about the same as the carrier synchronization method. No wire line or monitor is needed; the crystal control frequency of a particular station is merely chosen to produce a carrier 10.5 kc higher or lower than that of the neighboring stations.

The investigation of ultra-high frequencies for television broadcasting has centered on the frequency range from 475 to 890 Mc, a region of the spectrum previously set aside by the FCC for experimental television stations. In planning to turn over all or part of this band to commercial broadcasting, several decisions have to be weighed: (1) what standards of transmission to adopt,

including the question of whether the service should be in black-and-white, in color, or both; (2) the bandwidth of the channels, and consequently the number of channels available in a given portion of the band; and (3) whether to assign ultra-high-frequency (uhf) stations to cities already possessing vhf stations, or to separate the two services geographically as much as possible.

Since the demand for additional black-and-white stations is so great, it has been conceded that at least part of the uhf band must be turned over to the black-and-white service. Moreover, to make the additional service available to owners of existing receivers at the least expense, the standards of transmission, including the channel width of 6 Mc, should be identical to those of the vhf service. This latter requirement exists even if the uhf stations are to be confined to cities not now served by vhf stations, since owners of existing receivers may move from a vhf city to a uhf city.

This leaves unsettled the question of whether color service should also be provided in the uhf band. Prior to 1948, all planning for commercial color television was on the basis of channels 12 to 16 Mc wide, and there seemed to be no room for a national allocation of such channels, even if the whole of the uhf band were used. But since that time color service on 6-Mc channels has been authorized, as outlined below, and it is now planned that color transmissions be offered by black-and-white stations on 6-Mc vhf and uhf channels.

The third question, whether or not to mix uhf and vhf assignments in a given locality, arises from the fact that the propagation conditions affecting uhf service indicate that the primary service area of a uhf station would be appreciably smaller than that of a vhf station of equal radiated power. Field tests conducted in Washington, D. C., and Bridgeport, Conn., have confirmed this assumption, at least to the extent of indicating that the shadowing effect of obstructions on uhf channels is much sharper than on vhf channels. Out to perhaps 25 miles, the service on the two bands is expected to be nearly equivalent, except for shadow effects, but beyond this limit, and out to the radio horizon, the vhf station would provide a better grade of service.

If these preliminary findings hold true generally, the licensee of a uhf station would find himself at a competitive disadvantage with respect to the licensees of vhf stations in his locality, and this would be particularly true if the potential audience of the stations extends in any substantial density beyond the 25-mile limit. In such cases, it may be questioned whether broadcasters would wish to make the investment in a uhf station.

On the other hand, if no vhf assignments are made in certain cities, the potential viewers located beyond the range of a uhf station might be denied service which otherwise could be rendered by a vhf station.

The uhf allocation proposed by the FCC in the Fall of 1949 envisages 42 additional 6-Mc channels, starting at 475 Mc or 500 Mc, and extending upward to 727

Mc or 752 Mc. Vhf and uhf stations are assigned together in certain localities in this plan. The FCC proposal was made simply as a basis for discussion in the hearing which is currently under way. Detailed argument on the proposal began in October, 1950.

THEATER TELEVISION

Throughout the development of television as a medium of home entertainment there has existed a parallel effort directed toward a system suitable for large audiences in theaters. The earliest demonstration of large-screen television was conducted by E. F. W. Alexanderson in Schenectady in 1929, using the scanning disk method to project 60-line images. But the low optical efficiency of this system did not permit a sufficiently bright picture to be projected when the number of lines was increased to 525.

Attention then turned on the method of projecting the image formed on the face of a cathode-ray tube. Since large lens apertures were required, refractive projection lenses proved exorbitantly expensive for projecting images of theater size. A more efficient system using reflective optics, based on the Schmidt telescope, was finally adopted as the basis for direct projection. In the Schmidt system, the image is reflected from a spherical mirror through an aspherical correction plate which removes spherical aberration. The first demonstration of a Schmidt projector was held by RCA at the New Yorker Theater in New York on January 24, 1941. The equipment employed a seven-inch picture tube with a second anode voltage of 70,000. A highlight brightness of about 5 foot-lamberts was achieved on a 15-by-20 foot screen.

In an attempt to achieve greater brightness on larger screens (film projectors produce about 10 foot-lamberts on screens as large as 18 by 24 feet), the intermediate film method was developed. In this process, the image on a picture tube is photographed on motion picture film, which is processed immediately and passed through the conventional film projector. The processing time has been reduced to less than one minute, so the loss of immediacy is not important, except possibly in sporting events. The film serves as a permanent record of the performance and permits repeat showings of programs. The first demonstration of the intermediate film method was given at the Paramount Theater in New York on April 14, 1948. This equipment has since been used to televise to the theater audience such events as the national political conventions in 1948 and the Joe Louis-Joe Walcott prize fight.

COLOR TELEVISION

The recent history of color television in the United States starts in 1940, when the Columbia Broadcasting System, demonstrated a 343-line 120-field system employing sequentially-scanned fields in three primary colors. The system as then proposed used a 6-Mc channel, and experimental broadcasts were made in the 50-

to-56-Mc channel then occupied by the CBS black-and-white transmitter. This work was interrupted by the war. Later, in 1946, the standards were changed to 525 lines, 144 fields, to provide higher resolution and greater freedom from flicker. These values required a channel 16 Mc wide. To bring the channel width more in line with existing 6-Mc black-and-white service, the channel was later reduced to 12 Mc and the number of lines was reduced to 441. The 144-per second field rate was retained to avoid flicker. This system was proposed by CBS for commercial use in the ultra-high frequencies in 1946, but in March, 1947, the FCC denied the CBS petition on the ground that art had not advanced sufficiently to justify adopting standards at that time.

By 1948, the CBS system had been shifted to a 6-Mc channel, employing 405 lines, 144-fields, but otherwise similar to the previous proposals. At first this system was shown only on a "closed circuit" basis (i.e., not broadcast) but in the summer of 1949 the FCC asked for information concerning the possibility of immediate introduction of color service on 6-Mc channels, and the CBS proposed their system for this purpose.

The CBS system is known as the field sequential system, since the color sequence is introduced by changing the color at the completion of each scanning field. The high field rate of 144 per second is necessary to avoid flicker at image brightness (in the highlights) up to about 25 foot-lamberts. Since the system uses the same bandwidth as the black-and-white system, the total number of resolvable picture elements in the color image is in the inverse ratio of the field scanning rates, or $60/144 = 0.42$, that is, 42 per cent of the resolution of the standard black-and-white resolution image. This loss of resolution, plus the fact that existing receivers would have to be converted to new line- and field-scanning rates to permit reception of the color signals, have been urged as disadvantages of the field-sequential system.

As early as 1946, the desirability of providing color service on scanning standards identical to those of black-and-white service, thus minimizing obsolescence of existing equipment, was manifest. In that year the Radio Corporation of America announced the so-called simultaneous system, in which three entirely separate and complete images, each scanned at 525 lines, 60 fields, were produced in the three primary colors by three camera tubes, in optical and electrical register. For color service, the three signals, radiated in three adjacent subchannels occupying a total band about 15 Mc wide, were applied to separate picture tubes, and the images combined, in register, by projection on a common viewing screen. The black-and-white version of the color transmission would be available to existing receivers by tuning to the green channel which contains most of the tonal information of the color image. Since this channel, as well as the red and blue ones, is based on 525-line, 60-field scanning, no change in the equipment, beyond a uhf antenna and radio-frequency converter to

tune to new channels, would be required. Later a technique known as mixed highs (which allowed reduction in the bandwidth required for the red and blue images) permitted this system to operate on a 12-Mc channel. When attention was directed, in 1948, toward the 6-Mc color service, the simultaneous system was discontinued, and work on the dot-sequential system was instituted.

The dot-sequential system introduces the color sequence by changing the color between successive picture elements (dots) along each line. This permits a second interlace between dots to be added to the conventional line interlace. A color image transmitted by this method at the black-and-white standard of 60 fields per second has a flicker performance equal to that of the black-and-white system, that is, high light brightness above 100 foot-lamberts is permissible without evident flicker. The image structure is divided among the sets of interlaced lines and the sets of interlaced dots in such a way that all points on the image are scanned in all colors 15 times per second.

The dot sequential system is particularly adapted to transmission by the time-multiplex method, which is considerably more efficient in its use of the spectrum than is the continuous modulation method employed in black-and-white system and the other proposed color systems. In fact, time-multiplex transmission provides nearly two-to-one improvement in resolution for a given bandwidth, i.e., the image detail is equal to that provided by continuous modulation over an 8-Mc band, when transmission occurs by time multiplex over a 4-Mc band. By this technique it is possible to transmit a color image, within a 6-Mc channel, having nearly as high resolution, and equal freedom from flicker, as a black-and-white image transmitted by continuous modulation over the same channel. Moreover, the scanning rates of the dot-sequential color system are identical to those of the black-and-white system so obsolescence of existing equipment is avoided.

The time multiplex transmission is achieved by sampling in sequence the outputs of three camera tubes (which televise the scene simultaneously in the three primary colors) at a rate of 3.6 Mc. Sinewaves in three-phase relationship are developed from this sampling process, each representative of the scanning of alternate dots along the lines of the respective images. The sine-waves are combined vectorially into a single sinewave which is radiated as a sideband component separated 3.6 Mc from the picture carrier. At the receiver, the combined sinewave is sampled by an electronic switch synchronized with the sampling switch at the transmitter (the synchronization is accomplished by short bursts of 3.6 Mc sinewave inserted on the sync pedestal during the horizontal blanking period).

The separated sinewaves resulting from this process control three electron guns in a tricolor picture tube. The viewing screen of the tricolor tube consists of several hundred thousand dots of phosphor material arranged in groups of three. One phosphor dot in each

group fluoresces with red light, the second with blue light, and the third with green. The area of the three phosphor dots as a group corresponds to the area of a single picture element. Accordingly, each picture element may be caused to assume the desired combination of primary colors by sequential excitation of the phosphor dots within its area. The three electron guns are so positioned that the electron beam of one gun can excite only the red phosphor dots, the second gun only blue dots, and the third only green dots. A single-gun type of tube, in which the beam traverses a spiral in impinging on the screen and hence can excite one phosphor dot to the exclusion of the other two in the group, has also been demonstrated.

The terminal apparatus (camera and picture-reproducing equipment) of the dot-sequential system is more complicated than that of the field-sequential system. Moreover, it is vital that the transmission system cover the full video frequency range up to and including the sampling frequency of 3.6 Mc; if this frequency is not transmitted, the color values are lost and a rendition in tones of gray results.

The third color television system considered by the FCC is the line-sequential system developed by Color Television, Inc. In this system the color sequence is introduced by a change in color at the end of each scanning line. The scanning rates are 525-lines, 60-fields, as in the black-and-white system and dot-sequential color system. The color sequence is obtained by focusing on the mosaic of an image orthicon, three congruent images side by side, in the three primary colors. The group of three images is scanned at one third the usual line scanning rate ($15,750/3 = 5,250$ cps). Each horizontal passage of the scanning beam crosses three images, so the lines are scanned at 15,750 cps in the sequence red, green, blue. Since the number of lines per frame (525) is exactly divisible by three, it would follow that a given line in the scanning pattern would always be scanned in the same color, and the rendition of solid tones would display very poor vertical resolution. To avoid this effect, the colors are commutated by a special sync signal which causes a vertical shift of certain lines. In this manner every line is scanned in three colors at a rate of 10 per second. This rate is sufficiently low to create interline flicker and line crawl.

On October 11, 1950, the FCC announced its decision to adopt the CBS field-sequential color system, and stated that it would authorize commercial color broadcasts using this system on and after November 20, 1950.

ACKNOWLEDGMENT

The permission given by the Institution of Electrical Engineers to reprint portions of the paper, "Television Broadcasting Practice in America—1927 to 1944," presented by the writer and published in the *Journal of the I.E.E.*, Volume 92, Number 19, September, 1945, is hereby gratefully acknowledged.

Analysis of Synchronizing Systems for Dot-Interlaced Color Television*

T. S. GEORGE†, ASSOCIATE, IRE

Summary—A mathematical analysis is made of two synchronizing systems which might be used in "dot" color television to synchronize the dotting or sampling frequency in the receiver. Synchronizing information is transmitted in bursts of carrier coherent in phase of approximately 3 Mc during line fly-back time. The two systems analyzed are (1) a simple high- Q resonant filter and (2) an oscillator with automatic frequency control (afc).

In order to maintain sufficient phase accuracy in the sampling frequency, crystal control at the transmitter is necessary. Since the variations of the frequency response of a particular crystal filter with time may be made essentially negligible, the problem resolves itself into calculating the parameters of the synchronizing system to keep below an acceptable value the random phase error due to noise together with the phase error caused by variations in frequency (static phase error) from crystal to crystal. Rather than attempt to minimize the sum of the random and static phase errors, the two have been dealt with separately because of their different character. A fundamental parameter in the calculations is the power carrier-to-noise ratio in the intermediate frequency, the carrier being measured at the sync tips. Calculations are made for values of this ratio of 1, 3, 5, this being considered the critical range.

Results of the calculation show that when the phase error due to noise alone is fixed, the simple resonant filter and the afc with single time constant suffer the same static phase error. If phase errors in the neighborhood of 10° can be tolerated, it appears then that receivers can be designed to operate without manual control of the dotting frequency down to carrier-to-noise ratios of about 2. This should be satisfactory since picture quality at this level is very poor.

IN DESIGNING a "dot interlace" system¹ of color television, synchronizing problems over and above those of ordinary black-and-white television are encountered. A "dot" system consists essentially of a three-channel time division multiplex system with one channel devoted to the transmission of each primary color. This involves sampling each color at the transmitting end of the system at approximately a 3-Mc rate, transmitting information so derived to the receiver, separating this information by resampling at the same 3-Mc rate and applying it to control the three colors displayed on the cathode-ray tube. Thus a sample of each color is obtained on every third pulse. In order to avoid deleterious color distortion, the sampling frequency in the receiver must be closely synchronized in phase with that of the transmitter.

In the receiver we have the problem of first synchronizing the frame, then the line, and finally the dots within each line. The first two of these are common to both color and black-and-white television and since these problems are relatively well understood, less at-

tention will be given to them than to dot synchronizing. There appear to be no smaller tolerances required for frame and line synchronizing in color television than in black-and-white. A continuous-wave 3-Mc wave could be transmitted, picked out by frequency separation, and used for synchronizing purposes. This has obvious disadvantages, however. A better scheme, the one which will be considered here, consists in transmitting a burst of 3-Mc carrier during horizontal sync pulse. This burst together with the sync pulse may be separated from the video in the usual way by clipping. The 3-Mc information may then be separated from the pulse by filtering or by gating. Alternatively, one could first gate out the 3-Mc burst and then filter. The clipped pulse and burst may be applied directly to the conventional pulse afc system without difficulty. However, the pulse must be removed in some way before the burst is applied to a sine-wave afc system.

Assuming that the 3-Mc burst has been in some way separated, it is necessary to consider what mechanism will be used to effect synchronization. Since the tolerances on the stability of the transmitted synchronizing wave will largely determine the mechanism to be used, these will be established. It will be assumed that all synchronizing frequencies in the transmitter are crystal-controlled so that it may be expected that variations in the 3-Mc frequency will not exceed ± 50 cps when switching from station to station. Furthermore, the drift in frequency of a given crystal will be so small as to be negligible. Also, the ratio between the dotting frequency and the line frequency is so chosen that there is no necessity to shift the phase of the dotting frequency at the end of each line or frame. Under these conditions three possible synchronizing devices appear possible: first, a simple high- Q filter (e.g., a crystal filter) which picks out the 3-Mc component, amplifies it, and applies it directly as the sampling wave; second, a locked sine-wave oscillator controlled in frequency by the 3-Mc burst; third, an afc system which controls the frequency of a sine-wave oscillator. Since any sync system must operate satisfactorily under bad fluctuation noise conditions, it must be realized that this requirement will ultimately determine the choice of system.

If, in order to achieve good noise protection, the simple filter device is narrowed down, the point will eventually be reached where the slope of the phase characteristic becomes so large that shifts in frequency such as may be encountered in switching from station to station will cause such an intolerably large static phase error that a manual frequency trimmer must be used. Furthermore, lock-in time on sudden phase transi-

* Decimal classification: R583.13. Original manuscript received by the Institute, May 19, 1950; revised manuscript received, October 9, 1950.

† Philco Corporation, Philadelphia, Pa.

¹ W. P. Boothroyd, "Dot systems of color television," *Electronics*, vol. 22, pp. 88-93; December, 1949.

tions may be too long. This dilemma is common to any sync system in various degrees; that is, if the system is designed to ignore noise fluctuations it tends also to ignore variations from any source.

All three of the possible systems will track variations in phase and frequency with varying degrees of fidelity. The locked oscillator may have some advantage over the simple filter in that its effective bandwidth varies directly as the voltage of the applied synchronizing signal, although its chief merit appears to be in the fact that it is a Q multiplier.² Automatic-frequency-control sync would appear to be the most efficient of the three since it separates the functions of phase detection, filtering and amplifying, and generation of the correct synchronizing signal, thus permitting the parameters in each part of the system to be adjusted for optimum performance. The validity of these statements requires some proof and this will now be undertaken. The simple tuned circuit will be compared quantitatively with afc sync, since it is believed that locked oscillator performance lies somewhere between these two.

Since crystal frequency control is assumed used in the transmitter, the problem essentially reduces to the calculation of phase error introduced by random noise, and the static phase error caused by a shift of frequency when station switching. The delay in tracking a phase shift caused by station switching is not believed to be important.

The characteristics of each system which will keep the phase error due to random noise alone below 5° will now be determined, and then the respective static phase errors caused by transients of frequency will be found. This will be done for various signal-to-noise ratios in the intermediate frequency and will furnish a measure of the fidelity of the two systems. The average carrier power-to-noise ratio in the intermediate frequency will be used where the carrier is measured at the sync tips.

If the carrier burst occupies 4 μ seconds out of 64 μ seconds, when gated, clipped, and filtered, it will yield a sinusoid of amplitude $(C/128)\beta$ where C is the amplitude of the intermediate-frequency carrier during the sync pulse and β is the modulation suppression term derived in Appendix A.

The noise power out of a filter of total bandwidth 2γ will be $2\gamma F_0$ where F_0 is the amplitude of the noise-power spectrum at 3 Mc as derived in Appendix A and 2γ is the equivalent noise bandwidth of the filter. 2γ will turn out to be so small compared with the 4-Mc video bandwidth that the power spectrum may be considered flat across it. When noise is added to a sinusoid, the phase of the sinusoid becomes indeterminate to a degree. It is shown in Appendix C that in such a case, the rms value of the phase error due to noise alone is $\sqrt{\psi_0}/Q$ where ψ_0 is the total noise power added to the sinusoid, and Q is the amplitude of the sinusoid. Thus if it is desired that the rms value of the phase error due

to noise alone be less than 5° ,

$$\frac{\sqrt{2\gamma F_0}}{Q} < \frac{5}{57.3}$$

Using the values of F_0 from Appendix A and considering the filter to be a single-tuned circuit it is found that the half bandwidth α must be less than 22, 85, and 135 cps, respectively, for intermediate-frequency signal-to-noise ratios of 1, 3, and 5.

To calculate the static phase error, the filter is again taken to be a single-tuned circuit and the maximum frequency deviation to be ± 50 cps. Then the slope of the phase characteristic at resonance is

$$\left. \frac{d\theta}{d\omega} \right|_{\omega=\omega_0} = \frac{1}{\alpha}$$

where α is the half bandwidth. Thus measuring frequency deviation from resonance, one has $d\theta = d\omega/\alpha$. This yields a phase shift of 2.3, 0.6, and 0.37 radians for intermediate-frequency signal-to-noise ratios of 1, 3, and 5. This amount of phase shift obviously requires an auxiliary manual phase control. If the allowable rms phase error is 10° , then the bandwidths become 88, 340, and 540 cps, respectively, and the static phase shift becomes 33° , 8.4° , and 5.3° . The picture probably becomes unusable for a carrier-to-noise ratio in the intermediate frequency of about 2, so that if these phase errors can be tolerated in the sampling frequency, then the receiver can be operated without auxiliary manual hold control. The transient caused by a sudden step of phase in the input to the filter will have the time constant of the filter. This will occur when switching stations, but it is not considered to be important.

To determine the characteristics of the afc synchronizing system, the configuration of Fig. 1 is assumed.

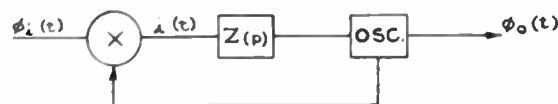

Fig. 1—Automatic-frequency-control servo loop.

The incoming sync information after detection and separation is fed into a phase comparator where its phase is compared with that of the free-running oscillator which determines the frequency of the receiver sync. Thus the incoming phase information is denoted by $\phi_i(t)$. Out of the phase comparator comes an error current $i(t)$ which passes through a filter $Z(p)$ before correcting the oscillator whose output is $\phi_o(t)$. Then out of the phase detector there is obtained

$$i(t) = K_1[\phi_i(t) - \phi_o(t)]$$

where K_1 is the sensitivity parameter of the phase comparator and is taken to be a constant. From the filter $Z(p)$ there is a voltage $e(t)$ which defined by

² Kurt Schlesinger, "Locked oscillator for television synchronization," *Electronics*, vol. 22, pp. 112-118; January, 1949.

$$e(p) = Z(p)i(p).$$

It is assumed that the voltage controlling the oscillator is held at a bias which yields the nominal sync frequency so that the voltage applied here results in deviation about that frequency. It is further assumed that the instantaneous deviation of oscillator frequency from the nominal value is directly proportional to $e(t)$.

Then

$$\frac{d\phi_0}{dt} = K_2 e$$

where K_2 is the sensitivity constant of the oscillator.

Since the phase comparator is a nonlinear device, K_1 is not an absolute constant but depends somewhat on the input signal and noise level. However, when measured or otherwise determined for a particular signal and noise, it will not vary much for reasonably small deviations from that value of signal and noise. Presumably, in designing an afc sync system one must first decide the lowest signal-to-noise ratio under which the system is to operate satisfactorily. The design is then optimized for that condition with the expectation that performance will be better when the noise level falls. K_2 will be essentially constant for small values of $e(t)$ for sine-wave oscillators controlled by reactance tubes or for blocking oscillators. Then, solving these equations in the frequency domain, it is seen that

$$\phi_0(p) = \frac{K_1 K_2 Z(p)}{p + K_1 K_2 Z(p)} \phi_1(p).$$

If $Z(p)$ is taken as a simple RC low-pass filter,

$$Z(p) = \frac{A_0}{p + \alpha}$$

Then

$$\phi_0(p) = \frac{A_1}{p^2 + \alpha p + A_1} \phi_1(p)$$

where $A_1 = K_1 K_2 A_0$. Thus the over-all gain function of the system is given by

$$Z_0(p) = \frac{A_1}{p^2 + \alpha p + A_1}$$

Now consider the effect on the system of introducing signals such as a step of phase or a step of frequency. These situations will exist when stations are switched. The output phase is given by a Laplace transform, thus

$$\phi_0(t) = \frac{A_1}{2\pi j} \int_{-j\infty}^{j\infty} \frac{g(p)e^{pt} dp}{p^2 + \alpha p + A_1}$$

where $g(p)$ is the spectrum of the input $\phi_1(t)$. In the case of a step of phase of magnitude I_0 ,

$$\phi_0(t) = \frac{A_1 I_0}{2\pi j} \int_{-j\infty}^{j\infty} \frac{e^{pt} dp}{p[p^2 + \alpha p + A_1]}$$

where

$$p^2 + \alpha p + A_1 = (p - p_1)(p - p_2)$$

and

$$p_1 = \frac{-\alpha + \sqrt{\alpha^2 - 4A_1}}{2}, \quad p_2 = \frac{-\alpha - \sqrt{\alpha^2 - 4A_1}}{2}$$

These roots are always in the left half plane and may be complex or real depending on $\alpha^2 - 4A_1$ being less than or greater than zero. In the former case, there is no oscillatory approach to the final tracking position while the latter provides a hunting approach. Operation at or near the critically damped position when $4A_1 = \alpha^2$ is generally preferred. In case the system is under-damped, the output is

$$\phi_0(t) = I_0 \left[1 - \frac{e^{-(\alpha/2)t} \left(\frac{\beta}{2} \cos \frac{\beta}{2} t + \frac{\alpha}{2} \sin \frac{\beta}{2} t \right)}{\frac{\beta}{2}} \right]$$

where $\beta = \sqrt{4A_1 - \alpha^2}$. This will reduce to the critically damped case when $\beta = 0$. $\phi_0(t)$ can be written as

$$\phi_0(t) = I_0 \left[1 - \frac{2\sqrt{A_1}}{\beta} e^{-(\alpha/2)t} \cos \left(\frac{\beta}{2} t - \tan^{-1} \frac{\alpha}{\beta} \right) \right]$$

The output then is as shown in Fig. 2.

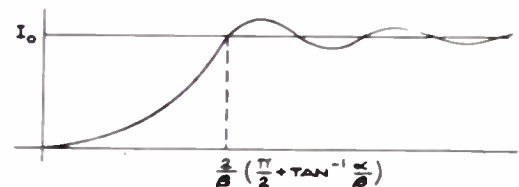

Fig. 2—Output of afc system to a step of phase.

The actual crossing of the line occurs at

$$t = \frac{2}{\beta} \left(\frac{\pi}{2} + \tan^{-1} \frac{\alpha}{\beta} \right)$$

so that if this crossing is taken as a measure of lock-in time, it appears that the lock-in time can be made small by making α large and β large. However, the overshoot becomes larger in such a case, so that a reasonable compromise must be made between fast lock-in time and initial overshoot. By minimizing the error $i(t)$, κ_1 in the mean square sense, it can easily be shown to vary as $1/\alpha$ so that in this sense, optimum tracking is obtained by making α as large as possible. All of this is in the absence of noise. It may be further noted that the output actually tracks I_0 regardless of loop gain or filter bandwidth and that tracking time is independent of the magnitude of the phase error. To maintain an oscillatory approach, $4A_1 > \alpha^2$. If for example $4A_1$ is taken to be equal to $2\alpha^2$ and $4\alpha^2$, respectively, the first overshoot is 4 per cent and 16 per cent, which gives an idea of the

magnitude of the oscillation. The magnitude of the first overshoot is $I_0(1 + e^{-\pi\alpha/\beta})$. These oscillations have been observed experimentally.

Now suppose that the input signal is in correct phase but off in frequency by a fixed amount, due to oscillator drift or station switching. Then beginning at $t=0$, $\phi_i(t) = \omega_0 t$ where ω_0 is the frequency difference. Then $g(p) = \omega_0/p^2$ and

$$\phi_0(t) = \frac{2\omega_0}{\beta} e^{-(\alpha/2)t} \cos \left[\frac{\beta t}{2} - \tan^{-1} \left(\frac{\alpha^2 - 2A_1}{\alpha\beta} \right) \right] + \omega_0 t - \frac{\omega_0\alpha}{A_1}$$

This last function is asymptotic to $\omega_0 t - (\omega_0\alpha/A_1)$ so that there is a static phase error $\omega_0\alpha/A_1$. This static phase error results in a static shift in the voltage $e(t)$ applied to the oscillator which is just enough to change its frequency by ω_0 . One notes that this error is ω_0/RK_1K_2 and is thus independent of the capacity of the filter. The output is as shown in Fig. 3.

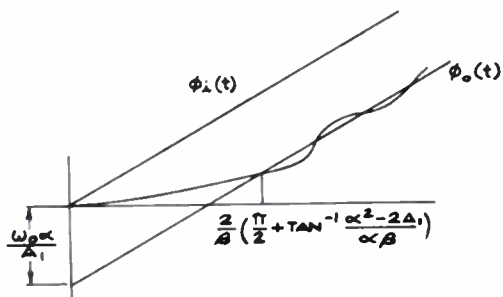

Fig. 3—Output of afc system to a step of frequency.

In general, in designing an afc system, it is necessary to consider the necessity of tracking relatively slow variations in the incoming signal in the presence of noise as well as the more severe transients such as steps of frequency and phase. Having decided upon a typical input signal to be tracked with optimum fidelity in the presence of a given noise level, an attempt would then be made to find the parameters which would minimize the error in some sense. This objective leads naturally to the theory of Wiener³ in which an attempt is made to find the filter which will minimize the difference between input and output in the mean square sense. In principle, this procedure is straightforward. However, it will generally yield a filter characteristic which is not physically realizable and must therefore be approximated. It is therefore the practice of servomechanists to start with a servo of a given type having adjustable parameters. The mean square error can then be computed directly and the parameters adjusted to minimize it. For our purposes here the simple low-pass filter heretofore assumed is believed adequate. An additional degree of freedom

³ H. M. James, N. B. Nichols, and R. S. Phillips, "Theory of Servomechanisms," Radiation Laboratory Series, vol. 25, McGraw-Hill Book Co., New York, N. Y., chap. 7; 1947.

with some improvement in performance can be obtained by starting off with a double time-constant filter. However, this complicates the calculations considerably and will not be gone into here.

The output of the servo as a convolution integral can be given as

$$\phi_0(t) = \int_0^\infty [\phi_i(t - \tau) + \phi_N(t - \tau)]K(\tau)d\tau$$

where ϕ_N is the noise assumed to enter the system with $\phi_i(t)$ and $K(\tau)$ is the characteristic transient of the servo system. The phase error is given by

$$\frac{i(t)}{K_1} = \phi_i(t) - \phi_0(t) = \phi_i(t) - \int_0^\infty [\phi_i(t - \tau) + \phi_N(t - \tau)]K(\tau)d\tau$$

Assuming no error in the incoming signal, the phase error becomes

$$\frac{i(t)}{K_1} = - \int_0^\infty \phi_N(t - \tau)K(\tau)d\tau$$

Thus using Plancherel's theorem, the mean-square phase error due to noise alone is

$$\frac{1}{4\pi} \int_{-\infty}^\infty F_1(\omega) |Z_0(\omega)|^2 d\omega$$

where $F_1(\omega)$ is the phase noise power spectrum and $Z_0(\omega)$ the over-all servo gain function. The above considerations are quite general and apply to any afc system of the type considered here. It may be assumed that the bandwidth of $Z_0(\omega)$ will be so small compared to 4 Mc that $F_1(\omega)$ can be considered flat across it. Therefore, the mean-squared phase error is

$$\frac{1}{4\pi} F_1 \int_{-\infty}^\infty |Z_0(\omega)|^2 d\omega = \frac{F_1}{4\pi} \int_{-\infty}^\infty \frac{A_1^2 \alpha \omega}{(A_1 - \omega^2) + \alpha^2 \omega^2} d\omega = \frac{F_1 A_1}{4\alpha}$$

It may be observed here that in trying to minimize this error, the static phase error $\omega_0\alpha/A_1$ is made large so that a compromise must be struck between the two. Since this result will be evaluated for $4A_1 = \alpha^2$, little error is caused here by taking the integral to ∞ .

Now consider that the afc is applied to the 3-Mc carrier. First the burst is put through a narrow tuned circuit to pick out the 3-Mc sine wave. No phase information is lost by this maneuver. This filter must be wide enough so that an objectionable phase shift does not develop here. Then a sine wave plus noise is put into the phase detector. The power spectrum of the phase noise is, as shown in Appendix A,

$$F_1(\omega) = \frac{2F_0}{Q^2}, \quad 0 < \omega < \gamma$$

where Q is the amplitude of the sinusoid, 2γ the bandwidth of the prephase-comparator filter, and F_0 the power spectrum of the video noise at 3 Mc.

Now we wish to compare the simple filter with the afc by constraining them to have the same rms phase noise error and then comparing the ensuing static phase error. If the phase noise errors are equated, it is found that $\alpha_1 = A_1/\alpha_2$ where α_1 is the half bandwidth of the simple filter, and α_2 the half bandwidth of the filter in the afc loop. Then the static phase error for the afc case is $\omega_0\alpha_2/A_1 = \omega_0/\alpha_1$ which is identical with the result for the simple filter, independent of the relationship between A_1 and α_2 . If a double time-constant filter is used in the afc loop, it can be shown that for equal static phase errors, the noise error in the double time-constant case can always be made less than that for the single time-constant filter. In such a case, there will then be improvement in performance over the case analyzed here at some reduction in lock-in time.

It will now be shown how the foregoing analysis may be applied to pulsed sync systems, although specific calculations will not be carried through, since such systems are not the primary interest here.

Consider the conventional black-and-white afc pulse sync system. Here the sync information is not provided continuously but intermittently so that there is a little difficulty in defining phase in a sense that may be compared with the continuous case. The position of incoming pulses is determined in a conventional balanced

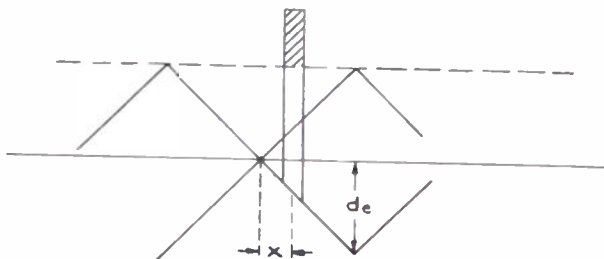

Fig. 4—Balanced pulse phase comparator.

phase detector⁴ by feeding back part of the sawtooth output of the oscillator in the fashion shown in Fig. 4. In effect, the pulse is caused to ride on each of two sawteeth which differ only in polarity. In each case the pulse top is then clipped at a fixed (ideally) bias level and the two clipped pulses subtracted. The difference is the output of the phase detector. At the center position there is no output, hence the term balanced-phase detector. If the slope of the sawtooth is d , then the height of the output pulse is $2dx$ where x is the deviation of the pulse from its proper position. If the pulses are to the left of the center point, the polarity of the output (as well as any noise present) is reversed. Thus the output

of this phase detector consists of pulses of current of varying amplitude and polarity. If, at time $t=0$, the frequency of the oscillator is correct but there exists a constant phase error, then the input to the servo consists of a sequence of pulses of the same height and polarity.

To make this type of input signal fit in with the previously derived equations describing the servomechanism, it is convenient to observe that the time constant of the over-all servo will be large compared to the time between pulses (of the order of 15 to 1) so that one may without appreciable error spread the area of the input pulse over the entire interval 0 to T . This provides a continuous input to the servo. The area of the error pulse is $2dxW$, where W is its width. The equivalent pulse after spreading then has a height $(2dxw/T)$. x is defined as the phase error. The quantity $2dW/T$ has the dimensions of amperes per unit phase error and is therefore defined as the sensitivity constant K_1 of the phase detector. Under these assumptions all of the preceding results on tracking, lock-in time, and so forth, are valid.

If the sync pulses are not gated, as is generally the case in black-and-white television, there is some difficulty in calculating the noise output of such a phase detector. To design for the worst condition, one would presumably assume the video at black level and then calculate the noise output of the device. This can be done only by numerical methods and will not be gone into here. In practice, the clipping levels of the two diodes in the balanced phase detector are allowed to set themselves. These levels are determined by the pulse signal level, the noise level, the pulse signal position, the diode internal resistance, and the diode plate load resistance. For a given input signal-to-noise ratio and with the input pulse at the neutral position, a solution can be found for the proper plate load resistor to position the clipping level where desired. For small errors in phase then the clipping level will not deviate much from the optimum value. The height of the sync pulse is $C/4$ where $(C/4) > 2de$ in all cases. Ideally, clipping should be done at $(C/4) - de$ since at this level full indication of phase error is obtained while the clipping level is as high as possible to avoid picking up noise. Presumably then, the clipping level is established for the minimum signal at which the device is expected to operate satisfactorily and suffers a design somewhat less than optimum at the higher signal-to-noise ratios. The plate load resistor thus determined affects the value of α in the filter following the phase detector but the capacity there can be varied within limits to adjust α for optimum value in terms of tracking, and so forth.

APPENDIX A

In the usual sync system, the sync tips are passed into the video and separated there by clipping. The top 25 per cent of the peak carrier may be devoted to hori-

⁴ K. R. Wendt and G. L. Fredendall, "Automatic frequency and phase control of synchronization in television receivers," *Proc. I.R.E.*, vol. 31, pp. 7-15; January, 1943.

zontal sync information for about 10 μseconds out of every line of 63.5 μseconds. The usable burst of carrier is probably 4 μseconds long and C/4 volts in amplitude where C is the intermediate-frequency carrier amplitude during sync pulse. It is assumed that this burst has been gated so that no noise appears in the sync system except during the burst itself. The noise in the intermediate frequency may be assumed to have a normal first probability density function of the form.

$$W_1(I) = \frac{1}{\sqrt{2\pi\psi_0}} e^{-I^2/2\psi_0}$$

where I is the instantaneous noise current and ψ₀ the average noise power. If the second detector is an envelope tracer, the density function of noise alone in the video is no longer normal but has a Rayleigh distribution

$$W_1(R) = \frac{R}{\psi_0} e^{-R^2/2\psi_0}$$

where R is the voltage of the envelope and ψ₀ the intermediate-frequency noise. If an unmodulated carrier C is added to the intermediate-frequency, the probability density function then becomes

$$W_1(R) = \frac{R}{\psi_0} e^{-(R^2+C^2)/2\psi_0} I_0\left(\frac{RC}{\psi_0}\right) \quad (1)$$

when I₀ is the modified Bessel function. This density function does not depend on the position of the carrier in the intermediate-frequency pass band. To a first approximation, the continuous part of the noise power spectrum F(f) of a sine wave and noise in the video following an envelope is given by⁵

$$F(f) = \pi^2 h_{11}^2 [W(fq - f) + W(fq + f)] + \pi^2 \frac{h_{02}^2}{4} \int_{-\infty}^{\infty} W(x)W(f-x) \alpha x \quad (2)$$

where

$$h_{11} = \frac{1}{2} \left(\frac{y}{\pi}\right)^{1/2} {}_1F_1(1/2; 2; -y)$$

$$h_{02} = (2\pi\psi_0)^{-1/2} {}_1F_1(1/2; 1; -y)$$

$$y = \frac{C^2}{2\psi_0}$$

₁F₁(α; β, γ) is the hypergeometric function. The first part of F(f) is due to the modulation products of signal and noise while the second part is due to the intermodulation of the noise alone. In the case of vestigial side-band transmission, there is only half of the first part of this, namely, W(fq+f) where now f extends over

the entire intermediate-frequency and video bandwidth. If W'(f) is flat, = W₀, the noise power spectrum in the video is as shown in Fig. 5.

Here

$$A = (ch_{02})^2 \left[\frac{BH_0^2}{4C^2} \right] = \frac{W_0}{8} (ch_{02})^2 \frac{1}{\left(\frac{S}{N}\right)_{if}}$$

The values of (ch₀₂)² and h₁₁² are obtained from the curves in the literature.⁶ As the signal becomes larger compared with the noise, the contribution due to noise intermodulation drops off until ultimately the noise rides on top of the signal and the spectrum in the video has the same shape as in the intermediate frequency. On the other hand, for zero signal, the spectrum becomes triangular.

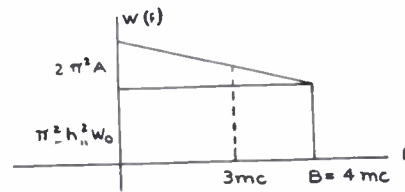

Fig. 5—Power spectrum of sine wave plus noise in the video.

The above shows the power spectrum of the noise alone. As is generally known, when the noise power becomes comparable to that of the signal, the second detector causes a suppression of modulation. Since the modulation index of the carrier burst is small (1,8), the preceding result concerning noise-power spectrum is not altered perceptibly by the addition of the modulation. However, it is necessary to know the extent of modulation suppression and it is convenient, since the modulation index is small, to use the procedure of Ragazzini.⁷ The input to the detector can be written

$$e(t) = C \cos \omega_0 t + mC \cos (\omega_0 + \omega_s) t + \sum_0^{m_0} c_n \cos (\omega_n t + \phi_n)$$

where the last term encompasses all noise components with random phase angles φ_n. Then the envelope can be written as

$$E(t) \cong [C^2 + m^2 C^2 + 2\psi_0 + 2mC^2 \cos \omega_s t]^{1/2}$$

where ψ₀ is the entire intermediate-frequency noise power. This is approximately

$$E(t) = \sqrt{C^2 + 2\psi_0} \left(1 + \frac{mC^2 \cos \omega_s t}{C^2 + 2\psi_0} \right)$$

⁵ S. O. Rice, "Mathematical analysis of random noise," *Bell Sys. Tech. Jour.*, vol. 24, pp. 46-157; January, 1945. Rice's constant 1/π² has been eliminated here.

⁶ See page 148 of footnote reference 5.
⁷ J. R. Ragazzini, "The effect of fluctuation voltages on the linear detector," *PROC. I.R.E.*, vol. 30, pp. 277-287; June, 1942.

Thus the detected signal has the amplitude

$$\frac{mC^2}{\sqrt{C^2 + 2\psi_0}} = \frac{mC}{\sqrt{1 + \frac{2\psi_0}{C^2}}}$$

and the modulation suppression is

$$\frac{1}{\sqrt{1 + \left(\frac{S}{N}\right)_{if}}}$$

For $S/N_{if} = 1, 3,$ and $5,$ the suppression factor becomes $0.71, 0.87,$ and $0.91.$

Now, if in the video, the burst and associated noise is simply gated, it is possible, as is shown in appendix B, to find the signal-to-noise ratio of the 3-Mc sine wave and noise as it leaves the filter. However, some improvement can be made by clipping as well as gating. As shown in Appendix B, the noise spectrum at 3 Mc is, to a first approximation, reduced by the gating factor. The noise may be further reduced by clipping at $3/4C$ since this does not reduce the signal but does reduce the noise. Numerical integration of the second density function (1) shows that the total dc suppressed noise power is reduced from $0.65\psi_0$ to $0.50\psi_0,$ $0.83\psi_0$ to $0.52\psi_0,$ and $0.93\psi_0$ to $0.61\psi_0,$ respectively, for input signal-to-noise ratios of 1, 3, and 5. Thus assuming that the spectral distribution does not change materially in shape, the power spectrum level at 3 Mc can be found.

Utilizing the results of (2), this is to be found to be $0.027W_0, 0.032W_0,$ and $0.037W_0,$ respectively. Since ψ_0 the total intermediate-frequency noise = BW_0 this may be written

$$\frac{0.027\psi_0}{B}, \quad \frac{0.032\psi_0}{B}, \quad \text{and} \quad \frac{0.037\psi_0}{B}$$

APPENDIX B

If we have an ideal gate which opens and closes at intervals $T,$ it may be represented as the time function shown in Fig. 6. To gate noise this time function is

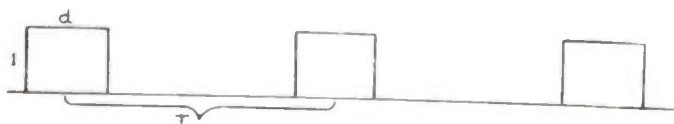

Fig. 6—Gating time function.

multiplied by the noise-voltage time function. It is desired then to find the power spectrum of the product. The autocorrelation of the product is the product of the separate autocorrelations since the two time functions are independent. To each autocorrelation function corresponds, by Fourier transform (Wiener's theorem), the power spectrum of the original time function. Thus,

$$G(\omega) = 4 \int_0^\infty R(\tau) \cos \omega \tau d\tau$$

$$R(\tau) = \frac{1}{2\pi} \int_0^\infty G(\omega) \cos \omega \tau d\omega$$

where $G(\omega)$ is the power spectrum and $R(\tau)$ the un-normalized autocorrelation function. The spectrum of the product of two autocorrelation functions (time functions in the power domain) is given by the complex convolution integral. Thus the power spectrum of the two original time functions is given by

$$G(\omega) = \frac{1}{4\pi} \int_{-\infty}^\infty F_1(\omega - s)F_2(s)ds$$

where $F_1(S)$ is the power spectrum of the noise, say, and $F_2(S)$ is the power spectrum of the gating pulses. For the simple gate assumed, the result is given by

$$F(\omega) = \frac{d^2}{T^2} \sum_{-\infty}^\infty \left[\frac{\sin \frac{n\pi d}{T}}{\frac{n\pi d}{T}} \right]^2 G_1\left(\omega - \frac{2\pi n}{T}\right)$$

This sum may be approximated by an integral

$$F(\omega) \cong \frac{d^2}{T^2} \int_{-\infty}^\infty \left[\frac{\sin \frac{n\pi d}{T}}{\frac{n\pi d}{T}} \right]^2 G_1\left(\omega - \frac{2\pi n}{T}\right) dn$$

which is valid when the gating frequency is small compared to the bandwidth of the noise, so that successive G 's overlap substantially.

If $G_1(\omega)$ is constant and = G_{11}

$$F_1(\omega) = \frac{G_{11}d^2}{T^2} \left[1 + 2 \sum_1^\infty \left[\frac{\sin \frac{n\pi d}{T}}{\frac{n\pi d}{T}} \right]^2 \right] = \frac{G_{11}d}{T}$$

showing that the noise spectrum and the total noise power are each reduced by the gating factor $d/T.$ By the same argument one may show that for any spectrum $G_1(\omega),$ the total noise power is reduced by $d/T.$

It may be of some interest to observe here that when gates are used in the sense of samplers of a video signal, the signal-to-noise ratio after gating does not depend on the gating factor d/T in any way, provided that the noise bandwidth is limited to ω_0 prior to sampling where ω_0 is the highest video frequency sampled. This is apparently not generally realized but may be easily shown with the aid of the above formulas.

In the application used here, the gating frequency is small compared with a bandwidth of 4 Mc so that the integral approximation is valid. Under these conditions, it is not hard to show that to a first approximation the

spectrum at 3 Mc is also reduced by d/T when the total power is reduced by that amount.

APPENDIX C

In the case of normally distributed noise in a range of frequencies that is small compared to the center frequency, the noise current may be written after the method of Rice⁸ as

$$\begin{aligned}
 I_n &= \sum_1^N C_n \cos(\omega_n t + \phi_n) \\
 &= \sum_1^N C_n \cos[(\omega_n - q)t + \phi_n + qt] \\
 &= I_c \cos qt - I_s \sin qt
 \end{aligned}$$

where

$$\begin{aligned}
 I_c &= \sum_1^N C_n \cos[(\omega_n - q)t + \phi_n] \\
 I_s &= \sum_1^N C_n \sin[(\omega_n - q)t + \phi_n].
 \end{aligned}$$

Here q is the center frequency of the band,

$$\omega_n = 2\pi f_n, \quad f_n = n\Delta f, \quad C_n^2 = 2F(f_n)\Delta f.$$

$F(f)$ is the noise power spectrum. I_c and I_s are normally distributed and each have the rms value $\sqrt{\psi_0}$. If a sinusoid $Q \cos qt$ is added to the noise,

$$\begin{aligned}
 I &= Q \cos qt + I_n \\
 &= (Q + I_c) \cos at - I_s \sin qt \\
 &= R \cos (qt + \theta)
 \end{aligned}$$

where R is the envelope and θ the phase. Then

$$\theta = \tan^{-1} \frac{I_s}{I_c + Q} \cong \frac{I_s}{Q} \quad \text{if } Q \gg \sqrt{\psi_0}$$

and under these conditions the density function for θ may immediately be written as

$$W_1(\theta) = \frac{Q}{\sqrt{2\pi\psi_0}} e^{-\frac{\theta^2 Q^2}{2\psi_0}}$$

Then the rms phase deviation from that of the sinusoid is $\sqrt{\psi_0}/Q$ radians. From the representation of noise in the Fourier series, it is evident that I_s behaves like a noise current whose power spectrum is concentrated in the power part of the power spectrum and is, in fact,

⁸ S. O. Rice, "Statistical properties of a sine wave plus random noise," *Bell Sys. Tech. Jour.*, vol. 27, pp. 109-158; January, 1948.

$$F_1(\omega) = F(\omega_q + \omega) + F(\omega_q - \omega)$$

where $F(\omega)$ is the power spectrum of I_n . Thus if

$$F(\omega) = \begin{cases} F_0 = \frac{\psi_0}{B} & \text{for } \omega_q - \frac{\beta}{2} < \omega < \omega_q + \frac{\beta}{2} \\ 0 & \text{elsewhere,} \end{cases}$$

then

$$F_1(\omega) = \begin{cases} \frac{2F_0}{Q^2}, & 0 < \omega < \frac{\beta}{2} \\ 0 & \text{elsewhere.} \end{cases}$$

The noise in the video is not normally distributed. However, if a narrow filter at 3 Mc is inserted, randomness is restored and the noise out of the filter can be considered normal, so that the preceding argument can be applied. The filter may be assumed so narrow that the noise spectrum picked out by it will be flat. However, the level of the noise power at 3 Mc must be determined.

Using the results of Appendix B, it can be shown without difficulty that the condition $Q \gg \sqrt{\psi_0}$ is satisfied for the three values of S/N_{if} assumed. A filter 2 kc wide will quite satisfactorily pick out the 3-Mc carrier without the adjacent sidebands which are 15 kc away. This filter width does not give rise to any appreciable static phase error in itself due to changes in frequency and provides a Q suitably larger than $\sqrt{\psi_0}$.

It is of interest to note here that the phase noise-power spectrum has the dimensions of time so that when integrated over ω , it yields phase in radians. The phase correlation may also be easily calculated from the phase power spectrum, being given by Wiener's theorem as

$$R(\tau) = \frac{1}{2\pi} \int_0^\infty F(\omega) \cos \omega\tau d\omega.$$

In the case of a uniform spectrum of width γ this yields

$$R(\tau) = \frac{F_0\gamma}{4\pi} \frac{\sin \frac{\gamma\tau}{2}}{\frac{\gamma\tau}{2}}$$

showing that phase correlation due to noise does not become small until

$$\tau = \frac{2\pi}{\gamma}$$



The Control Chart as a Tool for Analyzing Experimental Data*

ENOCH B. FERRELL†, SENIOR MEMBER, IRE

This paper is published at the suggestion and on the recommendation of the IRE Professional Group on Quality Control.

Summary—The statistical methods that have been developed for use in quality control are a powerful tool in the interpretation of laboratory experiments where only a small amount of data is available. An understanding of these methods also permits more logical planning of experiments and improves what we might call “the efficiency of experimentation.” One of the simplest and most broadly useful of these tools is the control chart. It is easy to understand and use and in many cases can take the place of more laborious and complicated methods of analysis.

ONE OF THE simplest and most useful tools for statistical analysis is the control chart. As originally developed by Shewhart, the control chart was primarily a tool for the production man who dealt with large numbers of repetitive operations. In recent years, Shewhart and others have been giving much thought to the question: “Can the simple statistical tools that have proved so valuable in quality control in the factory be just as useful in research and development work, in laboratory experimentation?” The answer is yes.

It is the purpose of this paper to give a very brief description of the control chart and point out how the experimenter can use it in his laboratory. He may not be an expert statistician. But he wants to make most of the analysis by himself and call in the expert only on the more difficult problems. He needs a technique that is not cloaked in mathematical symbolism. He needs a method of analysis that can be applied in a straightforward manner, and that can be explained to others who, like himself, are not steeped in statistical lore. He is more interested in relations and interpretations that lead to sound and useful judgments than he is in mathematical elegance or numerical precision.

The control chart pays its way as a simple and efficient method of analyzing and summarizing our data. Then it pays a bonus. It tells us when our data are good and when not. It tells us when we have enough data and when we need more. It tells us when our methods can be improved and when we have reached the limit in refining them along any particular line. It points a finger at those spots in our development where concentrated effort will do the most good.

* Decimal classification: R001XR010. Original manuscript received by the Institute, May 19, 1950. Presented, 1950 IRE National Convention, New York, N. Y., March 7, 1950.

† Bell Telephone Laboratories, Inc., New York, N. Y.

In appearance, the control chart is a simple plotting of points and guide lines. Typically it is a double chart like that in Fig. 1. The abscissa is some independent variable such as observer, the number of the subgroup or setup, or ambient conditions. Often it is simply a serial number representing the order in which the experiment is carried out. The ordinate is the characteristic of interest: some physical property of an alloy under study, or the transconductance of a tube of new design.

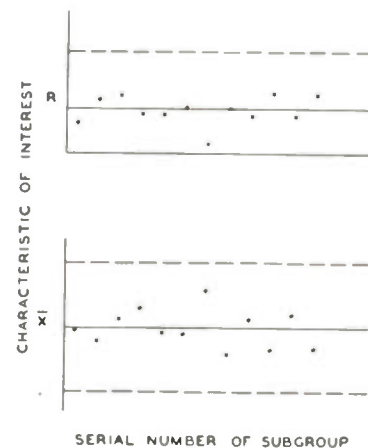

Fig. 1—Control chart subgroups of 4.

In plotting our control chart, we group our data into small rational subgroups. The “small” means, preferably, 4 or 5, although we sometimes use subgroups as small as 2 or as large as 6 or more. The “rational” means that we have reason to believe the members of a subgroup are alike because they involve the same calibration setting, or the same bottle of reagent, or simply because they represent work all done at about the same time. The “rational” also means that we have reason to suspect that the subgroups might be different from each other, because they represent different observers, or different calibrations, or simply different days.

We treat the few observations in each subgroup as a set and we compute and plot their range R and their average \bar{X} . The range is the difference between the largest and smallest, and is a measure of dispersion. The average is the usual arithmetic mean. The range and the average are the points on the control chart.

On our control chart we draw two central lines, one

at the average of the ranges \bar{R} ; one at the average of the averages, which is the grand average $\bar{\bar{X}}$.

On the control chart we also draw limit lines.

$$\lim R = D_3\bar{R} \text{ or } D_4\bar{R}$$

$$\lim \bar{X} = \bar{X} \pm A_2\bar{R}$$

where D_3 , D_4 , and A_2 are factors that we find in published tables,¹ just as we find sines or logarithms. They depend on the number of observations in each subgroup.

The central line on the average chart represents the average in the usual sense. It is the average strength of our plastic, the average permeability of our iron, or the average g_m of our tubes.

The central line on our range chart tells us what dispersion to expect. If these data represent reliable information about a stable process, then we expect future observations to have a root-mean-square deviation σ of about

$$\sigma = \bar{R}/d_2$$

where d_2 is another factor from the tables,¹ and depends on the subgroups size. We expect nearly all future observations to lie between $\bar{X} + 3\sigma$ and $\bar{X} - 3\sigma$.

The limit lines tell us something about the reliability and stability. If we have points outside limits we should question the reliability and stability. Points outside, outages, tell us that our experimental process is probably being affected by differences in calibration, by the mood of the observer, or by the intrusion of some foreign influence. Outages tell us that our measurements are being affected by some identifiable or assignable cause for variation—a cause not normally present—a cause that stands out above that system of causes that produce the variations inherent in our process. Outages tell us that our experiment is in trouble and tell us when it got that way. This information is most important in tracking down and eliminating that trouble.

If there are no outages, this indicates that the variations we observe are due to a mass of minor causes, and not to any one or two causes that are important or even identifiable. So we know that we should not waste time tinkering with the process in an effort at improvement. For this indication to be reliable, we should have something like 25 consecutive subgroups all within limits.

As a corollary to this, the limit lines sometimes tell us when to abandon a particular process or type of experimentation. The limits which the process gives us for itself way be wider than we can tolerate. But if we have enough points all inside limits, with no outage, and still want something better, we must make a fundamental change in the process.

We should emphasize the fact that these limits are not based on any customer's requirements, or on management's stated objectives, or on what some old hand

¹ "A.S.T.M. Manual on Presentation of Data," American Society for Testing Materials, Philadelphia, Pa.; April, 1945.

tells us we ought to be able to do. They are based on the measurements we have just made on the process we are working with. By these limits the process itself tells us what to expect from it in the future.

The control chart is a system of bookkeeping for studying the causes of variation. We use it to analyze the same data we would analyze by any other method. It helps us draw the same conclusions we ought to draw by whatever method we use. It is simple and straight forward.

Let us consider a couple of simple illustrations of how the control chart might be useful in laboratory work. Suppose we have a paper design for a new type of vacuum tube. We make a small batch of tubes according to this design—4 or 5, or maybe 8 or 10. We measure their characteristics. For this illustration, let us confine our attention to the trans-conductance g_m . Perhaps our first models do not turn out as well as we had hoped. We revise our design and make another lot. It is still pretty poor, but we think we are beginning to see what is wrong so we try again. This time we get something worth while. This is the familiar history of experimental progress. Finally, after more trials, we arrive at a design that we think may be satisfactory. We take it to the production man and the customer for their opinions.

They like it, and the eight tubes we made according to the last design look good. Then comes the inevitable question, shot at us in two forms. From the user: "How much variation will I have to put up with?" From the producer: "How tight tolerances must I meet?"

Fig. 2 shows a simple historical record of all the tubes we have made. In preparing this hypothetical example, it was assumed that nine different designs, A, B, \dots, J

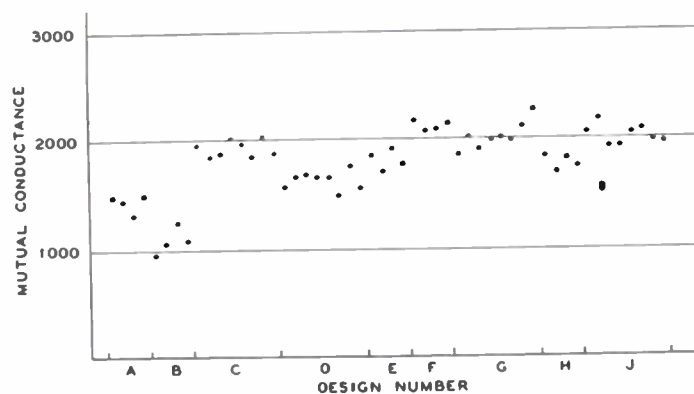

Fig. 2—Historical record. Individual points.

on the chart, were tried and that the later ones were the better ones. The g_m varies all the way from 950 to 2,270. It is not apparent from this chart just what variation is to be expected.

Now let us put these same data in control-chart form as shown in Fig. 3. Some of our design lots contained four tubes. Others contained eight and we have treated such a lot as two subgroups of four. Altogether, we have thirteen subgroups of four. Design changes have been made between subgroups so that any subgroup relates to a single design.

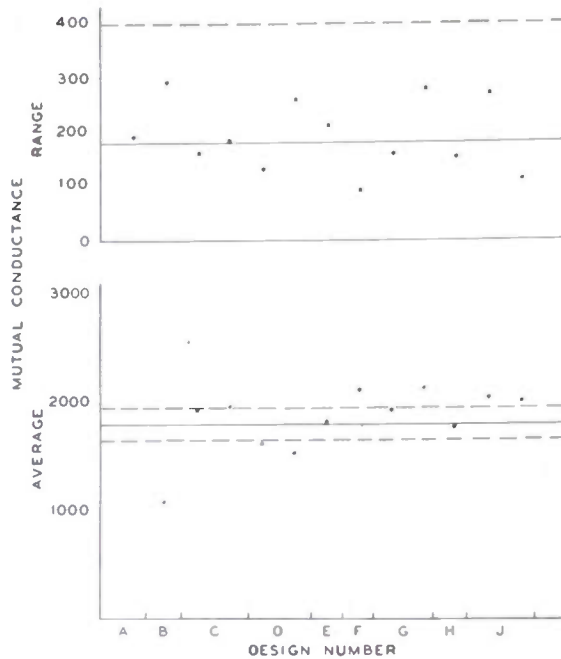

Fig. 3—Historical record in control-chart form.

From the control chart of averages we see, as was assumed in the illustration, that designs *A*, *B*, and *D* give significantly low g_m while designs *C*, *F*, *G*, and *J* give significantly high g_m .

These control charts should, of course, have been plotted day by day as our work progressed. In the early stages, we would have used tentative values, based on the data available then, for the central lines and limits. These control charts should have been used to guide each step in our development. They would have helped us to evaluate the intended effects of our design changes. They would have helped us recognize unintended effects which we might desire either to avoid or to use. They would have helped us to recognize and eliminate extraneous effects that might interfere with our experimentation.

The range control chart does its share in this guiding of the course of our work. It also helps us answer that question about variations or tolerances. Every time we changed our design we may have changed our design average. If we computed a single dispersion on the basis of all the tubes lumped together, that dispersion would probably describe principally our design changes. But within each subgroup of four there was no design change. The range of each subgroup represents the dispersion that is present with constant design. We have thirteen such ranges, and from their average we can form an estimate of the inherent dispersion that exists when the design is not changed, and that is based on an over-all sample of 52 tubes and not merely on the eight tubes of the final design.

One may well ask: But may not these intentional design changes have produced changes in inherent dispersion just as they did in the average? The answer obviously is: Yes, they may have. Fortunately, it is rather common experience that they do not. But let us not

take this for granted. Let us go back to the limit line and the outages on our range chart. In this illustration it was assumed that there were not outages. This is an indication that there was no significant change in dispersion, due either to the design changes or to extraneous causes. We may, therefore, take the average range as a measure of dispersion with some confidence.

But suppose that for some subgroups the range is outside limits. This may indicate that this design tends to give greater inherent variation than the others and may cause us to abandon this design. Or it may indicate the intrusion of some foreign influence into our model building or our measurements. In either case, we would not include the range of this subgroup in the basis of our estimate of dispersion.

We may compare this method to the analysis of variance. The latter also gives us a measure of the changes that our designs have introduced and a measure of the inherent or residual dispersion that exists with a fixed design. The analysis of variance, however, makes no use of limits and outages. The analysis of variance assumes that the residual variation is constant. It waves no red flags when the inherent dispersion changes or when extraneous influences interfere. It does not tell us to ignore certain subgroups in estimating the residual dispersion.

In planning this series of experiments we would have used our knowledge of our intended method of analysis to plan the size of our subgroups, to plan the essential similarity of items within any one subgroup, and to plan specific changes between subgroups.

Now consider an example in which statistics play a more important part in planning an experiment. Suppose we are working on a 3-stage intermediate-frequency amplifier for a television receiver and want to determine experimentally the variation in gain that is to be expected from variation in certain components. This gain depends, among other things, on the g_m 's of the three tubes. We might get the three worst tubes we can find, and the three best tubes we can find, and try each set in our circuit. This is unrealistic and may be unnecessarily pessimistic. From our knowledge of the dispersion of this type of tube, and by the use of known statistical factors² we can write down the g_m for each tube in an idealized sample of nine. We know, for example, that, on the average, the largest value in a sample of nine from a normal universe will be 1.48σ above the universe average. Let us get a number of tubes from the stockroom, measure each, and select the nine which most nearly correspond to the idealized sample. We also know the expected values of the three averages we would get by an idealized sampling process which gave us three sets of three tubes each. So we divide our nine tubes into three sets of three each whose averages most nearly correspond to those expected

² Cecil Hastings, Jr., F. Mosteller, J. W. Tukey, and C. P. Winsor, "Low moments for small samples," *Inst. Math. Stat.*, vol. 18, no 3; September, 1947.

averages. This is illustrated in Fig. 4. We put each of these three sets of tubes in our circuit and measure the resulting gain.

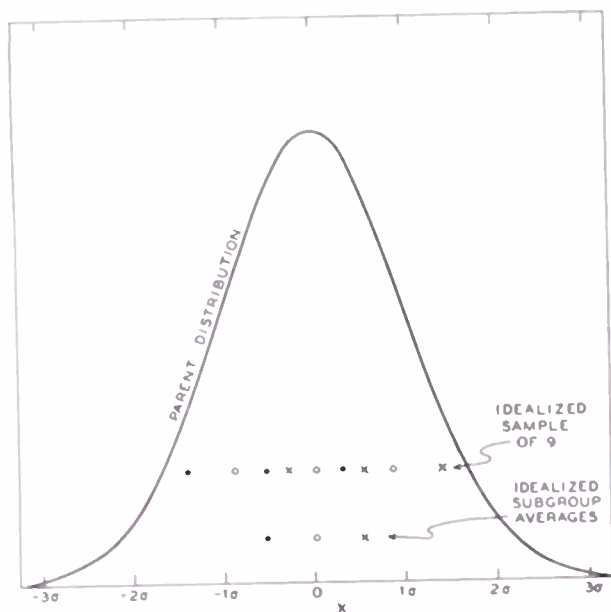

analysis of variance gives us quantitative measures of the three main effects. It tells us, for example, how much variation in gain was related to the variation in transconductance. It also gives us quantitative measures of the interactions, such as the effect that variation in biasing resistors had on the dispersion due to variation in transconductance. And it gives us a quantitative measure of the residual dispersion.

We can get comparable information from an analysis by the control-chart method. We can get it more readily, and we can get it in a form that the ordinary engineer can understand. Let us outline a schedule for such an analysis. Part of such a schedule is shown in Table I. Columns *a*, *b*, and *c* give the values of the three independent parameters, and these are arranged in some logical order such as that indicated. In our example these are transconductance and biasing resistors, in each case the average of the three used, together with the supply

TABLE I
ANALYSIS OF VARIATION BY CONTROL-CHART METHODS

<i>a</i>	<i>b</i>	<i>c</i>	<i>d</i>	<i>e</i>	<i>f</i>	<i>g</i>	<i>h</i>	<i>j</i>	<i>k</i>
(<i>R_m</i>)	(<i>R_A</i>)	(<i>E_B</i>)	(Gain)	<i>R_c</i>	<i>Y_c</i>	<i>R_b[*]</i>	\bar{X}_b^*	<i>R_a[*]</i>	\bar{X}_a^*
1	1	1	—						
		2	—						
		3	—	—	—				
	2	1	—						
		2	—						
		3	—	—	—				
	3	1	—						
		2	—						
		3	—	—	—				
	2	1	—						
		2	—						
		3	—	—	—				
	3	1	—						
		2	—						
		3	—	—	—				
	2	1	—						
		2	—						
		3	—	—	—				
	3	1	—						
		2	—						
		3	—	—	—				
Average Limits			\bar{X}	\bar{R}	\bar{Y}	R_b^*	\bar{X}	R_a^*	\bar{X}
			{	—	—	—	—	—	—

Note—*a*, *b*, and *c* are independent parameters. *X* is quantity measured. *R_c* is range of subgroup in which *c* is only variable parameter. \bar{X}_c is similar average. *R_b^{*}* is range of a subgroup of \bar{X}_c in which *b* is only variable parameter. Similarly \bar{X}_b^* , \bar{R}_a^* , and \bar{X}_a^* . σ_a , σ_b , and σ_c are estimates of main effect dispersions. σ_r is estimate of residual dispersion. *d*₁ and factors for computing limits are taken from published tables.

$$\sqrt{\sigma_c^2 + \sigma_r^2} = \bar{R}_c/d_2 \tag{1}$$

$$\sqrt{\sigma_b^2 + (\sigma_c^2 + \sigma_r^2)/3} = \bar{R}_b^*/d_2 \tag{2}$$

$$\sqrt{\sigma_a^2 + (\sigma_c^2 + \sigma_r^2)/3} = \bar{R}_a^*/d_2 \tag{3}$$

Rearrange primary data similarly in orders *b*, *c*, *a* and *c*, *a*, *b*. Obtain two solutions each for σ_a , σ_b , and σ_c . Average each pair. Obtain three solutions for σ_r . Average. Significant interactions and unstable residuals appear as ranges outside limits. Significant main differences appear as averages outside limits.

There are probably some other circuit elements that are important to the gain of the amplifier—perhaps the three biasing resistors. Here again, we can pick three similarly selected sets of biasing resistors to form purposeful samples just as we did with the tubes. We would build three amplifier circuits, one with each set of resistors. Then we would test each set of tubes in each circuit.

We might make each test at three supply voltages: rated voltage, 10-per cent high and 10-per cent low. This gives us a total of 27 gain measurements to be made.

This gives us no guarantee against errors in judgment as to the most important variables nor against the intrusion of other factors into our experiment. But this kind of logical planning will increase the amount of information and the reliability of the information that we get from a given amount of effort and equipment.

Note that this planning assumed that we knew the dispersion of the tubes and of the resistors. This means that the supplier of our components has been keeping control charts of his product and that he can and will give us his pertinent quality data. With this co-operation from our supplier we can make enormous improvements in the efficiency of our experimentation.

After we make the measurements we must analyze the data. We might do this in the conventional manner by the analysis of variance. Our assumed experiment involves a three-way classification according to transconductance, cathode resistor, and supply voltage. We have no explicit replication, that is, no simple repetition, but each measurement is affected by the residual dispersion that we would observe if we made simple repetitive observations under each condition. The an-

voltage. In the table we have called the three values of each parameter simply 1, 2, and 3. We might have called them $g_{m1}, g_{m2}, \dots, E_3$. In column d is the observed quantity in which we are interested, the gain. These 27 measurements, in the order shown, fall into nine subgroups within each of which voltage is the only variable parameter. These are rational subgroups in so far as the transconductance and biasing resistor are constant within groups but variable between groups.

In column e are the ranges of these subgroups. They represent a combination of two dispersions, one the inherent variation that would be present if we attempted simple repetitive measurements, the other the variation that is due to the variation in voltage. This is stated in (1) of Table I. We have called these ranges R_c since column c contains the only variable parameter in the subgroup.

We also compute the averages of each of the nine subgroups, as shown in column f . In these averages \bar{X}_c , the effects of the two causes just mentioned have been reduced by the averaging process. We can divide these averages \bar{X}_c into secondary groups so that g_m is constant within any secondary group but variable between secondary groups. The ranges of these secondary groups R_b^* are shown in column g . The average of these ranges represents the dispersion due to biasing resistors, in combination with the dispersion already measured and here reduced by the first averaging process. This is shown in (2). Equations (1) and (2) may now be easily solved for the dispersion due to resistors alone.

By carrying out this last process with a different grouping of our first averages, \bar{X}_c in column f , so that the resistors are constant within each new secondary group, we find the dispersion due to g_m alone. This is indicated in column j and (3). The ranges used here are called R_a^* .

Then we go back to our original data and rearrange it so tubes are the only variables in our first subgroups. We repeat the analysis as outlined above and obtain the dispersions due to resistors and voltage. Similarly, with another rearrangement of the original data, we obtain the dispersions due to voltage and tubes.

We now have two determinations or, more properly, two estimates of each main effect σ_a, σ_b , and σ_c . Because of sampling fluctuation, and because we have ignored the interactions, these two determinations may not be in perfect agreement with each other or with that made by an analysis of variance. Some experience has indicated that the average of these two determinations is a useful estimate of the main effect.

Finally, we compute the residual dispersion. We had determined it in combination with each main effect. We now know these main effects, we subtract them out and average the three remaining determinations to obtain an estimate of the residual dispersion.

So far we have ignored the interactions. We have no numerical values for them, such as the analysis of variance gives. But at each stage of our analysis we will

have computed control-chart limits for all the subgroup and secondary ranges and averages mentioned, and for the secondary group averages, \bar{X}_b^* in column h and \bar{X}_a^* in column k . Outages in our ranges tell us which interactions are significant just as outages in our averages tell us which main effects are significant.

These interactions may be shown by a mass chart of outages, as in Table II. Here, in Part A, are all the subgroup ranges R_c of column e . This table is a rectangular array with the ranges for one set of tubes in one column and the ranges for another set of tubes in another column. That puts the ranges for one set of resistors in one row and the ranges for another set of resistors in another row. Part B is a similar table for the averages of column f .

TABLE II
MASS CHART OF OUTAGES
(From an experiment similar to that outlined in Table I.)
A. Ranges for 7 Voltages¹

Tubes	1	2	3	4	5	6	7	8	9	10	11	\bar{R}_c
Resistors	1											
	2											
	3											
	4											
	5											
	6											
	7											
	8											
	9											
	10											
\bar{R}_c						—	—					

B. Averages for 7 Voltages¹

Tubes	1	2	3	4	5	6	7	8	9	10	11	$R_b^* \bar{X}_b^*$
Resistors	1	—	—	—	—							
	2	—	—	—	—							
	3	—	—	—	—							
	4	—	—	—	—							
	5	—	—	—	—							
	6	—	—	—	—							
	7	—	—	—	—							
	8	—	—	—	—							
	9	—	—	—	—							
	10	—	—	—	—							
R_a^*												
\bar{X}_a^*	—	—	—	—	—	—	—					

¹ | = Values above upper limits. — = Values below lower limits.

Now this is to be a study of outages. So, on these charts, we write no numerical values. If a range or average is within limits we leave a blank. If it is outside limits and high, we write a short vertical bar. If it is an outage and low, we write a short horizontal bar. On work sheets, we can use blue circles for high values and red circles for low values.

The data for Table II were taken from an experiment that had nothing to do with amplifiers. It has been relabeled to fit the hypothetical example of Table I. There were eleven sets of tubes, ten sets of resistors, and measurements were made at seven different voltages.

Part A shows a large number of range outages for

tubes 11. This means either that the tubes in this set are more sensitive to voltage change than the others, or that they have a higher residual dispersion. In either case, this is a significant interaction. It is indicated by a pattern of outages.

In the range table is a single outage under tubes 5. This is a "wild shot."

In Part B, showing outages of averages, we see that the higher-numbered tubes give higher gain and that the lower-numbered resistors give lower gain. These are main effects.

It has been mentioned that data of this type could be studied by the analysis of variance. The control-chart method has its advantages. For one thing, it requires less work. Some experience indicates that the control chart method takes less than half the time required for an analysis of variance.

More important is the ability of the control chart to pinpoint troubles and to test the validity of the assumptions made.

A large number of outages on our control charts, arranged in some logical pattern, gives us good indication of both the existence and the nature of real differences or real interactions. A fair number of outages, scattered over the whole experiment in an irregular fashion, usually indicates poor experimentation—sloppy work. A small number of outages, particularly if they can be traced back to a few pieces of primary data, indicates that these observations were abnormal—"wild shots."

The analysis of variance assumes a stable residual dispersion and then forgets it. The control chart sets a trap for instability and waves a red flag when it appears. The analysis of variance assumes that certain interactions are possible and ignores all others. The control chart method makes an initial assumption of no interaction and then highlights any interaction that comes along.

The control chart continually invites us to examine the quality of our experimentation and furnishes us with the means for making that examination.

Statistical Evaluation of Life Expectancy of Vacuum Tubes Designed for Long-Life Operation*

ELEANOR M. McELWEE†

Summary—Life-test data on subminiature vacuum tubes designed for 5,000 hours are analyzed statistically and an equation is derived for the curve of life survival percentages. Correlation of individual types to the general curve is found to be extremely high. Controls are determined for normal 500-hour life tests which assure rated long-life quality and are presented as a method for evaluating life expectancy before completion of long-life tests. Life test samples of lots of tubes released by this 500-hour plan were continued in operation for 5,000 hours, and the results are shown to be satisfactory.

IN RECENT YEARS, the expanding field of industrial applications of vacuum tubes has contributed to an increased demand for greater reliability over a longer period of time. In response to this demand, engineers throughout the industry have attempted to design a line of electron tubes which might safely be rated far beyond the customary 500 hours used to evaluate the life of radio receiving tubes. The innovations in design and processing which produced the longer-life tubes, although undoubtedly of tremendous interest, are not within the scope of this paper. The problem with which we are concerned is one introduced by the development of such tubes—that of evaluating "long-life" quality within a reasonable length of time. It is obviously impractical for tube manufacturers to conduct life tests for

5,000 hours before release of lots of tubes, or for customers to wait seven to eight months for delivery. The efforts of many engineers were therefore applied to the search for a life test plan which would effectively measure 5,000-hour quality within the normal 500-hour life test period.

The life of a vacuum tube is commonly understood to be the length of time it will operate within a specified range of characteristics. Thus a tube is considered to have reached the end of life when it becomes inoperable for any reason, or when its characteristics fall outside the end point limits specified for the particular type. The normal life rating of 500 hours did not guarantee, however, that each tube had a minimum life of 500 hours, nor even that the average life of a group of tubes would be 500 hours. As defined in the JAN-1A specification, a 500-hour rating guarantees an aggregate useful life of at least 80 per cent of the total rated life. For example, a group of five tubes would have a total rated life of 2,500 tube hours. These tubes would pass the JAN specification if their total operation within specified limits was 2,000 tube hours or better. This total figure could be amassed in any one of a number of ways; e.g., by all tubes operating for 400 hours, by one failure immediately and four good to 500 hours, by two tubes good to 250 hours and three good to 500 hours, and so on. What is actually required is an average life of at least 80 per cent of the rating for any group of tubes life-tested for

* Decimal classification: R351.5. Original manuscript received by the Institute, March 13, 1950. Presented, 1950 National IRE Convention, New York, N. Y., March 6, 1950.

† Sylvania Electric Products Inc., Kew Gardens, L. I., N. Y.

the specified time. For the purpose of better understanding of this paper, it will be assumed that a 5,000-hour life rating is applied in the same manner; i.e., that the 80 per cent limit will apply to a 5,000-hour, rather than a 500-hour test point, and that the average life of any group of tubes must be at least 4,000, rather than 400 hours.

It was apparent in the beginning that there were two approaches to the problem of a shorter life test: (1) an accelerated test which would be equivalent to 5,000 hours of normal operation, or (2) statistical controls on a normal 500-hour life test which would adequately predict 5,000-hour quality. Considerable time and effort were expended in the attempt to set up a reliable accelerated test. Various changes were made in voltages, currents and/or power dissipations in the hope of discovering a test exactly ten times as rigorous as normal operation. Unfortunately, it was impossible to determine test conditions which would accelerate normal tube failures without introducing contributory factors not present in normal operation. Several tests were found satisfactory for individual types of failures; e.g., cycling tests to determine the quality of heaters, immersion test for air leaks, fatigue test for shorts or poor welds, etc. However, it remained impossible to obtain satisfactory correlation between emission deterioration resulting from any accelerated test, and that resulting from normal operation. Consequently, the emphasis was transferred to statistical analysis in the hope of determining a consistent pattern to which the quality control method could be applied.

The first step in the statistical analysis of data was logically a survey of the occurrence of failures in operation with relation to time. In order to include results on as many tubes as possible, the initial survey was made on life test samples of early subminiature indirectly heated cathode-type vacuum tubes, rated for normal 500-hour operation. Failures per 500-hour period were listed for a heterogeneous group of 1,864 vacuum tubes, and the average life percentage¹ at the end of each period was calculated in accordance with the JAN specification, as shown in Table I. The ratio between these percentages seemed to indicate that they would follow the exponential curve $y = ab^x$, where y = average life percentage, x = hours of life expressed in thousands of hours, and a and b are constants denoting the y intercept and the slope of the line, respectively. In order to determine the goodness of fit of the empirical curve $y = ab^x$, or the straight line $\log y = \log a + x \log b$, the

¹ Average life percentage at X hours =

$$\frac{\sum (\text{life hours for each tube}^*)}{X \text{ hours (number of tubes started)}} \times 100$$

E.g., if 5 tubes were started on life, one failed at 700 hours, 4 remained good past 1,000 hours, the average life percentage at 1,000 hours would be

$$\frac{700 + 4(1000)}{5(1000)} \times 100 = 94 \text{ per cent.}$$

* The life for any individual tube shall be a maximum of X hours.

values of a and b were found by the statistical method of least squares.² Then the calculated equation becomes

$$y = 93.1(0.875)^x$$

By substituting the given values of x , computed values of y are obtained, and y residuals are found by subtraction. From the statistical formula for the standard error of estimate,

$$S_y = \left[\frac{\sum (y \text{ observed} - y \text{ computed})^2}{\text{the number of observations}} \right]^{1/2}$$

$$S_y = (4.05406)^{1/2}$$

The index of correlation of the curve is determined by the formula

$$\rho_{xy} = \left(1 - \frac{S_y^2}{\sigma_y^2} \right)^{1/2}$$

where S_y is the standard error of estimate of the curve, and σ_y is the standard deviation of the observed values of y . Substituting,

$$\rho_{xy} = \left(1 - \frac{4.05406}{173.333} \right)^{1/2}$$

$$\rho_{xy} = 0.988$$

The high degree of correlation obtained was a positive indication that the empirical equation $y = ab^x$ was a close representation of these data, at least. In order to verify the results of this first experiment, the same method was followed with two additional groups of data. For a group of 1,240 vacuum tubes of various types, most of which were experimental tubes designed for a longer life rating, the calculated curve was $y = 98.2(0.966)^x$. The index of correlation with observed data was 0.998. For a group of 130 tubes of six types released as 5,000-hour tubes, the equation of the calculated curve was $y = 98.3(0.973)^x$; the index of correlation was 0.995. Both the observed data and the calculated curve are plotted for each group in Fig. 1.

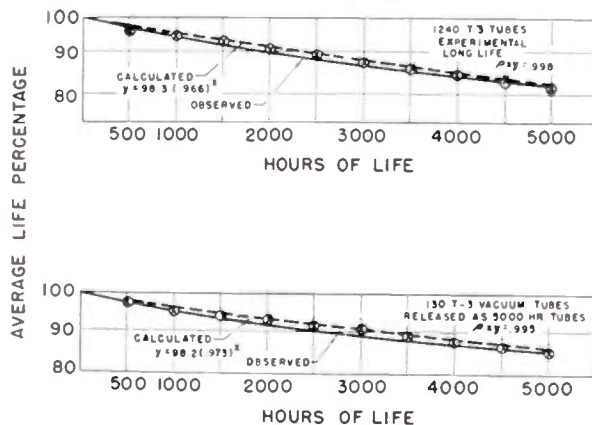

Fig. 1—Life survival curves: $y = ab^x$. Observed data and calculated curves for two heterogeneous groups of longer-life tubes.

² C. H. Richardson, "An Introduction to Statistical Analysis," Revised Edition, Harcourt, Brace and Co., New York, N. Y., pp. 210-219; 1944.

With the acceptance of the curve $y = ab^x$ as a general pattern for life survival percentages, there remained two essential points to be determined: (1) Could a universal value of the constant a be assumed that would satisfy all types of tubes? (2) If the value of the constant b were calculated from observed 500-hour results, how closely would the predicted percentages approximate actual life test operation? The answer to the former question at first seemed evident. Since only good tubes are subjected to life test, it was assumed that the y intercept of the curve would be 100 per cent, and therefore the equation would be $y = 100b^x$. Accordingly, the equation was checked with observed data, but it was noted that actual life test results beyond 1,500 or 2,000 hours were in all cases better than predicted percentages. Further analysis of data revealed that the rate of failure during the first 500-hour period of operation was higher than the rate of failure for any succeeding 500-hour period. The data seemed to indicate, in fact, that the rate of failure beyond 500 hours would be fairly constant, and would be approximately half that of the first 500-hour period. To compensate for this phenomenon, it was decided to use the value 99 for the constant a . In order to check the validity of predicted percentages, the same groups of data used previously were checked with percentages calculated from the equation $y = 99b^x$, the value of b being determined in each case by the observed 500-hour results. The correlation indices for the three groups were 0.975, 0.996 and 0.948, respectively. Curves for all three groups are plotted in Fig. 2. As an additional check on the general fit of the curve $y = 99b^x$, several types of 5,000-hour tubes were analyzed for correlation between observed data and the straight line based on the 500-hour per-

centage for each type. The index of correlation with the straight line was 0.986 for triode oscillators, 0.968 for radio-frequency pentodes and 0.976 for audio and video power amplifiers. Observed and calculated curves for each type are shown in Fig. 3.

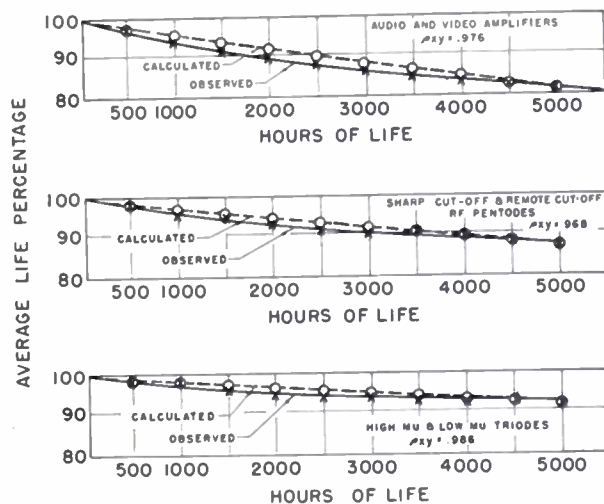

Fig. 3—Life survival curves: 5,000-hour tubes. Curves showing the correlation of observed and calculated percentages for several types of Premium Subminiature Tubes. Life-test conditions for types indicated were as follows:

	<i>Ef</i>	<i>Eb</i>	<i>Rk</i>	<i>Ec2</i>	<i>Rg</i>	<i>Ehk</i>
audio beam power tube	6.3	110	270Ω	110	500K	117Vrms
video amplifier	6.3	150	100Ω	100	500K	117Vrms
sharp cutoff pentode	6.3	100	150Ω	100	1 meg	117Vrms
semi-remote cutoff pentode	6.3	100	120Ω	100	1 meg	117Vrms
high mu triode	6.3	150	680Ω	—	1 meg	117Vrms
low mu triode	6.3	100	150Ω	—	1 meg	117Vrms

The correlation between predicted percentages and actual results was in all cases so high that the equation $y = 99b^x$ was accepted as the basis for all future statistical controls to be applied to life tests. This pattern of failure was a definite departure from the normal curve expected, and posed additional problems in the development of statistical controls. Earlier experience with incandescent and fluorescent lamps, and with tungsten filament-type vacuum tubes, indicated a certain wear-out point around which regular sigma limits could be plotted, as on a normal Gaussian type curve. A recent

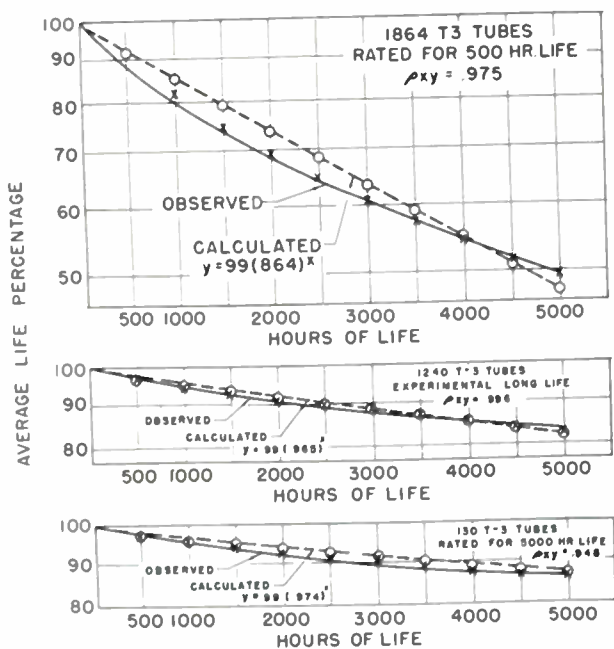

Fig. 2—Life survival curves: $y = 99b^x$. Correlation of observed data with curves calculated from 500-hour percentages for three heterogeneous groups of tubes.

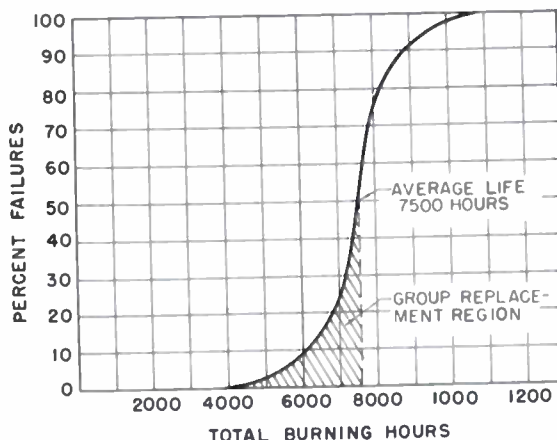

Fig. 4—Life failure curve for fluorescent lamps. Fluorescent lamp life data plotted as a normal Gaussian type curve.

advertising bulletin for improved fluorescent lamps showed this type of curve plotted for failure percentages, with the average life marked at 7,500 hours, and standard deviations of 1,000 hours counted off on either side, as in Fig. 4. With such data, engineers can plan on a minimum life for each lamp, or an optimum replacement point for any group of lamps. Manufacturer's advertisements recommend the replacement of panels of lamps after 5,500 hours, a point at which a maximum of 2.5 per cent of the lamps will have failed. The 20 per cent, or 50 per cent, or 90 per cent failure points could be located just as easily.

Unfortunately, failure data for subminiature vacuum tubes do not follow a normal distribution, and conventional measures of central tendency and dispersion are not applicable to the problem of determining proper control limits. Therefore, it became necessary to devise a system of controls which might be applied to the exponential curve $y = 99b^x$.

The first step in the process of setting up controls was to determine, from the 80 per cent—5,000 hour specification and the calculated $y = 99b^x$ curve, a minimum limit to be applied at 500 hours. This 500-hour percentage was found to be 96.9 per cent. Then from accumulated data on subminiature tubes, 133 sample life tests of five tubes each were chosen which passed this 96.9 per cent—500-hour limit. Of these tests, not one failed to meet an 80 per cent—5,000-hour limit at the conclusion of the specified life test. These results led naturally to the conclusion that the minimum limit calculated was well chosen, and that the modified 500-hour test would serve as an adequate control on 5,000-hour quality.

Although the choice of a 500-hour limit was the solution to the original problem, it raised a new question of equal importance to manufacturer and customer. This new topic was the probability of release of a lot of tubes which would fail to meet the 5,000-hour life specification. In order to calculate the range of probability of such an occurrence, the five-tube sample life tests mentioned above were used to plot a frequency distribution of 5,000-hour percentages, as shown in Fig. 5. The average 5,000-hour percentage was found to be 89.4 per cent, with 2-sigma limits of 80.3 per cent and 98.5 per cent. These limits on the sample distribution were changed to limits on the universe or parent population by use of the formula

$$\sigma_{\text{sample}} = \left(\frac{N-1}{N} \right)^{1/2} \sigma_{\text{universe}}$$

resulting in new 2-sigma limits of the universe of 80.1 per cent and 98.7 per cent. Statistically speaking, 95 per cent of all released lots of tubes will fall within these limits. Conversely, 2.5 per cent of all released lots may fall on either side of these limits. To use a phrase common to all fields in which quality control is applied, it seems safe to assume an acceptable quality level (AQL) of 2.5 per cent at 5,000 hours.

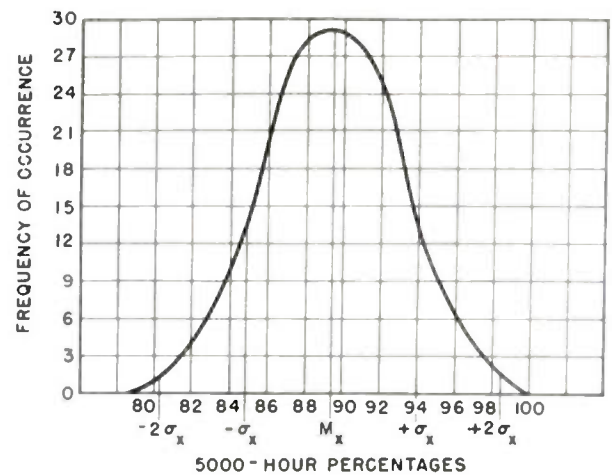

Fig. 5—Distribution of 5,000 hour percentage: 133 sample life tests, 5 tubes each. Range of average life percentages at 5,000 hours for a heterogeneous group of 133 sample life tests.

It would not be reasonable to assume that this life test plan will work equally well for all types of vacuum tubes, made by various manufacturers, until sufficient data to 5,000 hours has been collected and analyzed. The data included in this paper represent only subminiature indirectly heated cathode-type vacuum tubes made at the Kew Gardens Development Laboratory of Sylvania Electric Products Inc. Whether other tube types, or even the same types manufactured elsewhere, would produce equivalent results is a question which only the comparison of actual data will answer. Experience shows that the plan may be applied only to tubes which are designed for long-life operation, are conservatively rated, and are carefully controlled during production. To the writer's knowledge, there has been only one other published indication of an exponential curve of life percentages versus time, a life curve on repeater tubes published by the Bell Telephone Laboratories.³ It is to be hoped that long-life data may be collected throughout the industry, and that universal life test specifications may be agreed upon by manufacturers and customers. The 500-hour test specification included in this paper was developed with the co-operation of the Bureau of Ships, the chief customer for the tube types represented, and was accepted by them for these particular types as manufactured in Kew Gardens, L. I., N. Y.

There remains one important point not yet mentioned: what kind of guarantee can be given to the customer? What will the manufacturer do if a group of tubes fails to meet the specified life rating in actual operation? Unfortunately, there is no satisfactory answer as yet. For subminiature long-life tubes, there are certain applications, such as hermetically sealed assemblies, where replacement of tubes is impossible. In many other applications for which subminiature tubes have been specially designed, replacement is difficult and expensive. In some cases, the failure of a tube may

³ D. K. Gannett, "Determination of the average life of vacuum tubes," *Bell Tel. Lab. Rec.*; August, 1940.

TABLE I
STATISTICAL EVALUATION OF LIFE EXPECTANCY OF VACUUM
TUBES DESIGNED FOR LONG-LIFE OPERATION
1,864 T-3 Vacuum Tubes Rated for 500 Hours Life

Hours of Life	Number of Failures	Average Life Percentage at End of Period
0- 500	298	92.0
500-1,000	153	82.0
1,001-1,500	113	74.8
1,501-2,000	84	69.2
2,001-2,500	72	64.8
2,501-3,000	75	61.0
3,001-3,500	43	57.2
3,501-4,000	65	54.8
4,001-4,500	36	51.4
4,501-5,000	53	49.5

cause the destruction of the entire unit. What the customer requires, therefore, is not a replacement guarantee

for tubes which prove unsatisfactory, but a certain degree of assurance of reliability of operation. The plan proposed is an illustration of the application of statistical analysis to this difficult quality control problem. Although this plan may not be the perfect answer to the customers' requirements, it is a step in the right direction. It is at least a foundation for future improvements.

BIBLIOGRAPHY

- (1) W. A. Shewhart, "Economic Control of Quality of Manufactured Product," D. Van Nostrand Co., Inc., New York, N. Y.; 1931.
- (2) K. A. Brownlee, "Industrial Experimentation," Chemical Publishing Co., Inc., Brooklyn, N. Y.; 1947.
- (3) C. Eisenhart, M. W. Hastay, and W. A. Wallis, "Selected Techniques of Statistical Analysis," McGraw-Hill Book Co., Inc., New York, N. Y.; 1947

Magnetic Recording with AC Bias*

R. E. ZENNER†, SENIOR MEMBER, IRE

Summary—The function of alternating-current (ac) bias in magnetic recording is analyzed in a manner similar to that used to explain amplitude modulation. Certain simplifying assumptions are made to facilitate manipulation of mathematical expressions. The analytical results are compared with experimental observations of harmonic distortion, amplitude of fundamental, spurious recorded frequencies, frequency response, difficulty of erasure, and the like.

INTRODUCTION

IN A MODULATOR for amplitude modulation (AM) radio transmission, an audio frequency and a much higher "carrier" frequency are combined in a nonlinear impedance. The output contains the two original frequencies, their sum, their difference, certain harmonics of each depending upon the character of the nonlinear impedance, and sums and differences of harmonics and fundamentals. A value of carrier amplitude must be selected for the particular nonlinear element to provide linearity and sufficient output in the desired band, which includes the carrier frequency and the carrier-audio sum and difference frequencies. A band-pass filter (tank circuit) is provided to attenuate undesired frequencies. The need for selecting a particular carrier amplitude is most obvious in the case of grid modulation.

In like manner, the action of alternating current (ac) bias in magnetic recording may be explained. The desired audio frequency and a much higher "bias" frequency are simultaneously fed into a nonlinear record-

ing system. The recording contains the audio frequency, the bias frequency, and in addition to these, certain harmonics of each, and sums and differences of harmonics and fundamentals. A value of bias amplitude must be selected for the particular nonlinear recording characteristic to provide linearity and sufficient output in the desired audio band. Self-demagnetization in the recording medium and limited playback head resolution provide a low-pass filter which attenuates undesired (higher than audio) frequencies.

With the shapes of nonlinear recording characteristics in general use, this "bias" technique provides greatly reduced harmonic distortion of the audio, as compared to direct current (dc) bias or no bias.

This technique is capable of improving linearity of response for desired frequencies in a variety of nonlinear systems, whether for transmission or recording.

SCHEME FOR ANALYSIS

The transfer characteristics for a magnetic recording material is the B_r - I curve,¹ (see Fig. 1). Such a curve may be plotted from data taken by single dc exposures or from data taken in the symmetrically cyclically magnetized condition (SCMC). Curves plotted in these two ways are very similar, though not identical. A convenient set of measuring equipment for the SCMC case has been described by Wiegand and Hansen.²

* Decimal classification: R365.35. Original manuscript received by the Institute, April 28, 1950; revised manuscript received, August 31, 1950.

† Armour Research Foundation, Illinois Institute of Technology, Chicago, Ill.

¹ Marvin Camras, "Graphical analysis of linear magnetic recording using high-frequency excitation," *Proc. I.R.E.*, vol. 37, pp. 569-573; May, 1949.

² D. E. Wiegand and W. W. Hansen, "A 60-cycle hysteresis loop tracer for small samples of low-permeability material," *Trans. AIEE*, vol. 66; 1947.

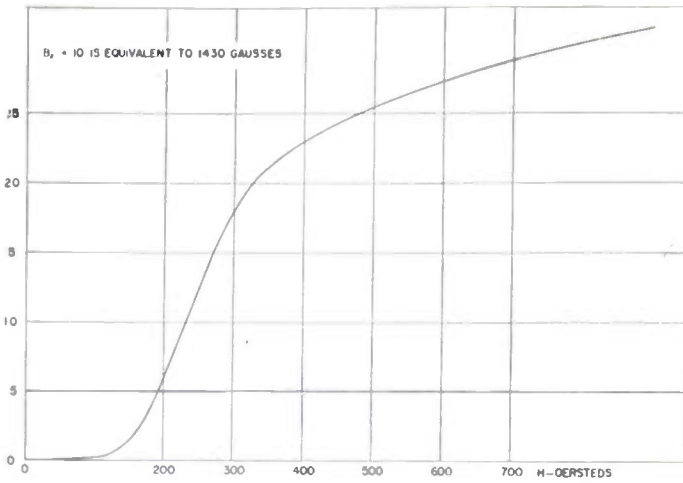

Fig. 1—Retained flux density versus peak magnetizing field. (B_r - H curve) for wire no. 449.

In a practical magnetic recorder, each element of length of the recording medium is subjected to substantially a single value of audio field and to several decaying cycles of bias field. The similarity of single exposure and SMC B_r - H curves permits us to assume that each element of length of the recording medium is subjected to a single instantaneous value of both audio and bias. We shall later discuss phenomena inconsistent with this assumption.

It would be desirable to find an expression $B_r = F_1(H)$ which closely fits the B_r - H curve, assume constant velocity of the recording medium, set in $H = F_2(t)$, and manipulate the resulting equation into forms which can be physically interpreted.

An expression which provides a good fit is

$$B_r = \frac{2B_{rs}}{\pi} (\tan^{-1} K_1 H - K_1 H e^{-K_2 H^2}).$$

However, this expression is quite resistant to a desired kind of manipulation, so we resort to a series,

$$B_r = -K_1 H + K_2 H^3 - K_3 H^5. \quad (1)$$

Fits provided by two and three terms are illustrated in Figs. 2 and 3. Use of more terms should improve the fit, but the difficulties of manipulation then become severe. In the following, the general expressions are now and then reduced to numerical values for the particular curves shown in order to insure that conclusions drawn are limited to the regions of reasonably good curve fits.

Case I. Ac Bias

Assuming a sine wave of audio, $A \sin at$, and a sine wave of bias,

$$B \sin bt, \text{ we let } H = A \sin at + B \sin bt \quad (2)$$

and substitute this in (1).

$$B_r = -K_1 [A \sin at + B \sin bt] + K_2 [A \sin at + B \sin bt]^3 - K_3 [A \sin at + B \sin bt]^5. \quad (3)$$

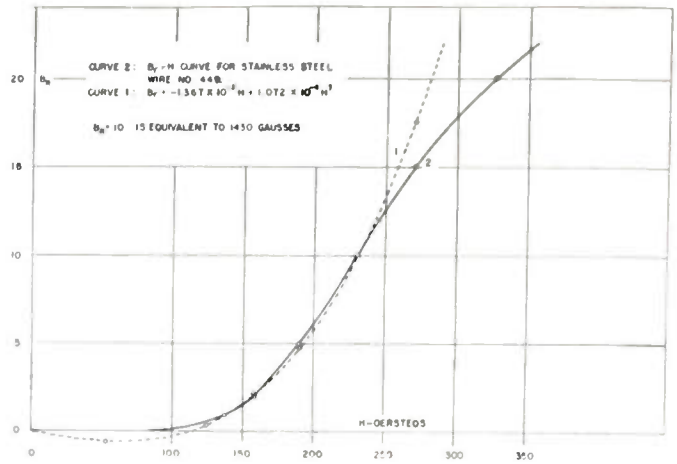

Fig. 2—Cubic or third-order fit to the B_r - H curve.

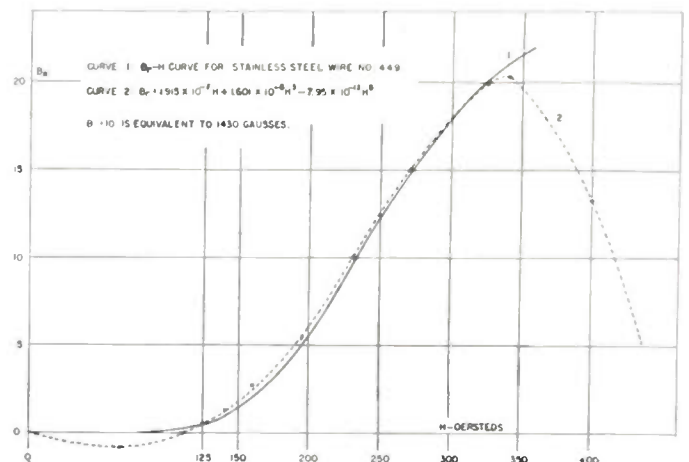

Fig. 3—Fifth-order fit to the B_r - H curve.

To simplify notation let $X = A \sin at$

$$Y = B \sin bt,$$

then

$$B_r = -K_1 [X + Y] + K_2 [X^3 + 3X^2Y + 3XY^2 + Y^3] - K_3 [X^5 + 5X^4Y + 10X^3Y^2 + 10X^2Y^3 + 5XY^4 + Y^5]. \quad (4)$$

The following identities are useful:

$$A^3 \sin^3 at = A^3 \frac{3 \sin at - \sin 3at}{4}, \quad (5)$$

$$B^3 \sin^3 bt = B^3 \frac{3 \sin bt - \sin 3bt}{4}, \quad (6)$$

$$A^5 \sin^5 at = A^5 \frac{\sin 5at - 5 \sin 3at + 10 \sin at}{16}, \quad (7)$$

$$B^5 \sin^5 bt = B^5 \frac{\sin 5bt - 5 \sin 3bt + 10 \sin bt}{16}, \quad (8)$$

$$A^2 B \sin^2 at \sin bt = A^2 B \left\{ \frac{\sin bt}{2} - \frac{1}{4} [\sin (2a + b)t - \sin (2a - b)t] \right\}. \quad (9)$$

$$AB^2 \sin at \sin^2 bt = AB^2 \left\{ \frac{\sin at}{2} - \frac{1}{4} [\sin (2b+a)t - \sin (2b-a)t] \right\}, \quad (10)$$

$$A^3 B^2 \sin^3 at \sin^2 bt = A^3 B^2 \left\{ \frac{3}{8} \sin at - \frac{1}{8} \sin 3at - \frac{3}{16} [\sin (a-2b)t + \sin (a+2b)t] + \frac{1}{16} [\sin (3a-2b)t + \sin (3a+2b)t] \right\}, \quad (11)$$

$$A^2 B^3 \sin^2 at \sin^3 bt = A^2 B^3 \left\{ \frac{3}{8} \sin bt - \frac{1}{8} \sin 3bt - \frac{3}{16} [\sin (b-2a)t + \sin (b+2a)t] + \frac{1}{16} [\sin (3b-2a)t + \sin (3b+2a)t] \right\}, \quad (12)$$

$$A^4 B \sin^4 at \sin bt = A^4 B \left\{ \frac{3}{8} \sin bt - \frac{1}{4} [\sin (b-2a)t + \sin (b+2a)t] + \frac{1}{16} [\sin (b-4a)t + \sin (b+4a)t] \right\}, \quad (13)$$

$$AB^4 \sin at \sin^4 bt = AB^4 \left\{ \frac{3}{8} \sin at - \frac{1}{4} [\sin (a-2b)t + \sin (a+2b)t] + \frac{1}{16} [\sin (a-4b)t + \sin (a+4b)t] \right\}. \quad (14)$$

Although it is not desirable, a recorder might be designed for an upper audio limit of 15,000 cps ($a = 2\pi \times 15,000$) while using a bias frequency of 40,000 cps ($b = 2\pi \times 40,000$). Visualizing such values, we may now inspect the above identities to see what terms occur in the audio region. Self-demagnetization and limited playback resolution will attenuate short wavelengths (high frequencies) and permit us to drop such terms, provided we have chosen an appropriate recording medium speed.

We can see that angular frequencies a , $3a$, $5a$, $(b-2a)$, and $(b-4a)$ fall in the audio range. If we had chosen a higher bias frequency, say 80,000 cps, the last two difference frequencies would be outside the audio band and therefore negligible. Practical design experience has also shown that a bias frequency at least 5 times the highest audio frequency admitted to the recording head is desirable to avoid distortion from audible beat frequencies. Slightly lower bias frequency may be satisfactory if the recording current amplitude is very small at the upper audio frequencies, as is often true in sound recording.

Let us now decide to use a bias frequency sufficiently high to make these beat notes negligible. Then our expansion of B_r contains terms in a , $3a$, and $5a$.

$$B_r = \left[- .1K_1 + \frac{3.1^3 K_2}{4} + \frac{3.1 B^2 K_2}{2} - \frac{5.1^5 K_3}{8} - \frac{15A^3 B^2 K_3}{4} - \frac{15A B^4 K_3}{8} \right] \sin at + \left[\frac{5.1^5 K_3}{16} + \frac{5A^3 B^2 K_3}{4} - \frac{A^3 K_2}{4} \right] \sin 3at - \frac{A^5 K_3}{16} \sin 5at. \quad (15)$$

Let us call the coefficient of $\sin at$, C_a , the coefficient

of $\sin 3at$, C_{3a} . For zero third harmonic,

$$C_{3a} = 0$$

$$\frac{5.1^5 K_3}{16} + \frac{5A^3 B^2 K_3}{4} - \frac{A^3 K_2}{4} = 0$$

$$20K_3 B^2 = 4K_2 - 5A^2 K_3$$

$$B^2 = \frac{K_2}{5K_3} - \frac{A^2}{4}, \quad (16)$$

which indicates that the amount of bias for zero third harmonic varies with audio amplitude, decreasing as the audio increases.

$$\text{As } A \rightarrow 0, B^2 \rightarrow \frac{K_2}{5K_3} \text{ or } 0.2 \frac{K_2}{K_3}. \quad (17)$$

$B = 200$ oersteds for the material shown in Fig. 3, which is in the region of a reasonable curve fit.

It is also of interest to note that the sign of C_{3a} reverses as B increases from near zero to above the value for $C_{3a} = 0$.

Let us now investigate C_a , seeking a maximum value.

$$C_a = - .1K_1 + \frac{3.1^3 K_2}{4} + \frac{3}{2} AB^2 K_2 - \frac{5A^5 K_3}{8} - \frac{15}{4} A^3 B^2 K_3 - \frac{15}{8} AB^4 K_3 \quad (18)$$

$$\frac{dC_a}{dB} = 3ABK_2 - \frac{15}{2} A^3 BK_3 - \frac{15}{2} AB^3 K_3$$

when $d(C_a)/dB = 0$ (disregarding root at $B = 0$)

$$15B^2 K_3 = 6K_2 - 15A^2 K_3$$

$$B^2 = 0.4 \frac{K_2}{K_3} - A^2, \quad (19)$$

which indicates that the amount of bias for maximum C_a decreases when A increases. When $A \rightarrow 0$,

$$B^2 \rightarrow 0.4 \frac{K_2}{K_3}$$

$$B = \sqrt{0.4 \frac{K_2}{K_3}} \quad (20)$$

which is $\sqrt{2}$ the value of B for $C_{3a} = 0$.

$B \doteq 284$ oersteds for the material of Fig. 3.

If we had chosen to drop the fifth order term from (1), we would have

$$B_r = -K_1 H + K_2 H^3$$

$$\frac{dB_r}{dH} = -K_1 + 3K_2 H^2$$

$$\frac{d^2 B_r}{dH^2} = 6K_2 H.$$

The only inflection point is at $H = 0$, and the saturation phenomenon is not represented. Applying the sub-

stitution $H = A \sin at + B \sin bt$, we get an expression for B , involving fewer angular frequencies than in the fifth-order case. Assuming a high bias frequency and low pass filtering, we get

$$B_r = \left[-AK_1 + \frac{3}{4}A^3K_2 + \frac{3}{2}AB^2K_2 \right] \sin at - \frac{A^3K_2}{4} \sin 3at. \quad (21)$$

If we seek a value for zero third harmonic, we find it only at $A = 0$, which is a trivial result. When we seek the value of B for maximum fundamental, we find it at $B = \pm \infty$, which is due to failure to include the saturation phenomenon.

It is, therefore, apparent that at least 3 terms of (1) must be taken into account to get physically significant results.

Case II. No Bias Compared to Ac Bias

If the signal is only audio, $H = A \sin at$, we have from (1)

$$B_r = -K_1A \sin at + K_2A^3 \sin^3 at - K_3A^5 \sin^5 at \quad (22)$$

or

$$B_r = -K_1A \sin at + K_2A^2 \frac{3 \sin at - \sin 3at}{4}$$

$$- K_3A^5 \frac{\sin 5at - 5 \sin 3at + \sin at}{16}$$

$$B_r = \left[-K_1A + \frac{3}{4}K_2A^3 - \frac{5}{8}K_3A^5 \right] \sin at$$

$$+ \left[-\frac{K_2A^3}{4} + \frac{5}{16}K_3A^5 \right] \sin 3at$$

$$- K_3A^5 \sin 5at. \quad (23)$$

Comparing this with (15), we find all terms common except those involving B in (15). Using ac bias as against no bias, C_a is increased in the case of ac bias by the addition of the quantity

$$\left(\frac{3}{2}AB^2K_2 - \frac{15}{4}A^3B^2K_3 - \frac{15}{8}AB^4K_3 \right)$$

and C_{3a} is increased by the addition of $(5/4)A_3B^2K_3$. In order for any benefit to result from the use of ac bias, an improvement in linearity must result, that is, C_a must be more nearly proportional to A . This will occur if the value of terms in C_a which involve A^3 or A^5 are reduced by the use of bias.

Let us test

$$\frac{3}{4}K_2A^3 = \frac{15}{4}B^2K_3A^3 \quad (24)$$

$$K_2 = 5K_3B^2$$

$$B^2 = 0.2 \frac{K_2}{K_3}$$

This value of B will eliminate the A^3 term from C_a , and it is the value of bias for zero third harmonic when $A \rightarrow 0$, deduced in (17). Assuming this value of bias, we have

$$C_a = -AK_1 + \frac{3}{4}A^3K_2 + \frac{3}{10} \frac{AK_2^2}{K_3} - \frac{5}{8}A^5K_3 - \frac{3}{4}A^3K_2 - \frac{3}{40} \frac{AK_2^2}{K_3},$$

$$C_a = -AK_1 + \frac{9}{40} \frac{AK_2^2}{K_3} - \frac{5}{8}A^5K_3. \quad (25)$$

It appears that good linearity and high sensitivity with ac bias will result if K_3 is very small compared to K_2 , and if K_1 is small compared to K_2^2/K_3 . However, as K_3 decreases, the bias required increases.

It seems probable that a seventh-order equation would provide a term involving BA^5 which would reduce the A^5 term in C_a .

Case III. Dc Bias on a Neutral Medium

If the signal is audio plus a dc bias, $H = D + A \sin at$, and

$$B_r = -K_1[D + A \sin at] + K_2[D + A \sin at]^3 - K_3[D + A \sin at]^5, \quad (26)$$

$$B_r = -K_1D - K_1A \sin at + K_2[D^3 + 3AD^2 \sin at + 3A^2D \sin^2 at + A^3 \sin^3 at] - K_3[D^5 + 5AD^4 \sin at + 10A^2D^3 \sin^2 at + 10D^2A^3 \sin^3 at + 5DA^4 \sin^4 at + A^5 \sin^5 at]. \quad (27)$$

The following additional identities are now useful:

$$\sin^2 at = \frac{1 - \cos 2at}{2}, \quad (28)$$

$$\sin^4 at = \frac{1}{8} (3 - 4 \cos 2at + \cos 4at). \quad (29)$$

Substituting in (26),

$$B_r = -K_1D + K_2D^3 + \frac{3}{2}K_2D.A^2 - K_3D^5 - 5K_3D^3.A^2 - \frac{15}{8}K_3D.A^4 + \left[-K_1A + 3K_2D^2A + \frac{3}{4}A^3K_2 - 5K_3D^4A - \frac{15}{2}K_3D^2.A^3 - \frac{5}{8}K_3A^5 \right] \sin at + \left[-\frac{3}{2}K_2D.A^2 + 5K_3D^3.A^2 + \frac{5}{2}K_3DA^4 \right] \cos 2at + \left[-\frac{A^3K_2}{4} + \frac{5}{2}K_3D^2.A^3 + \frac{5}{16}K_3A^5 \right] \sin 3at$$

$$+ \left[-\frac{5}{8} K_3 D^4 \right] \cos 4at - \frac{K_3 A^4}{16} \sin 5at. \tag{30}$$

The condition for $C_{2a}=0$ is

$$\frac{3}{2} K_2 = 5K_3 D^2 + \frac{5}{2} K_3 A^2, \tag{31}$$

$$D^2 = \frac{3K_2 - 5K_3 A^2}{10K_3}, \tag{32}$$

which indicates that the value of dc bias for zero second harmonic varies with audio amplitude.

$$\text{As } A \rightarrow 0, D^2 \rightarrow \frac{3K_2}{10K_3}. \tag{33}$$

This is the inflection point of (1), or $D = 245$ oersteds, for the material shown in Fig. 3.

The condition for $C_{3a}=0$ is

$$\frac{5}{2} K_3 D^2 + \frac{5}{16} K_3 A^2 = \frac{K_2}{4}, \tag{34}$$

$$D^2 = \frac{4K_2 - 5K_3 A^2}{40K_3} \text{ (D for zero third varies with A)} \tag{35}$$

as $A \rightarrow 0$ $D^2 \rightarrow (K_2/10K_3)$ so that D differs by a factor of $\sqrt{3}$ from the value of D for $C_{3a}=0$, indicating that no one value of dc bias minimizes even and odd harmonics. However, no spurious beat frequencies are encountered as in ac bias.

This analysis does not apply directly to the use of dc bias on previously saturated recording medium. Equation (1) does not apply to this situation.

PHENOMENA CONSISTENT WITH THE ANALYSIS

Fig. 4 shows some experimental data on amplitude and phase of third harmonic and fundamental as a function of bias amplitude, using a small constant value of audio current. The recording wire used in these experiments is the same as was used for the B_R-H curve shown in Fig. 1. The following points of agreement between the data of Fig. 4 and the analysis are found:

1. The change in sign of the third harmonic as ac bias is increased, and the existence of a value of ac bias which provides zero third harmonic.
2. The existence of a maximum value for the coefficient of the fundamental at an ac bias amplitude higher than that required for zero third harmonic.

In other experimental work, the following additional points of agreement with the analysis have been found:

3. The existence of beat notes between the ac bias frequency or its harmonics and harmonics of high audio frequencies. The frequencies $(b-2a)$, $(b-4a)$, and $(2b-5a)$ have been identified. The last of these would appear in the analysis if a seventh-order series were used for (1).

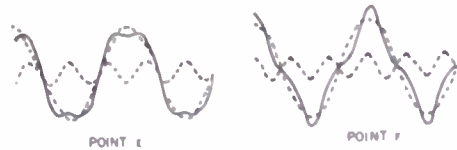

PLAYBACK WAVE FORMS (SOLID) AND HARMONIC ANALYSIS (DOTTED) THESE PATTERNS INCLUDE THE DIFFERENTIATING EFFECT OF THE PLAYBACK PROCESS

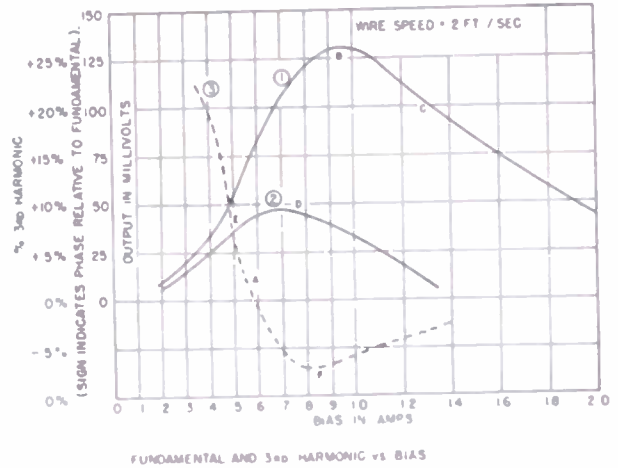

Fig. 4—Experimental results.

- ① 100 cycles: fundamental output versus bias.
 - ② 5,000 cycles: fundamental output versus bias.
 - ③ 100 cycles: per cent third harmonic versus bias.
- Audio recording current constant for all data.

4. The change with audio amplitude of the value of ac bias required for maximum amplitude of fundamental.
5. The change with audio amplitude of the value of ac bias required for zero third harmonic.
6. The occurrence of even-order harmonics in the presence of dc bias, dc bias may be a result of direct current in the recording head, or residual magnetization in the recording head or residual magnetization in the medium as it reaches the recording head.
7. The improvement in linearity with appropriate amplitude of ac bias.

SOME PHENOMENA INCONSISTENT WITH THE ASSUMPTIONS OR OUTSIDE THE SCOPE OF THE ANALYSIS

1. Frequency Response

The analysis offered does not show that relative high-frequency response falls off more rapidly in the case of ac bias than with dc bias on neutral medium. This does occur, however, and it is ascribed to an erasing or aging action in the case of ac bias. An element of length of the medium is exposed to several decaying ac cycles. This is more effective in reducing the amplitude of short wavelengths than in reducing the amplitude of long wavelengths. Short magnets are more easily demagnetized than long magnets. This aging action is desirable in that the recording is more stable if ac bias is used.

2. Difficulty of Erase

Nothing in the analysis ascribes a different quality to a B_r , achieved with small audio and large ac bias than to

the same value of B_r , achieved with larger audio and less ac bias. Herr, Murphy, and Wetzel³ have shown that the signal resulting from small audio and large bias is the more difficult to erase. In the charging of permanent magnets for meters and transducers, it is found that more stable (more difficult to demagnetize) magnets result from initially saturating the magnet with dc, and then "aging" it down to the desired B_r with ac fields, than by only exposing it to sufficient dc to bring it up to the desired B_r from the demagnetized condition. This is analogous to the results described by Herr, Murphy, and Wetzel.

3. Even Harmonics Resulting from Asymmetry of Bias Wave Form

The analysis does not account for even harmonics resulting from asymmetry of the bias wave form.

Textbooks on magnetic phenomena describe the fact that the residual induction in a piece of iron which has been exposed to a varying unidirectional field is determined by the peak value of the field, independent of the time variations of the field.

Thus, so far as the recording process is concerned, asymmetrical bias wave form has a dc effect, even when there is no dc component in the bias field itself. The field has zero dc component if the area bounded by the curve on each side of zero is equal. The recorded effect is quite independent of this area, and sensitive to peak values. Quantitative evaluation of this phenomenon is complicated by the fact that ac bias swings past zero, into the opposite polarity.

4. Variation of Bias with Wavelength

From the analysis presented it would appear that for small audio amplitudes, maximum fundamental amplitude and zero third harmonic appear at particular values of bias, independent of audio frequency or wavelength. This is not true, actually, for at very short wavelengths no appreciable third harmonic is apparent at any level of bias, because of low pass filtering effects (self-demagnetization, playback gap effect, eddy current effects, and electrical circuit filtering effects). At frequencies well below the frequency of maximum response, the third harmonic is accentuated in playback due to rising frequency response. Playback voltage is proportional to the rate of change of B_r , rather than proportional to B_r itself, thus producing rising frequency response in the range of wavelengths which suffer little, or constant, self-demagnetization.

Erasing or aging effectiveness of the bias is also greater at short wavelengths.

³ R. Herr, B. F. Murphy, and W. W. Wetzel, "Some distinctive properties of magnetic-recording media," *Jour. Soc. Mot. Pic. Eng.*, vol. 52; January, 1949.

5. Decrease of Distortion at Large Bias Amplitudes

The analysis presented does not account for the decrease in distortion at bias amplitudes larger than that at point F in Fig. 4. High bias values are outside the region of good fit of even the fifth-order series. It is believed that, if many more terms were used, this decrease in third harmonic would appear.

OPTIMUM BIAS FREQUENCY

For thin recording wires and tapes, it is desirable that the bias frequency be as high as practical considerations will permit. In designing a recorder, one usually wishes to use the same oscillator for erase and bias. Eddy current losses in the erase head cause the designer to consider the use of low erase-bias frequencies. The designer usually decides upon an erase-bias frequency slightly lower than five times the upper audio limit of his system as the best compromise.

OPTIMUM AC BIAS AMPLITUDE

It has been shown that the bias amplitudes for maximum fundamental output and zero third harmonic are not the same, and further that the bias amplitudes for maximum fundamental and zero third harmonic vary with audio amplitude. Also, the bias amplitude for any of these conditions varies with the magnetic materials and geometries of heads, tapes, and wires. Thus it is not surprising that there should be a variety of schemes favored by various people for setting the bias amplitude.

For low-cost, low tape-speed equipment, designers often set the bias amplitude for maximum sensitivity at short wavelengths, tolerating the accompanying distortion of long waves on the tape. In such equipment the harmonic distortion in the recording process is often negligible compared to the distortions present in the amplifier.

In high-cost, high-quality equipment, a larger bias amplitude is usually favored. This is much greater than the bias for zero third harmonic at medium and high audio frequencies, and is in the region of low distortion to the right of point F in Fig. 4. Operation in this region provides low distortion at all wavelengths and some reduction of relative playback amplitude at short wavelengths. The latter is corrected by the use of a sufficiently high tape speed and suitable equalizer circuits.

ACKNOWLEDGMENT

A number of present and former staff members of Armour Research Foundation have contributed to the theoretical and experimental studies on which this paper is based. Two major contributors were John J. Fischer and Joseph Markin.

The author is grateful to H. Ekstein and T. L. Gilbert for their constructive criticisms of this presentation.

Representations of Speech Sounds and Some of Their Statistical Properties*

SZE-HOU CHANG†, ASSOCIATE, IRE, GEORGE E. PIHL†, ASSOCIATE, IRE, AND MARTIN W. ESSIGMANN†

Summary—Spectrographic analysis, autocorrelation, and infinite clipping are considered as methods of transforming and analyzing speech sounds with the object of obtaining simple representations without excessive loss of intelligibility. Although not mathematically equivalent in the exact sense, these methods when properly approximated are shown to provide parameters of statistical nature that are simply related. It is conjectured that the parameters describe some essential elements of speech sounds and are statistically invariant. Some experimental results are included.

THERE HAS ALWAYS BEEN a need of pictorial or other physical representation ever since man began to analyze speech sounds. The objective may be twofold. One is to find an accurate representation so that every detailed characteristic of the original sound, including naturalness and emotional content, is retained. The other is to obtain as simple a representation as possible without excessive loss of intelligibility. This paper is concerned with the second type.

Speech compression and sensory replacement are two examples of the fields in which application can be made of the representations to be considered. There is considerable interest in both of these fields at the present time as evidenced by current literature and development work by the Bell Laboratories and others in the vocoder field;¹⁻⁴ and RCA,⁵ Haskins Laboratories,⁶ and others^{7,8} in the sensory-replacement field.

A problem common to both fields is that of identifying the essential elements for intelligibility as distinguished from the redundant information contained in the original sound. It is conjectured that these essential elements are statistically invariant because of the

structural similarity of vocal mechanisms and the tendency of speakers to conform through the process of learning. Names that have been suggested for these essential elements are "gesture," "articulation" and "modulation."^{9,10} The problem is to identify and extract them from the original speech sound.

It is the purpose of this paper to compare some methods of analyses and representations which are prevalent, and to attempt to derive therefrom some statistical parameters which may retain part of the invariant essential elements. One method would be to obtain the representation directly from the vocal or hearing mechanisms; for example, to take pictures showing the movements of the articulators^{11,12} (vocal chord, lips, tongue, and the like) or pictures, if possible, showing the responses of the tremendous number of auditory nerves.¹³ The anatomical and neurological techniques involved are, however, not quite within the reach of a communication engineer. This paper, therefore, will be confined to the acoustic aspects of speech sounds.

A commonly used visual representation of speech sounds is the oscillogram, or the intensity-time graph. The intensity may correspond to the pressure of the original sound or the voltage derived from a microphone. Experience with oscillograms indicates that while simple in appearance, they are very complicated in analysis. Therefore, before invariant elements can be obtained, it is necessary to transform the intensity-time function of the sound to a more suitable form. Since many sounds are periodic, it is natural to introduce the concept of frequency and the use of Fourier analysis, the representation in this case being the spectrogram.¹⁴ Some sounds, however, like fricatives, do not possess a high degree of periodicity; yet, they are not entirely random noise. Spectrographic representations of these sounds are not very satisfactory. Since speech sounds, including fricatives, possess a certain degree of continuity, the correlation between intensities of successive intervals is not insignificant. This type of

* Decimal classification: 534. Original manuscript received by the Institute, April 25, 1950. Presented, 1950 IRE National Convention, New York, N. Y., March 6, 1950.

The research reported in this paper was made possible through support extended to Northeastern University by the Air Materiel Command under Contracts No. W28-099-ac-386, Item II, and No. AF 19(122)-7.

† Northeastern University, Boston, Mass.

¹ H. Dudley, "Remaking speech," *Jour. Acous. Soc. Amer.*, vol. 11, p. 169; October, 1939.

² D. Gabor, "New possibilities in speech transmission," *Jour. IEE (London)*, Part III, vol. 94, p. 369; November, 1947.

³ R. J. Halsey and J. Swaffield, "Analysis-synthesis telephony with special reference to the vocoder," *Jour. IEE (London)*, Part III, vol. 95, pp. 391-411; September, 1948.

⁴ British Patent No. 543,238, February 16, 1942, on Electric Signalling System. Communicated by Western Electric Company, Inc.

⁵ V. K. Zworykin, L. E. Flory, and W. S. Pike, "Letter reading machine," *Electronics*, vol. 22, p. 80; June, 1949.

⁶ F. S. Cooper, J. M. Borst, and A. M. Liberman, "Analysis and Synthesis of Speech-like Sounds," presented, Acoustic Society of America, New York, N. Y.; May 5, 1949.

⁷ R. K. Potter, G. A. Kopp, and H. C. Green, "Visible Speech," D. Van Nostrand Co., Inc., New York, N. Y.; 1947.

⁸ Drefus-Graf J. Schweig, "The sonograph: elementary principles," *Arch. Angen. Wiss. Tech.* (in French), vol. 14, pp. 353-362; December, 1948.

⁹ R. Paget, "Human Speech," Kegan, Paul, Trench, Trubner & Co., Ltd., London, England; 1930.

¹⁰ H. Dudley, "The carrier nature of speech," *Bell Sys. Tech. Jour.*, vol. 19, pp. 495-515; October, 1940.

¹¹ J. Tiffin, "Moving pictures of the vocal chords in operation," *Jour. Acous. Soc. Amer.*, vol. 8, p. 68; July 1936.

¹² H. Dudley and T. H. Tarnoczy, "The speaking machine of Wolfgang Von Kimpelen," *Jour. Acous. Soc. Amer.*, vol. 22, pp. 151-166; March, 1950.

¹³ R. K. Potter, "Objectives for sound portrayal," *Jour. Acous. Soc. Amer.*, vol. 21, pp. 1-5; January, 1949.

¹⁴ W. Koenig, H. K. Dunn, and L. Y. Lacy, "The sound spectrogram," *Jour. Acous. Soc. Amer.*, vol. 17, p. 19; July, 1946.

correlation can be expressed by a plot of the autocorrelation function $\phi(\tau)$ versus τ .^{16,16} For purely random noise, $\phi(\tau)$ drops instantaneously as τ exceeds zero. For periodic functions, $\phi(\tau)$ varies with the same periodicity. For fricatives with hidden periodicity, $\phi(\tau)$ may fall rather rapidly, followed by small ripples. The spectrogram and the autocorrelationgram are two transforms of the oscillogram and have been considered previously by others.

A representation which heretofore has not received much consideration is clipped speech.¹⁷ It is reported that high intelligibility is retained by replacing the original speech wave with rectangular waves having the same zero crossings. There are, of course, other types of representations, such as pulse-code sampling,¹⁸ complex-frequency mapping,¹⁹ and so forth; however, this paper is concerned with only the four types mentioned above because of the apparent feasibility of experimental attack.

Fig. 1 shows these four representations: the oscillo-

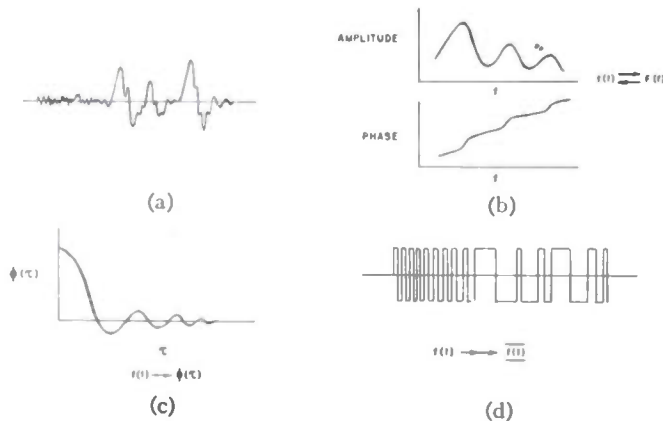

Fig. 1—Some transformations. (a) Original wave form $f(t)$. (b) Spectrogram

$$F(f) = \int_{-\infty}^{\infty} f(t)e^{-i\omega t} dt.$$

(c) Autocorrelation function

$$\phi(\tau) = \lim_{T \rightarrow \infty} \frac{1}{2T} \int_{-T}^T f(t)f(t - \tau) dt.$$

(d) Clipped speech $\bar{f}(t)$.

gram, the spectrogram, the autocorrelation function, and clipped speech. Mathematically, if we denote the original sound by $f(t)$, the spectrogram is the Fourier

transform of $f(t)$, denoted by $F(f)$. It contains information concerning both amplitude and phase. Under usual conditions, this transform is reversible as indicated by an arrow pointed both ways. This transform can be used in the direct sense (\rightarrow) for analysis, or in the inverse sense (\leftarrow) for synthesis. The autocorrelation function $\phi(\tau)$ as shown is defined as the average of the product of the original function $f(t)$ and the function shifted in time $f(t - \tau)$. This transformation is expressed mathematically as

$$\phi(\tau) = \lim_{T \rightarrow \infty} \frac{1}{2T} \int_{-T}^{+T} f(t)f(t - \tau) dt. \quad (1)$$

This function, having the dimension of power, can be proved¹⁶ to be the Fourier transform of the power spectrum. Information about phase is not contained in $\phi(\tau)$ and, therefore, the transform is not reversible as indicated by the unidirectional arrow. In the case of clipped speech the transformation is inherently non-linear, and no mathematical formulation is ventured here, except to assign the symbol $\bar{f}(t)$ to the process. The two arrows pointed the same way indicate the very obvious unidirectional properties of the clipping transformation.

These four representations, although not mathematically equivalent in the exact sense, provide equivalent parameters after proper approximations have been made. These same approximations are necessary for the practical performance of the transformations. Fig. 2 shows the effects of these approximations. The part

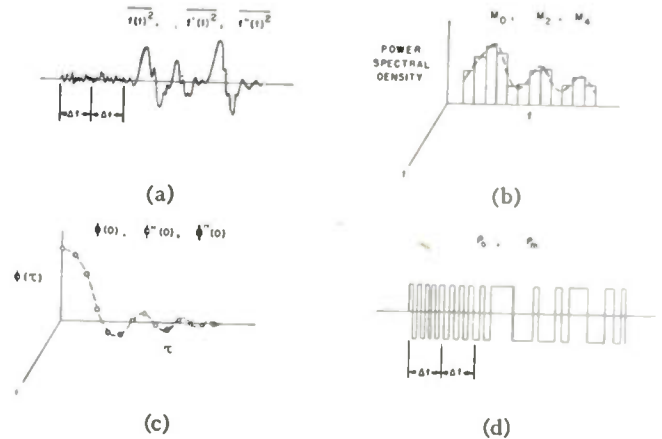

Fig. 2—Approximations in transformations. (a) $f(t)$. (b) $F(f)$. (c) $\phi(\tau)$. (d) $\bar{f}(t)$.

of the Fourier transform which represents phase is omitted. The magnitude has been changed into power spectral density and lumped into rectangular blocks corresponding to finite bands of frequencies. The spectrogram is considered to be changing with respect to time; hence the inclusion of the time axis. For the autocorrelationgram, the continuous curve is replaced by a finite number of points, corresponding to discrete autocorrelation intervals τ . A time axis t is also introduced.

¹⁶ N. Wiener, "Extrapolation, Interpolation and Smoothing of Stationary Time Series (with Engineering Applications)," Published jointly by the Technological Press of MIT, Cambridge, Mass., and John Wiley and Sons, Inc., New York, N. Y.; 1949.

¹⁷ Y. W. Lee, "Theory of Optimum Linear Systems," Notes at MIT, Course 6.563 (not yet published).

¹⁸ J. C. R. Licklider and I. Pollack, "Effects of differentiation, integration, and infinite peak clipping upon the intelligibility of speech," *Jour. Acous. Soc. Amer.*, vol. 20, p. 42; January, 1948.

¹⁹ W. M. Goodall, "Telephony by pulse code modulation," *Bell Sys. Tech. Jour.*, vol. 26, pp. 395-409; July, 1947.

²⁰ W. H. Huggins, "Conjectures Concerning the Analysis and Synthesis of Speech in Terms of Natural Frequencies," an unpublished memorandum, Air Force Cambridge Research Laboratories, Cambridge, Mass., February 9, 1949.

In the case of clipped speech, the approximation has already been considered. It consists of replacing the different intensity levels by only two fixed levels.

In summary, the approximations involved in modifying the three transformations are: (1) the lumping of frequencies in the case of the spectrogram; (2) the use of discrete intervals for autocorrelation time τ ; and (3) the use of only two fixed amplitude levels for intensity in the case of clipped speech. Although these approximations involve three different domains—frequency, time, and intensity—it is felt that if they are carried far enough, the results would probably retain about the same amount of information. Licklider and Pollack¹⁷ have shown experimentally that clipped speech retains a high degree of intelligibility. For this reason, and for simplicity, it is appropriate to begin with clipped speech in showing the equivalence of the three transformations.

If the spacing between zeroes is fairly constant in a short interval of time Δt (e.g., of the order of 1/100 second) further simplification is possible. This involves defining a new function ρ_0 giving the average number of zero crossings in the interval Δt (or the zeroes per second). Licklider and Pollack have also reported that a still higher degree of intelligibility is retained if the original speech is differentiated before clipping. In this case, the points of maxima and minima of the original function are retained rather than the points of zero crossing; and a similar density function ρ_m can be defined to give the number of maxima and minima per second. This could be carried still further by defining a third function ρ_i as the density of points of inflection, and so forth. The symbols ρ_0 and ρ_m thus indicate in Fig. 2 two indices which retain certain essential elements and represent a step toward simplification of the original speech sound.

In the study of noise, Rice²⁰ of the Bell Telephone Laboratories has found that a simple relation exists between the expected density of zeroes $\bar{\rho}_0$ and the averages of the original function and its first derivative. The derivation of this relation as outlined in the Appendix leads to

$$\bar{\rho}_0 = k_0 \sqrt{\frac{f'(t)^2}{f(t)^2}} \quad (2)$$

A similar relation can be derived to show that, subject to the same restrictions,

$$\bar{\rho}_m = k_m \sqrt{\frac{f''(t)^2}{f'(t)^2}} \quad (3)$$

In these equations, the proportionality constants k_0 and k_m depend upon the statistical characteristics of the function $f(t)$. For a stationary time series, the ensemble and time averages are indistinguishable. Hence, the

mean values $\overline{f(t)^2}$, $\overline{f'(t)^2}$, and $\overline{f''(t)^2}$ are included in Fig. 2 to indicate additional indices leading to simplification of speech sounds.

It can be shown²¹ that these averages values are equivalent to the values of the autocorrelation function $\phi(\tau)$ and certain of its first few derivatives with respect to τ at $\tau=0$; thus the symbols $\phi(0)$, $\phi''(0)$, $\phi^{IV}(0)$ appear beside the autocorrelation graph. The relationships between these quantities are given by

$$k_0 \sqrt{\frac{\overline{f'(t)^2}}{f(t)^2}} = k_0 \sqrt{\frac{-\phi''(0)}{\phi(0)}} = \bar{\rho}_0 \quad (4)$$

and

$$k_m \sqrt{\frac{\overline{f''(t)^2}}{f'(t)^2}} = k_m \sqrt{\frac{\phi^{IV}(0)}{-\phi''(0)}} = \bar{\rho}_m \quad (5)$$

It will be noted that, for smooth functions, the first and the third derivatives at $\tau=0$ are both zero. With the knowledge of these five initial values, the initial portion of the $\rho(\tau)$ curve is fairly well defined.

It can also be shown^{15,20} that these initial characteristics of the autocorrelation function are related to the moments of the power spectrum. For example, the moment of zeroth order M_0 is the average power and equals $\phi(0)$. The other two moments M_2 and M_4 , are related to the derivatives $\phi''(0)$ and $\phi^{IV}(0)$ as shown by the following equations:

$$k_0 \sqrt{\frac{-\phi''(0)}{\phi(0)}} = 2\pi k_0 \sqrt{\frac{M_2}{M_0}} = \bar{\rho}_0 \quad (6)$$

$$k_m \sqrt{\frac{\phi^{IV}(0)}{-\phi''(0)}} = 2\pi k_m \sqrt{\frac{M_4}{M_2}} = \bar{\rho}_m \quad (7)$$

The symbols M_0 , M_2 , and M_4 are therefore included along with the spectrogram in the figure.

For the special cases where $f(t)$ is a sine wave and where it is a random function having a Gaussian distribution, it can be proved that k_0 and k_m are equal to $1/\pi$. Application of the relations given by (2) through (7) to a speech sound assumes that it can be regarded as a stationary time series to which a definite distribution can be assigned. Since an exact mathematical formulation of the distribution is very difficult, the extent that this requirement is met can only be conjectured at the present time. However, assuming that these relations do apply to speech sounds, it is suggested that the proportionality constants may not be very much different from $1/\pi$.

The previous discussion has presented three types of analysis from a theoretical standpoint. Certain experimental results will now be described that support the conclusions reached using this approach. Fig. 3 shows ρ_0 - and ρ_m -grams, together with the spectrogram,

²⁰ S. O. Rice, "Mathematical analysis of random noise," *Bell Sys. Tech. Jour.*, vol. 23, pp. 282-332, July, 1944; and vol. 24, pp. 46-156, January, 1945.

²¹ R. Cohen, "Some analytical and practical aspects of Wiener's theory of prediction," Technical Report No. 69, Research Laboratory of Electronics, MIT, Cambridge, Mass., June, 1948.

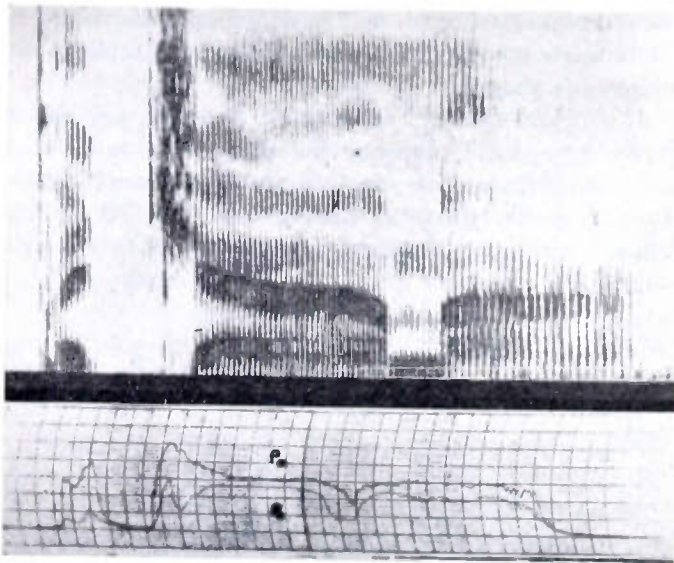

Fig. 3—Spectrogram and P_m and P_0 graphs of "pajama."

for the word "pajama." It is to be noted that there is close similarity between the shapes of the ρ_0 - and ρ_m -grams and the first two bars of the spectrogram. The first and second bars of the spectrogram represent the first and second formants, or resonance regions, of the sound. Since the frequency components in the first bar are usually strong enough to cause zero crossings, the ρ_0 -gram is a close approximation of this bar. The frequency components in the second resonance region may not be strong enough to cause extra zero crossings, but they will affect the slope of the wave and may, therefore, contribute extra maxima and minima which are included in ρ_m . Fig. 4 shows the graphs of the sounds "i," "e," "a," and "u" which give additional evidence of this resemblance. Usually vowel and vowel-like sounds such as these, having bars which are clearly distinguishable, will show closer resemblance than other types.

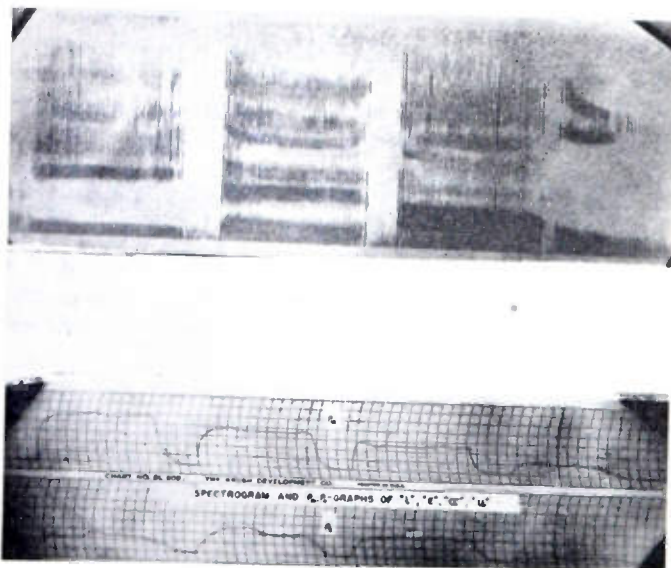

Fig. 4

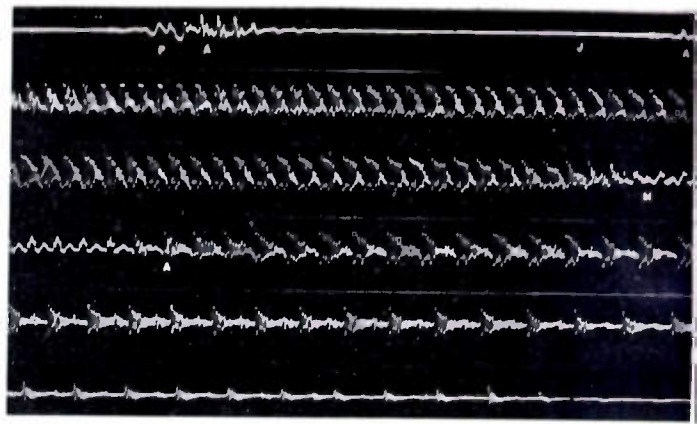

Fig. 5—Oscillogram of the word "pajama."

A comparison of the ρ_0 - and ρ_m -grams of the word "pajama" with the oscillogram of the same word, as shown in Fig. 5, justifies the contention that the former is a considerably simpler representation. Visual inspection of the zero crossings of the oscillogram will show that the general shape of the given ρ_0 -gram is correct. The same is true in the case of the maxima and minima.

Some work has been done on the experimental verification of the theoretical relations involving ρ_0 , ρ_m , and the other three sets of statistical parameters as applied to speech wave forms. The relationship between ρ_0 and $f(t)^2$ and $f'(t)^2$ has been checked for some sustained vowel and sustained fricative sounds. This involves the computation of the ratio of the root-mean-square value of $f'(t)$ to that of $f(t)$, i.e., the value of the former normalized with respect to the latter. It is preferable that the mean-square value of the original $f(t)$, that is, $f(t)^2$, be kept relatively constant so that $f'(t)^2$ will be automatically normalized. This is an inherent property of the types of sounds that have been checked.

For transitional sounds, such as those contained in the words "pajama" and "question," experimental verification is at present impossible since $\sqrt{f(t)^2}$ is dependent upon both amplitude and frequency varia-

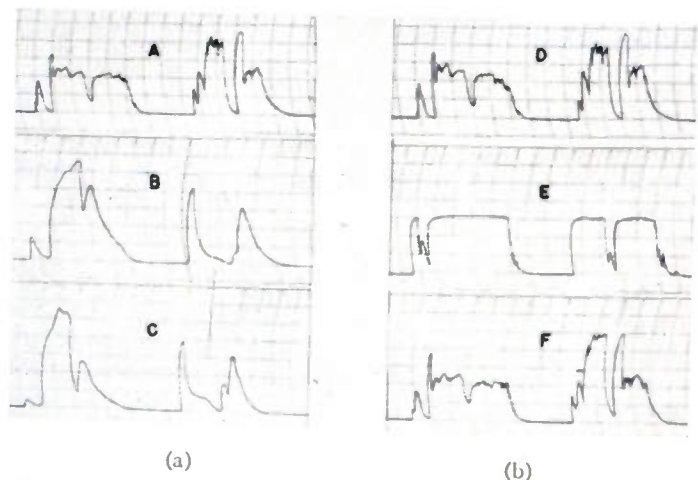

Fig. 6—Graphs for the words "pajama" and "question." (a) Ordinary speech: (A) ρ_0 ; (B) $f(t)^2$; (C) $f'(t)^2$. (b) Clipped speech: (D) ρ_0 ; (E) $f(t)^2$; (F) $f'(t)^2$.

tions, with the former predominating. Since the $\sqrt{f(t)^2}$ itself is dependent only upon the same amplitude variations, the ratio as determined by computation using independent measurements does not yield significant results. It would be necessary to employ some automatic-amplitude-control method to either minimize the changes in amplitude, or to obtain the ratio of the two quantities directly. This effect is illustrated for ordinary speech by graphs (A), (B), and (C) of Fig. 6. Visual examination of (B) and (C) indicates that the amplitude effect predominates. Since clipped speech is an extreme case of amplitude control, data from graphs (D), (E) and (F) should give a better check of the relation in question. Visual examination will show that this is true.

Experimental verification of the other theoretical relations has not as yet been attempted because the autocorrelator and moment computer, while under construction, have not been completed.

CONCLUSIONS

It has been shown that, from a mathematical standpoint, the three methods of analysis considered, namely, spectrographic analysis, autocorrelation, and infinite clipping, provide parameters which are equivalent for certain time functions. Since speech sounds are too complex for mathematical treatment of these types, an experimental attempt at verification of the equivalence for speech sounds is justified. Furthermore, an experimental attempt to determine the degree of invariance of these parameters is advisable. It is hoped that a subsequent paper will report progress currently being made along these lines.

APPENDIX

I. MATHEMATICAL DERIVATIONS²²

The Expected Density of Zeroes

Consider a random curve $f(t)$ for which the following figure is a sample of the ensemble. The expected density of

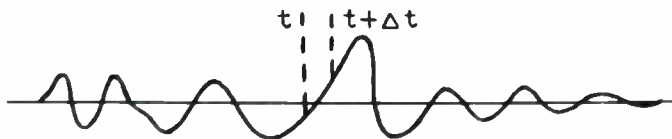

zeroes is given by

$$\bar{\rho}_0 = \int_{-\infty}^{\infty} |\eta| p(0, \eta) d\eta. \tag{8}$$

In this expression $p(0, \eta)$ is $p(\xi, \eta)$ for $\xi=0$, where $p(\xi, \eta)$ is the probability density function for the two variables

$$\begin{aligned} \xi &= f && \text{(at time } t) \\ \eta &= \frac{df}{dt} = f' && \text{(at time } t); \end{aligned}$$

i.e., the probability that at time t the value of f in the ensemble lies between ξ and $\xi+d\xi$, and the value of f' lies between η and $\eta+d\eta$ is $p(\xi, \eta)d\xi d\eta$. Equation (8) may be proved as follows:

Referring to the figure, in the interval between t and $t+\Delta t$ for all the ensemble, if the slope is positive, i.e.,

$$0 < \eta < \infty, \tag{9}$$

then, in order for the curve to pass through zero in the interval Δt , the following inequality must be satisfied:

$$0 > > \eta \Delta t. \tag{10}$$

This is evident from the geometry. The amplitude of ξ must be negative so that the curve will cross the axis with a positive slope η . Its absolute magnitude must be sufficiently small so that the crossing occurs within the interval. The portion of the curve in the interval Δt is assumed to be linear.

Since the intervals of the variables ξ, η are defined by (10) and (9), the expected density of zeroes can be obtained.

$$\bar{\rho}_0 = \lim_{\Delta t \rightarrow 0} \frac{\int_0^{\infty} \int_{\eta \Delta t}^0 p(\xi, \eta) d\xi d\eta}{\Delta t} = \int_0^{\infty} \eta p(0, \eta) d\eta.$$

Similarly, for the interval between t and $t+\Delta t$, if the slope is negative or $-\infty < \eta < 0$, then

$$\bar{\rho}_0 = - \int_{-\infty}^0 \eta p(0, \eta) d\eta.$$

Combining these two expressions, (8) is obtained.

Relation Between ρ_0 and ξ^2, η^2

This relation is expressed by

$$\bar{\rho}_0 = k_0 \sqrt{\frac{\eta^2}{\xi^2}} = k_0 \sqrt{\frac{f'(t)^2}{f(t)^2}} \tag{11}$$

where k_0 is a constant and the bars indicate the ensemble average. For stationary time series, the time average and ensemble average are not distinguishable.

To prove (11), let the bivariate probability density function $p(\xi, \eta)$ be expressed in normalized form

$$p(\xi, \eta) = \xi_0^{-1} \eta_0^{-1} f\left(\frac{\xi}{\xi_0}, \frac{\eta}{\eta_0}\right) = \xi_0^{-1} \eta_0^{-1} f(x, y)$$

where

$$x \equiv \frac{\xi}{\xi_0} \quad y \equiv \frac{\eta}{\eta_0}$$

and ξ_0 and η_0 are the bases of normalization.

In so doing, the two variables in the probability density function become dimensionless, and

$$p(\xi, \eta) d\xi d\eta = f(x, y) dx dy.$$

The ensemble averages of η^2 and ξ^2 are

²² This derivation is essentially similar to that of Rice. See footnote reference 20.

$$\begin{aligned} \overline{\eta^2} &= \int_{-\infty}^{\infty} \int_{-\infty}^{\infty} \eta^2 p(\xi, \eta) d\xi d\eta \\ &= \eta_0^2 \int_{-\infty}^{\infty} \int_{-\infty}^{\infty} y^2 f(x, y) dx dy \\ &= c_1 \eta_0^2 \end{aligned} \tag{12}$$

$$\begin{aligned} \overline{\xi^2} &= \int_{-\infty}^{\infty} \int_{-\infty}^{\infty} \xi^2 p(\xi, \eta) d\xi d\eta \\ &= \xi_0^2 \int_{-\infty}^{\infty} \int_{-\infty}^{\infty} x^2 f(x, y) dx dy \\ &= c_2 \xi_0^2. \end{aligned} \tag{13}$$

The expected density of zeroes is, from (8),

$$\begin{aligned} \overline{\rho_0} &= \int_{-\infty}^{\infty} |\eta| p(0, \eta) d\eta \\ &= \eta_0 \int_{-\infty}^{\infty} |y| \xi_0^{-1} \eta_0^{-1} f(0, y) \eta_0 dy \\ &= \frac{\eta_0}{\xi_0} \int_{-\infty}^{\infty} |y| f(0, y) dy \\ &= c_3 \frac{\eta_0}{\xi_0} \end{aligned} \tag{14}$$

where c_1 , c_2 , and c_3 are characteristic constants of the original distribution. Combining (12), (13), and (14)

$$\overline{\rho_0} = c_3 \sqrt{\frac{c_2}{c_1}} \sqrt{\frac{\eta^2}{\xi^2}} = k_0 \sqrt{\frac{\eta^2}{\xi^2}} = k_0 \sqrt{\frac{f'(t)^2}{f(t)^2}}$$

which is (11).

Thus, it is proved that for a stationary time series whose distribution is definite, as expressed by $p(\xi, \eta)$, the expected density of zeroes is proportional to the ratio of the root-mean-square value of the first time derivative and the root-mean-square value of the time series itself, provided the integrals contained in c_1 , c_2 , and c_3 also exist.

Relation Between $\overline{\rho_0}$ and the Autocorrelation Function

The autocorrelation function is defined as

$$\phi(\tau) = \overline{f(t)f(t-\tau)}$$

The bar indicates either the time average or the ensemble average. For $\tau=0$

$$\phi(0) = \overline{f(t)^2} = \overline{\xi^2} \tag{15}$$

It may be proved that ²⁰

$$-\frac{d^2\phi}{d\tau^2} = -\phi''(\tau) = \overline{f'(t)f'(t-\tau)}$$

For $\tau=0$

$$-\phi''(0) = \overline{f'(t)^2} = \overline{\eta^2} \tag{16}$$

Combining (11), (15), and (16), the expected density of zeroes can be expressed alternatively as

$$\overline{\rho_0} = k_0 \sqrt{\frac{f'(t)^2}{f(t)^2}} = k_0 \sqrt{\frac{-\phi''(0)}{\phi(0)}} \tag{17}$$

It is proportional to the square root of the ratio of the negative second derivative of the autocorrelation function to the autocorrelation function itself both evaluated at $\tau=0$.

Relation Between $\overline{\rho_0}$ and the Moments of the Power Spectrum

The power spectral density, $\Phi(f)$, is related to the autocorrelation function by the Fourier transform

$$\phi(\tau) = \int_0^{\infty} \Phi(f) \cos 2\pi f\tau df$$

For $\tau=0$,

$$\phi(0) = \int_0^{\infty} \Phi(f) df = M_0 \tag{18}$$

Similarly, it may be proved that

$$-\phi''(0) = 4\pi^2 \int_0^{\infty} f^2 \Phi(f) df = 4\pi^2 M_2 \tag{19}$$

Where M_0 and M_2 are used to designate the zero- and second-order moments of the power spectrum, $\Phi(f)$ versus f .

Combining (17), (18), and (19)

$$\overline{\rho_0} = k_0 \sqrt{\frac{f'(t)^2}{f(t)^2}} = k_0 \sqrt{\frac{-\phi''(0)}{\phi(0)}} = 2\pi k_0 \sqrt{\frac{M_2}{M_0}} \tag{20}$$

Equation (20) gives another interpretation to $\overline{\rho_0}$. It indicates that the expected density of zeroes is proportional to the square root of the ratio of the second moment of the zeroth moment of the power spectrum.

The Proportionality Constant k_0 for Random Noise

The above derivations are specially applicable to the case when $f(t)$ represents random noise for which $p(\xi, \eta)$ is "Gaussian." To show this, consider the Fourier series representation of random noise

$$f(t) = \sum_{n=1}^N c_n \cos(\omega_n t - \phi_n) \tag{21}$$

Where $\phi_1, \phi_2, \dots, \phi_N$ are angles distributed at random over the range $(0, 2\pi)$

$$c_n = [2\Phi(f_n)\Delta f]^{1/2}$$

$$\omega_n = 2\pi f_n$$

$$f_n = n\Delta f$$

Under certain conditions the "central-limit theorem" of probability can be applied and the distribution approaches the "normal" or "Gaussian" form. These

conditions may be stated qualitatively along with (21) as follows:²³

(a) $f(t)$ has a large number of Fourier series components, i.e., $N \rightarrow \infty$.

(b) The ratio of the quadratic constant (i.e., the average power) of any one component in comparison with the total is vanishingly small, i.e., $c_n \rightarrow 0$.

(c) The phases of the components are distributed at random, i.e., ϕ_n a random variable.

(d) There is no direct-current component, i.e., $c_0 = 0$. These conditions are usually satisfied by random noise. The probability density function $p(\xi, \eta)$ can be written in the form

$$p(\xi, \eta) = \frac{(\bar{\xi}^2 \bar{\eta}^2)^{-1/2}}{2\pi} \exp \left[-\frac{\xi^2}{2\bar{\xi}^2} - \frac{\eta^2}{2\bar{\eta}^2} \right]. \quad (22)$$

Instead of going through the steps to derive (11) which is for the more general case, it is simpler here to substitute (22) directly into (8) whence

$$\bar{\rho}_0 = \int_{-\infty}^{\infty} |\eta| \frac{(\bar{\xi}^2 \bar{\eta}^2)^{-1/2}}{2\pi} \exp \left[-\frac{\eta^2}{2\bar{\eta}^2} \right] d\eta = \frac{1}{\pi} \sqrt{\frac{\bar{\eta}^2}{\bar{\xi}^2}} \quad (23)$$

²³ S. Goldman, "Frequency Analysis, Modulation and Noise," McGraw-Hill Book Co., New York, N. Y., p. 329; 1948.

Comparing (23) with (11), it is found that for a Gaussian distribution, the proportionality constant

$$k_0 = \frac{1}{\pi}.$$

For other distributions, k_0 would be different. It is interesting to note at this point that for a single sine wave of frequency f

$$f(t) = A \sin 2\pi ft.$$

If $\bar{\rho}_0$ is taken as $2f$, the proportionality constant between $\bar{\rho}_0$ and $\sqrt{f'(t)^2/f(t)^2}$ is also $1/\pi$. This perhaps suggests that for distributions other than Gaussian, as long as (5) applies, the proportionality constant k_0 may not be very much different from $1/\pi$.

The Expected Number of Maxima and Minima

By a similar process,²⁰ the expected number of maxima in a random function may be expressed as

$$\rho_m = k_m \sqrt{\frac{f''(t)^2}{f'(t)^2}} = k_m \sqrt{\frac{\phi^{IV}(0)}{-\phi''(0)}} = 2\pi k_m \sqrt{\frac{M_4}{M_2}} \quad (24)$$

where k_m is a constant dependent upon the distribution, $\phi^{IV}(0)$ is the fourth derivative of the autocorrelation curve, $\phi(\tau)$ versus τ , and M_4 is the fourth moment of the power spectrum of $f(t)$.

Periodic-Waveguide Traveling-Wave Amplifier for Medium Powers*

G. C. DEWEY†, ASSOCIATE, IRE, P. PARZEN‡, AND T. J. MARCHESE‡, SENIOR MEMBER, IRE

Summary—A theoretical and experimental study of singly corrugated coaxial transmission lines is given here. The properties of the structure as a transmission line are calculated and the effect of the electron beam is taken into account by a field method. Theoretical values of gain and bandwidth are obtained. The results of the experimental study are compared with the theory. An amplifier giving 50-watts output with 20-db gain and 100-Mc bandwidth at a wavelength of 6.5 cm has been obtained. The best power output and efficiency which have been obtained are 125 watts and 7 per cent, respectively.

INTRODUCTION

THEORETICAL ANALYSES and experimental studies of helix-type traveling-wave tubes have been carried out by Kompfner¹ and Pierce.² Other

* Decimal classification: R339.2. Original manuscript received by the Institute, January 25, 1950; revised manuscript received October 2, 1950. A partial summary report under the same title was presented at the National Electronics Conference, Chicago, Ill., November 5, 1948.

This development was sponsored by Coles Laboratory, Signal Corps, United States Army.

† Formerly, Federal Telecommunication Laboratories, Inc., Nutley, N. J.; now, Weapons Systems Evaluation Group, Office of the Secretary of Defense, Washington, D. C.

‡ Federal Telecommunication Laboratories, Inc., Nutley, N. J.

¹ R. Kompfner, "Traveling wave valve," *Wireless World*, vol. 52, pp. 369-372; November, 1946.

workers have contributed to the theoretical problem, notably Chu³ who obtained a boundary value solution to the problem using Pierce's ideal helical current-sheet boundary and including the effect of Pierce's electron beam by the method of Hahn and Ramo. Field⁴ has investigated other types of waveguide structures.

This paper is concerned with a traveling-wave tube using a corrugated inner-conductor coaxial transmission line with an annular electron beam between the inner and outer conductors. The first part deals with the theoretical analysis of the structure following the method of Goldstein⁵ for a field solution in the absence of the electron beam and includes the electronic parameters by the method Chu used for the helix traveling-wave tube. The second part deals with an experimental

² J. R. Pierce, "Theory of the beam-type traveling-wave tube," *Proc. I.R.E.*, vol. 35, pp. 111-123; February, 1947.

³ L. J. Chu and J. D. Jackson, "Field theory of traveling-wave tubes," *Proc. I.R.E.*, vol. 36, pp. 853-862; July, 1948.

⁴ L. M. Field, "Some slow-wave structures for traveling-wave tubes," *Proc. I.R.E.*, vol. 37, pp. 34-40; January, 1949.

⁵ H. H. Goldstein, "Cavity Resonators and Waveguides Containing Periodic Elements," Doctoral Thesis, Massachusetts Institute of Technology, 1943.

study and the comparison of the results with the theory.

The choice of the corrugated coaxial structure from the plethora of possible slow waveguide structures was made after a wide investigation. The type of amplifier described by Field and the iris-loaded waveguide structure proved to have very limited bandwidth; the singly corrugated coaxial line represented a compromise between gain, power output, and bandwidth.

PART I

A. Calculation of the Cold Phase Velocity

The structure we are considering, which is assumed to be lossless, is shown in Fig. 1. It belongs to a large class of periodic waveguides along with the linear magnetron and the iris-loaded waveguide used in linear-accelerator

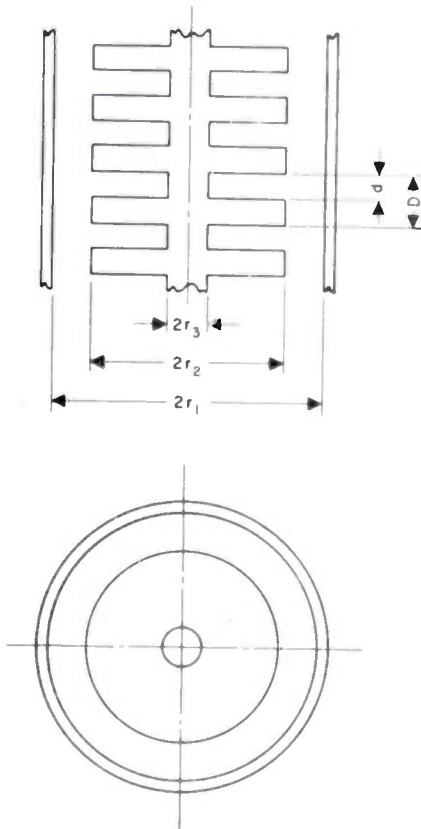

Fig. 1—Singly corrugated coaxial transmission line.

work. The properties of such structures are dealt with extensively by Brillouin,⁶ Slater,⁷ and Goldstein,⁸ the latter treats in detail, but with certain approximations, the properties of our structure.

The method of solution is to obtain in the annular or "hole" region $r_1 > r > r_2$ solutions satisfying Maxwell's equation and meeting the boundary conditions at $r = r_1$, and to obtain standing-wave solutions for the fields in the slots $r_2 > r > r_3$, including higher-order cutoff

⁶ L. Brillouin, "Wave Propagation in Periodic Structures," McGraw-Hill Book Co., New York, N. Y.; 1946.

⁷ J. C. Slater, "Electromagnetic Waves in Iris-Loaded Waveguides," Report #48, Massachusetts Institute of Technology, Research Laboratory of Electronics, Cambridge, Mass.; September 19, 1947.

modes. The field expansions are Fourier series, and by equating coefficients, an equation may be obtained with the required degree of approximation depending on the number of terms used.

The wave functions for circularly symmetric *TM* waves in this geometry are Bessel functions of order zero of the first and second kinds. The wave equation is easily separated and the following functions are obtained, taking into account that $E_z = 0$ at $r = r_1$ and at $r = r_3$. For $r_1 > r > r_2$

$$\begin{aligned} E_z &= \sum_n A_n Z_0(\gamma_n, r, r_1) e^{ih_n z} \\ H_\theta &= \sum_n \frac{ik^2 A_n}{\mu\omega\gamma_n} Z_0'(\gamma_n, r, r_1) e^{ih_n z} \end{aligned} \quad (1)$$

where

$$k^2 = \gamma_n^2 + h_n^2 \quad \text{and} \quad h_n = H_0 + \frac{2\pi n}{D}$$

$$Z_0(\gamma_n, r, r_1) \equiv J_0(\gamma_n r) Y_0(\gamma_n r_1) - J_0(\gamma_n r_1) Y_0(\gamma_n r)$$

where the derivatives are taken with respect to the arguments, and k is the free-space wave number.

For $r_3 \leq r \leq r_2$ in the s th slot the fields can be written

$$\begin{aligned} E_z &= \sum_{-\infty}^{\infty} e^{ih_0 s D} \left(a_p Z_0(k_p, r, r_3) \cos \frac{2\pi p z}{d} \right. \\ &\quad \left. + b_p Z_0(K_p, r, r_3) \sin \frac{(2p+1)\pi z}{d} \right) \\ H_\theta &= \sum_{-\infty}^{\infty} e^{ih_0 s D} i k^2 \left(\frac{a_p}{k_p} Z_0'(k_p, r, r_3) \cos \frac{2\pi p z}{d} \right. \\ &\quad \left. + \frac{b_p}{K_p} Z_0'(K_p, r, r_3) \sin \frac{(2p+1)\pi z}{d} \right) \end{aligned} \quad (2)$$

where

$$k_p = \sqrt{k^2 - \left(\frac{2\pi p}{d}\right)^2}$$

and

$$K_p = \sqrt{k^2 - \left(\frac{(2p+1)\pi}{d}\right)^2}$$

For one period of the structure at $r = r_2$ the longitudinal electric field must be zero for

$$\frac{D}{2} \geq Z \geq \frac{d}{2}$$

and for $|Z| \leq d/2$, continuity of the fields is required. By the usual manipulation of the Fourier coefficients, (3) is obtained.

$$A_n Z_0(\gamma_n, r_2, r_1) D = \sum_p \sum_q \frac{A_q}{\gamma_q} Z_0'(\gamma_q, r_2, r_3) \frac{2}{d} R_{pqn}$$

$$K_{pqn} = \left\{ \begin{aligned} & k_p \frac{4h_n h_q \sin \frac{h_n d}{2} \sin \frac{h_q d}{2}}{\left(\left(\frac{2\pi p}{d} \right)^2 - h_n^2 \right) \left(\left(\frac{2\pi q}{d} \right)^2 - h_q^2 \right)} \frac{Z_0(k_p, r_2, r_3)}{Z_0'(k_p, r_2, r_3)} \frac{1}{\epsilon_p} \\ & - K_p \frac{4h_n h_q \cos \frac{h_n d}{2} \cos \frac{h_q d}{2}}{\left(\left[(2p+1) \frac{\pi}{d} \right]^2 - h_n^2 \right) \left(\left[(2q+1) \frac{\pi}{d} \right]^2 - h_q^2 \right)} \frac{Z_0(K_p, r_2, r_3)}{Z_0'(K_p, r_2, r_3)} \end{aligned} \right\} \quad (3)$$

where

$$\begin{aligned} \epsilon_p &= 1 & p \neq 0 \\ \epsilon_p &= 2 & p = 0. \end{aligned}$$

Equation (3) is a set of n homogeneous equations in n unknowns; it is the usual type of equation obtained in these problems and can be solved in principle. Provided the guide wavelength is large compared to D , the amplitudes of the space harmonics are small and one can consider the case where $n = p = q = 0$. This amounts to taking the principal mode in the hole and the first even and odd modes in the slot. For values of $H_0 \rightarrow (\pi/D)$, the space harmonics must be included and Slater⁵ has given a more general method of solution to this type of problem.

We are concerned only with geometrics where $D < r_2$ and $|H_0 D / 2\pi| < 1$. Under these conditions, letting $\gamma_0 = i\gamma_0$, and going to the modified Bessel functions, (3) becomes

$$\begin{aligned} \gamma_0 \frac{I_0(\gamma_0 r_2) K_0(\gamma_0 r_1) - I_0(\gamma_0 r_1) K_0(\gamma_0 r_2)}{I_1(\gamma_0 r_2) K_0(\gamma_0 r_1) + I_0(\gamma_0 r_1) K_1(\gamma_0 r_2)} &= \frac{d}{D} k \frac{J_0(kr_2) Y_0(kr_3) - J_0(kr_3) Y_0(kr_2)}{J_1(kr_2) Y_0(kr_3) - J_0(kr_3) Y_1(kr_2)} \left(\frac{\sin \frac{H_0 d}{2}}{\frac{H_0 d}{2}} \right)^2 \\ &+ \frac{8(H_0 d)^2}{D\pi^2} \left(\cos^2 \frac{H_0 d}{2} \right) \frac{I_0\left(\frac{\pi r_2}{d}\right) K_0\left(\frac{\pi r_3}{d}\right) - I_0\left(\frac{\pi r_3}{d}\right) K_0\left(\frac{\pi r_2}{d}\right)}{I_1\left(\frac{\pi r_2}{d}\right) K_0\left(\frac{\pi r_3}{d}\right) + I_0\left(\frac{\pi r_3}{d}\right) K_1\left(\frac{\pi r_2}{d}\right)}. \end{aligned} \quad (4)$$

It is convenient to regard (4) as an impedance equation. It can be obtained without the second term on the

right by equating at $r = r_2$ the values of E_z/H_θ averaged over a period of the structure for the fields of the two regions. This latter method does not allow one to calculate the effect of the odd slot mode, which gives an important correction to the phase velocity obtained from the simple method. A qualitative picture of the electric field is shown in Fig. 2.

For very low frequencies the asymptotic values of the Bessel functions for small arguments may be used in (4), except in the second term on the right, which is, for most traveling-wave tube geometries, very nearly unity. The resulting asymptotic phase velocity for low frequencies is

$$\frac{V}{C} = \frac{1}{\sqrt{\frac{8d^2}{\pi^3 D r_2} - \frac{d}{D} \log \frac{r_2}{r_3} \left(\frac{8d^2}{\pi^3 D r_2} - \log \frac{r_1}{r_2} \right)}} \quad (5)$$

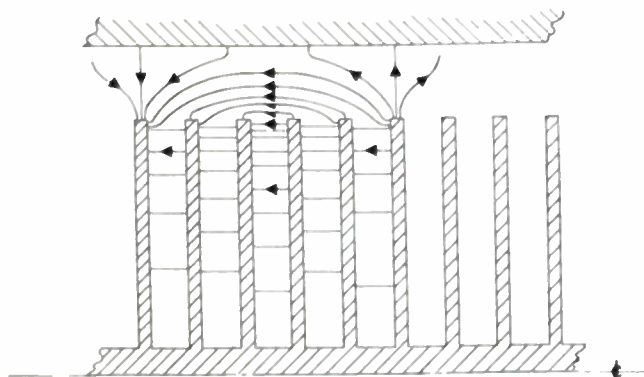

Fig. 2—Qualitative picture of the electric field.

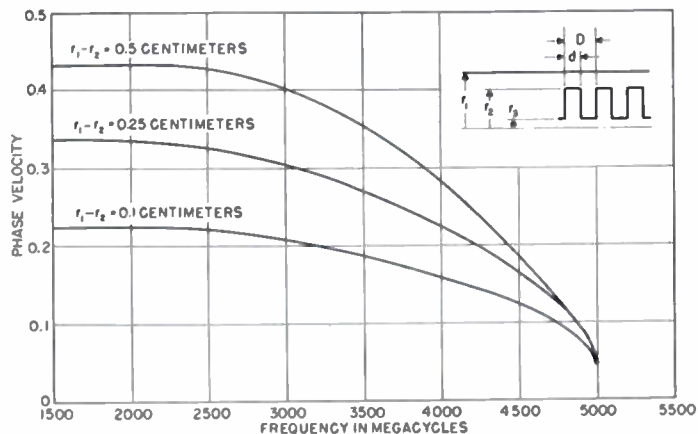

Fig. 3—Approximate theoretical phase velocity for a tube in which $d/D = 0.135$ and which has dimensions in centimeters of $r_2 = 1.2$, $r_3 = 0.4$, and $D = 0.15$.

which is independent of the frequency and always less than the velocity of light. Fig. 3 shows the results of an approximate phase-velocity calculation for a typical structure. Fig. 4 shows a comparison between measured results and the data computed from (3). The mean error is about four per cent and cannot be much reduced without including the effect of several space harmonics.

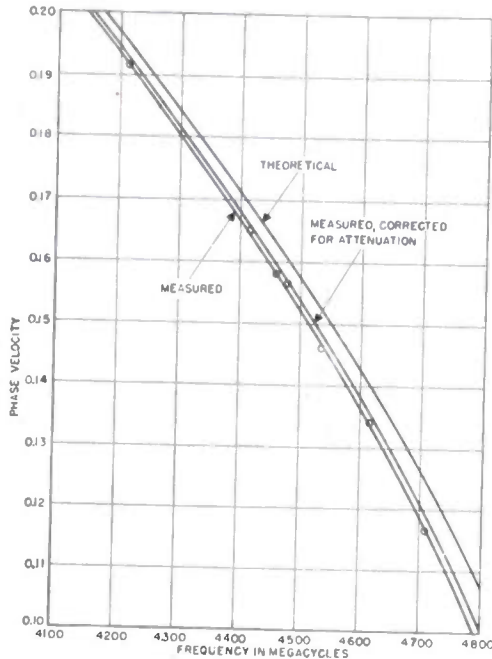

Fig. 4—Comparison of the experimental phase velocity with theoretical values calculated from the complete theory.

B. Properties with an Electron Beam Filling the Region, $r_2 \leq r \leq r_1$

We calculate here, by a small signal approximation, the modification of the cold properties introduced by a monochromatic electron beam constrained to move axially at a velocity small compared to that of light. Under these conditions only the z component of the electric field (always neglecting the Lorentz forces) interacts with the electron stream, and it may easily be shown³ that the ac current density has only a z component, which is linearly related to the longitudinal electric field by the relationship

$$J = \left(\frac{-\omega e/mJ_0}{v_0^3(\beta - H)^2} \right) E_z \text{ where } \beta = \frac{\omega}{v_0}$$

$$\frac{\gamma}{1 - \frac{\alpha}{(\beta - H)^2}} P(\gamma, r_2, r_1) = \frac{d}{D} k_0 \frac{Z_0(k_0, r_2, r_3)}{Z_0'(k_0, r_2, r_3)} \left[\frac{\sin Hd/2}{2} \right]^2 + \left(\cos^2 \frac{Hd}{2} \right) \left(\frac{8(Hd)^2}{D\pi^3} \right) \tag{6}$$

where

$$P = \frac{I_0(\gamma r_2)K_0(\gamma r_1) - I_0(\gamma r_1)K_0(\gamma r_2)}{I_1(\gamma r_2)K_0(\gamma r_1) + I_0(\gamma r_1)K_1(\gamma r_2)}$$

and

$$\gamma^2 = (H^2 - k_0^2) \left(1 - \frac{\alpha}{(\beta - H)^2} \right)$$

and

$$\alpha = \frac{4\pi(e/m)\rho_0}{v_0^2} = 9.5 \times 10^4 \frac{J_0 \text{ amp/cm}^2}{V_0^{3/2} \text{ Volts}}$$

Equation (6) can be solved exactly numerically, but it is far easier to obtain a solution by considering the hot propagation constant as a perturbation on the cold case. This method is in contradistinction to the method of Pierce² who considers the hot modes to be perturbations of the Hahn-Ramo waves traveling on the electron stream.

The propagation constant H , with the electron beam, differs from the cold constant H_0 by a small quantity δ which may be complex. One may modify (6) by expanding P in a Taylor series about $\gamma = \gamma_0$ to the first order in α and δ . Setting $H = H_0$ in the terms on the right (since the term is a correction, the error so introduced is negligible), the equation can be reduced to the following form:

$$\delta(u - \delta)^2 + A = 0 \tag{7}$$

where

$$u = \beta - H_0$$

and

$$A = \left[\frac{\alpha}{2} \left\{ \frac{d}{D} k \frac{Z_0(k, r_2, r_3)}{Z_0'(k, r_2, r_3)} \left[\frac{\sin \frac{H_0 d}{2}}{2} \right]^2 + \left(\cos^2 \frac{H_0 d}{2} \right) \left(\frac{8(H_0 d)^2}{D\pi^3} \right) \right\} \right]_{\gamma=\gamma_0} \left(P + H_0 \frac{dP}{d\gamma} \right)$$

With this relation the analysis of Section IA may be carried out and an equation analogous to (3) obtained.

Equation (7) is a form of the usual cubic equation obtained in traveling-wave tube theory.

The imaginary part of the complex pair of roots is the gain in nepers per cm. Reduced values of the imaginary part of the complex pair of roots are shown in Fig. 5 and for the real part in Fig. 6. For calculating the frequency dependence of the gain, one must calculate A as a function of the frequency from the cold theory and then one readily gets the gain and hot phase velocity from Figs. 5 and 6 and (7).

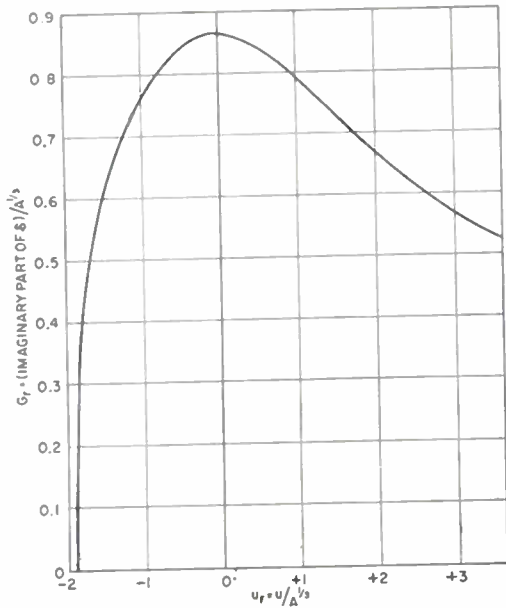

Fig. 5—Reduced imaginary part of the complex pair of roots of (7).

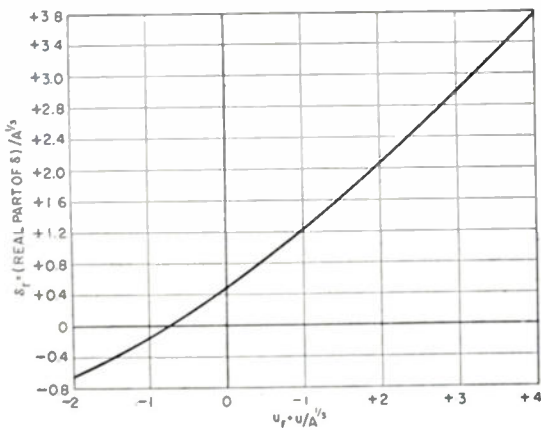

Fig. 6—Reduced real part of complex pair of roots of (7).

For small values of α , i.e., low beam current, the frequency dependence of the gain is mainly determined by the rate of change of u with frequency, i.e., the cold dispersion of the structure. For large values of α the frequency dependence of A becomes important.

Actual calculation of the performance of a given length of this structure depends on the initial boundary conditions and corrections for the presence of loss. The method in which these calculations are carried out is similar to that used for helix-type traveling-wave tubes for which extensive analyses are available in the literature.^{2,3,8,9}

II. EXPERIMENTAL STUDY

A. Description of the Experimental Tube

A number of different structures based on the previous calculation have been made and tested. A drawing of a typical structure is shown in Fig. 7.

The corrugated inner conductor is made by assembling punched metallic disks with small metal spacers on a refractory metal mandrel and clamping the ends. The dimensions of the active part of the tube are, in the notation of Fig. 1,

$$\begin{aligned} r_1 &= 1.35 \text{ cm} & d &= 0.10 \text{ cm} \\ r_2 &= 1.20 \text{ cm} & D &= 0.125 \text{ cm} \\ r_3 &= 0.20 \text{ cm} & \text{length} = l &= 14.2 \text{ cm.} \end{aligned}$$

The input and output of the corrugated coaxial structure are matched to 5/8-inch outside-diameter 50-ohm coaxial transmission line. The outer conductor has three longitudinal slots cut through it; the slots have been found to prevent propagation of an asymmetrical mode, which otherwise propagates freely and causes the amplifier to oscillate.

The annular electron beam is obtained from a pure tantalum ring emitter operated temperature limited for control of the beam current. The electrostatic and mag-

⁸ M. Goudet, "Les Recents Progres des Tube Amplificateurs pour Ondes Centrimétriques," *Ann. Télécommun.*, vol. 3, pp. 445-455; December, 1948.

⁹ O. E. H. Rydbeck, "Theory of Traveling-Wave Tubes," Ericsson Techniques No. 46, Telefonaktiebolaget L. M. Ericsson, Stockholm; 1948.

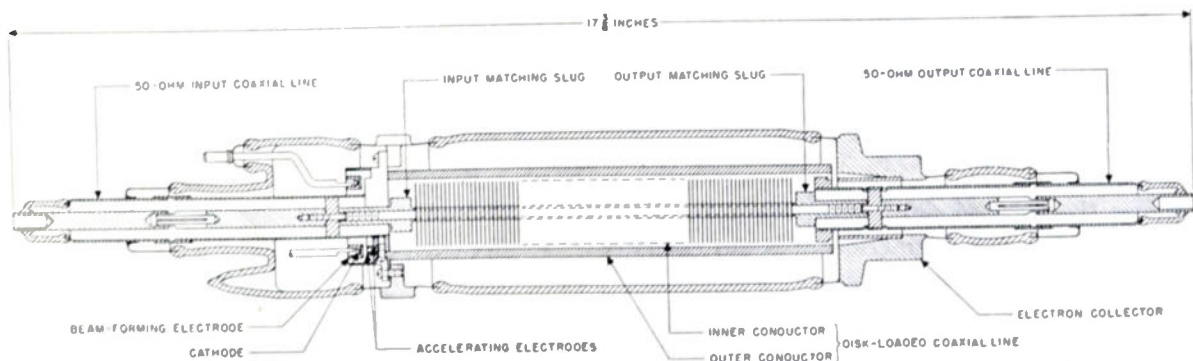

Fig. 7—Experimental tube.

netic fields are so controlled that the electron orbits are very nearly rectilinear and space charge forces, in the range of currents used, are generally small. The annular beam enters the coaxial structure through an annulus with four transverse spokes which serve to connect the outer conductors for radio-frequency currents. The beam leaves through a similar structure and is collected on a separate collector. The ratio of collected current to cathode current has varied between 0.6 and 0.8. The maximum possible beam efficiency is about 0.8 due to the part of the area of the annulus subtended by the radial spokes.

B. Experimental Results and Comparison with Theory

The operation of a dispersive traveling-wave tube of this type is characterized by a resonant dependence of the electronic gain and power output on frequency. The terminal impedance match is sufficiently broad-band so that the electronic properties alone determine the frequency response of the amplifier.

Fig. 8 shows the resonance voltage¹⁰ as a function of frequency taken with very small beam currents. This curve gives a relation between beam voltage and frequency which allows one to plot the various parameters as a function of this beam voltage. Operation in a region of power saturation causes an upward shift in the resonance beam voltage, but the shift has never exceeded 10 per cent.

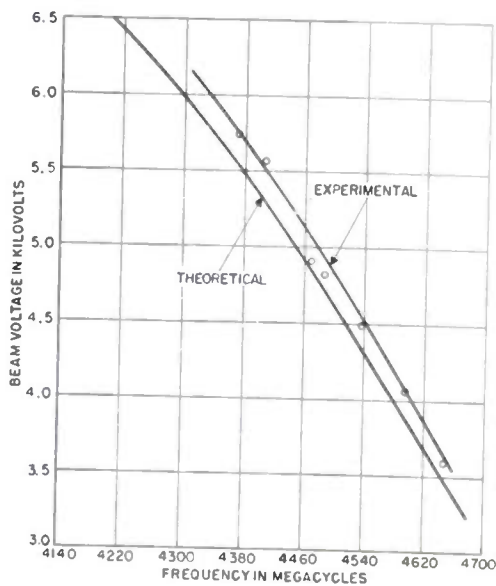

Fig. 8—Experimental resonance beam voltage for very small beam currents.

Fig. 9 shows the small-signal gain of the tube, with finite cold attenuation, as a function of beam current for various values of the beam voltage, which corre-

¹⁰ The ratio of d/D for the theoretical curve is larger than that for the experimental curve which explains the higher experimental voltages in contrast to Fig. 4.

sponds to the values of frequency given in parenthesis.

The gain of the amplifier as a function of power level exhibits the usual marked saturation effect seen in traveling-wave tubes. As the power input increases, a point is finally reached where an increase in the input power results in a decrease in the output power. The power output is then the maximum power output of the tube.

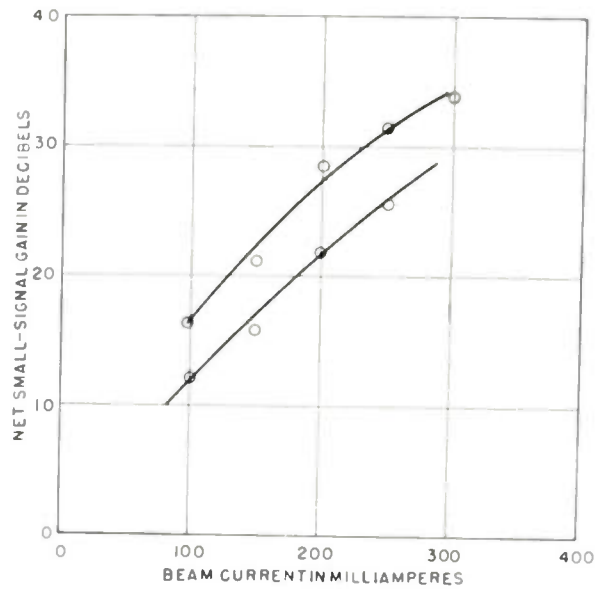

Fig. 9—Small-signal gain plotted against beam current. The values of V_0 in kilovolts and frequency in megacycles for the upper curve are 3.6 and 4,650 and, for the lower curve, 4.6 and 4,550.

Fig. 10 shows the saturation power output as a function of beam current. In the curves in Fig. 10 a slight shift towards higher voltage has taken place due to saturation.

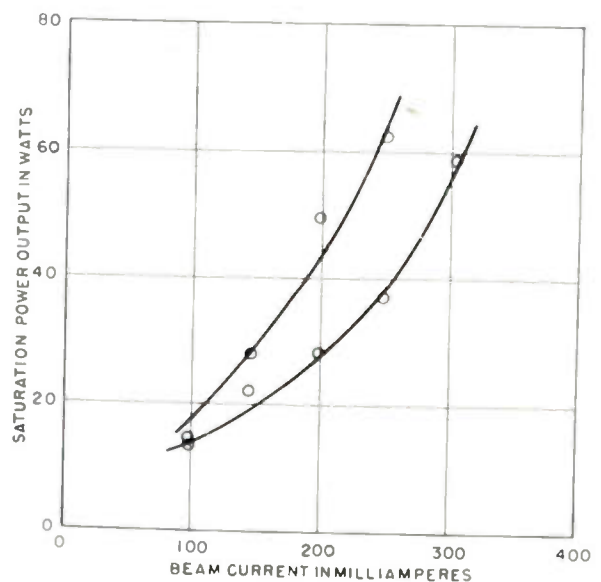

Fig. 10—Saturation power output plotted against beam current. In the upper curve, $V_0=4.9$ kv, $f=4,550$ Mc, and the gain is 16.9 db. The values for the lower curve are, respectively, 4.0, 4,650, and 20.

In comparing these results with the theory, it is necessary to take into account the excitation of the three forward waves at the input and the effect of the insertion loss. Excitation of the three forward waves results in a loss calculated^{2,11} to be 9 db in the growing wave at synchronism. The value of this excitation loss can be shown by (7) to depend in a complicated fashion on the cold attenuation and the separation of the beam velocity from that for synchronism. The nature of this dependence is not sensitive and the value of excitation loss varies from 6 to 12 db for practical ranges of operation. The correction obtained for attenuation L , uniform along the structure, has been calculated by numerous authors^{2,8} and it can be shown that (7) leads to the same conclusion, that one must subtract one third the attenuation from the gross electronic gain for small values of attenuation. The behavior for values of attenuation comparable to the gain can be shown by (7) to require subtracting about one half the total loss. Subject to the use of approximate values, the formula relating the net gain G_{net} to the gain per unit length G which was calculated in Part I is

$$G_{net} = lG - 9 - \frac{2L}{5} \text{ db.} \quad (8)$$

The values G in db per cm obtained from the experimental results by (8) are compared to the theoretical values in Fig. 11.

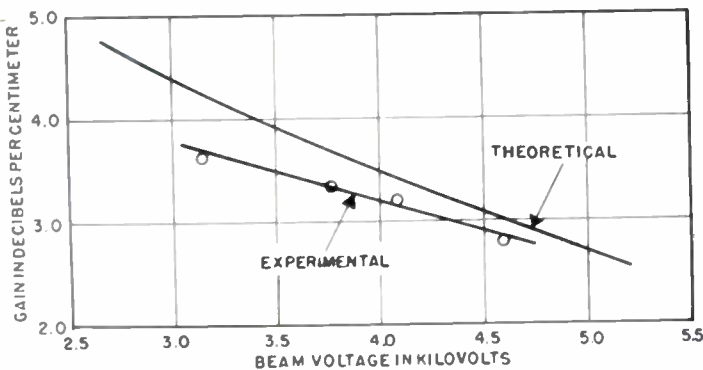

Fig. 11—Gain per unit length for an experimental tube with small-signal input compared with theoretical values, for 250 ma beam current.

The frequency dependence of the gain for fixed beam voltage is readily calculated from (7), and Fig. 12 shows the experimental gain as a function of frequency com-

pared to the theoretical value, again by means of (8). The tube was operating partly saturated when this curve was taken, which has resulted in a shift of the center frequency of the experimental curve towards the theoretical value.

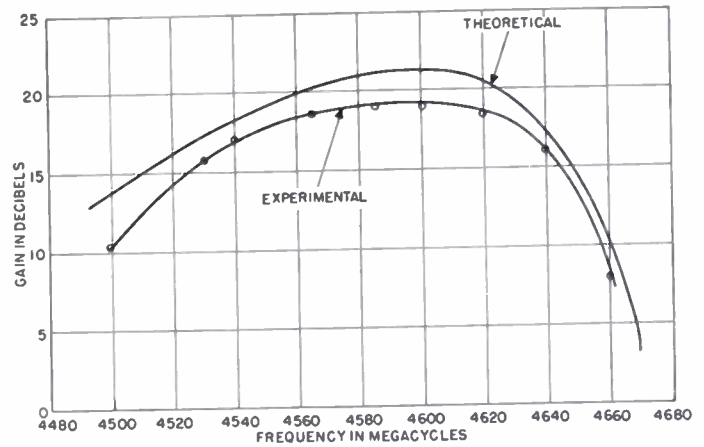

Fig. 12—Experimental and theoretical gain plotted against frequency. In the experimental case, the power input was 0.50 watt. The beam values were 4 kv and 200 ma.

C. Power Output

The power output of a traveling-wave tube cannot be calculated from the foregoing analysis due to the failure of the small signal approximation. In general, numerical techniques are required. However, experimental studies of helix tubes and qualitative theoretical arguments indicate that the power output is in general given by

$$P_{net} = \frac{KG\lambda_0}{8.68\pi\sqrt{3}} I_0 V_0 \quad (9)$$

where G is the electronic gain in db per cm and K is a constant which depends on a variety of factors; K is most sensitive to the uniformity and losslessness of the output section of the tube. For helix tubes, values of K as high as three have occasionally been obtained. We have been largely unable to control the magnitude of the attenuation in the output section of our tube. The values of K corresponding to the measured powers shown in Fig. 10 range between 0.9 and 1.2. The best values of efficiency and power output that have been obtained are about 7 per cent and 125 watts at about 4.5 kv and 380 ma beam current with a gain of about 17 db. In view of the work with the helix tubes and of certain theoretical arguments, it is likely that efficiencies the order of 15 to 25 per cent and power outputs in the vicinity of 500 watts are possible in this frequency range with tubes of this general type.

¹¹ J. R. Pierce, "Effect of passive modes in traveling-wave tubes," Proc. I.R.E., vol. 36, pp. 993-996; August, 1948.

Gain of Electromagnetic Horns*

W. C. JAKES, JR.†, ASSOCIATE, IRE

Summary—An experimental investigation of the gain of pyramidal electromagnetic horns is described. For the horns tested it was found that (1) the “edge effects” are less than 0.2 db so that the gain of the horns may be computed to that accuracy from their physical dimensions and Schelkunoff’s curves; and (2) for the transmission of power between two horns the ordinary transmission formula is valid, provided that the separation distance between the horns is measured between the proper reference points on the horns, rather than between their apertures.

I. INTRODUCTION

THE CUSTOMARY method of measuring the gain of large microwave antennas is by comparison with a small standard pyramidal horn. The gain of the standard horn is usually determined by calculation from the physical dimensions of the horn and use of curves given by Schelkunoff.¹ Since these curves are based on the assumption that the aperture field of the horn is the same as though the sides were continued indefinitely, it is apparent that the computed gain of the horn may be somewhat in error because of the doubtful validity of this assumption.

An experimental determination of the amount of error in the theoretically calculated gain due to this “edge effect” could be made by measuring the power transmitted between two identical horns at a separation distance r , measured between apertures, great enough so that the familiar transmission formula holds:

$$P_R = \left(\frac{G\lambda}{4\pi r}\right)^2 P_T \tag{1}$$

where

- P_R = received power
- P_T = transmitted power
- G = gain of each individual horn
- λ = free-space wavelength.

Any measurable difference between the gain computed from the horn dimensions and that given by (1) may be ascribed to edge effects.

Several considerations complicate the simple experiment described above. Ordinarily it is not practicable to make transmission measurements at extremely large values of r where it is reasonably certain that (1) holds. One condition, at least, that must be fulfilled is that the variation in phase of the transmitted wave over the aperture of the receiving horn should not exceed $\lambda/16$.

If the transmitter were a point source, this would fix the minimum separation distance r_{min} between the two antennas as

$$r_{min} = 2 \frac{b^2}{\lambda} \tag{2}$$

where b is the larger dimension of the horn aperture. Since the transmitting antenna is not a point source, there is some uncertainty about the point from which to measure r_{min} ; however if one measures from the aperture plane of the transmitter horn, it seems reasonable that the phase error will not exceed $\lambda/16$ at an r_{min} given by (2). It is not necessarily true, however, that if r is the distance between aperture planes the transmission formula (1) will be obeyed for the entire range of $r_{min} < r < \infty$.

II. EXPERIMENTS

The experimental part of this study was carried out at a wavelength of 1.25 cm, as the distances and physical dimensions of the horns involved become small and easily managed in this range. The variation of P_R with r (between apertures) for $40\lambda \leq r \leq 200\lambda$ was measured for a number of pyramidal horns of various dimensions. Fig. 1 shows the physical setup employed. To reduce the effect of reflections, no objects were allowed to come closer than 70λ to the center line of the horn.

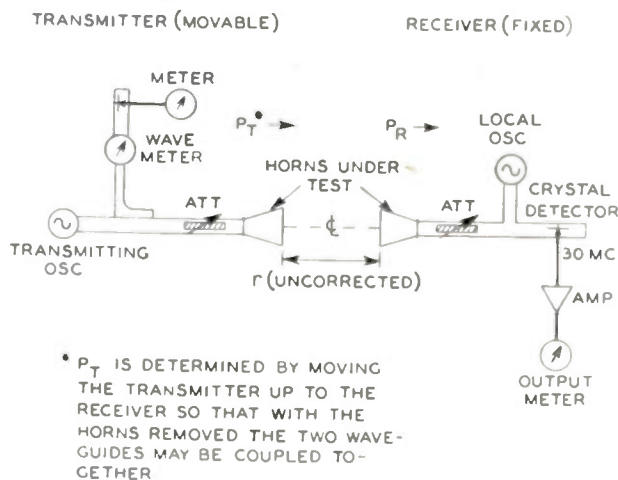

Fig. 1—Physical setup for measuring the variation with distance of the power transmission between two horn antennas.

Before listing the experimental results it will be helpful to give the horn nomenclature, as shown in Fig. 2. Note that in general the E -plane and H -plane slant lengths, l_E and l_H , are not necessarily equal. The “axial height” of the horn will be designated by h ; if the horn

* Decimal classification: R325.82. Original manuscript received by the Institute, May 9, 1950; revised manuscript received, August 22, 1950.

† Bell Telephone Laboratories, Inc., Holmdel, N. J.
¹ S. A. Schelkunoff, “Electromagnetic Waves,” D. Van Nostrand, Inc., New York, N. Y., pp. 363–365; 1943.

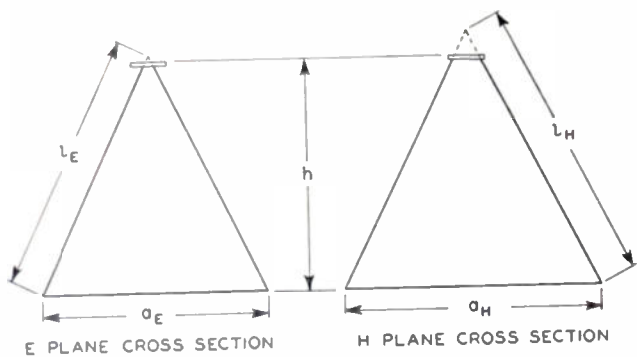

Fig. 2—Nomenclature for horn flared in both planes.

is optimum² the axial height will be designated by h_0 . In all, four pairs of horns were constructed and tested. They were made from sheet brass of 1/16 inch thickness; their physical dimensions are given in Table I. Note that horns 1 and 4 were optimum horns.

TABLE I

Horn	a_E	a_H	h
1	4.72λ	6.03λ	$10\lambda (=h_0)$
2	4.72λ	6.03λ	$20\lambda (>h_0)$
3	4.72λ	6.03λ	$5\lambda (<h_0)$
4	6.73λ	8.49λ	$20\lambda (=h_0)$

Curve A of Fig. 3 shows the experimental results for a pair of optimum horns (No. 1 in Table I); this is typical of the results obtained in general. It is to be noted that P_R does not vary as $1/r^2$, the departure being greater as r decreases. A distance d was found which, when added to the r co-ordinates of curve A, caused these points to lie on a straight line (curve B) whose slope corresponds to an inverse square variation of received power with distance. This indicates that if the separation distance is measured between the proper reference points on the horns, the inverse square relationship of (1) will be obeyed. The distance from the horn aperture back to this reference point will be called D .

Since the transmitting and receiving horns were identical in the above experiments, it follows that $D=d/2$. For the optimum horns (with $h=h_0$) D was found to be equal to the axial height. However, for the other horns the following was observed: if $h>h_0$, (horn 2) $D<h$; if $h<h_0$, (horn 3) $D>h$.

Since it has been experimentally demonstrated that (1) is valid for $r_{min}<r<\infty$ provided r is measured between the proper horn reference points, this equation may now be used with the proper r to compute the actual horn gain. Curve B of Fig. 4 shows the results of this computation for horn 1. For comparison, curve A of Fig. 4 was computed using for r in (1) the separation distance between horn apertures. Curve C is the gain calculated from the physical dimensions of the horn

² An optimum horn is one for which the flare angles in both planes are so chosen that, for a given length of horn, the gain is a maximum. This follows if:

$$a_E^2 \approx 2l_E\lambda; a_H^2 \approx 3l_H\lambda.$$

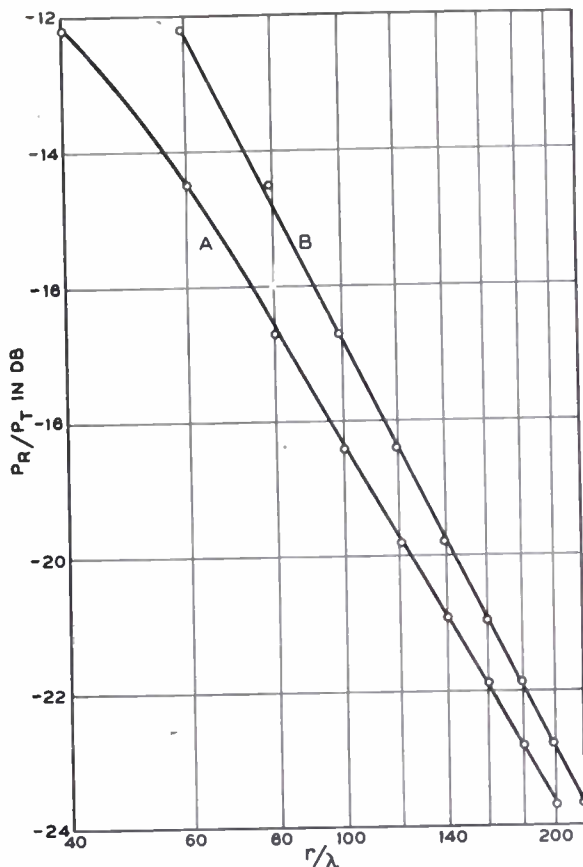

Fig. 3—Variation with distance of the power transmission between two horns. A. Experimental results. B. Experimental results corrected by adding a constant, d/λ , to the abscissae of the observed points.

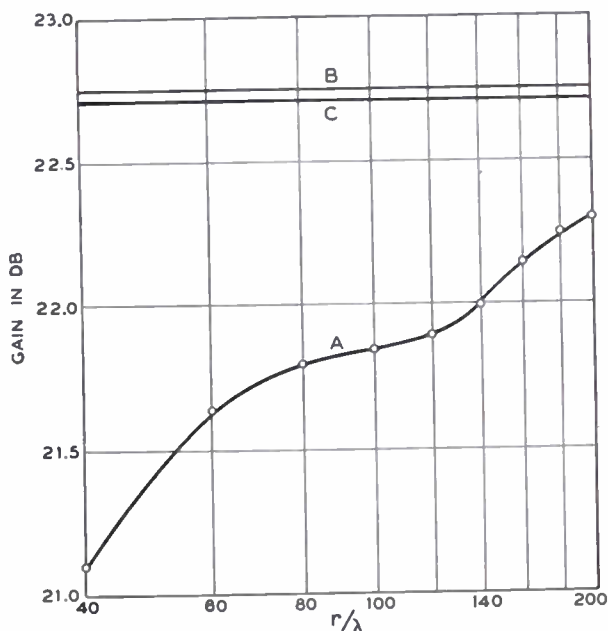

Fig. 4—Theoretical and experimentally observed horn gain. (Horn No. 1 in Table I.) A. Gain computed from (1) using for r the separation distance between apertures. B. Gain computed from (1) using for r the value r_0+d , where r_0 is the separation between apertures, d is a constant described in the text. C. Gain computed from the physical dimensions of the horn and Schelkunoff's curves.

and Schelkunoff's curves. These three curves are representative of the results for the four pairs of horns; in general, the difference between curves *B* and *C* did not exceed 0.2 db, and for the optimum horns it was less than 0.1 db.

III. CONCLUSIONS

When computing the gain of pyramidal electromagnetic horns it is permissible to use their actual physical dimensions and Schelkunoff's curves. The error due to

edge effects is less than 0.1 db for optimum horns, with aperture dimensions greater than 4λ .

If it is desired to compute the transmitted power between two identical horns, (1) is valid even in the transition zone between the Fraunhofer and Fresnel regions provided r is replaced by $r_0 + 2D$. Here, r_0 is the separation between apertures and D is described above.

D for an optimum horn is equal to the axial height but for horns shorter or longer than optimum, D is greater or less than the axial height and must be determined by experiment.

Evaluation of Coaxial Slotted-Line Impedance Measurements*

H. E. SORROWS†, ASSOCIATE, IRE, W. E. RYAN†, ASSOCIATE, IRE, AND
R. C. ELLENWOOD†, ASSOCIATE, IRE

Summary—Most ultra-high-frequency impedance measurements are made by detecting the voltage-standing-wave ratio and nodal position in a slotted section of coaxial transmission line. Sources of error in these measurements are discussed and methods of eliminating or evaluating them are presented. It is shown that the maximum error due to structural defects in determining the relative voltage can be predicted experimentally for most standing-wave machines and that the resulting maximum error in the voltage-standing-wave ratio is twice the maximum error in determining the relative voltage. The resulting maximum error in the nodal position and, also, the fractional errors in the load resistance and reactance due to the errors in the voltage-standing-wave ratio and nodal position are calculated and presented in graphical form.

I. INTRODUCTION

AS A PART of a program to establish standards of measurement of electrical quantities at ultra-high frequencies, the accuracy of impedance measurements using current techniques has been evaluated. The accuracy of measurement of most other uhf electrical quantities is related to the accuracy of impedance measurements. The slotted section of transmission line with a traveling probe is the most widely used measuring instrument in this frequency range. This instrument utilizes what can be regarded as a comparison method, in which the impedance to be measured is compared with the characteristic impedance of the slotted section. Since the characteristic impedance can be determined accurately from the physical dimensions and the electrical properties of the

slotted section, the instrument can be considered an "impedance meter" with an inherent reference standard.

In most uhf impedance measurements, the comparison of the unknown impedance with the characteristic impedance of the slotted section is made by determining the voltage-standing-wave ratio (VSWR) and a nodal position by either direct or indirect methods. Obviously, the accuracy of such impedance measurements is a function of the accuracy of the determination of VSWR and nodal position. The purpose of this paper is to present: (1) a brief survey of the literature on sources of error in measurements of VSWR and nodal position together with references to methods of eliminating or evaluating the errors; (2) a study of the maximum errors in determining VSWR and nodal position which result from errors in measuring relative-voltage distribution along the slotted section; and (3) curves for evaluating the errors in impedance measurements resulting from these errors in VSWR and nodal position.

II. SOURCES OF ERROR IN VSWR AND NODAL POSITION MEASUREMENTS

The principal errors in the determination of VSWR and nodal position originate in the voltage generator, detector, and slotted section. These errors are discussed in the following paragraphs, together with references which describe techniques for reducing the errors to a negligible amount or evaluating the magnitude of the errors.

1. Impure and Unstable UHF Voltage Input

The harmonic content of most unfiltered uhf power sources is of sufficient magnitude to cause serious errors in the measurement of both VSWR and nodal position,

* Decimal classification: R244.211. Original manuscript received by the Institute, March 20, 1950; revised manuscript received, July 17, 1950. For the most part, this paper was presented, Joint URSI-IRE Spring Meeting, May 2, 1949, Washington, D. C.

† Central Radio Propagation Laboratory, National Bureau of Standards, Washington, D. C.

specially if an untuned probe is used. The probe is usually part of a high- Q circuit which is tuned to the fundamental frequency and discriminates against even harmonics. Low-pass filters with low insertion loss can be inserted between the generator and the slotted section to limit harmonic content to a negligible percentage of the fundamental.¹

Instability and unwanted frequency modulation of the voltage generator output during an impedance measurement are other sources of error.² Variations in the amplitude of the uhf voltage generator output also cause errors in the measured values of VSWR. Fortunately, the amplitude and frequency stability of most uhf generators is sufficient for impedance measurements if the generators are operated from highly stabilized power supplies,³ and proper care is taken to reduce unwanted frequency modulation.

2. Undetermined Response Law of Detector System

The voltage standing-wave existing in a slotted section is determined by sampling the electric field along the length of the slotted section and taking the ratio of the maximum to the minimum field. The response law of the detector system (consisting of detector element, amplifier unit, and indicator) can be determined by terminating the slotted section in a short circuit and plotting the indicated output as a function of probe position.^{2,4} If the necessary equipment is available, it is preferable to determine the law of the detector system with a calibrated attenuator. The response of detector elements, such as Littelfuses, Wollaston wires, and barretters can be considered "square law" for low-power levels or for small values of VSWR. Of course, the accuracy of indication of any detector is limited by the accuracy of associated dc and af measuring instruments.

3. Alteration of Standing-Wave Pattern by the Probe

The error in measurement of VSWR and nodal position caused by the loading of the slotted section of transmission line by the probe is negligible if the probe is loosely coupled to the line. If the probe penetration does cause distortion in the observed standing-wave pattern, this distortion can be determined by noting the interaction between two identical probes in the same slotted section. If the motion of either probe causes a change in the indicated output of the other probe, which is kept stationary at various selected positions, then the probe

penetration is considered excessive. If it is necessary to tightly couple the probe to the slotted section of transmission line in order to perform standing-wave measurements, the magnitude of the errors introduced in the measurement of VSWR and nodal position can be determined as a function of the effective admittance of the probe shunting the slotted section.⁵⁻⁶

4. Attenuation

Attenuation in a slotted section is caused by dielectric, conductor, and radiation losses. These losses are usually of such small magnitude that they seldom affect VSWR measurements. However, errors in impedance calculated from VSWR and nodal position measurements can occur if the attenuation between the load terminals and the position at which the VSWR is measured is large. This error can be corrected if the attenuation constant is known.⁷

5. Effect of Slot

A narrow longitudinal slot cut in the outer conductor of a section of coaxial transmission line decreases the capacitance per unit length of line⁴ and permits radiation losses. The radiation losses are negligible for most types of measurements, and the capacitance decrease causes a slight increase in the characteristic impedance of the transmission line. The ends of the slot cause impedance discontinuities at the junction of the slotted and unslotted sections. The approximate residual VSWR introduced by these discontinuities can be easily calculated.⁴ A commercially available $\frac{1}{4}$ -inch standing-wave machine was found to have a calculated residual VSWR of less than 1.004 due to the slot. If the effect of discontinuities at the end of the slot and in connectors is appreciable, equivalent impedances can be determined experimentally.⁸⁻¹²

6. Structural Defects of Slotted Section and Probe Carriage

It may be concluded that the errors in the measurement of VSWR and nodal position discussed above can

¹ R. M. Redheffer and Y. Dowker, "An Investigation of R-F Probes," Radiation Laboratory Report 483-14.

² W. Altar, F. B. Marshall, and L. P. Hunter, "Probe errors in standing-wave detectors," *Proc. I.R.E.*, vol. 34, pp. 33-44; January, 1946.

³ G. Glinski, "The solution of transmission-line problems in the case of an attenuating transmission line," *Trans. AIEE*, vol. 65, pp. 46-49; February, 1946.

⁴ E. Feenberg, "The relation between nodal positions and standing-wave ratio in a composite transmission system," *Jour. Appl. Phys.*, vol. 17, pp. 530-532; June, 1946.

⁵ W. H. Pickering, O. W. Hagelbarger, C. V. Ming, and S. C. Snowden, "A New Method for the Precision Measurement of Waveguide Discontinuities," NDRC, Div. 14, Report No. 317; October, 1944.

⁶ M. S. Wong, "Microwave impedance through an arbitrary four-terminal network," Presented, URSI-IRE Spring Meeting, Washington, D. C., 1948.

⁷ D. M. Kerns, "The Basis of the Application of Network Equations to Waveguide Problems," CRPL-9-5, National Bureau of Standards; 1948.

⁸ M. H. Oliver, "Discontinuities in concentric-line impedance-measuring apparatus," *Jour. IEE*, Part III, vol. 97, p. 29; January, 1950.

¹ C. L. Cuccia and H. R. Hegbar, "An Ultra-High-Frequency Low-Pass Filter of Coaxial Construction," *Radio at UHF*, RCA, Princeton, N. J., vol. II, pp. 424-431; 1947.

² Radio Research Laboratory Staff, "Very-High Frequency Techniques," McGraw-Hill Book Co., Inc., New York, N. Y., vol. 1, p. 35; 1947.

³ R. C. Ellenwood and H. E. Sorrows, "Cathode heater compensation as applied to degenerative d.c. power supplies," *Jour. Res. Nat. Bur. Stand.*, vol. 42, no. 9; September, 1949.

⁴ MIT Radiation Laboratory Series, "Techniques of Microwave Measurements," McGraw-Hill Book Co., Inc., New York, N. Y., vol. 11; 1947.

be evaluated or reduced to a negligible magnitude by the use of appropriate experimental techniques. It is, however, difficult if not impossible to evaluate or completely correct for the errors in VSWR and nodal-position measurements caused by structural defects or mechanical irregularities of the slotted section and probe carriage.⁵ The sag of the center conductor between supports, the mechanical irregularities in probe carriage ways which result in vertical or lateral motion of the probe, and the nonuniformity of cross section of the coaxial slotted section are examples of structural defects. Mechanical irregularities in the probe carriage ways (slotted section mounted horizontally) which result in vertical or lateral displacement of the probe relative to the center conductor as the probe traverses the length of the slotted section are usually found to be the chief sources of error. Because of the large number of parameters involved, it is difficult to predict theoretically the errors in the measurement of VSWR for a given slotted section, but these errors can be predicted from experimental data. One method which can be used to predict the performance of a standing-wave machine involves approximately matching the load end of the slotted section in order that the irregularities in detector response may be measured as a function of probe position along the line. Experimental data for predicting the performance of a selected standing-wave machine are shown in Fig. 1. For this particular standing-wave

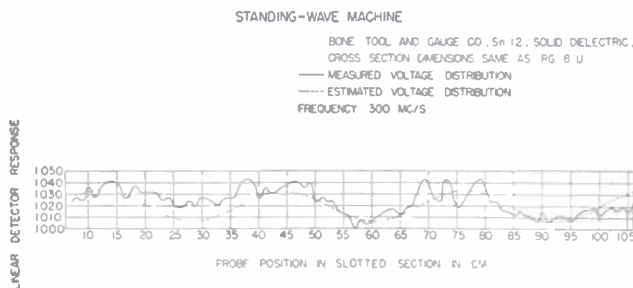

Fig. 1—Measured and estimated uhf voltage distribution for low VSWR.

machine there is a maximum deviation of the measured relative-voltage distribution of about ± 2 per cent from the estimated, true relative-voltage distribution. The magnitude of this deviation was found to be constant for frequencies in the range of 300 to 600 Mc. It can, therefore, be assumed that there is a maximum error of 2 per cent in the determination of relative-voltage distribution in this standing-wave machine when measurements are made in the indicated frequency range.

Methods using either audio-frequency voltages or precise mechanical measurements for calibrating or determining the performance of a given slotted section are desired. However, though experimental studies on some slotted sections show correlation, on others no correlation is observed between af, mechanical, and uhf measurements. It is, therefore, concluded that the performance of a slotted-section type of standing-wave

machine can be best determined by experiments performed at uhf. The important property to be determined is the fractional error in measuring the relative-voltage distribution. From this, the maximum fractional errors in measuring VSWR and nodal position can be determined, and from these, in turn, can be obtained the resulting errors in impedance measurements.

II. ACCURACY OF MEASUREMENT OF VSWR AND NODAL POSITION¹³

Theoretically, all errors in the measurements of VSWR and nodal position can be eliminated or evaluated except those errors caused by structural defects in the standing-wave machine. It has been shown that the fractional error (b) in the determination of relative voltage due to these structural defects can be obtained experimentally. The maximum error in the measured value of VSWR (ρ_0) resulting from this fractional error (b) can then be predicted. Since

$$\rho = \frac{V_{\max}}{V_{\min}}, \quad (1)$$

where ρ , V_{\max} , and V_{\min} are, respectively, the true values of VSWR, voltage maximum, and voltage minimum, the limiting values of the measured VSWR (ρ_0) are

$$\frac{V_{\max}(1-b)}{V_{\min}(1+b)} \leq \rho_0 \leq \frac{V_{\max}(1+b)}{V_{\min}(1-b)}. \quad (2)$$

For small values of b , (2) reduces to

$$\rho(1-2b) \leq \rho_0 \leq \rho(1+2b). \quad (3)$$

Therefore, the maximum fractional error in measured VSWR will not be more than twice the maximum fractional error in relative-voltage measurement. The maximum error in measurement of VSWR with the standing-wave machine for which sample experimental curves are shown in Fig. 1 would thus be less than 4 per cent.

The error in the determination of the nodal position can also be related to the error in relative-voltage measurement. The nodal position is usually obtained by finding the midpoint between two positions of equal detector response on each side of the minimum. A method of determining the error in measured nodal position resulting from errors in relative-voltage measurements is best described with the aid of Fig. 2. The solid line represents the true voltage distribution (V) and the dashed lines represent the limits of the measured values of relative voltage, $(1 \pm b)V$. The measured values, therefore, lie within the area bounded by the dashed lines. There is seen to be a maximum error of $\pm \delta\theta$ in the location of a given voltage because of possible errors in relative-voltage measurements. An error in the location of the nodal position results from this error, $\delta\theta$, in location of the equal-response voltages.

¹³ The analysis in Sections III and IV applies to waveguides as well as to coaxial transmission lines.

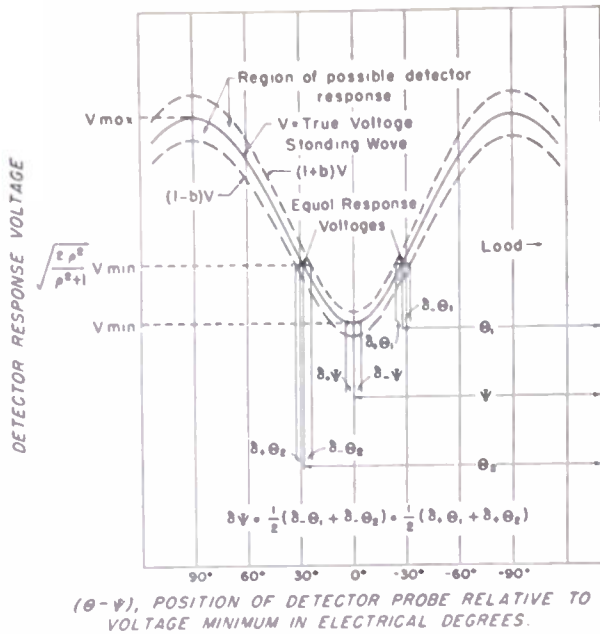

Fig. 2—The determination of the maximum error in nodal position from the fractional error b in relative-voltage measurement.

It is shown in Appendix A that, if it is assumed that the slotted section is lossless and that the probe does not distort the standing-wave pattern, the maximum error ($\delta\Psi$) in the location of the nodal position is given by the equation

$$\delta\Psi = \frac{1}{4} \arccos \left[\frac{\rho^2 + 1}{\rho^2 - 1} \frac{1 + (\rho^2 - 1) \sin^2(\theta - \Psi)}{2(1 - b)^2} \right] - \frac{1}{4} \arccos \left[\frac{\rho^2 + 1}{\rho^2 - 1} \frac{1 + (\rho^2 - 1) \sin^2(\theta - \Psi)}{2(1 + b)^2} \right], \quad (4)$$

where $(\theta - \Psi)$ is the magnitude of the distance in electrical degrees from the nodal position to the true equal-response voltage positions.

$\delta\Psi$ is seen to be a function of ρ , b , and $(\theta - \Psi)$. For a given impedance measurement, ρ is the measured VSWR and b is a constant for the slotted section used, whereas $(\theta - \Psi)$ is a function of the equal-response voltages.

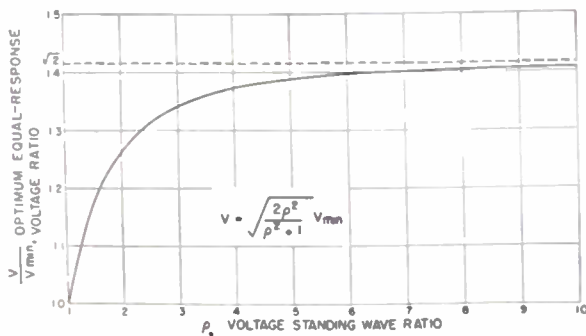

Fig. 3—Curve of optimum equal-response voltage for minimum error in determination of nodal position.

It is shown in Appendix B that $\delta\Psi$ is a minimum if equal-response voltages are selected having a magnitude

$$V = \sqrt{\frac{2\rho^2(1 + b^2)}{\rho^2 + 1}} V_{\min}. \quad (5)$$

Since b^2 is very small compared to unity, it may be neglected. V rapidly approaches $\sqrt{2}V_{\min}$ as ρ increases as shown in Fig. 3. From equations (4) and (5), the minimum value, $\delta\Psi_m$, of the maximum error in nodal position is found to be

$$\delta\Psi_m = \frac{1}{4} \arccos \left[1 - \frac{32\rho^2 b^2}{(\rho^2 - 1)^2(1 - b^2)^2} \right]. \quad (6)$$

Curves for (6) are shown in Fig. 4.

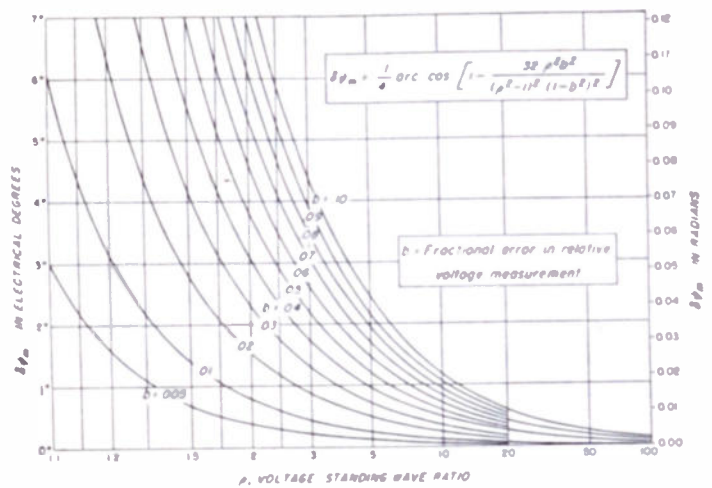

Fig. 4—Curves of maximum error in nodal position determined from positions of equal-response voltages of

$$\sqrt{\frac{2\rho^2(1 + b^2)}{\rho^2 + 1}} V_{\min}$$

versus voltage-standing-wave ratio for various fractional errors b in measurement of relative voltage.

For small values of b and of the error $\delta\Psi_m$, (6) can be approximated by

$$\delta\Psi_m \approx \frac{2\rho b}{\rho^2 - 1}. \quad (7)$$

It is easily shown that the VSWR and nodal-position measurements are meaningless for $\rho \leq (1 + b/1 - b)$.

III. EVALUATION OF ERRORS IN IMPEDANCE MEASUREMENTS AS A FUNCTION OF THE ERROR IN VSWR AND NODAL POSITION¹⁴

The terminating impedance of a lossless uniform transmission line can be expressed as a function of the

¹⁴ Following completion of this paper it was brought to the authors' attention that an essentially identical development of the material presented in Section III and Figs. 5-8a was independently given by F. M. Millican in U. S. Navy Electronics Laboratory Report No. 110, "Error Analysis of Slotted Transmission Line Impedance Measurements."

VSWR (ρ) and the distance (Ψ) from the nodal position to the load terminals by the following equation:

$$Z = \frac{\cos \Psi - j\rho \sin \Psi}{\rho \cos \Psi - j \sin \Psi}, \quad (8)$$

where Z is the normalized impedance at the load terminals. The assumption, in (8), that the slotted section is lossless introduces only a negligible error in most measurements. However, if the section of transmission line between the load and the measured nodal position has excessive loss, (8) must be modified as described in the literature.⁷

The normalized resistive and reactive components of the complex impedance Z are given respectively by the following equations:

$$r = \frac{\rho}{\rho^2 \cos^2 \Psi + \sin^2 \Psi} \quad (9)$$

$$x = \frac{(1 - \rho^2) \sin \Psi \cos \Psi}{\rho^2 \cos^2 \Psi + \sin^2 \Psi}. \quad (10)$$

From the differentials of these equations with respect to ρ and Ψ , it is possible to obtain the fractional errors in normalized resistance and reactance that result from the errors in the determination of VSWR and nodal position. The fractional errors in resistance and reactance due to small incremental errors $\delta\rho$ and $\delta\Psi$ can be expressed as follows:

$$\frac{\delta r}{r} = \frac{1 - \frac{(\rho^2 + 1)}{2} (1 - \cos 2\Psi)}{1 + \frac{(\rho^2 - 1)}{2} (1 + \cos 2\Psi)} \frac{\delta\rho}{\rho} \quad (11)$$

$$\frac{\delta r}{r} = \frac{(\rho^2 - 1) \sin 2\Psi}{1 + \frac{(\rho^2 - 1)}{2} (1 + \cos 2\Psi)} \delta\Psi \quad (12)$$

$$\frac{\delta x}{x} = \frac{\frac{2\rho^2}{(\rho^2 - 1)}}{1 + \frac{(\rho^2 - 1)}{2} (1 + \cos 2\Psi)} \frac{\delta\rho}{\rho} \quad (13)$$

$$\frac{\delta x}{x} = \frac{-2 \left[1 - \frac{(\rho^2 + 1)}{2} (1 + \cos 2\Psi) \right]}{(\sin 2\Psi) \left[1 + \frac{(\rho^2 - 1)}{2} (1 + \cos 2\Psi) \right]} \delta\Psi. \quad (14)$$

These equations are plotted in Figs. 5, 6, 7, 8(a), and 8(b). The graphs present the absolute values of the factors by which any fractional errors in the determination of VSWR, and any errors in nodal position, should be multiplied in order to obtain the resulting fractional errors in the load resistance and reactance. The abscissas Ψ of the curves are distances in electrical degrees

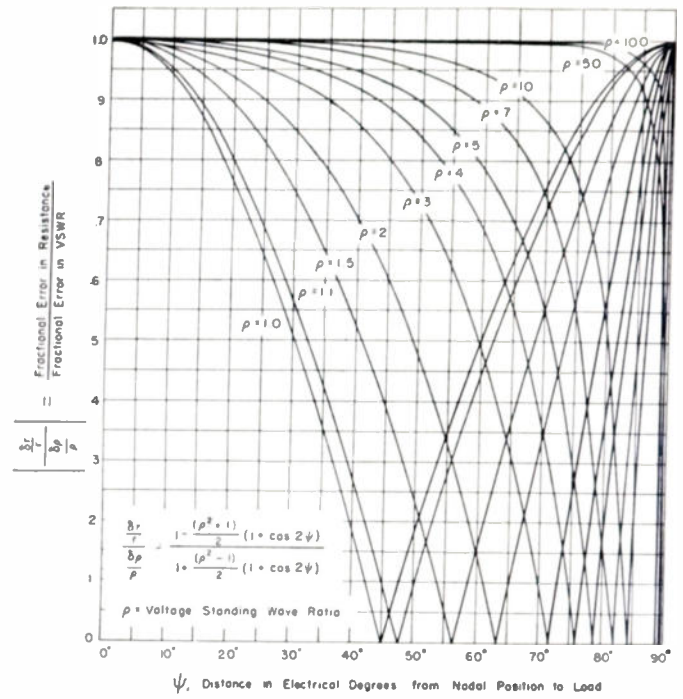

Fig. 5—Curves for determining errors in resistance caused by small errors in measurement of VSWR.

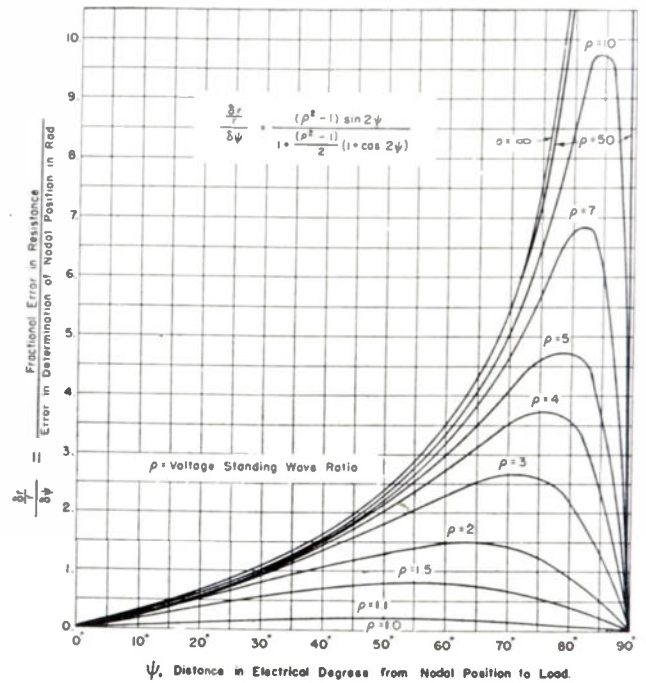

Fig. 6—Curves for determining errors in resistance caused by small errors in measurement of nodal position.

from the load terminals to the nearest voltage minimum. If Ψ is between 90° and 180° , the errors are the same as for an electrical distance of $180^\circ - \Psi$ since the curves are symmetrical about $\Psi = 90^\circ$.

A Smith Chart¹⁵ is useful in understanding the shape of the curves of Figs. 5, 6, 7, 8(a), and 8(b). For example, in Fig. 5 the error in resistance is found to be zero for certain combinations of values of VSWR and nodal

¹⁵ P. H. Smith, "Transmission-line calculator," *Electronics*, vols. 12 and 17; January, 1939, and January, 1944.

position. An inspection of the portion of the Smith Chart which includes these values of VSWR and nodal position shows that the resistance is practically constant for small changes in VSWR. Similarly, in Figs. 8(a) and 8(b), the error in reactance is seen to be zero for certain values of VSWR and nodal position. For these values, the Smith Chart shows the reactance to be practically constant for small changes in nodal position. Fig. 8(b) is a supplement to Fig. 8(a) and presents the ratio $\delta x/\delta\psi$ for values of ψ near 0° and 90° . Fig. 8(b) is desirable since the ratio $(\delta x/x)/\delta\psi$ in Fig. (8a) becomes too large for graphical representation with the selected scale as ψ approaches 0° or 90° .

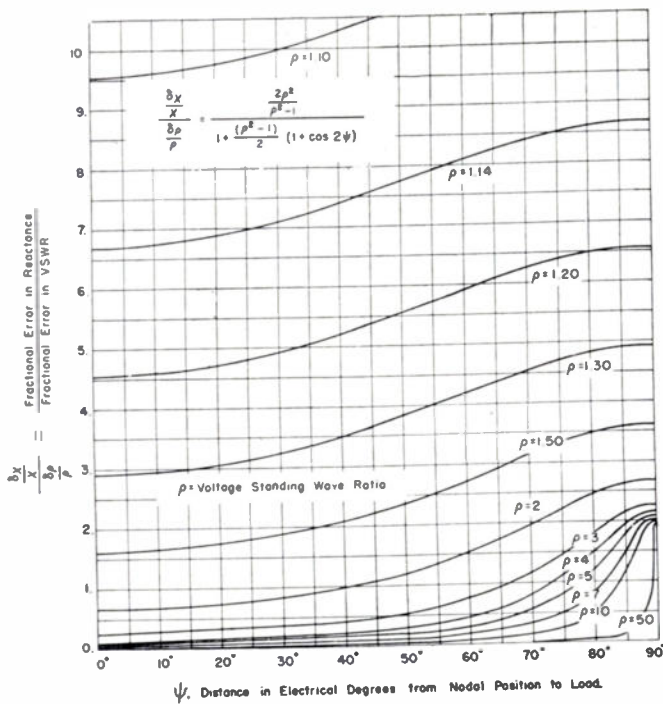

Fig. 7—Curves for determining errors in reactance caused by small errors in measurement of VSWR.

CONCLUSION

A study of the accuracy of impedance measurements made by determining the voltage-standing-wave ratio and nodal position in a slotted transmission line indicates that all errors except those introduced by structural imperfections can be corrected or evaluated by known techniques. It is possible to obtain the maximum magnitude of this last type of error by experimentally determining the maximum error in relative-voltage measurement for each standing-wave machine and frequency band. The maximum fractional error in the voltage-standing-wave ratio is twice this constant, and the maximum error in nodal position can then be obtained from a graph, provided the proper equal-response voltages are used.

The effect of these and any other errors in VSWR and nodal position on the accuracy of the calculated terminal resistance and reactance can also be obtained

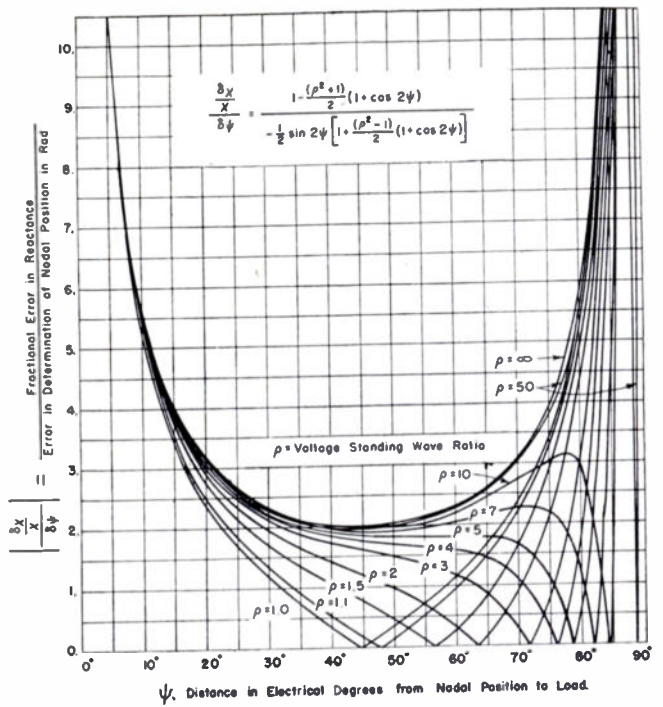

Fig. 8(a)—Curves for determining errors in reactance caused by small errors in measurement of nodal position.

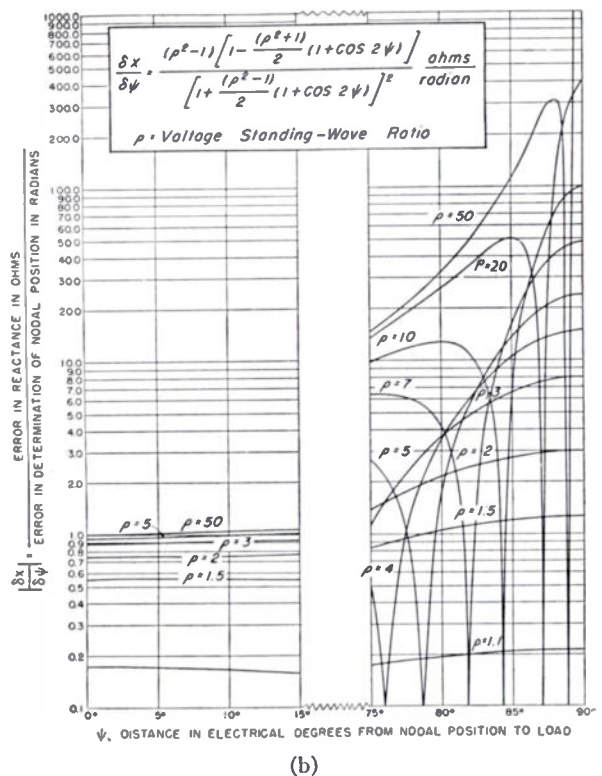

Fig. 8 (b)—Supplementary curves for determining errors in reactance caused by small errors in measurement of nodal position for values of ψ near 0° or 90° .

from graphs. Therefore, although the errors in impedance caused by imperfections in the standing-wave machine cannot be easily corrected, their maximum values can be obtained from an experimentally determined constant and a few equations or graphs.

APPENDIX

A. Maximum Error in Locating Nodal Position

In Fig. 2, Ψ and θ are respectively the distances in electrical degrees from the load terminals to the nodal and probe positions. θ_1 and θ_2 are the probe locations of two equal response voltages. The maximum error $\delta\Psi$ in determining the nodal position is half the sum of the maximum errors, $\delta\theta_1$ and $\delta\theta_2$, in the location of the equal response voltages. The limits of the measured nodal position may be expressed as follows:

$$\Psi \pm \delta\Psi = \frac{(\theta_1 \pm \delta\theta_1) + (\theta_2 \pm \delta\theta_2)}{2} \quad (15)$$

or

$$\Psi \pm \delta\Psi = \frac{\theta_1 + \theta_2}{2} \pm \frac{\delta\theta_1 + \delta\theta_2}{2} \quad (16)$$

The maximum error in the location of the nodal position is, therefore:

$$\delta\Psi = \pm \frac{\delta\theta_1 + \delta\theta_2}{2} \quad (17)$$

Expressions for $\delta\theta_1$ and $\delta\theta_2$ can be obtained from the equation for a voltage standing-wave on a lossless transmission line,

$$V = V_{\min} [1 + (\rho^2 - 1) \sin^2(\theta - \Psi)]^{1/2} \quad (18)$$

where $(\theta - \Psi)$ is the distance in electrical degrees from the probe position to the position of a voltage minimum. The maximum error in the location of a selected response voltage is obtained by calculating the distance between positions at which the expressions for V and either $(1+b)V$ or $(1-b)V$ are equal. Because of the symmetry of the voltage distribution curve, the distances $\delta_+\theta_1$ and $\delta_-\theta_2$ of Fig. 2 are equal. Therefore, by substituting $\delta_-\theta_2$ for $\delta_+\theta_1$, $\delta\Psi$ becomes equal to one-half the sum of the absolute values of $\delta_+\theta_2$ and $\delta_-\theta_2$. By equating the expressions for V and $(1-b)V$ at θ_2 ,

$$(1-b)[1 - (\rho^2 - 1) \sin^2(\theta_2 - \Psi + \delta_+\theta_2)]^{1/2} V_{\min} \\ = [1 + (\rho^2 - 1) \sin^2(\theta_2 - \Psi)]^{1/2} V_{\min} \quad (19)$$

Similarly, by equating the expressions for V and $(1+b)V$ at θ_2 ,

$$(1+b)[1 + (\rho^2 - 1) \sin^2(\theta_2 - \Psi - \delta_-\theta_2)]^{1/2} V_{\min} \\ = [1 + (\rho^2 - 1) \sin^2(\theta_2 - \Psi)]^{1/2} V_{\min} \quad (20)$$

From (19),

$$\delta_+\theta_2 = \frac{1}{2} \cos^{-1} \left[\frac{\rho^2 + 1}{\rho^2 - 1} - \frac{1 + (\rho^2 - 1) \sin^2(\theta_2 - \Psi)}{\frac{(\rho^2 - 1)}{2} (1 - b)^2} \right] \\ - (\theta_2 - \Psi) \quad (21)$$

From (20), and the equality of the absolute values of $\delta_+\theta_1$ and $\delta_-\theta_2$,

$$\delta_+\theta_1 = \delta_-\theta_2 = (\theta_2 - \Psi)$$

$$- \frac{1}{2} \cos^{-1} \left[\frac{\rho^2 + 1}{\rho^2 - 1} - \frac{1 + (\rho^2 - 1) \sin^2(\theta_2 - \Psi)}{\frac{(\rho^2 - 1)}{2} (1 + b)^2} \right] \quad (22)$$

The maximum error, $\delta\Psi$, in the nodal position determined from two equal-response voltages at a distance $(\theta - \Psi)$ electrical degrees from the voltage minimum is equal to half the sum of (21) and (22), or

$$\delta\Psi = \frac{\delta_+\theta_1 + \delta_+\theta_2}{2} \\ = \frac{1}{4} \cos^{-1} \left[\frac{\rho^2 + 1}{\rho^2 - 1} - \frac{1 + (\rho^2 - 1) \sin^2(\theta - \Psi)}{\frac{(\rho^2 - 1)}{2} (1 - b)^2} \right] \\ - \frac{1}{4} \cos^{-1} \left[\frac{\rho^2 + 1}{\rho^2 - 1} - \frac{1 + (\rho^2 - 1) \sin^2(\theta - \Psi)}{\frac{(\rho^2 - 1)}{2} (1 + b)^2} \right] \quad (23)$$

Since $1 + (\rho^2 - 1) \sin^2(\theta - \Psi) = (V/V_{\min})^2$ from (18), $\delta\Psi$ may be expressed as a function of the equal-response voltages used, or

$$\delta\Psi = \frac{1}{4} \cos^{-1} \left[\frac{(\rho^2 + 1)(1 - b)^2 - 2 \left[\frac{V}{V_{\min}} \right]^2}{(\rho^2 - 1)(1 - b)^2} \right] \\ - \frac{1}{4} \cos^{-1} \left[\frac{(\rho^2 + 1)(1 + b)^2 - 2 \left[\frac{V}{V_{\min}} \right]^2}{(\rho^2 - 1)(1 + b)^2} \right] \quad (24)$$

B. The Minimum Value of $\delta\Psi$

The value of V for which $\delta\Psi$ is a minimum is obtained by equating to zero the derivative of (24) with respect to V . The value of this equal-response voltage V for which $\delta\Psi$ is a minimum is found to be

$$V = \sqrt{\frac{2\rho^2(1 + b^2)}{\rho^2 + 1}} V_{\min} \quad (25)$$

Since b^2 is very small compared to unity, the expression for V reduces to

$$V = \sqrt{\frac{2\rho^2}{\rho^2 + 1}} V_{\min} \quad (26)$$

The voltage is of this magnitude at values of $(\theta - \Psi)$ such that

$$\sin(\theta - \Psi) = \sqrt{\frac{\rho^2(1 + 2b^2) - 1}{\rho^4 - 1}} \quad (27)$$

If the expression for V in (25) is substituted in (24), the minimum value $\delta\Psi_m$ of the maximum error in determining nodal position is given by

$$\delta\Psi_m = \frac{1}{4} \cos^{-1} \left[1 - \frac{32\rho^2 b^2}{(\rho^2 - 1)^2 (1 - b^2)^2} \right] \quad (28)$$

Alternate Ways in the Analysis of a Feedback Oscillator and its Application*

E. J. POST† AND H. F. PIT‡

Summary—It is a well-known fact that negative feedback has a favorable influence on the phase stability of an amplifier. However, if the negative feedback is applied between the input and output terminals of an amplifier, which is the active part of an oscillating loop, it turns out that the negative feedback may be interpreted either in terms of phase stability of the amplifying section or in terms of phase discriminating properties of the passive frequency determining section of the loop.

The consequences of this alternate point of view for the design of oscillator networks are discussed.

I. INTRODUCTION

AN ANALYSIS of an oscillator circuit, obtained by writing down the complete set of circuit equations, in principle may give all information available about the behavior of a particular circuit.

Because of the algebraic complexity of the problem, the consequences of changes in circuit elements or the influence of additional elements are not always easily understood.

However, Llewellyn's¹ principles, which make oscillator frequency substantially independent of plate- and filament voltage, may serve as a brilliant example that a complete analysis of the circuit is extremely useful.

From a designer's point of view, some principles allowing a more synthetic approach of the problem may be of use.

Most oscillators may be regarded as a closed loop of an active and a passive four-terminal. In general, the passive four-terminal has a frequency determining function, whereas the active four-terminal is necessary to compensate losses in the frequency determining part.

The problem of generating constant frequencies may be summarized in the conditions which have to be imposed on the active and passive part of the closed loop.

A necessary and sufficient condition for a single closed loop to cause oscillation is given by a Nyquist plot surrounding the appropriate critical point. This criterion, however, gives little information about the frequency which is to be generated.

To study frequency behavior the following necessary, although not sufficient conditions can be used:

1. The net phase-shift ϕ around the oscillating loop must be zero or an integral number of times 2π .

$$\phi = n \times 2\pi, \quad n = 0, 1, 2, \dots \quad (1)$$

2. The net gain g around the closed loop must be one or greater than one:

$$g \geq 1. \quad (2)$$

In the following text it will be supposed that, moreover, the Nyquist criterion is always satisfied.²

Before proceeding to formulate the conditions which have to be imposed on the amplifying and frequency determining part of the closed loop, in order to obtain constant frequencies, we want to call the attention to the fact that the splitting up of a closed loop into an active and passive part is not necessarily unique.

A very instructive example may be illustrated in the following section by means of the network of Meacham's well-known crystal oscillator.³

II. A TOPOLOGICAL PECULIARITY OF MEACHAM'S OSCILLATOR⁴

The network shown in Fig. 1(a) is the conventional concept of the Meacham oscillator. In the neighborhood of the generated frequency the tuned transformers will be regarded as ideal. The frequency determining section with in- and output transformer of the amplifier are drawn once more in Fig. 1(b). The dotted line in Fig. 1(b) is of no consequence, in case the connection to the primary of the transformer is suitably chosen no current will flow in it. According to this, the circuit of the Meacham oscillator (Fig. 1(a)) can be rearranged as shown in (Fig. 1(c)). An inspection of Figs. 1(b) and 1(c) shows that the dotted line of 1(b) is a full drawn line in 1(c), connecting a tap of the input transformer to one side of the secondary of the output transformer of the amplifier. Moreover, the resistive branch of the bridge circuit of Fig. 1(a) is included in the amplifier section of Fig. 1(c).

Apparently oscillator networks Figs. 1(a) and 1(c) are equivalent from a point of view of loop transmission.

The only difference between the networks Figs. 1(a) and 1(c) is the sectioning of the loop into amplifying and frequency determining part.

Once the equivalence of networks 1(a) and 1(c) has been established an interesting conclusion may be drawn.

According to Meacham, the frequency stability of oscillator network 1(a) is explained by the extraordinary

* Decimal classification: R139.1×R133. Original manuscript received by the Institute, December 12, 1949; revised manuscript received, July 21, 1950.

† Radio Laboratory of the Netherlands' Postal and Telecommunication Services, 's-Gravenhage, Netherlands.

‡ F. B. Llewellyn, "Constant frequency oscillators," *Proc. I.R.E.*, vol. 19, pp. 2063-2095; December, 1931.

² In case of a multiple loop transmission this applies to the intentionally positive feedback loop.

³ L. A. Meacham, "The bridge-stabilized oscillator," *Proc. I.R.E.*, vol. 26, pp. 1278-1295; October, 1938.

⁴ The point of view developed in this section has been suggested by the comments of G. H. Bast and W. H. van Zoest.

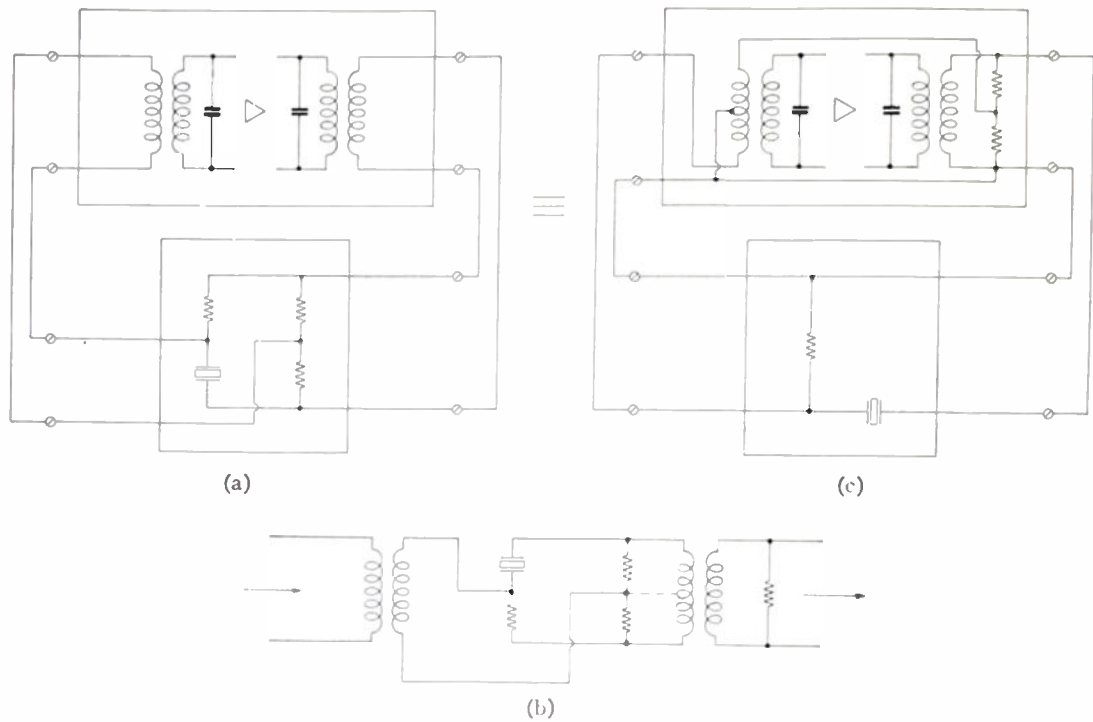

Fig. 1—Network equivalence for Meacham oscillator circuit.

phase discriminating features of the bridge circuit in the frequency determining four-terminal, however, obtained at the expense of additional attenuation.

The frequency determining four-terminal of network 1(c) has a comparatively moderate attenuation, and exhibits no extraordinary phase-discriminating qualities. The amplifier part, on the other hand, has a considerable amount of negative feedback, reducing its excess of gain and resulting in an improved phase stability of the loop circuit.

With regard to general relations between phase and attenuation, the following rule is suggested:

An additional attenuation associated with a corresponding improvement in the phase discriminating properties of the frequency determining four-terminal may as well be interpreted as an inversed feedback between the output and input terminals of the amplifier.

The rule enunciated above allows one to approach the problem in more than one way, and can be used as a suitable tool in oscillator network synthesis.

In the same way as the bridge circuit can be interpreted in terms of voltage feedback, the bridge-T circuit may be interpreted in terms of current feedback. As discussed by Shepherd and Wise⁵ the phase discriminating properties of the Hartley (or Colpitts) oscillator can be improved by the use of a bridged-T section. Figs. 2(a) and 2(b) show that a frequency determining section of a Hartley oscillator connected to an amplifier with current feedback is equivalent to a bridged-T section combined with an amplifier of which the current feedback has been removed.

⁵ W. G. Shepherd and R. O. Wise. "Variable-frequency bridge-type frequency-stabilized oscillators," *Proc. I.R.E.*, vol. 31, pp. 256-269; June, 1943.

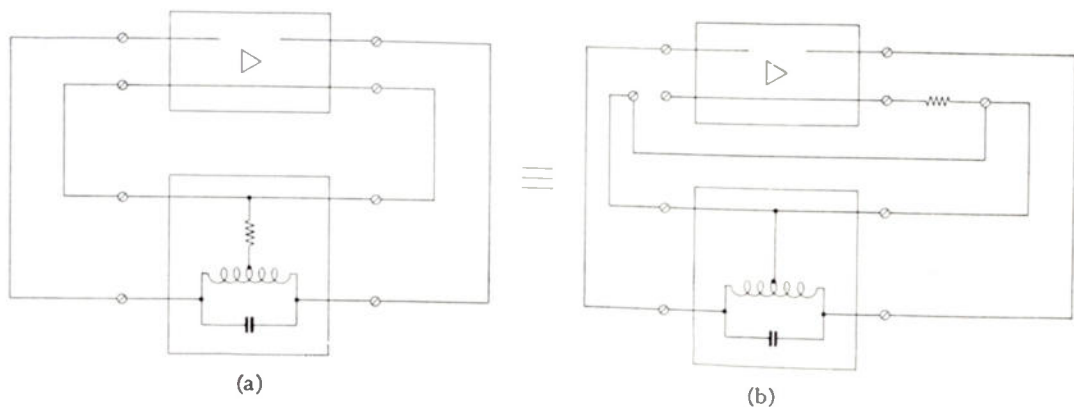

Fig. 2—Network equivalence for Hartley oscillator circuit.

III. PHASE PROPERTIES OF ACTIVE AND PASSIVE SECTIONS

Having made a definite separation between active and passive section of the closed loop, the attention may be directed to a more detailed study of the phase-frequency characteristics of amplifier $\phi_1(\omega)$ and frequency determining four-terminal $\phi_2(\omega)$ (see Fig. 3). In the neigh-

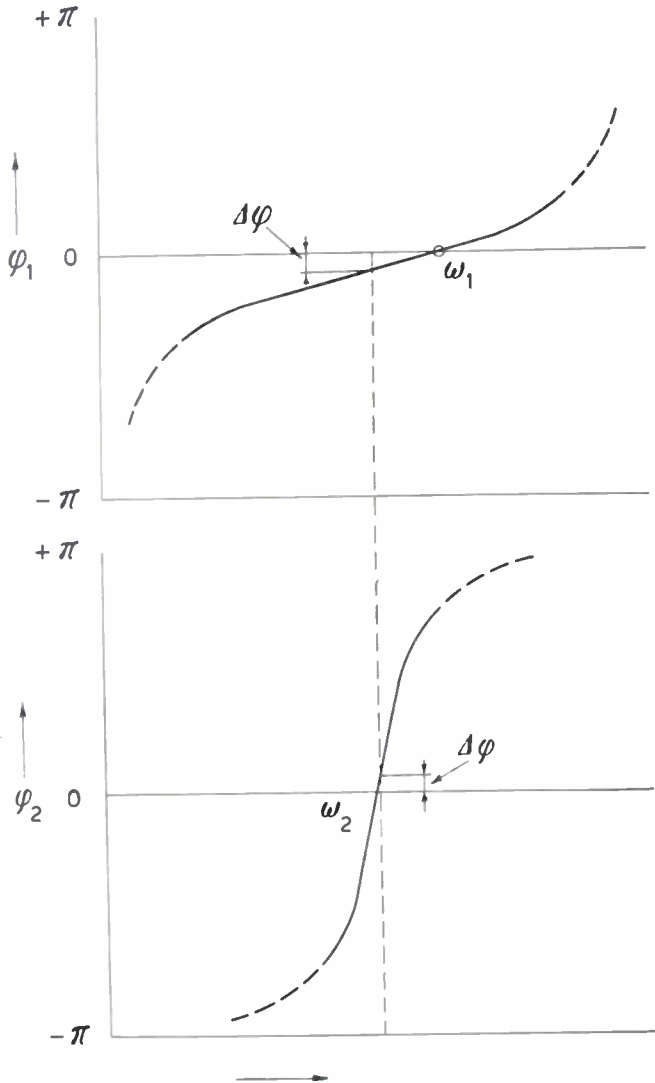

Fig. 3—Phase response of the active and passive loop sections near the frequency of oscillation.

borhood of the frequency to be generated, ϕ_1 and ϕ_2 may be developed around their points of zero phase⁶ ω_1 and ω_2

$$\phi_1(\omega) = \frac{\partial\phi_1(\omega_1)}{\partial\omega} (\omega - \omega_1) + \dots$$

$$\phi_2(\omega) = \frac{\partial\phi_2(\omega_2)}{\partial\omega} (\omega - \omega_2) + \dots$$

adding and making use of condition 1 (page 169)

$$\phi_1(\omega) + \phi_2(\omega) = 0.$$

⁶ Here phase shift eventually with reference to 180°.

Hence

$$\omega = \omega_1 \frac{1}{1+S} + \omega_2 \frac{1}{1+\frac{1}{S}} \tag{3}$$

if

$$S = \frac{\frac{\partial\phi_2(\omega_2)}{\partial\omega}}{\frac{\partial\phi_1(\omega_1)}{\partial\omega}} \tag{4}$$

The natural condition to make the influence of the frequency determining part predominating is:

$$S \gg 1. \tag{5}$$

The magnitude of S , defined in (4), has to be regarded as a criterion to what extent the frequency generated in the loop can be made independent of the amplifier section. However, an excessive high figure for S only is by no means a guarantee for frequency constancy.

It is worth while to point out that the definition of S satisfies the principle of equivalence enunciated in section II. A moderate slope $\partial\phi_2(\omega_2)/\partial\omega$ combined with a very small $\partial\phi_1(\omega_1)/\partial\omega$ of the active section yields a same figure for S as a very large slope $\partial\phi_2(\omega_2)/\partial\omega$ combined with a moderate slope of $\partial\phi_1(\omega_1)/\partial\omega$.

The relations (3) and (5) may serve as a starting point to formulate the prevailing properties which have to be satisfied by the active and passive four-terminal sections of the loop for generation of constant frequencies.

AMPLIFIER A

1. The slope of phase versus frequency must be small and constant in the neighborhood of the generated frequency ω .
2. The frequency of zero phase ω_1 is fixed near ω .

The importance of negative feedback is obvious as a means to diminish the slope of phase versus frequency.⁷

It is believed that, in the long run, the phase stability of capacity resistance coupled amplifiers compare favorably to tuned amplifiers.

FREQUENCY DETERMINING CIRCUIT B

1. The point of zero phase ω_2 must be fixed.
2. The slope of phase versus frequency must be large and constant.

Fluctuating stray capacities across input and output terminals of the frequency determining circuit must have little influence on ω_2 . In many cases low impedance filter sections are favorable.^{8,9}

⁷ F. E. Terman, "Radio Engineer's Handbook," p. 401, Fig. 38, McGraw-Hill Book Co., Inc., New York, N. Y.; 1943.

⁸ J. K. Clapp, "An inductance-capacitance oscillator of unusual frequency stability," Proc. I.R.E., vol. 36, pp. 356-359; March, 1948.

⁹ G. F. Lampkin, "An improvement in constant-frequency oscillators," Proc. I.R.E., vol. 27, pp. 199-202; March, 1939

Requirement B_2 involves the use of nearly purely reactive elements, hence high Q . In case of electromechanical elements like crystals, the accessory reactive elements of the four terminals must be chosen with care so that the favorable properties with regard to requirement B_1 are not impaired. For crystal oscillators this is an argument to use series resonance, using the electro-mechanical branch of the crystal only.

It must be kept in mind that condition B_1 has a priority over condition B_2 . An extremely high Q is useless, unless condition B_1 is satisfied. From a designer's point of view it is very instructive to study existing oscillator circuits by splitting up in passive and active sections and analyzing the subsequent parts in order to learn to what extent the conditions mentioned above are satisfied.

IV. OSCILLATOR CIRCUITS

Any properly matched combination of amplifier stages and frequency determining four terminals, possibly on low impedance basis, allowing a net phase shift of zero or $n \times 2\pi$ radians and a loop gain adjustable to unity, may give a suitable, linearly operating, oscillator.

An amplifier section operating in a linear part of its characteristic is an essential condition to guarantee phase stability, hence frequency stability of the complete loop.⁷

An adjustment of the loop gain of a purely linear oscillator to unity exactly is well beyond the aims which can be realized physically, unless an automatically regulating device is included.

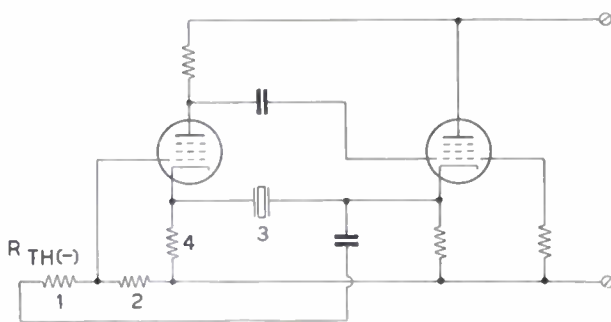

Fig. 4

The oscillator circuit shown in Fig. 4 may serve as an example for the principles of design developed in the foregoing sections.¹⁰ A low impedance output stage of the amplifier has been used to supply the input voltage of the bridge. The positive feedback loop is connected to the cathode, the negative feedback loop to the grid of the differential input stage of the amplifier. The two tubes

¹⁰ A similar design using two tubes has been advocated by Goldberg and Crosby. The circuit Fig. 4 differs from Goldberg and Crosby's design by the application of negative feedback and by its amplitude controlling features. (H. Goldberg and E. L. Crosby, Jr., *Proc. NEC*, (Chicago), p. 240; November 2-5, 1947.)

are coupled by a conventional capacity resistance network to close the loop.

The amplitude controlling device is usually included in the negative feedback loop by means of a thermal resistance. The properties of this system of amplitude control are not identical to those of the conventional Meacham bridge, because of the fact that one of the bridge elements is a dynamic impedance. The influence of this impedance is such that a completely compensating control of the amplitude can be obtained in spite of a very moderate gain of the amplifier.

Moreover, the bridge is not seriously affected if crystals with considerable difference in loss resistance are inserted, in view of the fact that the dynamic cathode impedance of the differential input-stage automatically readjusts the bridge equilibrium.

An analysis of the amplitude controlling device is somewhat lengthy, but straightforward (see Appendix).

V. CONCLUSION

The alternate points of view discussed in Sections II and III of this paper have been illustrated by methods of "network geometry."¹¹

The principal aim of its application has been to emphasize the prevailing points which make oscillator frequency substantially independent of ambient influences on the amplifying section, e.g., variations in power supply, and aging of tubes and circuit elements.

A searching investigation may be necessary to scan the practical boundaries. The difficulties arising from very high figures of S (see (4) and (5)) being used, are analogous and partly identical to the problems encountered in feedback amplifier design and must be attacked accordingly.¹²

APPENDIX

Analysis of the Amplitude Control

In case one of the bridge elements is the cathode-resistance of an amplifier tube, one has to deal with the effective impedance of the cathode circuit.

For an amplifier stage with a differential input, the input impedance on the cathode is a function of the voltage ratio e_g/e_k , e_g = grid voltage, e_k = cathode voltage. (Fig. 5.) The input impedance Z_i on the cathode is defined as

$$Z_i = \frac{e_k}{I_1} \quad (6)$$

The circuit equations are

$$e_k = I_1 Z_k - I_2 Z_k \quad (7)$$

$$\mu(e_k - e_g) = I_2(R_i + Z_k + Z_a) - I_1 Z_k \quad (8)$$

¹¹ As shown by one of the reviewers of the original manuscript, the equivalence is obvious from an analytical point of view as well.
¹² H. W. Bode, "Relations between attenuation and phase in feedback amplifier design," *Bell Sys. Tech. Jour.*, vol. 19, pp. 421-455; July, 1940.

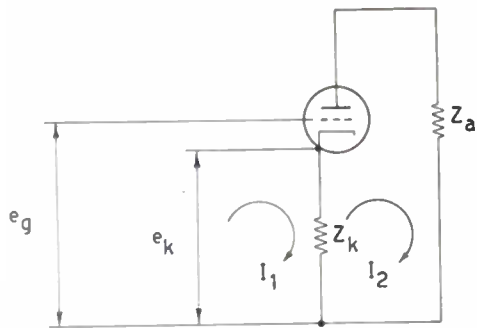

Fig. 5—Amplifier stage with differential input.

Equations (6) and (7) give

$$Z_i = Z_k \left(1 - \frac{I_2}{I_1} \right) \tag{9}$$

Solving (7) and (8) for I_1 and I_2

$$I_1 = - \frac{\mu e_g Z_k - e_k \{ R_i + Z_a + (\mu + 1) Z_k \}}{Z_k (R_i + R_a)}$$

$$I_2 = \frac{(\mu + 1) e_k - \mu e_g}{R_i + Z_a}$$

Substitution in (9), yields an expression for Z_i :

$$Z_i = \frac{(R_i + Z_a) Z_k}{R_i + Z_a + Z_k \{ 1 + \mu(1 - \alpha) \}} \tag{10}$$

α is written for the voltage ratio e_g/e_k . It is easily verified that $\alpha=0$ reproduces the input impedance of a grounded grid stage, whereas $\alpha=1$ (cathode and grid shortcircuited) gives

$$Z_i = \frac{(R_i + Z_a) Z_k}{(R_i + Z_a) + Z_k}$$

expressing that the cathode impedance is shunted by the plate load impedance and internal resistance of the tube in series.

In view of the following application, we will write (10) in the form:

$$R_4 = R_k \frac{R_i + R_a}{R_i + R_a + R_k(1 + \mu(1 - \alpha))} \tag{10a}$$

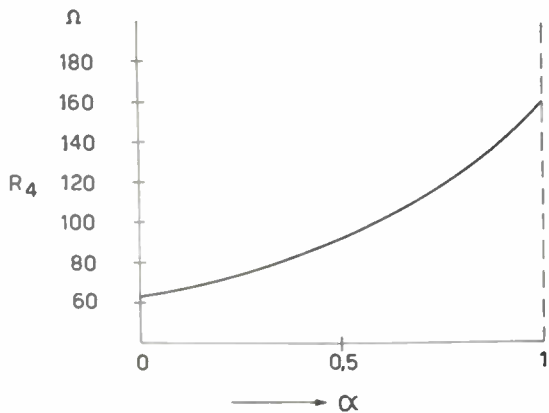

Fig. 6—Cathode input impedance of a differential amplifier stage as a function of voltage ratio α .

in which all the elements are supposed to be purely resistive and R_4 is written for Z_i , being the fourth element of the bridge. Fig. 6 gives a plot for a television pentode of R_4 as a function of the voltage ratio $\alpha = e_g/e_k$, e_g and e_k having the same phase.

The bridge circuit connecting the cathode of the grounded plate stage to the cathode and grid of the differential input stage of oscillator circuit Fig. 4 is shown separately in Fig. 7.

The voltage ratio α may be expressed in the bridge elements R_1, \dots, R_4 ; R_3 being the selective series-resistance of the crystal. The resulting expression for $(1 - \alpha)$ is (Fig. 7)

$$(1 - \alpha) = \frac{e_k - e_g}{e_k} = \frac{R_1 R_4 - R_3 R_2}{R_1 R_4 + R_2 R_3} \tag{11}$$

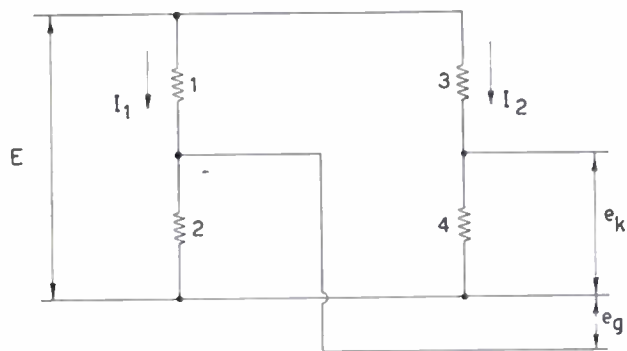

Fig. 7—Bridge circuit connected to the differential amplifier.

Inserting (11) in (10a) gives a linear equation for R_4 . Solving for R_4 yields a formula expressing R_4 as a function of the remaining bridge elements R_{1-3} and the parameters of the differential amplifying stage:

$$R_4 = R_k \frac{R_i + R_a + \frac{\mu R_2 R_3}{R_1 + R_2}}{R_i + R_a + \frac{\mu R_1 R_k}{R_1 + R_2}} \text{ if } R_k \ll (R_i + R_a)$$

Writing S_o for the effective transconductance $S R / (R_i + R_a)$, we have the expression:

$$R_4 = R_k \frac{R_1 + R_2 + S_o R_2 R_3}{R_1 + R_2 + S_o R_1 R_k} \tag{12}$$

An inspection of equation (12) shows that R_4 approximates

$$\frac{R_2 R_3}{R_1} \text{ if } S_o \gg \left\{ \begin{array}{l} \frac{R_1 + R_2}{R_2 R_3} \\ \frac{R_1 + R_2}{R_1 R_k} \end{array} \right.$$

or, in other words, the effective resistance R_4 tends to approximate bridge equilibrium.

The practical consequence of this peculiarity is that, within certain limits, crystals with arbitrary differences in loss resistance may be inserted without seriously disturbing the adjustment of the bridge.

It must be emphasized, however, that the phenomenon, being strictly linear, must be looked upon as a device of automatic bridge-readjustment. It has no amplitude controlling features of its own.

A control of the amplitude can be obtained with a nonlinear element only. Let us suppose the bridge element R_1 to be a thermal resistance with negative characteristic. Its nonlinear properties will be explained by the formula

$$R_1 = R_0(1 - \gamma \Delta I_1)$$

now

$$I_1 = \frac{E}{R_1 + R_2} \quad (\text{see Fig. 7})$$

and

$$dR_1 = \frac{dR_1}{dE} dE = - \frac{\gamma R_0}{R_1 + R_2} dE. \quad (13)$$

If the loop is in a steady state of oscillation, the net gain is exactly unity. Therefore the attenuation of the bridge is reciprocal to the gain g of the amplifier. Hence the bridge circuit (Fig. 7) gives an expression for the gain:

$$\frac{e_k - e_g}{E} = \frac{1}{g} = \frac{R_4}{R_3 + R_4} - \frac{R_2}{R_1 + R_2}. \quad (14)$$

Differentiation to the variable elements g , R_1 and R_4 gives

$$- \frac{dg}{g^2} = \frac{R_3}{(R_3 + R_4)^2} dR_4 + \frac{R_2}{(R_1 + R_2)^2} dR_1. \quad (15)$$

According to formula (12) the differential dR_4 can be expressed in the differentials of R_1 and the differential of the gain of the amplifier, because g is proportional to S_e .

$$dR_4 = \frac{\partial R_4}{\partial g} dg + \frac{\partial R_4}{\partial R_1} dR_1. \quad (16)$$

Inserting (16) and (13) in (15) and solving for dE ,

$$dE = - \frac{\frac{1}{g^2} + \frac{\partial R_4}{\partial g} \frac{R_3}{(R_3 + R_4)^2}}{\frac{dR_1}{dE} \left[\frac{R_3 \frac{\partial R_4}{\partial R_1}}{(R_3 + R_4)^2} + \frac{R_2}{(R_1 + R_2)^2} \right]} dg.$$

This expression relates a change in gain to a corresponding change in E , the input voltage of the bridge. A compensated control of the amplitude is possible if

$$\frac{\partial R_4}{\partial g} = - \frac{(R_3 + R_4)^2}{g^2 R_3}. \quad (17)$$

An inspection of formula (17) shows that $\partial R_4 / \partial g < 0$ if $R_4 R_1 \gg R_2 R_3$. The last inequality being a necessary condition to assure an excess of positive feedback.

For the computation of the differential quotient $\partial R_4 / \partial g$ it has to be remembered that the gain of the amplifier depends on S_e . There are other factors affecting the gain; the influence, however, of the second (cathode follower) tube is comparatively small because of its individual inversed feedback.

A similar conclusion is obtained if R_2 is taken as a thermal resistance with positive characteristics.

Hence, the combined efforts of pseudo-linear element and dynamic impedance as elements in the bridge create the possibility of a compensated control of the amplitude for a finite and very moderate gain of the amplifier.

In general, the source supplying the input voltage of the bridge has a finite internal impedance. Therefore, the use of a thermistor (negative characteristic) being a constant voltage device on its own, assists the stabilizing properties of the control action.

CORRECTION

D. D. King, author of the paper, "Two standard field-strength meters for very-high frequencies," which appeared on pages 1048-1051 of the September, 1950, issue of the PROCEEDINGS OF THE I.R.E., has brought the following error to the attention of the editors.

In the caption for Fig. 7 on page 1051, "1 volt per wavelength ($E\lambda_r = 1$)," should read "1 volt per resonant wavelength ($E\lambda_r = 1$)."

Spectrum Analysis of Transient Response Curves*

H. A. SAMULON†, ASSOCIATE MEMBER, IRE

Summary—The paper describes a method of computation of amplitude and phase response of a network from its measured transient response. Tables and nomographs have been included to facilitate the numerical evaluation.

INTRODUCTION

SINCE TRANSIENT tests are rapidly becoming standard engineering tools, the importance of spectrum analysis of measured response curves is steadily increasing.

It is well known that such an analysis can be made in cases where the mathematical expression of the respective curve is given by evaluating the Fourier integral. In cases where only the graph of the response curve is known, this leads to a lengthy and laborious graphical integration and is hardly practical.

Another method will be briefly described here which was presented by Bedford and Fredendall.¹ The principle of this method, called by its authors "square-wave analysis," is as follows:

The given curve is approximated by the sum of several step-functions which are regularly spaced in time (Fig. 1). The complex Fourier spectrum of each step function is computed. The sum of the individual spectra

function and τ the spacing between adjacent steps:

$$F(t) \approx \sum_{n=0}^{\infty} B_n f(t - n\tau) \tag{1}$$

where B_n are the amplitudes of the individual step functions.

The Fourier spectrum of a single step function is:

$$\phi(\omega) = \int_{-\infty}^{+\infty} B_n f(t - n\tau) e^{-j\omega t} dt = B_n \frac{e^{-jn\omega\tau}}{j\omega} \tag{2}$$

and the spectrum of the function $F(t)$:

$$\Phi \approx \frac{1}{j\omega} \sum_{n=0}^{\infty} B_n e^{-jn\omega\tau} \tag{3}$$

The equation for the (complex) transfer function $H(\omega)$, if we assume an ideal unit function at the input terminals, is, therefore:

$$H(\omega) \approx \sum_{n=0}^{\infty} B_n e^{-jn\omega\tau} \tag{4}$$

METHOD USING $(\sin x/x)$ -FUNCTIONS

This method which has proved very useful in a great number of cases is based on the following fact: Almost all transient response curves have one property in common; namely, their spectrum does not contain components above a certain limit, say f_c , to any appreciable amount. This is due to the inherent properties of the system under test and of the test equipment itself. In cases where an oscilloscope is used, the scope amplifier might be the limiting item; in other cases, different parts of the test setup might cause the frequency limitation. A function of this type, namely, a function the frequency spectrum of which has an upper limit f_c , can be synthesized exactly by a sum of functions of the type $\sin x/x$. This was proved by Shannon in a recent pub-

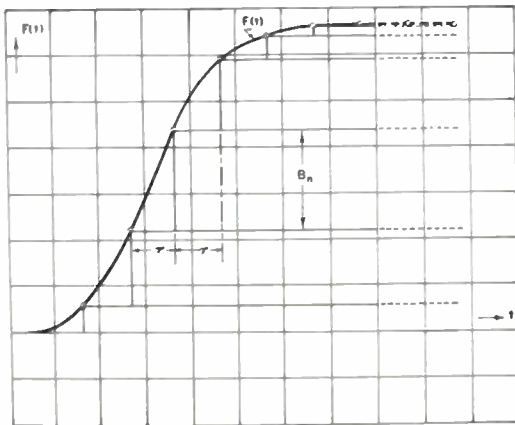

Fig. 1—Stair-step approximation of a given curve.

is the spectrum of the sum of step functions. Since this sum is assumed to be a good approximation of the given curve, it is reasonable to assume that its spectrum is a good approximation of the spectrum of the original curve. The corresponding mathematical operations are given below: If $F(t)$ is the given curve, $f(t)$ a unit step

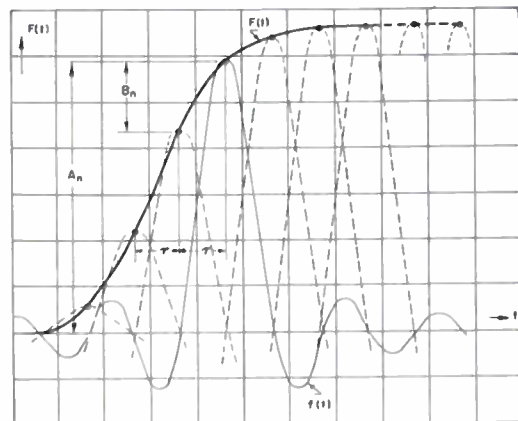

Fig. 2—Synthesis of a given curve by $\sin x/x$ functions.

* Decimal classification: R143X537.7. Original manuscript received by the Institute, March 15, 1950; revised manuscript received, August 22, 1950. Presented, 1949 National IRE Convention, New York, N. Y., March 8, 1949.

† General Electric Company, Electronics Park, Syracuse, N. Y.
¹ A. V. Bedford and G. L. Fredendall, "Analysis, synthesis, and evaluation of the transient response of television apparatus," *Proc. I.R.E.*, vol. 30, pp. 440-458; October, 1942.

lication.² The conditions for the synthesis will be explained with the help of Fig. 2: The measured curve is "sampled" at regular intervals (τ) which must be smaller than or equal to $(1/2f_c)$. At each sample point, a curve of the described type is placed with an amplitude equal to the amplitude of the corresponding sample point. In Fig. 2 the $\sin x/x$ curves are only partly drawn in order to improve the clarity of the figure. The next step is to find the complex Fourier spectrum of each individual

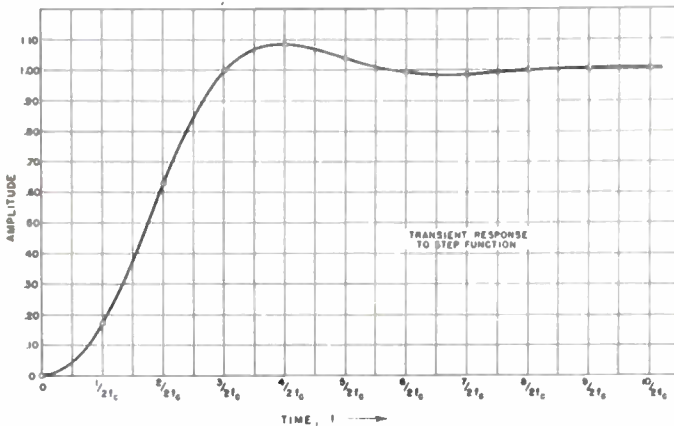

Fig. 3—Transient response curve.

$\sin x/x$ function. Then, the sum of these spectra is the Fourier spectrum of the measured curve. Provided that the above assumption holds, that is, that no frequency components above f_c are present, this would be the correct answer, not an approximation. The validity of this assumption will be discussed later.

The mathematical derivations for the method described above, follow: Let the given time function be again $F(t)$ and τ the time spacing between adjacent sampling points, then:

$$F(t) = \sum_{n=0}^{\infty} A_n \frac{\sin f_c(t - n\tau)2\pi}{f_c(t - n\tau)2\pi}; \quad \tau \leq \frac{1}{2f_c} \quad (5)$$

where A_n are the amplitudes of the sampling points, and f_c is the highest component in the frequency spectrum of $F(t)$. It can be shown that the spectrum of the n th term of the sum of (5) is

$$\begin{aligned} \phi(\omega) &= \int_{-\infty}^{+\infty} A_n \frac{\sin 2\pi f_c(t - n\tau)}{2\pi f_c(t - n\tau)} e^{-j\omega t} dt \\ &= A_n \frac{e^{-jn\tau\omega}}{2f_c} \end{aligned} \quad (6)$$

Hence, the Fourier spectrum of the given curve $F(t)$ is:

$$\Phi(\omega) = \sum_{n=0}^{\infty} A_n \frac{e^{-jn\tau\omega}}{2f_c}; \quad \tau = \frac{1}{2f_c} \quad (7)$$

This equation relates the spectrum to the measured points $A_0, A_1, A_2 \dots$ of the transient response curve and is, therefore, the answer to our problem. In many cases, however, it is of advantage to express the spectra not by the sample amplitudes A , but by the first differences or increments of A . If we define $B_n = A_n - A_{n-1}$ and neglect constant time delay, then (7) becomes (8), as derived in the mathematical Appendix.

$$\Phi(\omega) = \frac{1}{j4f_c \sin \frac{\pi}{2} f/f_c} \sum_{n=0}^{\infty} B_n e^{-jn\pi f/f_c} \quad (8)$$

In a case where the measured curve is the response to an ideal step function the complex transfer function of the system under test will be described by (9). The transfer function is, of course, the complex notation of amplitude and phase response of a network.

$$H(\omega) = \frac{\pi/2 \cdot f/f_c}{\sin(\pi/2 \cdot f/f_c)} \sum_{n=0}^{\infty} B_n e^{-jn\pi f/f_c} \quad (9)$$

Our assumption, on which the derived formulas (8) and (9) are based, was that the spectrum of the response curve does not contain frequencies above a certain limit f_c . Since this assumption will never be fulfilled with full mathematical rigor for a practical network, the practical value of the method might be questioned. It can, however, be shown that the amount of the error, which will be largest near the nominal cutoff frequency f_c , will be in general smaller than the amplitude response at f_c , provided that the response does not rise again above its value at f_c for frequencies $f/f_c > 1$. An example, in which the condition for a frequency cutoff has been fulfilled only approximately, follows here.

A certain transient response curve (Fig. 3) was assumed of which the accurate mathematical expression is given by (10)

$$F(t) = 1 - e^{-2\pi f_0 t} - \frac{2}{\sqrt{3}} e^{-\pi f_0 t} \sin(\sqrt{3} \pi f_0 t) \quad (10)$$

and analyzed by three different methods: First, by the evaluation of the Fourier-integral which, of course, provides the exact answer;³ second, by the method just described and, third, by the "square-wave method" mentioned earlier. The time spacing for the sampling was chosen to be $1/5f_0$. The results are shown in Fig. 4. The solid curve shows the correct solution, the crosses the results of the proposed method and the circles the results of the "square-wave method." The time delay-response is omitted for reasons of space.

In spite of the fact that our assumption was not completely fulfilled (we have at f_c only 24 db instead

³ The solution is:

$$H(\omega) = \frac{1}{-(f/f_0 - e^{+j\pi/6})(f/f_0 + e^{-j\pi/6})(1 + jf/f_0)}$$

² C. Shannon, "Communications in the presence of noise," PROC. I.R.E., vol. 37, pp. 10-22; January, 1949.

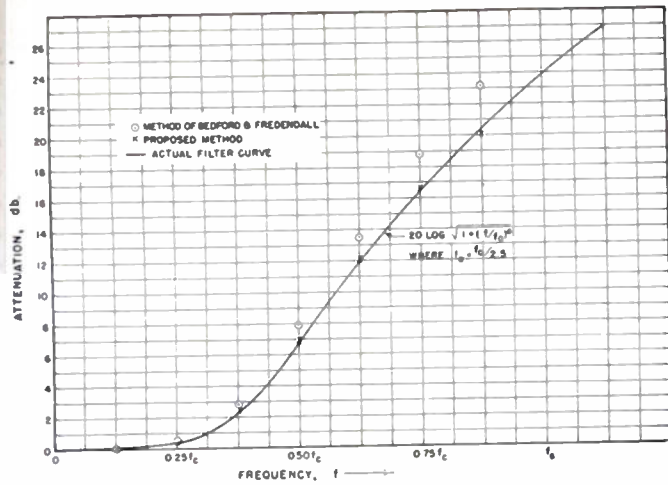

Fig. 4—Amplitude response corresponding to transient response of Fig. 3.

of an infinitely large attenuation), the results obtained are of considerable accuracy. This can also be seen from Fig. 5, which shows the relative error of the amplitude responses.

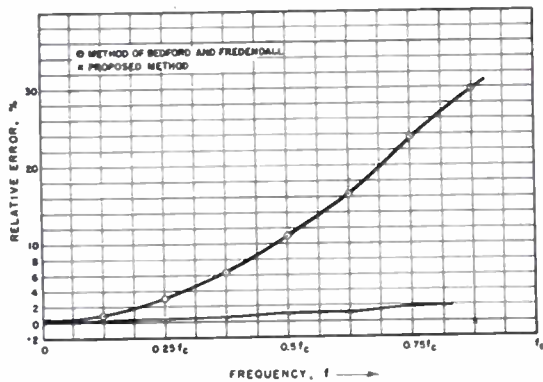

Fig. 5—Relative error of amplitude response.

It is believed that for the same accuracy the proposed method allows a considerable decrease of the number of sampling points compared with previous methods and, therefore, constitutes a time saving in the numerical evaluation.

It might be mentioned that in a case where the natural cutoff frequency f_c is far above the frequency of interest, the cutoff can be lowered artificially by the use of a low-pass filter. One can thus avoid an unnecessarily large number of sampling points.

THE NUMERICAL EVALUATION

In this paragraph it will be shown how the numerical evaluation of the formula for the transfer function can be made. Since the following simple relationship exists between the transfer function $H(\omega)$ and the spectrum (assuming an ideal step function input),

$$H(\omega) = \frac{\Phi(\omega)}{E/j\omega} \tag{11}$$

where

$H(\omega)$ = complex transfer function

$\Phi(\omega)$ = complex Fourier spectrum

$E/j\omega$ = complex spectrum of an ideal input step function of amplitude E

it is not necessary to discuss the numerical evaluation of $\Phi(\omega)$ as well.

For a certain frequency f_0 for which the calculation of phase and amplitude of a network is desired, the expression for $H(\omega)$ takes the form:

$$H(\omega_0) = \frac{\pi/2 \cdot f_0}{f_c \sin \frac{\pi}{2} f_0/f_c} \cdot \sum_{n=0}^{\infty} B_n e^{-in\pi f_0/f_c} \tag{12}$$

On the right side, all values are known; the B 's are the differences of the sample amplitudes, f_0 is the frequency for which the evaluation is being performed, and f_c is the cutoff frequency. The main part of the evaluation is to form the complex sum $\sum B_n e^{-in\pi f_0/f_c}$. This can be done graphically (as for a similar case proposed by Bedford and Fredendall).¹ Another method is used here; we write:

$$\sum_{n=0}^{\infty} B_n e^{-in\pi f_0/f_c} = \sum_{n=0}^{\infty} B_n \cos(n\pi f_0/f_c) - j \sum_{n=0}^{\infty} B_n \sin(n\pi f_0/f_c) \tag{13}$$

$$\sum B_n e^{-in\pi f_0/f_c} = \sum_0^{\infty} c_{n \cos} - j \sum_0^{\infty} c_{n \sin} \tag{14}$$

Tables are computed for different values of n , B_n and f_0/f_c which allow one to find $c_{r \sin}$ and $c_{n \cos}$. If the sums $\sum c_{\sin}$ and $\sum c_{\cos}$ are found and called C_{\sin} and C_{\cos} the nomographs I or II allow one to find the amplitude response of the network being analyzed ($|H(\omega)|$) for f_0 . Nomograph III gives the phase for f_0 .

It should be mentioned that the phase angle thus obtained is the so-called "principal value," i.e., it might be necessary to add a multiple of π to it.

The constant time delay cannot be computed by this method, since terms pertaining to it were neglected in the course of the derivation.

INSTRUCTIONS FOR THE USE OF TABLES AND NOMOGRAPHS

General

The tables are computed for a sampling point spacing of $0.05 \mu s$; they are valid for any other sampling point spacing τ^* if the frequency values printed on tables and nomographs are multiplied by $0.05/\tau^* \mu s$.

The Sampling

(a) Use a spacing τ smaller than $1/2 f_c$ where f_c is the cutoff frequency, defined in the first part of this paper.

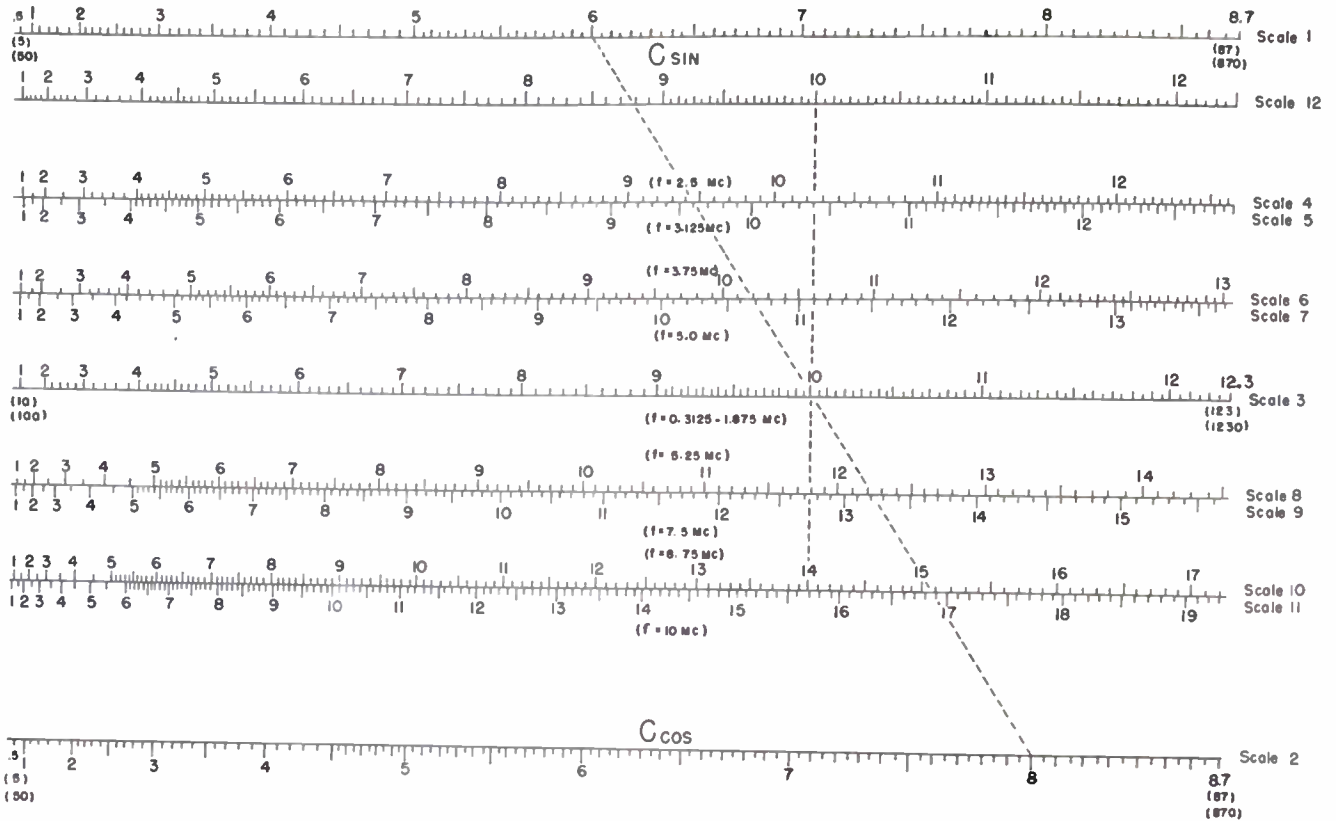

NOTE: TO ESTABLISH THE LINE PERPENDICULAR TO SCALE 3 AND ANY VALUE, CONNECT THIS VALUE ON SCALE 3 WITH THE SAME VALUE ON SCALE 12.

Nomograph I

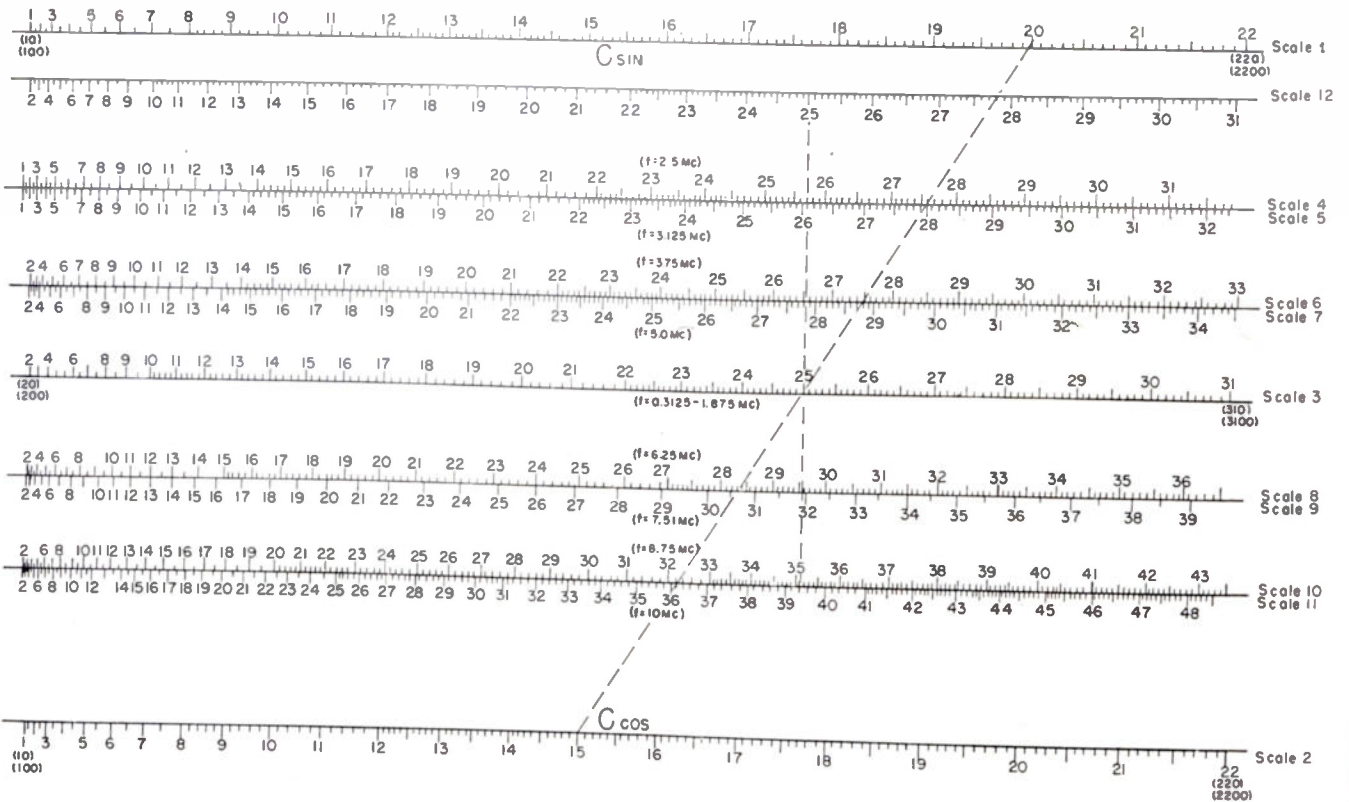

NOTE: TO ESTABLISH THE LINE PERPENDICULAR TO SCALE 3 AT ANY VALUE, CONNECT THIS VALUE ON SCALE 3 WITH THE SAME VALUE ON SCALE 12.

Nomograph II

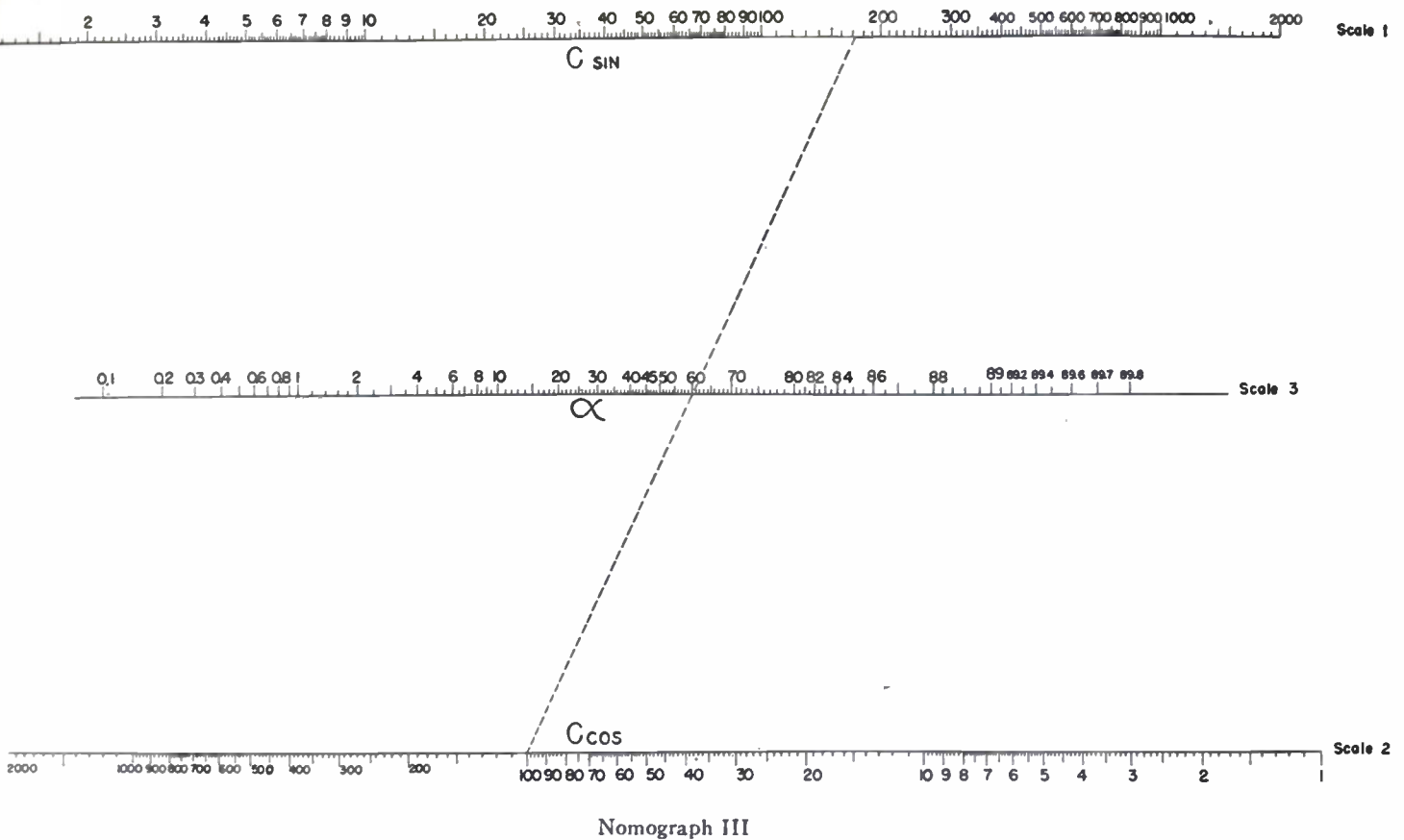

(b) Place the sampling points so that the first point (subscript $n=0$) is not farther to the right than one interval τ past the start of the variation of the curve (see Fig. 6). Sampling points must continue to the point where the curve ceases varying.

this assures higher accuracy in the results.⁴

(e) Round off the values of B thus found to the nearest whole number.

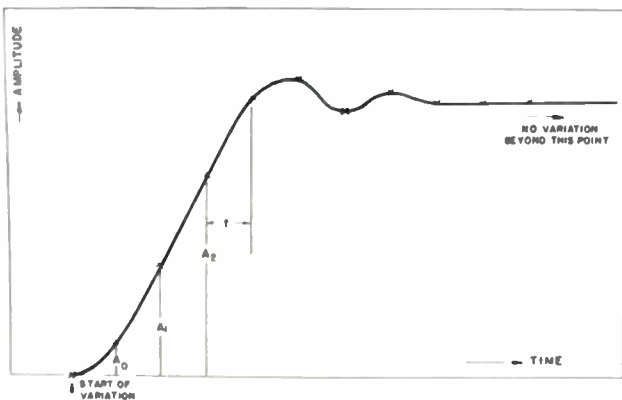

Fig. 6—Sampling of an experimentally determined transient response curve.

(c) Tabulate the amplitudes at the sampling points. Let these be called $A_0, A_1, A_2, A_3, \dots, A_n, \dots$.

(d) Form the differences $A_0 - 0, A_1 - A_0, A_2 - A_1, \dots$, and let these be called $B_0, B_1, B_2, \dots, B_n, \dots$. (Some values of B might be negative.) If necessary, the values of B should be multiplied by an arbitrary scale factor so that the largest value of B lies between 70 and 99;

The Computation of the Auxiliary Values C_{sin} and C_{cos}

Select the table (Tables I–XII) for the frequency for which amplitude and phase is to be computed. For calculation of C_{sin} use the heading marked “for C_{sin} .” Enter the argument column (under the heading B_n) with the B_n value; proceed horizontally to that column for which the heading contains the corresponding subscript number N and tabulate the value thus obtained. (Note: The value $c_{n_{sin}}$ which has been found, normally has the same sign as B_n unless the subscript in the heading is preceded by an asterisk, in which case they have opposite sign.) This must be done for all B_n 's of which the subscripts are listed in the heading.

It is advisable to perform this conversion not in the sequence of the points (i.e., B_0, B_1, B_2, \dots) but rather in the sequence of the groups indicated by the headings (e.g., for 0.625 Mc and C_{sin} : first for the points with the subscripts 1, 15, 17, 31 then for the next group 2, 14, 18, 30, etc.).

Add all values $c_{n_{sin}}$ thus found, retaining proper signs. The sum is the auxiliary value C_{sin} .

⁴ The scale factor will only appear in the final result for the amplitude; it can be eliminated by dividing the result by the scale factor. This, however, is not necessary if only relative values are of interest.

F=3125 MC

B _N	N																FOR C _{SIN}	FOR C _{COS}
	1	2	3	4	5	6	7	8	9	10	11	12	13	14	15	16		
	15 +17	14 +16	13 +15	12 +14	11 +13	10 +12	9 +11	8 +10	7 +9	6 +8	5 +7	4 +6	3 +5	2 +4	1 +3	0		
1	00.10	00.20	00.30	00.38	00.47	00.56	00.63	00.71	00.77	00.83	00.88	00.92	00.96	00.98	01.00	2		
2	00.20	00.39	00.58	00.77	00.94	01.11	01.27	01.41	01.55	01.66	01.76	01.85	01.91	01.96	01.99	3		
3	00.29	00.59	00.87	01.15	01.41	01.67	01.90	02.12	02.32	02.49	02.65	02.77	02.87	02.94	02.99	4		
4	00.39	00.78	01.16	01.53	01.89	02.22	02.54	02.83	03.09	03.33	03.53	03.70	03.83	03.92	03.98	5		
5	00.49	00.98	01.45	01.91	02.36	02.78	03.17	03.54	03.87	04.16	04.41	04.62	04.78	04.90	04.98	6		
6	00.59	01.17	01.74	02.30	02.83	03.33	03.81	04.24	04.64	04.99	05.29	05.54	05.74	05.88	05.97	7		
7	00.69	01.37	02.03	02.68	03.30	03.89	04.40	04.95	05.41	05.82	06.17	06.47	06.70	06.86	06.97	8		
8	00.78	01.56	02.32	03.06	03.77	04.44	05.08	05.66	06.18	06.65	07.06	07.39	07.66	07.85	07.96	9		
9	00.88	01.76	02.61	03.44	04.24	05.00	05.71	06.36	06.96	07.48	07.94	08.32	08.61	08.83	08.96	10		
10	00.98	01.95	02.90	03.83	04.71	05.56	06.34	07.07	07.73	08.32	08.82	09.24	09.57	09.81	09.95			
11	01.08	02.15	03.19	04.21	05.19	06.11	06.98	07.78	08.50	09.15	09.70	10.16	10.53	10.79	10.95	11		
12	01.18	02.34	03.48	04.60	05.66	06.67	07.61	08.49	09.28	09.98	10.58	11.09	11.48	11.77	11.94	12		
13	01.27	02.54	03.77	04.98	06.13	07.22	08.25	09.19	10.05	10.81	11.48	12.01	12.44	12.75	12.94	13		
14	01.37	02.73	04.06	05.36	06.60	07.78	08.88	09.90	10.81	11.60	12.47	13.23	13.86	14.35	14.71	14.93	14	
15	01.47	02.93	04.35	05.74	07.07	08.33	09.52	10.61	11.51	12.37	13.10	14.11	14.78	15.31	15.69	15.92	15	
16	01.57	03.12	04.64	06.12	07.54	08.89	10.15	11.31	12.37	13.30	14.11	14.99	15.71	16.27	16.67	16.92	16	
17	01.67	03.32	04.94	06.51	08.01	09.45	10.78	12.02	13.14	14.11	14.99	15.71	16.27	16.67	16.92	17		
18	01.76	03.51	05.23	06.89	08.49	10.00	11.42	12.73	13.91	14.97	15.87	16.63	17.22	17.65	17.91	18		
19	01.86	03.71	05.52	07.27	08.96	10.56	12.05	13.43	14.69	15.80	16.76	17.55	18.18	18.64	18.91	19		
20	01.96	03.90	05.81	07.65	09.43	11.11	12.69	14.14	15.46	16.63	17.64	18.40	19.14	19.62	19.90	20		
21	02.06	04.10	06.10	08.04	09.90	11.67	13.32	14.85	16.23	17.46	18.52	19.40	20.09	20.60	20.90	21		
22	02.16	04.29	06.39	08.42	10.37	12.22	13.96	15.56	17.01	18.29	19.40	20.33	21.05	21.58	21.89	22		
23	02.25	04.49	06.68	08.80	10.84	12.78	14.59	16.26	17.78	19.12	20.28	21.25	22.01	22.56	22.89	23		
24	02.35	04.68	06.97	09.18	11.31	13.33	15.23	16.97	18.55	19.96	21.17	22.17	22.97	23.54	23.88	24		
25	02.45	04.88	07.26	09.57	11.79	13.89	15.66	17.68	19.33	20.79	22.05	23.10	23.92	24.52	24.88	25		
26	02.55	05.07	07.55	09.95	12.26	14.45	16.49	18.38	20.10	21.62	22.93	24.02	24.68	25.50	25.88	26		
27	02.65	05.27	07.84	10.33	12.73	15.00	17.13	19.09	20.87	22.45	23.81	24.95	25.84	26.48	26.87	27		
28	02.74	05.46	08.13	10.72	13.20	15.56	17.76	19.80	21.64	23.28	24.69	25.87	26.79	27.46	27.87	28		
29	02.84	05.66	08.42	11.10	13.67	16.11	18.40	20.51	22.42	24.11	25.58	26.79	27.75	28.44	28.86	29		
30	02.94	05.85	08.71	11.48	14.14	16.67	19.03	21.21	23.19	24.95	26.46	27.72	28.71	29.42	29.86	30		
31	03.04	06.05	09.00	11.86	14.61	17.22	19.67	21.92	23.96	25.78	27.34	28.64	29.66	30.40	30.85	31		
32	03.14	06.24	09.29	12.25	15.08	17.78	20.30	22.63	24.74	26.61	28.22	29.56	30.62	31.39	31.85	32		
33	03.23	06.44	09.58	12.63	15.56	18.33	20.94	23.33	25.51	27.44	29.10	30.49	31.58	32.37	32.84	33		
34	03.33	06.63	09.87	13.01	16.03	18.89	21.57	24.04	26.28	28.27	29.98	31.44	32.53	33.35	33.84	34		
35	03.43	06.83	10.16	13.39	16.50	19.45	22.20	24.75	27.06	29.10	30.87	32.34	33.49	34.33	34.83	35		
36	03.53	07.02	10.45	13.78	16.97	20.00	22.84	25.46	27.93	29.93	31.75	33.26	34.45	35.31	35.83	36		
37	03.63	07.22	10.74	14.16	17.44	20.56	23.47	26.16	28.60	30.77	32.63	34.10	35.44	36.29	36.82	37		
38	03.72	07.41	11.03	14.54	17.94	21.11	24.11	26.87	29.37	31.60	33.51	35.11	36.36	37.27	37.82	38		
39	03.82	07.61	11.32	14.93	18.38	21.67	24.78	27.58	30.15	32.43	34.39	36.03	37.32	38.25	38.81	39		
40	03.92	07.80	11.61	15.31	18.86	22.22	25.38	28.28	30.92	32.26	35.28	36.96	38.28	39.23	39.81	40		
41	04.02	08.00	11.90	15.69	19.33	22.78	26.01	28.99	31.09	34.09	36.16	37.88	39.24	40.21	40.80	41		
42	04.12	08.19	12.19	16.07	19.80	23.34	26.64	29.70	32.47	34.92	37.04	38.80	40.19	41.19	41.80	42		
43	04.21	08.39	12.48	16.46	20.27	23.89	27.28	30.41	33.24	35.75	37.92	39.73	41.15	42.17	42.79	43		
44	04.31	08.58	12.77	16.84	20.74	24.45	27.91	31.11	34.01	36.59	38.80	40.65	42.10	43.16	43.79	44		
45	04.41	08.78	13.06	17.22	21.24	25.00	28.55	31.92	34.79	37.42	39.68	41.58	43.06	44.14	44.78	45		
46	04.51	08.97	13.35	17.60	21.68	25.56	29.18	32.59	35.56	38.25	40.54	42.50	44.02	45.12	45.78	46		
47	04.61	09.17	13.64	17.99	22.16	26.11	29.82	33.23	36.33	39.08	41.45	43.42	44.97	46.10	46.77	47		
48	04.70	09.36	13.93	18.37	22.63	26.67	30.45	33.94	37.10	39.91	42.33	44.35	45.93	47.08	47.77	48		
49	04.80	09.56	14.22	18.75	23.10	27.22	31.09	34.65	37.88	40.74	43.21	45.27	46.89	48.06	48.76	49		
50	04.90	09.75	14.52	19.14	23.57	27.78	31.72	35.36	38.65	41.57	44.10	46.20	47.85	49.04	49.76	50		
51	05.00	09.95	14.81	19.52	24.04	28.34	32.35	36.06	39.42	42.41	44.98	47.12	48.80	50.02	50.76	51		
52	05.10	10.14	15.10	19.90	24.53	28.89	32.99	36.77	40.20	43.24	45.86	48.04	49.76	51.00	51.75	52		
53	05.19	10.34	15.39	20.28	25.03	29.45	33.62	37.48	40.97	44.07	46.74	48.97	50.72	51.98	52.75	53		
54	05.29	10.53	15.68	20.67	25.46	30.00	34.26	38.18	41.74	44.90	47.62	49.89	51.67	52.96	53.74	54		
55	05.39	10.73	15.97	21.05	25.93	30.56	34.89	38.89	42.52	45.73	48.50	50.81	52.63	53.94	54.74	55		
56	05.49	10.92	16.26	21.43	26.40	31.11	35.53	39.60	43.29	46.56	49.39	51.74	53.59	54.92	55.73	56		
57	05.59	11.12	16.55	21.81	26.87	31.67	36.16	40.30	44.06	47.40	50.27	52.66	54.54	55.91	56.73	57		
58	05.68	11.31	16.84	22.20	27.34	32.22	36.80	41.01	44.83	48.23	51.15	53.59	55.50	56.89	57.72	58		
59	05.78	11.51	17.13	22.58	27.81	32.78	37.43	41.72	45.61	49.06	52.03	54.51	56.46	57.87	58.72	59		
60	05.88	11.70	17.42	22.96	28.28	33.34	38.06	42.43	46.38	49.89	52.91	55.43	57.44	58.85	59.71	60		
61	05.98	11.90	17.71	23.34	28.76	33.89	38.70	43.13	47.15	50.72	53.80	56.36	58.37	59.83	60.71	61		
62	06.08	12.09	18.00	23.73	29.23	34.45	39.33	43.84	47.93	51.55	54.68	57.28	59.33	60.81	61.70	62		
63	06.17	12.29	18.29	24.11	29.70	35.00	39.97	44.55	48.70	52.38	55.56	58.21	60.28	61.79	62.70	63		
64	06.27	12.48	18.58	24.49	30.17	35.56	40.66	45.25	49.47	53.22	56.44	59.13	61.24	62.77	63.69	64		
65	06.37	12.68	18.87	24.88	30.64	36.11	41.24	45.96	50.25	54.05	57.32	60.05	62.20	63.75	64.69	65		
66	06.47	12.87	19.25	25.26	31.11	36.67	41.87	46.67	51.02	54.88	58.21	60.98	63.16	64.73	65.68	66		
67	06.57	13.07	19.45	25.64	31.58	37.22	42.50	47.38	51.79	55.71	59.09	61.90	64.11	65.71	66.68	67		
68	06.66	13.26	19.74	26.02	32.06	37.78	43.14	48.08	52.56	56.54	59.97	62.83	65.07	66.69	67.67	68		
69	06.76	13.46	20.03	26.41	32.53</													

F=625MC

F=1.25MC

		N								
B_N	1	2	3	4	5	6	7	8	FOR C _{SIN} FOR C _{COS}	
	15	14	13	12	11	10	9	8		
	*17	*18	*19	*20	*21	*22	*23	*24		
	*31	*30	*29	*28	*27	*26	*25	*24		
7	6	5	4	3	2	1	0			
*9	*8	*11	*12	*13	*14	*15	*16			
*23	*22	*21	*20	*19	*18	*17	*16			
25	26	27	28	29	30	31				

		N								
B_N	1	7	2	6	3	5	4		FOR C _{SIN} FOR C _{COS}	
	*9	*15	*10	*14	*11	*13	*12	*10		
	*17	*23	*18	*22	*19	*21	*20	*22		
	*25	*31	*26	*30	*27	*29	*28	*26		
3	5	2	4	1	7	0				
*11	*13	*10	*14	*9	*15	*8	*6			
*19	*21	*18	*22	*17	*23	*16	*18			
*27	*29	*26	*30	*25	*31	*24	*24			

1	00.20	00.38	00.56	00.71	00.83	00.92	00.98	1
2	00.39	00.77	01.11	01.41	01.66	01.85	01.96	2
3	00.59	01.15	01.67	02.12	02.49	02.77	02.94	3
4	00.78	01.53	02.22	02.83	03.33	03.70	03.98	4
5	00.98	01.91	02.78	03.54	04.24	04.80	05.25	5
6	01.17	02.30	03.33	04.24	04.99	05.54	05.88	6
7	01.37	02.68	03.89	04.95	05.82	06.47	06.86	7
8	01.56	03.06	04.44	05.66	06.65	07.39	07.85	8
9	01.76	03.44	05.00	06.36	07.48	08.32	08.83	9
10	01.95	03.83	05.56	07.07	08.32	09.24	09.81	10
11	02.15	04.21	06.11	07.78	09.15	10.16	10.79	11
12	02.34	04.60	06.67	08.49	09.98	11.09	11.77	12
13	02.54	05.08	07.22	09.19	10.81	12.01	12.75	13
14	02.73	05.56	07.78	09.90	11.64	12.93	13.73	14
15	02.93	06.04	08.33	10.61	12.47	13.86	14.71	15
16	03.12	06.52	08.89	11.31	13.30	14.78	15.69	16
17	03.32	06.51	09.45	12.02	14.14	15.71	16.67	17
18	03.51	06.89	10.00	12.73	14.97	16.63	17.65	18
19	03.71	07.27	10.56	13.43	15.80	17.55	18.64	19
20	03.90	07.65	11.11	14.14	16.63	18.48	19.62	20
21	04.10	08.04	11.67	14.85	17.46	19.40	20.60	21
22	04.29	08.42	12.22	15.56	18.29	20.33	21.58	22
23	04.49	08.80	12.78	16.26	19.12	21.25	22.56	23
24	04.68	09.18	13.33	16.97	19.96	22.17	23.54	24
25	04.88	09.57	13.85	17.68	20.79	23.10	24.52	25
26	05.07	09.95	14.45	18.38	21.62	24.02	25.50	26
27	05.27	10.33	15.00	19.09	22.45	24.95	26.48	27
28	05.46	10.72	15.56	19.80	23.28	25.87	27.46	28
29	05.66	11.10	16.11	20.51	24.11	26.79	28.44	29
30	05.85	11.48	16.67	21.21	24.95	27.72	29.42	30
31	06.05	11.86	17.22	21.92	25.78	28.64	30.40	31
32	06.24	12.25	17.78	22.63	26.61	29.56	31.39	32
33	06.44	12.63	18.33	23.33	27.44	30.49	32.37	33
34	06.63	13.01	18.89	24.04	28.27	31.41	33.35	34
35	06.83	13.39	19.45	24.75	29.10	32.34	34.33	35
36	07.02	13.78	20.00	25.46	29.93	33.26	35.31	36
37	07.22	14.16	20.56	26.16	30.77	34.18	36.29	37
38	07.41	14.54	21.11	26.87	31.60	35.11	37.27	38
39	07.61	14.92	21.67	27.58	32.43	36.03	38.25	39
40	07.80	15.31	22.22	28.28	33.26	36.96	39.23	40
41	08.00	15.69	22.78	28.99	34.09	37.88	40.21	41
42	08.19	16.07	23.34	29.70	34.92	38.80	41.19	42
43	08.39	16.46	23.89	30.41	35.75	39.73	42.17	43
44	08.58	16.84	24.45	31.11	36.59	40.65	43.16	44
45	08.78	17.22	25.00	31.82	37.42	41.58	44.14	45
46	08.97	17.60	25.56	32.53	38.25	42.50	45.12	46
47	09.17	17.99	26.11	33.23	39.08	43.42	46.10	47
48	09.36	18.37	26.67	33.94	39.91	44.35	47.08	48
49	09.56	18.75	27.22	34.65	40.74	45.27	48.06	49
50	09.75	19.14	27.78	35.36	41.57	46.20	49.04	50
51	09.95	19.52	28.34	36.06	42.41	47.12	50.02	51
52	10.14	19.90	28.89	36.77	43.24	48.04	51.00	52
53	10.34	20.28	29.45	37.48	44.07	48.97	51.98	53
54	10.53	20.67	30.00	38.18	44.90	49.89	52.96	54
55	10.73	21.05	30.56	38.89	45.73	50.81	53.94	55
56	10.92	21.43	31.11	39.60	46.56	51.74	54.92	56
57	11.12	21.81	31.67	40.30	47.40	52.66	55.91	57
58	11.31	22.20	32.22	41.01	48.23	53.59	56.89	58
59	11.51	22.58	32.78	41.72	49.06	54.51	57.87	59
60	11.70	22.96	33.34	42.43	49.89	55.43	58.85	60
61	11.90	23.34	33.89	43.13	50.72	56.36	59.83	61
62	12.09	23.73	34.44	43.84	51.55	57.28	60.81	62
63	12.29	24.11	35.00	44.55	52.38	58.21	61.79	63
64	12.48	24.49	35.56	45.25	53.22	59.13	62.77	64
65	12.68	24.88	36.11	45.96	54.05	60.05	63.75	65
66	12.87	25.26	36.67	46.67	54.88	60.98	64.73	66
67	13.07	25.64	37.22	47.38	55.71	61.90	65.71	67
68	13.26	26.02	37.78	48.08	56.54	62.83	66.69	68
69	13.46	26.41	38.34	48.79	57.37	63.75	67.68	69
70	13.65	26.79	38.89	49.50	58.21	64.67	68.66	70
71	13.85	27.17	39.45	50.20	59.04	65.60	69.64	71
72	14.04	27.55	40.00	50.91	59.87	66.52	70.62	72
73	14.24	27.94	40.56	51.62	60.70	67.44	71.60	73
74	14.43	28.32	41.11	52.33	61.53	68.37	72.58	74
75	14.63	28.70	41.67	53.03	62.36	69.29	73.56	75
76	14.82	29.09	42.23	53.74	63.19	70.22	74.54	76
77	15.02	29.47	42.78	54.45	64.03	71.14	75.52	77
78	15.21	29.85	43.34	55.15	64.86	72.06	76.50	78
79	15.41	30.23	43.89	55.86	65.69	72.99	77.48	79
80	15.60	30.62	44.45	56.57	66.52	73.91	78.46	80
81	15.80	31.00	45.00	57.28	67.35	74.84	79.44	81
82	15.99	31.38	45.56	57.98	68.18	75.76	80.43	82
83	16.10	31.76	46.11	58.69	69.01	76.68	81.41	83
84	16.30	32.15	46.67	59.40	69.85	77.61	82.39	84
85	16.49	32.53	47.23	60.10	70.68	78.53	83.37	85
86	16.77	32.91	47.78	60.81	71.51	79.46	84.35	86
87	16.97	33.29	48.34	61.52	72.34	80.38	85.33	87
88	17.16	33.68	48.89	62.22	73.17	81.30	86.31	88
89	17.36	34.06	49.45	62.93	74.00	82.23	87.29	89
90	17.55	34.44	50.00	63.64	74.84	83.15	88.27	90
91	17.75	34.83	50.56	64.35	75.67	84.07	89.25	91
92	17.94	35.21	51.12	65.05	76.50	85.00	90.23	92
93	18.14	35.59	51.67	65.76	77.33	85.92	91.21	93
94	18.33	35.97	52.23	66.47	78.16	86.85	92.20	94
95	18.53	36.36	52.78	67.17	78.99	87.77	93.18	95
96	18.72	36.74	53.34	67.88	79.82	88.69	94.15	96
97	18.92	37.12	53.89	68.59	80.65	89.62	95.13	97
98	19.11	37.50	54.45	69.30	81.47	90.54	96.12	98
99	19.31	37.88	55.00	70.00	82.32	91.47	97.10	99

1	00.38	00.71	00.92	1
2	00.77	01.41	01.85	2
3	01.15	02.12	02.77	3
4	01.53	02.83	03.70	4
5	01.91	03.54	04.62	5
6	02.30	04.24	05.54	6
7	02.68	04.95	06.47	7
8	03.06	05.66	07.39	8
9	03.44	06.36	08.32	9
10	03.83	07.07	09.24	10
11	04.21	07.78	10.16	11
12	04.60	08.49	11.09	12
13	04.98	09.19	12.01	13
14	05.36	09.90	12.93	14
15	05.74	10.61	13.86	15
16	06.12	11.31	14.78	16
17	06.51	12.02	15.71	17
18	06.89	12.73	16.63	18
19	07.27	13.43	17.55	19
20	07.65	14.14	18.48	20
21	08.04	14.85	19.40	21
22	08.42	15.56	20.33	22
23	08.80	16.26	21.25	23
24	09.18	16.97	22.17	24
25	09.57	17.68	23.10	25
26	09.95	18.38	24.02	26
27	10.33	19.09	24.95	27
28	10.72	19.80	25.87	28
29	11.10	20.51	26.79	29
30	11.48	21.21	27.72	30
31	11.86	21.92	28.64	31
32	12.25	22.63	29.56	32
33	12.63	23.33	30.49	33
34	13.01	24.04	31.41	34
35	13.39	24.75	32.34	35
36	13.78	25.46	33.26	36
37	14.16	26.16	34.18	37
38	14.54	26.87	35.11	38
39	14.92	27.58	36.03	39
40	15.31	28.28	36.96	40
41	15.69	28.99	37.88	41
42	16.07	29.70	38.80	42
43	16.46	30.41	39.73	43
44				

F=1.875MC

F=2.5MC

B _N	N								FOR C _{SIN} FOR C _{COS}
	5	*6	1	4	*7	2	3	*8	
	11	*10	15	12	*9	14	13	24	
	*21	22	*17	*20	23	*18	*19	24	
1	00.20	00.38	00.56	00.71	00.83	00.92	00.98	1	
2	00.39	00.77	01.11	01.44	01.66	01.85	01.96	2	
3	00.59	01.15	01.67	02.12	02.49	02.77	02.94	3	
4	00.78	01.53	02.22	02.83	03.33	03.70	03.92	4	
5	00.98	01.91	02.78	03.54	04.16	04.62	04.90	5	
6	01.17	02.30	03.33	04.24	04.99	05.54	05.88	6	
7	01.37	02.68	03.89	04.95	05.82	06.47	06.86	7	
8	01.56	03.06	04.44	05.66	06.05	07.39	07.85	8	
9	01.76	03.44	05.00	06.36	07.48	08.32	08.83	9	
10	01.95	03.83	05.54	07.07	08.32	09.24	09.81	10	
11	22.15	04.21	06.11	07.78	09.15	10.16	10.79	11	
12	02.34	04.60	06.67	08.49	09.98	11.09	11.77	12	
13	02.54	04.98	07.22	09.19	10.81	12.01	12.75	13	
14	02.73	05.36	07.78	09.90	11.64	12.93	13.73	14	
15	02.93	05.74	08.33	10.61	12.47	13.86	14.71	15	
16	03.12	06.12	08.89	11.31	13.30	14.78	15.69	16	
17	03.32	06.51	09.45	12.02	14.14	15.71	16.67	17	
18	03.51	06.89	10.00	12.73	14.97	16.63	17.65	18	
19	03.71	07.27	10.56	13.43	15.80	17.55	18.64	19	
20	03.90	07.65	11.11	14.14	16.63	18.48	19.62	20	
21	04.10	08.04	11.67	14.85	17.46	19.40	20.60	21	
22	04.29	08.42	12.22	15.56	18.29	20.33	21.58	22	
23	04.49	08.80	12.78	16.26	19.12	21.25	22.56	23	
24	04.68	09.18	13.33	16.97	19.96	22.11	23.54	24	
25	04.88	09.57	13.89	17.68	20.79	23.10	24.52	25	
26	05.07	09.95	14.45	18.38	21.62	24.02	25.50	26	
27	05.27	10.33	15.00	19.09	22.45	24.95	26.48	27	
28	05.46	10.72	15.56	19.80	23.28	25.87	27.46	28	
29	05.66	11.10	16.11	20.51	24.11	26.79	28.44	29	
30	05.85	11.48	16.67	21.21	24.95	27.72	29.42	30	
31	06.05	11.86	17.22	21.92	25.78	28.64	30.40	31	
32	06.24	12.25	17.78	22.63	26.61	29.56	31.39	32	
33	06.44	12.63	18.33	23.33	27.44	30.49	32.37	33	
34	06.63	13.01	18.89	24.04	28.27	31.44	33.35	34	
35	06.83	13.39	19.45	24.75	29.10	32.34	34.33	35	
36	07.02	13.78	20.00	25.46	29.93	33.26	35.31	36	
37	07.22	14.16	20.56	26.16	30.77	34.18	36.29	37	
38	07.41	14.54	21.11	26.87	31.60	35.13	37.27	38	
39	07.61	14.92	21.67	27.58	32.43	36.03	38.25	39	
40	07.80	15.31	22.22	28.28	33.26	36.96	39.23	40	
41	08.00	15.69	22.78	28.99	34.09	37.88	40.21	41	
42	08.19	16.07	23.34	29.70	34.92	38.80	41.19	42	
43	08.39	16.46	23.89	30.41	35.75	39.73	42.17	43	
44	08.58	16.84	24.45	31.11	36.59	40.65	43.14	44	
45	08.78	17.22	25.00	31.82	37.42	41.58	44.14	45	
46	08.97	17.60	25.56	32.53	38.25	42.50	45.12	46	
47	09.17	17.99	26.11	33.23	39.08	43.42	46.10	47	
48	09.36	18.37	26.67	33.94	39.91	44.35	47.08	48	
49	09.56	18.75	27.22	34.65	40.74	45.27	48.06	49	
50	09.75	19.14	27.78	35.36	41.57	46.20	49.04	50	
51	09.95	19.52	28.34	36.06	42.41	47.12	50.02	51	
52	10.14	19.90	28.89	36.77	43.24	48.04	51.00	52	
53	10.34	20.28	29.45	37.48	44.07	48.97	51.98	53	
54	10.53	20.67	30.00	38.18	44.90	49.89	52.96	54	
55	10.73	21.05	30.56	38.89	45.73	50.81	53.94	55	
56	10.92	21.43	31.11	39.60	46.56	51.74	54.92	56	
57	11.12	21.81	31.67	40.30	47.40	52.66	55.91	57	
58	11.31	22.20	32.22	41.01	48.23	53.59	56.89	58	
59	11.51	22.58	32.78	41.72	49.06	54.51	57.87	59	
60	11.70	22.96	33.34	42.43	49.89	55.43	58.85	60	
61	11.90	23.34	33.89	43.13	50.72	56.36	59.83	61	
62	12.09	23.73	34.45	43.84	51.55	57.28	60.81	62	
63	12.29	24.11	35.00	44.55	52.38	58.21	61.79	63	
64	12.48	24.49	35.56	45.25	53.22	59.13	62.77	64	
65	12.68	24.88	36.11	45.96	54.05	60.05	63.75	65	
66	1.87	25.26	36.67	46.67	54.88	60.98	64.73	66	
67	13.07	25.64	37.22	47.38	55.71	61.90	65.71	67	
68	13.26	26.02	37.78	48.08	56.54	62.83	66.69	68	
69	13.46	26.41	38.34	48.79	57.37	63.75	67.68	69	
70	13.65	26.79	38.89	49.50	58.21	64.67	68.66	70	
71	13.85	27.17	39.45	50.20	59.04	65.60	69.64	71	
72	14.04	27.55	40.00	50.91	59.87	66.52	70.62	72	
73	14.24	27.94	40.56	51.62	60.70	67.44	71.60	73	
74	14.43	28.32	41.11	52.33	61.53	68.37	72.58	74	
75	14.63	28.70	41.67	53.03	62.36	69.29	73.56	75	
76	14.82	29.09	42.23	53.74	63.17	70.22	74.54	76	
77	15.02	29.47	42.78	54.45	64.03	71.14	75.52	77	
78	15.21	29.85	43.34	55.15	64.86	72.06	76.50	78	
79	15.41	30.23	43.89	55.86	65.69	72.99	77.48	79	
80	15.60	30.62	44.45	56.57	66.52	73.91	78.46	80	
81	15.80	31.00	45.00	57.28	67.35	74.84	79.44	81	
82	15.99	31.38	45.56	57.98	68.18	75.76	80.43	82	
83	16.10	31.76	46.11	58.69	69.01	76.68	81.41	83	
84	16.30	32.15	46.67	59.40	69.85	77.61	82.39	84	
85	16.50	32.53	47.23	60.10	70.68	78.53	83.37	85	
86	16.7	32.91	47.78	60.81	71.51	79.46	84.35	86	
87	16.97	33.29	48.34	61.52	72.34	80.38	85.33	87	
88	17.16	33.68	48.89	62.22	73.17	81.30	86.31	88	
89	17.36	34.06	49.45	62.93	74.00	82.23	87.29	89	
90	17.55	34.44	50.00	63.64	74.84	83.15	88.27	90	
91	17.75	34.83	50.56	64.35	75.67	84.07	89.25	91	
92	17.94	35.21	51.12	65.05	76.50	85.00	90.23	92	
93	18.14	35.59	51.67	65.76	77.33	85.92	91.21	93	
94	18.33	35.97	52.23	66.47	78.16	86.85	92.20	94	
95	18.53	36.36	52.78	67.17	78.99	87.77	93.18	95	
96	18.72	36.74	53.34	67.88	79.82	88.69	94.15	96	
97	18.92	37.12	53.89	68.59	80.66	89.62	95.14	97	
98	19.11	37.50	54.45	69.30	81.49	90.54	96.12	98	
99	19.31	37.89	55.00	70.00	82.32	91.47	97.10	99	

TABLE IV

B _N	N								FOR C _{SIN} FOR C _{COS}
	1	3	*5	*7	2	*6	4	*8	
	9	11	*13	*15	10	*14	18	*22	
	17	*19	*21	*23	16	*20	26	*30	
1	00.71	01.41	02.11	02.81	03.51	04.21	04.91	1	
2	01.11	02.21	03.31	04.41	05.51	06.61	07.71	2	
3	01.51	03.01	04.51	06.01	07.51	09.01	10.51	3	
4	01.91	03.81	05.71	07.61	09.51	11.41	13.31	4	
5	02.31	04.61	06.91	09.21	11.91	14.61	17.31	5	
6	02.71	05.71	08.41	11.11	13.81	16.51	19.21	6	
7	03.11	06.81	10.11	12.81	15.51	18.41	21.11	7	
8	03.51	07.91	11.61	13.71	16.41	19.31	21.91	8	
9	03.91	09.01	12.51	14.61	17.31	20.21	22.81	9	
10	04.31	10.11	13.41	15.51	18.21	21.11	23.71	10	
11	04.71	11.21	14.31	16.41	19.11	22.01	24.61	11	
12	05.11	12.31	15.21	17.31	20.01	22.91	25.51	12	
13	05.51	13.41	16.11	18.21	20.91	23.81	26.41	13	
14	05.91	14.51	17.01	19.11	21.81	24.71	27.31	14	
15	06.31	15.61	17.91	20.01	22.71	25.61	28.21	15	
16	06.71	16.71	18.81	20.91	23.61	26.51	29.11	16	
17	07.11	17.81	19.71	21.81	24.51	2			

F=3.125MC

F=3.75MC

B _N	N							
	3	*6	7	*4	1	2	*5	8
	13	*10	9	*12	15	14	*11	
	*19	22	*23	20	*17	*18	21	*24
		26	*25	28	*31	*30	27	
	5	*2	1	*4	7	6	*3	0
	*11	14	*15	12	*9	*10	13	*16
	*21	18	*17	20	*23	*22	19	
	27	*30	31	*28	25	26	*29	

FOR C_{SIN}

FOR C_{COS}

B _N	N							
	*3	*5	2	6	*10	*14	*9	*15
	11	13	*10	*14	*9	*15	17	*23
	*19	*21	18	22	17	23	*25	*31
	27	29	*26	*30				
	1	*7	*2	6	*3	5		0
	*9	15	*10	*14	11	*13		*8
	17	*21	*18	22	*19	21		16
	*25	31	26	*30	27	*29		*24

FOR C_{SIN}

FOR C_{COS}

1	00.20	00.38	00.56	00.71	00.83	00.92	00.98	1
2	00.39	00.77	01.11	01.41	01.66	01.85	01.96	2
3	00.59	01.15	01.67	02.12	02.49	02.77	02.94	3
4	00.78	01.53	02.22	02.83	03.33	03.70	03.92	4
5	00.98	01.91	02.78	03.54	04.16	04.62	04.90	5
6	01.17	02.30	03.33	04.24	04.99	05.54	05.88	6
7	01.37	02.68	03.89	04.95	05.82	06.47	06.86	7
8	01.56	03.06	04.44	05.66	06.05	07.39	07.85	8
9	01.76	03.44	05.00	06.36	07.40	08.32	08.81	9
10	01.95	03.83	05.56	07.07	08.32	09.24	09.81	10
11	02.15	04.21	06.11	07.78	09.15	10.16	10.79	11
12	02.34	04.60	06.67	08.49	09.98	11.09	11.77	12
13	02.54	04.98	07.22	09.19	10.81	12.01	12.75	13
14	02.73	05.36	07.78	09.90	11.44	12.93	13.73	14
15	02.93	05.74	08.33	10.61	12.47	13.86	14.71	15
16	03.12	06.12	08.89	11.31	13.30	14.78	15.69	16
17	03.32	06.51	09.45	12.02	14.14	15.71	16.67	17
18	03.51	06.89	10.00	12.73	14.97	16.63	17.65	18
19	03.71	07.27	10.56	13.43	15.80	17.55	18.64	19
20	03.90	07.65	11.11	14.14	16.63	18.48	19.62	20
21	04.10	08.04	11.67	14.85	17.46	19.40	20.60	21
22	04.29	08.42	12.22	15.56	18.29	20.33	21.58	22
23	04.49	08.80	12.78	16.26	19.12	21.25	22.56	23
24	04.68	09.18	13.33	16.97	19.96	22.17	23.54	24
25	04.88	09.57	13.89	17.68	20.79	23.10	24.52	25
26	05.07	09.95	14.45	18.38	21.62	24.02	25.50	26
27	05.27	10.33	15.00	19.09	22.45	24.95	26.48	27
28	05.46	10.72	15.56	19.80	23.28	25.87	27.46	28
29	05.66	11.10	16.11	20.51	24.11	26.79	28.44	29
30	05.85	11.48	16.67	21.21	24.95	27.72	29.42	30
31	06.05	11.86	17.22	21.92	25.78	28.64	30.40	31
32	06.24	12.25	17.78	22.63	26.61	29.56	31.39	32
33	06.44	12.63	18.33	23.33	27.44	30.49	32.37	33
34	06.63	13.01	18.89	24.04	28.27	31.41	33.35	34
35	06.83	13.39	19.45	24.75	29.10	32.34	34.33	35
36	07.02	13.78	20.00	25.46	29.93	33.26	35.31	36
37	07.22	14.16	20.56	26.16	30.77	34.18	36.29	37
38	07.41	14.54	21.11	26.87	31.60	35.11	37.27	38
39	07.61	14.92	21.67	27.58	32.43	36.03	38.25	39
40	07.80	15.31	22.22	28.28	33.26	36.96	39.23	40
41	08.00	15.69	22.78	28.99	34.09	37.88	40.21	41
42	08.19	16.07	23.34	29.70	34.92	38.80	41.19	42
43	08.39	16.46	23.89	30.41	35.75	39.73	42.17	43
44	08.58	16.84	24.45	31.11	36.59	40.65	43.16	44
45	08.78	17.22	25.00	31.82	37.42	41.58	44.14	45
46	08.97	17.60	25.56	32.53	38.25	42.50	45.12	46
47	09.17	17.99	26.11	33.23	39.08	43.42	46.10	47
48	09.36	18.37	26.67	33.94	39.91	44.35	47.08	48
49	09.56	18.75	27.22	34.65	40.74	45.27	48.06	49
50	09.75	19.14	27.78	35.36	41.57	46.20	49.04	50
51	09.95	19.52	28.34	36.06	42.41	47.12	50.02	51
52	10.14	19.90	28.89	36.77	43.24	48.04	51.00	52
53	10.34	20.28	29.45	37.48	44.07	48.97	51.98	53
54	10.53	20.67	30.00	38.18	44.90	49.89	52.96	54
55	10.73	21.05	30.56	38.89	45.73	50.81	53.94	55
56	10.92	21.43	31.11	39.60	46.56	51.74	54.92	56
57	11.12	21.81	31.67	40.30	47.40	52.66	55.91	57
58	11.31	22.20	32.22	41.01	48.23	53.59	56.89	58
59	11.51	22.58	32.78	41.72	49.06	54.51	57.87	59
60	11.70	22.96	33.34	42.43	49.89	55.43	58.85	60
61	11.90	23.34	33.89	43.13	50.72	56.36	59.83	61
62	12.09	23.73	34.45	43.84	51.55	57.28	60.81	62
63	12.29	24.11	35.00	44.55	52.38	58.21	61.79	63
64	12.48	24.49	35.56	45.25	53.22	59.13	62.77	64
65	12.68	24.88	36.11	45.96	54.05	60.06	63.75	65
66	12.87	25.26	36.67	46.67	54.88	60.98	64.73	66
67	13.07	25.64	37.22	47.38	55.71	61.90	65.71	67
68	13.26	26.02	37.78	48.08	56.54	62.83	66.69	68
69	13.46	26.41	38.34	48.79	57.37	63.75	67.68	69
70	13.65	26.79	38.89	49.50	58.21	64.67	68.66	70
71	13.85	27.17	39.45	50.20	59.04	65.60	69.64	71
72	14.04	27.55	40.00	50.91	59.87	66.52	70.62	72
73	14.24	27.94	40.56	51.62	60.70	67.44	71.60	73
74	14.43	28.32	41.11	52.33	61.53	68.37	72.58	74
75	14.63	28.70	41.67	53.03	62.36	69.29	73.56	75
76	14.82	29.09	42.23	53.74	63.19	70.22	74.54	76
77	15.02	29.47	42.78	54.45	64.01	71.14	75.52	77
78	15.21	29.85	43.34	55.15	64.86	72.06	76.50	78
79	15.41	30.23	43.89	55.86	65.69	72.99	77.48	79
80	15.60	30.62	44.45	56.57	66.52	73.91	78.46	80
81	15.80	31.00	45.00	57.28	67.35	74.84	79.44	81
82	15.99	31.38	45.56	57.98	68.18	75.76	80.43	82
83	16.10	31.76	46.11	58.69	69.01	76.68	81.41	83
84	16.38	32.15	46.67	59.40	69.85	77.61	82.39	84
85	16.58	32.53	47.23	60.10	70.68	78.53	83.37	85
86	16.77	32.91	47.78	60.81	71.51	79.46	84.35	86
87	16.97	33.29	48.34	61.52	72.34	80.38	85.33	87
88	17.16	33.68	48.89	62.22	73.17	81.30	86.31	88
89	17.36	34.06	49.45	62.93	74.00	82.23	87.29	89
90	17.55	34.44	50.00	63.64	74.84	83.15	88.27	90
91	17.75	34.83	50.56	64.35	75.67	84.07	89.25	91
92	17.94	35.21	51.12	65.05	76.50	85.00	90.23	92
93	18.13	35.59	51.67	65.76	77.33	85.92	91.21	93
94	18.33	35.97	52.23	66.47	78.16	86.85	92.19	94
95	18.53	36.36	52.78	67.17	78.99	87.77	93.17	95
96	18.72	36.74	53.34	67.88	79.82	88.69	94.15	96
97	18.92	37.12	53.89	68.59	80.66	89.62	95.13	97
98	19.11	37.50	54.45	69.30	81.49	90.54	96.11	98
99	19.31	37.89	55.00	70.00	82.32	91.47	97.10	99

TABLE VI

1	00.38	30.71	00.92	1
2	00.77	01.41	01.85	2
3	01.15	02.12	02.77	3
4	01.53	02.83	03.70	4
5	01.91	03.54	04.62	5
6	02.30	04.24	05.54	6
7	02.68	04.95	06.47	7
8	03.06	05.66	07.39	8
9	03.44	06.36	08.32	9
10	03.83	07.07	09.24	10
11	04.21	07.78	10.16	11
12	04.60	08.49	11.09	12
13	04.98	09.19	12.01	13
14	05.36	09.90	12.93	14
15	05.74	10.61	13.86	15
16	06.12	11.31	14.78	16
17	06.51	12.02	15.71	17
18	06.89	12.73	16.63	18
19	07.27	13.43	17.55	19
20	07.65	14.14	18.48	20
21	08.04	14.85	19.40	21
22	08.42	15.56	20.33	22
23	08.80	16.26	21.25	23
24	09.18	16.97	22.17	24
25	09.57	17.68	23.10	25
26	09.95	18.38	24.02	26
27	10.33	19.09	24.95	27
28	10.72	19.80	25.87	28
29	11.10	20.51	26.79	29
30	11.48	21.21	27.72	30
31	11.86	21.92	28.64	31
32	12.25	22.63	29.56	32
33	12.63	23.33	30.49	33
34	13.01	24.04	31.41	34
35	13.39	24.75	32.34	35
36	13.78	25.46	33.26	36
37	14.16	2		

TABLE VIII

$F = 5 \text{ Mc}$

For C_{sin}

Add the values of B_n for the following subscripts (retaining proper signs)

1 5 9 13 17 21 25 29

and add the values for the following subscripts (reversing their signs)

3 7 11 15 19 23 27 31

For C_{cos}

Add the values of B_n for the following subscripts (retaining proper signs)

0 4 8 12 16 20 24 28

and add the values for the following subscripts (reversing their signs)

2 6 10 14 18 22 26 30

For the calculation of the auxiliary value C_{cos} proceed in exactly the same way, using the heading "for C_{cos} ."

The tables are prepared for a maximum of 32 points. It is, however, easy to use these tables for any number of points if the following is kept in mind:

For all frequencies except the lowest (0.3125 Mc) the column which applies to B_n applies as well to B_{n+32} . The same is true for the lowest frequency (0.3125 Mc) but, in addition, the sign of B_{n+32} must be reversed.

Computation of Amplitude

Use nomograph II unless the first digit of the larger one of the auxiliary values C_{sin} and C_{cos} lies between 2 and 8, in which case nomograph I should be used for higher accuracy. Connect, with the aid of a straight edge, the C_{sin} value on scale 1 with the C_{cos} value of scale 2. The value at the intersection of scale 3 with the straight edge is the desired value in cases where the frequency is equal to or smaller than 1.875 Mc. For higher frequencies, proceed perpendicularly from the value found on scale 3 to the scale marked with the proper frequency.

Computation of Phase

Use nomograph III. Connect the values C_{sin} on scale 1 with the value of C_{cos} on scale 2 with a straight edge and find the phase angle α on scale 3 at the intersection with the straight edge. If C_{sin} and C_{cos} have the same sign, take the angle as positive; if they have opposite signs, take it as negative.

Example:

Subscript n of sample points
 A_n 1 9.2 21.9 17.5 18.5 18.0 18.5 18.0
 B_n 1 8.2 12.7 -4.4 1 -0.5 0.5 -5
 $B_n \times$ Scale Factor (=7) 7 57 89 -31 7 -4 4 -4
 Evaluation for $f_0 = 0.625 \text{ Mc/s}$
 $C_{sin} = 11.12 + 34.0 - 17.22 + 4.95 - 3.33 + 3.7 - 3.92 = 29.3$
 $C_{cos} = -0.78 + 1.53 - 2.22 + 4.95 - 25.78 + 82.23 + 55.91 + 7 = 122.84$
 Nomograph II gives $|H(0.625 \text{ Mc})| = 126.0$
 Nomograph III gives $\alpha = 13.5^\circ$

$F = 6.25 \text{ MC}$

B_n	N				FOR C_{sin}	FOR C_{cos}
	*3 *5	*2 *6	1 7	4		
	11 13	10 14	*9 *15	*12		
1	00.38	30.71	00.92	1		
2	00.77	21.41	01.85	2		
3	01.15	32.12	02.77	3		
4	01.53	02.83	03.70	4		
5	01.91	03.54	04.62	5		
6	02.30	04.24	05.54	6		
7	02.68	04.95	06.47	7		
8	03.06	05.66	07.39	8		
9	03.44	06.36	08.32	9		
10	03.83	07.07	09.24	10		
11	04.21	07.78	10.16	11		
12	04.60	08.49	11.07	12		
13	04.98	09.19	12.01	13		
14	05.36	09.90	12.93	14		
15	05.74	10.61	13.86	15		
16	06.12	11.31	14.78	16		
17	06.51	12.02	15.71	17		
18	06.89	12.73	16.63	18		
19	07.27	13.44	17.55	19		
20	07.65	14.14	18.48	20		
21	08.04	14.85	19.40	21		
22	08.42	15.56	20.33	22		
23	08.80	16.26	21.25	23		
24	09.18	16.97	22.17	24		
25	09.57	17.68	23.10	25		
26	09.95	18.38	24.02	26		
27	10.33	19.09	24.95	27		
28	10.72	19.80	25.87	28		
29	11.10	20.51	26.79	29		
30	11.48	21.21	27.72	30		
31	11.86	21.92	28.64	31		
32	12.25	22.63	29.56	32		
33	12.63	23.33	30.49	33		
34	13.01	24.04	31.41	34		
35	13.39	24.75	32.34	35		
36	13.78	25.46	33.26	36		
37	14.16	26.16	34.18	37		
38	14.54	26.87	35.11	38		
39	14.92	27.58	36.03	39		
40	15.31	28.28	36.96	40		
41	15.69	28.99	37.88	41		
42	16.07	29.70	38.80	42		
43	16.46	30.41	39.73	43		
44	16.84	31.11	40.65	44		
45	17.22	31.82	41.58	45		
46	17.60	32.53	42.50	46		
47	17.99	33.23	43.42	47		
48	18.37	33.94	44.35	48		
49	18.75	34.65	45.27	49		
50	19.14	35.36	46.20	50		
51	19.52	36.06	47.12	51		
52	19.90	36.77	48.04	52		
53	20.28	37.48	48.97	53		
54	20.67	38.18	49.89	54		
55	21.05	38.89	50.81	55		
56	21.43	39.60	51.74	56		
57	21.81	40.30	52.66	57		
58	22.20	41.01	53.59	58		
59	22.58	41.72	54.51	59		
60	22.96	42.43	55.43	60		
61	23.34	43.13	56.36	61		
62	23.73	43.84	57.28	62		
63	24.11	44.55	58.21	63		
64	24.49	45.25	59.13	64		
65	24.88	45.96	60.05	65		
66	25.26	46.67	60.98	66		
67	25.64	47.38	61.90	67		
68	26.02	48.08	62.83	68		
69	26.41	48.79	63.75	69		
70	26.79	49.50	64.67	70		
71	27.17	50.20	65.60	71		
72	27.55	50.91	66.52	72		
73	27.94	51.62	67.44	73		
74	28.32	52.33	68.37	74		
75	28.70	53.03	69.29	75		
76	29.09	53.74	70.22	76		
77	29.47	54.45	71.14	77		
78	29.85	55.15	72.06	78		
79	30.23	55.86	72.99	79		
80	30.62	56.57	73.91	80		
81	31.00	57.28	74.84	81		
82	31.38	57.98	75.76	82		
83	31.76	58.69	76.68	83		
84	32.15	59.40	77.61	84		
85	32.53	60.10	78.53	85		
86	32.91	60.81	79.46	86		
87	33.29	61.52	80.38	87		
88	33.68	62.22	81.30	88		
89	34.06	62.93	82.23	89		
90	34.44	63.64	83.15	90		
91	34.83	64.35	84.07	91		
92	35.21	65.05	85.00	92		
93	35.59	65.76	85.92	93		
94	35.97	66.47	86.85	94		
95	36.36	67.17	87.77	95		
96	36.74	67.88	88.69	96		
97	37.12	68.59	89.62	97		
98	37.50	69.30	90.54	98		
99	37.89	70.00	91.47	99		

TABLE IX

F=75MC

F=8.75MC

B _N	N						FOR C _{SIN}	FOR C _{COS}
	1	3	5	*7	*2	6		
	9	11	*13	*15	*10	14		
1	00.71						1	
2	01.41						2	
3	02.12						3	
4	02.83						4	
5	03.54						5	
6	04.24						6	
7	04.95						7	
8	05.66						8	
9	06.36						9	
10	07.07						10	
11	07.78						11	
12	08.49						12	
13	09.19						13	
14	09.90						14	
15	10.61						15	
16	11.31						16	
17	12.02						17	
18	12.73						18	
19	13.43						19	
20	14.14						20	
21	14.85						21	
22	15.56						22	
23	16.26						23	
24	16.97						24	
25	17.68						25	
26	18.38						26	
27	19.09						27	
28	19.80						28	
29	20.51						29	
30	21.21						30	
31	21.92						31	
32	22.63						32	
33	23.33						33	
34	24.04						34	
35	24.75						35	
36	25.46						36	
37	26.16						37	
38	26.87						38	
39	27.58						39	
40	28.28						40	
41	28.99						41	
42	29.70						42	
43	30.41						43	
44	31.11						44	
45	31.82						45	
46	32.53						46	
47	33.23						47	
48	33.94						48	
49	34.65						49	
50	35.36						50	
51	36.06						51	
52	36.77						52	
53	37.48						53	
54	38.18						54	
55	38.89						55	
56	39.60						56	
57	40.30						57	
58	41.01						58	
59	41.72						59	
60	42.43						60	
61	43.13						61	
62	43.84						62	
63	44.55						63	
64	45.25						64	
65	45.96						65	
66	46.67						66	
67	47.38						67	
68	48.08						68	
69	48.79						69	
70	49.50						70	
71	50.20						71	
72	50.91						72	
73	51.62						73	
74	52.33						74	
75	53.03						75	
76	53.74						76	
77	54.45						77	
78	55.15						78	
79	55.86						79	
80	56.57						80	
81	57.28						81	
82	57.98						82	
83	58.69						83	
84	59.40						84	
85	60.10						85	
86	60.81						86	
87	61.52						87	
88	62.22						88	
89	62.93						89	
90	63.64						90	
91	64.35						91	
92	65.05						92	
93	65.76						93	
94	66.47						94	
95	67.17						95	
96	67.88						96	
97	68.59						97	
98	69.30						98	
99	70.00						99	

TABLE X

B _N	N						FOR C _{SIN}	FOR C _{COS}
	1	7	*2	*6	3	5		
	*9	*15	10	14	*11	*13		
1	00.38	00.71	00.92				1	
2	00.77	01.41	01.85				2	
3	01.15	02.12	02.77				3	
4	01.53	02.83	03.70				4	
5	01.91	03.54	04.62				5	
6	02.30	04.24	05.54				6	
7	02.68	04.95	06.47				7	
8	03.06	05.66	07.39				8	
9	03.44	06.36	08.32				9	
10	03.83	07.07	09.24				10	
11	04.21	07.78	10.16				11	
12	04.60	08.49	11.09				12	
13	04.98	09.19	12.01				13	
14	05.36	09.90	12.93				14	
15	05.74	10.61	13.86				15	
16	06.12	11.31	14.78				16	
17	06.51	12.02	15.71				17	
18	06.89	12.73	16.63				18	
19	07.27	13.43	17.55				19	
20	07.65	14.14	18.48				20	
21	08.04	14.85	19.40				21	
22	08.42	15.56	20.33				22	
23	08.80	16.26	21.25				23	
24	09.18	16.97	22.17				24	
25	09.57	17.68	23.10				25	
26	09.95	18.38	24.02				26	
27	10.33	19.09	24.95				27	
28	10.72	19.80	25.87				28	
29	11.10	20.51	26.79				29	
30	11.48	21.21	27.72				30	
31	11.86	21.92	28.64				31	
32	12.25	22.63	29.56				32	
33	12.63	23.33	30.49				33	
34	13.01	24.04	31.41				34	
35	13.39	24.75	32.34				35	
36	13.78	25.46	33.26				36	
37	14.16	26.16	34.18				37	
38	14.54	26.87	35.11				38	
39	14.92	27.58	36.03				39	
40	15.31	28.28	36.96				40	
41	15.69	28.99	37.88				41	
42	16.07	29.70	38.80				42	
43	16.46	30.41	39.73				43	
44	16.84	31.11	40.65				44	
45	17.22	31.82	41.58				45	
46	17.60	32.53	42.50				46	
47	17.99	33.23	43.42				47	
48	18.37	33.94	44.35				48	
49	18.75	34.65	45.27				49	
50	19.14	35.36	46.20				50	
51	19.52	36.06	47.12				51	
52	19.90	36.77	48.04				52	
53	20.28	37.48	48.97				53	
54	20.67	38.18	49.89				54	
55	21.05	38.89	50.81				55	
56	21.43	39.60	51.74				56	
57	21.81	40.30	52.66				57	
58	22.20	41.01	53.59				58	
59	22.58	41.72	54.51				59	
60	22.96	42.43	55.43				60	
61	23.34	43.13	56.36				61	
62	23.73	43.84	57.28				62	
63	24.11	44.55	58.21				63	
64	24.49	45.25	59.13				64	
65	24.88	45.96	60.05				65	
66	25.26	46.67	60.98				66	
67	25.64	47.38	61.90				67	
68	26.02	48.08	62.83				68	
69	26.41	48.79	63.75				69	
70	26.79	49.50	64.67				70	
71	27.17	50.20	65.60				71	
72	27.55	50.91	66.52				72	
73	27.94	51.62	67.44				73	
74	28.32	52.33	68.37				74	
75	28.70	53.03	69.29				75	
76	29.09	53.74	70.22				76	
77	29.47	54.45	71.14				77	
78	29.85	55.15	72.06				78	
79	30.23	55.86	72.99				79	
80	30.62	56.57	73.91				80	
81	31.00	57.28	74.84				81	
82	31.38	57.98	75.76				82	
83	31.76	58.69	76.68				83	

TABLE XII

		$F = 10 Mc$															
$C_{sin} = 0$																	
For C_{cos}																	
Add the values of B_n for the following subscripts (retaining proper signs)		0	2	4	6	8	10	12	14	16	18	20	22	24	26	28	30
and add the values for the following subscripts (reversing their signs)		1	3	5	7	9	11	13	15	17	19	21	23	25	27	29	31

APPENDIX: SUBSTITUTION OF SAMPLE POINT AMPLITUDES A BY THEIR DIFFERENCES B IN (7)

To solve this problem we introduce the following artifice: let the sequence $A_0, A_1, A_2, A_3, \dots$ decrease by an attenuation factor $e^{-n\tau/\delta}$, so that the sequence becomes: $A_0, A_1e^{-\tau/\delta}, A_2e^{-2\tau/\delta}, \dots$. For very large values of δ this will not affect our transient except for very large values of τ or—in the frequency domain—for very small values of ω .

If we use the relationship,

$$\sum_{m=0}^n B_m = A_n \tag{15}$$

(7) takes the form:

$$\Phi(\omega) = \frac{\pi}{\omega_c} \sum_{n=0}^{\infty} \left(\sum_{m=0}^n B_m \right) e^{-jn\tau\omega - n\tau/\delta} \tag{16}$$

Writing $n\epsilon$ for $(jn\tau\omega + n\tau/\delta)$ it will be after several transformations,

$$\frac{\omega_c}{\pi} \Phi(\omega) = \left(\sum_0^{\infty} e^{-n\epsilon} \right) \left(\sum_0^{\infty} B_n e^{-n\epsilon} \right) \tag{17}$$

The series $\sum e^{-n\epsilon}$ is absolutely convergent if

$$\sum_0^{\infty} |e^{-n\epsilon}| = \sum_0^{\infty} |e^{-jn\tau\omega - n\tau/\delta}| \text{ converges.}$$

Since

$$|e^{-jn\tau\omega - n\tau/\delta}| = e^{-n\tau/\delta}$$

the series

$$\sum_0^{\infty} |e^{-jn\tau\omega - n\tau/\delta}|$$

can be considered to be a geometrical progression, which is known to be convergent for $e^{-\tau/\delta} < 1$, i.e., the series is convergent for any positive, finite values of δ .

Using the formula for the sum of an infinite geometrical progression, we obtain:

$$\begin{aligned} \sum_0^{\infty} e^{-n\epsilon} &= \frac{1}{1 - e^{-\epsilon}} = \frac{1}{1 - e^{-j\omega\tau - \tau/\delta}} \\ &= \frac{1}{1 - e^{-\tau/\delta} \cdot e^{-j\omega\tau}} \end{aligned} \tag{18}$$

Since δ can be made arbitrarily large, the factor $e^{-\tau/\delta}$ can be made as close to unity as desired; we will, therefore, write:

$$\sum_0^{\infty} e^{-n\epsilon} = \frac{1}{1 - e^{-j\omega\tau}} \tag{19}$$

or after a transformation:

$$\sum_0^{\infty} e^{-n\epsilon} = \frac{e^{j\omega\tau/2}}{2j \sin \omega\tau/2} \tag{20}$$

Finally, we obtain (neglecting the constant time delay $e^{+j\omega\tau/2}$):

$$\Phi(\omega) = \frac{\pi}{\omega_c} \frac{1}{2j \sin \omega\tau/2} \sum_0^{\infty} B_n e^{-jn\tau\omega} \tag{21}$$

With $\tau = 1/2f_c = \pi/\omega_c$ we obtain (8).

Vertical Incidence Ionosphere Absorption at 150 Kc*

A. H. BENNER†, MEMBER, IRE

Summary—The results of a year's experimental observations of the ionospheric absorption at vertical incidence at 150 kc are presented. In particular, the diurnal and seasonal variations of the ab-

sorption are examined. The existence of relationship between the variation of the absorption and the sun's zenith angle and vertical incidence critical frequency is established.

INTRODUCTION

THE ABSORPTION of radio waves in the ionosphere has been investigated by a number of workers, primarily at frequencies above the stand-

ard broadcast band. At the low end of the spectrum, scientists in England have explored the very long waves from 16 to 30 kc. That portion of the spectrum between 30 and 500 kc has, until recently, suffered a considerable lack of attention. This region is now becoming a center of active interest, partially because of its possible use for long-range navigational aids.

A rather cursory estimation of the daytime reflection

* Decimal classification: R113.22. Original manuscript received by the Institute, May 25, 1950.

† Radio Propagation Laboratory, The Pennsylvania State College, State College, Pa.

coefficient as a function of frequency in this portion of the spectrum has indicated that this coefficient is near unity at the very low frequencies near 16 kc drops to a low minimum near 100 kc, and rises slowly again near 500 kc. The Radio Propagation Laboratory has been conducting measurements of virtual height and absorption at vertical incidence at 150 kc since February, 1949. It is the purpose of this paper to present a résumé of the experimental results obtained from the absorption measurements.

EQUIPMENT

Measurements were conducted on transmissions from a high-power pulse transmitter at a carrier frequency of 150 kc, a pulse rate of 1.5625 pps, and a Gaussian pulse shape 150 microseconds in width. The transmitter consists of a self-excited oscillator using ten 304TH triodes, pulsed by a hydrogen thyatron modulator through a pulse-forming network. The transmitting antenna is a folded dipole 3,000 feet long and 96 feet high. The receiving site is separated approximately 4 km from the transmitter, and an automatic record of the virtual height, the amplitude of the echo, and the amplitude of the ground pulse is made.

Investigations of the polarization of the echo indicated that under normal conditions it was elliptical, left-handed, and rather constant in orientation and configuration with variation of time; at least during night hours. This alleviated the necessity for attempting to devise a discriminator for use with the receiver in separating the two, non-split, magneto-ionic components. The receivers are superheterodyne type especially designed for this application. The height is recorded continuously and simultaneously from an oscilloscopic presentation by two cameras, one on a 150-km range and one on a 300-km range. The short-range record is scaled every fifteen minutes to an estimated accuracy of ±1 km. The absorption is recorded by a servo on the gain of another receiver.

EXPERIMENTAL PROCEDURE

The method of recording the reflection coefficient is the familiar procedure of Appleton.¹ The reflection coefficient ρ is given by:

$$\rho = \frac{2hE'}{k_1G}$$

where ρ is the reflection coefficient, $2h$ is the total path, G is the amplitude of the ground pulse, E' is the amplitude of the first E -layer echo, and k_1 is a constant to be determined. k_1 may be determined by observation of the second E -layer reflection, E'' , since

$$\rho^2 = \frac{E''4h}{k_1Gk_2}$$

¹ E. V. Appleton, "Regularities and irregularities in the ionosphere," *Proc. Roy. Soc.*, vol. 162, pp. 451-499; October, 1937.

where k_2 is the ground reflection coefficient. From Terman,² for a dielectric constant of 10 and a conductivity of 6×10^{-14} emu at 150 kc k_2 for both vertical and horizontally polarized waves at normal incidence is in order of 0.96. Therefore,

$$\rho = \frac{2E''}{0.96E'} = \frac{2hE'}{k_1G} \tag{1}$$

The constant k_1 may thus be determined by plotting hE'/G versus E''/E' , and observing the slope of the least-square radial line passing through the experimental points. Such a calibration is performed at least once a week.

The reflection coefficient is related to the absorption coefficient k by $\rho = \exp(-\int k ds)$ where ds is the differential of the total path traversed by the wave and $\int k ds$ is the total absorption. Hence, the absolute value of the total absorption in nepers is equal to $|\log_e \rho|$.

The records are scaled for G and E' , and the reflection coefficient is computed from (1). $|\log_e \rho|$ is then plotted and a smooth mean curve drawn as shown in Fig. 1. The original records are examined for fine detail correlations such as sudden ionospheric disturbances, magnetic storms, and ionospheric storminess reported at short waves. The diurnal curves of $|\log_e \rho|$ are studied for relationship to the E -layer critical frequencies, the sun's zenith angle, and for seasonal trends.

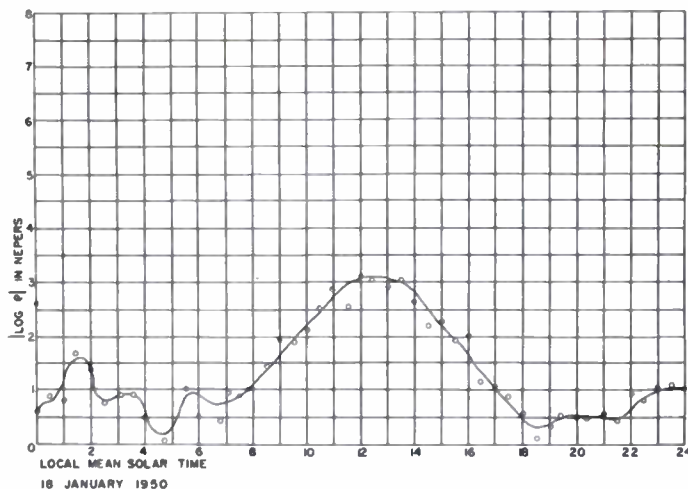

Fig. 1— $|\log \rho|$ versus time for 1/18/50.

EXPERIMENTAL RESULTS

Since the virtual height enters into the calculation of the total absorption, some mention must be made of its general behavior. The virtual height of the layer as studied at 150 kc is similar to that reported by Helliwell³ from measurements at 100 kc. From midnight the

² F. E. Terman, "Radio Engineers Handbook," McGraw-Hill Book Co., New York, N. Y.; 1943.

³ R. A. Helliwell, "Ionospheric virtual height measurements at 100 kilocycles," *Proc. I.R.E.*, vol. 37, pp. 887-894; August, 1949.

virtual height rises from a median value near 95 km to about 98 km at sunrise. At sunrise it drops rapidly about 10 km, then reaches a minimum near 85 km just after local mean solar noon to rise slowly again toward the midnight value. Splitting of the echo is quite prevalent, and in such cases the first echo is recorded. Tentative polarization measurements have indicated that such splits are not magneto-ionic.

Fig. 2 is a dual plot presenting the seasonal variation of the average nighttime absorption (from 2200 to 0200) and the maximum value of absorption attained

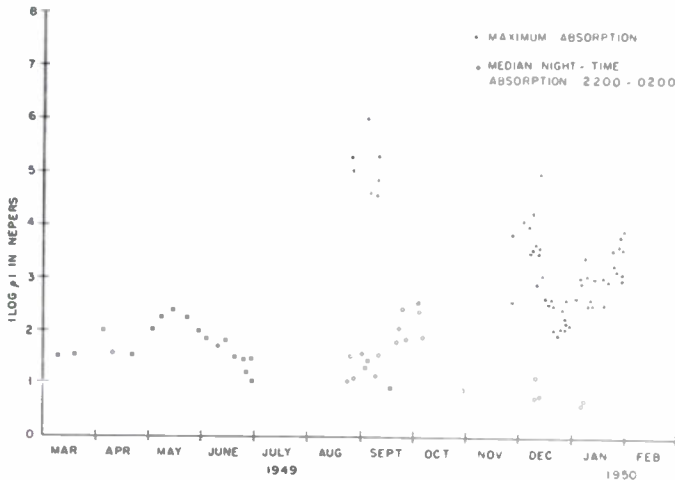

Fig. 2—Seasonal variation of maximum absorption and average nighttime value.

each day. As will be shown later, the maximum absorption does not normally fall at local noon. The gap in the maximum absorption during the summer months represents insufficient system gain to close the curve near noon. The gap between October and November is due to equipment modification. Evident from this figure is a minimum in absorption both in day and night near the winter solistic on December 21. During this time some short period nighttime reflection coefficients were greater than unity, which could be due to some phenomenon such as focusing. Although no noon-day records have been obtained near the summer solstice, the maximum absorption can be estimated to be in the order of 7 nepers. This value is obtained by extrapolating the $|\log_e \rho|$ curve from a known value of 0800 or 0900 to 1200 LMST by the relation

$$\frac{|\log \rho_1|}{|\log \rho_2|} = \left(\frac{\cos \chi_1}{\cos \chi_2} \right)^n \quad (2)$$

where χ is the sun's zenith angle, and n is an exponent that will be determined below.

Appleton⁴ has shown that the total absorption,

⁴ See page 458 of footnote reference 1.

theoretically, should follow $\cos \chi$ to the $3/2$ power for nondeviating absorption such as is experienced by F_2 layer reflections. It is therefore logical to assume that the total absorption at these low frequencies should also follow some $\cos \chi$ law. It may be further assumed that the exponent will be smaller than $3/2$, since in the low frequency case we are dealing with deviating absorption in a level in the layer where collision is large. Computations have established that the quasi-longitudinal approximation to the Appleton-Hartree dispersion equation is valid for this application. Using this approximation,⁵ a double parabolic fit to the Chapman electron distribution curve,⁶ and an exponential collisional frequency versus height relation, a proportionality between the total absorption and $\cos \chi$ may be established.⁷ Such a determination is dependent on the ability to accurately, experimentally fix the location of the height of the maximum ionization, and the value of the collisional frequency at some specified height, for a given value of the sun's zenith angle. These computations have given an exponent on $\cos \chi$ to be in the order of 0.8, but with an absolute value of $|\log_e \rho|$ that is too small. The data have been studied to determine this exponent. It is obtained by plotting $\log |\log_e \rho|$ versus $\log \cos \chi$. If the plot is linear, the exponent on $\cos \chi$ is the linear slope of the curve. An example of such a plot is shown in Fig. 3. The results of this study are presented in Table I.

The row entitled "total data" represents all days

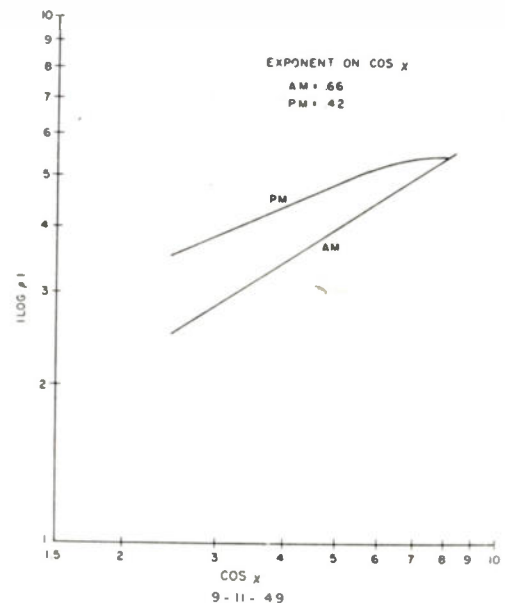

Fig. 3— $|\log \rho|$ versus $\cos \chi$ for 9/11/49.

⁵ S. K. Mitra, "The upper atmosphere," *Roy. Asiatic Soc. (Bengal)*, p. 168; Calcutta, India.

⁶ J. E. Hacke, "An approach to the approximate solution of the ionosphere absorption problem," *Proc. I.R.E.*, vol. 36, pp. 724-727; June, 1948.

⁷ This problem will be examined in a later paper.

whose $|\log_e \rho|$ curves did not visually indicate any unusually perturbed condition. The second row and the third row represent the total data less any days in the CRPL-F bulletins⁸ with a storm character number of 4 or greater on short-wave ionospheric storminess or geomagnetic storminess, respectively. No significant change is evident from this elimination. The fourth row gives the total data purged of days with evidences of sporadic E. Rather paradoxically, although the mean exponent has remained the same, the coefficient of variance has spread to a value of 54 per cent for the AM data. In the last row, all of the days with storms or sporadic E were cast out and in addition, only the very smoothest $|\log_e \rho|$ curves were considered. Both the morning and afternoon mean values dropped, and the PM coefficient of variance closed up to 37.6 per cent. The consistently smaller amount of data in the afternoon is a result of a lag in the ionization, which will be discussed later, causing the PM cases to be nonlinear. It should be emphasized that the object of this Table is to find the best value of X , and not to demonstrate the control of storms or sporadic E on these data. These values agree in order of magnitude with the value of the exponent cited above.

An important ionospheric quantity is the ratio of the noon-day values of the total absorption for summer and winter. Using the exponent 0.75 in (2) the ratio for the midday absorption between December 21 and June 21 is 1.8. This, however, does not check with the experimental value. The December 21 noon value is about 2 nepers, but the noon value at June 21 is much greater than 1.8 times this value. Using the estimated value of 7 nepers, the experimental ratio would be greater than 3.5. Such a seasonal anomaly has been reported by observers on nondeviating absorption at short waves. White and Straker⁹ reported a value of 2.9 experimentally against 3.73 theoretically. Appleton¹⁰ cites a value of 2.6 experimentally against a value of 6.4 theoretically for southeast England. Best and Ratcliffe¹¹ found that both the diurnal and seasonal changes obeyed the 1.5 exponent for selected days of F -layer reflection. It is of some significance that at 150 kc the exponent necessary to explain the seasonal change is considerably larger than that given by the diurnal curves, while the converse is true at short waves.

The $3/2$ law on $\cos \chi$ for nondeviating absorption at short waves has been confirmed for selected days by Best and Ratcliffe.¹¹ A number of other investigators

have measured this exponent and found it to be lower than the theoretical value of $3/2$. These lower values have been attributed to the presence of an absorbing region below the normal E region, referred to as the D layer. It is hoped that more information can be obtained on this region from a thorough study of these low-frequency results.

Fig. 4 shows the relative coincidence of the point of "inflection" of the $|\log_e \rho|$ curve near sunrise and sunset to the variation of the actual ground sunset as given in the Ephemeris.¹² These curves show that there is a close correlation of the sunrise data, but that there is a noticeable lag in the sunset point of inflection. An explanation for this latter effect will be given below.

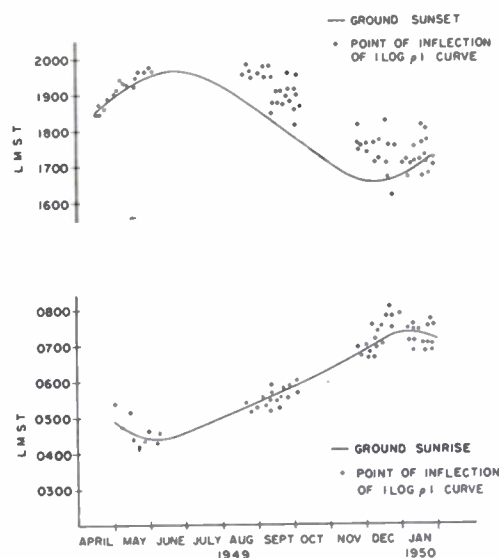

Fig. 4—Sunrise and sunset correlation.

An inspection of the complete diurnal curves of $|\log_e \rho|$ reveals that there is a distinct skewness or displacement of these curves past local noon, contrary to the simple Chapman theory. All available complete $|\log_e \rho|$ curves were examined for the point of maximum absorption, and a histogram of the results of this study is presented in Fig. 5. From this figure, it is evident that the maximum absorption occurs in the vicinity of 1300 hours LMST. This displacement or lag of the absorption with the sun's zenith angle corresponds with the lag noted in the sunset point of inflection in Fig. 4. Since we have seen that the AM value of $|\log_e \rho|$ varies as the $3/4$ power of $\cos \chi$, and it has previously been established that the E -layer critical frequency varies as the $1/4$ power of $\cos \chi$,¹³ we then should expect $|\log_e \rho|$ to

⁸ Ionospheric Data, CRPL-F, U. S. Dept. of Commerce, National Bureau of Standards, Central Radio Propagation Laboratory, Washington, D. C.

⁹ F. W. G. White and T. W. Straker, "The diurnal variation of absorption of wireless waves," *Proc. Phys. Soc.*, vol. 151, pp. 865-875; September, 1939.

¹⁰ See page 464 of footnote reference 1.

¹¹ J. E. Best and J. A. Ratcliffe, "The diurnal variation of the ionospheric absorption of wireless waves," *Proc. Phys. Soc.*, vol. 50, pp. 233-247; March, 1938.

¹² "The American Ephemeris and Nautical Almanac," United States Government Printing Office, Washington, D. C.; 1949.

¹³ S. Chapman, "The absorption and dissociative or ionizing effect of monochromatic radiation in an atmosphere on a rotating earth," *Proc. Phys. Soc.*, Part I, vol. 43, pp. 26-45; January, 1931.

vary as the cube of the E -layer vertical incidence critical frequency f_c . Examining the records for such a relationship, we are immediately impressed by a similar skewness of these critical frequencies. Using critical frequencies taken from sweep-frequency records the AM value of exponent for 5 cases is 3.8 and the PM, 3.2. Using CRPL monthly means, the values are 2.85 for AM and 2.46 for PM. No other cases were examined because of the lack of high accuracy, local critical frequencies. For so few cases, these values check reasonably well with the value of 3.0. Because of a lag in the critical frequencies, the morning and afternoon values of these exponents are more nearly equal than are the exponents on $\cos \chi$.

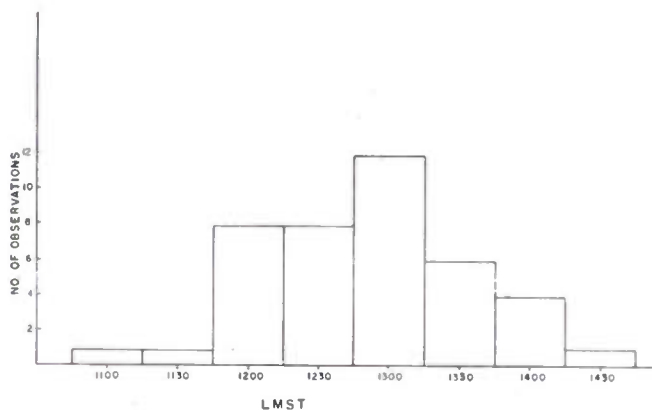

Fig. 5—Histogram of the location of the daily maximum absorption.

The lag in the diurnal variation of the ionization by observation of critical frequencies has previously been reported by Best, Farmer, and Ratcliffe,¹⁴ and Kirby, Gilliland, and Judson.¹⁵ This phenomenon can be explained in terms of recombination in Chapman's theory. Wilkes¹⁶ has calculated the value of recombination

¹⁴ J. E. Best, F. T. Farmer, and J. A. Ratcliffe, "Studies of region E of the ionosphere," *Proc. Roy. Soc.*, vol. 164, pp. 96-116; January, 1938.

¹⁵ S. S. Kirby, T. R. Gilliland, and E. B. Judson, "Ionospheric studies during partial solar eclipse of February 3, 1945," *Proc. I.R.E.*, vol. 24, pp. 1027-1041; July, 1936.

¹⁶ M. V. Wilkes, "Theoretical ionization curves for the E region," *Proc. Phys. Soc.*, vol. 51, pp. 138-146; January, 1939.

coefficient from the above investigator's experimental results. He has shown that the lag is small where the layer is the densest, but that the lag increases at lower levels, which conforms nicely with the 150-kc results.

CONCLUSIONS

The analysis of the absorption data has brought out several important facts. First, the vertical incidence absorption at night is in the order of 1 neper, and the maximum absorption in the daytime varies from 2 nepers in midwinter to about 7 nepers in midsummer. Second, the exponent on $\cos \chi$ that relates it to the total absorption is about 0.7 for the morning and 0.6 for the afternoon. Third, a seasonal anomaly exists on long waves. Finally, a lag in the absorption with the sun's zenith angle is quite predominant.

ACKNOWLEDGMENT

The author would like to acknowledge the guidance of A. H. Waynick. This work was supported in part by Contract AF19(122)-44 with the U. S. Air Force, through the sponsorship of the Geophysical Research Directorate, Air Materiel Command.

TABLE I
STATISTICAL ANALYSIS ON EXPONENT ON $\cos \chi$

	AM				PM			
	N	\bar{X}	σ	CV	N	\bar{X}	σ	CV
1. Total Data	41	0.75	0.265	35%	27	0.65	0.454	70%
2. Without Ionospheric Storms	39	0.763	0.26	35%	27	0.65	0.454	70%
3. Without Magnetic Storms	37	0.75	0.26	34.6%	27	0.65	0.454	70%
4. Less Sporadic	32	0.755	0.41	54%	25	0.654	0.46	71%
5. Best Data	10	0.62	0.202	32.5%	8	0.42	0.158	37.6%

Legend: N = the number of days
 \bar{X} = arithmetic mean of exponent on $\cos \chi$
 σ = standard deviation
 CV = coefficient of variation = σ/\bar{X} .



Secondary-Emitting Surfaces in the Presence of Oxide-Coated Cathodes*

S. NEVIN†, AND H. SALINGER†, FELLOW, IRE

Summary—The experiments described here show that the deleterious effect of oxide cathodes on secondary-emitting surfaces of silver magnesium can be overcome by using tantalum instead of nickel as the base metal for the oxide coating.

IT IS WELL KNOWN that secondary-emitting materials are subject to contamination from heated cathodes. The deterioration in secondary emission caused by this contamination is so serious that tubes using a hot cathode source and electron multiplication have usually¹⁻³ been specially designed so as to make the target ("dynode") less accessible to material coming from the cathode. According to a recent paper by Mueller,⁴ this difficulty has been overcome for filamentary cathodes and also, to some extent, for indirectly heated cathodes.

The experiments described here were entirely confined to indirectly heated cathodes, and as they resulted in a novel means to avoid the contamination, a short report on them may be of interest.

I. EXPERIMENTAL TECHNIQUE

A. Tubes

While an oxide cathode is being formed, its temperature is raised, for a short time, to a value which may be about 200° above its operating temperature. It is thus possible that the target contamination occurs, at least in part, during the forming process. Most of the experiments were therefore performed with tubes as shown in Fig. 1, with a sliding target which did not face the cathode during formation. The arrangement is cylindrical. The straight cathode *K* (diameter $\frac{1}{8}$ inch) occupies the center; it is surrounded by a collector which is shaped as a squirrel cage (24 tantalum wires, three of them 0.015 inch, the others 0.005 inch thick, held together by top and bottom Ta ribbons; outside diameter $\frac{3}{8}$ inch). The target is coaxial with the cathode and collector and can slide on three support rods *S*. On the pump the tube is mounted upside down, so that the target slides by gravity into the position shown in the drawing. In operation, it slides down to surround the collector.

* Decimal classification: R331. Original manuscript received by the Institute, May 11, 1950.

This work was done in 1948 under Contract W36-039-sc-33864 with the Evans Signal Laboratory.

† Capehart-Farnsworth Corporation, Fort Wayne, Ind.
¹ M. Chauvierre, "Secondary emission amplifier tube," *Tele-Tech.*, vol. 6, p. 69; July, 1947.

² H. M. Wagner and W. R. Ferris, "The orbital-beam secondary-emission multiplier for uhf amplification," *Proc. I.R.E.*, vol. 29, pp. 598-602; November, 1941.

³ C. S. Bull and A. H. Atherton, "A new secondary cathode," *Proc. IEE*, vol. 97, pp. 65-71; March, 1950.

⁴ C. W. Mueller, "Receiving tubes employing secondary electron emitting surfaces exposed to evaporation from oxide cathodes," *Proc. I.R.E.*, vol. 38, pp. 159-164; February, 1950.

A similar construction, without the movable features, was used on fixed-target tubes, in which the target is permanently exposed to the cathode.

Eight per cent, 4 per cent, and 1.7 per cent Mg-Ag alloy was used as target material, but the final experiments all used the 1.7 per cent alloy.

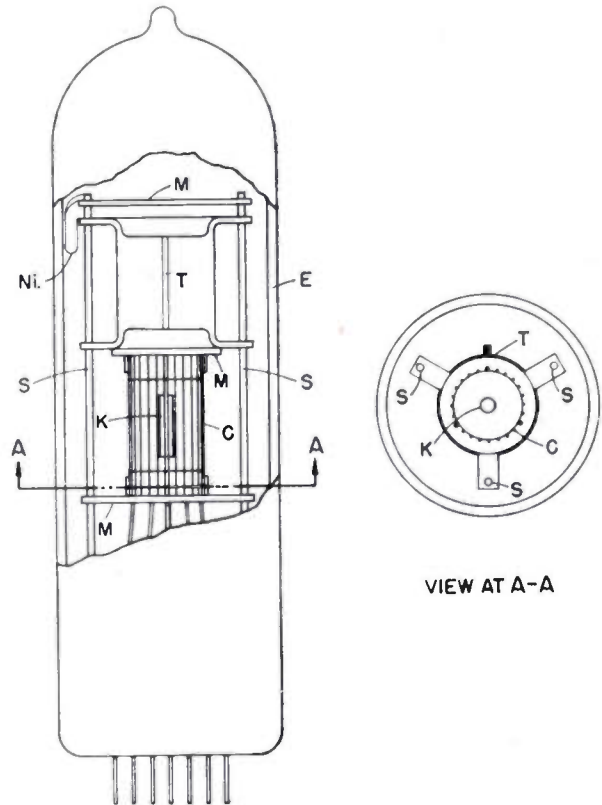

Fig. 1—Sliding target tube.

K = cathode
C = collector
T = target
M = mica disks
Ni = nickel ribbon
S = support rods
E = glass envelope.

B. Forming Schedules

The procedure which worked best was as follows: The tube, after assembly of parts, is given a vacuum bake-out at 460°C, and then the cathode temperature is raised in steps, so as to outgas it. The cathode is then flashed to about 1,150°C (true temperature), and then the collector is brought up to about 200 v, with the emission rising up to 80 ma. Thereafter, the cathode is cooled, oxygen is admitted, and the target is heated for about 1 minute with radio-frequency current. This oxidizes the target, but damages the cathode so that it

has to be re-formed. Then the getter (if a getter was used) is flashed and the target once more outgassed by radio-frequency current after which the tube is sealed off.

Numerous variations of this process (such as a bake in ozone) were used at one time or other.

C. Secondary Emission

The secondary emission was measured under standardized conditions: 100 volts on the target, 200 volts on the collector; the primary current density on the target was 2.6 ma per square centimeter.

The secondary emission coefficient K was defined as

$$K = \frac{I_c}{I_c - I_t} \quad (1)$$

where I_c and I_t are collector and target currents. This formula neglects the fraction α of the primary electrons which are intercepted by the collector without ever reaching the target. If this fraction is taken into account, it is found that the "true" secondary-emission coefficient K_t is connected to K as defined above by the formula

$$K - 1 = (K_t - 1)(1 - \alpha). \quad (2)$$

Attempts to determine α met only with a limited success; the best estimate is that $\alpha = 20$ per cent in our tubes. This would mean that $K = 3$ really corresponds to a "true" coefficient $K_t = 3.5$. The data recorded below refer to K rather than K_t , because K gives a more direct measure of the practical gain than can be realized in a secondary-emission tube.

The K measurements were performed with direct current, but in order to guard against the possible presence of time delays, as in the Malter effect,⁵ it was ascertained that the collector current perfectly reproduces the cathode-emission variations, at least up to 1 Mc.

For life tests, it was necessary to keep the primary emission current of the cathode constant. This proved difficult, because any excess emission led to a noticeable increase in collector temperature which, by radiation, caused the cathode temperature to rise, thus increasing the emission still further. For the life tests, therefore, a thyatron circuit was used in the filament supply, controlled by the emission current so as to keep it constant.⁶

II. RESULTS

Early results indicated that the decay in secondary emission depended very much on the cathode temperature. It became increasingly clear that the contamination came from the nickel base rather than from the oxide (barium-strontium carbonate, sprayed to a

thickness of 0.002 inch with an amyl acetate binder, was used throughout). The base was a nickel sleeve (#799 DII in most cases). By a properly chosen formation schedule, we finally succeeded in achieving a constant secondary-emission ratio over several hundred hours on sliding targets. But even more constant results were obtained, on fixed as well as sliding targets, after the nickel sleeve had been replaced by tantalum. This was done on the assumption that a material which evaporated less easily than Ni should be used.

Fig. 2 shows life data taken on tube #365 (sliding target) and #368 (fixed target), both of which had a Ta sleeve as base for the oxide coating. As a further proof that Ta sleeves, even when run at overtemperature, cause no contamination, the record of tube #358

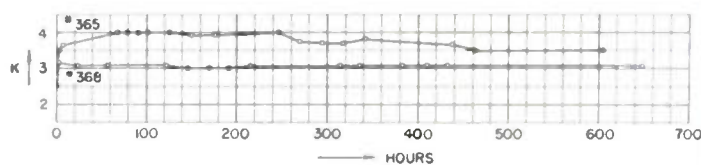

Fig. 2—Effective secondary-emission coefficient K of two representative tubes with tantalum cathode bases as a function of hours of operation.

is offered: This tube was operated at the usual emission current of 10 ma for 240 hours, showing a secondary-emission coefficient of $K = 3.2$. From 240 to 375 hours the emission was raised to 15 ma, giving $K = 3.4$. Thereafter, the emission was raised to 40 ma for 8 hours. During this time, values of K between 2.3 and 2.5 were measured, but it is almost certain that space charge formed between target and collector. When the emission was again lowered to 10 ma, K was 2.9 and stayed at this value. Similar, though less exacting, experiments with Ni always showed a rapid and permanent decay of K to values below 2.

One other experiment may be quoted to support the idea that the nickel sleeve is the source of contamination. In a tube of somewhat different construction it was possible to expose a target to a #799 Ni base without oxide coating. This base was heated to about 900°C. K dropped within 4 hours from its initial value of 3.2 to 1.9.

A similar experiment was performed in which Ba was evaporated. This, too, caused a rapid decay in secondary emission. The decay caused by an oxide cathode has commonly been ascribed to barium^{3,4,7,8} while there are also accounts⁹ which seem to minimize the importance of Ba. From our experiments, we are inclined to agree with this latter view.

⁷ J. B. Johnson, "Secondary electron emission from targets of Ba-Sr oxide," *Phys. Rev.*, vol. 73, pp. 1058-1073; May 1, 1948.

⁸ J. L. H. Jonker and A. J. Overbeck, "Application of secondary emission in amplifying valves," *Wireless Eng.*, vol. 15, pp. 150-156; March, 1938.

⁹ G. E. Moore and H. W. Allison, "Thermionic emission from thin films," *Phys. Rev.*, vol. 77, pp. 246-257; January 15, 1950.

⁵ L. Malter, "Thin film field emission," *Phys. Rev.*, vol. 50, pp. 48-59; July 1, 1936.

⁶ This circuit was designed and built by H. Beach.

III. DISCUSSION

While these experiments prove that the main source of contamination comes from the Ni sleeve, there may be some doubt whether the nickel itself is to blame or some impurity in it. It may however be noted that Ni reaches a vapor pressure of 10^{-5} mm Hg at $1,160^{\circ}\text{C}$, i.e., slightly above the operating temperature, whereas Ta would have to be heated to $2,400^{\circ}\text{C}$ in order to reach the same vapor pressure.¹⁰ It is, therefore, quite possible that the contaminating substance is the nickel itself.

Using Ta, or some other metal with a low vapor pressure, instead of Ni, is entirely practical. It has been

¹⁰ Data taken from S. Dushman, "Scientific Foundations of Vacuum Technique," John Wiley and Sons, Inc., New York, N. Y., and London, England, pp. 745-751; 1949.

On Poisoning of Oxide Cathodes by Atmospheric Sulfur*

H. A. STAHL†

BY ELECTRON diffraction Huber and Wagener have found that on commercial oxide cathodes occasionally a face-centered space lattice appears.¹ According to the lattice constant ($d=6, 37 \text{ \AA}$ u.), this lattice had to be attributed to barium sulfide. The question as to the origin, and effect of that sulfide on the emissivity was followed up during World War II.

This investigation was carried through both on colloidal mixed carbonates, after Buzágh and co-workers, and routine pastes precipitated from barium-strontium nitrate, or hydroxids. All the cathodes were either spread cathodically, or sprayed upon flat casings. In the latter case, an additional surface glazing by means of an amber roller was necessary. After conversion to oxide in the diffraction camera the cathodes were scrutinized at grazing incidence.

So as to identify the origin of cathodic sulfur, about 120 cathodes were distributed into several groups and stored for several months. They were laid on routine bakelite trays, on fluted cardboards, in Petri dishes, or were hung on nail boards, all exposed to the free access of air. Some control cathodes were sealed into glass bulbs, and evacuated.

These storage experiments showed that the strongest diffraction rings of BaS space lattice appear after a period fluctuating

* Decimal classification: R331. Original manuscript received by the Institute, March 21, 1949; abstract received, August 31, 1950. This paper has appeared in *Applied Scientific Research*, vol. B1, p. 397; 1950. Ir. C. W. Kosten, Editor, Mijnbouwplein 11, Delft, Holland.

† U. S. Troop Information and Education School, Stuttgart-Vaihingen, U. S. Zone, Germany.

¹ H. Huber and S. Wagener, "Die kristallographische Struktur von Erdalkalioxydgemischen," *Zeit. für tech. Phys.*, vol. 23, p. 10; 1942.

within wide limits from some days to several months, and that on all cathodes, except in sealed ones, nearly simultaneously. If so, the barium sulfide ring intensity gradually increased with storing period. As to the speed of sulfurizing, no reproducible results could be attained, however.

The observations suggested that cathodic sulfur originates from atmospheric air, the sulfur content of which varies, especially in cities and industrial districts, by a factor of 10^4 . An average value is approximately 10³ per cent by volume.

Tests on freshly made cathodes showed strong barium sulfide rings after exposing them for some seconds to hot combustion gases of a city gas-fed Bunsen burner. The same result appeared with cathodes exposed for 15 minutes to air containing 1 per cent sulfur dioxide, hydrogen sulfide, or carbon disulfide.

Emission measurements on sulfurized cathodes yielded a remarkable decrease of emissivity with increasing sulfur content (see Fig. 1). In accordance with Hiroshi Kamagawa's results on glasses rich in barium oxide,² it was concluded that on the cathode surface that was not broken down, a barium sulfite or sulfate was formed by atmospheric sulfur. This was thought to be reduced while converting at 1360°K , because of the carbon content of the colloidal paste used. Attempts to confirm the existence of sulfite or sulfate on the spread carbonate surface failed, however.

It was felt worth while mentioning that several air-hygienists employ Ost's "barya

² Hiroshi Kamagawa, "Secondary emission and electron diffraction on the glass surface," *Phys. Rev.*, vol. 2, pp. 58, 660; 1940.

argued that oxide cathodes on a Ni base have a higher efficiency than those on other base metals. Our experiments have not extended in that direction; however, even if it should be found that the cathode temperature has to be slightly higher on Ta than on Ni, this would be a small price to pay for the resulting increase in tube life.

As good results were obtained in fixed-target tubes, it is seen that no special structure is required to prevent exposure of the target to the cathode during formation. This may be stated somewhat more generally as follows: Any contaminating agent which might come from the cathode during formation will be harmless if it is either not evaporated below the cathode-forming temperature ($1,100^{\circ}\text{C}$) or else if it does not react with the target and can be re-evaporated below the target outgassing temperature (about 600°C).

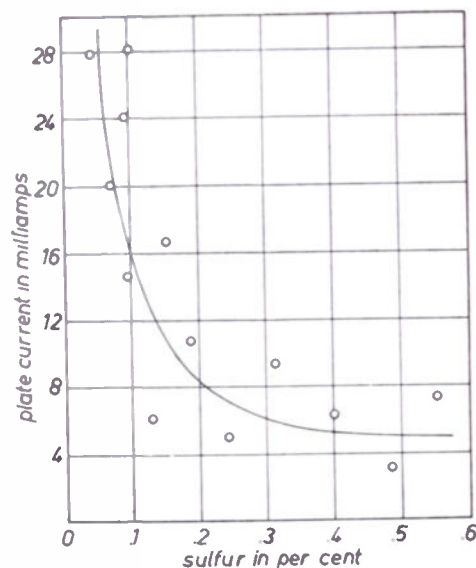

Fig. 1

patch method," the main feature of which is barium carbonate as a detergent for atmospheric sulfur (both SO_2 and SO_3).³ The action of barium carbonate in this case is, in several respects, much the same as on the cathode surface. Their manners of spreading differ by irrelevant subordinates only.

³ H. Ost, "Schwefelsäure in der Atmosphäre," *Chem. Industrie*, vol. 23, p. 292; 1900. Also "Der Kampf gegen schädliche Industriegase," *Zeits. für angew. Chem.*, vol. 20, p. 1692; 1907. Also M. Bamberger and T. Nussbaum, "Luftuntersuchungen zur Feststellung Rauchsäden," *Z. angew. Chem.*, vol. 41, p. 23; 1928.

Correspondence

Amplification by Acceleration and Deceleration of a Single-Velocity Stream*

A method of amplification at microwave frequencies based upon the growth of space-charge waves in a decelerating stream of electrons has recently come to our notice. This mechanism became evident during a study of the type of waves described by Hahn¹ and Ramo.² It was found here that these waves not only change in length as the stream velocity changes, but also change in amplitude.

By a suitable combination of gradual decelerations and sudden accelerations, the amplitude of the space-charge wave may be essentially arbitrarily increased without the necessity of either wave carrying circuits, additional ions, or electron streams with different or distributed velocities, or space-charge-produced differences of velocity in a single stream.

An even simpler mechanism of amplification involving only short accelerating and decelerating gaps and constant potential drift regions exists which is closely related to the one just described. Consider a space-charge wave with ac velocity v_1 and an ac convection current density i_1 on a stream of electrons at a dc velocity u_1 , described by

$$v = v_{1m} \cos \left(\frac{\omega p_1}{u_1} z \right) e^{j(\omega t - \omega z/u_1)} \quad (1)$$

$$i_1 = j v_{1m} \frac{\omega}{\omega p_1} \frac{I_0}{u_1} \sin \left(\frac{\omega p_1}{u_1} z \right) e^{j(\omega t - \omega z/u_1)}, \quad (2)$$

where $\omega p_1^2 = \eta I_0 / \epsilon u_1$ and I_0 is the dc beam-current density. Now if at a position along the stream at which the ac velocity reaches its maximum value v_{1m} , the dc velocity is suddenly changed from u_1 to a lower value u_2 , the ac velocity will increase from v_{1m} to v_{2m} such that

$$v_{2m} = v_{1m} \frac{u_1}{u_2}, \quad (3)$$

provided only that the dc velocity change occurs in a distance which is short compared with a quarter space-charge wavelength at the lower velocity. That this is so can be demonstrated by simple kinematics or by application of the Llewellyn-Peterson diode equations.³

If the beam is then allowed to drift at the low velocity u_2 for an odd number of quarter space-charge wavelengths, that is, until the ac velocity has disappeared and the ac convection current which it produces is a maximum, this current i_2 will be

$$i_2 = i_{2m} = i_{1m} \left(\frac{u_1}{u_2} \right)^{3/2}, \quad (4)$$

in which i_{1m} is the maximum ac convection-current density which would have been produced by the velocity modulation v_{1m} , if the stream had remained at the velocity u_1 . At this point the stream may be suddenly returned to the dc velocity u_1 . If this is again done in a distance which is short compared with the quarter space-charge wavelength at the lower velocity, the ac convection current is continuous across the gap, and the stream has returned to the original dc velocity with an ac current modulation which has been amplified from its original value by $(u_1/u_2)^{3/2}$. If the beam is again allowed to drift an odd number of quarter space-charge wavelengths, this current will convert to an ac velocity which is also $(u_1/u_2)^{3/2}$ times its original maximum value.

The dc velocity may be suddenly dropped again and the whole process repeated. Thus each stage consisting of one short low-velocity drift space and one long high-velocity drift space will provide an ac power amplification of $(V_1/V_2)^{3/2}$, where V_1 and V_2 are the dc voltages in the high- and the low-velocity drift spaces, respectively.

Amplification appears to be essentially independent of beam-current density, although the density determines the required lengths of the drift spaces, and the total beam current determines the maximum obtainable ac convection current, and hence the large signal saturation level.

An amplifier based on the above principles has been constructed and has provided a net power gain of 22 db at 3,000 Mc, using a single low-voltage drift region at 51 volts and two helices at 1,900 volts for modulation and demodulation of the stream. With the potential of the center drift region raised to 1,900 volts, the gain changed to zero db. Gain of progressively larger amounts was observed at drift region voltages of 178 volts, 117 volts, 78 volts, and 51 volts corresponding to n quarter space-charge wavelengths in the 5-cm drift space where n was 5, 7, 9, and 11, respectively. The total beam current was 0.7 ma and the approximate beam diameter, 0.15 cm.

At sufficiently low signal frequencies, the effective plasma frequency in the stream is reduced because of the finite beam size, and consequently the gain is reduced. At very high frequencies, it becomes difficult to excite the first-order plasma waves used in the above discussion, and higher-order space-charge waves will appear. It seems that they can be used to give gain, but require longer drift spaces and will saturate at lower power levels.

Finally, it might be mentioned that space-charge waves may be decreased as well as amplified by using similar principles, and where noise exists on the stream in the form of space-charge waves, the noise content in a limited frequency range may

be reduced in this fashion. This has been experimentally verified in some low-noise traveling-wave amplifiers.

LESTER M. FIELD
PING KING TIEN
DEAN A. WATKINS
Electronics Research Laboratory
Stanford University
Stanford, Calif.

The Traveling-Wave Cathode-Ray Tube*

The paper by K. Owaki, S. Terahata, T. Hada, and T. Nakamura on "The Traveling-Wave Cathode-Ray Tube," in the October, 1950, issue of the PROCEEDINGS OF THE I.R.E. reveals significant progress in the field of microwave oscillography. In order to establish the development of this art—for 20 years one of the writer's hobbies—the following comments may be of some interest.

The prototype of the traveling-wave deflecting system are the multiphase deflecting plates.¹⁻³ According to Fig. 1(b) and (c), they consist of subsequent pairs of deflecting plates exhibiting alternate polarity due to their criss-cross connections. Maximum

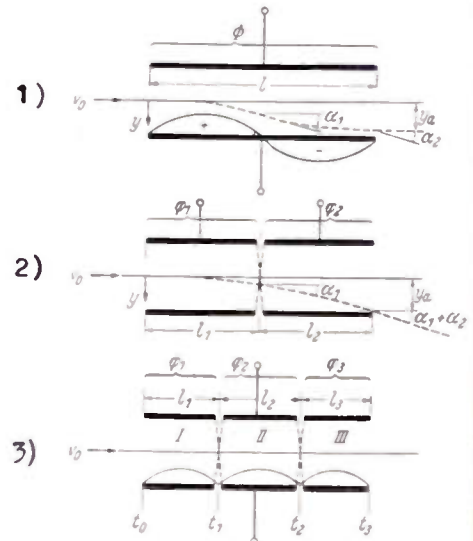

Fig. 1—(1) Single-, (2) two-, and (3) three-phase deflecting field.

* Received by the Institute, November 8, 1950.

¹ H. E. Hollmann, "Die Quersteuerung eines Kathodenstrahls in Mehrphasenfeldern." (Deflection of an electron beam in multiphase fields). *Elek. Nach. Tech.*, vol. 15, p. 336; 1938.

² H. E. Hollmann, "Das Verhalten der Kathodenstrahlröhre im Laufzeitgebiet." (The behavior of the cathode ray tube in the transit-time range). *Foris. der Hochfrequenz.*, vol. 1, p. 453; 1941.

³ H. E. Hollmann, "Physik und Technik der Ultrakurzen Wellen." (Physics and technique of vhf), vol. 2, chapter 6, section 3, d; Berlin, 1936.

* Received by the Institute, November 29, 1950. The research necessary for this correspondence was sponsored by the Office of Naval Research, the United States Army Signal Corps and the United States Air Force.

¹ W. C. Hahn, "Small signal theory of velocity modulated electron beams." *Gen. Elec. Rev.*, vol. 42, pp. 258-270; June, 1939.

² S. Ramo, "Space charge and field waves in an electron beam." *Phys. Rev.*, vol. 56, p. 276; August, 1939.

³ F. B. Llewellyn and L. C. Peterson, "Vacuum-tube networks." *Proc. I.R.E.*, vol. 32, pp. 144-166; March, 1944.

sensitivity occurs, of course, if frequency and beam velocity are matched in such a manner that the traveling electrons pass the partial fields always whenever they have the same polarity.

The improvement caused by the multiphase deflection, as compared with a single field (Fig. 1(a)) under dc operation, can be expressed by means of the multiphase inversion formulas:

$$P_1 = \frac{\sin \frac{\Phi}{2}}{\frac{\Phi}{2}} = \frac{1}{\Phi} \sqrt{2(1 - \cos \Phi)}$$

$$P_2 = \frac{\sin^2 \frac{\Phi}{4}}{\frac{\Phi}{4}} = \frac{2}{\Phi} \left(1 - \cos \frac{\Phi}{2}\right)$$

$$P_3 = \frac{\sin \frac{\Phi}{2} - 2 \sin \frac{\Phi}{6}}{\frac{\Phi}{2}} = P_1 - \frac{4}{\Phi} \sin \frac{\Phi}{6}$$

wherein Φ denotes the transit-time angle over the total deflecting system:

$$\Phi = \frac{\omega l}{v_0} = 2\pi \frac{lc}{\lambda v_0} = \frac{\pi l}{\lambda \sqrt{V_p} \text{ volts}} \times 10^3$$

(c =velocity of light; v_0 =beam velocity; V_p =plate voltage). The function P_1 is the almost classic inversion factor of a single field,²⁻⁶ i.e., the dynamic sensitivity at any vhf referred to the static sensitivity. The functions P_2 and P_3 are the two- and three-phase versions. All three functions are diagrammed in Fig. 2. The two-phase system for dc produces no deflection whatsoever because the first partial field compensates

the second field. The curve of the three-phase system starts at $\frac{1}{2}$ because only one partial field remains effective. The loss of static sensitivity, however, is compensated for by the shifting of the dynamic maxima towards higher Φ -values or higher frequencies, respectively. The first P_2 -maximum occurs in the vicinity of 2π and P_3 in the vicinity of 3π which, in terms of present-day language, means accord between phase and beam velocity.

The inversion spectrograph^{2,7,8} produces the inversion spectra shown in Fig. 3. The stray fields,⁶ not included in the multiphase analysis, assure only a qualitative agreement between formulas and experiment. The fact

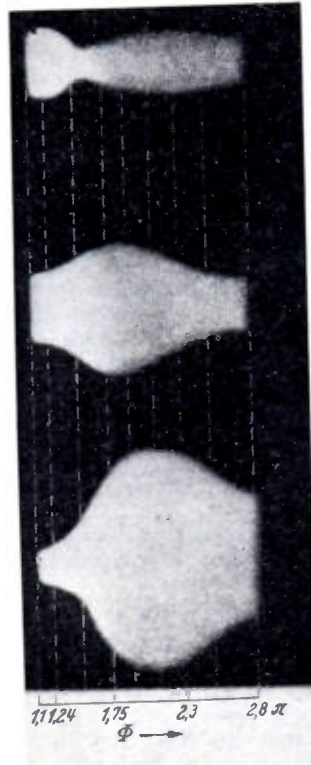

Fig. 3—Experimental inversion spectra of the multiphase systems.

that the maxima of an N -phase system remain below one and do not appear accurately at $N\pi$ is caused by the transit-time effects of the first kind, i.e., by the transit time elapsing in each individual field as well as by the phase-jumps.

The disadvantage of the earlier multiphase systems with equal and adjacent fields can be overcome by various means. The simplest method is to diminish the axial length of the partial fields so that they operate quasi-statically with sufficient interspace in-between; however, this does not eliminate the stray field effects. Another method was applied by Pierce⁹ in his multiphase or traveling-wave oscilloscope, wherein

the former phase opposition is reduced by means of lumped-constant circuits, each feeding an individual pair of plates. From this device, only a short step leads to the traveling-wave oscilloscope described in Heaff's patent¹⁰ and by the Japanese authors.

The ultradynamic Lissajous figures shown in the Japanese paper are the same as the writer's figures taken as far back as ten years ago.^{2,8,11,12} The writer's method of a graphical analysis may well be applied to the Japanese figures. This may easily be understood because the traveling-wave system eliminates only the transit-time effect of the first kind but does not affect that of the second kind, namely, the transit time between both perpendicular deflecting fields.

All in all, the analogy between the step from the multiphase plates to the traveling-wave oscilloscope on the one hand and the step from the linear electron decelerator to the traveling-wave tube on the other hand is quite obvious.

HANS E. HOLLMANN
Oxnard, Calif.

¹⁰ A. Heaff, U. S. Patent No. 2,064, 469.
¹¹ H. E. Hollmann, "Ultradynamische Lissajous-Figuren." (Ultradynamic Lissajous figures), *Zeit. für Hochfrequenz.*, vol. 54, p. 19; 1939.
¹² H. E. Hollmann, "Mikrowellen-Oszillographie" (Microwave oscillography), *Zeit. für Hochfrequenz.*, vol. 54, p. 188; 1939.

Representation on Circuit Diagrams of Conductors in Contact*

In Fig. 14 of M. A. Schultz's paper¹ on "Linear Amplifiers," the lead to C26 and J4 (discriminator output) is drawn as making contact with the "ground" line. This is an obvious mistake, caused by putting a spot at the intersection of two conductors.

This occurrence prompts me to draw attention to the recommendation which has appeared for the last sixteen years in the British Standard Specification No. 530:²

"Of wires meeting at a connecting point, not more than two should be shown colinear."

They should be shown thus:



and not:



In my experience, neglect of this recommendation has been responsible for many mistakes, and I am careful never to draw a cross with a spot at the point of intersection.

I suggest that this recommendation might with advantage be adopted in an American Standard.

It is suggested that readers having comments on this subject address them to the chairman, IRE Symbols Committee, 1 East 79 Street, New York 21, N. Y.—The Editor.

L. H. BAINBRIDGE-BELL
Haslemere, Surrey
England

Fig. 2—The dynamic sensitivities of the three systems shown in Fig. 1 versus transit-time angle.

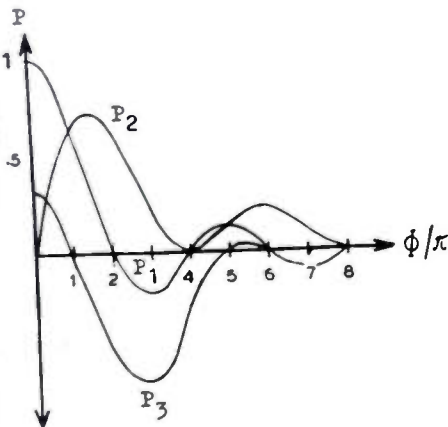

⁴ H. E. Hollmann, "Die Braunsche Röhre bei sehr hohen Frequenzen" (The cathode-ray tube at vhf), *Zeit. für Hochfrequenz.*, vol. 40, p. 97; 1932.
⁵ H. E. Hollmann, "The use of the cathode-ray oscilloscope at ultra-high frequencies," *Wireless Eng.*, vol. 10, pp. 430 and 484; 1933.
⁶ H. E. Hollmann, "The dynamic sensitivity and calibration of cathode-ray oscilloscopes at very high frequencies," *Proc. I.R.E.*, vol. 38, p. 32; January, 1950.

⁷ H. E. Hollmann, "Das Inversionsspektrum einer Braunschen Röhre." (The inversion spectrum of a cathode-ray tube), *Zeit. für Tech. Phys.*, vol. 19, p. 259; 1938.
⁸ H. E. Hollmann, "Ultra-high frequency oscillography," *Proc. I.R.E.*, vol. 28, p. 213; 1940.
⁹ J. R. Pierce, "Traveling-wave oscilloscope," *Electronics*, vol. 22, p. 97; November, 1949.

* Received by the Institute, June 22, 1950.
¹ M. A. Schultz, "Linear amplifiers," *Proc. I.R.E.*, vol. 38, pp. 475-485; May, 1950.
² For further details, see L. Bainbridge-Bell, "Drawing circuit diagrams," *Wireless World*, vol. 55, pp. 179-180; May, 1949.

Contributors to the Proceedings of the I.R.E.

Arthur H. Benner (S'43-M'50) was born on March 29, 1922, in Leavenworth, Kan. He received the B.S. degree in electrical engineering from the University of Kansas in 1944, and the M.S. degree from the Pennsylvania State College in 1948. In 1950 he completed his work toward the Ph.D. degree at the Pennsylvania State College.



A. H. BENNER

From 1946 to 1949 Dr. Benner was a research engineer with the Ordnance Research Laboratory, State College, Pa. From 1949 through 1950 he was associated with the Radio Propagation Laboratory of that College. He is a member of Sigma Xi and Tau Beta Pi.



Robert C. Ellenwood (A'44) was born in Wooster, Ohio, on July 13, 1917. He received the B.S. degree from Ohio University in February, 1942, and after graduation he was employed by the Crosley Radio Corporation as a development engineer. During the war he served as a radio technician in the United States Navy. From 1945 until 1950 he was employed by the National Bureau of Standards as a research engineer to work on ultra-high-frequency standards and associated problems.

At present Mr. Ellenwood is an electronics engineer for the Electronics Shore Division, Bureau of Ships, Navy Department, in Washington, D. C.



Gordon C. Dewey (A'47) was born in New York, N. Y., in 1923. He received the B.A. and the M.A. degrees in physics, both from Harvard University.



GORDON C. DEWEY

Mr. Dewey was a wartime member of the staff of the Radiation Laboratory at the Massachusetts Institute of Technology. From February, 1947, to July, 1949, he was associated with the Federal Telecommunication Laboratories, Inc., during which time the work described elsewhere in this issue was carried out.

Since September, 1949, Mr. Dewey has been a member of the Weapons Systems Evaluation Group which was formed in the

National Military Establishment during February, 1949, under the sponsorship of the Joint Chiefs of Staff, the Office of the Secretary of Defense, and the Research and Development Board.



Sze-Hou Chang (S'46-A'48) was born on September 23, 1913, in Ningpo, Chekiang, China. He received the B.S. degree in electrical communications from Chiao Tung University, Shanghai, in 1934. In 1946 he received the M.S. degree in communications engineering and, in 1948, the Ph.D. degree in engineering sciences and applied physics, both from Harvard University.



SZE-HOU CHANG

During the period from 1934 to 1945, Dr. Chang served successively as assistant, lecturer, and professor in Tsing Hua University, Hunan University, and Chiao Tung University, all in China. He was associated with Cambridge Research Laboratories in Cambridge, Mass., as an electronic engineer from 1946 until 1948.

Dr. Chang is now an associate professor of electronic research at Northeastern University, Boston, Mass.



Enoch B. Ferrell (A'25-M'29-SM'43) was born in Sedan, Kan., on June 1, 1898. He received the B.A., B.S. in electrical engineering, and M.A. degrees from the University of Oklahoma in 1920, 1921, and 1924, respectively.



ENOCH B. FERRELL

Mr. Ferrell taught in the department of mathematics of that university until 1924. Since 1924 Mr. Ferrell has been a member of the research department of the Bell Telephone Laboratories, where he has been engaged in work on short-wave and ultra-short-wave radio transmitters, and on relays and switching systems for use in the telephone central-office plant.



Martin W. Essigmann was born in Bethel, Vt., on January 14, 1917. He received the B.S.E.E. degree from Tufts Col-

lege in 1938 and the S.M.E.E. degree from the Massachusetts Institute of Technology in 1947. He was appointed an instructor in



M. W. ESSIGMANN

electrical engineering at Northeastern University in 1938 and served in this capacity until 1944 when he became associated with the MIT Radar School. In 1947 Mr. Essigmann returned to Northeastern University where he is now an associate professor of electrical engineering.

Mr. Essigmann holds associate membership in the American Institute of Electrical Engineers and Sigma Xi, and he is a member of the American Association for the Advancement of Science, the American Society for Engineering Education, and Tau Beta Pi.



Donald Glen Fink (A'35-SM'45-F'47) was born on November 8, 1911, in Englewood, N. J. He was graduated in 1933 from



DONALD G. FINK

the Massachusetts Institute of Technology with the B.Sc. degree in electrical communications. After a year as a research assistant on the staff of the departments of geology and electrical engineering at MIT, Mr. Fink joined the staff of the journal *Electronics*, as editorial assistant. In 1937 he became managing editor; in 1945, executive editor; and in 1946, editor-in-chief. In 1942 he was awarded the degree of M.Sc. in electrical engineering by Columbia University.

Obtaining a leave of absence from *Electronics* in 1941, Mr. Fink became a member of the staff of the Radiation Laboratory at MIT, where, in 1943, he headed the loran division. He then transferred to the Office of the Secretary of War as an expert consultant on radio navigation and radar. During his war service Mr. Fink traveled over 80,000 miles from Cairo, Egypt, to Darwin, Australia, siting loran stations and arranging for the use of the loran system by the allied forces. He participated in the atom bomb tests at Bikini, also.

Mr. Fink is the author of numerous books, including "Engineering Electronics," "Principles of Television Engineering," and "Radar Engineering." As editor of the

Contributors to the Proceedings of the I.R.E.

Proceedings of the National Television System Committee, member of the Television Panel of the Radio Technical Planning Board, and currently as a member of the Joint Technical Advisory Committee, he is active in standardization work, particularly in the field of television.

In 1948, Mr. Fink was chairman of the N.E. Television System Committee, and in 1950 he was a member of the Senate Advisory Committee in Color Television. He is also a member of the Committee on Navigation of the Research and Development Board. He is a member of Tau Beta Pi, Sigma Xi, and Eta Kappa Nu.



Theodore S. George was born on October 10, 1911, at Grove City, Pa. He received the B.S. degree in mathematics from Grove City College in 1932, and the M.A. and Ph.D. degrees in mathematics from Duke University in 1936 and 1942, respectively. From 1938 to 1945 he served as instructor and assistant professor of mathematics at the University of Florida. During the period



T. S. GEORGE

from 1942 to 1945 he was on military leave as a Naval electronics officer, leaving the navy with the rank of lieutenant commander. During this time, he served at sea as radar officer aboard a carrier and later in the Bureau of Aeronautics in charge of development of electronic bombing and fire-control devices.

Since the war Dr. George has been a consulting engineer in the research division of the Philco Corporation doing theoretical work in a variety of electronic problems.



William C. Jakes, Jr. (S'43-A'49) was born in Milwaukee, Wis., on May 15, 1922. He received the B.S.E.E. degree from Northwestern University in 1944, then entered the Navy and served for two years as airborne electronics officer. He returned to Northwestern University in 1946 for graduate study, receiving the M.S. degree in 1947 and the Ph.D. degree in 1949. During part of this time he



W. C. JAKES, JR.

was employed by the Microwave Laboratory at Northwestern as a research associate.

Since July, 1949, Dr. Jakes has been a member of the technical staff of the Bell Telephone Laboratories, Inc., engaged in microwave propagation and antenna studies. He is a member of Sigma Xi, Eta Kappa Nu, and Pi Mu Epsilon.



Theodore J. Marchese (A'44-SM'50) was born in Carlstadt, N. J., on October 17, 1912. In 1932 he was employed by the Federal Telegraph Company as a technician in their vacuum-tube department and he worked at a number of technical and supervisory jobs until 1941, when he joined the engineering department of Federal Telephone and Radio Corporation as a vacuum-tube engineer on large tubes.



T. J. MARCHESE

In 1947 he transferred to the Federal Telecommunication Laboratories, Inc., as an engineer on microwave power generators, and is presently employed in the development of negative-grid and traveling-wave amplifier tubes.

He received the B.S. degree in electrical engineering in 1948 from the evening school of Newark College of Engineering.



Eleanor M. McElwee was born in New York, N. Y., in 1924. She received the A.B. degree in English and mathematics from Ladycliff College, Highland Falls, N. Y., in 1944, and has done additional work in science at Cooper Union.



ELEANOR McELWEE

Miss McElwee was employed by the Western Electric Tube Shop in New York, N. Y., from 1944 to 1947 as assistant product engineer. She joined the staff of Sylvania Electric Products Inc., in 1947, and was in charge of the statistical analysis program and life-testing of tubes for the Product Development Laboratories at Kew Gardens, L. I., N. Y., until early in 1950. She is at present a member of the editorial and information section at the same Laboratory.

Scott Nevin was born on September 11, 1924, in Ithaca, N. Y. He received the B.M.E. degree from Cornell University in 1945.



SCOTT NEVIN

He joined the Capehart - Farnsworth Corporation in Fort Wayne, Ind., in 1946. Since that time, Mr. Nevin has worked on photocathodes. His recent research has also included the study of secondary-emission devices.



Philip Parzen was born on June 28, 1916, in Poland. He received the B.S. degree in physics from the College of the City of New York in 1939 and the M.S. degree in physics from New York University in June, 1946. He is at present completing his work for the Ph.D. degree in mathematics at New York University.



PHILIP PARZEN

During the war he was employed at the Westinghouse Research Laboratories and, since 1947, at the Federal Telecommunication Laboratories, Inc., working on problems in microwave tubes and electromagnetic wave propagation.

Mr. Parzen is a member of the American Physical Society.



George E. Pihl (A'41) was born on February 22, 1915, at Brockton, Mass. He received the B.S. degree in electrical engineering from Northeastern University in 1937 and the M.S. degree in communications engineering from the Harvard Graduate School of Engineering in 1939.



GEORGE E. PIHL

Since 1938 Mr. Pihl has been a member of the faculty of Northeastern University, where he is at present an associate professor. He is a member of the American Institute of Electrical Engineers and Tau Beta Pi.

Contributors to the Proceedings of the I.R.E.

Hugo F. Pit was born in Utrecht, Netherlands, on April 3, 1924. Having attended the Haarlem Gymnasium, he is now studying electrical engineering at the Delft Institute of Technology.



HUGO F. PIT

ing the summer of 1949.

The study of oscillator behavior in this issue of the PROCEEDINGS was a result of his activities in the Central Laboratory of the Netherlands Postal and Telecommunications Services during



Evert J. Post was born in Rotterdam, Netherlands, on October 20, 1914. He received the degree of Physical Engineer from the Delft Institute of Technology.



EVERT J. POST

In 1946 Mr. Post joined the Central Laboratory of the Netherlands Postal and Telecommunications Services at The Hague where he has been primarily concerned with the development of quartz crystals and oscillators.



Mr. William E. Ryan (S'43-A'45) was born in Springfield, Mass., on February 6, 1920. He received the B.S. in both electrical engineering and mathematics from Michigan University in 1943. He was enrolled in evening classes at George Washington University Graduate School in Washington, D. C., from 1946 to 1950. From 1943 to 1944 he was employed by the Naval Research Laboratory



WILLIAM E. RYAN

as a radio engineer assisting in tests of anti-aircraft gun directors.

Since 1944, Mr. Ryan has been employed by the National Bureau of Standards, assisting in the development of field intensity standards. At present he is associated with the Ultra-High Frequency Standards Group of CRPL in Washington, D. C. He is a member of Eta Kappa Nu and Sigma Pi Sigma.

Hans Salinger (A'37-SM'46-F'51) was born in Berlin, Germany, on April 1, 1891. In 1915, he received the Ph.D. degree from the University of Berlin. From 1919 to 1929 he was a research associate at the Reichspostzentramt and, from 1929 to 1935, a professor at the Heinrich Hertz Institute, both in Berlin. In 1936, he joined Farnsworth Television, Inc., and is now a research engineer with the Cape-



HANS SALINGER

hart-Farnsworth Corporation in Fort Wayne, Ind. He is also doing part-time teaching at the Purdue University Extension Center in Fort Wayne.

Dr. Salinger has published numerous papers on filters, measuring methods, electron multipliers, and other subjects. He is a member of Sigma Xi, the American Association for Advancement of Science, and the American Physical Society.



H. A. Samulon (A'46) was born in Graudenz, Germany, in 1915. He attended the Swiss Federal Institute of Technology in Zurich, graduating with the degree of dipl. ing. in 1939. After doing post-graduate work at the Institute of High-Frequency Techniques, he was employed from 1943 to 1947 as an instructor and research engineer at the Institute of Communication Techniques



HENRY A. SAMULON

and the Acoustical Laboratory of the Swiss Federal Institute of Technology.

In 1947, Mr. Samulon joined the Electronics Department (Electronics Laboratory Division) of the General Electric Company, where at present he is mainly engaged in TV problems, with special regard to transient phenomena as well as system problems in black-and-white and color television.



Howard E. Sorrows (A'48) was born in Hewitt, Texas, on August 10, 1918. He received the B.A. degree in mathematics from

Baylor University in 1940. After a year as instructor of mathematics and physics in the Sabinal, Texas, Public High School, he joined the technical staff of the National Bureau of Standards. He attended night classes of the George Washington Electrical Engineering School from 1941 to 1945, following which he entered the Graduate School, receiving the M.A. degree in physics in 1948. At present he is



H. E. SORROWS

enrolled in the University of Maryland Graduate School. From 1941 to 1943 he assisted in various phases of the program for the development of field intensity and voltage standards. During World War II he assisted in several projects of the radar electronic countermeasures program conducted by the National Bureau of Standards for the Bureau of Ships. From 1947 to present he has been in charge of the Ultra-High Frequency Standards Group, Microwave Standards Section, CRPL, Washington D. C.

Mr. Sorrows was a student member of AIEE and is an associate member of Sigma Pi Sigma and Sigma Xi. At present he is a member of the AIEE Sub-Committee Radiation Measurements above 300 Mc.



Raymond E. Zenner (M'46-SM'50) was born in Chicago, Ill., on April 16, 1910. He received the B.S. degree in physics from the University of Chicago in 1933, and has pursued graduate studies at the Illinois Institute of Technology.



R. E. ZENNER

He has been employed in development and research work with the Teletype Corp., the A.B. Dick Co., Eicor, Inc., and the Armour Research Foundation, all of Chicago, on printing telegraph systems and terminal equipment, mimeograph products, magnetic recording research and product design, ordnance development, and tactical situation simulators for training military personnel. He is now supervisor of instrumentation and recording, electrical engineering department, at Armour Research Foundation.

Mr. Zenner is serving on the Sound Recording and Reproducing Committee, the Magnetic Recording Subcommittee, and the Annual Review Committee of the IRE, and also on the RMA Magnetic Recording Subcommittee.

Institute News and Radio Notes

TECHNICAL COMMITTEE NOTES

The Standards Committee, under the chairmanship of Professor J. G. Brainerd, held a meeting on December 14. The following Standards have been approved by this committee: **Proposed Standard on Electroacoustics: Definition of Terms**, prepared by the Electroacoustics Committee of IRE; and **Standard Abbreviations of Radio Electronic Terms**, prepared by the Symbols Committee. . . . On November 28, the **Wave Propagation Committee** held a meeting, at which C. R. Burrows presided as Acting Chairman. Reports on the activities of the various Subcommittees were given by the Chairmen. . . . The **Receivers Committee** under the Chairmanship of R. F. Shea held a meeting on November 1. Reports on the progress of work going on in the Subcommittees were given by the Chairmen. This committee is working towards the completion of a **Standard on Radio Receivers: Methods of Measurement of Spurious Radiation, Frequency Modulation and Television Receivers**. It is expected that this Standard will be available in the Fall of 1951. . . . A meeting of the **Video Techniques Committee** was held on November 16, under the Chairmanship of J. E. Keister. Subcommittee 23.3, **Video Systems and Components**, prepared two tutorial papers which appeared in the January issue of the PROCEEDINGS, and work towards the preparation of more tutorial papers is continuing. The Video Techniques Committee also prepared a **Standard on Television: Methods of Measurement of Electronically Regulated Power Supplies**, published in the January issue of the PROCEEDINGS, reprints of which may now be purchased from Headquarters. . . . Reprints of **Standards on Circuits: Definitions of Terms in Network Topology**, may also be purchased at Headquarters. . . . The proposed **Standards on Electronic Computers: Definition of Terms**, prepared by the Electronic Computers Committee of the IRE, has been approved as an IRE Standard and will be published in the March issue of the PROCEEDINGS. . . . Axel G. Jensen, Chairman of the Definitions Co-ordinating Subcommittee, has distributed to all Technical Committee Chairmen copies of a Proposed standard on **Definitions of Receiver Terms**, prepared by the Receivers Committee, and also a proposed definition for the term "transfer characteristics." This is in line with the new procedure to obtain comments on the definitions by mail prior to submission to the Standards Committee for approval. . . . A **Joint IRE/AIEE Conference on Electron Tubes for Computers** was held on December 11 and 12 at the Haddon Hall Hotel, Atlantic City, N. J. Members of the IRE Technical Committee on **Electron Tubes and Solid-State Devices**, and the Committee on **Electronic Computers**, participated in formulating plans for this Conference. The sessions were well attended and enthusiastic.

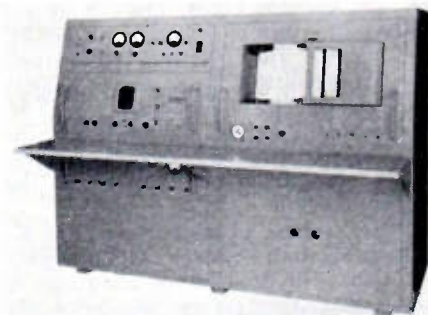

TO BE DISPLAYED AT IRE CONVENTION

The devices shown above, which will be on display at the Armed Services exhibit, are typical of the wide variety of electronic equipment to be shown at Grand Central Palace during the IRE Convention.

At top is the console of a Cloud Base and Top Indicator, capable of measuring the thickness of overhead cloud decks from 300 to 50,000 feet, through rain if necessary. Continuous facsimile recordings are provided.

At bottom is a new device for measuring the extent of exposure of individuals to atomic radiation. The dosimeter, which is worn about the neck, gives readings one minute after exposure through a self-developing photographic process.

Calendar of COMING EVENTS

- 1951 IRE National Convention, Waldorf-Astoria Hotel and Grand Central Palace, New York, N. Y., March 19-22
- URSI Spring Meeting, Washington, D. C., April 16-18
- IRE Southwestern Conference, Dallas, Texas, April 20-21
- 1951 Convention of SMPTE, April 30-May 4, Hotel Statler, N. Y.
- 1951 Annual Meeting of the Engineering Institute of Canada, Mount Royal Hotel, Montreal, May 9-11
- 1951 IRE Technical Conference on Airborne Electronics, Biltmore Hotel, Dayton, Ohio, May 23-25
- 1951 IRE 7th Regional Conference, University of Washington, Seattle, Wash., June 20-22
- 1951 Summer General Meeting of AIEE, June 25-29, Royal York Hotel, Toronto, Canada
- 1951 IRE West Coast Convention, San Francisco, Calif., August 29-31

1951 IRE CONVENTION SLATED FOR MARCH 19-22 IN NEW YORK

The 1951 IRE National Convention, to be held on March 19-22 in New York, N. Y., promises to be the largest and most important convention in Institute history. An extensive technical program of over 200 papers will be presented in 43 sessions and symposia at the Waldorf-Astoria Hotel, Belmont Plaza Hotel, and Grand Central Palace. The Radio Engineering Show, comprising 269 exhibits of electronic and communications equipment and their applications, will fill three floors of Grand Central Palace.

The Convention will open with the Annual Meeting of the Institute on Monday morning, March 19, in the Grand Ballroom of the Waldorf. James W. McRae, director of transmission development for Bell Telephone Laboratories, will be the principal speaker. In addition, reports will be heard from IRE officers concerning the operations of the Institute during 1950. The program of technical sessions will commence on Monday afternoon.

A noteworthy feature of the technical program is the prominent part played by IRE Professional Groups in organizing symposia in their respective fields of interest.

Fourteen symposia are scheduled for this year's program, eleven of which are the result of Professional Group activities. The sponsoring Groups and the titles of their symposia are as follows: Audio Group—"Loudspeakers"; Broadcast Transmission Systems Group—"Broadcast Transmission Systems" and "Panel Discussion on the Empire State Story"; Circuit Theory Group—"New Extensions of Network Theory"; Instrumentation Group—"Amplification of DC Signals," "Panel Discussion on Performance of DC Amplifiers," and "Industrial Instrumentation"; Nuclear Science Group—"Nuclear Reactors"; Quality Control Group—"Panel Discussion on Tube Reliability"; Radio Telemetry and Remote Control Group—"Telemetering Systems" and "Simulation as an Aid To Design of Remote Control Systems."

Symposia will also be held on the following subjects: "Matching Schools and Industry" (sponsored by the IRE Education Committee), "Color Television," and "Some Systems Problems of Air Traffic Control."

The complete program, with abstracts of all papers, will be published in the March issue of the PROCEEDINGS.

The attention of broadcast engineers is called to "Broadcast Day" on Tuesday, March 20, when two Broadcast Group symposia (as noted above) will be held in the morning and afternoon, climaxed by the Color Television symposium on Tuesday night.

Of particular interest to all Professional Group members will be the President's Luncheon on Tuesday where tables will be assigned to each Group, affording Group members a unique opportunity to broaden their contacts within their own fields.

Tutorial Papers Series Begins in this Issue

The first paper in this issue, "Television Broadcasting in the United States, 1927-1950," (pp. 116-123) by Donald G. Fink, marks the beginning of a series of tutorial papers on a wide variety of subjects which are to be published at frequent intervals in the PROCEEDINGS OF THE I.R.E. during 1951 and 1952. These papers are to be educational in nature, of exceptional clarity, and prepared by leading authorities on topics of both present and historical interest.

These tutorial papers are procured by, and published on the recommendation of the Subcommittee on Tutorial Papers (Prof. Ernst Weber, Chairman) of the IRE Committee on Education (Prof. Herbert J. Reich, Chairman). It is believed that members in all grades will derive considerable benefit from this series of tutorial papers.

SARNOFF GOLD MEDAL AWARD IS ESTABLISHED BY SMPTE

The establishment of the David Sarnoff Gold Medal as an annual award for an outstanding contribution to television engineering has been announced by the Society of Motion Picture and Television Engineers.

The award will be presented at the Society's fall meeting to that individual who has done outstanding work in some technical phase of the broad field of television engineering, whether in research, development, design, manufacture or operation, or in any similar phase of theater television.

Terminology for IRE Publications

The publication activities of the Institute may be expanded at some date in the future not as yet determined. In order to avoid confusion, the membership is urged to use the following terminology in their discussions and correspondence when referring to existing and possible future IRE publications:

1. **PROCEEDINGS OF THE I.R.E.**—the official monthly publication of the Institute.

2. **TRANSACTIONS**—publications sponsored by IRE Professional Groups, either in conjunction with or independent of Professional Group symposia and conferences.

3. **CONVENTION JOURNAL**—a publication containing all papers presented at an IRE national convention.

Adoption of the above terminology in no way signifies that plans for the latter two publications are necessarily contemplated or as yet approved by the Institute.

FIRST CALL FOR PAPERS FOR WEST COAST IRE CONVENTION

Authors are invited to submit prospective papers for the 1951 West Coast IRE Convention, particularly in the fields of Antennas, Circuits, Computers, Propagation, and Vacuum Tubes. The Convention will be held in San Francisco on August 29, 30, and 31. The following information should be submitted: (1) Name and address of author, (2) title of paper, and (3) a 100-word abstract and such additional information as may be required in order to properly evaluate the paper for inclusion in the technical program.

Please address all material to J. V. N. Granger, Stanford Research Institute, Stanford, Calif. The deadline for acceptance is May 1, 1951. Your prompt submission will insure full consideration.

DEADLINE SET FOR PAPERS FOR IRE 7TH REGIONAL CONFERENCE

Persons or companies are invited to submit prospective papers for the IRE 7th Regional Conference of 1951, to be held at the University of Washington, Seattle, Wash., on June 20, 21 and 22. In addition, manufacturers are invited to display equipment specifically tied in with the papers they may present. The following information should be submitted: (1) Name of paper, (2) author, (3) person or persons who will present it, (4) synopsis and (5) will equipment tying in with the paper be displayed.

The deadline for acceptance is March 31. Please send all material to J. E. Hogg, Electronics Department, General Electric Co., 1146 Dexter Horton Building, Seattle, Wash.

NAB CONDUCTS THIRD ANNUAL SURVEY OF TV EMPLOYMENT

Approximately 8,500 persons comprise the staffs of the TV stations and networks now on the air, according to an estimate announced by Richard P. Doherty, director of the National Association of Broadcasters' Employee-Employer Relations Department, in the third NAB annual TV employment survey. The compilation was based on information supplied by 56 TV stations (exclusive of networks) for a typical operative week during the late spring of 1950.

The increasing number of television stations which have become operative during the past year has reduced the "per station" employment average from 60 to 57 persons, according to the findings of the survey. The "per station" employment decline is a statistical consequence of the operational increase within the industry. The 1949 survey revealed the average station (exclusive of networks) employed 66 persons (46 full-time and 20 part-time); the mean in the spring of 1950 was 57 (39 full-time and 18 part-time). The reasons, in part, for this drop are that new stations are on the air less time than the established telecasters; and,

for the most part, are located in smaller cities where over-all operation permits a smaller staff.

On the basis of the data collected in 1950, the average staff of 57 persons was made up of the following figures:

Average Staff per TV Station	Number Full-Time Employees	Number Part-Time Employees
Technical	18	1
Film	3	0
Program	10	10
Administrative	6	6
Sales	2	1
Total	39	18

IRE Official Appointed Selective Service Advisor

The six Scientific Advisory Committees, appointed in 1948 by Major General Lewis B. Hershey, Director of the Selective Service System, have recently submitted to the Director a joint report presenting recommendations concerning the training and utilization of scientific, professional, and specialized personnel. The committees represent the six following fields: Agricultural and Biological Sciences, Engineering Sciences, Healing Arts, Humanities, Physical Sciences, and Social Sciences. George W. Bailey, Executive Secretary of the IRE, was appointed by General Hershey to the Engineering Sciences Advisory Committee and has been attending the committee meetings at which the recommendations contained in the recently published report have been formulated. The three other members of that committee are: Chairman, Stephen L. Tyler, American Institute of Chemical Engineers; Alex C. Monteith, Westinghouse Electric Corporation; and Carl R. Soderberg, Massachusetts Institute of Technology.

FELLOWSHIPS ARE AVAILABLE AT STANFORD UNIVERSITY

Stanford University announces that financial assistance, in the form of fellowships and assistantships, is available to a substantial number of well-qualified graduate students who wish to work toward the higher degrees of M.S., Engineer, or Ph.D., either in physics or in electrical engineering, with a special interest in electronics.

Letters of inquiry will be welcomed. For application forms and further details, those who expect to major in electrical engineering should write to Assistantship Committee, E. E. Dept., Stanford University, Stanford, Calif. Those who expect to major in physics should write to Director, Microwave Laboratory, Stanford, Calif.

Applications should be submitted by March 15, 1951.

The Expansion of the IRE Professional Group System

The membership of the Institute may be justly proud of the healthy development of the IRE Professional Groups. It was the aim of these Groups to offer every member the opportunity to affiliate with other members interested in the same engineering specialties as himself. Thus the most advanced information in his preferred fields is rapidly made available to him. The Groups are, in fact, essentially technical societies within the IRE framework. They are an extremely important development, and warrant the interest and support of every member. A detailed description of their work follows. Each member should particularly study that part of this description dealing with fields of particular interest to him. It would be well if each member were to join the corresponding Professional Groups, if he has not already done so.

To join a Group, a member need only write to L. G. Cumming, Technical Secretary, The Institute of Radio Engineers, 1 East 79 Street, New York 21, N. Y., asking for details as to the necessary procedure.—*The Editor.*

In the space of two and one-half years, since the formation of the first IRE Professional Group, the growth of the Group system and the continuing interest in it have proven the worth of the Groups.

Since June 2, 1948, when the Institute approved the petition for the formation of the first IRE Professional Group, nine other Groups have been approved, and all have contributed to the Institute's program. The ten groups are, namely: Audio; Broadcast Transmission Systems; Antennas and Propagation; Nuclear Science; Vehicular Communications; Circuit Theory; Quality Control; Broadcast and Television Receivers; Instrumentation; and Radio Telemetry and Remote Control. Approval is now pending or the petition to form the eleventh, the IRE Professional Group on Airborne Electronics. Membership in the Groups is steadily increasing and bringing with it new members of the IRE. By now the total membership of the ten Groups is in excess of 1,500. Applications for Group membership may be obtained by applying to the Technical Secretary of the IRE.

The growth of the Professional Group System is evidenced by the fact that at the 1950 National Convention, five Groups sponsored symposia. All ten of the Groups are planning to participate at the 1951 National Convention and each has nominated a representative to serve on the Technical Program Committee for this Convention. In addition, plans are underway to set up a procedure for the systematic publication of *Transactions* of Group symposia, which will be accomplished with the cooperation of the Editorial Department. One of the Groups has recently reviewed papers for possible publication in the *PROCEEDINGS*. IRE Sections are kept constantly informed of the activities of the Groups by copies of "Newsletters," Conference Notes, Minutes, etc. Moreover, an account of the Group activities is published each month in the *PROCEEDINGS OF THE I.R.E.*

A short history of the progress made to date by each of the ten Groups follows:

The **IRE Professional Group on Audio** was formed with the approval of the Executive Committee on June 2, 1948. A large national meeting of the Group members took

place on March 9, 1950, during the IRE National Convention. The Group has three times sponsored symposia of national scope: at the Radio Fall Meeting in Syracuse in October, 1949; at the 1950 National Convention of the IRE; and at the Radio Fall Meeting in Syracuse in November, 1950. The electroacoustics session at the 1950 National Electronics Conference in Chicago was arranged by the Group. As a service to its members, the Group began the distribution of Newsletters in March of last year. The Group has reviewed two papers for publication in the *PROCEEDINGS*, and on the initiative of the Group, and in co-operation with the Group, the Editorial Department at Headquarters is attempting to procure six or eight papers on Audio for forthcoming issues of the *PROCEEDINGS*. In December, 1949, a local Group was formed in Boston which has held technical meetings on a monthly basis since its formation. Active local Groups exist in Milwaukee and Washington, D. C., and in Detroit, the local Audio Group has been holding meetings for the past two years. Dr. Leo Beranek of the Massachusetts Institute of Technology is currently serving as the Group's Chairman. A total of 1,126 engineers are now enrolled as members of the national Group.

On July 7, 1948, the second Professional Group came into existence with the approval of a petition to form the Professional Group on Broadcast Engineers. The name of this Group was changed in August, 1949, and it is now known as the **IRE Professional Group on Broadcast Transmission Systems**. The Group is currently conducting a large membership drive aimed at the engineers in all broadcast stations and engineers concerned with the manufacture of broadcast equipment. A substantial mailing has been accomplished for the Group by IRE Headquarters which will undoubtedly result in an increase of IRE membership. The Group in the past two years was not sufficiently organized to sponsor a national symposium, but is looking toward the 1951 National Convention with a great deal of interest. A full day's program is being planned for "Broadcast Day" in March. It is anticipated that several papers presented on Broadcast Day will be submitted for possible publication in the *PROCEEDINGS*. In the summer of

1949 a lively program was inaugurated by the local Boston Group which has resulted in several technical meetings. Mr. Lewis Winner of Bryan Davis Publishing Company is the Group's Chairman and 808 members of the national Group are now enrolled.

On February 1, 1949, the third Group, **IRE Professional Group on Antennas and Propagation**, was formed. The national Group has been very active since the date of its formation and a great deal of time has been given by its officers toward a full and stimulating program. On October 31, November 1 and 2, 1949, in Washington, D. C., the Group, together with URSI, sponsored a highly successful symposium. On April 3 and 4, 1950, another successful symposium was sponsored with URSI, this time in San Diego, Calif. Dr. L. C. Van Atta, last year's Group Chairman, has prepared an excellent article entitled "The Role of Professional Groups in the IRE," which was published in the October, 1950, issue of the *PROCEEDINGS*. In accordance with the Institute's policy, abstracts of the papers presented at the Group's San Diego symposium were published in the *PROCEEDINGS* in August, 1950, and the Group has sponsored four papers which will be packaged as a single article for publication in a forthcoming issue. The Group's present Chairman is Mr. Newbern Smith of the National Bureau of Standards. A total of 910 members are presently enrolled in the national Group and, in addition, 300 applications for membership are pending. The Group will undoubtedly be one of the largest in the Institute.

On April 5, 1949, the Institute approved petitions for formation of three new Groups. One of these was the **IRE Professional Group on Nuclear Science**. Prior to the formation of the Group, the Technical Committee on Nuclear Studies had sponsored a nucleonics symposium jointly with AIEE. The responsibility for this annual project was assumed by the Group and on October 31, November 1 and 2, 1949, the IRE/AIEE Joint Conference on Electronic Instrumentation in Nucleonics and Medicine was held. Over 750 attended the Conference, which included an exhibition staged by the Atomic Energy Commission and a trip to the Brookhaven National Laboratory. The Group sponsored a similar Conference this year

with the AIEE on October 23, 24, and 25, again in New York City, and a technical session at the 1950 National Convention. Soon after its formation, the Group initiated a regular Newsletter which has been stimulating and informative. The former Committee on Nuclear Studies had initiated the procurement of a series of papers for the PROCEEDINGS. A dozen of these papers were published in 1948 and 1949. Upon the formation of the Group, procurement activities were assumed by the Group and four papers were published in 1950. It is expected that five more will soon be submitted. The Group's present Chairman is Mr. M. M. Hubbard of the Massachusetts Institute of Technology, and its membership totals 518.

Another Group formed on April 5, 1949, was called the Group on Vehicular and Railroad Radio Communications. The name of this Group was changed on July 12, 1950, to IRE Professional Group on Vehicular Communications. On November 3, 1950, in Detroit, the national Group held a full day's technical meeting on Land Mobile Communications at which eight papers were presented. A local Group has been formed in Detroit and steps are being taken toward the formation of local Groups in Chicago, New York, and Portland, Ore. Mr. Austin Bailey of the American Telephone and Telegraph Company is the present Chairman, and the membership totals 413.

The petition to form an IRE Professional Group on Circuit Theory was approved by the Institute's Executive Committee on April 5, 1949. The Group sponsored a technical session at the 1950 National Convention and plans to participate in the 1951 Na-

tional Convention. Organization of the Group has not been completed. In addition to the 29 petition signers who are at present listed as members of the Group, Headquarters has received applications for membership totaling 994. It is expected that organization of the Group will have been accomplished by the time these notes are published. The acting Chairman for the Group is Professor J. G. Brainerd, of the University of Pennsylvania.

On July 12, 1949, the IRE Professional Group on Quality Control was formed by the Executive Committee's approval of its petition. The Group sponsored a technical session at the Radio Fall Meeting in 1949, and a technical session and a symposium at the 1950 National Convention. The Group again sponsored a technical session at the Radio Fall Meeting in 1950. Three papers are being published in the PROCEEDINGS on the recommendation of the Group, two of which are an outcome of the Group's symposium. Mr. R. F. Rollman of Allen B. DuMont Laboratories, Inc., is the Group's present Chairman. The membership totals 316.

The petition to form an IRE Professional Group on Broadcast and Television Receivers was approved by the Institute on August 9, 1949. The Group has been active in sponsoring technical meetings, including two sessions at the Radio Fall Meeting in 1949, a symposium at the 1950 National Convention, and two sessions at the Radio Fall Meeting in 1950. An article by Mr. John D. Reid, procured by the Group, was published in the October, 1949, issue of the PROCEEDINGS. The Group has an active Canadian section. There are 302 presently enrolled as

members of the national Group, and 612 pending applications for membership. The Group's Chairman is Mr. Virgil Graham, of Sylvania Electric Products Inc.

January 31, 1950, saw the inauguration of the IRE Professional Group on Instrumentation. The Group sponsored a symposium on Improved Quality Electronic Components in co-operation with AIEE and RMA in Washington, D. C., on May 9, 10, 11, 1950. The Group sponsored the High Frequency Measurements Conference in co-operation with the Joint IRE/AIEE Committee on High Frequency Measurements which was held in Washington, D. C., on January 10, 11 and 12, 1951. The Group's Vice-Chairman, Mr. H. L. Byerly, has prepared a short article entitled, "Organizing the Professional Group on Instrumentation at the Section Level." Copies of this article may be secured from IRE Headquarters. There exists the nucleus of a local Group in Detroit, but no action has yet been taken to set up local Groups. The Group's Chairman is Professor Ernst Weber, of the Polytechnic Institute of Brooklyn. Its membership totals 1,362, the largest of all the Groups.

The petition for the formation of the IRE Professional Group on Radio Telemetry and Remote Control was approved by the Institute's Executive Committee on July 12, 1950. Members have been appointed to the Administrative Committee and a meeting will soon be called to discuss plans for participation in the 1951 National Convention. The Group has not yet had an opportunity to carry on a membership drive, so at the present its members consist of the twenty-seven petition signers.

PROFESSIONAL GROUP NOTES

The Committee on Professional Groups has drafted revisions to certain pages of the Manual for Professional Groups in order to outline a tentative plan for the publication of papers resulting from Group-sponsored symposia and technical meetings. The proposed plan will provide the Groups with a systematic, and effective manner of publishing the *Transactions* of their conferences and will facilitate the publication of several of these papers in the PROCEEDINGS OF THE I.R.E. . . . A petition to form an IRE Professional Group on Airborne Electronics has been received at Headquarters from George Rappaport of the Dayton Section. It is hoped that the Institute's Executive Committee will be able to act on the petition at its February meeting. If it is approved, the future Group will sponsor the "1951 National Conference on Airborne Electronics" in co-operation with the Dayton Section of the IRE. The Conference will be held on May 23, 24, and 25, 1951. The success of a similar conference held in 1950 lead a group of people to petition for the Professional Group. . . . The regular joint spring meeting of the U.S.A. National Committee of the International Scientific Radio Union (URSI) and the IRE Professional Group on Antennas and Propagation will be held April 16, 17, and 18, 1951, at the Na-

tional Bureau of Standards in Washington, D. C. Information regarding the meeting may be secured from Newbern Smith, Chairman of the Group, at the National Bureau of Standards, Washington 25, D. C. . . . The IRE Professional Group on Audio has distributed Newsletter No. 4 to its members. The letter contains abstracts of five papers presented by the Group at the Radio Fall Meeting and at the Boston and Milwaukee Sections. A ballot for election of new officers and Administrative Committee members was included with the letter. . . . The Administrative Committee of the IRE Professional Group on Broadcast Transmission Systems held a meeting on December 1, 1950, at which plans for Broadcast Day at the 1951 National Convention were discussed. Two hundred applications for membership in the Group have been received as a result of the Group's recent mailing to chief engineers of broadcast stations and manufacturers of broadcast equipment. . . . Members of the initial Administrative Committee of the IRE Professional Group on Circuit Theory have been appointed. J. G. Brainerd, E. A. Guillemin, and W. N. Tuttle will serve on the Committee for a three-year term; W. E. Bradley and J. M. Petit for a two-year term; and R. L. Dietzold, C. H. Page, and J. R. Ragazzini for a one-year term. Professor Brainerd is Acting Chairman of the Group. . . . The IRE Profes-

sional Group on Quality Control has begun implementation of its plan outlined in these Notes in the January issue of the PROCEEDINGS to establish facilities to assist the IRE Sections in preparing local programs and securing outstanding authorities as speakers for meetings. Questionnaires have been sent to all Sections and these will be filled in to indicate the Section's interest or needs for speakers on quality control in the electronics field. The Group's first Newsletter has been mailed to the members. It is planned that a Newsletter will be distributed bi-monthly and will include information relevant to the general subject of quality control, abstracts of papers, and news of Group activities. . . . The recently formed IRE Professional Group on Radio Telemetry and Remote Control has held its first Administrative Committee meeting. In order to secure members for the new Group, a card announcing its formation has been mailed to eight of the IRE Sections which will be most interested in the Group. . . . During the past few months Headquarters has received word of plans on the part of various IRE members which may lead to petitions for several new Professional Groups. The fields in which interest has been expressed in recent communications are: basic science, electronic computers, engineering management, industrial electronics, information theory, and piezoelectricity.

Industrial Engineering Notes¹

MICA REPORT AVAILABLE

The Office of Technical Services has released a transcript of a round-table discussion by industry-military representatives on mica and mica substitutes. Subjects covered in the report include solid-state synthetic mica; World War II mica research; miniature capacitors; cellulose esters; glass and vitreous enamel insulating materials; dimensionally stable ceramics; the use of bloc talc; integrated mica; and new use of mica. Copies of the transcript PB 101 142 may be obtained for 50 cents at the OTS, U. S. Department of Commerce, Washington 25, D. C.

RTCM RELEASES PAPER ON MARINE STANDARDIZATION

The Radio Technical Commission for Marine Services has released a detailed paper on the "Consideration of the Difficulties Which Would Result from a Failure to Standardize Internationally Upon the Use of FM for VHF Marine Communications, including an Analysis of the Advantages of FM over AM for Such Use."

The RTCM report deals with two specific subjects: (1) the operational difficulties which would be brought about by a dual system (FM in Region 2, AM in United Kingdom or other areas), and (2) the advantages which would result from international standardization upon the use of FM.

Copies of the report may be obtained from the Executive Secretary, R. T. Brown, Federal Communications Commission, Washington 25, D. C.

FCC ACTIONS

The FCC has issued detailed statistics on the financial operations of AM and TV stations in 1949. The FCC tabulations, copies of which may be obtained from the Secretary of the Federal Communications Commission, Washington 25, D. C., showed that AM stations had total revenue of \$413,784,633 and total income of \$56,262,915. The four TV networks and their 13 owned and operated stations together with 85 other video outlets had revenues of \$34,329,957 and expenses of \$59,591,906 for a total broadcast loss of \$25,261,950 in 1949. The FCC estimated the investment in TV broadcast stations after depreciation of \$44,941,469.

TELEVISION NEWS

A long list of prominent educators have asked the FCC to set aside vhf-uhf television frequencies and reserve them "indefinitely" for noncommercial educational purposes. Theme of the educators' contentions was that educational broadcasting could not

compete with commercial TV broadcasting either for audience or for frequencies, but that the public interest required the setting aside of TV channels for educational purposes.

CREDIT REGULATION IS AMENDED; DISTRIBUTORS PROTEST RULING

The Federal Reserve Board has announced that it is amending its recently established Regulation "W" which controls consumer credit.

The revised regulation, which increases the required down payment on a TV or radio receiver from 15 per cent to 25 per cent, immediately drew the fire of radio and television distributors and dealers. The revised rules also would reduce the maximum maturity for such purchases from 18 to 15 months and lower the controlled sale from \$100 to \$50.

CONTROLS

The National Production Authority has issued an order which, in effect, sets aside 10 per cent of the zinc produced for military use. The order was issued, NPA said, "to provide for the equitable distribution of priority rated orders among all producers and fabricators of zinc . . ." Two orders affecting the use and distribution of copper were issued by the National Production Authority in efforts to "assure copper supplies for the expanding rearmament program." The NPA order (M-12) limiting non-defense use of copper was milder than had been expected by observers. However, NPA copper officials told RTMA that the current copper situation is worse than it was at any time during World War II. This week's orders were described as the initial step. We are "merely getting our feet wet," one NPA official stated. . . . The National Production Authority has issued an order requiring tin inventories to be held to a 60 days' supply. NPA also called for reports on inventories, receipts, consumption, imports, and distribution of tin. Under the new reporting requirements, all persons having 1,000 pounds or more of pig tin in their possession or under control on the first day of the month must file a report. . . . The National Production Authority has issued an order restricting the use of aluminum for nondefense purposes to 65 per cent of the average quarterly use of the metal during the first six months of this year. The NPA directive became effective January 1. In December of this year, NPA said, users of aluminum will be permitted 100 per cent of their average monthly consumption in the first months of 1950.

MOBILIZATION

John D. Small, former vice-president and executive assistant to the president of Emerson Radio and Phonograph Corp., was recently sworn in as Chairman of the Munitions Board. He was named to his new post by President Truman.

FCC AUTHORIZES TESTS OF SUBSCRIBER-VISION SYSTEM

The FCC has granted the request of the General Teleradio, Inc., licensee of WOR-TV, New York, N. Y., for special temporary authority to test, under certain expressed conditions, the "Skiatron Subscriber-Vision System" during the nonregular hours of operation of that station.

The "subscriber-vision" system of Skiatron Corp. sends a coded "scrambled" TV picture over the air. It can be received only by a receiver equipped with a special decoder. The system employs a coder unit at the camera and another at the receiver. The standard TV synchronizing pulses are fed into a small kinescope tube and projected onto a photoelectric cell, the output of which is used to supply the final synchronizing pulse.

FCC TV NETWORK RESTRICTIONS OPPOSED BY TV BROADCASTERS

About forty petitions were filed in connection with the FCC's proposal to adopt rules that would require TV stations in areas served by less than four stations to use a minimum of program time from each of the four television networks.

Majority of the petitions opposed the FCC proposal to limit one-station areas to the use of only two hours of a single network's programs in the afternoon and nighttime. Most of the petitions also recommended that full-scale hearings be held before the FCC takes any final action.

NEARLY SIX MILLION TV TUBES ARE SOLD IN SIX MONTHS' PERIOD

Television receiver manufacturers purchased 5,934,391 TV picture tubes in the first 10 months of 1950, according to reports to RTMA. October tube sales to set manufacturers totaled 848,387 units valued at \$23,513,590, compared with 764,913 tubes valued at \$20,423,353 in September.

The trend to large-type cathode-ray tubes continued in October with tubes 16 inches in size and larger representing 92 per cent of the month's sales. Rectangular tubes comprised 58 per cent of the October sales to set producers.

Total sales of all types of cathode-ray tubes, including oscillographs, camera pickup tubes, etc., in October amounted to 947,872 units valued at \$26,206,183 and brought the ten months' total to 6,378,210 tubes valued at \$165,611,700. . . . Television receiver production in eleven months of 1950 aggregated 6,529,615 sets, according to preliminary industry estimates. RTMA's estimates represent production by member and nonmember companies. November radio and television production each dropped eight per cent below the previous month's output. TV sets produced in November numbered 752,005 units and radio receiver production amounted to 1,304,094. Radio receivers, including home sets, auto and portables, manufactured in the 11-month period, totaled 12,785,917.

¹ The data on which these NOTES are based were selected by permission from *Industry Reports*, issues of November 17, November 24, December 1, December 8, published by the Radio-Television Manufacturers Association, whose helpful attitude is gladly acknowledged.

IRE People

Rudolph Goldschmidt, eminent radio engineer who originated one of the first high-frequency alternators which was named for the inventor, died in November at the age of 74 in England.

Dr. Goldschmidt, who was born on March 9, 1876, at Mecklenburg, Germany, received his engineering education at the Technical University of Darmstadt. Following his graduation he served as an assistant professor.

The inventor of reflex alternators built for powers up to 100 kilowatts, Dr. Goldschmidt also invented the receiver instrument known as the tone wheel which receives continuous waves on a musical note before heterodyning.

He was president of his own company, The High Frequency Machine Company, at Berlin, during the years 1912 to 1923, and was at one time a member of the IRE.

Later Dr. Goldschmidt became an independent inventor in Berlin, and designed mechanical means for changing rotating into reciprocating motion. He also invented an electromechanical banner utilizing these means.

Thomas McLellan Davis (M'28-SM'43), head of the Radio Techniques Branch of Radio Division 11 of the Naval Research Laboratory, Washington, D. C., recently will have completed 40 years of military and civilian service in the Navy.



THOMAS McL. DAVIS

A pioneer radio engineer, Mr. Davis was born in Farmington, Maine. His naval career began with his enlistment on October 21, 1910.

After a course at the Navy Electrical School, he was assigned as radio operator on the staff of Admiral Ward on the *USS Florida*, with similar duty subsequently in New York Navy Yard. From 1915 to July, 1919, he was on radio duty on Atlantic Fleet flagship, *USS Wyoming*, which was attached to the British Grand Fleet in the latter part of World War I.

He transferred from the *Wyoming* at Scapa Flow to U.S. Fleet flagship *Pennsylvania*, from which he conducted a school in British radio procedure for the radio personnel of ships stationed at New York Navy Yard. After similar duty at Norfolk, he became assistant to the Radio Officer of Washington Navy Yard's Ratio Test Shop in October, 1919. A year later he converted to civilian status at the Yard, becoming the ranking civilian in charge of the engineering

and test phases of Radio Test Shop activities (except transmitters) a year prior to his transfer to NRL.

In September, 1923, Mr. Davis joined the radio staff at the Laboratory. As Head of the Radio Receiver Section, he became responsible for research, development, and design of nearly all military types of radio receiving equipment, including in addition radio direction-finder research in the period 1933 to 1940. Since 1947, he has been head of the Radio Techniques Branch, which was formed by merger of the former Receiver Section with the Radio Measurements and Components Section, encompassing a broad field of research and development in electronics.

The Navy's radio receiving equipment for the past three decades has been outstanding in reliability and performance. A major factor in this has been Mr. Davis' keen appreciation of naval radio problems and his ability to provide highly successful engineering solutions thereto.

Mr. Davis is a member of the American Physical Society and was Chairman of the Washington Section of the IRE in 1934. He served as representative to the D. C. Council of Engineering and Architectural Societies from 1935 to 1948.



Carl L. Frederick (M'45) of Chevy Chase, Md., was recently awarded the degree of Doctor of Science by Nebraska Wesleyan University, Lincoln, Neb. The degree was recommended by J. C. Jensen, professor of physics, and was presented by Carl C. Bracy on the occasion of his installation as Chancellor.

The citation reads as follows: "Carl Leroy Frederick—Scholar and leader in scientific research, a physicist of high repute devoting time and skill to research in and for the development of means of defense from those who would destroy our democratic way of life, an alumnus of whom your alma mater is justly proud—upon recommendation of the faculty and by vote of the Board of Trustees, I am highly honored to confer upon you the Degree of Doctor of Science with all the rights, honors, and privileges of this degree."

Dr. Frederick delivered an address before a joint meeting of Sigma Pi Sigma and Phi Kappa Phi, honorary fraternities, on the subject, "Training for a Scientific Career."



Thomas G. Banks, Jr., (A'39) has been appointed to the newly created position of Director of Research and Development at Gates Radio Co., Quincy, Ill. Prior to accepting the new position, Mr. Banks served as a Gates sales engineer for the Oklahoma-Kansas territory.

Previously he owned and managed his own broadcast station. Mr. Banks is a recognized broadcast consultant before the FCC.

Robert Charles Woodhead (A'37-M'46) died suddenly on November 8 at the age of 36. Born at Edmonton, Alberta, Canada, Wing Commander Woodhead received his engineering education at McGill University, Montreal, from which he was graduated with the degrees of B.Sc. and B.Eng.

From 1935 until World War II, he was employed in an engineering capacity by the Bell Telephone Company of Canada. Joining the Royal Canadian Air Force shortly after the outbreak of war, he was employed for a period as a navigator, and then in the Telecommunication Branch.

Retiring from the service at the cessation of hostilities to resume employment with the Bell Telephone Company, he rejoined the service in 1946 and was appointed to permanent commission in the Telecommunication Branch of the Royal Canadian Air Force. At the time of his death, he held the appointment of Director of Telecommunication Engineering, RCAF, Headquarters, Ottawa, Canada.

Wing Commander Woodhead was largely responsible for the basic engineering work connected with the domestic and overseas radio teletypewriter circuits activated by the Royal Canadian Air Force.

He also led, for a period, a joint service group which engineered an automatic tape relay which formed the backbone of the National Defense Communication System in Canada and into which RCAF major radio teletypewriter circuits were integrated.

More recently, he was responsible for the engineering decisions leading to the selection of all telecommunication equipment adopted by the RCAF, and for the general technical policy governing its use.

Marvin Hobbs (A'35-M'41-SM'43) was recently appointed Chief of the Electronics Division of the Munitions Board and Government Chairman of the Electronics Equipment Industry Advisory Committee. He has served with the Munitions Board, which is a part of the Office of the Secretary of Defense, since May, 1950, when he was appointed Deputy Director of the Secretariat of the Joint Electronics Committee.



Norman Snyder (M'43-SM'43) of the International Standard Electric Corp., a subsidiary of the International Telephone and Telegraph Corp., is at present engaged in company activities in Saudi Arabia.

RE People (Continued)

Hector R. Skifter (A'31-M'36-SM'43-51), president of Airborne Instruments Laboratory, Mineola, L. I., N. Y., has

announced that a group of executives and employees of Airborne Instruments Laboratory in association with Laurance S. Rockefeller and certain of his associates, and with the American Research and Development Corporation, Boston, Mass., have purchased the entire



HECTOR R. SKIFTER

capital stock of the Laboratory from Aeronautical Radio, Inc.

The transaction provides for the three groups to share nearly equal ownership of the research and development laboratory organized in 1945 as an outgrowth of three World War II laboratories associated with Columbia University, Harvard, and the Massachusetts Institute of Technology.

Management of AIL will remain in the hands of Mr. Skifter, as general manager and resident; D. M. Miller, vice-president; and J. May, secretary-treasurer. The new board of Directors is comprised of Stuart N. Cott, Joseph Powell, Jr., Georges Doriot, Randolph B. Marston, Harper Woodward, John N. Dyer, Mr. Miller, and Mr. Skifter.

❖

J. Gilman Reid, Jr., (A'50-M'50-SM'50) has been appointed Chief of the Electronics Division of the National Bureau of Standards. He has been Chief of the Engineering Electronics Section since January 3, 1939. For the present he will continue to act in his capacity, in addition to assuming duties as division chief.

In 1937 Mr. Reid joined the staff of the National Bureau of Standards as a member of the Heat and Power Division. In 1941 he became a project engineer for the uranium project at the Bureau, working on the design and development of electrical and electronic control equipment for special process control in isotope separation. From 1943 to 1944 he worked on power supply systems for radio proximity fuzes, and from 1944 to 1946 carried a major fuze project through final development and production phases. From 1946 until his appointment as Chief of the Engineering Electronics Section, he was chief engineer for the Electronic Instrumentation Laboratory, working on special instrument systems for the Navy's Bureau of Ships and Bureau of Aeronautics, the Treasury Department, and other laboratories within the NBS.

Mr. Reid attended the University of Mississippi, where he received the B.A. degree in physics in 1931 and the M.A. degree, also in physics, in 1933. From 1933 to 1936 he was a member of the staff of the Museum of Science and Industry in Chicago, and from 1936 to 1937 was on the teaching staff

of the RCA Institute, instructing in physics, electronics, and mathematics.

He is a member of the American Physical Society and of the American Institute of Electrical Engineers. He has represented the Bureau on a number of society committees concerned with various phases of electronics and instrumentation.

❖

M. A. Acheson (A'36-M'37-F'41), has been transferred to the staff of E. Finley Carter, as vice-president in charge of engineering of Sylvania Electric Products Inc., in New York, N. Y.



M. A. ACHESON

Mr. Acheson joined the engineering staff of Sylvania Electric in 1934. From 1935 to 1942 he supervised development engineering for radio receiving tubes, including portable types. During the war he directed Sylvania's development of proximity-fuze tubes for the Navy Bureau of Ordnance and received an award for exceptional service from the Bureau.

Appointed as manager of research and development in 1942, he served as manager of the Advanced Product Development Department of Sylvania's Central Engineering Laboratories, until he was named chief engineer for the radio tube division in 1948.

Previously, Mr. Acheson had been a member of the research staff of the General Electric Company, where he specialized in the design and development of high-power radio transmitting tubes and broadcast transmitters.

He holds approximately thirty patents on radio transmitter circuits, water-cooled power tubes, and tubes for television transmission.

❖

B. Richard Teare, Jr., (A'41-SM'45-F'51) has been appointed Dean of Graduate Studies in the Carnegie Institute of Technology College of Engineering and Science. He is also head of Carnegie's electrical engineering department and Buhl professor of electrical engineering. He will remain in these posts.

He joined the Carnegie faculty in 1939, and was named Buhl Professor in 1943. He worked toward the establishment and organization of a graduate program in the electrical engineering department, and became head of the department in 1944.

Dr. Teare has been secretary and vice-chairman of the committee on graduate degrees for the College of Engineering and Science. As Dean of Graduate Studies he will now be chairman of this committee.

As chairman of the basic course committee, and as an active teacher, Dr. Teare has contributed to the development of the Carnegie Plan of Professional Education.

In 1947, he received the George Westinghouse Award in recognition of his "distinguished contributions to engineering education."

A Fellow in the AIEE, Dr. Teare was chairman of the Institute's Committee on Education from 1948 to this year. He has been chairman of the Graduate Study Division of the American Society for Engineering Education, and is currently chairman of the Society's Division on Relations with Industry.

❖

Leister F. Graffis (S'43-A'45) has been appointed chief field engineer of the Bendix Radio Division of Bendix Aviation Corporation.

In his new capacity, Mr. Graffis will be in charge of field engineering service, maintenance training programs, and will direct the activities of technical representatives of the Bendix Radio Division who will assist government agencies in installation and maintenance. Personnel of his group will be assigned to work in many parts of this country, as well as outside the U. S. borders.

Prior to his association with the field engineering group, Mr. Graffis was with the technical publications department. Earlier he was assistant service manager of the television and broadcast receiver sales department.

Before coming to Bendix he was a Lieutenant Commander in the Navy, and was engaged in the setup of search radar equipment on the west coast and the supervision of the preparation of instructional material for all radio technician schools in that area.

He attended North Dakota State School of Science, Colorado State College, and completed radar courses at Harvard and the Massachusetts Institute of Technology. He served overseas for two years, handling the maintenance and installation of electronic equipment in military aircraft.

❖

F. C. Cahill (S'38-A'40-SM'45) supervisor of the Receiver Section at Airborne Instruments Laboratory, Mineola, L. I., N. Y., has been named supervising engineer of a combined engineering group to be known as the Radar Section. The new group, a combination of the former Receiver and Radar Sections, now comprises about 40 engineers.

Associated with Mr. Cahill in the technical operation of the new Radar Section will be assistant supervisors **Richard N. Close** (A'45), **Matthew T. Lebenbaum** (A'42-M'46-SM'47), and **William R. Rambo** (S'39-A'40-SM'46).

Mr. Cahill has been with AIL since November, 1945. He was experienced in designing commercial radio receivers and radar systems prior to joining the Radio Research Laboratory in 1942.

Books

Electrical Communications by Arthur L. Albert

Published (1950) by John Wiley and Sons, Inc., 440 Fourth Ave., New York 16, N. Y. 581 pages + 11-page index + ix figures. 9 X 6. \$6.50.

This is the third edition of a work, the first edition of which appeared in 1934, and the second in 1940. The current edition has been thoroughly revised and brought up to date.

The book covers the entire field of communication, although television is treated more briefly than one might expect in view of its importance in the industry. The first portion of the book deals with the fundamentals of acoustics, electroacoustic devices, networks, lines, cables, waveguides, and various electronic devices, including recently developed ones such as the transistor. Later chapters deal with telegraph, telephone, and radio systems. The material on dial telephone and radio systems has been greatly expanded.

This book is primarily intended for use as a college text, and it should serve admirably to acquaint the students with important circuit principles, transmission systems, and terminology encountered in communication engineering. It should also be useful to one who is interested in the subject as a whole, rather than any specialized branch. The text is arranged so that the topics can be understood, even though the mathematics be ignored.

The book is thoroughly indexed, and the words and phrases listed in the index will be found printed in boldface type on the corresponding pages of the text. This is a great time saver in using the index.

Review questions have been added to the chapters, and the problems have been revised and increased in number. Extensive and modernized lists of references are given at the end of each chapter.

C. O. MALLINCKRODT
Bell Telephone Laboratories, Inc.
Murray Hill, N. J.

Principles and Applications of Waveguide Transmission by George C. Southworth

Published (1950) by D. Van Nostrand Co., Inc., 250 Fourth Ave., New York, N. Y. 657 pages + xi pages + 13-page index + 465 figures. 6 1/2 X 9 1/2. \$9.50.

This is an up-to-date book dealing with a new art which has had a spectacular growth during the past 15 years. During all of this period of rapid growth, the author has held a position of preeminent leadership in the development of this art.

The book appears to be particularly suitable for use as a college textbook and as a reference book of great value to practicing engineers and technicians.

Two different orders of presentation are followed. The first, which is quantitative, follows the conventional theories of electricity as they apply to lumped circuits, transmission lines, waves in free space, and to waveguides. This approach includes the basic mathematical treatment of the subject. The second approach, which is largely qualitative, may be regarded as a verbal

interpretation of the first, serving to develop a physical concept of the various phenomena involved.

The general background and theory are presented in the first 178 pages of text, following which, numerous applications and waveguide devices are described, including their characteristics and design factors. Included in these are transmission lines, impedance matching devices (transformers), microwave filters, balancers, amplifiers, oscillators, antennas, resonators, microwave measurements, receiving methods, radar applications, and many others.

The paper and print are of excellent quality and the presentation is enhanced by an exceptional number (465 figures) of clear-cut diagrams, curves, drawings and photographs.

H. O. PETERSON
RCA Laboratories, Inc.
Riverhead, N. Y.

Frequency Modulated Radar by David G. C. Luck

Published (1950) by McGraw-Hill Book Co., Inc., 330 W. 42 St., New York 18, N. Y. 437 pages + 27-page index + xviii pages. 118 figures. 6 X 9. \$4.00.

This book is concerned primarily with the results of a Navy-sponsored research and development program at RCA in the field of frequency-modulated radar, covering a period from 1938 through the war years. The manuscript was originally prepared as a final report on a Navy contract and expectedly, therefore, considerable emphasis is placed on the theory and design of a few specific equipments. However, since the general treatment of the subject successfully transcends specific equipments, this book represents a distinct contribution to the literature, since in most radar treatises, frequency modulation systems are passed over all too briefly.

The author has done an excellent job in presenting his material in a thoroughly readable fashion using a clear, simple, and understandable style, markedly devoid of the stilted phrases and clichés often present in many technical books. A thorough knowledge of the techniques of radio engineering is assumed, together with some familiarity with pulse radar and servo mechanisms.

The book is aptly divided into two parts. Part One is devoted to the development of the theory of frequency-modulated types of systems and to discussions of various techniques used to describe the various systems developed by RCA. Particular emphasis is given to techniques that have been developed in connection with the fabrication of operable systems. The author also presents information on several developmental systems which were investigated, but not carried to completion as production items. Finally, there is included a chapter on multiple target systems in which performance comparisons are made between frequency-modulated and pulse-type radar systems. The author outlines some of the limitations as well as advantages of both types of systems.

In general, it is the conclusion of the reviewers that this book is timely, and further that it provides the electronic engineer with excellent background on the subject of frequency-modulated radar with particular emphasis on unclassified aspects of airborne fire-control and bombing systems—subjects obviously difficult to discuss in full completeness because of security requirements.

HAROLD A. ZABI
JAMES T. EVERS
Signal Corps Engineering Laboratories
Fort Monmouth, N. J.

Super-Regenerative Receivers by J. R. Whitehead

Published (1950) by Cambridge University Press, 51 Madison Ave., New York 10, N. Y. 157 pages + 3-page index + xiii pages. 77 figures. 5 1/2 X 8 1/2. \$4.75.

The author brings to his writing a wealth of experiences in direct contact with the experimental development and continuing philosophical study of one of the most unusual of all radar sets—the Mark III IFF transponder. After pioneering work in England, this super-regenerative receiver and pulse transmitter was engineered and put in large-scale production in U. S., then installed in every allied seacraft and aircraft for protection against friendly fire. Its reliable, unattended operation as an adjunct to diversified types of radar, has forever dispelled the prejudice against super-regeneration as being tricky or undependable.

After an adequate introduction to orient the reader, the author proceeds with a skillful theoretical presentation of certain special topics under his subject. Each is presented with adequate mathematical derivations and formulas, mostly relying on techniques no more advanced than the Fourier integral.

The outstanding contribution of this work is the formulation of the frequency response of a super-regenerator, which had been neglected in the few excellent studies before the war. Here the author has adeptly applied the basic principles and design formulas developed by this reviewer in Hazeltine Laboratory Reports* during the engineering of the Mark III IFF, and duly credited in other reports and publications of the author and his British associates.

Spectacular skirt selectivity is obtained by a quench wave form which provides "slope-controlled" frequency response as distinguished from "step-controlled." The properties of each are formulated and presented clearly by diagrams showing their physical significance.

The emphasis is on the "linear mode"

* H. A. Wheeler, "Superregeneration formulas," Hazeltine Report 1457W, January 5, 1943. Same, Part II, 1457 aW, February 16, 1943. (Formulas for gain and bandwidth in cases of conductance step and conductance slope.)

J. F. Craib, "Theory of superregeneration," Hazeltine Report 1506W, May, 1943. (Tests of gain and selectivity, verifying formulas in case of conductance slope.)

H. A. Wheeler, "A simple theory and design formulas for super-regenerative receivers," Wheeler Monographs, no. 3, June, 1948.

H. A. Wheeler, "Supersensitivity in a super-regenerative receiver," Wheeler Monographs, no. 7, November, 1948.

the "automatic gain stabilization" which insured the reliability of this mode in the Mark III IFF. The "logarithmic mode" is presented clearly, with its limitations in approaching the slope-controlled selectivity.

The simplification of the presentation is achieved by dividing the quench cycle into the following periods: (1) regenerative coupling; (2) super-regenerative build-up; (3) oscillating; (4) damping. The sampling grid governs the frequency response.

Some attention is paid to the noise accent, but the author stops short of stating some rather simple rules which express the excess noise, as compared with a simple receiver that would respond to equally short pulses.

The treatment is well illustrated by computed examples, also practical circuits and references to their war-time and post-war applications. For design purposes, the key formulas are tabulated and some are graphed. There is selective bibliography of published papers.

This work is presented on the level of an advanced student with a thorough background in the theory of communication networks. However, the diagrams and simple formulas will be instructive and helpful to the less specialized radio engineer.

HAROLD A. WHEELER
Wheeler Laboratories
Great Neck, L. I., N. Y.

Mobile Radio Handbook, First Edition, Editor, Milton B. Sleeper; Associate Editors, Leah Courtney and Roy Allison.

Published (1950) by FM-TV Magazine, Great Barrington, Mass. 190 pages, 249 illustrations, 26 plates. 8 1/2 x 11 1/2. \$4.00, cloth bound. \$2.00, in paper cover.

The Mobile Radio Handbook is a compilation of material of practical and technical interest to anyone considering the development of a vhf-FM radio communication system. It contains a discussion of FCC regulatory problems such as the availability of frequencies, the regulations with respect to equipment operation and operator licensing provisions. It describes in some detail any of the practical problems involved in planning, operating, and maintaining a vhf system based upon the actual experiences of those who have been active in this field. Illustrative descriptions are given of the problems involved in antenna erection, and in the maintenance of equipment as well as with the more involved problems of frequency selection, choice of equipment, siting, etc. The Handbook includes also a very good and comprehensive chapter on general FM theory.

Unfortunately much of the intensive development which has taken place in recent years in the mobile radio field has not been passed upon careful over-all systems planning. Although the first chapter in the handbook deals with basic systems planning, there could well be more emphasis on this philosophy of approach and upon the importance of providing in advance for future expansion. The Handbook suffers slightly in that it is a compilation of several separate articles, some of which apparently were not prepared specifically for inclusion in the Handbook but for presentation as

magazine articles. These sections tend to be a little more specific and less objective than they perhaps should be. However, so long as the reader is interested in utilizing the Handbook as a means of acquainting himself with the general problems that may be confronted in the development, operation and maintenance of a communication system, and does not expect an exhaustive, strictly handbook-type treatment, the Mobile Radio Handbook serves a valuable purpose. It is clearly and interestingly written and very easy to read and understand.

With the extensive use now being made of vhf-FM communication systems to satisfy the operational needs of services which heretofore have not been able to use radio, and with the special problems brought about by the extensive use of such systems, there is a definite need for a handbook on mobile radio and point-to-point systems to provide guidance in the direction of proper planning and sound systems engineering. The present Handbook is a step in the right direction.

C. M. JANSKY, JR.
970 National Press Building
Washington, D. C.

Short-Wave Radio and the Ionosphere by T. W. Bennington

Published (1950) by Iliffe and Sons, Ltd., London, England. 136 pages + 2-page index + 57 figures. 5 x 8. 10s 6d.

When speaking of books, of all the branches and offshoots of the art of radio communication, the subject of radio wave propagation through the ionosphere is the most neglected. While it is true that there are few workers in the field and that the field does not lend itself towards ready experimentation, the engineer, technician, or amateur operator who feels that he would like a better and more practical knowledge of propagation finds that this is almost impossible without delving into electromagnetic theory via higher order mathematics.

Thus, it may be truly said that what this field needs is a concisely and clearly written account of the vagaries of radio wave propagation. In this reviewer's opinion, this latest volume by T. W. Bennington goes a long way toward accomplishing this very end. With greatly improved and expanded editorial and graphic content over his original volume published in 1944, this book can be readily used as a minor supplemental physics text, or simply read in one or two evenings as an interesting and well-written summation of our present state of knowledge of propagation.

The contents of the book are divided into ten chapters, each of which is then sharply subdivided by subject. Practically every phase of communication is covered in this manner and it is difficult to isolate one subject which has not been given some treatment. The entire volume is written with a complete absence of mathematics higher than fractions or simple multiplication. Each term applicable to propagation is described descriptively and with little loss of pertinent detail.

A unique part of this book was Chapter 8, which is devoted to radio amateur transmission on the high frequencies. Emphasis is placed on the inherent differences between

amateur and commercial or professional practices in attempting to predict the usefulness of certain radio frequencies. The part played by sporadic-E propagation in upsetting propagation predictions is also given attention.

Considering the pains the author has gone to in literally bringing a subject down out of the clouds, it is probably very unfair to indicate pointedly the places where excess liberties in interpretations have been made. In addition, the present state is so fluid and some of our knowledge so theoretical that an author attempting to write this type of book must be granted considerable leeway. However, for example, a somewhat more up-to-date explanation of "long-scatter" would appear to be in order.

OLIVER P. FERRELL
Radio Magazines, Inc.
RASO, 121 South Broad St.
Philadelphia 7, Pa.

Radio Engineering Handbook by Keith Henney

Published (1950) by McGraw-Hill Book Co., Inc., 330 W. 42 St., New York 18, N. Y. 1183 pages + 12-page index + x pages. 1034 figures. 6 1/2 x 9 1/2. \$10.00.

The fourth edition of this well-known handbook has been revised and expanded to increase its usefulness. It contains nearly twice the information of the previous edition, and has entirely new chapters on "Wave Guides and Cavity Resonators," "Electron Tubes," "Radio Aids to Navigation," "Antennas," "Receiving Systems," and "Inductance and Magnetic Materials."

The object has been to keep a working handbook with an abundance of applied information for all branches of radio engineering. Naturally, in a single volume there is considerable abridgement, but most of the chapters have excellent bibliographies attached for those who require fuller information.

This reviewer was particularly impressed by the following chapters: "Combined Circuits of L, C, and R," by W. F. Lanterman; and "V.T. Oscillators," by R. I. Sanbacher and D. C. Fielder.

Both of the above are unusually complete both in text and in references.

The chapter "Antennas," by Edward A. Laport, of 75 pages, is supplemented with a bibliography of 291 items.

"Wave Guides and Resonators," by Theodore Doreno, was excellent, well written, and terse.

"Loud Speakers and Room Acoustics," by Hugh Knowles, contains a wealth of information packed into 42 pages.

"Receiving Systems," by Charles Dean, covers the field and should constitute a valuable reference source.

"Television," by Donald Fink, is a clear exposition of basic principles which includes color basics, but not latest color systems.

"Radio Aids to Navigation," by Harry Diamond, is presented in a manner for clear, easy reading, and is comprehensive in its coverage.

In summary, the Radio Engineering Handbook is recommended as a valuable addition to any radio engineer's library.

JOHN D. REID
American Radio and TV, Inc.
Conway, Ark.

(Continued on page 211)

Conference on High-Frequency Measurements*

WASHINGTON, D. C.—JANUARY 10-12, 1951

SUMMARIES OF TECHNICAL PAPERS

Measurement of Frequency and Time

1. PROGRAM FOR ATOMIC FREQUENCY AND TIME STANDARDS—A SURVEY

HAROLD LYONS

(National Bureau of Standards,
Washington, D. C.)

A survey will be given of the NBS program on atomic clocks and oscillators. Figures for noise-limited resolving power will be given for gases, including ammonia and oxygen, for atomic beams and nuclear quadrupole absorption. The program status will be outlined for the atomic beam clock, precision spectrograph and spectrum tables, new microwave amplifier, and multiplier tubes. A brief discussion of potential applications will include measurements of earth rotation, comparison of atomic time and the mean sidereal year, and a mm-band interferometer driven by an atomic clock for basing both time and length standards on one spectrum line.

2. IMPROVED NBS AMMONIA CLOCK

BENJAMIN F. HUSTEN

(National Bureau of Standards,
Washington, D. C.)

The absorption line of ammonia is utilized to control a quartz crystal oscillator and frequency multiplier chain by means of a servo system. The servo system is designed to correct the drift of the crystal oscillator without impairing the normal short time stability of the oscillator. The control system is analyzed for stability and attainable accuracy. Minimum allowable stability figures for the uncontrolled oscillator are obtained. The theoretical limits of stability, as imposed by thermal noise and other factors, are calculated. Circuit details and performance figures are given for the complete clock and further improvements to be made indicated.

3. THE STABILIZATION OF A MICROWAVE OSCILLATOR WITH AN AMMONIA ABSORPTION LINE REFERENCE

E. W. FLETCHER AND S. P. COOKE

(Harvard University, Cambridge, Mass.)

This paper is primarily concerned with the problem of stabilizing a microwave oscillator on the 23,870-Mc absorption line of ammonia gas. First, the various causes of instability of any stabilized microwave

oscillator are examined theoretically, and means for improving the stability are described and experimental results are given. Second, the feedback loop is analyzed as a servomechanism, and its design and operation are discussed. Third, the use of a spectral absorption line as a frequency reference is examined theoretically, and the design of the Cruft stabilizer is discussed.

Possibilities for further improvement of absorption-line frequency references are examined. This includes a discussion of the dependence of the feedback signal on the pressure and temperature of the ammonia and the dimensions of the waveguide cell.

4. PERFORMANCE OF OSCILLATORS FREQUENCY-CONTROLLED BY GAS ABSORPTION LINES

L. E. NORTON

(RCA Laboratories, Princeton, N. J.)

Frequency stabilization of an oscillator implies comparison of two frequencies, output and standard, with provision for output frequency correction derived from any difference between the two. At microwave frequencies molecular absorption lines are particularly useful frequency standards. Over-all stability of a frequency-controlled oscillator is specified by three things: namely, original frequency stability of the uncontrolled oscillator, stability of a standard frequency derived from an absorption line, and a multitude of factors related to comparison circuit-servo control loop elements. Stabilized oscillator performance is predicted by calculating the error magnitude or uncertainty introduced by each of these various causes. Details of these effects are described for specific circuits.

5. MILLIMETER-WAVE MEASUREMENTS

WALTER GORDY

(Duke University, Durham, N. C.)

The discussion will include methods of generating, detecting, and measuring millimeter-wave frequencies in the range of 30,000 to 150,000 Mc. A table of accurately measured spectrum lines will be given. These provide suitable frequency standards for calibration of cavity wave meters in the millimeter range. The millimeter-wave absorption of oxygen, carbon monoxide, and other gases will be discussed.

6. QUARTZ-CRYSTAL FREQUENCY STANDARDS

W. D. GEORGE

(National Bureau of Standards,
Washington, D. C.)

The past and present performance of low-frequency quartz-crystal resonators and oscillators, as used in maintaining the

national standard of frequency and time interval, will be summarized. Improved accuracy of the frequency standard is resulting from recent improvements in uniformity of standard time, greater reliability in temperature control and better G² crystal units and other components. Problems in connection with distribution of the standard via radio broadcasts will be discussed, e.g., accuracy as received, coverage continuity, corrections, type of service, and simultaneous use of two or more stations.

7. HIGH-FREQUENCY CRYSTAL UNITS FOR PRIMARY FREQUENCY STANDARDS

A. W. WARNER

(Bell Telephone Laboratories, Inc.,
Murray Hill, N. J.)

A new approach to the design of crystal units for primary frequency standard use has resulted in crystal units, in the 3-to-20-Mc frequency range, characterized by high Q and low capacitance in the series arm of the equivalent electrical circuit.

By utilizing the overtone frequency of specially designed AT-cut quartz plates, both Q and the rate of impedance change with frequency are enhanced together, and in addition the stability with time of the crystal unit is increased, due to a larger frequency determining dimension. Additional characteristics of the crystal units include small size, stability under conditions of vibration and shock, and low temperature coefficient.

Stabilities of one part in 10^8 per month have been achieved without recourse to stabilized circuits.

Measurement of Impedance

8. INFLECTION-POINT METHOD OF MEASURING Q AT VERY-HIGH FREQUENCIES

NELSON E. BEVERLY

(Sperry Gyroscope Company,
Great Neck, L. I., N. Y.)

A new method of measuring Q has been developed for measurements at very-high and microwave frequencies. This method determines the inflection points of a resonance curve by a null indication, and Q is obtained only as a function of the frequency at which these null indications occur. The method is broad in application in that it can be used to locate the inflection points of lumped-constant circuits, transmission lines, and microwave cavities.

Experimental measurements have been made at vhf and microwave frequencies. The results indicate that the accuracy may be equal or better than results obtained by other known methods.

* Sponsored by The Institute of Radio Engineers, the American Institute of Electrical Engineers, and the National Bureau of Standards; and organized by the Joint AIEE-IRE Committee on High-Frequency Measurements, the IRE Professional Group on Instrumentation, and the AIEE Committee on Instruments and Measurements.

A PRECISE SWEEP-FREQUENCY METHOD OF VECTOR IMPEDANCE MEASUREMENT

D. A. ALSBERG

(Bell Telephone Laboratories, Inc.,
Murray Hill, N. J.)

The impedance of a two-terminal network is defined completely by the insertion loss and phase shift it produces when inserted between known sending and receiving impedances.

Recent advances in precise wide-band phase and transmission measuring circuits have permitted practical use of this principle. These circuits are free from zero corrections as the measuring frequency is changed, which in one specific circuit can be swept continuously from 0.05 to 20 Mc while data can be recorded automatically with accuracies up to ± 0.25 per cent. Reactive and resistive impedance components are read directly from a simple graphical chart in which frequency is not a parameter. The basic principle described promises attractive possibilities in many cases of impedance measurements at still higher frequencies, where present methods are inadequate.

PRECISION COAXIAL RESONANCE LINE FOR IMPEDANCE MEASUREMENTS

HOWARD E. SORROWS, ROBERT E. HAMILTON, AND WILLIAM E. RYAN

(National Bureau of Standards,
Washington, D. C.)

MING S. WONG

(Aircraft Radiation Laboratory, Wright Field, Dayton, Ohio)

As a part of a program to develop standards of measurements of electrical quantities at ultra-high frequencies, an instrument has been constructed with which precise measurements can be made by a resonance-irradiation method. Sources of error in measurements made with this "Chipman" type line are discussed, and methods are presented for evaluating the magnitudes of those errors which cannot be made negligible by use of proper techniques. A theoretical analysis of the errors is presented in a form which can be applied directly to the determination of the accuracy of impedance measurements made with the line. The results of this study, and those of a similar and recent study of the slotted line, provide a direct comparison of the accuracy which can be obtained by the two methods of measurement.

11. A 2,600- to 4,000-Mc VSWR-MEASURING SET

S. F. KAISEL

(RCA Laboratories, Princeton, N. J.)

J. W. KEARNEY

(Airborne Instruments Laboratory,
Mineola, L. I., N. Y.)

A VSWR-measuring unit is described which will present on an oscilloscope a quantitative picture of the VSWR looking into a waveguide or coaxial-line element over the frequency range 2,600 to 4,000 Mc.

Standing-wave ratios of 1.5 to 1 or greater can easily be measured. The unit consists of a mechanically-swept reflex klystron oscillator, which tunes from 2,200 to 4,600 Mc continuously, as an rf signal source, feeding a waveguide Magic Tee as the measuring element. The unbalance of the Magic-Tee bridge is presented on an oscilloscope. Means are provided for calibrating the oscilloscope directly in terms of voltage standing-wave ratio.

12. MEASUREMENT OF WAVEGUIDE AND COAXIAL LINE IMPEDANCES WITH A CIRCULAR WAVEGUIDE

ARTHUR E. LAEMMEL

(Polytechnic Institute of Brooklyn,
Brooklyn, N. Y.)

A pickup loop is rotated in a circular waveguide which is joined to the waveguide or coaxial line containing the unknown impedance. The rotary variation of voltage induced in the loop can be used to measure impedance in the same way that the linear variation of voltage picked up by the probe of a slotted section is used, since both patterns are the same under suitable conditions. Some of the advantages of the rotary device are smaller size, constancy of wavelength (always being one rotation), and ease of mechanical drive.

13. SURVEY OF MICROWAVE DIELECTRIC TECHNIQUES FOR SMALL LIQUID AND SOLID SAMPLES

GEORGE BIRNBAUM

(National Bureau of Standards,
Washington, D. C.)

This paper surveys the theory and application of cavity systems suitable for measuring the microwave dielectric properties of liquids and solids in the form of small-diameter cylindrical samples. The particularly simple equations, connecting dielectric constant with resonance frequency and loss factor with Q , for such samples, suitably located in a TM_{010} cylindrical cavity or a TE_{10} rectangular cavity, are discussed. Simple, yet sensitive apparatus for measuring these cavity parameters are described. Data obtained by several observers in determinations of the dielectric properties of threads and ionized gases, as well as liquids and solids, are discussed to demonstrate the accuracy and limitations of these methods.

Demonstration Lectures

14. MICROWAVE SPECTROSCOPY WITH APPLICATION TO CHEMISTRY, NUCLEAR PHYSICS, AND FREQUENCY STANDARDS

L. J. RUEGER, R. G. NUCKOLLS, AND HAROLD LYONS

(National Bureau of Standards,
Washington, D. C.)

A Stark-modulation type of microwave spectrograph will be demonstrated by displaying the absorption lines of ammonia gas on a projection oscilloscope. Nuclear quadrupole hyperfine structure lines will be

shown, the Stark effect, pressure broadening of the lines, and possibly power saturation. It will be seen how applications to chemical analysis, chemical reaction rates, isotope analysis, and nuclear physics are possible. The usefulness of the lines as invariant frequency standards will be seen, and the possible application of precision designs of spectrograph to measurements of the rotation of the earth using these lines will be pointed out.

15. RECORDING ATMOSPHERIC INDEX OF REFRACTION AT MICROWAVES

GEORGE BIRNBAUM, S. J. KRYDER, AND R. R. LARSON

(National Bureau of Standards,
Washington, D. C.)

The recording microwave refractometer is an instrument which measures and records minute differences in frequency between a test cavity and a reference cavity. The operating principle and the applications of this instrument for research and industrial control work will be briefly described.

The use of this instrument to measure and record fluctuations in the refractive index of the atmosphere will be demonstrated. The output meter of the instrument will be projected on a screen, and the variations in meter readings will be noted as someone breathes into the test cavity or a moist blotter is held near it. Recordings of fluctuations in the refractive index of the atmosphere obtained at the National Bureau of Standards will be projected, and the significance of these records will be briefly discussed.

16. MEASUREMENT OF MICROWAVE FIELD PATTERNS USING PHOTOGRAPHIC TECHNIQUES

W. E. KOCK

(Bell Telephone Laboratories, Inc.,
Murray Hill, N. J.)

A description of a mechanical scanning method for photographically displaying the space patterns of microwaves and centimeter wavelength sound waves will be followed by a demonstration of refraction, diffraction, and focusing of these waves by iterative metallic structures. Photographs of a large variety of field patterns will be shown. The position of the individual wave crests and the direction of wave motion can be indicated by the addition of a constant amplitude signal. Simultaneous focusing of sound waves and microwaves by the same lens will be demonstrated.

Measurements of Power and Attenuation

17. ABSOLUTE MICROWAVE POWER MEASUREMENTS

A. C. MACPHERSON AND D. M. KERNS

(National Bureau of Standards,
Washington, D. C.)

Work done at the NBS concerning bolometers and calorimeters as devices for

precise, absolute measurement of microwave power will be reviewed. Special techniques developed for the determination of bolometer mount efficiency by means of impedance measurements will be described briefly. A differential microcalorimeter, developed and used for power measurement at the milliwatt level, will also be described. A summary of measurements consisting largely of cross-checks between the bolometric and the calorimetric methods will be presented, and evidence for the failure of the impedance method of determining efficiency for thermistors and the success of the method for platinum-wire bolometers will be discussed.

18. BROAD-BAND BOLOMETER DEVELOPMENT

W. E. WALLER

(Polytechnic Research and Development Co., Inc., Brooklyn, N. Y.)

Broad-band bolometers for high-frequency power measurements have been developed to cover the ranges 20 to 1,000 Mc, 1,000 to 4,000 Mc, and 4,000 to 10,000 Mc. All units have a VSWR under 1.3 over their specified operating ranges. Low-power and high-power elements, capable of dissipating 1 milliwatt and 100 milliwatts, respectively, have been made to the above specifications. The response and power handling capabilities of these elements to short pulses will be discussed.

19. CALIBRATING AMMETERS ABOVE 100 MC

H. R. MEAHL AND CHARLES C. ALLEN

(General Electric Company, Schenectady, N. Y.)

A survey is made of the progress to date in measuring current above 100 megacycles. The types of vacuum thermocouples available for ultra-high-frequency current measurement are discussed, and the several methods of calibration are reviewed. A calorimeter method and a thermistor bridge method are presented. The advantages and limitations of the calibrating methods are brought out. The electrodynamic method is particularly suited to large currents, the calorimeter method to medium currents, and the thermistor bridge method to small currents. The importance of obtaining agreement between methods that do not depend on the same principles is emphasized.

20. A MICROWAVE OSCILLOGRAPH

W. B. SELL AND J. V. LEBACQZ

(The Johns Hopkins University, Baltimore, Md.)

A cold-cathode, high voltage, single transient Rogowski oscillograph was given to The Johns Hopkins University by the Aberdeen Proving Grounds. The oscillographic chamber was redesigned to permit the direct observation of frequencies in the 10,000-Mc range. This has been accomplished in two ways: first, by velocity-modulating the beam by the E field of a waveguide, then deflecting it through a constant magnetic field; second, by using a short Lecher wire system for the transmission of the microwave energy. In this latter case,

deflections due to both the E and H fields have been observed. A theory is offered which checks the E -field deflection much more closely than the predictions of Hollmann.¹ A qualitative explanation of the H -field deflection is also given.

21. PRECISION MILLIDECIBEL WAVEGUIDE ATTENUATION MEASUREMENTS

J. H. VOGELMAN

(Watson Laboratories, Red Bank, N. J.)

The precision measurement of the attenuation of four-terminal low-loss microwave structures is based on the relationship between the attenuation and the resultant standing wave at the input terminal when the structure is terminated in a short circuit. The techniques and necessary precision measurement equipment have been developed to permit accurate measurement of attenuation values between 0.01 and 0.5 db, and with decreasing accuracy down to 0.001 db. Since the resultant VSWR values are very large, the ultimate accuracy depends on the determination of the relative magnitude of the minimum with respect to the readily measurable maximum. Techniques and equipment will be described which minimize the errors due to non-linearity of detectors, power reflections from the test sample, noise in the detector amplifiers, residual frequency modulation of signal source (long-line effects), and attenuation in measuring line. The attenuation measurement has been reduced to the measurement of two physical lengths.

22. DISSIPATIVE AND PISTON ATTENUATOR CORRECTIONS

CHARLES M. ALLRED

(National Bureau of Standards, Washington, D. C.)

Termination impedances and corrections on rated values of dissipative-type attenuators terminated in any complex impedances will be discussed. Derivation construction and application of several circle diagrams and nomographs will be presented, and experimental verification data shown for a wide range of frequencies and impedances. In addition, derivation and construction of nomographs will be presented, giving both cutoff frequency and skin penetration corrections for TE_{11} piston attenuators. Slides will be shown of the above nomographs, circle diagrams, theoretical highlights, and some of the latest NBS attenuation standard equipment.

Measurement of Transmission and Reception

23. A FIELD-STRENGTH METER FOR 600 MC

J. A. SAXTON

(National Physical Laboratory, Teddington, England)

The equipment has been designed primarily for use in the study of radio wave

¹ Hans E. Hollmann, "The dynamic sensitivity and calibration of cathode-ray oscilloscopes at very high frequencies," *Proc. I.R.E.*, vol. 38, p. 32; January, 1950.

propagation at 600 Mc, and has a fair wide-band intermediate-frequency amplifier (0.5 Mc centered on 30 Mc) to ensure that a received signal remains in tune during long periods of recording. As a calibrated instrument, however, it may be used for the accurate comparison of radio field strength or powers, over a frequency range 500-700 Mc. It can be operated with a continuous-wave signal, when the sensitivity (for signal equal to noise) with a dipole receiving aerial is about 35 $\mu\text{V}/\text{m}$, or with a modulated signal; in the latter case a narrow-band audio-frequency amplifier is added, and the over-all sensitivity of the equipment is about 18 db greater than with an unmodulated signal.

24. MEASURING TECHNIQUES FOR BROAD-BAND LONG-DISTANCE RADIO RELAYS

W. J. ALBERSHEIM

(Bell Telephone Laboratories, Inc., Deal, N. J.)

Adjustment and maintenance of radio relays require sensitive, yet rapid, measurements.

By rapid scanning, transmission characteristics can be traced on paper strips or cathode-ray screens. Alternating switches permit superposition of reference traces.

Frequency functions thus measurable include gain, phase, impedance, reflection coefficient, and their rates of change; time functions include amplitude and frequency modulation; amplitude functions—FM distortion caused by discrete frequency or noise modulation, by interference and by transmission characteristics.

Time and level distributions of atmospheric disturbances are recorded, and the effects of selective fading and echoes evaluated by simulating them under controlled laboratory conditions.

25. WIDE-BAND SWEEP-FREQUENCY MEASUREMENTS APPLICABLE TO TRAVELING-WAVE TUBES

FREDERICK E. RADCLIFFE

(Bell Telephone Laboratories, Inc., Murray Hill, N. J.)

Methods of measuring transmission and impedance of traveling-wave tubes operating in the 4,000-Mc common-carrier band are described in which the frequency is swept over a 500-Mc band. The characteristics are displayed on a standard oscilloscope.

A gain-comparator type of transmission measuring set is described in which moderate oscillator amplitude variations with frequency do not affect the accuracy of measurement. By this method transmission characteristics are measured to accuracies of about 0.25 db and return loss can be measured up to values of 40 db.

A new technique, which is useful in broad-band amplifier measurements in general, is described in which both the transmission and output impedance-versus-frequency characteristics of an amplifier delivering its normal power output to its load, are displayed simultaneously on the oscilloscope. Thus adjustments of the output

impedance of a multistage amplifier can be made while compensating the transmission characteristic in another part of the amplifier circuit.

26. MICROWAVE TECHNIQUES IN THE 28,000- to 300,000-MC REGION

LEONARD SWERN

(Sperry Gyroscope Company,
Great Neck, L. I., N. Y.)

This paper will survey the techniques of microwave measurements in the millimeter region. The problems involved in using short wavelengths will be discussed, and certain solutions to these problems indicated. Several examples of new millimeter-region components will be described and illustrated by photographs. These designs will be evaluated. In addition, certain new design proposals will be described. The paper's emphasis will be on techniques fundamentally similar to those effective at lower frequencies. However, new approaches to the microwave measurements problem will be discussed, among them, optical and semi-optical approaches, and the applicability of molecular resonance absorption.

27. MEASUREMENT OF CHARACTERISTICS OF CRYSTAL UNITS

L. F. KOERNER

(Bell Telephone Laboratories, Inc.,
Murray Hill, N. J.)

Recent extensions of the useful frequency range of crystal control into the microwave region by harmonic generation, and the extension of the frequency range of crystal units in filter networks, have called for more accurate measurements of the electrical elements of the equivalent network of the crystal unit. The agreement of frequency measurements of a crystal unit in various test circuits is a function of its Q , and the ratio r of its shunt capacitance to the capacitance in the series branch of the equivalent network. Measurements of the resonant frequency of the series branch in various circuits may vary by $100 \times r/2Q^2$ per cent, and the spread between the frequency of zero phase angle and the frequency of minimum impedance of the equivalent network may be double this value. If the quality of the crystal unit is maintained sufficiently high, these variations are of the order of a few cycles per megacycle and may be neglected except for precision applications, as in frequency standards. For crystal units operating at frequencies in excess of about 10 Mc, the shunt capacitance is equalized by an equivalent positive reactance to reduce these variations.

28. REFLECTING SURFACE TO SIMULATE AN INFINITE CONDUCTING PLANE AT MICROWAVE FREQUENCIES

S. J. RAFF

(U. S. Naval Ordnance Laboratory,
Silver Spring, Md.)

The shape of a flat conducting surface has considerable effect on the microwave reflections from it, when the source to reflector distance is of the order of magnitude of the dimensions of the reflector. An optimum shape is designed for simulating the reflection back to the source of an infinite-plane reflector. If the reflection is summed by Fresnel zones, the large effect of the shape of the surface on the reflections can be attributed to the slow rate of decrease of reflections from successive zones. Using the calculus of variations, an optimum shape is designed for a surface inscribed in a circle of 23 wavelengths diameter, 25 wavelengths from a dipole antenna. The maximum error in simulating an infinite-plane reflection was calculated to be 3 per cent. The reflection from this surface has been measured, and is within 4 per cent of the infinite-plane reflection over the range of 15 to 35 wavelengths from the antenna.

Books (Continued)

Television Installation Techniques by Samuel L. Marshall

Published (1950) by John F. Rider Publishers, Inc.,
480 Canal Street, New York 13, N. Y. 336 pages+4-
page index+270 figures. 5 1/2 x 8 1/2. \$3.60.

This outstanding book was written as a reference and handbook, primarily for the television service man, but it is of great interest to the experimenter, the engineer, and the service manager.

The first four chapters of the book present a well-balanced discussion of the nature of television, radio propagation antenna and transmission lines, and transmission and special antenna systems, supported by a clear-cut discussion of the essential theory, and supplemented by specific design methods and practical design information to meet almost any installation requirement.

The next two chapters entitled, "Materials and Methods used in Installations" and "High Mast and Tower Installations," cover the installation of antennas in primary service areas, with particular regard to safety and best installation practices. In the case of the high-mast and tower installations, the principles of construction design formulas and data to take care of wind and ice loadings, and special design considerations are discussed in detail for most types of masts and towers.

Two chapters are devoted to problems

arising from television installations and receiver adjustments in the home. Problems in connection with reflections, multiple installations, fringe area operations, television interference, TV filters, and the adjustment and servicing of sets in the home are covered in a most factual and satisfactory manner.

The last chapter, "Municipal Regulations," covers safety precautions in general, and the National Board of Fire Underwriters Bulletin 275, the municipal codes and television ordinances of many of the cities of the United States.

The Appendix includes a great deal of useful information in its ten tables and three charts pertaining to vhf TV stations on the air: Data on coaxial cables and transmission lines, data relative to the safe loads of anchors, bolts and guy cables, tape sizes, and a list of the various sizes and characteristics of cathode-ray picture tubes.

This book includes authoritative information describing the best field practices in the installation of antennas to meet practical field problems and the installation and servicing of receivers to give maximum satisfaction to the customer, and points out the importance of attention to details in installations, both in the interest of the customer and of safety.

LEWIS M. CLEMENT

Crosley Division
Avco Manufacturing Corporation
Cincinnati, Ohio

Nuclear Data is a new publication of 310 pages available from the Superintendent of Documents, U. S. Government Printing Office, Washington 25, D. C. The price of \$4.25 a copy includes the cost of three supplements (about 60 pages each) which the purchaser will automatically receive at six-month intervals. Remittances from foreign countries must be made in United States exchange and must include an additional sum of one-third the publication price to cover mailing costs.

Nuclear Data is a valuable publication for nuclear physicists and engineers, radiochemists, biophysicists, and other workers in the rapidly expanding field of nuclear physics. It presents a collection of experimental values of half-lives, radiation energies, relative isotopic abundances, nuclear moments, and cross sections. Decay schemes and level diagrams, over 125 of which are included in the tables now ready, are to be provided wherever possible.

The National Bureau of Standards, with the assistance of the Oak Ridge National Laboratory, the Brookhaven National Laboratory, the Massachusetts Institute of Technology, and the University of California Radiation Laboratory, is making the first effort to present a continuing compilation in this rapidly developing field. The present tables and the supplements to follow are therefore designed for easy assimilation of new material in loose-leaf form.

Abstracts and References

Prepared by the National Physical Laboratory, Teddington, England, Published by Arrangement with the Department of Scientific and Industrial Research, England, and *Wireless Engineer*, London, England

NOTE: The Institute of Radio Engineers does not have available copies of the publications mentioned in these pages, nor does it have reprints of the articles abstracted. Correspondence regarding these articles and requests for their procurement should be addressed to the individual publications, and not to the IRE.

Acoustics and Audio Frequencies	212
Antennas and Transmission Lines	213
Circuits and Circuit Elements	214
General Physics	216
Geophysical and Extraterrestrial Phenomena	217
Location and Aids to Navigation	217
Materials and Subsidiary Techniques	218
Mathematics	219
Measurements and Test Gear	219
Other Applications of Radio and Electrons	220
Propagation of Waves	221
Reception	221
Stations and Communication Systems	222
Subsidiary Apparatus	222
Television and Phototelegraphy	223
Transmission	224
Tubes and Thermionics	224
Miscellaneous	224

The number in heavy type at the upper left of each Abstract is its Universal Decimal Classification number and is not to be confused with the Decimal Classification used by the United States National Bureau of Standards. The number in heavy type at the top right is the serial number of the Abstract. DC numbers marked with a dagger (†) must be regarded as provisional.

ACOUSTICS AND AUDIO FREQUENCIES

- 016:534 **1**
References to Contemporary Papers on Acoustics—A. Taber Jones. (*Jour. Acous. Soc. Amer.*, vol. 22, pp. 643-652; September, 1950.) Continuation of 2682 of 1950.
- 534.213.4 **2**
On the Propagation of Sound Waves in a Cylindrical Conduit—F. B. Daniels. (*Jour. Acous. Soc. Amer.*, vol. 22, pp. 563-564; September, 1950.) "The characteristic impedance and propagation constant of a cylindrical conduit are calculated on the basis of an equivalent electrical T section. Numerical values of the results are plotted for air at 20°C, for a range of values of the independent variable which includes the region of transition from isothermal to adiabatic conditions."
- 534.213.4 **3**
On the Propagation of Sound in Narrow Conduits—O. K. Mavardi. (*Jour. Acous. Soc. Amer.*, vol. 22, p. 640; September, 1950.) Correction to paper abstracted in 2 of 1950.
- 534.231 **4**
Reaction of Medium and Acoustic Radiation Damping for a Disk—H. Braumann. (*Z. Naturf.*, vol. 3a, pp. 340-350; 1948.) In order to calculate the sound field of a disk executing small harmonic oscillations in the direction of its axis, the acoustic wave equation is formulated in bipolar co-ordinates. For the case where the medium may be regarded as incompressible the wave equation leads to the potential equation; an exact solution is given for this. The effect of the medium on the disk is equivalent to an increase of $8R^3\rho_0/3$ in its mass, where R is the radius of the disk and ρ_0 the density of the medium. For a compressible medium there is an additional effect due to radiation damping. The time average of the radiated power is approxi-

The Annual Index to these Abstracts and References, covering those published in the PROC. I.R.E. from February, 1950, through January, 1951, may be obtained for 2s.8d. postage included from the *Wireless Engineer*, Dorset House, Stamford St., London S. E., England. This index includes a list of the journals abstracted together with the addresses of their publishers.

mately $8R^3\rho_0\omega^4 V^2/27\pi c^3$, where ω is the angular frequency, V the maximum velocity of the disk, and c the velocity of sound.

534.231:534.133 **5**
The Sound Field of a Straubel X-Cut Crystal—E. W. Samuel and R. S. Shankland. (*Jour. Acous. Soc. Amer.*, vol. 22, pp. 589-592; September, 1950.) The streaming patterns in CCl_4 were determined, using a 7.5-Mc crystal and measuring the velocities of sugar particles whose density is nearly that of the liquid. The results indicate that the intensity of the sound radiated by a crystal of the Straubel type is very uniform across the beam.

534.231:621.395.623.75 **6**
Response Peaks in Finite Horns—C. T. Molloy. (*Jour. Acous. Soc. Amer.*, vol. 22, pp. 551-557; September, 1950.) The axial sound field of horn-type loudspeakers is calculated theoretically. The frequencies at which peaks occur in the response curves, and the dimensions of hyperbolic and exponential horns having peaks at specified points in their response curves, can be derived. A comparison between a measured and a computed axial response curve shows good agreement.

534.231.3:621.395.623.75 **7**
Resonance Characteristics of a Finite Catenoidal Horn—G. J. Thiessen. (*Jour. Acous. Soc. Amer.*, vol. 22, pp. 558-562; September, 1950.) Expressions for the impedance components of a finite catenoidal horn are derived and a comparison with similar exponential and conical horns is made. The impedance of a section of a catenoidal horn is also calculated; for the finite as well as the infinite horn, this impedance approaches that of the exponential horn as more length is trimmed from the throat end.

534.232:517.564.3 **8**
On the Extension of Some Lommel Integrals to Struve Functions with an Application to Acoustic Radiation—C. W. Horton. (*Jour. Math. Phys.*, vol. 29, pp. 31-37; April, 1950.)

534.24 **9**
On the Non-specular Reflection of Plane Waves of Sound—V. Twersky. (*Jour. Acoust. Soc. Amer.*, vol. 22, pp. 539-546; September, 1950.) Mathematical analysis of the scattering of sound by various rigid nonabsorbent nonporous surfaces consisting of semicylindrical or hemispherical bosses on an infinite plane. Exact solutions are given for the case of a single boss and a plane wave at an arbitrary angle of incidence. The theory is extended to the case of finite arrangements of bosses, neglecting secondary excitation effects. The solutions contain the usual Fraunhofer terms for a grating or lattice. The cases of finite and infinite random distributions are considered, and various extensions of the treatment are mentioned.

534.321.9:061.3 **10**
Rome Ultrasonics Convention—G. Bradfield. (*Electronic Eng.* (London), vol. 22, pp. 391-394; September, 1950.) Brief account of lectures and exhibited equipment, including commercial apparatus for many purposes. The advantages of BaTiO_3 ceramics for piezoelectric applications were pointed out. A method of investigating the properties of auditoriums, using models and ultrasonic frequencies, was described.

534.321.9:534.614-14 **11**
A New Method for Measuring Velocities of Ultrasonic Waves in Liquids—B. R. Rao. (*Nature* (London), vol. 166, p. 742; October 28, 1950.) A rapid, accurate method requiring only a very small quantity of the liquid and applicable to both opaque and transparent liquids over a wide range of frequencies is described.

534.374 **12**
Mathematical Analysis of an Acoustic Filter—N. Olson. (*Canad. Jour. Res.*, vol. 28, Sec. A, pp. 377-388; July, 1950.) The attenuation, phase, and impedance functions are calculated for acoustic filters constructed from conduits with a series of equal wider sections at regular intervals. Theoretical impedance and attenuation curves are shown and are confirmed by measurements on filters of circular and square section. Such filters are easy to construct and terminate and they may be used in parallel to form units of large cross section.

534.612+534.641 **13**
A Method for Measuring Source Impedance and Tube Attenuation—J. E. White. (*Jour. Acous. Soc. Amer.*, vol. 22, pp. 565-567; September, 1950.) A description of a sensitive and accurate method of determining attenuation and velocity of sound from sound-pressure measurements in gases at medium audio frequencies. By using a microphone movable along an open-ended tube, the acoustic impedance of any sound source coupled to the air column can be found if the acoustic impedance of the microphone is known. All necessary formulas are derived.

534.841/.844 **14**
Reverberation Time and Sound Power Required for Ordinary Rooms—E. de Gruyter. (*Bull. Schweiz. elektrotech. Ver.*, vol. 40, pp. 757-761; September 17, 1949. In German.) A new interpretation of Sabine's formula is given which takes account of measurements of reverberation duration made in halls with good acoustical properties. Reverberation constants are derived which characterize the acoustic quality of a room for any particular purpose and which are independent of room dimensions. A formula for the necessary acoustic power is then established by analogy of the reverberation constants with the power constants of an electrical circuit. Psychological considerations

lecting the question of good acoustics are discussed, in particular in connection with modern electroacoustic transmissions.

4.843 **15**
On the Acoustics of Coupled Rooms—C. M. Harris and H. Feshbach. (*Jour. Acous. Soc. Amer.*, vol. 22, pp. 572-578; September, 1950.) The problem of coupled rooms is treated as a three-theory boundary-value problem. Experimental data for isolated modes of vibration of a coupled system confirm the theoretical formulae.

4.845 **16**
Parameters for Sound Transmission in Random Absorbing Materials—M. Ferrero and G. Sacerdote. (*Nuovo Cim.*, vol. 5, pp. 551-566; December 1, 1948.) The parameters are deduced from acoustic-impedance measurements on lead shot and on sand of various grain sizes and are discussed in relation to theory previously developed (*ibid.*, vol. 4, p. 262, 1947).

4.86 **17**
The "Expressor" System for Transmission Music—R. Vermeulen and W. K. Westijze. (*Philips Tech. Rev.*, vol. 11, pp. 281-290; April, 1950.) It is claimed that in the transmission of music, either by radio or via a sound-recording system, adjustment of the degree of plume compression by a capable hand has great advantages over automatic control. But with manual control the relations between the tenor of the original music and that of the put signal of the expander is ambiguous, and special methods have to be used to ensure that the expander always exactly compensates the compression. In the 'Expressor' system, a pilot signal consisting of impulses is transmitted via a separate channel and causes the potentiometer of the expander to follow continuously the movements of the compressor.

8.1:537 **18**
Piezoelectric Equations of State and Their Application to Thickness-Vibration Transducers—Cady. (See 99.)

1.395.61.089.6 **19**
American Standard Method for the Pressure Calibration of Laboratory Standard Microphones: Z24.4—1949 (Abridged)—L. L. Beranek, R. K. Cook, F. F. Romanow, F. M. Tiener, and B. B. Bauer. (*Jour. Acous. Soc. Amer.*, vol. 22, pp. 611-613; September, 1950.) The complete standard may be obtained from the American Standards Association, 70 East 45th Street, New York 17, N. Y., for 75 cents.

1.395.613.37 **20**
A Second-Order-Gradient Noise-Canceling Microphone Using a Single Diaphragm—W. A. Stevenson and A. M. Wiggins. (*Jour. Acous. Soc. Amer.*, vol. 22, pp. 592-601; September, 1950.) The four openings admitting sound to the two surfaces of the microphone diaphragm are so spaced and oriented that the response depends on the second differential of the sound pressure with respect to the direction of propagation. Theoretical analysis, confirmed by experimental results, shows that a better signal-to-noise ratio is obtained than with first-order gradient microphones.

1.395.623.54.089.6 **21**
American Standard Method for the Coupler Calibration of Earphones: Z24.9—1949 (Abridged)—L. L. Beranek, F. F. Romanow, C. Morrill, L. J. Anderson, B. B. Bauer, R. K. Cook, and W. Wathen-Dunn. (*Jour. Acous. Soc. Amer.*, vol. 22, No. 5, pp. 602-608; September, 1950.) The complete standard may be obtained from the American Standards Association, 70 East 45th Street, New York 17, N. Y., for 75 cents.

621.395.625.2:621.396.933 **22**
An Automatic Monitoring Recorder—See 207.)

621.395.92 **23**
Hearing-Aid Design—A. Poliakoff. (*Wireless World*, vol. 56, pp. 274-276; August, 1950.) Among the essential qualities of a good instrument, the most important is the provision of optimum volume to suit each patient in all reasonable conditions of use. In most cases this cannot be achieved without automatic volume controls. There should be no pronounced peaks in the response curve and case noise should be reduced by mounting the microphone in rubber and making the surface of the case very smooth.

621.396.822:621.316.8 **24**
A Thermal-Noise Generator for Low-Frequency Tests—H. Meister. (*Tech. Mitt. Schweiz. Telegr.-Teleph. Verw.*, vol. 28, pp. 320-324; August 1, 1950. In French and German.) A description is given, with a circuit diagram showing all component values, of a generator providing a continuous noise spectrum from 30 cps to 15 kc. Reasons for the choice of a resistor as the primary noise source are given. The problems connected with the high amplification necessary with such a source are discussed and means for reducing instability are indicated.

621.396.822:621.385.38 **25**
A High-Level Noise Source for the Audio-Frequency Band—H. D. Harwood and D. E. L. Shorter. (*Jour. Sci. Instr.*, vol. 27, pp. 250-251; September, 1950.) An argon-filled thyratron is used to generate a continuous noise spectrum for audio-frequency testing. Large unwanted ultrasonic components are removed by means of a low-pass filter cutting off at 20 kc, leaving a noise spectrum with power distributed uniformly over the audio-frequency band. Where required, the power per octave band can be made uniform by adding a weighting network. The output into 600Ω is -20 db with reference to 1 mw. The generator is mains operated.

ANTENNAS AND TRANSMISSION LINES

621.315.21.017.71.029.4/6 **26**
The Power Rating of Radio-Frequency Cables—R. C. Mildner. (*Trans. AIEE*, vol. 68, Part I, pp. 289-298; discussion, p. 298; 1949.) The limitations to the power that can be transmitted by various types of radio-frequency cable are considered, suitable rating factors to deal with different maximum permissible cable temperatures and different ambient temperatures are proposed, and the influence of modulation, standing waves, and load factor on the thermal and voltage rating is discussed. The principles outlined are applied to determine the ratings of three types of cable.

621.315.212:621.397.24.018.78† **27**
Characteristics of Coaxial Pairs of Frequencies Involved in High-Definition Television Transmission—G. Fuchs. (*Câbles & Trans.* (Paris), vol. 4, pp. 248-254; July, 1950.) The distortion, caused by irregularities of cable impedance, which would occur in the transmission of a television signal of 20-Mc bandwidth over a distance of 1,000 km is calculated, assuming unfavorable conditions and basing the calculation on experimental results for cables (a) with central conductor of diameter 5 mm and outer conductor of internal diameter 18 mm, the insulation consisting of spiral ribbons of styroflex and the outer conductor formed of two half shells of copper, (b) of corresponding dimensions 2.6 and 9.4 mm, disks of polythene being used for insulation. The mean-square values of phase and amplitude distortion are 0.05 μs and 1.6 per cent respectively for a 5/18-mm pair cable. The corre-

sponding values for a 2.6/9.4 mm pair are significantly lower: 0.001 μs and 0.04 per cent.

621.315.212.017.71 **28**
Heating of Radio-Frequency Cables—W. W. Macalpine. (*Trans. AIEE*, vol. 68, Part I, pp. 283-288; 1949.) See 3014 of 1948.

621.315.213.12:621.315.221:621.3.011.4 **29**
Sheathed Lecher System—R. Gans. (*Z. Naturf.*, vol. 3a, pp. 519-521; 1948.) A formula is derived for the capacitance between the two wires of a Lecher system within a sheath. The degree of approximation is considerably better than obtained with Breisig's formula. A numerical example is worked. See also 2416 of 1950 (Wise).

621.392.211 **30**
The Propagation of Waves along an Endless Helix—S. Kh. Kogan. (*Compt. Rend. Acad. Sci.* (URSS), vol. 66, pp. 867-870; June 11, 1949. In Russian.) An equation (12) is derived determining the current distribution along the helix and methods for its solution are indicated. The theoretical results obtained have been confirmed experimentally.

621.396.67 **31**
Radiation from Circular Current Sheets—W. R. LePage, C. S. Roys, and S. Seely. (*Proc. I.R.E.*, vol. 38, pp. 1069-1072; September, 1950.) A theoretical treatment of radiation from a system of current elements arranged on the circumferences of concentric circles. Series formulas are given for the radiation field produced by a specified excitation of these elements. Integral formulas are given for the excitation required to produce any desired radiation pattern. There is no consideration of how the required excitation can be produced.

621.396.67:538.566 **32**
Cylindrically Diverging Electromagnetic Waves in a Medium with Nonuniform Electrical Properties (Elias-Layer) above a Semi-conducting Earth—C. T. F. van der Wyck. (*Tijdschr. ned. Radiogenoot.*, vol. 15, pp. 195-209; July and September, 1950.) Expressions in terms of the Hertzian vector potential are derived for the field of a vertical dipole above a flat, homogeneous, imperfectly conducting earth in a medium with refractive index depending exponentially on height. A geometrical-optical interpretation of the expressions is given, using the saddle-point method.

621.396.67:621.396.9 **33**
Radar Aerial Systems for Uniform Irradiation of a Surface—Huynen. (See 117.)

621.396.671 **34**
Impedance Transformation in Folded Dipoles—R. Guertler. (*Proc. I.R.E.*, vol. 38, pp. 1042-1047; September, 1950.) Reprint. See 3342 of 1949.

621.396.671 **35**
Input Impedance of Horizontal Dipole Aerials at Low Heights above the Ground—R. F. Proctor. (*Proc. IEE*, Part III, vol. 97, p. 321; September, 1950.) Discussion on 2134 of 1950.

621.396.677 **36**
Microwave Lenses—J. Brown and S. S. D. Jones. (*Electronic Eng.* (London), vol. 22, pp. 127-131, 183-187, 227-231, 264-268, 358-362, and 429-434; April-July, September and October, 1950.) A comprehensive review of the subject, including theory of the principal types of lenses.

621.396.677 **37**
Development of Artificial Microwave Optics in Germany—O. M. Stuetzer. (*Proc. I.R.E.*, vol. 38, pp. 1053-1056; September, 1950.) Discussion of the development of microwave delay lenses using parallel metal strips or waveguide

sections. A lens of the latter type, for use on wavelengths of about 5 cm and with a diameter of 300 cm, is illustrated.

621.396.677 38

Factors Governing the Radiation Characteristics of Dielectric-Tube Aerials—D. G. Kiely. (*Proc. IEE*, Part III, vol. 97, pp. 311-321; September, 1950.) The effects of changes of tube length, diameter, and wall thickness on the radiation pattern were investigated experimentally. It is suggested that the mechanism of radiation of thin-walled dielectric tubes more closely resembles that of a lens than that of a leaking waveguide, such as a dielectric rod antenna. The gain of a dielectric-tube antenna of length 8λ , diameter 1.16λ , and wall thickness 0.03λ is approximately 21 db.

621.396.677 39

Pattern Calculations for Antennas of Elliptical Aperture—R. J. Adams and K. S. Kelleher. (*Proc. I.R.E.*, vol. 38, p. 1052; September, 1950.) The aperture illumination patterns in the directions of the major and minor axes are calculated from a knowledge of the patterns of the feed horn, and then expressed as Fourier series of up to four terms. The radiation pattern is given by

$$F(u_1, u_2) = \pi ab \sum \sum a_r + b_s G_{rs}(u_1, u_2),$$

where $u_1 = (2\pi a \sin \phi)/\lambda$, $u_2 = (2\pi b \sin \theta)/\lambda$, a and b are the semimajor and semiminor axes of the aperture, a_r and b_s coefficients of the Fourier series and G_{rs} a complicated function which has been tabulated elsewhere by the authors. Very good agreement with the theory was obtained in experiments on several horns.

621.396.677 40

The Radiation of 'Beam' Aerials in Particular and of Large Surfaces in General—B. van der Pol. (*Tijdschr. ned. Radiogenoot.*, vol. 15, pp. 151-155; July and September, 1950.) The calculation of the power radiated by a beam antenna is simplified by imagining the system of parallel-wire radiators replaced by an equivalent extended current-carrying surface. Approximate formulas are derived for the radiated power for different limiting cases of the dimensions. Where the dimensions are large compared with λ the radiated power is independent of λ and is proportional to the area of the surface.

621.396.677 41

Measured Directivity Induced by a Conducting Cylinder of Arbitrary Length and Spacing Parallel to a Monopole Antenna—F. R. Abbott and C. R. Fisher. (*Proc. I.R.E.*, vol. 38, pp. 1040-1041; September, 1950.) Curves are given for determining the directivity, given the separation of the parasite from the antenna and also its height.

621.396.679.4:621.392.094 42

Effects of Linear Distortion on a Band of Frequencies Transmitted along a Long Mismatched Line—J. Fagot. (*Ann. Radiol. Elect.*, vol. 5, pp. 179-184; July, 1950.) The following formulas are derived for the irregularities caused by the mismatch when the frequency varies within the band considered:

$$\text{period of variations } \Delta f = v/2e$$

$$\text{max./min. amplitude variation} \\ = (1 + \rho\rho') / (\rho + \rho')$$

$$\text{phase displacement or propagation-time} \\ \text{deviation } \Delta\tau = (\rho - 1)(\rho' - 1)e/v$$

where v is the phase velocity, e the length of line, and ρ and ρ' the swr at the ends of the line. These formulas are independent of the carrier frequency and hold for the usual practical case where the terminal impedance is not highly selective.

621.396.679.4:621.392.094:621.396.619.13 43
Study of the Effects of a Long Line on a

Frequency-Modulation Signal: Distortion, Compensation and Applications—M. Denis. (*Ann. Radiol. Elect.*, vol. 5, pp. 185-205; July, 1950.) The long feeder lines used in cm-wave transmission are a source of distortion; this is particularly severe when the modulated oscillator is tightly coupled to a long, slightly mismatched feeder. The only effective remedy is the insertion of an amplifier between source and feeder. The existence of several junctions in a feeder, each causing slight reflection, may transform the line into a dispersive quadripole, so that phase distortion occurs, accompanied in certain cases by nonlinear frequency distortion. Numerical examples show the importance of this. Long lines are best avoided for high-quality transmissions using a cm-wave carrier with FM. Methods of correcting distortion and possible uses of long lines in measurement technique are discussed.

CIRCUITS AND CIRCUIT ELEMENTS

537.312.6:621.315.592 44

Semiconductors with Large Negative Temperature Coefficient: Thermistors—N'Guyen Thien-Chi and J. Suchet. (*Ann. Radiol. Elect.*, vol. 5, pp. 155-167; July 1950.) Review of the development of the thermistor in the CSF laboratories, and discussion of properties and applications.

621.314.12:621.317.088.4 45

The Fundamental Limitations of the Second-Harmonic Type of Magnetic Modulator as Applied to the Amplification of Small D.C. Signals—Williams and Noble. (See 142.)

621.314.3† 46

Dynamoelectric Amplifiers—R. M. Saunders. (*Elec. Eng.*, vol. 69, pp. 711-716; August, 1950.) Basic principles are presented, five types are distinguished, salient features discussed, and methods proposed for predicting performance.

621.314.3† 47

Analytical Determination of Characteristics of Magnetic Amplifiers with Feedback—D. W. Planck, L. A. Finzi, and D. C. Beaumariage. (*Trans. AIEE*, vol. 68, Part I, pp. 565-570; 1949.) See also 2447, 2448 and 3064 of 1949 (ver Planck, Fishman, and Beaumariage).

621.314.3† 48

A New Theory of the Magnetic Amplifier—A. G. Milnes. (*Proc. IEE*, (London), Part II, vol. 97, pp. 460-474; Discussion, pp. 474-483; August, 1950.) Assuming that the B/H curve for the core material has a constant slope up to saturation level, followed by zero slope, flux waveforms are derived and equations developed for the magnetomotive forces operating throughout the cycle for a transductor with any degree of self excitation. Analytical expressions are thence derived for the output characteristics and for the current amplification and time constant of a transductor, which are of considerable importance in design work.

"An important phenomenon explained by the new theory is the variation of the current amplification with change of load resistance. This is readily detected in practice even for a simple transductor, and becomes of increasing significance as the percentage of self excitation is increased. The assumptions made in the analysis are such that the theory can be applied successfully only to transductors with cores which have high permeability and are readily saturable."

621.314.3† 49

New Core Materials Widen Scope of Saturable Reactors—(*Elec. Mfg.*, vol. 42, pp. 126-214; September, 1948.) A general account of the subjects discussed in papers presented at a symposium on magnetic materials at the Naval Ordnance Laboratory, Washington, June 15, 1948.

621.316.8:621.396.822 50

Distribution in Energy of Johnson Noise Pulses—B. R. Gossick. (*Jour. Appl. Phys.*, vol. 21, pp. 847-850; September, 1950.) An analysis is made using Maxwell-Boltzmann statistics with a time-energy phase space. The results are checked against pulse-height measurements made with a linear amplifier and electronic counter. The following parameters are determined from the distribution function: (a) time of flight associated with a Lorentz mean free path; (b) number of electrons producing pulses of a given height; (c) the potential through which an electron falls along a Lorentz mean free path.

621.317.35:621.39.001.11 51

Signals with Limited Spectra and Their Transformations—J. Oswald. (*Cables & Trans.* (Paris), vol. 4, pp. 197-215; July, 1950.) Detailed mathematical treatment. See also 3069 of 1949.

621.318.371:621.392.53 52

The Compensation of Delay Distortion in Video Delay Lines—R. A. Erickson and H. Sommer. (*Proc. I.R.E.*, vol. 38, pp. 1036-1040; September, 1950.) A theoretical and practical investigation into the effect of placing isolated metal patches of various sizes in the vicinity of solenoid delay lines. These patches are equivalent to capacitors bridging sections of the solenoid. The relation between size of patch and effective capacitance is given. Relations necessary for determining the delay distortion and effective bandwidth corresponding to different amounts of capacitance are determined. Oscillograms illustrate the reduction of distortion due to patches of different sizes. See also 41 of 1947 (Kallmann).

621.319.4 53

Metallized Paper Capacitors—J. R. Weeks. (*Proc. I.R.E.*, vol. 38, pp. 1015-1018; September, 1950.) See also 134 below (McLean).

621.392 54

Simplifying Assumptions—W. T. C. (*Wireless Eng.*, vol. 27, pp. 217-219; August and September, 1950.) Examples are discussed which illustrate the need for great care in making simplifying assumptions. Neglect of the leakage inductance of a transformer, for instance, results in considerable discrepancy between the wave form to be expected in a branch of a television line-scanning circuit and the wave form actually observed.

621.392 55

The Distinction Between Effective and Circuit Bandwidths—W. J. Kessler. (*Trans. AIEE*, vol. 68, Part I, pp. 98-99; 1949.) See 3074 of 1949.

621.392 56

Wideband Two-Phase Networks—N. O. Johannesson. (*Wireless Eng.*, vol. 27, pp. 237-238; August and September, 1950.) Comment on 1356 of 1950. A method of approximation based on θ functions is given which facilitate numerical computations.

621.392.5 57

Application of the Methods of Synthesis of Electrical Circuits to the Construction of Quadripoles, Given the Transmission Coefficient for a Finite Frequency Band—V. A. Taft. (*Bull. Acad. Sci. (URSS)*, pp. 873-887; June 1950. In Russian.) The methods used for designing a quadripole are normally based on trials of different values for circuit parameters. A general design method based on the synthesis of electrical circuits is here proposed. The theory of quadripoles is discussed and the necessary and sufficient conditions are established for the physical realization of a passive reactive quadripole. The various stages of the design work are then laid out for realizing a quadripole with a given transmission coefficient.

for a finite frequency band or, in other words, with given attenuation and phase-displacement coefficients for the same frequency band.

52.1392 58
Summary of Transformations Useful in Constructing Analogs of Linear Vibration Problems—J. P. Corbett. (*Trans. AIEE*, vol. 68, Part I, pp. 661-664; 1949.) Full paper. Summary noted in 834 of 1950.

621.392:519.272.15 59
Short-Time Autocorrelation Functions and Power Spectra—Fano. (See 141.)

621.392:681.142 60
A High-Speed Multiplier for Analogue Computers—B. N. Locanthi. (*Elec. Eng.*, vol. 69, p. 717; August, 1950.) Summary of AIEE Summer General Meeting paper. A circuit developed at the California Institute of Technology for multiplying together two voltages is described. One voltage is fed to a ring modulator; the output, together with the other voltage is fed to a balanced modulator whose output provides the required product. Phase and amplitude distortion are low.

621.392.4 61
Two-Pole Compensation Networks—A. Pincioli. (*Bull. schweiz. elektrotech. Ver.*, vol. 40, pp. 644-646; August 20, 1949. In French.) Paper presented at the International Television Conference. Zürich, 1948. Discussion of the characteristics of a triode circuit equivalent to a tube with negative transconductance. Such a circuit, when connected between two points of an electrical network, can within certain limits compensate the resistive and capacitive parameters of the network between the two points. Applied to the output terminals of a RC amplifier, a compensation two-pole can increase the upper frequency limit considerably and also the amplification factor. See also 1882 of 1948.

621.392.52:621.396.611.3 62
Tuned Absorption Circuits—R. E. Spencer. (*Wireless Eng.*, vol. 27, pp. 219-224; August and September, 1950.) An analysis is given of circuits in which input and output terminals are connected to the same tuned circuit and a coupled circuit absorbs power over a comparatively narrow band of frequencies. Approximate mathematical solutions are given, with graphical illustrations of response curves and a discussion of the depth and shape of the trough between the two humps of the response curve.

621.392.52:621.396.619 63
Polyphase Modulation as a Solution of Certain Filtration Problems in Telecommunication—Macdiarmid and Tucker. (See 213.)

621.392.6 64
Synthesis of $2n$ -Terminal Passive Networks—R. Leroy. (*Cables & Trans.*, (Paris), vol. 4, pp. 234-247; July, 1950.) Analytical investigation of certain aspects of the theory discussed in 62 of 1950 (Bayard). By extension of Gewertz's method to a positive real completely reduced matrix of order n it is possible to obtain a matrix of the same order but with elements of degree lower by $(2n-2)$. A singular type of matrix appears in the calculations when the degree of the elements is $< (2n-2)$, so that the reduction of the initial matrix generally involves the derivation from a singular matrix of a non-singular matrix of lower order, to which the Gewertz method is then applied. The corresponding network always includes only one resistor. An alternative method for effecting the synthesis of completely reduced matrices consists in determining the reactive network which includes this resistor through a supplementary pair of terminals. Further, reduced positive real matrices of row q can be realized as networks comprising q resistors.

621.392.6 65
Synthesis of a Finite $2n$ -Terminal Network by a Group of Networks each of which Contains Only One Ohmic Resistance—Y. Oono. (*Jour. Math. Phys.*, vol. 29, pp. 13-26; April, 1950.)

621.396.611.1 66
Periodic and Aperiodic Oscillations in an Oscillatory Circuit including an Iron-Cored Coil and Approximately Tuned to an Impressed Alternating Voltage—J. M. Op den Orth. (*Tijdschr. ned. Radiogenoot.*, vol. 15, pp. 211-236; July and September, 1950.) The investigation relates particularly to a circuit including little or no resistance. The inductance is assumed to be only slightly nonlinear, thus permitting the circuit differential equations to be solved by an approximate method, due to Poincaré. Periodic forced oscillations are represented by singular points (generally two isolated points and a saddle-point). If damping is zero, all other solutions correspond to closed curves around one or the other of the isolated points, or around both points. If damping is not zero the curves become spirals tending to one or the other of the isolated points (corresponding to stable forced oscillations). Jump phenomena are discussed. The importance of the solution curves through the third singular point (a saddle-point representing an unstable forced oscillation) is made clear.

621.396.611.1 67
Nonharmonic Oscillations as Caused by Magnetic Saturation—R. Rüdberg. (*Trans. AIEE*, vol. 68, Part I, pp. 676-685; 1949.) A detailed investigation of the effect produced on the waveform by the nonlinear characteristics of circuits containing capacitors and saturated inductors. Rigorous analysis shows that the natural oscillations in such circuits remain harmonic and have constant frequency only at small amplitudes. With increasing amplitude the wave form becomes more and more distorted and the natural frequency increases. Transient and steady-state forced oscillations are treated by means of a differential equation which involves only four parameters, but which covers all possible cases. A solution is obtained by a step-by-step method. In the transient state, strange shapes are found for the flux, current and voltage curves, with no regularity as regards either symmetry or periodic repetition. Natural oscillations can be maintained by application of a voltage of definite magnitude and wave form. In series circuits a peaked voltage curve is required. Subharmonics of the supply voltage may consequently be developed. The theoretical results are illustrated by oscillograms obtained with circuits including highly saturated components.

621.396.611.1 68
The Fourier Spectrum of Forced Oscillations Produced by Step and Needle Impulses—M. Päsler and W. Reichardt. (*Frequenz*, vol. 4, pp. 211-215; August, 1950.) The combined effect of a voltage step and its derivative on an oscillatory circuit is analysed by means of Fourier integrals, and the dependence of the spectral functions on frequency and damping is investigated. The results are presented in graphs and discussed. See also 1324 of 1949 (Päsler). •

621.396.611.21 69
High-Frequency Vibrations of Plates Made from Isometric and Tetragonal Crystals—E. A. Gerber. (*Proc. I.R.E.*, vol. 38, pp. 1073-1078; September, 1950.) Beveling of crystals is described as a method for obtaining a single response frequency in crystal units. Electrical characteristics and temperature coefficients of NaClO_3 , NaBrO_3 , $\text{HN}_3\text{H}_2\text{PO}_4$ (ADP) and KH_2PO_4 (KDP) crystal units were measured. The two cuts (zxw) 45° and ($zxtw$) $45^\circ/54^\circ44'$ [See IRE Standard on Piezoelectric Crystals

(655 of 1950)] were used. Fair agreement was obtained with the theory presented in the paper. The NaBrO_3 thickness modes have about the same quality factor as that of quartz, the quality factor of ADP crystals being about one order of magnitude lower.

621.396.611.4 70
Some Perturbation Effects in Cavity Resonators—A. Cunliffe and L. E. S. Mathias. (*Proc. IEE* (London), Part III, vol. 97, pp. 367-376; September, 1950.) "An investigation, partly theoretical and partly experimental, has been made of some effects which occur when the boundary of a cavity is deformed slightly. First, the theory of natural electromagnetic oscillations inside lossless cavities is summarized. Then a general theory, following along the lines of conventional first-order perturbation theory, is given. The theory has been applied to the perturbation of a right-circular cylindrical cavity. Two cases have been considered: the E_{010} mode, a non-degenerate case, and the H_{011} and E_{111} modes, a triply degenerate case. These two cases have also been investigated experimentally. Theory and experiment are in reasonable agreement, even for quite large deformations, when the deformation is applied gradually over a large area of the cavity wall. For sharp abrupt changes in the geometry of the cavity wall, however, it appears that the first-order perturbation theory can be applied only for very small distortions. The general results, theoretical and experimental, which have been obtained, show that if the frequency of the operating mode is well separated from the frequencies of other modes, a deformation of the boundary changes only the frequency of the operating mode and not its electromagnetic field configuration. If the frequency of the operating mode is near to the frequencies of other modes, a slight deformation of the cavity boundary, as well as changing the frequency of the operating mode, may also change its electromagnetic field configuration. 'Lossy' material or resistance wires, introduced into a cavity with a view to damping out unwanted modes, may also affect the desired resonance if certain types of deformation are present."

621.396.615 71
The Reactance-Tube Oscillator—A. Giger. (*Proc. I.R.E.*, vol. 38, p. 1096; September, 1950.) Comment on 326 of 1950 (Chang and Rideout), pointing out that the transconductance of the oscillator tube has a fixed value and hence cannot affect the frequency. An explanation of the observed frequency variation is given which is based on practical work in Switzerland, where the reactance tube oscillator has been in commercial use for years.

621.396.615.17 72
Calculation of the Time Delay of a Multi-vibrator—H. de Lange Dzn. (*Tijdschr. ned. Radiogenoot.*, vol. 15, pp. 275-291; July and September, 1950.) A general solution is derived for a linear differential equation of n th order with constant coefficients by the method of variation of parameters, in which a discontinuity of the n th order is reduced to one of zero order during integration. The solution is applied to calculate the time delay of a multi-vibrator by means of a differential equation of fourth order.

621.396.615.17:621.317.755 73
Spiral Time Base—(*Wireless Eng.*, vol. 27, pp. 224-226; August and September, 1950.) A description of the mode of operation of the basic circuit, with particular attention to the effect of varying the time at which the trigger switch is opened. A simple circuit using a thyatron switch is shown, and a more complex switching circuit used in radar is fully described. The timebase was developed at the Radar Research and Development Establish-

ment and is the subject of British Patent No. 582419.

621.396.645 74

A Selective Relay Amplifier for Recording WWV Time Signals—E. F. Carome and H. C. Nash. (*Trans. Amer. Geophys. Union*, vol. 30, pp. 328–329; June, 1949.) Full circuit details are given of an amplifier which discriminates against all frequencies except 440 cps, the modulation frequency of the wvw signals, so that the operation of a relay in the anode circuit of the output tube is unaffected by the pulses sent out at second intervals, or by atmospheric or background noises. The selective element consists of a twin-T RC bridge.

621.396.645:612.8 75

Biological Requirements for the Design of Amplifiers—H. Grundfest. (*Proc. I.R.E.*, vol. 38, pp. 1018–1028; September, 1950.) Discussion of the nature and properties of bioelectric potentials and description of amplifiers specially suitable for investigating such potentials.

621.396.645:621.3.015.7† 76

The Amplification of Pulse-Form Modulated Voltages and the Accompanying Reduction of Slope and Time Delay—J. W. Alexander. (*Tijdschr. ned. Radiogenoot.*, vol. 15, pp. 237–251; July and September, 1950.) In assessing the performance of an amplifier dealing with pulse signals the criteria to be considered are the slope of the output-pulse envelope and its retardation with respect to the input pulse. According to the method developed, these factors are easier to determine than the output-pulse envelope itself. The theory is applied to amplifiers with several single-tuned circuits and to amplifiers with coupled- and stagger-tuned circuits.

621.396.645.012.3 77

The Determination of Quiescent Voltages and Currents in Pentode Amplifiers—A. J. Shummins. (*Electronic Eng.*, vol. 22, pp. 386–388; September, 1950.) A method is described for determining the quiescent values of anode, screen-grid and control-grid voltages and currents graphically or by calculation from a family of dynamic characteristics for various screen voltages. The solution is approximate but is useful for predicting effect due to changes in circuit parameters such as cathode and screen resistances.

621.396.645.36 78

"The Cathamplifier"—C. A. Parry. (*Proc. I.R.E.* (Australia), vol. 11, pp. 199–204; August, 1950.) An amplifier circuit with high input impedance which permits push-pull operation from an unbalanced source. The input voltage is applied between earth and the grid of one of the tubes, and a voltage proportional to the total circulating current is obtained from a transformer whose center-tapped primary is connected between the two cathodes; this voltage is applied, in the correct phase, between earth and the grid of the other tube. A resistance shunted across the transformer primary is varied to obtain anode-ac balance. Over-all performance similar to that usual in push-pull operation may be obtained. Two modes of oscillation are possible which are independently adjustable.

GENERAL PHYSICS

533.723+621.396.822 79

Spontaneous Fluctuations—D. K. C. MacDonald. (*Rep. Progr. Phys.*, vol. 12, pp. 56–79. References, pp. 79–81; 1948–49.) A survey of developments of fluctuations analysis, and a review of research on fluctuation phenomena in the last decade, omitting general problems treated in standard works. The correlation

function is discussed, with examples of its use. Recent developments treated are mainly concerned with electrical and tube noise, and include discussion of thermal, shot, and low-frequency noise.

535.215.9:537.315 80

Contact-Potential Measurements on Irradiated Metal-Oxide Surfaces—H. Neuert. (*Z. Naturf.*, vol. 3a, pp. 226–228; 1948.) Account of experimental work demonstrating that a slightly oxidized surface can be activated by sw ultraviolet radiation, or by ionic or electronic charging, or by mechanical treatment.

535.312:539.23 81

Reflection Reduction in Optics—M. Auwärter. (*Bull. schweiz. elektrotech. Ver.*, vol. 40, pp. 605–607; August 20, 1949. In German.) Paper presented at the International Television Conference, Zürich, 1948. Investigation of the properties of single- and multiple-surface layers.

535.317.9:621.397.5 82

The Schmidt Optical System—H. Rinia. (*Bull. schweiz. elektrotech. Ver.*, vol. 40, pp. 580–585; August 20, 1949. In English.) Paper presented at the International Television Conference, Zürich, 1948. An outline is given of the basic principles of the Schmidt system. The conventional form gives fifth-order coma for low magnifications. Means are indicated for compensating this coma. The cause and magnitude of the lateral spherical aberration are discussed and a new method of aberration correction is described. See also 63 and 1215 of 1949 (Rinia and van Alphen).

535.42 83

Critical Report on the General Laws of Diffraction, Submitted to the International Optics Commission—G. Toraldo di Francia. (*Nuovo Cim.*, vol. 5, pp. 591–605; December 1, 1948.) A review of classical and modern theories.

537.312.5 84

Theory of Photoelectric Conduction in Composite Conductors—F. Stockmann. (*Z. Phys.*, vol. 128, pp. 185–211; July, 1950.) The fundamental equations of electrical conduction are examined for the case of circuits including electron sources and sinks. General laws for photoelectric currents are hence derived which agree with laws derived directly by other workers, and saturation current, amplification and exponential law of loss are discussed. Non-linear conductors and semiconductors are studied as special cases.

557.525 85

The High-Frequency Gas Discharge—F. Kirchner. (*Z. Naturf.*, vol. 2a, pp. 620–621; 1948.) A description is given of a simple experimental arrangement for investigating the discharge without introducing a probe. The results indicate strong positive space-charge and high positive potential within the gas. The discharge can be maintained with voltages below the ionization potential.

537.528 86

X-Ray Investigation of Sound Waves Associated with Breakdown of Dielectrics—W. Schaaffs and F. Trendelenburg. (*Z. Naturf.*, vol. 3a, pp. 656–668; 1948.)

537.533 87

General Properties of the Electronoptical Image—F. Borgnis. (*Bull. schweiz. elektrotech. Ver.*, vol. 40, p. 571; August 4, 1949. In German.) Paper presented at the International Television Conference, Zürich, 1948. See also 1351 and 2780 of 1949, for which the above UDC number is preferable.

537.534:621.385.82 88

The Production of Ion Beams by Means of a High-Frequency Discharge—H. Neuert. (*Z. Naturf.*, vol. 3a, pp. 310–312; 1948.) An ar-

angement similar to that described by Thonemann (3261 of 1946) was studied. With 100 w exciting power and 10 kv field voltage an ion current of 20 ma was obtained.

538.3 89

A Notation for Electrodynamics Adaptable to any System of Units—R. Fleischmann. (*Z. Naturf.*, vol. 3a, pp. 492–495; 1948.) The fundamental equations of electricity and the principal formulas of four-dimensional electrodynamics are presented in a notation which is independent of the system of units and which for special cases yields the formulas valid for the usual systems of units.

538.31+538.65 90

Fields within and around Cavities in a Magnetically Strained Medium, Ponderomotive Forces acting thereon in a Magnetic Field with Current in the Cavity, and the Electric Field generated on Movement of the Cavity—J. P. Schouten. (*Tijdschr. ned. Radiogenoot.*, vol. 15, pp. 163–177; July and September, 1950.) It is shown analytically that the total electric field inside a cavity moving in a medium subjected to a homogeneous magnetic field is independent of the inhomogeneity introduced by the cavity wall, and the total mechanical force on the cavity is the same as if the medium were continuous.

538.311 91

Formulas and Tables for the Calculation of the Magnetic Field Components of Circular Filaments and Solenoids—F. W. Grover. (*Trans. AIEE*, vol. 68, Part I, pp. 665–675; 1949.) Existing formulas are discussed and new formulas are derived. Tables of the functions involved are presented in a form which facilitates routine calculations.

538.322 92

The Forces between Two Current Conductors—B. D. H. Tellegen. (*Tijdschr. ned. Radiogenoot.*, vol. 15, pp. 157–161; July and September, 1950.) Conditions for steady currents in closed conductors are considered, and the total force is regarded as the resultant of attractive forces and couples due to the interaction of current elements of the two conductors.

538.56:535.3 93

Reflection and Transmission of Electromagnetic Waves by Thin Curved Shells—J. B. Keller. (*Jour. Appl. Phys.*, vol. 21, pp. 896–901; September, 1950.) "The scattering of an arbitrary electromagnetic field by a conducting or non-conducting obstacle is investigated. The differential equations and boundary conditions satisfied by the field are transformed into a pair of inhomogeneous linear integro-differential equations for E and H . For an obstacle which is a thin shell of constant thickness h , a formal procedure for obtaining a solution of these equations as power series in h is given. The lowest order term in this solution is the incident field. An explicit expression for the next term is found in the form of a surface integral. This integral is evaluated approximately by the method of stationary phase. The physical properties of the solution are examined in detail, and satisfactory agreement is found with many results previously obtained by other methods."

538.56:535.42 94

Rigorous Theory of the Diffraction of Electromagnetic Waves by a Perfectly Conducting Disk—J. Meixner. (*Z. Naturf.*, vol. 3a, pp. 506–518; 1948.) The solution of this problem is given and is extended to the related problem of diffraction by a circular aperture in a perfectly conducting plane sheet of infinite extent by a generalization of Babinet's principle.

38.56:537.56:523.74

95

The Characteristics of Radio-Frequency Radiation in an Ionized Gas, with Applications to the Transfer of Radiation in the Solar Atmosphere—S. F. Smerd and K. C. Westfold. *Phil. Mag.*, vol. 40, pp. 831-848; August, 1949.) The function E which determines the adiation at any point is the ratio of the missivity to the product of the absorption coefficient and the square of the index of refraction. The intensity of 'quiet' radio-frequency solar radiation reaching the earth can be expressed in terms of E and the optical depth of the various ray trajectories. Formulas are derived for emissivity, absorption coefficient and refractive index, from which E can be found. The formulas are expressed in terms of the electron and ion densities and the kinetic temperature, assuming a Maxwellian velocity distribution. A heuristic theory of the absorption and emission processes on a volume element is given which takes account of the effect of the surrounding particles of the medium.

538.56.029.64:537.562:535.43

96

The Scattering of 3-cm Radiation by Ionized Gases—S. N. Denno, H. A. Prime, and J. D. Craggs. (*Proc. Phys. Soc.*, vol. 63, pp. 726-727; September 1, 1950.) Radiation of wavelength 3 cm is scattered by a commercial cylindrical mercury discharge tube. Scatter at right angles to the incident radiation is received and its power measured. Curves showing the received power as a function of tube current are given for radiation polarized (a) perpendicular to and (b) parallel to the tube axis, or two tubes of diameters 3.1 cm and 6.4 cm respectively. It is intended to use the information to determine the electron concentration in the discharge.

539

97

Masses of Fundamental Particles—R. Fürth. (*Nature* (London), vol. 166, pp. 727-728; October 28, 1950.)

548.1:537

98

A Derivation and Tabulation of the Piezoelectric Equations of State—J. F. Haskins and J. S. Hickman. (*Jour. Acoust. Soc. Amer.*, vol. 22, pp. 584-585; September, 1950.) The conservation-of-energy principle is applied to derive the general equations, with strain, electric displacement and entropy as independent variables. The special case of constant entropy is then considered, with polarization as an additional parameter, and all possible linear adiabatic equations of state are developed, using in turn as independent variables stress and electric field, strain and polarization, and stress and polarization. Hence the relations between the elastic, electric and piezoelectric coefficients for the various pairs of independent parameters are determined and tabulated.

548.1:537

99

Piezoelectric Equations of State and their Application to Thickness-Vibration Transducers—W. G. Cady. (*Jour. Acoust. Soc. Amer.*, vol. 22, pp. 579-583; September, 1950.) The electromechanical equations of state are given in several forms and those most appropriate in theoretical work are indicated. A detailed treatment of the thickness-vibration transducer is given, resulting in expressions for the electrical characteristics and acoustic power. Various special cases are briefly considered.

GEOPHYSICAL AND EXTRATERRESTRIAL PHENOMENA

523.5:[621.396.9+77

100

Meteor Velocities—P. M. Millman and D. W. R. McKinley. (*Observatory*, vol. 70, pp. 156-158; August, 1950.) Photographic and radio techniques are discussed in relation to their capabilities of detecting fast meteors.

Meteors with speeds as high as 150 km should be detectable by radio methods.

523.7:538.12

101

The Effect of Turbulence on a Magnetic Field—P. A. Sweet. (*Mon. Not. R. Astr. Soc.* vol. 110, pp. 69-83; 1950.) Extension of earlier work (1677 of 1950). Mathematical analysis indicates that (a) turbulence reduces the effective conductivity in the core and in the outer layers of the sun, but sunspot fields are not affected; (b) the decay time of the sun's general magnetic field is somewhat less than 10^{10} years, while the mean field in the core, if the general field is decaying from some initial state, is irrotational; (c) no system of meridian-plane convection currents in the sun can provide a general amplification of a field produced by a given emf, while turbulence in fact reduces the field.

523.71

102

The Solar Constant—C. W. Allen. (*Observatory*, vol. 70, pp. 154-155; August, 1950.) Discussion leads to a tentative value of $1.97 \text{ cal/cm}^2/\text{min}$.

523.72

103

Cosmic Radiation from the Sun—A. Ehmert. (*Z. Naturf.*, vol. 3a, pp. 264-285; 1948.) The phenomena of chromosphere eruptions may be related to the ionization of chromosphere regions by protons accelerated in the varying magnetic fields of sunspots; in the same way accelerated electrons may give up their energy as usw radiation.

523.72:621.396.822

104

Solar Radio-Frequency Radiation—J. L. Pawsey. (*Proc. IEE* (London) Part III, vol. 97, pp. 290-308; September, 1950. Discussion, pp. 308-310.) A survey of solar-noise research from 1932 to 1948. Observed characteristics in the wavelength range from 1 cm to a few meters are described. From the intensity, region of origin, association with visual phenomena and polarization a classification is suggested. A thermal component is recognized corresponding in intensity to a black-body radiation of a temperature that rises from 10^4K at a wavelength of 1 cm to 10^6K at wavelengths of a few meters. This is believed to be associated with a rise in the region of origin from the lower chromosphere to the corona. Non-thermal components, prominent at meter wavelengths and believed to originate from electrical disturbances in the solar atmosphere, vary rapidly and have occasional peak intensities 10^3 to 10^6 times the thermal ones. 66 references are given.

523.74:538.56:537.56

105

The Characteristics of Radio-Frequency Radiation in an Ionized Gas, with Applications to the Transfer of Radiation in the Solar Atmosphere—Smerd and Westfold. (See 95.)

523.74/.75:621.396.11

106

Solar Notes—H. W. Newton. (*Observatory*, vol. 70, pp. 163-164; August, 1950.) Solar activity during the first six months of 1950 is briefly reviewed. Observed correlations between special solar phenomena, such as flares, and radio propagation conditions are described.

523.8:538.12

107

Stellar Magnetic Fields and Rotation—S. K. Runcorn. (*Observatory*, vol. 70, pp. 155-156; August, 1950.) Using data applying to eight stars, the correlation coefficient between magnetic field and angular momentum is 0.6. Possible causes of varying and reversing magnetic fields are discussed.

538.12:521.12

108

Gravitational Field and Magnetism—A. Maior. (*Compt. Rend. Acad. Sci. (Paris)*, vol. 231, pp. 607-608; September 25, 1950.) Argument indicating that a charged body moving in

a gravitational field produces a convection current accompanied by a magnetic field. Formulas are derived which are more general than the empirical formula of Blackett.

550.372

109

The Earth's Constants from Combined Electric and Magnetic Measurements partly in the Vicinity of the Emitter—K. F. Niessen. (*Z. Naturf.*, vol. 3a pp. 552-558; 1948. In English.) The dielectric constant and conductivity of the earth in the vicinity of a projected transmitter are found by making measurements of E and H at points close to (distance $2\lambda-4\lambda$) and remote from an experimental transmitter. The method depends on the fact that at short distances the electric and magnetic field strengths vary according to different laws. The analysis is based on Sommerfeld's vector-function formula for the radiation from an ideal dipole, and the required constants are obtained from a simple system of curves. See also 3893 of 1947.

550.38

110

The 'Absolute Quadrupole-Moment'—a Fundamental Magnetostatic Quantity and its Geophysical Significance—H. G. Macht. (*Z. Naturf.*, vol. 3a, pp. 189-195; 1948.)

551.5:621.396.81.029.63/.64

111

A Radio Meteorological Investigation in the South Island of New Zealand—Milnes and Unwin. (See 200.)

551.510.535

112

Ionosphere Observations in Adélie Land—M. Barré and K. Rawer. (*Compt. Rend. Acad. Sci. (Paris)*, vol. 231, pp. 436-437; August, 16, 1950.) An interim report of observations made during the antarctic cruise of the *Commandant Charcot* (see also 3429 of 1949 and 97 of 1950). Features noted from recordings obtained during 24 hours on January 3-4, 1950 include: (a) a sporadic-E layer giving echoes at high frequencies (10 Mc); frequent stratification of this layer and increase of its height with frequency; (b) permanent diffusion of the F layer, extending with increase of frequency; (c) horizontal traces resembling those of the sporadic-E layer but at heights of 250-800 km; (d) selective absorption at about 3.5 Mc masking all trace of layers.

551.510.535:538.566

113

The Poynting Vector in the Ionosphere—Scott. (See 193.)

551.594.6(729)

114

Air Weather Service Sferics Operations in the Caribbean Area—H. F. Willey. (*Trans. Amer. Geophys. Union*, vol. 30, pp. 330-332; June, 1949.) A general description is given of the sferics 4-station network and its operation, with discussion of the correlation of sferics with weather conditions.

523.72+523.854]:621.396.822

115

Bruits Radio-Électriques Solaires et Galactiques (Solar and Galactic Radio Noise) [Book Review]—URSI (Union Radio Scientifique Internationale) Special Report No. 1. Brussels, 1950, 51 pp. (*HF, Brussels*, p. 200; 1950.) A résumé of present knowledge. The report was presented at the Stockholm meeting, 1948. An English edition is also available.

LOCATION AND AIDS TO NAVIGATION

534.88

116

Sound Ranging at the Morris Dam Torpedo Ranges—R. N. Skeeters. (*Elec. Eng.*, vol. 69, p. 718; August, 1950.) Summary of AIEE Summer General Meeting paper. For making accurate determinations of the trajectories of under-water missiles, the latter are caused to generate sounds which are picked up by suitably located hydrophones arrayed in groups of eight. An oscillograph record is obtained. Re-

duction of the data is accomplished by means of a computer which is a scale model of one of the hydrophone groups.

621.396.9:621.396.67 117
Radar Aerial Systems for Uniform Irradiation of a Surface—J. R. Huynen. (*Tijdschr. ned. Radiogenoot.*, vol. 15, pp. 293-297; July and September, 1950.) The problem of achieving uniformity of energy at all points of a spiral scan is studied.

621.396.93 118
The Relative Merits of Presentation of Bearings by Aural-Null and Twin-Channel Cathod-Ray Direction-Finders—S. de Walden and J. C. Swallow. (*Proc. IEE (London)*, Part III, vol. 97, pp. 362-365; September, 1950.) Discussion on 3142 of 1949.

621.396.93 119
Some Experiments on the Accuracy of Bearings taken on an Aural-Null Direction-Finder—F. Horner. (*Proc. IEE (London)*, Part III, vol. 97, pp. 359-361; Discussion, pp. 362-365; September, 1950.) The paper describes some tests to determine how the accuracy of a bearing taken on an aural-null rotating H-Adcock direction-finder depends on the width of the minimum and on the receiver output noise-level. The results pertain to bearings taken on a steady tone-modulated signal by an experienced observer working under good conditions. They indicate that bearings taken under these conditions will have standard deviation of between 1/40 and 1/20 of the arc of silence except for very small arcs, even when the bearings are derived from very few oscillations of the antenna system. Accuracy is improved if the number of complete oscillations is greater than about five. Accuracy is degraded if the angle through which the antenna is swung is increased to improve the quality of the signal at the limits of the swing.

Differences of at least two to one in the standard deviation of observed bearings may occur between different observers, and with one observer at different times. Compared with these changes, any changes due to the use of different receiver output noise-levels are considered to be small.

MATERIALS AND SUBSIDIARY TECHNIQUES

531.787.9 120
The Pirani Effect in a Thermionic Filament as a Means of Measuring Low Pressures—(*Brit. Jour. Appl. Phys.*, vol. 1, p. 240; September, 1950.) Correction to paper abstracted in 1922 of 1950. W. P. Jolly is the sole author.

533.56 121
Characteristics of Diffusion Pumps—R. Witty. (*Brit. Jour. Appl. Phys.*, vol. 1, pp. 232-237; September, 1950.)

533.583:621.385 122
A Method for Measuring the Efficiency of Getters at Low Pressures—S. Wagener. (*Brit. Jour. Appl. Phys.*, vol. 1, pp. 225-231; September, 1950.) The method is based on measurement of the pressure drop along a narrow tube connecting the bulb containing the getter to the manifold of the pumping system. The values found for the rate of absorption of air ranged from 10 cm³/s for Mg to 1,500 cm³/s for Th getter, the bulb pressure being 1.5×10⁻⁶ mm Hg.

535.37 123
Phosphors and Phosphorescence—G. F. J. Garlick. (*Rep. Progr. Phys.*, vol. 12, pp. 34-53; References, pp. 53-55; 1948-49.) Recent investigations of luminescence in crystalline impurity-activated phosphors are reviewed. The electron-energy-band model and experimental support for it are discussed. Long-duration phosphorescence, due to electrons trapped in

thermally metastable levels, correlates with thermoluminescence. Advances are reported in knowledge of the structure of luminescence emission centers in sulphide and silicate phosphors. The emission spectra of manganese-activated silicates, recent studies of oxides and tungstates, and infrared-sensitive phosphors are treated. The latter need a secondary activator for marked sensitivity; infrared light appears to cause the ejection of trapped electrons, but there is no simple correlation between optical and thermal ejection.

535.37:546.472.21 124
The Introduction of Copper into a Luminescent Zinc Sulphide—N. Ril' and G. Ortman. (*Compt. Rend. Sci. (URSS)*, vol. 66, pp. 841-845; June 11, 1949. In Russian.) If copper is introduced by diffusion into ZnS crystals it may be in two states, one causing blue luminescence and the other green luminescence. An experimental study of these effects is described.

537.311.31:546.92:541.183.56 125
Resistance Variation of a Platinum Foil due to Gas Adsorption—W. Braunbek. (*Z. Naturf.*, Vol. 3a, pp. 216-220; 1948.) Experiments made with Pt foil in oxygen, argon and helium indicate a resistance reduction of the order of 10⁻⁴ as compared with the value in vacuo, the effect being greatest in oxygen.

538.221 126
On Ferromagnetic States—J. Giltay. (*Tijdschr. ned. Radiogenoot.*, vol. 15, pp. 253-274; July and September, 1950.) The form of Madelung's laws is criticized and new expressions are formulated covering effects observed in ferromagnetic materials. Operating-cycle diagrams derived from auxiliary loop curves are introduced.

538.221:538.562 127
Magnetostriction of Permanent-Magnet Alloys—E. A. Nesbitt. (*Jour. Appl. Phys.*, vol. 21, pp. 879-889; September, 1950.) Magnetostriction measurements were made on various alloys having coercive forces from 50 to 600 oersted. In the older carbon-hardening permanent magnets, high coercive force and high magnetostriction appear together; for the newer carbon-free type this coincidence does not hold. These results are discussed in the light of recent theories.

548.0:537.228.1 128
Determination of the Elastic and Piezoelectric Coefficients of Monoclinic Crystals, with particular Reference to Ethylene Diamine Tartrate—R. Bechmann. (*Proc. Phys. Soc.*, vol. 63, pp. 577-589; August 1, 1950.) Longitudinal modes of vibration were used for narrow bars, low-frequency longitudinal and face-shear modes for square plates containing the axis of symmetry, coupled modes for square plates perpendicular to the axis of symmetry, and thickness-shear modes for plates containing the axis of symmetry. New values of the coefficients and their temperature coefficients are given for EDT. Some properties are considered of face-shear vibrating square plates of EDT rotated about the axis of symmetry as functions of the orientation, and of Y-cut plates as functions of the width-to-length ratio.

548.0:549.451 129
Influence of Plastic Flow on the Electrical and Photographic Properties of the Alkali-Halide Crystals—F. Seitz. (*Phys. Rev.*, vol. 80, pp. 239-243; October 15, 1950.)

620.193:621.315.61 130
Methods for Determining the Effect of Contaminants on Electrical Insulation—K. N. Mathes, L. E. Sieffert, H. P. Walker, and R. H. Lindsey. (*Trans. AIEE*, vol. 68, Part I, pp. 113-118. Discussion, pp. 118-119; 1949.) The results of tests made under laboratory condi-

tions with carefully controlled mixtures of such contaminants as are commonly encountered on board ship are tabulated according to the effects on the physical and electrical properties of insulating materials, including surface breakdown voltage, dimensional stability, and so forth.

621.315.61:621.317.331 131
Some Measurements of the Resistivity of Good Insulators—N. W. Ramsey. (*Proc. Phys. Soc.*, vol. 63, pp. 590-594; August 1, 1950.) A method depending on the loss of charge on a capacitor was used. The resistances of amber, alkathene, distrene and perspex increased over a period of weeks, the final values being considerably higher than previously published figures.

621.315.612.011.5 132
Ceramic Dielectrics with High Permittivity Titanates—A. Danzin. (*Ann. Radiol. lect.*, vol. 5, pp. 230-242; July, 1950. *Onde élect.*, vol. 30, pp. 253-258 and 335-340; June and July, 1950.) The mode of preparation of ceramic dielectrics is described and the properties of normal mineral insulating materials and of titanates are compared. Crystal structure and anomalous temperature coefficients are discussed and methods of obtaining a specified dielectric constant are outlined. Titanates are broadly classified into two groups and applications are listed.

621.315.612.4:621.3.011.5 133
The Structure, Electrical Properties and Potential Applications of the Barium-Titanate Class of Ceramic Materials—W. Jackson. (*Proc. IEE (London)*, Part III, vol. 97, pp. 285-289; September, 1950.) Abstract of IEE lecture, March, 1950, reviewing present knowledge. The 75 references given are intended to afford a preliminary guide to the published work on the subject.

621.319.4:621.793:621.315.614.6 134
Metallized Paper for Capacitors—D. A. McLean. (*PROC. I.R.E.*, vol. 38, pp. 1010-1014; September, 1950.) An account of development work in the Bell laboratories. Lacquering the paper prior to metallizing increases the dielectric strength and insulation resistance, reduces corrosion of the metal coating and also loss of coating by electrolysis. Special precautions are necessary to exclude moisture from metallized-paper capacitors. See also 123 of 1950 (Wehe).

666.1.037.5 135
The Physical Aspect of Glass/Metal Sealing in the Electronic Valve Industry: Part 2—G. Trébuchon and J. Fieffer. (*Ann. Radiol. élect.*, vol. 5, pp. 243-258; July, 1950.) The processing technique for the glass alone is discussed: graphs show the optimum annealing temperature and duration, and optimum cooling rate, for glasses of different thicknesses and expansion coefficients. The effects of annealing on the quality of seal are discussed. Graphs based on polarimetric observations show the effects on the stresses produced in the seal in numerous cases. A table summarizes the effects of the different variables in the annealing cycle and also of the intrinsic properties of the materials. Part 1: 2253 of 1950.

669.15.26:666.1.037.5:621.385.832 136
Stainless Steel for Television—A. S. Rose. (*Metal Progress*, vol. 57, pp. 761-764; June, 1950.) The use of an alloy containing only 17 per cent Cr for the metal cones of large cathode-ray tubes for television results in a saving in cost compared with that for the alloy previously used, which contained 28 per cent Cr. The addition of small amounts of other metals is necessary to make the new alloy suitable for sealing to glass.

MATHEMATICS

- 2.31 137
On Certain Polynomials Introduced by Chebyshev—H. Delange. (*Compt. Rend. Acad. Sci. (Paris)*, vol. 231, pp. 602-604; September 25, 1950.) A study of the asymptotic distribution of the zeros of P_n polynomials when n becomes infinitely great.
- 17.564.3:534.232 138
On the Extension of Some Lommel Integrals to Struve Functions with an Application to Coustic Radiation—C. W. Horton. (*Jour. Math. Phys.*, vol. 29, pp. 31-37; April, 1950.)
- 17.564.3(083.5) 139
Tables of Integrals of Struve Functions—f. Abramowitz. (*Jour. Math. Phys.*, vol. 29, p. 49-51; April, 1950.)
- 17.564.3(083.5) 140
A Short Table of Struve Functions and of some Integrals Involving Bessel and Struve Functions—C. W. Horton. (*Jour. Math. Phys.*, vol. 29, pp. 56-58; April, 1950.)
- 19.272.15:621.392 141
Short Time Autocorrelation Functions and Power Spectra—R. M. Fano. (*Jour. Acoust. Soc. Amer.*, vol. 22, pp. 546-550; September, 1950.) The reciprocal relations between autocorrelation functions and power spectra, known as Wiener's theorem, are extended in a modified form to the case of experimental results obtained by means of filters with finite time-constants.
- 81.142 142
Comparison of Long-Time and Short-Time Analog Computers—V. Paschkis. (*Trans. AIEE*, vol. 68, Part I, pp. 70-73; 1949.)
- 81.142 143
Application of the California Institute of Technology Electric Analog Computer to Non-linear Mechanics and Servomechanisms—G. J. McCann, C. H. Wilts, and B. N. Locanthi. (*Trans. AIEE*, vol. 68, Part I, pp. 652-660; 1949.) Full paper. Summary abstracted in 918 f 1950.
- 81.142:517.512.2 144
A New Fourier-Coefficient Harmonic Analyzer—S. Sharp. (*Trans. AIEE*, vol. 68, Part I, pp. 644-649; Discussion 649-651; 1949.) Full paper. Summary abstracted in 674 of 1950.
- 81.142:621.392 145
A High-Speed Multiplier for Analogue Computers—Locanthi. (See 60.)
- 801:517.5:53 146
Formulas and Theorems for the Special Functions of Mathematical Physics [Book Review]—W. Magnus and F. Oberhettinger. Publishers: Chelsea Publishing Co., New York, 1949, 172 pp. (*Proc. Phys. Soc.*, vol. 63, p. 733 September, 1950.) This book, which is a reference work rather than a textbook, deals with Bessel functions, spherical harmonics, hypergeometric functions and elliptic functions, and, as special cases, Laguerre, Hermite and other functions. Chapters are included on integral transformations and on coordinate transformations.
- 517.43:[5+6] 147
Operatorenrechnung und Laplacesche Transformation [Book Review]—K. W. Wagner. Publishers: J. A. Barth, Leipzig, 1950, 471 pp., 42.80 DM. (*Tech. Mitt. Schweiz. Telegr. Verw.*, vol. 28, p. 334; August 1, 1950. In German.) Second revised edition of the book noted in 2827 of 1949.
- 517.9:[5+6] 148
Die Differentialgleichungen der Technik und Physik (Differential Equations of Technology and Physics). [Book Review]—W. Hort

and A. Thoma. Publishers: J. A. Barth, Leipzig 5th edn., 1950, 576 pp., 46.80 DM. (*Tech. Mitt. Schweiz. Telegr.-Teleph. Verw.*, vol. 28, pp. 335-336; August 1, 1950. In German.) This edition of "Die Differentialgleichungen des Ingenieurs," newly revised by Thoma, is a comprehensive textbook in eight parts dealing with the subject from elementary differential and integral calculus to differential and difference equations, Fourier series, variational calculus and integral equations. Graphical and mechanical methods of solution are described in addition to analytical methods.

"The book is clearly written and is recommended both for the beginner and the practising engineer."

517.91 149
Differential Equations [Book Review]—H. W. Reddick. Publishers: Wiley & Sons, New York, and Chapman & Hall, London, 2nd edn., 1949, 288 pp., 24s. (*Proc. Phys. Soc.*, vol. 63, p. 733; September 1, 1950.) A relatively elementary, but clear and accurate, textbook for intending engineers; partial differential equations are not dealt with.

MEASUREMENTS AND TEST GEAR

- 529.1:529.786 150
On a Periodic Fluctuation in the Length of the Day—H. F. Finch. (*Mon. Not. R. Astr. Soc.*, vol. 110, pp. 3-14; 1950.) From a study of the performance of a number of quartz-crystal clocks used in the Greenwich Time Service, and annual periodic fluctuation in the length of the day is deduced. The variation is of the order of ± 0.001 sec and has an accumulative effect in time of approximately ± 0.060 sec. This is in very close agreement with results obtained from independent data by N. Stoyko and demonstrates the persistent character of the phenomenon. See also 2275 of 1950 (Scheibe and Adelsberger).
- 621.3.011.5:621.365.55† 151
The Measurement of Dielectric Loss at High Frequencies and Under Changing Temperature—J. B. Whitehead and W. Rueggeberg. (*Trans. AIEE*, vol. 68, Part I, pp. 520-524; 1949.) Full paper. Summary abstracted in 137 of 1950.
- 621.317.088.4:621.314.12 152
The Fundamental Limitations of the second-Harmonic Type of Magnetic Modulator as Applied to the Amplification of Small D.C. Signals—F. C. Williams and S. W. Noble. (*Proc. IEE (London)*, Part II, vol. 97, pp. 445-459; Discussion, pp. 474-483; August, 1950.) The advantages of the second-harmonic type of magnetic modulator for the conversion of dc to ac are discussed and theoretical analysis is presented for an idealized modulator of this type, with particular reference to the influence of various controllable parameters on the signal-to-noise ratio and the zero error. Experimental work is described which provides qualitative verification of the theory when allowance is made for the assumption of a simplified B/H characteristic for the core material. Great care in the design of the various circuits is necessary to eliminate additional sources of noise and zero error. In apparatus described the noise output is mainly Barkhausen noise in the cores and is equivalent to a signal input of about 10^{-10} w for a bandwidth of 1 cps, the zero drift being equivalent to an input of about 3×10^{-18} w over a 2-hour period.
- 621.317.2:621.397.62 153
Television Laboratory Equipment—W. Werner. (*Bull. Schweiz. elektrotech. Ver.*, vol. 40, pp. 635-637; August 20, 1949. In English.) Paper presented at the International Television Conference, Zürich, 1948. Short descriptions of

the special features and the uses of video signal generator, video distribution amplifier, high-frequency signal generator, microscope cro for observing any small portion of a television waveform, wide-band cro, sine-wave signal generator (up to at least 5 Mc), high-voltage voltmeter, film scanner, camera and studio-lighting equipment.

621.317.324(083.74)† 154
Two Standard Field-Strength Meters for Very-High Frequencies—D. D. King. (*Proc. I.R.E.*, vol. 38, pp. 1048-1051; September, 1950.) "Methods of field-strength measurement are reviewed briefly and the design of field meters conforming closely to the conditions imposed by antenna theory is considered. Two instruments approaching ideal theoretical conditions and suitable for reference standards are described. The first of these contains an adjustable matching network. The second utilizes very fine wires on a styrofoam support."

621.317.353.3†:621.396.11:551.510.535 155
Ionospheric Cross-Modulation: Techniques of Measurement—C. C. Newton, F. J. Hyde, and H. G. Foster. (*Proc. Phys. Soc.*, vol. 63, pp. 616-623; August 1, 1950.) The techniques described were used for the investigations noted in 3219 of 1948 (Ratcliffe and Shaw), 194 of 1949 (Huxley, Foster, and Newton) and 1220 of 1950 (Huxley). The transferred modulation was deduced from receiver measurements of the carrier voltage and the af voltage of the wanted signal. The phase of the transferred modulation relative to that of the directly received disturbing signal was determined by forming a Lissajous figure; a phase changer was used to measure the phase difference. A development is described which permits modulation depth and phase to be displayed on a single cro.

621.317.411††:621.317.43 156
Measurement of Permeability and Magnetic Losses of Straight Samples—P. M. Prache and R. Cazenave. (*Câbles & Trans. (Paris)*, vol. 4, pp. 216-233; July, 1950.) Advantages are gained by using a straight rod of the material under test in place of the toroidal sample normally introduced into the magnetic circuit. The calculation involved and the interpretation of results are simplified by considering the cylindrical sample replaced by an equivalent oblate spheroid and by using a coil much longer than this core so as to eliminate end effects. Practical inductance formulas are derived which may be used to determine permeability and loss coefficients.

621.317.443 157
A Permeameter for Magnetic Testing at Magnetizing Forces up to 300 Oersted—R. L. Sanford and P. H. Winter. (*Bur. Stand. Jour. Res.*, vol. 45, pp. 17-21; July, 1950.) An instrument designed to test specimens up to 3 cm wide and 1 cm thick, with a preferred length of 28 cm. It is simpler and more rapid in operation than the Burrows permeameter and requires only a single specimen. Accuracy is within 1 per cent.

621.317.444† 158
Underwater Gaussmeter—L. Vérain and P. Jolivet. (*Rev. gén. Élect.*, vol. 59, pp. 405-408; September, 1950.) The instrument described comprises an air-driven rotor of special design located in the unknown field and having two collector brushes connected by line to a fluxmeter. The brushes are periodically short-circuited, so that the fluxmeter needle has a steady deflection proportional to the unknown field and independent of the duration of the deflection or the speed of rotation of the rotor. Results are reported of measurements made at Algiers, in 1940, of the vertical component of the earth's magnetic field at various depths in the vicinity of a destroyer.

- 621.317.723 159
A Simple Vibrating Condenser Electrometer—D. G. A. Thomas and H. W. Finch. (*Electronic Eng.*, vol. 22, pp. 395-399; September, 1950.) The dc input is converted to ac by applying it through a series resistor to the plates of a capacitor consisting of a stainless-steel reed vibrating at 550 cps close to a polished steel disk. The resultant alternating voltage is amplified, rectified and fed back to cancel the input voltage, the electrometer acting as a null detector. Diurnal zero drift is 1 mv on a full-scale sensitivity of 30 mv. An important application is to the measurement of ionization currents.
- 621.317.725 160
A New Expanded-Scale A.C. Voltmeter—N. P. Millar. (*Trans. AIEE*, vol. 68, Part I, pp. 641-643; 1949.) Full paper. Summary abstracted in 687 of 1950.
- 621.317.725.029.5 161
A Thermal Millivoltmeter for Measuring Radio-Frequency Voltages—N. Coulson. (*Proc. IEE* (London), Part III, vol. 97, pp. 344-348; September, 1950.) The measuring element is a thermocouple milliammeter. The input impedance is varied by means of a turret switch which connects resistors in series or in parallel with the thermocouple, so that the output voltage of a source may be measured with various loads. At frequencies up to 100 Mc the error is less than 1 per cent for purely resistive 70- Ω sources, but may amount to 5 per cent when reactive elements are present.
- 621.317.727.025 162
The Polar Ammeter as an A.C. Potentiometer—The Synchropotentiometer—E. B. Brown. (*Jour. Sci. Instr.*, vol. 27, pp. 251-252; September, 1950.) Description of experiments showing that the voltage generated in the moving coil of a polar ammeter (1084 of 1948) can be varied both in phase and magnitude, so that the instrument can fulfil the functions of an ac potentiometer. An almost linear variation of amplitude can be obtained by moving the pointer over the scale. The phase can be varied by angular adjustment of the cradled synchronous motor. Results are quoted and a description is given of the apparatus.
- 621.317.73 163
A Direct-Reading Impedance-Measuring Instrument for the U.H.F. Range—W. R. Thurston. (*Gen. Radio Exp.*, vol. 24, pp. 1-7; May, 1950.) This null-type instrument measures, on scales independent of frequency, conductances, and susceptances of either sign, from 1 to 400 millimhos at frequencies from 70 to 1,000 Mc. Three coaxial lines, one terminated by a resistance equal to its characteristic impedance, one a stub adjusted to $\lambda/8$ at the operating frequency and forming the susceptance standard, and the other connected to the unknown impedance, are fed at a common junction from a common source and have adjustable pickup loops which are so oriented that their combined output is zero. The loop-position scales are calibrated to read susceptance and conductance directly.
- 621.317.733.089.6:621.3.018.78† 164
A Method for Calibrating Distortion-Measurement Bridges—W. Hübner. (*Arch. tech. Messen*, pp. T73-T74; July, 1950.) Measurement of distortion with an ac bridge-comparator is liable to errors depending on the Q of the resonant circuit and especially on the order number of the harmonics present. In the calibration and test method described the measurement bridge is connected in the fourth arm of a resistance bridge to which, after balancing, a voltage of fundamental frequency is applied across one diagonal and a known harmonic voltage across the other diagonal. The distortion factor of the voltage appearing across the measurement bridge is thus known accurately.
- 621.317.755:621.3.015.3 165
Technique of Autosynchronous Observation of Transients—F. Lepri, I. F. Quercia, and B. Rispoli. (*Nuovo Cim.*, vol. 5, pp. 569-585; December 1, 1948.) Discussion of modifications to a circuit previously described *ibid.*, vol. 5, p. 384; 1948) to make the whole of the transient visible. The cro timebase is triggered by the transient, which passes through a delay line before being applied to the y-plates of the cro. Operation of the bootstrap, Miller and phantatron sawtooth-wave generators and the design of delay lines are considered.
- 621.317.755:621.317.791 166
Polar Vector Indicator—F. A. Walker, A. H. Waynick, and P. G. Sulzer. (*Trans. AIEE*, vol. 68, Part I, pp. 154-159; 1949.) See 2569 of 1949.
- 621.317.757 167
A Frequency-Spectrum Analyser for Radio Signals—J. Marique. (*HF, Brussels*, pp. 177-184; 1950.) An account is given of an instrument for analysis of signals from a distance. The principal features are described and other uses indicated. Various examples of measurements are illustrated.
- 621.317.78.029.64 168
The Measurement of Microwave Power at Wavelengths of 3 cm and 10 cm—R. Street and P. D. Whitaker. (*Proc. Phys. Soc.*, vol. 63, pp. 623-624; August 1, 1950.) A magnetron or klystron was connected via a waveguide to a matched-wedge constant-flow calorimeter. A directional coupler of known coupling factor was inserted in the waveguide. The absolute power delivered to a milliwattmeter matched to the low-power guide of the coupler can be calculated. For three types of instrument the ratios of absolute to indicated power were respectively 1.04, 1.04 and 1.10. The accuracy of the measurements is within about 2 per cent.
- 621.317.79:551.594.6 169
A Subjective Method of Measuring Radio Noise—H. A. Thomas. (*Proc. IEE*, (London), Part III, vol. 97, pp. 329-334; September, 1950.) The equipment described can be operated by inexperienced personnel. Sources of error are analyzed fully. Noise levels greater than 1 $\mu\text{V/m}$ over the frequency range 2.5-20 Mc can be measured to within ± 5 db.
- 621.317.79:621.396.933 170
Monitoring Airways Radio—(*Wireless World*, vol. 56, p. 335; September, 1950.) A short account of the work carried out at the frequency-measurement station of the Ministry of Civil Aviation at Pailton, near Rugby, with illustrations of some of the equipment. Records are kept of all routine measurements and a monthly chart gives a day-to-day record of the frequencies of all the navigational beacons.
- 621.395.61.089.6 171
American Standard Method for the Pressure Calibration of Laboratory Standard Microphones: Z24.4—1949 (Abridged)—Beranek, Cook, Romanow, Wiener, and Bauer. (See 19.)
- 621.395.623.54.089.6 172
American Standard Method for the Coupler Calibration of Earphones: Z24.9—1949 (Abridged)—Beranek, Romanow, Morrill, Anderson, Bauer, Cook, and Wathen-Dunn. (See 21.)
- 534.321.9:061.3 173
Rome Ultrasonics Convention—Bradfield. (See 10.)
- 534.321.9.001.8:669.71:621.791 174
Ultrasonic Soldering of Aluminium—B. E. Noltingk and E. A. Neppiras. (*Nature*, (London), vol. 166, p. 615; October 7, 1950.) Experiments are described which show that in the process of tinning Al and its alloys by application of molten solder together with intense ultrasonic vibration, the action is that of removing the oxide skin by cavitation erosion. Relatively low frequencies were found preferable: a 50-w 18-kc oscillator was quite effective, while a 1-Mc oscillator supplied with 3 kv (rms) was ineffective.
- 538.569.2.047:621.38.001.8 175
Effects of Intense Microwave Radiation on Living Organisms—J. W. Clark. (*Proc. I. R. E.*, vol. 38, pp. 1028-1032; September, 1950.) Radiation of wavelength about 10 cm was found the most dangerous. With much shorter waves, surface heating is produced and underlying tissues are little affected, while with much longer waves there is a general elevation of body temperature but no particular damage to the tissue. See also 2284 of 1949 (Salisbury, Clark, and Hines).
- 551.508.1:621.317.083.7 176
Automatic Range-Adjusting Radiosonde Recorder—G. E. Beggs, Jr. (*Trans. AIEE*, vol. 68, Part I, pp. 602-607; 1949.) Full paper. Summary noted in 703 of 1950.
- 621.317.755:531.771 177
An Electronic Tachometer—H. G. Jerrard and S. W. Punnett. (*Jour. Sci. Instr.*, vol. 27, pp. 244-245; September, 1950.) Details are given of an instrument capable of measuring the speed of revolution of a shaft, in any speed range, to within 0.05 per cent. The rotation of the shaft is made to generate an alternating voltage which, after amplification, is connected to the y-plates of a cathode-ray tube whose x-plates are connected to a variable-frequency oscillator.
- 621.365.54:55† 178
The Design of H.F. Generators for Industrial Use and the Development of their Application in France—J. Girardeau. (*Ann. Radioélect.*, vol. 5, pp. 259-275; July, 1950.) Illustrated account of many different applications of dielectric-loss and induction heating in industry, and of the equipment used.
- 621.384.611.2† 179
The Design of the Bevatron Magnet—D. Sewell. (*Elect. Eng.*, vol. 69, p. 721; August, 1950.) Summary of AIEE Summer General Meeting paper. The ring magnet for the Berkeley proton synchrotron will consist of four spaced quadrants, with an overall diameter of 135 ft. 9,700 tons of mild-steel plate will be required.
- 621.384.62† 180
Linear Accelerators—D. W. Fry and W. Walkinshaw. (*Rep. Progr. Phys.*, vol. 12, pp. 102-130; References, pp. 130-132; 1948-49.) The axial and the radial stability of particles in radio-frequency fields are examined, basic types of particle accelerator are described and the traveling-wave and standing-wave types are considered in more detail. Methods of construction are described and also methods of applying radio-frequency power and of particle injection. Reported performance data of different linear electron accelerators are tabulated and possible future developments are outlined. Accelerators for heavy particles are discussed briefly.
- 621.385.833 181
Certain Properties of Electrostatic Fields encountered in Electron Lenses—P. A. Lindsay. (*Proc. Phys. Soc.*, vol. 63, pp. 699-702; September 1, 1950.) Fine details of the form of the equipotential lines in a bipotential electron

OTHER APPLICATIONS OF RADIO AND ELECTRONS

are revealed by application of the relaxation method to the solution of the Laplace equation in cylindrical co-ordinates. Asymmetry of the field between the adjacent ends of the two cylinders forming the lens is corrected by the same method and is found to be of the order of 2 per cent in a particular case.

1.385.833 **182**
An Electron-Optical Apochromat—O. Scherzer. (*Z. Naturf.*, vol. 3a, pp. 544-545; 1948.) An example is calculated to show how chromatic aberration in electron lenses can be corrected by the use of plane metal foils permeable to electrons.

1.385.833 **183**
Reduction of the Spherical Aberration of Magnetic Electron Lenses—U. F. Gianola. (*Proc. Phys. Soc.*, vol. 63, pp. 703-708; September 1, 1950.) Discussion of a method for increasing the resolving power of asymmetrical magnetic electron lenses; the lens field is enforced with the field of a small air-cored coil.

1.385.833 **184**
Second-Order Beam Focusing of Charged Particles in Homogeneous Magnetic Fields—H. Hintenberger. (*Z. Naturf.*, vol. 3a, pp. 669-670; 1948.)

1.385.833 **185**
A Removable Intermediate Lens for Extending the Magnification Range of an Electron Microscope—J. Hillier. (*Jour. Appl. Phys.*, vol. 21, pp. 785-790; August, 1950.) A lens is described which increases the ratio of maximum to minimum magnification of a conventional instrument to 25 to 1 without affecting the accessibility of the objective and projection as pole pieces, thus making available the low magnifications needed for survey purposes, and forth.

1.387.4† **186**
Hydrogen-Filled Geiger Counters—B. Collinge. (*Proc. Phys. Soc.*, vol. 63, pp. 665-667; September 1, 1950.) A new quench circuit described and the characteristics of counters with permanent-gas filling are discussed in detail.

1.387.4† **187**
Temperature Dependence of Counter Characteristics in Self-Quenching Geiger-Füller Counters—W. R. Loosemore and D. Taylor. (*Proc. Phys. Soc.*, vol. 63, pp. 728-729; September 1, 1950.) Comment on 1983 of 1950 (Parkash and Kapur).

1.387.4† **188**
After-Effects in Ultraviolet-Sensitive Counters—H. Neuert. (*Z. Naturf.*, vol. 3a, pp. 221-225; 1948.)

1.142:533.6 **189**
Electric Analogue Computing Techniques for Complex Vibration and Aeroelastic Problems—G. D. McCann and R. H. MacNeal. (*Elec. Eng.*, vol. 69, p. 724; August, 1950.) Summary of AIEE Summer General Meeting paper.

21.384.6† **190**
The Acceleration of Particles to High Energies [Book Review]—Publishers: Institute of Physics, London, 58 pp., 10s.6d. (*Jour. Sci. Instr.*, vol. 27, p. 255; September, 1950.) This volume in the Institute's 'Physics in Industry' series is based on papers presented at the Institute's 1949 Convention at Buxton.

21.385.833 **191**
The Practice of Electron Microscopy [Book review]—D. G. Drummond (Ed.). Publishers: Royal Microscopical Society, London, pp. 41, 21s. (*Jour. Sci. Instr.*, vol. 27, p. 255; September, 1950.) A comprehensive treatise on

the detailed techniques used. It was produced by a group of twelve members of the Electron Microscopy Group of the Institute of Physics.

PROPAGATION OF WAVES

538.566 **192**
Formulation of Huygens' Principle—W. Franz. (*Z. Naturf.*, vol. 3a, pp. 500-506; 1948.) Making use of Green's dyad, a formulation of Huygens' principle for em waves is derived which, like Kirchhoff's scalar formula, makes it clear that for selected boundary values the wave equations are satisfied. Kirchhoff's theory does not solve a boundary-value problem but a discontinuity problem. In contradistinction to Kottler, the discontinuity is regarded as basic to Kirchhoff's theory and not as a property of the 'black' screen.

538.566:551.510.535 **193**
The Poynting Vector in the Ionosphere—J. C. W. Scott. (*Proc. I.R.E.*, vol. 38, pp. 1057-1068; September, 1950.) Formulas and curves are given for calculating the polarization and complex Poynting vector of a radio wave in the ionosphere in the most general case. Deductions are made concerning the direction of energy flow for the ordinary and extraordinary modes in a parabolic distribution of ionization, for vertical incidence. When collision is taken into account the deflection from the vertical has a small westward component for both modes. The normal ionization gradient with latitude, together with diurnal changes in the ionized region, can explain the diurnal variation in the $f_x - f_0$ critical-frequency difference as due to the variation in the total path deflection. See also 2516 of 1949.

538.566:621.396.67 **194**
Cylindrically Diverging Electromagnetic Waves in a Medium with Nonuniform Electrical Properties (Elias-Layer) above a Semi-conducting Earth—van der Wyck. (See 32.)

621.396.11:523.74/75 **195**
Solar Notes—Newton. (See 106.)

621.396.11:621.317.353.3† **196**
Gyro-interaction—Please note that the above UDC number will be used in future instead of 621.396.812.

621.396.11:621.317.353.3† **197**
Variability of the Resonance Frequency in Gyro-interaction of Radio Waves—M. Carlevaro. (*Nuovo Cim.*, vol. 5, pp. 535-550; December 1, 1948.) It is suggested that small variations of ionic density in the E layer satisfactorily account for the variations in resonance frequency found experimentally (513 of 1947 and 2328 of 1950). Theoretical calculations predict a smaller range of variation than that observed, unless it is assumed that in the lower levels of the E layer the electronic density is reduced mainly by negative-ion formation, while in the upper levels it is reduced by recombination with positive ions.

621.396.11:621.317.353.3†:551.510.535 **198**
Ionospheric Cross-Modulation: Techniques of Measurement—Newton, Hyde, and Foster. (See 155.)

621.396.11.029.62 **199**
Experimental Study of the Propagation of Metre Waves: Measurements in Aircraft—H. Vigneron. (*IIF, Brussels*, pp. 191-198; 1950.) Conflicting theories of propagation are discussed. The field calculated according to the ray theory has a series of maxima and minima, and is limited to the optical range. Theories based on diffraction give a field decreasing progressively with increasing distance and extending beyond the optical range. Measurements were made of 116.1-Mc signals received in aircraft at heights of 300, 1,500 and 3,000

m as the transmitter was approached. At great altitudes results conform to the ray theory; at small altitudes and well below the line of sight, van der Pol curves are applicable, with a gain with height which can only be determined by systematic experiments.

621.396.81.029.63/64:551.5 **200**
A Radio Meteorological Investigation in the South Island of New Zealand—B. Milnes and R. S. Unwin. (*Proc. Phys. Soc.*, vol. 63, pp. 595-616; August 1, 1950.) Local conditions in New Zealand, particularly with off-shore föhn winds, are favourable to the formation of radio ducts. Modern techniques were used to explore thoroughly the atmospheric conditions over a range of 200 km from the coast and up to 600 m above sea level. The results, obtained over the period from September 1946 to the end of 1947, are displayed as isopleths of the atmospheric parameters and of refractive index. Contours of radio field-strength are shown for selected days for wavelengths of 300 cm, 60 cm, 10 cm, and 3 cm. The properties of the ducts and the experimental technique are fully described.

621.396.812.3:551.510.535 **201**
The Fading of Radio Waves of Medium and High Frequencies—R. W. E. McNicol. (*Proc. IEE (London)*, Part III, vol. 97, p. 366; September, 1950.) Discussion on 443 of 1950.

621.396.812.4.029.64 **202**
Microwave Propagation Experiments—L. E. Thompson. (*Proc. I.R.E.*, (Australia), vol. 11, pp. 204-209; August, 1950.) Reprint. See 2894 of 1948.

RECEPTION

551.594.6 **203**
Some Measurements of Atmospheric Noise at High Frequencies—H. A. Thomas. (*Proc. IEE (London)*, Part III, vol. 97, pp. 335-343; September, 1950.) Measurements of atmospheric noise at a number of stations in various parts of the world have been made since 1922 over periods ranging from a few days to several years. A summary of these observations has previously been given [534 of 1948 (Thomas & Burgess)]. The frequencies used were 2.5, 5, 10, 15 and 20 Mc, and the method was based on aural comparison of the received noise and a locally generated noise signal of controllable amplitude (see 169 above). Some of the results obtained are presented in the form of mean values for each month and for each hour of the day, together with figures indicating the degree of scatter about the mean value. The characteristics of atmospheric noise at one location do not appear to be applicable over a large area; this and other considerations throw doubt on the concept that lightning discharges are practically the sole source of high-frequency noise. It is suggested tentatively that some noise sources may be quite local, but more experimental data are required to confirm or disprove this.

621.396.621:621.396.619.11 **204**
The Synchrodyne as a Precision Demodulator—D. G. Tucker and R. A. Seymour. (*Wireless Eng.*, vol. 27, pp. 227-237; August and September, 1950.) The synchrodyne circuit, in which the modulation frequency is extracted by filtration after the detector, may lead to distortion due to phase modulation of the local oscillator at the modulation frequency. An analysis of this distortion in the basic circuit is given, and practical methods of achieving precision, stability and freedom from distortion are described. Phase modulation is limited by the use of tube reactors, and constancy of gain is achieved by application of negative feedback.

621.396.823:537.523.3 205
Radio Influence from High-Voltage Corona—G. R. Slemon. (*Trans. AIEE*, vol. 68, Part I, pp. 198-204; Discussion, pp. 204-205; 1949.) See 1780 of 1949.

621.396.828 206
Reduction of Interference from Radio-Frequency Heating Equipment—G. W. Klingaman. (*Trans. AIEE*, vol. 68, Part I, pp. 718-724; Discussion, p. 724; 1949.) Discussion of the causes of the generation of very high frequencies by radio-frequency heating equipment, and of measures for its reduction, particular attention being given to harmonic suppression and effective screening.

621.396.933:621.395.625.2 207
An Automatic Monitoring Recorder—(*Engineer*, (London), vol. 190, p. 186; August, 18, 1950.) Short description of equipment for continuous recording of speech signals transmitted from an aircraft to a ground control station. The speech-frequency range is limited to 500-3,000 cps. Recording is on standard Kodak film, a sapphire needle producing lateral indents, without cutting. The recording head is traversed across the film to obtain 120 sound tracks on each side, so that 120 ft of film suffice for a 24-hour period. Any portion of the record can be reproduced without interrupting the recording.

STATIONS AND COMMUNICATION SYSTEMS

621.39.001.11 208
Photons and Waves—D. Gabor. (*Nature*, (London), vol. 166, pp. 724-727; October 28, 1950.) Abstract of parts of a lecture delivered in Paris, May 9, 1950. on 'La Théorie des Communications et la Physique.' A comparison is made of the quantum and classical methods of describing signals. The 'information cell' is taken as a convenient unit for discussing communication problems; by the classical method this has two data associated with it, an amplitude and a phase, but by the quantum method only one datum, of the nature of an amplitude. More information, however, is gained by the latter method since the total number of distinguishable steps of the single datum is greater than the product of the numbers of distinguishable steps of the two data in the classical analysis. The theory is illustrated by a determination of the optimum conditions for interchange of energy between a weak signal and a transverse electron beam in a waveguide.

621.39.001.11:535.42 209
Diffraction and Quantity of Information—A. Blanc-Lapierre and M. Perrot. (*Compt. Rend. Acad. Sci.*, (Paris), vol. 231, pp. 539-541; September 11, 1950.) The system considered is that constituted by an aperture, an object at infinity composed of incoherent sources, and a diffraction image at infinity. From the correspondence between image and object, the quantity of information transmitted by the aperture is deduced.

621.39.001.11:621.317.35 210
Signals with Limited Spectra and their Transformations—J. Oswald. (*Câbles & Trans.* (Paris), vol. 4, pp. 197-215; July, 1950.) Detailed mathematical treatment. See also 3069 of 1949.

621.395.44:621.315.052.63 211
Line Tuning Equipment Used with Coaxial Cable for Carrier-Current Installation on Power Lines—H. J. Sutton. (*Trans. AIEE*, vol. 68, Part I, pp. 44-48; Discussion, pp. 48-49; 1949.)

621.396.61/.62 212
A Frequency-Modulated Transmitter-Receiver for Motor Cycles—(*Engineer* (London),

vol. 190, p. 172; August 18, 1950.) A 27-tube equipment in two units mounted on either side of the rear wheel. It is crystal controlled and has an FM radio-frequency output of 10 w on a spot frequency in the band 68-100 Mc. Sensitivity is 1 μ v carrier input for 10-db quieting. 'Standby' power consumption is only 18 w. The equipment can be used within the temperature range -40°C to 70°C. In conjunction with a 20-w control transmitter it has a specified service radius of 20 miles. A selective calling system enables any one, or all, of 90 such units to be called from the control station.

621.396.619:621.392.52 213
Polyphase Modulation as a Solution of Certain Filtration Problems in Telecommunication—I. F. Macdiarmid and D. G. Tucker. (*Proc. IEE*, Part III, vol. 97, pp. 349-358; September, 1950.) An important class of filtration problems in telecommunication is associated with frequency changing; it includes the generation and demodulation of single-sideband carrier channels and the elimination of image-frequency interference in heterodyne radio receiver or the conventional wave analyzer. Filters for these applications are often difficult to design or realize, or may be inconvenient on account of variable tuning, and so forth.

Polyphase modulation can be used as part of the frequency-changing process with great advantage. It can eliminate the need for difficult or inconvenient filters, although other design problems are introduced which may sometimes be as difficult to solve. The basis of the advantages given by polyphase working is that polyphase signals possess an identifying property additional to that of frequency, namely sequence. By using circuits which distinguish between signals of the same frequency but opposite sequence, it is possible, without any preliminary filtration, to separate signals which lie in the same frequency band after modulation, and which, therefore, could be separated by normal means only by filters before the modulation stage.

The first section of the paper outlines the main filtration problems which can be tackled by polyphase methods, and then the necessary polyphase theory is given. This is followed by a discussion of circuit design for polyphase modulation and sequence discrimination. The list of 30 references shows that there have been many publications covering some of the separate applications of this work, but the paper is believed to present for the first time a comprehensive theory of polyphase modulation embracing all the known applications.

621.396.619.16:621.396.41 214
A Time Division Multiplexing System—W. P. Boothroyd and E. M. Creamer, Jr. (*Trans. AIEE*, vol. 68, Part I, pp. 92-97; 1949.) See 3258 of 1949.

621.396.65 215
A Microwave Communication Relay System—W. P. Boothroyd and H. J. Churchill. (*Trans. AIEE*, vol. 68, Part I, pp. 637-641; 1949.) An incoming FM radio-frequency carrier causes deviation of the output of a local oscillator in accordance with the modulation of the incoming carrier, the oscillator output being amplified and radiated as the repeated signal. The whole system constitutes a negative-feedback amplifier and a study of its performance as a repeater is made on this basis. The extreme simplicity of its electrical and mechanical design makes the use of a tower unnecessary, a simple pole being sufficient to support the repeater equipment.

621.396.65 216
Problems to be Solved in the Application of Microwave Equipment—R. C. Cheek.

(*Elec. Eng.*, vol. 69, p. 718; August, 1950.) Summary of AIEE Summer General Meeting paper. Points to be dealt with in establishing a microwave channel include determination of frequency band, selection of terminal sites, and calculation of inherent losses.

621.396.65:621.311 217
Microwave Channels for Power System Applications—(*Trans. AIEE*, vol. 68, Part I, pp. 40-42; discussion pp. 42-43; 1949.) An AIEE committee report discussing the advantages and disadvantages of microwave links for telemetry, supervisory control, and communication.

621.396.65:621.396.43.029.6 218
Radio-Beam System Planning—W. Gerber. (*Bull. schweiz. elektrotech. Ver.*, vol. 40, pp. 648-650; August 20, 1949. In German.) Paper presented at the International Television Conference, Zürich, 1948. Discussion of the possible international extension of the present Swiss system of high-altitude stations.

621.396.65.029.6.001.4(494) 219
Directional Transmission Tests in the Alps Contributing to the Establishment of a Swiss R/T Network—W. K. Pein. (*Tech. Mitt. schweiz. Telegr.-Teleph. Verw.*, vol. 28, pp. 303-317; August 1, 1950.) French and Italian versions based on paper abstracted in 2326 of 1949.

621.396.65.029.64 220
Passive Relay Stations of the Afouer/Binel-Ouidane Link—R. Chauv and J. Dascotte. (*Ann. Radioléec.*, vol. 5, pp. 220-229; July, 1950.) Expressions for the radiation pattern and gain of a plane metallic mirror are derived. The link considered is between two stations in Morocco 15 km apart in mountainous country. Two intermediate relay stations are used. At one a plane duralumin mirror of area 10 m² is mounted in a rigid frame 2 m above the ground. At the other, two similar plane mirrors are supported in an open cage on a 40-m pylon. Both mirrors are hinged to facilitate adjustment. Terminal transmitter and receiver antennas use parabolic mirrors of 10-m² aperture. Polarization is vertical. $\lambda = 9.5$ cm. Using a 1-w FM signal and a 1.5-Mc passband in the receivers, communication has been maintained since 1949 in extreme climatic conditions. Calculated field strength and noise level are in fair agreement with actual values.

621.396.932 221
Liverpool Harbour Communications—(*Wireless World*, vol. 56, pp. 277-279; August, 1950.) See also 2633 of 1950.

SUBSIDIARY APPARATUS

621-526 222
Comparison of Steady-State and Transient Performance of Servomechanisms—H. Chestnut and R. W. Mayer. (*Trans. AIEE*, vol. 68, Part I, pp. 765-777; 1949.)

621-526 223
Instrument Inaccuracies in Feed-Back Control Systems with Particular Reference to Backlash—H. T. March, M. Yachter, and J. Zauderer. (*Trans. AIEE*, vol. 68, Part I, pp. 778-788; 1949.)

621-526 224
Analyzing Contactor Servomechanisms by Frequency-Response Methods—J. Kochenburger. (*Elec. Eng.*, vol. 69, pp. 697-692; August, 1950.) An approximation method which facilitates the selection of compensating networks for improving the performance of contactor servomechanisms.

621.314.6 225
New Developments in Rectifier Technique—F. Kesselring. (*Tech. Mitt. schweiz. Telegr.-*

Zeph. Verw., vol. 28, pp. 297-303; August 1, 1950. In French and German.) Description of two types of rectifier. The first is a vibrator mechanism. The interrupter tongues are prism-shaped and weigh about 60 mg; enclosed in a sealed container with inert gas under pressure they can withstand over 10 kv. Models developed include a 200-A and 1,000-A type. The second design is a grid-controlled rectifier tube with Cs-vapor filling. Operating voltage is 1 kv; peak voltage 800-3,000 v. Tubes passing 3 A have been constructed; a 150-A type is under development.

61.316.578.1 226
Electrical Timing Devices—F. E. Reeves. (*Elec. Mfg.*, vol. 42, pp. 114-119, 168; September, 1948.) Ten points to be considered in the selection and application of electrical switch timers are enumerated and a chart is given outlining the operating characteristics of commercially available equipment.

61.316.722.1 227
A New Precision A.C. Voltage Stabilizer—N. Patchett. (*Proc. IEE*, Part II, vol. 97, no. 58, pp. 529-538; discussion, pp. 538-540; August, 1950.) Various types of stabilizer are discussed and an account is given of the designed performance of a stabilizer for meter testing applications which uses a temperature-compensated thermistor bridge. The stabilization ratio for a 10-v change of mains voltage (10 v nominal) is about 1,100. An output up to 2 kva can be obtained.

61.316.722.1 228
A Simple Form of Voltage Stabilizer—N. K. Chha, B. S. Chandrasekhara, and M. K. Sundaresan. (*Proc. Nat. Inst. Sci. (India)*, vol. 16, no. 127-133; March and April, 1950.) Operating in the range 600-2,000 v and suitable for Geiger-Müller counters, the stabilizer consists of an air-discharge tube, under variable pressure and connected, in series with a 30-40-MΩ resistor, in parallel with the rectified output of a transformer. The voltage drop across the tube remains constant, for a given pressure, over a wide range of transformer output voltage, owing to gas ionization, the stabilized voltage increasing with pressure. A deviation of about 2.5 per cent at a stabilized voltage of 1,500 v is quoted for transformer-output variation from 2,000 to 3,500 v.

61.316.722.1 229
Voltage Stabilizers assure Top Performance—(*Elec. Mfg.*, vol. 42, pp. 108-113; August 2; September, 1948.) Operating principles and performance data for magnetic, electronic, and servomechanism types of equipment for supplying constant-voltage power.

61.316.722.1 230
A Modified Moving-Coil Voltage Regulator of High Sensitivity—N. W. Ellis. (*Four. Sci. Instr.*, vol. 27, pp. 248-249; September, 1950.) "Modifications to a standard commercial voltage regulator are described, which result in stabilization of a mains supply line to within ± 0.1 v for changes of load or input supply voltage and frequency within the ranges normally encountered. Loads of up to 7.5 kva may be applied."

61.316.722.1.076.7 231
The Cathode Follower as a Voltage Regulator—A. P. Willmore. (*Electronic Eng.* (London), vol. 22, pp. 399-400; September, 1950.) Since the output voltage developed across the cathode load resistor is proportional to $V_0 + V_0/\mu$, where μ is the amplification factor, fluctuations of V_0 are reduced by a factor depending on μ . The cathode follower may be used (a) to increase the current range over which stabilization is satisfactory with a particular voltage-reference tube, (b) to provide

a high reference potential for a series-parallel type of voltage regulator.

621.352/355 232
Special Purpose Batteries—A. Fischbach. (*Elec. Eng.*, vol. 69, pp. 701-704; August, 1950.) Three types developed for service use are discussed.

621.355 233
Electric Batteries: Recent Patents—L. Jumau. (*Rev. gén. Élec.*, vol. 59, pp. 372-378; September, 1950.) Developments in primary batteries, chiefly of the dry type, are reviewed. See also 3177 of 1950.

621.396.683:621.396.65 234
Power Supplies for Microwave Relay Systems—H. M. Ward. (*Trans. AIEE*, vol. 68, Part I, pp. 631-636; 1949.) Interruption of the main ac supply causes the load to be transferred to a battery-operated vibrator in under 0.1 second. This is cut out when a petrol-electric set, whose start is delayed 15 seconds to avoid unnecessary starting during very short power failures, reaches a steady operating condition. The various units of the equipment are described. Performance data for various radio-beam links indicate the high degree of reliability achieved.

771.36:537.228.4 235
An Electro-optical Shutter for Photographic Purposes—A. M. Zarem, F. R. Marshall, and F. L. Poole. (*Trans. AIEE*, vol. 68, Part I, pp. 84-91; 1949.) A description of the development of a simple and reliable optical shutter using a Kerr cell as a light tube, with which photographic studies of electric discharges have been made using an effective exposure time of 0.04 μ second. The control can be made sufficiently positive and accurate to permit initiation of operation at any pre-selected instant to within about 0.005 μ second.

TELEVISION AND PHOTOTELEGRAPHY

621.397.2 236
Considerations on Facsimile Transmission Speed—H. F. Burkhard. (*Trans. AIEE*, vol. 68, Part I, pp. 418-423; discussion, p. 423; 1949.) A résumé of the work of many investigators and mathematical analysis of the factors which limit the speed of facsimile transmission in various systems. A method capable of transmitting 640 square inches of copy per minute over a channel 192 kc wide, or 160 square inches with a channel width of 48 kc, is described.

621.397.2 237
New Facsimile System—M. Frank. (*Ann. Geophys.*, vol. 2, pp. 532-544; October, 1949.) Suitable for transmission of weather maps, graphs, and printed matter of size up to 25 cm \times 30 cm, by telephone line or radio link. An electromechanical recording system is used, the modulated subcarrier being obtained by interrupting the scanning beam at 3 kc. The number of scanning lines can be 4 per mm or less. The subcarrier frequency, after frequency division, is used to synchronize the movements of transmitter and receiver drums. Several copies can be produced simultaneously at the receiving end.

621.397.24/26 238
Long-Distance Television Links between Fixed Points—F. Vecchiacchi. (*Bull. Schweiz. elektrotech. Ver.*, vol. 40, pp. 647-648; August 20, 1949. In French.) Paper presented at the International Television Conference, Zürich, 1948. A short discussion of the economics of cable and radio links, with examples of both types at present in use.

621.397.24 239
Television Distribution over Short Wire Lines—P. Adorian. (*Bull. Schweiz. elektrotech.*

Ver., vol. 40, pp. 650-653; August 20, 1949. In English.) Paper presented at the International Television Conference, Zürich, 1948. See 2339 of 1949.

621.397.24.018.78†:621.315.212 240
Characteristics of Coaxial Pairs at Frequencies Involved in High-Definition Television Transmission—Fuchs. (See 27.)

621.397.26:621.396.615.142.2:621.396.621.53 241
The Klystron Mixer Applied to Television Relaying—Learned. (See 275.)

621.397.26:629.135 242
First Results of Stratovision Tests in the United States of America—E. J. Aubort. (*Bull. Schweiz. elektrotech. Ver.*, vol. 40, pp. 653-657; August 20, 1949. In French.) Paper presented at the International Television Conference, Zürich, 1948. An account of tests carried out near Pittsburg with the relay aircraft at a height of 8,000 m, when the useful ground range exceeded 400 km. A map shows corresponding ranges in Europe for an aircraft at the same height over Zürich. A second map indicates the possibilities of international program exchange in Europe, using seven aircraft and taking account of the coaxial cable envisaged by the CCIF for 1952. See also 3801 of 1946, 3279 of 1947 (Nobles) and 233 of 1949 (Sleeper).

621.397.331.2 243
'Knight' Scanning, Method giving Improvement of Television Picture Definition without Increase of Bandwidth—P. M. G. Toulon. (*Bull. Schweiz. elektrotech. Ver.*, vol. 40, pp. 638-641; August 20, 1949. In French.) Paper presented at the International Television Conference, Zürich, 1948. Summary abstracted in 870 of 1949.

621.397.331.2:778.5 244
Notes on [Picture] Analysis in Television with Continuously Moving Film—S. Mallein. (*Bull. Schweiz. elektrotech. Ver.*, vol. 40, pp. 603-605; August 20, 1949. In French.) Paper presented at the International Television Conference, Zürich, 1948.

621.397.331.2:778.5 245
Luminescent-Screen 875-Line Scanning of Film Pictures—A. Karolus. (*Bull. Schweiz. elektrotech. Ver.*, vol. 40, pp. 566-569; August 20, 1949. In German.) Paper presented at the International Television Conference, Zürich, 1948. A description of the apparatus, with a diagram illustrating the general layout, is given. The cathode-ray tube used is identical in construction with the usual type of projection tube and is operated at 25-40 kv. The raster surface is 6 cm \times 9 cm and the screen is of the low-persistence type. Experiments showed that a ZnO phosphor gave a much higher degree of modulation than other phosphors tested. Operation of the equipment, using a flat type of photocell with a semitransparent photo layer about 6 cm in diameter, was satisfactory for both carrier-frequency and low-frequency scanning.

621.397.335 246
New Possibilities for External Synchronization of Home-Television Pictures—W. Gerber. (*Bull. Schweiz. elektrotech. Ver.*, vol. 40, pp. 646-647; August 20, 1949. In German.) Paper presented at the International Television Conference, Zürich, 1948.

621.397.5 247
Work towards International Television—R. Barthelemy. (*Bull. Schweiz. elektrotech. Ver.*, vol. 40, pp. 535-538; August 20, 1949. In French.) Paper presented at the International Television Conference, Zürich, 1948. Discussion of the various problems involved, par-

ticularly the choice of the line standard and the question of interlacing.

621.397.5 248
Evolution of Television—A. Ory. (*Bull. schweiz. elektrotech. Ver.*, vol. 40, pp. 545-547; August 20, 1949. In French.) Paper presented at the International Television Conference, Zurich, 1948.

621.397.5 249
The Present Status of Color Television—(Proc. I.R.E., vol. 38, pp. 980-1002; September, 1950.) The report of the Senate Advisory Committee on Color Television, given in full. A bandwidth of 6 Mc is considered adequate, representing an optimum compromise between quality and quantity of service. The general principles of the CTI line-sequential system, the CBS field-sequential systems involving line and dot interlace, and the RCA system employing a dot-sequential system with the method of mixed highs to increase definition, are explained in detail and performance characteristics, such as color fidelity, flicker, resolution and break-up of the picture for moving objects, are tabulated for each system. Appendices reproduce official correspondence concerning the report, and also the results of tests of flicker and color fidelity by the National Bureau of Standards.

621.397.5 250
Mixed Highs in Color Television—A. V. Bedford. (Proc. I.R.E., vol. 38, pp. 1003-1009; September, 1950.) Tests on the human eye, using projected color-test slides, are described in detail; these indicate that the acuity for resolving color differences is less than half as great as that for differences in brightness, so that the bandwidth used for the color transmissions can be correspondingly reduced. In the system described, of three color signals each use a 2-Mc frequency band and the red and green 'mixed highs,' which represent the brightness values, use an additional 2-Mc band, so that the total video bandwidth required will be 8 Mc, compared with 12 Mc that would be required if all the three colors required bandwidths of 4 Mc. The dot-interlace method, as used in the latest RCA system, reduces the required bandwidth to 6 Mc.

621.397.5:534.321.9 251
Underwater Television by means of Ultrasonics—M. Federici. (*Bull. schweiz. elektrotech. Ver.*, vol. 40, pp. 657-659; August 20, 1949. In Italian.) Paper presented at the International Television Conference, Zurich, 1948. Discussion of a possible system which should be quite practical for short-distance transmissions.

621.397.5:535.317.9 252
The Schmidt Optical System—Rinia. (See 82.)

621.397.5:621.38 253
Electronics in Television—V. K. Zworykin. (*Bull. schweiz. elektrotech. Ver.*, vol. 40, pp. 549-560; August 20, 1949. In English.) Paper presented at the International Television Conference, Zurich, 1948. General discussion of the subject, with special reference to recent developments in electronic camera tubes, direct-viewing receiver tubes, and color television.

621.397.5:778.5 254
Recording of Television Transmissions on Film with a view to International Exchange of Programmes—Y. L. Delbord. (*Bull. schweiz. elektrotech. Ver.*, vol. 40, pp. 571-580; August 20, 1949. In French.) Paper presented at the International Television Conference, Zurich, 1948. A detailed discussion of the various problems involved, description of different methods

and types of equipment, and illustrations of the quality of picture possible with such systems. Summary noted in 877 of 1949.

621.397.62:621.317.2 255
Television Laboratory Equipment—Werner. (See 153.)

TRANSMISSION

621.396.615.142.2:621.396.621.53:621.397.26 256
The Klystron Mixer Applied to Television Relaying—V. Learned. (Proc. I.R.E., vol. 38, No. 9, pp. 1033-1035; September, 1950.) The phase-modulation sidebands obtained from a klystron amplifier with beam-voltage modulation are used to give a mixing action, and the output resonator is used to select one of the sidebands. The construction and operating details are given for a klystron amplifier, Type SAC-19, with a mixer output of 1 w over a 20-Mc band centered at about 6,000 Mc.

TUBES AND THERMIONICS

533.723+621.396.822 257
Spontaneous Fluctuations—MacDonald. (See 79.)

621.314.65/67 258
Fundamental Processes in Gaseous Tube Rectifiers—A. W. Hull. (*Elec. Eng.*, vol. 69, pp. 695-700; August, 1950.) Phenomena in gas-filled tubes are considered in relation to the laws of thermionic emission and electron space charge.

621.383.4 259
Photoconductive Cells of Cadmium Selenide—E. Schwarz. (*Proc. Phys. Soc. (London)*, vol. 63, pp. 624-625; August 1, 1950.) Operating characteristics are given for a cell produced by methods described in 1102 of 1949. The theory given in 3578 of 1949 is supported by the present experimental results.

621.385.029.63/.65 260
The Anticyclotron, a New Type of Traveling-Wave Valve with Magnetic Field—G. Mourier. (*Ann. Radioelec.*, vol. 5, pp. 206-219; July, 1950.) Steady-state conditions possible in tubes with magnetic fields are discussed. The principle of the projected tube, which is ring shaped and has no radial field, is analogous to that of the cyclotron; but in this case the electron beam is slowed down as a result of its synchronism with a retarded traveling wave. The interaction of the two may be compared to the oscillations in a magnetron. A first approximation based on Doehler's theory (250, 261 and 1544 of 1949) shows the theoretical gain to be of the same order as in a helix traveling-wave tube, while the efficiency and dc input may be much higher. The induction field required is comparatively very small. According to the relative value of this field, the tube behaves like a linear traveling-wave tube of the Kompfner-Pierce type or like one with a transverse magnetic field. On account of the low field-strength required, the anticyclotron may possibly be used to generate mm waves.

621.385.029.63/.64 261
Small-Signal Theory of Wave Propagation in a Uniform Electron Beam—G. G. Macfarlane and A. M. Woodward. (*Proc. IEE*, Part III, vol. 97, pp. 322-329; September, 1950.) Analysis is presented for the three systems constituted by a planar uniform beam (a) between conducting sheets, (b) in free space, (c) between reactive-impedance sheets, the last being a simple form of traveling-wave tube. For small signals, the em field in a traveling-wave tube may be split up into an infinite set of modes and for each mode there can be two forward and two reverse waves. The amount of each mode present depends

on the method of excitation. At high frequencies the maximum amplification occurs when the ratio of beam velocity to phase velocity is slightly greater than unity.

621.385.029.63/.64:537.525.92 262
On Certain Effects of the Space Charge in Traveling-Wave Valves—R. Berterottiere and G. Convert. (*Ann. Radioelec.*, vol. 5, pp. 168-178; July, 1950.) The effects of space charge are investigated theoretically by introducing into the equations for the electron dispersion a complex coefficient analogous to the coupling resistance function for the beam and the field. Electron trajectories are assumed to be rectilinear. For signals of small amplitude the theory may be applied up to the limiting case of a very weak focusing field, when space-charge effects are negligible. In the case of signals of large amplitude the effects are complex they may result in increased efficiency.

621.385.032.216 263
The Barium-Oxide-on-Tungsten Cathode Interface—E. B. Hensley and J. H. Affleck. (*Jour. Appl. Phys.*, vol. 21, pp. 938-939; September, 1950.) The compound formed at the interface between a w cathode base and its BaO coating has been identified, by X-ray diffraction, as principally BaWO₃. Corresponding tungstites are found when SrO or the solid solution (BaSr)O is used for the coating.

621.385.032.24:537.311.315 264
Variations of Grid Contact Potential and Associated Grid Currents—H. B. Michaelson. (*Jour. Frank. Inst.*, vol. 249, pp. 455-473; June, 1950.) A review of the subject, with a comprehensive bibliography. The grid-cathode Volta potential, or 'true contact potential,' is shown to be the difference between the work functions of the grid and cathode; it differs essentially from the quantity called 'contact potential' that is generally measured in routine tests of tubes. When the potential of the grid is negative, the current in the external grid circuit consists of several small currents due to various causes which change during the life of the tube and thus alter the tube characteristics. Methods that have been suggested for controlling these changes are outlined. Thermionic work functions are listed for 44 pure metals, for monolayers of various substances on Ni, Mo or w bases, and also for oxide coatings. Another list gives the effect of various gases and vapors on the work function of 15 metals.

621.385.4 265
The Internal Resistance of a Pentode—J. L. H. Jonker. (*Tijdschr. ned. Radiogenoot.*, vol. 15, pp. 179-194; July and September 1950.) For output pentodes the main factor determining the internal resistance is the direct effect of anode voltage on cathode current. For high-frequency pentodes two further effects are of importance, viz., (a) the absorption by the screen grid of electrons repelled by the suppressor, and (b) the absorption by the screen grid of electrons reflected by the anode and transmitted by the suppressor. Both these effects again depend on the anode voltage. Measured values of the resistance are compared with values calculated from theory, and the discrepancies are related to the simplifying assumptions made regarding the operation of the tube.

MISCELLANEOUS

621.396:061.4 266
The 17th National Radio Exhibition, Castle Bromwich, September 6 to 16, 1950—(*Electronic Eng. (London)*, vol. 22, pp. 378-384; September, 1950.) Brief descriptions of selected radio and television equipment and accessories, compiled from information supplied by the manufacturers.

CENTRALAB CERAMIC CAPACITORS GIVE YOU THE WIDEST CHOICE PLUS FINEST QUALITY AT ANY PRICE!

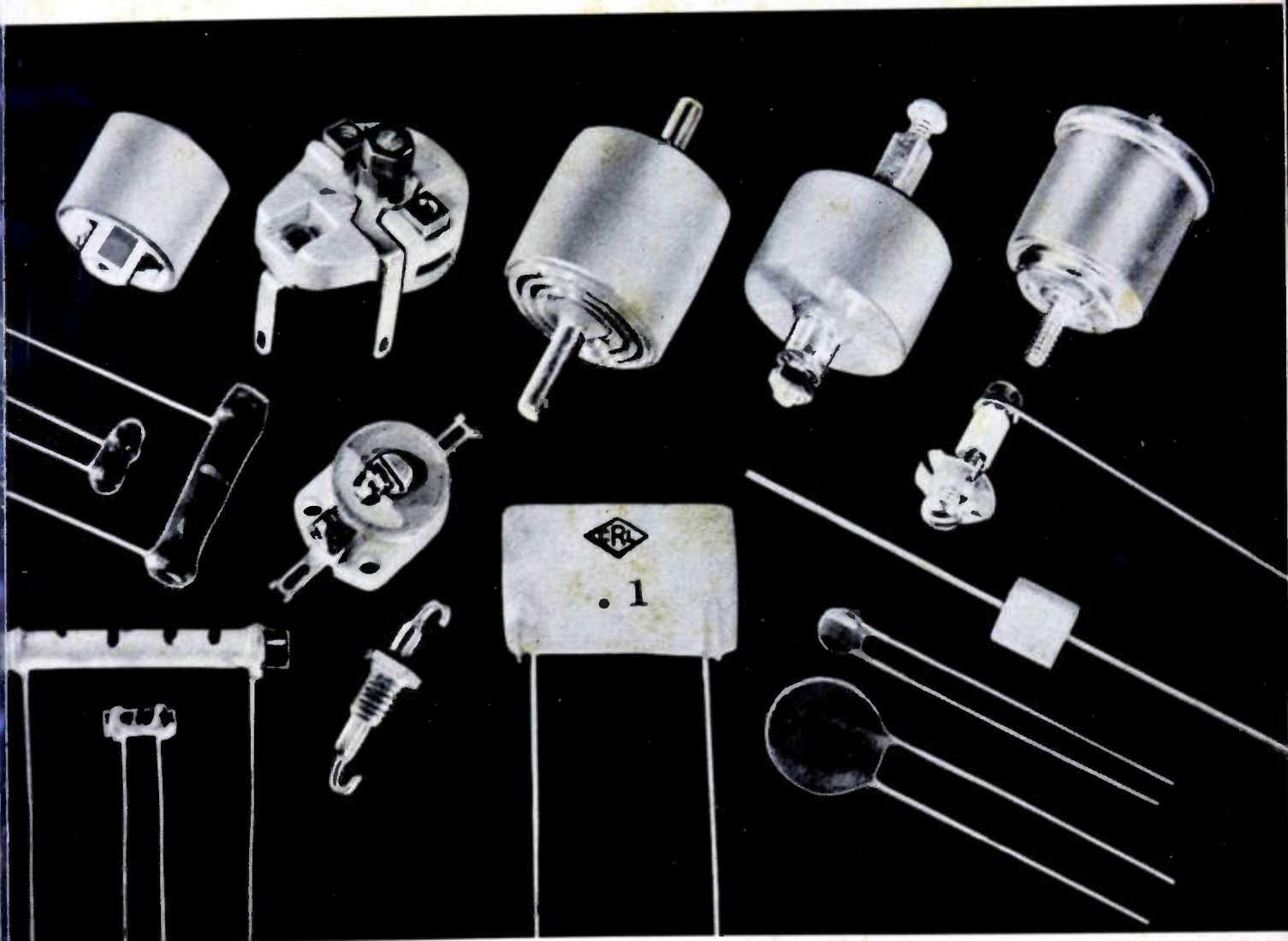

HERE'S WHAT YOU GET FROM CENTRALAB CERAMICS

Centralab ceramic capacitors provide a permanence never before achieved with old-fashioned paper or mica condensers. The ceramic body provides imperviousness to moisture, plus unmatched ability to withstand any temperatures normally encountered in electrical apparatus. What's more, ceramics make possible tremendous savings in space; many Centralab ceramic capacitors are $\frac{1}{4}$ th the size of ordinary capacitors. This is particularly important

where new design requirements call for less bulk. You can rely on Centralab ceramic capacitors for close tolerance, high accuracy, low power factors, and excellent temperature compensating qualities. Compare Centralab Ceramic capacitors for small size, wide range of ratings, variety of types and top quality characteristics. Compare their price. The results will show you why you'll standardize on Centralab—first in the field of electronic ceramics.

WANT MORE INFORMATION? SEE NEXT TWO PAGES 

CENTRALAB Offers America's Most

FOR COMMERCIAL A

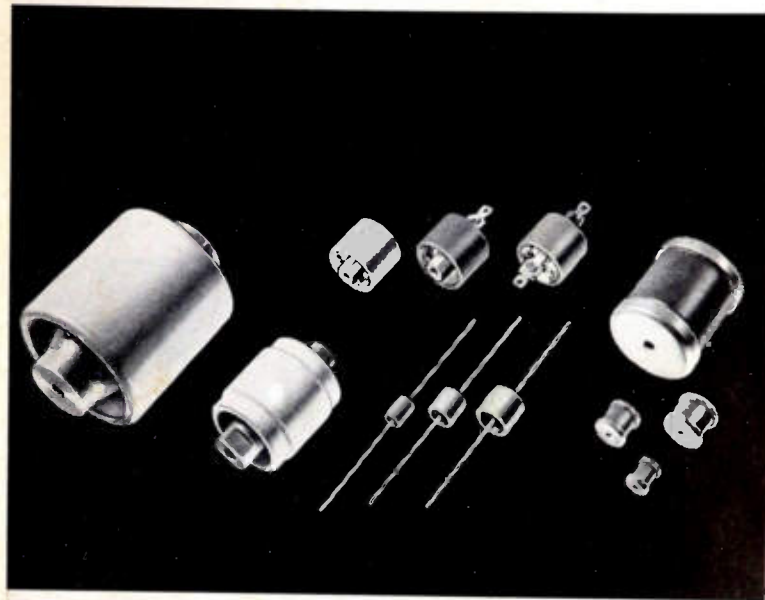

High voltage ceramic capacitors. Capacitance: 5 to 500 mmf., 5 KV to 40 KV D.C. working. Ideal for portable or mobile equipment. Primarily designed for high voltage, high frequency gear. For complete information, check Bulletin No. 42-102 in coupon below.



Centralab's famous TV Hi-Vo-Kaps are the standard for the TV industry. Capacitance: 500 mmf., 10 KV, 20 KV and 30 KV D.C. working. Best suited for high voltage, low power applications. For complete information, check Bulletin No. 42-10R in coupon below.

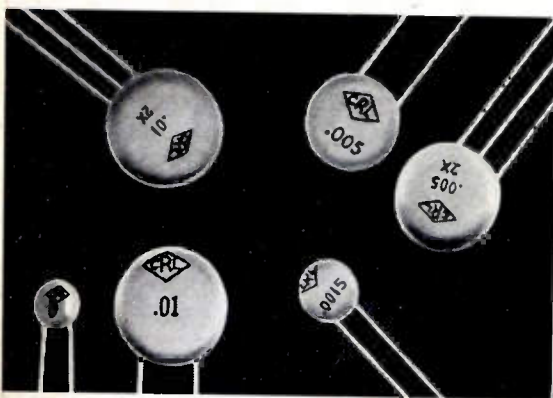

Ceramic Disc Hi-Kap Capacitors hold thickness to a minimum. Make possible very high capacity in extremely small size. Use in HF bypass and coupling. Bulletin No. 42-4R.

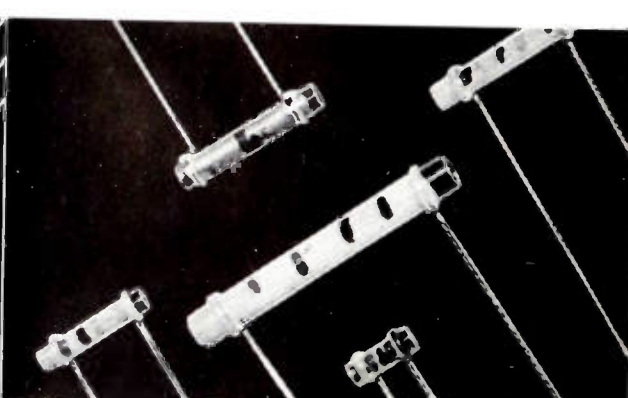

TC (Temperature Compensating) Tubulars—Type TCZ show no capacitance change over wide range of temperature. Type TCN have special ceramic body to vary capacitance according to temperature. Bulletin No. 42-18.



BC (Bypass Coupling) Tubulars—Recommended for bypass coupling. Well suited to general circuit use. Bulletin No. 42-10R.



FT (Feed Through) Hi-Kaps — Designed for single hole mounting with ground to chassis or shield. Bulletin No. 975.



Something new in miniature ceramic capacitors! These "button types" are available in 5 different styles. Used for bypassing in low-power, high frequency applications where small size, low inductance and light weight are essential. Check Bulletin No. 42-122 in coupon for more information.

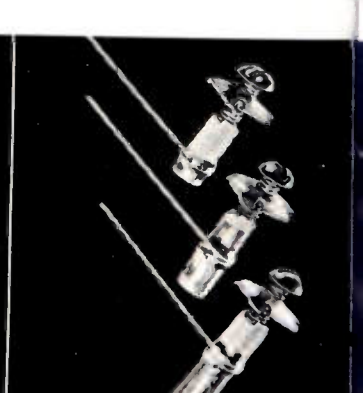

TV Trimmer Capacitors — Ceramic tubulars—threaded. Complete with lock-nut and screw. Used in TV, FM. Bulletin No. 42-10R.

Complete Line of Ceramic Capacitors

(N) MILITARY APPLICATION

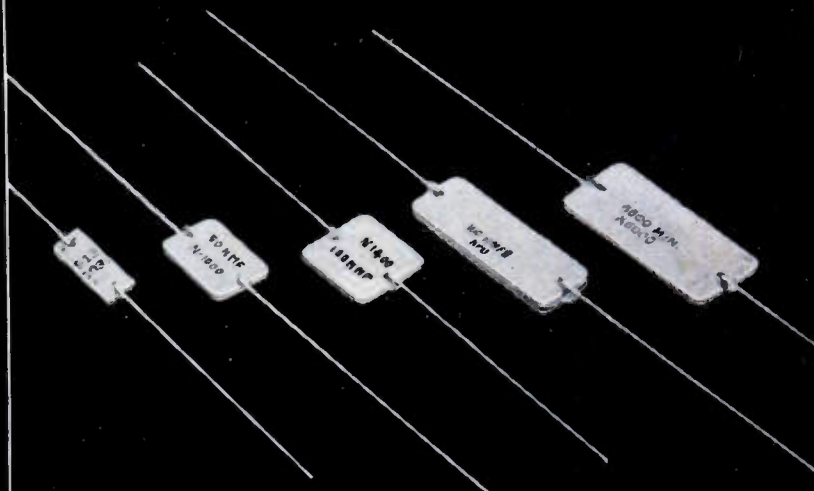
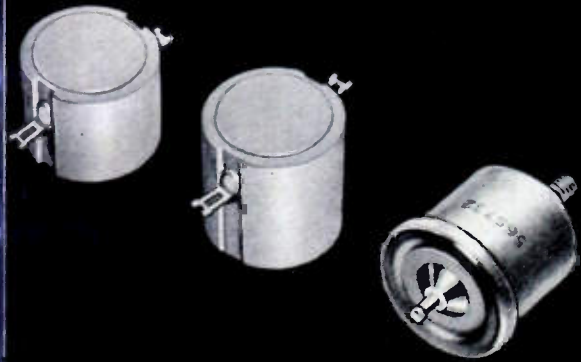

Accuracy capacitors. Precision units to meet exacting requirements requiring extremely rigid frequency control. Extensively used for hold-off oscillator frequencies to close limits. For complete information, check Bulletin No. 42-123 in coupon below.

Flat Plate, end-lead capacitors. Temperature compensating. Capacitances: 5, 10, 20, 50 and 100 mmf., 500 volts D. C. working. Temperature Compensating Tolerance: 15% or 30 PPM whichever is larger. For complete information check Bulletin No. 42-124 in coupon below.

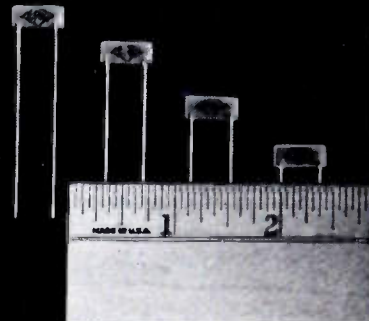
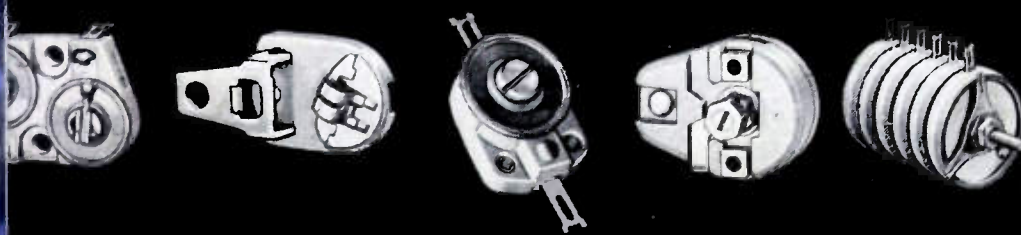

Centralab Ceramic and Steatite Trimmers provide high quality stable capacitors, with small size, light weight, easy mounting. Readily adjustable with screw driver and give full capacity range with 180° rotation. Equal accuracy maintained in any position — minimum to maximum. Have excellent stability under vibration. Rotor contact under spring pressure on optically ground flat surface. Check Bulletin No. 42-101 for more data.

Min-Kaps are very tiny capacitors used where space is at extreme premium. Ask for Bulletin No. 42-24.

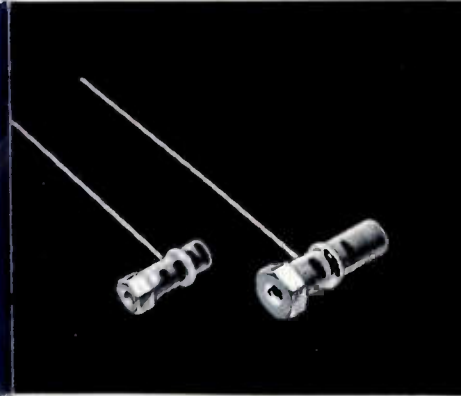

End-off ceramic capacitors — both Bypass Coupling and Temperature Compensating types. One end threaded. For complete information check No. 42-121 in coupon below.

Centralab

Division of GLOBE-UNION INC. • Milwaukee

CENTRALAB
Division of Globe-Union Inc.
920 East Keefe Avenue, Milwaukee, Wisconsin

Yes — I would like to have the CRL bulletins, checked below, for my technical library!

- | | | | | |
|---------------------------------|---------------------------------|---------------------------------|---------------------------------|---------------------------------|
| <input type="checkbox"/> 42-102 | <input type="checkbox"/> 42-124 | <input type="checkbox"/> 42-3 | <input type="checkbox"/> 975 | <input type="checkbox"/> 42-122 |
| <input type="checkbox"/> 42-10R | <input type="checkbox"/> 42-4R | <input type="checkbox"/> 42-101 | <input type="checkbox"/> 42-121 | |
| <input type="checkbox"/> 42-123 | <input type="checkbox"/> 42-18 | <input type="checkbox"/> 42-24 | <input type="checkbox"/> 42-59 | |

Name.....

Address.....

City..... State.....

Standard RADIO INTERFERENCE and FIELD INTENSITY Measuring Equipment

Complete Frequency Coverage - 14kc to 1000 mc!



VLF!

NM - 10A

14kc to 250kc

Commercial Equivalent of AN/URM-6.

Very low frequencies.



HF!

NM - 20A 150kc to 25mc

Commercial Equivalent of AN/PRM-1. Self-contained batteries. A.C. supply optional. Includes standard broadcast band, radio range, WWV, and communications frequencies.

VHF!

NMA - 5

15mc to 400mc

Commercial Equivalent of TS-587/U.

Frequency range includes FM and TV Bands.



UHF!

375mc to 1000mc **NM - 50A**

Commercial Equivalent of AN/URM-17.

Frequency range includes Citizens Band and UHF color TV Band.



These instruments comply with test equipment requirements of such radio interference specifications as JAN-I-225, ASA C63.2, 16E4(SHIPS), AN-I-24a, AN-I-42, AN-I-27a, AN-I-40 and others.

STODDART AIRCRAFT RADIO CO.

6644-C SANTA MONICA BLVD., HOLLYWOOD 38, CALIFORNIA

Hillside 9294



AKRON

"Engineering Aspects of Mechanism of Body Control," by R. Mayne, Goodyear Aircraft Corporation; November 21, 1950.

"Amusing Patents," by A. Oldham; December 19, 1950.

ATLANTA

"Discussion and Demonstration of Microwave Techniques," by R. E. Honer and J. S. Hollis, State Engineering Experiment Station; November 17, 1950.

BALTIMORE

"Review of The Institute of Radio Engineers' Growth and Activities," and "Results of NBC-RCA UHF TV Tests in Bridgeport-Stratford, Connecticut Area," by R. F. Guy, National Broadcasting Company; December 13, 1950.

BEAUMONT-PORT ARTHUR

Election of Officers; December 7, 1950.

BOSTON

"WCON-TV 1060-Foot Tower and Supergain Antenna," by L. J. Wolfe, RCA Victor Division, and S. E. Wilson, International Derrick and Equipment Company; November 9, 1950.

"The Validity of the Mixed-Highs Principle in Color Television," by Charles Hirsch, Hazeltine Electronics Corporation; December 14, 1950.

BUFFALO-NIAGARA

"The Requirements for a New Field of Industrial Electronics Equipment," by E. D. Cook, General Electric Company; November 15, 1950.

"Instrumentation of the Twelve-Foot Variable Density Wind Tunnel at Cornell Aeronautical Laboratory," by Robert MacArthur, Cornell Aeronautical Laboratory; December 13, 1950.

CEDAR RAPIDS

"Some Recent Developments at Eimas," by W. G. Wagener, Eitel-McCullough, Inc.; November 21, 1950.

"Metallized Paper Capacitors," by Louis Kahn, Aerovox Company; "Tantalum Capacitors," by L. W. Foster, General Electric Company; Nomination of Officers; December 13, 1950.

CLEVELAND

"Audio Transducers," by H. F. Olson, RCA Laboratories; October 13, 1950.

COLUMBUS

"Omni-Bearing Distance System of Air Navigation," by J. W. Leas, Air Navigation Development Board; December 12, 1950.

CONNECTICUT VALLEY

"Color Television," by Axel Jensen, Bell Telephone Laboratories; November 21, 1950.

"Magnetic Amplifiers," by W. A. Geyger, United States Naval Ordnance Bureau; December 14, 1950.

DALLAS-FORT WORTH

"High-Fidelity Phono Systems," by E. J. O'Brien, Faculty, Southern Methodist University; November 16, 1950.

"A Small Permanent Magnet Electron Microscope," by R. J. Miller, Radio Corporation of America; December 4, 1950.

DENVER

"Recent Organizational Developments in The Institute of Radio Engineers," by T. A. Hunter, Hunter Manufacturing Company; December 8, 1950.

DES MOINES-AMES

"Electronic Instrumentation," by Alfred Crossley, Alfred Crossley and Associates Company; Business Meeting; October 31, 1950.

(Continued on page 38A)

NEW



CAUTION ON HIGH VOLTS

**1/2%
RESISTORS**

**COMPENSATED
OHMMETER
CIRCUIT**

**LONG
HAND-DRAWN
MIRRORED
SCALES**

ACCURACY

Designed for the engineer and technician who wants laboratory accuracy. Achieved in Model 630-A by more accurate components and hand-drawn scales that compensate for the average individual characteristic of each instrument. Also includes knife-edge pointer and mirror scale to eliminate parallax.

Model
630-A

ONLY \$49.50 AT YOUR DISTRIBUTOR

FOR THE MAN WHO TAKES PRIDE IN HIS WORK
Triplett
TRIPLETT ELECTRICAL INSTRUMENT COMPANY • BLUFFTON, OHIO, U.S.A.

BALLANTINE

STILL THE FINEST

in

ELECTRONIC VOLTMETERS

Ballantine pioneered circuitry and manufacturing integrity assures the maximum in
SENSITIVITY • ACCURACY • STABILITY

- All models have a single easy-to-read logarithmic voltage scale and a uniform DB scale.
- The logarithmic scale assures the same accuracy at all points on the scale.
- Multipliers, decade amplifiers and shunts also available to extend range and usefulness of voltmeters.
- Each model may also be used as a wide-band amplifier.



MODEL 300

MODEL	FREQUENCY RANGE	VOLTAGE RANGE	INPUT IMPEDANCE	ACCURACY	PRICE
300	10 to 150,000 cycles	1 millivolt to 100 volts	1/2 meg. shunted by 30 mmfds.	2% up to 100 KC 3% above 100 KC	\$210.
302B Battery Operated	2 to 150,000 cycles	100 microvolts to 100 volts	2 megs. shunted by 8 mmfds. on high ranges and 15 mmfds. on low ranges	3% from 5 to 100,000 cycles; 5% elsewhere	\$225.
304	30 cycles to 5.5 megacycles	1 millivolt to 100 volts except below 5 KC where max. range is 1 volt	1 meg. shunted by 9 mmfds. on low ranges. 4 mmfds. on highest range	3% except 5% for frequencies under 100 cycles and over 3 megacycles and for voltages over 1 volt	\$235.
305	Measures peak values of pulses as short as 3 microseconds with a repetition rate as low as 20 per sec. Also measures peak values for sine waves from 10 to 150,000 cps.	1 millivolt to 1000 volts Peak to Peak	Same as Model 302B	3% on sine waves 5% on pulses	\$280.
310A	10 cycles to 2 megacycles	100 microvolts to 100 volts	Same as Model 302B	3% below 1 MC 5% above 1 MC	\$235.

For further information, write for catalog.

BALLANTINE LABORATORIES, INC.

102 Fanny Road, Boonton, New Jersey



(Continued from page 36A)

"Previews of Reviews of Engineering," by C. S. Scarlott, Westinghouse Electric Corporation; November 13, 1950.

EMPORIUM

"Control Problems in Nuclear Power Plants," by M. A. Schultz, Westinghouse Electric Corporation; November 21, 1950.

"The Humor Spectrum in Seven Colors," by Marius Risley, Faculty, University of Buffalo; Election of Officers; December 12, 1950.

FORT WAYNE

"Frequency Stability of Tuned Oscillators," by Leonard Mayberry, Magnavox Company; November 20, 1950.

HAWAII

"Common Radio Interference Types in the Hawaiian Islands," by Lee Dawson, Federal Communications Commission; August 9, 1950.

"The Electronic Aspects of Radiological Defense," by Vaughn Kelly, Pearl Harbor Naval Shipyard; September 20, 1950.

"The Status of TV and its Prospects for the Hawaiian Islands," by Royal Howard, Radio Station KIKI; October 18, 1950.

LONDON

"The Trends in High-Fidelity Loud Speakers," by G. R. Hosker, Richards-Wilcox Canadian, Ltd.; December 13, 1950.

MONTREAL

"A Multichannel PAM-FM Radio Telemetering System," by G. W. Farnell, Faculty, McGill University; Business Meeting; November 29, 1950.

"Master Control Facilities at the Radio Canada Building, Montreal," by R. H. Tanner, Northern Electric Company; December 13, 1950.

NEW MEXICO

"Recent Klystron Developments," by H. M. Stearns, Varian Associates; "A 10 MC Counter," by Raymond Bagley, Hewlett-Packard Company; November 4, 1950.

NEW YORK

"Transmitters and Transmitting Systems," by Lloyd Espenschied, Bell Telephone Laboratories; "Receivers and Receiving Systems," by J. V. L. Hogan, Hogan Laboratories, Inc.; February 1, 1950.

"WOR-TV Television Station Construction Problems," by C. H. Singer, Radio Station WOR; April 25, 1950.

"Control Problems of Nuclear Power Plants," by M. A. Schultz, Westinghouse Electric Corporation; May 3, 1950.

"Some Aspects of G-Wire Transmission," by H. Engelmann, J. A. Kostriza, and D. D. Grieg, Federal Telecommunications Laboratories; June 7, 1950.

"Trends in Electronic Components and Assemblies," by E. I. Green, Bell Telephone Laboratories; November 1, 1950.

"A Multichannel Radio Relay System for Long Distances," by A. C. Dickieson and T. J. Grieser, Bell Telephone Laboratories; November 16, 1950.

OMAHA-LINCOLN

"Development and Applications of Traveling-Wave Tubes," by M. D. Hare, Faculty, Union College; November 27, 1950.

OTTAWA

"Kinescope Recording," by J. E. Hayes, Canadian Broadcasting Corporation; November 23, 1950.

"VHF and UHF Radiotelephone Systems," by H. C. Sheffield, Federal Electric Manufacturing Company; December 14, 1950.

(Continued on page 40A)

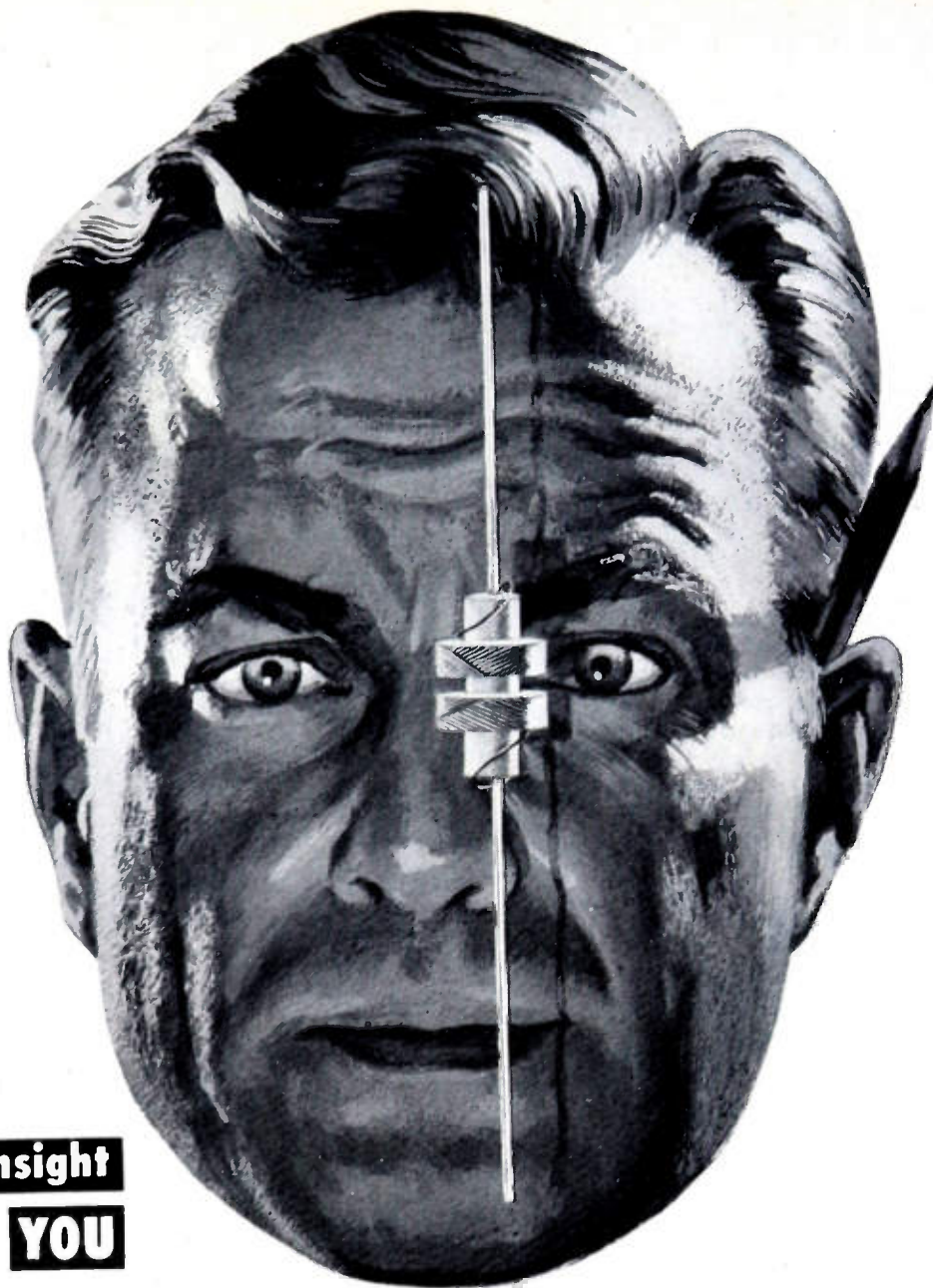

**we'll sight our
engineering insight
especially for YOU**

...if electronic components, such as chokes, are your problem

*Built in quantity
to your most exacting specifications
for stability in service*

JEFFERS
Electronics **INC.**

A SPEER CARBON COMPANY SUBSIDIARY
DU BOIS, PENNSYLVANIA

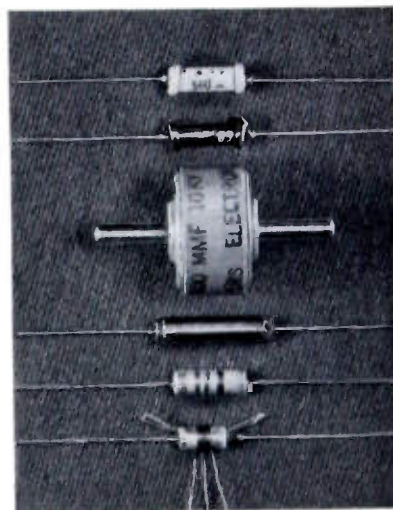

Complete your Circuits with Resistors, Coil Forms and Iron Cores by Speer Resistor Corp., St. Marys, Pa. another SPEER CARBON CO. subsidiary

MORE GEO. STEVENS COIL WINDING EQUIPMENT IS IN USE THAN ALL OTHER MAKES COMBINED!

- **MORE OUTPUT . . . LOWER COSTS . . .** from **EXCLUSIVE SPEED FEATURE.** Universal motors permit variable speeds without changing belts and pulleys. Coil design permitting, speeds as high as 7500 RPM are not uncommon.
- **PORTABILITY.** Conveniently carried from place to place. Machines come mounted on bases to constitute one complete unit.
- **MUCH LOWER ORIGINAL COST.** The same investment buys more GEO. STEVENS machines than any other coil winding machines.
- **LONG LIFE.** Most of the original

GEO. STEVENS machines bought 14 years ago are still operating daily at full capacity.

- **MUCH FASTER CHANGING OF SET-UPS** than any other general purpose coil winding machine. Quickly changed gears and cams save time between jobs.
- **VERY LOW MAINTENANCE.** Replacement parts are inexpensive, can be replaced in minutes, and are stocked for "same day" shipment, thus saving valuable production time.
- **EASIEST TO OPERATE.** In one hour, any girl can learn to operate a GEO. STEVENS machine.

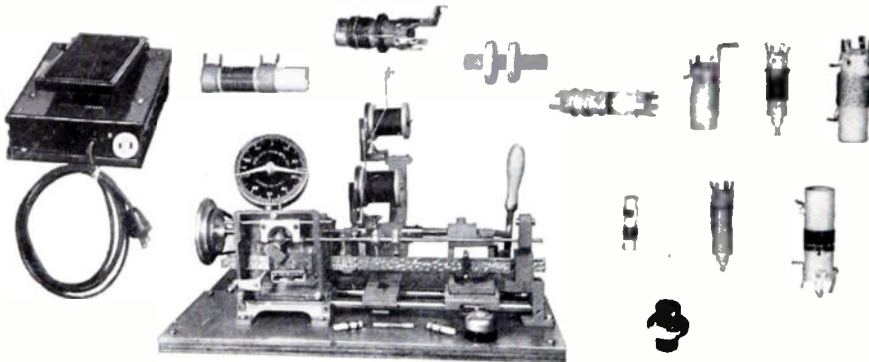

Progressive universal winding machine, Model 125, handles space wound coils and solenoids up to 8" in length, progressive universal coils up to 4" in length and 3" in diameter, universal coils up to 3/4" in width, and I.F. coils. Winds wire from 20 to 44 gauge. Cams are stocked from 3/4" to 1/16" in decrements of 1/64". Sizes larger than 3/4" or less than 1/64" are made upon request.

Cam, gears and idler forming the pattern are enclosed in front. Traverse rack is driven by change gears and idler enclosed in back of the head. The traverse rack has an adjustable stop to insure return to identical starting position. Large ball bearings on head stock spindle give long life and easy running. Ball bearing tailstock with spring tension lever permits quick change of coil forms.

Standard equipment: 1/4 H.P. universal motor, foot operated speed controller, V belt drive, and double spool carrier with two adjustable oilite bearing tensions to control wire during winding.

Dial Counter (Model 50 or 51) with 6" full vision clock dial, accurately registers all turns.

There is a GEO. STEVENS machine for every coil winding need. Machines that wind ANY kind of coil are available for laboratory or production line. . . . Send in a sample of your coil or a print to determine which model best fits your needs. Special designs can be made for special applications. Write for further information today.

World's Largest Manufacturer of Coil Winding Machines

REPRESENTATIVES

Frank Tatro
6022 No. Rogers Ave., Chicago 30, Illinois
Ralph K. Reid
1911 W. 9th St., Los Angeles 6, California
R. A. Staff & Co.
1213 W. 3rd St., Cleveland 13, Ohio



SECTION MEETINGS

(Continued from page 38A)

PHILADELPHIA

"Air Traffic Control," by D. H. Ewing; December 7, 1950.

PORTLAND

"Observations and Experiences in the Communication Field," by Ralph Deardorff, Pacific Telephone and Telegraph Company; "Miniaturization and Plastic Casting Techniques in Radio," by W. F. Biggerstaff, United States Forest Service Laboratory; and "Practical Circuitry, Cathode Ray Oscilloscopes," by Richard Ropiquet, Tektronix, Inc.; November 20, 1950.

ROCHESTER

"Radio Noise from the Stars," by Charles Burrows, Faculty, Cornell University; November 14, 1950.

"Radio and Television as of Today," by Sidney Curtis, Stromberg-Carlson Company; December 12, 1950.

SALT LAKE

"Industrial Equipment in the Electronic Era," by H. H. Leigh, General Electric Company; November 20, 1950.

SAN DIEGO

"A 10-Megacycle Pulse Counter," by A. S. Bagley, Hewlett-Packard Company; November 7, 1950.

SAN FRANCISCO

"Aircraft Antenna System," by John Granger, Stanford Research Institute; November 15, 1950.

"Control and Measurement of Distortion on 16-mm TV Films," by J. K. Hilliard, Altec-Lansing Corporation; November 29, 1950.

SCHENECTADY

"Nuclear Instrumentation," by F. A. White and F. G. LaViolette, Knolls Atomic Power Laboratory; December 11, 1950.

SEATTLE

"Airplane Antennae, Their Development, Types, and Uses," by Gerald Weinstein, Boeing Airplane Company; December 1, 1950.

SYRACUSE

"Solar Noise," by Lief Owren, Faculty, University of Oslo, on leave at Cornell University; November 30, 1950.

TORONTO

"The Design of an Automatic Ionosphere Recorder," by F. H. Margolick, Canadian Marconi Company, Ltd., and paper discussed by Charles Bridgeland; December 4, 1950.

TWIN CITIES

"High-Speed Magnetic Generation of Numerical Characters," by J. W. Hogan, Engineering Research Associates, Inc.; "A Magnetic Memory System for Pulse-Coded Information," by J. L. Hill, Engineering Research Associates, Inc.; November 16, 1950.

Tests and Demonstrations by representatives of Alfred Crossley and Associates; November 1, 1950.

VANCOUVER

"Master Control Facilities for a Large Broadcasting Studio Center," by R. H. Tanner, Northern Electric Company, Ltd.; October 16, 1950.

"Some Electronic Instruments Used in Nuclear Physics," by F. K. Bowers, Faculty, University of British Columbia; November 20, 1950.

WILLIAMSPORT

"Applications of Magnetostriction," by B. H. Bueffel, Jr., Faculty, Bucknell University; December 6, 1950.

(Continued on page 42A)

4

Normally
Open
Contacts

4

Normally
Closed
Contacts

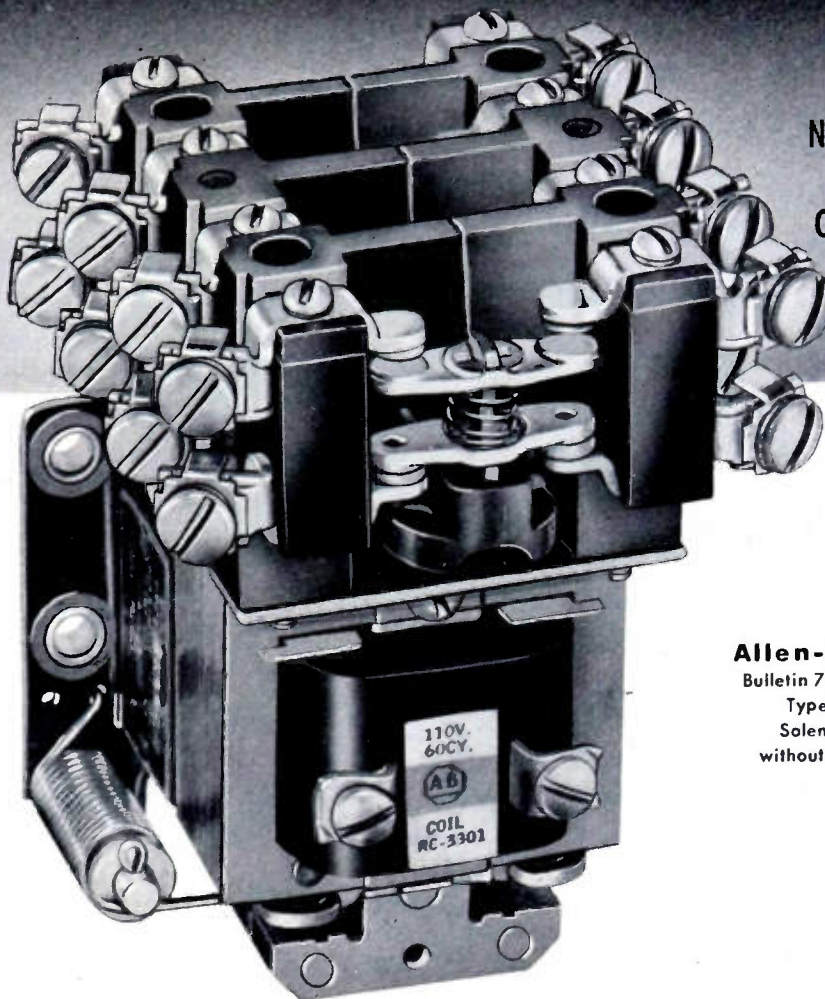

Dimensions
of Universal Relay
High—3-15/16 in.
Wide—2-15/16 in.
Deep—3-5/16 in.

Allen-Bradley
Bulletin 700 Universal
Type BX 440
Solenoid Relay
without enclosure.

These SMALL UNIVERSAL RELAYS are instantly adaptable for switching a wide variety of power supply circuits

There are literally thousands of places for these small, dependable solenoid relays in electronic power circuits. These Bulletin 700 relays are built in an amazing variety of contact arrangements . . . normally open and normally closed . . . from one to eight poles. Enclosures are available for almost any service requirement.

The Type BX 440 Universal Solenoid Relay has

four normally open and four normally closed contacts which may be used interchangeably for handling a wide variety of circuit arrangements.

It will pay you to get a full listing of Allen-Bradley Bulletin 700 A-C Relays. And for heavier currents, Allen-Bradley solenoid contactors are available up to 900 amperes . . . with or without enclosures. Investigate the Allen-Bradley line.

Allen-Bradley Co., 114 W. Greenfield Ave., Milwaukee 4, Wis.

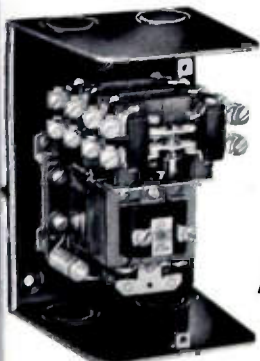

Allen-Bradley Relay in
general purpose enclosure.

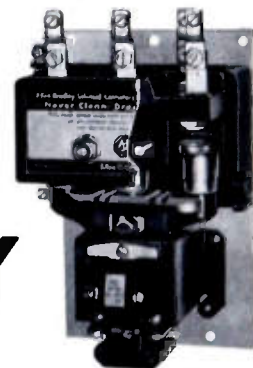

Bulletin 702 Solenoid Con-
tactor—50 ampere rating.

ALLEN-BRADLEY
RELAYS • RESISTORS
QUALITY

Specify Sorensen



AC

MODEL NO. 500-S

VOLTAGE REGULATORS

Accuracy, with rugged construction, economical and trouble-free operation, reasonable cost — those are features that you expect, and get, when you specify Sorensen regulators!

ALL SORENSEN REGULATORS HAVE THESE ADVANTAGES:

- WIDE INPUT RANGE
- EXCELLENT WAVEFORM
- ADJUSTABLE OUTPUT VOLTAGE THAT STAYS SET
- FAST RECOVERY TIME
- REGULATION ACCURACY OF $\pm 0.1\%$
- INSENSITIVITY TO LINE FREQUENCY FLUCTUATIONS.

STANDARD AC SPECIFICATIONS

VA capacity	150	250	2000	5000
	500	1000	3000	10000
				15000
Harmonic Distortion	3% max.	2% max.	3% max.	3% max.
Regulation accuracy	$\pm 0.1\%$ against line or load			
Input voltage	95-130 VAC; also available for 190-260 VAC single phase 50-60 cycles			
Output voltage	Adjustable between 110-120; 220-240 in 230 VAC models			
Load range	0 to full load			
P.F. range	Down to 0.7 P.F. All models temperature compensated			

NOTE: THREE PHASE AND 400 CYCLE REGULATORS ALSO AVAILABLE. ALL REGULATORS CAN BE HERMETICALLY SEALED.

Write for Complete Literature

For regulated DC problems investigate Sorensen's line of Voltage Reference Standards,

DC Supplies, and NOBATRONS

Sorensen and company, inc.
375 FAIRFIELD AVE. • STAMFORD, CONN.

MANUFACTURERS OF AC LINE REGULATORS, 60 AND 400 CYCLES; REGULATED DC POWER SOURCES; ELECTRONIC INVERTERS; VOLTAGE REFERENCE STANDARDS; CUSTOM BUILT TRANSFORMERS; SATURABLE CORE REACTORS



(Continued from page 40A)

SUBSECTIONS

CENTRE COUNTY

"Dust Precipitation by Electrostatic Fields," by J. E. Coolidge, Faculty, Pennsylvania State College; "Parallel-Plate Electrostatic Precipitation," by G. J. Schulz, Faculty, Pennsylvania State College; November 15, 1950.

EMPORIUM

"Dynamic Balancing of Large Rotors," by P. E. Shields, Faculty, Pennsylvania State College; "Through the Swiss Alps Via the Ionosphere," by A. H. Waynick, Faculty, Pennsylvania State College; December 12, 1950.

LONG ISLAND

"Analysis of Color TV," by A. V. Loughren, Hazeltine Electronics Corporation; November 22, 1950.

MID-HUDSON

"Uses of Carrier Frequencies in Power Systems," by H. A. McLaughlin, Central Hudson Gas and Electric Corporation; November 14, 1950.

MONMOUTH

"Electronics in Medicine," by Stanley Briller, Bellevue Medical Center; and Nathan Marchand, Sylvania Electric Products Inc.; November 15, 1950.

NORTHERN NEW JERSEY

"Phase Distortion in Audio Systems," by L. de Rosa, Federal Telecommunication Laboratories; November 8, 1950.

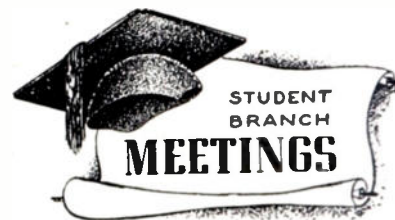

UNIVERSITY OF ALBERTA, IRE BRANCH
"Industrial Relations," by L. Pugh, Chairman Board of Industrial Relations; December 5, 1950.

UNIVERSITY OF CALIFORNIA, IRE-AIEE BRANCH
"Sales Engineering in the Electrical Field," by W. F. Poynter, Pacific Electric Company, A. W. Moody, General Electric Company; and W. M. Knot, Sangmore Electric Company; November 16, 1950.

"Toxic Hazards of Materials in Electrical Applications," by B. D. Tebbens, Faculty, University of California; November 28, 1950.

CALIFORNIA STATE POLYTECHNIC COLLEGE, IRE BRANCH

"Los Angeles-to-San Francisco Microwave Link," by Charles Minder, Pacific Telephone and Telegraph Company; November 9, 1950.

CLARKSON COLLEGE OF TECHNOLOGY, IRE BRANCH

"Patents and Inventions," by Frank Record, Faculty, Clarkson College of Technology; December 14, 1950.

UNIVERSITY OF COLORADO, IRE-AIEE BRANCH
"Protective Relays," by Edward Gray, Westinghouse Relay Specialist; November 28, 1950.

(Continued on page 44A)

We are ready NOW...



Can we serve YOU?

For IMMEDIATE ACTION, phone—wire—
or write direct to the attention of Mr.
Albert Finkel, Vice-President.



... World's largest producer of television antennas and accessories, has allocated a most substantial portion of its facilities for prime and sub-contract orders. We offer:

EXPERIENCE! Leaders in the industry whom we have serviced in the past, include such outstanding organizations as RCA, PHILCO, ADMIRAL, MOTOROLA, BENDIX, EMERSON, PILOT, STROMBERG-CARLSON, etc.

80,000 square feet of floor space with modern production machinery and high-speed assembly lines.

TRAINED manufacturing personnel geared to the type of mass-production that meets "deadlines" and lowers costs.

EXCELLENT sources of supply for raw material.

KNOW-HOW in purchasing and delivery expediting.

FINANCIAL resources that are ample and liquid.

DIVISION OF CONTRACT OPERATIONS



MANUFACTURING CO., Inc.
6137B 16th AVENUE, BROOKLYN 4, N. Y.
FIRST in Television Antennas and Accessories

Airtron

DESIGNS AND PRODUCES

Flexible and Rigid

WAVEGUIDE

COMPONENTS

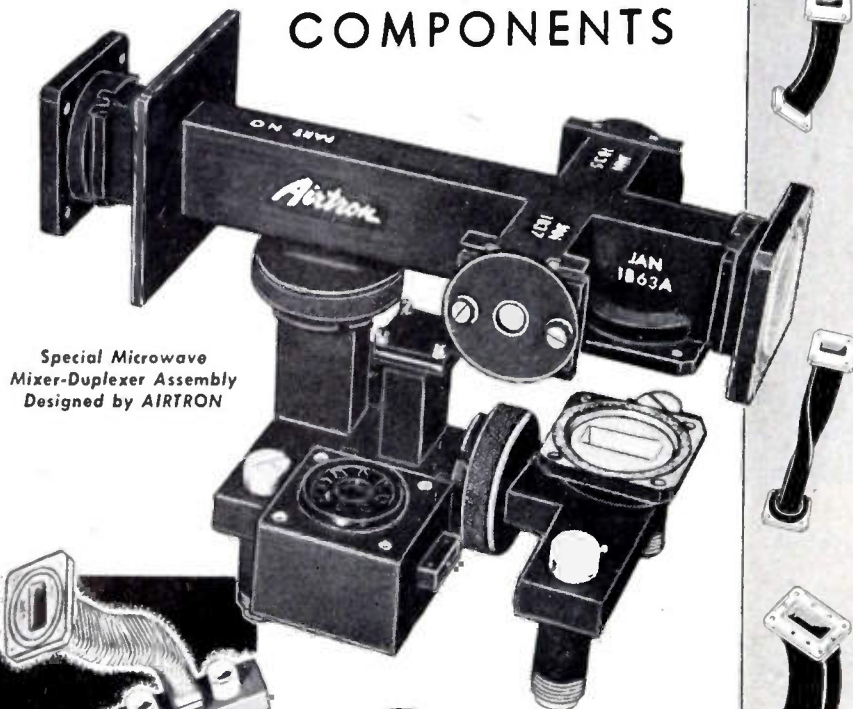

Special Microwave Mixer-Duplexer Assembly Designed by AIRTRON

From the smallest waveguide component to complete transmission systems... from the first "doodle" memo or blueprint to the finished precision product... make AIRTRON your FIRST source for all types of microwave plumbing. Unique in background, technical savvy, plant facilities and the WILL to SERVE, this organization is prepared to engineer and manufacture your staple or special requirements in:

- Mixers
- Duplexer Assemblies
- Magic Tees
- Waveguide Switches
- Elbow Bends
- Elbow Mitters
- Twisted Sections
- Rigid Twists
- Choke Fittings
- Flexible Waveguides
- Straight Section
- Rotary Joints

Send for AIRTRON Engineering Data on Microwave Plumbing



Airtron
INC.

105 East Elizabeth Ave., Linden, New Jersey

BRANCH OFFICES

Baltimore Los Angeles New York
Boston St. Louis Dallas Dayton

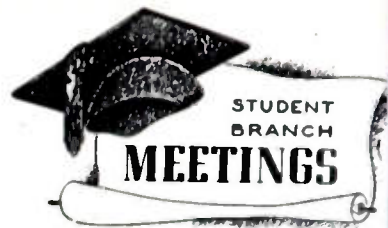

(Continued from page 42A)

COOPER UNION, IRE BRANCH

- "Color Television," by Axel Jensen, Telephone Company; November 20, 1950. Tour Radio Station WOR-TV; November 22, 1950.
- "Practical Problems of Illuminating Engineering," by G. F. Greene; December 4, 1950.
- Tour of Radio City Music Hall; December 1950.

UNIVERSITY OF DENVER, IRE-AIEE BRANCH

- "Lightning Investigation and Protection Problems," by L. M. Robertson. Public Service Company; December 1, 1950.

DREXEL INSTITUTE OF TECHNOLOGY, IRE-AIEE BRANCH

- "Microwave Communications," by J. Williams, Philco Corporation; November 16, 1950.

UNIVERSITY OF FLORIDA, IRE-AIEE BRANCH

- "Presenting a Technical Paper," by H. Constans, Faculty, University of Florida; December 5, 1950.

GEORGIA INSTITUTE OF TECHNOLOGY, IRE BRANCH

- Business Meeting; October 24, 1950.
- "Construction of WGST-FM Transmitter," Ben Akerman, Radio Station WGST; November 1950.
- Film: "Power in the South"; November 1950.
- Business Meeting; December 5, 1950.

ILLINOIS INSTITUTE OF TECHNOLOGY, IRE BRANCH

- "Electronics in Industry," by Tracy Johnson, General Electric Company; November 28, 1950.

UNIVERSITY OF KENTUCKY, IRE BRANCH

- "Psychology, Science, and Technology," J. S. Calvin, Faculty, University of Kentucky; November 30, 1950.

MANHATTAN COLLEGE, IRE BRANCH

- "Color Television, Three Systems," by George Anner, Faculty, New York University; December 1950.

UNIVERSITY OF MARYLAND, IRE-AIEE BRANCH

- Films: "DC Machines," and "Westinghouse Fluorescent Bulb Factory in West Virginia"; December 6, 1950.

UNIVERSITY OF MIAMI, IRE BRANCH

- Election of Officers; November 3, 1950.
- "Construction of an FM Station," by Ben Akerman, Radio Station WGST; November 1950.
- "Demonstration of an Electronic Counter," by C. N. Hoyer, RCA Laboratories; Film: "Analog Computer"; December 8, 1950.

MICHIGAN COLLEGE OF MINING AND TECHNOLOGY, IRE-AIEE BRANCH

- Business Meeting; Film: "Power Station and Its Problems"; November 14, 1950.

UNIVERSITY OF MICHIGAN, IRE-AIEE BRANCH

- "The Electrical Engineer in the Fields of Sales Development, Design, and Research," by Gammell, Allis-Chalmers Corporation; December 1950.

MISSOURI SCHOOL OF MINES & METALLURGY, IRE-AIEE BRANCH

- "Electronic Research at Midwest Research Institute," by H. L. Stout, Faculty, Midwest Research Institute; November 30, 1950.

(Continued on page 46A)

DESIGNED

FOR

SERVICE

More Rugged Electrically
More Rugged Mechanically
More Rugged in Safety Factor
More Rugged for Longer Life

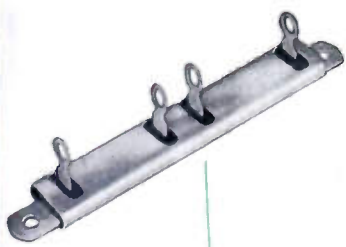
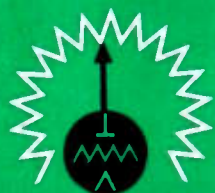

Armor-clad voltage dividers that stand up to mechanical and electrical abuse.



The toughest wire-wound power resistors in use today — Greenahms and Standees.

Dual carbon-element controls with single shaft or with dual concentric shaft.

Constant-impedance L- and T-pads for distortionless volume control of sound systems.

Plug-in ballasts and line-voltage regulators for smoother set operation and protection.

Wire-wound potentiometers with that velvety-smooth mechanical and electrical precision.

Power rheostats "built like a battleship" for dependable control functions.



★ A dependable control or resistor costs but a few cents. But an *uncertain* control or resistor that fails out in the field can cost you thousands of dollars by way of impaired reputation.

The fact that Clarostat controls and resistors are used in the majority of today's TV, radio and electronic assemblies, speaks for itself. Clarostat not only supplies such initial equipment but also the service replacements for the further protection of the manufacturer's good name and good will.

Designed for Service! That's precisely what you are demanding and getting, when you simply specify CLAROSTAT for controls and resistors.

CLAROSTAT
 CLAROSTAT MFG. CO., INC. DOVER, NEW HAMPSHIRE

PUT OUT A STRONGER SIGNAL... INCREASE YOUR SERVICE AREA

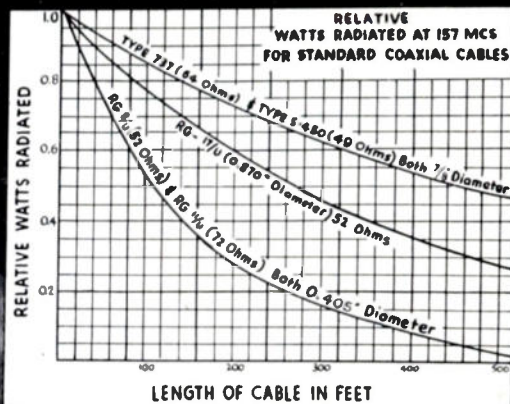

with ANDREW Low Loss, High Economy Coaxial Cable

- 1/3 to 1/2 Less Loss than same diameter plastic type cables because 96% of insulation is air—the most effective insulation.
- No maintenance or operational costs. This advantage far offsets slightly greater original cost. Seamless cable and fittings remain completely gas tight and weatherproof indefinitely.
- Maintains original characteristics indefinitely. Lasts practically forever.
- TO INSTALL — JUST UNCOIL INTO PLACE. Each coil contains up to 2,000 feet of seamless semi-flexible tubing. No soldering. No splicing. Bends easily around corners or obstructions. Shipped under gas pressure at no extra cost when pressure-tight end fittings are ordered.

Low loss and economical operation will add extra miles to your service radius as well as give you a stronger signal in your present area. There's no waste. You get the greatest possible range and strength from your available power.

Whether you need transmission line for your Communications,

AM or FM transmitter, Directional Antenna System, or Rhombic Receiving Array, the solution to your problem is ANDREW low loss, high economy, semi-flexible transmission line. Write for further information on Types 737 and S-450 TODAY.



WORLD'S LARGEST ANTENNA EQUIPMENT SPECIALISTS
TRANSMISSION LINES FOR AM-FM-TV • ANTENNAS • DIRECTIONAL ANTENNA EQUIPMENT
ANTENNA TUNING UNITS • TOWER LIGHTING EQUIPMENT

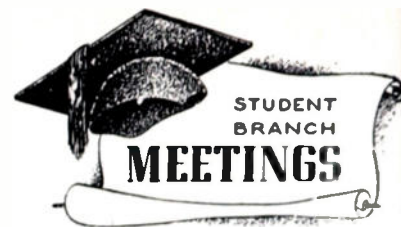

(Continued from page 44A)

COLLEGE OF THE CITY OF NEW YORK
IRE BRANCH

"Problems and Theory of Diode-Controlled Magnetic Amplifiers," by Leo Heltterline, Sorenson Company; November 31, 1950.

NEW YORK UNIVERSITY, IRE-AIEE BRANCH
(EVENING DIVISION)

"Major Operations in the Manufacture of Vacuum Tubes," by W. H. Greenbaum, Student Associated with Sonotone Corporation, and "Telephone Cable Carrier Systems," by V. J. Sanseverino, Student, Associated with American Telephone and Telegraph Company; December 15, 1950.

NORTHEASTERN UNIVERSITY, IRE-AIEE BRANCH

"Present Status of Color Television," by Hollis Baird, Faculty, Northeastern University, November 30, 1950.

"Electrical Memory," by Patrick Youtz, Massachusetts Institute of Technology; December 7, 1950.

"Time and Frequency, Signal and Noise," by Sze-Hou Chang, Faculty, Northeastern University, December 14, 1950.

OREGON STATE COLLEGE, IRE BRANCH

"Measurements on Aircraft Antennas by Means of Models," by G. L. Hollingsworth, Boeing Airplane Company; November 9, 1950.

"Miniaturization and Plastic Casting Techniques in Radio," by W. F. Biggerstaff, United States Forest Service Radio Laboratory, and "Practical Circuitry, Cathode-Ray Oscilloscopes," by Richard Ropiequet, Tektronix, Inc.; November 20, 1950.

"The Federal Communications Commission," by F. H. McCann, Federal Communications Commission; December 7, 1950.

PENNSYLVANIA STATE COLLEGE
IRE-AIEE BRANCH

"More Waves, More Words, Less Wires," by J. O. Perrine, American Telephone and Telegraph Company; November 9, 1950.

UNIVERSITY OF PENNSYLVANIA, IRE-AIEE BRANCH

"Starting in an Engineering Career," by C. G. Veinott, Lima Motor Works of Westinghouse; November 7, 1950.

"Industrial Television Equipment and Applications," by M. C. Banca, Radio Corporation of America; November 13, 1950.

PRINCETON UNIVERSITY, IRE-AIEE BRANCH

"The AIEE, its Structure, and What it Means to You," by J. H. Neher, Philadelphia Electric Company, and "The Institute of Radio Engineers," by A. W. Friend, RCA Laboratories; November 16, 1950.

"The Engineering and Industry," by C. S. Purnell, Westinghouse Electric Corporation; Film: "Electrical Proving Ground"; November 30, 1950.

SAN JOSE STATE COLLEGE, IRE BRANCH

"Problems in the Operation of Low-Frequency Loran," by Hugo Romander, Sierra Electronics; November 20, 1950.

SEATTLE UNIVERSITY, IRE BRANCH

"Systems of Amplitude Modulation," by J. R. Hall, Student, Seattle University; November 21, 1950.

(Continued on page 48A)

no washday blues

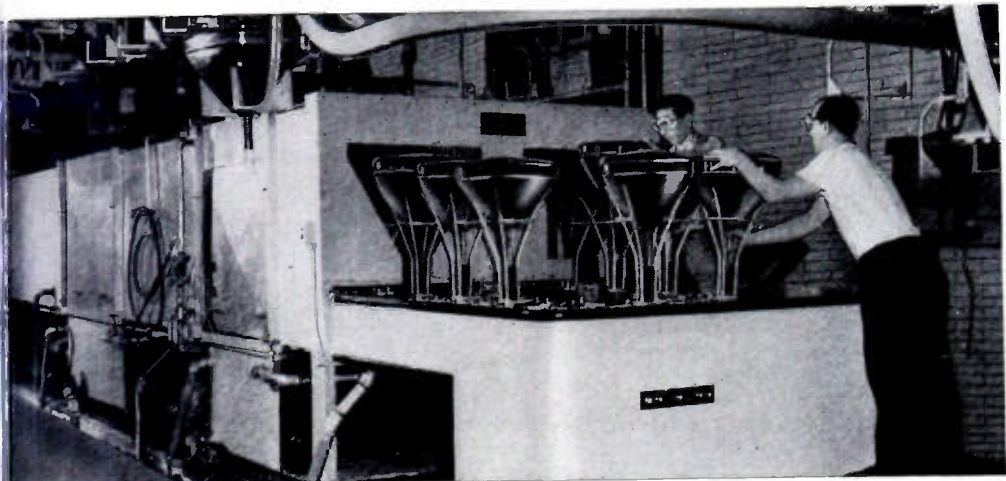
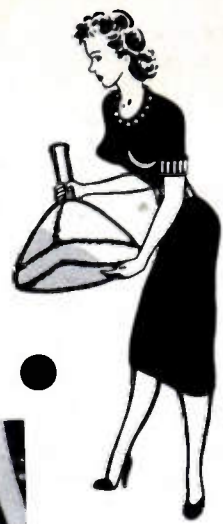

at
Sheldon

The new Sheldon giant washing machine that uses over 1,000 gallons of water every hour of the day. Sheldon's Irvington, N. J. plant uses 360,000 gallons of water per day much of which comes from wells within the plant.

The sensational, extra-fast washing and trouble-free efficiency of our newest type glass-blank washing machine allows us to take care of the tremendous demand for Sheldon Television Picture Tubes . . . and to maintain the perfect screen quality of these tubes.

This specially designed automatic washing machine actually washes our glass-blanks in three cycles: First, the inside face of the glass-blank gets an acid wash; then it is rinsed with water. Next, the inside face is given a caustic wash, and then rinsed again with water. As the final step, the inside face is rinsed for several minutes with a high pressure stream of "thirsty water" — water from which all minerals and foreign substances have been removed by our special equipment and techniques.

When the glass blank leaves our washing machine, the inside surface of the glass-blank is bacteriologically clean and medically pure . . . so pure, in fact, that it is "thirsty" or "hungry" to reabsorb foreign substances . . . PRIMED to receive the phosphor coating. The phosphor coating is applied over this "thirsty" surface to consistently produce the uniformly perfect blemish-free, "TELEGENIC" screen for which Sheldon Picture Tubes are famous.

WRITE today for the latest "Sheldon 'TELEGENIC' Picture Tubes—General Characteristics & Dimensions Wall Chart" containing the new Sheldon VITATRON Glass-Metal 19AP4B and 19AP4D, and the New Rectangular 20CP4!

TELEVISION MIS-INFORMATION NO. 4 is off the press! Write for your copy today!



SHELDON ELECTRIC CO.

A Division of ALLIED ELECTRIC PRODUCTS INC.
68-98 Coit Street, Irvington 11, N. J.

Branch Offices & Warehouses: CHICAGO 7, ILL., 426 S. Clinton St. • LOS ANGELES 26, CAL., 1755 Glendale Blvd.
SHELDON TELEVISION PICTURE TUBES • CATHODE RAY TUBES • FLUORESCENT STARTERS AND LAMP HOLDERS • SHELDON REFLECTOR & INFRA-RED LAMPS
PHOTOFLOOD & PHOTOSPOT LAMPS • SPRING-ACTION PLUGS • TAPMASTER EXTENSION CORD SETS & CUBE TAPS • RECTIFIER BULBS

➡ VISIT SHELDON BOOTHS NO. 390-1-2 AT THE RADIO ENGINEERING SHOW, MARCH 19-22, GRAND CENTRAL PALACE, N. Y. ◀

© 1951—ALLIED ELECTRIC PRODUCTS INC.

you get MORE PERFORMANCE for LESS MONEY with the NEW Browning OSCILLOSYNCHROSCOPE



For only
\$485.00

this new five-inch Browning 'scope gives you the basic laboratory equipment for pulse work — in a single, compact unit with:

- Triggered sweep rate continuously variable from 1.0 to 25,000 microseconds per inch.
- Sawtooth sweep rate 10 cycles to 100 KC.
- Sweep calibration (triggered and sawtooth) in microseconds per screen division accurate to $\pm 10\%$.
- Vertical amplifier flat within 3 db. from 5 cycles to 5 megacycles.
- Sensitivity 0.075 volts RMS per inch.
- Horizontal amplifier d.c. to 500 KC, sensitivity 2 volts per inch.
- Self-calibrating on both X and Y axis.
- Readily portable . . . weighs but 50 pounds.

plus these ELECTRICAL and MECHANICAL features

- 5UP1 cathode-ray tube operates at accelerating potential of 2600 volts
- Sweep starting time is approximately 0.1 microsecond
- Sweep may be triggered or synchronized by positive or negative sine-wave or pulse signals of 0.5 volts (external) or 0.75 inches deflection (from vertical amplifier)
- Three-step attenuator — 100:1, 10:1, and 1:1, plus continuous adjustability over entire range
- Peak-to-peak vertical calibration voltages of 0.2-20-200 at accuracy of $\pm 10\%$
- Cathode connection, brought out to front panel, allows external blanking and marker connection
- All deflection plates are available for direct connection
- Steel cabinet finished in black wrinkle
- Steel panel finished in black leatherette
- Copper-plated steel chassis with lacquer finish
- Controls grouped by function for operating convenience
- Free-view screen has graduated X- and Y-axis scales
- Size: 10" wide, 14 $\frac{1}{2}$ " high, 16 $\frac{3}{4}$ " deep
- Instrument draws 180 volt-amperes at 115 volts 60 cycles.

NET PRICE, F.O.B. Winchester, Mass. \$485.00

FREE BULLETIN gives further data on this new, low-cost, versatile oscillosynchroscope. Ask for data sheet ON-54

In Canada, address Measurement Engineering Ltd., Arnprior, Ontario

Export Sales
9 Rockefeller Plaza
Room 1422
New York 20



Student Branch Meeting

(Continued from page 46A)

SOUTHERN METHODIST UNIVERSITY,
IRE-AIEE BRANCH

Film: "Mobile Telephones"; November 1, 1950.

"Sanganio Thermocouple Instruments," by Wendell Fowler; November 27, 1950.

SYRACUSE UNIVERSITY, IRE-AIEE BRANCH

"Propagation of 100-Kc Radio Waves," S. E. Clements, Faculty, Syracuse University, December 13, 1950.

UNIVERSITY OF TEXAS, IRE-AIEE BRANCH

"Registration of Professional Engineers," C. L. Svenson, Texas Board of Registration for Professional Engineers; November 20, 1950

Film: "Refining Copper and Manufacture of Cables," by Anaconda Wire and Cable Company, December 4, 1950.

"Radio Astronomy," by C. R. Burrows, Faculty, Cornell University; December 14, 1950.

TULANE UNIVERSITY, IRE-AIEE BRANCH

Business Meeting; November 30, 1950.

UNIVERSITY OF VIRGINIA, IRE BRANCH

"Employment Possibilities with General Electric," by Alvil Clay, General Electric Company; November 14, 1950.

"Television Station Planning and Proof of Performance," by W. L. Braun; November 28, 1950.

Tour through Telephone Exchange; December 5, 1950.

UNIVERSITY OF WASHINGTON, IRE-AIEE BRANCH

"Branch Activities, Membership, and How to Join AIEE and IRE as a Student Member," by E. A. Loew, Faculty, University of Washington, October 5, 1950.

"Constitutional Amendment," by G. W. Arnold; October 19, 1950.

"After College, What?" by Bob Lemman, Allis-Chalmers Company, and Migue Talcott, Radio Station KING-TV; November 1, 1950

"Engineering Economics," by W. S. Gordon, November 28, 1950.



The following transfers and admissions were approved and will be effective as of February 1, 1951:

Transfer to Senior Member

Bamford, H. S., 300 Oak Rd., Glenside, Pa.
Bueffel, B. H., Jr., Bucknell University, Lewisburg, Pa.

Burgett, M. I., Jr., 7143 Lincoln Dr., Philadelphia 19, Pa.

Colodny, S. H., 2908 Princeton Ave., Philadelphia, Pa.

Fontana, R. E., 214 N. Monroe, Albuquerque, N. Mex.

Garman, R. L., General Precision Laboratory, 63 Bedford St., Pleasantville, N. Y.

Grimm, A. C., RCA, Lancaster, Pa.

Janes, R. B., RCA, Lancaster, Pa.

Lloyd, C. G., 830 Lansdowne Ave., Toronto, Ont., Canada

Masters, E. W., 2743 Farwell Ave., Chicago 45, Ill.

Moore, R. C., 201 Glendalough Rd., Philadelphia 18, Pa.

Myers, J. F., 204 Clark St., Kenmore 17, N. Y.

Nekut, A. G., RCA Victor Division, Lancaster, Pa.

Nims, A. A., Jr., 206 Huron Rd., Baltimore 28, Md.

O'Brien, B. C., c/o WHEC, 40 Franklin St., Rochester 4, N. Y.

(Continued on page 64A)

FERRAMIC

cores

by
GENERAL CERAMICS

Ferramics are soft magnetic materials featuring:

- HIGH PERMEABILITY**
- HIGH VOLUME RESISTIVITY**
- HIGH EFFICIENCY**
- LIGHT WEIGHT**
- ELIMINATE LAMINATIONS**



TYPE OF FERRAMIC MATERIAL

PROPERTY	UNIT	A 34	B 90	C 159	D 216	E 174	G 254	H 419	I 141	J 472
Initial permeability at 1mc/sec	—	15	95	220	410	750	410	850	600	330
Maximum permeability	—	97	183	710	1030	1710	3300	4300	1010	750
Saturation flux density	Gauss	840	1900	3800	3100	3800	3200	3400	1540	2900
Residual magnetism	Gauss	615	830	2700	1320	1950	1050	1470	660	1600
Coercive force	Oersted	3.7	3.0	2.1	1.0	0.65	0.25	0.18	0.40	.80
Temperature coefficient of initial permeability	%/°C.	0.65	0.04	0.4	0.3	0.25	1.3	0.66	0.3	0.22
Curie point	°C.	280	260	330	165	160	160	150	70	180
Volume resistivity	Ohm-cm	1x10 ⁹	2x10 ⁵	2x10 ³	3x10 ⁷	4x10 ⁵	1.5x10 ⁸	1x10 ⁴	2x10 ⁵	—
Loss Factor:										
at 1 mc/sec	—	—	.00016	.00007	.00005	.00008	.00008	.00030	.0003	.00055
at 5 mc/sec	—	.0004	.0011	.0008	.0012	.002	.00075	.00155	.005	—
at 10 mc/sec	—	.0005	—	—	—	—	.0017	.00275	—	—

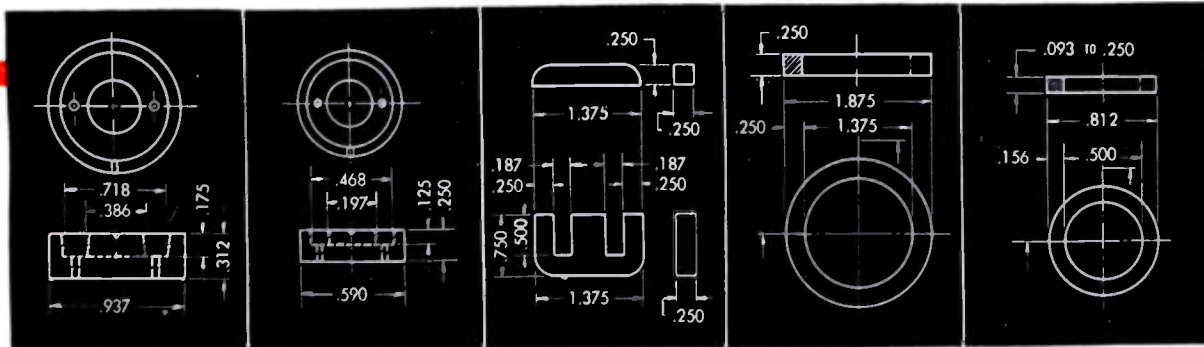

General CERAMICS AND STEATITE CORP.
GENERAL OFFICES and PLANT, KEASBEY, NEW JERSEY

MAKERS OF STEATITE, TITANATES, ZIRCON PORCELAIN, FERRAMICS, LIGHT DUTY REFRACTORIES, CHEMICAL STONEWARE, IMPERVIOUS GRAPHITE

**POSITIONS OPEN IN RE-
SEARCH AND ADVANCED
DEVELOPMENT
PROGRAMS**

TO

**Research Physicists
Senior Electronic
Engineers
Senior Mechanical
Engineers
Engineering Physicists
Circuit Engineers
Microwave Engineers
Vacuum Tube Research
Engineers
Technical Report
Writers
Electronic Technicians**

**Experienced or Holding
Advanced Degrees
For Research, Design, or
Development In**

**Radar, Servomechanisms,
Computers, Receivers, Photo
Emission, Secondary Emis-
sion, Converters, Pulse and
Timing Techniques, Special
Test Equipment, Special Pur-
pose Tubes, Circuit Design,
Solid State Physics, Light and
Electron Optics, etc.**

**We invite interested person-
nel with experience in the
above fields to submit a com-
plete and detailed resume of
education and experience,
together with salary require-
ments and availability date,
to:**

**The Employment Department
CAPEHART-FARNSWORTH
CORPORATION
Fort Wayne 1, Indiana**



The following positions of interest to I.R.E. members have been reported as open. Apply in writing, addressing reply to company mentioned or to Box No. ... The Institute reserves the right to refuse any announcement without giving a reason for the refusal.

**PROCEEDINGS of the I.R.E.
1 East 79th St., New York 21, N.Y.**

ELECTRONIC ENGINEER

Small California transmitting tube company requires engineer for medium frequency tube work, also for development and manufacture of klystrons and pulse tubes. Give full details giving age, experience, availability and salary expected. Box 632.

ENGINEERS AND PHYSICISTS

Project and senior engineers desired for work on several theoretical and experimental programs of diversified nature involving military applications of electronics. Applicants should have 3 or more years of experience in research and development in some branch of electronics and preferably advanced graduate training. Command of physical fundamentals and analytical ability important. Small, expanding company located in college town. Opportunities of graduate study. Reply Personnel Manager, Haller, Raymond and Brown, Inc., State College, Pa., stating education, experience, salary expected.

(Continued on page 52A)

**electronic
engineers
(3 seniors)
wanted by**

Freed-Eisemann

The manufacturer of world-famous Freed-Eisemann Radio-Phonographs and Television Consoles requires 3 engineers to act as group leaders on design and production of communication equipment on important government contracts. Must have a minimum of 7 years experience in this field.

Write, giving complete outline of education, experience and salary required to Freed Radio Corp., 200 Hudson Street, New York 13, N.Y.

**ELECTRONICS
ENGINEERS FOR
SOUTHWEST
ATOMIC ENERGY
INSTALLATION**

**2 to 10 years experience in re-
search, design, development,
or test**

**A variety of positions open for
men with Bachelor's or ad-
vanced degrees qualified in
one or more of the following
fields:**

- UHF TECHNIQUES
- PULSE CIRCUITS
- SERVO-MECHANISMS
- TELEMETERING
- RELAYS
- LOW POWER APPLICATION
- INSTRUMENTATION
- STATISTICAL ANALYSIS
- TEST EQUIPMENT RELATING
TO ABOVE FIELDS

**Patent History Desirable But
Not Necessary**

**These openings are for per-
manent positions at the
Sandia Laboratory in Albu-
querque, New Mexico. Al-
buquerque is the largest city
in New Mexico, a mile above
sea level, with a sunny, warm,
dry climate, and a population
of 100,000. Located in the Rio
Grande Valley at the foot of
the Sandia Mountains, which
rise to 11,000 ft., Sandia
Laboratory is operated by
Sandia Corporation, a sub-
sidiary of the Western Electric
Company, under contract with
the Atomic Energy Commis-
sion. This laboratory offers
pleasant working conditions
and liberal employee benefit
plans.**

MAKE APPLICATION TO:

**PROFESSIONAL
EMPLOYMENT DIVISION
SANDIA CORPORATION
SANDIA BASE
ALBUQUERQUE,
NEW MEXICO**

OPPORTUNITY FOR ELECTRONIC ENGINEERS

A leading new (1946) company in the field of high quality electronic equipment has openings for outstanding

PRODUCTION DESIGN ENGINEERS

Engineers of outstanding ability and five to ten years experience in the development and design for production of electronic equipment are desired.

RESEARCH MEN

are needed for enlargement of an important research and development program on government and industrial projects. Applied physicists, electronic engineers, and applied mathematicians are sought. Considerable advanced development experience and advanced degrees are desirable.

WORKING CONDITIONS ARE ATTRACTIVE

Interesting projects are underway in the fields of radar, air traffic control, blind landing, computers, servos, and general electronics. New projects will be established to suit the qualifications of the staff.

Liberal vacation and sick leave policies are furnished, together with excellent hospitalization and insurance plans.

Access to the Graduate Schools of Massachusetts Institute of Technology, Harvard University, and Boston University is provided.

HOUSING IS ADEQUATE IN BOSTON AREA

Houses for purchase or rental and apartments are readily available in the Boston area. Assistance will be provided new employees in locating living quarters. Moving expenses will be paid.

New York interviews March 19-22. Call Mr. A. D. Cole
Waldorf Astoria Hotel, El 5-3000

OR WRITE PERSONNEL MANAGER

LABORATORY FOR ELECTRONICS, INC.

11 LEON STREET
BOSTON 15, MASS.

Physicists • Mathematicians • Engineers

Applied Physics Laboratory
The Johns Hopkins University

has openings for

SENIOR STAFF MEMBERS

Physicists
Theoretical and Experimental

Mathematicians
Applied—Dynamics
Analysis

Electrical Engineers
Micro-waves, UHF Pulse
Circuits, Telemetering,
Radar

Excellent opportunities in modern research laboratory.
Interviews will be arranged for qualified candidates.
All replies confidential.

Aerodynamacists
Dynamics, General Supersonic Performance

Mechanical Engineers
Servo-mechanisms,
Engineering Design

Project Engineers
Engineering Test Program
Coordination

Computing Machine Operators
Maddida, Reac, Simulators

For further information write to—

E. M. LANE

Applied Physics Laboratory

The Johns Hopkins University

8621 Georgia Avenue, Silver Spring, Maryland

SCIENTISTS AND ENGINEERS

for

challenging research and advanced development in fields of

RADAR
GYROSCOPES
SERVOMECHANISMS
MECHANICAL SYSTEMS
ELECTRONICS CIRCUITS
APPLIED PHYSICS AND MATH
PRECISION MECHANICAL DEVICES
ELECTRICAL SYSTEM DESIGN
GENERAL ELECTRONICS
INSTRUMENTATION
MICROWAVES
COMPUTERS
AUTOPILOTS

Scientific or engineering degree and extensive technical experience required.

WRITE:

Manager, ENGINEERING PERSONNEL

BELL AIRCRAFT CORPORATION

P.O. Box 1, Buffalo 5, N.Y.

VIBRATION ENGINEER

Product development laboratories Kew Gardens, L. I. needs experienced engineer to do shock & vibration work relating to microphonism & strength of vacuum tubes. Must be able to work and design electro-mechanical devices. EE or ME degree plus minimum 2 years experience in electronics preferably with specific vibration experience. Please address replies to personnel manager:

Sylvania Electric
Products, Inc.
40-22 Lawrence St.
Flushing, N.Y.

POSITIONS OPEN

(Continued from page 50A)

ENGINEERS

National Broadcasting Company needs experienced engineers with commercial television operating experience or standard broadcasting control room experience. Apply Room 505, 30 Rockefeller Plaza, New York, N.Y.

ELECTRON TUBE ENGINEERS

For development and production. Experience miniature or sub-miniature tube desirable. Apply by letter only to Personnel Dept., Sonotone Corp., Elmsford, New York.

RADIO AND TELEVISION ENGINEERS

Experienced in design of high frequency circuits such as FM tuners, TV booster and TV antennae. Salary commensurate with ability. Write giving full details—Mr. Stone, Talk-A-Phone Company, 151 South Pulaski Road, Chicago 23, Ill. Lawndale 1-8414.

ENGINEERS

Physicists, chemists or EE's with Ph.D. or equivalent and experience in the field of solid state physics for research work on semi-conductor devices employing germanium and silicon. An excellent opportunity in a research laboratory of a leading manufacturer with laboratories in New York State. Send complete resume. Our employees have been notified. Box 633.

DEVELOPMENT TECHNICIANS

At least 3 years experience in layout (including rough drafting) of electronic chassis. Should also be experienced in electronics testing and trouble shooting. Write: Personnel Director, Box 30, State College, Pa.

SENIOR ELECTRONICS ENGINEER

For design and development of circuitry for ultra-sonic equipment timing circuits, audio oscillators, amplifiers, and audio measuring equipment to meet Navy specifications. Experience required: 3-5 years in development of audio or supersonic equipment for government or industrial usage. Must have B.S. in physics or electrical engineering. Write: Personnel Director, Box 30, State College, Pa.

ELECTRICAL ENGINEER

Graduate electrical engineer with a minimum of 2 years' experience, for design and development of audio transformers and filters. Permanent position with progressive firm located in Chicago. Give details stating age, education, experience, references, availability for work and salary expected. Box 634.

ELECTRONIC SCIENTIST

For research in upper atmosphere rocket program. Must have an appropriate degree, and at least 3 years' experience, with emphasis on electronics as applied to upper atmosphere research or an allied field. Please address replies, containing a brief resume of experience to Employment Officer, Naval Research Laboratory, Washington 25, D.C.

(Continued on page 54A)

Presenting
 another great new G-E
 triode for FM and
TELEVISION



GL-6039



RATINGS

Filament voltage	5 v
Filament current	78 amp
Grid-plate transconductance	11,000 micromhos
Interelectrode capacitances:	
Grid-filament	24 micromicrofarads
Grid-plate	15.7 micromicrofarads
Plate-filament	0.47 micromicrofarads
Type of cooling	water and forced air

Plate ratings per tube, Class B r-f power amplifier (video service, synchronizing peak conditions):

Max voltage	6,000 v
Max current	2.25 amp
Max input	13.5 kw
Max dissipation	7 kw

*Power output, typical operation (at 5,000 v and 2.2 amp, band width 5 mc) 5.4 kw

Plate ratings per tube, Class C r-f power amplifier (key-down conditions without amplitude modulation):

Max voltage	7,500 v
Max current	2.25 amp
Max input	16 kw
Max dissipation	7 kw

*Power output, typical operation (at 7,000 v and 2.08 amp) 12.8 kw

*Includes power transferred from driver to output of grounded-grid amplifier.

● Has an output over one-third higher than the famed GL-9C24, its predecessor.

● Requires 1,100 w less filament power, or a 75-percent reduction.

Plenty of output... Two GL-6039's will put out 25 kw in FM—10 kw in television. Here's sufficient final power for medium-size transmitters... or output to spare for the intermediate stage of large commercial installations.

Low operating cost... The modest 5-v, 78-amp requirement of the GL-6039's filament, slashes by three-quarters the watts needed for Type GL-9C24, itself a pioneering FM-TV triode with fine performance. Thoriated-tungsten construction, among other filament features, cuts your power bills materially.

Real v-h-f operation... 220 mc at max plate input gives you full FM-TV band coverage.

Easy to install... The GL-6039 needs no neutralizing, when employed in a properly designed

grounded-grid amplifier circuit. Features which help make the tube so efficient, are its low lead inductance, the fact that all outer metal parts are silver-plated to cut r-f losses, and the large terminal-contact areas made possible by G-E ring-seal design.

Sturdy, dependable... Newest of a family of modern G-E power tubes for FM-TV that has proved its worth in hard station service, Type GL-6039 is engineered to stand up! The tube is trim, with real built-in structural strength—mounts solidly and closely in today's compact transmitters. You can rely on its full-time, full-life performance. Ask for a visit by a G-E tube engineer, to prove that the GL-6039 will give your new circuit peak power, improved economy! *Electronics Department, General Electric Company, Schenectady 5, New York.*

GENERAL  **ELECTRIC**

100-K2

The W. L. MAXSON
CORPORATION
IS
SEEKING
Outstanding
ENGINEERS
AND
PHYSICISTS
with
AMBITION
TO
FURTHER
PRESENT
STANDING
Immediately

Minimum Requirements are:

1. Five to ten years experience in advanced electronic research and development
2. Outstanding record of ingenuity
3. Ph.D., M.S. or equivalent

Please send résumé and salary requirements to:

The W. L. MAXSON
CORPORATION
460 W. 34th St.
New York 1, N.Y.



(Continued from page 52A)

RADIO & RADAR ENGINEERS

Radio and radar engineers for aircraft installation and application design work. Should have 5 or more years' experience with aircraft radio or radar systems and preferably have aircraft installation or antenna design, selection and application experience. Experienced aircraft electrical engineers are also needed. Contact Engineering Personnel Section, Chance Vought Aircraft, P.O. Box 5907, Dallas, Texas.

ELECTRONIC ENGINEER

Electronic engineer to head engineering department. Must have had experience in development and design of quartz crystals for frequency control and thorough knowledge of manufacturing processes. Box 636.

ENGINEERS

Florida East Coast opportunity for permanent positions in Electronic Instrumentation Research and Development. Telemetering, Pulse Circuits and Computer experience desirable. Junior, Senior and Project Engineers may send résumé of education, experience, references, availability and salary expected to Radiation, Inc. Melbourne, Florida.

ELECTRONICS ENGINEER-WRITER

A long-established concern of high repute in the military instruction book field requires a technical writer of project
(Continued on page 56A)

Graduate
ENGINEERS

Good Opportunities
for
ELECTRONICS

Engineers or Physicists

M.S. or Ph.D. in Physics, Physical Chemistry, E.E., M.E., or Ch.E. for industrial electronics research. Must be outstanding technically with at least a few years research experience, and interested in the development of instruments and physical techniques.

Give experience, education, age, references, personal history, salary received and salary expected. Please be complete and specific.

All inquiries will be considered promptly and kept confidential.

E. I. du Pont de Nemours & Co. (Inc.)
Engineering Department Personnel
Wilmington 98, Delaware

CIRCUITS AND MICROWAVE ENGINEERS

Permanent Positions for Men with Several Years of Experience

A rapidly expanding organization with long range programs for commercial and government developments offers excellent opportunities in the field of general instrumentation including VHF, UHF, and microwave test equipment.

Our modern, well equipped laboratories are conveniently located in downtown Brooklyn and offer a stimulating and pleasant working atmosphere. Men with Master's or Ph.D. degrees are preferred.



RESEARCH and DEVELOPMENT CO. Inc.
202 TILLARY STREET, BROOKLYN 1 N. Y.

RESEARCH OPPORTUNITIES IN THE LOS ANGELES AREA

Unusual Opportunity for Senior men with degrees and at least five years of outstanding proven accomplishment to achieve further growth by working with some of the nation's outstanding scientists on commercial and military projects in large modern electronics laboratories.

ELECTRONIC ENGINEERS	SERVOMECHANISMS ENGINEERS
PHYSICISTS—CIRCUITRY	ELECTRO MECHANICAL ENGINEERS
PHYSICISTS—ANALYSIS	MECHANICAL DESIGNERS
PHYSICISTS—OPTICS	
PHYSICISTS—ELECTRON TUBES	

Long term program of research and development in the fields of Radar, Guided Missiles, Computers, Electron Tubes, and related equipment.

Please do not answer unless you meet the above requirements.

RESEARCH AND DEVELOPMENT LABORATORIES
Hughes Aircraft Company CULVER CITY, CALIFORNIA

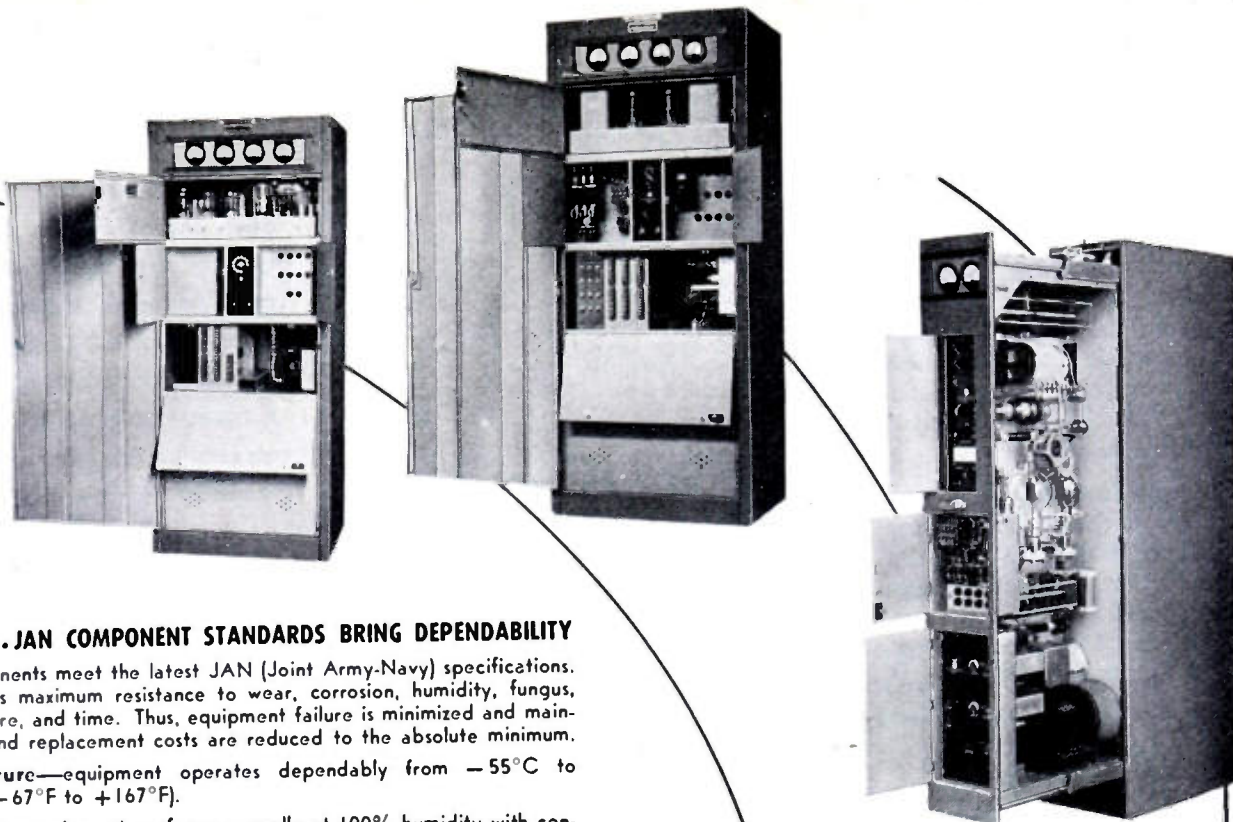

NEW... JAN COMPONENT STANDARDS BRING DEPENDABILITY

All components meet the latest JAN (Joint Army-Navy) specifications. This means maximum resistance to wear, corrosion, humidity, fungus, temperature, and time. Thus, equipment failure is minimized and maintenance and replacement costs are reduced to the absolute minimum.

Temperature—equipment operates dependably from -55°C to $+75^{\circ}\text{C}$ (-67°F to $+167^{\circ}\text{F}$).

Humidity—equipment performs normally at 100% humidity with condensation.

Altitude—equipment operates at full power at altitudes up to 10,000 feet (3,048 meters), and withstands shipping altitudes up to 30,000 feet (9,144 meters).

NEW... UNIT CONSTRUCTION PROVIDES OPERATING FLEXIBILITY

A flexible, multifrequency station can be formed from a combination of 96D and 96-200C Transmitters, one or two 50H Modulators and a 16D Rectifier. This provides for either simultaneous transmission on several frequencies or the selection of an individual frequency best suited to your particular communication problem.

NEW... FRONT CONTROLS PROVIDE ADJUSTMENT CONVENIENCE

All controls are located on the front of the transmitter: all R. F. stages and antenna tuning, under and overload and tone-keying adjustments, selection switch for external frequency shift excitation, rotary meter switch, exciter output control.

NEW... DRAWER-TYPE CONSTRUCTION Means Easy Maintenance

Ball bearing, drawer-type construction permits the transmitter to be quickly withdrawn from cabinet. All components are instantly accessible... no components are hidden or buried.

WILCOX ANNOUNCES A
COMPLETELY NEW
96 Series
Transmitting Station
2-18 mc/s 2500 Watts

Write Today

for complete information and specifications.

WILCOX
ELECTRIC COMPANY
 KANSAS CITY 1, MISSOURI • U. S. A.

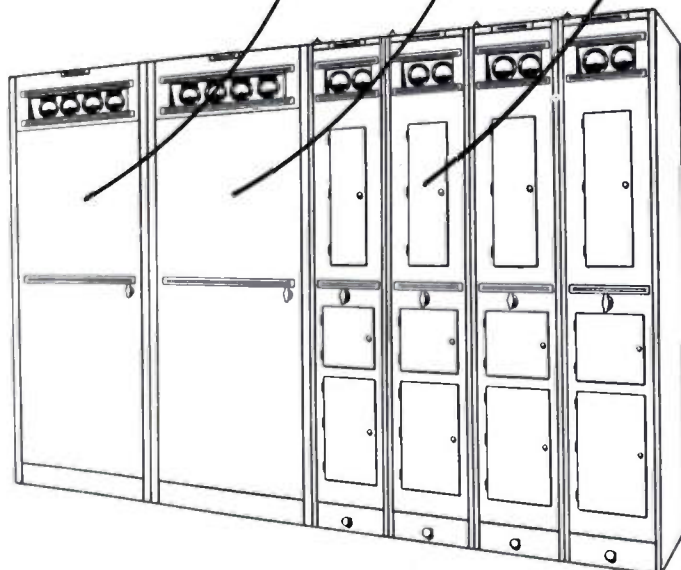

Electronic Engineers

BENDIX RADIO DIVISION
Bendix Aviation Corporation

PRODUCTION DESIGN RESEARCH

Openings for experienced engineers or recent graduates who are seeking a permanent position in a modern, well-equipped electronics organization working with a specialized and highly technical professional group.

Positions available for work on: Search and Airport Surveillance Radar; G.C.A.; Communication and Navigation Equipment; Broadcast and Television; Mobile Equipment; Test Equipment.

Housing and rentals in area are plentiful

Send resume to:

MR. W. L. WEBB, *Director*
Engineering and Research

BENDIX RADIO DIVISION

Baltimore 4, Maryland



(Continued from page 54A)

director calibre for permanent employment. A solid electronics background is essential, as is direct experience in the planning and writing of instruction books to Navy, Air Force, and Signal Corps specifications. Security clearance will be required after employment. Concern is located in downtown New York City. Send detailed resume to Box No. 638.

ELECTRONIC ENGINEERS

Senior engineers or Physicists, degree and experience in Radar, Pulse Circuits, Digital or Analogue Computers, or Servomechanisms. Electronic Engineering Company 180 S. Alvarado Street, Los Angeles 4, California.

CIRCUITS AND MICROWAVE ENGINEERS

Rapidly expanding company in the instrumentation field has openings for Senior engineers with several years of experience. Men with Masters or PhD Degrees preferred. Excellent opportunities in field of VHF, UHF and microwave test equipment. Location Brooklyn. Send complete resume to Box 639 I.R.E.

ELECTRONIC ENGINEERS

Naval Ordnance Laboratory, outside Washington, D.C., offers unusual opportunities to men with college degrees, in the fields of communications and instrumentation. Starting salaries may run as

(Continued on page 58A)

Position available in the midwest for a competent electronics circuit engineer. Duties consist of directing the operation of an electronics instrument group in an A.E.C. laboratory. The candidate should have broad experience in electronic circuitry, particularly that used in connection with nuclear physics measurements. Salary commensurate with qualifications.

Box 647

The Institute of Radio
Engineers, Inc.

1 East 79th Street, New York 21,
N.Y.

An invitation from Lockheed in California to

SENIOR ELECTRONIC SYSTEMS ENGINEERS

Lockheed invites you to participate in its long-range production program, developing the aircraft of the future.

Lockheed offers an attractive salary commensurate with your ability and background, a future in aeronautical science. In addition, Lockheed provides generous travel allowances for those who qualify.

If you have:

1. An M. S. or Ph. D. in Electrical Engineering or Physics—
2. A minimum of three years' experience in advanced electronic systems development, including radar microwave techniques, servomechanisms, computers and fire control—
3. Familiarity with airborne electronics equipment requirements—

Write today—giving full details as to education, experience and salary requirements. Address:

Karl R. Kunze, *Employment Manager*
LOCKHEED Aircraft Corporation
Burbank, California

NATIONAL UNION RESEARCH DIVISION

Senior engineers and physicists are needed for research and development of Cathode Ray, Subminiature, Secondary Emission and highly specialized types of Vacuum Tubes.

Junior Electrical Engineers are desired for training as tube or circuit design engineers.

Men qualified by virtue of education or experience to handle problems in the field of tube or circuit design are invited to send their resumes to:

Divisional Personnel Manager
National Union Research Division,
350 Scotland Rd., Orange, N.J.

ENGINEERS ELECTRONICS RESEARCH AND DEVELOPMENT

In Baltimore, Maryland

Career Positions
for

Top Engineers and Analysts
in

Radar Pulse, Timing and Indicator Circuit Design
Digital and Analogue Computer Design
Automatic Telephone Switchboard Design

Also

Electro-Mechanical Engineers

Experience in servo-mechanism, special weapons, fire control, and guided missile design.

Recent E.E. graduates and those with at least one year electronics research and development work will also be considered.

Salary commensurate with ability. Housing reasonable and plentiful. Submit resume outlining qualifications in detail. Information will be kept strictly confidential. Personal interviews will be arranged.

THE GLENN L. MARTIN COMPANY
Employment Department
Baltimore 3, Maryland

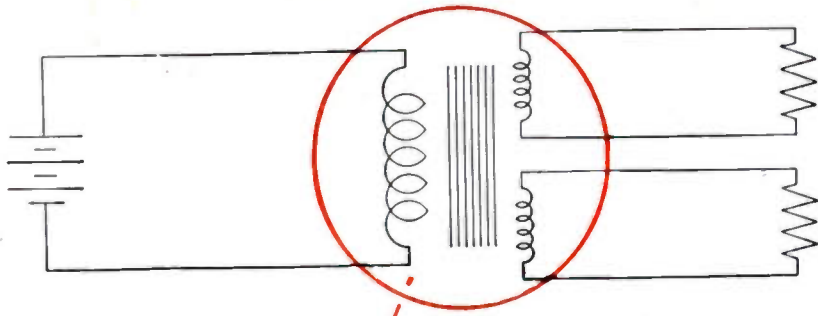

a DC transformer?

Certainly...

Bendix Specialized Dynamotors are made for the Job!



Whenever DC power is required at other than the supply voltage, Bendix* Specialized Dynamotors function as DC transformers. They can be wound for any input or output voltage between 5 and 1200 volts, and they can deliver power up to 500 watts. Multiple outputs can be supplied to correspond with several secondaries on transformers, and their output voltages can be regulated within close limits regardless of input voltage or load variations. Bendix Specialized Dynamotors are tailored to the exact requirements of each application by the design of the windings used in standardized frames. This reduces the cost, size and weight to an absolute minimum, consistent with the operational requirements. Compliance with Government specifications is assured by the choice and treatment of materials and the basic design. *A complete description of your requirements will enable our engineers to make concrete recommendations . . . All orders are filled promptly and at moderate cost.*

*REG. U. S. PAT. OFF.

**RED BANK DIVISION OF
BENDIX AVIATION CORPORATION**
RED BANK, NEW JERSEY

Export Sales: Bendix International Division, 72 Fifth Avenue, N. Y. 11, N. Y.

Write for this colorful and informative book
—it's free. You'll find it loaded with facts
and figures about all types of dynamotors.



OPPORTUNITIES FOR ENGINEERS SCIENTISTS

GENERAL ELECTRIC COMPANY, Electronics Dept., has excellent opportunities for experienced technical personnel in the following areas:

ADVANCED DEVELOPMENT
DESIGN—CIRCUIT, COMPONENT, AND PRODUCT
FIELD SERVICE
TECHNICAL WRITING

These positions available in the following fields:

TRANSMITTERS, RADAR, TUBE, RECEIVERS—TELEVISION AND COMMUNICATIONS

If you have a bachelors or advanced degree in Electrical or Mechanical Engineering, Physics, Metallurgy, or Physical Chemistry and experience in the electronics industry it will be worth your while to investigate these opportunities.

Send complete resume (Listing salary requirements and availability) to: TECHNICAL PERSONNEL, ELECTRONICS PARK, SYRACUSE, N.Y.

General Electric Co.



(Continued from page 56A)

high as \$6400. Men with specialized experience in the video or the instruments fields are urgently required. Attractive openings exist for men with inclinations in other directions. Address: Personnel Department, Attn: UT, Naval Ordnance Laboratory, White Oak, Silver Spring 19, Maryland.

ELECTRONIC ENGINEERS

At least three (3) years' post-college experience in development, DC amplifier, digital computers, pulse and servo design. Establish Company, New York City, Box 640.

ELECTRONICS ENGINEERS

Sales, design and application engineering. Positions open in Sales and Engineering Depts. of manufacturer of communications equipment. Salary commensurate with experience. Location Chicago. Box 642.

TELEVISION ENGINEER

For design and development of Television and Radio Receivers' by one of Chicago's oldest Television and Radio manufacturers. Applicant required to have college degree or equivalent. Experience necessary in design and measuring technique. Give age, experience, reference, etc. Salary open. Apply box 643.

(Continued on page 60A)

PROJECT ENGINEERS

**An Invitation
is Extended to**

**ELECTRONIC & RADIO
ENGINEERS**

**ATTENDING THE
I R E CONVENTION**

**TO VISIT OUR PLANT
AND INVESTIGATE THE
OPPORTUNITIES AVAILABLE
AT PRESENT IN OUR
ENGINEERING DIVISION**

APPLY OR PHONE FOR APPOINTMENT

EMPLOYMENT OFFICE

SPERRY

GYROSCOPE CO.

DIVISION OF THE SPERRY CORP.

GREAT NECK, L.I., N.Y.

PHYSICISTS AND ENGINEERS

You can find plenty of positions where you will work on minor improvements on radar, telemetering systems, and other conventional devices. However, you will find very few positions where you can break ground in new fields having tremendous significance. This you can do at the JACOBS INSTRUMENT COMPANY, whose entire effort is devoted to pioneering activities in new fields that it has opened up itself. One of these fields, for example, is that of ultra-high speed, ultra-compact digital computers and controllers. This company's JAINCOMP family of computers dominates this field. Other equally important fields are being developed. Engineers and physicists with sound backgrounds and experience in the design of advanced electronic circuits or precision mechanical instruments may qualify, also individuals with good backgrounds in applied physics. A few openings exist for outstanding junior E. E.'s and physicists, also experienced technicians; applicants for these positions must apply in person.

**JACOBS
INSTRUMENT CO.**

4718 Bethesda Ave.
Bethesda 14, Maryland

ENGINEERING OPPORTUNITIES IN Westinghouse

Wanted:

**Design Engineers
Field Engineers
Technical Writers**

Must have at least one year's experience.

For work on airborne radar, shipborne radar, radio communications equip., microwave relay, or micro-wave communications.

Good pay, excellent working conditions; advancement on individual merit; location Baltimore.

Send resume of experience and education to: Manager of Industrial Relations, Westinghouse Electric Corp., 2519 Wilkens Ave., Baltimore 3, Maryland.

RESEARCH OPPORTUNITIES

The University of Michigan is expanding its research organization and will have a number of excellent opportunities open in important research programs for ENGINEERS, PHYSICISTS AND MATHEMATICIANS. Work classifications are in the field of:

Electronics
Systems Analysis
Simulation and Automatic Computation
Propulsion and Combustion
Servo-mechanisms

Researchers have an opportunity to complete their requirements for graduate degrees while employed. Salaries are commensurate with training and experience. Applicants are invited to send a resume of education, background and experience to

Personnel Office
University of Michigan
Ann Arbor, Michigan

MYCALEX

low loss miniature **TUBE SOCKETS**

OFFER ALL THESE ADVANTAGES:

- CLOSER TOLERANCES
- LOWER DIELECTRIC LOSS
- HIGH ARC RESISTANCE
- HIGH DIELECTRIC STRENGTH
- GREAT DIMENSIONAL STABILITY
- IMMUNITY TO HUMIDITY
- HIGH SAFE OPERATING TEMPERATURE

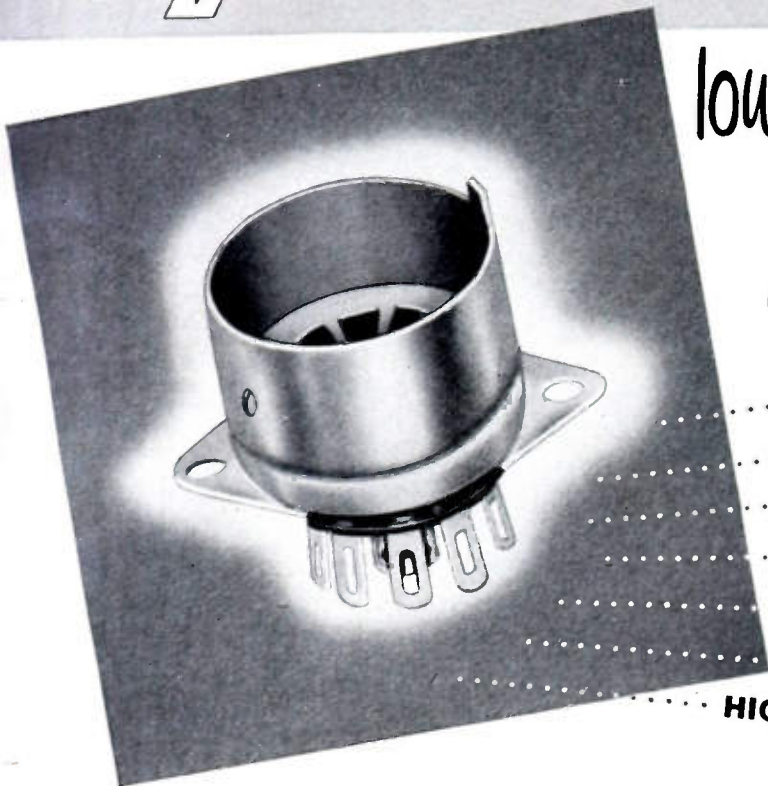

-cost no more than
PHENOLIC TYPES

These glass-bonded mica sockets are produced by an exclusive MYCALEX process that reduces their cost to the level of phenolic sockets. Electrical characteristics are far superior to phenolics while dimensional accuracy and uniformity exceed that of ceramic types.

MYCALEX miniature tube sockets, available in 7-pin and 9-pin types, are injection molded with great precision and fully meet RTMA standards. They are produced in two grades,

described as follows, to meet diversified requirements.

MYCALEX 410 conforms to Grade L-4 specifications, is priced comparable to mica-filled phenolics. Loss factor is only .015 at 1 mc., insulation resistance 10,000 megohms.

MYCALEX 410X is low in cost but insulating properties greatly exceed those of ordinary materials. Loss factor is only one-fourth that of phenolics (.083 at 1 mc.) but cost is the same. Insulations resistance 10,000 megohms.

MYCALEX TUBE SOCKET CORPORATION

Under Exclusive License of
MYCALEX CORPORATION OF AMERICA
30 ROCKEFELLER PLAZA, NEW YORK 20, N. Y.



CORPORATION OF AMERICA

"Owners of 'MYCALEX' Patents"

Executive Offices: 30 Rockefeller Plaza, New York 20 • Plant and General Offices: Clifton, New Jersey

The little **SHURE** cartridges
 that fill the Big need
 for High Fidelity
 Phonograph Reproduction..

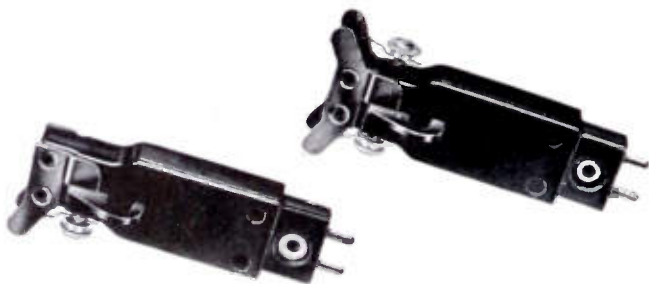

THE
 NEW SHURE "VERTICAL
 DRIVE"

CRYSTAL PICKUP CARTRIDGES

Big things often come in little packages... So it is with the superlative new Shure "Vertical Drive" Crystal Cartridges. They reproduce *all* the recorded music on the new fine-groove recordings—a reproduction that meets the strict requirements of high compliance and full fidelity. The "Vertical Drive" cartridges are requisite for the critical listener—the lover of fine music. They are especially recommended for those applications where *true fidelity* is essential.

SINGLE MODELS:
 W23A for standard width-groove records.
 W21A for fine-groove records.

TURNOVER MODELS:
 W22A and W22AB for both standard and fine-groove recordings.

Unusually highly compliant, these "Vertical Drive" Cartridges will faithfully track standard records with a force of only 6 grams—micro-groove records with a force of only 5 grams (an added protection for treasured recordings). Will fit standard or special mountings. Have more than adequate output for the average audio stage.



SHURE BROTHERS, INC.

Microphones and Acoustic Devices

225 WEST HURON STREET, CHICAGO 10, ILL.

CABLE ADDRESS: SHUREMICRO

Positions Open

(Continued from page 58A)

ELECTRONICS ENGINEERS

A large Cleveland manufacturer of Automotive and Aircraft Engine Parts is entering the Electronics Field. Development Engineers and Laboratory Technicians are needed to conduct development testing of qualification test samples, design and build test setups, writing reports etc. Work is original in the field of high frequency signal transmissions (frequencies up to 11,000 mega-cycles per second). Reply should give training, experience in detail, past employers, earnings and other pertinent facts. Thompson Products, Inc., 2196 Clarkwood Road, Cleveland 3, Ohio.

ENGINEERS

Four senior electronics research and development engineers with a minimum of five years' experience in pulse and general radar design. Assignments will include microwave test equipment projects and guided missile development. Degree essential. Excellent opportunity for advancement in rapidly expanding company. Modern plant of 250 workers located in Los Angeles area. Three experienced junior engineers also required. Send resume of education, experience, salary desired, to Box 644.

ELECTRICAL ENGINEER

B.S. or M.S. to work with group on circuits and miniaturization problems relating to electronic equipment and technique. Must be capable of job planning and project control. Minimum 5 years' (Continued on page 62A)

**PHYSICISTS
 AND
 SENIOR RESEARCH
 ENGINEERS**

**POSITIONS NOW
 OPEN**

Senior Engineers and Physicists having outstanding academic background and experience in the fields of:

- Microwave Techniques
- Moving Target Indication
- Servomechanisms
- Applied Physics
- Gyroscopic Equipment
- Optical Equipment
- Computers
- Pulse Techniques
- Radar
- Fire Control
- Circuit Analysis
- Autopilot Design
- Applied Mathematics
- Electronic Subminiaturization
- Instrument Design
- Automatic Production Equipment
- Test Equipment
- Electronic Design
- Flight Test Instrumentation

are offered excellent working conditions and opportunities for advancement in our Aerophysics Laboratory. Salaries are commensurate with ability, experience and background. Send information as to age, education, experience and work preference to:

NORTH AMERICAN AVIATION, INC.
 Aerophysics Laboratory
 Box No. N-4, 12214 South Lakewood Blvd.
 Downey, California

You Can Depend on

DAVEN

for

Accuracy
in Attenuators

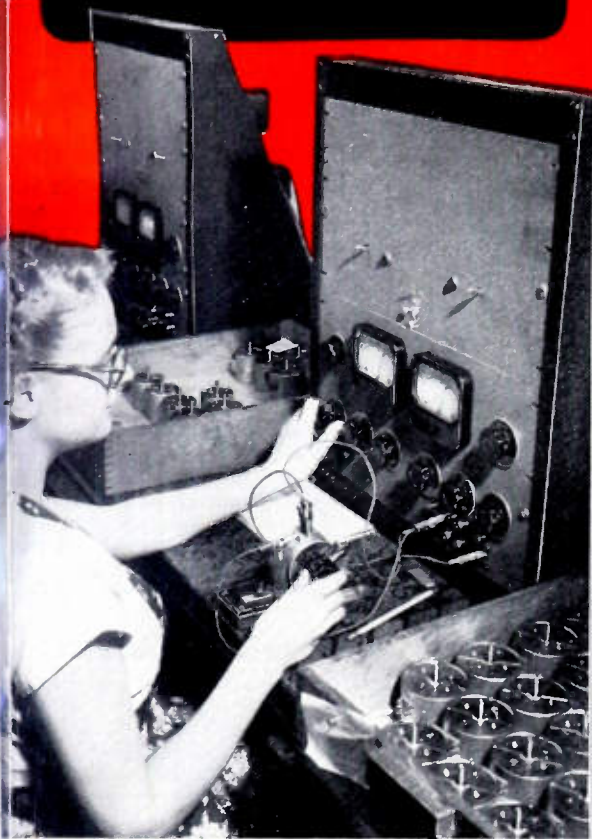

RF Attenuation Network



This equipment is an exclusive Daven development. It is a moderately priced attenuator incorporated in an RF Attenuation Box to insert accurate losses from D.C. to 225 MC. The unit has many applications where attenuation of UHF is desired, since it can be utilized as an all-purpose laboratory and test instrument.

SPECIFICATIONS:

ZERO INSERTION LOSS OVER ENTIRE FREQUENCY RANGE.
FREQUENCY RANGE: Zero to 225 MC.
IMPEDANCE ACCURACY: Within $\pm 5\%$ over frequency range.
ATTENUATION ACCURACY: $\pm 5\%$ over frequency range.
CONNECTORS: Receptacles are supplied. Cable plugs, if required, will be supplied at a slight additional cost. When ordering, specify which type connector is desired—either Series "BNC" (UG-185/U) or Series "N" (UG-58/U).
CIRCUIT: Constant input and output impedance (unbalanced). Zero initial loss.
RESISTOR ACCURACY: $\pm 2\%$ at D.C.

Carrier Frequency Decade Attenuator



This equipment is particularly applicable to extremely accurate measurements from D.C. to 200 kc. and can be used up to the lower radio frequencies. The Decade type switches make the box convenient to use. In addition, there are switch stops which prevent return from full to zero attenuation when making adjustments. A total of 110 Db. is available in 1.0 Db. steps, or 111 Db. is available in 0.1 Db. steps. Both of these types may be obtained in either a balanced H or an unbalanced T network.

SPECIFICATIONS:

ACCURACY: Each individual resistor is adjusted within $\pm 0.25\%$ of its correct value. The error in attenuation is less than $\pm 1\%$ of the indicated value, provided the output is matched by a pure resistance.
FREQUENCY ERROR: At frequencies below 200 kc., the total error in attenuation will not be greater than $\pm 1\%$ of the indicated value.

For many years Daven has been known for the quality of its attenuators. And, although production has grown to include a wide variety of instruments for the electronics industry, the development of its attenuators has kept pace. Much of the testing equipment used by Daven to guide them in the manufacture of attenuators has been developed by Daven's own engineering specialists. As a result, Daven attenuators have become the standard of the industry, by which all other similar equipment is measured. Shown and described here are two of the newest units that are typical of the latest Daven line of attenuators. Your inquiry for specific information to apply to your own particular problems is invited. Let Daven help you with completely detailed catalog

THE DAVEN CO.
195 CENTRAL AVENUE
NEWARK 4, N. J.

KINGS

Microwave Equipment

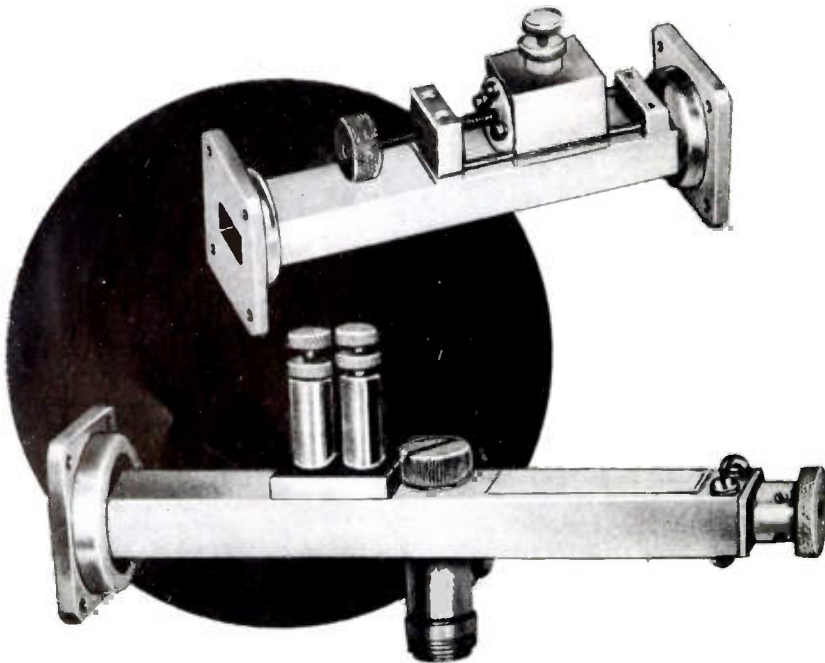

KINGS proudly introduces a new and complete line of microwave equipment. Many improvements in design and construction are your assurance of the finest in precision instrumentation. Our engineering department is ready to cooperate on your most exacting microwave and research problems. Inquiries are invited.

KINGS MICROWAVE CO., INC.

50 Marbledale Road, Tuckahoe 7, N. Y.
an affiliate of Kings Electronics Company, Inc.

Positions Open

(Continued from page 60A)

experience in both audio and TV circuits and tube component design or equipment production. Prefer engineering physicist or electrical engineer with some mechanical design experience and major interest in circuits. Position is with physics Laboratories, Sylvania Electric Products Inc., Bayside, Long Island. Please address replies to Personnel Manager, 40-22 Lawrence Street, Flushing, New York.

ELECTRONICS SALES ENGINEERS

Positions open for mature graduate sales engineers over 28 years of age, preferably with practical experience in application of dielectric heating to industrial problems. Excellent opportunities for type of individuals interested in affiliation with successful rapidly expanding organization. Locations in Chicago and other territories. Box 646.

PHYSICIST

To conduct research on gaseous discharges. Prefer man with PhD in Physics with courses in Atomic Physics, Spectroscopy and Chemistry, or M.S. with two years experience in nuclear research or gas discharges or thermionic emission. Position is with Long Island Laboratory of nationally known electronics company. Box 645.

ENGINEERS AND PHYSICISTS

Electrical engineers and physicists in University connected Research Institute outside continental United States. Mini-
(Continued on page 63A)

Positions available for

SENIOR ELECTRONIC ENGINEERS

with
Development & Design
Experience

in
MICROWAVE RECEIVERS
PULSE CIRCUITS
SONAR EQUIPMENTS
MICROWAVE
COMMUNICATIONS
SYSTEMS

Opportunity For Advancement
Limited only by Individual
Ability

Send complete Resume to:
Personnel Department

MELPAR, INC.
452 Swann Ave.
Alexandria, Virginia

Positions Open

(Continued from page 62A)

... B.S. degree. Security clearance necessary. Send Airmail resume of training and professional experience, photograph, references, salary desired to Box 9.

PHYSICISTS-ENGINEERS

Cornell Aeronautical Laboratory, an affiliate of Cornell University, has permanent positions open in fields of pure and applied physics for men of project engineer caliber with advanced degrees and experience in physics, applied mathematics, electronics, and mechanical instrument design. The position of our laboratory is between those of universities and commercial research institutes, and combines, we believe, many of the traditional advantages of both. Inquiries confidential; address Mr. Nathaniel Stimson, Capt. R, Cornell Aeronautical Lab., P.O. Box 235, Buffalo 21, New York.

TECHNICAL WRITERS

Electronics section of leading technical publisher offers permanent positions to experienced writers with engineering background; must be familiar with Government instruction book specs. Send resume and salary desired, P.O. Box 311, Yonkers, New York.



Positions Wanted By Armed Forces Veterans

In order to give a reasonably equal opportunity to all applicants, and to avoid overcrowding of the corresponding column, the following rules have been adopted:

The Institute publishes free of charge notices of positions wanted by I.R.E. members who are now in the Service or have received an honorable discharge. Such notices should not have more than one line. They may be inserted only after a lapse of one month or more following a previous insertion and the maximum number of insertions is three per year. The Institute necessarily reserves the right to decline any announcement without assignment of reason.

ELECTRONIC ENGINEER

B.E.E. 1942. Age 30, married, 1 child. One year's experience in research and development. Experience includes UHF, microwaves and servomechanisms. Interested in changing position. Box 495 W.

ENGINEER

Mature engineer, age 40, broad experience including industrial design, field engineer, foreign experience. B.S. in E.E. University of Illinois, UHF major. Now competing work for M.S. in E.E., physics emphasis in research. Domestic or foreign employment (supervision of overseas branch) will be considered. Box 496 W.

(Continued on page 64A)

KINGS COAXIAL CONNECTORS

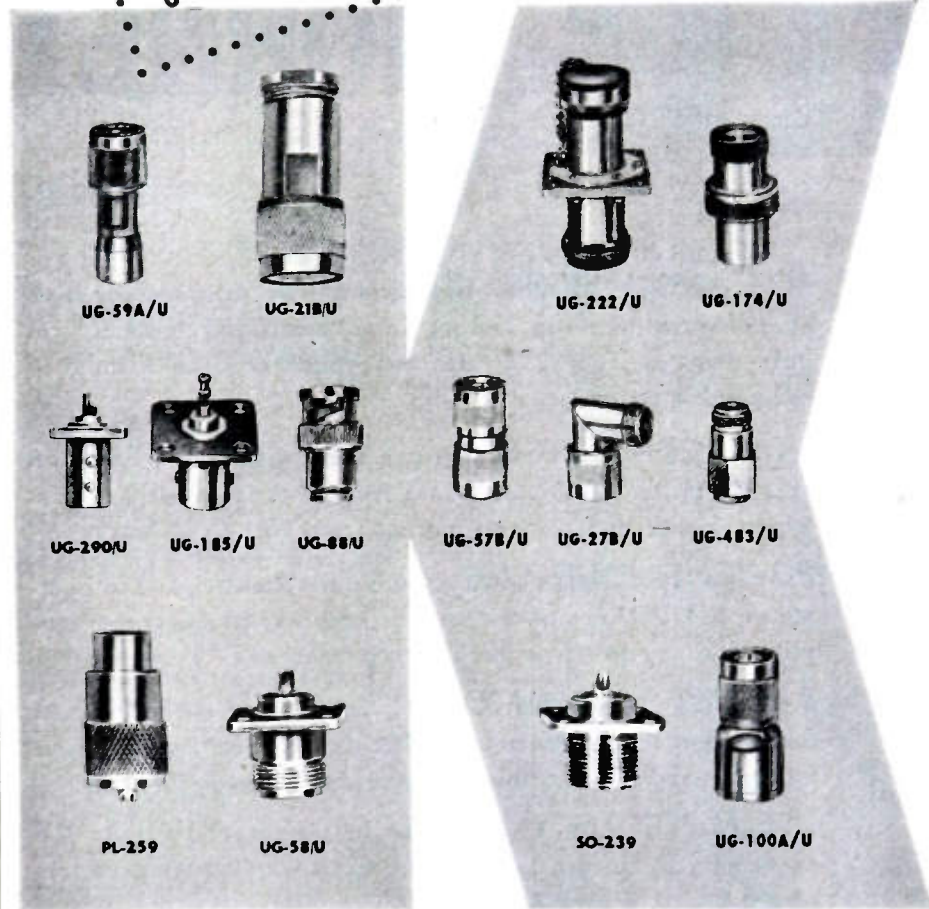

preferred by engineers everywhere

From coast-to-coast, engineers in all fields look to Kings Electronics for the finest coaxial connectors.

Special problems in design and fabrication receive the wholehearted cooperation of Kings own engineering department.

For precision-made, pressurized R. F. Connectors call on Kings — the leader. Quotations on request.



811 LEXINGTON AVENUE, BROOKLYN 21, N. Y.

WHEN YOU NEED A MINIATURE TRANSFORMER

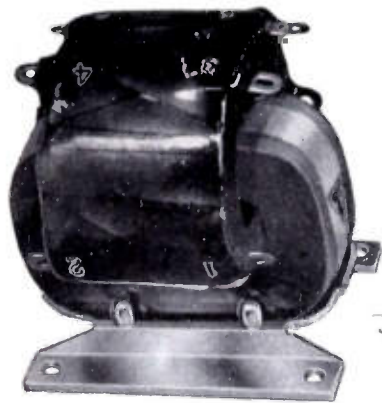

CHECK THESE FEATURES OF THE HORNET

- ✓ **SIZE AND WEIGHT** Because they are designed for high operating temperatures, Hornet Transformers and Reactors have only about one-fourth the size and weight of Class A units of comparable rating.
- ✓ **VOLTAGE RATINGS** Designs are available for RMS test voltages up to 10,000 volts at sea level, and up to 5,000 volts at 50,000 feet altitude. Power ratings from 2VA to 5KVA.
- ✓ **POWER FREQUENCIES** These units are designed to operate on 380/1600 cps aircraft power supplies, 60 cps power supplies, and any other required power frequency.
- ✓ **AMBIENT TEMPERATURES** Hornet Units can be designed for ambient temperatures up to 200 deg. C. Size for any given rating depends upon ambient temperature and required life.
- ✓ **LIFE EXPECTANCY** Extensive tests indicate that the life expectancy of Hornet units at continuous winding temperatures of 200 deg. C. is over 50,000 hours.
- ✓ **MOISTURE RESISTANCE** Since Hornet Transformers and Reactors contain only inorganic insulation, they are far more moisture resistant than conventional Class A insulated units.
- ✓ **EFFICIENCY** Regulation and efficiency of Hornet Transformers compare favorably with Class A units.
- ✓ **SPECIFICATIONS** Hornet Transformers meet the requirements of Government specifications covering this type of equipment.



Bulletin B300, containing full electrical and dimensional data on Hornet units, is now available. Write for it, or tell us your specifications for special units.



**NEW YORK
TRANSFORMER CO., INC.**
ALPHA NEW JERSEY

Positions Wanted

(Continued from page 63A)

ELECTRICAL ENGINEER

B.S.E.E. Columbia, Tau Beta Pi, 31, married. Seven years' development and administrative experience. Wide shop background, inventive and capable trouble shooter. Designed, developed, manufactured electronic controls machinery precision electro-mechanical devices. 2½ years Navy, radar and sonar instructor. New York metropolitan area. Box 499 W.

COMMUNICATIONS TECHNICIAN

Age 34, married. Extensive experience installation maintenance D.S.B., S.S. Diversity communications receivers; radio-telephone terminal units, etc., radio facsimile specialist. Six years' wartime experience line communication and mobile radio. Five years' British communication company. Consider suggestions for 1951. Canada preferred. Box 505 W.

ENGINEER

Three years' experience as Product Supervisor and test B.S.T.E. A.T.I. some experience at circuit design, seven years' analyzing and repair TV and radio receivers. Age 27, married, one child. Desires either production or design. Midwest. Box 506 W.

ENGINEER

B.E.E. Age 27, married, child. Present salary \$5300. Eight years' experience radar, radio-facsimile, pulse, video circuits development. Now with large research laboratory. M.S. expected in July 1951. Interested in position requiring greater responsibility. Metropolitan New York City. Box 507 W.



(Continued from page 48A)

- Patterson, T. C., "Vindomora," Gillas Lane (E. Houghton-Le-Spring, Co. Durham, England
- Pedersen, I. C., 1830 S. 54 Ave., Chicago 50, Ill.
- Richards, P. A., 1409 New Holland Pike, Lancaster, R.F.D. 5, Pa.
- Seal, R. K-F., 3513 Idaho Ave., N. W., Washington 16, D. C.
- Smith, H. M., Box 578, Sackville, N. B., Canada
- Smullin, L. D., Massachusetts Institute of Technology, Rm. 20-B-003, Cambridge 39, Mass.
- Stewart, N. H., Westinghouse Electric Corporation, Bloomfield, N. J.
- Veith, F. S., 28 Kreider Ave., R. D. 3, Lancaster, Pa.
- Webb, D. T., Philco Corporation, C & Tioga Sts., Philadelphia, Pa.
- Webb, E. L. R., 31 Dunvegan Rd., Manor Park, Ottawa, Ont., Canada

Admission to Senior Member

- DeFrance, J. J., 35-06 201 St., Bayside, L. I., N. Y.
- Golay, M. J. E., 372 Hollywood Ave., West Englewood, N. J.
- Greer, W. J., Box 2535, Houston 1, Tex.
- Kearney, J. P., 2315 Westbrook Dr., Toledo, Ohio
- Mostafa, A. E., Faculty of Engineering, Farouk University, Alexandria, Egypt
- Rinia, H., Philips Research Laboratories, Eindhoven, Holland
- Swift, M. E., R. D. 1, Lansdale, Pa.
- Zeitz, A., 1048 Norwood Ave., Elberon, N. J.

(Continued on page 66A)

INCREDUCTOR

—newest component in the electronic field

INCREDUCTOR is the trademark designating a new type variable inductor that is:

- electrically controlled—no moving parts
- variable over a useful inductance range of 100 to 1—or 200 to 1—or even more in some applications
- low in loss—maintains high Q even at megacycles
- controlled with minimal power, compact and light in weight
- the result of years of intensive research by C. G. S. engineers*

These valuable characteristics of the INCREDUCTOR are attained by the use of separate control and signal windings, specially arranged on a ceramic core having unusual magnetic properties.

Alternating or direct current variations through the low power control winding produce corresponding variations in the inductance of the INCREDUCTOR signal winding.

The standard line of C. G. S. INCREDUCTORS now available includes units with a wide range of starting inductances and frequencies. For those applications in which the standard C. G. S. INCREDUCTORS will not provide the requisite characteristics, C. G. S. will design and produce INCREDUCTORS to meet your specific requirements.

Write us on your letterhead for a descriptive bulletin, including information and prices on standard units, together with helpful design data.**

* Pat. applied for.

** See also "300 to 4000 Kc Electrically Tuned Oscillator" by A. I. Pressman and J. P. Blewett, Proc. I. R. E. January 1951.

C. G. S. LABORATORIES, INC.

390 Ludlow Street

Stamford, Connecticut

WORKSHOP

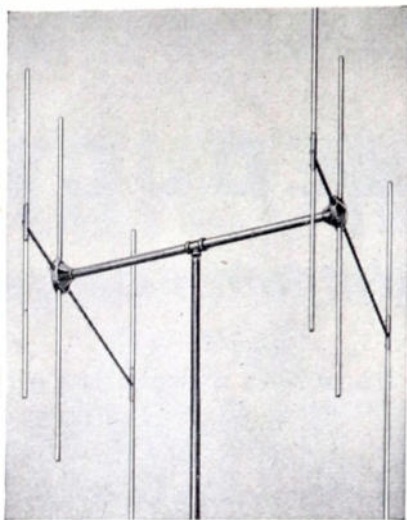

DIRECTIONAL ANTENNAS

Workshop directional (and bi-directional) antennas are designed expressly for point-to-point communications, particularly — railway, highway patrol, public safety, police, utility, pipe lines, forestry, and other similar uses. Their high gain and sharp directivity provide strong, clear reception and long-range coverage at minimum cost. Rugged, heavy-gauge aluminum elements and enameled steel supports guarantee long, dependable service with no maintenance expense. Installation is very simple, requiring only an iron pipe mast and cable. Ten different models are available, one for each operating band.

GAIN — Conservatively rated at 7.6 db. over a $\frac{1}{2}$ -wave dipole; 15.2 db. for system when used in pairs — one at each end of circuit

RUGGED CONSTRUCTION — Withstands steady 65 mph wind with $\frac{1}{2}$ " radial ice; 85-90 mph without ice with adequate safety factor

$\frac{1}{2}$ -POWER ANGLES — 64° Horizontal, 68° Vertical

FRONT-TO-BACK RATIO — 20 db., measured

VSWR — Less than 1.5:1

IMPEDANCE — 52 ohms

VERTICAL POLARIZATION — Horizontal on request

MOUNTING — $\frac{1}{2}$ " standard threaded pipe

ENGINEERING and CONTRACT SERVICE. The WORKSHOP handles scores of special government and commercial antenna problems every year from design through production. If your product or service requires high-frequency antennas — research, design, or production — get in touch with the WORKSHOP. Write, or phone Needham 3-0005. No obligation.

The WORKSHOP ASSOCIATES, Inc.

Specialists in High Frequency Antennas

135 Crescent Road, Needham Heights 94, Massachusetts



(Continued from page 64A)

Transfer to Member

- Bourret, P. L., Ateneo de Manila, 406 Padre Faura, Manila, P. I.
- Coe, J. C., 4468 Stoddard St., San Bernardino, Calif.
- Fankhauser, J. E., Department of Electrical Engineering, State University of Iowa, Iowa City, Iowa
- Fitch, W. M., 734 N. Taylor Ave., Oak Park, Ill.
- Graulung, C. H., Jr., 127 E. Clement St., Baltimore 30, Md.
- Hafstrom, J. R., 618 Glenwood Rd., Madison 5, Wis.
- Howard, L. L., 818 W. Vine St., Champaign, Ill.
- Jones, R. B., 4322 Arlington Ave., Fort Wayne, Ind.
- Klehfoth, W. G., 516 19 St., N. E., Cedar Rapids, Iowa
- Koppel, R. J., 67-71 Yellowstone Blvd., Forest Hills, L. I., N. Y.
- Letts, R., 2440 Trenton Rd., Town of Mt. Royal, Que., Canada
- Manoog, J. C., 70 June St., Worcester, Mass.
- Michael, F. R., 1300 Church Rd., Oreland, Pa.
- Murakami, T., 1112 Mercer Dr., Haddonfield, N. J.
- Nordstrom, G. J., 1651 11 St., N. W., Cedar Rapids, Iowa
- Parnell, J., 545 Locust Ave., Philadelphia 44, Pa.
- Paulin, W. P., 422 Davenport Rd., Toronto, Ont., Canada
- Pratt, G. W., Philco Corporation, Church Rd., Lansdale, Pa.
- Sheldon, H. W., 8102 New Second St., Elkins Park, Philadelphia, Pa.
- Stubbe, R. R., R. D. 1, Sunbury, Pa.
- Tustin, W., 13941 12 St., S. W., Seattle 66, Wash.
- Vijayaraghavan, K., Lecturer in Physics, Annamalai University, Annamalaiagar, S. India
- White, W. H., 1454 S. Gordon St., S. W., Atlanta, Ga.
- Ziniuk, M. A., 4517 Springwells Ave., Detroit 10, Mich.

Admission to Member

- Adams, R. L., 131 Albany Ave., Westbury, L. I., N. Y.
- Ball, D. F., 3910 Purdue St., Houston, Tex.
- Beaton, C. R., 63 Cedarlawn, Valley Stream, L. I., N. Y.
- Colvin, J. W., 212 Linden Ave., Towson 4, Md.
- Crail, A. C., 18204 Waterbury, Maple Heights, Ohio
- DeZube, L. H., 1728 Wagner Ave., Philadelphia 41, Pa.
- Eike, O. M., 506 N. Lincoln Ave., O'Fallon, Ill.
- Ellis, C. O., c/o Rock Island Lines, Chicago 5, Ill.
- Follis, F. R., 10775 Galvin St., Culver City, Calif.
- French, H. N., 66 Fairview Ave., Chatham, N. J.
- Gay, W. D., 15883 Evanston, Detroit 24, Mich.
- Greenspan, J., 575 Ocean Ave., Brooklyn 26, N. Y.
- Greig, C., Provincial Wireless Officer, Wireless Sta., Dilkusha, Lucknow, India
- Jewell, R. L., Jr., 826 Parker St., Roxbury 20, Mass.
- Kline, L. H., 2677 Euclid Heights Blvd., Cleveland Heights 6, Ohio
- Mathews, K. C., 5633 N. Kenmore Ave., Chicago, Ill.
- Murray, R. W., Jr., 528 Spruce Ave., Upper Darby, Pa.
- Phillips, T. L., 9 Pond St., Jamaica Plain 30, Mass.
- Reynolds, J. H., c/o Mackay Radio & Telegraph Company, 345 Hudson St., New York, N. Y.
- Sauber, J. W., Electrical Engineering Department, University of Tennessee, Knoxville, Tenn.
- Tompkins, F. G., 547 E. Ford Ave., Barberton, Ohio
- Turner, R. J. A., c/o Chalmers, R. R. 3, Belleville, Ont., Canada
- Warr, G. D., 405-B Langley, China Lake, Calif.
- Woodbury, C. P., 54 Roydon Dr., E., Merrick, L. I., N. Y.

(Continued on page 68A)

OTHER WORKSHOP ANTENNAS

Aeronautical Ground Station
For aircraft communications — omnidirectional.

Parabolic Antennas
For radio, microwave, STL and TV relay and communications.

Beacon
For fire, police, taxicab, and private fleet communications.
TV, FM and Amateur

SPECIFY *Simpson*

for Accurate, Dependable Electrical Measurements

BECAUSE—Simpson has developed quality control to a new modern high with *this* successful production policy. Design everything that goes into an instrument—make everything that goes into an instrument—keep designing for the future—keep quality steadily higher—keep prices consistent with material and labor costs without exploitation. This quality control is evident

in every Simpson instrument whether panel or switch-board, custom-built or stock. The instruments illustrated in panel below are only a few of the wide variety of instruments in the complete Simpson line. Let Simpson engineers help you solve your panel instrument problems—and for your standard instrument requirements take advantage of our large stock.

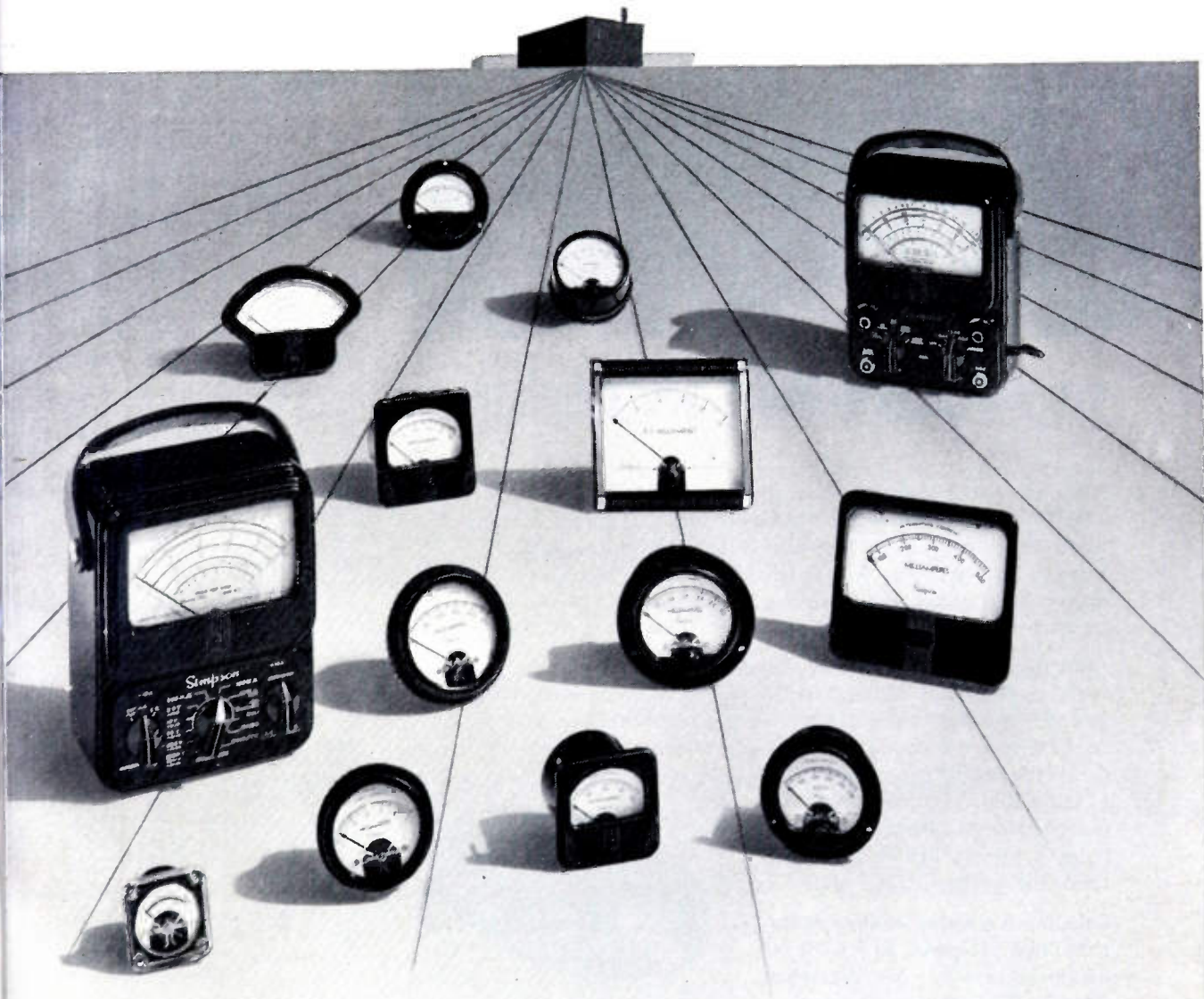

Simpson ELECTRIC COMPANY



5200 W. KINZIE ST., CHICAGO 44 • COLUMBUS 1-1221 • In Canada: BACH-SIMPSON, LTD., LONDON, ONT.

PRESTO... most carefully made recording disc in the world

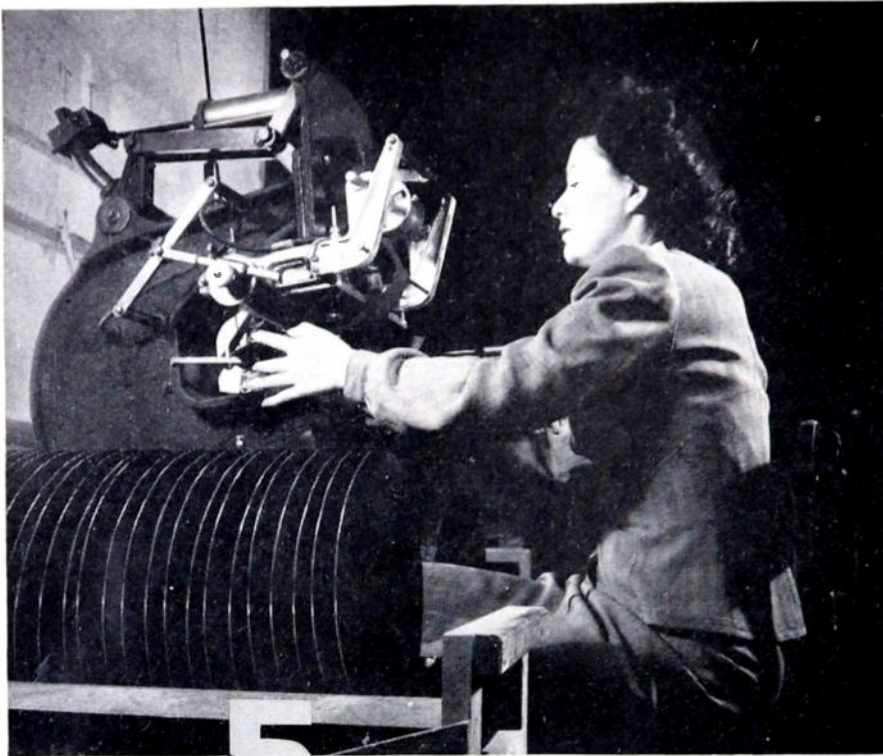

step 5 - grading and labeling

Although every recording disc that leaves the modern PRESTO plant is made with meticulous care and the finest materials, only those that have passed the most rigid inspection can qualify for the "Green Label." This label on a disc means that it possesses as perfect a recording surface as can be created by modern methods.

After discs have been carefully graded, they are assigned various color label distinctions. Drive holes are punched and they are sent to the labeling press, where brilliant colored labels are stamped into the lacquer surface. "Green" means the finest, "Brown" is applied to those discs with slight imperfections, while the "Orange" label denotes a disc of lighter gauge and smaller diameter.

Labeling is another of the quality-controlled processes in PRESTO disc manufacture... another reason why the PRESTO label is always a reliable guide in your selection of a recording disc.

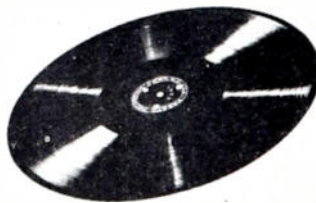

The famous PRESTO "Green Label"
... world's finest recording disc.

PRESTO
RECORDING CORPORATION

Paramus, New Jersey
Mailing Address:
Box 500, Hockensock, New Jersey

In Canada:
Walter P. Downs, Ltd.
Dominion Sq. Bldg.
Montreal, Canada

Overseas:
M. Simons & Son Co., Inc.
25 Warren Street
New York, New York



(Continued from page 66A)

The following elections to Associate grade were approved and are effective as of January 1, 1951:

- Ackley, R. M., 755 Carnegie Ave., Johnstown, Pa.
Boedecker, H. F., 3023 N. Broadway, Chicago 22, Ill.
Brooks, K. L., 4325 S. E. Madison, Portland, Ore.
Brown, E. A., 519-A E. South St. Angola, Ind.
Buchbinder, M. M., 40 Featherbed Lane, New York 52, N. Y.
Carlson, R. C., 1816 Lamont St., Washington, D. C.
Chermack, L., 1272 Van Pelt Ave., Los Angeles 63, Calif.
Coltun, L., 1846 76th St., Brooklyn 14, N. Y.
Coyle, P. L., 1508 N. Washitena, Chicago 22, Ill.
Dahinden, D. T., 7965 Earl St., Oakland 5, Calif.
Dander, D. A., 30 W. Fourth St., Emporium, Pa.
Dielman, J. P., 3548 Douglas Rd., Toledo, Ohio
Dimenna, D. L., 746 Maple St., Bridgeport 8, Conn.
Doherty, R. P., Box 8114, Albuquerque, N. Mex.
Eash, G. H., 845 W. Woodruff Ave., Toledo 7, Ohio
English, E. H., 160 St. James St., Burnley Lanes, England
Erskine, H. E., Old Mill Rd., Ayer, Mass.
Flosdorf, F. H., 636 Anderson Ave., Cliffside Park 2, N. J.
Flynn, M. W., 24 Fairbank Ave., Toronto 10, Ont., Canada
French, J. C., 449 Poplar St., Hazard, Ky.
Gopalakrishnan, E. S., 7 Hunters Rd., Madras 7, India
Gray, L. D., Glenn L. Martin Co., Holloman Air Force Base, Alamogordo, N. Mex.
Hackney, C. B., 5647 W. North Ave., Chicago 39, Ill.
Hallisey, R. J., 5 California Ave., Saco, Maine
Hancock, J. B., 334 Severin St., Modesto, Calif.
Hanna, R. N., 908 Prospect Ave., Toledo 6, Ohio
Heron, L. R., Electronics Division, Naval Air Station, Squantum, Mass.
Herrick, K. R., 2516 Fulton, Toledo 10, Ohio
Hickerson, J. E., Albany Post Rd., Wappingers Falls, N. Y.
Hilbers, G. R., 108 E. Broadway, Anaheim, Calif.
Hill, E. W., 2502 St. Isabel St., Tampa 7, Fla.
Hines, L. J., 712 E. Ogden Ave., Milwaukee 2, Wis.
Hollowed, E. J., 1327 N. Massasoit Ave., Chicago 51, Ill.
House, H. J., 19 Grove Ave., Auburn, N. Y.
Icibakis, M. A., 65 Ag. Meletiou, Athens 8, Greece
Ingersoll, G. F., 634 Spencer, Toledo, Ohio
James, F. L., 6172-May Way, Honolulu, Oahu, T. H.
Jensen, R. E., 5633 N. Mozart St., Chicago 45, Ill.
Johnson, C. L., 324 S. Grand, Independence, Mo.
Jones, C. W., Box 305, Paris, Tenn.
Kalet, E., 29 04 169 St., Flushing, L. I., N. Y.
Karr, R. J., 1066 W. Winona, Chicago 40, Ill.
Kennewell, E. M., 3 Highway Grove, E. Prahran S. 1, Victoria, Australia
Kerbin, J. F., Millbrook, N. Y.
Kerfoot, J. H., 23 Kings Lynn Rd., Toronto 18, Ont., Canada
Kirby, R. P., 2805 Lucas Dr., Beaumont, Tex.
Klein, J., 2400 W. Wilson Ave., Chicago, Ill.
Koehler, J. A., 68 Lafayette Ave., Maywood, N. J.
Kounalis, L. E., 155 N. Main 64, Salt Lake City, Utah
Kronengold, M., Video Corporation of America, 229 W. 28 St., New York 1, N. Y.
Lambert, R., 3736 Ledgewood Dr., Cincinnati 7, Ohio
Long, M. G., 108 Timothy St., Johnstown, Pa.
Makleff, P., 1368 50 St., Brooklyn, N. Y.
Markowitz, R. S., 4948 Boudinot St., Philadelphia 20, Pa.
Marsh, W. F., 308 N. Scoville Ave., Oak Park, Ill.
Martin, P. E., Bendix International, 72 Fifth Ave., New York, N. Y.
Mason, N. O., 239 E. 211 St., Cleveland 23, Ohio

(Continued on page 71A)

LOOKING FOR A Better WAY?

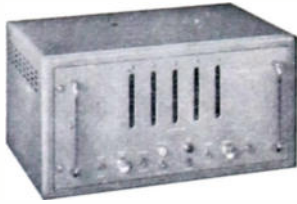

EPUT* for

- ELECTRONIC TACHOMETRY • SECONDARY FREQUENCY STANDARD • FREQUENCY MEASUREMENTS
- HIGH SPEED COUNTING

The Berkeley Events-Per-Unit-Time* Meter will automatically count and display the number of events that occur during a precise one second interval at rates up to 100,000 per second. Accuracy is \pm one event. These events may be any mechanical, electrical, or optical occurrences regularly or randomly spaced that can be converted into changing voltages. Thus the EPUT becomes an extremely flexible tool which may be used as a precision electronic tachometer, a secondary frequency standard, a device for rapid determination of unknown frequencies or simply a multi-purpose general laboratory instrument.

AUTOMATIC: This unit will count for a precise one second interval, display the results in direct reading form for a period variable from one to five seconds, and then automatically recycle. On "Manual" operation the instrument

will count for one second and display the result indefinitely until the "reset-count" button is again depressed.

SELF-CHECKING: Important test feature permits one-second check of the entire circuit with the exception of the 100 kc crystal itself. A panel "test" switch allows the instrument to count its own 100 kc crystal and display the "00000" result directly.

MODIFICATIONS: Standard modifications available: a selectable 0.1, 1, and 10 second time base; addition of mechanical register for extended range; addition of panel switch to permit use as straight counter; scanning feature to provide a time base in any multiple of 10 seconds. Special modification including accessories such as tachometer pickups and photocell arrangements can be supplied to meet specific requirements.

TIM* for

- TIME INTERVAL MEASUREMENTS
- PRECISE LOW-FREQUENCY MEASUREMENTS
- HIGH SPEED COUNTING



The Berkeley Time Interval Meter*, Model 510, provides a direct reading of elapsed time between any two events in the range of 0.000010 to 1.0000 seconds. Accuracy of measurement is \pm 10/u secs. Any occurrences that can be translated into changing voltages may be timed. Timing may be started and stopped by independent voltages. The polarity of these control voltages may be selected by means of toggle switches so that the unit may be started and stopped by either positive or negative pulses. A sensitivity control permits selection of the amplitude of the start or stop voltages at optimum level for elimination of interference.

OPERATION: By use of photocell attachments the interval between two separate light flashes may be timed. Similarly by use of an added photochannel and a single photocell duration of a light period or a dark period may be determined.

MODIFICATIONS: Standard modifications available: addition of a photocell channel; the addition of a mechanical register to extend range to 10 seconds; threshold control to permit selection of precise amplitude of input pulse so unit may be made to operate at any desired position on sine wave; panel switch to permit use as straight counter.

For LABORATORY OR PRODUCTION LINE!

DIRECT READING: The only truly direct reading equipment of its kind, presenting results in decimal form on an illuminated panel. No interpolation, no lights to add. A convenience in the laboratory; a necessity in production.

COMPACT: The Models 554 and 510 are standard 19" single rack units mounted in Berkeley cabinets 20 $\frac{3}{4}$ " wide x 10 $\frac{1}{2}$ " high x 15" deep. Weight per unit, approximately 60 pounds.

RELIABILITY: Both of these instruments utilize the standard plug-in Decimal Counting Units that Berkeley has long pioneered in the electronic industry. These are the same units now being incorporated into the standard equipment of other leading instrument manufacturers and research laboratories.

The Models 554 and 510 are themselves standard production units that have been manufactured in quantity for many months. Continued repeat orders from industrial users are the best tribute to performance of this equipment.

WARRANTY: Complete facilities, from research and design to final quality control inspection, insure fine electronic workmanship, good clean pack-

aging, and optimum performance. All Berkeley instruments are warranted for 1 year from date of delivery to your plant or laboratory.

MODEL 550: A combination of the EPUT and the TIM is available in the Model 550. This is a double 19" rack unit providing all of the facilities of the Models 554 and 510, plus a provision for the direct determination of frequency ratios.

For complete information, write for Bulletins IRE-510 and IRE-554

Berkeley Scientific Corporation

2200 WRIGHT AVE. • RICHMOND, CALIF.

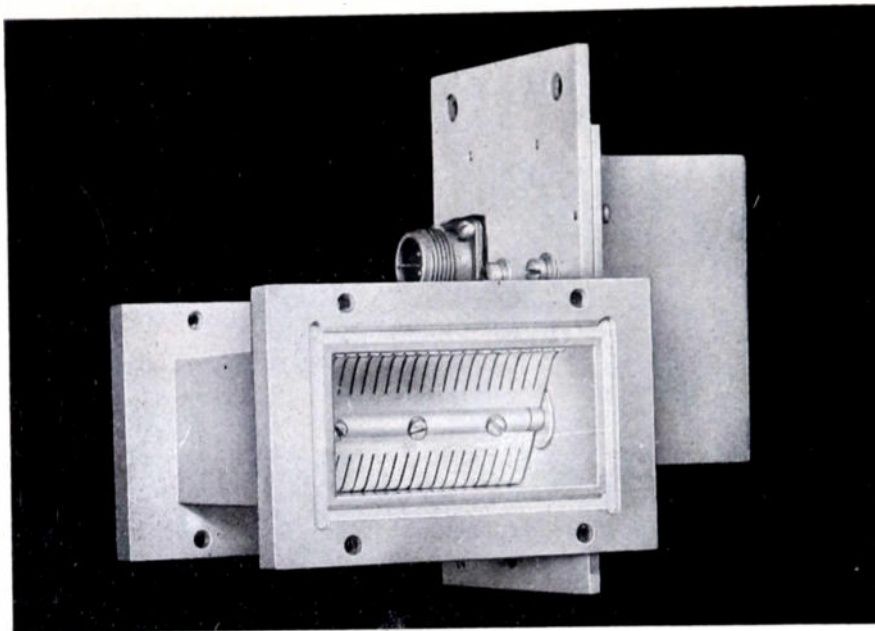

Microwave "Shutter" by TERPENING

The "shutter" you see in the waveguide section above is designed to close automatically when the radar is not operating. This prevents damage to the crystal detector, which might be caused by radiation from other nearby radars.

Specifications called for very high attenuation when closed, extremely low attenuation when open, and fully automatic operation.

As designed and produced in quantity in our plant, the performance of this component exceeded our customer's expectations. For example:

- with the solenoid-actuated shutter in closed position, attenuation is greater than 40 db,
- with shutter open, attenuation is negligible—a few hundredths of one db.

This is a typical example of the work we are set up to handle—from design through production—from single component to entire transmission line. Although our engineering staff, laboratories, and fully equipped shop are usually busy on government contracts, our unusual facilities may permit us to work with you on special components for military microwave systems. We shall be happy to talk with you about your present and/or future needs.



L. H. TERPENING COMPANY
DESIGN • RESEARCH • PRODUCTION
Microwave Transmission Lines and Associated Components
16 West 61st St. • New York 23, N. Y. • Circle 6-4760

Need **VOLUME**
on Small Parts
Like
These?

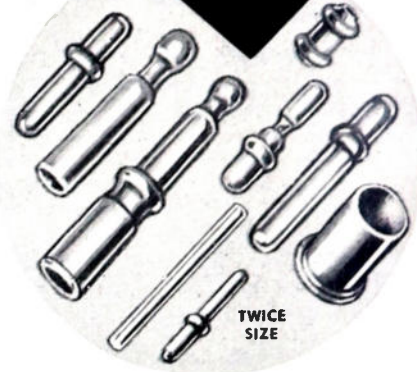

Investigate **MULTI-SWAGE**

Economy Way to Get Volume!

If it's **VOLUME** you need on small tubular metal parts similar to these, be sure to look into Bead Chain's **MULTI-SWAGE** Process. Send the part (up to $\frac{1}{4}$ " dia. and to $1\frac{1}{2}$ " length) and your specs for a quotation. Chances are you'll find a new way to effect important savings.

Much Cheaper Than Solid Pins

Many prominent users of solid pins for electronic and mechanical purposes have cut costs by switching to Multi-Swaged tubular pins . . . without sacrificing strength or accuracy. Often this is possible to accomplish.

Typical Applications —

As terminals, contacts, bearing pins, stop pins, male-female connections, etc., in a wide variety of electronic and mechanical products:—Toys . . . Business Machines . . . Ventilator louvers . . . Radio and Television apparatus . . . Terminal-boards . . . Electric Shavers . . . Phono Pick-ups, etc. For **DATA BULLETIN**, write to



The **BEAD CHAIN** Mfg. Co.

11 Mountain Grove St., Bridgeport 5, Conn.

Manufacturers of **BEAD CHAIN**—the kinkless chain of a thousand uses, for fishing tackle, novelty, plumbing, electrical, jewelry and industrial products.



(Continued from page 68A)

- Matuzich, J. D., Scipio Center, N. Y.
 McCarter, W. L., 4684 W. Eighth Ave., Vancouver, B. C., Canada
 Mike, J. G., 71 Elmwood Ave., Bridgeport 5, Conn.
 Muir, L. M., British Insulated Callenders IED Cables, Ltd., Prescott, Lancs., England
 Nartonis, W. C., 12254 Gallagher, Detroit 12, Mich.
 Newell, P. A., 12201 Woodland Ave., Cleveland 20, Ohio
 Noffsinger, D. T., 354 H. Rock Springs, Wyo.
 Oess, F. G., 314 Poplar St., Emporium, Pa.
 Parker, H. L., Kansas Highway Patrol, Marysville, Kan.
 Pattenson, C. F., 3 Braemar St., Ottawa, Ont., Canada
 Petty, D. E., 1838 Harlan Rd., Toledo, Ohio
 Pivarnik, W., 3624 N. Lotus Ave., Chicago 41, Ill.
 Poonpatana, S., Signal Inspector Department, Span-Dang Bang-Sue, Banghob, Thailand
 Proferes, N. J., 1511 Timber Lane, Falls Church, Va.
 Rao, K. L., Planning & Development Unit, All India Radio Broadcasting, New Delhi, India
 Raymond, W. D., 7614 S. Jeffery Ave., Chicago 49, Ill.
 Raziuddin, S. M., Telecommunication Inspector, P. O. Railway Bldg., Chittagong, E. P., India
 Rivers, L. B., 11 Bank St., Red Bank, N. J.
 Roberts, W. L., 1016 Alvarado Rd., Berkeley 5, Calif.
 Robinson, W. H., 2053 E. 17 St., Salt Lake City 5, Utah
 Rocheleau, G. S., 9 Broad St., Emporium, Pa.
 Romano, S. S., 104 N. Caryl Ave., North Lake City, Ill.
 Romans, W. E., 4030 N. Sheridan Rd., Chicago, Ill.
 Roynance, D. T., 275 E. Truman, Salt Lake City, Utah
 Schwartz, E. V., 3869 Sawtelle Blvd., Culver City, Calif.
 Scott, R. E., Walter Kidde & Company, Inc., 675 Main St., Belleville 9, N. J.
 Seitz, S. S., 10 Midwood St., Brooklyn 25, N. Y.
 Slaughter, W. R., 5050 N. Broadway, Chicago 40, Ill.
 Spencer, R. E., Prince George, B. C., Canada
 Stanchiff, V. A., 145 Dessa Dr., Hamden 14, Conn.
 Stone, E. O., R. D. 1, Seneca Falls, N. Y.
 Stone, J. L., III, 3170 17 St., N. W., Washington, D. C.
 Stuff, A. C., British Embassy, Washington, D. C.
 Surton, R. H., 1258 Ridgedale Lane, Salt Lake City, Utah
 Tait, R. B., 2325 N. 30 St., Milwaukee, Wis.
 Taylor, D. P., 110 Forest Hill Rd., Toronto, Ont., Canada
 Thiruvankatam, K., c/o M. S. Rallis India, Ltd., Oil Factory, Cuddalore Old Town, South Arcot District, S. India
 Thomas, J. K., II, 8200 Ridge Ave., Philadelphia 28, Pa.
 Truesdell, R. M., 608 21 Ave., S. W., Cedar Rapids, Iowa
 Venkatasubalam, K., E. T. 21 Railway Quarters, Egmore, Madras, India
 Walsh, R. J., 26 S. Wood St., Emporium, Pa.
 Whitley, K. C., 19 Currong, Canberra City, Australia
 Winter, L. E., 310 Eighth Ave., Marion, Iowa
 Wozniak, A. J., 1002 E. Third St., Port Clinton, Ohio
 Young, E. A., 2171 Sugar Grove Ave., Indianapolis, Ind.
 Zahnier, R. M., 473 Sherman Ave., Sharon, Pa.

Specify CP TEF-LINE SUPER TRANSMISSION LINE

A new transmission line based upon a new plastic—TEFLON

CP TEF-LINE transmission line, utilizing DuPont Teflon insulators, greatly reduces high frequency power losses. Furthermore, operation of transmission line at frequencies heretofore impossible owing to excessive power loss now becomes easily possible. For TV, FM and other services utilizing increasingly high frequencies, TEF-LINE by CP is a timely and valuable development worthy of investigation by every user of transmission line.

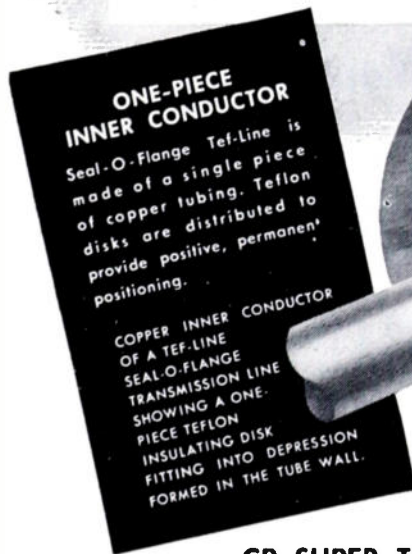

ONE-PIECE INNER CONDUCTOR
 Seal-O-Flange Tef-Line is made of a single piece of copper tubing. Teflon disks are distributed to provide positive, permanent positioning.

COPPER INNER CONDUCTOR OF A TEF-LINE SEAL-O-FLANGE TRANSMISSION LINE SHOWING A ONE-PIECE TEFLON INSULATING DISK FITTING INTO DEPRESSION FORMED IN THE TUBE WALL.



CP SUPER TEF-LINE IS AVAILABLE NOW!

Tef-Line can be delivered immediately in three standard sizes— $\frac{7}{8}$ ", $1\frac{1}{8}$ " and $3\frac{1}{8}$ ". With the exception of elbows and gas stops, the new Seal-O-Flange Super Transmission Line is interchangeable with all other CP fittings including end seals, tower hardware, flanges, "O" rings, inner conductor connectors and miscellaneous accessories.

Check your transmission line requirements with the new CP TEF-LINE BULLETIN which is available on request. If you need help in planning installations, our engineers will be happy to talk over specific problems at your convenience.

- TOWER HARDWARE • AUTO-DRY-AIRE DEHYDRATORS
- LO-LOSS SWITCHES • COAXIAL DIPOLE ANTENNAS
- SEAL-O-FLANGE TRANSMISSION LINE

Communication Products Company, Inc.

KEYPORT  NEW JERSEY

We will be grateful if you will mention PROCEEDINGS of the I.R.E. when writing to our advertisers.

Specify BREEZE "Monobloc" Waterproof and Pressure Sealed CONNECTORS



The only APPROVED Monobloc System for Advanced Radar, Communications, and Electronic Equipment

Breeze "Monoblocs", with single piece plastic inserts, offer outstanding advantages in assembly, wiring, mounting and service in the field.

Single piece inserts make a tighter unit, eliminate the air spaces within conventional multiple-piece inserts, greatly reduce the opportunity for moisture shorts.

Removable contact pins make possible bench soldering of leads, quick, error free assembly of Breeze Waterproof Connectors and panel-type "Monobloc Miniatures."

Single-Hole Panel Mounting is all that is required for either Waterproof or Pressure Sealed types.

Pressure Sealed types are available for values up to and including 75 psi, or they can be specially engineered for greater pressures. They meet specified requirements of shock, vibration, salt spray, humidity and temperature cycling from -65° to $+185^{\circ}$ F.

Breeze "Monobloc" Waterproof and Pressure Sealed Connectors are engineered to your requirements in aluminum, brass or steel—in all sizes and capacities. They are fully tested and approved... cost no more than ordinary types.

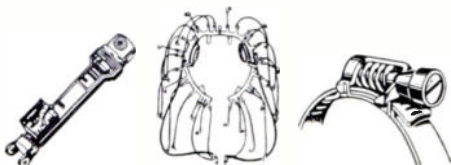

Other Breeze Precision Products

ACTUATORS: All types, sizes. Complete control systems engineered to requirements. Above: Landing gear actuator Fairchild Packet.

RADIO SHIELDING: For any type of high or low tension system. New type "unit leads" or re-wirable leads. Flexible shielded conduit.

"AERO-SEAL" Worm-Drive Hose Clamps. Vibration proof, uniform clamping, use again and again. All clamps have stainless steel bands.

Write for Details
If you have a tough connector problem, ask BREEZE for the answer!

BREEZE
CORPORATIONS, INC.
41G SOUTH SIXTH ST., NEWARK, N.J.



In only 1 SECOND! COMPLETE AUDIO WAVEFORM ANALYSIS with the AP-1 PANORAMIC SONIC ANALYZER



Oscillograph of waveform to be analyzed

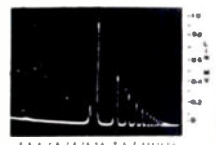

Panoramic Sonic Analysis of the same wave

Provides the very utmost in speed, simplicity and directness of complex waveform analysis. In only one second the AP-1 automatically separates and measures the frequency and amplitude of wave components between 40 and 20,000 cps. Optimum frequency resolution is maintained throughout the entire frequency range. Measures components down to 0.1%.

- Direct Reading
- Logarithmic Frequency Scale
- Linear and Two Decade Log Voltage Scales
- Input voltage range 10.000.000:1

AP-1 is THE answer for practical investigations of waveforms which vary in a random manner or while operating or design constants are changed. If your problem is measurement of harmonics, high frequency vibration, noise, intermodulation, acoustics or other sonic phenomena, investigate the overall advantages offered by AP-1.

Write NOW for complete specifications, price and delivery.



Just 60 SECONDS
from now . . .

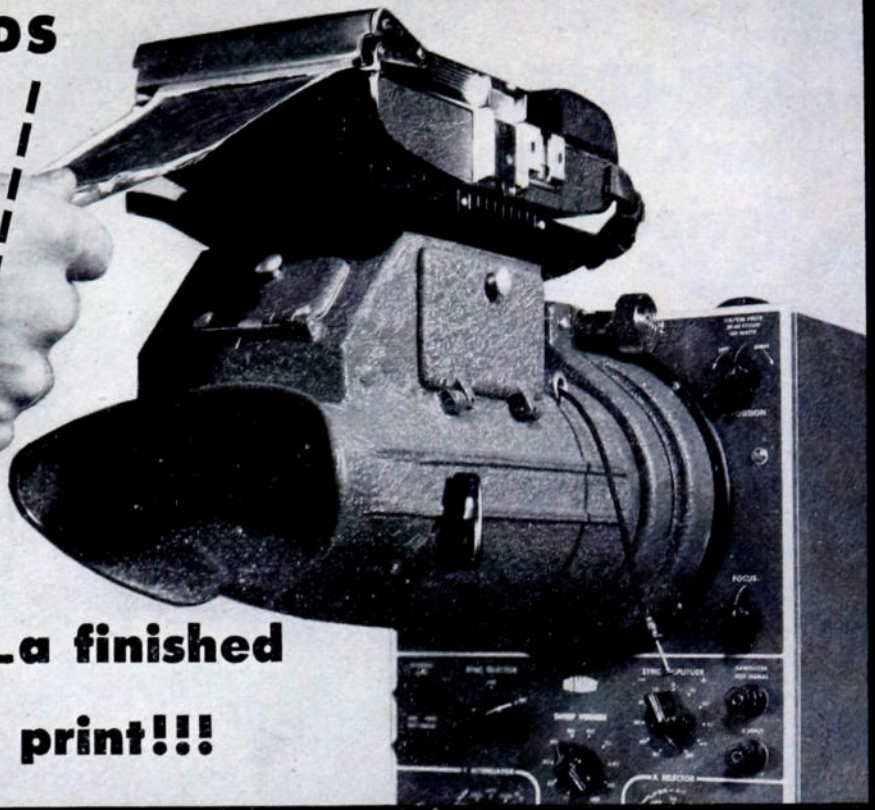
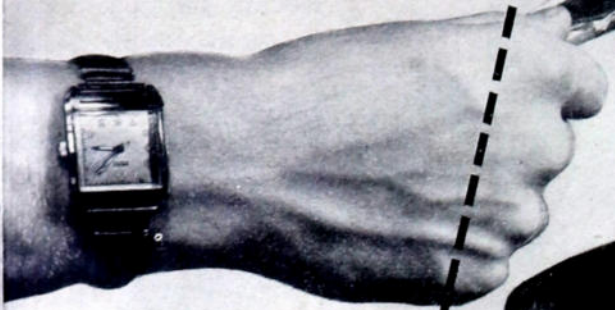

... a finished print!!!

... with the camera that brings a new speed and efficiency to oscillograph-recording techniques



The DU MONT TYPE 297 Oscillograph-record Camera

... and for thrifty
SINGLE-FRAME
recording



THE DU MONT TYPE 296 Oscillograph-record Camera

◆ The Type 296 is an inexpensive oscillograph-record camera, greatly improved for general-purpose application with any standard 5-inch cathode-ray oscillograph. It incorporates a compact, all-metal, 35mm camera, calibrated shutter and a high-quality 1/2.8, 75mm, coated lens which increases its capability 57% over the Type 271-A which it supersedes. Construction is rugged and durable; operation simple and foolproof. The Type 296 weighs only 4 1/2 lbs.

PRICE . . . \$149.50

◆ You've just advanced the film after making an exposure. That starts the Polaroid-Land "packaged" developing process. And while you're waiting for its completion—in just 60 seconds—you can start the next exposure or set of exposures. With the Type 297, once you've snapped the shutter, its self-contained, 60-second, developing process lets you forget

about the variables of the darkroom.

And with such special oscillographic features as simultaneous viewing and recording, an illuminated data-card, sturdy and easily attached mounting, and overall economy of the Polaroid film, Du Mont has added even greater meaning to this excitingly fast method for "printing" the oscillograph image.

SPECIFICATIONS

LENS—Du Mont-Wollensak f/2.8 or f/1.9, 75mm, coated.

SHUTTER—Wollensak Alphax; shutter speeds of 1/25, 1/50, 1/100 sec. Time and Bulb.

FOCUS—Fixed. May be adjusted for special oscillographic work.

WRITING SPEED—Writing rates of 3.5 in usec. have been recorded consistently at 12,000 volts accelerating potential.

PRINT SIZE—3 1/4 x 4 1/4 in.—one, two, three, or more exposures per print.

IMAGE REDUCTION RATIO—2.25:1.

PHYSICAL SIZE—Length, 14 5/8 in.; height, 10 in.; width, 6 in.

WEIGHT—12 lbs.

PRICE \$285.00 with f/2.8 lens
\$355.00 with f/1.9 lens

Write for bulletin on photographic techniques.

ALLEN B. DU MONT LABORATORIES, INC., INSTRUMENT DIVISION, 1000 MAIN AVENUE, CLIFTON, NEW JERSEY

LOW-COST PROTECTION for Airborne Electronic Equipment

New LORD *TEMPROOF Mountings

- Exceed AN-E-19 Drop Test Requirements
- Designed for JAN-C-172A Equipment
- Maintain Efficiency from -80°F to $+250^{\circ}\text{F}$



*Temperature-proof

Here is reliable vibration protection for base-mounted airborne electronic equipment . . . and for other apparatus which must function properly above and below usual temperatures. And TEMPROOF Mountings are priced to meet the needs of manufacturers in competitive markets.

TEMPROOF Mountings provide superior protection by maintaining their high vibration-isolating efficiency from -80°F to $+250^{\circ}\text{F}$. Selective-action friction dampers prevent excessive movement at resonant frequencies. Equipment does not sag or droop . . . mounting drift is negligible. The unusually wide load range of TEMPROOF Mountings makes it possible to standardize on one mounting for several types of equipment, and to effect additional economies in purchasing, storage and assembly.

For complete information on TEMPROOF Mountings, or for specific recommendations concerning their use, write to Product and Sales Engineering Department. A quantity of Vibration Isolation and Natural Frequency Charts in full color is available. Copy of each will be sent free upon request.

LORD MANUFACTURING COMPANY • ERIE, PA.
Canadian Representative: Railway & Power Engineering Corp., Ltd.



**Vibration-Control Mountings
... Bonded-Rubber Parts**

News—New Products

These manufacturers have invited PROCEEDINGS readers to write for literature and further technical information. Please mention your I.R.E. affiliation.

(Continued from page 23A)

Recent Catalog

... Parts Section, Receiver Div., General Electric Co., Electronics Park, Syracuse, N. Y., has prepared a phono accessory catalog with descriptions and data on variable reluctance cartridges, replacement baton styli, tone arms, and phono preamplifiers.

Electronic Counter Tachometer

The Potter Instrument Co., Inc., 115 Cutter Mill Rd., Great Neck, L. I., N. Y. announces a new high-speed electronic counter tachometer for high accuracy revolution and frequency measurements.



Fundamentally, the instrument totalizes the number of counts derived from the source being measured during a precisely established time interval of 0.6 second (0.01 minute). This reading is displayed on a direct-reading, four-digit electronic counter using ten neon glow lamps for each digit. After each measurement and display period, the instrument automatically resets and recycles. The display time is adjustable over a period of from 0.5 second to 4 seconds, or can be set to hold the count indefinitely.

The 0.6-second time interval is established by counting 60,000 cps of the 100-ke crystal oscillator contained in the unit.

The instrument can be used to measure frequencies up to 100,000 cps with an accuracy of ± 1 cps. In addition to the electronic counter registration of the measured frequency, the unit also includes a count rate meter which can be used when the unknown frequency source is being adjusted. This type of indication reflects instantaneous changes and is useful when the course of frequency must be manually adjusted to a specific point.

Two-Signal Audio Generator

A new Type 1303-A, two-signal audio generator, designed specifically for supplying the test signals necessary in the various methods of measuring intermodulation distortion in audio systems, has been developed by General Radio Co., 275 Massachusetts Ave., Cambridge 39, Mass.

(Continued on page 76A)

After 3,000,000

SARKES TARZIAN "Centre-Kooled" RECTIFIERS
(Radio, Television and Electronics)

NOW

in service

the Sarkes Tarzian

Centre-Kooled

POWER RECTIFIER

*with the
high quality
Sarkes Tarzian
has offered in
radio-type
rectifiers*

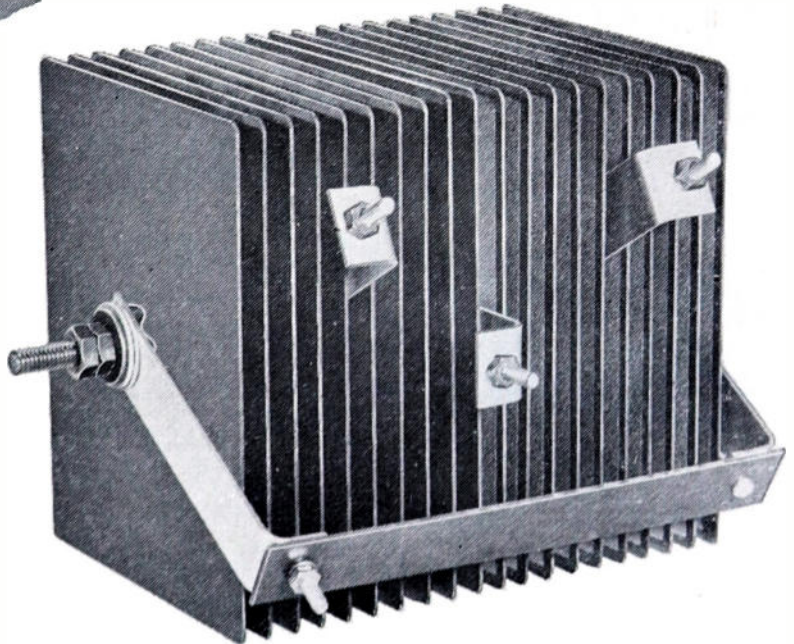

- ▼ For all current and voltage ranges
- ▼ Revolutionary center cooling allows complete sealing against humidity
- ▼ Small size and light weight for any power rating
- ▼ Salt spray resistant finish on request

**Sarkes
Tarzian** inc.

*Take advantage of our free engineering service
on all types of selenium rectifiers*

RECTIFIER DIVISION Dept. K, 415 North College Avenue, Bloomington, Indiana

These manufacturers have invited PROCEEDINGS readers to write for literature and further technical information. Please mention your I.R.E. affiliation.

(Continued from page 74A)

This generator can also be used as a general purpose laboratory beat-frequency oscillator. This oscillator will supply any of the following signals: A single low-distortion sinusoidal voltage adjustable in frequency from 20 cps to 40 kc in two ranges, 20 cps to 20 kc, and 20 kc to 40 kc; two low-distortion sinusoidal voltages,

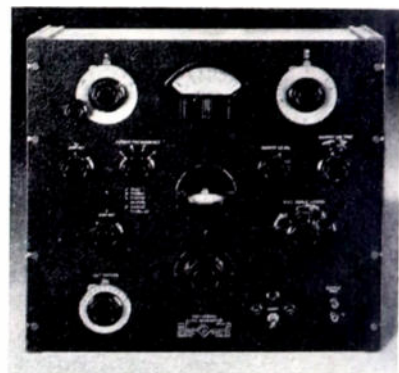

each separately adjustable, one to 20 kc and the other to 10 kc and two low-distortion sinusoidal voltages, with a fixed difference in frequency maintained between the two as the frequency of one voltage is varied. The fixed difference frequency is adjustable up to 10 kc, and the lower of the two frequencies is adjustable up to 20 kc.

The output of the oscillator is continuously adjustable up to 10 milliwatts into 600 ohms with less than 0.25 per cent distortion, and up to 1 watt with less than 0.5 per cent distortion. Output is calibrated both in volts and in db with respect to 1 milliwatt in 600 ohms.

Plant Expansion

Radio Receptor Co., Inc., 84 N. 9th St., Brooklyn 11, N. Y., announces purchase of a 90,000 square foot factory at Wythe Ave. & N. 3 St., Brooklyn, N. Y., to increase space for their manufacture of rectifiers, hf heat sealing machines, and airport radio equipment.

Nuclear Test Equipment

Four new radiation detecting instruments, are now available from the General Electric Co., Electronics Park, Syracuse, N. Y.

The small radiation monitor measures the total amount of gamma radiation in a given area over a period of time. It is self-contained, and because it has no batteries or tubes is not susceptible to moisture or dirt. Charging is immediately accomplished by inverting the device.

The portable alpha survey meter completely self-contained, is for the detection and indication of alpha radiation. It utilizes a proportional counting chamber as the detector. Output is given quantitatively on a meter and audibly on headphones.

(Continued on page 79A)



INSTRUMENTS THAT BELONG IN *Your* LABORATORY



Type 310-A Z-Angle Meter —
30 to 20,000 c.p.s.

Measures impedance directly in polar coordinates as an impedance magnitude in ohms and phase angle in degrees Z/\angle . Measures, with equal ease, pure resistance, inductance, capacitance or complex impedances comprised of most any RLC combinations. Range: Impedance (Z), 0.5 to 100,000 ohms; Phase Angle (\angle), $+90^\circ$ (X_L) through 0° (R) to -90° (X_C). Accuracy: Within $\pm 1\%$ for impedance and $\pm 2^\circ$ for phase angle. Price: \$470.00.

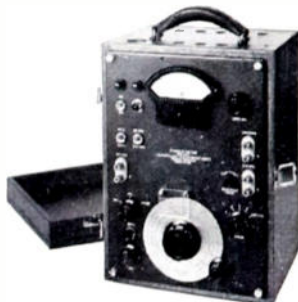

Type 311-A R-F Z-Angle Meter
for radio frequencies — 100 kc to 2 mc.

Simplifies laboratory and field impedance and phase angle measurements. Ideal for checking impedance of coils, transformers, coupling networks, lines, filters, antennas, etc. Direct-reading Impedance Range: 10 to 5,000 ohms up to 200 kc, and 10 to 1,000 ohms at 1 mc. Phase Angle: $+90^\circ$ (X_L) through 0° (R) to -90° (X_C). Accuracy: Impedance to within $\pm 3\%$, and phase angle $\pm 4^\circ$. Price: \$385.00.

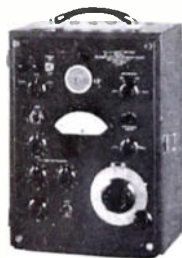

Type 410-A R-F Oscillator —
100 kc to 10 mc. (Special models
46.5 kc to 4.65 mc available.)

Power oscillator for use as bridge driver and general laboratory measurements. Features: High stability, high output (approximate 30 volts), 50-60 Ω output impedance, expanded frequency scale, direct reading output voltmeter, compact design. Price: \$385.00.

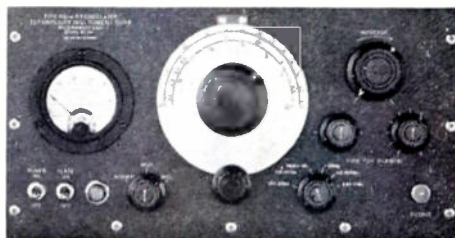

Type 320-A Phase Meter —
frequency range 20 cycles to 100 kc.

The first commercially available all-electronic instrument that directly measures the phase angle between two voltages in a simple operation. Ideally suited to applications in such fields as audio facilities, ultrasonics, servomechanisms, geophysics, vibrations, acoustics and many others.

Phase angle readings made directly without balancing . . . stable at frequencies as low as 2 to 3 cycles. Voltage range: 1 to 170 peak volts. Terminals for recorder . . . choice of relay-rack or cabinet mounting. Price: \$525.00. Cabinet: \$25.00.



Type 500-A Wide Band Decade Amplifier

Designed for use with the phase meter at voltage levels below one volt and as a general purpose laboratory amplifier—features high gain negligible phase shift and wide band width. Unique circuitry—which employs three cathode followers—offers wider frequency range, higher input impedance and lower output impedance than other types. Panel switch selects proper feedback compensation when either optimum amplification or phase shift operation is desired.

Outstanding specifications: Amplification—10; 100; 1000 selected by rotary switch . . . Accuracy— $\pm 2\%$ nominal . . . Frequency response— ± 0.5 db from 5 cycles to 2mc on gain of 10; ± 0.5 db on 5 cycles to 1.5mc on gain of 100; ± 0.8 db from 5 cycles to 1mc on gain of 1000 . . . Phase shift— $0 \pm 2^\circ$ from 20 cycles through 100kc . . . Gain stability—constant with line voltages (105-125v).



Prices: Single Type 500-A in cabinet, \$205.00 (Rack mount, \$200.00); Dual Type 500-AR in cabinet, \$425.00.

Technical catalog—yours for the asking. Contains detailed information on all TIC Instruments, Potentiometers and other equipment. Get your copy without obligation—write today.



TECHNOLOGY INSTRUMENT CORP.

531 Main Street, Acton, Massachusetts

Engineering Representatives Cleveland, Ohio PROspect 6171

Chicago, Ill.—Uptown 8-1141 Boonton, N.J.—Boonton 8-3097 Rochester, N.Y.—Munroe 3143
Cambridge, Mass.—ELiot 4-1751 Canaan, Conn.—Canaan 649 Hollywood, Cal.—HOLlywood 9-6305
Manhasset, N.Y.—Manhasset 7-3424 Dayton, Ohio—Michigan 8721

ZOPHAR

---WAXES
---COMPOUNDS

Anti-Corona high heat-resistant compounds for Fly Back Transformers.

Waxes and compounds from 100° F to 285° F Melting Points for electrical, radio, television, and electronic components of all types.

Pioneers in fungus-resistant waxes.

Our efficient and experienced laboratory staff is at your service.



ZOPHAR MILLS, INC.
112-130 26th Street,
Brooklyn 32, N. Y.



C.T.C. can get you "out from under!"

Long experience with the ever-increasing, constantly changing government specifications for electronic components has gained C.T.C. nationwide acceptance as a supplier to manufacturers handling U. S. contracts — especially for the armed forces.

With complete, up-to-date facilities for manufacturing electronic components in production quantities, C.T.C. meets the most exacting government standards for materials, tolerances, finishes, moisture prevention, anti-fungus treatment and similar requirements the government demands in the units you make.

Years of designing and manufacturing to government specifications enable us to handle *your* problems and save you time, money and worry! So, if "spec" problems are getting you down, why not unload them on recognized experts?

Here's What C.T.C. Can Furnish:

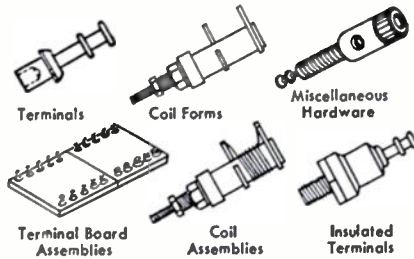

bottom wiring. Remove the screw and you can mount components directly to the screw end. Or you can adapt terminal to provide removable link connections at screw end. Unit is plated with bright alloy for corrosion resistance and easy soldering. Shank heavily knurled for secure mounting. Comes in three sizes. Send for more information.

SPECIAL CONSULTING SERVICE

To aid you in securing exactly the *right* components to meet the requirements of your designs, prototypes, etc., C.T.C. maintains a staff of thoroughly experienced component engineers. These experts will work closely with you for the most economical and satisfactory results — and where standard parts are not suitable will design special units. *This service is always available to you — without cost!*



Have You Seen This C.T.C. Combination Terminal?

With a screw on top and a terminal lug on the bottom, this combination simplifies top and

The New STAVER MINI-SHIELD

TRADE MARK REG. AND PAT. PEND.

The shield that fits all Miniature Tubes



A flexible shield that snugly fits all miniature tubes because it compensates for all variations in tube dimensions. Mini-Shields are made for both T5 1/2 and T6 1/2 bulb tubes. Send for catalog sheet.

THE Staver COMPANY
INCORPORATED
91 PEARL ST. • BROOKLYN 1, N. Y.
ULSTER 5-6303

CAMBRIDGE THERMIONIC CORPORATION

456 Concord Ave., Cambridge 38, Mass.

Please send me:

- More information on how C.T.C. can lighten my "spec" load.
- More information on C.T.C.'s cooperative engineering service.

More information on the following C.T.C. products:

Name..... Position.....
Firm.....
Street.....
City..... Zone..... State.....

custom or standard the guaranteed components

Another
**PRECISION
PRODUCT**



FOLLOW THE PARADE TO THE *New*

Burlington

Hermetically Sealed INSTRUMENT

**JUST PLAIN
RUGGED**
... yet an
instrument of
highest **QUALITY**
... **PRECISION**
... **ACCURACY**

The Burlington "Hermetically Sealed" Instrument was designed and is manufactured to conform to JAN specifications for sealed instruments.

- Steel case with heavy copper-cadmium plate and black finish.
- Excellent shielding due to case material and construction.
- Double strength clear glass.
- Black satin onodized aluminum bezel.
- Glass to metal seal under controlled humidity and temperature conditions.
- D'Arsonval permanent magnet type movement for DC applications
- Designed to enhance panel appearance.
- Available in 1 1/2" square, 2 1/2" and 3 1/2" round case types.
- Guaranteed for one year against workmanship and materials.



Best Buy Burlington

BURLINGTON INSTRUMENT COMPANY
DEPT. I-21, BURLINGTON, IOWA

INTERMODULATION METER *Model 31*



- **Completely Self-Contained**
- **Direct Reading For Rapid, Accurate Measurements**

To insure peak performance from all audio systems; for correct adjustment and maintenance of AM and FM receivers and transmitters; checking linearity of film and disc recordings and reproductions; checking phonograph pickups and recording styli; checking record matrices; adjusting bias in tape recordings, etc.

GENERATOR
LOW FREQUENCY: 60 cycles.*
HIGH FREQUENCY: 3000 cycles.*
LF/HF VOLTAGE RATIO: Fixed 4/1.
OUTPUT VOLTAGE: 10v. max. into high impedance or +5 DBM matched to 600 ohms.
OUTPUT IMPEDANCE: 2000 ohms.
RESIDUAL IM: 0.2% max.
 (*Other frequencies an special order)

ANALYZER
INPUT VOLTAGE: Full scale ranges of 3, 10 and 30 volts RMS. Less than one volt of mixed signal is sufficient for operation.
INPUT IMPEDANCE: Greater than 400 K ohms.
INTERMODULATION: Full scale ranges of 3, 10 and 30%.
ACCURACY: ±10% of full scale.
OSCILLOSCOPE connection at meter.

**MEASUREMENTS
CORPORATION**

BOONTON NEW JERSEY

You can
NOW BUY
TOWER LIGHTING EQUIPMENT

COMPLETE KITS
EVERYTHING NEEDED
for ANY Tower
150 to 900 Feet
Exposed or Conduit Wired

Don't let lack of some critical fitting hold-up completion of **YOUR JOB!**

H & P Lighting equipment, consistently specified by outstanding electronic engineers, is furnished as standard equipment by most leading tower manufacturers.



COMPLETE LIGHTING KITS
SAVE...
Purchasing Time!
Erection Time!
Completion Time!

**300 MM
CODE
BEACON**

Patented ventilator dome circulates the air, assures cooler operation, longer lamp life. Concave base with drainage port at lowest point.

**SINGLE and DOUBLE
OBSTRUCTION LIGHTS**

Designed for standard A-21 traffic signal lamps. Prismatic globes meet CAA specifications.



**MERCURY
CODE FLASHER**

No contact points to wear out. 14-52 flashes per minute.



**"PECA" SERIES
PHOTO-ELECTRIC
CONTROL**

Lights automatically, if any part fails.



PROMPT SERVICE and DELIVERY
Order through your jobber or Tower Manufacturer. We will send his name an request.

Send for **FREE Catalog**
Gives complete bill of material for each of our 7 kits, with itemized costs.

HUGHEY & PHILLIPS
TOWER LIGHTING DIVISION
326 N. LA CIENEGA BLVD.
LOS ANGELES 48, CALIF.
60 E. 42ND ST., NEW YORK 17, N.Y.

News—New Products

These manufacturers have invited PROCEEDINGS readers to write for literature and further technical information. Please mention your I.R.E. affiliation. (Continued from page 76A)

phones. The semilog meter covers two decades without range switch. Power supply is by storage type batteries. The instrument is calibrated from four to five mev.

The explosion proof ionization chamber instrument is a survey meter suitable for use in class 1, group D hazardous atmospheres. Indication of all types of radiation is on a standard 3½ inch instrument. It is pressurized to 15 pounds per square inch and has a pressure relief valve and pressure operated switches to open battery circuit upon loss of pressure. Conductive rubber bumpers insure against accumulation of electrostatic charge.

The beta-gamma survey meter utilizes two Geiger-Mueller tubes operating from an electronic high-voltage supply to provide high sensitivity over a wide range of levels. The compact unit features a scale changing meter, the selecting switch also selecting the G-M tube to be used for each of the four ranges from 0 to 500 milliroentgens per hour. A detachable probe also contains a G-M counter. Battery voltage is regulated electronically to provide long-term metering accuracy, and battery condition is indicated on a meter. The instrument is furnished calibrated in milliroentgens per hour using a radium source. Calibration of each range can be individually varied.

(Continued on page 80A)

Here's why those in the know

—demand

CANNON PLUGS

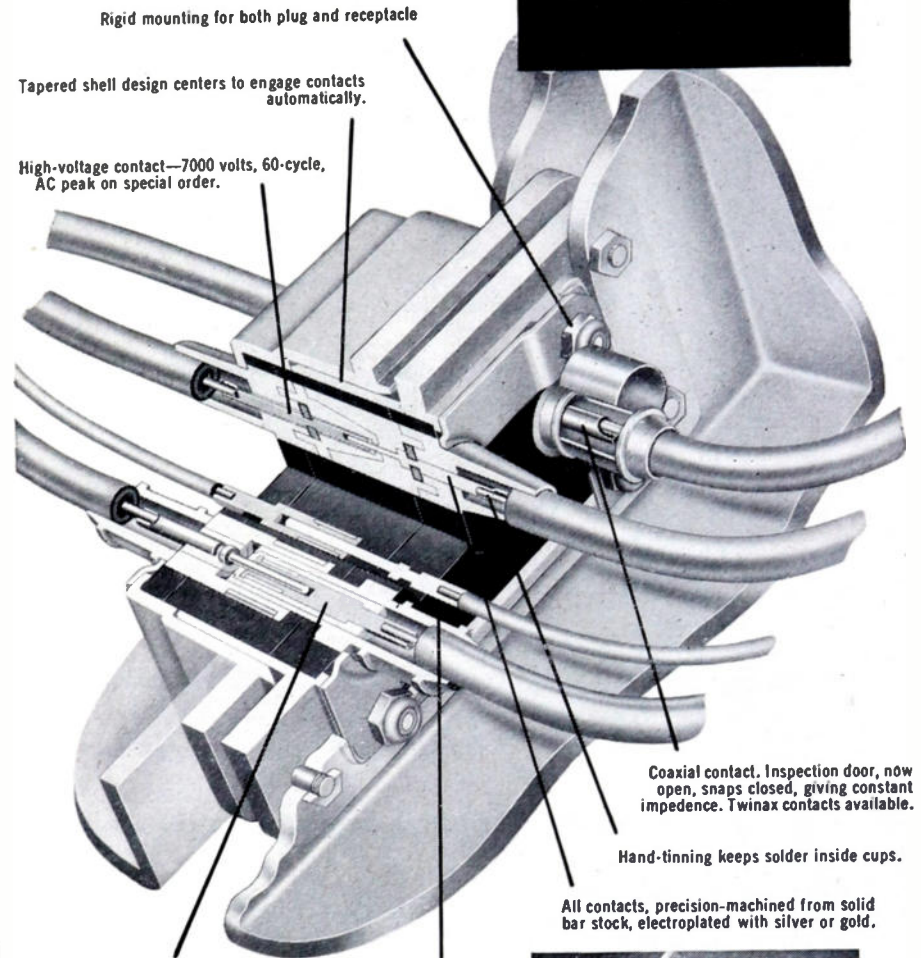

Rigid mounting for both plug and receptacle

Tapered shell design centers to engage contacts automatically.

High-voltage contact—7000 volts, 60-cycle, AC peak on special order.

Coaxial contact. Inspection door, now open, snaps closed, giving constant impedance. Twinax contacts available.

Hand-tinning keeps solder inside cups.

All contacts, precision-machined from solid bar stock, electroplated with silver or gold.

Socket contacts are full-floating—turn through 360°. Quick, self-centering—eases inspection.

Highly legible contact numbers on insert faces.

Inserts of latest approved high dielectric materials.

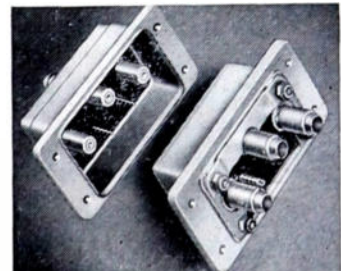

Insert arrangements are available with 2 to 45 contacts ranging from 15 amp to 200 amp capacity. Continuous shielding available in Coaxial and Twinax. Metal finish on shells for shielding and bonding . . . tin plating on aluminum. Other finishes available on special request.

SYNTRON SELENIUM RECTIFIERS

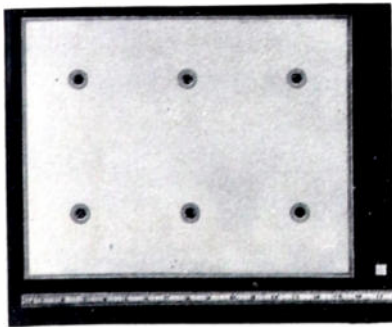

½" sq. to 12" x 16" cells—in stacks, or single cells for customer assembly.

Made by a new process to a uniform, high quality for continuous, heavy-duty service.

Write for literature

SYNTRON CO.

242 Lexington, Homer City, Pa.

Your requirements are responsible for the 8 to 10 design advantages found in each type of Cannon Plug. That's why engineers know the specification is right when it calls for CANNON. The DP Connector Series is just one of many Cannon types—world's most complete line. Request bulletins by required type or describe connector service you need.

CANNON ELECTRIC

Since 1915

LOS ANGELES 31, CALIFORNIA
REPRESENTATIVES IN PRINCIPAL CITIES

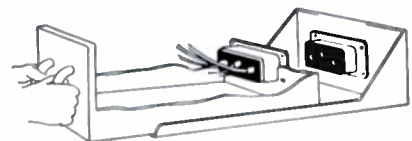

Type DPD Connectors are permanent installations in rack and panel equipment . . . mate automatically . . . have weight and space-saving advantages over other connector types.

S.S. White MOLDED RESISTORS

The All-Weather Resistors



ARE USED IN THIS ULTRA SENSITIVE ELECTRONIC PHOTOMETER

In this instrument—designed for measurement of very low light values—S.S. White Resistors serve as the grid resistance in the all-important high-gain D.C. amplifier circuit. The manufacturer, Photovolt Corp., New York, N.Y., reports that the resistors "work very satisfactorily"—which checks with the experience of the many other electronic equipment manufacturers who use S.S. White resistors.

WRITE FOR BULLETIN 4906

It gives essential data about S.S. White Resistors, including construction, characteristics, dimensions, etc. Copy with price list on request.

Photo courtesy of Photovolt Corp., New York, N.Y.



S.S. WHITE RESISTORS

are of particular interest to all who need resistors with inherent low noise level and good stability in all climates.

HIGH VALUE RANGE
10 to 10,000,000 MEGOHMS
STANDARD RANGE
1000 OHMS to 9 MEGOHMS

THE S.S. White INDUSTRIAL DIVISION
DENTAL MFG. CO.



Dept. G-R, 10 E. 40th St.
NEW YORK 16, N.Y.

News—New Products

These manufacturers have invited PROCEEDINGS readers to write for literature and further technical information. Please mention your I.R.E. affiliation.

(Continued from page 79A)

New Small Armature Winder

A new Model 36 armature winder, designed to wind small armatures and featuring an exclusive stationary armature, has just been announced by Geo. Stevens

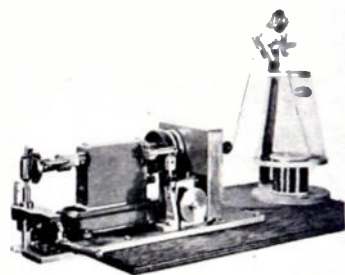

Mfg. Co., Inc., 6022 N. Rogers Ave., Chicago 30, Ill. Wire is fed through a hollow spindle to a revolving arm which winds wire in the armature slots, permitting armature to remain stationary so that it cannot fly out and injure the operator.

(Continued on page 83A)

FOR BETTER PERFORMANCE BETTER BUY

Acme  Electric
TRANSFORMERS

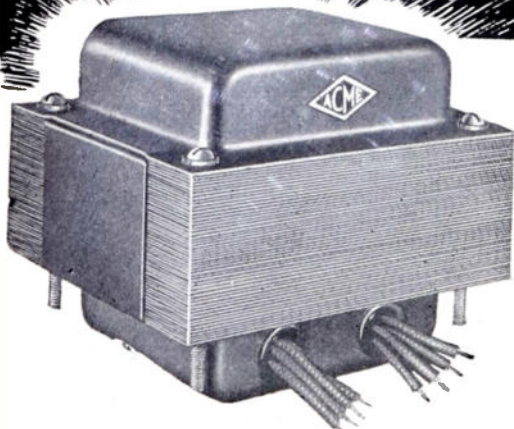

You write the specifications and Acme engineers will design a transformer with the exact output characteristics to provide "top" performance for your product. And remember, in addition to quality performance, Acme also can provide quality production in custom designed electronic transformers.

ACME ELECTRIC CORPORATION • 442 Water St., Cuba, N.Y., U.S.A.

don't fail
to see the
AMPEREX
advertisement
next month
announcing a
NEW
AMPEREX
TUBE

You'll find the details on the
inside front cover next month
. . . be sure to see them.

Acme  Electric
TRANSFORMERS

AMPEREX ELECTRONIC CORP.
25 WASHINGTON STREET, BROOKLYN 1, N. Y.
In Canada and Newfoundland: Rogers Majestic Limited
11-19 Brentcliffe Road, Leaside, Toronto, Ontario, Canada



ELECTRONICALLY REGULATED
**LABORATORY
 POWER SUPPLIES**



• STABLE
 • DEPENDABLE
 • MODERATELY PRICED
 •

- **INPUT:** 105 to 125 VAC, 50-60 cy
- **OUTPUT #1:** 200 to 325 Volts DC at 100 ma regulated
- **OUTPUT #2:** 6.3 Volts - AC CT at 3A unregulated
- **RIPPLE OUTPUT:** Less than 10 millivolts rms

MODEL 28
 STANDARD
 RACK
 MOUNTING

PANEL SIZE
 5 1/2" x 19"
 WEIGHT 16 LBS.

For complete information write
 for Bulletin G8



LAMBDA ELECTRONICS
 CORPORATION
 CORONA NEW YORK

Langevin

AMPLIFIERS



For broadcast, public address, recording, and music services — custom designs for special applications.

Langevin

TRANSFORMERS



Open-core, encased, hermetically sealed, high-temperature. Built to your own or MIL-T-27 specifications.

Langevin

ENGINEERING



Available for the development and manufacture of special electronic devices.

For detailed information on our products and services, write to

Langevin

MANUFACTURING CORPORATION
 37 W. 65th St., New York 23, N. Y.

P R E C I S I O N
 R E C O R D I N G W I T H T H E

Variplotter

MODEL 205



The Model 205 Variplotter, highlighting accuracy, speed, and versatility, brings to industry and laboratory a new tool with a wide field of application. This instrument will present on a 30-inch square plotting surface a precise graphic representation of one variable as a function of another variable, requiring only that the variables be expressed by d-c voltages.

ACCURACY

The static accuracy is .05 percent of full scale at 70°F. The dynamic accuracy averages .05 percent of full scale plus the static accuracy at a writing speed of 8 1/2 inches per second.

SENSITIVITY

The standard sensitivity of the Variplotter is fifty millivolts per inch with other ranges of sensitivity available.

RESPONSE

The maximum pen and arm accelerations are 350 and 150 inches per second squared, respectively. Slewing speeds of both pen and arm are 10 inches per second.

The Variplotter may be adapted for special use by the addition of accessories selected from our standard line—such as multiple variable conversion kits, low-drift d-c amplifiers, analog computer components; or components designed for your specific need.

YOUR INQUIRIES ARE CORDIALLY INVITED

ELECTRONIC ASSOCIATES, INC.

LONG BRANCH

NEW JERSEY

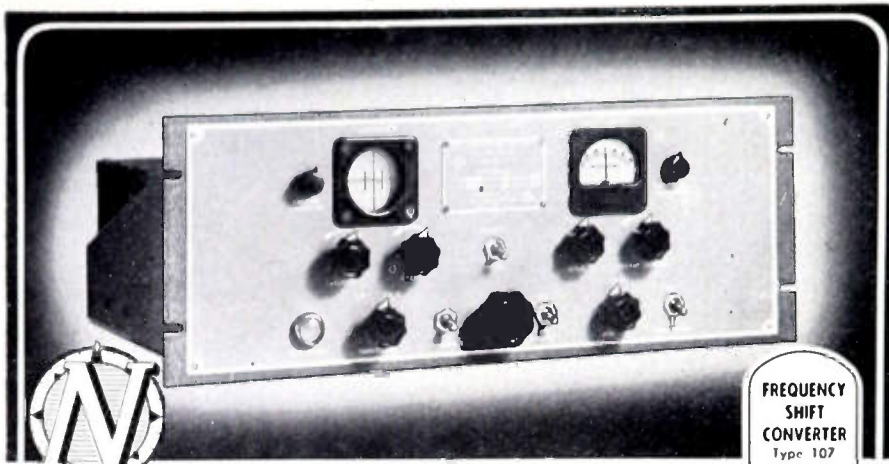

FREQUENCY
SHIFT
CONVERTER
Type 107
Model 2

BIGGEST PERFORMANCE—Smallest Size

Four exclusives are yours with the Northern Radio FREQUENCY SHIFT CONVERTER — utmost simplicity of operation, precision tuning, highest quality performance, and smallest size in the industry.

For single and diversity FS receiving systems, this dual channel unit converts mark and space tones into DC pulses, and drives teleprinters and other recorders directly. Its unique 2" oscilloscope provides the industry's most meaningful tuning pattern for precise receiver adjustment—during initial setup and while keying. Its specially designed limiter and discriminator afford an exceptionally high degree of performance. Polar or neutral output is available. Keying speeds up to 600 w.p.m. It's only 19" wide x 7" high x 15" deep.

This unit may also be used as a make and break CW or ICW demodulator.

See the specifications on this outstanding model in the 1950 IRE Directory. For complete data on the precision-built Northern Radio line, write today for your free latest Catalog P-3.

NORTHERN RADIO COMPANY, inc. : 143-145 West 22nd Street
: New York 11, N. Y.

Pace-Setters in Quality Communication Equipment

THE TWIN TUBE POCKETSCOPE

BY WATERMAN



MODEL
S-15-A

Wt. 16¼ lbs.
12" x 6" x 7"

A new concept in multiple trace oscilloscopy made possible by Waterman developed RAYONIC rectangular cathode ray tube, providing for the first time, optional screen characteristics in each channel. S-15-A is a portable twin tube, high sensitivity oscilloscope, with two independent vertical as well as horizontal channels. A "must" for investigation of electronic circuits in industry, school or laboratory.

Vertical channels: 10mv rms/inch, with response within -2DB from DC to 200kc, with pulse rise of 1.8µs. Horizontal channels: 1v rms/inch within -2DB from DC to 150kc, with pulse rise of 3µs. Non-frequency discriminating attenuators and gain controls, with internal calibration of traces. Repetitive or trigger time base, with linearization, from ½cps to 50kc, with ± sync. or trigger. Mu metal shield. Filter graph screen. And a host of other features.

WATERMAN PRODUCTS CO., INC.

PHILADELPHIA 25, PA.

CABLE ADDRESS: POKETSCOPE

WATERMAN PRODUCTS INCLUDE:

S-10-B GENERAL	POCKETSCOPE
S-11-A INDUSTRIAL	POCKETSCOPE
S-14-A HI-GAIN	POCKETSCOPE
S-14-B WIDE BAND	POCKETSCOPE
S-21-A LINEAR TIME BASE	

Also RAKSCOPES, LINEAR
AMPLIFIERS, RAYONIC® TUBES
and other equipment



E-I HERMETIC SEALING COMPONENTS

Announcing: AN IMPORTANT ADDITION
TO THE E-I FAMILY OF SEALED LEADS—

NEW R and RR SERIES TERMINALS



R-80W-PP
Current 16 amps.



RR-60W-HP
Current 10 amps.



RR-60W-PP
Current 10 amps.



R-90-TL
Current equal
to copper lead
+10 amps.

A completely new line of double barrel terminals that provide added protection against flashover without any appreciable increase in terminal size. The double barrel results in a longer leakage path on both ends of the terminal while the upper barrel increases the mechanical strength of the terminal and facilitates soldering. For information call or write today.

Write for These Descriptive Bulletins:

849 — Hermetically Sealed Terminals
850 — Hermetically Sealed Headers
851 — Gasket Type Bushings



ELECTRICAL INDUSTRIES

INCORPORATED

44 SUMMER AVENUE • NEWARK 4, N. J.

News—New Products

These manufacturers have invited PROCEEDINGS readers to write for literature and further technical information. Please mention your I.R.E. affiliation.

(Continued from page 80A)

The machine operates at high speed, winding 1,000 turns per minute on either straight or skewed armatures. Very tight armatures may be wound because of the uniform tension with which the wire is automatically guided and laid in the slots. Amount of tension is limited solely by the strength of the wire. Positive control over number of turns is attained by automatically winding a predetermined number of turns. Armature is also automatically indexed.

Frequency Shift Converter

A small frequency shift converter has been designed and manufactured by Northern Radio Co., Inc., 143 W. 22 St., New York 11, N. Y., for single and diversity receiving systems.

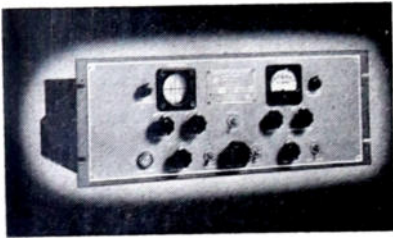

The Type 107 Model 2 is a dual channel unit which converts mark and space tones into dc pulses and drives teleprinters, tape and other recorders directly. Its integral 2-inch oscilloscope provides a tuning pattern for precise receiver adjustment, during initial setup and while keying.

This unit may also be used as a make and break cw or icw demodulator.

Other specifications of this unit are: input FS limits, 100- to 1,000-cps frequency shift; mark frequency set at 2,975 cps. The cw-icw input, 400 to 7,500 cps. Output (1) neutral dc pulses, 60 ma in 1,800 ohm load, one side grounded; (2) polar dc pulses, ± 30 ma in 1,800 load, center grounded; (3) may be operated into any impedance from 100 to 100,000 ohms.

Compact Four-Decade Audio Oscillator

The new Model 510-A audio oscillator, with a frequency range from 18 to 210,000 cps in four decades, is available from The Electronic Workshop, Inc., 351 Bleeker St., New York 14, N. Y.

The unit (dimensions $4 \times 5 \frac{1}{2} \times 4$ inches) will deliver 10 volts into 10,000 ohms, with output constant within 0.5 db over the entire frequency range. Distortion at this amplitude is less than 0.3 per cent from 100 to 15,000 cps and rises to no more than 0.5 per cent at 30 cps. Source impedance of the cathode-follower output is 560 ohms; a matching transformer will be made available to feed low-impedance balanced lines. The total frequency error due to drift and dial calibration is less than ± 2 per cent; the 320° dial gives a scale length

(Continued on page 84A)



Events are changing so rapidly from day to day that it is difficult to predict what will happen next . . . material may be restricted or abundant . . . prices may be higher or lower . . . deliveries may be better or worse . . . your guess is as good as ours. However, in spite of unsettled conditions, we may be in a position to give you just what you want. So send in your orders or call us when you need radio and electronics components or sheet metal products. We'll be honest with you and tell you exactly what we can do for you.

You will always make more sales and more profits when you sell BUD Products. First of all, you sell the highest quality, precision made parts. Second, you save time and money by getting so many of your items from one source of supply . . . because BUD makes the most complete line in the field. Third, you get more store traffic because BUD has the most "wanted" products. You will do a bigger business and have more satisfied customers when you standardize on BUD Products.

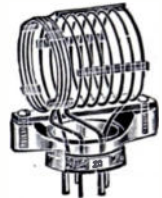

The Mark of
Perfection

BUD RADIO, Inc.

2110 East 55th Street

Cleveland 3, Ohio

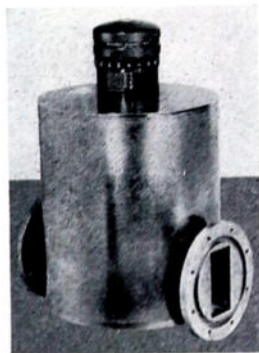

ONE OF OUR
PRECISION PRODUCTS

CAVITY WAVEMETER

Frequency Range 3700 to 4200 MC

Q over 20,000

MANUFACTURERS THREAD GRINDING, INC.

P. O. Box 66

EATONTOWN, N. J.

ASBURY PARK 1-1019

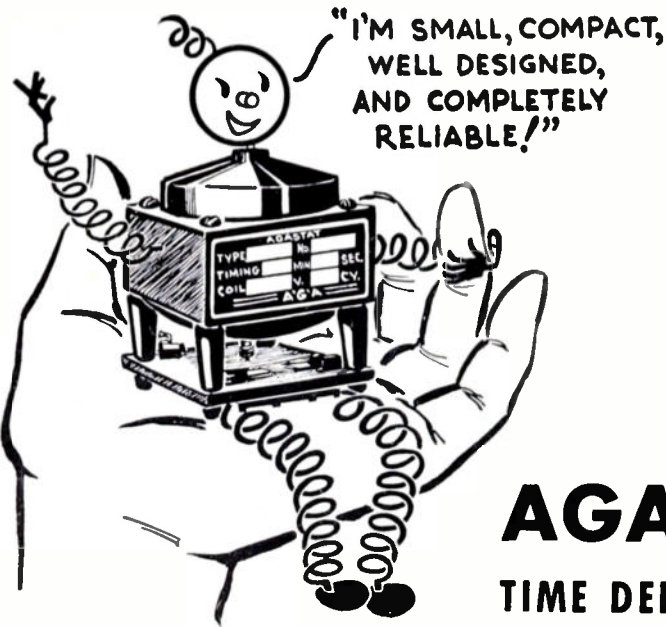

AGASTAT TIME DELAY RELAY

Solenoid actuated — pneumatically timed. For AC and DC service. A special diaphragm and cap encase the head, providing an enclosed, dustproof timing chamber in which the air used for timing is recirculated. Low cost with dependability.



AIRPORT LIGHTING



STINSONITE REFLECTORS



MARINE LIGHTING EQUIPMENT



AGASTAT TIME DELAY RELAY

AMERICAN GAS ACCUMULATOR COMPANY
1027 NEWARK AVENUE • ELIZABETH 3, N. J.

News—New Products

These manufacturers have invited PROCEEDINGS readers to write for literature and further technical information. Please mention your I.R.E. affiliation.

(Continued from page 83A)



of over eight inches. The output control is logarithmic and is calibrated approximately in output voltage.

Recent Catalogs

••• Allied Electric Products, Inc., and Sheldon Electric Co., Division, 68 98 Coit St., Irvington 11, N. J., have printed a comprehensive 1950-1951 catalog #161, with technical data and prices concerning electrical cords, plugs, female outlets, television tubes, and lamps.

A Wide Band Sweep With Markers For Aligning Radar IF Amplifiers. Displays Amplitude vs. Frequency Response on Standard Oscilloscope

Oscilloscope Display

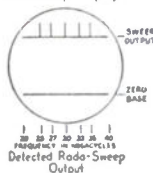

Oscilloscope Display

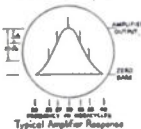

FEATURES:

- Increases Production Speed when substituted for conventional CW point-by-point methods
- Wide Band Linear Sweep
- Pulse Type Crystal Positioned Marks at Specified Frequencies
- Marks Individually Switched On or Off
- Output Amplitude Remains Virtually Constant While Sweeping
- Output Level Control on IF and Pulse Outputs



KAY

THE
RADA-SWEEP
•
NEW

Designed specifically for producing a constant amplitude frequency modulated signal for exploring the frequency response of Radar IF amplifiers. Frequency marks of pulse type are connected directly to oscilloscope and are not affected by IF amplifier under test. These marks are controlled by front panel switches which turn them on or off individually. Marks at any specified frequency can be supplied and frequency is changed by changing plug-in crystals. A wide or a narrow sweep may be selected by front panel switch.

Price: \$395.00 F.O.B. Factory with marks as above. Special marks at \$20.00 each. Prices 10% higher outside U.S.A. and Canada.

ENGRAVING

ROUTING

PROFILING

MODELING

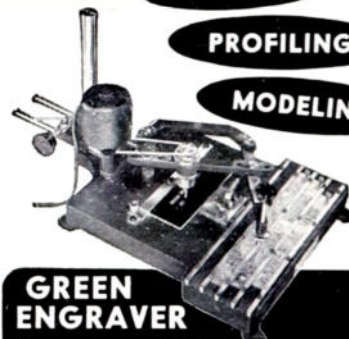

GREEN ENGRAVER

Proved Profitable —

Machine Tool, Radio, Electrical and Instrument Mfrs., Sales Promotion and Advertising.

Fast, rugged, convenient—and inexpensive. The Green Engraver is tops for low-cost performance—rips out precision work on metal, plastics or wood . . . cuts four lines of letters from 3/64" to 1" on curved or flat surfaces . . . operates by tracing . . . makes anyone an expert . . . engraves panels, name plates, scales, dials, molds, lenses and instruments. (Also widely used for routing, profiling and three dimensional modeling.) Electric etching attachment available.

Special attachments and engineering service available for production work.

FREE—Fact-packed folder. Send for yours today

GREEN INSTRUMENT CO.

GREEN

361 Putnam Ave.
Cambridge, Mass.

ELECTRIC

KAY

COMPANY

14 Maple Avenue

Pine Brook, N. J.

Phone CAldwell 6-4000



Universal dependability

The "Planet" trade name marks the most completely reliable line of popular type, dry electrolytic condensers that high-quality materials, the best workmanship, and long experience can produce.

All "Planet" Capacitors carry a 1-year replacement guarantee, are attractively packaged, and manufactured in specifications and mounts best suited to your needs.

For complete information write today for our latest catalog "C-2".



PLANET MFG. CORPORATION
 225 Belleville Ave.
 Bloomfield, New Jersey

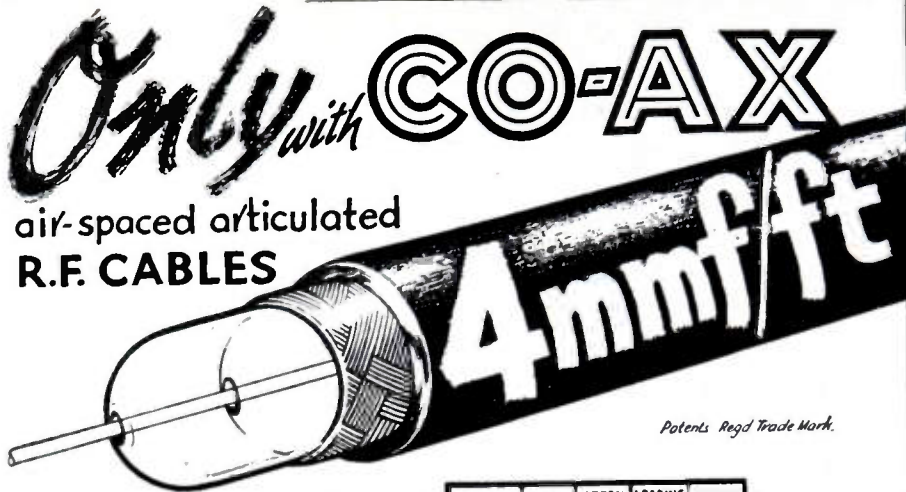

air-spaced articulated R.F. CABLES

Patents Regd Trade Mark.

THE LOWEST EVER CAPACITANCE OR ATTENUATION

We are specially organized to give SPOT DELIVERIES TO U.S.A Cable your rush order for shipment by air freight. Settlement by your own \$ check

LOW ATTEN TYPES	IMPED OHMS	ATTEN db/100ft of 100 Mc/s	LOADING μw	O.D"
A 1	74	1.7	0.11	0.36
A 2	74	1.3	0.24	0.44
A 34	73	0.6	1.5	0.88

LOW CAPAC TYPES	CAPAC mmf/ft	IMPED OHMS	ATTEN db/100ft 100Mc/s	O.D"
C 1	7.3	150	2.5	0.36
PC 1	10.2	132	3.1	0.36
C 11	6.3	173	3.2	0.36
C 2	6.3	171	2.15	0.44
C 22	5.5	184	2.8	0.44
C 3	5.4	197	1.9	0.64
C 33	4.8	220	2.4	0.64
C 44	4.1	252	2.1	1.03

HIGH POWER FLEXIBLE

PHOTOCELL CABLE

V.L.C. ★

TRANSRADIO LTD
 CONTRACTORS TO H.M. GOVERNMENT
 13BA CROMWELL ROAD, LONDON SW7, ENGLAND
 CABLES: TRANSRAD, LONDON.

★ Very Low Capacitance cable.

MODEL 300 VARIABLE ELECTRONIC FILTER

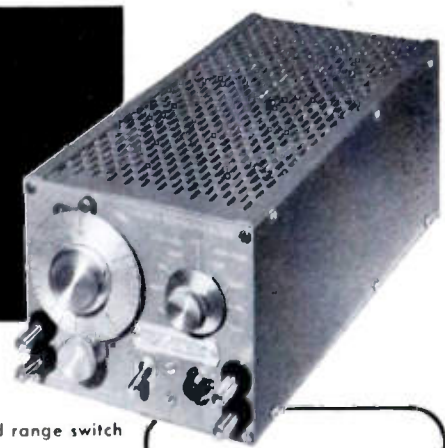

Two simple controls are all that are necessary to operate the Model 300 Variable Electronic Filter. With the variable frequency dial and range switch any cut-off frequency from 20 cps to 200 KC may be quickly and accurately selected and reselected. With the range switch either low-pass or high-pass filter action may be chosen. In either case the rate of attenuation is 18 db per octave and the insertion loss 0 db. For higher rates of attenuation or continuous band pass operation two or more sections can be cascaded. Its low noise level and flexibility of operation make the Model 300 indispensable in geophysical and acoustic research, industrial noise measurements, in the automotive and aircraft industries as well as the radio broadcasting, recording and motion picture studio.

Write for further information today.

SPECIFICATIONS

- CUT-OFF RANGE 20 cps to 200 KC
- ATTENUATION RATE 18 db per octave
- SECTIONS Single, can be high pass and low pass
- INSERTION LOSS 0 db
- PASS BAND LIMITS 2 cycles to 4 MC
- NOISE LEVEL 80 db below 1 volt

SKL SPENCER-KENNEDY LABORATORIES, INC.
 181 MASSACHUSETTS AVE., CAMBRIDGE 39, MASS.

NEY Precious Metals in Industry

YOUR DESIGN PROBLEM SIMPLIFIED WITH THE USE OF ONE OF OUR STANDARD CONTACTS

HEADED AND FORMED WIRE CONTACTS

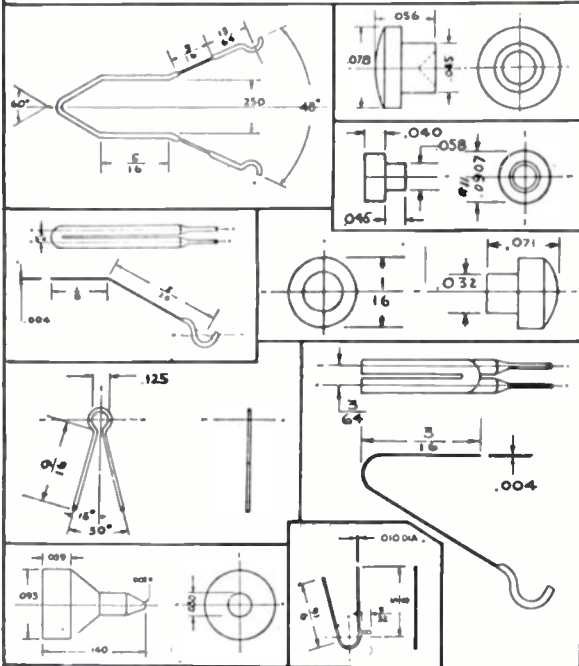

This simplified chart shows the form and overall dimensions of a few of the many types of contacts made from Ney Precious Metal Alloys with electrical and physical properties that have proved exceptionally satisfactory for brush or wiping contact applications. Full technical and test data are available on request. Other Ney Precious Metal Alloys have solved many special industrial application problems. Consult us freely without obligation.



Write or phone (Hartford 2-4271) our Research Department.

THE J. M. NEY COMPANY 171 ELM STREET • HARTFORD 1, CONN.
SPECIALISTS IN PRECIOUS METAL METALLURGY SINCE 1812

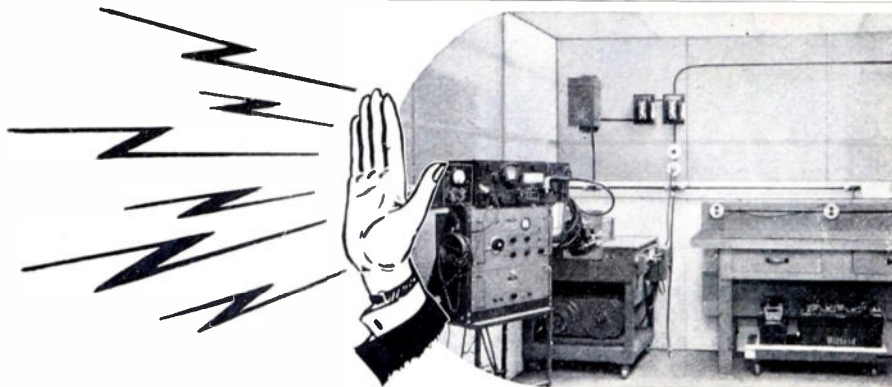

SUPPRESS RADIO INTERFERENCE ...Eliminate Errors in Critical RF Measurements

Reduce the area background level of radio interference to a negligible minimum for critical tests and measurements! Ace Pre-Built Screen Rooms are moderately priced—suppress interference far more efficiently than ordinary screen rooms or enclosures—and provide for a high degree of accuracy by eliminating gross systematic errors in your test setup and calculations. They're easy to install and easy to enlarge or move. Write, wire or 'phone for further details.



ATTENUATIONS of 100 to 140 db.
FROM 0.15 to 10,000 mc.

ACE ENGINEERING and MACHINE CO., INC.
3644 N. Lawrence St. Philadelphia 40, Pa.

Telephone:
REgent 9-1019

Where the Requirements are Extreme...

Use SILVER GRAPHALLOY

For extraordinary electrical performance



THE SUPREME BRUSH AND CONTACT MATERIAL

IN BRUSHES



- for high current density

- minimum wear



- low contact drop

- low electrical noise

- self-lubrication

IN CONTACTS



- for low resistance

- non-welding character



Graphalloy is a special silver-impregnated graphite

Accumulated design experience counts—call on us!

GRAPHITE METALLIZING CORPORATION

1001 NEPPERHAN AVENUE, YONKERS 3, NEW YORK

PARTRIDGE

the

AUDIO TRANSFORMERS

that pass
all tests!



The test of time, no less than test by leading technicians, has proved the range of Partridge Audio Transformers to be the most efficient and reliable in the world. For example the famous

*WILLIAMSON Output TRANSFORMER, of which there is no U.S. equivalent (vide "Audio Engineering" Nov. 1949) is produced to the original specification and comes to you for \$21.00, mail and insurance paid. Then there is the

*PARTRIDGE CFB 20 Watt output type, universally accepted as without rival anywhere. Here are some brief figures: Series leakage induct. 10 m.H; primary shunt induct. 130 H, with 'C' core construction and hermetically sealed—to you for \$30.00, mail and insurance paid.



Send for fullest data, including square wave tests, distortion curves etc. We'll rush this Air Mail together with list of U.S. stockists.



YOU CAN
JUDGE FOR YOURSELF

of the
RADIO

ENGINEERING SHOW, N.Y.

(STAND 363) March 19th-23rd 1951
where the range of Partridge Audio
transformers is being exhibited.

NOTE. We despatch by insured mail per return upon receipt of your ordinary dollar check.

Jobbers are invited to handle the transformer that the States is eager to buy—remember, immediate delivery from large stocks in New York!

PARTRIDGE TRANSFORMERS LTD.

ROEBUCK ROAD TOLWORTH
SURREY ENGLAND

DO YOU KNOW?

—that a PILOT LIGHT
CAN IMPROVE YOUR PRODUCT

... add attraction — safety — service?

Ask



- what lamp to use
- how to use it
- what it will do
- what it will cost

THIS MAY BE THE ONE
Designed for low cost NE-51 Neon

- Built-in Resistor • Patented
- U/L Listed • Rugged

Catalogue Number 521308 — 997
for 110 or 220 volts.

SAMPLES
for design purpose
NO CHARGE

NEW! Write for the
"HANDBOOK OF PILOT LIGHTS."
Write us on your design problems.



The DIAL LIGHT COMPANY of AMERICA

Foremost Manufacturer of Pilot Lights.

900 BROADWAY, NEW YORK 3, N. Y. TELEPHONE SPRING 7-1300

INCREASED ACCURACY

- SWEEPS .01 sec/cm to .1 μ sec/cm
Accuracy 5% or greater.
- .04 μ sec RISE TIME
- FULLY REGULATED POWER
SUPPLY.
- VOLTAGE CALIBRATOR
5% Full Scale Accuracy.



TEKTRONIX TYPE 511 AD OSCILLOSCOPE
Price \$845.00 f. o. b. Factory

Increased accuracy in sweep time calibration is made possible by the use of dual Sweep Multiplier dials. The 2 megohm variable carbon resistor formerly used has been replaced by a combination of 1% fixed resistors and a variable element which comprises only 10% of the total.

Electronic regulation of all DC voltages preserves the inherent accuracy regardless of severe line voltage variations.

Write for further information on the Type 511 AD
and other Tektronix instruments.



TEKTRONIX, INC.

712 S. E. Hawthorne Blvd. Portland 14, Ore.

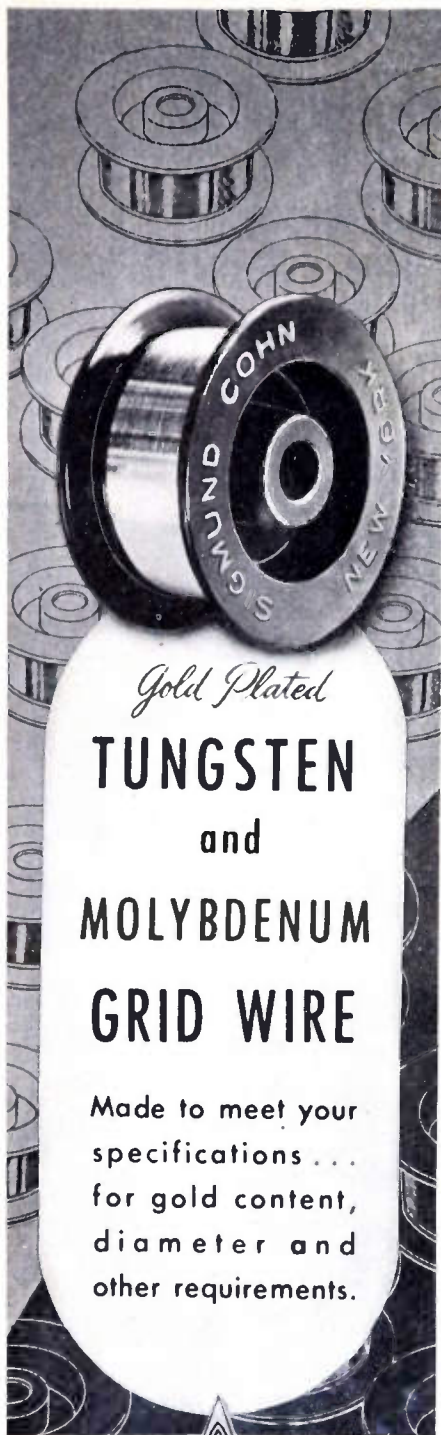

Gold Plated
TUNGSTEN
 and
MOLYBDENUM
GRID WIRE

Made to meet your specifications... for gold content, diameter and other requirements.

SINCE  1901

SIGMUND COHN CORP.
 44 GOLD ST. NEW YORK



NEW! FREQUENCY AND TIME MEASUREMENTS ACCURATELY . . . CONVENIENTLY!

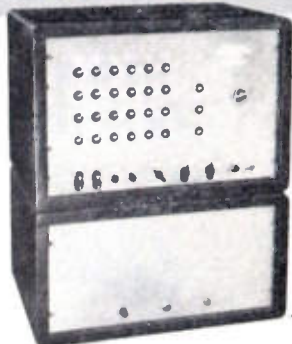

-using $f = \frac{N}{t}$

ANY FACTOR MAY BE MEASURED FOR FIXED VALUE OF THE OTHER

**Universal 6-in-One
 MEGACYCLE
 FREQUENCY-TIME
 COUNTER**

Model 801
 by **Potter**

Now, the Potter Instrument Company offers all in one equipment, the features heretofore available only in separate counting systems. Two complete counting channels, a 100 kc crystal oscillator time base and unique gating circuits are combined to provide the new FREQUENCY-TIME COUNTER.

FREQUENCY MEASUREMENTS	0 to 1 mc range by counting cycles per pre-selected time or by measuring time per pre-selected count Accuracy 0.001% minimum
TIME INTERVAL MEASUREMENTS	0 to 10 seconds \pm 10 micro-seconds.
FREQUENCY RATIO MEASUREMENTS	Ratio of two external frequencies can be measured.
SECONDARY FREQUENCY	100 kc crystal oscillator with divided frequencies available at 10, 1 kc and 100, 10, 1 cps
TOTALIZING COUNTER	Six decades, pulses 0 to 1 mc. sine wave 10 cps to 1 mc
DIRECT RPM READING TACHOMETER	Through the use of an external, 60 count per revolution photoelectric disc generator an accuracy of \pm 1 rpm is obtained.

Please address inquiries to Dept. 5-F



POTTER INSTRUMENT COMPANY
 INCORPORATED
 115 CUTTER MILL RD., GREAT NECK, NEW YORK

Announcing! A NEW, IMPROVED OVEN . . .
 the **JK07E**



With Thermostat Sealed In Helium

Here's another important JAMES KNIGHTS development, the JK07E Oven. It features a thermostat that's sealed in a glass envelope that has been filled with helium. Contact arcing is eliminated—temperature differential is greatly minimized by providing closer thermo-coupling to the thermostat! In addition, it's completely dust and tamper proof!

The new design results in greater frequency stability—longer life—greater reliability than is possible with mercury thermostats! The JK07E is available with either a 6.3 volt 10 watt heater, or a 115 volt 12 watt heater. It's broadcast, FM & TV, F.C.C. approved!

Additional JK07E Specifications

- Will hold any JK type crystal except H-6, H-18T and H-19
- Normal operating temperature 50° C \pm 2° C
- Will hold any temperature as much as 75° C above the ambient
- Supplied complete with Johnson No. 237 Socket

Also Ideal As Frequency Standard When Used With JK Stabilized H-18

The JK07E, when used with the JK H-18, 100 KC Crystal, or similar type, is also ideal for extremely accurate frequency measurements.

JK Stabilized H-18 Specifications

- Frequency Range: 80 KC to 2 MC
- Hermetically sealed metal holder
- Wire mounted silver plated crystal
- Octal base

Complete Information On Request



The James Knights Company
 SANDWICH, ILLINOIS

Behind the Scenes at the Radio Engineering Show

Power can be a problem at the annual Radio Engineering Show! It takes as much as 235 kw to run and light the exhibits in addition to the normal lighting of the halls.

A Caterpillar standby installation "saved the day" for IRE in March 1950. New York City was observing an amusement brown-out due to the coal strike when the last show opened. Faced with a power reduction to 25% of its needs, the Show turned to one of its exhibitors for help.

The Caterpillar Tractor Company of Peoria, Illinois, was exhibiting standby diesel power plants in the show. William C. Copp, Exhibits Manager, appealed to the firm for use of the model to be displayed, but found it was to be a non-operating, cut-away display unit. However, The Caterpillar Company flew in its standby experts and shipped units to carry the whole load—enough electric power generators to carry a small midwestern town.

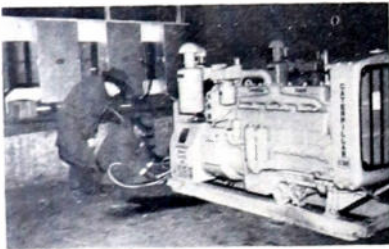

The picture shows Chief Engineer E. Olin switching in the first unit only twenty hours after the "Cats" left Peoria. The whole battery was composed of four 45 kw units and one 65 kw giant. The unit in the picture is a self-regulating ac 45 kw diesel generator.

The installation carried the load for two days. When the "brown-out" was lifted, standard power was resumed but only because five big diesels in a tiny court between two high buildings naturally were noisy. Another few hours and the big "residential mufflers" which arrived later, would have cured this.

The "Cats" solved a crisis in the nick of time and demonstrated conclusively that as exacting a power requirement as the Radio Engineering Show could be met. The Caterpillar Tractor Company contributed the entire installation and travel costs to IRE.

"A Parcel or Two!"



This is what that beautiful Amphenol exhibit looks like before it is all assembled. Floor crew handlers bring in 35,000 boxes, crates and packages to set up the Radio Engineering Show. About 180 truck loads of equipment worth over seven million dollars come into the show each year.

COMING AGAIN

September 1951

(Closing May 30)

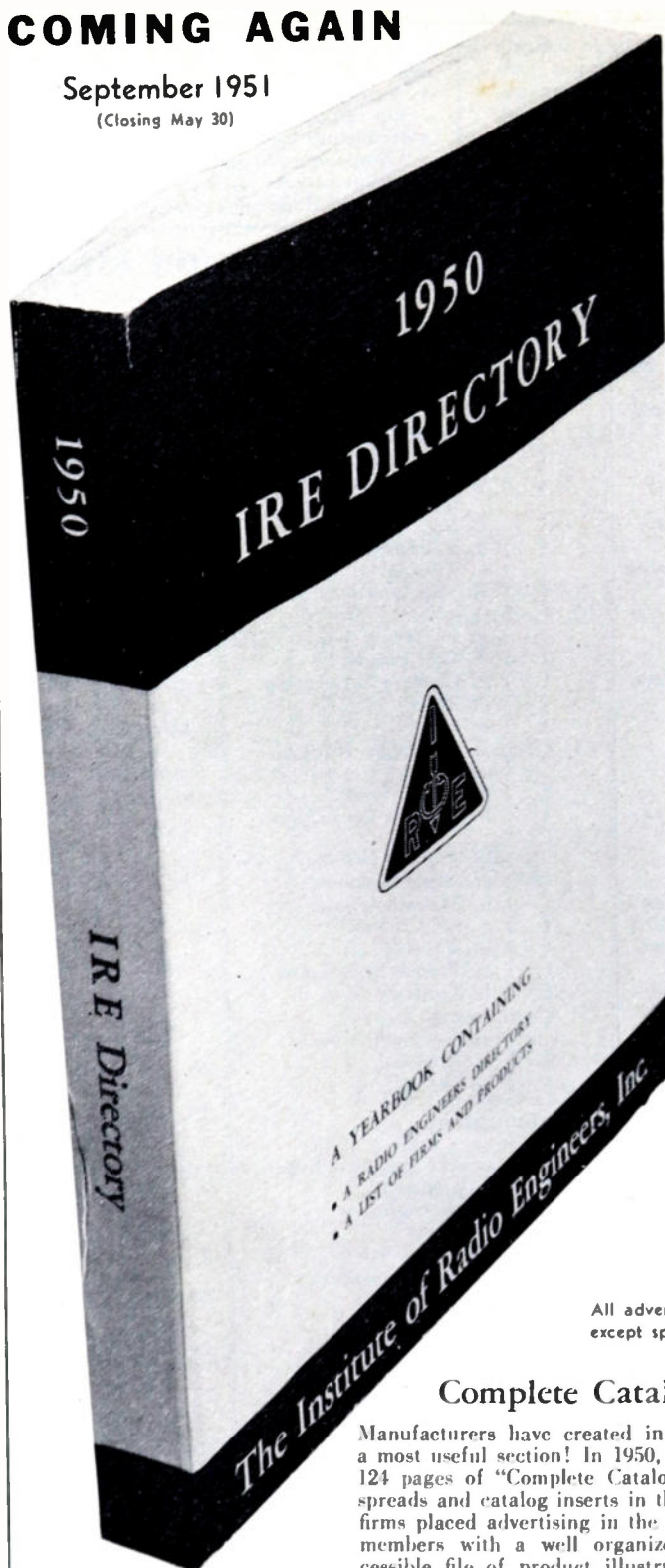

Weights
3 1/2 lbs.

712 PAGES

△
Lists 19,049
Engineers

△
Directory to
2500 Firms

△
Indexes 75
Engineering
Product Classes

△
Goes to Every
IRE Engineer.
Distributors
Edition 1500

△
Hundreds of sub-
classifications

△
FILL OUT
NEW 1951
PRODUCT
LISTINGS ON
NEXT PAGE

△
Size 8 1/2" x 11"
Print Page 7" x 10"

All advertising faces listings
except spreads and catalogs

Complete Catalog Section

Manufacturers have created in the IRE DIRECTORY a most useful section! In 1950, twenty-four firms placed 124 pages of "Complete Catalog Data" in the form of spreads and catalog inserts in this book. Altogether, 212 firms placed advertising in the directory, providing IRE members with a well organized and permanently accessible file of product illustrations, specifications and "where-to-buy" information of the utmost practical value.

- Rates for display advertising and for catalog inserts are economical. Write "Advertising Department" for details.

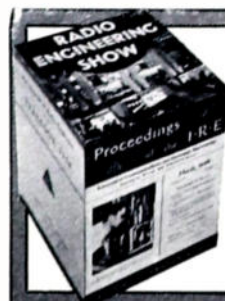

THE INSTITUTE OF RADIO ENGINEERS

Established  1913

A Balanced Promotion Package

**"Proceedings of the I.R.E." The IRE Yearbook
The Radio Engineering Show**

303 WEST 42nd STREET, NEW YORK 18, N. Y.

Circle 6-3026

I R E D I R E C T O R Y Q U E S T I O N N A I R E

Method to be used by firms to indicate products manufactured or services rendered. Please read the entire questionnaire. Products are grouped beneath basic headings to facilitate location. Immediately following each major product group is a space to check whether or not your firm carries this item in stock. Please indicate

this with every item you check off, no discrimination in your listing will result if you check "no."

Do not check products that you do not manufacture for sale to the industry.

Components manufactured for incorporation in your own end products (and not intended for sale) should not be listed,

as this will only result in annoyance to you, and the firms who make inquiries concerning product availability.

After checking off the products please fill in the coupon carefully and mail the entire form to: Frank MacAloon, Industry Research Div., Proceedings of I.R.E., 303 W. 42nd St., New York 18, N.Y.

Industry Research Division Information Service

1. **Amplifiers.**
In Stock () Yes () No.
() a. Broadcast Speech Input Equipment.
() b. Dynamic Noise Suppressors.
() c. High Fidelity.
() d. Inter-communication Systems.
() e. Medical Equipment.
() f. Peak Limiting.
() g. Phonograph Pre-amplifiers-equalized.
() h. Power Amplifiers.
() i. Pre-amplifiers.
() j. PA Systems.
() k. Recording Amplifiers.
() l. Television.
2. **Antennas.**
In Stock () Yes () No.
() a. AM Broadcast.
() b. Dummy.
() c. FM Broadcast.
() d. Miscellaneous.
() e. Receiving Types.
() f. Relay Systems.
() g. Television Broadcast.
() h. TV Multiple Outlet Distribution Systems.
() i. UHF-VHF
3. **Antenna Accessories.**
In Stock () Yes () No.
() a. Feeder Systems.
() b. Insulators.
() c. Phasing & Tuning Equipment.
() d. Support Towers.
() e. Tower Lighting Equip.
4. **Attenuators.**
In Stock () Yes () No.
() a. Audio Frequency.
() b. Radio Frequency.
5. **Batteries.**
In Stock () Yes () No.
() a. Flashlight & Miscellaneous Dry.
() b. Hearing Aid.
() c. Portable Radio.
() d. Storage.
6. **Blowers & Cooling Fans.**
In Stock () Yes () No.
7. **Books & Book Publishers.**
Bridges, see 67a.
8. **Cabinets & Consoles.**
In Stock () Yes () No.
() a. Metal.
() b. Plastic.
() c. Wood.
9. **Cable & Wire.**
In Stock () Yes () No.
() a. Coaxial Cable.
() b. Copper.
() c. Molybdenum.
() d. Precious Metal.
() e. Pre-formed Harnesses.
() f. Rubber Insulated.
() g. Shielded Types.
() h. Synthetic Insulated.
() i. Tungsten.
() j. UHF Types.
10. **Capacitors: Fixed.**
In Stock () Yes () No.
() a. Ceramics.
() b. Electrolytic.
() c. Mica.
() d. Oil Filled.
() e. Paper.
() f. Pressurized Gas.
() g. Printed Circuit.
() h. Vacuum.
11. **Capacitors: Variable.**
In Stock () Yes () No.
() a. Neutralizing.
() b. Precision.
() c. Temperature Frequency Compensating.
() d. Trimmers.
() e. Tuning.
() f. Vacuum.
12. **Ceramics.**
In Stock () Yes () No.
() a. Coil Forms.
() b. Custom Fabrication.
() c. Rods.
() d. Sheets.
13. **Chassis & Relay Racks.**
In Stock () Yes () No.
() a. Open Stock.
() b. Custom Fabrication.
14. **Coils.**
In Stock () Yes () No.
() a. AF Chokes.
() b. Miscellaneous.
() c. RF Chokes.
() d. Toroids.
() e. Transformer Coils.
() f. Tuning.
15. **Computers.**
In Stock () Yes () No.
() a. Analog.
() b. Digital.
Condensers, see 10 & 11.
16. **Connectors.**
In Stock () Yes () No.
() a. AN Standard Types.
() b. Coaxial.
() c. Microphone.
() d. Power.
Consoles, see 8.
17. **Consulting Engineers.**
() a. Accoustical.
() b. Electrical.
() c. Mechanical.
() d. Radio.
18. **Converters.**
In Stock () Yes () No.
() a. Frequency.
() b. Vibrator.
19. **Cores & Core Materials.**
In Stock () Yes () No.
() a. Complete Cores.
() b. Laminations.
() c. Powdered Metal.
20. **Crystals.**
In Stock () Yes () No.
() a. Germanium & Silicon, etc.
() b. Oscillating Quartz.
() c. Piezo-Electric.
21. **Crystal Holders.**
In Stock () Yes () No.
Discs, Recording, see 56a.
22. **Distribution.**
() a. Jobbers and Wholesalers.
() b. Manufacturers Representatives.
() c. Sales & Service.
Dynamotors, see 44a.
23. **Electronic Control Equipment.**
In Stock () Yes () No.
() a. Air Conditioning Controls.
() b. Burglar Alarm & Protection Devices.
() c. Combustion & Smoke Elimination.
() d. Fire Prevention & Detection.
() e. Production Controls, Counting & Sorting.
() f. Variable Speed Regulators.
() g. Voltage Control & Stabilization.
24. **Equalizers.**
In Stock () Yes () No.
() a. Dialogue.
() b. Line.
() c. Magnetic Reproducer Types.
() d. Sound Effects.
25. **Fabricators.**
() a. Contract Assemblers.
() b. Electro Plating.
() c. Hermetic Sealing Service.
() d. Metal Spinners.
() e. Plastic Moulders.
() f. Stampings.
() g. Other,
() Metal
() Laminated Plastic
26. **Facsimile Equipment**
In Stock () Yes () No.
27. **Filters.**
In Stock () Yes () No.
() a. Band Pass & Band Rejection.
() b. Dividing Networks.
() c. Noise Elimination.
Sound effects, see 24d.
Frequency Measuring Equip., see 43, 66, 69.
28. **Fuses & Fuse Holders.**
In Stock () Yes () No.
Generators, see 44c.
29. **Graphic Recorders.**
In Stock () Yes () No.
() a. Industrial.
() b. Medical.
30. **Hardware & Manufacturing Aids.**
In Stock () Yes () No.
() a. Adhesive Lables.
() b. Bushings.
() c. Cans.
() d. Dials.
() e. Gaskets.
() f. Gromets.
() g. Knobs.
() h. Metal Bolts, Nuts, Rivets, Screws, Studs.
() i. Terminals.
() j. Other.
31. **Induction Heating Equipment.**
In Stock () Yes () No.
() a. Manufacturing Processes.
() b. Medical Applications.
Inductors, see 14.
32. **Insulation.**
In Stock () Yes () No.
() a. Cloth.
() b. Glass.
() c. Mica.
() d. Paper.
() e. Plastic.
() f. Rubber.
() g. Synthetic.
() h. Varnished Cambric
33. **Jacks, Jack Fields, Plugs & Patch Cords.**
In Stock () Yes () No.
34. **Keys.**
In Stock () Yes () No.
() a. Switching.
() b. Telegraph.
Knobs, see 30g, 46c.
35. **Laboratories & Custom Builders of Equipment.**
36. **Lacquers & Paints.**
In Stock () Yes () No.
() a. Conducting & Magnetic.
() b. Finishing.
() c. Fungus Proofing.
() d. Moisture Proofing.
37. **Loudspeakers & Headphones.**
In Stock () Yes () No.
() a. Commercial Grade Loudspeakers.
() b. Headphones.
() c. High Fidelity Loudspeaking Systems.
() d. High Frequency.
() e. Low Frequency.
38. **Machinery & Tools.**
In Stock () Yes () No.
() a. Coil Winders.
() b. General Production Machy.
() c. Marking & Engraving Machy.
() d. Soldering Irons & Guns.
() e. Tube Machinery.
() f. Vacuum Pumps.
() g. Welders—Brazers.
() h. Other.
39. **Magnets.**
In Stock () Yes () No.
() a. Electro.
() b. Permanent.
Measuring Equipment, see 41, 66, 67, 68, 69.
40. **Metals: Base.**
In Stock () Yes () No.
() a. Copper.
() b. Ferrous.
() c. Non-ferrous, excluding Copper.
() d. Powdered.
() e. Precious & Rare.
41. **Meters.**
In Stock () Yes () No.
() a. Ammeters.
() b. Elapsed Time.
() c. Frequency Indicating.
() d. Voltmeters.
() e. Volume level Meters (db & vu).
() f. Wattmeters & Watt Hour Meters.
Vacuum tube Voltmeters, see 67i.
42. **Microphones.**
In Stock () Yes () No.
() a. Carbon.
() b. Condenser.
() c. Crystal.
() d. Magnetic.

- 3. Monitoring Equipment.**
In Stock () Yes () No.
() a. Frequency.
() b. Modulation.
() c. Television.
- 4. Motor Generators.**
In Stock () Yes () No.
() a. Dynamotors.
() b. Frequency Changers.
() c. Motor-Generators.
() d. Rotary Converters.
- 5. Motors: Very Small.**
In Stock () Yes () No.
() a. Blower Motors.
() b. Syncro Controls.
() c. Timing Devices.
- 6. Moulded Products & Services.**
In Stock () Yes () No.
() a. Cabinets.
() b. Insulators.
() c. Knobs & Parts.
() d. Proprietary Mouldings.
() e. Special Fabrication.
- 7. Optical Systems, Mirrors, Screens, & Accessories.**
In Stock () Yes () No.
Oscillators, see 66a, 69b, c, d, e.
- 8. Oscillographs & Accessories.**
In Stock () Yes () No.
() a. General Purpose, Cathode Ray.
() b. Recording.
() c. Recording Cameras.
() d. Synchroscopes, Cathode Ray.
() e. UHF C-R Equip.
Panels, see 13.
- 9. Phonograph & Transcription Reproducing Equipment.**
In Stock () Yes () No.
() a. Crystal Pick-ups.
() b. Magnetic Pick-ups.
() c. Phonograph Motors.
() d. Playback Arms.
() e. Record Changers.
() f. Styli.
() g. Turntables, complete.
Pre-Amplifiers, see 11.
- 10. Pilot Lights & Assemblies.**
In Stock () Yes () No.
() a. Incandescent.
() b. Neon.
- 11. Plastics.**
In Stock () Yes () No.
() a. Raw Powders, for Moulding.
() b. Rods.
() c. Sheets.
Plugs, see 16, 33.
- 12. Point To Point Communication Equipment.**
In Stock () Yes () No.
() a. Aircraft & Airport Equipment.
() b. Citizen Radio.
() c. Emergency Communications.
() d. Fleet Dispatching.
() e. Police & Fire Department Equipment.
() f. Ship to Shore Equip.
() g. Telemetering Equip.
- 13. Power Supplies.**
In Stock () Yes () No.
() a. Electrically Powered.
- () b. Gasoline Driven.
() c. Voltage Regulated Output types.
Printed Circuits, see, 10g, 36a, 60e.
- 54. Receivers.**
In Stock () Yes () No.
() a. Broadcast.
() b. Communications.
() c. Fixed Frequency.
() d. Frequency Modulation.
() e. Radar.
() f. Special Purpose.
() g. Television.
() h. UHF-VHF
Racks, see 13.
Radar, see 54e, 71d.
- 55. Recording Equipment.**
In Stock () Yes () No.
() a. Disc Recorders.
() b. Magnetic Tape Recorders.
() c. Magnetic Wire Recorders.
- 56. Recording Accessories & Supplies.**
In Stock () Yes () No.
() a. Blanks.
() b. Cutting Needles.
() c. Disc Recording Heads.
() d. Magnetic Recording Playback & Biasing Heads.
() e. Magnetic Recording Tape.
() f. Magnetic Recording Wire.
- 57. Rectifiers.**
In Stock () Yes () No.
() a. Metallic.
() b. Vacuum Tube.
Regulators, Voltage, see 74.
- 58. Relays.**
In Stock () Yes () No.
() a. Hermetically sealed.
() b. Instrument.
() c. Keying.
() d. Mercury.
() e. Power Control & Overload.
() f. Stepping.
() g. Telephone Types.
() h. Time Delay.
- 59. Remote Controlling Equipment.**
In Stock () Yes () No.
() a. Automatic Tuning Mechanisms.
() b. Flexible Shafts.
() c. Remote Controls.
() d. Switching Functions.
() e. Servo-Mechanisms.
- 60. Resistors.**
In Stock () Yes () No.
() a. Carbon Fixed.
() b. Carbon Variable.
() c. Potentiometers.
() d. Precision.
() e. Printed Circuit.
() f. Rheostats.
() g. Vacuum Sealed.
() h. Wire Wound, Fixed.
() i. Wire Wound, Variable.
- 61. Schools & Institutions, Technical.**
- 62. Sockets, Vacuum Tube.**
In Stock () Yes () No.
() a. Receiving Tube Types.
- () b. Transmitting Tube Types.
- () c. Underwriters Laboratories Approved Types.
- 63. Solder.**
In Stock () Yes () No.
() a. Acid Cored.
() b. Plain.
() c. Precious Metal.
() d. Pre-forms.
() e. Rosin Cored.
Speakers, see 37.
- 64. Switches.**
In Stock () Yes () No.
() a. Band Switches.
() b. Circuit Breaking.
() c. Key.
() d. Mercury Switches.
() e. Momentary Contact.
() f. Power.
() g. Precision Snap-Acting.
() h. Rotary.
() i. Time Delay.
() j. Toggle & Push Button.
- 65. Television Equipment.**
In Stock () Yes () No.
() a. Cameras.
() b. Camera Chains.
() c. Color Adaptors.
() d. Color Converters.
() e. Projectors.
() f. Studio Lighting Equipment.
() g. TV Tuners.
Also see, 11, 2g, h, 43c, 54g, 69d, 71f, and 72c, d, f, g.
- 66. Testing & Measuring Equipment: Audio Frequency.**
In Stock () Yes () No.
() a. Beat Frequency Oscillators.
() b. Distortion & Noise Analyzers.
() c. Intermodulation Distortion Analyzers.
() d. Resistance Capacity Oscillators.
() e. Square Wave Generators.
() f. Wave Form Analysis Equipment.
- 67. Testing & Measuring Equipment: General.**
In Stock () Yes () No.
() a. Bridges, all types.
() b. Capacitance Decades.
() c. Capacitor Testers.
() d. Multi-meters.
() e. Resistance Decades.
() f. Resistor Testers—Ohmmeters.
() g. Stroboscopes.
() h. Tube Testers.
() i. Vacuum Tube Voltmeters.
() j. Vibration Testing Equipment.
- 68. Testing & Measuring Equipment: Nuclear.**
In Stock () Yes () No.
() a. Dosimeters.
() b. Ionization Chambers.
() c. Scalers.
() d. Scintillation Counters.
- () e. Survey Meters, Geiger-Mueller tubes, see 72b.
- 69. Testing & Measuring Equipment: Radio Frequency.**
In Stock () Yes () No.
() a. "Q" Meters.
() b. Signal Generators, AM.
() c. Signal Generators, FM.
() d. Signal Generators, TV.
() e. Standard Frequency Generators & Multi-Vibrators.
() f. Sweep Generators & Calibrators.
() g. Wavemeters.
- 70. Transformers.**
In Stock () Yes () No.
() a. Audio Frequency.
() b. Hermetically Sealed.
() c. High Fidelity Audio.
() d. Power Components.
() e. Pulse Generating.
() f. Radio Frequency.
() g. Voltage Regulating.
- 71. Transmitters.**
In Stock () Yes () No.
() a. AM Broadcast.
() b. Communications.
() c. FM Broadcast.
() d. Radar.
() e. Special Types.
() f. TV Broadcast.
() g. UHF-VHF
- 72. Vacuum Tubes.**
In Stock () Yes () No.
() a. Cathode Ray.
() b. Geiger-Mueller.
() c. Iconoscopes.
() d. Image Orthicon.
() e. Industrial Types.
() f. Kinescopes, Black & White.
() g. Kinescopes, Color.
() h. Klystrons & Magnetrons.
() i. Phototubes.
() j. Pirani Tubes.
() k. Receiving Types.
() l. Rectifiers.
() m. Special Purpose.
() n. Thyratrons.
() o. Transmitting Types.
() p. Voltage Regulators.
- 73. Vacuum Tube Component Parts.**
In Stock () Yes () No.
() a. Anodes.
() b. Envelopes, Glass.
() c. Envelopes, Metal.
() d. Grids.
() e. Guns—Gun Parts.
() f. Pins—Prongs.
Varnishes, see 36.
- 74. Voltage Regulators.**
In Stock () Yes () No.
() a. Automatic.
() b. Manually Controlled.
- 75. Waveguides.**
In Stock () Yes () No.
() a. Couplings.
() b. Flexible Types.
() c. Rigid Types.
- 76. Waxes, Potting & Sealing Compounds.**
In Stock () Yes () No.

COUPON

Send to: Industry Research Div., Proceedings of the I.R.E.
Rm. 707, 303 West 42nd St., New York 18, N.Y.

Date

Firm Name: Phone No.

Address: Place Zone State

To whom in your organization should we direct correspondence concerning:

Product Data Advertising

IRE Yearly Convention

RADAR

SONAR

3000 MC BENCH TEST PLUMBING TEST EQUIPMENT

10 CM Wavemeter WE type H435400 Transmission Type, Type N Fittings, Vocoder Root Micrometer dial, Gold Plated W/Cath. Chart 170 Freq. Meter X100A, New \$89.50
 AS14/AP 10 CM Pickup Dipole with "N" Coaxial \$47.50
 LIGHTHOUSE ANSEMBLY, Part of RT-39 APG 5 & APG 15, Receiver and Trans. Cavities w/assort. Tr. Cavities and Type N C/PAG, To Rev. Used 2040, 2041, 1B27, Tunable APX 2400 2700 MC's Silver Plated \$49.50
 Beacon Lighthouse cavity 10 cm with miniature 28 volt DC FM meter, 3M, Bernard Rice \$47.50 ea.
 Magnetron to Waveguide Coupler with 721A Duplexer Cavity, gold plated \$48.00
 721A TR Box complete with tube and tuning plungers \$12.50
 McNally Klystron Cavities for 707B or 2K48, Three types available \$4.00
 F-26 SPR 2 Filters Type "N", input and output \$12.50
 720 Klystron Mnt Tunable output, to type "N" complete, with socket & M2, barbed \$12.50
 WAVEGUIDE TO "N" RIGHT COAX "DODGE" NO. 1 ADAPTER \$32.50
 CHOKE FLANGE, SILVER PLATED BROAD BAND \$32.50
 WAVEGUIDE DIRECTIONAL COUPLER, 20 db, Navy type CABY 47AAN with 1 in. slotted section \$32.50
 SQ. FLANGE to rd choke adapter, 18 in long QA 12 in x 1 in, guide, type "N" output and sampling probe \$27.50
 AN/APRCA 10 cm antenna equipment consisting of two 10 cm. waveguide sections, each polarized, 45 degree \$75.00 per set
 POWER SPLITTER 720 Klystron input dual "N" output \$5.00

MODULATOR UNIT BC 1203-B

Provides 2000 4,000 PPS Sweep time, 100 to 2,000 microsec. in 1 steps, fixed mod pulse sup precision pulse, sliding mod delay, bidirectional modulating, volt age, marker pulse, sweep volt ages, calibration voltages, 10 volts, Operates 115 vac 50 60 Hz Provides various types of voltage pulse outputs to the modulation of a signal generator such as Central Radio 4001B or 2501 used in depot bench test of SCR 505, SCR 505 and SCR 515 New a show \$125.00

COUPLINGS—UG-CONNECTORS

UG 10 U	\$.75	UG 40U	\$.70	UG 39 U	\$.60
UG 40A	\$1.10	7/8 Coax	\$.50	UG 10 U	\$.80
UG 44	\$2.35	3/4 Coax	\$.95	UG 15U	\$.75
UG 45	\$3.00	UG 53 U	\$4.00	UG 206U	\$.90
UG 125	\$2.00	UG 54 U	\$4.00	UG 87U	\$.125
UG 116	\$1.95	UG 55 U	\$4.00	UG 27U	\$.169
UG 117	\$2.50	UG 56 U	\$4.00	UG 21U	\$.89
UG 51	\$1.00	UG 65 U	\$.65	UG 17U	\$.225
UG 52	\$1.35	UG 149 U	\$.30	UG 29U	\$.90
UG 210	\$1.85	UG 142 U	\$4.00	UG 254U	\$.169
UG 212	\$2.40	UG 153 U	\$.30		

4000 to 6000 mcs. Bench Test Plumbing 2" x 1" WAVEGUIDE

SLOTTED LINE, Dornay Type 332 complete with choke etc. \$600.00
 FLAP ATTENUATOR \$48.00
 VARIABLE STUB TUNER AND LOW POWER TLR MOUNTING \$48.00
 WAVEMETER TEE \$48.00
 ADAPTERS \$18.00
 Choke to choke \$14.00
 Cover to cover \$16.00
 Choke to cover \$16.00
 WAVEGUIDE TO TYPE "N" ADAPTER \$45.00
 DIRECTIONAL COUPLER Two hole type, Type "N" out put \$48.00
 KLYSTRON MOUNT, Equipped with tunable termination and micrometer adjust, klystron antenna tuning \$110.00
 CRYSTAL MOUNT, Equipped with tunable termination and micrometer adjust crystal tuning \$125.00

23,000 TO 27,000 MC. BENCH TEST PLUMBING 1/2" x 1/4" WAVEGUIDE

PRECISION SLOTTED LINE, Adjustable probe \$200.00
 DIRECTIONAL COUPLER, Wave-meter Mount, 12DB \$60.00
 PRECISION VARIABLE ATTENUATOR, inf, Bernard Rice \$90.00
 LOW POWER LOAD \$20.00
 SHUNT TEE \$35.00
 WAVEGUIDE LENGTHS 2" to 6" long, goldplated with circular flanges and couplings, both \$2.25 per inch
 Right Angle Bend E or H Plane, specify combination of couplings desired \$12.00
 45° Bend E or H Plane, Choke

PULSE TRANSFORMERS

G.E.K.-2745 \$39.50
 G.E.K.-2744-A, 11.5 KV High Voltage, 3.2 KV Low Voltage @ 200 KW oper, 1250 KW max., 1 microsec or 1/2 microsec, @ 500 PPS \$39.50
 W.E. 1166173 11 Volt input transformer, W.E. Impedance ratio 50 ohms to 500 ohms, Freq. range: 10 kc. to 2 mc. 2 sections parallel connected, plated in oil \$36.00
 W.E. KS 9800 Input trans-

FUNABLE TERMINATION Precision adjust \$90.00

6000 Mc. to 8500 Mc. Bench Test Plumbing 1 1/2" x 3/4" WAVEGUIDE KLYSTRON MOUNT, DB556 complete with shield and tunable terminations \$125.00
 FLAP ATTENUATOR, DB551 \$45.00
 VARIABLE STUB TUNER \$90.00
 WAVEGUIDE TO TYPE "N" ADAPTER \$18.50
 WAVEMETER TEE DB551 \$32.50
 MAGIC TEE \$80.00
 DIRECTIONAL COUPLER Two hole 25DB coupling, Type "N" output \$25.00
 PRECISION CRYSTAL MOUNT, Equipped with tuning slugs and tunable termination \$125.00
 TUNABLE TERMINATION Precision adjust \$70.00
 LOW POWER LOAD \$30.00

To cover \$12.00
 Mt. Elbow, cov. to cov \$4.00
 TR/ATR Sect. choke to cov \$4.00
 Flex. Sec. 1" choke to choke \$5.00
 "S" Curve Choke to Cover \$5.00
 Adapter, ind. to sq. cov \$5.00
 Feedback to Parabola Horn with pressurized window \$27.50
 K Band Mixer Block \$45.00
 Waveguide 1/2 x 1/4" \$1.00 per ft.
 90° Twist \$10.00
 K Band Directional Coupler CU10/AP5 31 20 DB \$19.50 ea.
 Many Others

MAGNETRONS

Tube	
2127	
2131	
2121 A	
2122	
2126	
2132	
2137	
2138	
2139	
2140	
2149	
2134	
2161	
2162	
3131	
5130	
7144Y	
718DY	
720BY	
720CY	
725-A	
730-A	
728	
700	
706	
KLYSTRONS	
723A	
707B	
417A	
2K41	

TEST SETS

TS 12	
TS 13	
TS 33	
TS 35	
TS 56	
TS 45/APM3	
TS 62 3CM	
TS 108	
I-105A	
I-158	
I-233	
RC 438	
RF Preamp.	
G. R. 8rdg, #216	
G. R. Shunt #229	
G. R. Osc. #213	
TS 226A/AP	
Sig Gen #804	
BC 221	
TS 10A/AP	
TS 69/AP	
I-114	
I-126	
Meter 43A	
Sig. Gen. 788	
Megometer 0-5 Meg	
TS 1-49	
I-166	
Sig Gen 9.5-500 MC	
CY 81/AP	
TS 59/APN1	
CW 60/ABM	
BC 438	

SONAR SYSTEMS

QBF	
QBG	
QC	
QCJ	
QCL	
QCO	
QCS	
QCU	
WEA	

MICROWAVE ANTENNAS

An 122 Dipole Assy.	\$22.50
LP 21-A APF Loop W/Shaft and Housing, New	\$8.00
DBK Helium Toroid DF Loop	\$125.00
Adcock DF Arrays, Complete	\$65.00
NA Radar 200 MC Bed Springs Complete with Pedestal, Loop Drive	\$600.00
Dish for Parabola 30"	\$1.85
AP5 15 Antenna New	\$99.50
AN APG 1 Antenna, Rotary feed type high speed scanner antenna assembly, including horn parabola reflector, 1 a mounted mechanism, 10 db. circ. atten. Approx. 12.4 x 1.4 x 3.4" Flange (Gov't Cost \$1500.00)	\$283.00
AP5 4 3 cm antenna Complete 1 1/2" dish Outer feed dipole directional coupler all standard 1 1/2" x 1/2" waveguide, klystron and rear mechanisms for horizontal and vertical scan New, complete	\$65.00
AN/TPS: Parabola dish type reflector approx 10 diam. Extremely lightweight construction New in carrying cases	\$89.50
RELAY SYSTEM PARABOLIC REFLECTORS: approx range 200 to 6000 mc. Dimensions 1' x 2 1/2' to 10' x 3'	\$35.00
TDY "JAM" RADAR ROTATING ANTENNA, 10 cm 30 deg beam 115 vac drive New	\$100.00
DBM ANTENNA, Dual back to back parabolas with dipole, Freq coverage 1000 4500 mc. No drive mechanism	\$65.00
AS125 APR Com type receiving antenna 1080 to 3208 mc range New	\$4.50
140-600 MC. CONE type antenna complete with 25' sectional steel mast guys, cables carrying case, etc. New	\$19.50
ASD 1 cm antenna, 1000 to 4000 mc. cond	\$49.50
YAGI ANTENNA AS-46A, APG 1 7 elements	\$14.50 ea
AS17/AP5 10 CM Antenna APG 2 20 inch Dish with 7/8 Coax Dipole and fittings New and Comp. with 24 V DC Drive motor Nelson 300 Deck Rotation and Vertical TR	\$94.50
RC 221 Antenna, 10 CM, 30" Dish PZO, SCR 717 Radar Head and Complete	\$94.50

3/8" RIGID COAX—3/8" I.C.

3/8" rigid coaxial tuning stubs with vernier stub adjustment Gold Plated \$17.50
 3/8" RIGID COAX ROTARY JOINT, Pressurized, Sterilized, 50 Ohm Gold Plated \$27.50
 Direct assembly Part of SCR 581 \$25.00 ea.
 Rotary joint Part of SCR 581 \$35.00 ea.
 RIGHT ANGLE BEND with flexible coax output pickup \$8.00
 SHORT RIGHT ANGLE BEND, with pressurized nipple \$3.00
 RIGID COAX to flex coax connector \$3.50
 STUB-SUPPORTED RIGID COAX, gold plated 5' lengths \$5.00
 RT. ANGLES for above \$2.50
 RT. ANGLE BEND 15" L. OA \$2.50
 FLEXIBLE SECTION, 15" L. Male to female \$4.25
 MAGNETRON COUPLINGS to 3/8" rigid coax, with TR pickup loop, gold plated \$7.50
 FLEX COAX SECT. Approx. 30 ft \$16.50
 CG 54 U 4 foot flexible section 1/4" 10' pre sized \$15.00
 3/8" RIGID COAX, Bend Supported \$1.20
 SHORT RIGHT ANGLE BEND \$2.50

WAVEGUIDE

1/2" x 1/4" ID	\$1.00 per foot
1" x 1/2" OD	1.50 per foot
3/4" x 1 1/4" OD	1.65 per foot
6" x 1 1/4" OD Aluminum	.75 per foot
1 1/2" x 3" OD	3.00 per foot
2 1/2" x 3" OD	3.50 per foot
1" x 1 1/2" OD Flexible	4.00 per foot
7" x 1 1/2" OD 10' to 15 ft. lengths or smaller.	1.20 per foot
	\$8.50 each

WRITE FOR LISTING OF VARISTORS & THERMISTORS

3 cm. airborne radar designed for sector scan surface search, mapping and navigation, weather forecasting, intercepting of enemy aircraft. Entirely enclosed in a streamlined housing for optional mounting on aircraft bomb rack, or on nose of large bombers. Complete sets with indicator equipment, and power unit ready for installation, quantity available.

8500 Mc to 9600 Mc BENCH TEST PLUMBING 1 1/4" x 1/2" WAVEGUIDE

Variable Stub Tuner, DB556, 180 degree phase shifting capacity \$17.50
 Low Power Termination, DB581 \$70.00
 Uni-Directional Coupler, DB580 25 DB Type "N" output \$18.50
 Right Up Horn, Type "N" output \$18.50
 Wavemeter, 8500 to 9600 mcs., with calibration, Micrometer adjust head, Reaction type \$85.00
 Waveguide Length, 1 1/4" x 1/2" and fitted with couplings available in 6", 12", 24", 30", 48" sections \$2.00 per ft.
 90 Degree Elbow, E or H plane, 2 1/2" radius \$12.50
 90 Degree Twist, 6" long \$8.00
 Bulkhead Feed-Thru Assembly \$15.00
 Pressure Gauge Section, 15 lb. gauge and pressure nipple \$10.00
 Pressure Gauge, 15 lbs \$2.50
 Dual Oscillator-Beacon Mount, PZO AP510 Radar for mounting, two 720A/B klystron with crystal mix, matching slugs, shields \$42.50
 Dual Oscillator, Mount, tunable termination attenuating, slugs, with crystal mount, tunable \$18.50
 Directional Coupler, UG 49 U Take off 20 DB \$17.50
 Directional coupler, AP5 6 type "N" take off 20 DB calibrated \$17.50
 Rotary Joint, Choke to Choke \$10.00
 2K25/723 AB Receiver local oscillator Klystron Mount, complete with crystal mount, bias coupling, and choke coupling to TR \$22.50
 TR-ATR Duplexer section for above \$8.50
 Stabilizer cavity with bellows \$1.50
 3 cm. 90 bend with pressurizing nipple \$6.00 ea.
 3 cm. 90 bend, 14" long, 90 twist with pressurizing nipple \$6.00 ea.
 3 cm "S" curve 18" long \$5.50 ea.
 3 cm "S" curve 48" long \$5.50 ea.
 3 cm right angle bend, 48" plane 18" long cover to cover \$6.50 ea.
 3 cm cutter feed dipole 11" from parabola mount to feed 3 cm directional coupler One way waveguide output \$8.50 ea.
 Circular Choke Flange, solid brass \$15.00 ea.
 Sq. Flange, Flat Brass, solid brass \$5.00 ea.
 AP5 10 TR ATR Duplexer section with additional iris flange \$5.00 ea.
 "N" Band Preampifier, consisting of 2 722 A/B local oscillator beacon feeding waveguide and TR/ATR Duplex set, incl 60 db. IF amp \$47.50

SCR 515 RADAR TRAILER "L" BAND SEARCH—"S" BAND TRACK

All merch. guar. Mail orders promptly filled. All prices, F.O.B., N.Y.C. Send Money Order or Check. Only shipping charges sent C.O.D. Rated Concerns send P.O.

COMMUNICATIONS EQUIPMENT COMPANY

131 LIBERTY STREET, NEW YORK, N.Y. DEPT. 1-2

P. J. PLISNER PHONE: MAIN-1-0373

ADVERTISEMENT

HF and UHF power leakage positively and economically controlled by new gasket material

The unique combination of controlled resiliency, stability and conductivity found in Metex "Electronic Weather Stripping" makes it particularly effective as a shielding material for such electronic applications as radar equipment, high frequency heating, television broadcasting and high frequency communication.

It is available in strips or in die-formed gaskets of the shape, size and volume required by the particular application. Economical in cost, the use of this material permits further savings in assembly time and eliminates much costly machining of closure surfaces that would normally be required.



Metex "Electronic Weather Stripping"

The base material is a knitted—not woven—wire mesh which is made from any metal that can be drawn into wire. Knitting produces a mesh consisting of a multiplicity of interlaced loops which increase the normal resiliency of the wire and, by their hinge-like action, permit freedom of motion without loss of stability.

These characteristics are retained even when multiple layers of this mesh are compressed to form gaskets or strips. The result is a compressible, resilient, cohesive, conducting material with a large internal surface area. Where hermetic sealing is also required, these gaskets are made in combination with neoprene or similar materials.

Applications

Among the varied applications where Metex "Electronic Weather Stripping" has already proved its effectiveness and economy are: Air craft pulse modulator shields, wave-guide choke-flange gaskets, shielding metal housings, replacing beryllium-copper fingers and springs on TR or ATR tubes, and ignition shielding to prevent radio noise interference.

The facilities of our engineering department are available at any time to assist you in determining the possible adaptability of "Electronic Weather Stripping" to your specific requirements. A letter, addressed to Mr. R. L. Hartwell, Executive Vice President, and outlining briefly your particular problem, will receive immediate attention. No obligation, of course.

METAL TEXTILE CORP.

637 East First Ave., Roselle, N.J.

MICROLAB

ANNOUNCES A NEW LINE OF MICROWAVE PRODUCTS

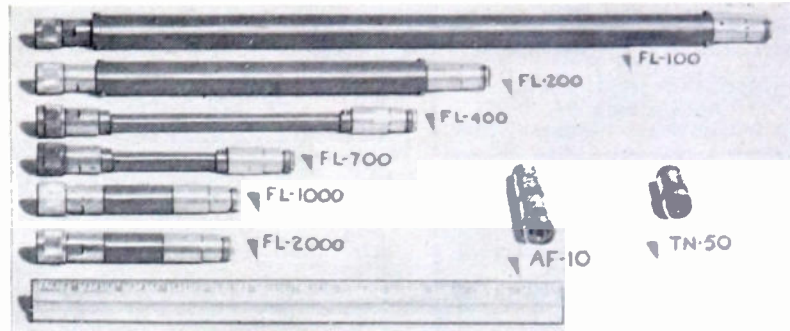

LOW PASS FILTERS			FIXED ATTENUATORS		LOW POWER TERMINATION
Type No.	Cut-off Freq.	Price	Type No.	Atten.	TYPE NO.
FL-100	100 Mc.	\$40	AF-3	3db	TN-50
FL-200	200	35	AF-6	6	IMPEDANCE
FL-400	400	30	AF-10	10	50 OHMS
FL-700	700	30	AF-20	20	MAX. POWER
FL-1000	1000	25	AF-30	30	1/2 WATT
FL-2000	2000	25	AF-40	40	PRICE \$10
Impedance—50 ohms			Impedance—50 ohms		
			Price—\$20		

AVAILABLE FROM STOCK—WRITE FOR TECHNICAL INFORMATION

MICROLAB

301 S. Ridgewood Rd.
South Orange, N.J.
South Orange 2-7422

Test Equipment FOR RADAR and PULSE APPLICATIONS

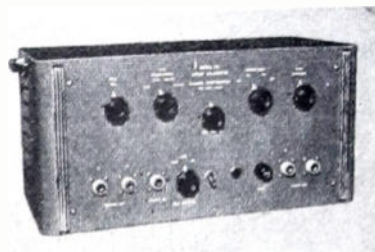

MODEL 712 SWEEP CALIBRATOR

Pip markers at 2.5, 10, 50, and 100 microseconds; spacings either positive or negative. Internal or external trigger from 200 cps to 3000 cps. Continuously variable gate on markers to 2500 microseconds. Accuracy within 0.2% with ambient of 10°C to 65°C. Calibrate directly from CW frequency standard. Power—115 volts 60 to 400 cycles, 85 volt-amperes.

MODEL 708 SPECTRUM ANALYZER

Frequency range—8500 mc to 9600 mc. Receiver—Double conversion superheterodyne. IF bandwidth—approximately 10 kc. Sweep frequency—10 cps to 25 cps. Minimum frequency dispersion—1 mc/inch. Maximum frequency dispersion—10 mc/inch. Signal input attenuator—100 db linear. Power—115V or 230V, 50 cps to 800 cps.

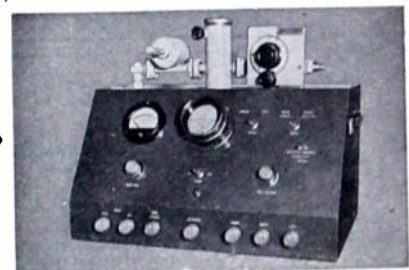

Write for complete technical data

Canoga Corporation

14315 Bessemer St., Van Nuys, Calif. • Box 361

PROFESSIONAL CARDS

INDEX AND DISPLAY ADVERTISERS

Section Meetings	36A
Student Branch Meetings	42A
Membership	48A
Position Open	50A
Positions Wanted	63A
New—New Products	18A

DISPLAY ADVERTISERS

Ace Engineering & Machine Co., Inc.	86A
Acme Electric Corp.	80A
Aircraft Radio Corp.	28A
Airtron, Inc.	44A
Allen-Bradley Co.	41A
American Gas Accumulator Co.	84A
American Lava Corp.	25A
American Phenolic Corp.	23A
Amperex Electronic Corp.	80A
Andrew Corp.	46A
Antara Prods. Div. of General Dyestuff Corp.	30A & 31A
Arnold Engineering Co.	19A

Lester W. Bailey	94A
Ballantine Labs., Inc.	38A
Alfred W. Barber	94A
Bead Chain Mfg. Co.	70A
Bell Aircraft Corp.	52A
Bell Telephone Labs., Inc.	4A
Bendix Aviation (Radio Div.)	56A
Bendix Aviation (Red Bank Div.)	57A
Berkeley Scientific Corp.	69A
Boonton Radio Corp.	95A
Breeze Corp., Inc.	72A
Harold J. Brown	94A
W. J. Brown	94A
Browning Labs., Inc.	48A
Bud Radio, Inc.	83A
Burlington Instrument Co.	78A
Cambridge Thermionic Corp.	77A
Cannon Elec. Development Co.	79A
Canoga Corp.	93A
Capehart-Farnsworth Corp.	50A
Capitol Radio Engineering Inst.	95A
Centralab	33A, 34A & 35A
C. P. Clare & Co.	27A
Clarostat Mfg. Co., Inc.	45A
C. G. S. Laboratories, Inc.	65A
Cleveland Container Co.	13A
Sigmund Cohn Corp.	88A
Communication Prods. Co.	71A
Communications Equipment Co.	92A
E. J. Content	94A
Cornell-Dubilier Electric Corp.	Cover III
Crosby Labs.	94A
Daven Co.	61A
Dial Light Co. of America, Inc.	87A
Allen B. DuMont Labs., Inc.	12A, 73A
E. I. DuPont de Nemours & Co.	54A
Eitel-McCullough, Inc.	16A
Electrical Industries	82A
Electrical Reactance Corp.	17A
Electro-Motive Mfg. Co.	21A
Electronic Assoc.	81A
Electro Search	94A
Elk Electronics	94A
Formica Co.	18A
W. L. Foss	94A
Freed Radio Corp.	50A
Fusite Corp.	11A
General Ceramics & Steatite Co.	49A
General Elec. Co.	3A, 53A & 58A
General Precision Labs.	29A
General Radio Co.	Cover IV

WHEELER LABORATORIES, INC.
 Radio and Electronics
 Consulting — Research — Development
 R-F Circuits — Lines — Antennas
 Microwave Components — Test Equipment
 Harold A. Wheeler and Engineering Staff
 Great Neck, N.Y. Great Neck 2-7806

LESTER W. BAILEY
 Registered Patent Agent
 Senior Member IRE
PATENT OFFICE PRACTICE specializing in
 ELECTRONICS MECHANICS
 RADIO
LINCOLN-LIBERTY BUILDING
 PHILADELPHIA 7
 Broad & Chestnut Streets Rittenhouse 6-3267

ALFRED W. BARBER
LABORATORIES
 Specializing in the Communications Field and
 in Laboratory Equipment
 Offices, Laboratory and Model Shop at:
 32-44 Francis Lewis Blvd., Flushing, L.I., N.Y.
 Telephone: Independence 3-3306

HAROLD J. BROWN
Vibrators
 Vibrator Power Supplies
 Electrical Contact Systems
 Mattapoisett, Mass.

W. J. BROWN
 International Electronics Consultant
 AT PRESENT IN GREAT BRITAIN
 Will undertake assignments for American or
 British Clients. Please address inquiries to 11
 Public Square, Cleveland 13, Ohio.
 TO 1-6498 FA-1-0030

EDWARD J. CONTENT
Acoustical Consultant
Functional Studio-Theater Design
 On contractual foreign assignment with In-
 ternational Standard Electric Corporation un-
 til January 1, 1952.
 STAMFORD, CONN.

CROSBY LABORATORIES, INC.
 Murray G. Crosby & Staff
 Radio-Electronic Engineering,
 Research & Development
 FM, Communications, TV
 Test Equipment
 Offices, Laboratory & Model Shop at:
 126 Herricks Rd., Mineola, N.Y.
 Garden City 7-0284

Richard B. Schulz
Electro-Search
 Radio-Interference Reduction;
 Development of
 Interference-Free Equipment,
 Filters, Shielded Rooms
 515 W. Wyoming Ave., Philadelphia 40, Pa.
 Gladstone 5-5353

ELK ELECTRONIC LABORATORIES
 Jack Rosenbaum
 Specializing in the design and
 development of
 Test Equipment for the communications,
 radar and allied fields.
 333 West 52nd St. Telephone:
 New York 19, N.Y. PLAZA 7-0520

WILLIAM L. FOSS, INC.
 927 15th St., N.W. Rpublic 3883
 WASHINGTON, D.C.

PAUL GODLEY CO.
Consulting Radio Engineers
 P.O. Box J, Upper Montclair, N.J.
 Offs & Lab.: Great Notch, N.J.
 Phone: Montclair 3-3000
 Established 1926

HERMAN LEWIS GORDON
 Registered Patent Attorney
 Patent Investigations and Opinions
 Warner Building 100 Normandy Drive
 Washington 4, D.C. Silver Spring, Md.
 National 2497 Shepherd 2433

HOGAN LABORATORIES, INC.
 John V. L. Hogan, Pres.
**APPLIED RESEARCH, DEVELOPMENT,
 ENGINEERING**
 Est. 1929. Exceptionally competent staff. Elec-
 tronics, Optics, Mechanisms, Facsimile Com-
 munication, Electro-sensitive recording media,
 Instrumentation.
 155 Perry Street, New York 14 Chelsea 2-7855

MEASUREMENTS CORP.
 RESEARCH & MANUFACTURING
 ENGINEERS
 Harry W. Houck Jerry B. Minter
 John M. van Beuren
 Specialists in the Design and
 Development of Electronic Test Instruments
 BOONTON, N.J.

Eugene Mittelmann, E.E., Ph.D.
Consulting Engineer & Physicist
 High Frequency Heating—Industrial Electronics
 Applied Physics and Mathematics
 549 W. Washington Blvd. Chicago 6, Ill.
 State 2-8021

PICKARD AND BURNS, INC.
 Consulting
Electronic Engineers
 240 HIGHLAND AVE.
 NEEDHAM, MASS.

SERVO
CORPORATION OF AMERICA
 Henry Blackstone, President
 Consultants on
 Electronic Control Problems
 for Industry
 New Hyde Park Long Island, N.Y.

TECHNICAL
MATERIEL CORPORATION
 COMMUNICATIONS CONSULTANTS
 RADIOTELETYPE - FREQUENCY SHIFT
 INK SLIP RECORDING - TELETYPE NETWORKS
 121 Spencer Place, Mamaroneck, N.Y.

TELREX, INC.
 M. D. Ercolino, Pres.
H. F. ANTENNA SPECIALISTS
 • The Skill to Design
 • The Facilities to Produce
 • The Ability to Deliver
 Asbury Park, N.J.—Phone AP 2-7252

SPECIAL LEADERSHIP TRAINING
for the Technical Man Who Wants to
Advance to a Supervisory or Managerial Job

Holmes

INSTITUTE

Established and Endorsed by CAPITOL
RADIO ENGINEERING INSTITUTE Pioneer
Electronics Technical School since 1927

● Investigate today: Holmes new
streamlined methods for adding
management-know-what to your
technical know-how.

● Write for full information
& free catalog: Dept. 262C
3308 14th St., N.W., Washington 10, D.C.

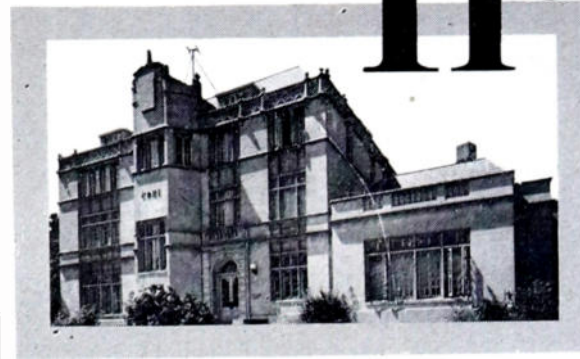

Paul Godley	94A
H. L. Gordon	94A
Graphite Metallizing Corp.	86A
Green Instruments Co.	84A
Guardian Electric Co.	5A
Helipot Corp.	15A
Hewlett-Packard Co.	7A
Hogan Labs.	94A
Johns Hopkins University	52A
Hughes Aircraft Co.	54A
Hughey & Phillips	78A
International Resistance Co.	8A & 9A
Jacobs Instrument Co.	58A
Jeffers Electronics, Inc.	39A
JFD Mfg. Co.	43A
Kay Electric Co.	84A
Kings Electronics	63A
Kings Microwave Co., Inc.	62A
James Knights Co.	88A
Krohn-Hite Instrument Co.	95A
Laboratory for Electronics	51A
Lambda Electronics	81A
Langevin Mfg. Corp.	81A
Lockheed Aircraft Corp.	56A
Lord Mfg. Co.	74A
Magnecord, Inc.	22A
P. R. Mallory & Co., Inc.	14A
Manufacturers Thread Grinding, Inc.	83A
Glenn L. Martin Co.	56A
W. L. Maxson Corp.	54A
Measurements Corp.	78A & 94A
Melpar, Inc.	62A
Metal Textile Corp.	93A
Microlab	93A
Eugene Mittleman	94A
Mycalex Corp. of America	59A
Nat'l. Union Radio Corp.	56A
New York Transformer Co., Inc.	64A
J. M. Ney Co.	86A
North American Aviation	60A
Northern Radio Co., Inc.	82A
Ohmite Mfg. Co.	20A
Panoramic Radio Prods., Inc.	72A
Partridge Transformers, Ltd.	87A
Pickard & Burns	94A
Planet Mfg. Corp.	85A
Polytechnic Research & Development Co.	54A
Potter Instrument Co.	88A
Presto Recording Corp.	68A
Radio Corp. of America	32A & 96A
Revere Copper & Brass, Inc.	26A
Sandia Corp.	50A
Servo Corp. of America	94A
Shallcross Mfg. Co.	24A
Sheldon Electric Co.	47A
Shure Brothers, Inc.	60A
Simpson Electric Co.	67A
Sorensen & Co.	42A
Spencer-Kennedy Labs.	85A
Sperry Gyroscope Co.	58A
Sprague Electric Co.	2A
Stackpole Carbon Co.	10A
Staver Co.	77A
Geo. Stevens Mfg. Co., Inc.	40A
Stoddart Aircraft Radio Co.	36A
Sylvania Electric Prods., Inc.	52A
Syntron Co.	79A
Sarkes Tarzian, Inc.	75A
Technical Materiel	94A
Technology Instrument Corp.	76A
Tektronix, Inc.	87A
Telrex, Inc.	94A
L. H. Terpening Co.	70A
Transradio, Ltd.	85A
Triplet Electrical Instrument Co.	37A
Truscon Steel Co.	6A
United Transformer Co.	Cover II
University of Michigan	58A
Waterman Prods. Co.	82A
Westinghouse Elec. Corp.	58A
H. A. Wheeler Labs.	94A
S. S. White Dental Mfg. Co.	80A
Wilcox Electric Co.	55A
Workshop Assoc., Inc.	66A
Zophar Mills, Inc.	77A



MODEL 350-A

ULTRA-LOW FREQUENCY REJECTION FILTER

variable from 0.02 to 2,000 cps

FEATURING: ADJUSTABLE CENTER FREQUENCY AND BAND WIDTH • BAND REJECTION OR SHARP NULL FILTERING • 24 DB/OCTAVE SLOPE • CORNER FREQUENCY PEAKING • LOW INTERNAL NOISE

DESCRIPTION: Provides either a rejection band in which the gain falls at a rate of 24 db/octave or a sharp single frequency null. Especially useful for vibration studies, for electro-medical research and geophysical and seismological instrumentation.



KROHN-HITE INSTRUMENT CO.
580 MASSACHUSETTS AVE., CAMBRIDGE 39, MASS., U.S.A.

SPECIFICATIONS:

BAND WIDTH: Sharp null, or continuously variable to maximum width, from 0.02 to 2,000 cps.
FREQUENCY RANGE: High and low cut-off frequencies independent, from 0.02 to 2,000 cps.
NULL: Continuous from 0.1 to 500 cps.
SLOPE: 24 db/octave with peaking at cut-off frequencies.
INTERNAL NOISE: Less than 100 microvolts



The **Q-METER**
TYPE 160-A

ACCURATE • DEPENDABLE • VERSATILE

For the measurement of Q, inductance, and capacitance, the 160-A Q-Meter is the universal choice of radio and electronics engineers. Its wide frequency coverage from 50 kc. to 75 mc. is an outstanding feature which makes possible the accurate and rapid evaluation of components and insulating materials at the actual operating frequency.

SPECIFICATIONS

OSCILLATOR FREQUENCY RANGE: 50 kc. to 75 mc. 8 self contained ranges.
OSCILLATOR FREQUENCY ACCURACY: ± 1%, 50 kc.-50 mc. ± 3%, 50 mc.-75 mc.
Q-MEASUREMENT RANGE: Directly calibrated in Q, 20-250. "Multiply-Q-By" Meter also at x2.5, extending Q-range to 625.
Q-MEASUREMENT ACCURACY: Approx-

imately 5% for direct reading measurement, for frequencies up to 30 mc. Accuracy less at higher frequencies.
CAPACITANCE CALIBRATION RANGE: Main capacitor section 30-450 mmf, accuracy 1% or 1 mmf, whichever is greater. Vernier capacitor section ± 3 mmf., zero, -3 mmf. calibrated in 0.1 mmf. steps. Accuracy ± 0.1 mmf.

Write for literature containing further details

BOONTON RADIO Corporation
BOONTON, N.J., U.S.A.

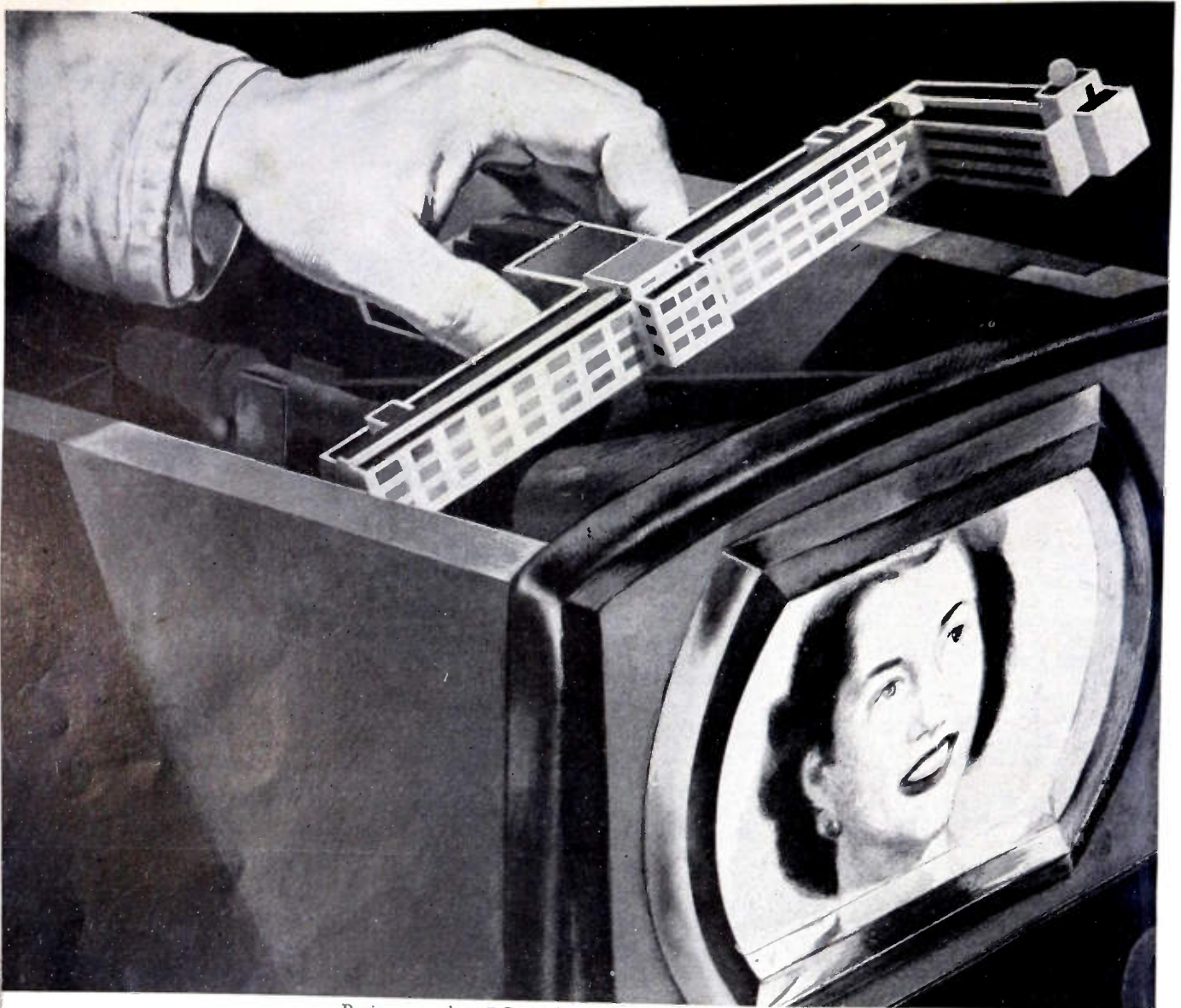

Basic research at RCA Laboratories has led to most of today's all-electronic television advances.

At the heart of every television set!

Why show RCA Laboratories *inside* your television receiver? Because almost every advance leading to all-electronic TV was pioneered by the scientists and research men of this institution.

The supersensitive image orthicon television camera was brought to its present perfection at RCA Laboratories. The kinescope, in these laboratories, became the mass-produced electron tube on the face of which you see television pictures. New sound systems, better microphones—even

the phosphors which light your TV screen—first reached practical perfection here.

Most important of all, the great bulk of these advances have been made available to the television industry. If you've ever seen a television picture, you've seen RCA Laboratories at work.

* * *

See the latest wonders of radio, television, and electronics at RCA Exhibition Hall, 36 West 49th St., N. Y. Admission is free. Radio Corporation of America, RCA Building, Radio City, New York 20, New York.



Through research from RCA Laboratories, today's RCA Victor television receivers are the finest example of electronic engineering.



RADIO CORPORATION of AMERICA
World Leader in Radio — First in Television

they

may

look

alike,

but:

there

is

only

one

C-D

A C-D FILTER FOR EVERY APPLICATION!



In a wide range of sizes and container shapes to meet every known interference filtering application. A few typical types are listed below. Thousands of other types on request. Our engineers will be glad to consult with you on your specific noise problems. Engineering bulletin on request. CORNELL-DUBILIER ELECTRIC CORPORATION, Dept. M21 South Plainfield, New Jersey. Other plants in New Bedford, Brookline and Worcester, Mass.; Providence, R. I.; Indianapolis, Ind., and subsidiary, the Radiart Corp., Cleveland, Ohio.

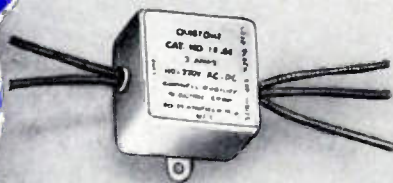

Capacitive inductive filters — single and multiple section pi circuits in hermetically sealed containers for aircraft, marine, and heavy-duty application requiring filters with high insertion loss over temperature range from -55 to $+85^{\circ}\text{C}$.



Feed-through capacitive TV and radio noise filters — Compact! Lightweight! Numerous insertion-loss patterns available. Hermetically sealed! Dykanal impregnation!



Electrical appliance filters — for fluorescent lamps, food mixers, vacuum cleaners, business machines, and a wide variety of other electrical equipment available in many styles with both flexible lead and solder lug electrical connections.

FOR EFFECTIVE NOISE ELIMINATION . . . FOR DEPENDABLE RESULTS
. . . FOR PREMIUM QUALITY PERFORMANCE . . . ALWAYS SPECIFY C-D!



1910-1951

CONSISTENTLY DEPENDABLE

CORNELL-DUBILIER

CAPACITORS • VIBRATORS • ANTENNAS • CONVERTERS



Input Voltage range:

1,000,000 to 1

This analyzer offers the simplest, most accurate and most direct method of measuring the amplitude and frequency of the components of any complex electrical waveform.

In its essentials it consists of a heterodyne-type vacuum-tube voltmeter with a highly selective i-f filter using three quartz bars. At only 60 cycles from resonance the attenuation is down by 75 decibels, yet tuning is very easy by virtue of the 4-cycle flat-top characteristic at resonance. Standards for both voltage and frequency are built into the analyzer and can be used to check its calibration at any time.

The Type 736-A Wave Analyzer is ideally suited for hundreds of types of harmonic-distortion measurements on any type of audio apparatus, broadcast receivers and transmitters, telephone and public address systems, oscillators, amplifiers and other vacuum-tube circuits; hum measurements on a-c operated communications equipment; harmonic induction studies on telephone lines.

WRITE FOR COMPLETE DATA

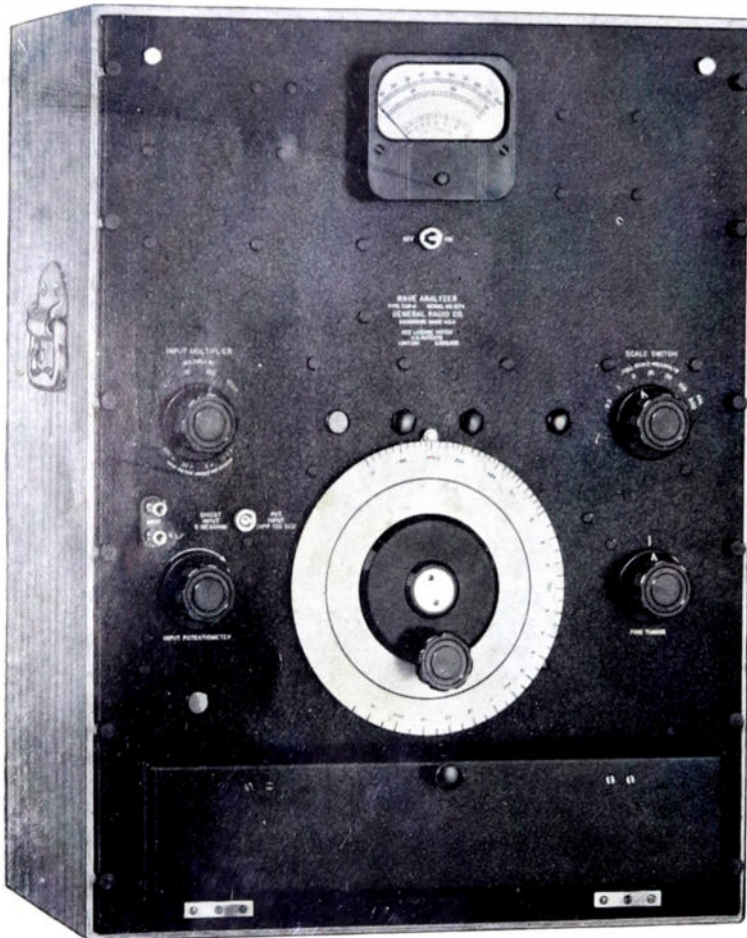

Type 736-A WAVE ANALYZER \$1075

Specifications

- ★ **FREQUENCY RANGE:** 20 to 16,000 cycles.
- ★ **SELECTIVITY:** About 4 cycles flat-top band width. Response is down 15 db at 5 cycles, 30 db at 10 cycles, 60 db at 30 cycles from peak.
- ★ **VOLTAGE RANGE:** 300 microvolts to 300 volts full scale. Over-all range is divided into four major ranges, each of which is divided into seven scale ranges.
- ★ **VOLTAGE ACCURACY:** Within $\pm 5\%$ on all ranges.
- ★ **HUM:** Suppressed by at least 75 db.
- ★ **INPUT IMPEDANCE:** 1 meg ohm for direct voltage measurements; 100,000 ohms with input potentiometer.
- ★ **ACCURACY OF FREQUENCY CALIBRATION:** $\pm (2\% + 1 \text{ cycle})$.
- ★ **BUILT-IN CALIBRATORS:** For both voltage and frequency.

GENERAL RADIO COMPANY

Cambridge 39,
Massachusetts

90 West St., New York 6 920 S. Michigan Ave., Chicago 5 1000 N. Seward St., Los Angeles 38

