

Proceedings



of the I·R·E

A Journal of Communications and Electronic Engineering

September, 1950

Volume 38

Number 9

PROCEEDINGS OF THE I.R.E.

Present Status of Color Television
Mixed Highs in Color Television
Metallized Paper for Capacitors
Metallized Paper Capacitors
Biological Requirements in Amplifiers
Effects of Microwave Radiation on Organisms
Klystron Mixer for Television Relaying
Distortion Compensation in Video Delay Lines
Antenna Directivity Measurements (Abstract)
Folded Dipole Impedance Transformation
VHF Field-Strength Meters
Elliptical-Aperture Antenna Patterns (Abstract)
Artificial Microwave Optics
Poynting Vector in the Ionosphere
Radiation from Circular Current Sheets
High-Frequency Vibrations of Crystal Plates
IRE Standards on Electron Tubes, Part II
Abstract and References

TABLE OF CONTENTS, INDICATED BY BLACK-AND-WHITE MARGIN, FOLLOWS PAGE 32A

1951 Convention Authors, see page 1098



Chicago IRE Section celebrates its Silver Anniversary in the Midwestern radio broadcasting and manufacturing metropolis.

Part II of the IRE Standards on Electron Tubes: Methods of Testing, 1950, appears in this issue.

The Institute of Radio Engineers

...to get more for your money

Re-Tube with

AMPEREX

AMPEREX TUBES

replacements
for your rectifier...
regardless of make!

- ★ are DESIGNED by ELECTRONIC TUBE Specialists... in a laboratory that is second to none in the world—and with a background of experience that encompasses the entire history of electronic development.
- ★ are BUILT BETTER... and while most makes may look alike, there are hundreds of little structural design differences in AMPEREX tubes that combine to make a BIG difference in stability and resistance to shock or vibration.
- ★ are LONGER LASTING... because of close electrical tolerances, conservative ratings, rigid mechanical requirements, careful construction, plus painstaking inspection and test... to assure the maximum number of operating hours within our specified ratings.
- ★ are LOWER in COST... lower in initial cost—lower in cost per operating hour—As thousands of others already have done, try AMPEREX—prove it yourself, in your equipment.
- ★ are AVAILABLE for IMMEDIATE DELIVERY... by leading radio parts distributors, who have AMPEREX tubes *IN STOCK*. We list a few of these establishments that are prepared to serve you instantly:

ALLIED RADIO CORP., 833 West Jackson Blvd., Chicago 7, Illinois
 W. D. BRILL & CO., 198 10th Street, Oakland, California
 DE MAMBRO RADIO SUPPLY INC., 1111 Commonwealth Avenue, Boston 15, Massachusetts
 CRABTREE'S WHOLESALE RADIO, 2608 Ross Avenue, Dallas 1, Texas
 A. W. MAYER CO., 895 Boylston Street, Boston 15, Massachusetts
 RADIO & ELECTRONICS PARTS CORP., 3235 Prospect Avenue, Cleveland 15, Ohio
 SOUTHEAST AUDIO CO., 112 West Union Street, Jacksonville, Florida

There are approximately 200 standard types in the complete line of

AMPEREX TUBES

Rectifying, Transmitting, Industrial, Radiation Counter, Electro-Medical... there's an AMPEREX tube for almost any electronic application. Have you our latest catalog? If not, write for it.

RE-TUBE WITH AMPEREX
AMPEREX ELECTRONIC CORP.

25 WASHINGTON STREET, BROOKLYN 1, N. Y.

In Canada and Newfoundland:

Canadian Radio Manufacturing Corp. Ltd.

11-19 Brentcliffe Road, Leaside, Toronto, Ontario, Canada



575-A



315-A



321-A



255-B



857-B



266-B



FIFTH NATIONAL INSTRUMENT CONFERENCE & EXHIBIT

Memorial Auditorium

Buffalo, September 18-22, 1950



TENTATIVE TECHNICAL PROGRAM

Monday, September 18
10:00 A.M.

I.S.A. Session on Instrumentation for Production Processes. Assembly Hall. Chairman, Warren H. Brand (Oak Ridge National Lab., Oak Ridge, Tenn.)

A.S.M.E. Industrial Instruments and Regulators Session. Lounge. Chairman, A. A. Markson (Hagan Corp., Pittsburgh, Pa.). Vice Chairman, E. K. Newton (Hooker Electrochemical Co., Niagara Falls, N.Y.).

Monday, September 18
2:30 P.M.

A.S.M.E. Industrial Instruments and Regulators Session. Lounge. Chairman, Floyd S. Eckhardt (Bethlehem Steel Co., Lackawanna, N.Y.). Vice Chairman, Harvey Busch (National Aniline & Chemical Co., Buffalo, N.Y.).

Tuesday, September 19
10:00 A.M.

I.S.A. Session on Instrumentation for Production Processes. Assembly Hall. Chairman, C. E. Bragg (Standard Oil Co., Whiting, Ind.)

A.S.M.E. Industrial Instruments and Regulators Session. Lounge. Education in Instrument Engineering Panel Discussion. Chairman, Prof. D. P. Eckman (Case Institute of Technology, Cleveland, Ohio). Vice Chairman, W. E. Belcher (Brown Instrument Co., Philadelphia, Pa.).

A.I.P. Scientific Instrument Session. Room 224. Chairman to be announced. Three papers on Spectrometry.

I.S.A. Session on Instrumentation for Testing. Room A. Chairman to be announced.

I.R.E.—Institute of Radio Engineers Technical Session. Room B. Chairman and Technical Speakers to be announced.

Tuesday, September 19
2:00 P.M.

A.S.M.E. Industrial Instruments and Regulators Joint Session with A.I.E.E. Niagara Room, Hotel Statler. Co-Chairman, Claire E. Gaylord, A.I.E.E. (N.Y. Telephone Co., Buffalo, N.Y.). Co-Chairman, Paul E. Mohn, A.S.M.E. (University of Buffalo, Buffalo, N.Y.).

Wednesday, September 20
10:00 A.M.

I.S.A. Session on Instrumentation for Production Processes. Assembly Hall. Chairman, A. V. Novak (E. I. duPont de Nemours & Co., Orange, Texas). Panel Discussion. Subject: "Graphic Panels." Speakers to be announced.

I.S.A. Session on Instrumentation for Testing. Room A. Chairman to be announced.

I.S.A. Inspection and Gaging Session. Room B. Chairman to be announced.

I.S.A. Maintenance and Operation Session. Lounge. Chairman, L. C. Laird (Corn Products Refining Co., Argo, Ill.).

A.I.P. Scientific Instrument Session. Room 224. Chairman to be announced.

Wednesday, September 20
2:30 P.M.

A.I.E.E. Electrical Instruments and Measurements Session. Lounge. Chairman to be announced.

Thursday, September 21
10:00 A.M.

I.S.A. Session on Instrumentation for Production Processes. Assembly Hall. Chairman, D. M. Boyd, Jr. (Universal Oil Products Co., Chicago, Ill.) Panel Discussion. Subject: "Flow Control."

I.S.A. Session on Instrumentation for Testing. Room A. Chairman to be announced.

I.S.A. Inspection and Gaging Session. Room B. Chairman to be announced.

I.S.A. Analysis Instrumentation Session. Lounge. Chairman to be announced.

"Continuous Electronic Recording of the Water Content of Oil Field Emulsions," by P. O. Engelder.

"Mass Flowmeter—A Method for the Measurement of Pulsating Flow."

"Continuous Measurements of Vapor Pressure of Petroleum Products."

Thursday, September 21
2:30 P.M.

I.S.A. Session on Instrumentation for Production Processes. Assembly Hall. Chairman, F. H. Trapnell (E. I. duPont de Nemours, Wilmington, Del.) "Flow Control" Panel Discussion. Two papers to be announced.

A.I.E.E. Electrical Instruments and Measurements Technical Session. Niagara Room, Hotel Statler.

Friday, September 22
10:00 A.M.

I.S.A. Session on Instrumentation for Production Processes. Assembly Hall. Chairman and papers to be announced.

I.S.A. Session on Instrumentation for Testing. Room A. Chairman to be announced.

I.S.A. Analysis Instrumentation Session. Lounge. Chairman to be announced.

I.S.A. Transportation Instruments Session. Lounge. Chairman to be announced.



Taking the Akins Film

Automatic Control Demonstration

At the first 3 National Instrument Conferences, J. Akins and John Kowalski gave their Automatic Control Demonstration. This demonstration has been filmed in color and sound and in addition to showing the film at the General Meeting of the I.S.A., it will be shown on Monday, Tuesday and Thursday evening in the Assembly Hall of the Memorial Auditorium at 8 P.M.

IRE Members Admitted Free to Sessions & Exhibits

PROCEEDINGS OF THE I.R.E. September, 1950, Vol. 38, No. 9. Published monthly by The Institute of Radio Engineers, Inc., at 1 East 79 Street, New York 21, N.Y. Price per copy: members of the Institute of Radio Engineers \$1.00; non-members \$2.25. Yearly subscription price: to members \$9.00; to non-members in United States, Canada and U.S. Possessions \$18.00; to non-members in foreign countries \$19.00. Entered as second class matter, October 26, 1927, at the post office at Menasha, Wisconsin, under the act of March 3, 1879. Acceptance for mailing at a special rate of postage is provided for in the act of February 28, 1925, embodied in Paragraph 4, Section 412, P. L. and R., authorized October 26, 1927.

Table of Contents will be found following page 32A

Mounting Bell's new microwave lens in a horn-lens antenna. Other blocks will complete the lens.

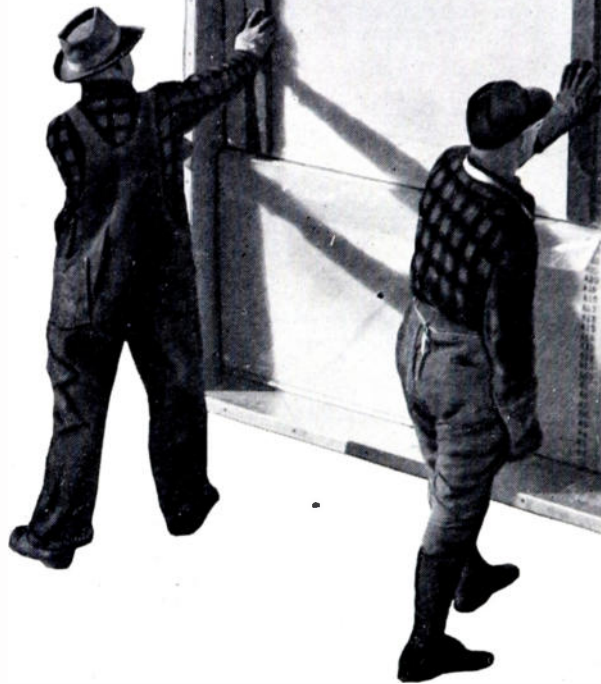

A focus on better, low-cost telephone service

In the new microwave radio relay system between New York and Chicago, giant lenses shape and aim the wave energy as a searchlight aims a light beam.

Reasoning from the action of molecules in a glass lens which focuses light waves, Bell Laboratories scientists focus a broad band of microwaves by means of an array of metal strips. To support the strips these scientists embedded them in foam plastic which is virtually transparent to microwaves. Rigid and light in weight, the plastic is easily mounted on relay towers.

This unique lens receives waves from a wave guide at the back of the horn. As they pass across the strips, the waves are bent inward, or focused to form a beam like a spotlight. A similar antenna at the next relay station receives the waves and directs them into a wave guide for transmission to amplifiers.

This new lens will help to carry still more television and telephone service over longer distances by microwaves. It's another example of the Bell Telephone Laboratories research which makes your telephone service grow bigger in value while the cost stays low.



Laboratory model of the new lens. A similar arrangement of metal strips is concealed in the foam plastic blocks in the large picture.



BELL TELEPHONE LABORATORIES

Working continually to keep your telephone service big in value and low in cost.

SWIFT, SURE FREQUENCY COMPARISON

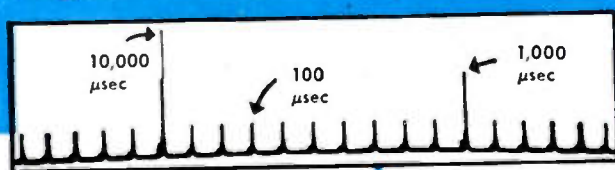

FIG. 1. Timing Comb, -hp- Model 100D

NEW **hp** SECONDARY FREQUENCY STANDARDS

MODELS 100C AND 100D

- Sine or rectangular waves
- 100 μ sec time markers
- Built-in oscilloscope
- Stability 1/1,000,000
- Low output impedance
- New, improved circuits
- Audio, supersonic, rf measurements

SPECIFICATIONS

-hp- 100D Secondary Frequency Standard

Accuracy:

About 2 parts per million per week, normal room temperature.

Stability:

About 1 part per million over short intervals.

Output:

Controlled frequencies: 100 kc, 10 kc, 1 kc, 100 cps, 10 cps. Sine or rectangular waves; marker pips. Internal impedance approx. 200 ohms.

Wave Shape:

Sine wave: less than 4% distortion into 5,000 ohms or higher load.

Marker Pips:

10,000, 1,000 and 100 μ sec intervals.

Oscilloscope:

Integral with circuit. Establishes 10:1 Lissajous figures to show division ratio. May be used independently of standard.

-hp- 100C Secondary Frequency Standard

Accuracy:

Within $\pm .001\%$ normal room temperature.

Output:

Controlled frequencies of 100 kc, 10 kc, 1 kc, and 100 cps. Internal impedance approx. 200 ohms.

Wave Shape:

Sinusoidal only. 4% distortion into 5,000 ohm load.

Power Supply:

(100C and 100D) 115 v, 50/60 cps, regulated to minimize line voltage fluctuations. Power drawn approx. 150 watts.

Mounting:

(100C and 100D) Cabinet or relay rack. Panel 19" x 10 $\frac{1}{2}$ " x 12" deep.

Data Subject to Change Without Notice

The new -hp- 100C and 100D Secondary Frequency Standards incorporate all the features of the time-tested -hp- models 100A and 100B, plus important new advantages including rectangular wave output, timing pips, and an internal oscilloscope for convenient frequency comparison. The -hp- 100D may be conveniently standardized against station WWV with a minimum of external equipment, and thus provide most of the advantages of an expensive primary standard.

Crystal Controlled Frequencies

The new -hp- Models 100D and 100C employ a crystal-controlled oscillator and divider circuits offering a new high in stability and simplicity of operation. Standard frequencies are available through a panel selector switch, and may be employed simultaneously. Internal impedance is low (about 200 ohms), so that standard frequencies can be delivered at some distance from the instrument.

The -hp- 100D Secondary Frequency Standard offers sine waves at 5

frequencies and rectangular waves at 4 frequencies, plus a built-in oscilloscope. The instrument also provides a timing comb with markers 100, 1,000 and 10,000 microsecond intervals. Rectangular wave output has a rise time of approximately 5 microseconds. Accuracy is 2 parts per million.

5 v. at all Frequencies

The more moderately priced -hp- 100C Standard offers sinusoidal frequencies at 4 crystal-controlled frequencies and, like the -hp- 100D, provides 5 volts of output at all frequencies. Accuracy .001%.

Both models operate from a 115 v. ac power supply, and power is regulated to minimize power line voltage fluctuations.

Get full details... see your
-hp- representative or write
direct... today!

HEWLETT-PACKARD CO.

1977D Page Mill Road • Palo Alto, Calif.

Export: FRAZAR & HANSEN, LTD.

301 Cloy Street, San Francisco, Calif., U. S. A.
Offices: New York, N. Y.; Los Angeles, Calif.

hp laboratory instruments
FOR SPEED AND ACCURACY

TINY • DEPENDABLE • SPACE-SAVING

Cera-mite^{} Capacitors*



THE *First* COMPLETE DISC CERAMIC LINE

Sprague-Herlec Cera-mite Capacitors are a "must" for modern television circuits.

Now available in NP0 and N750 temperature-compensating bodies and in two different high-K bodies, Cera-mites meet most application needs in the 10 mmf to 15,000 mmf capacitance range.

These miniature capacitors offer set designers maximum space economy, ease of mounting, and improved very-high-frequency performance.

The flat disc with uni-directional lead construction has minimum self-inductance and a higher self-resonant frequency than a tubular design; hence improved v-f bypass efficiency.

Sprague-Herlec Engineering Bulletin 601B gives the complete list of standard ratings as well as performance specifications. Write for your copy today!

*Trademark

SPRAGUE[®]

PIONEERS IN

SPRAGUE ELECTRIC COMPANY
North Adams, Massachusetts

ELECTRIC AND ELECTRONIC DEVELOPMENT

THE HERLEC CORPORATION • Milwaukee 3, Wisconsin
(Wholly owned Sprague Subsidiary)

Opportunities for Saving



CLEVELAND CONTAINER

**LOW COST, SPIRALLY LAMINATED,
PHENOLIC TUBING**

Manufacturers of radio and television receivers know the outstanding advantages of Cleveland Cosmalite* and Clevelite* on both performance and cost.



Designed to replace at a considerable saving the ordinary phenolic and fibre tubing . . . its properties include great strength, low moisture absorption, high dielectric strength, low loss and good machineability, made in lengths up to 8½ ft. with types, diameters and thicknesses as desired. May be punched, notched, threaded and grooved to meet individual needs.

Excellent for
MOTORS

—
RELAYS

—
TRANSFORMERS

—
FANS

—
CONTROLS

—
TELEPHONE EQUIPMENT

—
SWITCHES

—
BOBBINS

—
TRANSMITTERS



* Trade Marks.

Send for samples today
and investigate its low cost
possibilities for you.

The **CLEVELAND CONTAINER Co.**
6201 BARBERTON AVE. CLEVELAND 2, OHIO

PLANTS AND SALES OFFICES at Plymouth, Wis., Chicago, Detroit, Ogdensburg, N.Y., Jamesburg, N.J.
ABRASIVE DIVISION at Cleveland, Ohio
CANADIAN PLANT: The Cleveland Container, Canada, Ltd., Prescott, Ontario

REPRESENTATIVES

NEW YORK AREA
NEW ENGLAND
CANADA

R. T. MURRAY, 614 CENTRAL AVE., EAST ORANGE, N. J.
R. S. PETTIGREW & CO., 968 FARMINGTON AVE.
WEST HARTFORD, CONN.
WM. T. BARRON, EIGHTH LINE, RR #1, OAKVILLE, ONTARIO



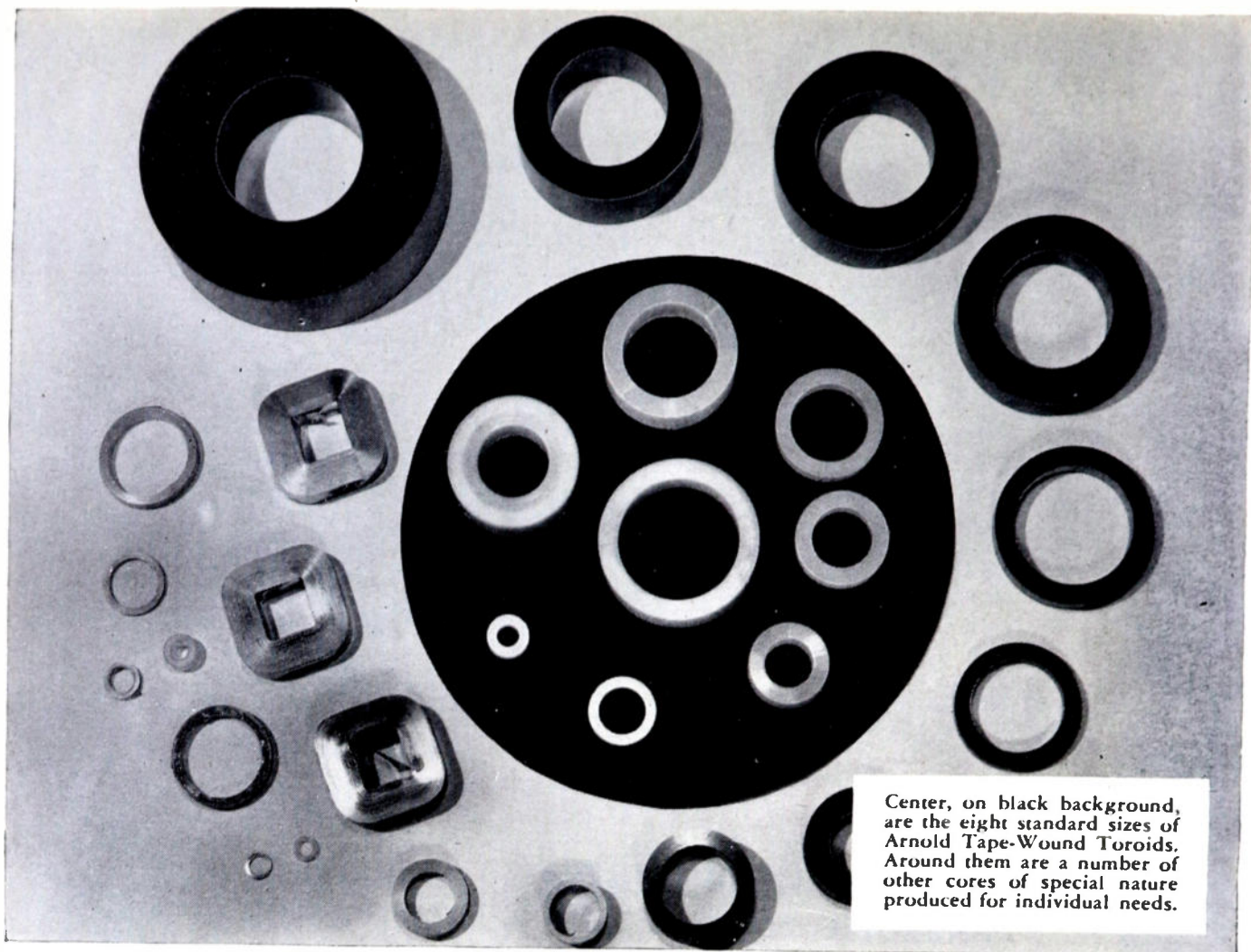

Center, on black background, are the eight standard sizes of Arnold Tape-Wound Toroids. Around them are a number of other cores of special nature produced for individual needs.

ARNOLD TAPE-WOUND TOROIDAL CORES

of DELTAMAX
 4-79 MO-PERMALLOY
 SUPERMALLOY*

APPLICATIONS

MAGNETIC AMPLIFIERS
 PULSE TRANSFORMERS
 NON-LINEAR RETARD COILS
 and TRANSFORMERS
 PEAKING STRIPS, and many other
 specialized applications.

RANGE OF SIZES

Arnold Tape-Wound Toroids are available in eight sizes of standard cores—all furnished encased in molded nylon containers, and ranging in size from 1/2" to 2 1/2" I.D., 3/4" to 3" O.D., and 1/8" to 1/2" high.

RANGE OF TYPES

These standard core sizes are available in each of the three magnetic materials named, made from either .004", .002" or .001" tape, as required.

In addition to the standard toroids described at left, Arnold Tape-Wound Cores are available in special sizes manufactured to meet your requirements—toroidal, rectangular or square. Toroidal cores are supplied in protective cases.

*Manufactured under licensing arrangements with Western Electric Company.

W&D 3182

THE ARNOLD ENGINEERING COMPANY
 SUBSIDIARY OF ALLEGHENY LUDLUM STEEL CORPORATION
 General Office & Plant: Marengo, Illinois



MALLORY VIBRATORS

Mallory Vibrators are based on exclusive design and manufacturing methods that assure long, trouble-free service. Send the details of your application. Get Mallory's recommendation on the Vibrator or Vibrapack* power supply best suited to your needs.

Mallory Vibrators Roll Up Big Savings... Protect Customer Good Will!

Reducing component parts costs—and at the same time, improving performance—is a welcome combination! The economy and dependability of Mallory Vibrators have made important contributions of this kind for Mallory customers.

Here's just *one* example! A radio manufacturer was receiving serious field complaints on vibrator performance. The substitution of two Mallory Vibrators—one a standard type, and the other especially designed for his problem—not only eliminated the difficulty but saved the customer \$30,000 in vibrator costs alone! And the changes were accomplished with virtually no modification in circuit designs.

That's service beyond the sale!

And whether your problem is electronic or metallurgical what Mallory has done for others can be done for you.

Vibrators and Vibrapack* Power Supplies

P. R. MALLORY & CO., Inc.
MALLORY

P. R. MALLORY & CO., Inc., INDIANAPOLIS 6, INDIANA

SERVING INDUSTRY WITH

| | |
|------------------------------|----------------|
| Capacitors | Contacts |
| Controls | Resistors |
| Rectifiers | Vibrators |
| Special Switches | Power Supplies |
| Resistance Welding Materials | |

*Reg. U. S. Pat. Off.

KAA-284 is of "inestimable value" to Northern Natural Gas Company

Radio Station KAA-284, Owatonna, Minn., is part of a radio network used in the operation of a pipe line system owned by the Northern Natural Gas Company, Omaha, Neb.

Typical equipment is the Motorola special FM transmitter, operating on 33.18 megacycles, 500 watt input, 250 watt output. Station range is approximately 100 miles.

The Truscon tower at Owatonna, Minn. is one unit of this system which in total consists of twenty-one fixed stations used in connection with 150 mobile units in cars, trucks and two airplanes. "They are of inestimable value for communication in control of line pressures, emer-

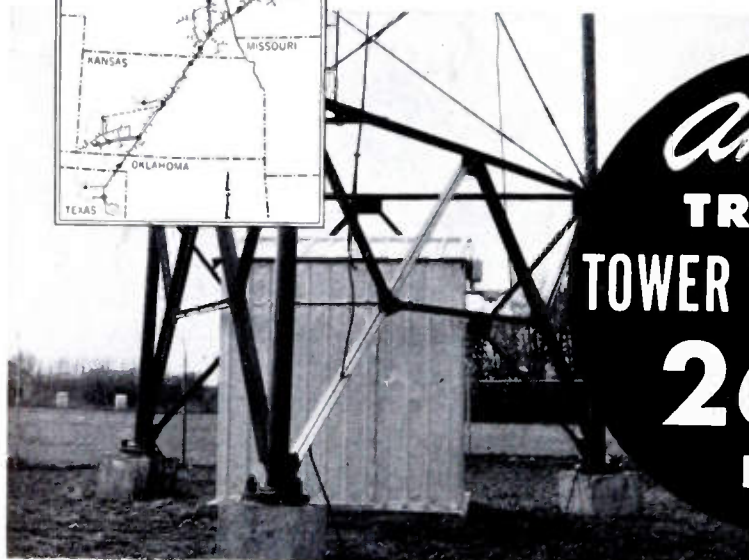

Another
TRUSCON
TOWER OF STRENGTH
260 FT.
HIGH

gency repairs, and general operation and maintenance," according to the Northern Natural Gas Company.

Truscon Radio Towers are serving all types of communication and broadcasting needs, under a wide variety of conditions in all parts of the world. Truscon can draw upon this extensive experience in engineering and erecting exactly the tower you need—tall or small . . . guyed or self-supporting . . . tapered or uniform in cross-section . . . for AM, FM and TV transmission. Your phone call or letter to any convenient Truscon district office, or to our home office in Youngstown, will bring you immediate, capable engineering assistance. Call or write today.

TRUSCON STEEL COMPANY

YOUNGSTOWN 1, OHIO
Subsidiary of Republic Steel Corporation

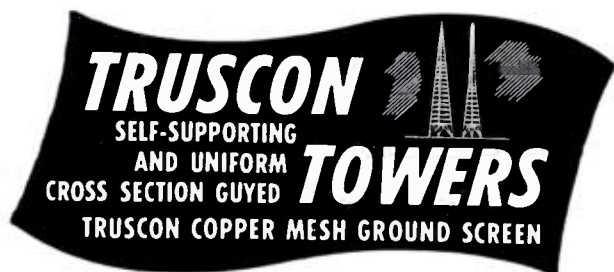

A Problem?

THE ANSWER MAY BE

ALSiMAG[®]

APPLIANCE PARTS
AND INSULATORS

RADIO AND
TELEVISION PARTS

ELECTRONIC
COMPONENTS

MACHINE PARTS

THREAD GUIDES

Your use may be similar to, or completely different from, those listed here . . . yet ALSiMag may solve your problem.

HELLARC WELDING TIPS

EXTRUSION AND
DRAWING DIES

This versatile material is solving production, design and technical problems for many industries. For your business, ALSiMag may offer lower costs, improved manufacturing processes, increased production, or possibilities of a new product.

CAN YOU USE ALSiMAG? ALSiMag is the trade marked name of a large family of technical ceramic compositions. They are now being used in production machines, electronic equipment, chemical processing equipment, gas and electric appliances and in many other consumer products. ALSiMag ceramics are custom made as to physical characteristics, size and shape. Special combinations of raw materials, fluxes, pressures, processes and firing temperatures produce ceramics with characteristics to meet individual requirements. These compositions are fabricated by us into finished parts, ready for your production line.

Given your requirements, our Research Division can frequently develop a special composition to suit your need. Carefully cross-indexed research records usually permit a prompt and accurate reply to inquiries, even if they involve most unusual requirements. If you have a problem that can be solved by a special component of unusual physical characteristics, outline that problem to us. We can indicate the possibilities of its solution by the use of ALSiMag Technical Ceramics. Your inquiry involves no cost or obligation.

SENT FREE ON REQUEST

The ALSiMag Property Chart 501

STRAINER CORES FOR
MOLTEN METALS

OIL BURNER
IGNITION INSULATORS

AMERICAN LAVA CORPORATION

CHATTANOOGA 5, TENNESSEE

49th YEAR OF CERAMIC LEADERSHIP

OFFICES: METROPOLITAN AREA: 671 Broad Street, Newark, N. J., Mitchell 2-8159 • CHICAGO, 9 South Clinton Street, Central 6-1721
PHILADELPHIA, 1649 North Broad Street, Stevenson 4-2823
LOS ANGELES, 232 South Hill Street, Mutual 9076
NEW ENGLAND, 38-B Bottle Street, Cambridge, Massachusetts, Kirkland 7-4498 • ST. LOUIS, 1123 Washington Avenue, Garfield 4959

JIGS FOR RF HEATING

GAS BURNER TIPS

FIRING PINS AND PADS

HEAT SHOCK AND
CHEMICAL RESISTANCE

ELECTROPLATING
HOLDERS

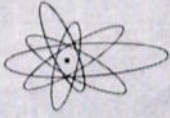

Designers



PANEL INSTRUMENTS—A COMPLETE LINE

Accurate and Reliable



FOR MEASURING D-C, A-C, RF, AF, VU

General Electric panel instruments have long been known for their reliability and accuracy. Recent design changes provide for better performance, readability, durability, and appearance. G-E voltmeters, kilovoltmeters, ammeters, milliammeters, microammeters, and vu volume-level indicators; thermocouple types and rectifier types; round or square, with conventional or long 250-degree scales—all will give your measurements the accuracy required and your panel that smooth, modern appearance. To bring you up to date on the latest improvements in cases, faces, and mechanisms, G.E. offers a comprehensive 24-page bulletin containing all information necessary for ordering. Write for Bulletin GEC-368. For vu indicators, see Bulletin GEC-369.

SOLVE DESIGN PROBLEMS WITH THE SWITCH OF 10,000 USES

A member of the well known SB-1 switch family can find a useful place on almost any large electronic control panel. The precision-built parts of this all-purpose switch permit as many as 40 stages—four banks of ten stages each—to be operated in tandem. Switches with up to 16 stages and 12 positions are commonly furnished. Over 10,000 circuit-sequence combinations are possible. Ratings go to 20 amperes at 600 volts a-c or d-c. See Bulletin GEC-270.



SB-1 switch, cover-removed

SAVE PANEL SPACE WITH ONE-UNIT PUSH-BUTTON AND INDICATING LIGHT



Illuminated push button

This space-saving pilot-circuit switch consists of a sturdy push-button unit, 2 5/8 inches high, with a hollow translucent cap and 6-volt lamp. The switch is the momentary contact type, single-pole, with one normally open and one normally closed circuit. It uses movable-disk type contacts. Buttons are supplied in clear, red, green, blue, amber, and white. For more data on this and other G-E push-button units, see Bulletin GEA-4254.

GENERAL  ELECTRIC

Digest

TIMELY HIGHLIGHTS ON G-E COMPONENTS



PERMAFIL CAPACITORS

NO DERATING AT 125° C OPERATION

For operation at high ambient temperatures, these standard-line G-E Permafil capacitors are naturals. They're paper dielectric units and can be used at temperatures up to 125° C without derating. All are metal encased, compression-sealed, and have long-life silicone bushings. Ratings: up to 2 muf for operation at 400 volts d-c and below. Case styles: 53, 61, 63, and 65 (JAN-C-25 specifications). For more data, write Capacitor Sales Div., General Electric Co., Pittsfield, Mass.



HIGH-VOLTAGE SELENIUM RECTIFIERS

WITH LIFE EXPECTANCY OF 60,000 HOURS!

Now available from G.E. are 26-volt RMS selenium rectifier cells with a continuous-service life expectancy of over 60,000 hours. Their initial forward resistance is very low and samples show an average increase in resistance of less than 6% after 10,000 hours of operation. General Electric knows of no other high-voltage selenium cell on the market that can even approach their performance.

The high output voltage permits the design of smaller stacks while the low resistance means cooler operation and the space saving that goes with it.

Stacks made with the new G-E cells may be obtained with rated outputs from 18 to 126 volts d-c at .15 to 3.75 amps. Write now for Bulletin GEA-5280.



INDUCTROLS



STEPLESS VOLTAGE VARIATION

Inductrols are G-E dry-type induction voltage regulators for 120 and 240-volt operation. Hand-operated models provide smooth and extremely precise voltage adjustment for such uses as instrument calibration and rectifier control. Motor-operated models are used with automatic control to maintain voltage within narrow limits, irrespective of supply variations. Sizes range from 10 1/4 x 6 1/8 x 7 7/8 inches for the smallest hand-operated unit to 14 x 6 x 10 7/8 for the largest motor-operated unit. One unit provides a voltage range of 10% raise and lower on 3 and 6-kva circuits, another gives 100% raise and lower for 2.4 and 3.6 kva circuits. Complete information in Bulletin GEA-4508.

General Electric Company, Section D667-7
Apparatus Department, Schenectady 5, N. Y.

Please send me the following bulletins:

- | | | |
|--------------|--------------------------|------------------------------------|
| Indicate | <input type="checkbox"/> | GEA-4254 Push-button units |
| for | <input type="checkbox"/> | GEA-4508 Inductrols |
| reference | <input type="checkbox"/> | GEA-5280 Selenium rectifiers |
| only (V) | <input type="checkbox"/> | GEC-270 SB-1 switch |
| for planning | <input type="checkbox"/> | GEC-36B Panel instruments |
| an immediate | <input type="checkbox"/> | GEC-369 Vu volume-level indicators |
| project (X) | | |

NAME _____

COMPANY _____

ADDRESS _____

CITY _____ STATE _____



TYPE LR
without line switch

Space and Cost Savers...

Only $57/64$ " in diameter...

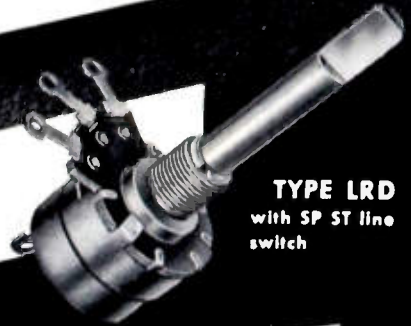

TYPE LRD
with SP ST line
switch

CONSERVATIVELY RATED .5 WATT

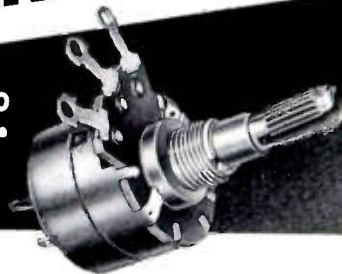

TYPE LRA-10
with DP ST line
switch

**DUAL
CONCENTRICS
FOR TV**



These sturdy little Stackpole LR type controls handle higher wattages more dependably than most controls that are a good bit larger in size. Less than an inch in diameter, they're conservatively rated at .5 watt for use where voltage across the units does not exceed 350 volts for linear tapers, or for non-linear ones having a taper of no less than 10% of the total resistance at 50% rotation, provided that 225 volts is not exceeded. Thus there is plenty of wattage capacity for a wide variety of present day uses including many television applications. Stackpole LP type controls, slightly larger, are rated .6 watt at linear taper if 500 volts is not exceeded and also at .6 watt if the resistance is not less than 10% at 50% rotation, provided that 250 volts is not exceeded.

LR controls are available as concentric shaft duals.

Electronic Components Division

STACKPOLE CARBON COMPANY
ST. MARYS, PA.

STACKPOLE

PRODUCED BY THE MILLIONS

- by the top specialists in the ceramic field

Hi-Q

CERAMIC DISK CAPACITORS

Hi-Q Ceramic Disk Capacitors for by-passing, blocking, or coupling are being used by the millions by television receiver manufacturers who demand the utmost in performance.

Unit cost, time and labor may be saved by using several of the multiple capacity Hi-Q Disks where applicable in your television circuit. Multiple capacities having a common ground are available in standard units as shown in the chart below. Hi-Q Disks are coated with a non-hydroscopic phenolic to insure protection against moisture and high humidities. Hi-Q Disks like all other Hi-Q components assure you of the highest quality workmanship at the lowest possible cost.

Our Engineers are ready and willing to discuss the application of these highly efficient, dependable capacitors in your circuits. Write today for your FREE copy of the new Hi-Q Datalog.

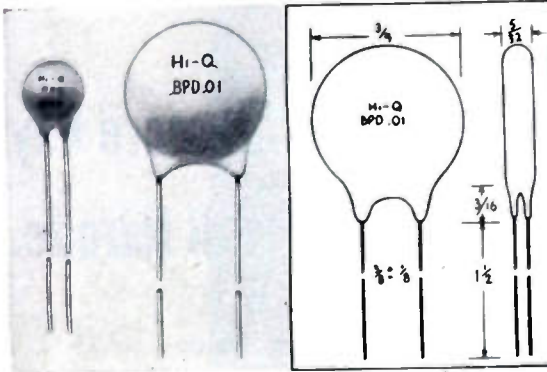

Hi-Q COMPONENTS

Capacitors
Trimmers • Choke Coils
Wire Wound Resistors

BETTER 4 WAYS

UNIFORMITY ✓ DEPENDABILITY
PRECISION ✓ MINIATURIZATION

| Type | A Diameter | B Lead Width | C Thickness |
|----------------|-------------|---------------|-------------|
| B.P.D. .00047 | 5/16" max. | 3/16" + 1/16" | 5/32" max. |
| B.P.D. .0008 | 5/16" max. | 3/16" + 1/16" | 5/32" max. |
| B.P.D. .001 | 3/8" max. | 1/4" + 1/16" | 5/32" max. |
| B.P.D. .0015 | 3/8" max. | 1/4" + 1/16" | 5/32" max. |
| B.P.D. .002 | 7/16" max. | 1/4" + 0 | 5/32" max. |
| B.P.D. .004 | 19/32" max. | 1/4" + 1/8" | 5/32" max. |
| B.P.D. .005 | 19/32" max. | 1/4" + 1/8" | 5/32" max. |
| B.P.D. .01 | 3/4" max. | 3/8" + 1/8" | 5/32" max. |
| B.P.D. 2x.001 | 19/32" max. | 3/8" + 1/8" | 5/32" max. |
| B.P.D. 2x.0015 | 19/32" max. | 3/8" + 1/8" | 5/32" max. |
| B.P.D. 2x.002 | 19/32" max. | 3/8" + 1/8" | 5/32" max. |
| B.P.D. 2x.003 | 3/4" max. | 3/8" + 1/8" | 5/32" max. |
| B.P.D. 2x.004 | 3/4" max. | 3/8" + 1/8" | 5/32" max. |
| B.P.D. 3x.0015 | 3/4" max. | 3/8" + 1/8" | 5/32" max. |
| B.P.D. 3x.002 | 3/4" max. | 3/8" + 1/8" | 5/32" max. |

Insulation: Durez and Wax impregnated.
Leads: 22 gauge pure tinned dead soft copper.
Capacity: Guaranteed minimum as stamped.
All capacitance measurements made at 25°C at 1 KC at a test voltage not over 5 volts RMS.

Insulation Resistance: 7500 megohms min.
Power Factor: Max. 2.5% at 1 KC at not over 5 volts RMS.
Test Voltage: 1500 volts D. C.

JOBBERS — ADDRESS: 740 Belleville Ave., New Bedford, Mass.

Hi-Q

Electrical Reactance Corp.

OLEAN, N. Y.

SALES OFFICES: New York, Philadelphia
Detroit, Chicago, Los Angeles

PLANTS: Olean, N. Y., Franklinville, N. Y.
Jessup, Pa., Myrtle Beach, S. C.

Because Of 5 Outstanding Features

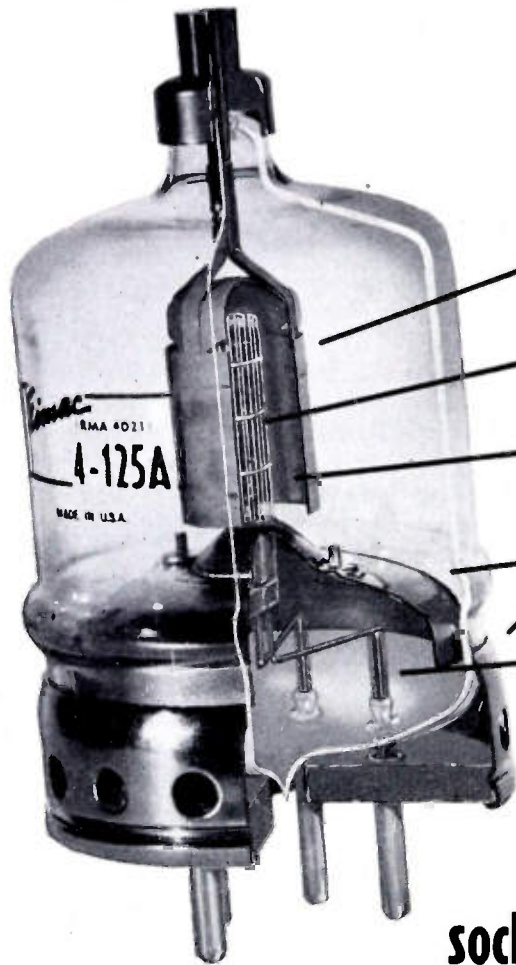

Pyrovac Plate

Long-Life Filament

Non-Emitting Grids

Input-Output Shielding

Low-Inductance Leads

Eimac 4-125A tetrodes fill more key sockets than any other 125-watt tetrode.

The Eimac 4-125A is the heart of modern radio communication systems. Its dependability-of-performance has been proved over years of service in many thousand transmitters. It will be to your advantage to consider carefully the economy and circuit simplification the Eimac 4-125A offers.

As an example of Eimac 4-125A performance, two tubes in typical class-C telegraphy or FM telephony operation with less than 5 watts of grid-driving power will handle 1000 watts input; or, two 4-125A's in high-level modulated service will handle 750 watts input.

Take advantage of the engineering experience of America's foremost tetrode manufacturer . . . Eimac. Write for complete data on the 4-125A and other equally famous Eimac tetrodes.

EITEL-McCULLOUGH, INC.
San Bruno, California

Export Agents: Frazar & Hansen, 301 Clay St., San Francisco, California

Follow the Leaders to

Eimac
TUBES
The Power for R-F

The 4-125A is another

Eimac contribution to electronic progress.



General Electric Capacitors are all individually tested

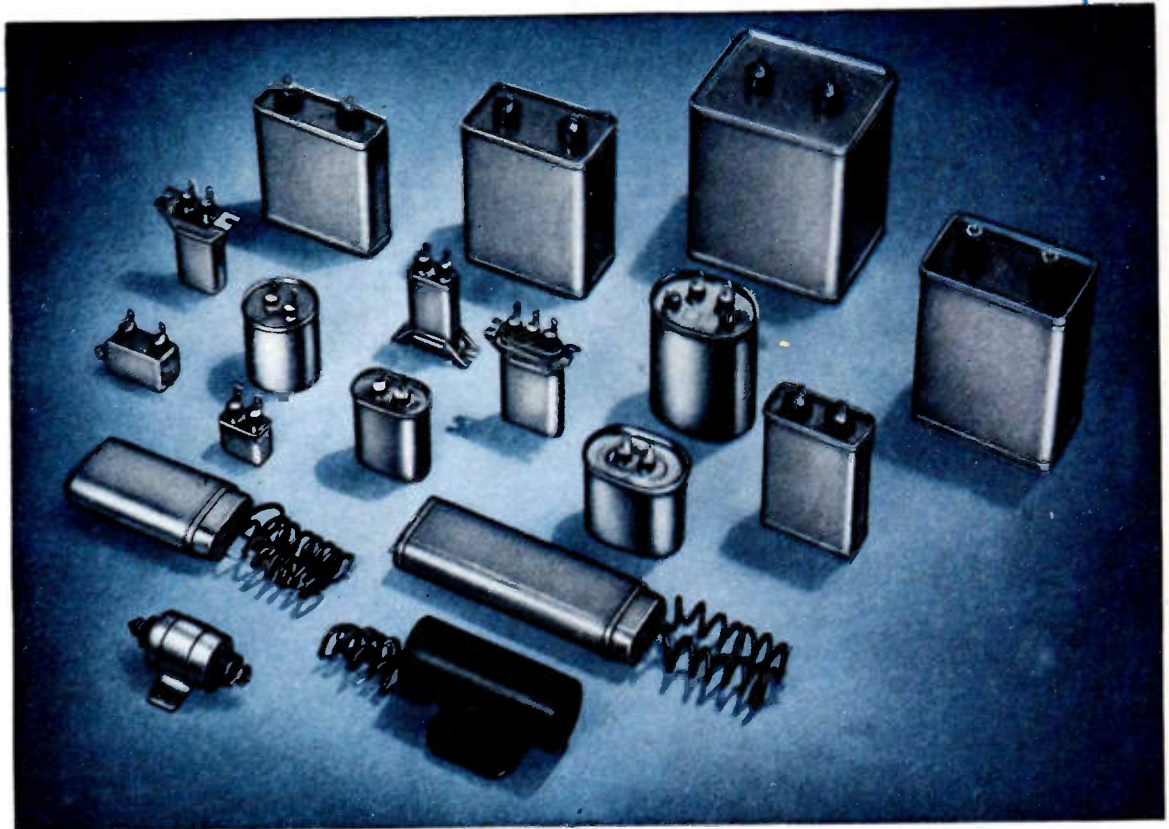

THAT'S WHY YOU CAN DEPEND ON THEM.

Every G-E capacitor receives an individual seal test, capacitance check and a thorough test for opens, shorts, and grounds.

This is in addition to one of the most extensive and elaborate systems of checks and controls on raw materials and manufacture that has ever been developed for any electrical product.

General Electric Capacitors, both a-c and d-c, are available in a wide range of capacitance ratings, voltages and case styles. They are designed and manufactured to meet the latest commercial standards and armed-service specifications. The use of General Electric's recently developed silicone bushings material is being rapidly extended throughout the entire line. In addition to superior electrical qualities these bushings meet new standards of physical endurance under exacting conditions. *Apparatus Department, General Electric Company, Schenectady 5, N. Y.*

Write for descriptive information on d-c capacitors, a-c capacitors, or ballast capacitors to: Capacitors Sales Division, 42-304, General Electric Company, Pittsfield, Mass.

GENERAL  ELECTRIC
407-169

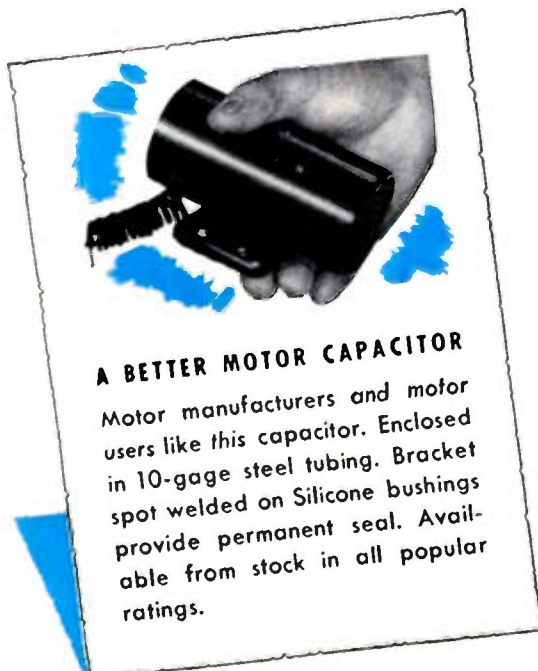

A BETTER MOTOR CAPACITOR

Motor manufacturers and motor users like this capacitor. Enclosed in 10-gage steel tubing. Bracket spot welded on Silicone bushings provide permanent seal. Available from stock in all popular ratings.

MYCALEX

MINIATURE TUBE SOCKETS

7-PIN and 9-PIN...and SUBMINIATURES

New Low Prices

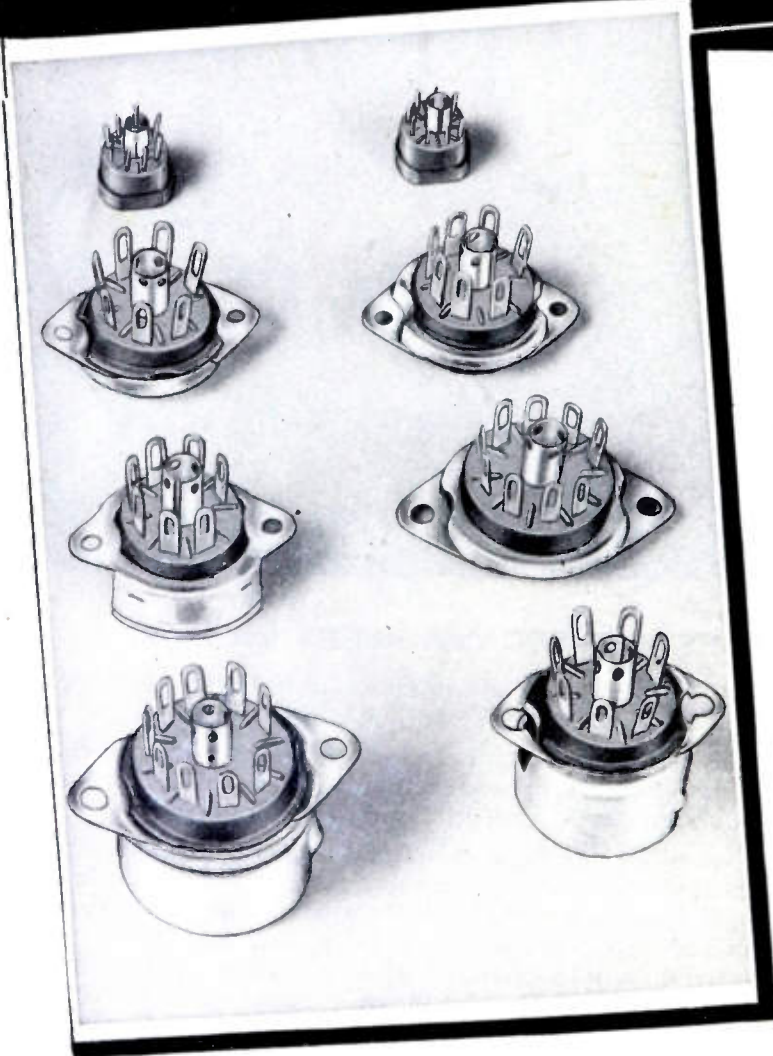

Now MYCALEX offers both 7-pin and 9-pin miniature tube sockets . . . with superior low loss insulating properties, at new low prices that offer ceramic quality for the cost of phenolics.

MYCALEX miniature tube sockets are injection molded with precision that affords uniformity and extremely close tolerances. MYCALEX insulation has high dielectric strength, very low dielectric loss, high arc resistance and great dimensional stability.

Produced in two grades: MYCALEX 410 conforms to Grade L4 specifications, having a loss factor of only .015 at 1 MC. It is priced comparably with mica filled phenolics.

MYCALEX 410X is for applications where low cost of parts is vital. It has a loss factor only one-fourth that of "everyday" quality insulating materials, and a cost no greater.

Prices gladly quoted on your specific requirements. Samples and data sheets by return mail. Our engineers will cooperate in solving your problems of design and cost.

Mycalex Tube Socket Corporation

"Under Exclusive License of Mycalex Corporation of America"

30 Rockefeller Plaza, New York 20, N.Y.



MYCALEX CORP. OF AMERICA

"Owners of 'MYCALEX' Patents"

Executive Offices: 30 Rockefeller Plaza, New York 20, N. Y.

Plant and General Offices: Clifton, N. J.

DUMONT

announces
four new
OSCILLOGRAPH-RECORD
cameras

FOR more versatile **SINGLE-TRANSIENT** recording

The New Du Mont
Type 295

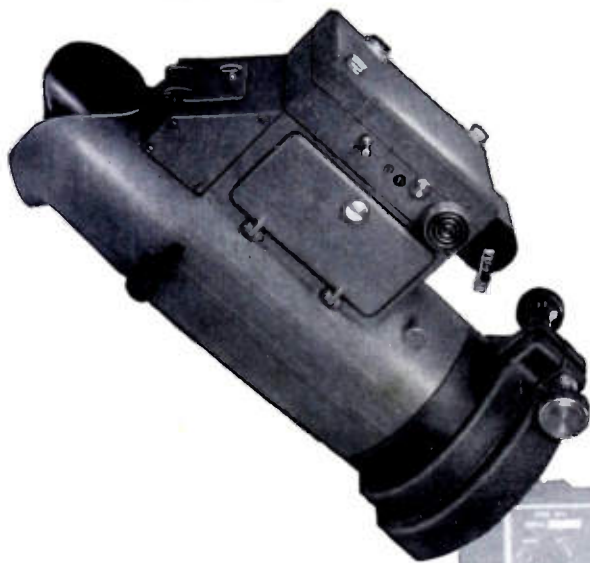

...FOR thrifty **SINGLE-FRAME** recording

The New Du Mont
Type 296



...FOR improved **FINISHED-PRINT** recording

The New Du Mont
Type 297

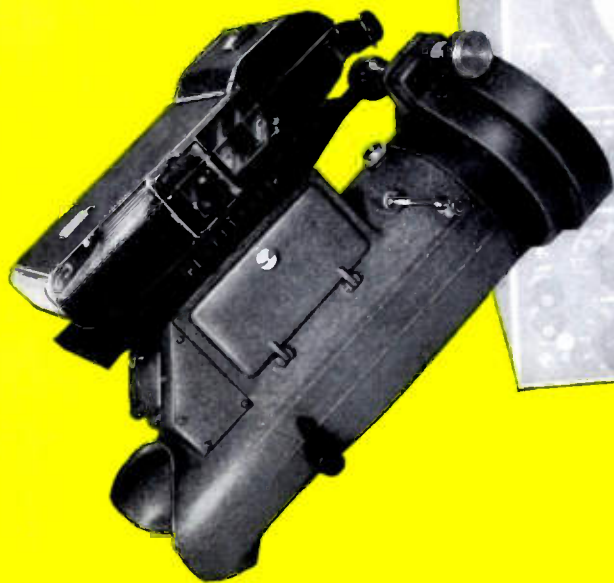

...FOR simplified **MOVING-FILM** recording

The New Du Mont
Type 321



NOW! more than ever it's **DuMont** when you **RECORD TO REMEMBER**

A new and complete line of oscillograph-record cameras.

The Du Mont
Type 295

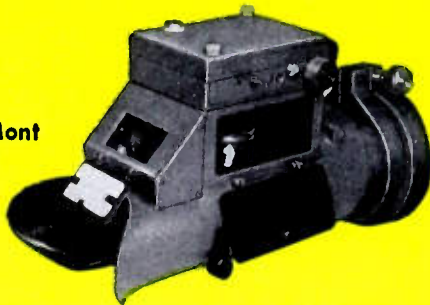

Transient phenomena representing writing rates as high as 180 inches per microsecond are recorded effectively with the Du Mont Type 295. The high-writing-rate capabilities of the Type 295 are obtained by the use of an $f/1.5$, 50mm, coated lens having excellent resolution and a minimum of rectilinear distortion. The camera accommodates plain or perforated 35mm film or paper and will make 40 exposures from a standard 36-exposure cassette. Film may be removed from the camera as it is exposed by use of a cut-off knife and a detachable, light-

tight, film take-up cassette. Thus, a portion of the film may be developed while subsequent exposures are being made. Comfortable binocular viewing is possible while recording. An illuminated data card records pertinent hand-written information directly below the exposed trace. The housing has a side-access door through which the lens aperture is accessible. The aperture control has "click" settings. Both Time and Bulb exposures may be taken. The camera may be adapted for remote control of film advance and shutter release.



The Du Mont
Type 296

Single-frame recording provided by the Type 296 represents the most versatile and inexpensive general-purpose technique. Oscillograph-record application of the Type 296 is unlimited except by the specialized needs of moving-film recording and ultra-high writing speeds. Compact in design, light in weight, and sturdy in construction, the Type 296 is easy to handle and is mounted quickly to all 5-inch cathode-ray oscillographs equipped with the Du Mont

Type 2501 Bezel. A high-quality, $f/2.8$, 41.5mm, coated lens increases the writing-rate capabilities of the Type 296 approximately 57% over the Type 271-A, which it supersedes. Shorter focal length shortens the overall length of the Type 296. A self-winding shutter has speeds of 1/200, 1/100, 1/50, 1/25, 1/10 sec., Time and Bulb. A comfortable, soft-rubber eyepiece permits simultaneous viewing and recording. The Type 296 weighs only 5 lbs.

The Du Mont
Type 297

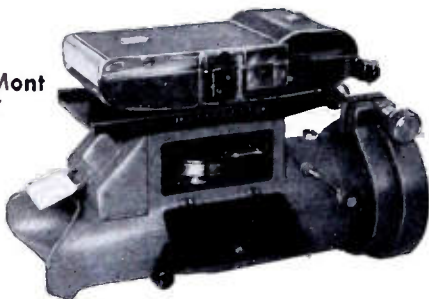

For applications where minute-to-minute comparison of waveforms is required, the Du Mont Type 297 furnishes a finished print in a minute, by the Polaroid-Land Process. The Polaroid-Land camera-back is attached to the mirror housing by means of a slide adaptor which has three snap stops making it possible to record one, two, or three traces on a single print. The camera may be set at any point along the slide so that adjustment may also be continuous where more than three traces are desired on a single print. An illuminated data card permits recording information photographically on

the print. All possible confusion between similar prints is eliminated. The camera is positioned so that the operator pulls the film toward him. Thus, the quick, smooth motion necessary to obtain clean prints is achieved with ease and comfort. The Type 297 incorporates a special, $f/2.8$ coated lens. Exposures may be taken at shutter speeds of 1/200, 1/100, 1/50, 1/25, 1/10 sec., Time, and Bulb. The recorded image is reduced to one-third the object size. The Type 297 is mountable on any 5-inch cathode-ray oscillograph and is supported completely by clamping it to the Du Mont Type 2501 Bezel.



The Du Mont
Type 321

The moving-film camera makes possible the presentation of waveforms upon an unusually long time-base, and augments the performance of the cathode-ray oscillograph.

Many improvements from the standpoints of performance and operation have been incorporated in the Type 321 to simplify moving-film recording. The camera accommodates 400 feet of perforated or unperforated 35mm film or recording paper. Both the load and take-up magazines may be detached from the camera in a few seconds. Film-loading is amazingly simple — there is no threading necessary, no complicated path to follow. Film speed is variable in eighteen steps from approximately one inch per minute to 10,800 inches per minute (15 feet per second).

Full speed is attained almost instantly. Less than one inch of film is wasted in stopping the motion of the film even when the camera is operating at the highest speed. Specially designed film-braking minimizes the possibility of clogging, jamming, or breaking of the film. A film-supply indicator gives positive indication when

the recording film is exhausted.

The camera may be rotated 90 degrees, permitting either vertical or horizontal recordings to be made without rotating the cathode-ray tube or reversing deflection-plate leads. Single-frame records may also be made with the Type 321. Film travel may be time-calibrated by a flashing glow lamp. The light shield permits simultaneous viewing and recording. An illuminated data-card transfers pertinent information to the film. The Type 321 uses an $f/1.5$, 50mm, coated lens. Focus is fixed for general oscillographic applications but may be adjusted where required. Any desired length of exposed film may be removed from the camera by means of a cut-off knife. The take-up magazine may be removed quickly and carried to the darkroom. Additional magazines are relatively inexpensive. Stand

mounting makes the Type 321 highly mobile. It can be mounted either from the floor or bench top. There is no mechanical connection between the camera and the oscillograph. A sponge-rubber sleeve makes the mounting light-tight and vibration proof.

ALLEN B. DU MONT LABORATORIES, INC.
INSTRUMENT DIVISION
1000 MAIN AVE., CLIFTON, N. J.



for Military Components

UTC was the largest supplier of transformer components in World War II. Present UTC production is on a similar basis. Illustrated below are a few of the thousand military types in UTC 1950 production.

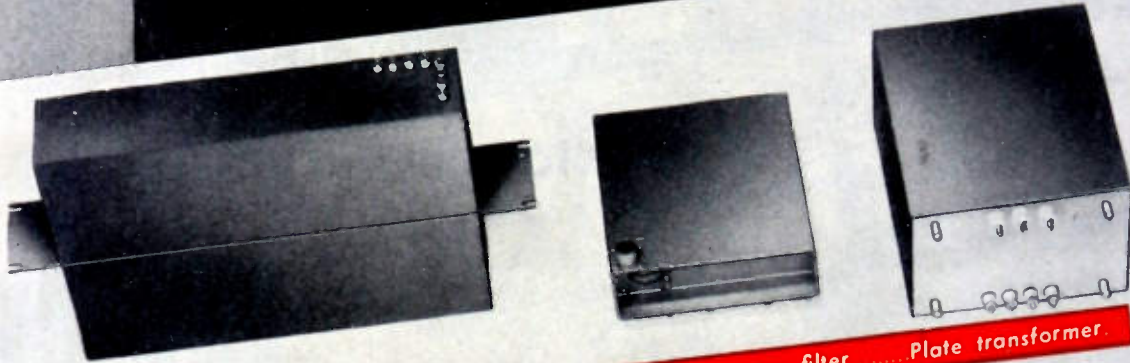

Carrier frequency filter.....Aircraft low frequency filter.....Plate transformer.



Typical hermetically sealed power transformers for 60 cycle service.



Hermetically sealed audio and pulse transformers.



60 cycle and 400 cycle components hermetically sealed and fosterized.



Miniaturized audio units, magnetic amplifiers, etc.

United Transformer Co.

150 VARICK STREET • NEW YORK 13, N. Y.
EXPORT DIVISION: 13 EAST 40th STREET, NEW YORK 16, N. Y. CABLES: "ARLAB"

*A page
from the
note-book
of Sylvania
Research*

Sylvania research develops new germanium subminiature photo-electric units

A tiny photocell of high efficiency and photo-sensitivity is another outstanding development of Sylvania research.

Achieved after careful studies of the photo-electric characteristics of germanium, these devices are so sensitive that useful current changes are obtained with very small changes in light intensity.

Among the many potential applications of these units are such varied uses as: decoding punched tape, electronic computing and sorting, and the direct operation of relays for many tasks such as opening and closing doors, and actuating alarm and signal devices.

Although these photocells are still in the research stage and not yet commercially available, their compactness and unusual sensitivity promise to suit them for many jobs where cost, circuit complexity, and space limitation are important factors.



Measuring the sensitivity and internal noise of a germanium subminiature photocell with Sylvania-designed testing equipment.

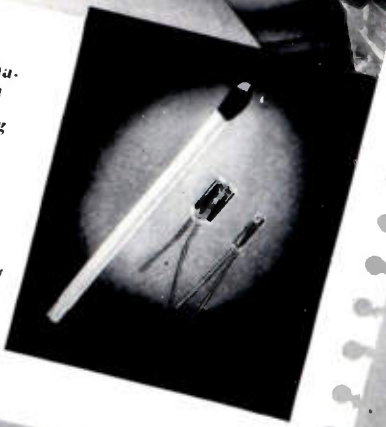

(Insert) Showing size of new Sylvania photocell compared to an ordinary sulphur match.

SYLVANIA ELECTRIC

ELECTRONIC DEVICES; RADIO TUBES; TELEVISION PICTURE TUBES; ELECTRONIC TEST EQUIPMENT; FLUORESCENT TUBES, FIXTURES, SIGN TUBING, WIRING DEVICES; LIGHT BULBS; PHOTOLAMPS; TELEVISION SETS

STANDARD RI-FI* METERS

14 kc to 1000 mc!

DEVELOPED BY STODDART
FOR THE ARMED FORCES.

AVAILABLE COMMERCIALY.



VHF!
15 MC
to
400 MC
NMA - 5

Commercial equivalent of TS-587/U.
Sensitivity as two-terminal voltmeter, (95 ohms balanced)
2 microvolts 15-125 MC; 5 microvolts 88-400 MC. Field
intensity measurements using calibrated dipole. Frequency
range includes FM and TV Bands.



VLF!
14 KC
to
250 KC
NM - 10A

Commercial equivalent of AN/URM-6.
A new achievement in sensitivity! Field intensity measure-
ments, 1 microvolt-per-meter using rod; 10 microvolts-per-
meter using shielded directive loop. As two-terminal volt-
meter, 1 microvolt.

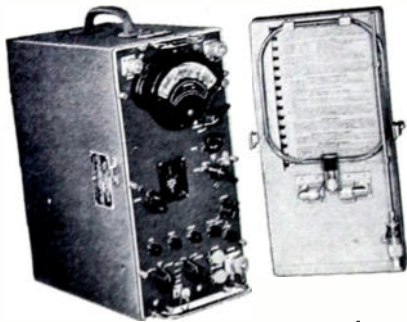

HF!
150 KC
to
25 MC
NM - 20A

Commercial equivalent of AN/PRM-1.
Self-contained batteries. A.C. supply optional. Sensitivity as
two-terminal voltmeter, 1 microvolt. Field intensity with 1/2
meter rod antenna, 2 microvolts-per-meter; rotatable loop
supplied. Includes standard broadcast band, radio range,
WWV, and communications frequencies.



UHF!
375 MC
to
1000 MC
NM - 50A

Commercial equivalent of AN/URM-17.
Sensitivity as two-terminal voltmeter, (50-ohm coaxial input)
10 microvolts. Field intensity measurements using calibrated
dipole. Frequency range includes Citizens Band and UHF
color TV Band.

Since 1944 Stoddart RI-FI* instruments have established the
standard for superior quality and unexcelled performance.
These instruments fully comply with test equipment require-
ments of such radio interference specifications as JAN-1-225,
ASA C63.2, 16E4(SHIPS), AN-1-24a, AN-1-42, AN-1-27a, AN-1-40
and others. Many of these specifications were written or re-
vised to the standards of performance demonstrated in
Stoddart equipment.

The rugged and reliable instruments illustrated above serve
equally well in field or laboratory. Individually calibrated
for consistent results using internal standard of reference.
Meter scales marked in microvolts and DB above one microvolt.
Function selector enables measurement of sinusoidal or complex
waveforms, giving average, peak or quasi-peak values.
Accessories provide means for measuring either conducted
or radiated r.f. voltages. Graphic recorder available.

*Radio Interference and Field Intensity.

STODDART AIRCRAFT RADIO CO.

6644 SANTA MONICA BLVD., HOLLYWOOD 38, CALIF.
Hillside 9294

Precision Attenuation for UHF !

Less than 1.2 VSWR to 3000 MC.

Turret Attenuators:

0, 10, 20, 30, 40, 50 DB.

Accuracy \pm .5 DB.

Patents applied for.



Another successful start with **DUMONT**

WHBF-TV

ROCK ISLAND, ILLINOIS

Channel 4

Another Television station with an eye to the future! WHBF-TV now goes on the air with Du Mont equipment assuring dependable, economical operation with all the advantages of the Du Mont "Grow As You Earn" system of equipment expansion. Air-cooled tubes, finest TV transmitter engineering and quality workmanship stand for low-operating expense characteristic of Du Mont TV transmitting equipment.

WHBF-TV operates on Channel 4 in Rock Island, Ill., covering the Quad Cities Area. We take this opportunity to congratulate WHBF-TV and welcome it to the ranks of the ever-increasing commercial TV stations of America.

Remember, it's smart business to investigate Du Mont first — and then compare.

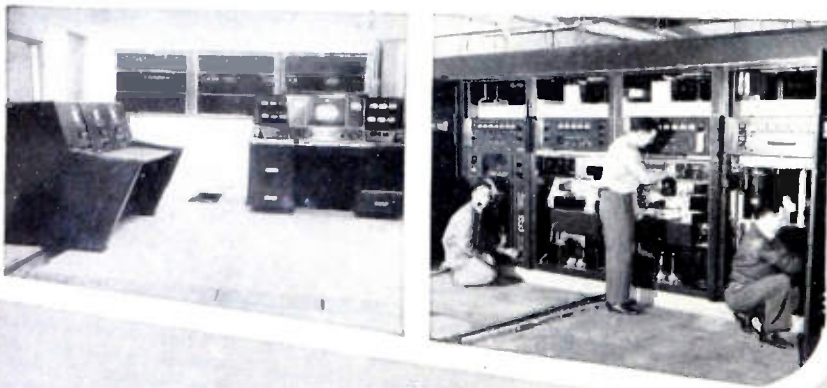

DUMONT

First with the Finest in Television

ALLEN B. DU MONT LABORATORIES, INC., TELEVISION TRANSMITTER DIVISION, CLIFTON, N. J.

Performance

PROTECTION

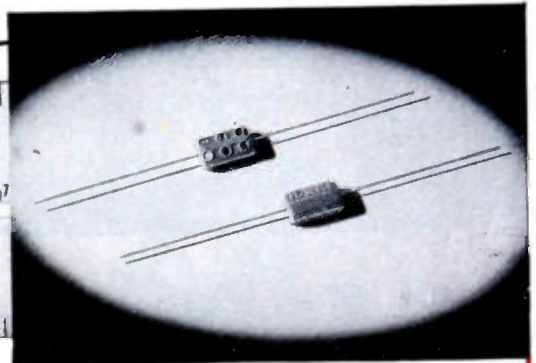
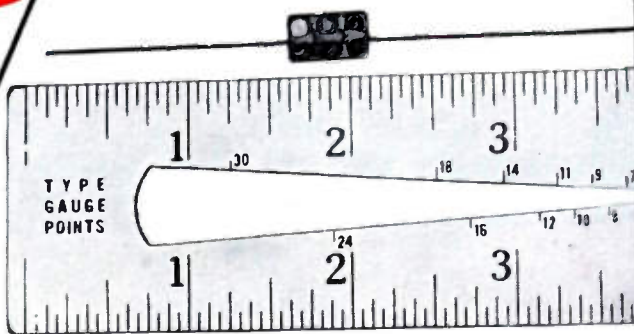

EL-MENCO CAPACITORS

Small, high-capacity fixed mica El-Menco capacitors are made to protect the performance of your products under severest operating conditions. They give long, dependable service because they must meet exacting conditions of Quality Test *before* they can be incorporated in your product. Tested at double their working voltage for dielectric strength, for insulation resistance and capacity value, El-Menco condensers can be depended upon for the utmost in performance protection.

CM-15

Actual Size 9/32" x 1/2" x 3/16"
For Television, Radio and other Electronic Applications.

2 mmf. — 420 mmf. cap. at 500v DCw.

2 mmf. — 525 mmf. cap. at 300v DCw.

Temp. Co-efficient 50 parts per million per degree C for most capacity values.

6-dot Color Coded.

SPECIFY EL-MENCO —

First Choice For Long Life and Dependability

THE ELECTRO MOTIVE MFG. CO., Inc.
WILLIMANTIC CONNECTICUT

Write on your firm letterhead for Catalog and Samples.



MOLDED MICA

El-Menco

CAPACITORS

MICA TRIMMER

FOREIGN RADIO AND ELECTRONIC MANUFACTURERS COMMUNICATE DIRECT WITH OUR EXPORT DEPT. AT WILLIMANTIC, CONN. FOR INFORMATION.
ARCO ELECTRONICS, INC. 135 Liberty St., New York, N. Y.—Sole Agent for Jobbers and Distributors in U.S. and Canada



Design and Production Facilities
E-X-P-A-N-D-E-D
for Contract and Sub-Contract

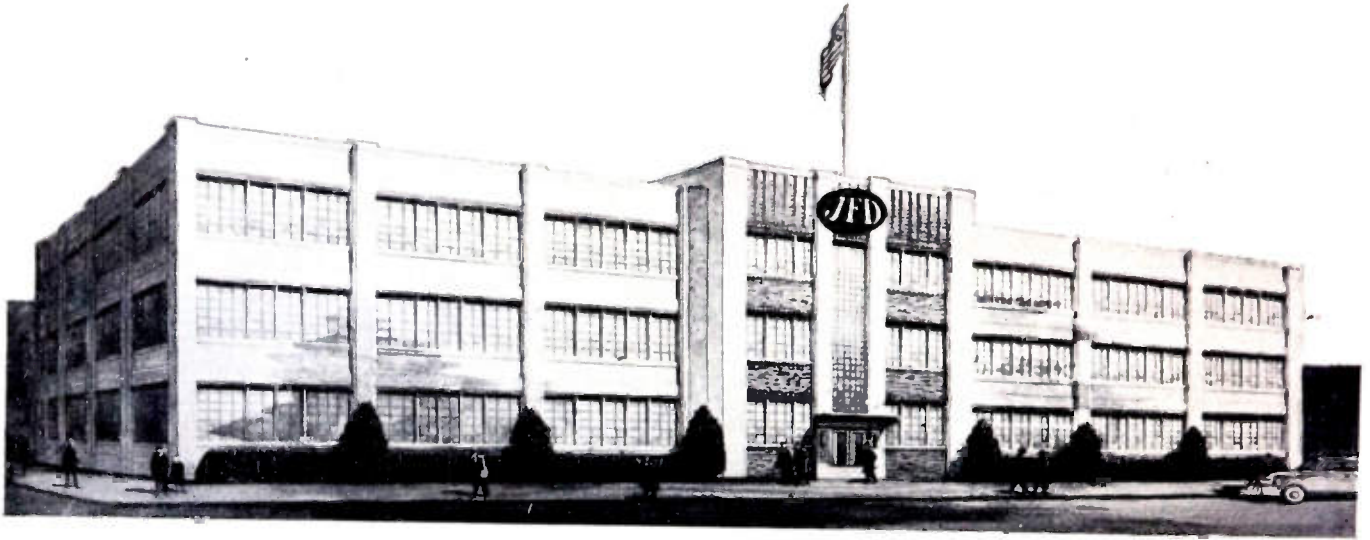

JFD is the world's largest producer of communications and television parts and accessories. We grew up with the industry... and know it well.

JFD's new, increased facilities for the design and manufacture of television and communications accessories are second to none. Two large plants are completely equipped with the latest, most efficient machinery... and staffed by experienced personnel with the required "know-how".

Inquiries Invited

FIRST in Antennae
and Accessories
—Established 1929



MANUFACTURING CO., Inc.
6107 16th AVENUE, BROOKLYN 4, N. Y.
FIRST in Television Antennas and Accessories

New Instruments for Microwave Testing

COMPLEMENT SPERRY'S *Microline**

Models 348, 349 and 350, new cavity frequency meters shown below, extend to the SHF and EHF frequency ranges, techniques which are now available at lower frequencies. These broadband instruments are designed for both transmission and absorption-type indications. They are suitable for search-type frequency measurements or any other requirement where an accuracy of .1 percent frequency set is needed. These are among the many new microwave test and measuring instruments which have been added to the ever-increasing Sperry Microline.

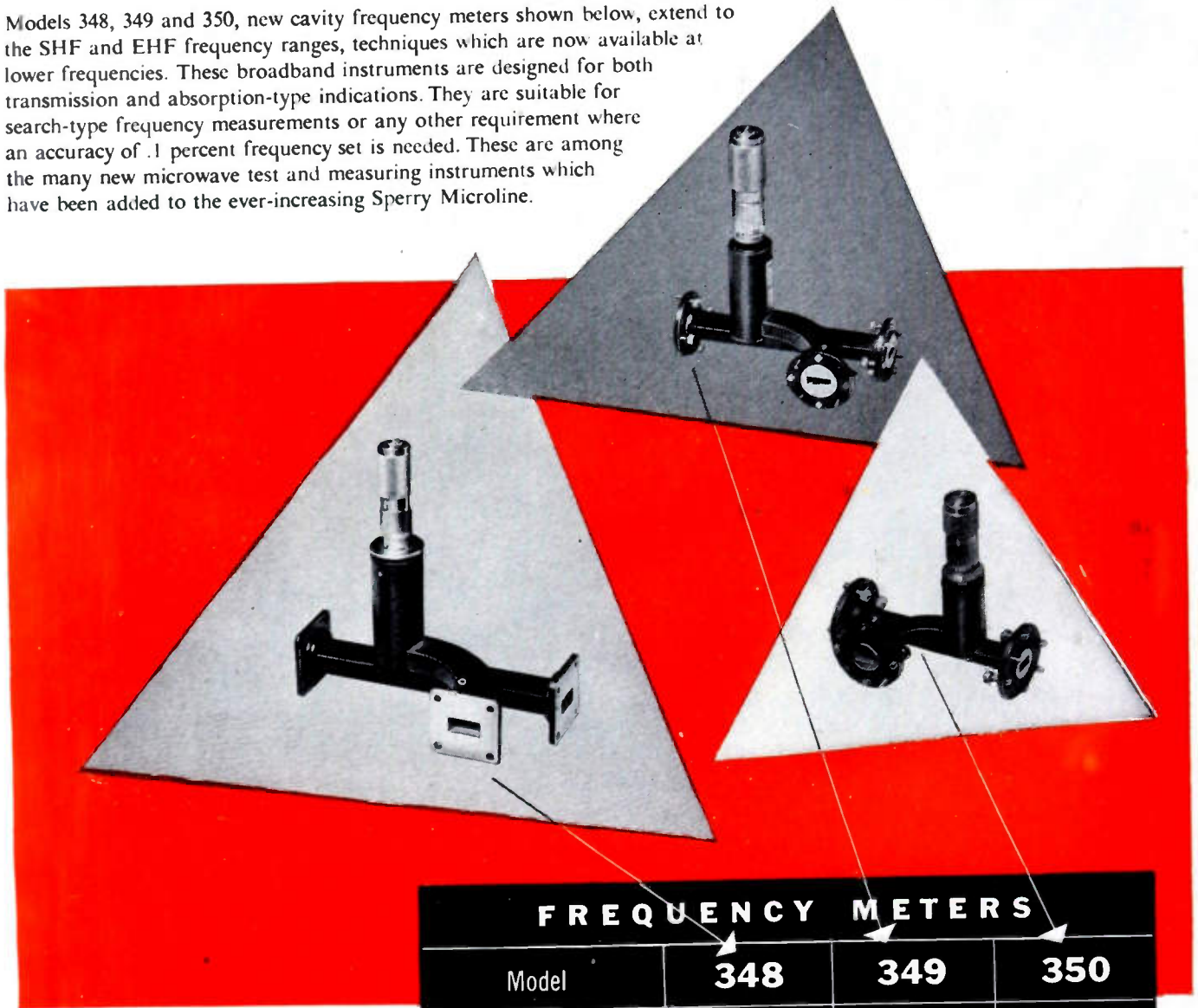

FREQUENCY METERS

| Model | 348 | 349 | 350 |
|---------------------------|----------------------|-----------------|----------------------|
| Description | CAVITY | CAVITY | CAVITY |
| Frequency Range mc | 13,000-18,000 | 19,000-26,000 | 26,500-39,000 |
| Absolute Accuracy | 1/1000 | 1/1000 | 1/1000 |
| Approximate Loaded Q | 1000 | 450 | 1000 |
| Fittings } R-F } Video | UG-419/U UG-419/U | UG-425/U UHF | UG-381/U UG-381/U |

Catalog information on these and other Microline Instruments is available on request.

*Trade Mark

Other new instruments in the frequency ranges of the above mentioned meters are:

| Instrument | Model | Frequency Range mc |
|-----------------------|-------|--------------------|
| Impedance Meter | 320 | 18,000-26,500 |
| Impedance Meter | 346 | 26,500-40,000 |
| Impedance Transformer | 347 | 26,500-40,000 |
| Directional Coupler | 405 | 26,500-39,000 |
| Directional Coupler | 413 | 18,000-26,500 |
| Directional Coupler | 415 | 18,000-26,500 |
| Directional Coupler | 388 | 12,400-17,000 |
| Directional Coupler | 429 | 32,000-39,000 |
| Short | 371 | 26,500-40,000 |
| Short | 372 | 12,400-18,000 |
| Termination | 401 | 12,400-18,000 |
| Termination | 402 | 26,500-40,000 |
| Detector and Mixer | 357 | 17,400-18,000 |
| Detector and Mixer | 358 | 18,000-26,500 |
| Detector and Mixer | 359 | 26,500-40,000 |
| Detector and Mixer | 382 | 26,500-40,000 |
| Magic Tee | 390 | 18,000-26,500 |
| Magic Tee | 391 | 26,500-40,000 |

SPERRY

GYROSCOPE COMPANY

DIVISION OF THE SPERRY CORPORATION, GREAT NECK, NEW YORK • CLEVELAND • NEW ORLEANS • NEW YORK • LOS ANGELES • SAN FRANCISCO • SEATTLE

PROCEEDINGS OF THE I.R.E. September, 1950

KEEP INFORMED!



Over 30,000 readers in the Television Industry look to the pages of the exciting, informative and entertaining TELEVISION MIS-INFORMATION for the "lowdown" on the news, the facts behind distortions of the news that rarely make the trade press, and predictions of things to come.

Here are a few of the two previous issues' predictions that came true:

- 1 — New Tube Types
- 2 — The Great Demand for 19" T-V Sets
- 3 — Advertising Exaggerations
- 4 — Establishment of Standards for the Industry

The third issue of *Television Mis-Information* is on the press! Its circulation will be limited to 40,000 copies. Be sure you reserve your copy. Mail coupon below.

KEEP INFORMED! Get the latest information on Sheldon's complete line of Rectangular, Glass-Metal and Round Television Picture Tubes shown in its "General Characteristics & Dimensions" Wall Chart.

SHELDON ELECTRIC CO.

Division of Allied Electric Products Inc.

68-98 Coit Street, Irvington 11, N. J.

Branch Offices & Warehouses: CHICAGO 7, ILL., 426 S. Clinton St. • LOS ANGELES 26, CAL., 1755 Glendale Blvd.

Sheldon

NATURAL IMAGE



SOFT GLOW

Picture Tube



KEEP INFORMED! Mail coupon **TODAY** for your **FREE** copy of *Television Mis-Information* No. 3 and Sheldon Picture Tube Wall Chart.

Sheldon Electric Co., 68-98 Coit St., Irvington 11, N. J. 3

Send me "Television Mis-Information"

Send me Sheldon Picture Tube Wall Chart

(They're both FREE . . . but please print your name)

Name Title

Company

Street

City Zone State

TELEVISION PICTURE TUBES • CATHODE RAY TUBES • FLUORESCENT LAMP STARTERS AND LAMPHOLDERS • SHELDON REFLECTOR AND INFRA-RED LAMPS
PHOTOFLOOD AND PHOTOSPOT LAMPS • SPRING-ACTION PLUGS • TAPMASTER EXTENSION CORD SETS AND CUBE TAPS • RECTIFIER BULBS

The Most Complete Line of Wirewound Resistors ...

The **OHMITE** Line



TYPES AND SIZES For Every Resistor Need!

In addition to the many types of resistors shown, Ohmite offers resistors in more than 60 sizes—ranging from 2½" diameter by 20" long, to ⅛" diameter by 1" long—to meet your exact requirements. Many sizes are carried in stock.

No matter what your resistor requirements, the chances are that Ohmite has exactly the resistor you need. Ohmite offers fixed, adjustable, tapped, non-inductive, and precision-type resistors in many sizes, types of terminals, and in a wide range of wattage and resistance values. Ohmite application engineers will be pleased to help in the selection of the right resistor for your needs.

OHMITE MANUFACTURING CO
4862. Flournoy St., Chicago 44, Illinois

Write on Company Letterhead
for Catalog 40

Be Right with

OHMITE

Reg. U. S. Pat. Off.

RHEOSTATS • RESISTORS • TAP SWITCHES

Industry's First Choice

MANY TYPES OF TERMINALS



LUG TYPE



WIRE LEAD



INTEGRAL FLEXIBLE LEAD



LUG MOUNTED FLEXIBLE LEAD



EDISON SCREW BASES



CUP STYLE FERRULES



SLEEVE STYLE FERRULES



CARTRIDGE STYLE FERRULES

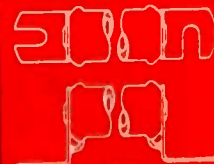

LIVE BRACKETS

Divides a second
into 1,600,000 parts—

1.6 MEGACYCLE COUNTER- CHRONOGRAPH



FEATURES:

- High Resolution and Accuracy— $1/1,600,000$ second.
- Direct Indication of intervals up to one second — recycling of counter can be observed or recorded for longer intervals.
- Retains Indication of measurement until reset.
- Easy to actuate — pulses from common or separate sources can be used.
- Dependable and stable — no adjustments required.
- Accepted standard in practically all government proving grounds.

APPLICATIONS:

PROJECTILE VELOCITY MEASUREMENTS
CAMERA SHUTTER TIMING
FREQUENCY MEASUREMENTS
PRECISION TACHOMETER
RELAY CONTACT TIMING
GEOPHYSICAL MEASUREMENTS
GAS TUBE MEASUREMENTS

PRINCIPLE OF OPERATION:

A quartz crystal, continuously oscillating at 1.6 mc is used as a time base. During the time interval to be measured the cycles are gated into four binary counting stages having a capacity of 16 counts. The neon indicator lights of these stages are numbered $1/16$, $2/16$, $4/16$, and $8/16$ (sixteenths of 10 microseconds or 0.625 microsecond). Following the binary stages are five decade counting units having a capacity of 100,000 counts. Each count entering the decades from the binary stages represents 10 microseconds. Therefore, the time interval between 10 microseconds and 1 second is registered in the decades and the remainder is registered in the binary stages. For instance a time interval of .5374825 second would be indicated as follows: .53748 on the decade indicators plus $4/16$ (of 10 microseconds) on the binary indicators.

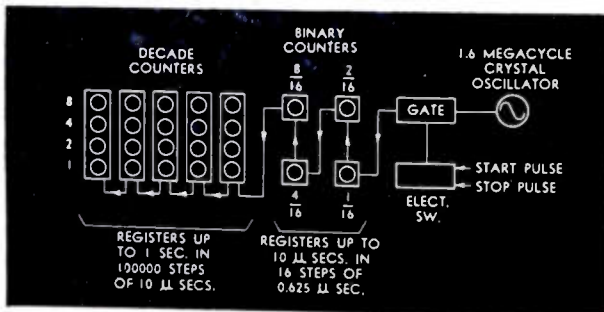

HIGH SPEED ELECTRONIC COUNTERS, COMPUTERS AND PRECISION INTERVAL TIMERS FOR ALL APPLICATIONS—ADDRESS INQUIRIES TO DEPT. 5A

POTTER INSTRUMENT COMPANY
INCORPORATED

115 CUTTER MILL ROAD • GREAT NECK • NEW YORK



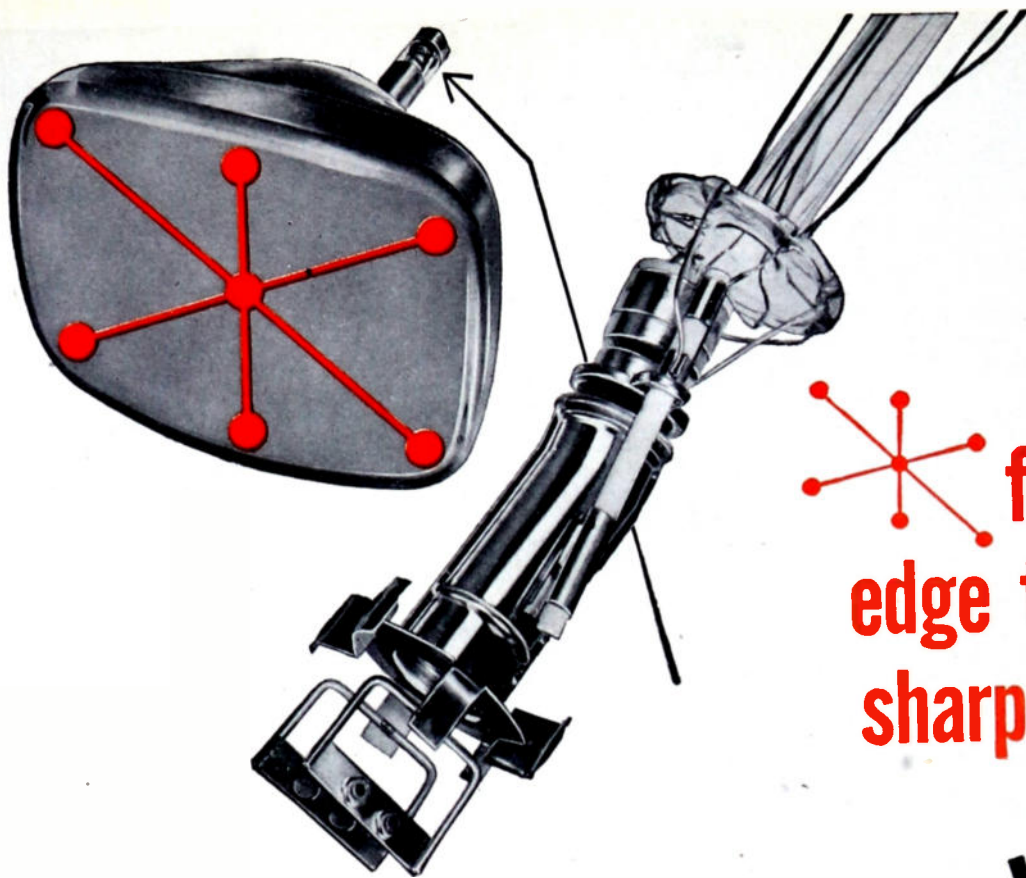

for
edge to edge
sharpness...

the **New** Du Mont Bent-Gun

the latest refinement in the most copied gun structure.

Uniform sharpness of trace to the very edges of the screen distinguishes the new Du Mont Bent-Gun.

A higher degree of pre-focusing passes a smaller-diameter beam through the deflection field. Spot distortion is reduced and a uniform overall focus results. Other design changes are: Improved bulb spacer insures proper anode contact and electron gun centering; rounded corners on pertinent gun parts eliminates stray emission at higher anode voltages; new grid-cathode assembly allows a longer G-2 (second grid) without increasing overall length.

This new Du Mont Bent-Gun is now being incorporated in ALL Du Mont Teletrons. Therefore, whether planning a new TV receiver or modifying an old one, be sure to include the Du Mont Teletron for the best in TV pictures. Simply specify DU MONT.

FIRST WITH THE FINEST IN T-V TUBES

DU MONT

*Teletrons**

ALLEN B. DU MONT LABORATORIES, INC.,
Tube Division, Clifton, N. J.

*Trade-mark.

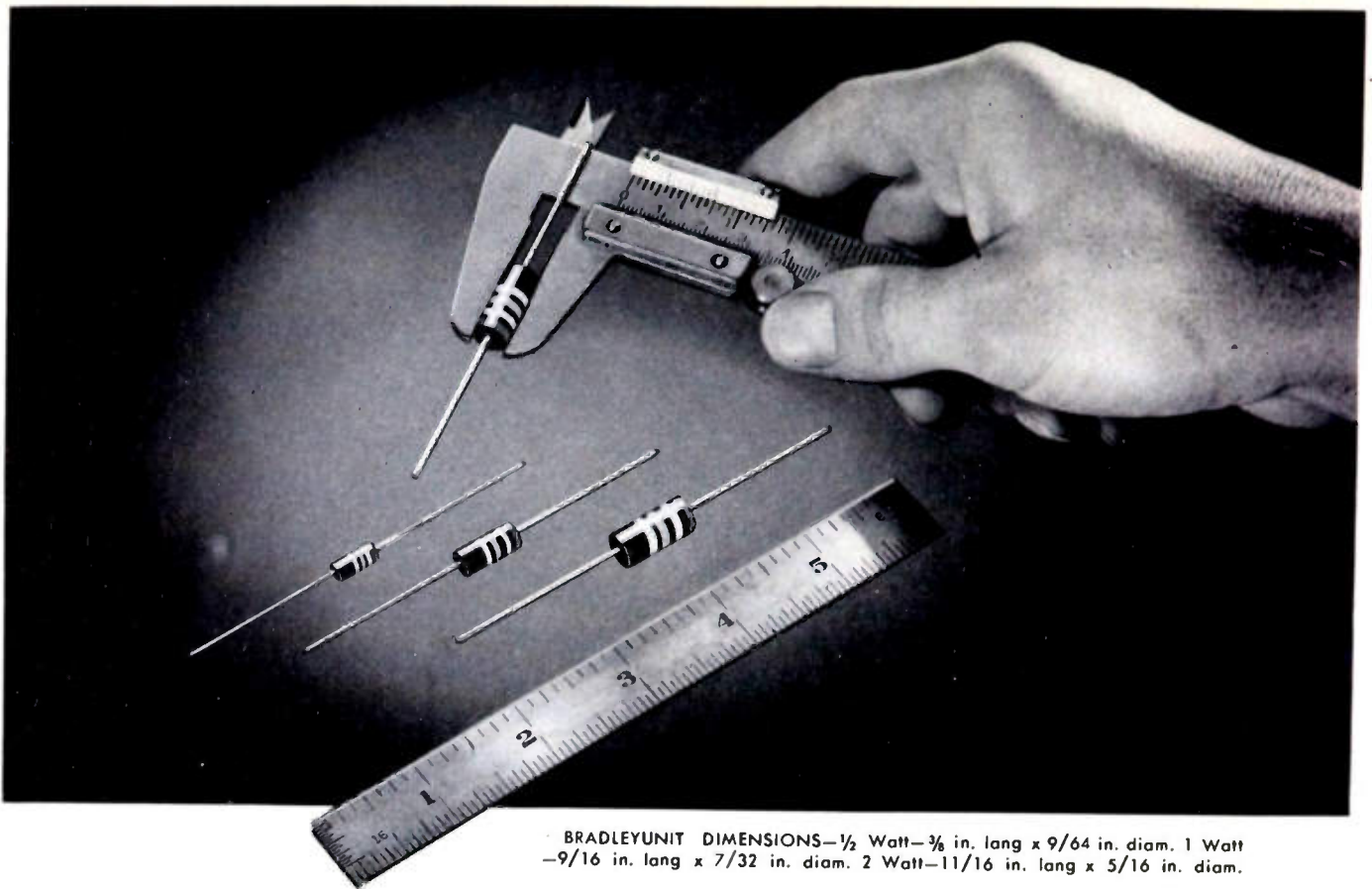

BRADLEYUNIT DIMENSIONS— $\frac{1}{2}$ Watt— $\frac{3}{8}$ in. lang x $\frac{9}{64}$ in. diam. 1 Watt— $\frac{9}{16}$ in. lang x $\frac{7}{32}$ in. diam. 2 Watt— $\frac{11}{16}$ in. lang x $\frac{5}{16}$ in. diam.

QUALITY FIXED RESISTORS for Electronic Circuits

SOLID MOLDED ADJUSTABLE RESISTORS

Available in single, dual, and triple unit constructions with solid molded resistor elements. Any resistance-rotation curve. Rated at 2 watts.

Bradleyunit resistors are small in size . . . but "super" in the performance demanded by electronic engineers. Bradleyunits are rated at 70 C ambient temperature, not 40 C. Thus, they have a much wider safety factor. Furthermore, under continuous full load for 1000 hours, resistance change is less than 5 per cent. And, Bradleyunits require no wax impregnation to pass salt water immersion tests. Another advantage is the differentially tempered leads which prevent sharp bends near the resistor.

Bradleyunits are packed in honeycomb cartons to keep the leads straight and avoid tangling. They are available in $\frac{1}{2}$, 1, and 2 watt ratings in standard R. M. A. values up to 22 megohms.

114 W. Greenfield Ave., Milwaukee 4, Wis.
Allen-Bradley Co.



ALLEN-BRADLEY
FIXED & ADJUSTABLE RADIO RESISTORS

Sold exclusively to manufacturers



QUALITY

of radia and electronic equipment

FREED

TRANSFORMERS & INSTRUMENTS

"PRODUCTS OF EXTENSIVE RESEARCH"



NO. 1060 VACUUM
TUBE VOLTMETER
INPUT IMPEDANCE
50 MEGOHMS



NO. 1030 LOW
FREQUENCY "Q"
INDICATOR

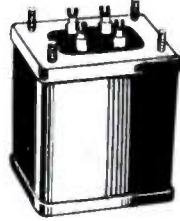

HIGH FIDELITY
TRANSFORMERS
1/2 DB 20 CPS TO 30 KC



DISCRIMINATORS
10 CPS TO 1 MC

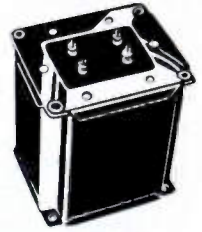

COMMERCIAL
COMPONENTS
QUALITY —
DEPENDABILITY — PRICE

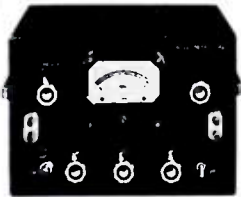

NO. 1140 NULL
DETECTOR
COMPLETE WITH
SELECTIVE CIRCUITS



NO. 1020 MEGOHMMETER
2,000,000 MEGOHMS
DIRECT READING

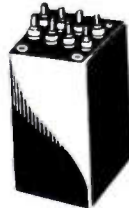

HERMETICALLY
SEALED COMPONENTS
TO MEET MIL-T-27 SPECS.

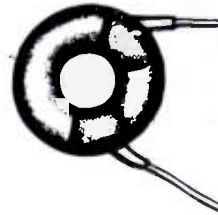

TOROIDAL INDUCTORS
60 CPS TO 1 MC



MINIATURE INDUCTORS
1000 CPS TO 100 KC



NO. 1210 NULL
DETECTOR & VACUUM
TUBE VOLTMETER



DECADE INDUCTORS
30 CPS TO 300 KC



SUB MINIATURE
HERMETICALLY SEALED
TOROIDAL INDUCTORS



SUB MINIATURE
HERMETICALLY SEALED
COMMUNICATION
COMPONENTS



SLUG TUNED
COMPONENTS
1000 CPS TO 1 MC



NO. 1150 UNIVERSAL
BRIDGE
5 A.C. BRIDGES IN ONE
UNIT



NO. 1010 COMPARISON
BRIDGE
FAST, ACCURATE,
RELIABLE

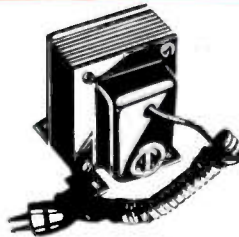

STEPDOWN
TRANSFORMERS
50 WATTS TO 3 KW



PULSE TRANSFORMERS
FROM WATTS TO
MEGAWATTS



POWER
TRANSFORMERS
RUGGED, DEPENDABLE,
INEXPENSIVE.



1170 D.C. SUPPLY
DIRECT CURRENT UP TO
500 MA.



NO. 1110 INCREMENTAL
INDUCTANCE BRIDGE
A NECESSITY FOR
EVERY LAB.



PRECISION FILTERS
10 CPS. TO 1 MC.



CHANNEL MOUNTING
INEXPENSIVE—RELIABLE

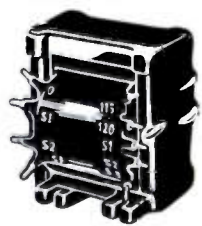

FOSTERITE TREATMENT
ANE-19 SPECS.

SEND FOR LATEST CATALOG!

FREED TRANSFORMER CO., INC.

DEPT. SP 1718-36 WEIRFIELD ST., (RIDGEWOOD) BROOKLYN 27, NEW YORK



SEPTEMBER, 1950

Wide-Band DC Amplifier

The Model 120, wide-band dc amplifier was designed by **Furst Electronics**, 12 S. Jefferson St., Chicago 6, Ill., to increase the sensitivity of cathode-ray oscilloscopes with extended low-frequency response. It is also suitable to extend the range of vacuum-tube voltmeters, frequency analyzers, and other instruments, when unusually low frequencies are involved.



The amplifier uses push-pull amplification throughout, and a special cross-coupled circuit is used to achieve stability and low drift. Another advantage of this circuit is the good phase-inversion obtained through its use, so that the amplifier can be used equally well with balanced or unbalanced input signals. If two different signals are applied to the input terminals, the instrument acts as a differential amplifier whereby the difference of these two signals appears push-pull at the output terminals. This makes it possible to observe both the signal to be investigated and a marker or timing signal at the same time. Two independent push-button operated input attenuators permit, in the latter case, mixing of signals of different amplitudes.

The maximum gain is adjusted to approximately 100 and the input attenuators reduce this gain to approximately 10 and 1 (40 db, 30 db, and 0 db, respectively). A fourth position on each attenuator grounds the grid of its input tube, a convenient feature, when, for instance, a single-ended signal is applied to one input terminal only. Grounded terminals are also provided near both dc and ac terminals.

Low Loss Capacitors

A line of vitreous enamel capacitors: 0.68 μf to 1,000 μf rated at 500 volts dc is being marketed by **Vitramon, Inc.**, Stepney, Conn.

Each unit is a laminant of a low loss ceramic dielectric and metallic silver, sintered to produce a monolithic block with stable temperature characteristics. The properties of the materials and the small size insure low losses for all frequencies at temperatures from -55°C to $+200^{\circ}\text{C}$. The capacitors are finished to meet JAN requirements.

These manufacturers have invited PROCEEDINGS readers to write for literature and further technical information. Please mention your I.R.E. affiliation.

New RF Millivolt Meter for VHF

A new type MV-18b high-frequency vacuum-tube millivolt meter to measure frequencies from 1 Mc to 200 Mc flat with direct calibration charts is available from the manufacturer, **Millivac Instruments**, P.O. Box 3027, New Haven, Conn. Its sensitive ranges cover millivolt measurements at frequencies up to 200 Mc and down to a single millivolt.



The instrument contains a new carrier-type dc amplifier having exceptionally heavy negative feedback to insure accuracy and stability. Germanium crystal probes are used to rectify weak rf signals with minimum circuit loading. These new probes are designed to have 1.0- μf input capacity with a tolerance of ± 25 per cent.

Sharp-Cutoff Miniature Pentode for TV Receivers

The 6CB6, a miniature pentode, for use in television rf tuners and video if amplifiers, with design schematic for a video if amplifier system operating in the 40-Mc region, is available from **Radio Corp. of America**, Tube Dept., 415 S. Fifth St., Harrison, N. J.

The manufacturer admits that there are various other rf pentodes having lower grid capacitance; however, this is accomplished by shielding the plate, which increases the output capacitance. Because the only capacitance in the tuned circuits of most TV, rf, and if amplifiers is that of the tube electrodes and the wiring, an increase in output capacitance causes a decrease in plate-circuit impedance and a consequent loss in gain. The maximum grid-plate capacitance of the 6CB6 is 0.020 μf ; its output capacitance is 1.9 μf .

New Vibrator

A new vibrator for dc conversion is hereby announced by **Harold J. Brown**, Mattapoisett, Mass., specifically designed for severe and exacting requirements; and embodying new concepts of design.

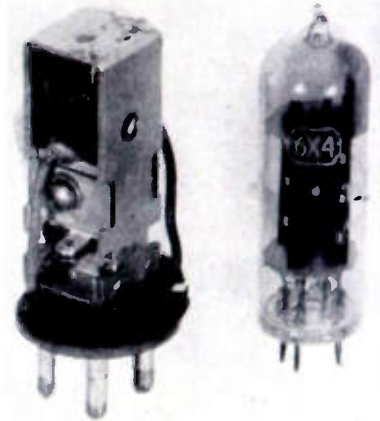

This vibrator will be available in both standard and high frequency forms, and for low and high power applications. It is generally smaller and more easily applied than is usual, while at the same time it is rugged and shock resistant. When combined with proper circuitry, either long life or high power may be obtained. A minimum of excitation power is needed for use in very low power applications such as in zero output devices.

Electronic Television Mixer

A new electronic television mixer, Type TV-19-A, for automatic and manual fading, lapping, and dissolving of television pictures, has been announced by the **Commercial Equipment Div., General Electric Co.**, Electronics Park, Syracuse, N. Y.

When combined with GE control panels TC-21-A or TC-31-A, the mixer will provide split-second timing between channels and, because the operation of the system is largely automatic, switching errors are reduced. It is built for both portable and studio use.

The new electronic mixer will take up to four noncomposite inputs from camera channels and will fade or switch between any two of the four. The output of the video mixer is fed to a sync mixer and then to the output stage. The output is composite and ready for transmission use. Any one of the four mixer inputs can be bypassed around the video mixer to the sync mixer and output circuits; and thus leave the remainder of the mixer free for rehearsals which can be viewed by the non-composite monitor output. Manual operation is also provided for special effects, such as superpositions.

(Continued on page 40A)

Lavoie

VHF

Omni-directional

RADIO RANGE SYSTEM

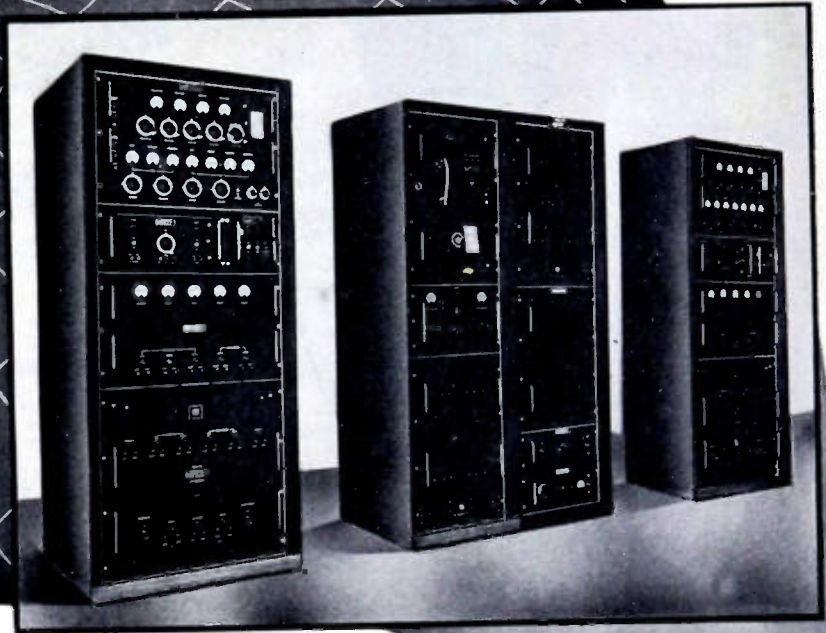

The Very High Frequency Omnidirectional Radio Range System, more simply known as VHF Omni Range (or VOR), has been standardized by international agreement as the most desirable method of short range aircraft navigation. A multiplicity of courses, theoretically infinite, is provided instead of the usual four courses obtained from the conventional Aural A-N system. The advantages of this are immediately apparent. Tangential courses are practical, as well as the conventional 'head-on' approach. By means of 'fixes' on two Omni stations, absolute position may quickly be determined, and by presetting the aircraft receiver, a pilot may maintain any angle of approach.

This Omnidirectional Radio Range System was DEVELOPED-DESIGNED-PRODUCED by LAVOIE LABORATORIES, Inc. We have both the experience and the facilities for the precise mass production of ELECTRONIC SYSTEMS at low unit cost.



If you will address us on your letterhead we shall be glad to send you a detailed description of the LAVOIE Omnidirectional Radio Range System.



Lavoie Laboratories, Inc.

RADIO ENGINEERS AND MANUFACTURERS
MORGANVILLE, N. J.

Specialists in the Development and Manufacture of UHF Equipment

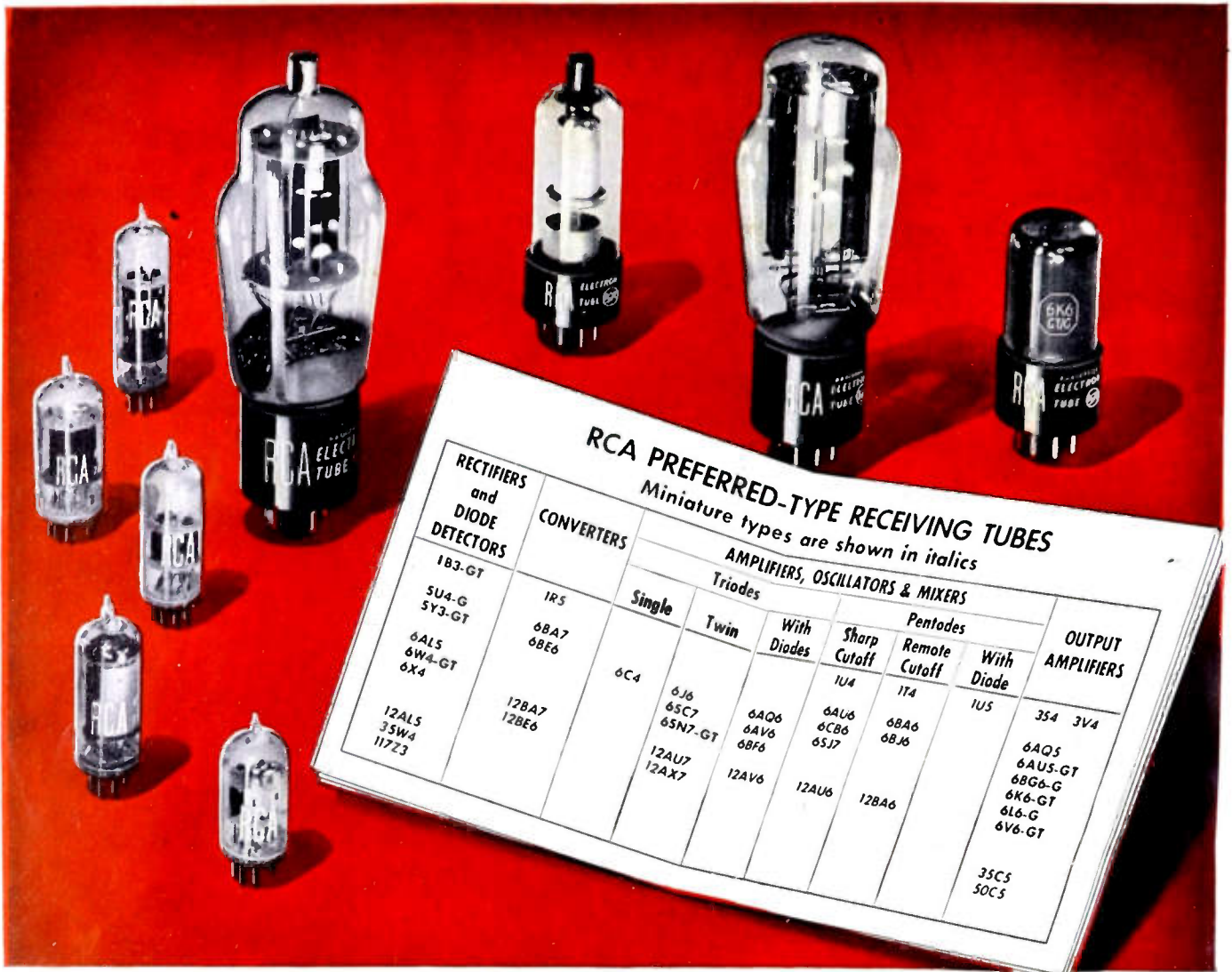

RCA PREFERRED-TYPE RECEIVING TUBES
Miniature types are shown in italics

| RECTIFIERS and DIODE DETECTORS | CONVERTERS | AMPLIFIERS, OSCILLATORS & MIXERS | | | | | | OUTPUT AMPLIFIERS |
|---|---|----------------------------------|---|---|---|---|--|---|
| | | Triodes | | | Pentodes | | | |
| | | Single | Twin | With Diodes | Sharp Cutoff | Remote Cutoff | With Diode | |
| 1B3-GT <i>SU4-G</i> <i>5Y3-GT</i> <i>6AL5</i> <i>6W4-GT</i> <i>6X4</i> <i>12AL5</i> <i>35W4</i> <i>11Z3</i> | 1R5 <i>6BA7</i> <i>6BE6</i> <i>12BA7</i> <i>12BE6</i> | <i>6C4</i> | <i>6J6</i> <i>6SC7</i> <i>6SN7-GT</i> <i>12AU7</i> <i>12AX7</i> | <i>6AQ6</i> <i>6AV6</i> <i>6BF6</i> <i>12AV6</i> | <i>6AU6</i> <i>6CB6</i> <i>6SJ7</i> <i>12AU6</i> | <i>104</i> <i>6AU6</i> <i>6CB6</i> <i>6SJ7</i> | <i>174</i> <i>6BA6</i> <i>6B16</i> <i>12BA6</i> | <i>354</i> <i>3V4</i> <i>6AQ5</i> <i>6AUS-GT</i> <i>6BG6-G</i> <i>6K6-GT</i> <i>6L6-G</i> <i>6V6-GT</i> <i>35CS</i> <i>50CS</i> |

Balanced Program for design engineers

For TV, FM, and AM . . . RCA preferred-type receiving tubes offer these important advantages . . .

Flexibility—RCA preferred-type receiving tubes cover virtually every tube function essential in TV, AM, and FM receivers . . . and allow the engineer latitude to express individuality in his circuit designs.

Performance—These types have demonstrated their reliability over a period of time in circuits of widely different designs. Proved in service, they are most likely to succeed in future designs.

Economy—This group of 44 tube types represents more than half of RCA's current receiving tube volume. By concentrating production on these few types, substantial savings are realized in manufacturing costs which are passed on to the equipment manufacturer . . . and quality and uniformity are sustained at a high level.

Standardization—By concentrating on RCA preferred tube types, the equipment manufacturer also benefits

by his ability to standardize on component parts . . . resulting in purchasing and stocking economies.

A reference booklet (3F953), describing RCA's preferred-type receiving tubes and a wall chart (3F955R), listing these types, are available without charge. Write RCA, Commercial Engineering, Section 147R, Harrison, New Jersey.



The Fountainhead of Modern Tube Development is RCA



RADIO CORPORATION of AMERICA

ELECTRON TUBES

HARRISON, N. J.

PROCEEDINGS OF THE I.R.E.

BOARD OF DIRECTORS, 1950*

Published Monthly by

The Institute of Radio Engineers, Inc.

Raymond F. Guy
President

R. A. Watson-Watt
Vice-President

D. B. Sinclair
Treasurer

Haraden Pratt
Secretary

Alfred N. Goldsmith
Editor

B. E. Shackelford
Senior Past President

Stuart L. Bailey
Junior Past President

1950

Ben Akerman (6)

W. R. G. Baker

T. H. Clark

J. V. L. Hogan (2)

T. A. Hunter

H. E. Kranz (4)

F. H. R. Pounsett (8)

J. E. Shepherd

J. A. Stratton

1950-1951

A. V. Eastman (7)

W. L. Everitt

D. G. Fink

F. Hamburger Jr. (3)

H. J. Reich (1)

J. D. Reid (5)

1950-1952

W. R. Hewlett

J. W. McRae

Harold R. Zeamans
General Counsel

George W. Bailey
Executive Secretary

Laurence G. Cumming
Technical Secretary

Changes of address (with advance notice of fifteen days) and communications regarding subscriptions and payments should be mailed to the Secretary of the Institute, at 450 Ahnaip St., Menasha, Wisconsin, or 1 East 79 Street, New York 21, N. Y.

All rights of republication, including translation into foreign languages, are reserved by the Institute. Abstracts of papers with mention of their source, may be printed. Requests for republication privileges should be addressed to The Institute of Radio Engineers.

* Numerals in parenthesis following Directors' names designate Region number.

VOLUME 38

September, 1950

NUMBER 9

PROCEEDINGS OF THE I.R.E.

| | |
|---|---|
| Trevor H. Clark, Director—1950 | 978 |
| Growth and Amplification | Henri Busignies 979 |
| 3704. The Present Status of Color Television | 980 |
| 3705. Mixed Highs in Color Television | A. V. Bedford 1003 |
| 3706. Metallized Paper for Capacitors | D. A. McLean 1010 |
| 3707. Metallized Paper Capacitors | J. R. Weeks 1015 |
| 3708. Biological Requirements for the Design of Amplifiers | Harry Grundfest 1018 |
| 3709. Effects of Intense Microwave Radiation on Living Organisms | John W. Clark 1028 |
| 3710. The Klystron Mixer Applied to Television Relaying | Vincent Learned 1033 |
| 3711. The Compensation of Delay Distortion in Video Delay Lines | R. A. Erickson and H. Sommer 1036 |
| 3712. Measured Directivity Induced by a Conducting Cylinder of Arbitrary Length and Spacing Parallel to a Monopole Antenna (Abstract) | F. R. Abbott and C. R. Fisher 1040 |
| 3713. Impedance Transformation in Folded Dipoles | Rudolf Guertler 1042 |
| 3714. Two Standard Field-Strength Meters for Very-High Frequencies | D. D. King 1048 |
| 3715. Pattern Calculations for Antennas of Elliptical Aperture (Abstract) | R. J. Adams and K. S. Kelleher 1052 |
| 3716. Development of Artificial Microwave Optics in Germany | Otmar M. Stuetzer 1053 |
| 3717. The Poynting Vector in the Ionosphere | James C. W. Scott 1057 |
| 3718. Radiation from Circular Current Sheets | W. R. LePage, C. S. Roys, and S. Seely 1069 |
| 3719. High-Frequency Vibrations of Plates Made from Isometric and Tetragonal Crystals | E. A. Gerber 1073 |
| 3720. Standards on Electron Tubes: Methods of Testing, 1950, Part II | 1079 |
| Contributors to PROCEEDINGS OF THE I.R.E. | 1094 |
| Correspondence: | |
| 3497. Note on the Reactance-Tube Oscillator | Adolf Giger 1096 |
| 3497. The Reactance-Tube Oscillators | V. C. Rideout and Han Chang 1096 |
| 3721. Feedback and the Future of the Sciences | R. G. Silson 1097 |
| 3722. Comment on "Psychical Physics" | Ted Powell 1097 |
| 3723. Nikola Tesla, Inventor | Ted Powell 1097 |

INSTITUTE NEWS AND RADIO NOTES SECTION

| | |
|--|------|
| Technical Committee and Professional Group Notes | 1098 |
| Industrial Engineering Notes | 1100 |
| IRE People | 1102 |
| Books: | |
| 3724. Radio Operating Questions and Answers by J. L. Hornung | 1104 |
| Reviewed by Donald McNicol | |
| 3725. Electronics in Engineering by W. Ryland Hill | 1104 |
| Reviewed by J. D. Ryder | |
| 3726. Facsimile by Charles R. Jones | 1104 |
| Reviewed by Nathan Marchand | |
| Sections | 1105 |
| Professional Groups | 1106 |
| 3727. Abstracts and References | 1107 |
| News—New Products | 30A |
| Membership | 36A |
| Section Meetings | 34A |
| Positions Open | 50A |
| Student Branch Meetings | 35A |
| Positions Wanted | 54A |
| Advertising Index | 79A |

EDITORIAL DEPARTMENT

Alfred N. Goldsmith
Editor

E. K. Gannett
Technical Editor

Mary L. Potter
Assistant Editor

ADVERTISING DEPARTMENT

William C. Copp
Advertising Manager

Lillian Petranek
Assistant Advertising Manager

BOARD OF EDITORS

Alfred N. Goldsmith
Chairman

PAPERS REVIEW COMMITTEE

George F. Metcalf
Chairman

Responsibility for the contents of papers published in the PROCEEDINGS OF THE I.R.E. rests upon the authors. Statements made in papers are not binding on the Institute or its members.



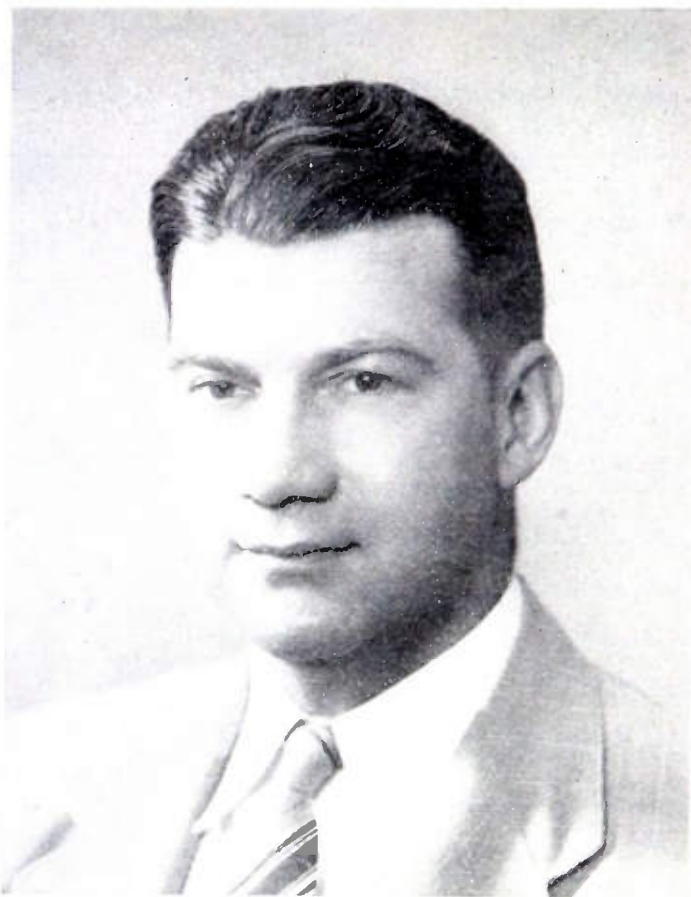

Trevor H. Clark

DIRECTOR—1950

Trevor H. Clark, assistant to the president of the Federal Telephone and Radio Corporation, Clifton, N. J., was born on July 16, 1909, in Haviland, Kansas. He received the A.B. degree in physics and mathematics from Friends University in 1930. Upon graduation he became service manager for the George E. Marshall Company in Wichita, Kan.

Mr. Clark received the M.S. degree in physics from the graduate school of the University of Michigan in 1933, and continued his studies during 1934, when he joined the Research Laboratories of RCA at Harrison, N. J., as assistant to Browder J. Thompson. Until 1938, he conducted experiments on magnetrons, velocity modulated tubes, photoelectric and secondary emission surfaces, and vacuum systems in the RCA Laboratories.

In 1938 he joined the International Telephone and Telegraph Corp. and was sent to their Paris Laboratories (Les Laboratoires LMT) where he continued his work on unconventional electronic devices. After the French Armistice in 1940, Mr. Clark was transferred to Standard Electrica in Lisbon, Portugal, where he studied communication problems of the Portuguese Colonial Administration and the Portuguese Navy. During this time he made a survey trip to Angola, Portuguese West Africa, to study a comprehensive communication network then being installed.

Mr. Clark was recalled to the United States in 1941 to assist in setting up the research laboratories of the International Telephone and Telegraph Corp., in New York, N. Y. He occupied various positions during the formation of these laboratories, and in 1943 he became department head in charge of research and development of certain direction finders for the Armed Forces. For his work in this field he was awarded the U. S. Navy Certificate of Commendation. In 1946 Mr. Clark was made head of the Special Projects Division of the Federal Telecommunication Laboratories, later becoming assistant to the executive vice-president and in 1948 assistant to the president of the Federal Telephone and Radio Corp. He is now in charge of engineering services for the Federal Telecommunication Laboratories.

Mr. Clark is a Senior Member of the IRE, and a member of the Acoustical Society of America, the American Institute of Physics, and the Armed Forces Communication Association. He has served on the following IRE Committees: Membership, 1937; Tellers, 1945-1946—Chairman, 1947; Banquet Committee of the National Convention, 1946-1947—Chairman, 1948; National Convention Committee, 1948—Vice-Chairman, 1949 and 1950; Annual Review, 1948-1949; Admissions, Chairman, 1949; Membership, Chairman, 1950.

For centuries, classical theories in the field of physics sufficed for the study of phenomena and the prediction of effects. More recently, complex and puzzling small-scale occurrences forced the development of a more penetrating set of theories. Heisenberg's uncertainty principle, the methods of statistical mechanics, modern communications theories, the laws governing certain nuclear phenomena, and even developments in cybernetics have largely revolutionized scientific thought in branches of physics, chemistry, and biology and begin to impinge on psychology.

It is already clear that, on the "micro" scale, phenomena are largely random, unpredictable, statistical in nature and influenced by extremely minute disturbances. The "micro" phenomena then build up to, and "control" the larger-scale or "macro" effects. Thus initial uncertainty, minute influences, a definite effect, amplification of that effect, and a major result all seem parts of the same chain of events.

Modern communications engineers will therefore find much to interest and stimulate them in the following searching and inspiring guest editorial by the Technical Director of the Federal Telecommunications Laboratories, Inc., who has received the Fellow Award of The Institute of Radio Engineers and has served on a number of its Technical Committees.—*The Editor.*

Growth and Amplification

HENRI BUSIGNIES

THE urge of educated man to see, feel, and analyze smaller and smaller quantities, as well as to see and communicate farther, has been satisfied with no greater brilliance than in the production of the microscope, telescope, and electronic amplifier. Actually, amplification has already reached in some fields that extreme limit where distinguishable patterns of intelligence or orderliness have disappeared in the apparent chaos of random effects.

It is at this low level of random effect that all events and all things that later become perceptible to man are born and grow. This applies to thoughts that, in the originating or some other brain, are developed intentionally or otherwise to produce a masterpiece of art or literature, an airplane crash, the tallest building, or a concept of human progress. It includes such things as the molecules that assemble into the seed that may precede by even a decade or two a mature living creature, and also the agitation of the still air that produces the tornado.

History shows that at some particular place and time and in a favorable environment a very minute pattern emerges from chaos and, supported by other forces, feedback, and correlation, attains a growth that finally produces a significant phenomenon of distinguishable proportions. Then through some such effect as saturation, growth stops and stabilization occurs, only to be succeeded by decay. Growth is not linear in most cases; it proceeds through thresholds and intermediate steps, and consumes from microseconds to years to produce an end result. At its origin and for a fraction of its early life, the magnitude of the emerging pattern is so minute that it could be influenced, shifted, modified, or destroyed by a force of the same order of magnitude. One is led to believe that, however small they may be, brain waves could influence the outcome of physical events if they were available in suitable form at just the right time, and thus by the proper application of man-made patterns of very small magnitude, beneficial control of large physical effects could be achieved.

In the superregenerative circuit of Professor Armstrong, a small electromotive force corresponding to a signal pattern just above the thermal-agitation level builds up in a fraction of a millisecond to become perceptible to the human senses; but it could have been influenced by a dissimilar, although just as minute, force applied with a timing accuracy of some microseconds.

An effect of very small relative magnitude is used by Doctor Langmuir in seeding clouds to throw out of balance a low-level threshold controlling atmospheric conditions over a large area. Similar thresholds exist in many forms and at varying levels; they represent stages of development where potential growth has momentarily stopped.

In the fields of education and propaganda, thought seeds that are properly timed produce opinions and prejudices that become strongly entrenched. Although they may encounter many thresholds and, particularly, saturations, they are very difficult to modify once they have reached a high level of acceptance.

From an engineering point of view, one marvels at the possibilities of low-level control of the growth of events and things favorable to humanity. The electronic engineer, with his knowledge and experience in amplification and control, together with his accurate notion of timing, may soon explore and harvest in this promising field of growth control.

The Present Status of Color Television*

The Senate Advisory Committee on Color Television, under the Chairmanship of Dr. E. U. Condon, Director of the National Bureau of Standards and Senior Member of the IRE, has issued a comprehensive report on the principles, practices, and major factors involved in color television systems, together with an analytical study of various presently available color television systems (followed by appendices giving relevant and supporting technical data).

The members of the above committee are:

Stuart L. Bailey, Fellow, IRE
 Wm. L. Everitt, Fellow, IRE
 Donald G. Fink, Fellow, IRE
 Newbern Smith, Senior Member, IRE.

In view of its technical and tutorial value, the above report is here presented in full with the consent of Senator E. C. Johnson, Chairman of the U. S. Senate Committee on Interstate and Foreign Commerce.

It is further planned to publish in early issues of the PROCEEDINGS OF THE I.R.E. summaries or complete versions of reports of other committees actively studying technical and scientific aspects of color television. These committees include the Joint Technical Advisory Committee (JTAC), under the chairmanship of John V. L. Hogan, and the National Television System Committee (NTSC), under the Chairmanship of Dr. W. R. G. Baker.

It is believed that the membership will derive direct engineering benefit from these publications.
 —The Editor.

CHAPTER 1—SCOPE OF THE INVESTIGATION AND SOME BASIC CONCLUSIONS

I. INTRODUCTION

THIS REPORT has been prepared at the request of the Chairman of the Senate Committee on Interstate and Foreign Commerce. It represents an independent appraisal of the present status of color television in the United States, and takes into account observations of the black-and-white television service now offered to the public, as well as demonstrations of three color-television systems proposed for public use by Color Television, Incorporated, the Columbia Broadcasting System, and the Radio Corporation of America. The report is confined to technical factors, expressed so far as possible in nontechnical terms.

The report is organized as follows: Chapter 1 outlines the activity of the Committee, describes the approach of the Committee to its assignment, and sets forth some basic conclusions. Chapter 2 analyzes color-television service in general and lists the apparatus and performance characteristics by which competing color systems should be judged. Chapters 3, 4, and 5 describe, respectively, the three proposed color systems, in alphabetical order, namely, those of Color Television, Incorporated, the Columbia Broadcasting System, and the Radio Corporation of America. These chapters state the actual and potential performance of the systems, in terms of the characteristics listed in Chapter 2. Chapter 6 consists of a comparison of the three color systems and the black-and-white system, and includes a tabular tally sheet on which the systems may be judged.

* Decimal classification: R583. Original manuscript received by the Institute, July 12, 1950. This material comprised the Report of the Senate Advisory Committee on Color Television to the Senate Committee on Interstate and Foreign Commerce.

No recommendation for the adoption of a specific system is given, since the Committee believes that the decision to adopt a system must include consideration of many social and economic factors not properly the concern of the technical analyst. It is hoped that the report will provide a comprehensive and understandable basis on which the technical factors may be considered in arriving at a decision.

II. NARRATIVE OF THE COMMITTEE ACTIVITY

The Senate Advisory Committee on Color Television was appointed in June, 1949, by its Chairman, Dr. E. U. Condon, the Director of the National Bureau of Standards, in response to a request by Senator Edwin C. Johnson of Colorado, Chairman of the Senate Committee on Interstate and Foreign Commerce. The letter from Senator Johnson to Dr. Condon requesting the investigation, dated May 20, 1949, is appended to this report as Annex A.

On May 26, 1949, the Federal Communications Commission announced that, at a hearing to be convened to consider expansion of the commercial television service, evidence would be taken concerning the possibility of instituting a public color-television service. Excerpts from the FCC Public Notice No. 49-948 relating to the color-television aspects of this hearing are appended as Annex B.

Meetings of the Senate Advisory Committee (hereinafter referred to as "the Committee") were held August 3, 17-19, October 7-10, November 21-22, 1949, January 19, 20, February 1, 20, 23, March 11, 14, April 26, May 22, and July 5, 6, 1950. During these meetings, demonstrations of color television were attended by two or more members of the Committee as follows: CTI system, February 20, 23, March 14, 1950; CBS system, October 6-10, November 21-22, 1949. January 20, February 1,

23, April 26, 1950; RCA system, October 6-10, November 21-22, 1949, January 19, 23, 1950; Hazeltine demonstration, May 22, 1950. These demonstrations included the comparative demonstrations of the color systems before the FCC held November 21-22, 1949, and February 23, 1950, at which all members of the committee, or designated alternates, were present.

At its meeting of November 21, 1949, the Committee discussed the question of the basic terms of reference of the report, particularly regarding the availability of additional channels not then contemplated by the FCC proposals. As a result of this discussion, an inquiry was prepared and forwarded to Senator Johnson as of February 2, 1950. A copy of this inquiry is appended hereto as Annex C.

Shortly thereafter, the formation of the President's Communications Policy Board was announced. In view of the contemplated activity of this Board, Senator Johnson advised the Committee to proceed within the terms of reference proposed by the FCC, namely, to consider channels in the very-high-frequency (vhf) band from 54 to 88 and 174 to 216 megacycles, and channels in the ultra-high-frequency (uhf) band from 475 to 890 megacycles.

At its meeting of March 11, 1950, the Committee met with Senator Johnson and discussed matters pertinent to the report. The final report, approved unanimously at the meeting of the Committee, July 5-6, 1950, is presented herewith.

III. TERMS OF REFERENCE OF THE REPORT

(A) The 6-Mc Radio-Frequency Channel.

This report is concerned only with color-television systems intended for a 6-Mc radio-frequency channel, that is, a channel equal in width to that now assigned to black-and-white stations. Since color systems of superior performance have been demonstrated using channels wider than 6 Mc the justifica-

tion for confining this report to the 6-Mc channel is stated at the outset.

As shown in greater detail in Chapter 2, the choice of the channel width in a television system is necessarily a compromise between *quality* and *quantity*; *quality* of the reproduced television image on the one hand, and *quantity* of television service on the other.

If the radio channel width were doubled, a clearly perceptible improvement in the quality of the image should be apparent, but the number of channels available would be halved, thereby greatly reducing the possible number of stations.

Moreover, as the width of the channel is progressively increased, the corresponding improvement in picture quality apparent to the observer under normal viewing conditions, becomes less pronounced. There is, in other words, a law of diminishing returns that ultimately affects the attempt to improve image quality by increasing the width of the channel. On the other hand, no such diminishing law affects the relation between channel width and the number of channels. Each time the channel width is doubled, the number of channels is halved, and this law holds without diminution as the channel width is increased.

Evidently a point is reached, as wider channels are considered, at which the slight improvement in image quality afforded by a substantial increase in channel width is not worth the reduction of service that would be entailed. The optimum channel width must be chosen, therefore, by a body qualified to judge that combination of quality of image and quantity of service which best serves the public interest.

This judgment has been entrusted by statute to the Federal Communications Commission, which established the 6-Mc channel for black-and-white television as early as 1937. This channel width provides an image quality roughly comparable to that of 16-millimeter home motion pictures, and allows 12 channels to be assigned in the very-high-frequency spectrum, due account having been taken of the needs of other services.

When a color-television service is considered, the optimum compromise between quality and quantity, similarly determined as meeting the public interest, does not necessarily lead to the same value of channel width. In fact, the addition of color to the image brings about a degradation of certain other qualities in the image (particularly pictorial detail and freedom from flicker, see Chapter 2) when the channel width is unchanged. To avoid degradation of these qualities in the color image, a wider channel must be assigned.

In the face of this fact, a mitigating circumstance has appeared, in the form of a new development (known as "dot interlace," explained in Chapter 2) which is capable of substantially improving the pictorial detail of the television image, without requiring any increase in the width of the channel.

Specifically, when dot interlace is adopted in a color television system, the technique can provide a color image whose pictorial detail is substantially equal to that of the black-and-white images currently rendered to the public. This fact implies

that color service, capable of being rendered on a 6-Mc channel, may achieve a quality generally as satisfactory as that of current black-and-white broadcasts.

Another factor affecting the choice of channel widths is an economic one, relating to the investment by the public in black-and-white television receivers when color television is first offered as a regular public service. If the investment is substantial, when compared to the ultimate per capita investment to be expected in the then foreseeable future, it is desirable that after any change or extension of the television service, the service can be used with then-existing receivers with a minimum of expense, inconvenience and/or degradation of the quality or quantity of the service. If the new service operates on channels wider than 6-Mc, existing receivers cannot use the new service.

Based on the foregoing analysis, the Committee concludes that the allocation of 6-Mc radio-frequency channels for color television is the proper compromise between the quality and the quantity of the color service.

(B) Comprehensive Nature of Systems Considered.

In restricting its consideration to three color-television systems, the Committee is aware that certain other systems, known to the members, might have been considered. The report is confined to these three systems, not merely because they are the ones actively proposed at present, but rather because they comprise, as a group, *all* of the basic types of sequential color systems.

Television images, as outlined in greater detail in Chapter 2, consist of picture elements (dots) arranged along lines, the lines being assembled to cover the field (the picture area). A succession of fields is transmitted to create the illusion of continuity and motion in the image. The dot, the line, and the field are then the three basic elements of a television picture. No matter how the picture is analyzed in the television camera or synthesized at the receiver screen the process of transmission can always be described in terms of these three elements.

It is most fortunate, therefore, that the systems of color television actively proposed are based respectively on these three attributes of the image. The RCA system is a *dot system*, since the color is assigned to successive picture elements, or dots, of the image. In the CTI system, a *line system*, the color is assigned to successive lines of the image. The CBS system is a *field system*, the color values being assigned to successive fields of the image. Other color systems (notably the simultaneous system developed in 1946 by RCA but discontinued in favor of the dot system) are known, but they are difficult if not impossible, to adapt to a 6-Mc channel.

If, therefore, only 6-Mc systems are to be considered, the Committee concludes that the color television system ultimately adopted must be either a dot sequential system, a line sequential system or a field sequential system. No other methods need be considered, in the light of present or foreseeable technical developments.

(C) Mutually Exclusive Nature of the Color Systems.

Because the three color systems herein discussed are based on fundamentally different aspects of the television image, they are to a very large extent mutually exclusive, so far as public service is concerned. All use the 6-Mc channels, and in many other respects are similar (each uses the same type of sound system, for example). Each, however, is fundamentally different from the others in the way in which the color values are distributed among the dots, lines, and fields of the image, and this difference is so profound that the receivers for one system cannot be converted to another except at considerable expense.

At the present stage of the art, a universal receiver, capable of receiving transmissions of all three types, would represent three separate receivers in a single cabinet, with certain elements in common. Changing the connections of the common elements, to convert from the dot-system to the line-system or to the field-system of reception would involve a highly complicated and vulnerable mechanism. Moreover, the compromises inherent in the design of such a universal receiver would most certainly impair the performance of at least one system, and perhaps of all three systems.

Past experience, notably in Great Britain in 1936, with multiple standards of television transmission has proved that such action encourages a portion of the viewing public to purchase equipment which loses its value when the final decision is made among the multiple standards. The decision can be made, and should be made, on the basis of analyses and tests conducted prior to the inauguration of the public service. Moreover, these analyses and tests are well under way, and the final decision can be made without unwarranted delay. But any authorization of color television transmission on a multiple-standards basis is a guarantee of confusion that may well impose a much greater delay in the development of the color-television service.

The Committee concludes that one and only one of these systems should be licensed for service to the public and that therefore the decision among the dot, line and field systems must be made in advance of the introduction of a color television service

IV. SUMMARY

In summary, the Committee bases this report on the following basic conclusions.

1. A 6-Mc radio frequency channel is adequate for color television service, and represents a proper compromise between quality and quantity of service.
2. The three systems of color television herein described comprise all of the basic systems of color television which need be considered for a 6-Mc channel.
3. The three systems are mutually exclusive. One, and only one, of these systems must be chosen in advance of the inauguration of a public color television service.

CHAPTER 2—COLOR TELEVISION PRINCIPLES

V. NATURAL VISION VERSUS TELEVISION

In natural vision, the scene before the observer is focused on the retina of the eye, which contains millions of tiny light-sensitive elements, all of which are continuously exposed. These retinal elements are connected to the optic nerve, which comprises hundreds of thousands of separate fibers, each of which is capable of carrying a part of the visual impression to the brain. In this manner all parts of the scene are apprehended simultaneously.

When an artificial medium, such as motion pictures or television, is interposed between the scene and the eye, it is not practicable to imitate the continuous nature of the actual scene. Rather, it is necessary to present to the viewer a rapid succession of still pictures, each differing very slightly from the ones preceding and following it. In motion pictures, this is done by printing a succession of pictures on a strip of film and passing the film through a projector. Each picture on a movie film is a comprehensive still picture of the whole scene. In motion pictures, therefore, the camera apprehends the whole scene at once, but it does so in discontinuous fashion, one still picture at a time.

In television, a similar succession of still pictures is transmitted, but it is not practicable to transmit the whole area of each still picture at once. This would require hundreds of thousands of separate cable or radio circuits, corresponding to the hundreds of thousands of separate fibers in the optic nerve. Any channel of an electrical communication system using telephone lines or radio waves can transmit only one thing at a time. Therefore the picture must be analyzed into a finite number of picture elements whose light intensity must be converted into signals *one after the other*, sent over the communication channel, and reassembled on the viewing screen in the proper position, all within the time normally used in a motion picture for showing one frame. The number of picture elements which must be distinguished in television is dependent upon the detail desired.

If the processes of dissecting and reassembling are carried out very rapidly, the whole receiver screen appears to be illuminated simultaneously.

VI. TELEVISION SCANNING: "READING" THE CONTENT OF THE SCENE

Television images are dissected and reassembled by a process known as "scanning," a term which arises from the similarity of the process to the action of the eye in scanning pages of printed matter. The eye reads from left to right along the first line of type, then returns rapidly to the beginning of the next line, scans it, and so on until the bottom of the page is reached. The page is then turned, and the process is repeated on the next page.

In a televised scene, corresponding to the individual letters of print are rapid or gradual variations in light and shade, depending upon the nature of the scene. These variations are arranged in horizontal lines,

like lines of print, and the lines are arranged parallel to one another, filling the picture area. In the television camera the variations along the uppermost line are explored rapidly from left to right, and signals are generated which correspond to the degree of light or shade along the line. When the first line is thus scanned, another line below the first is similarly covered, and so on, until the bottom of the picture is reached. In a communication system the signal cannot change abruptly from one value to another, and the shortest distance along the line which can be made to change from white to black is called a picture element. The shorter this distance the greater is the detail which can be transmitted, but the greater are the requirements on the system, particularly the wider is the bandwidth which must be allocated to the communication channel. In some cases these picture elements may be made up of dots definitely located along the lines, but in the present black-and-white system variations may start or stop at any point and no dot structure is observable, although the line structure always is observable. However, for purposes of explanation these picture elements will be generally referred to as dots.

Like the lines of print in a double-spaced typewritten page, each line of elements is separated from the line above it and the line below it by a blank space of the same height as the line. The blank spaces are filled in during the next successive scanning of the picture area. The two sets of lines are thus "interlaced" one within the other. As these two sets of lines are scanned, all of the light and shade values, over the whole area of the picture, are translated into a succession of electrical counterparts. The picture is scanned in two sets of interlaced lines, rather than in one set of consecutive lines, in order to minimize flicker in the image. This is explained in Section VIII.

At the receiver, a spot of light moves across the picture screen in the same scanning motion. Acting under the control of the broadcast station, the spot changes in brightness as it moves along each line and thus recreates the light and shadows of the original scene. Since the light spot on the viewing screen moves in precise step with the scanning process at the television camera each dot of light falls in its proper place, and has its proper value of light or shade.

This description of scanning shows how important it is that the operation of the television system be standardized. Once the number of lines and the number of pictures per second have been established, it is essential that all receivers be capable of operating with that number of lines and that number of pictures per second. Any change in the scanning standards adopted for the transmitter thus requires an exactly equivalent change in the scanning process at each of the many millions of receivers in the hands of the public.

VII. PICTORIAL DETAIL: HOW MANY DOTS IN THE PICTURE?

The choice of scanning standards starts with this basic question: How many dots are required in the whole picture area to reproduce a picture of acceptable quality?

If there were no economic limitations, and if the radio spectrum was limitless, it might be desirable to transmit a picture containing many millions of dots. Thus an 8- by 10-inch printed photo engraving of the highest quality (150-line-per-inch halftone, printed on high-gloss paper), contains about 2 million dots. Such a picture can be examined closely by the unaided eye, without the dots themselves becoming separately visible.

In television and motion pictures, it is not necessary to examine the picture minutely. When a performance is to be viewed continuously for many minutes or hours, in fact, it is necessary that the whole picture area be contained within such a field of view as to avoid excessive movement of the neck or eyes. For example, most people find it uncomfortable and fatiguing to view continuously a picture one foot high from a distance less than three feet. This ratio of viewing distance to picture height applies equally well with other picture sizes; i.e., the minimum viewing distance, to avoid excessive fatigue, is generally taken to be three times the height of the picture. Many individuals cannot look for long periods at a picture unless it is viewed from a considerably greater distance than this, say five to eight times the picture height. These points are indicated by the location of the seats chosen in a motion picture theater by patrons who have a free choice.

When the image is to be viewed at a distance greater than three times the picture height a pictorial detail of several hundred thousand dots suffices, as against the millions of dots that would be required for closer inspection. If a larger number of dots were used, the excess would be wasted, since the eye cannot perceive the additional detail from a distance.

This limit on required detail has led to the choice of various sizes of motion-picture film. Professional 35-mm film, as commonly projected in motion picture theaters, has a pictorial detail equivalent to about one million halftone dots. The 16-mm movie film, used by the advanced amateur, has the equivalent of 250,000 halftone dots in the picture area, when film and projector are in first-class shape. The average performance of 16-mm home-movie film and projectors is such, however, that the effective pictorial detail seldom exceeds the equivalent of 200,000 dots. The smallest movie film currently used is the 8-mm size. This film has the equivalent of about 50,000 halftone dots in the picture area.

The pictorial detail offered by various motion-picture systems, professional and amateur, is a compromise. The upper limit is set by the cost of film and processing, cameras, and projectors. The lower limit is set by the reactions of the viewer, who objects to an image having so little detail that it is incapable of portraying a wide variety of subjects satisfactorily. All those who have viewed 16-mm and 8-mm movies of the same subject matter are well aware of the greater sharpness of the larger films. In payment for the superior performance of the 16-mm system, approximately four times as much money must be paid for film and processing for a given period of viewing time, relative to the 8-mm type. Accord-

ingly, economic factors have given the 8-mm film a commanding position in the amateur film market. At the other end of the scale, movie theatres employ virtually nothing but 35-mm film to meet the high standard required for elaborate and expensive production.

In television, a similar compromise must be found, since it is expensive to set up a television system having too much detail in the image. The expense resides not only in the extra cost of transmitting and receiving equipment, but also in the extra space occupied by the television channels in the radio spectrum. In a given portion of the spectrum, for example, the number of channels which can be accommodated varies in inverse proportion to the number of picture elements in the image, all other factors remaining unchanged. Thus, a change from a television system approximately equivalent to 16-mm home movies (200,000 dots) to one equivalent to 35-mm professional movies (1,000,000 dots), would force a reduction in the number of channels in the ratio of five to one. For the sake of completeness, it should be mentioned that on the basis of geometric resolution alone a 200,000-dot motion picture system will be superior to a 200,000-dot television system, because the line structure is not present in a motion picture.

Faced by this conflict between *quality* (pictorial detail) on the one hand and *quantity* (number of stations and choice of programs) on the other hand, the Federal Communications Commission in 1941 adopted for public television broadcasting a black-and-white system having about the equivalent of 200,000 halftone dots in the picture area. This choice appears to have merit, because it follows the standard of the best visual medium of entertainment hitherto used in homes, 16-mm home movie systems. More fundamentally the 200,000-dot television system permits the picture to be viewed at a distance as close as four times the picture height, without the picture structure's becoming too evident. This viewing distance is close to the minimum value of three times the picture height, set by the fatigue factors previously discussed.

When it is decided that the television picture should be equivalent to 200,000 halftone dots, it is necessary to select the number of lines and the number of dots per line. This is not a critical matter. For example, a picture of 400 lines, each having 500 dots, would provide a 200,000-dot picture ($200,000 = 400 \times 500$). A picture having 500 lines, each containing 400 dots, would serve equally well. The present black-and-white system employs 525 lines, about 490 of which are actually visible on the screen, and each line has the equivalent of about 420 dots along its length. As previously stated, the 490 visible lines are actually scanned in two sets of 245 lines each, one set interlaced within the other.

Experience with the 525-line black-and-white system since 1941 has shown that it provides an adequate basis for a public television service, so far as pictorial detail is concerned. But this is not to imply that additional detail would not be desirable if it were available without excessively reducing the *quantity* of service. For this reason, the

introduction of dot-interlace to the black-and-white system is being considered. This recently-developed technique would increase the pictorial detail of the black-and-white image from 200,000 dots to something over 350,000 dots, without any increase in channel width.

Before leaving the question of pictorial detail, it must be emphasized that this aspect of television system performance is capable of a considerable degree of misinterpretation in comparing the merits of different proposals. The difficulty arises from the various types of subject matter which may be portrayed by television.

When a scene is viewed in a close-up shot, as for example when the face of a performer fills the whole screen, not much pictorial detail is required. To show the essential features and details of a face it is not necessary to use more than 50,000 dots, as experience with the 8-mm movie system has amply demonstrated. When, however, it is desired to show the whole area of a baseball diamond, or some other equally extensive subject, the requirement for pictorial detail is very much larger. In fact 200,000 picture elements may then be insufficient to show more than the bare outline of the individual players.

Since a television system is called upon to depict *both* close-ups and long shots, sufficient pictorial detail must be provided to take care of the long shots, despite the fact that a large part of the detail is wasted when close-up shots are being transmitted. A test of a television system which comprises only close-up shots does not reveal the pictorial-detail limit of the system. Such tests must show the whole range of subject matter for which the television system is intended.

Since the appreciation of pictorial detail is a highly individual reaction of the viewer, it is unlikely that complete agreement on this aspect of system performance will be reached by all participants in a test. But it is possible to state categorically the effect of pictorial detail in the following terms:

Consider a subject viewed in a close-up shot, and suppose that the camera moves back from the subject so that the close-up shot gradually becomes a medium-length shot and finally a long shot. At some point, as the camera recedes from the subject, a given viewer will find that the pictorial detail becomes inadequate and the portrayal is unsatisfactory. This is the point at which the pictorial detail of the image becomes the limiting factor, for that particular observer.

If now the picture detail in the television image is increased, the area viewed by the camera can be increased in the same proportion, without exceeding the critical limit set by that observer. Suppose for example, that the number of dots is increased four times, from 50,000 to 200,000. Then the camera can take into view an area four times as great, with the same degree of visual satisfaction. In concrete terms, if the face of one actor can be shown, with a given degree of satisfaction, on a screen of 50,000 dots, four actors can be shown with the same degree of satisfaction with a screen of 200,000 dots; if the action covering 1,000 square feet of a basketball court is portrayed satisfactorily

with a 50,000-dot image, action covering 4,000 square feet may be portrayed with the same satisfaction with 200,000 dots.

Any limitation in the detail of the television image constitutes, therefore, a limitation on the program director with respect to the area which he can pick up with a given degree of satisfaction. If the pictorial detail is low, say, 50,000 dots, the cameraman must use close-up shots almost exclusively; whereas if 200,000 dots were available, medium shots could be used with the same degree of satisfaction. Finally, if very high detail were available, say a million or more dots, long shots would display the same degree of visual distinction as medium shots and close-ups.

It follows that the flexibility with which the program director can use lenses and cameras is intimately tied up with the detail provided in the image, and any restriction on pictorial detail implies a restriction on the use of the camera. It is true that this restriction can be circumvented in many types of programs by rapid switching from camera to camera, each showing a close-up shot. In athletic contests and other large-scale presentations, however, the restriction on viewing angles may prevent the viewer from following the over-all aspect of the action. This limitation is clearly evident in telecasts of football and hockey, but is much less noticeable in the confined arena of a boxing or wrestling match.

The technical term for pictorial detail is "*resolution*," because this quantity represents the ability of the television image to resolve the fine details of the scenes it depicts. As we have seen, resolution is measured by the total number of equivalent halftone dots in the image. The number of equivalent dots along each line (conventionally measured as the number of dots in a distance equal to the picture height) is the "*horizontal resolution*." The number of dots resolved at right angles to the lines is known as the "*vertical resolution*." As outlined in the following chapters of this report, resolution, measured in the horizontal and vertical directions, is one of the basic criteria by which the proposed color television systems must be compared.

VIII. IMAGE CONTINUITY: HOW MANY PICTURES MUST BE TRANSMITTED PER SECOND?

The second question in the choice of scanning standards is the number of complete pictures to be sent per second. In considering this question it is necessary to have clearly in mind the meaning of the terms "field" and "frame." In Section VI it was pointed out that the television image is scanned in two sets of lines, one interlaced within the other. One set of these lines, having blank spaces between lines, is known as a *field*. The lines of one field cover only one half the area of the picture. The other half of the area (the space between the lines) is filled in by the lines of the next successively scanned field. Hence all points in the picture have been covered when two successive fields have been scanned. Two successive fields, comprising all the lines in the image, are known as a *frame*.

To insure continuity in the motion of

the image, it is necessary that the fields succeed one another at a rapid rate. If the fields are presented at a rate slower than about 15 per second, the apparent motion in the image will be disjointed or "jerky." This corresponds to running a motion picture film through a projector at too slow a speed.

In practice the rate of scanning the successive fields must be much higher than this minimum value of 15 per second, because of another effect known as *flicker*. Flicker appears because the light on the screen is cut off between the successive pictures. If the rate of scanning successive fields is too low, the light on the screen will appear to blink on and off in a manner which is annoying to watch and induces severe visual fatigue. If the successive fields are scanned at a sufficiently rapid rate, however, the sensation from one picture persists throughout the dark interval between fields and the screen appears as if it were continuously illuminated.

The brighter the television image, the more perceptible is the flicker. Hence, in deciding how many fields must be scanned each second, it is necessary to decide how bright the picture must be, and then choose a field rate high enough to avoid flicker at that level of brightness.

Different compromises have been adopted in this respect in different countries. In Great Britain, the pictures are scanned at a rate of 50 fields per second, whereas in the United States, in the black-and-white system, they are scanned at 60 fields per second. The brightness at which flicker is perceptible goes up very much faster than the increase in field rates, with the result that the American rate of 60 per second permits pictures to be about 6 times as bright as the British pictures. In consequence, British receivers must be viewed in a darkened room, whereas most American receivers can be viewed satisfactorily in rooms illuminated by direct daylight.

Two types of flicker must be distinguished in comparing the performance of color television systems. The first is "*large-area flicker*," which applies to the whole area of the image, or to any bright part of the image occupying a substantial portion of the field of view. The more closely the image is viewed, the larger is the portion of the field of view occupied by the bright portions of the image, and the more noticeable is the large-area flicker effect.

The second type of flicker, known as "*small-area flicker*," appears in areas having the size of a few picture elements or the width of a few scanning lines. This type of flicker is most noticeable on close inspection of the image, but it may be apparent at normal viewing distances under certain conditions.

One form of small-area flicker applies to individual scanning lines. We have noted that each picture is scanned successively in two sets of lines, one set interlaced within the other. Hence any one line in the image is illuminated only half of the time, and the flicker rate which applies to a single line is accordingly half that applying to the image as a whole. This low flicker rate gives rise to the so-called *interline flicker* and *line crawl*. Interline flicker manifests itself as a blinking of thin horizontal lines in the image,

such as the roof line of a house. Line crawl is an apparent motion of the lines upward or downward through the image, due to the successive illumination of adjacent lines in the picture, particularly in bright parts of the image.

Flicker can be controlled either by dimming the image, or by increasing the rate at which the successive fields are scanned. Both methods of flicker control are subject to severe limitations. If the image is dimmed too far, the fine detail in the image cannot be perceived by the eye, and eyestrain results. Also, even at considerably brighter levels than the eyestrain limit, it is necessary to darken the room to secure accurate rendition of all the shades of gray (in a black-and-white picture) or all the saturations of color (in a color picture). On the other hand, if the picture-scanning rate is raised too high, the spectrum space required by the signal becomes exorbitant, as explained in Section X below. The choice is essentially a compromise. Experience has shown that rates between 48 and 60 fields per second are required to produce flicker-free pictures of adequate brightness.

In passing, it should be noted that the picture scanning rate is sometimes expressed in frames per second. Since a frame contains two scanning fields, the frame rate is one-half the field rate. Thus the 60-field per second rate of the American black-and-white system may also be stated as 30 frames per second. The most useful term, applicable to both black-and-white and color systems, is the rate in *fields* per second, and this term is used in this report unless specifically stated otherwise.

IX. CHANNEL WIDTH: HOW MANY MEGACYCLES FOR A TELEVISION STATION?

The channel width required by a television station is determined directly by the scanning specifications described in the preceding paragraphs, namely the number of equivalent dots per picture and the number of fields transmitted per second.

The relationship between these quantities can be traced as follows: From Section VII we recall that the standard black-and-white picture corresponds to about 200,000 dots, and that these dots are distributed in two sets of interlaced lines. One set of the interlaced lines (one field) thus encompasses about 100,000 dots. From Section VIII we recall that the fields are transmitted one after the other at a rate of 60 per second. Nominally, then, 100,000 dots must be transmitted in 1/60 of a second. Actually, since a portion of the lines is not visible in the picture the time available is about 1/80th of a second. Consequently, the rate of transmitting dots (100,000 of them in 1/80th second) is about 80 by 100,000 or eight million dots per second.

To transmit picture dots at a rate of eight million a second, it is necessary to employ a channel width of at least four million cycles per second (4 Mc). This bandwidth of 4 Mc is required for the picture alone and is referred to as the video channel. In addition to this 4-Mc minimum requirement, channel space of about 0.2 Mc must be allowed for the sound transmission, and additional space must be allowed to prevent mutual

interference between the picture and sound signals of the station. Finally a substantial amount of additional space (about 25 per cent) must be allowed to permit proper operation of the television transmitter and receiver (to permit "vestigial sidelband" operation). When all these requirements are added, the radio-frequency channel width required for transmitting picture dots at a rate of eight million per second plus associated sound, is 6 Mc.

The foregoing discussion shows that the channel width is determined fundamentally by the number of picture elements (dots) in each field multiplied by the number of fields transmitted per second. If the number of dots were increased from 200,000 to 400,000 per picture, the channel width would have to be doubled. Similarly if the number of fields per second were increased from 60 per second to 120 per second, the channel width would have to be doubled. If both the number of dots and the number of fields per second were doubled, the channel width would have to be quadrupled.

When the channel width is fixed at 6 Mc as is assumed throughout this report, and in the absence of dot interlace, the number of dots can be increased above the 200,000-dot limit only if the number of fields per second is correspondingly reduced below the 60 per second figure. Alternatively, the number of fields per second can be increased only if the number of dots is proportionately decreased.

The dots represent pictorial detail, and the field rate determines the brightness at which flicker becomes apparent. Hence pictorial detail can be increased only at the risk of incurring flicker, and flicker can be controlled only by incurring a loss in pictorial detail, once the channel width and picture brightness have been decided upon.

The conflict between pictorial detail and flicker has occupied the center of the stage in television development for many years. One result of this conflict is the division of the lines in a television picture into two groups, one interlaced within the other. This technique of "lien interlace" was developed as early as 1934 to reduce flicker while maintaining the pictorial detail at a satisfactory level. In line interlacing, the area of the image is illuminated twice while the pictorial detail (200,000 dots) is laid down only once. While interlacing introduces interline flicker and similar small-area defects, these faults are worth accepting in favor of the general reduction of flicker, and the permissible brightening of the picture.

Much more recently (first announced publicly in 1949), an extension of this principle known as "dot interlace" was developed. In dot interlace, the picture elements along each line are arranged with blank spaces between them. In other words they are actual dots, and the blanks are filled with dots on the next scanning of that line. When added to the line interlace just discussed, the dot-interlace system permits the area of the picture to be illuminated four times while the pictorial detail is laid down once. When the frequency of illumination is maintained at 60 fields per second, dot interlace plus line interlace thus permits all the pictorial detail to be laid down

in 1/15th second (actually about 1/20th second when the blanked-off portions of the lines are taken into account). Dot interlace therefore permits 400,000 dots to be accommodated in the picture as contrasted with 200,000 dots when only line interlace is used.

X. COLOR REPRODUCTION: THE ROLE OF PRIMARY COLORS

The addition of color values to a television picture involves the reproduction of the thousands of different colors which the eye can distinguish. This seemingly formidable task is vastly simplified by the fact established in Newton's time, that all colors can be very closely represented by combining just three colors, known as primary colors.

There are two types of primary colors. When the reproduction is effected with layers of colored material, one on top of another, through which light must pass in succession, the so-called "subtractive primaries" must be used to obtain a satisfactory range of mixture colors. The subtractive primaries are red, blue, and yellow. These are the familiar primary paint colors known to students in elementary school. Subtractive primaries are used in oil and water-color paintings, in color printing, and in color photography (prints and transparencies). In color printing and photography, the primary colors used are a bluish red ("magenta"), a greenish blue ("cyan"), and a greenish yellow. These subtractive primaries are the ones most commonly known to the public.

In color television, the reproduction is not effected with layers of colored material one over the other, but rather consists of individual lights of the primary colors presented one after the other in time sequence. For this type of color reproduction, the so-called "additive primaries" must be used. The additive primaries are red, blue, and green. If pieces of red glass and green glass are placed one beside the other (*not* one on top of the other) and white light is passed through them in such a manner that the red and green light thus formed falls on the same area of a viewing screen, the combined light will have a yellow color. If red, green, and blue glasses are similarly employed, the combined light on the screen will appear white, or near white.

With these primaries combined in proper proportions it is possible to reproduce any of the hues of the visible spectrum, plus purples which do not appear in the spectrum, plus all the shades of gray from white to black, as well as mixtures of the above. With only three primary colors it is not possible to reproduce all the spectrum colors *exactly*, but the color match can be made so close that only simultaneous inspection of the original color and the reproduction will reveal the difference. Experience with various types of color photography has shown, in fact, that a highly realistic rendition of natural colors can be achieved with three properly chosen primaries.

When only two primary colors are used, the rendition is very much less realistic. The primaries customarily used in the two-color process are a red-orange and a green-blue. With these, it is not possible to reproduce a

pure (saturated) red, a pure blue, a pure yellow, or a pure green. Some improvements have been obtained by making the two primary colors change with brightness, but even so a system of such limitations cannot properly reproduce the colors in nature. For this reason, two-color processes have not been widely employed in motion pictures, nor have they been proposed for public color-television service. All of the color-television systems discussed in this report use the three additive primary colors, red, green and blue.

Since at least three primary colors must be used to achieve realistic color reproduction, it follows that three color images must be transmitted by a color-television system. The three color images are transmitted in sequence, hence the name "sequential color television system." In the dot-sequential system, the primary colors are assigned to successive dots of the image. In the line-sequential system, the primary colors are assigned to successive lines of the image. In the field-sequential system, the colors are assigned to successive fields of the image.

The manner in which the colors are interspersed is discussed in detail in the following chapters relating to the three systems. Here it suffices to say that three separate images, one in each of the primary colors, must be dissected in a particular sequence at the transmitter and reassembled in the same sequence at the receiver. The dissecting and reassembling processes are performed so rapidly that the primary colors are not separately perceived one after the other, but appear to the observer to blend or "fuse," as though they existed simultaneously.

Thus, while it is true that only one primary color is actually present on the receiver screen at any one instant in each of the three sequential systems here described, persistence of vision causes the picture screen to appear as if all three primary colors were present simultaneously, throughout the area of the screen. We may then conclude that a color television image is equivalent to three images superimposed one on top of the other, each image being made up of light of one of the primary colors. As we shall see later, in each of the proposed systems the color images may be somewhat less detailed than the equivalent black-and-white image. But this is a difference merely of degree. In principle, a three-color television system employs the equivalent of three images, each depicted in light of one of the primary colors.

An important implication of this principle is this: All other factors being equal, the video channel occupied by a three-color television system must be three times as wide as that required for an equivalent black-and-white system. A color system equivalent in pictorial detail to the black-and-white system must transmit three images, each containing 200,000 dots, and all these images must be transmitted in the same time as that of one image in the black-and-white system. Hence the rate of transmitting picture elements (dots) in color is three times the rate in black and white, and the video channel width must be trebled to accommodate the transmission.

If a color-television system is to be fitted into a 6-Mc channel, something must be

sacrificed. Either the dots must be reduced in number, thereby reducing the pictorial detail, or the number of scanning lines must be reduced, thereby again reducing the pictorial detail, or the rate of scanning the fields must be reduced, thereby incurring flicker unless the picture brightness is dimmed by a substantial amount, or the number of fields per color picture must be increased, thereby increasing the blurring of motion. Some such compromise has been adopted in all three of the proposed color systems. The nature of the compromise, and its effect on the over-all image quality, is an important basis on which the systems must be compared.

The fact that three separate, apparently superimposed, images are involved in a color-television system gives rise to several potential sources of trouble. The first is "improper registration." The three primary-color images must be precisely the same size, have precisely the same shape, and must appear to lie one directly over the other if the color reproduction is to be accurate. Lack of registration is familiar in color printing. It occurs when the impression of one printing plate is out of position with respect to the other impressions. The outlines of objects are thereby blurred, the fine detail of the image is obliterated, and objects are outlined with color fringes.

Considerable care is required in the design and operation of a color-television system to secure proper registration. The three types of systems described herein employ different methods to secure registration, and their performance in this respect differs, as outlined in Chapter 6. In particular, the field-sequential camera has at present better performance in this respect than the dot- and line-sequential cameras.

The second source of difficulty, rooted in the sequential nature of a color-television image, is known as "color breakup." When the eye moves while viewing a color-television image, either casually or in following the motion of the image, the successive fields laid down on the screen occupy slightly different positions on the retina of the eye. If each successive field is displayed in one primary color, as in the field-sequential system, the separate primary colors are then visible in the form of fringes around the outlines of objects. This effect is present only in the field-sequential system, since in the dot- and line-sequential systems the color-switching rate is many times greater. Fortunately, the majority of observers possess, or soon acquire, a substantial tolerance for the color-breakup effect, under normal conditions.

The third effect is color fringing. This occurs when a rapidly moving object is televised in color. If the object has color components in more than one primary (as do the vast majority of objects), and if the object is scanned in successive fields of different color (as in the field-sequential system), the object will be scanned in one color on one field and in another color on the next successive field. If the object is moving rapidly, its position on the screen will have changed between the successive scanings, and the object will appear fringed with color or, if the motion is very rapid, as several objects in different colors. Like color breakup, color fringing does not occur to a noticeable

degree in the dot-sequential and line-sequential systems, since the color-switching rate is many times greater.

XI. COLOR FIDELITY. HOW TRUE IS THE COLOR REPRODUCTION?

It is evidently of paramount importance that the reproduced colors be sufficiently faithful copies of the original colors to induce a sense of realism in the observer. A first requirement of faithful color rendition is that the primary colors employed at the receiver are chosen to cover a suitably wide gamut of colors. Since a free choice of phosphors and color filters is open to all, this factor does not necessarily operate to the advantage of one system over the others.

A second requirement for proper color rendition is *color balance*, a term that indicates that the brightnesses of the three primary-color images are in proper proportion. This is especially important when all three primaries are combined to produce a white (or nearly white) element in the picture. Unless the three primary images are in precise balance, the element intended to be white will exhibit a greenish, reddish, or bluish tinge (or other off-color tinge), depending on what primary (or what pair of them) is present in disproportionate brightness. Color balance is particularly important in reproducing the delicate tones of flesh color. A slight excess of green, for example, can transform a ruddy glow into a sickly pallor. Color balance requires the correct choice of camera color filters to accord with the receiver color primaries and with the lights used in the studio. It also depends upon the correct operation of the transmitter, the correct functioning of the receiver, and the correct adjustment of contrast. Here again these basic techniques of maintaining color balance can be used by all three systems, although there are differences in the ease with which it can be accomplished.

So long as the dots, lines, and fields occur in their proper places and in the proper sequence, and so long as the proper color balance is maintained, a high standard of color reproduction is possible in each of the proposed systems of color television. The observed differences in color fidelity are ascribable partly to poor color balance, and partly to lack of registration (of dots, lines, or fields with minor effects due to color breakup and color fringing as described in Section X).

XII. THE ADDITION OF BLACK-AND-WHITE DETAIL TO A COLOR IMAGE

In color printing it is customary to employ four impressions, one in each of the primary colors, and the fourth in black (or dark brown). The black plate impresses shades of gray over the colors. One purpose of the black impression is to overcome an inherent shortcoming of the primary-color printing inks which, by themselves, are not able to represent as dark shades of gray as may be desired. Another purpose is to provide one impression (the black impression) which carries the basic pictorial detail of the subject, and thus relax to some extent the need for precise register among the three primary-color impressions.

This printing technique suggests that a similar method might be used in color tele-

vision. If all the fine pictorial detail of a color-television image is presented in shades of gray, the detail of the primary colors may be allowed to be somewhat coarser without adverse effect on the over-all sharpness of the color image. This would allow an image of given sharpness to be sent over a narrower channel than would be required if the primary colors were sent in full detail and no gray image was employed.

Suppose, then, that the color image is to have a pictorial detail corresponding to 200,000 dots, equal to the detail of the present standard black-and-white image, and is to be sent at a field rate of 60 per second with conventional line interlace. Suppose further that all fine details having a width not greater than corresponding to two dots are transmitted only in shades of gray, whereas all details of width greater than two dots are transmitted in three colors. Then the fine detail in the gray image corresponds to frequencies from 2 to 4 Mc and thus requires a video channel width of 2 Mc, while each of the three primary color images correspond to frequencies from zero to 2 Mc and thus require three more video channels of 2 Mc. The total video channel width is therefore 8 Mc. By the method of dot interlace the three 2-Mc color channels may now be interspersed and compressed. In the RCA form of the dot-interlace system the color channels are compressed into a single video channel from zero to 4 Mc, or two-thirds of the sum of the three channels. This color dot signal is finally mixed with the fine detail gray signal and we have the entire picture signal occupying a video channel width of 4 Mc, permitting it to be transmitted on a 6-Mc radio channel. (A more detailed description of dot interlacing the color images and mixing them with the fine detail gray image is given in Chapter V.)

Hence by confining the finest detail to shades of gray, and by using dot interlace, it is possible to compress a color transmission into the same channel now occupied by the black-and-white transmission, and to retain substantially the full detail of the image (200,000 dots) and the full flicker-brightness performance (60 fields per second).

The technique of transmitting fine detail in shades of gray only is known as the "mixed highs" system, from the fact that the highest frequencies in the three color signals are mixed together before transmission to the receiver.

In the example given above, the dividing line between full-color transmission and gray-tone transmission was taken at a detail size equal to the width of two dots. The dividing line can be set at details considerably larger than this. In fact, in the RCA system, as described in Chapter 5, certain practical shortcomings of the dot-interlace transmission process, currently embodied in the apparatus, reduce the detail transmitted in true color to items having the width of 8 dots. Since there are some 420 dots or more to the line, this still represents a very good color detail and no adverse effects are noted. Moreover, the shortcomings of the present apparatus in this respect are not fundamental and can be compensated rather exactly, should the need arise.

The technique of transmitting fine detail in tones of gray is applicable only to the dot-

sequential system of color television. It is not applicable to the line-sequential and field-sequential systems because these systems make no color distinction between the dots along any one line of the image. Hence whatever detail is provided, as each line is scanned, must necessarily be provided in full to the particular color present in that line. Thus all three color images contain the fine detail, and there is no opportunity to confine the fine detail to a single (gray) image.

XIII. RELATION OF COLOR SERVICE TO EXISTING BLACK-AND-WHITE SERVICE

The principles discussed in earlier sections of this report refer to the intrinsic properties of sequential color systems which are rooted in the choice of scanning method. These properties determine the long-time utility of each system, since they are based on the fundamental attributes of human vision.

There are several additional properties of a less fundamental nature, but of great economic importance, which refer to the transition from the existing black-and-white service to the future color service. The problems of this transitional period will endure so long as both black-and-white and color transmissions are available in a given locality, and this situation may continue in many populous areas for an indefinite period. Accordingly, the Committee believes that the relative suitability of the color systems for public use must be judged, in part, in terms of their relation to the existing black-and-white service.

The transitional properties of the color systems are described by three terms, compatibility, adaptability, and convertibility, defined as follows:

Compatible color system. A compatible color system is one capable of producing black-and-white images on existing black-and-white receivers without any modification of the receivers.¹

Adaptable color system. An adaptable color system is one in which existing black-and-white receivers can be modified to receive color transmissions in black-and-white.

Convertible color system. A convertible color system is one in which existing black-and-white receivers can be modified to receive color transmission in color.

In comparing systems on the basis of adaptability or convertibility, the cost, inconvenience, and technical complexity associated with the modifications are evidently important considerations. Comparative quantitative data on these aspects are at present inconclusive, in view of the rapid state of development of the systems, but it is possible to give a qualitative estimate of the relative adaptability or convertibility of each system.

The transitional properties of each system are stated in Chapters 3, 4 and 5, and compared in Chapter 6.

¹ This definition was first advanced by the Joint Technical Advisory Committee in testifying before the FCC at the color hearing and adopted by the majority of those testifying thereafter. It is restricted to the rendition of color transmission on black-and-white sets, as defined. Another form of compatibility, sometimes called "reverse compatibility," relates to the reception of black-and-white transmissions on color receivers. Since the latter type of compatibility can be possessed by color receivers of all three systems to a nearly equal degree, and will undoubtedly be possessed by all color receivers manufactured during the transitional phase, the Committee believes that reverse compatibility is not an important distinction between systems.

XIV. SYSTEM CHARACTERISTICS

Those performance characteristics which are of paramount importance in comparing color television systems are:

(A) *Resolution.* The amount of pictorial detail or the number of picture elements (dots) contained within the picture area. The greater the number of dots, the more copious the pictorial detail in the reproduced image.

(B) *The flicker-brightness relationship.* The rate at which the successive fields are scanned determines the maximum brightness of the reproduced picture, above which flicker becomes objectionably apparent.

(C) *Continuity of motion.* The number of fields presented per second must be high enough to permit motion in the image to be rendered in apparently continuous fashion.

(D) *Effectiveness of channel utilization.* Since the space in the radio spectrum for television channels is severely limited by the needs of other services, it is of paramount importance to determine the relative effectiveness of the color systems in utilizing the 6-Mc channel. The preceding sections have shown that the channel width is devoted to the performance characteristics above named, that is, adequate resolution, adequate brightness without flicker, and adequate continuity of motion. A system whose performance is inadequate in any of these aspects makes relatively ineffective use of the channel. In comparing two systems having equally adequate performance in one or two of these aspects, the system having superior performance in the remaining aspect or aspects is defined as making the most effective use of the channel. On this basis it is possible to compare the systems, on a qualitative basis, with respect to channel utilization.

The techniques for improving channel utilization include line interlace, dot interlace, the mixed high method, and the use of long persistence receiver screen materials to reduce flicker.

(E) *Color fidelity.* Color fidelity is the degree to which the television receiver reproduces the colors of the original scene. It is particularly important that the system be capable of maintaining color fidelity over extended periods of time.

(F) *Defects associated with superposition of primary-color images.* These defects include improper registration, color breakup, and color fringing.

(G) *Cost of color receivers.* A final basis of comparison is the cost of a color receiver having adequate performance in each of the respects listed above. While it is manifestly necessary to take this factor into account in arriving at a decision between the systems, the presently available cost figures are, in the opinion of the Committee, not indicative of the situation to be expected when manufacture of receivers actually commences on a large scale. If, as seems probable, a tri-color tube is to be used in future receivers, no matter which system is adopted, the costs will be more nearly equal than if a rotating filter disk is used in one system (CBS), a three-tube dichroic-mirror receiver in another (RCA), and a triple-projection receiver in the third (CTI). In view of the fact that a definitive answer to the question of receiver costs cannot be available until the

color service is actually instituted and large-scale production is under way, the Committee believes that it will not be possible to take the relative receiver cost factors into consideration in arriving at the necessary policy decisions affecting color television.

In the following chapters these factors are related explicitly to the three proposed systems, and the apparatus used in each system is described as it relates to performance, complexity, and cost.

CHAPTER 3—THE CTI LINE-SEQUENTIAL SYSTEM

XV. INTRODUCTION

The information on the CTI system, contained in this chapter, is based in part on the document "Written Comments of Color Television Incorporated" dated August 25, 1949 submitted in evidence before the FCC Hearing, and in part on verbal comments offered by representatives of CTI at the demonstrations of the system. The description is based on the system as demonstrated by CTI on May 17, 1950, namely, that using the so-called "interlaced color shift."

XVI. THE CTI SCANNING PATTERN: HOW THE PICTURE IS PUT TOGETHER

Fig. 1 illustrates the manner in which the CTI line-sequential color television image is scanned. The figure shows the scanning lines in the six fields required to make up a complete color picture. The lines are separated by blank spaces of equal depth. In the first field the top most line (line 1) is scanned wholly in green, the next line below (line 3) wholly in blue, and the next line (line 5) wholly in red. As successive lines are scanned (lines 7, 9, 11, etc.) the sequence of lines in green, blue, and red is repeated until the bottom of the image is reached. This completes the scanning of the first field.

Thereafter the second field is scanned in the same manner, also covering lines numbered 1, 3, 5, 7, 9, etc. Line 1, this time is scanned in red, line 3 in green, line 5 in blue, and so on until the bottom of the second field is reached.

The third field is scanned next, again covering only the odd lines. This time line 1 is scanned in blue, line 3 in red, and line 5 in green, and so on until the last odd line of the field is reached.

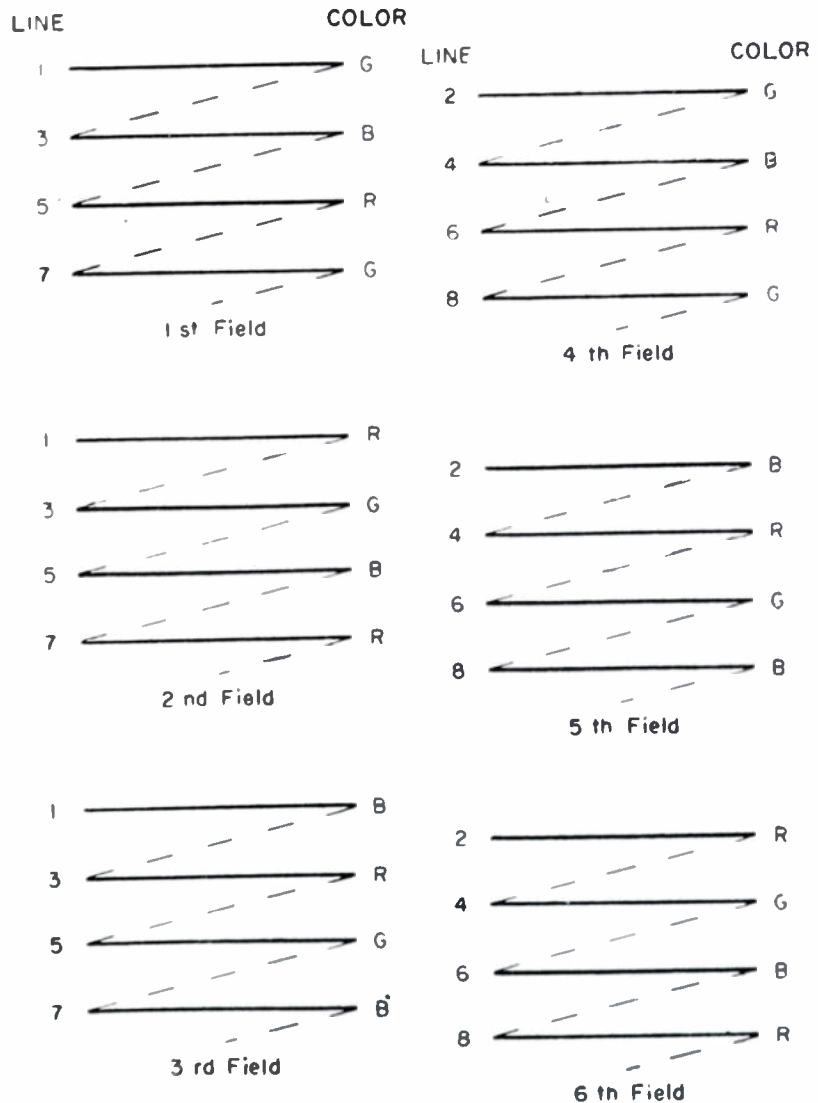

Fig. 1—Scanning pattern for CTI line sequential color television system. (Only first eight lines of the fields are shown.)

The image has now been scanned in all three colors covering the odd lines only, and this process is then repeated for the even lines, which lie midway between the odd lines scanned in the first three fields.

In the fourth field the color sequence is as follows: line 2 is scanned in green, line 4 in blue, line 6 in red and so on, down to the bottom of the field. For the fifth field the color sequence is line 2 blue, line 4 red, line 6 green and so on, and finally in the sixth field the color sequence is line 2 red, line 4 green, line 6 blue and so on.

All the lines have now been scanned in all three colors, and a complete color picture has been produced.

The image consists of 525 lines, about 490 of which are visible on the viewing screen, and the fields are scanned at a rate of 60 per second. The radio channel width used is 6 Mc, corresponding to a video bandwidth of about 4 Mc. These numbers are identical to those employed in the standard black-and-white system. Consequently the number of picture elements per line is the same as in the black-and-white system, about 420 picture elements per line. The maximum number of picture elements in the image, comprising 490 visible lines each with 420 dots, is about 200,000.

The whole sequence of color scanning is completed after six fields have been scanned, and the sequence then repeats. Since the field scanning rate is 60 per second, there are one-sixth as many, or 10, complete color pictures per second.

XVII. ESSENTIAL EQUIPMENT OF THE CTI SYSTEM

Before discussing the performance of the CTI system, it is necessary to describe briefly certain essential items of equipment, unique to this system. These include the camera at the transmitter and the viewing apparatus at the receiver (picture tubes and viewing screen).

The CTI camera employs one image orthicon camera tube, of the type commonly used in black-and-white broadcasts. When used for black-and-white transmissions, one lens focusses the image on the sensitive plate of the camera tube. When used for color transmission a system of color-selective filters is used for producing three images side by side on the sensitive plate, one for each of the three primary colors.

The lenses are so positioned that they form three images on the sensitive plate, one beside the other in a horizontal row. These images appear in the three filter colors, and are arranged in the order red, green, blue, from left to right.

The three images are scanned, from left to right as a group, by sweeping a beam of electrons across the sensitive plate. As the beam sweeps it creates an electrical signal proportional to the values of light and shade along a particular line in each of the images. Consequently as the beam sweeps *once* across the group of images, it scans first a line in red, then a line in green, and finally a line in blue.

The beam then scans across the group of three images, along an appropriate path parallel to the first, and thereby produces three more lines in red, green, blue, and so on. This scanning process continues, each

passage of the beam across the group creating three lines in the three primary colors, until the bottom of the group of images is reached. The beam has now scanned a complete field, corresponding to one of the scanning patterns shown in Fig. 1 and described in Section XVI.

The beam then returns to the top and the scanning process is repeated across the group of images. By properly adjusting the starting point of the scanning process in each successive field the color sequence is arranged to conform with the scanning sequence described in Section XVI and illustrated in Fig. 1.

The signal created by the camera is transmitted to the receiver. Here the images are reproduced on the screen of a picture tube. The screen is composed of three different types of fluorescent material, arranged side by side, one material producing red light, another green light and the third blue light. The scanning beam in the picture tube moves over this three-part screen in exactly the same pattern as the beam in the camera and thereby recreates on the screen three images side by side, in red, green, and blue. These images are, therefore, replicas of the optical images focussed on the sensitive plate of the camera tube.

The three primary color images are combined by projecting them through three lenses onto a common viewing screen. Care must be taken, in the scanning of the camera and picture tube and in the positioning of the camera and projection lenses, to insure that these three images are precisely in register on the viewing screen. A reproduction of the original scene in color thereby appears on the projection screen.

If a black-and-white receiver, of the type commercially available in the United States, is tuned to a color transmission from a CTI color camera, a black-and-white image results. This follows from the fact that the CTI system operates with 525 lines, 60 fields per second, which are identical to the scanning rates of the standard black-and-white system. For this reason, the CTI system is known as a "Compatible system," i.e., a color-television system which will provide a black-and-white version of the color transmission on present-day black-and-white receivers, without requiring any change in the receiver.

XVIII. PERFORMANCE CHARACTERISTICS OF THE CTI SYSTEM

On the basis of the foregoing description of the CTI system, we can examine its performance characteristics in accordance with the outline presented in Chapter 2, Section XIV.

The first of these characteristics is resolution, Section XIV (A). Since the scanning rates and channel width of the CTI system are identical to those of the standard black-and-white system, the number of picture elements per line is, in theory, the same in the two systems, namely about 420, and the number of lines visible in the image is also the same, about 490. Therefore the over-all resolution of the CTI and black-and-white systems are the same, about 200,000 picture elements.

These resolution figures are based wholly on the geometry of the scanning pattern, and

take no account of other effects, such as improper registration and line crawl, which may reduce the effective resolution available in the CTI system, as discussed below.

The second performance characteristic is the *flicker-brightness relationship* Section XIV (B). Since the number of fields per second in the CTI system is 60, the same number as in the black-and-white system, the large-area flicker performance is approximately the same. The small-area flicker effects are accentuated by the fact that each line is scanned in any one primary color only 10 times per second. Moreover, two lines of the same color in any one field are separated by two other lines in different colors, plus three blank spaces. These two effects together cause an apparent motion of the lines upward or downward in the picture, known as line crawl. In common with all flicker effects, line crawl becomes more pronounced as the image becomes brighter. Consequently this effect may in fact set the upper limit on the acceptable brightness of a line-sequential color image.

The phenomenon of line crawl is accompanied by an apparent grouping of the lines and this effect reduces the apparent vertical resolution below the value set by the scanning pattern geometry.

Interline flicker is also pronounced in the image produced in this system, particularly when a primary color is being transmitted, because each line is then illuminated only 10 times per second. If the image is bright, sharply defined horizontal edges exhibit a marked blinking effect.

The third performance characteristic Section XIV (C), is *continuity of motion*. So far as large-area portions of the image are concerned, the continuity is determined by the field rate, so the performance is not noticeably different from that of the black-and-white system. On the other hand, the sharpness of edges of colored objects in motion is noticeably affected by the fact that the complete color sequence occurs at a rate of 10 per second, whereas the complete sequence in black-and-white images occurs at 30 per second.

The fourth characteristic, Section XIV (D), is *effectiveness of channel utilization*. Here the principal shortcomings of the CTI system, as thus far demonstrated, are the impracticability of using dot interlace and the poor small-area flicker performance. If dot interlace were attempted, while the resolution would be doubled, the complete color sequence rate would be lowered to 5 per second, thus greatly accentuating the small-area flicker effects.

The nature of the compromise necessary to fit the CTI system into the 6-Mc channel can now be stated. The resolution and the large-area flicker performance are maintained, so far as scanning is concerned, at the values of the black-and-white system, but to secure this performance in color it is necessary to lower the rate of the complete scanning cycle to 10 per second, one-third the value of the black-and-white system. Accompanying the lower scanning cycle rate are small-area flicker effects, notably interline flicker and line crawl.

The fifth performance characteristic is *color fidelity*, Section XIV (E). On the assumption that proper fluorescent materials

and color filter are used in the picture tube and proper color filters are used in the camera, the large-area color fidelity of the system suffers no limitation. Lack of registration, noted below, may affect adversely the color fidelity in small areas, particularly in the fine details and along the edges of brightly colored objects.

Superposition defects, Section XIV(F), are limited to improper registration, since color breakup and color fringing are confined to the depth of one or two scanning lines. Faulty registration may appear in four independent ways: (1) misadjustment of the camera optics may produce color images of different size, shape, or orientation on the sensitive plate of the camera tube; (2) the motion of the camera electron beam may not be uniform or not properly aligned with the images; (3) the scanning at the receiver picture tube may not produce congruent and properly oriented images; and (4) the projection lenses of the receiver may not bring the images into correct superposition on the viewing screen.

Finally, the method of *depicting fine detail*, Section XIV(D), in this system is to impose the fine detail on all three primary color images. The mixed-highs system of transmitting fine detail only in shades of gray cannot be used in the line-sequential system for the reasons outlined in Section XII.

XIX. SUMMARY

The essential attributes of the CTI line-sequential system are as follows:

(A) It is a compatible system, employing the same number of lines per picture and the same number of fields per second as the black-and-white system. This permits a black-and-white version of the color image to be reproduced on standard black-and-white receivers, without modification of the receiver.

(B) It achieves resolution and large-area flicker performance equivalent to the black-and-white system, but is deficient in apparent vertical resolution and small-area flicker performance.

(C) It is subject to registration difficulties.

(D) It does not employ the channel width effectively, since neither the dot-interlace nor the mixed-highs principle are employed.

CHAPTER 4—THE CBS FIELD-SEQUENTIAL SYSTEM

XX. INTRODUCTION

The information in this chapter is based on the testimony submitted by the Columbia Broadcasting System to the FCC during the color television hearing, and on demonstrations of the CBS system viewed by members of the Committee prior to May 1, 1950.

XXI. THE CBS SCANNING PATTERN

Figs. 2 and 3 illustrate the manner in which the CBS field-sequential color television image is scanned. In Fig. 2 is shown the conventional line-interlaced version of the system. Each picture consists of 405 lines, divided into two fields of 202½ lines each. The fields are scanned at a rate of 144 fields per second. As shown in the figure, all

the lines in one field are scanned in blue, the next in green, and so on in the sequence red, blue, green.

After six successive fields have been scanned, every dot in the image has been scanned in all three primary colors. Consequently the whole scanning sequence occurs at a rate one sixth as great as the field scanning rate, that is, $144/6=24$ complete scanning cycles per second. The complete scanning cycle is termed a "color picture." The color picture rate of the CBS system is, accordingly, 24 per second.

In the dot-interlaced version of the CBS system (See Fig. 3), each line is broken up into dots, all of the same primary color, with blank spaces of equal size between the dots. These blank spaces are filled in with dots of another primary color, on the next successive scanning of that line. Consequently, a given dot in the image is scanned in all three colors only after twelve consecutive fields have been scanned, and the complete scanning cycle occurs at a rate of $144/12=12$ color pictures per second. The corresponding color picture rate of the CTI line-sequential system (Section XVI) is 10 per second, and that of the RCA dot-sequential system (Section XXVI) is 15 per second.

XXII. ESSENTIAL APPARATUS OF THE CBS SYSTEM

The CBS color camera employs one image orthicon camera tube and one lens. Between the lens and the sensitive plate of the camera tube is located a filter disk containing six transparent filter segments, two for each of the three primary colors. The disk rotates at 1,440 revolutions per minute, so the filter segments move past the sensitive plate at a rate of 144 segments per second. The disk rotation is synchronized with the 144-per-second field-scanning rate of the camera. In this manner, all the lines in one field are illuminated in red light, the lines of the next field in blue, and the lines of the third field in green, and so on in the sequence red, blue, green.

These elements of the CBS camera are the same in the line-interlaced and dot-interlaced versions of the system. In the dot-interlaced version, the electrical output of the camera is rapidly switched on and off. The camera is thus effectively connected to the circuit during the scanning of a particular dot, and is disconnected during the scanning of the adjacent blank space, then reconnected for the next dot, and so on. The rate of connecting and disconnecting the

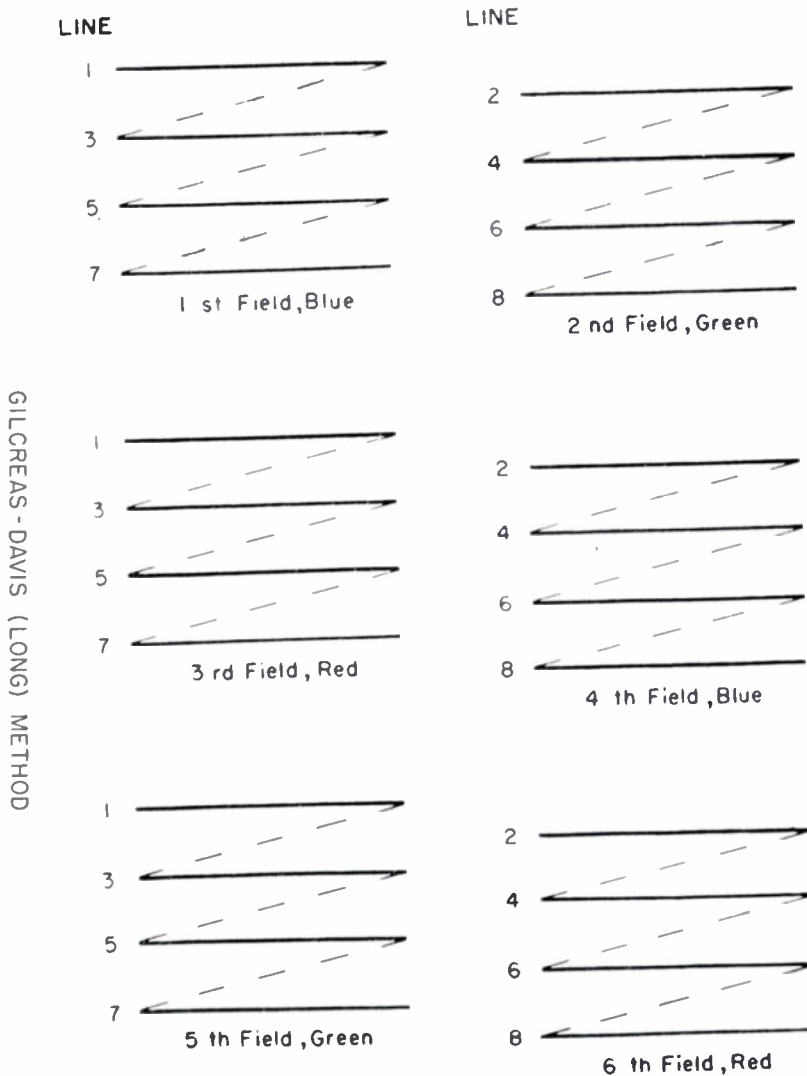

Fig. 2—Scanning pattern for CBS field sequential color system line interlaced. (Eight lines shown.)

camera is about nine million per second (9 Mc).

Two types of receiver have been demonstrated by CBS. In the first, a rotating filter disk, similar to that used in the camera, is positioned before the screen of the picture tube. This disk carries six filter segments, two in each of the three primary colors. The disk rotates at 1,440 rpm and is synchronized with the 144-per-second field-scanning rate of the receiver. The image formed on the screen of the picture tube is displayed in white light, and this light, passing through the colored filters, takes on successively the three primary colors. Thus, the light emerging from the receiver is red on one field, blue on the next successive field, and green on the third, and so on. By means of synchronizing impulses, the position of the receiver filter disk is controlled so that red light is produced by the receiver only when the red filter is positioned before the camera tube at

the transmitter, and similarly for the other two colors.

The system thus comprises two filter disks rotating in rigid synchronism, so positioned that the filters before the camera and the picture screen always have the same color at any instant.

It is not considered feasible to use a rotating disk with picture tubes exceeding about 12½ inches in diameter because of the physical size of the disk involved.

The second type of receiver is very similar to that used in the CTI system, described in Section XVII, Chapter 3. A single picture tube is used, but three separate images are formed on the screen, one above the other, one in each of the primary colors. The blue-colored image is formed only during the fields scanned in blue by the camera, and similarly for the images in the other two colors. An optical system comprising three lenses projects the three images so that they

fall, one on top of the other, on a common viewing screen. The scanning of the images, and the choice of lenses and positioning of the lenses with respect to the image, must be precisely controlled to preserve registration between the projected images. By using a green phosphor of comparatively long decay time this type of receiver eliminates practically all flicker and color breakup.

Both types of receiver may be used with the line-interlaced as well as the dot-interlaced version of the system. For dot-interlaced reception, additional circuits are required which effectively connect and disconnect the picture tube in synchronism with the corresponding connections and disconnections of the camera tube, described above.

XXIII. PERFORMANCE CHARACTERISTICS OF THE CBS SYSTEM

We proceed now to examine the performance characteristics of the CBS system, in accordance with the outline of Sections XIII and XIV, Chapter 2. *Resolution* (Section XIV-A): For reasons given below (under "Flicker-Brightness Relationship"), the field-scanning rate of the CBS system must be chosen substantially higher than that of the black-and-white system. The rate used in the CBS demonstrations is 144 fields per second.

In Section VII it was explained that the standard black-and-white television system has a geometric resolution of approximately 200,000 picture elements per frame (two interlaced fields). This corresponds to a field-repetition rate of 60 per second and a video bandwidth of 4 Mc (6-Mc radio channel).

In the CBS line-interlaced system the geometric resolution is also determined by the number of picture elements in two interlaced fields, but the field-repetition rate is now increased to 144 per second. It was explained in Section IX that, for a given bandwidth, the number of picture elements in a frame is inversely proportional to the field-scanning rate. The geometric resolution of the CBS line-interlaced system is therefore 200,000 times 60/144 or 83,000 picture elements. Thus, the higher field-repetition rate decreases the geometric resolution of the CBS line-interlaced system to 60/144 or 42 per cent of that of the standard black-and-white system.

In the dot-interlaced version of the CBS system, the resolution is doubled in theory, and very nearly doubled in practice. Thus, the resolution of the dot-interlaced CBS color image is about $2 \times 83,000 = 166,000$ picture elements, or 83 per cent of the resolution of the standard black-and-white image.

Flicker-Brightness Relationship (Section XIV-B)

In a field-sequential color system, such as the CBS system, flicker is a much more difficult problem than in a line-sequential or dot-sequential color system. This follows from the fact that the eye is more sensitive to large-area flicker than to small-area flicker and from the fact that in the field-sequential system, the interruption of the image in changing from color to color occurs over the whole picture area.

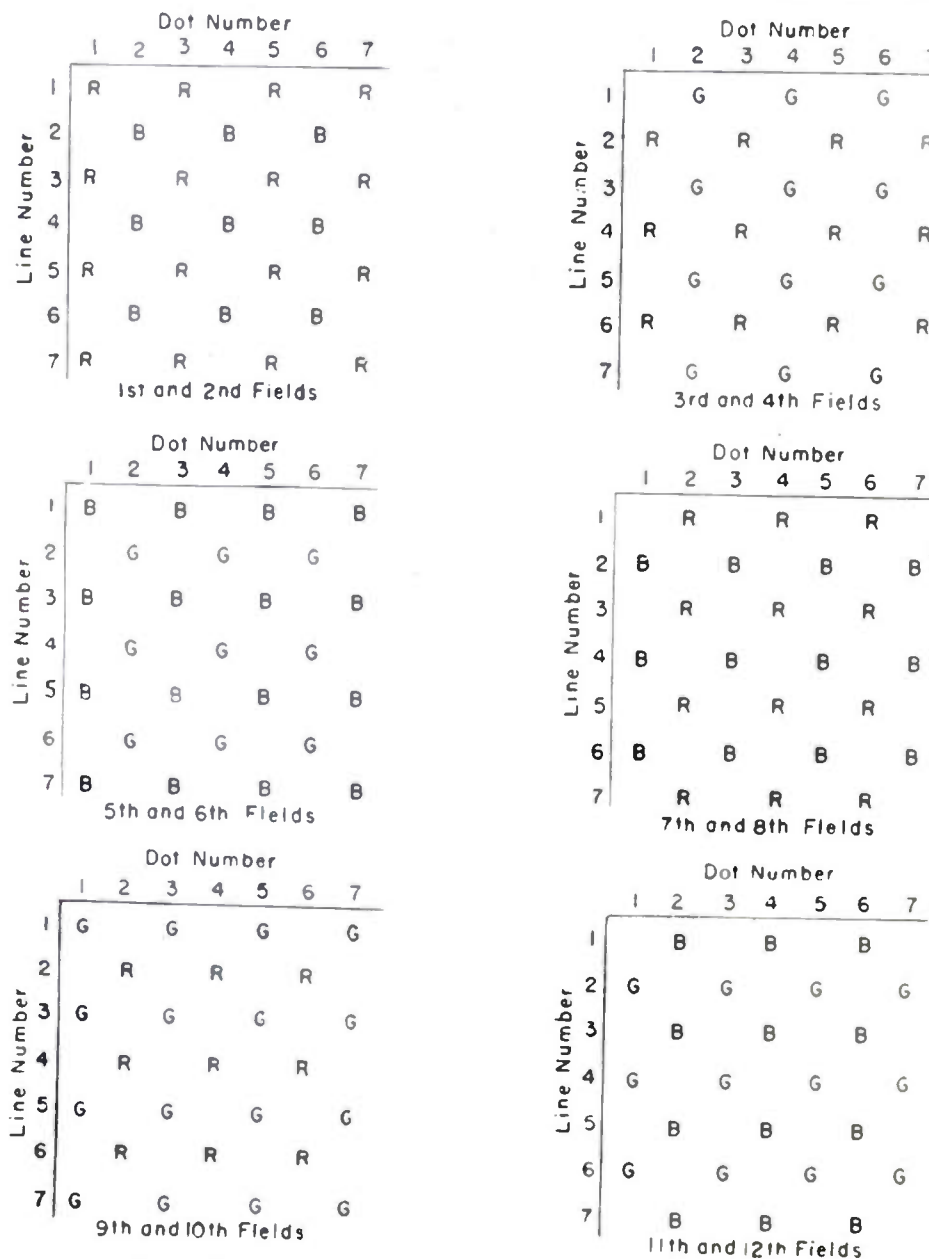

Fig. 3—Scanning pattern for CBS field-sequential color system, dot interlaced. (Seven lines and seven dots shown.)

To counteract the prominence of large-area flicker, it is necessary to increase the field scanning rate by a substantial amount. Experience has indicated that, for equal flicker-brightness performance under all conditions, the field-scanning rate of a field-sequential system should be about three times that of a black-and-white system. Actually, in the CBS system, the field rate has been increased by the ratio $144/60 = 2.4$ times, rather than 3 times. The lower value was chosen to preserve as much geometric resolution as possible within the confines of the 6-Mc radio channel.

It follows that large-area flicker is more prominent in the CBS system than in the black-and-white system. The comparable flicker rates in the two systems are 48 per second in the CBS color system (twice the complete picture rate), and 60 per second in the black-and-white system (the field-scanning rate). The difference in the rates is 12 per second. According to the Ferry-Porter flicker law, this difference in flicker rate would allow the black-and-white image to be about 9 times as bright as the color image, for equal visibility of flicker.

Corresponding to these theoretical values are various practical values quoted in the testimony given at the FCC Hearing. It was reported that flicker can be held within tolerable levels if the high-light brightness of the CBS color image is not greater than about 25 foot-lamberts, whereas the corresponding limit for the standard black-and-white image is well above 100 foot-lamberts. The 25-foot-lambert figure was quoted for the filter-disk-type CBS receiver. In the projection-type CBS receiver, using a long-persistence phosphor in the green image, higher brightnesses were attained within the tolerable limit of flicker.

At the request of the Committee, tests of large-area flicker were made by the National Bureau of Standards. The results are given in Annex D of this report.

So far as small-area flicker is concerned, the CBS line-interlaced system is not substantially different from that of the black-and-white system, and it may be somewhat superior when the colors transmitted are not too close to saturated red, green, or blue. The dot-interlace version of the CBS system is, on the other hand, somewhat inferior in this respect to the black-and-white system. Small areas (dimensions of the order of a picture element) are scanned at a color picture rate of 12 per second in the dot-interlaced CBS system.

Interline flicker should be somewhat more pronounced in the CBS system, when colors in the scene approximate the primary colors, because adjacent lines are then laid down at intervals of $1/48$ th second, compared to $1/60$ th second in the black-and-white system. However, when the colors comprise components of all three primaries in roughly equal amounts (and this is likely to be the case in bright, e.g., white, portions of the scene), adjacent lines are laid down at intervals of $1/144$ th second, and the interline flicker is then less noticeable than in the other systems.

Continuity of Motion (Section XIV-C)

Continuity of motion, like flicker, is affected in the CBS system by the composition

of the colors transmitted. If the object in motion is displayed in one of the primary colors, the other two primaries being substantially absent, then that portion of the image is illuminated only one third of the time, and the motion may appear jerky. If two or three primary color components are present, the illumination is more nearly continuous and the discontinuity is not so pronounced.

In either event, motion is portrayed with sufficient smoothness to satisfy the eye, at color picture rates in excess of 10 per second. So far as large areas are concerned, this requirement is met by both the line-interlaced and the dot-interlaced versions of the CBS system. In small areas, notably the detail of vertical and horizontal edges of objects, the dot-interlaced version of the system may display ragged edges on an object in rapid motion.

Noncompatible and Convertible Nature of the CBS System (Section XIII)

The fact that the field-scanning rate of the CBS system must be substantially higher than that of the black-and-white system leads to a most important difference in receivers designed for the two systems. In the black-and-white system, the vertical (field) scanning occurs at a rate of 60 per second, and the horizontal scanning at a rate of 15,750 per second (30 frames per second, each having 525 lines). In the CBS field-sequential system, the vertical (field) scanning occurs at 144 per second, and the horizontal scanning at 29,160 per second (72 frames per second, each of 405 lines).

The respective values in the two systems are so different that receivers built for black-and-white reception cannot be adjusted to scan at the higher rates required for the CBS color system, unless modifications are made in the receiver scanning circuits. This fact is the root of the "compatibility" argument. The cost of modifying existing receivers to make them operative on both sets of scanning standards may be substantial, and no reliable data have been submitted as to what this cost would be. However, by modifications of the circuits and the addition of a rotating disk, existing sets with picture tubes less than $12\frac{1}{2}$ inches diameter can be converted to color reception. Thus the CBS system is convertible but not compatible.

Effectiveness of Channel Utilization (Section XIV-D)

We have previously noted that both the line-interlaced and the dot-interlaced CBS systems have a flicker-brightness performance somewhat lower than that of the black-and-white system. The line-interlaced version displays resolution which is substantially lower than the black-and-white value. The dot-interlace version has poorer performance so far as small-area flicker and small-area continuity are concerned, but achieves resolution not markedly below that of the black-and-white system. The dot-interlace system makes substantially more effective use of the channel and is to be preferred, on this account, to the line-interlaced version of the system.

The nature of the compromise, adopted to fit the CBS system into the 6-Mc channel, is

determined principally by the large-area flicker effect. Since the color sequence is introduced by changing the color of the whole image at once, it is necessary to increase the field rate by a substantial amount, relative to the black-and-white system, and to lower the geometric resolution in proportion.

It may be argued, therefore, that the field-sequential scheme is less effective in channel utilization, because it devotes a disproportionately large amount of spectrum space to the reduction of flicker, at the expense of a substantial loss in resolution. Stated in another way, the use of the field-sequential technique, with dot-interlace, results in a picture having less geometric resolution (about 83 per cent of the black-and-white value) and lower large-area flicker-brightness performance (brightness at flicker threshold about one ninth the black-and-white value, for a given phosphor decay characteristic). Finally, the fact that the mixed-highs technique cannot be used in the field-sequential system has the effect of lowering the channel utilization, relative to that of a dot-sequential color system using mixed highs.

Color Fidelity (Section XIV-E)

There is, as noted previously, no basic difference in the color fidelity of the three color systems. This statement assumes a proper choice of filters, phosphors, and light sources, proper color balance and gradation, and freedom from superposition defects. In practice, as the systems were demonstrated to the Committee, the CBS system displayed superior color fidelity to the other two systems, when filter-disk receivers were employed. This superiority is explained by better color balance (the same area is scanned in all three primary colors in the CBS camera, and in the filter-disk-type CBS receiver as noted below), and by more accurate registration between the primary color images.

At the request of the Committee, tests on the fidelity of color reproduction by both the CBS and the RCA systems were undertaken by the National Bureau of Standards. Results are given in Annex E of this report.

Superposition Defects (Section XIV-F)

A noteworthy characteristic of the field-sequential system is the fact that the color sequence occurs at a slow rate (144 per second), compared with the CTI line-sequential system (15,750 per second) and the RCA dot-sequential system (10,800,000 per second). The slow color sequence, while making the flicker problem comparatively serious, has the compensating advantage of allowing the color sequence to be introduced mechanically by the rotating filter-disk method. Since, in this method, filter segments are placed successively in front of the camera tube and picture tube, it is necessary to employ only one scanned surface for all three primary colors. The CTI and RCA systems require in the camera a separate image for each of the three primary colors and similar images in the receiver.

Since only one scanned surface is used in the CBS filter-disk system, maintenance of proper registration between the primary color images is a simple matter. The optical

elements are common to all three images, so optical misregistration cannot occur. Electrical registration is assured if the scanning pattern of each field is precisely congruent to those preceding and following it, and this requirement is readily met, provided only that the scanning system is adequately protected from stray magnetic and electric fields. The absence of registration defects is a noteworthy characteristic of the CBS system, compared with the present state of development of equipment in the two other color systems.

The other types of superposition defects are, however, more pronounced in the CBS system than in the others, due to the inherent nature of the scanning process. Color breakup and color fringing are detectable when either the eye or the image is in rapid motion.

Depiction of Fine Detail

The CBS system cannot, by virtue of the nature of the scanning method used, take advantage of the mixed-highs principle. In compensation for this fact, and to improve the resolution, a circuit technique known as "crispening" has been developed by CBS. This is a method of causing the vertical edges of objects to appear more sharply defined. This technique is not unique to the CBS system, but may be used in any system to achieve the same result. It is believed, therefore, that the use of the crispening technique is not a significant difference between systems.

XXIV. SUMMARY

The essential characteristics of the CBS field-sequential system are as follows:

(A) The CBS system scanning standards are not compatible with the black-and-white scanning standards. This requires modification of existing black-and-white receivers, and additional complication in receivers of the future, to permit reception on both sets of scanning standards.

(B) The line-interlaced version of the CBS system has substantially poorer resolution than the black-and-white system. The dot-interlaced version has slightly poorer resolution than the black-and-white system. The crispening technique, applied to the CBS system, improves its resolution. However, this technique, applied to other systems, would improve their apparent resolution also.

(C) The large-area flicker-brightness performance of the CBS system is inferior to that of the black-and-white system. This means that CBS color image cannot be as bright, by a factor of 5 to 10 times, as the black-and-white image, for equal freedom from flicker. The dot-interlaced version of the CBS system, operating at the low color picture rate of 12 per second, has a small-area flicker performance (interdot flicker) not as good as the black-and-white system.

(D) The color fidelity of the CBS system, as demonstrated, is superior to that of the other color systems. This superiority is due to the maintenance of better color balance and more accurate registration, both of which are implicit in the use of but one scanned surface in the camera and one in the receiver. Much of this advantage is lost in the electronic version of the CBS re-

ceiver, since three surfaces are necessary at the receiver.

(E) The effectiveness of channel utilization is satisfactory in the line-interlaced version, and is good in the dot-interlaced version. The impossibility of employing the mixed-highs technique lowers the channel utilization with respect to the dot-sequential color system.

(F) Existing receivers with picture tubes of 12½ inches and smaller diameter can be converted to color reception, but at an appreciable cost.

CHAPTER 5—THE RCA DOT-SEQUENTIAL SYSTEM

XXV. INTRODUCTION

The information in this chapter is based on the testimony submitted by the Radio Corporation of America to the FCC during the color television hearing, and on demonstrations of the RCA system witnessed by members of the Committee prior to May 1, 1950.

XXVI. THE RCA SCANNING PATTERN

Fig. 4 shows the manner in which the RCA dot-sequential color television image

is scanned. The basic scanning pattern is identical to that of the standard black-and-white system, i.e., the image consists of 525 lines, scanned at a rate of 60 fields per second. About 490 lines of the image are active, and about 1/80th of a second is available for the active scanning of all the picture elements in a single field.

Each line of any one field in the image consists of dots in the three primary colors. The dots are arranged from left to right in the sequence red, blue, green. The space between two dots of the same color, e.g., green, is equal to the width of the dots; consequently the dots tend to overlap each other.

On successive scanings of the same line, the dots are shifted, so that the position of a dot of given color falls midway between the position of two dots of the other two colors, scanned on the preceding frame. Consequently at the end of two frames (four fields), every point on each line has been scanned in all three primary colors. The color picture rate is accordingly $60/4 = 15$ color pictures per second.

The positions of the dots on adjacent lines, scanned on successive fields, are shifted so

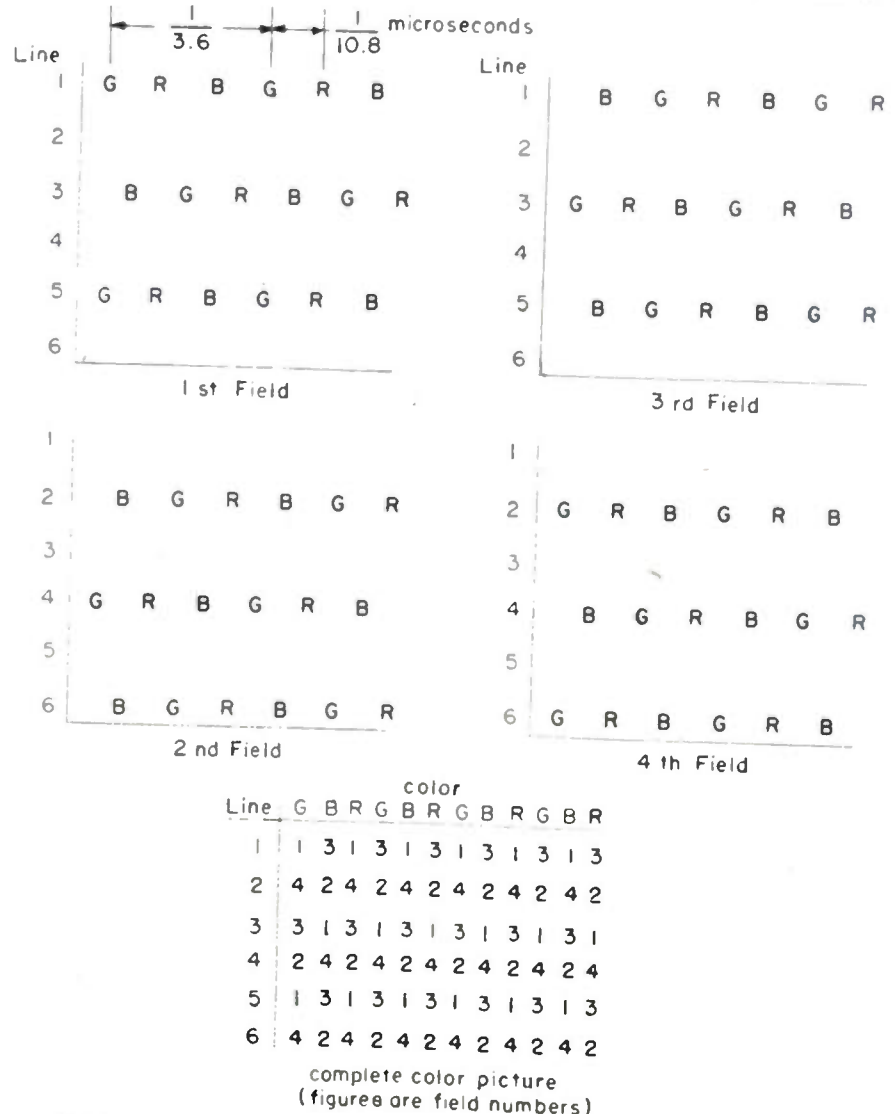

Fig. 4—Scanning pattern for RCA dot-sequential color-television system. (Only first six lines of fields are shown.)

that a dot of one color falls midway between the dots of the other two colors on the adjacent line. Consequently, the whole area of the image, after four fields have been scanned, is covered with a uniform distribution of dots in the three primary colors.

The scanning of the RCA dot-sequential image is of the dot-interlaced variety, as may be appreciated by considering dots of one color only, e.g., green. As noted above, two green dots on one line are separated by a blank space, in which dots of red and blue are fitted, with some overlap. On the next scanning of that line, the space midway between two green dots is filled in by a green dot. The same sequence applies, on successive scanning of any given line, in respect to the red and blue colors. As a consequence of this dot-interlaced technique, the resolution of the RCA image is approximately twice as great as it would be if the interlacing was confined to the lines alone. The dots of any one color are laid down along each line at a rate of 3.58 million per second.

XXVII. ESSENTIAL APPARATUS OF THE RCA SYSTEM

The camera, used in the demonstrations of the RCA System, employs three image orthicon camera tubes, one lens, and a set of color selective mirrors which separate the light from the scene into three colors. Red light enters one camera tube, blue light the second tube, and green light the third tube. The sensitive plate of each camera tube is scanned in identical fashion, at the normal scanning rates of the standard black-and-white system, i.e., 525 lines per picture, 60 fields per second. In this fashion, three complete images are televised, one for each of the primary colors. The optical and electrical adjustment of the camera must be such that each of these images is precisely congruent to, and properly oriented with the others.

When the camera views a scene having fine detail, the output signal of each camera tube contains signal components up to 4 Mc (actually components of higher frequency may be present but are not transmitted through the system). To take advantage of the mixed-highs principle, the signal from each camera tube is divided into two groups of frequencies. The components of frequencies above 2 Mc, representing the finest detail in the image, are combined at the outputs of the three camera tubes. This mixed signal represents the finest details of the picture in tones of gray.

The signal components lower than 2 Mc corresponding to the respective primary colors, and representing all details of larger size, are transmitted separately. The structure of the image is depicted in color except for the smallest details, which are shown in tones of gray.

The three color signals are transmitted in interspersed fashion by means of a switch which connects and disconnects each camera tube in sequence to the transmitter. This switch (which operates electronically since no mechanical switch could operate at the high speed required), makes and breaks the connection to each camera in rotation at a rate of 3.58 million times a second. Each time a camera tube is connected, it generates a dot of the respective color. When

disconnected, that camera is inactive, leaving a blank space in that color. As the switching progresses, the blank spaces between dots of one color are filled in by dots of the other two colors.

The net result is a sequence of overlapping dots along each line, in the sequence red, green, blue, each dot being somewhat larger than a picture element. Superimposed on the colored dot signal is the "mixed-high" signal, including details from the size of one picture element to several picture elements, in tones of gray.

Two types of receiver have been demonstrated by RCA. In the first type, three picture tubes are employed, one for each of the primary colors. By means of a high-speed electronic switch, like that at the transmitter, each tube is connected and disconnected from the receiver. This switch operates in strict synchronism with the transmitter switch. So the green tube, for example, is connected to the receiver only while green dots are being generated and is disconnected while the red and blue dots are generated. Consequently, on the face of the green tube, a dot-interlaced image appears which represents the image picked up by the camera tube which scans the scene in green. This image does not contain the finest detail of the picture, but the mixed-highs signal is also applied to each picture tube, through the switch, so that the fine detail is in fact present on the face of the green tube. The same arrangement is provided for the red and blue tubes, so that they reproduce images representative of those picked up by the red and blue camera tubes respectively, together with the mixed-highs component, derived from all the camera tubes.

The three primary-color images are combined by viewing them through a system of color-selective mirrors, which reflect light of a given primary color while transmitting light of the other two colors. Care must be taken to assure that the images on the three picture tubes are precisely the same size, have the proper orientation with respect to one another, and are congruent throughout. If these requirements are met, the primary-color images combine in register before the eye of the observer. The fine detail of the combined image, being present in equal amount in all three primary-color images, appears in tones of gray.

The second type of receiver employs but one picture tube, which is viewed directly. The viewing screen of this tube is composed of a very large number of small, precisely aligned areas, each area consisting of a cluster of three types of phosphor, which glow in the three primary colors. Each cluster represents a picture element which may be made to glow in any one of the primary colors. In one type of the tube demonstrated, three electron guns are used, one gun for each primary color. The guns are so positioned that the electron beams strike the screen at slightly different angles, having passed through perforations in a metal plate parallel to, and just behind, the screen. The angle of each beam is such as to cause it to fall on the phosphor of each cluster which glows in the color assigned to that beam. Thus each picture element in the image may be made to assume any primary color, by activating one gun as it passes

that particular cluster, the other two beams remaining inactive during that interval.

To recreate the color image in the single-tube receiver, a highspeed switch, like those previously described, applies the picture signal to the three electron guns in sequence. The timing of the switch is such that the gun associated with one color becomes active at the instant corresponding to the time the camera tube of the same color is connected at the transmitter, and similarly for the other two colors. In this manner, the clusters along each line in the image are caused to assume the color and intensity associated with the sequence of red, blue, and green dots transmitted over the system.

The single-tube receiver employs but one scanned surface, so the optical and electrical requirements for proper registration are considerably simpler than in the three-tube type of receiver. Moreover, the electrical and optical components of the single-tube receiver are substantially simpler.

XXVIII. PERFORMANCE CHARACTERISTICS OF THE RCA SYSTEM

The performance characteristics of the RCA system, based on the outline of Sections XIII and XIV Chapter 2, are as follows:

Resolution (Section XIV-A)

The resolution of the system must be considered in two categories—the mixed-highs component and the color components. In the mixed-highs component, the maximum picture-signal frequency is 4 Mc, the same as that of the black-and-white system. Since the time for scanning the active portion of each field is also the same, 1/80th of a second, the number of picture elements per field is the same, about 100,000, and the total resolution (contained in two successive fields) is 200,000 picture elements. This fine structure is, of course, depicted in tones of gray.

The color components, considered individually, each have a maximum picture-signal frequency of about 2 Mc. In the dot-interlace type of transmission each cycle produces one picture element. Moreover, in accordance with the dot-interlace technique, all the dots in any one color are laid down in four consecutive fields, or in 1/15th of a second. When account is taken of the portion of the image blanked off, this time is reduced to 1/20th of a second. Consequently 2 million green dots are scanned per second, or 100,000 green dots during the complete color picture period. Thus, nominally, the resolution in each color is one half that of the black-and-white image.

Actually the resolution in the individual primary colors is not as high as 100,000 dots because there is a certain amount of dilution of each color by the other two colors. This dilution occurs because the signal corresponding to one color dot overlaps that corresponding to the adjacent color dot by about 50 per cent. This phenomenon, known as "cross talk," has the effect of causing a part of the color values to combine into shades of gray, much in the manner of the mixed-highs portion of the image. The net effect is that details of width from one to eight picture elements are reproduced in shades of gray, whereas all larger portions

of the image are reproduced in their component colors.

As indicated in Section XII Chapter 2, the superimposed fine detail in the mixed-highs method of transmission provides a substantial economy in the use of the channel, without appreciable degradation of the color or tonal values of the image. In theory, therefore, the resolution of the RCA system is equal to that of the black-and-white system. It should be noted, however, that the tricolor tubes demonstrated had a resolution of 117,000 picture elements, rather than the 200,000 elements of which the system is theoretically capable. This limitation was imposed by the number of phosphor clusters on the screen and perforations in the metal plate which could be accommodated in the tube. Refinements in the design and construction of the tricolor tube may remove this limitation in the future.

In passing, it may be mentioned that the tubes as demonstrated were laboratory models of a special design which may involve considerable difficulty in adapting to factory production. At present, one of the most urgent needs of all color television systems is for a three-color receiver tube adaptable to quantity production. Besides RCA, a number of others are known to be actively engaged in seeking solutions to this important problem, notably Dr. E. O. Lawrence of Berkeley, California, and Dr. C. W. Geer of Los Angeles, California.

Flicker-Brightness Relationship (Section XIV-B)

The large-area flicker-brightness performance of the RCA system is equal to that of the black-and-white system, since the systems employ the same field rate, 60 per second. The small-area performance is inferior to that of the black-and-white system, however, since a given picture element is scanned in all colors at the comparatively slow rate of 15 per second. Accordingly, interdot and interline flicker are present at lower light levels than are the corresponding small-area flicker effects in the black-and-white image.

In early demonstrations of the RCA system a prominent form of dot crawl was evident along vertical or nearly vertical boundaries in the image. In later demonstrations, the geometry of the dot scanning had been altered to minimize this effect, and dot crawl was not then evident.

Continuity of Motion (Section XIV-C)

Since the field-scanning rate of the RCA system is equal to that of the black-and-white system, the continuity of large objects in motion is the same. The continuity of small objects (of the dimensions of a few picture elements) is adversely affected by the low color picture rate of 15 per second. This shortcoming is inherent in the dot-interlace system, and is parallel to the small-area effect noted in Section XXIII, Chapter 4, as applying to the dot-interlaced version of the CBS system.

Compatible Nature of RCA System (Section XIII)

Since the line- and field-scanning rates of the RCA color system are identical to those of the black-and-white system, the

two systems are compatible so far as scanning goes. Consequently, a black-and-white rendition of RCA color transmission can be received on existing and future sets designed for black-and-white reception only, without change in the scanning circuits of these receivers. Moreover, the presence of the mixed-highs component in the color transmission assures high resolution in the black-and-white rendition. The black-and-white rendition of the RCA color transmission has higher resolution and better flicker-brightness performance than do the black-and-white renditions of the CTI and CBS systems.

Effectiveness of Channel Utilization (Section XIV-D)

The RCA system makes highly effective use of the channel because it employs both the principal spectrum-saving techniques, dot-interlace scanning and mixed-highs transmission.

Color Fidelity (Section XIV-E)

As noted elsewhere in this report, proper choice of mirrors, filters, and phosphors permits the RCA system to achieve satisfactory color fidelity. However, if color balance and accurate superposition of the primary-color images are not maintained, the color fidelity suffers. The color fidelity demonstrated in the RCA system was considered by the Committee to be not as satisfactory as that of the CBS system. The larger colored areas in the RCA images were not always uniform in hue and saturation. This may have been caused by differences in the spectral responses of the three camera tubes. Color distortions noted in small areas are explained by overlapping and crosstalk between the color signals, described above. In the early demonstrations of the RCA system, gradual shifting of colors with time was observed, due to uncontrolled shifts in the relative positions of the interspersed color dots along each line. In the later demonstrations, these shifts were controlled by improvements in the synchronization of the high-speed switch of the receiver, and the colors were then found to be free of such variations with time. (See Annex E for results of National Bureau of Standards tests on color fidelity of the RCA system.)

Superposition Defects (Section XIV-F)

Of the three principal superposition defects—color breakup, color fringing, and faulty registration, only the last is present in the RCA system. Registration is more difficult to maintain in the RCA system than in the other systems. This follows from the fact that three separate camera tubes are used, introducing the possibility of optical and electrical errors in the size, orientation, and congruency of the primary images as transmitted. In the three-tube type of receiver, these possibilities of improper registration are present also in the receiver. In the single-tube receiver, faulty registration may occur between the scanning of the three electron guns, but optical misregistration does not occur.

Depiction of Fine Detail

The dot-sequential color system, alone of all sequential systems, can use the mixed-

highs method of depicting fine detail. In the RCA dot-sequential system, no color information is transmitted at frequencies above 2 Mc whereas the fine detail, transmitted by the signal from 2 to 4 Mc, is shown in shades of gray.

XXIX. SUMMARY

The essential performance characteristics of the RCA system are as follows:

(A) The RCA system scanning standards are compatible with the black-and-white scanning standards. Consequently a black-and-white rendition of the RCA color transmission can be received on receivers built for black-and-white reception, without modification of their scanning circuits. Moreover, the characteristics of the RCA color system are such that the quality of the black-and-white rendition may be equal to that of standard black-and-white reception, in resolution and large-area flicker-brightness performance.

(B) The RCA color image has an overall resolution approximately equal to that of the black-and-white system. The finest details are depicted in shades of gray, while larger details are rendered in color. The color transmission has sufficiently fine detail that, when the gray-tone detail is added to it, the apparent resolution of the image as a whole is approximately 200,000 picture elements.

(C) The large-area flicker-brightness and continuity performance of the RCA system is equal to that of the black-and-white system. The small-area performance in these respects is somewhat inferior, due to the fact that the color picture rate is 15 per second, half the corresponding rate in the black-and-white system.

(D) The color fidelity of the RCA system suffers to a certain extent from uneven color balance in large areas. Overlap and cross talk between the color components, and faulty registration, affect the color fidelity in small areas.

(E) The effectiveness of channel utilization of the RCA color system is the highest of all the systems discussed in this report.

(F) Existing receivers cannot be converted to color reception in the RCA system, except at a substantial cost.

CHAPTER 6—COMPARISON OF SYSTEMS AND CONCLUSIONS

XXX. INTRODUCTION

To avoid confusion, each of the foregoing three chapters has been confined to a discussion of one of the proposed color systems, with a minimum of comparative comment. The plan of the discussion in each chapter follows the same pattern, however, so it is possible to bring together comparably the data and conclusions on the performance of the three systems. This comparison has been set forth in table form, in the accompanying Table I, "Tabular Summary of Performance Characteristics." Explanatory comments are given below.

XXXI. COMMENTS ON THE TABULAR SUMMARY

The Committee is of the opinion that the essential differences among the three proposed color systems are embodied in nine categories, listed alphabetically at the

left of Table I, and defined in Sections XIII and XIV, Chapter 2, as follows: adaptability, color fidelity, compatibility, continuity of motion, convertibility, effectiveness of channel utilization, flicker-brightness performance, geometric resolution, and superposition defects.

This list purposely omits consideration of certain peculiarities of apparatus such as mechanical versus electronic operation of the receiver color-sequence device, limitation of size of image, and limitation of angle of view. These matters once loomed large in the competitive consideration of the systems, but they have become progressively less prominent as the development of the systems has proceeded. It appears, in fact, that all of the systems may use a tricolor tube to advantage, and this fact puts all three systems on a par with respect to all-electronic receiver operation, size of image, and angle of view. Moreover, such differences are not fundamental, either in the transition stage during which color service is introduced to the public, or in the long run as the color service consolidates its position.

The performance characteristics listed in Table I, on the other hand, are believed by the Committee to be fundamental,

either because they reside in the nature of the scanning process, or because (as in the case of adaptability, compatibility, and convertibility) they are matters of importance during the transition from black-and-white service to color service.

Under some of the main characteristics are listed a number of subdivisions. These subdivisions are not necessarily of equal importance; they merely represent items on which system performance displays a significant difference. For example, under geometric resolution, the total number of picture elements per frame is more fundamental than either the vertical or horizontal values of resolution considered separately. To aid the reader, the subdivision believed by the Committee to have outstanding importance within each main category is marked with an asterisk (*).

No attempt has been made to place relative emphasis on the main categories, which are listed alphabetically to avoid any connotation of relative importance. The emphasis on main categories must be assigned at the highest level of administrative decision, taking into account the economic, political, and sociological factors, as well as the technical factors, involved.

The difficulty of placing this emphasis can be well illustrated by such questions as: "Is compatibility (preservation of existing investment) more important than convertibility (converting existing investment)? How do each of these compare with effectiveness of channel utilization (conservation of the public domain) or geometric resolution (providing the maximum flexibility to program producers in choice of subject matter, range of action, and field of view)?" Answers to these vexing questions must be found but they are not properly the concern of technical specialists.

So much for the basis of the listings. Opposite each performance characteristic, the Committee has placed a verbal or numerical index to the relative performance of the three color systems. These indices represent technical judgments, based either on evident fact, well-established theory, or on the subjective reactions of the Committee members to the demonstrations. For the most part, the basis of the Committee's judgments will be found in the preceding chapters of this report. But the subjective reactions are difficult to analyze, and the terms "excellent, good, satisfactory, fair, poor" are, in the last analysis, merely words

TABLE I
TABULAR SUMMARY OF PERFORMANCE CHARACTERISTICS

| Performance Characteristic | System | | | | | Superior System |
|---|--------------------------|-----------------------------------|--|--|-----------------------------------|-----------------|
| | Standard Black-and-White | CTI Color | CBS Color; Line-Interlaced | CBS Color; Dot-Interlaced | RCA Color | |
| Adaptability | — | Not needed | Adaptable | Adaptable | Not needed | CTI-RCA |
| Color Fidelity | — | Satisfactory | Excellent | Excellent | Satisfactory | CBS |
| *Large areas | — | Fair | Excellent | Excellent | Fair | CBS |
| Small areas and edges of objects | | | | | | |
| Compatibility | — | Fair | Not Compatible | Not Compatible | Excellent | RCA |
| Quality of image rendered on existing sets | | | | | | |
| Continuity of Motion | Excellent | Good | Good | Good | Good | CBS (line)-RCA |
| *Large objects | Good | Fair | Good | Fair | Good | |
| Small objects | | | | | | |
| Convertibility | — | Not easily convertible at present | Convertible 12½-inch tube diameter maximum | Convertible 12½-inch tube diameter maximum | Not easily convertible at present | CBS |
| Effectiveness of Channel Utilization | Good | Good | Satisfactory | Good | Excellent | RCA |
| Flicker-Brightness Relationship | Excellent | Excellent | Good | Good | Excellent | CTI-RCA |
| *Large areas | Good | Fair | Good | Satisfactory | Good | CBS (line)-RCA |
| Small areas | Absent | Absent | Absent | Fair | Fair | CTI-CBS (line) |
| Interdot flicker | Good | Poor | Good | Good | Good | CBS-RCA |
| Interline flicker | | | | | | |
| Geometric resolution | 200,000 | 200,000 | 83,000 | 166,000 | 200,000 | CTI-RCA |
| *Number of picture elements per color picture | 490 lines | 490 lines ¹ | 378 lines | 378 lines | 490 lines | RCA |
| Vertical resolution | 320 lines | 320 lines | 185 lines | 370 lines | 320 lines | CBS (dot) |
| Horizontal resolution | | | | | | |
| Superposition Performance | — | Fair | Excellent | Excellent | Fair | CBS |
| *Registration | — | Excellent | Satisfactory | Satisfactory | Excellent | CTI-RCA |
| Color breakup | — | Excellent | Satisfactory | Satisfactory | Excellent | CTI-RCA |
| Color fringing | | | | | | |

* See explanation in Section XXI.

¹ This is the geometric resolution; the apparent vertical resolution is considerably less, due to interline flicker.

on which the Committee was able to agree as being most indicative of relative performance. The final column in the table indicates the system whose performance is, in the opinion of the Committee, superior in each category or subdivision. Where two systems share a superior position, both are listed in alphabetical order.

It is the belief of the Committee (1) that this table, with the accompanying text of the report, provides a sound basis for a technical decision among the three systems, and (2) that the only missing element is the relative weight to be accorded each main category. When such weights are assigned, a preponderance of advantage for one system over the others can be found.

The main conclusions reached by the Committee have been stated at the outset, in Chapter 1. These favor a color service based on the 6-Mc channel, the service to be limited to one of the sequential systems (dot, line, or field).

XXXII. COMMENTS ON POSSIBILITIES OF FUTURE DEVELOPMENTS

This report would not be complete without one additional observation, namely, that all the systems are subject to improvement as a result of further technical and operational development. The process of improvement will go on in each system until the decision between them is handed down, so long as the proponents and other members of the industry continue to expend man power and resources on their development.

However, the prospect for future improvement is not of equal magnitude in each system. This is a matter of evident importance in setting standards, since the standards may be expected to be in use for a long time after their full potential has been realized. The net long-term good to the public is thus greatest in that system which can be expected to reach the highest pitch of performance during the next few years. Such technical advances, presuming a choice of one system in the immediate future, will be limited to those matters capable of improvement within the framework of the then-established standards.

It is the opinion of the Committee that the CBS system has progressed furthest toward full realization of its potentialities, within the confines of the field-sequential system. It is not likely, for example, that the color fidelity will improve beyond the highly satisfactory state now achieved. Equally, the CBS system is not likely to improve substantially its channel utilization beyond that achieved in the dot-interlaced version of the system. Nor is the flicker-brightness performance capable of substantial improvement, except by methods equally available to other systems, once the picture rate is established at 24 color pictures per second.

The CTI system, being less fully developed, has somewhat greater possibility of future improvement, particularly with respect to correction of faulty registration and small-area color distortions and the development of convertible receiver circuits using a tricolor tube. But in other respects the CTI system cannot reasonably be expected to overcome certain inherent limitations imposed by the choice of scanning method. These include the difficulty of avoiding interline flicker and the impracticability of

using dot interlace (at a color picture rate of 5 per second, which is too low for satisfactory rendition of small areas and sharp edges).

The RCA system also has considerable opportunity for improvement within the confines of the scanning standards proposed for this system. The registration of the color images, and the balance of the color values in both large and small areas can be expected to improve substantially with advances in camera design. Convertible circuits, to convert existing sets to color, using the tricolor tube and auxiliary components, can be developed.

The systems discussed above are confined to those developed and demonstrated by their proponents, CTI, CBS, and RCA. An additional demonstration of a dot-sequential system was viewed by the Committee. The Hazeltine Electronics Corporation demonstrated a technique known as "constant-luminance sampling," which considerably reduces the visible effect of noise and interference in a dot-sequential color image. This demonstration also provided conclusive proof of the efficacy of the mixed-highs technique, in that a video channel of 4 Mc carrying a mixed-highs, dot-sequential transmission was found to offer substantially the same quality of image as a 12-Mc channel carrying an equivalent simultaneous color transmission. The Committee concludes that the Hazeltine developments are an important contribution to the dot-sequential system.

The present state of development of each system has been reached through the efforts of single organizations working in competition. Once the decision is reached among the systems, all that effort, plus additional effort from other quarters, can be applied to the one system then chosen. It may then be found that the real limit to future progress is that imposed by the nature of the scanning standards, not by present equipment limitations or present relative costs.

On this account, the final conclusion of the Committee is that principal importance should be attached to those fundamental capabilities and limitations which relate to the choice of scanning method. These fundamentals have been discussed at length in this report and listed in detail in Table I. Other factors, relating to the present performance and costs of apparatus, deserve consideration, but, in the opinion of the Committee, such matters should take second place in the technical assessment of the systems.

Respectfully submitted,

E. U. CONDON, *Chairman*
S. L. BAILEY
W. L. EVERITT
D. G. FINK
NEWBERN SMITH

ANNEX A

UNITED STATES SENATE

Committee on

Interstate and Foreign Commerce

May 20, 1949

Hon. E. U. Condon
Director
National Bureau of Standards
Washington, D. C.

My dear Dr. Condon:

The question of the present-day commercial use of color television has been a matter of raging controversy within the radio world for many months. There is a woeful lack of authentic and dependable information on this subject.

Hundreds of applicants for television licenses, as well as those now operating television stations, are vitally affected by its settlement. The capital investment involved in the installation of a television station runs into a tremendous sum. The operational costs of such a station are extremely high also. All of these expenses must be recovered through advertising. Those who are experienced in advertising believe that if color television were available now, attractive local advertising revenues could be obtained due to the strong consumer demand for it.

The Federal Communications Commission has declined to authorize commercial licensing of color television. It seems reluctant to indicate when and if it will act with respect to authorizing commercial licensing of color. As we understand it, the Commission must first fix minimum standards for color television before licensing can be undertaken, but it refuses to attempt to do so on the premise that color television has not been developed sufficiently for standards to be determined.

Accordingly, it is greatly in the public interest that a sound, factual ascertainment be had *now* whether or not minimum standards can be fixed today, or in the very near future, so that color television might develop and progress with complete freedom under the stimulus of commercial competition.

One unit in the industry has demonstrated color television six megacycles wide and asserts that if the Commission would allocate frequencies and license commercial operation, it could go ahead "tomorrow." Another large unit in the industry also has demonstrated color television of varying width from six to eighteen megacycles but believes that color is not yet ready for commercial operation; that much more experimental work must be done and field tests made before commercial licensing should be undertaken. Still another unit in the industry is said to be of the opinion that color television is several years away.

My objective, and the objective of the Senate Committee on Interstate and Foreign Commerce, is to encourage development of the radio art and to press for a nationwide, competitive television service in the public interest. Our Committee sees television as a great new industry, not only providing new jobs and new source of wealth but as the greatest medium of entertainment and diffusion of knowledge yet known to man. We believe that it has made great advances but we are concerned that through delay in opening up the ultra-high frequencies and holding up color until such time as some electronic experts believe that color has reached a state of perfection, a chain of circumstances will have been created which will tend toward monopoly control of the entire television art.

We are anxious, also, to reduce as much as possible any sharp impact on both station licensees and the general public, who already

have invested one-half billion dollars in receiver sets, of any sudden but eventually necessary conversion to color. It is our belief that if both potential licensees and the set-buying public are given all of the facts now with respect to color television, less exploitation will ensue and less wasteful expenditures will occur.

Frankly, it seems to us that this is the time to obtain these facts and make them public. The Commission has, in effect, a "freeze" on further television allocations in the vhf band. It faces the problem of opening up the uhf band in order to provide sufficient channel space for a competitive nationwide television system. Now, when there is at least the probability that both bands may be opened simultaneously for allocation, is the time to make certain regarding the color television situation so that, if it is technically feasible, the Commission might also simultaneously open color to commercial licensing in either or both bands.

It has occurred to me, therefore, that at this juncture you could be most helpful in giving this Committee sound, impartial, scientific advice. I am anxious that you individually, or in association with a small group of scientific persons of repute, none of whom are employed by or have any connection directly or indirectly, with any radio licensee or radio equipment manufacturer, shall investigate officially this matter for the Committee.

Specifically, I would like you and your group to visit the laboratories of the Radio Corporation of America, Columbia Broadcasting System, Du Mont, and any others engaged in color television research and development; confer with their engineers; witness demonstrations; ask questions, all with the purpose of coming to a definite opinion as to the present stage of development of color television. Your inquiries will necessitate an evaluation of present-day practicability of color television; in short, can a satisfactory color television picture be broadcast today in the vhf and uhf frequency bands?

We are aware, of course, that both transmission and reception equipment is not now available on a commercial scale but that is not a controlling factor in whether color television should or should not be licensed, or stations allocated. We are also aware that undoubtedly experience and further experiment will result in the development of a better color picture but that, also, is not a factor in the evaluation we seek. We realize, as you, that color television today is as different from what it will be in perhaps 5 years as were the old crystal radio sets as compared with present-day radio receivers. It is not necessary that the art be fully developed for minimum standards to be outlined.

I am particularly concerned with resolving once and for all the charges that have been made that the advance of color television has been held up by the Commission for reasons difficult for us to understand, and I feel certain that a committee headed by so eminent a scientist as you will help resolve these doubts and questions which have been tossed about.

You will want, I assume, to confer with the engineers and laboratory personnel of

the Federal Communications Commission as well as with the people in the industry. I feel certain that you will have the co-operation and willing assistance of the responsible officials of the industry in such a study, and I shall be pleased to ask them and any Government agencies who may be concerned to accord you and your group every assistance and co-operation.

I sincerely hope in the public interest that you will assume this difficult assignment. I shall be pleased to confer with you at your convenience.

Sincerely yours,
/s/ ED. C. JOHNSON
Chairman

ANNEX B

EXCERPT FROM FEDERAL COMMUNICATIONS COMMISSION NOTICE OF FURTHER PROPOSED RULE MAKING (FCC 49-948, Mimeo #37460, ADOPTED JULY 8, 1949), APPENDIX A

"II. TRANSMISSION STANDARDS

A. The Commission proposes that the Transmission Standards for channels 14 through 55 as well as for channels 2 through 13 shall be those standards which are set forth in the Standards of Good Engineering Practice concerning Television Broadcast Stations under Heading 2 entitled "Transmission Standards and Changes or Modifications Thereof."

B. The Commission will give consideration to proposals for a change in Transmission Standards on channels 2 through 55 looking toward color television or other television systems. Any such proposal shall:

1. Be specific as to any change or changes in the Transmission Standards proposed; and

2. Shall contain a showing as to the changes or modifications in existing receivers which would be required in order to enable them to receive programs transmitted in accordance with the new standards.

C. It is proposed to consider changes in Transmission Standards for channels 2 through 55 only upon a showing in these proceedings that:

1. Such system can operate in a 6-megacycle channel; and

2. Existing television receivers designed to receive television programs transmitted in accordance with present transmission standards will be able to receive television programs transmitted in accordance with the proposed new standards simply by making relatively minor modifications in such existing receivers."

ANNEX C

February 2, 1950

The Honorable Edwin C. Johnson
Senate Office Building
Washington, D. C.

Dear Senator Johnson:

Herewith for your information is a report drafted by our Color Television Committee. This report deals only with some aspects of the frequency allocation problem rather than with color television systems as such. As I have indicated, we shall probably not have a report on color systems until some-

time after the Federal Communications Commission demonstrations have been concluded.

The subject of the present report is, however, pertinent to the general television problem and represents the considered opinion of our Committee regarding the frequency allocation problem. I believe you and the members of your Committee may find this material helpful.

The report assumes a knowledge of the general setup of the frequency allocation structure in this country, and does not contain much background material on this. If you think that a more general background statement might be of assistance to the members of your Committee in considering this problem, we should be glad to furnish one.

I have marked this report confidential only to insure that it would not be released unless and until you wish. If you do not advise me to the contrary, I shall do the same with other reports also.

Sincerely yours,
E. U. CONDON, Director

STATEMENT BY THE SENATE ADVISORY COMMITTEE ON COLOR TELEVISION

The plans for expansion of the television service, whether for additional black-and-white stations or for a color service, must be evaluated in terms of the radio spectrum now reserved for television and other services. Television broadcast stations are currently allocated in 12 channels in the vhf spectrum in the following bands: 54-72 Mc, 76-88 Mc, 174-216 Mc.

In expanding the television service it would appear to this Committee that it would be highly advantageous to allocate additional vhf channels between 72 and 300 Mc. But the space in the vhf spectrum is currently occupied by, or nominally allocated to, other services. These are:

72-76 Mc—Government aeronautical navigation and nongovernment fixed

88-108 Mc—FM broadcasting

108-144 Mc—Aeronautical navigation and communication

144-148 Mc—Amateur

148-152 Mc—Aeronautical communication

152-156 Mc—Police

156-162 Mc—Nongovernment fixed and mobile

162-174 Mc—Government fixed and mobile

216-220 Mc—Government fixed and mobile

220-225 Mc—Amateur

225-400 Mc—Government aeronautical communication and navigation.

In view of this extensive occupancy of the vhf spectrum by nontelevision services, the FCC allocated a portion of the uhf spectrum, from 475 to 890 Mc for experimental television service, looking toward the development of improved television systems including high definition black-and-white and color systems. The FCC has recently issued a proposal to allocate a large segment of the uhf band to commercial black-and-white television broadcasting.

The proposal, to be debated shortly in hearings before the Commission, is to allocate approximately 42 channels, each 6 Mc wide, extending from 475 Mc to 727 Mc (or from 500 to 752 Mc, if the band 475-500 Mc is allocated to common-carrier fixed-mobile communications).

The proposal to allocate uhf channels is open to a number of serious objections which stem from differences in the performance of transmitters and receivers and in the propagation of radio waves. The available power of transmitters and the sensitivity of receivers are lower, in any given state of the art, in the uhf band than in the vhf band. The performance of the uhf system is impaired further than the vhf system by natural impediments to transmission over the earth's surface. These technical factors have important implications, which may be summed up in the statement that uhf television stations cannot cover as large an area (by a factor of the order of 3 times) as can vhf stations of the same effective radiated power.

The effect on the extent of the service to the public is manifest. In the first place, areas which might be covered by vhf stations cannot be covered by the same number of uhf stations. A second effect of a uhf allocation which is against the public interest, is the tendency to foster monopoly. In areas of dense population, such as the eastern seaboard, a vhf station can reach an audience much larger than can an equivalent uhf station. Accordingly there is serious doubt that a uhf station could, under these circumstances, compete with the vhf stations in the same area. The limited number of stations on the existing 12 vhf channels would then operate at a substantial competitive advantage.

These disadvantages of a uhf allocation may have to be faced, provided that no additional vhf channels can be found. But to the extent that space in the vhf spectrum could be transferred to the television service from other services, the technical, social, and economic shortcomings of uhf television service could be obviated. All the future needs of television may not be satisfied by additions to the vhf allocation. But with even a small addition (e.g., 6 channels) it is possible that an adequate public service can be achieved, both as to coverage and for fostering competition, without the necessity of the extensive uhf allocation proposed by the FCC.

This committee is concerned primarily with the technical factors underlying a color television service, and is not in a position to recommend specific changes in the vhf allocation. Moreover, the committee wishes to emphasize that the transfer of spectrum facilities from one service to another involves judgments which transcend technical factors. Such judgments must be based on sound technical knowledge, but they involve also the far more difficult determination of the needs of the various services, their established positions and investments, and the quantity and quality of the service they render to the public and the national security. No technical group can properly undertake judgments of the latter type. They must be made on a high administrative level, by a group of judicial merit, having knowledge of, and properly

responsive to, the needs of *all* the radio services.

It is the considered opinion of this committee that the distribution of the vhf and uhf regions of the spectrum to various services has not been carried out in the past on the basis just suggested. This failure has stemmed from the fact that no government agency has been given the authority or responsibility to make a judicial review of the use of the entire portion of the spectrum involved. Two groups, operating with different procedures and policies, have been responsible for the main features of the allocation. These are the FCC, which allocates frequencies to nongovernment services and the IRAC (Interdepartment Radio Advisory Committee) which allocates frequencies to government, including military services, and in addition, allocates frequencies for assignment by the FCC to nongovernment services. These groups have not operated, during peacetime, under a common policy and the IRAC has not reviewed, in the manner employed by the FCC for nongovernment requirements, the needs of all government and nongovernment services. Unless and until such a review is carried out, at an administrative level sufficiently high to command the respect and co-operation of the industries and government departments affected, serious doubt will remain that the allocations, as they now stand, are for the maximum benefit of the public and the national security.

While this situation exists, this committee is faced with a difficult choice in its deliberations. It may assume on the one hand, that a review of the allocations to both government and nongovernment services should be made, and will in fact be made by an appropriate government agency existing or to be set up, before the proposed expansion of television facilities takes place, and that such a review would probably result in the allocation of additional vhf channels. Alternatively it may assume that the creation of an administrative body to review the allocations, its deliberations, and the preparation of its findings, would take so much time that the expansion of television service should not be delayed so long. In the latter event, the committee has no alternative but to proceed within the terms of reference now proposed by the FCC, even though these terms may be faulty.

Since the members of the committee believe this to be a matter of great importance, not only to the future of the television service, but of other radio services as well, they respectfully bring the matter to the attention of the Senate Interstate Commerce Committee and request guidance in the matter.

ANNEX D

REPORT ON TESTS OF FLICKER IN COLOR TELEVISION, T. H. PROJECTOR NATIONAL BUREAU OF STANDARDS

I. SCOPE OF TESTS

Television receivers, both monochrome and color, are subject to various imperfections symptomatically visible as imperfections of the image viewed on the screen. Among these are a group of imperfections which may loosely be described as flicker. It is the purpose of this report to describe

tests made of a particular one of these imperfections: the cyclic variation of the brightness of the image associated inherently with the field and frame frequencies and with the kind of color synthesis and analysis used.

Tests have been made to date on the Columbia Broadcasting System's color television system only. This system is a "field-sequential" system with a field frequency of 144 per second and a frame frequency of 24 per second, or 6 fields per frame. The fields are successively red, blue, and green. Because of line interlace, two cycles of the three colors are required to complete a frame. The horizontal sweep frequency is 29,160 per second. The field colors are obtained with a 6-segment wheel rotating at 24 rps.

II. TEST MATERIAL

One CBS table-model color television receiver was delivered to this Bureau in January, 1950, for test purposes. It was equipped with a 7-inch cathode-ray tube and a magnifying optic yielding a magnified image of the screen approximately the size of a 10-inch tube screen. This receiver was used for physical measurements of the variation of brightness with time. Some preliminary measurements of subjective flicker were made on this instrument but the main group of measurements were made on one of the Smith, Kline, and French console receivers located at the Walker Building, where it was used for public demonstrations. The measurements were made at the Walker Building rather than at this Bureau in order to assure optimum reception conditions, and thereby to limit flicker to that which is inherent in the system.

III. PHYSICAL MEASUREMENTS OF BRIGHTNESS VARIATION

To measure the variation of the brightness of the screen with time, an electron multiplier, with a correction filter yielding approximately the ICI "Standard Observer" luminosity response, was used. The field of view of the photomultiplier was limited optically to a square area with sides approximately 1/7 of screen width. The output of the multiplier was amplified and fed into the deflection system of an oscillograph. The sweep frequency of the oscillograph was adjusted to approximately 24 per second, so that the oscillograph presented a curve of the average brightness of the square portion of the television screen viewed by the multiplier versus time for one complete frame.

The regular CBS broadcast test pattern was used for the test. Curves of all four test pattern colors, red, blue, green, and yellow, were obtained, as was a curve for white. The results are shown in Fig. 5. It should be noted that the color of the patterns could be altered easily by manipulation of the brightness and contrast controls of the receiver. These were adjusted before photographing the curves to give the best over-all effect, but the results should be considered qualitative only.

It is evident from the figure that the decay time of the phosphor is quite short. The relative vertical spread of the trace near the peaks indicates that the decay time

is of the order of a fraction of the time of one horizontal sweep. Evidently then, any small area of the television screen receives periodic sharp pulses of light at intervals of $1/144$ second. These pulses vary in intensity in accordance with the color composition and brightness of the area and will, on viewing, vary in color because of the interposition of the sequential filters.

IV. SUBJECTIVE FLICKER MEASUREMENTS

Because of the complex way in which the images are formed, previous work on flicker was not considered directly applicable. In addition, while there has been a considerable amount of work done on critical flicker frequencies (the frequency at which flicker vanishes), very little has been done relating to the observer's subjective judgments regarding a given amount of flicker. Accordingly, this part of the test was divided into two parts. First it was necessary to determine a "flicker tolerance scale" for the observers used in the test and then to determine where on the scale the observers considered the color television set to be.

A. Flicker Tolerance Scale

In order to obtain a flicker tolerance scale, a "flicker box" was constructed. This box had an opal glass window of the approximate form of a 10-inch television screen at one end. The window could be illuminated from behind so as to present for view a simulated television screen of uniform adjustable brightness. Through the use of a sector disk, the brightness of the window could be varied cyclically in a simple way, and the frequency of these cycles could be adjusted to any desired value. 100-per cent modulation was used in this test.

Eight observers were used for this part of the test. They were seated before the box at such distances that the angular subtense of the window for the several observers ranged from about 4° to 6° .

Prior to the test, the observers were asked to set up for themselves a flicker tolerance scale in five steps as follows:

- None*: no noticeable flicker.
- Noticeable*: flicker present but small enough not to be bothersome.
- Appreciable*: an obtrusive amount of flicker, although tolerable, even for prolonged viewing.
- Objectionable*: an amount of flicker which would be intolerable for prolonged viewing.
- Painful*: an amount of flicker which is immediately intolerable.

The flicker box was adjusted to one of three levels of average brightness, 5, 10, or 20 foot-lamberts. The flicker box was set at random at some value of flicker frequency. The observers viewed the box for 10 seconds and were asked to assign a step value on the flicker tolerance scale to this setting. The box was then turned off while judgments were recorded and the flicker box set for another flicker frequency. This procedure was repeated until the gamut of frequencies had been run and then the entire procedure was repeated for the other two brightness levels. The room in which the measurements were made was dark throughout.

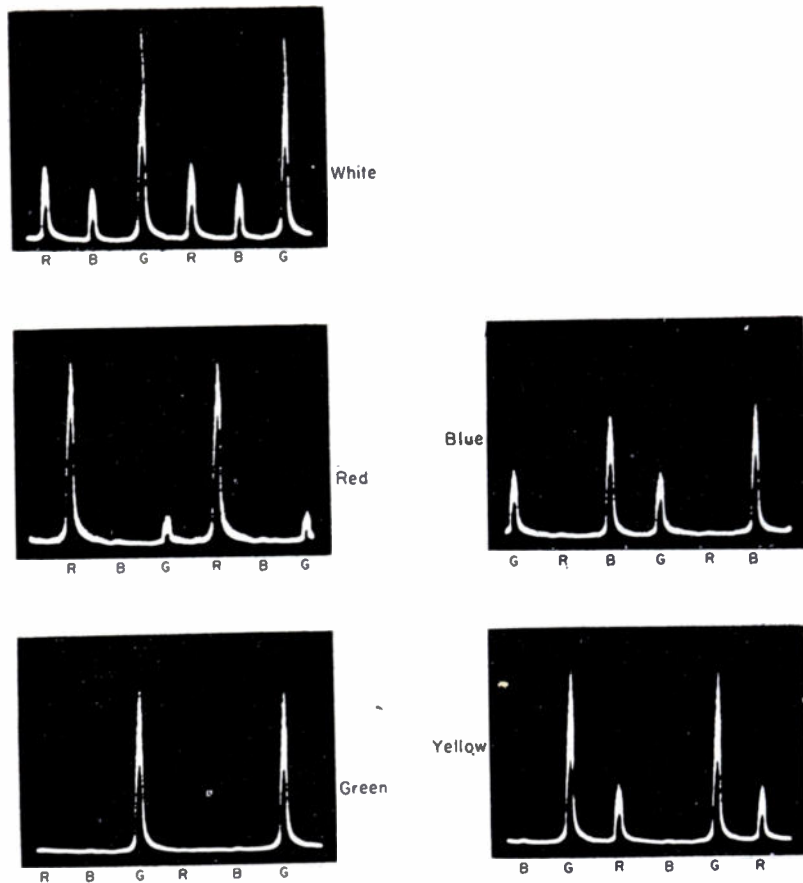

Fig. 5—Color television test for brightness versus time curves (CBS test pattern colors). Each record represents a sequence of six fields making a complete frame. The letters R, B, and G indicate red, blue, and green sequential fields. The field of view in these measurements was restricted to a square area with sides of length approximately $\frac{1}{7}$ of screen width.

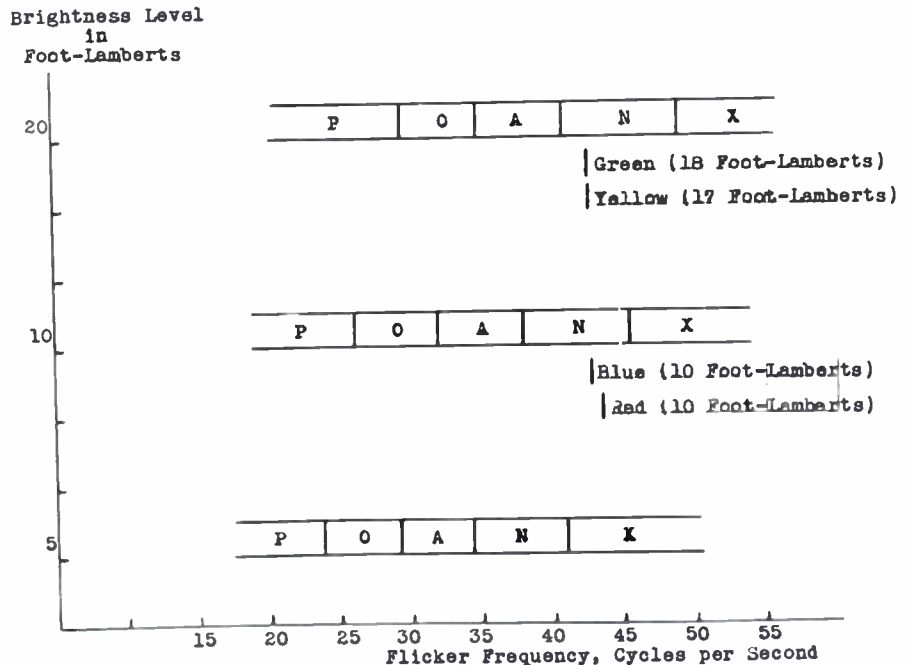

Fig. 6—Color-television test—flicker tolerance scale. Equivalent flicker frequencies for the four CBS test pattern colors are indicated. These are averages for eight observers, seven of whom are also represented in the tolerance scale data.

Tolerance Scale Symbols
 P = Painful
 O = Objectionable
 A = Appreciable
 N = Noticeable
 X = No flicker observed.

The results of this test are given in Figs. 6, 7, and 8. Fig. 6 gives the average tolerance scales for all eight observers at the three brightness levels. Figs. 7 and 8 give the results of the measurements at 10 and 20 foot-lambert brightness levels for seven individual observers. (These seven were used also in the second part of the test in which the equivalent flicker of the color television set was located on the scale.)

B. CBS Flicker Tolerance

The test to determine the tolerance scale value of the flicker of the CBS color television system was carried out on January 31, 1950, at the Walker Building, where CBS had set up several SKF receivers for a public demonstration. The flicker box was set up alongside an SKF receiver and the observers were seated in approximately the same relative positions they held for the flicker tolerance scale test. Eight observers were used in this test, seven of whom participated in the tolerance scale test also.

The room was darkened during this test.

Tests were made on the four CBS test pattern colors: red, green, blue, yellow. The transmission was set to fill the entire receiver screen with one selected color from the test pattern. The brightness level for each color was adjusted so as to obtain approximately the relative viewing conditions prevailing in "good" reception. The brightness values used were:

- red 10 foot-lamberts
- blue 10 foot-lamberts
- green 18 foot-lamberts
- yellow 17 foot-lamberts.

After the brightness of the television screen had been adjusted, the brightness of the flicker box was adjusted to the same level with the flicker rate set above the critical frequency. The flicker box was not color-matched to the television screen. With the SKF receiver left undisturbed, the flicker frequency of the flicker box was set successively and at random at various values. At

each setting, left on for about 5 seconds the observers were asked to judge which flickered more, the flicker box or the television set. After the 5-second comparison period, the flicker box was turned off and the judgments recorded. This procedure was repeated for all four colors.

The value of flicker-box flicker frequency at which the observer's judgments reversed was considered to be the "equivalent flicker frequency" of the color television set for that color at the set brightness level. The equivalent flicker frequencies for the four colors are shown in Fig. 6 underneath the flicker tolerance scale for the nearest brightness level. The results for seven individual observers are shown in Figs. 7 and 8.

V. DISCUSSION

It may be seen in Fig. 6 that the flicker of the CBS television set was classed as "noticeable" according to the flicker tolerance scale set up. At the higher brightness, the flicker was near the "appreciable" end of the "noticeable" region. At the lower brightness, the flicker was near the critical frequency. The judgments as to the tolerance of flicker seem to be more affected by the brightness level than by the particular color viewed.

The conditions of this test were relatively severe. The use of a field of uniform color completely devoid of subject interest or variety and the direction of the attention of the observers to the specific subject of flicker undoubtedly gave what flicker there was more prominence than it would have for the ordinary television program viewer. It is therefore evident that the amount of flicker inherently present in the CBS color television system, while noticeable, is unobjectionable.

The assistance of Dr. D. B. Judd and Mr. C. A. Douglas of the National Bureau of Standards in these tests is gratefully acknowledged.

ANNEX E

REPORT ON THE FIDELITY OF COLOR REPRODUCTION BY THE CBS AND RCA SYSTEMS, DEANE B. JUDD, L. PLAZA, AND M. M. BALCOM, NATIONAL BUREAU OF STANDARDS

I. INTRODUCTION

The question has been raised as to how faithfully can present-day systems of television in color reproduce the colors of the actual scene. How does this color reproduction compare with that in the graphic arts and in color photography-systems that already have consumer acceptance? This report compares the color fidelity achieved by the CBS and RCA systems in January and February of 1950 with that of color photography by the Kodachrome process.

An unfaithful reproduction of color can result in television from various types of failure:

- A. Failure to equip the camera with filters giving it the proper spectral sensitivity to control the receiver primaries.
- B. Improper adjustment of the camera resulting in its failure to initiate the proper signals to control the receiver primaries.
- C. Improper adjustment of the transmitter resulting in failure to broadcast the proper signals.

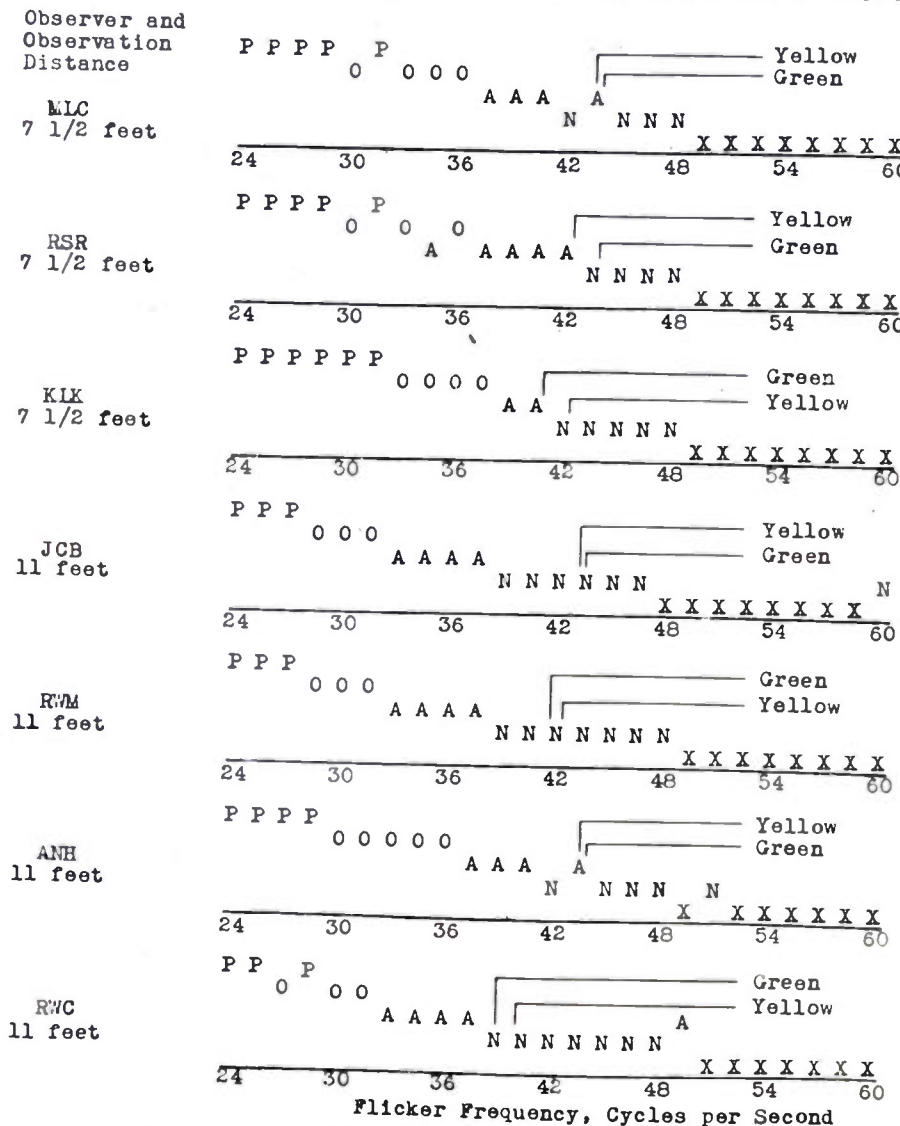

Fig. 7—Color-television test—flicker tolerance scale data (brightness level, 20 foot-lamberts). Equivalent flicker frequencies for two CBS test pattern colors are indicated. Brightness levels for green and yellow were 18 and 17 foot-lamberts, respectively.

Tolerance Scale Symbols
 P = Painful
 A = Appreciable
 O = Objectionable
 N = Noticeable
 X = No flicker observed.

D. Failure of the proper signals to arrive at the receiver due to various forms of interference to propagation of radio waves, superposition of extraneous signals, and so forth.

E. Improper adjustment of the receiver. Perfect reproduction of the colors of the scene is theoretically possible provided those colors lie within the gamut of colors producible by additive combination of the receiver primaries. An unfaithful reproduction of color from the above causes is said to come from poor color control or poor color balance. This report indicates the degree of color balance achieved by certain transmitter-receiver combinations operating in January and February of 1950 on the CBS and RCA systems. It does not indicate the ultimate color fidelity possible with those transmitter-receiver combinations, nor that theoretically possible by means of the CBS and RCA systems of color television in color, nor does it seek to point out the particular link of the system responsible for specific instances of unfaithful color reproduction. It is not a measure of the bad effects of misregistration of images, color fringing, or color breakup. It is simply a record of the color fidelity achieved at certain times by the CBS and RCA systems of color television.

II. METHOD

The method was to measure the colors of two test charts, each having four colors plus white; then to measure the rendition of these colors on the tube of the television receiver; then to compare the relationship of these eight rendered colors to the rendered white with the relationship between the eight actual colors to the actual white.

A. Test Charts

Each chart (18 by 24 inches) consisted of four colors covering the quadrants of a rectangle except for a central rectangle covered with white. Table II shows the Munsell notations of the nine colors, first estimated by visual comparison with the color scales in the literature,³ and second found by means of the colorimeter used to measure the colors produced by the television receivers.

B. Colorimeter

A special colorimeter for measuring the colors of self-luminous areas was assembled for this test. In this colorimeter one half of the field of the Martens photometer was filled with light from the test area; the other half was filled with light from an incandescent lamp (standard illuminant A) filtered through a combination of Lovibond glasses (red, yellow, blue) adjustable in number of Lovibond units.³ A double-cell liquid filter⁴ converting illuminant A to illuminant C (representative of average daylight) could also be inserted. For each combination of filters and setting of the Martens

photometer the luminance Y and chromaticity co-ordinates x and y are known by means of calibration graphs.

For each chart under illuminant C and for each rendition of each chart on the screen of the television receiver, measurements were made of the luminance Y and chromaticity co-ordinates⁵ x and y of the white area, and of the four test colors.

C. Reduction of Data

From the measured values of Y, x, and y, for each area, the tristimulus values X, Y, Z were computed by the formulas

$$\begin{aligned} X &= x(Y/y) \\ Y &= Y \\ Z &= z(Y/y) \end{aligned} \quad (1)$$

⁵ D. B. Judd, "The 1931 ICI standard observer and coordinate system for colorimetry," *Jour. Opt. Soc. Amer.*, vol. 23, p. 359; October, 1933.

TABLE II
MUNSELL BOOK NOTATIONS OF THE TEST COLORS (ILLUMINANT: ICI STANDARD C REPRESENTATIVE OF AVERAGE DAYLIGHT)

| Color | Munsell Book Notation | | | |
|---------|--|---------|-------------------------|---------|
| | Visual Comparison to Munsell Book of Color | | Measured by Colorimeter | |
| Red | 5R | 5.3/10 | 6R | 5.4/8.8 |
| Yellow | 5Y | 9.0/9.0 | 6Y | 9.0/9.3 |
| Purple | 6P | 4.2/9.5 | 5P | 4.3/9.4 |
| Green | 4G | 7.0/6.5 | 4G | 7.2/8.3 |
| Flesh | 6YR | 8.2/6.0 | 7YR | 8.0/5.2 |
| Blue | 10B | 5.3/8.0 | 1PB | 5.5/7.6 |
| Neutral | N | 6.7/ | 8G | 6.8/0.4 |
| Foliage | | | | |
| Green | 5GY | 5.4/4.5 | 6GY | 5.8/4.6 |

Observer and Observation Distance

MLC
7 1/2 feet

RSR
7 1/2 feet

KIK
7 1/2 feet

JCB
11 feet

RWM
11 feet

ANH
11 feet

RWC
11 feet

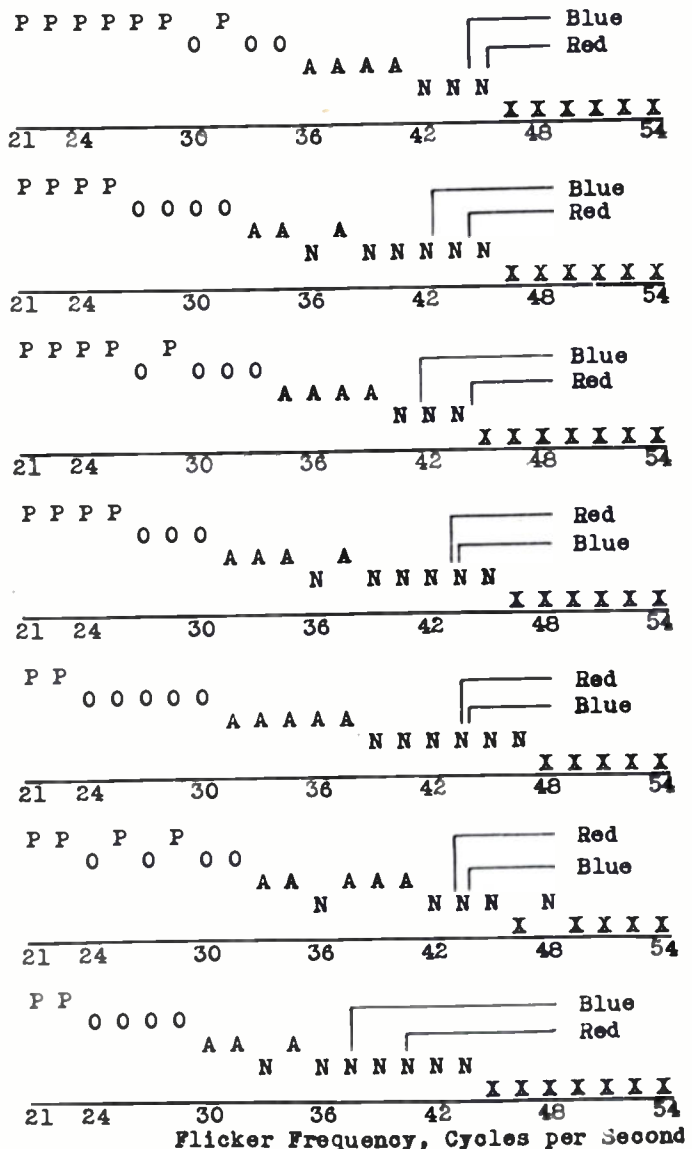

Fig. 8—Color-television test—flicker tolerance scale data (brightness level, 10 foot-lamberts). Equivalent flicker frequencies for two CBS test pattern colors are indicated. Brightness level for both was 10 foot-lamberts.

Tolerance Scale Symbols

P = Painful
A = Appreciable

O = Objectionable
N = Noticeable

X = No flicker observed.

³ "Munsell Book of Color," Hoffman Bros., Baltimore, Md., 1929 and 1942. Available also through the Munsell Color Company, 10 East Franklin St., Baltimore, Md.
⁴ K. S. Gibson and F. K. Harris, "The Lovibond color system," BS Sci. Paper No. 547, 1927.
⁵ R. Davis and K. S. Gibson, "Filters for the reproduction of sunlight and daylight and the determination of color temperature," Misc. Pub. BS. No. 114, 1931.

These tristimulus values X , Y , Z were then adjusted by constant factors so that the white area had the values $X'=0.847$, $Y'=0.864$, $Z'=1.020$, characteristic of a nonselective white surface of luminous reflectance, 0.864 illuminated by standard source C thus:

$$\begin{aligned} X' &= k_1 X \\ Y' &= k_2 Y \\ Z' &= k_3 Z \end{aligned} \quad (2)$$

where k_1 , k_2 , and k_3 are the factors constant for each rendition of each chart.

From the tristimulus values, X' , Y' , Z' , the adjusted chromaticity co-ordinates x' and y' were computed

$$\begin{aligned} x' &= X'/(X' + Y' + Z') \\ y' &= Y'/(X' + Y' + Z') \end{aligned} \quad (3)$$

From the values of Y' , x' and y' , the Munsell rennotations of the colors were read by interpolation on the graphs in literature.⁶

In Munsell terms, the first symbol (such as 6R) indicates the Munsell hue, the second symbol (such as 5.0/) the Munsell value, and the third symbol (such as /10) the Munsell chroma, the whole notation being written 5R 5.0/10 (see Table II). The Munsell system is useful for assessing the importance of the difference found between the actual colors and the rendition of the colors because of two properties—first, the Munsell scales have steps that are visually uniform; second, for usual observing conditions Munsell chroma correlates with the perceived departure of the color from gray; Munsell value correlates with the perceived lightness or darkness of the color; and Munsell hue correlates with the perceived hue. It has been found that the unfaithful reproduction of hue is more objectionable to the public than much more easily perceptible discrepancies either in lightness or in saturation (departure from gray).

The final step, therefore, is to find by subtraction the difference in Munsell hue between actual chart color and the rendered color, and the corresponding difference in Munsell value.

III. TESTS MADE

At the request of the Senate Advisory Committee on Color Television the following tests were made:

CBS System

Three tests were made on an RCA receiver, 7-inch tube with color converter and lens, called the "Dual Receiver" at this Bureau, brightness and contrast controls adjusted by us to give as close a duplication of the test chart as possible. Test charts were illuminated by 4,500° white fluorescent lamps in the studios of WTOP in the Warner Building.

Two tests were on a Smith, Kline, and French medical receiver built by Zenith and located in the Walker Building, Washington, D. C. The receiver (called "Zenith" receiver) was adjusted by CBS engineers to give what they considered to be the best possible picture. The first test was made with the transmitter adjusted to make the receiver rendition of the white area of the test chart color-match light from a daylight fluorescent lamp.

⁶ S. M. Newhall, D. Nickerson, and D. B. Judd. "Final report of the O.S.A. subcommittee on the spacing of the Munsell colors." *Jour. Opt. Soc. Amer.*, vol. 33, p. 385; July, 1943.

TABLE III
DISCREPANCIES IN MUNSELL VALUE, CHROMA, AND HUE BETWEEN TEST COLOR AND RENDITION OF IT, ALSO NUMERICAL EVALUATION OF OVERALL COLOR FIDELITY

| System | Date 1950 | Receiver | Transmitter Operation | Receiver Adjustment | Average Discrepancy Between Test Color and Rendition of It | | | Color Fidelity F |
|-------------|-----------|----------|-------------------------|--------------------------------------|--|------------|-------------------|--------------------|
| | | | | | ΔV | ΔC | $\bar{C}\Delta H$ | |
| CBS | 1/18 | Dual | Normal | By NBS to give best match for charts | 1.15 | 2.44 | 17.6 | 72 |
| | | Dual | Normal | | 0.90 | 1.59 | 24.5 | 72 |
| | 1/25 | Dual | Normal | By CBS to give normal operation | 0.59 | 2.56 | 25.2 | 71 |
| | | Zenith | Normal | | 1.36 | 2.31 | 18.9 | 71 |
| | 1/26 | Zenith | White to match daylight | | 1.50 | 2.94 | 31.9 | 59 |
| RCA | 2/24 | Cabinet | Normal | By RCA to give best match for charts | 0.64 | 1.72 | 41.2 | 63 |
| | | 3/2 | "High level" | | Normal | 0.97 | 3.64 | 34.1 |
| Koda-chrome | 2/6 | | | Exposure Under | 2.26 | 2.32 | 20.5 | 64 |
| | | | | Correct | 2.14 | 2.31 | 14.1 | 69 |
| | | | | Over | 2.25 | 2.32 | 18.6 | 65 |

RCA System

One test was made on a large cabinet, three-tube receiver, and one test on a smaller so-called "high-level" three-tube receiver such as used at the Laurel demonstration before the Federal Communications Commission; both tests were made at this Bureau. In both tests the receivers and the transmitter were adjusted for the best possible rendition of the test charts by RCA engineers. The test charts were illuminated by incandescent-lamp light in the studios of WNBW in the Wardman Park Hotel.

Color Photography by the Kodachrome System

Photographs on stock 8- by 10-inch Kodachrome film were made of the two test charts at this Bureau by the Photographic Technology Section on February 6, 1950. The charts were illuminated by light from 4,500° white fluorescent lamps. One pair of pictures was underexposed, one was exposed for the time interval suited to the illumination, and one was overexposed. The film was sent to Eastman Kodak Company for processing and, on being returned, was illuminated as a transparency by standard illuminant C and the colors measured in the same way as those produced by the television receivers.

IV. RESULTS

Table III shows the dates of the various tests, identifies the system of color television and the receiver tested, indicates the adjustment of the transmitter and the receiver, and gives the average discrepancy between test color and the rendition of it in terms of Munsell value, Munsell chroma, and Munsell hue. The average deviations in Munsell hue between test color and rendition have been multiplied by the chroma of the color (average of test chart and rendition), the perceptibility, and hence importance, of hue differences being proportional to chroma of the colors being compared.

V. DISCUSSION

It will be noted from Table III that the

CBS and RCA systems of television in color in these instances gave consistently more faithful reproduction (smaller discrepancies, ΔV) in Munsell value of the test colors than the Kodachrome system of color photography. The reverse is true for reproduction of hue, and there is little to choose between the systems in regard to reproduction of Munsell chroma of test colors.

If an over-all evaluation of color fidelity taking into account all three kinds of color departure (Munsell hue, value, and chroma) is to be given, some estimate of the relative importance of the Munsell hue step, the Munsell value step, and the Munsell chroma step must be made. We believe that in color rendition one Munsell value step is about as important as two Munsell chroma steps or one Munsell hue step at chroma /10. We propose tentatively, therefore, the following index of color fidelity F :

$$F = 100[1 - (\bar{C}\Delta H/5 + 2\Delta V + \Delta C)/30]. \quad (4)$$

The last column of Table III gives values of color fidelity F computed from the averages of $\bar{C}\Delta H$, ΔV , and ΔC , from this formula. It will be noted that the color fidelity achieved by the CBS system in these tests is about the same as that achieved by the Kodachrome system of color photography, and that by the RCA system is not importantly worse.

VI. CONCLUSIONS

A. In January, 1950, the CBS system of television in color was found to yield as faithful reproductions in color as is common by Kodachrome photographs. It was at that time sufficiently developed to give trouble-free operation at this level of color fidelity.

B. In February, 1950, the RCA system of television in color was found to yield substantially as faithful reproductions in color as is common by Kodachrome photographs. It was not shown at that time to be sufficiently developed to yield these results without constant expert attention to the receiver.

Mixed Highs in Color Television*

A. V. BEDFORD†, FELLOW, IRE

Summary—A high-quality color television system could be made by transmitting independent red, green, and blue images of equally high quality. The bandwidth required by this method would be three times as great as that required for a black-and-white picture of equal resolution and repetition rate, regardless of whether the images are transmitted in sequence or simultaneously.

Tests made on the human eye, and reported herein, indicate that the acuity for detail residing in color differences is less than half as great as the acuity for detail residing in brightness. Therefore, if the brightness values in a color television system are transmitted with fidelity up to 4 Mc, it is adequate to transmit the individual color values up to only 2 Mc, with a corresponding saving in bandwidth. In the "mixed-highs" system described, each of the three color images uses frequencies from zero up to 2 Mc and the "mixed highs," which carry only the brightness values of the fine detail, use a video frequency band from 2 to 4 Mc. The total width of the video bands then is only 8 Mc instead of 12 which would be required for three identical bands from zero up to 4 Mc.

The bandwidth saved by the mixed-highs technique is obtained not at the expense of picture quality, but is a legitimate saving that arises by avoiding the transmission of information which the eye is unable to use. In this sense the saving could be compared to that which occurs by transmitting only the visible spectrum of colors, omitting the ultraviolet which the eye cannot see.

The brightness acuity eye tests were made with projected charts without the use of television apparatus. A new-type test pattern was used having a calibrated blurred junction which corresponds to the light values resulting from the transient response of a video amplifier with restricted bandwidth in passing from a dark area to a light area. The measurement of acuity for detail in color was made with similar blurred junctions between areas of different colors.

Though the work reported was done a number of years ago and was applied to the simultaneous system demonstrated by RCA Laboratories in 1946, the principles and techniques are equally applicable to the new RCA color system demonstrated in 1949. In the latter system the mixed highs and the dot interlace jointly provide a three-to-one bandwidth reduction that allows a high-definition compatible color television service to be operated within the 6-Mc radio-frequency channels now allocated for black-and-white television.

I. BASIC THEORY AND METHOD OF MIXED HIGHS

A PROPER additive mixture of three suitably chosen primary colored lights (such as red, green, and blue lights) will produce practically all the colors commonly encountered. Therefore, a high-fidelity color television system requires the transmission of only three separate color images which are superimposed at the receiver. Originally, it was assumed that the three images would be transmitted at equal repetition rates and with equal resolution. Then the total bandwidth requirement would be three times as great as for a black-and-white picture of equal resolution and repetition rate, regardless of whether the three images are transmitted simultaneously or sequentially.

In 1940 Alfred N. Goldsmith¹ proposed that in the simultaneous system the bandwidth of the blue image could be made considerably less than that for the green and the red images without appreciably impairing the picture received. Since the human eye has less acuity for blue light than for red or for green, the nearest satisfactory viewing distance would be determined primarily by the resolution of the red and the green image components and the acuity of the eye for these colors; hence, if the blue image had resolution equal to the green or red, the eye would not appreciate the full value of this resolution and a portion of the bandwidth required to produce the blue image would be wasted. Thus, it is seen that a deficiency of the eye can be used to save bandwidth. It is noteworthy that the field-sequential and the line-sequential systems cannot readily take advantage of this saving because the same radio band is used in turn for the red, green and blue images.)

In the literature² there is a reference to "the well-known fact, first demonstrated by Aubert in 1865, that objects of small size or low intensity always appear colorless." This amounts to saying that the human eye is color-blind for small objects. The present author has indirectly confirmed Aubert's statement by tests reported herein, which show that the eye has less acuity for detail of a certain type residing in differences in color than for detail residing in differences in brightness. Then, to satisfy the eye observing a color television picture at a particular distance, it would not be necessary to transmit information regarding the color of certain tiny areas even though these areas are large enough to be distinguished by differences in brightness and therefore should be correctly reproduced in regard to brightness.

Accordingly, it is not necessary in scanning from area to area of the picture to be able to change from one color to another as quickly as it is necessary to change from one brightness to another. In the case of a television system transmitting three complete separate color images by identical means, the color in the received picture can change as abruptly along the scanning line as can the brightness. This system then is wasteful of bandwidth in that it transmits information which the eye is normally unable to use.

In the "mixed-highs" simultaneous system proposed by the author several years ago, this waste is avoided by transmitting the low-frequency components of the three color images separately and a fourth signal produced by mixing or adding the high-frequency com-

* Decimal classification: R583.1. Original manuscript received by the Institute, July 7, 1950.

† RCA Laboratories, Princeton, N. J.

¹ Alfred N. Goldsmith, U. S. Patent No. 2,335,180; November 23, 1943.

² Ragnar Granit, "Sensory Mechanisms of the Retina," Oxford University Press, London, England, p. 321; 1947.

ponents of the green and the red signals to form a single mixed high-frequency signal for transmission. At the receiver the mixed-highs component is added to the green or to the green and the red low-frequency signals for application to the respective color picture reproducers.

One version of the system is shown in Fig. 1. In Fig. 1(a) is shown the transmitter apparatus which receives the three separate simultaneous green, red, and blue signals, indicated as G , R , and B , from the camera, not shown. These signals are of full video bandwidth extending from 60 cycles or lower up to 4 Mc as shown in

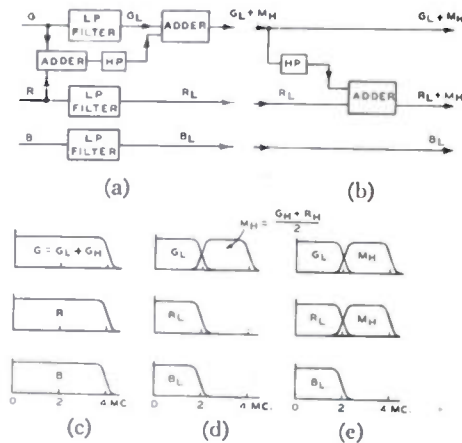

Fig. 1—Color television system with mixed highs. (a) Transmitter. (b) Receiver. (c) Pickup signals. (d) Transmitted signals. (e) Reproduced signals.

Fig. 1(c). The low-pass filters LP at the transmitter pass only the lower 2 Mc of each of these signals. The low frequency components are indicated as G_L , R_L , and B_L respectively, in the figure. The green and the red original signals are added in the adder and a mixture of higher-frequency components of both signals together are passed by the high-pass filter HP , no use being made of the blue highs. The mixed high-frequency components M_H so obtained are added to the low-frequency green components G_L to form the combined signal $G_L + M_H$ which is transmitted as a single signal. It is important that this combined signal may be used directly to operate a black-and-white receiver.

The low-frequency components of the red and the blue images, R_L and B_L , respectively, are separately transmitted as shown in Fig. 1(d). The color receiver as shown in Fig. 1(b) applies the green low frequencies and the mixed highs $G_L + M_H$ to the green kinescope directly. The signal for the red kinescope similarly is the red low-frequency signal and the mixed highs which are obtained by a suitable high-pass filter and adder as shown.³

³ This system was publicly demonstrated in October, 1946, and was described in testimony before the Federal Communications Commission presented in behalf of Radio Corporation of America in December, 1946 (Docket No. 7896), and in September, 1948 (Docket No. 8976).

The three diagrams in Fig. 1(e) show the signals applied respectively to the three kinescopes. The mixed-highs part of the signal applied to the green and the red kinescopes are the same as the high-frequency components which would be produced by a panchromatic camera for picking up a conventional black-and-white signal except that the unimportant blue highs are absent. If such a panchromatic camera had suitable sensitivity for the various colors, the signal would contain information for reproducing correctly all useful brightness values of the original subject in detail corresponding to 4 Mc. Therefore, so far as brightness only is concerned, the color picture would have full 4-Mc resolution. However, since both the green and the red kinescopes receive the same signal above 2 Mc, it is evident that the resolution in terms of different colors (which can be called "color resolution" as compared to "brightness resolution") extends only up to 2 Mc. It thus appears that the system described would accomplish the objective of saving bandwidth by avoiding the transmission of information which the eye cannot use.

The special measurements of the eye which will be reported below showed that the acuity for blue light alone is considerably less than the acuity for changes from red to green. Therefore, no advantage would be obtained in modifying the arrangement of Fig. 1 to use the blue highs as a component of the mixed highs. Neither would there be any advantage in applying the mixed-highs signal to the kinescope which reproduces the blue image.

Later it will be found that the circuit of Fig. 1 should be modified because of the cutoff characteristics of the kinescope. In the meantime, the tests of the eye will be presented.

II. MEASUREMENTS OF ACUITY FOR DIFFERENT SINGLE COLORS ON BLACK

In a television system the scanning spot sweeps over the picture at a very high speed. When it passes abruptly from a dark area to a light area the signal generated is a steep step wave. If the scanning spot is small enough that it does not appreciably limit the picture detail, the generated wave may be considered to be a Heaviside unit function for all practical purposes. If the video channel is uniform in amplitude and phase response up to the cutoff frequency, the time of rise of the transmitted step wave will be inversely proportional to the bandwidth of the video channel. A narrow bandwidth which causes a relatively long time of rise manifests itself in the reproduced picture as a gradual transition in brightness or color in going in a horizontal direction along the picture screen from one brightness or color to another. The junction between the two areas would be "blurred" instead of sharp and the picture would be said to have low resolution.

In the proposed mixed-highs system, the junctions between areas of different colors would be reproduced with wider blurs than would the junctions between areas of different brightnesses of the same color. The eyes have less acuity for differences in color than for differences in brightness. Then, when the minimum viewing distance for the picture is determined as that at which the blurs of the brightness transitions are not visible, the wider blurs of the color transitions also would be invisible.

In order to determine the frequency above which the highs can be mixed without degrading the picture, it is necessary to measure the relative acuity of the eye for detail residing in differences of color and for detail residing in differences of brightness. For this purpose, the author devised a special test pattern in which the observer attempts to detect a calibrated blurred transition when compared directly with other adjacent transitions which are extremely sharp. The basic test pattern as drawn is shown in Fig. 2. Films for both positive and negative lantern slides were made of this pattern. These

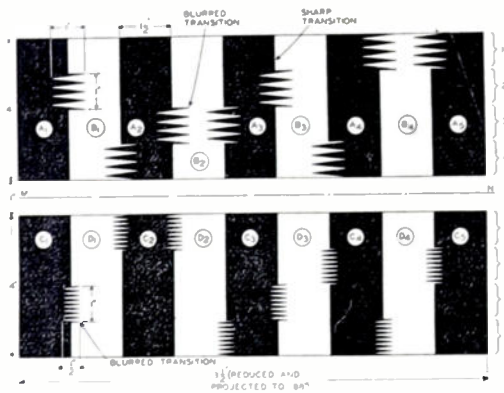

Fig. 2—Test pattern without surround, before reduction.

films were then cut in two along the horizontal line *MN* and reassembled into three slides as follows:

Slide No. 1—Positive of upper part; positive of lower part.

Slide No. 2—Negative of upper part; positive of lower part.

Slide No. 3—Opaque mask on upper part; positive of lower part.

Three 300-watt Society-for-Visual-Education slide projectors *R*, *B*, and *G* and half-silvered mirrors were arranged to project the three slides in registration upon a translucent screen 1.88 inches wide, as shown in Fig. 3. This translucent screen was surrounded by a large opaque apertured screen illuminated by white light from a fourth projector *W* having a transparent slide with a small opaque rectangle in its center for keeping light off the translucent screen. An observer positioned before the screen as shown in the figure saw a small reproduction of the basic test pattern surrounded by a large, uniformly illuminated screen as shown in Fig. 4. The three

projectors were provided with red, blue, and green Wratten color filters, Nos. 26, 48, and 57, respectively. Each projector was also provided with a coarse iris and a small-range voltage control for the lamp in order to obtain a wide range of brightness control without making a great change in lamp temperature which would seriously affect the color.

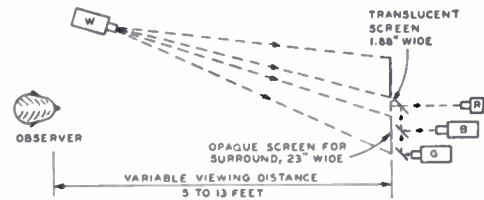

Fig. 3—Plan of eye-test apparatus.

When measuring acuity for white light, the three colored projectors simultaneously illuminated the D_1 to D_6 areas in the lower part of the test pattern as shown in Fig. 2. The individual brightnesses were chosen such as to make these areas white while the areas C_1 to C_6 were left black.⁴ The particular quality of the white light was arbitrarily made the same as that provided by the 300-watt "white" surround projector operating at 115 volts. The brightness of the white portion of the test pattern was adjusted to 20 foot-lamberts as measured by a Macbeth illuminometer. This value of brightness was arbitrarily given the relative value of 100 per cent. The brightness of the white surround was adjusted to 10 foot-lamberts upon the assumption that the mean brightness of a television picture might average about half of the peak brightness.

Three quarters of the border between areas C_1 and D_1 is sharp, but one quarter of the border consists of a jagged saw-tooth outline. When viewed at the distance used in the tests, the individual jags are not resolved.

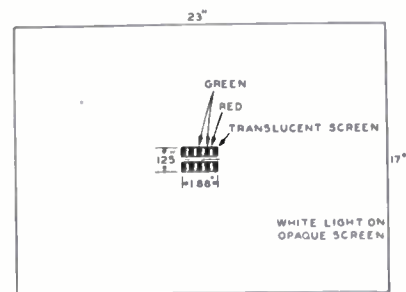

Fig. 4—Projected test pattern as observed with white surround.

Instead the eye attributes the light from the white areas of the "jags" equally to these white areas and to the adjacent intermeshed black areas. Therefore, since the

⁴ A single white projector could have been used to produce this black-white pattern. It had been planned originally to have the observer read the upper colored patterns during the same sitting at which he read the lower black-white pattern.

jags consist of straight lines the transition in a horizontal direction from the black area C_1 to the white area D_1 is effectively a linear transition, which will appear as a blur between the larger areas when seen beyond a critical distance. The width of the blur is shown as $\frac{1}{2}$ inch in Fig. 2 but it becomes 0.07 inch (0.0058 foot) when projected as in Fig. 4.

In conducting the test, the observer was allowed to sit at a distance of 15 feet in front of the illuminated screen with the room semidark for five minutes, in order to become adapted to the conditions. Then he was asked to say whether the blurred transition was in the first, second, third, or fourth position for each of the eight borders between C_1 and D_1 , between C_2 and D_2 , and so forth. Then he was seated nearer the screen and again asked to locate the blurred transitions. As an example of the results obtained, observer M30 gave two correct answers at 15 feet, three correct at 14 feet and seven correct at 13 feet. At shorter distances he was able to locate all eight blurred transitions with certainty. In interpreting the data, it was desired to determine and use the distance at which the true recognition is 50 per cent. Since the observer knows that each blur can occupy only one of the four possible positions, he would statistically get two out of the eight answers correct without seeing at all. This leaves only six more correct answers that could be made with perfect vision. Thus, if

his true recognition is 50 per cent of perfect he would get half of these six additional correct answers, making a total of five correct answers.

From the above readings taken on observer M30, it was estimated by rough interpolation that he would have required a viewing distance of about $13\frac{1}{2}$ feet to get the prescribed five correct answers. The white-black acuity of this observer was then calculated to be 2,330 reciprocal radians by dividing the viewing distance ($13\frac{1}{2}$ feet) by the width of blur (0.0058 feet). This value is recorded in line 1, column M30, of Table I. The values of white-black acuity obtained for three other observers, J31, D22 and D43 is recorded in other columns. The average for all four observers was 2,130 reciprocal radians. The numerical relation between the acuity obtained by this method and that obtained by resolving fine lines and other conventional methods, has not been determined. In fact, the present method may measure a somewhat different property of the eye since the linear blur used in the test produces the effect of a television system with a gradual frequency cutoff instead of a sharp cutoff such as that measured by the converging fine-line test pattern. Therefore, the values have not been given in minutes of arc, which might be improperly compared with conventional eye-acuity data. The use of absolute units is not necessary in this study since only relative values are used.

TABLE I
SUMMARY OF ACUITY TESTS

| Observer and His Age | | M30 | J31 | D22 | B43 | Averages of Four Observers | Average Ratio of Viewing Distance to Surround Height |
|--|---------------------------|-------|-------|-------|-------|----------------------------|--|
| Acuity in reciprocal radians. | | | | | | | |
| 1. | White-black | 2,330 | 1,900 | 2,240 | 2,070 | 2,130 | 8.3 |
| 2. | Green-black | 1,980 | 1,980 | 1,980 | 2,070 | 2,000 | 8.2 |
| 3. | Red-black | 2,330 | 1,730 | 1,900 | 1,730 | 1,920 | 7.8 |
| 4. | Blue-black | 390 | 650 | 470 | 730 | 560 | 4.6 |
| Acuity in reciprocal radians, with weaker light adjusted for minimum acuity. | | | | | | | |
| 5. | Green-red | 990 | 860 | 780 | 780 | 852 | 6.9 |
| 6. | Green-blue | 390 | 390 | 390 | 430 | 400 | 3.3 |
| 7. | Red-blue | 390 | 560 | 475 | 517 | 485 | 4.0 |
| Per cent brightness of weaker light in three above tests. | | | | | | | |
| 8. | G-R (red = 100 per cent) | 46 | 44 | 57 | 48 | 49 | |
| 9. | G-B (blue = 100 per cent) | 2.5 | 2.6 | 3.4 | 4.8 | 3.3 | |
| 10. | R-B (blue = 100 per cent) | 4.2 | 4.9 | 6.3 | 12.0 | 6.8 | |
| Acuity in per cent of average white-black acuity. | | | | | | | |
| 11. | White-black | 109 | 89 | 105 | 97 | 100 | |
| 12. | Green-black | 93 | 93 | 93 | 97 | 94 | |
| 13. | Red-black | 109 | 81 | 89 | 81 | 90 | |
| 14. | Blue-black | 18 | 30 | 22 | 34 | 26 | |
| 15. | Green-red | 46 | 40 | 37 | 37 | 40 | |
| 16. | Green-blue | 18 | 18 | 18 | 20 | 19 | |
| 17. | Red-blue | 18 | 26 | 22 | 24 | 23 | |

Note—Brightness of white surround in all tests was 10 foot-lamberts. Brightness of brightest color in pattern in all tests equaled the brightness that component would have to make a white brightness of 20 foot-lamberts.

At another sitting the same observers were individually used to measure the green-black acuity. This was done by using only the green projector, with the same adjustment of brightness that that projector had when used as one of the three color sources in projecting a white image of 20 foot-lamberts brightness. This value was arbitrarily called 100-per cent green brightness. The brightness of the surround was left at 10 foot-lamberts of white light. The procedure of the test was the same as that used for the white-black tests above. The average value of green-black acuity was 2,000 reciprocal radians as recorded in line 2 of Table I.

Similar tests were then made to determine the red-black and the blue-black acuity of the same persons. The blue-black tests differed from the previous tests in that the coarser upper part of the pattern (sections A_N and B_N) was used in order to allow the viewing distances to be more nearly like that used in other tests. The results indicated that the red-black acuity is nearly equal to the green-black acuity and the white-black acuity, but that the blue-black acuity is only 26 per cent of the other three.

III. MEASUREMENTS OF ACUITY FOR DIFFERENT COLOR COMBINATIONS

The above tests were measurements of acuity for detail residing in differences in brightness only.

The next tests used the same observers to measure acuity for detail residing in differences in color with the relative brightness being adjusted to minimize the acuity. In making the green-red test, the upper or coarse portion of the pattern of Fig. 2 was used with the areas A_1 , A_2 , and so forth being projected in green light by a projector, using negative Slide No. 2 (mentioned earlier) and the green filter (Wratten No. 57) while the areas B_1 , B_2 and the like were projected in red light by a projector using positive Slide No. 1 and the red filter (Wratten No. 26). The projected green and red images were carefully focused and positioned for accurate registration, so that the red and green jags between each pair of A_N and B_N areas accurately intermeshed. The surround was kept at 10-foot-lamberts of white light.

The red projector was adjusted to make the red portion of the image measure the same (100 per cent) brightness which it had in the previous tests. This brightness was measured with the Macbeth illuminometer, using a small red (Wratten No. 26) filter in the instrument to avoid the necessity of the eye having to compare brightnesses of two very different colors. (Of course, a reading of the brightness of the screen produced by the red projector alone had already been taken and recorded in a similar manner in the white-black tests.)

The observer was asked to adjust the brightness of the green light so that the junctions between the green

and the red areas appeared least sharp to him. This was done at a great enough distance that he could not recognize the blurred transition and thereby remember their positions in the next step of the test. For all observers, the green brightness setting obtained was less than 100 per cent green brightness. As recorded in line 8 of Table I, the mean setting of the four observers was 49 per cent. (Preliminary observations had already shown that the green brightness settings would be less than 100 per cent; otherwise, the green would have been set at 100 per cent and the red brightness cut down for minimum acuity.)

Then, with the brightness of the red image at the value which provided the *least* acuity for himself, each observer was tested by having him locate the blurred transitions from a series of viewing positions which became closer and closer to the screen as in previous tests. The average value of green-red acuity for the four observers was 852 reciprocal radians as shown in line 5 of Table I. This is only 40 per cent of the average white-black acuity, as shown in line 15.

The green-blue acuity and the red-blue acuity for the same observers were measured in a similar manner. In each of these cases, the minimum acuity was obtained with a blue brightness of 100 per cent, and with the other brightness reduced to very low values which averaged 3.3 and 6.8 per cent, respectively.

Since each of the various acuity tests was made by varying the viewing distance, the ratio of viewing distance to the height of the surround varied with the value of the acuity obtained. In order to restrict the range of this variation, the upper part of the test pattern, which has wider blurred transitions, was used for those tests in which the acuity was very low. The resulting viewing-distance ratio still varied considerably as shown in the last column of Table I. However, other tests have shown that the acuity is not greatly affected by such changes in the surround as long as the angle subtended by the surround is fairly large.

Each of the four persons tested said he had normal color vision and acuity. The two subjects who usually wear glasses used them in the tests. All of the four subjects were men and their ages were 30, 31, 22, and 43 years, respectively, as indicated by their code names in Table I. These ages cover the range which may be considered most important in designing a broadcast television system, since persons above this age range will generally have poorer sight. Since the data taken on these four subjects show relatively good correlation, it is considered adequate to prove the soundness of the mixed-highs principle in color television.

IV. APPLICATION OF ACUITY DATA IN MIXED-HIGHS SIMULTANEOUS COLOR TELEVISION SYSTEM

The most relevant average values from Table I are repeated in Table II for easy inspection.

The greatest acuity for detail residing in color variations was measured for the green-red combination. Since the value of acuity for these colors is 40 per cent of that for brightness variations as shown by the white-black test, it appears that the three color picture signal components need to be kept separate up to 40 per cent of the top frequency. Above this crossover frequency, the highs of all three color images could ideally be combined without appreciable loss when the picture is viewed at a distance where the brightness detail is satisfactory. In fact since very high-chroma high-brightness red and green areas will occur adjacent to one another rather infrequently, a much lower crossover frequency would generally be acceptable.

TABLE II

| Color Combination | Relative Brightness Values Used in Tests | Acuity in Per Cent |
|-------------------|---|--------------------|
| White-black | White = 100 per cent | 100 |
| Green-black | Green = 100 per cent | 94 |
| Red-black | Red = 100 per cent | 90 |
| Blue-black | Blue = 100 per cent | 26 |
| Green-red | Red = 100 per cent; Green = 49 per cent | 40 |
| Green-blue | Blue = 100 per cent; Green = 3.3 per cent | 19 |
| Red-blue | Blue = 100 per cent; Red = 6.3 per cent | 23 |

Note—Brightness values are given in per cent of the brightness of the red, green, and blue colors which combine to produce white.

Since the blue-black acuity is only 26 per cent, which is considerably lower than the green-red acuity, the blue frequency band can be restricted accordingly and there appears to be no reason for including the blue picture highs with the green and red highs to form the "mixed" highs.

It is noted that in the green-red test, the minimum acuity of 40 per cent was obtained by adjusting the green brightness to 49 per cent of the brightness of the red. The green-black acuity was 94 per cent and the red-black acuity was 90 per cent. Thus it can be seen that if one starts with the red-black condition and then adds 49 per cent of green light to the black area adjacent to the red area, the discernible difference in the character of the two areas is minimized. That is to say, the eye becomes less able to determine the character of the junction between the two areas.

Each light pattern thus operates to obscure the outline of the other. The two brightnesses are then equal in their ability mutually to mask resolution. This will be called the masking brightness. Stated in this terminology, the green-red masking brightness of the red light is 49 per cent compared with 100-per cent green-red masking brightness of the green light when the light values have the proportions in which green, red, and blue light combine to produce white.

Now we note that the minimum green-blue resolution

was obtained with a blue brightness of 100 per cent and the green brightness reduced to 3.3 per cent. From this one can conclude that the green-blue masking brightness of blue light is only 3.3 per cent compared with 100 per cent for green. The minimum red-blue acuity was obtained with 100-per cent blue brightness and 6.3-per cent red brightness. If now the red-blue masking brightness of the red light is arbitrarily set at 49 per cent, the same as was obtained above for the green-red masking brightness of the red light, the red-blue masking brightness for the blue light would then, by proportionality, become

$$0.49 \times 6.3 = 3.1 \text{ per cent.}$$

This value is close enough to the green-blue masking brightness of blue light obtained above to indicate that the masking effect of a particular colored light is essentially the same value regardless of what other color light it is tested with. Accordingly, the three colors could be assigned the following relative values of masking brightness:

$$\begin{aligned} \text{Green} &= 100 \text{ per cent} \\ \text{Red} &= 49 \text{ per cent} \\ \text{Blue} &= 3.1 \text{ per cent.} \end{aligned}$$

These values are applicable in determining the proportions of the red and the green signals to be used in making the mixed-highs signal. Specifically, the red and the green signals should be added in the proportions of 49 and 100 per cent, respectively, and then those highs above 40 per cent of the top frequency should be selected by a band-pass filter.

The correctness of this application of the data can be tested by considering the response of an abrupt transition from a green area of 49-per cent brightness to a red area of 100-per cent brightness. The green signal would have a downward or negative step of 49 per cent, and the red signal would have an upward or positive step of 100 per cent. In the mixed-highs circuits, these steps are multiplied by the factors 1.0 and 0.49, respectively, making their amplitudes equal. Since these steps have opposite polarities, the net mixed-highs component for this subject would be zero. This is the desired value since the tests showed that for adjacent green and red areas of these relative brightnesses, the eye is least able to observe the abruptness of the junction and, hence, no response is needed above 40 per cent of the top frequency.

At the receiver the mixed highs could ideally be applied to either the green or the red kinescope, or to both in equal or in unequal ratios. However, a given amount of highs added to the red kinescope is only 49 per cent as effective as the same amount applied to the green kinescope. In order to make the reproduction correct in regard to the total amplitude of highs, the "net effective gain" of the mixed-highs channel, from the light in the scene to light in the reproduced color picture,

should be the same as the low-frequency gain in one of the color chains.⁵ "Net effective gain," in this case, would be expressed by the ratio:

$$\frac{(\text{green high-frequency light output}) + 0.49(\text{red high-frequency light output})}{(\text{green high-frequency light input}) + 0.49(\text{red high-frequency light input})}$$

It should be remembered that each light value is expressed in per cent of the light of that color which is contained in subjective white light.

V. EFFECT OF NONLINEARITY IN KINESCOPES

Fig. 5 shows the waves generated in a system with mixed green and red highs, sketched by inspection. It is assumed that the scene being scanned has 16 areas of

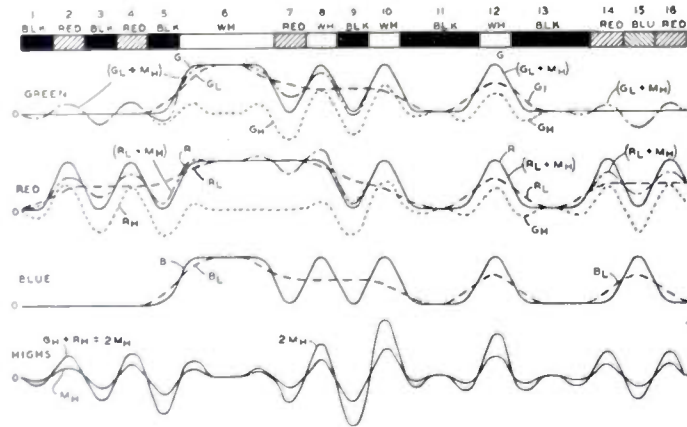

Fig. 5—Signal wave shapes in system using mixed green and red highs.

various colors as shown by the strip at the top of the figure. The wave marked G is the output of the green pickup device having response out to 4 Mc with ideal phase. The wave marked G_L is the same signal with its response limited to 2 Mc. The green highs wave G_H is the difference between G and the green lows G_L . Likewise the waves R , R_L , R_H , B , and B_L are the corresponding red and blue signals. No use is made of the blue highs. For the sake of simplicity, the different "masking" brightness of the green and red lights and their different treatments were ignored in these curves. Therefore the mixed-highs signal is one half the sum of waves G_H and R_H and is indicated by wave M_H . This wave is added to the green lows G_L and red lows R_L to make waves $(G_L + M_H)$ and $(R_L + M_H)$ which are the green and red kinescope signals, respectively. Careful comparison of these waves to the subject strip shows the nature of the picture produced by the mixed-highs system. The sum (not shown) of the waves $(G_L + M_H)$ and $(R_L + M_H)$ is equal to the sum of waves G and R . Therefore, if the kinescopes were entirely linear in brightness

⁵ A condition for color fidelity is that the low-frequency net gain is the same for each color.

output versus input signal voltage, the picture would have correct brightness in all areas up to 4 Mc. It will be noted that some of the curves showing the composite

kinescope signal, such as $(G_L + M_H)$, for example, swing slightly below the zero level for certain types of picture subject. For this signal to be properly reproduced in light, the kinescope would have to generate negative light at these times. This is impossible. The kinescope characteristic could be substantially linear for upward swings of light output but it must be nonlinear at cutoff. Actually it is preferred that the kinescope have a logarithmic relation between the signal voltage and the light output in order to minimize the visibility of noise in the signals. This relation, which is easily approximated in commercial kinescopes is implied in the standards for black-and-white television transmission.

Circuits have been developed for use at the transmitter that precompensate for these effects of nonlinearity of the kinescope upon the mixed-highs reproduction. The precompensating circuit generates new low-frequency signals and new high-frequency signals as a result of the combined signal being applied to nonlinear circuits that are complementary to the kinescope characteristics. Tests with these precompensating circuits in a simultaneous color television system have indicated that they are helpful but are not necessary to a satisfactory mixed-highs system.

VI. MIXED HIGHS IN THE RCA COLOR TELEVISION SYSTEM

The RCA color television system,⁶ which employs dot multiplexing of the color signals, provides the same resolution as the standard black-and-white television system within the same 4-Mc video bandwidth. This bandwidth is only one third as much as that which would be required by conventional methods.

The use of the mixed-highs principle reduces the required bandwidth to two-thirds of that which would otherwise be needed. A second bandwidth reduction to one-half of this reduced value is obtained by dot interlacing, which allows the picture repetition rate to be reduced from 30 complete pictures per second (as used in black-and-white television) down to 15 pictures per second. The property of the eye used in this case is that very small areas of light can flash on and off at a lower rate without the eye seeing flicker than can large areas. The above two bandwidth reduction factors together provide the net reduction factor of one-third which is required.

⁶ RCA Laboratories Division, "A six-megacycle compatible high-definition color television system," *RCA Rev.*, vol. 10, p. 504; December, 1949.

Metallized Paper for Capacitors*

D. A. McLEAN†

Summary—Metallized capacitor paper is attracting widespread interest as a way of reducing capacitor size. In metallized paper capacitors, the usual metal foil is replaced by a thin layer of metal evaporated onto the surface of the paper. Lacquering the paper prior to metallizing increases the dielectric strength and insulation resistance, reduces atmospheric corrosion of the metal, and diminishes the rate of loss of electrode metal by electrolysis. Owing to the extreme thinness of the metal layer, metallized paper capacitors are subject to a type of failure not ordinarily found in conventional capacitors. This type of failure consists of the loss of electrode by electrolysis and occurs under dc potential when the ionic conductivity is high, as results, for example, from the presence of moisture. For this reason, it is recommended that special precautions be taken to keep the ionic conductivity low, in particular with respect to thorough and effective drying and sealing of the capacitor units.

INTRODUCTION

THE DIELECTRIC of a conventional paper capacitor consists of two or more layers of thin dielectric tissue wound between metal foil electrodes and impregnated with an insulating liquid or solid. Obviously, the volume of such a capacitor exclusive of insulating margins, external wrapping, and moisture protection is the sum of (a) the volume of the dielectric between the electrodes and (b) the volume of the electrodes. Metallized paper in capacitors of relatively low voltage rating points the way to reduction in both of these volume factors. Reduction in volume of dielectric results from the "self-healing" property of thin metallic films which permits the use of a thinner dielectric. Reduction in the volume of the electrodes results from the use of a film of metal about one to two per cent as thick as the usual metallic foils.

The volume occupied by a wound capacitor unit, exclusive of insulating margins, outer wrappings, and housing, can be calculated from the following equation:

$$\frac{V}{C} = 72.9 \frac{d(d+t)}{e} \quad (1)$$

where

- V = volume in cc
- C = capacitance in microfarads
- d = thickness of dielectric in mils
- t = thickness of electrode metal in mils
- e = dielectric constant of dielectric.

Consider the hypothetical case of a capacitance C needed for a low-voltage application, say 100 volts or less. Conventionally, it is probable that two layers of

0.3-mil paper would be used with 0.25-mil aluminum foil so that

$$V_1 = 72.9 \frac{0.6(0.6 + 0.25)}{e} C = \frac{37.1}{e} C.$$

If chlorinated naphthalene is used as the impregnant, e for the impregnated paper dielectric will be about 5.8; hence

$$V_1 = 6.4C.$$

Now assume that in a metallized design it is found that one layer of 0.3-mil paper with a lacquer coat of 0.03 mils will give the properties desired. Then, since t is negligible

$$V_2 = 72.9 \frac{(0.33)^2}{e} C = \frac{7.94}{e} C.$$

High dielectric-constant chlorinated compounds, such as chlorinated naphthalene, preclude satisfactory self-healing in metallized designs. At present, the best impregnants appear to be hydrocarbon waxes, resulting in an effective dielectric constant in impregnated paper of about 4.0. Hence

$$V_2 = 1.99C.$$

The volume ratio of the metallized to the conventional design is

$$\frac{1.99}{6.40} = 0.31.$$

SELF-HEALING PROPERTIES

Despite great care and skill in its manufacture, single sheets of thin capacitor paper contain imperfections consisting of holes, extremely thin spots, and conducting particles. Therefore, it is normally necessary to use two or more sheets between electrodes in which case the probability of superposition of imperfections is low. If, on the other hand, one uses for electrodes thin layers of metal such as may be obtained by the evaporation process, they cannot carry the high concentration of current at the dielectrically weak areas, but act as a fuse for such areas, either oxidizing, vaporizing, or melting into isolated globules, relieving these areas of electrical stress.

This self-healing makes possible the use of metallized paper in single layers for low-voltage capacitors. Furthermore, it is reasonable to suppose that in capacitors for higher voltages, at least up to several hundred volts, the self-healing properties of metallized films will permit operation of the dielectric at higher electrical stress than would otherwise be possible and thus result in smaller

* Decimal classification: R282.1×R381.15. Original manuscript received by the Institute, December 5, 1949; revised manuscript received, May 4, 1950.

† Bell Telephone Laboratories, Inc., Murray Hill, N. J.

capacitors. In such cases one must make a choice based upon further experiment and upon specific circuit requirements between multilayer construction using thin paper or single-layer construction using a relatively thicker paper.

These advantages of metallized paper have long been recognized. A metallized paper made by applying finely divided tin with a binder and subsequently calendering was patented by Mansbridge in 1900.¹ Mansbridge clearly recognized the advantage of metallized paper from the standpoint of economy of metal, space savings, and self-healing characteristics. The so-called "Mansbridge foil" was commercialized and used by the British Post Office.² Its principal disadvantages were the high frequency of metallic conducting particles pushed through the paper by the calendering and the low insulation resistance of single-layer capacitors which is stated by Mansbridge to be caused by the binder.

In 1910, Dean was granted a U. S. Patent featuring the self-healing properties of thin metallic films.³ Considerable effort has since been expended toward solving

the problems associated with production of satisfactory metallic films by a commercial process, but it was not until World War II that metallized paper capacitors were used to any appreciable extent.⁴ During the war they were produced in both England and Germany, the Bosch Company being reported to have made some 40 million of them.

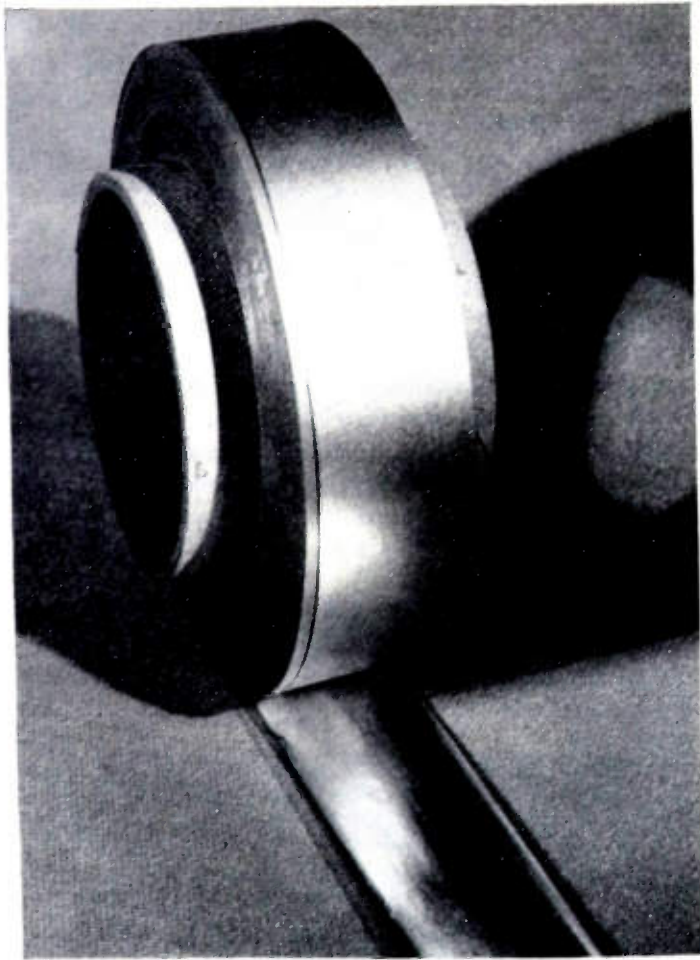

Fig. 1—A roll of capacitor paper which has been lacquered and metallized in laboratory equipment.

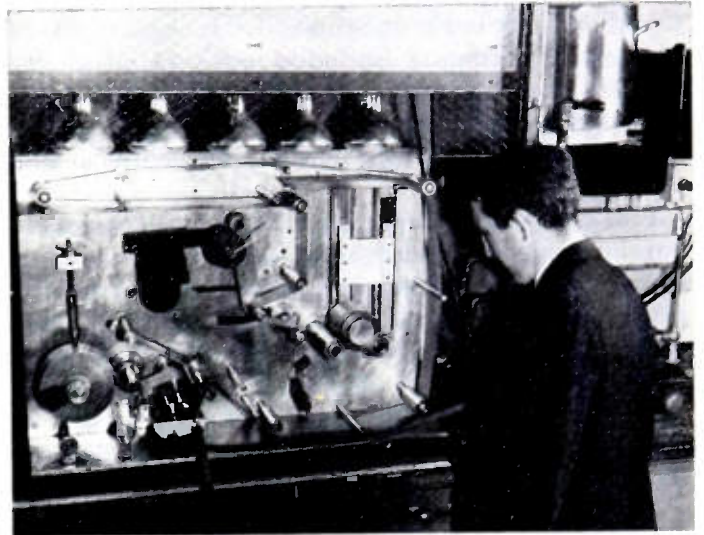

Fig. 2—Laboratory equipment for lacquering capacitor paper.

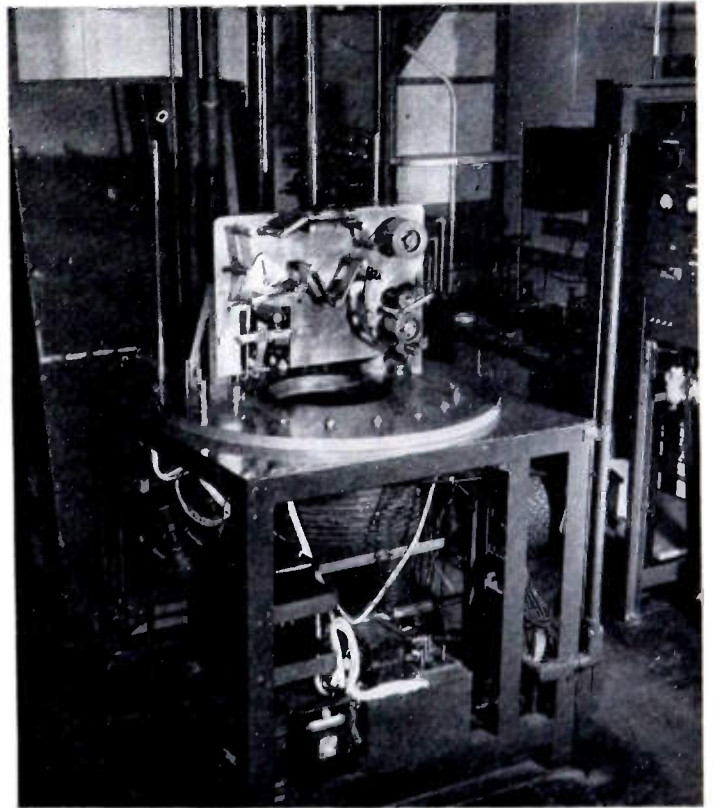

Fig. 3—Laboratory equipment for metallizing capacitor paper.

¹ G. F. Mansbridge, British Patent No. 19,451; 1900.

² G. F. Mansbridge, "The manufacture of electrical condensers," *Jour. IEE*, vol. 41, p. 535; October, 1908.

³ William Dean, U. S. Patent No. 965,992; 1910.

⁴ H. G. Wehe, "Metallizing paper for capacitors," *Bell Lab. Rec.*, vol. 27, p. 317; September, 1949.

Two features involved in the Bosch Company development are: (1) the addition to the paper of a thin lacquer film and (2) the technique of coating paper in vacuum with a high-vapor pressure metal (Zn). The first increases the electrical strength of the paper and produces other effects discussed below; the second enhances the speed and economy of producing metallized paper.

The successful commercial production of metallized capacitor paper in Europe stimulated interest in several places in this country, including our own laboratory. Fig. 1 is a photograph of a roll of metallized capacitor paper produced on our laboratory equipment. To provide an insulating margin, metal is omitted from a band along one edge.

Fig. 2 shows the laboratory roller-coating equipment on which the paper is lacquered, while Fig. 3 shows the experimental metallizing equipment with the vacuum bell jar removed. If zinc is used for metallizing, satisfactory coatings can be made at pressures up to about 100 microns.

Capacitor units of the noninductive type may be made by winding units from two rolls of paper, alternating the insulating margins and bridging the turns

with sprayed metal at the ends of the units. The metallized unit shown in Fig. 4 illustrates this construction.

FUNCTION OF THE LACQUER

It has been found in our laboratory that the lacquer has at least the important functions enumerated below:

1. Improvement in the Dielectric Strength and Insulation Resistance

If one places a strip of metallized paper over a metallic cylinder with the metallized side out and applies a gradually increasing dc potential between the drum and the metal film, the dielectric strength of the weaker points will be exceeded and "self-healing" will take place. The number of such points will of course be greater the higher the voltage. If one uses metal rollers instead of a drum, the paper can be re-reeled continuously through the burnout equipment and a relatively large area of metallized paper can be tested conveniently. Fig. 5 is a schematic drawing of equipment for

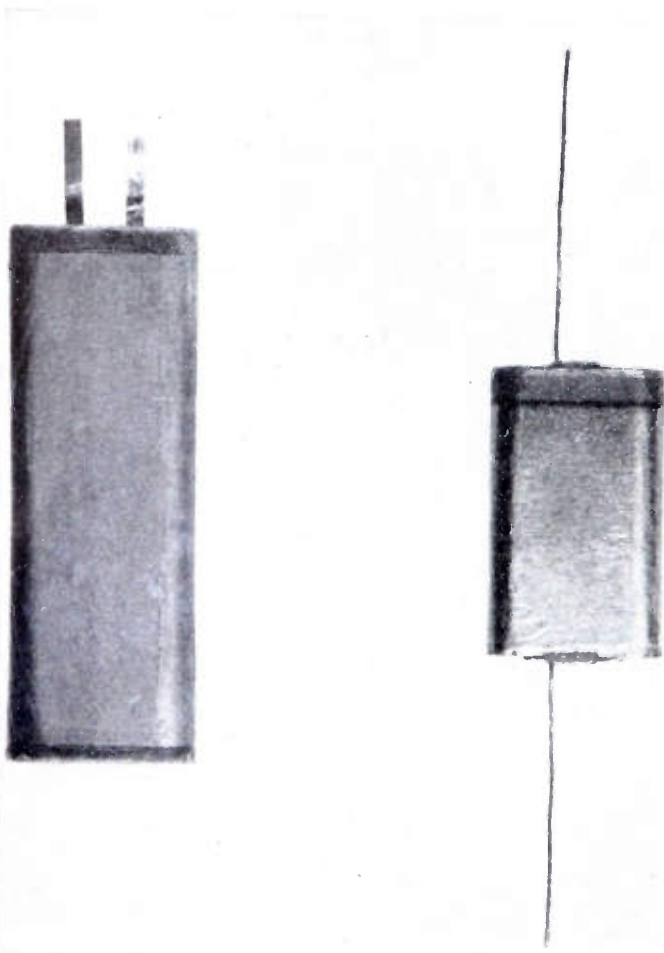

(a)

(b)

Fig. 4—(a) 2.0 microfarad conventional paper capacitor unit, 2 layers 0.3-mil paper. (b) 2.0-microfarad metallized paper capacitor unit, one layer 0.3-mil paper.

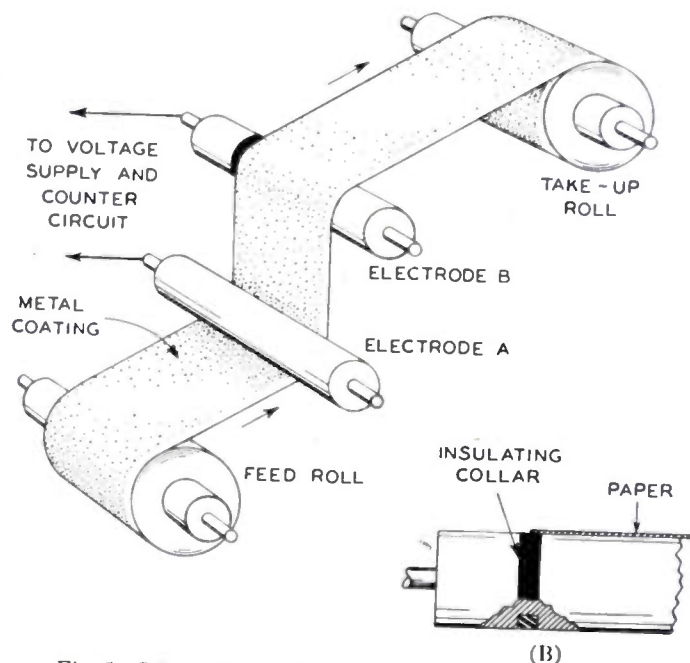

Fig. 5—Schematic drawing of equipment for making electrical burnout test on metallized paper.

such a test. Tests made with apparatus of this type show a marked effect of the presence of lacquer on the number of burnout spots. The results obtained depend upon voltage, time of contact, and relative humidity. Single-layer paper capacitors can be produced from metallized paper that has not been lacquered. However, one of the important advantages of using lacquer is that the insulation resistance of the capacitors is greatly increased. Measurements on dried and impregnated experimental units show improvements in insulation resistance of tenfold to one hundredfold due to the lacquer. Other results on unimpregnated units containing moisture are given in Fig. 7 which is discussed below.

2. Decrease in Atmospheric Corrosion

When a thin coat of zinc is deposited on unlacquered capacitor paper, it gradually corrodes unless maintained at quite a low humidity. At high humidity, e.g., 75 per cent, the corrosion may result in loss of a large proportion of the conductivity in a few days. The corrosion rate is much less rapid when a layer of lacquer is interposed between the paper and the metal.

The reason for the reduction in atmospheric corrosion rate by the lacquer film is believed to be twofold. In the first place, even the best paper contains small amounts of residual electrolytes which can promote corrosion in humid atmospheres. Secondly, cellulosic materials absorb moisture in humid atmospheres and attain high electrical conductivity. It is believed that when the metallic film lies directly on paper in moist atmospheres the high ionic conductivity of the paper backing facilitates corrosion. The amount of corrosion observed under a given condition is in general higher, the higher the moisture-sorptive capacity of the lacquer film.

3. Decrease in Electrolytic Deterioration of the Metal Electrodes

The dielectric in a paper capacitor has a certain amount of electrical conductivity which leads to electrode reactions when a dc field is applied. This may be serious in any type of capacitor if it produces electrolytic material which degrades the dielectric.⁵ In metallized paper capacitors, however, electrolytic processes are serious in an additional sense—the metal electrodes are so thin that they may be destroyed entirely by a moderate amount of electrolysis. It has been found that when electrolysis is promoted, as by exposing metallized paper units to high humidity while a dc voltage is applied, the anode can be destroyed in a comparatively short time. In fact, the service life of this type of capacitor may be determined by the life of the anode in contrast to the conventional capacitor, the life of which is determined by dielectric failure.

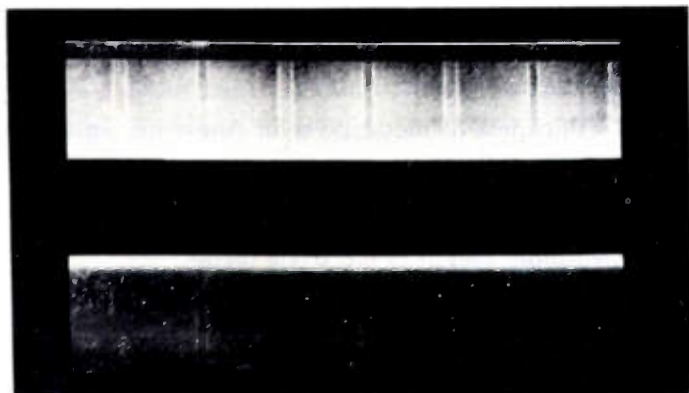

Fig. 6—Electrolytic corrosion of positive electrode at high humidity; taken from unlacquered metallized paper capacitor unit (unimpregnated), 45 volts, 77°F, 50 per cent relative humidity, 8 days. Top, positive electrode. Bottom, negative electrode.

⁵ D. A. McLean, L. Egerton, G. T. Kohman, and M. Brotherton, "Paper dielectrics containing chlorinated impregnants, deterioration in d.c. fields," *Ind. and Eng. Chem.*, vol. 34, p. 101; January, 1942.

Fig. 6 shows transmitted light photographs of the anode and cathode from unimpregnated single-layer metallized paper units made with unlacquered paper exposed to 50-per cent humidity for 8 days with 45 volts applied. Identical tests made with lacquered paper also result in some destruction of the anode, but the effect is much more serious in the unlacquered samples. As would be expected from the appearance of the electrodes, the unlacquered samples in the above tests decreased in capacity rapidly owing to destruction of electrode area, while the lacquered samples lost capacity only slowly. The cathodes of the samples containing unlacquered paper were also visibly attacked, possibly as a result of atmospheric corrosion of the type discussed in the previous section.

It is known from other work that a thin film of lacquer will not alter the equilibrium amount of water adsorbed by paper. The superior behavior of the lacquered paper samples in these tests is believed to result from a blocking of electrolysis by the lacquer film. The ions contributing to electrolysis can move fairly readily through the humidified paper, but the lacquer film pre-

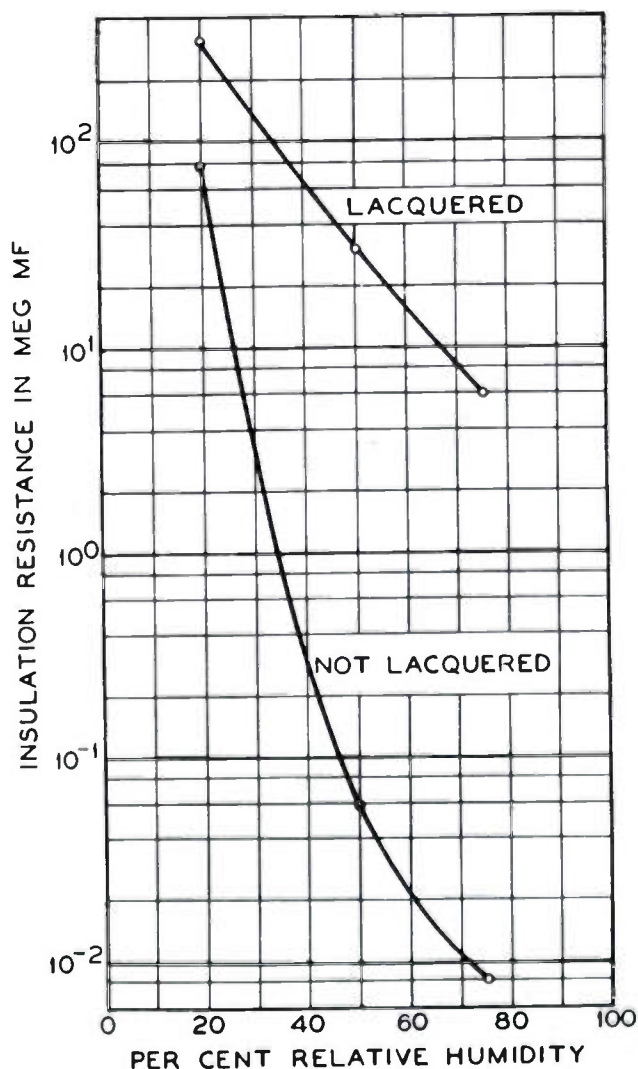

Fig. 7—Equilibrium value of insulation resistance of unimpregnated metallized paper capacitor units as a function of relative humidity.

sents a barrier in which the ion mobility is low. This is confirmed by the insulation resistance values of unimpregnated units exposed to various humidities. As shown in Fig. 7, lacquered paper units when humidified possess an insulation resistance higher than unlacquered paper units. The ratio increases with increasing humidity, reaching a value of several hundred at 75-per cent relative humidity.

While the results given above refer to samples in which conductivity has been enhanced by humidity, it is assumed that the barrier effect of the lacquer film will also be important in blocking other types of ions. This effect, like that of atmospheric corrosion, is dependent upon the type of lacquer used.

TYPES OF SELF-HEALING IN CAPACITOR UNITS

Examination of metallized paper from units in which self-healing burnouts have occurred discloses the two general types of burned-out areas illustrated in Fig. 8.

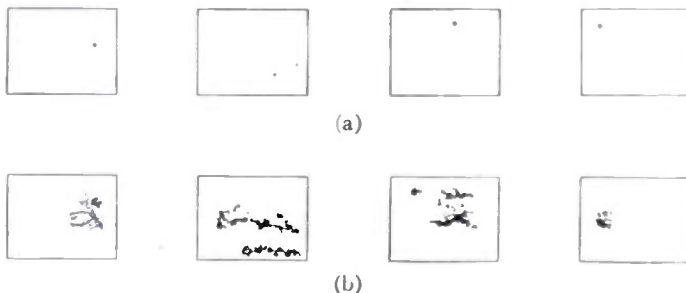

Fig. 8—Contact prints of metallized paper containing self-healing burnouts. (a) Satisfactory, small clean areas. (b) Unsatisfactory, areas have spread beyond original breakdown point.

In obtaining these prints, the metallized paper was used as a photographic negative normally would be used in making a contact print. The dark regions represent the areas from which metal was removed during the self-healing process. The burnouts illustrated at the top of the figure are of the type desired, being limited to a small approximately circular area surrounding the point of breakdown. The undesirable type shown at the bottom, although initiating at a point, has spread in a tree-like pattern to cover a substantial area. Capacitors containing this self-propagating type of burnout are likely to have low insulation resistance. In extreme cases these areas spread at such a low voltage that no satisfactory clearing of the units can be achieved.

Fig. 9 shows a section of one of these tree-like burnouts, magnified 20 times. It is evident from this photograph as it is from microscopic examination, that a crack in the lacquer runs along the center of each branch. A few small bright areas show where the lacquer has been completely peeled from the paper and, in some instances, the flake of lacquer which was thrown back can be seen. In our opinion, these cracks and peeled areas were not in the lacquer originally, but were formed by a spread of the burnout from an initial point during the self-healing process. Unsatisfactory burnout characteristics cannot be ascribed to any single type of defect.

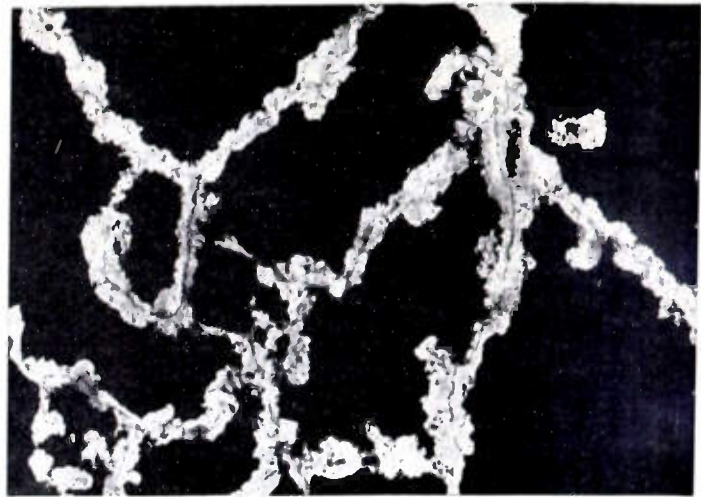

Fig. 9—Transmitted light photograph of tree-like self-healing burnout which has spread over large area. Note crack in lacquer running along center of each path.

Satisfactory results depend upon careful control of all materials and processes in the manufacture of metallized paper capacitors.

ELECTROLYTIC DESTRUCTION OF THE ELECTRODE

Rapid destruction of the anode in sustained direct-voltage tests was noted above for the cases where the conductivity is enhanced by moisture. In some of these tests, measurements of leakage current were made during the test and the condition of the anode checked by capacity measurements. Analysis of these results shows the loss of metal to be roughly in accord with Faraday's law. A more refined check would require conditions not attainable at present; namely, a perfectly uniform coating of metal and inhomogeneous conductivity in the dielectric.

On the assumption that Faraday's law holds, it can be shown that the rate of loss of electrode, expressed in terms of the commonly measured capacitor property of insulation resistance is

$$-\frac{d\delta}{dt} = \frac{EeM}{160DRn\rho} \quad (2)$$

where

- δ = thickness of metal layer in Angstrom units
- t = time in days
- E = applied direct voltage
- e = dielectric constant of the capacitor dielectric
- M = atomic weight of electrode metal
- n = valence of electrode metal
- ρ = density of electrode metal
- D = thickness of dielectric in mils
- R = insulation resistance in megohm microfarads.

Calculations based on this equation indicate that if metallized paper units are impregnated with stable compounds and if, in addition, they are well dried and sealed from moisture, a long electrode life can be expected.

Metallized Paper Capacitors*

J. R. WEEKS†

Summary—Metallized paper capacitors are being introduced into telephone apparatus wherever size is of prime importance. It is shown that low-voltage metallized paper capacitors with about half the volume of a foil-paper capacitor of conventional design have about the same characteristics as the latter. Performance data are discussed which indicate that such capacitors will give long service when used within their voltage rating and when well-protected against moisture. It is pointed out that this type of capacitor should be used within its voltage rating if sparking with its attendant circuit noise is to be avoided. When sparking does occur due to abnormal voltage conditions no permanent damage results.

IN A CONVENTIONAL low-voltage paper capacitor two sheets of thin paper are interposed between metal-foil electrodes even for the lowest working voltage since a single sheet contains a number of defective areas such as conducting particles imbedded in the paper structure, thin spots, and holes. By using two sheets of paper the chance of two such defective spots superimposing is reduced to a negligible amount but at the defective spots the dielectric strength of the insulation is that of a single sheet. When such capacitors fail, a permanent short circuit between the relatively thick foil electrodes usually results as the foils are capable of carrying the short-circuit currents.

In the metallized paper capacitor the foil electrodes are replaced by very thin metallic coatings deposited directly on the paper. A discussion of metallized paper is given in the literature.^{1,2} The metal coating is so thin, about 3×10^{-6} inch thick as contrasted with a foil thickness of 250×10^{-6} inch, that it can be removed by an electrical discharge from around defective areas in the paper without damaging the paper or resulting in a permanent short circuit. This action is referred to as self-healing, and permits the use of a single layer of paper between electrodes for low operating voltages.

For applications in the telephone plant where the working voltage is usually below 200 volts, maximum advantage can be taken of the size reductions possible with metallized paper. Table I shows the approximate

TABLE I

| Rating volts dc | Approximate volume reductions of unit |
|-----------------|---------------------------------------|
| 125 | 75 per cent |
| 200 | 65 per cent |
| 400 | 45 per cent |
| 600 | 30 per cent |

* Decimal classification: R381.15. Original manuscript received by the Institute, December 5, 1949; revised manuscript received, May 4, 1950.

† Bell Telephone Laboratories, Inc., Murray Hill, N. J.

¹ H. G. Wehe, "Metallizing paper for capacitors," *Bell Lab. Rec.*, vol. 27, p. 317; September, 1949.

² D. A. McLean, "Metallized paper for capacitors," *PROC. I.R.E.*, pp. 1010-1015.

reduction in volume of 2- μ f metallized paper units over that for conventional paper-foil units for dc working voltages from 125 to 600 volts. Of course, the space required for sealing, terminals, and so forth materially reduces the over-all volume savings in the finished capacitor.

After winding, metallized paper capacitor units are pressed into final shape and liquid solder is sprayed over a small area on each end in such a manner that it makes contact with practically every turn of the metal coating on one of the papers. The insulating margin on one edge of each sheet of metallized paper is sufficiently wide to prevent the metal spray from reaching the metallized area on the electrode of opposite polarity and short-circuiting the capacitor. The units are dried under vacuum to a very low moisture content and vacuum impregnated with a suitable impregnant such as mineral wax.

Following impregnation it is found that the majority of the units have quite low insulation resistance and some are short-circuited. Accordingly, before they can be used, they must be given a clearing process to melt or evaporate the metallic coating away from defective areas and to form a metal-free area around these weak spots sufficient to withstand the working voltage of the capacitor.

As explained in the literature,² the metal coating is so thin that a very small amount of moisture will produce considerable harmful corrosion of the metal electrode leading to loss of capacitance and increase in power factor. Accordingly, it is necessary not only to have a very well dried unit initially but to insure that the unit remains dry throughout its useful life. The latter is accomplished for the 4- μ f telephone capacitor shown at the left in Fig. 1 by potting the unit in an extruded aluminum can with a microcrystalline mineral wax. The capacitor shown at the right in Fig. 1 is a conventional type of paper-foil design of the same capacitance and voltage rating. Its volume is about twice that of the metallized capacitor.

Metallized paper capacitors have initial characteristics comparable to those of conventional paper-foil capacitors. For example, a 1- μ f capacitor at 25°C has an average insulation resistance of 8,000 megohms and a ratio of reactance to resistance of about 150 at 1 kc. It will withstand about $1\frac{1}{2}$ times its rated voltage for short intervals of time and will withstand rated voltages for indefinitely long periods without any momentary failure or sparking.

In determining the life performance of conventional capacitors under dc potentials it is customary to place a number of capacitors on voltages of $1\frac{1}{2}$ to $2\frac{1}{2}$ times their voltage ratings and determine the time required

for them to fail by short-circuiting. The expected life at rated voltage can be estimated by the fifth-power rule; that is, the life is inversely proportional to approximately the fifth power of the applied voltage.³ In the case of metallized paper capacitors, it is necessary to employ a different type of life test as these capacitors, when operated at voltage much above their rated voltage, will momentarily fail or spark and then be as good as new without operating any of the normal life-test-failure indicating devices such as fuses or circuit breakers.

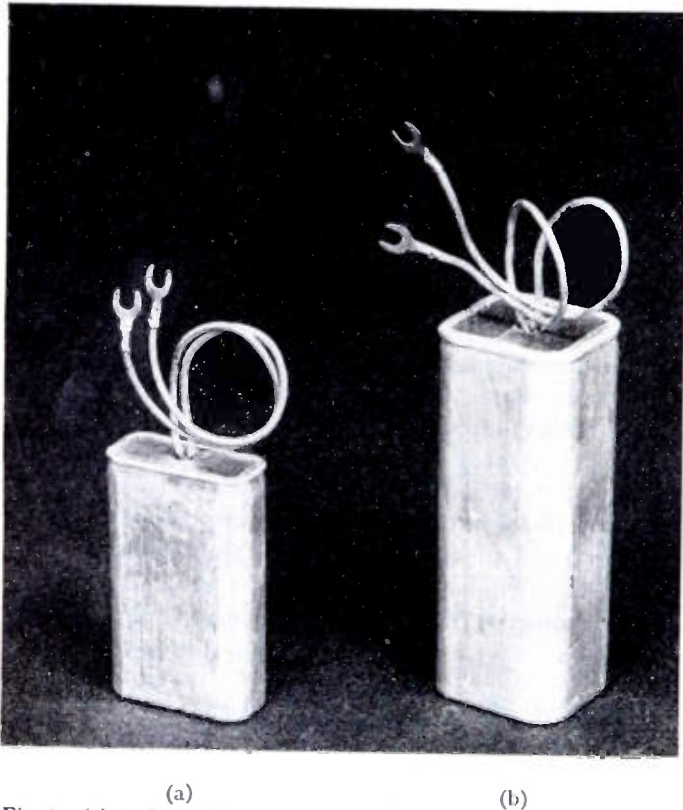

Fig. 1—(a) 4- μ f metallized paper capacitor rated at 125 volts dc. (b) Conventional foil-paper 4- μ f capacitor of same voltage rating.

While this would seem to indicate that almost indefinite life could be expected, sparking under normal operating voltage conditions cannot be tolerated in the telephone plant. For example, in a coast-to-coast toll circuit there may be as many as 5,000 capacitors in the transmission path in repeaters, networks, etc., and if each of these sparked only occasionally under normal conditions the whole circuit would be intolerably noisy. Accordingly, new life-test techniques had to be worked out to permit prediction from relatively short-time tests, that no sparking is likely to occur at the maximum rated operating voltage. This was accomplished by placing groups of capacitors on several test voltages each group being in series with an electronic circuit which records the number of instantaneous failures. From the number of current surges recorded in a given

³ J. R. Weeks, "Capacitor life testing," *Bell Lab. Rec.*, vol. 24, p. 296; August, 1946.

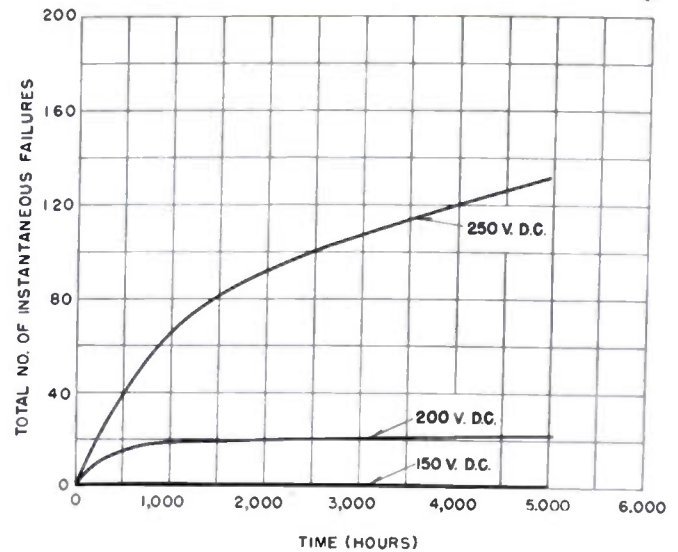

Fig. 2—Accelerated dc life tests at temperatures of 25° to 50°C showing how the number of instantaneous failures in groups of 8 capacitors of 2 μ f each at applied voltages of 150, 200, and 250 volts varies with time on test.

time it is possible to determine a voltage where the rate of sparking is negligibly small.

Typical results of this nature are shown in Fig. 2. This chart is for three test groups of eight 2- μ f capacitors rated at 125 volts dc, using a single layer of lacquered paper between evaporated metal electrodes. It will be noted that the number of momentary breakdowns is 65 at 250 volts in 1,000 hours, 19 at 200 volts in 1,000 hours, and 0 at 150 volts in 5,000 hours.

A number of sparking charts like Fig. 2 were examined to determine if any rule, like the fifth-power rule for predicting the life of conventional capacitors, was apparent. This study disclosed no simple relation between the time required for a given number of sparks and the applied voltage. However, from the limited data available it appears as though there is a threshold voltage below which sparking occurs only very rarely.

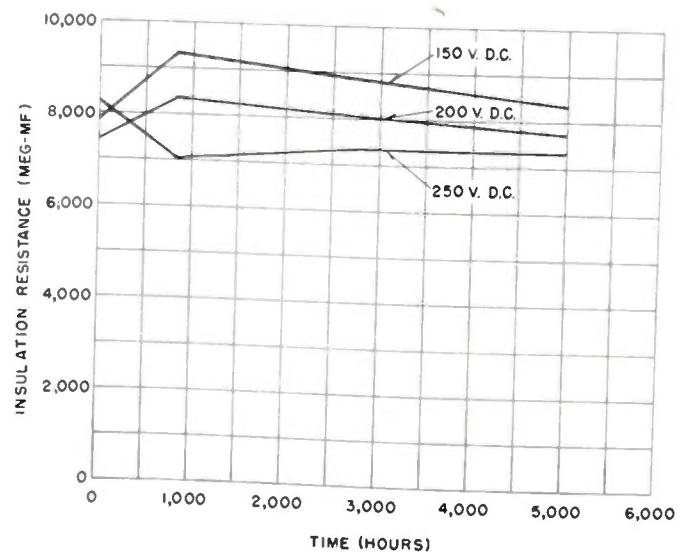

Fig. 3—Variation of insulation resistance with time for capacitors of Fig. 2.

Fig. 3 shows the change, with time, in insulation resistance of these capacitors, a characteristic which has been found to be a very sensitive measure of deterioration of the dielectric in a capacitor on dc circuits. In comparing these two sets of curves it is seen that while 250 volts gave a considerable number of sparks in 1,000 hours, the amount of permanent damage to the dielectric in the capacitor is small, as judged by the small decrease in insulation resistance during the test period. Also the loss in capacitance from the burning away of the metallic coating from the failure areas was found to be less than 1 per cent. For the 150-volt condition, the insulation resistance in this 1,000-hour period has actually increased slightly. This factor as well as the freedom from sparking is taken into account in setting up the voltage rating.

In checking the performance of metallized paper capacitors on 60-cycle circuits, reliance for detecting deterioration has been placed on the change of insulation resistance and power factor with time. Recently the counter circuit used in the dc voltage performance tests has been adapted to ac performance tests, and the initial data indicate that for a 60-cycle test voltage with a peak of 250 volts the number of counts is less in a given time than for 250 volts dc. This is believed due to a combination of the short time the capacitor is at a sparking voltage (over 200 volts) and to the more uniform dis-

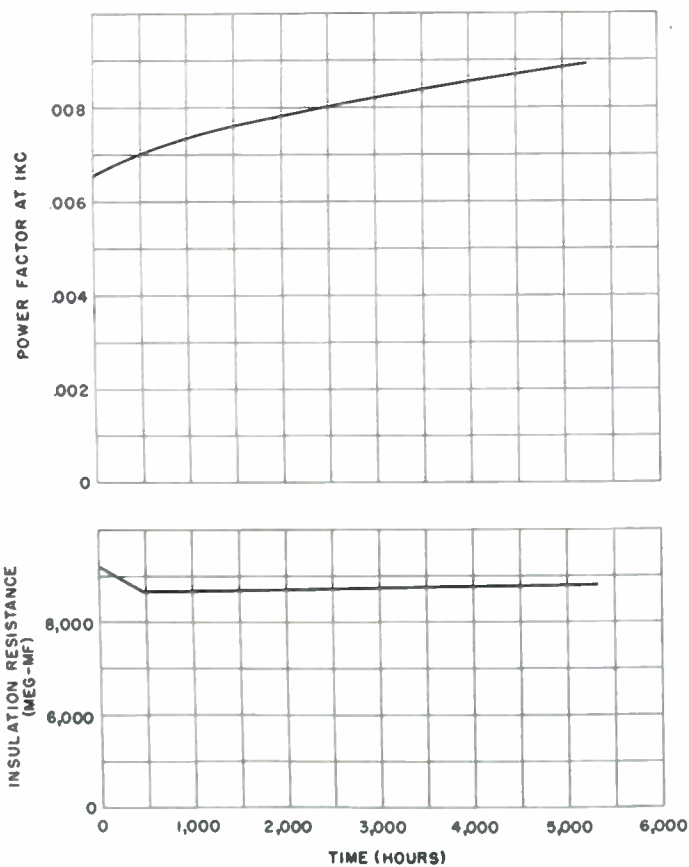

Fig. 4—Accelerated 60-cycle life tests showing variation in insulation resistance and power factor for a test condition of 180 volts rms at 25°C. Curves are the average of a group of eight 2- μ f capacitors.

tribution of the voltage gradient through the lacquer coating and the paper for the 60-cycle test condition. Typical results of the change in the insulation resistance and power factor under this test condition with time on test for 2- μ f capacitors wound with a single layer of metallized paper are shown in Fig. 4.

To determine if metallized paper capacitors deteriorate in storage some capacitors have been observed over a period of about two years when stored at room temperature and at 50°C without evidence of such action taking place. Furthermore, cycling tests where the capacitor is first cooled to -40°C and then heated to 50°C for a number of times have shown no evidence of the development of internal low resistance paths. Care was taken to insure that the voltage applied to the capacitor during the test periods was only a few volts, to avoid any clean-up effects the instant the test voltage was applied which would not be detected by the measuring apparatus.

Typical curves showing the change in capacitance with temperature for the 2- μ f capacitors of conventional design and of metallized paper are shown in Fig. 5. In Fig. 6 are given curves for the conventional and metal-

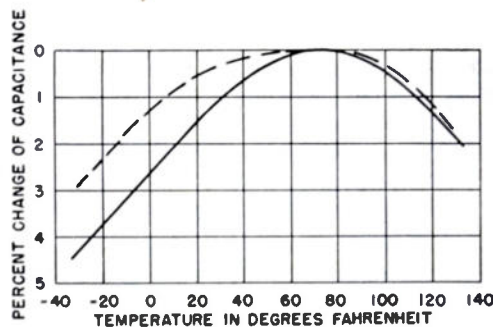

Fig. 5—Change in capacitance with temperature for metallized paper capacitors and conventional foil paper capacitors. Both are impregnated with mineral wax. — Metallized paper capacitor, - - - Conventional paper capacitor.

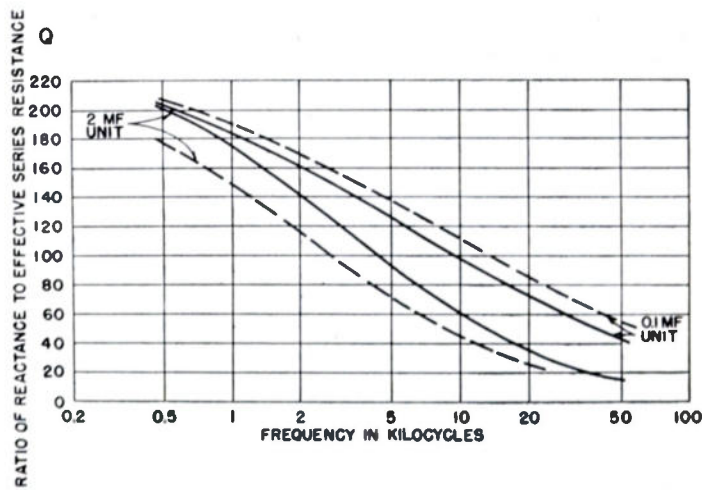

Fig. 6—Variations of Q , $(\omega C/G)$, with frequency for metallized and conventional foil-paper capacitors. Conventional capacitors have one terminal per foil laid in approximately at the center of each foil. — Metallized paper capacitor, - - - Conventional paper capacitor.

lized capacitors showing the variations in the ratio of reactance to effective series resistance (Q) with frequency over the frequency range normally encountered in audio and the lower carrier-frequency telephone circuits. The 2- μf metallized paper capacitor had a unit with a length approximately twice that of the 0.1- μf capacitor, with the result that the greater electrode resistance lowered the Q somewhat. The data on the conventional foil-paper capacitors were obtained on capacitors having a single laid-in terminal placed near the center of the foil length. Again the lower Q for the 2- μf capacitor is due to the greater foil resistance compared to that for the 0.1- μf capacitor.

In carrier circuits it frequently happens that the applied carrier-frequency voltage on the capacitor is quite low, being of the order of 10 to 100 microvolts, while the

steady-state direct potential may be 100 to 200 volts. It is important that under these conditions the capacitor be free of noise which otherwise would cause trouble in the telephone circuit. Groups of metallized paper capacitors have accordingly been operated for appreciable periods of time in a recorder circuit where a potential of 50 microvolts at 50 kc was superimposed on a direct potential of 100 volts. The recorder circuit was capable of detecting small fluctuations of the 50-kc impedance of the metallized paper capacitor and none was found of sufficient magnitude to be serious.

In conclusion, it is felt that metallized paper capacitors can be substituted for the conventional type without risk of degrading the performance of telephone circuits. Their small size makes their use attractive wherever small-sized apparatus is of prime importance.

Biological Requirements for the Design of Amplifiers*

HARRY GRUNDFEST†

Summary—The paper describes the nature of bioelectric potentials and their essential properties, with particular emphasis on the types of amplifiers needed to study various phases of bioelectric activity. Some of the problems and solutions to bioelectric instrumentation are discussed.

ELECTRONEUROPHYSIOLOGY, the study of electrical phenomena that are associated with the life and activity of nerve cells and nerve fibers, presents a number of interesting requirements in electronic instrumentation. (1) Most bioelectric generators have high impedance. (2) They are affected by small applied currents. (3) They produce transient responses with a rapid component, where the rise time may be of the order of 100 microseconds and slow components that may last for one or more seconds, or even minutes. (4) The potentials observed have amplitudes from a few microvolts to about 100 millivolts. (5) The smaller potentials are usually observed in the intact animal, where other bioelectric activity, such as from the heart, contracting muscles, or adjacent nervous tissue, may cause serious interference with the potentials it is desired to study. (6) Furthermore, the animal, or an isolated tissue has considerable capacity to ground. Large extraneous fields such as are produced for example by ac lines, may interfere severely.

It is of interest that electrophysiologists solved the problem of biological and physical interference quite successfully by using differential amplifiers a number of

years before this type of amplifier came into vogue in radar and computer applications. For example, the writer has used, since 1936, a variety of differential dc amplifiers designed originally by Toennies in 1938¹ and even then more advanced in design than the type described in 1948 by Gray.²

Bioelectric research makes still another demand upon the apparatus as regards ruggedness and stability. The work antecedent to actual pickup and recording of the electrical activity is frequently long and difficult. One or a series of aseptic operations may precede to produce in an animal a particular state of its nervous system, or an intricate acute (nonsterile) operation may be required to expose a particular region of the nervous system, and as a result the preparation may last only a relatively short time. In such cases it is important that the electronic apparatus be available reliably on demand and of such a design that troubles can be easily diagnosed and repaired.

The sensitivity range and other characteristics that are needed in electrophysiology are not found in any commercially available equipment and the usual commercial types of construction would probably have to be modified considerably to meet the other needs just mentioned.

The specific requirements for bioelectric amplifiers arise from the properties of the bioelectric phenomena

¹ J. F. Toennies, "Differential amplifiers," *Rev. Sci. Instr.*, vol. 9, p. 95; March, 1938.

² G. E. Valley and H. Wallman, "Vacuum Tube Amplifiers," MIT Radiation Laboratory Series, vol. 18, McGraw-Hill Book Co., New York, N. Y., 1948. See chap. 11, "Direct Coupled Amplifiers," by J. W. Gray.

* Decimal classification: R363×R594. Original manuscript received by the Institute, May 13, 1950.

† College of Physicians and Surgeons, Columbia University, New York, N. Y.

and can be understood best from a brief discussion of these phenomena and their physiological consequences. One of the simplest, but diagnostically very important reflex actions of the human body—the knee jerk—will serve to give an introduction to these biological facts.

The mechanism of the knee jerk reflex is shown in Fig. 1. A sharp blow on the knee cap (patella) stretches the tendon of a muscle. In the tendon certain specialized sensory endings, stretch receptors (muscle spindle), are stimulated. Their activity in turn sets up activity in a nerve (proprioceptive afferent). The complete nature of this action is as yet unknown, but it is always accompanied by an electrical manifestation, and by following this electrical impulse, which we can do relatively easily.

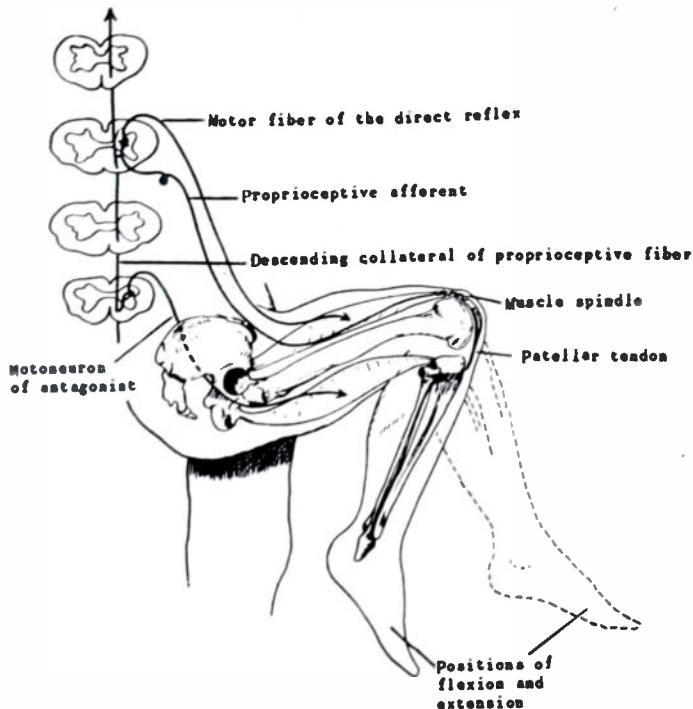

Fig. 1—Diagram of the paths involved in a simple proprioceptive reflex, the knee jerk. (From F. A. Mettler, "Neuroanatomy," 2nd ed., The C. V. Mosby Co., St. Louis, Mo., 1948.) An afferent fiber is shown relaying into the cell of a fiber which produces the motor effect (extension at the knee joint), into the cell and fiber for an antagonist (flexing) action, and ascending into upper levels of the spinal cord. Although individual elements are shown, the reflex involves a large number of nerve fibers and their cells.

we know that the impulse travels along the nerve at about 100 meters per second into the spinal cord, where the nerve fiber sends some shoots (collaterals) into the vicinity of cells known as motoneurons. These collaterals, which are anatomically separated from the motoneuron, relay the activity to the latter. It takes about 0.5 to 1 millisecond for this relay to operate, then a new impulse goes out in the efferent (motor) nerve fiber to the muscle, being conducted also at the rate of 100 meters per second. When the impulse gets down to the motor nerve's termination in the muscle, another relay takes place and sets the muscle into activity. This activity takes the form of both a short electrical pulse and a longer mechanical contraction. The latter causes the leg to kick (extension).

The phenomenon is actually more complicated. The afferent nerve fiber, in addition to terminating at the motoneurons, sends branches up and down the spinal cord. Some go to antagonist motoneurons, and if these happen to be active and the muscles they innervate are contracted, the new impulses stop the activity, relax the antagonist muscles, and thus help the reflex kick along. Eventually, too, the afferent impulses reach the brain and report the goings on. Furthermore, the amount of afferent nervous activity and the size of the knee jerk can be affected by other actions. Distraction by doing mental arithmetic will decrease the knee jerk. On the other hand the reflex can be augmented by contracting the arm muscles.

This is a picture, in miniature, of the kind and complexity of activity that goes on in the central nervous system. In this miniature are included the following steps:

1. Stimulation of the sense organ.
2. Excitation of the afferent nerve fiber.
3. Conduction of an impulse along the nerve fiber to to the cord, where there occur:
4. Relay of activity to motoneurons, and relay into other elements, e.g., brain.
5. Excitation of the motoneurone.
 - a. This is also affected by arrivals of impulses from various paths which augment or decrease the size of the response.
 - b. It is usually accompanied by inhibition of antagonistic activity.
6. Conduction outward of the nerve impulse in motor nerve fibers.
7. Relay into muscle junction.
8. Excitation of the muscle.
9. Propagation of associated electrical and mechanical responses along the muscle fiber to produce the movement.

Some of these steps are known in considerable detail. Others are not so well understood as yet. In order to make the underlying phenomena clear, it has taken considerable, and will take much more, anatomical and physiological research. Electrophysiology is an important tool here because the time relations are so brief. Again using the example of the knee jerk, the afferent impulse takes about 5 milliseconds to reach the cord. The relay takes another 0.5 to 1 millisecond; the afferent impulse also about 5 milliseconds, and the last relay under 1 millisecond. Altogether then, it takes about 11 milliseconds. Very frequently, electrophysiological means are the only ones available to study activity, for nerves and their cells remain to all intents and purposes inert while they are carrying on this activity. The brain, for example, doesn't writhe and boil when it is producing ideas even of the genius class, but its electrical manifestations of activity change even on doing simple jobs. Fig. 2 shows ink recordings of the electroencephalogram and its changes during mental arithmetic. This type of

record illustrates what is now a very common application of electronic engineering to medical science. The amplifiers used are essentially audio amplifiers with large RC coupling, having a pass band from about 0.1 to 200 cps. Their sensitivity to signals is high, and they

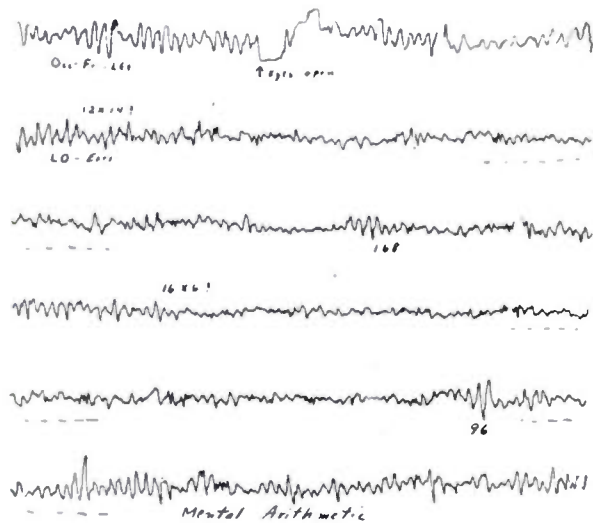

Fig. 2—Electroencephalographic records from a human subject. The uppermost line shows typical normal activity and an artifact produced by muscle movement (opening the eyes) together with the change in pattern of the "brain waves" with eyes open. The next four lines are a continuous record from a different lead and demonstrate the subsidence of the normal pattern during mental arithmetic and its return when the problem is solved.

are provided with means for rejecting extraneous pickup such as comes from the 60-cycle mains. They terminate in a power stage to drive a direct writing pen motor. The great demand for electroencephalographs has led to a relatively standardized, well-engineered product from a number of manufacturers. The latest equipment is generally available in a console assembly with 2 to 8 or more channels arranged to record simultaneously on one moving-strip chart.

Recent developments in electroencephalography employ as many as 25 pickup and recording channels and various scanning techniques to present a simultaneous picture of events occurring at many loci.^{3,4} Another class of instruments makes correlations between phase and/or amplitude of activities at several loci through the use of various types of electronic computers or comparators. A third of the more recent developments use automatic frequency analyzers to perform and record a Fourier analysis of the "brain waves." One circuit of this type and references to others are given in the literature.⁵

³ S. Goldman, W. E. Vivian, K. C. Chi, and H. N. Bowes, "Electronic mapping of the activity of the heart and the brain," *Science*, vol. 108, p. 720; December 24, 1948.

⁴ J. C. Lilly, "The 25-channel Bavatron and electro-iconograms," Presented, AIEE-IRE Conference on Electronic Instrumentation in Nucleonics and Medicine, New York, N. Y., October 31, 1949.

⁵ C. Markey, R. L. Schoenfeld, and P. F. A. Hoefler, "Frequency analyzer for bioelectric potentials in the sub-audio range," *Rev. Sci. Instr.*, vol. 20, p. 612; August, 1949.

THE NATURE OF THE BIOELECTRIC POTENTIAL

The nature of the electrical activity which occurs in nerves and muscles was the subject of a lively controversy between two eighteenth-century scientists whose names are immortalized in electrical nomenclature, Galvani and Volta. The former, in 1786, claimed that nerves and muscles were capable of producing "animal electricity." Galvani was correct as to the phenomenon, but as Volta showed, for the wrong reasons, and it was in the course of their argument that Volta developed the "voltaic pile" or battery.

Work since that time has established that the nerve or muscle fiber, the unit structure of these tissues, is electrically polarized. It is negatively charged on the inside, and positively charged on the outside of a boundary membrane (see Fig. 3). The potential difference is largely due to a complex and as yet incompletely understood mechanism which results in about a 30-fold accumulation of K^+ ions in the interior of the cell as compared to the outside fluid (blood, etc.) and a similar deficit of Na^+ ions in the interior.

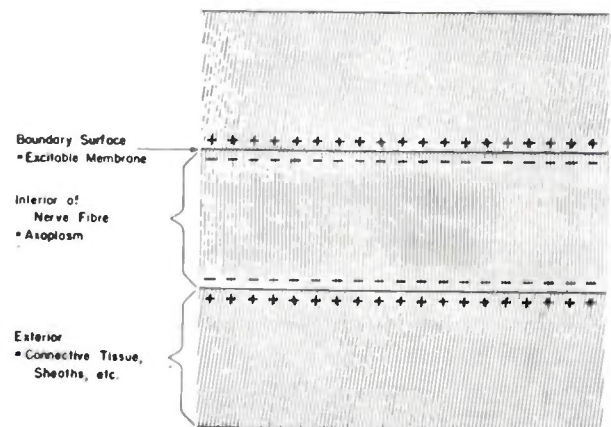
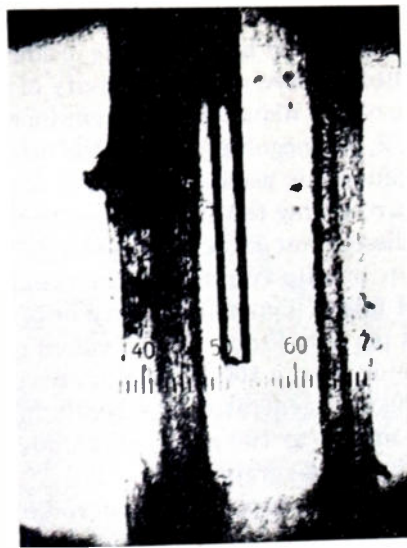

Fig. 3—Diagram of structure and organization of a nerve fiber.

Although most fibers have small diameters—30 microns to less than 1 micron ($\mu = 0.001 \text{ mm} = 0.00004 \text{ in}$)—some giant nerve fibers are found among invertebrates (notably the squid) 0.5 mm or more in diameter. An electrode can be inserted into such a fiber and the potential inside the fiber relative to the outside can be measured (see Fig. 4). The interior is found to be about 50 millivolts negative at rest.⁶ Older theories had postulated that the polarized, semipermeable membrane broke down during activity of the fiber. The transient response during this breakdown was thought to represent a temporary appearance of the internal negativity on the outside of the active region of the fiber, relative to an inactive region. The recent experiments with an electrode inserted into the giant nerve fiber have shown however that this is not the case (see Fig. 4 and also

⁶ A. L. Hodgkin and A. F. Huxley, "Resting and action potentials in single nerve fibers," *Jour. Physiol.*, vol. 104, p. 176; October, 1945.



(a)

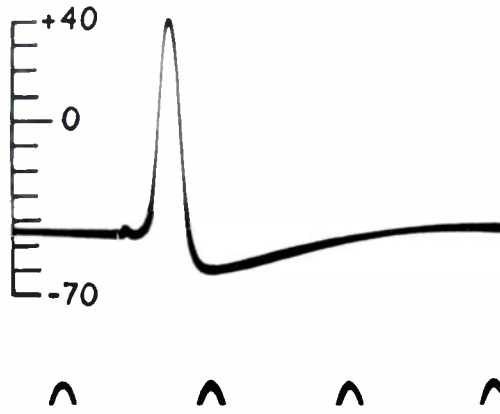

(b)

Fig. 4—(a) A photograph of a glass tube electrode inserted into the giant axon of the squid. (b) The potential difference between the interior and exterior of the nerve fiber at rest is about 45 millivolts, inside negative. An electric stimulus then sets off a response which travels along the nerve and is recorded when it arrives at the insertion electrode. This response has the typical form shown. At its peak the outside electrode appears to be about 35 millivolts negative to the internal electrode. Time line, 500 cps. (From A. L. Hodgkin and A. F. Huxley, "Resting and action potentials in single nerve fibers," *Jour. Physiol.*, vol. 104, p. 176; October, 1945.)

Fig. 6(a)). The potential of activity (the spike) recorded in these experiments is considerably (30 millivolts) higher than the resting potential difference, as if the membrane in activity underwent a temporary reversal of its polarity, becoming polarized negatively on the outer side in the active region. The explanation of this phenomenon seems to lie in complex changes of the membrane permeability. During activity, the membrane appears to become about 500 times more permeable to Na^+ than it is at rest.⁷ Experiments by the writer and his colleague, Nachmansohn, using radioactive tracer elements have confirmed this.⁸ In the resting nerve the

membrane acts essentially as a K^+ electrode recording the fact that there is more K^+ on the inside than on the outside. During activity, the membrane acts like a Na^+ electrode and records the reverse concentration ratio that prevails as regards Na^+ ions.

The electronic requirements for measurements of potentials across the membrane such as are shown in Fig. 4 are interesting.

1. The resistance of the membrane and of the fine insertion electrode is very high, of the order of megohms. Hence, very large grid-leak resistors are used, or none at all.

2. Small currents, of the order of 10^{-8} to 10^{-9} amp, flowing through the membrane change its properties. Hence, the grid current of the input stage must be of the order of 10^{-10} amp and preferably less.

3. The electrical activity develops very rapidly; hence, the amplifier must have a rise time of 10 microseconds or less, despite the high input resistance.

4. To measure the steady (resting) potential difference across the membrane required a dc amplifier, but in this particular application the sensitivity can be quite low, since the input signal is of the order of 50 to 100 millivolts.

FORM OF THE BIOELECTRIC POTENTIAL

The transient response of a nerve or muscle fiber during activity has the general form shown in Fig. 4, but there are some differences among different nerves, and these indeed form one basis for classifying nerve fibers. Thus, in the mammals, there are known to be 3 different types of nerve fibers. The rapid transient responses (spikes) of each type are shown in Fig. 5. The

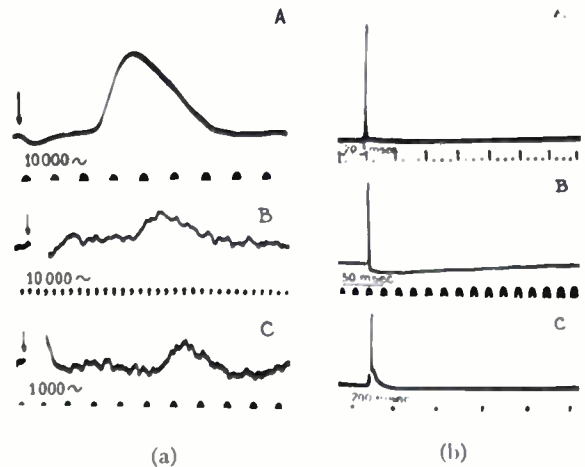

Fig. 5—Action potentials of the three different kinds of mammalian nerves. (a) The spikes of single nerve fibers of the three groups. (b) The action potentials of the three groups. Amplification has been adjusted so that the spikes are approximately the same heights to show relation magnitudes of the after potentials. Note the different time bases. (Composite from H. S. Gasser and H. Grundfest, "Action and excitability in mammalian A fibers," *Amer. Jour. Physiol.*, vol. 117, p. 113; September, 1936. H. Grundfest, "Properties of mammalian B fibers," *Amer. Jour. Physiol.*, vol. 127, p. 252; September, 1939; and H. Grundfest and H. S. Gasser, "Properties of mammalian nerve fibers of slowest conduction," *Amer. Jour. Physiol.*, vol. 123, p. 307; August, 1938.)

⁷ A. L. Hodgkin and B. Katz, "The effect of sodium ions on the electrical activity of the giant axon of the squid," *Jour. Physiol.*, vol. 108, p. 37; March, 1949.

⁸ H. Grundfest and D. Nachmansohn, "Increased sodium entry into squid giant axons during activity at high frequencies and during reversible inactivation of cholinesterase," *Fed. Proc.*, vol. 9, p. 53; March, 1950.

larger nerve fibers that carry messages into the nervous system and orders from the nervous system to voluntary muscles are called *A* fibers and have spikes of about 0.45-millisecond duration, roughly triangular in shape, with the peak at about one third of the total duration. The rise time of the spike is then about 150 microseconds and for its accurate recording the amplifier should have a rise time of about 15 microseconds. A group of smaller *B* fibers produces spikes of about 1.2 milliseconds total duration but of otherwise essentially similar form. These fibers chiefly carry messages from the central nervous system to the autonomic ganglia and relay them into the very small *C* fibers which control involuntary activity of the body, such as rate of the heart beat, constriction of blood vessels, activity of various glands and the viscera. The spike of the *C* fibers lasts about 2.5 milliseconds, but again has a form similar to that of the *A* and *B* spikes. The records of the *B* and *C* spikes demonstrate the requirement of the amplifier as to sensitivity. The potentials recorded are about 10 microvolts in amplitude. They are therefore near the range of noise level of the amplifier which was about 3 microvolts, whereas the potential recorded from the larger *A* fibers was about 100 microvolts. It is likely that all nerve fibers generate potentials of about the same magnitude, and the fact that small fibers produce small potentials is inherent in the physical properties of the physiological

longitudinal resistance is also high and becomes increasingly so for the smaller fibers. (If the inside of the nerve fiber is assumed to have the conductivity of 0.9 per cent NaCl, a tube of 2- μ diameter and 1 cm long will have a resistance of 2,700 megohms.) R_e , on the other hand will be small because it is usually composed of all the inactive tissue surrounding the fibers, since it is usually quite difficult to dissect out intact a single small nerve fiber from a nerve bundle containing thousands or ten of thousands of fibers. Typically R_e may be of the order of 25,000 ohms per cm. From the equivalent circuit it will be seen therefore that a 100-millivolt potential produced by the bioelectric generator will result in a recorded potential of only 1 to 100 microvolts under the conditions given in the diagram.

In addition to the rapid transient spike of their activity, nerves produce a slower sequence of potentials as shown in Fig. 3(b). Again the different groups of fibers have characteristic differences as to form of the sequence, its magnitude (measured relative to the spike height) and its duration. It will be seen that the *A* and *C* fibers produce a small negative tail and a longer lasting positive undershoot, while in *B* fibers only the positive undershoot is normally observed. The duration of this sequence has an important bearing on amplifier design for it will be noted that in *C* fibers it lasts nearly one second. Actually, under conditions of repetitive activity the late potentials are prolonged and may last one minute or more. Hence, in studies of this phase of bioelectric activity, direct-coupled amplifiers are obligatory, but unlike the earlier example of the use of dc amplifiers the slow potentials recorded here are below 100 microvolts in amplitude and the dc amplifiers must have high sensitivity—a demand which works against the requirement of stability during the period the potentials are produced and are being measured.

Returning to the diagram and equivalent circuit of Fig. 6 it will be of interest to mention that the membrane, in addition to its resistance, also has a rather high capacity as in Fig. 6(b). This makes the nerve quite similar in its electrical properties to a high-resistance, high-capacity transmission line like the transoceanic submarine cables. A current pulse impressed on the nerve as in Fig. 7 will be distorted and distributed not only between the electrodes but will also flow in the extrapolar regions to both sides of the electrodes. The magnitude of this current flow and the distortion of the impressed transient step function obey the cable equations first developed by Kelvin in 1858. In recent years studies of these phenomena have been used to derive the values of resistive and capacitive components of the nerve fiber. Instrumental requirements call for a dc amplifier of moderate sensitivity and rapid rise time.

During activity of the nerve fiber the membrane resistance undergoes a very marked drop.⁹ This decrease is

⁹ K. S. Cole and H. J. Curtis, "Electric impedance of the squid giant axon during activity," *Jour. Gen. Physiol.*, vol. 22, p. 649; May, 1939.

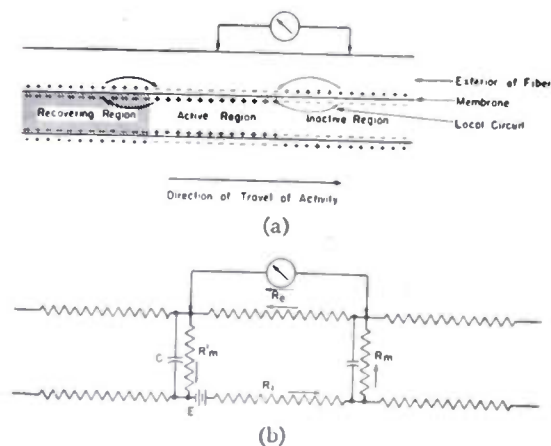

Fig. 6—(a) Diagram of the local circuit established at an active region of a nerve. (b) The equivalent circuit of (a).

R_i = resistance of the axoplasm

R_e = resistance of the external, inactive tissue.

Resistance of the membrane at an inactive region is R_m and at an active region it is R_m' .

C = membrane capacity

E = internal generator. (Strictly, this should be in series with the membrane.)

system (see Fig. 6(a)), which becomes apparent on considering its equivalent circuit (see Fig. 6(b)). The current produced by the generator within the nerve fiber flows, as shown in Fig. 6(a), from the interior of the fiber, out through the membrane, along the exterior, and again through the membrane. In other words, the region of activity is a sink for the bioelectric generators. R_m is quite high and becomes higher the smaller the fiber (since the current flows radially through a surface). The

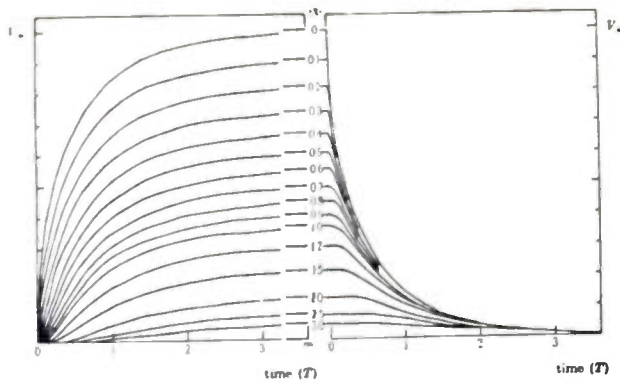

Fig. 7—A rectangular pulse is applied to a nerve fiber at $T=0$ (left) and is broken at $T=0$ (right). The rise of the pulse is distorted by the capacities of the tissue. Like in the submarine cable the pulse rises more slowly and to a lower height the farther along the network it is recorded ($+x$). Time T and distance X are in analytical units, referable to actual time and distance. The curves represent calculated values which are closely approximated experimentally. (From A. L. Hodgkin and W. A. H. Rushton, "The electrical constants of a crustacean nerve fibre," *Proc. Roy. Soc. (London)*, vol. 133B, p. 444; December, 1946.)

probably associated with the already-mentioned transient increase in the permeability of the membrane to Na^+ ions. Measurement of the resistance drop have been made by using a high-frequency ac bridge. Fig. 8 shows a double-exposure cathode-ray-oscillograph trace. One shows the spike produced on stimulating a giant single

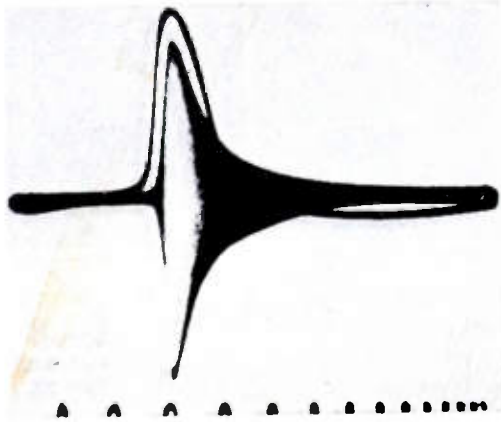

Fig. 8—Impedance change in the nerve during activity. Time in 1,000 cps. (From K. S. Cole and H. J. Curtis, "Electric impedance of the squid giant axon during activity," *Jour. Gen. Physiol.*, vol. 22, p. 649; May, 1939.)

axon of the squid. The other shows how an ac bridge balanced for the resistance of the same axon at rest becomes unbalanced during the spike because the resistance of the membrane has changed during activity. In the equivalent circuit of Fig. 6(b) this is indicated by the two values of R_m and R_m' .

INITIATION AND PROPAGATION OF THE NERVE IMPULSE

It was stated earlier that nerve impulses can travel at a rate as high as 100 meters per second but nothing has been said as yet as to what starts the nerve impulse. It is likely that all nerve impulses start through electrical stimulation. For example, a light falling upon the retina

of the eye sets up a fairly large retinal potential and it is probable that deformation of skin sensory reception also produces potentials somewhat like those produced by piezoelectric effects. Such potentials changes could readily stimulate a nerve, for an applied current of 10^{-5} amperes flowing through the nerve membrane for 10^{-4} second (hence, 10^{-9} coulomb of electricity) can stimulate a nerve fiber. Excitation occurs most readily at the cathode of the stimulating electrode. Once this stimulation has taken place, leading to a membrane change and a flow of current as described in Figs. 3, 4, and 6, the local circuit established through the nerve acting as a generator is now able (see fig. 6(a)) to excite neighboring regions. Their activity, in turn, will stimulate still other adjacent regions and so the impulse that arose as a result of a local electrical excitation is propagated along the nerve fiber. The mode of propagation is obviously not that in an electric cable system but is more like the transmission of a flash along a fuse of gunpowder, where local thermal changes progressively set off similar changes in neighboring grains of powder. As in a gunpowder train, where a stretch of wet powder will block transmission, a region of damaged nerve will also prevent propagation of the nerve impulse. Also, as in the fuse, the rate of propagation of the nerve is much slower than in electrical transmission. It depends among other things upon the temperature of the nerve so that in frogs at about 20°C the velocity is about 4 times as low as in mammals at 37°C .

In the best studied cases (mammalian A fibers) the rate is also a function of the diameters of the conducting fibers, so that a fiber of 20μ will conduct at about 120 mps while a $5\text{-}\mu$ fiber conducts at about 30 mps. Thus if a strong enough stimulus is given to a nerve to set all the fibers off into activity, the impulses in those fibers conducting more slowly will tend to lag behind more and more as the impulses travel away from the point of origin (see Fig. 9). Since in the human, some nerve fibers may be as long as 2 meters from the toes up to the base of the brain, this time difference may have an important physiological function in deciphering sensory data. A 100-mps impulse would arrive within 20 milliseconds while a 1-mps impulse would take 2 seconds.

Measurements of the conduction velocities are important also in the central nervous system. Impulses travel up and down the spinal cord in various tracts (see Fig. 10) which constitute rather specific trunk lines terminating on any given group of cells within the central nervous system, but, unlike the case in communication networks, the signals are always rather similar spikes carried by the individual fibers. The co-ordination of these signals must therefore be chiefly by the differences in the times of arrival of the different signal groups. An interesting example of such message discrimination has been worked out. Two closely juxtaposed tracts in the spinal cord carry messages up from the lower extremities. One (fasciculus gracilis in Fig. 10) carries them without relay directly from the extremity to the base of

the brain (medulla) where a relay occurs. Another is activated by impulses carried in the dorsal column relayed to the cells which originate the fibers of the dorsal spinocerebellar tract.¹⁰ In the relay about 0.5 millisecond is lost. But the fibers of this tract are considerably larger than are the biggest fibers of the dorsal columns. Hence their conduction velocity is greater (see Fig. 11) and they reach their termination in the cerebellum some milliseconds before other sensory messages arrive at the cerebral cortex.

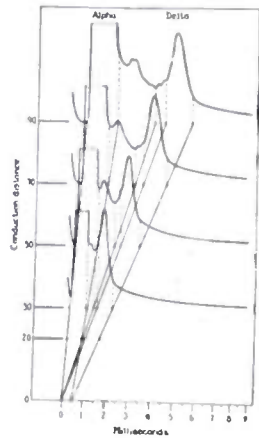

(a)

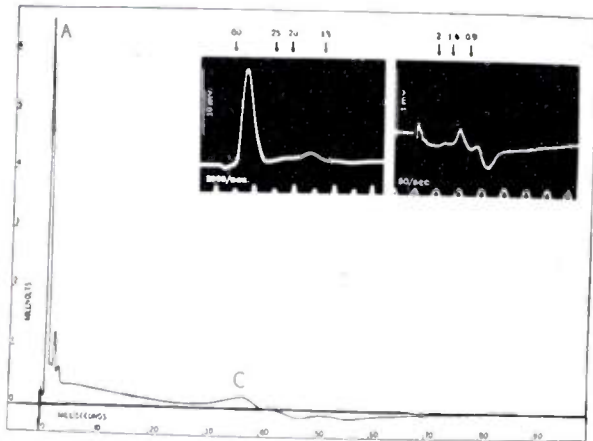

(b)

Fig. 9—The potential of a mammalian nerve (cat saphenous) is made up of component spikes of different velocities. As in a cross-country race, the longer the distance the impulses travel, the greater becomes the separation between the faster and the slower components. (a) The change in the form of the fast A spike with greater conduction distances is shown on amplified records. Straight lines connect the times of onset and end of several of the components. Their slopes give the conduction velocities. (From H. S. Gasser and H. Grundfest, "Axon diameters in relation to spike dimensions and the conduction velocity in mammalian A fibers," *Amer. Jour. Physiol.*, vol. 127, p. 393; September, 1939. (b) Drawing of the spikes of fast A and slow C conduction velocity on a single set of co-ordinates. Inserted are the oscillographic records from which the drawing was made, with the conduction velocities of different components indicated. (From J. F. Fulton, "Howell's Textbook of Physiology," 16th ed., Saunders, Philadelphia, Pa.; 1949.)

¹⁰ This terminology is not formidable. It says that a tract located in the dorsal (top, or in the human, the back) half of the spinal cord carries impulses from the spinal cord to the cerebellum, which is one of the divisions of the brain.

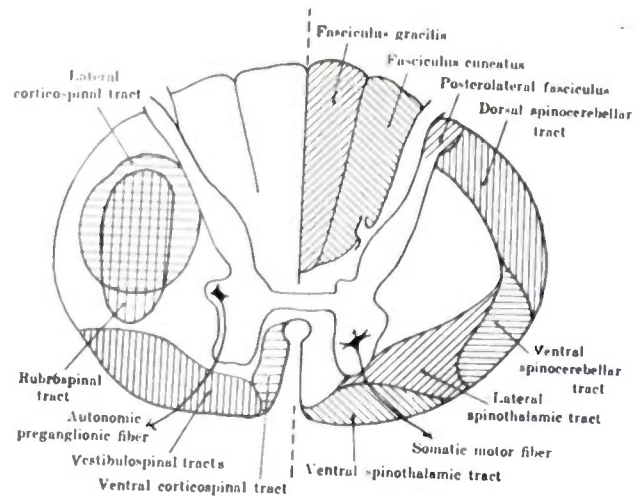

Fig. 10—Diagram of the principal tracts (fasciculi) of the spinal cord. (From F. A. Mettler, "Neuroanatomy," 2nd ed., The C. V. Mosby Co., St. Louis, Mo.; 1948.) On the right are tracts carrying impulses to the higher centers. On the left are shown the principal tracts descending from the higher centers.

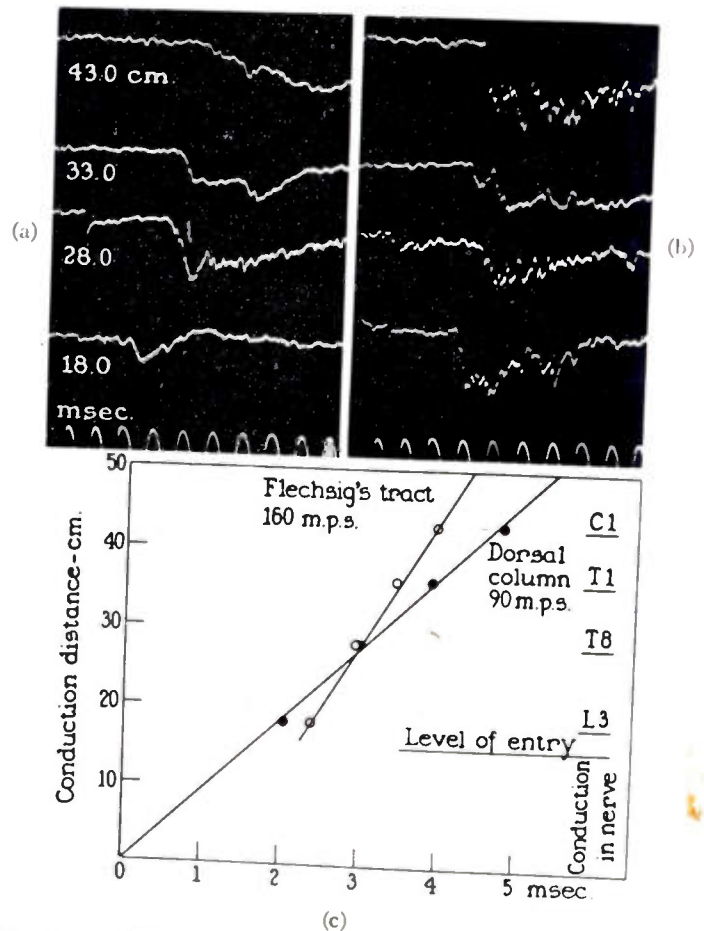

Fig. 11—(a) Potentials recorded from the fasciculus gracilis (also called Dorsal column), and (b) dorsal spinocerebellar tract (also called Flechsig's tract), in the cat at different distances in the spinal cord in response to a single electrical stimulus to a hind limb nerve. (c) Plot of the times at which the two responses arrive in the same levels of the spinal cord. The slopes give the conduction velocities. It is seen that the dorsal spinocerebellar impulses start about 0.5 millisecond later because they are produced by a relay after the nerve has entered the spinal cord. However, they overtake the impulses in the fasciculus gracilis and forge ahead. (From H. Grundfest and B. Campbell, "Origin, conduction, and termination of impulses in the dorsal spinocerebellar tract of cats," *Jour. Neurophys.*, vol. 5, p. 275; July, 1942.)

The records of potentials in Fig. 11 indicate another requirement for bioelectric amplifiers, for they represent pickups of different potentials occurring about 1 mm away from each other. The amplifier and electrode systems must be free from "cross talk" or there will be no possibility of localizing and discriminating these different activities.

Another type of discrimination required is that against extraneous potential fields. The relatively high impedance of the tissue and electrodes, the mass of the tissue (particularly where records are made from the entire animal, as in Fig. 11) with its consequent coupling to ground, and the small amplitudes of the recorded potentials make pickup of larger signals from extraneous potentials (ac, high-frequency commutator ripple in dc lines, and the like) extremely likely.

A third type of spurious signal is also often introduced since many experiments call for electrical stimulation of the nervous tissue. This usually takes the form of relatively short pulses, but of high amplitude—sometimes of 20 to 50 or more volts, which are supplied to nerves or the central nervous system close to the position of the pickup electrodes. Frequently, conventional RC amplifiers will be blocked by this pulse and the desired signal will be entirely lost in the recovery time of the amplifier.

A number of differential amplifier designs were therefore developed to overcome these difficulties. They are all based on the principle of having a reference electrode on inactive (or relatively inactive) tissue in addition to an active pickup electrode and a real or virtual ground electrode. The earliest of the amplifiers¹¹ employed two symmetrical amplifiers for the active and reference electrodes. An extraneous potential should be picked up by the two electrodes as a common-mode (or, in-phase) signal. If perfect symmetry were built into the amplifier, the output terminals would rise equally and in the same sense for these signals, whereas a signal at the active electrode (i.e., out-of-phase signals at the two pickup electrodes) would be amplified in opposite sense. The recording instrument would not respond to the former but would indicate the latter signals.

An obvious difficulty is the requirement for symmetry. A decided improvement was made by Offner¹² who inserted a high common resistor into the input cathodes, producing degeneration for in-phase but not for out-of-phase signals. This type of amplifier ("long-tailed pair") is used at present for electroencephalography as well as for research in electrophysiology. It has the great merit of all push-pull amplifiers in being relatively insensitive to power supply variations. Differential action [defined as $D = (E_{sig}/E_{extr})$ to produce a given output] is however dependent upon the magnitude of the common re-

sistor according to the relation $D = 1 + (A Rk/RL)$. A high order of differential action is possible only with prohibitively high cathode resistors. Differential action is considerably dependent upon the tube characteristics, particularly upon equality of gain in the symmetrical tubes. In some of his present circuits, Offner uses a single-envelope double triode in the first-stage pair and pentodes in the second stage. The screen current of this second-stage pair is returned to the resistor of the input-tube cathodes to increase common-mode degeneration. Other makes of eeg amplifiers use common cathode resistors in several stages. The differential ratio obtained is usually of the order of one to several thousand, particularly for low frequencies of common-mode signal, giving adequate rejection of ac line pickup.

Goldberg¹³ has substituted a pentode for the common cathode resistor Rk . In this circuit the low static resistance of the pentode allows a reasonably low voltage drop from the cathode current. To changing current, however, the pentode presents a high dynamic resistance and hence a high degree of degeneration for in-phase signals. With two such degenerative stages Goldberg has obtained a differential ratio of 1 to 100,000, but it is very likely that this ratio holds only for very low frequencies, since the high ac impedance of the pentode would discriminate against differential action at higher frequencies. An adaptation of this circuit which also incorporates a number of subsequent design improvements is described in the literature,¹⁴ which also provides an excellent discussion of some design problems and an extensive bibliography.

In 1936 Toennies¹⁵ developed a form of differential amplifier which uses a cathode-follower coupling tube to the cathode of a single-ended amplifier stage. This circuit appears to have been rediscovered by the radar workers and its theory is well treated in the literature.² Toennies pointed out¹⁴ that a pentode cathode follower will be more effective in differential formation and that an additional simple correction network can be used to improve differential action still further. A discussion of the theory of this type of differential amplifier is provided in the literature.² A more detailed general analysis is now under way,¹⁶ which is leading to the development of new circuits. This analysis and its results are at present being tested experimentally at our laboratory.

The Toennies differential input stage is relatively insensitive to many of the circuit parameters and its

¹¹ H. Goldberg, "Bioelectric research apparatus," Proc. I.R.E., vol. 32, p. 330; June, 1944.

¹² P. O. Bishop and E. J. Harris, "D.C. amplifier for biological applications," Rev. Sci. Instr., vol. 21, p. 366; April, 1950.

¹³ J. F. Toennies, "Differential amplifiers," Rev. Sci. Instr., vol. 9, p. 95; March, 1938. The paper describing this amplifier was held up by an editor who did not believe the very conservative claims made there as to magnitude of differential action. Hence it was not published until after two other papers on differential amplifiers had appeared. See footnote reference 11 as well as O. H. A. Schmitt, "A simple differential amplifier," Rev. Sci. Instr., vol. 8, p. 126; April, 1937.

¹⁶ Personal communication to the author from Ernest Amatneek.

¹¹ B. H. C. Matthews, "A special purpose amplifier," Jour. Physiol., vol. 81, p. 28P; May, 1934.

¹² F. F. Offner, "Push-pull resistance coupled amplifiers," Rev. Sci. Instr., vol. 8, p. 20; January, 1937.

single-sided output is then amplified as needed by a conventional single-sided amplifier. A very compact, and reliable 2-channel RC amplifier designed as a preamplifier to work into the DuMont type-279 double-beam oscillograph is shown in Fig. 12. It has a deflection sensitivity of about 200 μV peak-to-peak for the face of the

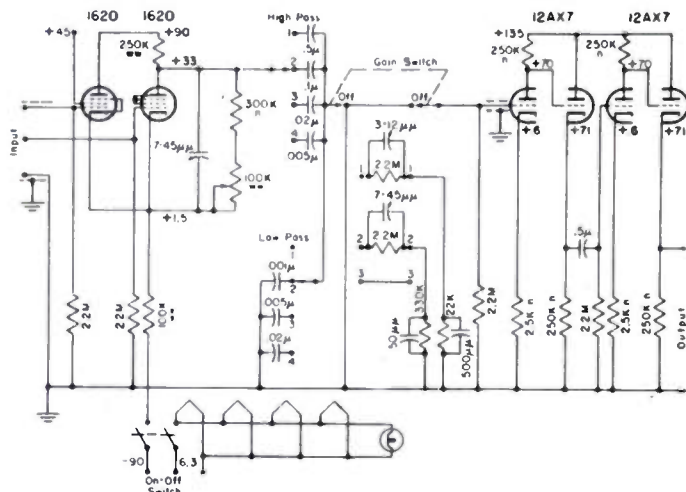

Fig. 12—Circuit diagram of a simple but very effective RC amplifier for bioelectric research. The first stage is a Toennies differential circuit. The output is designed to couple capacitively into one channel of a DuMont type-279 oscillograph. Batteries are used for heater and power supplies.

tube and a flat response from about 0.5 to 20 kc. This amplifier is used on a portable oscillographic unit shown in Fig. 13. It is frequently operated at full gain in an unshielded laboratory, with fine tipped pickup electrode on large animals and with various ac-operated equipment (stimulators, heaters, pumps, and the like) needed for the experiments close to the animal. The precautions needed are high differential action, all ac cables shielded and equipment grounded, and a heavy individual ground lead direct to earth.¹⁷ The type of amplifier shown in Fig. 12 is quite adequate for most physiological work except that requiring dc amplification.

Direct-current amplifiers present two problems that are absent with RC coupling:

1. Coupling into the grid of one stage from the high positive level at the plate of the previous stage, and
2. Instability of the base line.

The first problem can be solved in various ways,¹⁸ but the best require the use of a negative return supply as

¹⁷ Various laboratories report serious difficulty with pickup of television or FM signal components. I have not experienced such troubles, but whether because of the design of our amplifiers or because of a fortunate location (at the Rockefeller Institute and presently at the College of Physicians and Surgeons, Columbia University, New York, N. Y.) I do not know. One additional precaution as to grounds is that closed ground loops must be avoided in order to prevent induced pickup from magnetic fields. Hence, shields should be grounded only at one point.

¹⁸ H. Grundfest, "A stable line operated D.C. amplifier," Presented, AIEE-IRE Conference on Electronic Instrumentation in Nucleonics and Medicine, New York, N. Y., October 31, 1949.

well as the conventional positive supply. The coupling method we employ extensively uses a cathode follower returned to the negative supply. The cathode load is suitably divided to obtain a lead-off point at, or close to, zero potential. Its use is illustrated in the circuit of Fig. 14.¹⁹

The second problem, as yet only partly solved, is due to the fact that any voltage changes in the amplifier system, whether they be shifts in electrode potential heater voltage, cathode emission, plate supply variation, or changes in the value of components, are transmitted to subsequent stages.¹⁸ All the changes at the in-

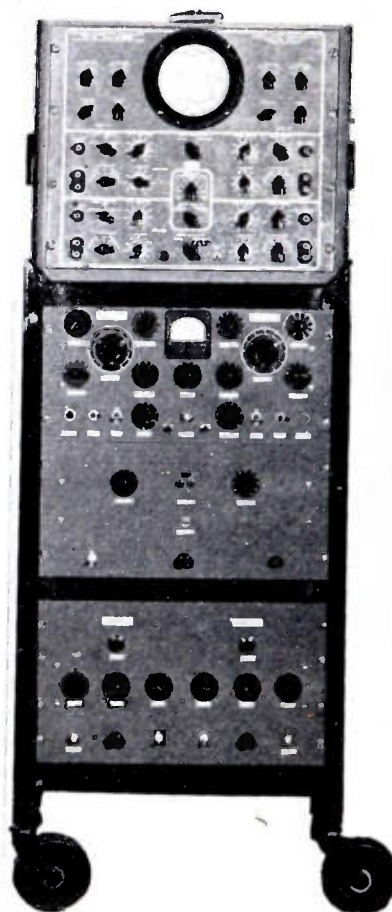

Fig. 13—Photograph of a complete portable unit for bioelectric research. The dual channel preamplifier with the circuit shown in Fig. 12 is mounted at the lowest level. Above, in order, are the power supply and timer-calibrator chassis, and a dual-channel stimulator unit. The timer-calibrator provides a bridge-stabilized oscillator at 10, 100 and 1,000 cps with peak-to-peak signals from 10 microvolts to 1 volt available at the output jacks. The power supply for the oscillator and stimulator is electronically regulated. The stimulator (upper chassis) can be set at repetition rates from one in 5 seconds to 200 per second. The oscillograph sweep can be driven at these rates. The two channels of stimuli are square pulses independently variable in widths from 0.1 to 20 milliseconds. Each can be delayed as desired after the sweep start. The output of each can be set by a voltmeter which is built into the chassis. Maximum output is 50 volts at 150 ohms with three ranges: 0 to 5, 0 to 15, and 0 to 50 volts.

¹⁹ This type of coupling was introduced into our circuits by Toennies in 1936.

put circuit (grid-to-ground, ground-to-cathode) are amplified by the entire amplifier and are therefore the most important. Changes in the plate circuit of the first stage and in the grid-cathode circuit of the second stage are already smaller than the former at least by the amplification factor of the first stage. Hence they are less decisive.

In biological work a limit is set on observation of a long-time character by the fluctuation in contact potential of the tissue and the pickup electrodes. These are of the order of 50 microvolts or more and unpredictable in their course. The amplifier must therefore introduce grid-cathode variations no larger, and preferably smaller, than 50 microvolts for the interval to be measured. In our designs we have arbitrarily settled upon a one-minute time interval.

A very formidable problem comes up in the heater supply, since cathode potential variation appears at the output amplified by the stage gain. It should be noted that the Toennies type of amplifier possesses intrinsic compensation against heater supply variation,²⁰ as does the double-ended amplifier.

Since the grid-cathode variation, given here an upper limit of 50 microvolts per minute, is amplified at the first stage (let us say by a factor of 20), variations in the output after that stage should be smaller than 20×50 microvolts, or 1 millivolt. This requires that tube emissions (assuming an output level of 100 v at 1 ma) remain steady to better than 1 part in 100,000; that the load resistor (here assumed as 100K ohms) also vary less

than 1 part in 100,000 and that the plate supply be steady also to approximately 1 part in 100,000. These are severe requirements, and it is surprising that they can be met as satisfactorily as they have been in practice.

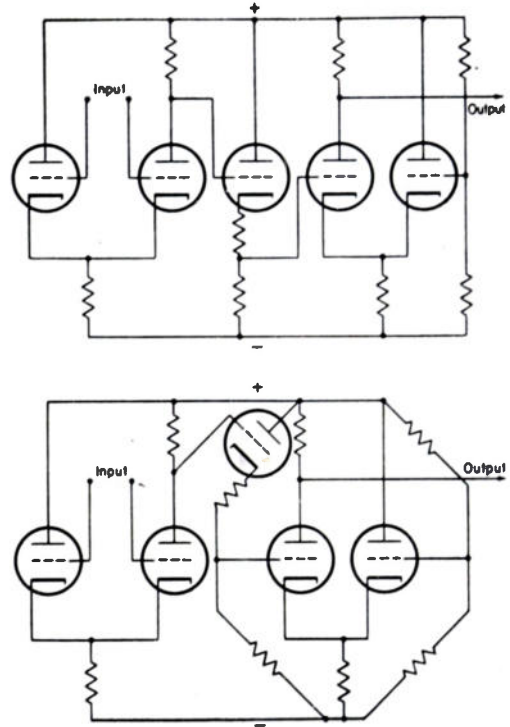

Fig. 15—The bridge arrangement of the Toennies differential amplifier to minimize drifts produced by power supply variation, as used in stages 2 and 3 of Fig. 14.

²⁰ See p. 462 of footnote reference 2.

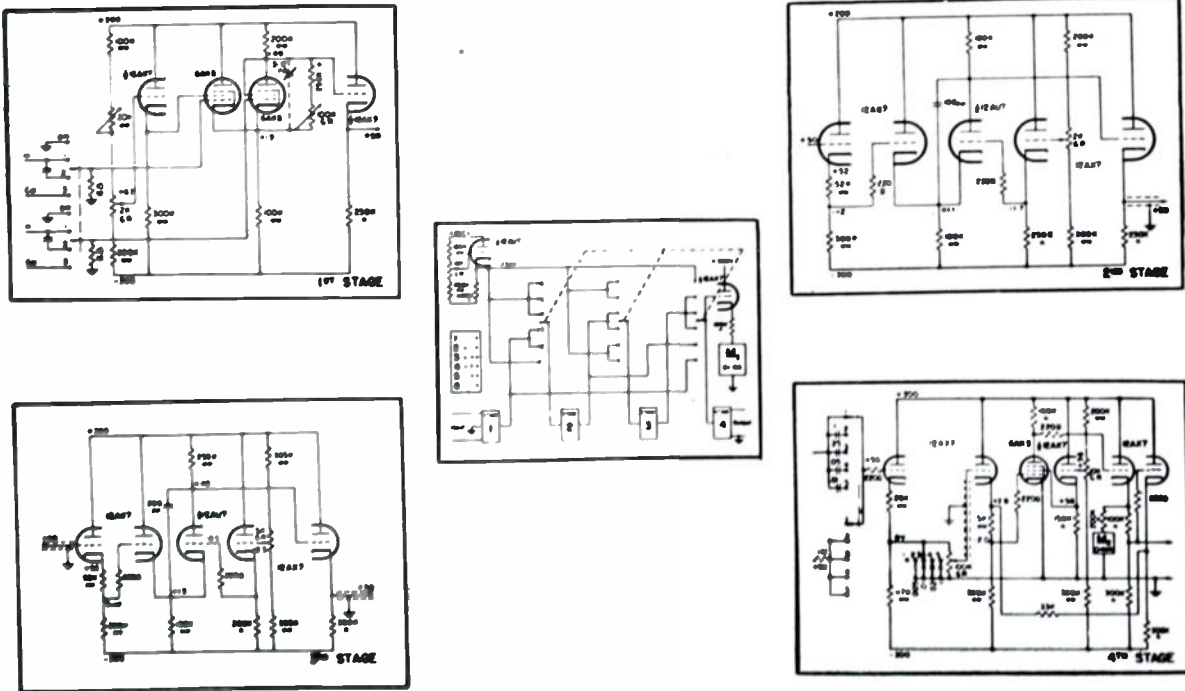

Fig. 14—The circuit of a completely line-operated dc amplifier. Each stage is shown separately with the switching circuit for coupling the various combinations.

The requirement as to plate supply stability (approximately 1 millivolt in 100 volts) is difficult to meet, although it can be attained. Simpler solutions have, however, been found. The symmetrical amplifiers described above, like all push-pull amplifiers can tolerate a much larger E_b variation. For the Toennies differential stage a bridge-balancing arrangement has been devised by Schoenfeld, which balances out a variation of 10- to 20-fold the minimum requirement.

Because of the necessity to control closely plate and heater supply variations, earlier dc amplifiers were entirely battery operated. A circuit designed by Toennies in 1935 was used by the writer at the Rockefeller Institute for many years. These amplifiers are still in use, have high gain and are very reliable. Their major disadvantage is the size and number of heavy-duty batteries

used, so that one amplifier channel occupies an entire relay rack.²¹

We have recently developed a completely line-operated, high-gain dc amplifier which is considerably less bulky, and permits 3 channels of amplifiers to be mounted in a single rack. The performance of this amplifier and its circuit characteristics are described in the literature.¹⁸ Fig. 14 shows the circuit.

One feature of this amplifier is the use of the balancing circuit mentioned earlier. The second and third stages of the amplifier have the bridge form shown in Fig. 15 which compensates to a large degree for plate supply variation. Two units built so far have a drift of 20 and 40 microvolts per minute, respectively, referred to the input, are flat to 20 to 30 kc, and have a differential formation ratio of 1 to 100,000 or better.

²¹ These amplifiers were additionally provided with a pair of cathode-follower impedance transformers which were brought out from the

chassis and could be placed close to the pickup leads. Like many other uses of cathode followers, this was employed by Toennies in 1936.



Effects of Intense Microwave Radiation on Living Organisms*

JOHN W. CLARK†, MEMBER, IRE

Summary—A search for deleterious effects upon animals exposed to intense microwave radiation was made and definite damage to the eye and to the testicle was found. Ten centimeters proved to be the most dangerous wavelength. The effects observed could be accounted for by the elevated temperatures produced by absorption of microwaves in the organism. A theory is presented in which these temperatures are calculated; fair agreement with experiment was obtained.

This work demonstrates the need for caution on the part of those who work with intense microwave sources, and for the establishment of standards for the protection of personnel exposed to such radiation.

The observations which are discussed below are made up of material most of which either has been or will be published elsewhere. The results are so important to radio engineers, however, that the writer feels justified in rewriting them for publication in PROCEEDINGS OF THE I.R.E., particularly since many of these results would otherwise appear only in the medical literature and would not be brought to the attention of the average radio engineer. A preliminary report on this work¹ was published early in 1949.

* Decimal classification: R594X537.87. Original manuscript received by the Institute, March 17, 1950. Presented, 1950 IRE National Convention, New York, N. Y., March 9, 1950.

† Varian Associates, San Carlos, Calif.; formerly, Collins Radio Co., Cedar Rapids, Iowa.

¹ W. W. Salisbury, J. W. Clark, and H. M. Hines, "Exposure to microwaves," *Electronics*, vol. 22, pp. 66-67; May, 1949.

INTRODUCTION

IT IS WELL KNOWN that all forms of intense radiation have effects upon living organisms which are exposed to them. These effects are almost invariably harmful. The damage to people exposed to X rays, gamma rays, and neutrons is now well known, although early workers in these fields were seriously injured or even killed before these facts became generally understood. Prolonged exposure to intense ultraviolet or infrared radiation is also dangerous. The wartime development of high-power microwave radar led to considerable speculation concerning possible danger to personnel exposed to these radiations. A number of experiments were performed upon animals exposed to radiations from various radar sets, and personnel engaged in operation or maintenance of radar sets were subjected to careful and continuous observations by doctors.^{2,3} No effects were found; it would be pointless

² L. E. Daily, "A Clinical Study of the Results of Exposure of Laboratory Personnel to Radar and High Frequency Radio," U. S. Naval Medical Bulletin XLI, pp. 1052-1065; July, 1943.

³ B. I. Lidman and C. Cohn, "Effect of Radar Emanations on the Hematopoietic System," Air Surgeon's Bulletin II, pp. 448-449; December, 1945.

to go into a detailed analysis of the reasons these early investigations discovered no damage.

In spite of these negative results, we at Collins Radio Company felt it advisable to look a little deeper into this matter since we are concerned with the development of transmitters developing larger amounts of continuous power at extremely high frequency than has previously been done. A joint project was set up between the Research Division of Collins Radio Company and the Department of Physiology at the State University of Iowa. The objective of the project was simply to discover what, if any, physiological effects might arise from exposure to intense microwave radiation. It was not at all clear at the beginning of this work what effects should be looked for. The well-known effects of exposure to intense X radiation are damage to the skin and to the mechanism which manufactures red blood corpuscles. Both of these effects had been sought for earlier and had not been found.

A systematic program of exposure of laboratory animals to microwave radiation at various frequencies and power levels was set up, and pathological conditions of all kinds were sought. The principal effect of this exposure appeared to be heating. With this clue as a starting point, we observed especially the effects of these radiations upon the parts of the body which are either particularly vulnerable to heat or particularly easily heated. Examples of such structures are the eye, some of the internal body cavities, and the testicle. Definite damage to these structures as a result of exposure to rather modest amounts of power at microwave frequency has been demonstrated. I should like to emphasize again that this damage is entirely due to the heat generated as a result of the absorption of microwave energy by the body's tissues and is not due to any mysterious property of the microwave radiation as such.

EXPERIMENTAL RESULTS

Fig. 1 is a photograph of the eye of an experimental rabbit. Rabbits were used for this work since their eyes are very nearly the same size and shape as those of

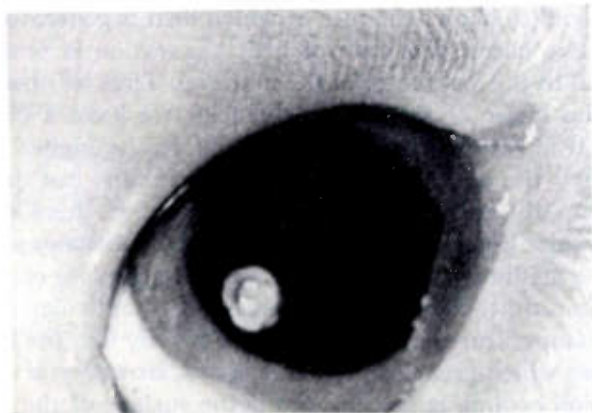

Fig. 1—Cataract induced in the eye of a rabbit by exposure to microwave radiation.

humans. The white, cloudy growth is a cataract of the lens, produced by a 10-minute exposure to about 100 watts of power at 12 cm wavelength. One does not have to be an ophthalmologist to recognize that a growth of this type will seriously impair vision. These growths have the further unfortunate property that once started they continue to become larger unless they are removed by an operation.

Fig. 2 shows a plot of the measured temperature within the eye ball. Note the difference in shape between the curves for the two different wavelengths. This plot clearly explains the formation of the cataract just shown. It will be observed that for 12 cm wavelength the highest temperature occurs near the back surface of the lens. The lens is constructed of protein

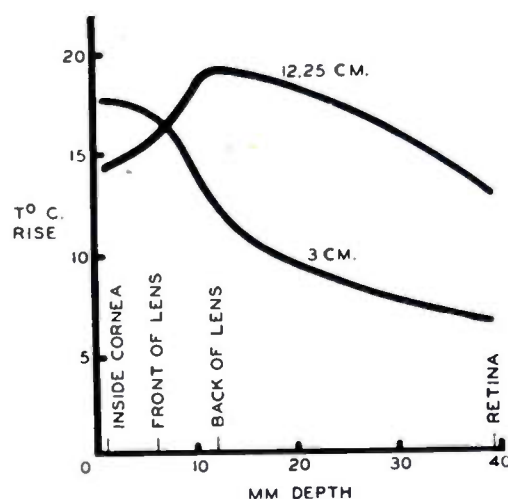

Fig. 2—Temperature distribution in the eye during irradiation.

which is very easily damaged by heat. The process is somewhat analogous to that of boiling an egg. The white substance which is referred to as cataract is similar to boiled egg white and is obviously not very useful for looking through. This particular type of damage has the interesting property that it does not become apparent immediately after exposure of the animal. A delay varying from a few hours to as long as a week between the time of exposure and the appearance of visible evidence of damage has been observed. This fact may account for the failure of some earlier workers to observe damage of this type. A detailed report on this work is given in the literature.⁴

Fig. 3 shows cross sections of the testicular structure of a rat. The one on the right has been exposed to microwave energy while the one on the left is normal. Again, one does not have to be a doctor to recognize that something rather disastrous has taken place here. Temporary or even permanent sterility can be caused by

⁴A. W. Richardson, T. D. Duane, and H. M. Hines, "Experimental lenticular opacities produced by microwave irradiations," *Archives Phys. Med.*, Vol. 29, pp. 765-769; December, 1949.

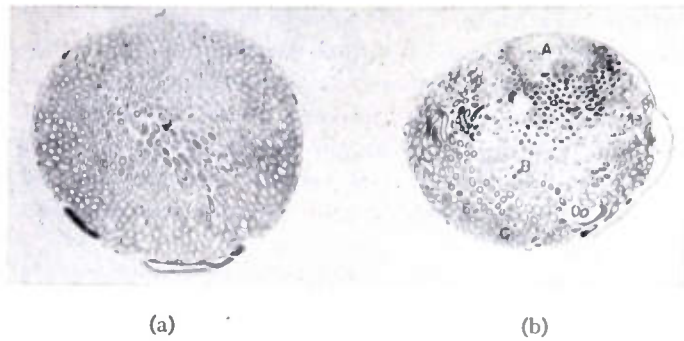

Fig. 3—Testicular structure of a rat. (a) Normal. (b) Irradiated.

rather moderate exposure to microwave radiation. This work is described in detail in the literature.⁵ Damage to the reproductive tissue is to be viewed with particular concern as some geneticists now believe that radiation far below the level which causes physiological damage may cause genetic damage that will not become apparent for several generations.⁶

No instances are as yet known in which human beings have been injured in any way by exposure to microwave radiation. This is probably because the sensation of pain will usually give warning and prevent excessive exposure. One must realize, however, that neither the eye nor the testicle has any sensory nerves in its interior. Thus one's senses do not very adequately protect the structures which are most vulnerable to heat and which get hottest on exposure to 12 cm wavelength.

It would be highly desirable in the light of these observations to set about establishing standards for the protection of personnel exposed to intense microwave radiation before anyone is injured. We have here a most unusual opportunity to lock the barn door before, rather than after, the horse is stolen.

The microwaves used in producing the damage shown in Figs. 1 and 3 were of approximately 10 cm wavelength. Exposure of the animals to other wavelengths produced markedly different results. At wavelengths much longer than 10 cm, a general elevation of body temperature or artificial fever is observed but no particular damage to the tissue. At wavelengths much shorter than 10 cm, on the other hand, the heating is mostly confined to the surface. Severe burning of the skin can be produced without much heating of the underlying tissues.

THEORETICAL EXPLANATION OF RESULTS

A theory has been developed which explains in a general way the phenomena just described and which is of some value in predicting the effects of varying wavelength, power level, or exposure time in experiments of

⁵ C. J. Imig, J. D. Thomson, and H. M. Hines, "Testicular degeneration as a result of microwave irradiation," *Proc. Soc. Experimental Biology and Medicine*, vol. 69, pp. 382-386; 1948.

⁶ H. J. Muller, "Radiation damage to the genetic material," *American Scientist*, vol. 38, pp. 33-59, 126; January, 1950.

this type. Like all physical theories this one is based upon a very much simplified model in order to reduce the mathematical complications to reasonable proportions. In spite of the simplicity of this model, the theory agrees quite well with experiments.

Fig. 4 shows the idealized "animal" upon which these calculations are based. This animal is simply a homogeneous dissipative medium with a plane boundary. Plane electromagnetic radiation falls upon this boundary and is exponentially absorbed in the fashion with which we are all familiar. The energy which is absorbed generates heat and raises the temperature of the medium. This results in a flow of heat by conduction to the surface. In our simplified analysis of the situation we are ignoring all means of removing heat except conduction to the surface. This means that our theory applies best to parts of the body which do not contain blood vessels in their internal structure. The eye and the testicle both satisfy this criterion so our work applies directly to the structures in which evidence of physiological damage has been found.

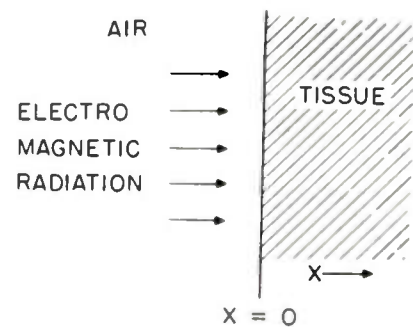

Fig. 4—The idealized "animal."

Fig. 5(a) shows power density as a function of depth due to the exponential absorption of microwave energy by the idealized homogeneous animal. Curves are shown for two different frequencies. Since most materials of which an animal is likely to be made are more lossy at high frequency than at low, the microwave energy is more rapidly absorbed at high frequency.

Fig. 5(b) shows the rate at which heat is generated in the two cases. The rate of heat generation is proportional to the loss factor of the material. Thus we observe at the lower of the two frequencies we have a curve which is rather low and flat, while at the higher frequency the curve starts out at a high value but drops off rapidly and crosses the other curve. If there were no conduction cooling, the temperature rise at any point in the medium would be proportional to the rate of generation of heat and to the time. At any particular time the temperature curves would look exactly like the heat curves which are shown on this figure. However, if conduction cooling is present and if the surface of the animal is maintained at a low temperature, either by air or by the blood stream, we must have a temperature dis-

tribution qualitatively like that shown on Fig. 5(c). We see here that we start at a temperature T_0 at the surface. As we go deeper into the animal the temperature rises, then finally drops off according to an exponential curve as before.

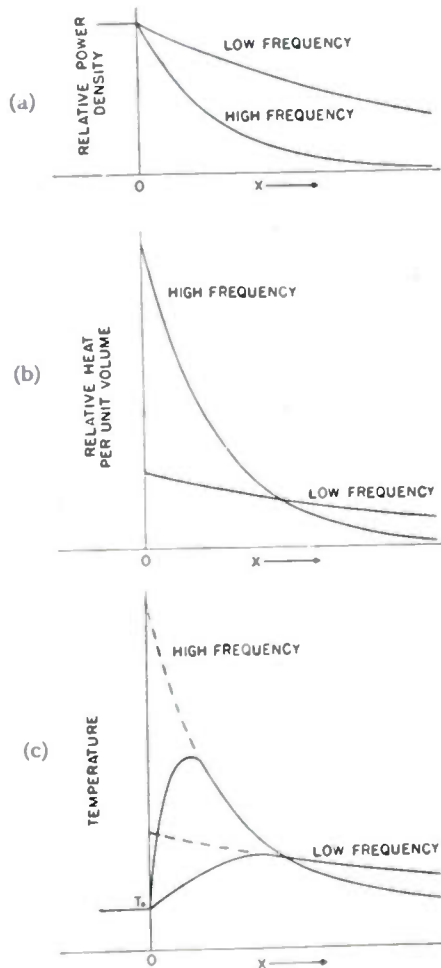

Fig. 5—Qualitative curves showing energy absorption, heat generation, and temperature in the idealized "animal."

The differential equation of heat flow for a distributed heat source such as we are now considering has the following form:

$$\frac{\partial T}{\partial t} = K^2 \frac{\partial^2 T}{\partial x^2} + \frac{\alpha P_0}{c\rho} e^{-\alpha x} \quad (1)$$

where

T = temperature

t = time

x = distance below the surface

α = attenuation constant

P_0 = power density at the surface

c = heat capacity

ρ = density

$K^2 = \sigma/c\rho$, where σ = thermal conductivity.

The detailed solution of (1) is to be published elsewhere;⁷ the result is the following:

$$T = T_0 + \frac{P_0}{\alpha\sigma} \left[1 - \operatorname{erf} \left(\frac{x}{2K\sqrt{t}} \right) - e^{-\alpha x} - \frac{1}{2} e^{K^2\alpha^2 t} \left\{ e^{\alpha x} \left[1 - \operatorname{erf} \left(\frac{x}{2K\sqrt{t}} + \alpha K\sqrt{t} \right) \right] - e^{-\alpha x} \left[1 + \operatorname{erf} \left(\frac{x}{2K\sqrt{t}} - \alpha K\sqrt{t} \right) \right] \right\} \right] \quad (2)$$

The "erf" which appears in (2) is the well-known error function of statistics; it is defined by this integral:

$$\operatorname{erf} x = \frac{2}{\sqrt{\pi}} \int_0^x e^{-u^2} du. \quad (3)$$

Since α , the attenuation constant, is a known function of wavelength⁸ it is possible to calculate temperature functions for various wavelengths from (2) and to compare these with observed temperature distributions. In this calculation the idealized animal is assumed to have the same physical properties as salt water.

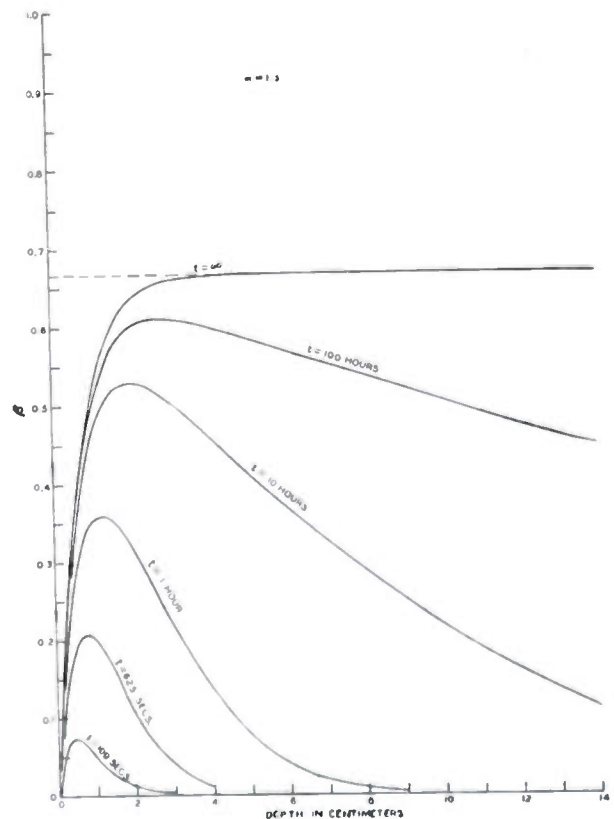

Fig. 6—Calculated temperature curves for $\alpha = 1.5$, corresponding to about 8 cm wavelength. Temperature rise is proportional to the parameter β ; see (4).

⁷J. W. Clark and L. W. Swanson, "A calculation of the temperature rise due to absorption of microwave energy in living tissue," *Jour. Appl. Phys.*, to be published.

⁸C. G. Montgomery, "Technique of Microwave Measurements," McGraw-Hill Book Co., New York, N. Y., p. 195; 1947.

The presentation of the results is facilitated by the use of a quantity β which is defined as $1/\alpha$ times the quantities in the square bracket in (2). Thus

$$T - T_0 = P_0\beta/\sigma = 169.5P_0\beta. \quad (4)$$

For a fixed power density P_0 , the temperature rise is proportional to β ; but β is a function of the attenuation constant α , which in turn is a function of wavelength. Thus the β curves show the shape of the temperature distribution at various values of wavelength and time. Fig. 6 shows a typical set of such curves for $\alpha=1.5$, corresponding to a wavelength of about 8 cm. These calculated curves have the same shape as the qualitative curves of Fig. 5(c) and as the observed curve of temperature distribution in the eye (see Fig. 2).

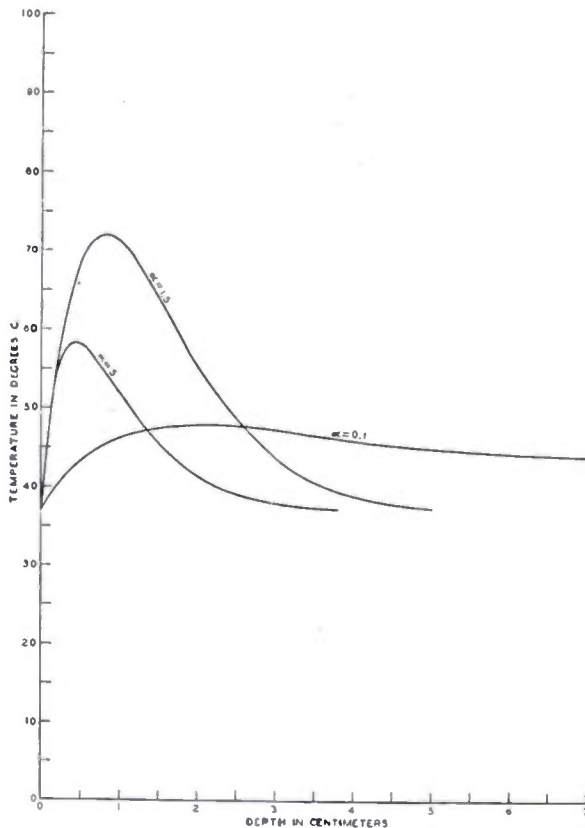

Fig. 7—Calculated temperature curves for exposure to one watt per square centimeter for 625 seconds. $\alpha=0.1$ corresponds to $\lambda \cong 50$ cm; $\alpha=1.5$ corresponds to $\lambda \cong 8$ cm; $\alpha=5$ corresponds to $\lambda \cong 4$ cm.

Fig. 7 shows calculated curves for a power density of one watt per square centimeter and an exposure time of 625 seconds for three different values of α . These correspond respectively to wavelengths of 50 cm, 8 cm, and 4 cm. The ordinate on these curves is degrees centigrade. You will observe that each curve shows a maximum temperature and that the longer the wavelength the deeper within the animal the maximum occurs. This agrees exactly with the observation mentioned earlier of the effect of radiation with varying wavelengths.

Inspection of Fig. 7 brings out the interesting fact that the 8-cm wavelength ($\alpha=1.5$) curve reaches the highest temperature of any. Thus this wavelength is the

most likely to cause damage of the type shown in Figs 1 and 3, since exposure to a given power density for a given time produces a higher temperature when the wavelength is about 8 cm than when it is either longer or shorter than this. The location of this hot spot happens to coincide with that of some physiological structures which are very vulnerable to heat.

This is not a resonance phenomenon, but occurs because of the balance between energy absorption and conduction cooling. It is not very critical; wavelengths between 6 and 12 cm are about equally effective in producing elevated temperature in the body.

A series of measurements upon animal tissue was made with wavelengths varying from 1,600 cm (19 Mc), as used in conventional diathermy, through the microwave spectrum at 75 cm, 12 cm, 8 cm, and 3 cm, and at infrared. The results of these measurements agree in general with the calculations; they are being published in detail.⁹ When one considers the great difference between the living animal and the simplified idealized animal upon which our calculations were based, the agreement between the observed and calculated curves is very gratifying.

CONCLUSION

The work which has been described is of a very preliminary nature. We have definitely established that it is possible to produce serious tissue damage with moderate amounts of microwave energy but have no idea of the threshold energy, if one exists, for these phenomena. We also do not know whether or not successive exposures are cumulative. Further work along these lines is urgently needed. It is particularly important to establish standards of safety for the guidance of personnel who must expose themselves to these radiations in the course of their work.

ACKNOWLEDGMENT

A project of this type cannot succeed without the cooperation of a great many people; specific mention can be made only of those who contributed directly to it. W. W. Salisbury, Director of Research, Collins Radio Company, recognized the need for this study and was instrumental in setting up the project in a flexible way appropriate to its peculiar nature. H. M. Hines, head of the Department of Physiology at the State University of Iowa, supervised the physiological phase of the work. The following members of the Research Division, Collins Radio Company, co-operated in the building of signal generators and measuring instruments: R. C. Kent, J. E. Randall, P. R. Finger. The following members of the Department of Physiology at the State University of Iowa carried out the data taking and physiological analysis of the results: A. W. Richardson, C. J. Imig, Alma J. Murphy, and Barbara Feucht Randall.

⁹ Alma J. Murphy, W. D. Paul, and H. M. Hines, "A comparative study of the temperature changes produced by various thermogenic agents", *Archives Phys. Med.*, to be published.

The Klystron Mixer Applied to Television Relaying*

VINCENT LEARNED†, SENIOR MEMBER, IRE

Summary—The phase-modulation sidebands obtained from a klystron amplifier with beam-voltage modulation may be used to give mixing action. The output resonator is used to select a phase-modulation side-frequency component to give power output at a sum or difference frequency. The method of obtaining phase modulation in a beam-type amplifier is described. The construction and operating details are given for a klystron amplifier which has a mixer output of 1 watt over a 20-Mc band for a 6,000-Mc television relay system.

I. INTRODUCTION

THERE ARE a number of system applications which can benefit from the use of a mixing device at power output levels. In television relaying a power mixer eliminates the demodulation and modulation through video at each repeater and hence greatly reduces repeater distortion. For microwave frequencies, a klystron has been developed for obtaining mixing action at power levels suitable for point-to-point television relaying. Two methods have been considered for obtaining side frequencies or mixing action in a klystron: (1) A special grid incorporated within the electron gun that will interrupt the beam current at an intermediate-frequency rate to give amplitude-modulation sidebands; and (2) modulation of the beam voltage to give phase-modulation sidebands.

The latter method is most naturally adapted to a beam-type tube such as the klystron. Modulation of the beam voltage varies the beam velocity and produces variations in the phase of the output current, and the sidebands produced have essentially the characteristics of phase modulation. If the modulation frequency is sufficiently high, the sideband components are separated enough to have one selected by the output resonator. The sum or difference side-frequency component may be selected to change the microwave carrier frequency by the amount of the modulation frequency. Variations in the modulation frequency will give corresponding variations in the microwave output frequency.

The word *synchrodyne* is often applied to the use of the klystron tube in systems where the frequency difference between the transmitter and local oscillator is determined by a signal of intermediate frequency. The word was associated originally with klystron mixers in a synchronous-detector applications. The word *synchrodyne* has usually been used with klystron mixer applications.

* Decimal classification: R335XR583. Original manuscript received by the Institute, May 10, 1949; revised manuscript received, May 1, 1950. Presented, 1949 IRE National Convention, New York, N. Y., March 10, 1949.

† Sperry Gyroscope Company, Great Neck, L. I., N. Y.

II. MECHANISM OF PHASE MODULATION

The principle of operation of a phase-modulated amplifier is in many ways similar to that of a frequency- or phase-modulated transmitter. For a single sinusoidal modulating frequency, the relationships for phase and frequency deviation and the relative sideband magnitudes are all given by the usual phase- or frequency-modulation theory. Fig. 1 shows a schematic drawing of a klystron with an input gap and an output gap separated

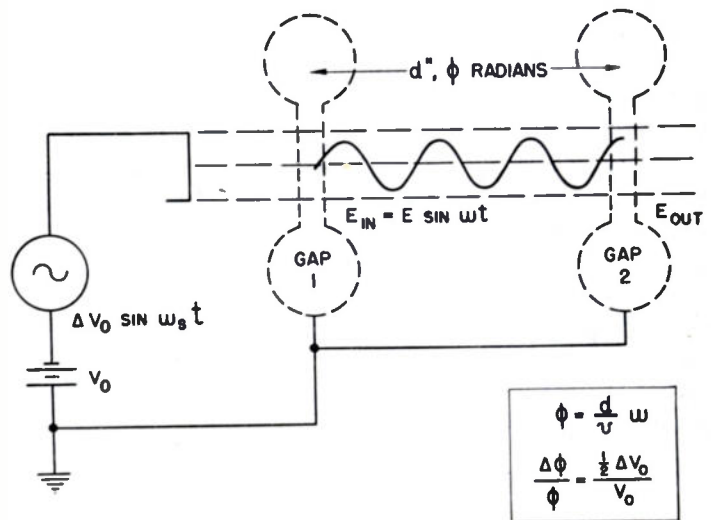

Fig. 1—Klystron schematic.

rated by a distance d with dc beam voltage V_0 and ac modulation ΔV_0 at an angular frequency ω_s . The input resonator is operated with a peak voltage E at gap 1 at angular frequency ω to give optimum bunched current at output gap 2. The time T for a beam traveling at a velocity v to transverse the distance d is d/v . The corresponding phase lag ϕ at angular frequency ω is ωT or $\omega d/v$. If this relationship is analyzed for the change $\Delta\phi$ in the total phase lag ϕ from a change ΔV_0 in the beam voltage V_0 , the following approximate relation is obtained:

$$\frac{\Delta\phi}{\phi} \approx \frac{1}{2} \frac{\Delta V_0}{V_0}$$

Because of the square root velocity-voltage relationship of an electron beam, the relative phase change is approximately one-half the relative voltage change.

The phase shift $\Delta\phi$ obtained in this manner yields sidebands determined in magnitude by Bessel functions in a manner similar to the usual phase modulation theory.¹ The frequency components thus obtained are de-

¹ F. E. Terman, "Radio Engineering Handbook," McGraw-Hill Book Co., New York, N. Y., pp. 578-579; 1943.

terminated in magnitude by $J_0(\Delta\phi)$ giving the carrier amplitude, and with $J_1(\Delta\phi)$ giving the amplitude of the first-order side frequencies. It is noted that the first maximum in the first side-frequency output is obtained for a $\Delta\phi$ of approximately 1.8. The separation of the side-bands is determined by the modulation frequency ω_m and, if sufficiently large, the output resonator may be tuned to any one of the frequency components.

With an ideal square wave modulation of phase the sideband current is 0.64 of the unmodulated bunched-beam current.² With a practical sine-wave modulation of the beam, the first order sideband is 0.58 of the unmodulated carrier. With this value of current, the output power of the usual low-power klystron is reduced by a factor of 3, so an amplifier designed for 3-watts output for straight-through operation will only give 1-watt output as a mixer.

In a typical klystron design having a drift distance of 4 cycles or approximately 25 radians, the rms modulation voltage required is approximately 10 per cent of the dc beam voltage. This is equivalent to a peak-to-peak voltage of approximately 30 per cent of the dc beam voltage. The value of modulation, of course, depends upon the number of cycles drift distance. The greater the number of cycles, the smaller the modulation. However, the efficiency of a low-power klystron in the microwave-frequency region is nearly optimum in the region of 4 cycles drift distance and will drop off with a greater number of cycles.

III. APPLICATIONS

Applications for which mixer type of amplifiers have been used are:

A. Television-relay-system repeaters which do not demodulate to video. Such a system was developed by the Philco Corporation for operation by Western Union Telegraph Company between New York City and Philadelphia.^{3,4} Fig. 2 is a block diagram of this system which shows a mixer on the input and a mixer on the output with both operated by the same local oscillator, the input mixer being a conventional crystal detector and the output mixer a phase-modulated klystron amplifier. The received signal is amplified by a stagger-tuned broadband intermediate-frequency amplifier, is changed in frequency by a second mixer and local oscillator, and is amplified to the necessary phase-modulation voltage level by a second broad-band intermediate-frequency amplifier.

The system is designed to amplify frequency-modulated signals. In Fig. 2, typical frequencies are shown

with a ± 10 -Mc frequency deviation. Amplitude limiting occurs at several places in the amplifying and mixing system. The synchrodyne-klystron input resonator is driven by the stabilized local oscillator and the beam is modulated by the second intermediate-frequency amplifier to give a sum or difference output frequency that is selected by the output resonator and carried to the transmitting antenna. The output of this system gives a one-to-one correspondence in the frequency changes of the received signal. The absolute magnitude of the input and output frequency is different by 40 Mc to prevent unwanted feedback between the transmitter and receiver. At low modulation frequencies there is negligible transmission phase shift and at high frequencies the phase shift is determined by the distribution of tuned circuits. The stabilized local oscillator is a klystron amplifier with a high- Q resonator in the feedback circuit.

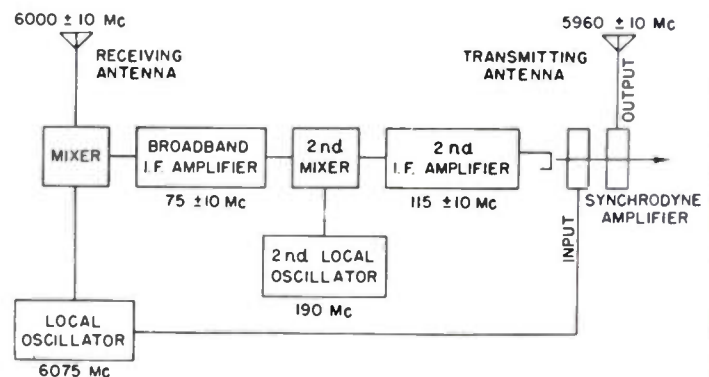

Fig. 2—Television relay repeater.

B. Other applications include microwave communication systems in which the crystal-controlled local oscillator of a receiver is amplified with a mixer amplifier to give multichanneled transmitter output by selecting different phase-modulation frequencies.

C. Coherent-type radar systems in which a fixed phase relationship between the frequency of the local oscillator and the frequency of the transmitter is desired.

D. Interpolation means for microwave frequency standards.

E. A method for obtaining amplitude modulation at microwaves.

IV. TUBE DEVELOPMENT

The klystron amplifier was developed for television relay applications having a power output of greater than 1 watt over a 20-Mc band, operating from a 500-volt beam supply at about 100 milliamperes, and requiring 50 volts rms beam modulation for maximum first side-frequency output. Fig. 3 shows a cutaway view of this tube, the SAC-19, which is designed for use over the 5,925- to 6,425-Mc common carrier band. It incorporates waveguide input and output, has a screw arrange-

² E. W. Herold, "Superheterodyne frequency conversion using phase-reversal modulation," *Proc. I.R.E.*, vol. 34, pp. 184-198; April, 1946.

³ W. P. Boothroyd, "The application of heterodyne modulation to wide-band frequency-modulated television relays," *AIEE Tech. Paper* 47-171, May, 1947.

⁴ W. H. Forster, "6,000 Mc television relay system," *Electronics*, vol. 22, p. 80; January, 1949.

ment for semifixed-tuned frequency adjustment, and has a standard octal 8-pin base connection through which the ac filament voltage, dc beam voltage, and phase-modulating voltage are supplied.

The cutaway shows the two-cavity resonators with their associated grids, the iris coupling to the output and input waveguide, the resonant waveguide window, the electron gun, the stem mount, and the general layout of the various parts. The gridded cavities with the iris-coupling window are conventional, the width of the iris being adjusted in size to give the desired coupling.

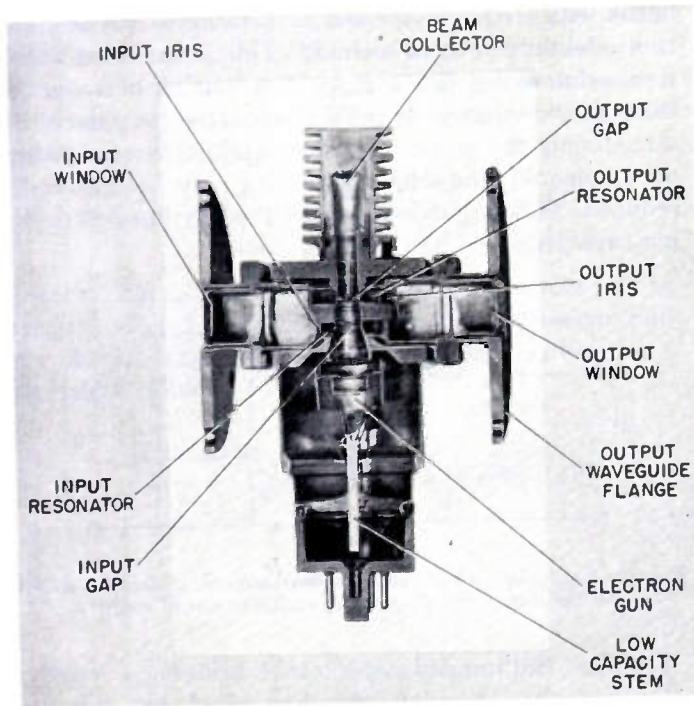

Fig. 3—SAC-19 klystron cross section.

The current density in the beam at the output gap is much greater than can be obtained from a conventional oxide-coated cathode for long life so a large button is used in the electron gun and a convergent beam employed. The resultant cathode current density is below 100 ma/cm² and the life obtained has been very good. Most of the first set of tubes installed in the system are still in operation after over a year of continuous operation.

A low-capacity electron gun is required for this application. It is found that much of the capacity is due to the conventional arrangement of wires coming out of the stem. In this tube, the wires have all been clustered to get as small an effective diameter as possible. The focusing electrode structure was designed in an electrolytic tank to give as low capacity as possible and yet have satisfactory properties.

The SAC-19 is temperature-compensated for stable operation with changes in ambient temperatures. The material of the tuning screws has been selected to com-

pensate each resonator to better than 5 parts in 10⁶ per degree C. In applying the tube to television relaying it is pretuned by the customer to the assigned frequency on a test bench. No further resonator tuning is required to place the tube in operation in the system. Because of the temperature compensation and heavy construction, the tubes have given stable operation.

In developing this tube, several problems not usually encountered in klystron development had to be considered:

A. The modulation voltage for the synchrodyne amplifier had to be as small as possible to minimize the size of the modulating intermediate-frequency amplifier. This makes a low-voltage, high-current type of amplifier desirable.

B. For the same reason, the cathode-anode capacity of the electron gun must be held as small as possible.

It is more difficult to build a klystron for efficient operation at low voltage and high current. To provide adequate coupling between the electron beam and a resonator gap at low voltage requires a fine mesh grid. This leads to high interception of the beam current and contributes to a loss in over-all efficiency. In addition, the larger percentage interception in the various grids leads to a larger amount of secondary-electron loading at the grid gaps, the effect of which tends to reduce further the klystron efficiency. In the SAC-19 design there are four grids between the cathode and the output gap. High-current, low-voltage beams are more difficult to make, the high-current beam tending not to focus as well as a low-current beam, and consequently, causing a further loss in current to the output gap. In the design of this tube, the efficiency of the klystron had to be compromised against the power required for phase modulation. When higher power is required for a relay system, it is better to design the synchrodyne amplifier in conjunction with the intermediate-frequency beam-voltage modulator and then use a more efficiently designed klystron tube as an amplifier stage.

Phase modulation has been applied to other klystron types. Three gap amplifiers have been used to give a stage of amplification either after or before the frequency-changing operation. More efficient performance can be obtained in this type of operation. Frequency-multiplier klystrons are phase-modulated successfully to give noninteger multiplication.

V. CONCLUSION

The mixer amplifier applied to television relaying has resulted in a relay system quality that has met high expectations. The phase-modulation technique has satisfactorily given the desired mixing action. The tube developed for this purpose has given reliable, long-life service. Tuning of the tube has been simple and the adjustments, once made, are permanent. The use of the mixer klystron now makes possible system techniques at microwaves which were previously possible only at lower frequencies.

The Compensation of Delay Distortion in Video Delay Lines*

R. A. ERICKSON† AND H. SOMMER‡, STUDENT MEMBER, IRE

Summary—Delay distortion in ordinary solenoidal delay lines is primarily caused by the decay of solenoid inductance resulting from a reduced magnetic coupling at the higher frequencies. An analysis of the phase characteristic of delay lines which employ solenoid bridging capacitances to compensate for this inductance variation is presented. The relations necessary for determining the delay distortion and effective bandwidth corresponding to any amount of compensation are given. The analysis is verified by observations on several experimental lines, wherein the bridging capacities are obtained by means of isolated metal patches placed in proximity to the solenoid.

I. INTRODUCTION

IN A TRANSMISSION line of conventional design, whether parallel conductor or coaxial cable, the series inductance and shunt capacitance are very small and appreciable delay times can only be obtained with a very long line. Both the series inductance and shunt capacitance can be greatly increased by replacing the conductors of the conventional transmission line by coaxial solenoids.¹⁻³ In some applications, however, the double solenoidal line is inconvenient, as it does not have the advantage of a common input and output terminal. Thus lines of the more common type employ a single solenoid wound either on a thin cylindrical conductor which is usually slit longitudinally to prevent excessive attenuation,^{1,4} or on a core of flexible dielectric material and enclosed in a braided shield of insulated wire.^{2,3,5}

Investigations of the delay characteristics of these lines show decreasing time delay with increasing frequency. To reduce this distortion Weekes⁴ has employed lumped corrective networks, Di Toro⁶ used a bank-wound multilayer solenoid, and Kallman⁷ obtained very satisfactory results by placing a series of isolated metal

patches in close proximity with the solenoid. It is the purpose of this paper to make a quantitative analysis of this latter type of compensation.

II. THEORY

The time delay of solenoidal video delay lines is nonlinear with frequency primarily because of variation in the inductance of the solenoid. This inductance variation is due to decreasing magnetic coupling between the turns of the solenoid as the wavelength is decreased. By introducing the proper electric coupling between points on a solenoid, the delay distortion may be materially reduced. This might be accomplished by lumped bridging capacitances.

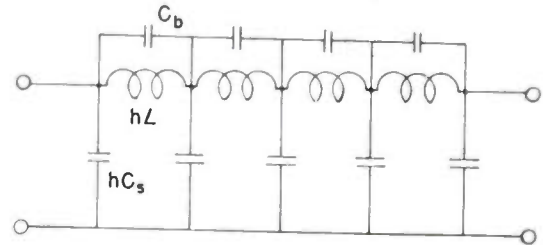

Fig. 1—Equivalent circuit of an ideal solenoidal delay line with lumped capacitances C_b bridging each element of length h .

If C_b is the lumped capacitance bridging a length h of a smooth solenoidal delay line which has series inductance L and shunt capacitance C_s per unit length, then the propagation function for a length h of line, treating the network as a recurrent structure, as shown in Fig. 1, will be given by

$$\gamma_h = \cosh^{-1} \left(1 + \frac{z_1}{2z_2} \right), \quad (1)$$

where

$$z_1 = \frac{j\omega h L}{1 - \omega^2 h L C_b} \quad \text{and} \quad z_2 = \frac{1}{j\omega h C_s}$$

are, respectively, the series and shunt impedances at a frequency $\omega/2\pi$. For cases in which $(|\gamma_h|^2/12) \ll 1$, a valid approximation is

$$\gamma_h \div \sqrt{\frac{z_1}{z_2}} = j\omega h \sqrt{\frac{L C_s}{1 - \omega^2 h L C_b}} \quad (2)$$

and, since $\gamma_h = \alpha_h + j\beta_h$, the attenuation and phase functions for a given length h of line are, respectively,

$$\alpha_h = 0 \quad \text{and} \quad \beta_h = \omega h \sqrt{\frac{L C_s}{1 - \omega^2 h L C_b}}$$

* Decimal classification: R117.19. Original manuscript received by the Institute, July 22, 1949; revised manuscript received, April 24, 1950.

This paper is based on work done for the Air Materiel Command, Army Air Force, under contract W-28-099-ac-134 with the Texas A & M Research Foundation.

† Oak Ridge National Laboratory, Oak Ridge, Tenn.

‡ National Bureau of Standards, Washington, D. C.

¹ H. E. Kallman, "Transversal filters," Proc. I.R.E., vol. 28, p. 306; July, 1940.

² J. P. Blewett, R. V. Langmuir, R. E. Nelson, and J. H. Rubel, "Delay Lines," General Electric Research Laboratory Report, May, 1943.

³ J. H. Rubel, H. E. Stevens, and R. F. Troell, "Design of delay Lines," General Electric Research Laboratory Report, October, 1943.

⁴ D. F. Weekes, "A Video Delay Line," MIT RL Report No. 302, April, 1943.

⁵ J. P. Blewett and J. H. Rubel, "Video delay lines," Proc. I.R.E., vol. 35, p. 1580; December, 1947.

⁶ J. J. Di Toro, "Phase-corrected delay lines," presented, 1948 IRE National Convention, New York, N. Y., March 22-25, 1948.

⁷ H. E. Kallman, "Equalized delay lines," MIT RL Report No. 550, June, 1944; also, Proc. I.R.E., vol. 34, p. 646; September, 1946.

If T_h is the time delay for a length h of the line at a frequency $\omega/2\pi$, then $T_h = \beta_h/\omega$, and it follows that

$$T_h = h \sqrt{\frac{JC_s}{1 - \omega^2 h LC_b}} \quad (3)$$

Now assume the shunt and bridging capacities to be independent of frequency and that the inductance varies according to the relation developed by Poritsky and Blewett,^{2,5}

$$L = L_0 \left[2K_1 \left(\frac{\pi D}{\lambda} \right) I_1 \left(\frac{\pi D}{\lambda} \right) \right], \quad (4)$$

where D is the diameter of the solenoid, λ is the wavelength on the line, L_0 is the low-frequency inductance per unit length, and K_1 and I_1 are Bessel functions of pure imaginary argument.⁸ Then, letting $x = \pi D/\lambda$, and substituting into (3)

$$T_h = h \sqrt{L_0 C_s} \left[\frac{2K_1(x) I_1(x)}{1 - 2\omega^2 h L_0 C_b K_1(x) I_1(x)} \right]^{1/2}.$$

However, $\lim_{\omega \rightarrow 0} (\pi D/\lambda) = 0$ and $\lim_{x \rightarrow 0} 2K_1(x) I_1(x) = 1$ so that $\lim_{\omega \rightarrow 0} T_h = T_{0h} = h \sqrt{L_0 C_s}$. Using this expression, and since $\beta_h = h\beta$, where $\beta = 2\pi/\lambda$ is the phase function for a unit length of line, one finds

$$\frac{T_h}{T_{0h}} = \left[\frac{2K_1(x) I_1(x)}{1 - \beta^2 (T_{0h}/T_h)^2 h (C_b/C_s) 2K_1(x) I_1(x)} \right]^{1/2}$$

or setting

$$M = \frac{4h C_b}{D^2 C_s},$$

$$\frac{T_h}{T_{0h}} = [(1 + Mx^2)(2K_1(x) I_1(x))]^{1/2}. \quad (5)$$

It is very difficult to add lumped bridging capacitances to a solenoidal delay line; however, a similar effect may be attained by placing isolated strips of metal in close proximity with the solenoid. In this case, the distributed capacitance between the metal strip and the solenoid would supply the desired bridging capacitance. The previous arguments can be extended to include the effect of distributed bridging capacitance in the following manner.

Consider the length h of an inductor having a series inductance L per unit length and which is shunted by a distributed capacitance C_d per unit length, as shown in Fig. 2.

The impedance between terminals 1 and 2 (Z_{12}) will be given by the ratio of the voltage difference between these terminals (V_{12}) and the current flowing at terminal 1 (I_s). If a voltage V_{12} is applied to terminals 1 and 2, it can be seen that

$$V_{13} = \frac{V_{12}}{2} = -V_{23}.$$

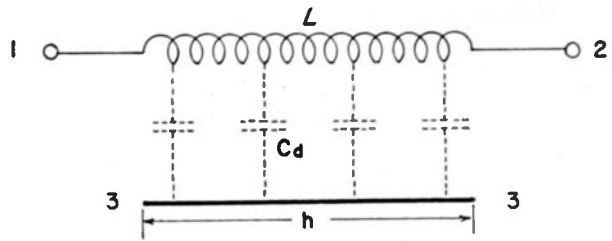

Fig. 2—Solenoidal inductance of length h bridged by distributed capacity C_d per unit length.

Since the network is a transmission line, it follows that

$$V_{23} = V_{13} \cosh \gamma h - I_s Z_0 \sinh \gamma h$$

where, since the line is lossless,

$$\gamma = j\omega \sqrt{LC_d} \quad \text{and} \quad Z_0 = \sqrt{\frac{L}{C_d}}.$$

Thus, substituting these values and solving for V_{12} gives

$$V_{12} = \frac{2I_s \sqrt{L/C_d} \sinh(j\omega \sqrt{LC_d} h)}{1 + \cosh(j\omega \sqrt{LC_d} h)}.$$

and

$$Z_{12} = \frac{V_{12}}{I_s} = \frac{2j\sqrt{L/C_d} \sin(\omega \sqrt{LC_d} h)}{1 + \cos(\omega \sqrt{LC_d} h)}.$$

Let

$$\omega_1 \equiv \frac{1}{h\sqrt{LC_d}} \quad \text{and} \quad Z \equiv j\omega h L.$$

Then

$$\frac{Z_{12}}{Z} = \frac{\omega_1}{\omega} \frac{2 \sin \omega/\omega_1}{1 + \cos \omega/\omega_1}. \quad (6)$$

Since

$$\lim_{\omega \rightarrow 0} \frac{Z_{12}}{Z} = \lim_{\omega \rightarrow 0} \frac{2 \sin \omega/\omega_1}{\omega/\omega_1} = 1$$

and

$$\lim_{\omega/\omega_1 \rightarrow \pi} \frac{Z_{12}}{Z} = \frac{2}{\pi} \lim_{\omega/\omega_1 \rightarrow \pi} \left[\frac{\cos \omega/\omega_1}{-\sin \omega/\omega_1} \right] = \frac{2}{\pi} \cdot \frac{1}{0}.$$

The circuit has a zero at $\omega = 0$ and a first pole at $\omega = \omega_1 \pi$.

Now consider the impedance of an inductance hL shunted by a lumped bridging capacitance C_b , as shown in Fig. 3.

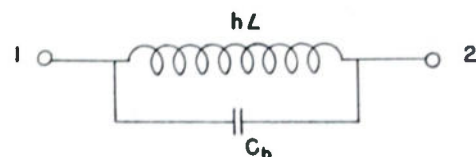

Fig. 3—Solenoidal inductance of length h bridged by lumped capacitance C_b .

⁸ N. M. McLachlan, "Bessel functions for engineers," Oxford University Press; 1934.

For this network,

$$Z_{12} = \frac{j\omega hL}{1 - \omega^2 hLC_b}$$

Let

$$\omega_2 = \frac{1}{\sqrt{hLC_b}} \quad \text{and} \quad Z = j\omega hL$$

Then

$$\frac{Z_{12}}{Z} = \frac{1}{1 - (\omega/\omega_2)^2} \quad (7)$$

From this expression it can be seen that the circuit has a zero at $\omega=0$ and a pole at $\omega=\omega_2$.

The first zeros and first poles of the two networks will be coincident if $\omega_1\pi = \omega_2$, and in the interval up to $\omega/\omega_2 = 0.6$, the impedances agree within 10 per cent. By shifting the relative position of the poles so that $0.925\omega_2 = \pi\omega_1$, a better agreement is obtained between the two impedances over the same interval. For this condition with the relations defining ω_1 and ω_2 , it follows that

$$C_b = \left(\frac{0.925}{\pi}\right)^2 hC_d \quad (8)$$

The impedance characteristics of the distributed network has been studied experimentally and the results agree with (8). It is concluded, therefore, that the expression previously obtained for T_h/T_{0h} will be valid for lines using distributed bridging capacitances if the above substitution for C_b is made. Since T_h/T_{0h} is independent of length, it may be replaced by T/T_0 which is thus the ratio between the delay T at any frequency and the low-frequency delay T_0 for any length of line. Therefore,

$$\frac{T}{T_0} = [1 + Mx^2 \langle 2K_1(x)I_1(x) \rangle]^{1/2} \quad (9)$$

gives the variation of time delay as a function of x , where

$$M = \left(\frac{1.85h}{\pi D}\right)^2 \frac{C_d}{C_e} \quad (10)$$

and $x = \pi D/\lambda$.

The approximation $\gamma_h = \sqrt{Z_1/Z_2}$ cannot be extended to frequencies where $\lambda < 3h$. An examination of (1) for shorter wavelengths ($\lambda < 3h$) shows that T_h/T_{0h} will rise to a maximum at $\lambda = 2h$ and then fall off rather sharply as ω is increased further.

For a given line, (9) may be used to give the delay characteristics as a function of frequency as follows:

Since $\beta_h = h\beta = h(2\pi/\lambda)$ and $T_h = \beta_h/\omega$, then

$$x = \frac{\pi D}{\lambda} = \frac{\beta_h D}{2h} = \frac{\omega T_h D}{2h}$$

Dividing and multiplying by $T_{0h} = h\sqrt{L_0 C_e}$ and solving for ω gives

$$\omega = \frac{2x}{D\sqrt{L_0 C_e} (T/T_0)} \quad (11)$$

An examination of (9) shows that for any $M \neq 0$, T/T_0 at first decreases with increasing x then increases above $T/T_0 = 1$ with an ever-increasing slope. For design purposes it is convenient to define the effective bandwidth of the line as the interval between zero and x_c , where $x_c \neq 0$ is the point at which $T/T_0 = 1$. Within the band so defined, the maximum delay distortion will be T_{\min}/T_0 , where T_{\min} is the minimum delay in this interval. The value of M which will give a minimum T/T_0 at any x can be determined by differentiating equation (9). This gives

$$M = \frac{1}{x^2} \left[\frac{2K_1(x)I_0(x)}{x[K_1(x)I_0(x) - I_1(x)K_0(x)]} - 1 \right] \quad (12)$$

The values of M and x which satisfy (12) can now be used in (9) to give T_{\min}/T_0 as a function of x . This relation is shown graphically in Fig. 4.

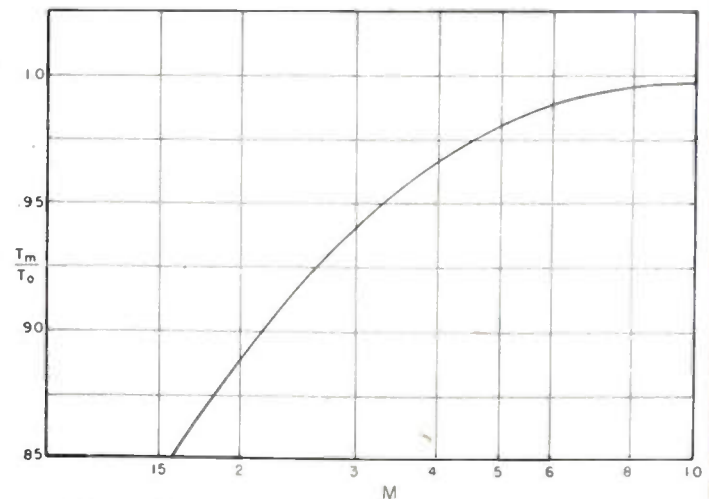

Fig. 4—Minimum T/T_0 versus compensation parameter.

By equating the expression T/T_0 to unity and solving for M in terms of $x = x_c$, the following equation is obtained:

$$M = \frac{1}{x_c^2} \left[\frac{1}{2K_1(x_c)I_1(x_c)} - 1 \right] \quad (13)$$

A plot of this equation, as shown in Fig. 5 yields the values of M for which $T/T_0 = 1$ at $x = x_c$.

Thus, other factors such as impedance and attenuation having determined the values of D , L_0 , and C_e , the value of M required for a specified T_{\min}/T_0 can be determined from Fig. 4; and Fig. 5 will then give the approximate bandwidth.

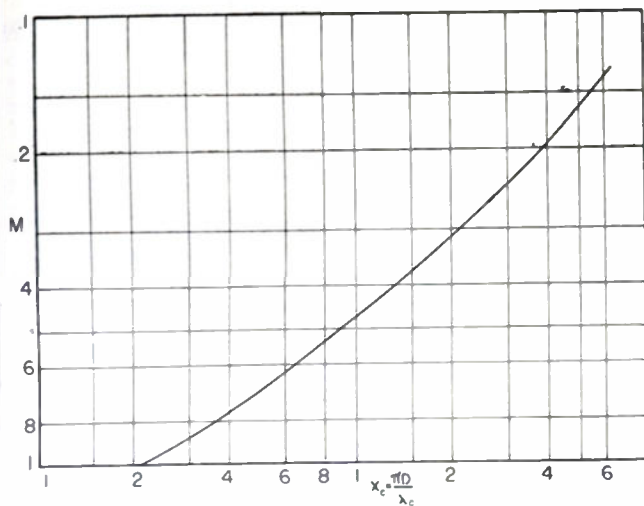

Fig. 5—Compensation parameter versus the value of x for which $T/T_0=1$.

III. EXPERIMENTAL INVESTIGATION

The delay lines constructed for investigating the effects of distributed compensation consisted of a close wound coil of No. 38 AWG Formex "F" wire, 10 inches long, on a 3/8-inch polystyrene rod. The rod was coated with a thin film of chemically deposited silver and segmented by 32 longitudinal slits to reduce the attenuation. The distributed bridging capacitances were obtained by isolating portions of the metal film or sheath with circumferential cuts of the desired length at appropriate intervals. Thus, the capacitance between the coil and the isolated patches formed the distributed bridging capacitance and the capacitance from the coil to the uncut portion of the metal film provided the shunt capacitance to ground. The five lines tested had patches that were 0/32, 17/32, 22/32, 24.5/32, and 27/32 of the circumference in width and 1/4 inch long. Since the bridging and shunt capacitances are directly proportional to the patched and unpatched areas, the values of the patching parameter M , as calculated from (10) are, 0, 0.18, 0.32, 0.50, and 0.83, respectively.

The initial resistance of the silver film, before patching, was in all cases about 20 ohms. Films of appreciably lower resistance are not only more difficult to slit and patch, but, because of increased circumferential sheath currents, these heavier films also effect an increase in attenuation which can be reduced only by cutting more longitudinal slits.

A quantitative measurement of the phase characteristics was accomplished by short circuiting the receiving end of the delay line and recording the frequencies at which the input impedance to the line was minimum. This condition of minimum impedance was detected by a voltmeter (GR-726A) connected to the input terminals of the line in parallel with a low impedance signal generator (GR-805C). Then at a frequency f for which the wavelength λ and the length of the line l satisfy the relation, $l = n\lambda/2$, where n is an integer, the input im-

pedance (and voltage) of the line is minimum, and the time delay is $T = n/2f$.

The experimental results are summarized in Fig. 6, where the data are shown as points and the dotted curves are obtained from (9) for the corresponding values of M . The agreement between the observed and theoretical behavior is in general very good, except at the larger values of x . This discrepancy is accounted for by the approximation $(|\gamma_h|^2/12) \ll 1$, introduced in obtaining (2); for at $x = \pi/2$, $\lambda = 3/4$ inch = $3h$ and $|\gamma_h|^2/12 = 0.37$.

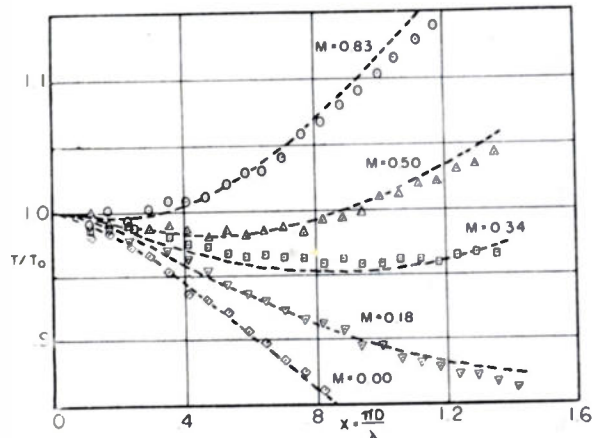

Fig. 6—Comparison between experimental data and the theoretical delay distortion. Dotted curves are calculated.

In each of the lines tested, and anomalous increase in the time delay was observed at the lowest resonant frequency. This increase was verified by calculations of the delay from measurements of the open and short circuit impedances at 1,000 cps. This phenomenon is attributed to an excessive decay of coil inductance at low frequencies resulting from the relatively rapid decrease in magnetic coupling at the ends of the solenoid. This effect also accounts for the observed difference between the characteristic impedance, as determined by adjusting the terminating resistance to give minimum reflection of a 1-microsecond pulse, and the impedance calculated from the open and short circuit impedances measured at 1,000 cps.

Since expression (4) is valid only for solenoids that are long compared with a wavelength, these end effects are not accounted for in (9). The experimental data were therefore analyzed by extrapolating the phase characteristic to zero frequency, disregarding the anomalous rise in delay time. The results shown in Fig. 6 are therefore quantitatively correct only for signals containing no very low frequency components.

In Table I, the delay times and characteristic impedances as obtained from impedance measurements at 1,000 cps are shown with the extrapolated zero frequency delays and the nominal terminating impedances which give minimum reflection of a 1-microsecond pulse.

TABLE I
CHARACTERISTICS OF EXPERIMENTAL LINES AT LOW FREQUENCIES

| Line | M | $\frac{Z_{sc}^*}{\omega}$ (mh) | $\frac{Y_{oc}^*}{\omega}$ ($\mu\mu fd$) | $\frac{1}{\omega} \sqrt{Z_{sc} Y_{oc}^*}$ (μsec) | $\sqrt{\frac{Z_{sc}}{Y_{oc}^*}}$ (ohms) | Extra- polated T_0 (μsec) | Nom- inal Z_0 (ohms) |
|------|------|-----------------------------------|--|--|--|---|---------------------------------|
| 1 | 0 | 1.56 | 4360 | 2.62 | 600. | 2.57 | 580. |
| 2 | 0.18 | 1.57 | 1980. | 1.77 | 890. | 1.73 | 860. |
| 3 | 0.34 | 1.62 | 1260. | 1.43 | 1130. | 1.37 | 1090. |
| 4 | 0.50 | 1.68 | 1060. | 1.34 | 1260. | 1.28 | 1100. |
| 5 | 0.83 | 1.64 | 740. | 1.10 | 1490. | 1.04 | 1300. |

* $f = 1000$ cps.

The effectiveness of distributed compensation in reducing delay distortion is demonstrated in the oscillograms shown in Fig. 7 where the pulse transmission characteristics of the previous five lines and an additional line with $M=0.67$ are shown. In each plate the upper wave form is a 1-microsecond input pulse and the lower wave form is the delayed, pulse received at the output terminals of the properly terminated line. To permit comparisons of time delay and attenuation, the same time base and amplitude scale were retained in obtaining the two pulses in each plate.

Fig. 7(a) shows clearly the phase distortion that results from inductance decay in an uncompensated line. Plates (b) and (c) demonstrate the improvement resulting from even small amounts of compensation, and (d) and (e) indicate that delay distortion may be essentially eliminated in a properly compensated line. Fig. 7(f) shows the effect of over-compensation, wherein the high-frequency components definitely lag the main pulse components.

From the oscillograms it can be seen that, although the low-frequency time delay is materially reduced, the

effective pulse delay time is not appreciably changed by using a portion of the sheath for compensation.

IV. ACKNOWLEDGMENT

The authors are indebted to D. F. Weekes for his direction and guidance during the inauguration of this work; to N. F. Rode for his inspiration and aid in carrying out the theoretical analysis; to O. D. Ferris for furnishing the chemically deposited silver rods; and to E. E. Vezey and L. Rohrabacher for their suggestions and assistance in constructing the delay lines.

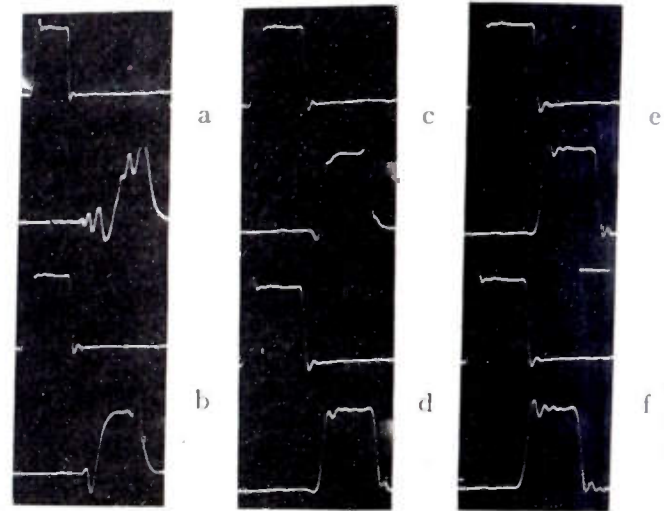

Fig. 7—Oscillograms showing input pulse of 1 microsecond and output pulse for lines (a) $M=0$, (b) $M=0.18$, (c) $M=0.34$, (d) $M=0.50$, (e) $M=0.67$, (f) $M=0.83$. The two pulses in each plate are on the same time base and amplitude scale.



Measured Directivity Induced by a Conducting Cylinder of Arbitrary Length and Spacing Parallel to a Monopole Antenna*

F. R. ABBOTT† AND C. R. FISHER†

THE HORIZONTAL-PLANE radiation field magnitude from two short linear radiating elements is expressible in the form

$$E_{\phi} = e_1 + e_2 \exp j \left(360 \frac{D}{\lambda} \cos \phi + \psi \right) \quad (1)$$

where

- e_1 = the component field due to the first, and in this case, the driven element
- e_2 = the component field due to the second or parasitic element
- ψ = the time-phase angle in degrees of

- the field resulting from the second element relative to that of the first
- D/λ = the spacing between the elements in wavelengths
- ϕ = the azimuthal angle of the position of measurement with respect to the line from the first element to the second
- λ = the wavelength of radiation.

* Decimal classification: R326.8 X R125.1. Original manuscript received by the Institute, September 15, 1949; abstract received, March 8, 1950. This paper is scheduled to be published by the U. S. Navy Electronics Laboratory, San Diego, Calif., Report No. 176.
† U. S. Navy Electronics Laboratory, San Diego, Calif.

Horizontal-plane directivity patterns of a monopole antenna in the vicinity of a thin, cylindrical, vertical, base-grounded parasitic element were taken, and curves showing e_2/e_1 and ψ versus D/λ were prepared. The spacing between the driven antenna and the parasitic element was increased in 0.05 wavelength steps from 0.05 wavelength to a separation of 1 wavelength. Parasite lengths were increased by small steps from 0.15 wavelength to 1 wavelength. The length of the driven element took values of 0.125, 0.25, 0.375 and 0.67 wavelength. Throughout this series of measurements, the diameter of both the driven antenna and the parasitic element was held at 0.01 wavelength. An additional set of data was taken with the driver length equal to 0.25 wavelength and the diameter of the parasitic element equal to 0.10 wavelength. Measurements were performed at 3,000 Mc, at which frequency the surrounding metal plane had a radius of 40 wavelengths.

The sample curves shown were fitted by inspection to the measured data. The relative magnitude of the pattern distorting field due to the parasite is given directly by Fig. 1. In case the pattern configuration is desired it may be computed using (1) and the phase information from Fig. 2.

Inspection of the curves showing relative magnitudes of the distant fields reveals that in all cases the contribution of the parasite to the total field drops to half that of the driven element by the time the separation of the two elements has increased to about 0.4 wavelength. In many cases, notably the short parasites, the ratio is less than 0.5 even at much closer spacing than 0.4 wavelength. The data show the tendency of the effective field of parasitic elements ranging in length from 0.7 to 1 wavelength to show less dependence on physical separation of the two elements. This is even more pronounced in the case of thicker parasites.

There is a tendency for thick parasites, regardless of their length, to behave as thin, resonant elements in the magnitude of their response. The curves of relative time phase show that the field due to the parasitic current tends to be nearly out of phase with the field from the driven element for extremely close spacing and short drivers. This is to be expected. However, it should be pointed out that such is not the case when the driver length is increased to 0.375 and 0.67 wavelength.

The final series of working curves derived from measurements facilitates the placement of antennas with predictable directivity due to parasitic currents in nearby linear conductors. The precise applicability of the curves is limited to the case of vertical ground-based conductors and the vertically polarized fields they produce over the horizontal ground plane.

The curves provide a much more complete and usable set of data for determining the directivity induced by a parasitic cylinder than is obtainable from published mutual impedance data.

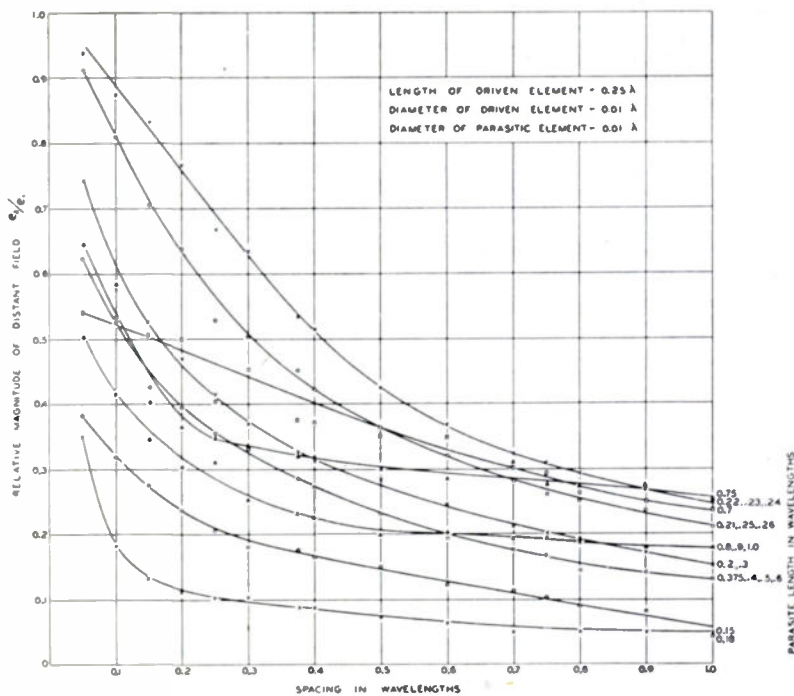

Fig. 1—Ratio of component field resulting from current flowing in the parasite to field due to current flowing in the driven element versus separation of the two elements. The height of the parasite is the parameter.

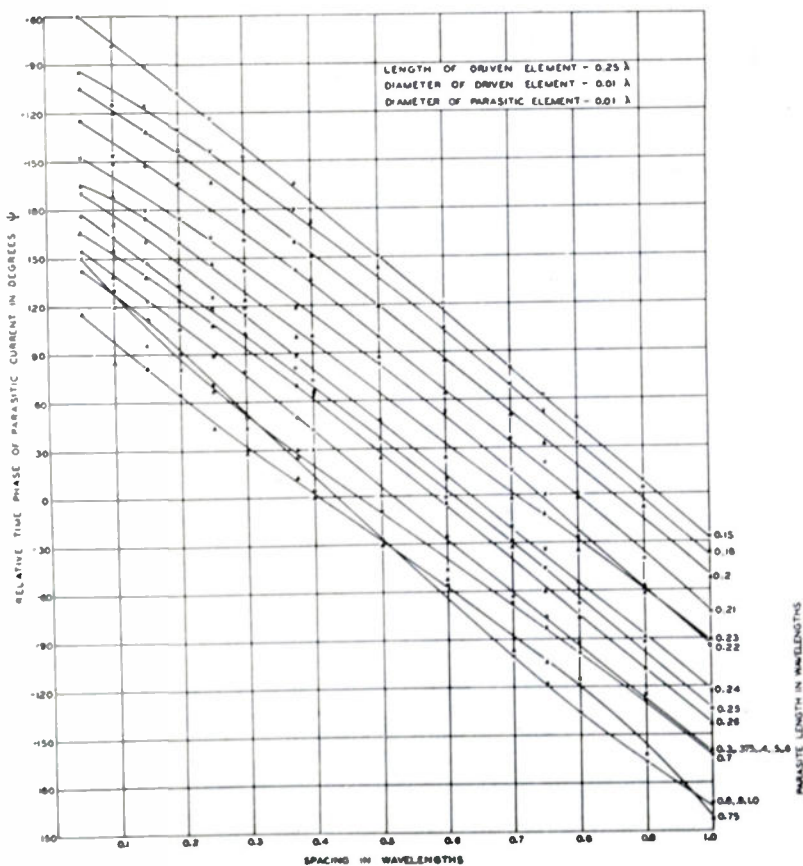

Fig. 2—Time-phase angle in degrees of the field resulting from the parasite relative to that from the driven element versus separation of the two elements. The height of the parasite is the parameter.

Impedance Transformation in Folded Dipoles*

RUDOLF GUERTLER†

Summary—It is pointed out that the impedance of a folded dipole relative to that of a simple dipole can be adjusted by employing conductors of different diameters for the separate elements of the folded dipole. Increased impedance ratios can be obtained by the use of additional elements.

It is shown that the impedance ratio can be obtained from the current ratio and suitable expressions are derived. Practical examples are given.

I. THE FOLDED DIPOLE AS AN IMPEDANCE TRANSFORMER

ANY FOLDED DIPOLE^{1,2} has a higher impedance at the input terminals than a simple dipole at the same place in any antenna or antenna array. This property of impedance transformation explains the increasing use of folded dipoles, especially at very-high frequencies.

The simplest folded dipole comprises two conductors of equal diameters (see Fig. 1) and gives a step-up

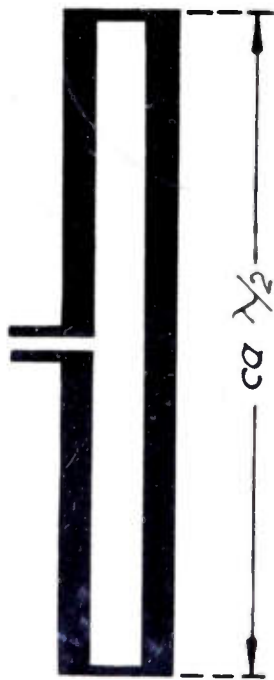

Fig. 1—Folded dipole of two elements of equal diameter.

impedance transformation of 4 to 1. By employing elements of different diameters as in Fig. 2, any desired step-up transformation ratio can be achieved.

If a high transformation ratio is desired, it is practicable to use more than two elements with parallel axes although they need not be in the same plane. A prac-

tically important application of three elements is shown in Fig. 3; the axes of the three conductors are in the same plane, the outer elements being identical with each other but generally different from the fed middle element from which they have equal separation.

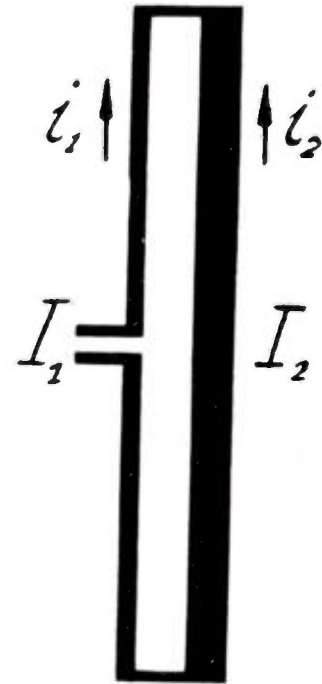

Fig. 2—Folded dipole of two elements of unequal diameter.

Assuming that the radiation from a folded dipole does not differ much from that of a simple dipole at the same place,³ it is possible to compute the transformation ratio, and consequently the impedance, at the feeding point if the ratio of the currents in the elements of the folded dipole is known.

In Fig. 2, the current (root-mean-square) at the feeding point is designated by I_1 and the current in the center of the auxiliary element by I_2 . It is assumed, for simplicity, that the dimensions of the dipole "match" the frequency so that the input impedance is real.

In any array in which the fed element is a simple dipole, let the input resistance at the feeding point be R_0 . When the simple dipole is replaced by a folded dipole, let the new input resistance be R_1 .

Then, with the above-mentioned assumption of equal radiation, we have the following relation:

$$I_1^2 R_1 = (I_1 + I_2)^2 R_0 \quad (1)$$

The folded dipole therefore gives the resistance transformation ratio u , where u is given by the following expression:

³ R. W. P. King, H. R. Minno, and A. H. Wing, "Transmission Lines, Antennas and Wave Guides," McGraw-Hill Book Co., New York, N. Y., 1945; p. 224.

* Decimal classification: R117.12×R326.7. Paper received by the Institute, November 4, 1949. Reprinted from the *Proceedings of the Institution of Radio Engineers, Australia*, vol. 10, pp. 95-100; April, 1949.

† Standard Telephones and Cables Pty. Ltd., Sydney, Australia.
¹ P. S. Carter, "Simple television antennas," *RCA Rev.*, vol. 4, p. 168; October, 1939.

² J. D. Kraus, "Multi-wire dipole antennas," *Electronics*, vol. 13, p. 26; January, 1940.

$$u = R_1/R_0 = [(I_2/I_1) + 1]^2 = (n + 1)^2 \quad (2)$$

in which n is the current ratio given by

$$n = I_2/I_1. \quad (3)$$

We can state the resistance transformation if we know the current ratio. The computation of the current ratio is the object of the following sections.



Fig. 3—Folded dipole of three elements.

II. COMPARISON OF A FOLDED DIPOLE WITH A SIMPLE DIPOLE OF EQUAL CONFIGURATION

Consider the dipole of Fig. 4, which is physically like the folded dipole of Fig. 2, except that the auxiliary element is folded and fed in parallel with the first element. The electrical difference is mainly this, that in Fig. 2 out-of-phase "line" currents are superimposed on the in-phase "antenna" currents i_1, i_2 . Since the out-of-phase "line" currents are negligible compared to the "antenna" currents at the center points and at the feeding point of the dipole elements,^{3,4} we do not need to consider them. Consequently we shall calculate the current partition in a simple unfolded dipole, comprising two or more conductors in parallel as in Fig. 4. The result will be an approximation suitable for engineering design of folded dipoles.

III. THE FIELD EQUATIONS IN FOUR-DIMENSIONAL FORM AS A BASIS FOR THE INVESTIGATION OF FOLDED DIPOLES

To describe the electromagnetic relations in the antenna of Fig. 4, we start with the field equations.

³ W. van B. Robert, "Input impedance of a folded dipole," *RCA Rev.*, vol. 8, p. 289; June, 1947.

To enjoy the advantages of more concise expression we shall use them in the four-dimensional representation.⁵⁻⁸ In addition, we shall choose the potential form which is accentuated by the problem—computation of current and charge distribution.

The four-potential is designated by Φ , the four-current by \mathbf{P} , the six-vector of the electromagnetic field by \mathbf{F} . Div and Curl are differential operations which may be represented by the four-dimensional differential operator

$$\diamond = k_1 \frac{\partial}{\partial x_1} + k_2 \frac{\partial}{\partial x_2} + k_3 \frac{\partial}{\partial x_3} + k_4 \frac{\partial}{\partial x_4}$$

where $x_1 \equiv x, x_2 \equiv y, x_3 \equiv z, x_4 \equiv jct$, and k_i are the unit vectors of the four-dimensional space.

$$\square = \diamond \cdot \diamond = \frac{\partial^2}{\partial x_1^2} + \frac{\partial^2}{\partial x_2^2} + \frac{\partial^2}{\partial x_3^2} + \frac{\partial^2}{\partial x_4^2} \\ = \frac{\partial^2}{\partial x^2} + \frac{\partial^2}{\partial y^2} + \frac{\partial^2}{\partial z^2} - \frac{1}{c^2} \frac{\partial^2}{\partial t^2}$$

is the four-dimensional form of the Laplace operator

$$\nabla^2 = \Delta.$$

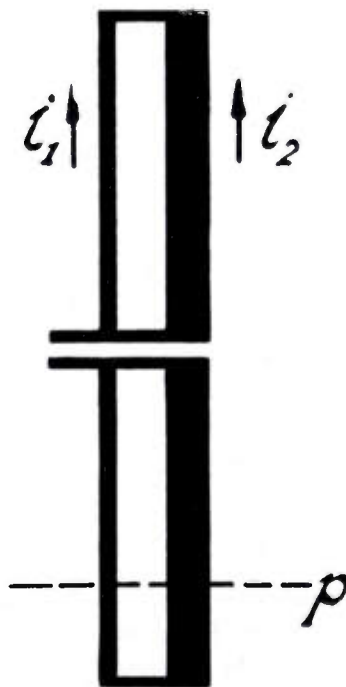

Fig. 4—Simple dipole of same physical elements as the folded dipole of Fig. 2.

⁵ A. Sommerfeld, "Zur Relativitaetstheorie. I—Vierdimensionale Vectoralgebra," *Ann. Phys.*, vol. 32, p. 749; June, 1910.

⁶ A. Sommerfeld, "Zur Relativitaetstheorie. II—Vierdimensionale Vectoranalysis," *Ann. Phys.*, vol. 33, p. 649; October, 1910

⁷ P. Frank and R. v. Mises, "Die Differential und Integralgleichungen der Mechanik und Physik," F. Vieweg, Braunschweig, Germany, vol. 2, 2nd ed., 1935; p. 767.

⁸ L. Page and N. I. Adams, "Electrodynamics," D. Van Nostrand Co., Inc., New York, N. Y., 1940; p. 426.

The field equations are now

$$\mathbf{F} = \text{Curl } \Phi \quad (4)$$

$$\text{Div } \Phi = 0 \quad (5)$$

$$\square \Phi = -\mathbf{P} \quad (6)$$

$$\text{Div } \mathbf{P} = 0. \quad (7)$$

Since we are interested in the current distribution i_1, i_2 on the two conductors of the dipole in Fig. 4, we do not require the knowledge of field strengths so that we can neglect (4) in the further considerations. It is obvious that on both conductors all points of the cross sections placed in plane p orthogonal to the axes of the conductors have equal potential at any moment. We may also assume that the currents are flowing only in the surface of conductors, an assumption permissible for practical purposes. The currents, therefore, have only components parallel to the axes. Thus the four current of an element is

$$\mathbf{P} = (1/c)ik_3 + j\rho k_4, \quad (8)$$

if the z axis is parallel to the axes of the conductors. In the formula i designates the current and ρ the charge for unit length of a conductor. Also the four-potential has in this case two components only,

$$\Phi = A_2 k_3 + j\phi k_4, \quad (9)$$

where A_2 denotes the vector potential and ϕ the scalar potential.

The currents will be distributed on both elements in such a way that the above-mentioned condition of equal potentials on the conductor cross sections in any plane p , in Fig. 4, will be fulfilled.

Before starting with the calculation of the retarded potentials,^{8,9} we shall consider a further simplification.

As a consequence of the equation of continuity (7) which establishes the time-space conservation of electrical charge, it follows that the ratio of charge densities equals the ratio of currents; i.e., from

$$\mathbf{P}_2 : \mathbf{P}_1 = n$$

follows

$$\rho_2 : \rho_1 = i_2 : i_1 = n. \quad (10)$$

Therefore we can confine ourselves to the calculation of the ratio of charges. The same fact is expressed by (5) which states that the four-potential is "divergence-free."¹⁰ Thus the vector potential of the conductor elements in a plane p is in proportion to the scalar potentials. Consequently we may confine ourselves to the calculation of the scalar potential.

We assume further a sinusoidal distribution of currents and charges along the dipole. In addition it will be obvious from the derivation below that the current ratio

is not critically dependent on the current and charge distribution along the antenna. Now we substitute the actual charge distribution on each cylindrical conductor by a line charge in parallel with the axis of the cylinder, which produces as far as possible the same potential distribution.

On the basis of these assumptions and simplifications we are able to compute relatively simply with sufficient approximation for practical purposes the potential determining the current distribution. The calculation is given in the Appendix.

IV. CALCULATION OF CURRENT RATIO AND IMPEDANCE TRANSFORMATION IN THE TWO-ELEMENT FOLDED DIPOLE

In the Appendix, the normalized scalar potential (i.e., for $\rho_{\max} = 4\pi\epsilon_0$ in the element 1) is derived for a point in the proximity of a conductor in the plane p if the plane is placed through an end of the dipole.

The formula reads

$$\phi = \log_e \frac{\lambda^{n+1}}{\delta\delta'^n} - \frac{n+1}{2} \text{Cin } 2\pi \quad (11)$$

where δ and δ' are the distances of the reference point and the axes of the conductor 1 and 2.

The "end effect" has not been considered in this formula. Nevertheless, it produces the same rule for designing as formulas derived for planes p which are not placed through an end of the dipole.

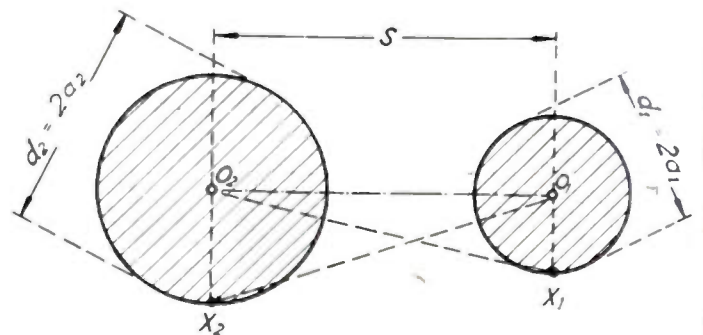

Fig. 5—Cross section through the dipole of Fig. 4 in the plane p .

We employ the formula for computation of the current ratio n if the diameters and the separation of the dipole elements are fixed. As stated above, the potential is the same for all elements of the cross sections of both conductors in a plane p . We consider the potential at the points X_1 and X_2 of Fig. 5, and that in a plane p through the end of the dipole at which (11) holds under the idealizations as assumed in Section III. The distance of X_1 from O_2 and of X_2 from O_1 is approximately $O_1O_2 = s$. For the reference point X_1 , we must therefore in (11) put $\delta = a_1$, $\delta' \cong s$, and we obtain the potential

$$\phi(X_1) = \log_e \frac{\lambda^{n+1}}{a_1 s^n} - \frac{n+1}{2} \text{Cin } 2\pi. \quad (12)$$

⁸ M. Abraham and R. Becker, "Electricity and Magnetism," Blackie and Son, London, England, 1937; p. 220.

¹⁰ H. Minkowski, "Das Relativitaetsprinzip," *Ann. Phys.*, vol. 47, p. 927; September, 1915.

Correspondingly we obtain the potential for X_2 at the same instant if we put $\delta \cong s$ and $\delta' = a_2$

$$\phi(X_2) = \log_e \frac{\lambda^{n+1}}{s a_2^n} - \frac{n+1}{2} \text{Cin } 2\pi. \quad (13)$$

Both values (12) and (13) of the potential must be equal; hence, we obtain immediately

$$a_1 s^n = a_2^n s. \quad (14)$$

The current ratio in question for both conductors is thus approximately

$$n = \log \frac{s}{a_1} / \log \frac{s}{a_2}. \quad (15)$$

The impedance transformation follows now from (2)

$$u = R_1/R_0 = (n+1)^2 = \left(\log \frac{s^2}{a_1 a_2} / \log \frac{s}{a_2} \right)^2. \quad (16)$$

These formulas are suitable both for design of folded dipoles if the transformation ratio is fixed, and for computation of the transformation ratio of a given dipole.

Sometimes the following formula obtained from (15) is more convenient

$$n-1 = \log \frac{a_2}{a_1} / \log \frac{s}{a_2}. \quad (17)$$

It is immaterial whether we use natural or decade logarithms.

The formulas give a good approximation if

$$a_2/a_1 \geq 1 \quad \text{and} \quad s/a_2 \geq 2.5$$

or

$$a_2/a_1 < 1 \quad \text{and} \quad s/a_1 \geq 2.5.$$

V. CALCULATION OF CURRENT RATIO AND IMPEDANCE TRANSFORMATION OF A FOLDED DIPOLE COMPRISING MORE THAN TWO ELEMENTS

As for a two-element dipole we obtain formulas for the design of multi-element folded dipoles by applying (28).

We shall consider only one such type which is of practical interest, namely the symmetrical three-element dipole of Fig. 3, in which the axes of the three elements are in a common plane. If a_1 denotes the radius of the inner element which is fed, a_2 denotes the radius of any of the outer equal elements, s denotes the separation of the inner element from any outer element, and m denotes the current ratio for one outer element to the fed inner element, we obtain approximately

$$m = \log \frac{s}{a_1} / \log \frac{s}{2a_2} \quad (18)$$

or, more convenient for some problems,

$$m-1 = \log \frac{2a_2}{a_1} / \log \frac{s}{2a_2}. \quad (19)$$

The impedance transformation ratio is obviously given by

$$u = (2m+1)^2 = \left(\log \frac{s^3}{2a_1^2 a_2} / \log \frac{s}{2a_2} \right)^2. \quad (20)$$

Especially it is clear from (18) and (19) that currents in the conductors of a three-element dipole of Fig. 3 are equal, i.e., that $m=1$ only if $a_1=2a_2$, that is to say if the inner element has twice the thickness of an outer element. For this case the current ratio is practically (that is, approximately) independent of the separation.

Another specially interesting case is $m=2$, i.e., a transformation ratio $u=25$; according to (19) it is achieved if $s/2a_2=2a_2/a_1$, i.e., if the diameter of an outer element is the geometric mean value of the radius of the inner element and the spacing.

The simple approximative formulas (18) to (20) become inaccurate if the separation is too small. The currents and the charges in the outer elements are shifted considerably to the outer parts of the outer elements so that the substituting linear charges ought to be placed some distance outside the axes of the outer elements.

For practical purposes the formulas (18) to (20) may be used for a_2/a_1 between 0.5 and 5, if $s/2a_2 > 2.5$, and for $a_2/a_1 < 0.5$ if $s/a_1 > 2.5$.

VI. MEASUREMENTS ON TWO-ELEMENT AND THREE-ELEMENT FOLDED DIPOLES

O'Shannassy and Wilkinson performed various measurements on folded dipoles at 150 Mc. They published a part of the results in the literature.¹¹ Because their measurements are very interesting, the following series are quoted.

Two-Element Folded Dipole

1. Series of measurements (constant spacing):

| DIMENSIONS | | | TRANSFORMATION RATIO u | |
|-----------------|-----------------|------------------|--------------------------|-----------------------------|
| $2a_1$ | $2a_2$ | s | Measured | Calculated from n of (15) |
| $\frac{3}{8}$ " | $\frac{3}{8}$ " | $1\frac{1}{2}$ " | 3.96 | 4.0 |
| $\frac{3}{4}$ " | $\frac{3}{4}$ " | $1\frac{1}{2}$ " | 4.6 | 4.8 |
| $\frac{3}{4}$ " | $\frac{3}{4}$ " | $1\frac{1}{2}$ " | 6.08 | 5.7 |
| 0.19" | $\frac{3}{4}$ " | $1\frac{1}{2}$ " | 8.3 | 6.5 |

2. Series of measurements (constant diameters):

| DIMENSIONS | | | TRANSFORMATION RATIO u | |
|-----------------|-----------------|------------------|--------------------------|-----------------------------|
| $2a_1$ | $2a_2$ | s | Measured | Calculated from n of (15) |
| $\frac{1}{4}$ " | $\frac{1}{4}$ " | $\frac{1}{2}$ " | 8.89 | 9.0 |
| | | 1 " | 6.19 | 6.25 |
| | | $1\frac{1}{2}$ " | 5.67 | 5.7 |
| | | 2 " | 5.48 | 5.44 |
| | | $2\frac{1}{2}$ " | 5.25 | 5.3 |

¹¹ J. O'Shannassy and E. J. Wilkinson, "Some measurements of the impedance multiplication factor of folded dipoles," *Amateur Radio*, vol. 16, p. 7; January, 1948.

Later on O'Shannassy made experiments on three-element folded dipoles which have not yet been concluded since it has proved very difficult to measure high SWR values correctly. The writer therefore quotes from a letter from O'Shannassy only two tentative measurements on symmetrical three-element dipoles (see Fig. 3).

| DIMENSIONS | | | TRANSFORMATION RATIO u | |
|----------------------|----------------------|-----------------------|--------------------------|-----------------------------|
| $2a_1$ | $2a_2$ | s | Measured | Calculated from m of (18) |
| $\frac{1}{4}\lambda$ | $\frac{1}{4}\lambda$ | $1\frac{1}{2}\lambda$ | 11.0 | 14 |
| $\frac{1}{4}\lambda$ | $\frac{1}{4}\lambda$ | 1λ | 12.5 | 16 |

VII. CONCLUSIONS

The folded dipole of two or more elements is being used as an impedance transformer, e.g., to match an antenna to a line of higher characteristic impedance.

The impedance transformation ratio can be calculated if the current ratio is known. To find this, the two-element folded dipole (see Fig. 2) is compared to a simple dipole of equal physical construction (see Fig. 4), i.e., of two elements in parallel. It is obvious that the charge and current distributions in both types of dipoles are essentially much the same. The charge distribution in the simple two-element dipole can be approximately calculated under the assumption that the (retarded) potentials on coplanar cross sections of both elements are equal.

Measurements seem to prove the practical applicability of the approximate formulas.

VII. ACKNOWLEDGMENTS

The author wishes to acknowledge his indebtedness to K. W. Magee (director of Austronic Engineering Laboratories, Melbourne) for the lively discussions which stimulated the investigations¹² which provided the basis for this paper, and to express his appreciation to Standard Telephones & Cables Pty. Ltd. for assistance in preparing the paper for publication.

He also wishes to thank J. O'Shannassy and E. J. Wilkinson of P.M.G.'s Department, Melbourne, for their measurements of which those on three-element dipoles were undertaken at the personal request of the author.

IX. APPENDIX

Calculation of Retarded Potential in the Proximity of a Folded Dipole

The first step is to draw according to Fig. 6 a system of co-ordinate axes through a folded dipole as in Fig.

2 or a single dipole of the same physical construction as in Fig. 4. The z -axis coincides with the straight line charge equivalent to the fed element 1. The potential at any point X is the sum of the potential of conductor 1 and the potential of conductor 2.

First we shall calculate the potential produced by the charge on conductor 1 only. The charge per unit length of conductor 1 will be designated by ρ , thus ρdz will be the charge of a conductor element of length dz . The distance of the charge ρdz from the reference point X may be called r , the distance of point X from the z -axis may be δ , and ζ denotes the height of X over the xy plane.

The retarded potential⁷⁻⁹ is given by

$$\Psi = \frac{1}{4\pi\epsilon_0} \int_{z=0}^{z=\lambda/2} \frac{1}{r} [\rho] dz \quad (21)$$

where $[\rho]$ denotes the retarded charge.

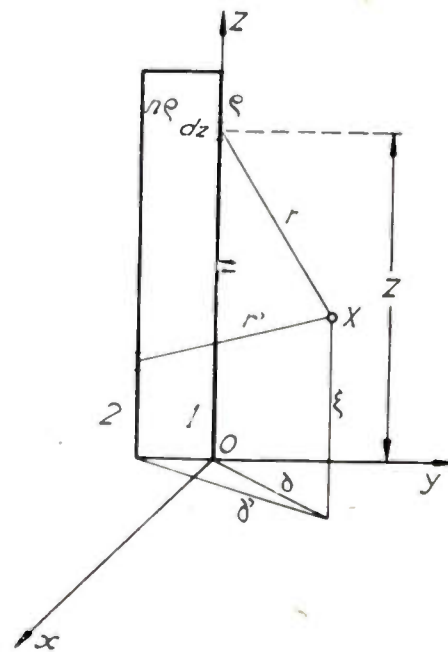

Fig. 6—Folded dipole showing co-ordinate system for calculation of the retarded potential.

If ρ_{\max} represents the maximum of charge density ρ with respect to time and space, and if we assume sinusoidal distribution of charge along the dipole, the retarded charge density along conductor 1 is

$$[\rho] = \rho_{\max} \cos 2\pi \frac{z}{\lambda} \cos \omega \left(t - \frac{r}{c} \right)$$

or, by suitable choice of zero time, more simply

$$[\rho] = 4\pi\epsilon_0 \cos 2\pi \frac{z}{\lambda} \cos 2\pi \frac{r}{\lambda} \quad (22)$$

where

$$[\rho] = 4\pi\epsilon_0 [\rho] / \rho_{\max}$$

¹² K. W. Magee, "Unfolding the folded dipole," *Amateur Radio*, vol. 15, p. 3; May, 1947.

denotes the "normalized" retarded charge which shall be used from now on. By substituting (22) in (21) we obtain the formula for the "normalized" scalar potential due to conductor 1

$$\psi = \int_{z=0}^{\lambda/2} \frac{1}{r} \cos 2\pi \frac{r}{\lambda} \cos 2\pi \frac{z}{\lambda} dz. \quad (23)$$

For convenience all quantities may be considered as measured in electrical angular degrees; i.e., we write now r instead of $2\pi r/\lambda$; z instead of $2\pi z/\lambda$; ζ instead of $2\pi \zeta/\lambda$; and δ instead of $2\pi \delta/\lambda$. The limits have also to be taken in angular scale, so that (23) becomes

$$\psi = \int_{z=0}^{\pi} \frac{1}{r} \cos r \cos z dz. \quad (24)$$

Applying the co-ordinate transformation $z - \zeta = u$ we obtain for (24)

$$\begin{aligned} \psi &= \int_{u_1=-\zeta}^{u_2=\pi-\zeta} r^{-1} \cos r \cos (u + \zeta) du \\ &= \int_{u_1}^{u_2} (u^2 + \delta^2)^{-1/2} \cos (u^2 + \delta^2)^{1/2} \cos (u + \zeta) du. \end{aligned}$$

This we transform by means of the addition theorem of trigonometric functions into

$$\begin{aligned} \psi &= \frac{1}{2} \cos \zeta \left[\int_{u_1}^{u_2} \frac{1}{r} \cos (r + u) du \right. \\ &\quad \left. + \int_{u_1}^{u_2} \frac{1}{r} \cos (r - u) du \right] \\ &\quad - \frac{1}{2} \sin \zeta \left[\int_{u_1}^{u_2} \frac{1}{r} \sin (r + u) du \right. \\ &\quad \left. - \int_{u_1}^{u_2} \frac{1}{r} \sin (r - u) du \right]. \end{aligned}$$

Introducing new variables for the arguments $(r+u)$ or $(r-u)$, we reduce the individual integrals to the cosine integral or sine integral. Substituting the limits we obtain the potential in numerically calculable form,

$$\begin{aligned} \psi &= \frac{1}{2} \cos \zeta [-\text{Ci}(r_1 + u_1) + \text{Ci}(r_1 - u_1) + \text{Ci}(r_2 + u_2) \\ &\quad - \text{Ci}(r_2 - u_2)] + \frac{1}{2} \sin \zeta [\text{Si}(r_1 + u_1) + \text{Si}(r_1 - u_1) \\ &\quad - \text{Si}(r_2 + u_2) - \text{Si}(r_2 - u_2)], \quad (25) \end{aligned}$$

putting, for simplicity,

$$r_1 = \sqrt{u_1^2 + \delta^2}, \quad r_2 = \sqrt{u_2^2 + \delta^2}.$$

Using the well-known definition^{13,14}

$$\text{Ci}(x) = \gamma + \log_e x - \text{Cin}(x)$$

where γ denotes the Euler constant, we can transform (25) in a more suitable form for our purpose

$$\begin{aligned} \psi &= \frac{1}{2} \cos \zeta \left[2 \log_e \frac{r_2 + u_2}{r_1 + u_1} + \text{Cin}(r_1 + u_1) \right. \\ &\quad \left. - \text{Cin}(r_1 - u_1) - \text{Cin}(r_2 + u_2) + \text{Cin}(r_2 - u_2) \right] \\ &\quad + \frac{1}{2} \sin \zeta [\text{Si}(r_1 + u_1) + \text{Si}(r_1 - u_1) \\ &\quad - \text{Si}(r_2 + u_2) - \text{Si}(r_2 - u_2)]. \quad (26) \end{aligned}$$

To simplify as much as possible the following considerations we choose a reference point X in the xy plane; i.e., we put $\zeta=0$. Thus $u_1=0$, $u_2=\pi$, $r_1=\delta$, $r_2=\sqrt{\pi^2+\delta^2}$. Hence, the potential of a point in the xy plane is

$$\begin{aligned} \psi &= \log_e \frac{\pi + \sqrt{\pi^2 + \delta^2}}{\delta} - \frac{1}{2} \text{Cin}(\pi + \sqrt{\pi^2 + \delta^2}) \\ &\quad + \frac{1}{2} \text{Cin}(-\pi + \sqrt{\pi^2 + \delta^2}). \quad (27) \end{aligned}$$

For a reference point in the proximity of the dipole is $\delta^2 \ll \pi^2$, thus with a good approximation

$$\psi \cong \log_e \frac{2\pi}{\delta} - \frac{1}{2} \text{Cin } 2\pi. \quad (28)$$

Since the charge of the second conductor (see Fig. 6) is n times larger according to (10), the potential produced by the second element at point X is

$$\psi' \cong n \left(\log_e \frac{2\pi}{\delta'} - \frac{1}{2} \text{Cin } 2\pi \right);$$

hence, the total potential

$$\phi = \psi + \psi' = \log_e \frac{(2\pi)^{n+1}}{\delta \delta'^n} - \frac{n+1}{2} \text{Cin } 2\pi.$$

By returning from the angular scale to length scale we have to write again $2\pi\delta/\lambda$ and $2\pi\delta'/\lambda$ instead of δ and δ' , so that we obtain finally for the potential in a plane through an end of the dipole of Fig. 4 the formula

$$\phi = \log_e \frac{\lambda^{n+1}}{\delta \delta'^n} - \frac{n+1}{2} \text{Cin } 2\pi, \quad (11)$$

which also holds for the folded dipole of Fig. 2, at least with good enough approximation for practical purposes.

¹³ F. E. Terman, "Radio Engineers Handbook," McGraw-Hill Book Co., New York, N. Y., 1943; p. 17.

¹⁴ W. Magnus and F. Oberhettinger, "Formeln und Sätze fuer die speziellen Funktionen der mathematischen Physik," Springer, Berlin, Germany, 1943; p. 97.

Two Standard Field-Strength Meters for Very-High Frequencies*

D. D. KING†, MEMBER, IRE

Summary—Methods of field-strength measurement are reviewed briefly and the design of field meters conforming closely to the conditions imposed by antenna theory is considered. Two instruments approaching ideal theoretical conditions and suitable for reference standards are described. The first of these contains an adjustable matching network. The second utilizes very fine wires on a styrofoam support.

I. INTRODUCTION

STANDARD FIELDS are established either in terms of a calibrated receiver or by means of a calibrated transmitter and a known propagation path.^{1,2} By virtue of the reciprocal theorem, the two methods are equivalent in principle. In practice, the receiving method is generally preferable for reasons enumerated below.

1. The contribution of the earth is avoided in the receiving method. The constants of the ground, as well as the exact positions of receiver and transmitter, are immaterial at heights of a wavelength or more.
2. A transmitting antenna is fed by a long line or mounted on a bulky transmitter. In either case, the antenna performance may differ from that of an isolated antenna.
3. Measuring transmitted power involves extrapolation from the sample taken by a monitor. In the receiving case a direct reading is made.
4. The intrinsic errors of the indicating devices are comparable in the two systems. However, the conversion from meter reading to field-strength reading appears simpler in the receiving case.

The present discussion is concerned only with receiving-type instruments. The range of field strengths that can be measured with such an instrument depends on the indicating device. For compact self-powered installations, crystals and thermocouples are the most suitable. A crystal is more sensitive by several orders of magnitude, but is not susceptible to direct calibration.

The required calibration information for either device is the input impedance and the sensitivity. The input impedance is easily measured at the operating frequency, but not the sensitivity. A comparison with direct-current or low-frequency power is made to obtain a primary calibration in a thermocouple or some other temperature-sensitive device such as a barretter or thermistor. At frequencies of 100 Mc or less, the crystal

admittance may be low enough to permit its use as a voltmeter. In general, however, the primary standard is one of power.

The present discussion is primarily directed toward standard meters calibrated in terms of dc. Thermocouples are therefore used, although this restricts the minimum measurable field intensities to hundreds of millivolts. The accuracy attainable with such an instrument depends on the limits of error of the thermocouple impedance Z_L and of the calibration. The calculation of the properties of the antenna as a transducer between field and load is a third significant factor in the final accuracy. The remainder of the paper is concerned with the properties of a standard receiving antenna suitable for a field meter.

II. RECEIVING ANTENNA PARAMETERS

The properties of a receiving antenna are described in terms of the effective height h_e and the input impedance Z_a . The equivalent circuit is shown in Fig. 1. Here Z_L is the load impedance and E the field strength in rms volts/meter.

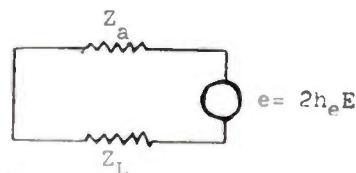

Fig. 1—Circuit of a receiving antenna.

The rms current in the load is

$$I = \frac{2h_e E}{|Z_a + Z_L|} \quad (1)$$

For a conjugate-matched load, $Z_L = Z_a^*$, the power in the load becomes

$$P_L = \frac{(E h_e)^2}{R_a} \quad (2)$$

Alternatively, the power in a matched load is expressed in terms of gain and power density.

$$P_L = \left(\frac{G \lambda^2}{4\pi} \right) \frac{E^2}{\rho} \quad (\zeta = 120\pi \text{ ohms}). \quad (3)$$

A plot of gain against electrical length for dipoles of various length-to-radius ratios is given in Fig. 2. The data for these curves is from a recent compilation of antenna data.³ The values of gain given in Fig. 2 show a significant increase with thickness. The values of imped-

* Decimal classification: R271. Original manuscript received by the Institute, September 16, 1949; revised manuscript received, April 21, 1950.

† The Johns Hopkins University, Baltimore, Md.

¹ Report CRPL-9-1, National Bureau of Standards, November, 1946.

² F. M. Greene and M. Solow, "Development of vhf field-intensity standards," presented, URSI-IRE Meeting, Washington, D. C., National Bureau of Standards, May 2, 1949.

³ R. King, "Graphical Representation of the Characteristics of Cylindrical Antennas," Cruft Laboratory, Harvard University, Report No. 20; October, 1947.

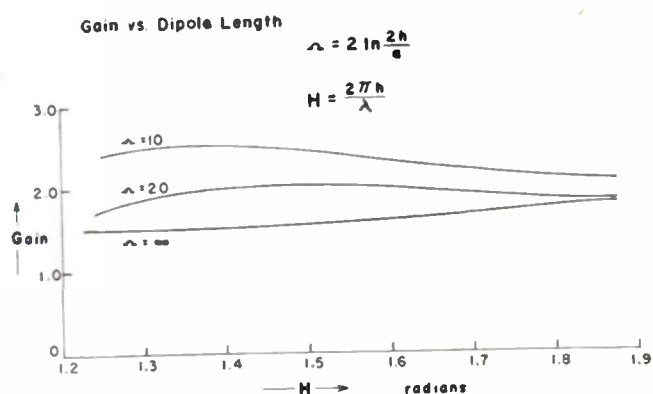

Fig. 2—Dipole gain as a function of length and thickness.
 a = radius; $2h$ = over-all length.

ance have been checked experimentally^{4,5} and are more reliable than the corresponding values of effective height. A decrease in theoretical accuracy with increasing thickness is inevitable, since the thick cylinder is regularly approximated by cones or ellipsoids.^{6,7} Direct data on the variation of G with dipole thickness has not come to the writer's attention.

In addition to requiring fairly thin conductors, theoretical treatments of dipoles assume a load concentrated at the center of the dipole. The gap at the center of a dipole attached to a parallel-wire line may cause considerable change in the properties of the antenna.⁸ Thus, a gap of 0.01λ increases the resonant resistance about 10 per cent by effectively increasing the resonant length.

In summary, the parameters Z_a , h_e , and G characterize the receiving properties of an antenna. The effect of dipole thickness on Z_a is known, but the data on G and h_e as functions of thickness are meager. In general, a thin dipole with concentrated load is most accurately calculable. Dipoles are used in preference to loops (magnetic dipoles) since the experimental and theoretical data on the latter is far less complete.⁹

III. FIELD METERS AS RECEIVING ANTENNAS

The ideal receiving antenna for a field meter is shown in Fig. 3(a). The shortcomings of actual field meters in approximating the theoretical model may be deduced from Fig. 3(b). The design illustrated there is fairly typical of a convenient mechanical structure. Similar mounting schemes are illustrated in the literature.¹ The points of difference are listed below.

1. *Thick antenna conductors.* About the thinnest dipole capable of being supported as in Fig. 3(b) has a thickness factor $\Omega \approx 10$. From the definition in Fig. 2,

⁴ G. H. Brown and O. M. Woodward, Jr., "Experimentally determined impedance characteristics of cylindrical antennas," *Proc. I.R.E.*, vol. 33, p. 257; April 1945.

⁵ D. D. King, "Measured impedance of cylindrical dipoles," *Jour. Appl. Phys.*, vol. 17, p. 844; October, 1946.

⁶ L. Brillouin, "Antennae for ultra-high frequencies—wide-band antennae," *Elec. Commun.*, vol. 21, no. 4, pp. 257-282; and vol. 22, pp. 11-40; 1944.

⁷ Aharoni, *Antennae*, Oxford, p. 244, 1946.

⁸ R. King, "Antennas and open-wire lines. Part I. Theory and summary of measurements," *Jour. Appl. Phys.*, vol. 20, pp. 832-850; September, 1949.

⁹ P. Chang, "The Impedance Characteristics of Antennas Involving Loop and Linear Elements," Cruft Laboratory, Harvard University, Report No. 16; July, 1947.

this corresponds to a ratio of length to diameter of roughly 100:1 or less. This approaches the maximum thickness commonly tabulated in theoretical treatments of the cylindrical dipole.^{3,10}

2. *Configuration of the load conductors.* The straight thick antenna conductors in Fig. 3(b) have a gap in the center. The thin leads of the thermocouple are not equal in length or thickness to the omitted center portion of the dipole. Some antenna capacitance is therefore omitted, and the lead inductance replaces the much smaller inductance of the dipole conductors which normally occupy the gap.

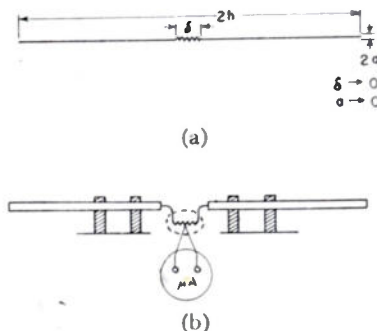

Fig. 3—(a) Idealized receiving antenna.
 (b) Mechanical structure of a field-strength meter.

3. *Capacitive loading.* Dielectric supports of appreciable size attached far from the center of a resonant dipole necessarily alter the current distribution and hence the values of Z_a , h_e , and b . Significant dielectric loading from sleeves on the dipole conductors has been observed.¹¹

4. *Presence of microammeter and leads.* Short leads and a small meter offer the advantage of a portable instrument which introduces a minimum disturbance in the field. Long leads of resistance wire are effective in eliminating field distortion, but bolometers and ac techniques are required to regain the loss in the wire. Of course, the accuracy gained by a precision indicating instrument may more than compensate for errors introduced by copper leads.

Two field meters of somewhat unconventional design are now described. In both instruments, a number of the discrepancies between a practical field meter and a receiving antenna have been reduced or eliminated.

IV. A MATCHED-LOAD FIELD-STRENGTH METER

When antenna and load are matched, (3) may be used. Therefore, only the gain and the thermocouple calibration need be known. The circuit of the matched-load meter consists of a series stub feeding a shunt circuit containing an inductance, a variable capacitance, and the thermocouple. The arrangement of elements is shown in Fig. 4. The sliding stub and variable capacitor permit matching any load impedance to the antenna. A series structure is used instead of a phase changer in order to maintain the external dimensions constant with tuning adjustment.

¹⁰ Schelkunoff, "Electromagnetic Waves," D. Van Nostrand and Co. Inc., New York, N.Y., p. 463; 1943.

¹¹ R. C. Raymond and W. Webb, "Current distributions on some simple antennas," *Jour. Appl. Phys.*, vol. 20, p. 328; April, 1949.

This instrument requires knowledge of only the antenna gain G . Unfortunately, exact data on the gain of a thick dipole with parallel-line load are not available at present. Losses in the matching network appear low, since a 600-ohm and a 2-ohm thermocouple both give nearly identical outputs in the same field.

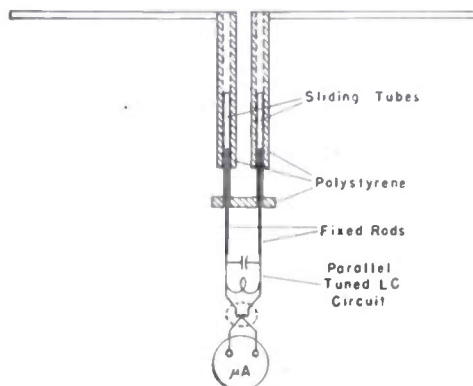

Fig. 4—Matched load field-strength meter.

The tuning adjustment itself is sensitive, but the inevitable proximity of the operator has no detectable effect on the final setting. In applications involving a spread of several per cent in frequency, the critical tuning disqualifies the meter. However, where interference from nearby channels is a significant factor, a narrow band is advantageous.

V. A STYROFOAM FIELD-STRENGTH METER

The theoretical ideal of a thin wire with concentrated load is closely approached with the aid of a styrofoam block (dielectric constant 1.02). Very thin wires are supported by the styrofoam, and a thermocouple¹² with input terminals on opposite sides of the bead, provides a straight connection to the load. A sketch of the arrangement of components is shown in Fig. 5. A two-inch slab of styrofoam supports a very thin (0.004 inch) antenna. The thermocouple heater-leads form a continuation of the antenna. The thermocouple bead is thus located at the center point of a thin straight conductor, as required for the most reliable calculations. The shunt capacitance

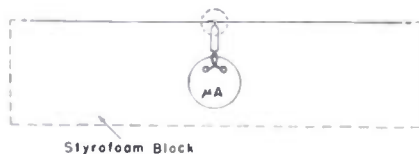

Fig. 5—Styrofoam field-strength meter.

due to the glass is less than $0.1 \mu\mu\text{fd}$, and the leads contribute negligible excess inductance. Comparison of Fig. 5 with Fig. 3(a) shows how closely the ideal system has been approached. The styrofoam construction also reduces the specifications for a standard design to a minimum. For this reason this type of meter might well serve as a reproducible reference. For convenience, a barreter and remote wattmeter can be used in place of the thermocouple.

¹² U.H.F. type, Best Products Ltd., supplied by Cossor Ltd., Montreal, Canada, and used with 0-500 μamp . 10-ohm movement made by Weston for the General Radio Company.

VI. PERFORMANCE DATA

The relations between field strength E and the thermocouple output current I_0 are easily derived from (1) and (3). For the matched-load meter the following expressions are convenient:

$$I_0 = \frac{E\lambda}{68.8} \left(\frac{G}{R_L} \right)^{1/2} \cdot S_I \tag{4a}$$

OR

$$I_0 = \frac{(E\lambda)^2 G S_p}{4740} \tag{4b}$$

where the thermocouple calibration constants are

$$\left. \begin{aligned} S_I &= \frac{\text{amp. output}}{\text{amp. input}} \\ S_p &= \frac{\text{amp. output}}{\text{watts input}} \end{aligned} \right\} \tag{5}$$

The expression for the conventional dipole is

$$I_0 = E \cdot \frac{2h_e}{\sqrt{(R_L + R_a)^2 + X_a^2}} \cdot S_I \tag{6}$$

A field meter of this type is not a sharply tuned device, and broadband operation is possible. In this respect a thick dipole is superior, since the variation of terminal impedance Z_a with electrical length is smaller than for a thin wire. However, the response is made virtually independent of Z_a by increasing the resistance to

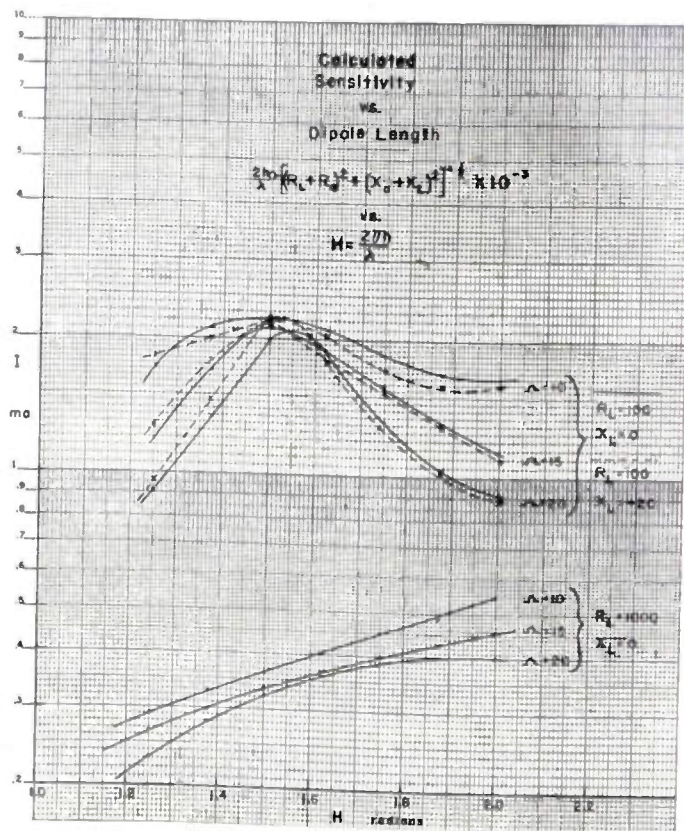

Fig. 6—Calculated field-meter response for various loads as a function of dipole length and thickness.

a large value, $R_L \gg R_a$. The sensitivity then depends on h_a only, and is an almost linear function of frequency. These statements are supported by the data in Fig. 6. Here the calculated response is plotted as a function of dipole length for various thicknesses and loads. The response in terms of volts per wavelength, appears flat within ± 5 per cent, over a ± 30 per cent bandwidth, as shown in Fig. 7.

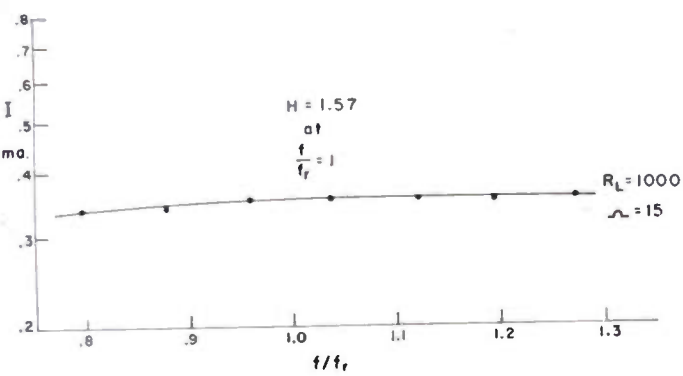

Fig. 7—Loaded styrofoam field-meter response in volts per wavelength. Field meter response to 1 volt per wavelength ($E\lambda=1$) versus normalized frequency.

Corresponding field-test data on the styrofoam instrument are given in Fig. 8. Agreement between theory and experiment is better for thin wires, as expected. Impedance measurements at the field test frequency indicate that the thermocouple and an equal length of thin wire

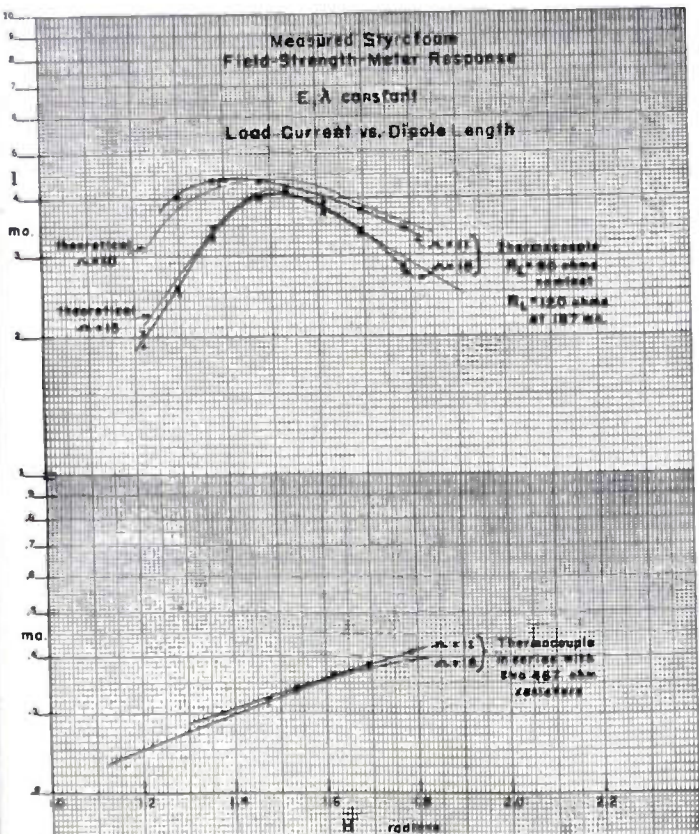

Fig. 8—Measured response of the styrofoam field meter.

(No. 36—No. 40) have about the same inductive reactance. Excess inductance of the order of $0.01-0.05 \mu h$ is produced by replacing the thick antenna ($\frac{1}{4}$ inch tube) by the thin thermocouple leads (0.020 inch wire). The effect of 20 ohms inductive reactance is shown in Fig. 6. Only minor changes in impedance occur when the power input to the couple is varied. To duplicate properly the terminal conditions, such impedance measurements should be made on a parallel-wire line. The results mentioned above are from coaxial-line measurements and indicate orders of magnitude.

A case of dielectric loading was inadvertently encountered in testing the styrofoam meter. Initial tests with No. 40 double-cotton-covered wire yielded the data plotted in Fig. 9. The significant effect of the insulation is established by the shift of the curves toward shorter lengths. The ratio of insulation diameter to wire diameter is 0.012 inch:0.003 inch. Proportionate shifts for thicker antennas have been reported.¹¹

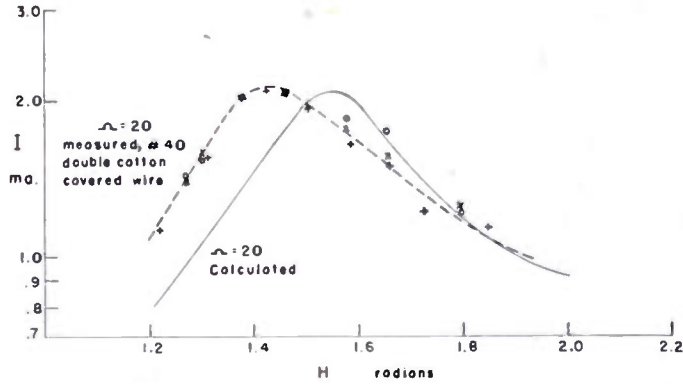

Fig. 9—Loading effect of double cotton covering on No. 40 wire. Meter response versus dipole length, $f=187$ Mc.

VII. CONCLUSION

The difference between the calculated properties of a receiving dipole and its performance as a standard field-strength meter may be significantly influenced by the structural design. The two instruments described attempt to minimize these differences. The tuned-load meter relates field strength to meter deflection by a particularly simple formula, (4). The sharp tuning adjustment is advantageous where interference problems are severe, but otherwise awkward. The styrofoam meter is perhaps the ultimate in simplicity of structure. The dipole, thermocouple, meter leads, and meter are all mounted on material whose electrical properties are here indistinguishable from those of air. Consequently, by specifying these four items, a reproducible standard of high theoretical merit is achieved. Fig. 6 furnishes conversion curves for use with a standard instrument of this design for operation in the range 100–1,000 Mc.

ACKNOWLEDGMENTS

The writer is indebted to H. Seidel, A. Trammel, and M. Brodwin for operating the field-test equipment, and to G. Kranz for calculating the response curves.

Pattern Calculations for Antennas of Elliptical Aperture*

R. J. ADAMS†, ASSOCIATE, IRE, AND K. S. KELLEHER†, MEMBER, IRE

A STRAIGHTFORWARD engineering method is presented for accurately determining the far field pattern of a paraboloid antenna of elliptical aperture from a knowledge of the characteristics of reflector and feed horn.

Using the measured principal plane patterns of a feed horn and an inverse-square attenuation factor, the illumination is obtained across the x and y axes of the aperture plane. These illumination data are changed into an analytical function, by means of a Fourier series approximation. In practice, the number of terms of the series required varies from two to four, depending upon the smoothness of the primary pattern.

It is then assumed that the illumination at any point (x, y) of the aperture plane is the product of the illumination at the point $(x, 0)$ and that at $(0, y)$. This assumption was checked for a typical horn and found to be accurate except in small regions of the aperture, along the lines $x = \pm y$, at some distance from the origin.

With this groundwork, the relative far-field pattern integral is written

$$F(u_1, u_2) = \int_{-a}^a \int_{-b}^b \frac{e^{j(u_1 x + u_2 y)}}{\sqrt{1-(x/a)^2} \sqrt{1-(y/b)^2}} \left(\sum a_r \cos \frac{r\pi y}{a} \right) \left(\sum b_s \cos \frac{s\pi y}{b} \right) e^{j(u_1 x + u_2 y)} dy dx$$

where a_r and b_s are coefficients of the illumination series, and a and b are the semi-major and semiminor axes of the elliptical aperture. The generalized variables u_1 and u_2 are related to the aperture size in wavelengths and to the pattern angles in the normal manner

$$u_1 = ak \sin \phi$$

$$u_2 = bk \sin \theta$$

where $k = 2\pi/\lambda$.

Upon performing the integration the pattern is

$$F(u_1, u_2) = \pi ab \sum \sum a_r b_s G_{rs}(u_1, u_2)$$

where $G_{rs}(u_1, u_2)$ involves a sum of Λ_1 functions. The principal plane patterns are obtained by setting either u_1 or u_2 equal to zero. In order to simplify the evaluation of such a pattern, a table of $G_{rs}(u, 0)$ has been prepared. The pattern is then obtained by summing the products of values from this table with values of the coefficients from the illumination series.

A correction to the pattern for the effect of the feed structure was made by the usual assumption that the pattern from the obstacle was constant over the region of interest. This constant value was easily determined and subtracted from the values for the amplitude pattern of an unobstructed aperture.

In order to check the validity of the method, measurements were made on a reflector of $48\lambda \times 24\lambda \times f = 22\lambda$, fed in turn by three different horns. A comparison of the measured and calculated patterns showed agreement in half-power beamwidths within the experimental error of 0.05 degree. The positions of the side lobes were predicted correctly, but a comparison of amplitudes is complicated by the lack of symmetry in the observed patterns. A typical pattern set is shown in Fig. 1.

Using the theory, an evaluation was made of the pattern characteristics in one principal plane as a function of variations in the other plane. From the pattern function itself, it is evident that the pattern in one plane does not depend on the antenna dimension in the other plane. However, a variation of the illumination in one plane does affect the integrated illumination in the other, so that the pattern in one principal plane depends, to some extent, on the illumination in the other principal plane.

In order to obtain realistic results, the calculations were based on actual measured

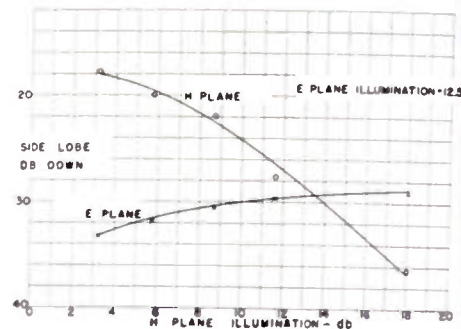

Fig. 2—Variation of side-lobe level with illumination taper. In the plane of varying illumination, the level decreases with increasing illumination taper, while in the other plane a slight increase in level is noted.

primary patterns. A single E -plane pattern, which gave an illumination taper of 12 db was used together with five H -plane patterns. The side-lobe levels, for the five cases (Fig. 2), show considerable variation in the H plane, and some change in the E plane. The beamwidths, obtained from the same calculations, showed, for the H plane, the expected increase with increasing illumination taper, while in the other plane the greater tapering produced a decrease in beamwidth.

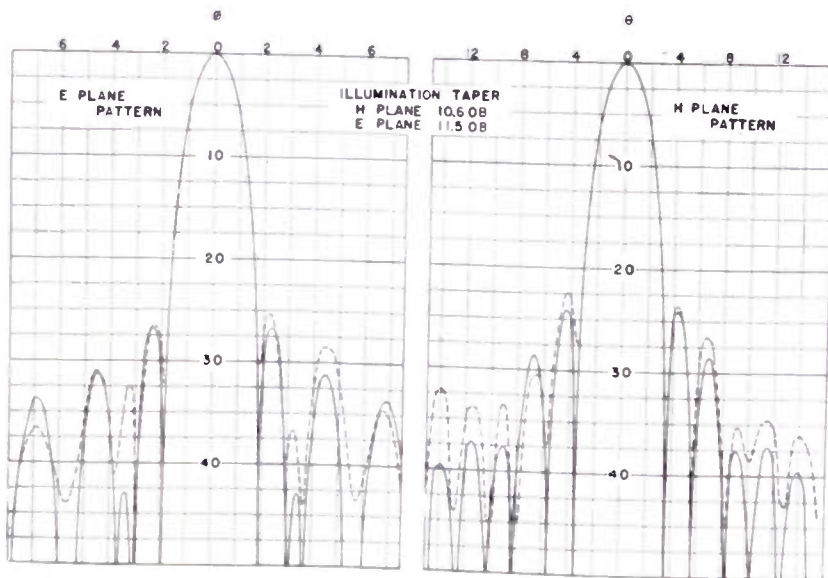

Fig. 1—Comparison of calculated and measured patterns. Signal strength in decibels is plotted against angle in degrees. The solid curves represent the calculated patterns.

* Decimal classification: R120.1. Original manuscript received by the Institute, May 27, 1949; abstract received, February 9, 1950. Presented, 1949 IRE National Convention, New York, N. Y., March 8, 1949.

† Naval Research Laboratory, Washington, D. C.

Development of Artificial Microwave Optics in Germany*

OTMAR M. STUETZER†, ASSOCIATE, IRE

Summary—This paper intends to give some aspects and results of early German work on microwave optics using artificial dielectrics. The line of approach was optical. The purpose of development and the state of technique being different, some of the conclusions reached were different from the parallel development in this country.

I. THE PROBLEM

WITH THE APPROACHING use of optical wavelengths in microwave technique, the question arose if and how optics could and should be transferred to the lower centimeter and the millimeter range. The absorption and weight of obtainable refractive dielectrics proved highly unsatisfactory. So the search was taken up for metal "imitated" dielectrics, a dielectric being considered as just a medium in which the phase velocity of an electromagnetic wave is different from that in vacuum.

Naturally the development ran rather similarly to some of the work of Kock^{1,2} in this country. In the following, only such points shall be considered where the line of approach or the conclusions drawn are different.

II. REMARKS ON ARTIFICIAL RETARDING DIELECTRIC

Any space in which small enough metal particles are distributed corresponds to the classical model of a dielectric. By superposition of secondary radiation of the excited particles to the primary wave, a phase velocity smaller than that of light in vacuum originates in general. Such an artificial dielectric has a big advantage in that it follows the optical laws of the known natural dielectrics, unless we give the elementary particles certain regular shapes or arrange them in distances no longer small compared to the wavelength used.

Schwede³ first used an artificial dielectric of parallel aluminum strips arranged in perpendicular to the electric vector of an incident field for matching purposes on lines and in free space. The author built a cylindrical lens for 6 cm wavelength, the refractive medium being imitated by parallel copper wires of 3 mm diameter, and a center distance of 6 mm.

But for the general case, i.e., spherical optics or circular polarization, a natural dielectric is required for embedding the metal particles. Foam materials were not

known at the time of development. So the idea was considered impractical and discarded.

III. WAVEGUIDE DIELECTRICS

If a boundary area of metal runs in parallel to the electric vector of a passing wave, the phase velocity along that boundary will be increased by reflection. The effect is best known for "waveguides," the properties of which shall not be repeated here. The ratio of light velocity to phase velocity in the guide we will call the index of refraction N ; for air-filled configurations it is smaller than unity.

By arranging very many of such waveguides in parallel, we can imitate a dielectric medium. Except for the unessential value of the refractive index, it will differ from the dielectrics mentioned above in two ways: The amplitude distribution is discontinuous, the amplitude being zero in the metal walls and sinusoidally distributed between (parallel) walls. The direction of energy transport is prescribed, namely along the waveguide axis.

It was felt that before using such a medium to build optical instruments, the basic optical laws that hold for it had to be investigated. A very brief outline of how this was done shall be given. Only first-order approximations are attempted; the simplifications of Huyghens' principle will be used.

A. Generalized Theorem of Refraction

Let a wave be incident at an angle α on a plane boundary of a waveguide system. We will assume that only the dominant mode may propagate without attenuation in each of our identical waveguides, and that the plane of incidence will be parallel to the waveguide axis. Fig. 1(a), a cut in the plane of incidence, illustrates the most general case.

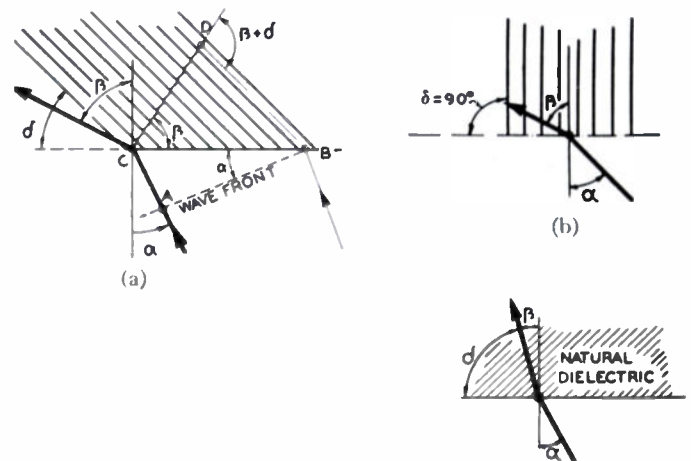

Fig. 1—Theorem of refraction. (a) $(AC) = N(BD) = (BC) \sin \alpha$. $\sin \beta : \sin (\beta + \delta) = ((BC) \sin \alpha / N) : (BC)$. $\sin \alpha = N \cdot [\sin \beta / \sin (\beta + \delta)]$. (b) $\sin \alpha = N \cdot \tan \beta$.

* Decimal classification: R310. Original manuscript received by the Institute, November 21, 1949; revised manuscript received, April 21, 1950. Presented, Joint Meeting, URSI, American Section, and IRE, Washington Section, Washington, D. C., October 31, 1949.

† Components and Systems Laboratory, Air Matériel Command, Dayton, Ohio.

¹ W. E. Kock, "Metal lens antennas," Proc. I.R.E., vol. 34, pp. 828-830; November, 1946.

² W. E. Kock, "Metallic delay lenses," Bell Sys. Tech. Jour., vol. 27, p. 58; January, 1948.

³ O. Schwede, "Fortleitung von Zentimeterwellen auf Leitungen und in Raumen," Lillenthal Society Report 111, pp. 15-19; February, 1939.

The impinging wave front will excite a dominant wave in each of the guide elements. The phase fronts of these elementary waves will, of course, be perpendicular to the waveguide axis, so they will not combine to an exact plane phase front in the medium. But all the centers of the elementary phase fronts will lie in a plane CD which we have to take as the phase front of the refracted wave. Its normal is the refracted "ray." With the notation of Fig. 1(a) we get by comparing the optical path lengths BD and AB

$$\sin \alpha = \frac{N}{\sin(\beta + \delta)} \cdot \sin \beta.$$

This generalized theorem of refraction holds, too, if the plane of incidence is not parallel to the "optical axis" of the medium, but then the refracted "ray" does not lie in the plane of incidence any more.

If $N=1$, for instance, for a TEM wave, there is still refraction. So this configuration can be used also for optical purposes, and is, of course, free of dispersion.

If the boundary plane is perpendicular to the elementary guides (Fig. 1(b), $\delta=90^\circ$), the law of refraction becomes a tangent law. As $\sin \alpha = N \cdot \tan \beta$ has always a solution for the angle β , there is no total reflection on the outside boundary, although N is smaller than unity.

If the waveguide system is degenerated to a parallel plate medium and the plane of incidence is assumed in parallel to the walls, the energy can move in any direction, just as in a natural dielectric. In this case the angle of energy transport δ and the angle of refraction β add up to 90° (see Fig. 1(c)), and we obtain the classical refraction law $\sin \alpha = N \sin \beta$.

The general case, where a wave of arbitrary polarization is incident on a waveguide system of arbitrary cross-section diameter, can be treated by applying the above knowledge to the components of the incident wave and to the unattenuated modes of excitation.

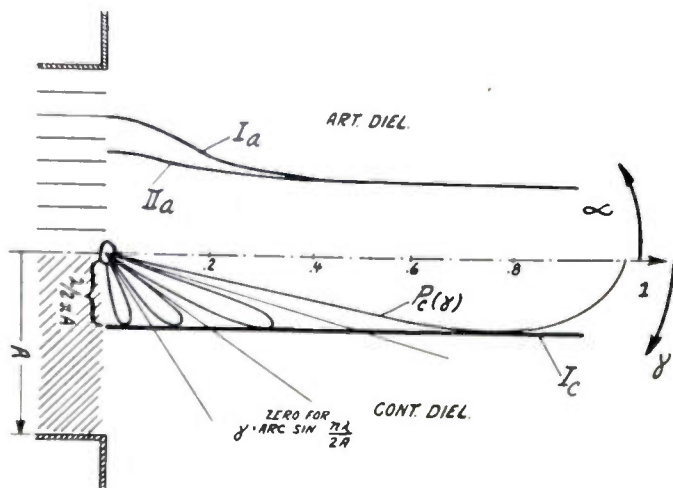

Fig. 2—Radiation pattern envelopes.

⁴ O. Stuetzer, "Artificial Dielectric Optics for Microwaves," ATI 23308, Air Documents Division, Wright-Patterson AFB; December, 1948.

B. The Influence of Diffraction

An optical device built from our waveguide dielectric will show diffraction not only on the boundary of the system, but on the boundaries of the single elements too. To obtain an estimate, the diffraction integrals (or radiation patterns) of two identical strips of dielectric, one natural, the other artificial, can be compared rather easily. The lengthy calculation cannot be elaborated upon;⁴ it shows that the patterns are rather similar and have identical directions of the zeros.

For perpendicular incidence the diffraction patterns are compared in Fig. 2, a common factor $\cos \gamma$ being omitted for clarity's sake. While for a natural dielectric (bottom) the side lobes are bounded by a straight line I_c , they are bounded by a curve marked II_a for our artificial dielectric. The shape of it depends somewhat on N . For $N=0.5$, as selected in Fig. 2, the high-order side lobes have about double the stray energy as for a continuous dielectric.

C. Energy Transport Relations

Equations corresponding to the Fresnel formulas, which connect the amplitude of incident and refracted wave with respect to polarization, have been obtained in this country by Carlson and Hein.⁵ In Germany only a very rough approximation limited to perpendicular incidence was known.⁶ From this it was concluded that within first-order approximation and for negligible wall thickness of the waveguide, our artificial dielectrics could be treated by line theory, representing a space of characteristic impedance $120\pi/N$ ohms as compared to 120π ohms for free space.

D. General Properties

From the theoretical knowledge partly sketched above, it can be seen that with very few restrictions we can use the vast experience of optics for our microwave dielectric. It lends itself especially easily to an imitation and expansion of crystal optics. We can easily produce double refractive crystals and "quarter wavelength plates" (i.e., circular polarizers) by use of rectangular or elliptical waveguide cross sections. By utilizing the cutoff properties of our elements we can build media with definite polarization properties of frequency selectivity. If we admit more than the dominant mode we can produce multifold refractive crystals for one polarization. And our dielectric shows dispersion almost without absorption.

IV. EXAMPLES OF APPLICATIONS

A few pictures, conserved by chance, shall illustrate the German development. Figs. 3, 4, and 5 show circular

⁵ J. F. Carlson and A. E. Heinz, "The reflection of an electromagnetic plane wave by an infinite set of plates," *Quart. Appl. Math.*, vol. 4, pp. 313-329; 1947.

⁶ O. Stuetzer, "Polarisations and Sperrgitter fuer Zentimeterwellen," *Jahrbuch d. D. Luftfahrtforschung III*, Verlag Oldenbourg, Munich, Germany, pp. 41-46; March, 1939.

waveguide lenses. Circular cross sections of the elements were used because they were the only ones obtainable

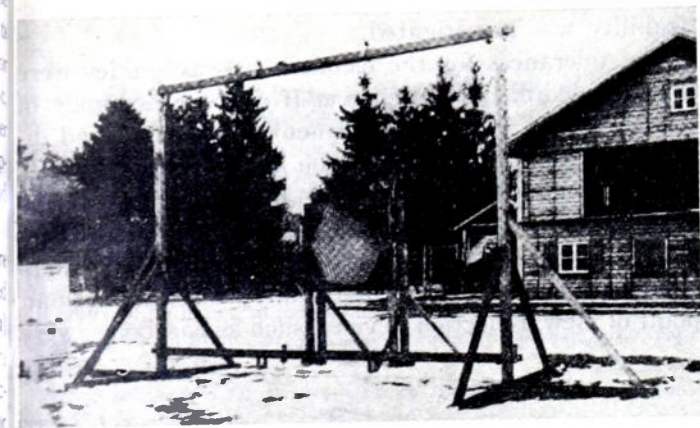

Fig. 3— $20\text{-}\lambda$ circular guide lens in setup for measuring field distribution.

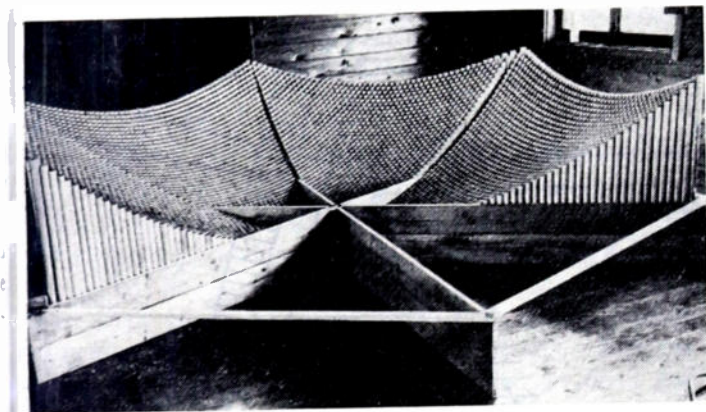

Fig. 4— $60\text{-}\lambda$ lens in assembly.

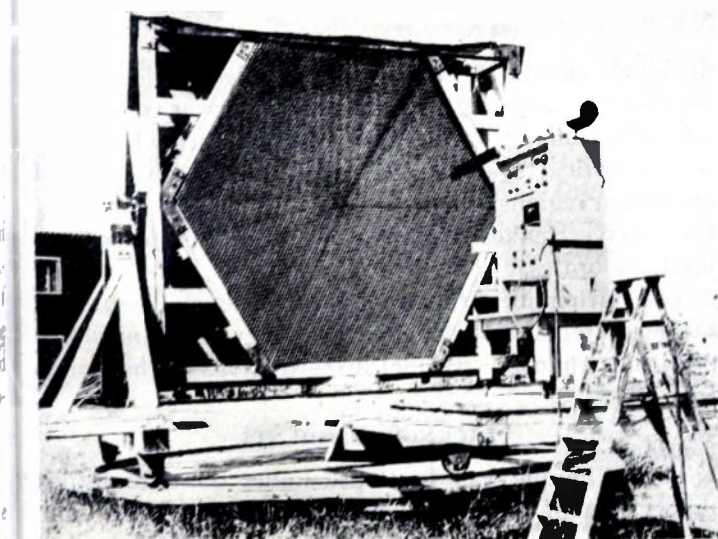

Fig. 5—Lens with microwave image converter.

within the necessary tolerances. In addition, they have no polarization properties.

The lens shapes were determined with the well-known

optical reference formulas for small apertures. Thick lenses were designed by computing the boundary surfaces by comparing the optical path lengths.⁷ Application of the law of refraction gives, of course, the same results; for correction of lenses the latter method seemed simpler. For designing corrected lens systems the fact has to be recognized that the orthogonal trajectories of the idealized wave fronts, the "rays" of geometrical optics, are, in general, not straight lines inside our medium.

Fig. 5 shows especially well what the German development was intended for. In the focal plane of a $60\text{-}\lambda$ wavelength lens for 5 cm , a polar co-ordinate scanning system, built by Bachem, was operated. It consisted of a rotating arm, bearing 20 crystal receivers, switched on consecutively by a tube switch. Through an amplifier, the microwave field distribution in the focal plane was transferred into a visible picture on a cathode-ray-tube screen.⁸

It is clear that for such an optical application, not only the sharpness of the focal point, but the representation properties of the lens in the neighborhood of this point are important; the lens has to be corrected (wide-angle scanning). The lens pictured fulfilled Abbes sine condition, both in the center and on a circle near the border for a wavelength of 5.2 cm , and gave good representation properties within 15° from the optical axis. Fig. 5 shows inaccuracies not expected with a "corrected

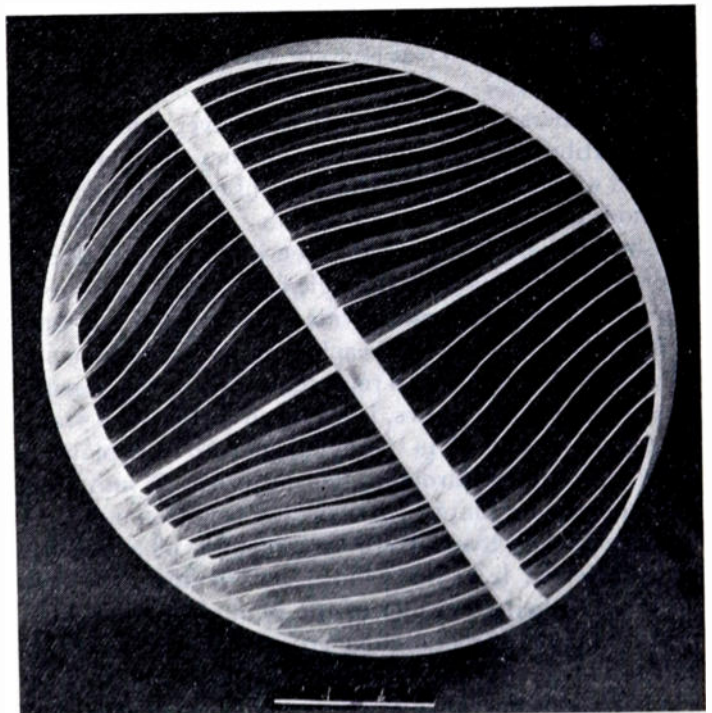

Fig. 6—Variable- N spherical lens.

⁷ O. Stuetzer, "Metallinsen fuer Zentimeterwellen," Zentralstelle fuer wissenschaftl. Berichtsw. d. Luftfahrtforschung, Berlin, Germany, FB 911/1; January, 1937.

⁸ O. Stuetzer, "Aus Hochfrequenztechnik und Flugfunkforschung," Oberpfaffenhofen, Germany, pp. 93-136; June, 1942.

system," but the tolerances of assembly are very uncritical compared to those for the elementary guides.

It is obvious that "stepped" lenses have rather bad representation properties, so they were ruled out for optical purposes. That they can be advantageously utilized as antennas was not recognized. Somewhat related to stepped lenses are the well-known "Fresnel zone plates"; the one represented in Fig. 6 has the same gain for 10-cm wavelength as the small guide lens on the side.

A spherical lens, where not the thickness of the dielectric but its refractive index N is varied to fulfill the optical path condition, is shown in Fig. 7. It was considered impractical for large optical systems and used only to improve the unsatisfactory radiation pattern of circular horns.

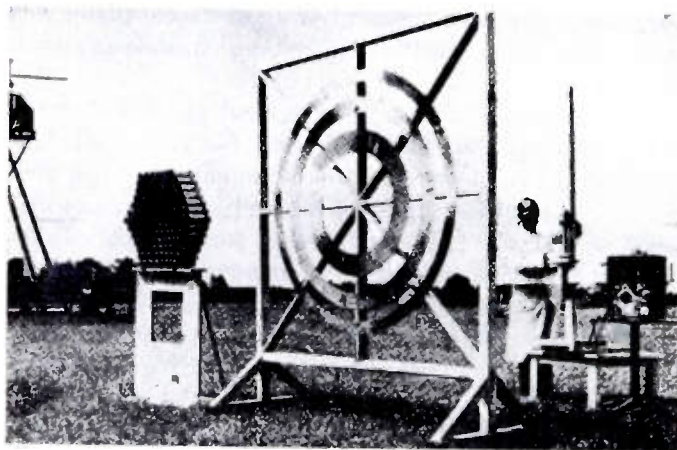

Fig. 7—Fresnel zone plate and waveguide lens of equivalent gain.

The dispersion properties of the waveguide medium can be utilized for scanning by frequency modulation by using a waveguide prism or prism-lens combination. The method and measurements are more fully described in the literature.⁸ A 3-cm radar set was designed during the war employing a small-angle fast-flicker scan superimposed on the customary wide-angle mechanical scan.

Another system, which reached only the experimental stage, but which is a good representative for the possibilities of microwave optics, is sketched in Fig. 8. A transmitter T , polarized in perpendicular to the plane of drawing, radiates through a lens, a prism P , and a circular polarizing plate C . If reflected from a nonpolarizing target, the wave will still be circularly polarized and be transferred by C into linear polarization, the field vector now being parallel to the plan of drawing. The prism is made of rectangular cross-section waveguides, and thus will tilt the returning wave front against the leaving one. Consequently, the energy will be collected in another focus R . The device was mainly intended to give evidence about the polarization properties of targets.

V. CONCLUSION

After proving the physical possibility of imitating optical systems by means of artificial dielectrics, the practicability was investigated.

The tolerances for the elementary waveguides were considered difficult to achieve. If a phase accuracy of $\pi/8$ is desired for a guide element of length L and diameter a , the diameter must be kept within $a^3N/8\lambda L$. Stepped lenses being ruled out for our purposes, the outside guides in a 50λ lens have to be constant within about 1 per cent. This consideration and some others were responsible for the fact that, from the German point of view, reflection devices, such as parabolas, were

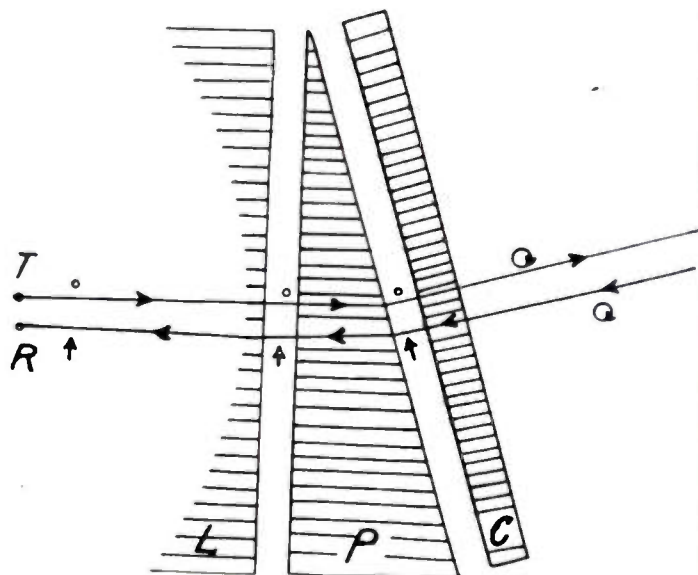

Fig. 8—Radar optics for distinguishing the polarization of targets.

decisively preferred—they have no reflection losses and no dispersion. Waveguide lens technique was considered advisable only in special cases, for instance where corrected optical systems were required, or for infrared transition regions where the spacious cooling system of the receiver makes it mandatory that it be placed behind the optics.

The author feels that the German development was rather systematic, but that it led to fewer technical applications than the parallel investigations in this country.

ACKNOWLEDGMENTS

The technique was developed under the stimulating supervision of Max Dieckmann. D. Graf Soden first expressed the idea of building waveguide lenses. C. Bachem took active interest in the early stages of the work.

The Poynting Vector in the Ionosphere*

JAMES C. W. SCOTT†, MEMBER, IRE

Summary—The equations of motion of ionospheric electrons in the field of plane electromagnetic waves subject to the frictional force of collision and to the force of the earth's magnetic field are developed in a form permitting graphical calculation of the wave polarization. The complex Poynting vector is then calculated in terms of the polarization, the complex refractive index, and a third function related to the forward tilt of the electric vector.

Graphical integration is used to obtain curves representing the direction of energy flow for the ordinary and extraordinary modes, in a parabolic distribution of ionization for fixed values of geomagnetic latitude, collision frequency, and wave frequency for the case of vertical wave propagation.

When collision is taken into account, the deflection has a small westward component for both ordinary and extraordinary modes. At zero collision frequency the deflections are in the vertical plane of the earth's field; the ordinary mode bending towards the poles and the extraordinary mode towards the equator.

The normal ionization gradient with latitude, together with diurnal expansion and contraction of the ionized region, can explain the diurnal variation in the $f^x - f^o$ critical frequency difference as due to the diurnal variation in the total path deflection.

INTRODUCTION

IN THIS PAPER we consider plane simple harmonic radiation in an uncharged ionized gaseous medium in the earth's magnetic field. Only the forces on free electrons are included and these are taken to be the electric force E , the earth's field H_0 , a frictional force that is proportional to the average electron momentum mV , and the frequency of collision with the surrounding gas ν . The Lorentz polarization term and the permeability of the medium are thus not included and the electron velocity is assumed small with respect to the velocity of radiation in free space.

We take right-handed axes so that the direction of wave propagation defined by the complex wave slowness S is x and the earth's field H_0 is in the plane xy with components H_L and H_T , longitudinal and transverse to the direction of propagation. We are concerned with propagation vertically upwards so that the direction of the positive y axis is north and of the positive z axis, west. The units used are Heaviside-Lorentz.

The equation of motion of free electrons is then

$$m\dot{V} = eE + \frac{e}{c} V \times H_0 - \nu mV. \tag{1}$$

Because we are dealing with simple harmonic waves, time is involved only in the factor $e^{-i\omega t}$, where ω is the angular frequency, so that the equation of motion may be written

$$eE = (\nu - i\omega)mV - \frac{e}{c} V \times H_0. \tag{2}$$

We consider only slowly varying media in which the coordinates appear only in the factor $e^{+i\omega z}$ where $d(sx)/dx \approx S$. Then if N is the electron density, neV is the current density and Maxwell's equations may be written

$$\begin{aligned} H_x &= 0 & E_x &= \frac{-iNe}{\omega} V_x \\ H_y &= -cSE_x & E_y &= \frac{-iNe}{\omega} V_y + cSH_x \\ H_z &= cSE_y & E_z &= \frac{-iNe}{\omega} V_z - cSH_y. \end{aligned} \tag{3}$$

The magnetic components of the radiation field may be eliminated and the electric components written in terms of the velocity from the equation of motion. We make the substitutions

$$\begin{aligned} \omega_0^2 &= \frac{Ne^2}{\omega^2 m} \dots \dots \omega_c^2 = \frac{\nu e^2}{m} && \text{angular critical frequency} \\ h &= \frac{eH_0}{\omega mc} \dots \dots \frac{eH_0}{mc} && \text{angular gyro frequency} \\ h_L &= \frac{eH_L}{\omega mc} \dots \dots \frac{eH_L}{mc} && \text{longitudinal gyro frequency} \\ h_T &= \frac{eH_T}{\omega mc} \dots \dots \frac{eH_T}{mc} && \text{transverse gyro frequency} \\ g &= \frac{\nu}{\omega} \dots \dots \nu && \text{collision frequency.} \end{aligned}$$

Thus the critical frequency, the collision frequency and the longitudinal and transverse components of the gyrofrequency are "normalized" or written as ratios to the wave frequency.

Three equations are obtained in the three components of electron velocity

$$\begin{aligned} (1 - \omega_0^2 + ig)V_x + ih_T V_z &= 0 \\ \left\{ \frac{\omega_0^2}{c^2 S^2 - 1} + 1 + ig \right\} V_y - ih_L V_z &= 0 \\ -ih_T V_x + ih_L V_y + \left\{ \frac{\omega_0^2}{c^2 S^2 - 1} + 1 + ig \right\} V_z &= 0. \end{aligned} \tag{4}$$

In order that these equations may be compatible, the determinant of the coefficients must vanish.

This determinant is of the form

$$\begin{vmatrix} a & 0 & b \\ 0 & x & -d \\ -b & d & x \end{vmatrix} = 0 \tag{5}$$

* Decimal classification: R113.6. Original manuscript received by the Institute, March 15, 1949; revised manuscript received, February 16, 1950. Presented, in condensed form, under the title "Energy flow in the ionosphere," Defence Research Board Symposium, Ottawa, Ontario, Canada, December, 1948.

† Radio Propagation Laboratory, Defence Research Board, Ottawa, Ontario, Canada.

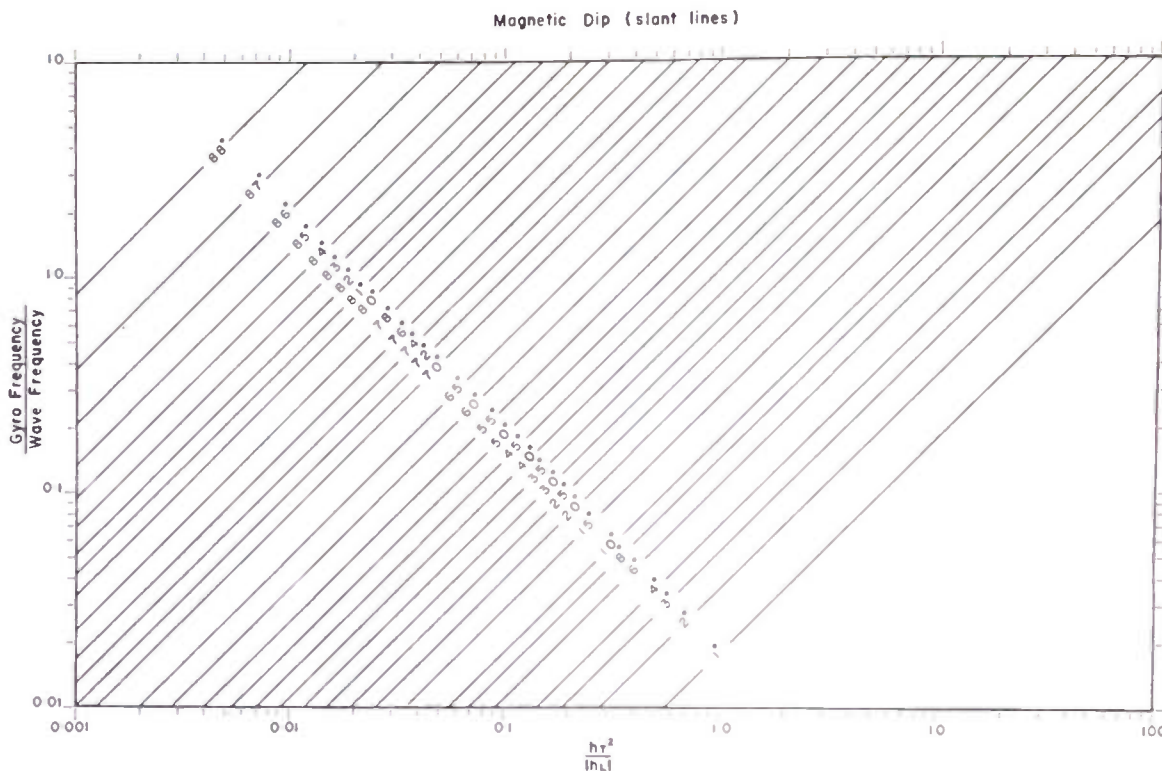

Fig. 1—Nomogram giving the normalized magnetic-field function.

where the coefficients are

$$\begin{aligned}
 x &= \frac{\omega_0^2}{c^2 s^2 - 1} + 1 + ig \\
 a &= 1 - \omega_0^2 + ig \\
 b &= ih_T \\
 d &= ih_L
 \end{aligned}
 \tag{6}$$

This equation may be solved for the wave slowness s in terms of the five frequencies: the wave frequency, the critical frequency, the collision frequency, and the two components of the earth's gyro-magnetic frequency. The solution is the well-known Appleton-Hartree equation¹ and need not be written out.

THE COMPLEX POLARIZATION

The determinant may be written in the form

$$\frac{x}{d} + \frac{d}{x} + \frac{b^2}{ad} = 0.
 \tag{7}$$

Now the polarization of plane waves advancing along x is defined by the ratio of the complex components of the field in the yz plane. Examination of (4) will show that

$$\frac{E_z}{E_y} = -\frac{H_y}{H_x} = \frac{V_x}{V_y} = \frac{x}{d}.
 \tag{8}$$

Consequently, if we write

$$Re^{i\phi} = \frac{x}{d},$$

$R = \epsilon_z / \epsilon_y$ is the ratio of the amplitudes of the z and y components of the electric field and ϕ is their angular phase difference, and the equation becomes

$$Re^{i\phi} + \frac{1}{R} e^{-i\phi} = -\frac{b^2}{ad}.
 \tag{9}$$

Then if we put $-b^2/ad = c_1 + ic_2$, we obtain

$$\begin{aligned}
 c_1 &= \left(R + \frac{1}{R}\right) \cos \phi \\
 c_2 &= \left(R - \frac{1}{R}\right) \sin \phi.
 \end{aligned}
 \tag{10}$$

We now evaluate the real and imaginary parts of $-b^2/ad$ in terms of the frequencies with the help of (6), obtaining

$$c_1 + ic_2 = -\frac{h_T^2}{h_L} \frac{g + i(1 - \omega_0^2)}{g^2 + (1 - \omega_0^2)^2}.
 \tag{11}$$

It follows that

$$\begin{aligned}
 \frac{c_1}{c_2} &= \frac{g}{1 - \omega_0^2} \\
 \frac{c_1^2 + c_2^2}{c_1} &= -\frac{h_T^2}{h_L g} \\
 \frac{c_1^2 + c_2^2}{c_2} &= -\frac{h_T^2}{h_L(1 - \omega_0^2)}.
 \end{aligned}
 \tag{12}$$

¹ E. V. Appleton, "Wireless studies of the ionosphere," *Jour. IEE*, vol. 71, p. 642; October, 1932.

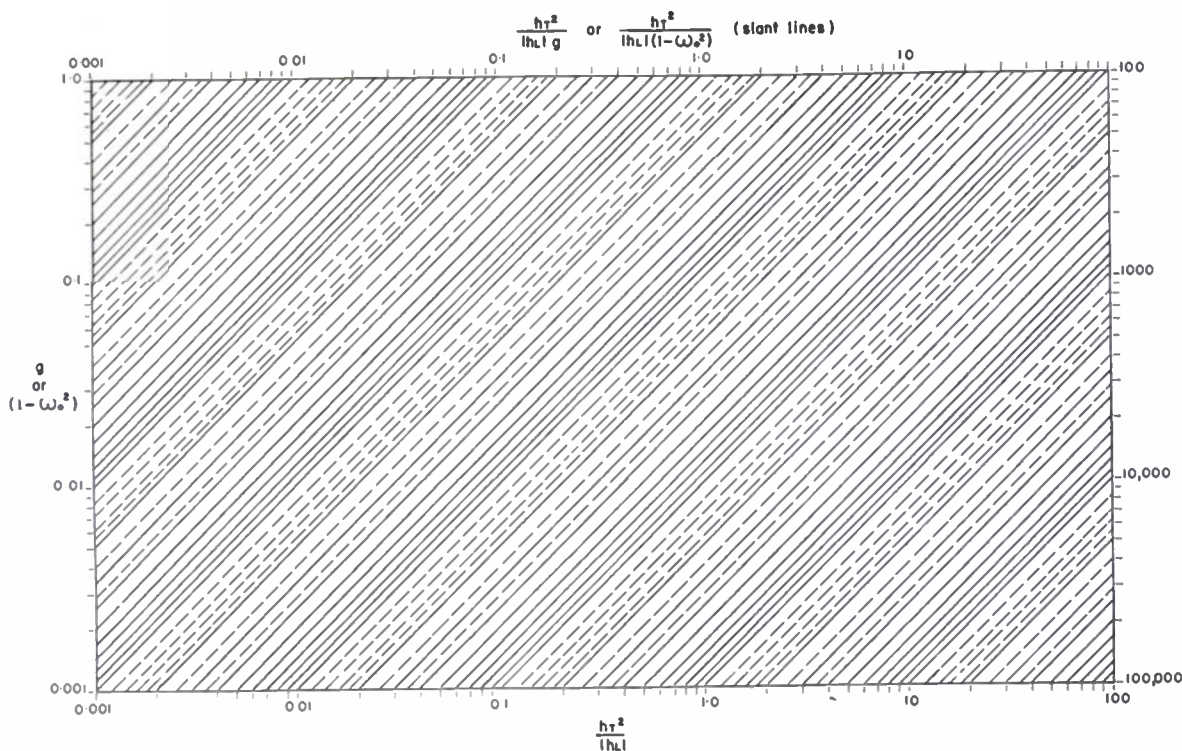

Fig. 2—Nomogram giving the co-ordinates of the wave polarization.

These equations may be solved for c_1 and c_2 and then the amplitude and phase angle of the polarization may be calculated. However, the tedious work involved can be shortened by the following simple graphical procedure.^{2,3}

Enter Fig. 1 with the assumed values of the magnetic dip θ and of the normalized gyrofrequency h . Read the corresponding value of the function

$$\frac{h_T^2}{|h_L|}$$

In the northern hemisphere h_L is negative since propagation is taken upwards. The dip angle is negative in the southern hemisphere.

Having $h_T^2/|h_L|$, enter Fig. 2 with the assumed value of the normalized collision frequency g , and read the value of the function

$$\frac{h_T^2}{|h_L|g}$$

Now enter Fig. 2 with the assumed value of the normalized critical frequency ω_0 , and read the value of

$$\frac{h_T^2}{|h_L|(1-\omega_0^2)}$$

The amplitude and phase angle of the polarization

² V. A. Bailey, "Study of the magneto-ionic theory of wave propagation by means of conformal representation," *Phil. Mag.*, vol. 18, p. 516; September, 1934.

³ V. A. Bailey and J. M. Somerville, "Study of the magneto-ionic theory of wave propagation by means of simple formulae, linkages and graphical devices," *Phil. Mag.*, vol. 26, p. 888; Supplement, November, 1938.

may then be read directly from Fig. 3 at the point fixed by the co-ordinates

$$\frac{h_T^2}{|h_L|g} \quad \text{and} \quad \frac{h_T^2}{|h_L|(1-\omega_0^2)}$$

The contours of Fig. 3 were calculated from the relations

$$\begin{aligned} c_1 &= \left(R + \frac{1}{R}\right) \cos \phi = 2 \cosh \sigma \cos \phi \\ c_2 &= \left(R - \frac{1}{R}\right) \sin \phi = 2 \sinh \sigma \sin \phi \end{aligned} \quad (13)$$

where we have substituted $\sigma = lgR$ so that

$$c_1 + ic_2 = 2 \cosh(\sigma + i\phi). \quad (14)$$

The use of tables or charts of hyperbolic cosines of complex arguments greatly simplifies the computation.⁴

The table shown below is of help in choosing the correct sign. c_1 is positive in the northern hemisphere and negative in the southern hemisphere. This is also true of c_2 when $\omega_0 < 1$ but when $\omega_0 > 1$ the polarity of c_2 is reversed.

Since $R + (1/R)$ is essentially positive, $\cos \phi$ has the same polarity as c_1 . However $R - (1/R)$ is positive or negative as $R >$ or < 1 . Consequently the polarity of $\sin \phi$ is that of c_2 in the first case and opposite in the second. From these considerations of sign it will be seen that the polarization is right handed or left handed as follows in Table I.

⁴ A. E. Kennelly, "Tables of Complex Hyperbolic and Circular Functions," Harvard University Press, Cambridge, Mass.; 1927.

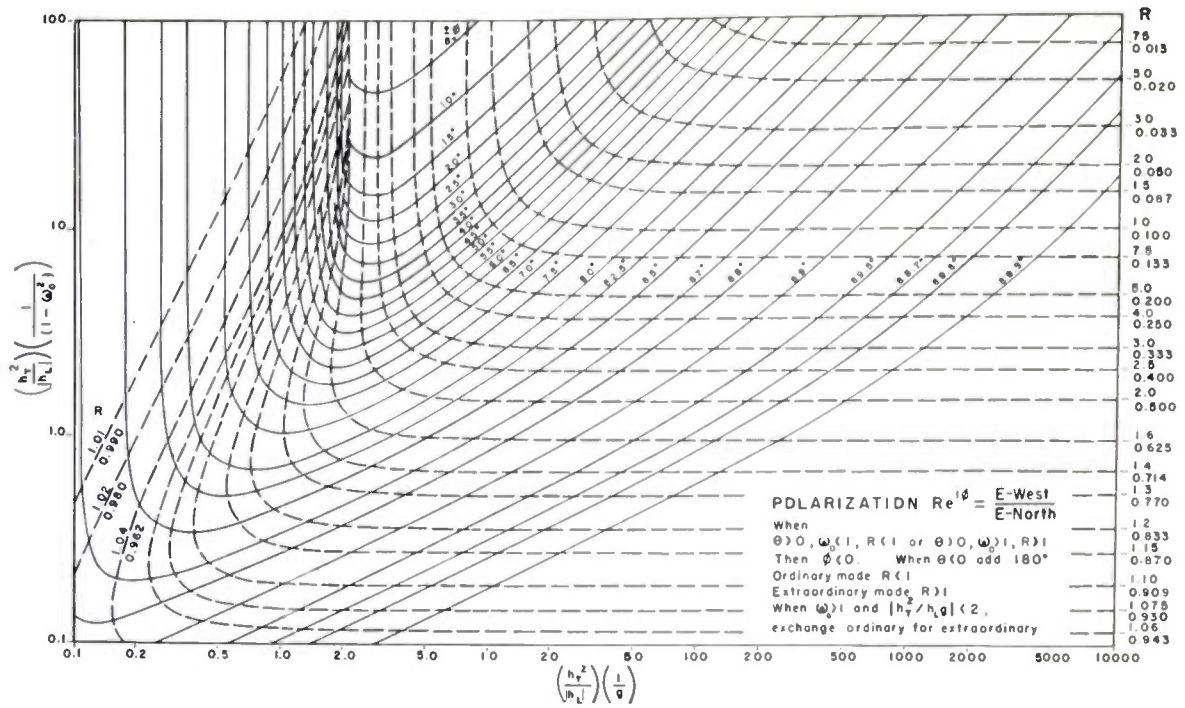

Fig. 3—The wave polarization in logarithmic co-ordinates.

TABLE I
PROPAGATION UPWARDS

| | Northern Hemisphere | | Southern Hemisphere | |
|---------------|--|--|---|---|
| | $\omega_0 < 1$ | $\omega_0 > 1$ | $\omega_0 < 1$ | $\omega_0 > 1$ |
| Extraordinary | $0 < \phi < \frac{\pi}{2}$ $R > 1$ left | $0 > \phi > -\frac{\pi}{2}$ $R > 1$ right | $-\frac{\pi}{2} > \phi > -\pi$ $R > 1$ right | $\frac{\pi}{2} < \phi < \pi$ $R > 1$ left |
| Ordinary | $0 > \phi > -\frac{\pi}{2}$ $R > 1$ right | $0 < \phi < \frac{\pi}{2}$ $R < 1$ left | $\frac{\pi}{2} < \phi < \pi$ $R < 1$ left | $-\frac{\pi}{2} > \phi > -\pi$ $R < 1$ right |

NOTE: When $\omega_0 > 1$ and $(h_T^2 / |h_L|g) < 2$, extraordinary and ordinary modes are reversed.

When the collision frequency is zero, $c_1 = 0$ and $\phi = \pm(\pi/2)$ so that if $R > 1$ the major axis of the electric field ellipse is east-west and if $R < 1$ the major axis is north-south. The former is the extraordinary mode and the latter the ordinary mode except in the region $\omega_0 > 1$ and

$$\frac{h_T^2}{|h_L|g} < 2$$

when quasi-longitudinal propagation occurs.

The effect of absorption is to reduce the phase difference in the northern hemisphere and increase it in the southern hemisphere. In the northern hemisphere, this turns the major axis of the polarization ellipse in the direction of rotation so that in both modes the major axis is turned towards the north-west. In the southern

hemisphere in both modes the major axis is turned towards the southwest.

It can be easily verified that the equation of the polarization ellipse is

$$y^2 + \frac{z^2}{R^2} - \frac{2 \cos \phi}{R} yz - \epsilon_y^2 \sin^2 \phi = 0 \quad (15)$$

and if γ is the angle made with the positive y axis by the major axis of the ellipse,

$$\tan 2\gamma = \frac{2R}{1 - R^2} \cos \phi. \quad (16)$$

The chart of Fig. 3 makes it possible to examine the change in the polarization as any of the five variables, wave frequency, critical frequency, collision frequency, and the two components of the earth's field are varied.

The collision frequency occurs only in the abscissa and the critical frequency only in the ordinate. The earth's field is involved in the same manner in both coordinates. Consequently, as we move up in the ionosphere to regions of greater ionization and lower gas density, we move up and to the right on the chart. An increase in the magnetic inclination or reduction of the field intensity reduces both co-ordinates equally.

The most striking feature of Fig. 3 is the transition that occurs in the polarization for large values of the ordinate at the abscissa

$$\frac{h_T^2}{|h_L|g} = 2.$$

This change corresponds to the well-known transition from quasi-longitudinal to quasi-transverse propagation. It will be remembered that reflection occurs when

the refractive index approaches zero. This condition is fulfilled for the extraordinary mode near $\omega_0^2 = 1 - h$ but for the ordinary mode it occurs near $\omega_0^2 = 1$ or $\omega_0^2 = 1 + h$ depending on whether

$$\frac{h_T^2}{|h_L|g} > \text{ or } < 2.$$

In order to clarify conditions in the vicinity of $\omega_0 = 1$, Fig. 4 has been drawn. This is simply an extension of the polarization chart of Fig. 3 using the same logarithmic scale for the abscissa but substituting an inverse linear scale in the ordinate so that the polarization can be followed as ω_0 goes through 1. For clarity, the values of R for the ordinary mode only are marked. The values for the extraordinary mode are the inverse of these.

(Note that by an oversight solid lines were used in Fig. 3 for ϕ and dashed lines in Fig. 4.)

When $\omega_0 = 1$, (11) and (13) reduce to

$$\begin{aligned} \left(R + \frac{1}{R}\right) \cos \phi &= 2 \cosh \sigma \cos \phi = \frac{-h_T^2}{h_L g} \\ \left(R - \frac{1}{R}\right) \sin \phi &= 2 \sinh \sigma \sin \phi = 0. \end{aligned} \quad (17)$$

These equations have the solutions

$$\begin{aligned} R &= 1 \\ \cos \phi &= -\frac{h_T^2}{2h_L g} \quad \text{when} \quad \frac{h_T^2}{|h_L|g} < 2 \end{aligned} \quad (18)$$

$$\begin{aligned} \cosh(\pm \lg R) &= \frac{h_T^2}{2|h_L|g} \\ \phi &= 0 \text{ or } \pi \quad \text{when} \quad \frac{h_T^2}{|h_L|g} > 2. \end{aligned} \quad (19)$$

The positive sign in (19) generates the extraordinary mode and the negative sign the ordinary mode. As can be verified in the table, $\phi = 0$ in the northern hemisphere and $\phi = \pi$ in the southern hemisphere.

When $\omega_0 = 1$ the contours of R and ϕ have a discontinuous slope at

$$\frac{h_T^2}{|h_L|g} = 2.$$

However, as seen in Fig. 4, at other values of ω_0 the transition from longitudinal to transverse propagation is continuous.

In the vicinity of the discontinuity the polarization varies so rapidly that the "slowly varying" theory is inadequate and independent modes cannot be propagated.

It is worthwhile following the changing polarization at $\omega_0 = 1$ as the abscissa is increased.

At high magnetic latitudes, high collision frequencies or low field intensities,

$$\frac{h_T^2}{|h_L|g}$$

is small and the polarization is nearly circular. As the abscissa is increased it becomes more and more elliptical but the direction of the major axis remains fixed, in the north-west in the northern hemisphere and in the south-west in the southern hemisphere, for both modes. At the critical point

$$\frac{h_T^2}{|h_L|g} = 2,$$

the polarization is linear. As the magnetic inclination or the collision frequency is further reduced, or the inten-

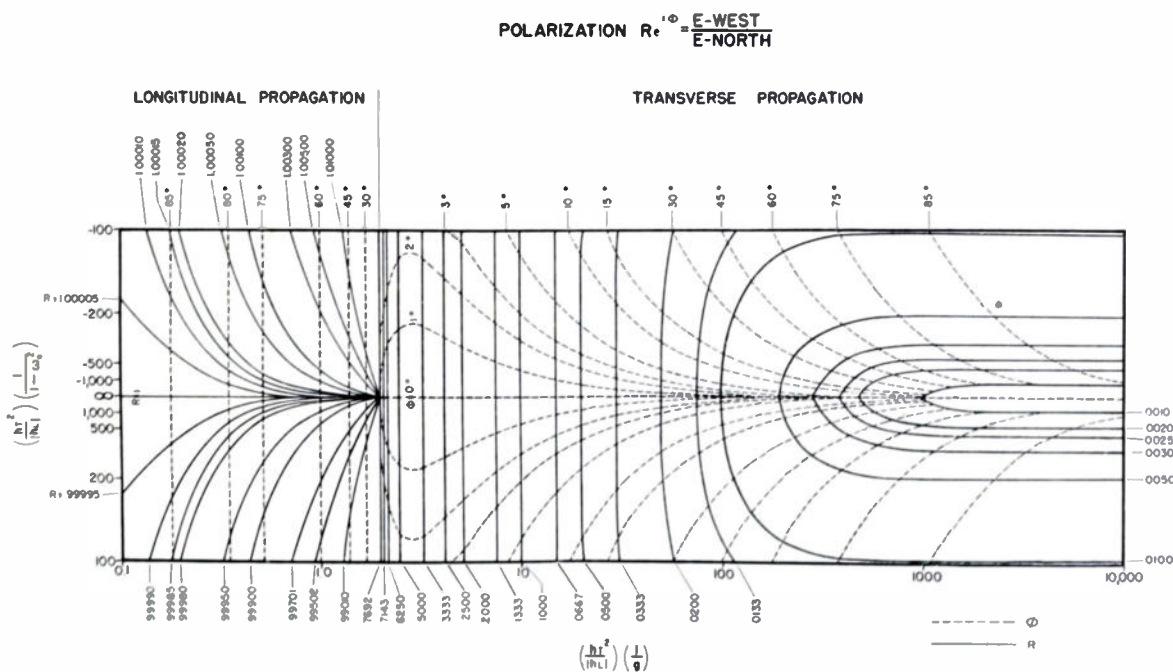

Fig. 4—Continuation of Fig. 3 through infinity on the ordinate using an inverse linear scale. The scale of the abscissa is unchanged. R is given for the ordinary mode and the sign of ϕ may be obtained from Table I.

sity increased, the polarization remains plane, but the direction of the electric vector turns until, at large values of the abscissa, it is directed north-south in the ordinary mode and east-west in the extraordinary mode in both hemispheres.

Another significant level in the ionosphere is $\omega_0^2 = 1 - h$; this is approximately the reflection level of the extraordinary mode. The polarization at this level is read at the ordinate

$$\frac{h_T^2}{|h_L| h}$$

which in terms of the dip angle is $|\cos \theta \cot \theta|$. The polarization is given by (11) and (14) and becomes

$$2 \cosh (lgR + i\phi) = \frac{h_T^2}{-h_L} \left\{ \frac{g + ih}{g^2 + h^2} \right\} \quad (20)$$

which for the special case of zero collision reduces to

$$R - \frac{1}{R} = \frac{h_T^2}{|h_L| h} \quad \text{and} \quad \phi = \pm \frac{\pi}{2} \quad (21)$$

which in terms of the dip angle is

$$R = \left| \frac{h_L}{h} \right| = |\sin \theta| \quad \text{ordinary mode}$$

$$R = \left| \frac{h}{h_L} \right| = |\csc \theta| \quad \text{extraordinary mode.}$$

The longitudinal ordinary mode goes through the barrier $\omega_0 = 1$ to be reflected near the level $\omega_0^2 = 1 + h$. The polarization at this level is given by

$$2 \cosh (lgR + i\phi) = \frac{h_T^2}{-h_L} \left\{ \frac{g - ih}{g^2 + h^2} \right\} \quad (22)$$

which may be read off the chart at the ordinate

$$-\frac{h_T^2}{|h_L| h}$$

Because of symmetry, the polarization at this level is the same as at $+(h_T^2/|h_L| h)$ but with inverse amplitude.

THE COMPLEX REFRACTIVE INDEX

The refractive index cs may be written in terms of the polarization from (5) and (7).

$$\frac{1}{1 - c^2 s^2} = \frac{1 + ig - ih_L Re^{i\phi}}{\omega_0^2} \quad (23)$$

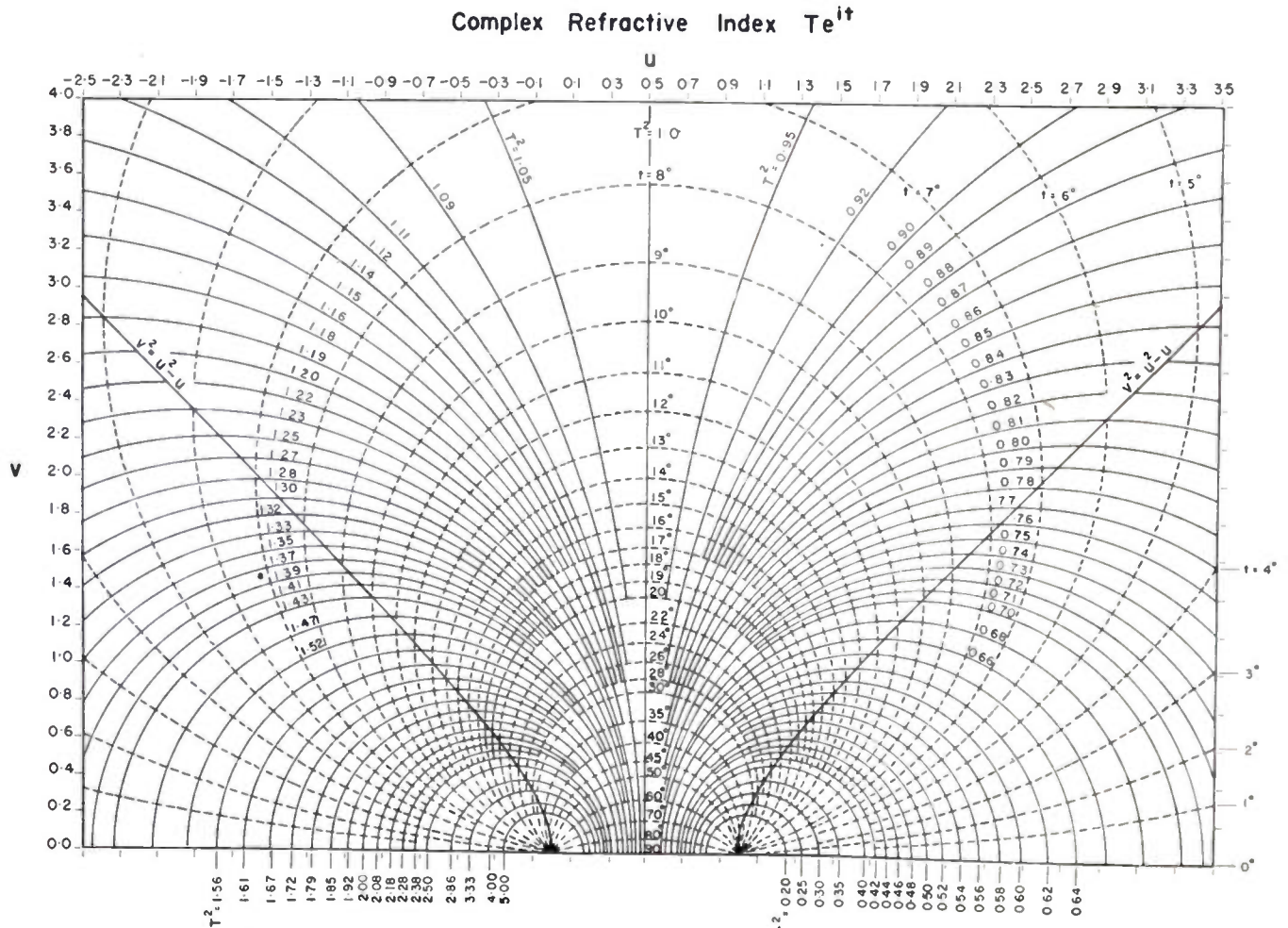

Fig. 5—The complex refractive index $Te^{i\phi}$, given by orthogonal circles of T^2 and t .

This expression has the real component

$$u = \frac{1 + h_L R \sin \phi}{\omega_0^2} \tag{24}$$

and imaginary component

$$v = \frac{g - h_L R \cos \phi}{\omega_0^2}$$

To calculate the direction of the Poynting vector, we require the refractive index in the form $Te^{i\theta}$. This is obtained in terms of u and v from

$$T^4 = \frac{(u - 1)^2 + v^2}{u^2 + v^2}$$

$$\tan 2\theta = \frac{v}{u^2 + v^2 - u} \tag{25}$$

These expressions are represented by two orthogonal families of circles in Fig. 5.

After the polarization has been found it is comparatively easy to calculate u and v . Having these co-ordinates, the complex refractive index can be read directly from the curves of T^2 and θ . The real refractive index is, of course, $T \cos \theta$ and the penetration for an attenuation to $1/e$ in vacuum wavelengths is

$$\frac{\csc \theta}{2\pi T}$$

THE DIRECTION OF ENERGY FLOW⁵⁻⁷

With these expressions for the polarization and the complex refractive index we are in a position to calculate the Poynting flux.

The Poynting flux determines the magnitude and direction of the flow of energy in the radiation field. The instantaneous value of this vector is defined by

$$p^r = cE^r \times H^r \tag{26}$$

where the superscripts denote the real components of the vector.

We are dealing only with plane waves progressing vertically. The magnetic vector which must be always in the wave front is therefore in the horizontal plane. The electric vector however has a longitudinal component.

From (3) we have

$$\frac{E_x}{E_y} = (1 - c^2s^2) \frac{V_x}{V_y}$$

$$\frac{E_z}{E_x} = (1 - c^2s^2) \frac{V_z}{V_x} \tag{27}$$

and from (4) and (6)

$$\frac{V_x}{V_y} = - \frac{b}{a} \frac{x}{d}$$

$$\frac{V_z}{V_x} = - \frac{b}{a} \tag{28}$$

Consequently, just as with the polarization, the forward tilt of the electric vector is defined by the ratio of the complex components

$$\frac{E_x}{E_y} = - (1 - c^2s^2) \frac{b}{a} Re^{i\phi}$$

$$\frac{E_z}{E_x} = - (1 - c^2s^2) \frac{b}{a} \tag{29}$$

In each cycle the magnetic vector traces out the polarization ellipse in the horizontal plane. Simultaneously the electric vector, which must always remain at right angles to the magnetic component, traces out an ellipse in an inclined plane with orientation and dimensions determined by (29).

Now the Poynting flux is normal to the plane defined by the electric and magnetic vectors and is proportional to their product. It follows that it revolves about a cone, having one edge vertical, at twice the wave frequency. The axis of the cone is therefore tilted from the vertical direction of phase progression.

In the propagation of light through transparent anisotropic crystals the Poynting vector is also tilted from the wave normal. But, in that case, it remains fixed in direction throughout the cycle and so defines uniquely the direction of energy flow.

The more complicated problem in the ionosphere can be solved simply by using the complex Poynting vector. This vector can be shown to give the magnitude and direction of energy flow averaged over a cycle.⁸ While the direction of the real Poynting vector oscillates over a cycle, the complex vector determines uniquely the average direction of flow.

It is given by

$$P = \frac{1}{2}cEX\bar{H} \tag{30}$$

where the bar over H indicates the complex conjugate of the vector.

With the aid of (3) we may write this

$$P = \frac{1}{2}c \begin{vmatrix} i & j & k \\ E_x & E_y & E_z \\ 0 & -csE_x & csE_y \end{vmatrix} \tag{31}$$

or putting ϵ for the amplitude of E

$$P = \frac{1}{2}c^2\epsilon^2 [i(\epsilon_y^2 + \epsilon_z^2) - jE_x\bar{E}_y - kE_x\bar{E}_z]$$

We use (29) to eliminate the complex electric com-

⁸ J. H. Stratton, "Electromagnetic Theory," McGraw-Hill Book Co., Inc., New York, N. Y., and London, pp. 135-137; 1941.

⁵ See footnote reference 9, p. 1110, W. G. Baker and A. L. Green, "The limiting polarization of downcoming radio waves traveling obliquely to the earth's magnetic field," PROC. I.R.E., vol. 21, pp. 1103-1131; August, 1933.

⁶ H. G. Booker, "Propagation of wave packets incident obliquely upon a stratified double refracting ionosphere," Phil. Trans. Roy. Soc., vol. 237, p. 411; September, 1938.

⁷ J. W. Cox, "The effect of the geomagnetic field on electromagnetic waves vertically incident on the ionosphere," Baddow Research Lab. Report T. R. 477; April, 1944.

ponents and so obtain

$$\begin{aligned} P_x &= \frac{1}{2}c^2\bar{s}(\epsilon_y^2 + \epsilon_z^2) \\ P_y &= \frac{1}{2}c^2\bar{s}(1 - c^2s^2)\frac{b}{a}\epsilon_y^2Re^{i\phi} \\ P_z &= \frac{1}{2}c^2\bar{s}(1 - c^2s^2)\frac{b}{a}\epsilon_z^2. \end{aligned} \quad (32)$$

The complex quantities are now put in terms of amplitude and angle to facilitate multiplication and the real components designated by the superscript r are written. The complex refractive index $Te^{it} = cs$, and we write $Ae^{i\alpha} = a/b$. The ratio of the amplitudes $\epsilon_z/\epsilon_y = R$.

The real components of the average flux over a cycle are then

$$\begin{aligned} P_x^r &= \frac{c}{2}T(R^2 + 1)\epsilon_y^2 \cos t \\ P_y^r &= \frac{c}{2}\frac{TR}{A}\epsilon_y^2[\cos(\phi - \alpha - t) - T^2 \cos(\phi - \alpha + t)] \\ P_z^r &= \frac{c}{2}\frac{TR^2}{A}\epsilon_y^2[\cos(\alpha + t) - T^2 \cos(\alpha - t)]. \end{aligned} \quad (33)$$

In order to find the direction of energy flow we take the ratios of these components and so find the components of the slope to the north and west and the direction in the horizontal plane.

$$\begin{aligned} \frac{dy}{dx} &= \frac{R}{A(R^2 + 1)} \frac{\cos(\phi - \alpha - t) - T^2 \cos(\phi - \alpha + t)}{\cos t} \\ \frac{dz}{dx} &= \frac{R^2}{A(R^2 + 1)} \frac{\cos(\alpha + t) - T^2 \cos(\alpha - t)}{\cos t} \\ \frac{dz}{dy} &= R \frac{\cos(\alpha + t) - T^2 \cos(\alpha - t)}{\cos(\phi - \alpha - t) - T^2 \cos(\phi - \alpha + t)}. \end{aligned} \quad (34)$$

In the special case where the collision frequency is zero, (23) reduces to

$$\frac{1}{1 - c^2s^2} = \frac{1 \pm h_L R}{\omega_0^2}$$

and the complex refractive index becomes

$$Te^{it} = \left\{ 1 - \frac{\omega_0^2}{1 \pm h_L R} \right\}^{1/2} \quad (35)$$

where the sign is positive or negative as $\phi = \pm(\pi/2)$. For the ordinary mode above the critical frequency

$$R < 1, \quad \omega_0 < 1, \quad \text{and} \quad \pm h_L = + |h_L|.$$

Consequently $t=0$ and $T < 1$. For the extraordinary mode above the gyro frequency in the range $\omega_0^2 < (1-h)$ we have

$$h < 1, \quad 1 < R < \left| \frac{h}{h_L} \right| \quad \text{and} \quad \pm h_L = - |h_L| \quad \text{from (21).}$$

Thus again $t=0$ and $T < 1$. Also, since $\omega_0 < 1$, we have $\alpha = -(\pi/2)$.

Under these conditions the slopes to the north and west reduce to

$$\frac{dy}{dx} = \pm \frac{R(1 - T^2)}{A(R^2 + 1)} \quad \text{and} \quad \frac{dz}{dx} = 0. \quad (36)$$

Since in the northern hemisphere the positive sign applies to the ordinary mode and the negative sign to the extraordinary mode, and vice versa in the southern hemisphere, when there is no absorption the ordinary mode is deflected towards the poles and the extraordinary mode towards the equator in the vertical plane of the earth's field.

The westward component of the deflection does not depend explicitly on the phase angle of the polarization. As g is increased from zero, since

$$\tan \alpha = - \frac{(1 - \omega_0^2)}{g}$$

α increases from $-\pi/2$, approaching zero for large values of g . At the same time t increases from zero to a maximum value, which may be evaluated with the aid of Figs. 3 and 5, and then it decreases again. T however approaches unity for large values of g , as is clear from Fig. 5. Consequently, $\cos(\alpha + t) > 0$ and, if $T < 1$, it follows that

$$\frac{dz}{dx} > 0$$

and both ordinary and extraordinary modes are deflected westward in the northern and southern hemispheres.

THE DIRECTION OF FLOW AT REFLECTION

It is of interest to evaluate the tilt of the Poynting vector in the limiting case when the ionization is that required to produce reflection. For this we require the corresponding values of $Ae^{i\alpha}$, $Re^{i\phi}$ and Te^{it} .

Considering first the ordinary mode and assuming the condition for reflection to be $\omega_0^2 = 1$ we have

$$Ae^{i\alpha} = \frac{g}{h_T}$$

and $\alpha = 0$. The limiting values of the polarization have already been found and the limiting value of the complex refractive index may be obtained from the expressions for T^2 and $\tan 2t$ given in (25).

When

$$\left| \frac{h_T^2}{h_L g} \right| > 2$$

these become

$$T^2 = \frac{g + |h_L| R}{[1 + (g + |h_L| R)^2]^{1/2}} \quad (37)$$

$$\tan 2t = \frac{1}{g + |h_L| R}$$

or if we put

$$\begin{aligned} \sinh \eta &= g + |h_L| R \\ T^2 &= \tanh \eta \\ \tan 2t &= \operatorname{csch} \eta. \end{aligned}$$

Since when $\omega_0=1$, $\alpha=0$, and $\phi=0$ north and $\phi=\pi$ south of the equator, the term

$$\frac{R}{A(R^2 + 1)}$$

which occurs in (34) for dy/dx reduces to

$$\frac{h_T}{g} \frac{|h_L| g}{h_T^2} = \frac{|h_L|}{h_T}.$$

The remaining term reduces to $\pm(1 - T^2)$ for latitudes north and south, respectively, so that

$$\frac{dy}{dx} = -\frac{h_L}{h_T}(1 - T^2). \tag{38}$$

In the special case, when $g=0$, then $R=0$ and $T^2=0$ and

$$\frac{dy}{dx} = \tan \theta \quad \text{since} \quad \tan \theta = -\frac{h_L}{h_T}. \tag{39}$$

Consequently, on reflection, when the collision frequency is zero, the ordinary mode is perpendicular to the magnetic field.

In a similar manner, the westward tilt when $\omega_0=1$ becomes

$$\frac{dz}{dx} = \frac{|h_L|}{h_T}(1 - T^2)R \tag{40}$$

which reduces to zero when the collision frequency is zero. The westward deflection in the horizontal plane becomes

$$\frac{dz}{dy} = \pm R. \tag{41}$$

At the transition value of $h_T^2/|h_L|g=2$, $R=1$ so that the component of the Poynting vector in the horizontal plane is north-west in the northern hemisphere and south-west in the southern hemisphere. Smaller values of

$$\frac{h_T^2}{|h_L|g}$$

give the quasi-longitudinal mode which is discussed in a following paper.

The tilt of the extraordinary mode on reflection can be calculated in a similar manner. The assumed condition for reflection is now $\omega_0^2=1-h$. We then have

$$Ae^{i\alpha} = \frac{g - ih}{h_T}.$$

The real and imaginary parts of $Re^{i\phi}$ may be evaluated from (20), with the aid of hyperbolic tables of

complex angles, and used in the expression for T^4 and $\tan 2t$ as for the ordinary mode.

In the special case of $g=0$ we have

$$A = \frac{h}{h_T}, \quad \alpha = -\frac{\pi}{2}, \quad R = \frac{h}{|h_L|}, \quad \phi = \pm \frac{\pi}{2}.$$

Substituting in (24), we obtain $u=1$ and $v=0$ so that $T^2=0$ and $t=0$. Consequently (34) reduces to

$$\frac{dy}{dx} = \frac{h_L h_T}{h^2 + h_L^2} \quad \text{and} \quad \frac{dz}{dx} = 0. \tag{42}$$

Since $h_L/h_T = -\tan \theta$ the extraordinary mode on reflection is tilted towards the equator at an angle whose tangent is

$$\frac{dy}{dx} = -\frac{\tan \theta}{1 + 2 \tan^2 \theta}. \tag{43}$$

THE RAY PATH IN A PARABOLIC IONOSPHERE

These expressions can be used to calculate the path traversed by the energy in an inhomogenous medium. The average Poynting vector has been calculated on the assumption that the ionospheric variables such as critical frequency, collision frequency, and the gyro-magnetic frequency are sufficiently slowly varying functions of position that

$$\frac{d(sx)}{dx} \approx S.$$

This basic assumption was made in deriving (3) from Maxwell's equations. Subject to this restriction we will consider the propagation of plane waves progressing vertically upwards in an ionosphere having a parabolic vertical distribution of ionization but with the collision frequency and the earth's field assumed constant.

This parabolic distribution of N may be described by

$$x = 100 \left[1 - \left(1 - \frac{N}{N_m} \right)^{1/2} \right] \tag{44}$$

where we have taken $x=0$ when $N=0$, and $x=100$ when N reaches its maximum value N_m . Since the critical frequency is proportional to the square root of the electron density this may be written

$$x = 100 \left[1 - \left(1 - \frac{\omega_c^2}{\omega_m^2} \right)^{1/2} \right] \tag{45}$$

where ω_m is the critical frequency at the level of maximum ionization.

We will calculate the energy path for the ordinary and extraordinary transverse modes for the maximum frequencies reflected at vertical incidence. It is well known that these maximum frequencies are $\omega=\omega_m$ for the ordinary mode and

$$\omega = \frac{\omega_m}{(1 \pm h)^{1/2}}$$

for the extraordinary mode.

The positive sign corresponds to $h > 1$ and the negative sign to $h < 1$, but we are considering only the latter case, that is, wave frequencies above the gyro frequency. Consequently, in terms of the ratio $\omega_0 = \omega_c/\omega$, we have for the ordinary wave frequency

$$x = 100[1 - (1 - \omega_0^2)^{1/2}] \quad (46)$$

and for the extraordinary wave frequency

$$x = 100 \left[1 - \left(1 - \frac{\omega_0^2}{1-h} \right)^{1/2} \right]. \quad (47)$$

Curves of dy/dx and dz/dx as a function of x have been calculated and drawn for the following arbitrarily chosen values:

- Maximum critical frequency = 2.4 Mc and 9 Mc
- Gyro frequency = 1.44 Mc
- Collision frequency = 0 and 2.4×10^{-2} Mc (1.5×10^5 collisions per second)
- Magnetic dip = 45° and 75°
- Ordinary wave frequency, $\omega = \omega_m = 2.4$ and 9 Mc
- Extraordinary wave frequency, $\omega = \frac{\omega_m}{(1-h)^{1/2}} = 3.23$ and 9.75 Mc.

The integrals

$$\int_0^x \frac{dy}{dx} dx \quad \text{and} \quad \int_0^x \frac{dz}{dx} dx$$

have then been obtained graphically from the areas under the curves to give the deflection north and the deflection west at any depth of penetration into the ionized region. The curved path taken by the Poynting vector is shown in the resulting graphs of y and z as a function of x .

Fig. 6 shows the northward slope of the ordinary mode as it penetrates the parabolic region for collision frequency zero. If the critical frequency of the region is increased, the slope at any height, measured from the

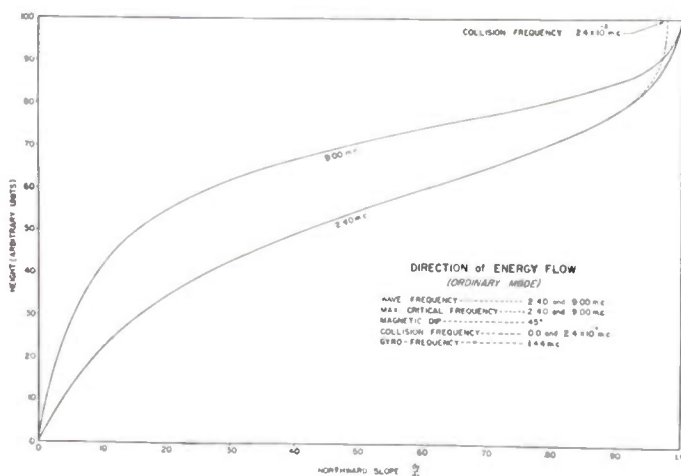

Fig. 6—The northward slope of the ordinary mode critical frequency for a dip of 45° .

vertical, is reduced. The slope on reflection at the level of maximum ionization is 1 and since the magnetic dip in this case is 45° , on reflection, the Poynting vector is perpendicular to the field, as was proven analytically.

Fig. 7 gives the slope for the same conditions, except that the dip is now 75° instead of 45° . As before, increased ionization results in reduced slope at all heights; but now the slope on reflection is 3.732 which is the tangent of 75° . Thus, on reflection, the Poynting vector is again perpendicular to the field. Comparison of Figs. 6 and 7 will show that except near the height of maximum ionization, the northward slope is lower at the higher latitude. The greater slope on reflection at the higher latitude is gained near the top of the path.

Fig. 8 presents the southward tilt of the extraordinary mode for the conditions of ionization given in Figs. 6 and 7. The wave frequencies are now 3.23 and 9.75 Mc, corresponding to the maximum critical frequencies of 2.4 and 9 Mc. As for the ordinary mode, at any height, the slope is reduced when the ionization is increased.

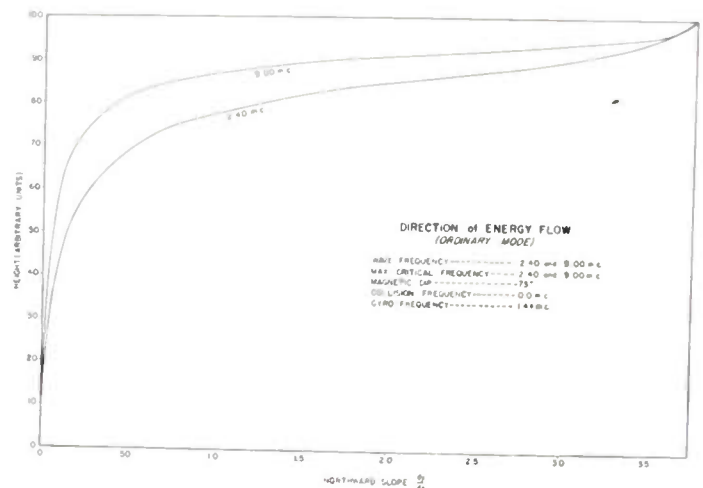

Fig. 7—The northward slope of the ordinary mode critical frequency for a dip of 75° .

Fig. 8 presents the southward tilt of the extraordinary mode for the conditions of ionization given in Figs. 6 and 7. The wave frequencies are now 3.23 and 9.75 Mc, corresponding to the maximum critical frequencies of 2.4 and 9 Mc. As for the ordinary mode, at any height, the slope is reduced when the ionization is increased.

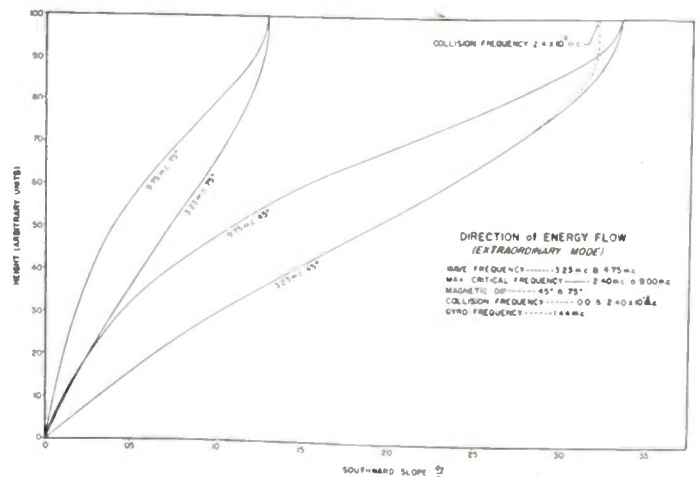

Fig. 8—The southward slope of the extraordinary mode critical frequency for the ionospheric conditions of Figs. 6 and 7.

But contrary to the condition for the ordinary mode, the slope at all heights, even at the level of reflection, is

lower when the dip is 75°. The slope on reflection is seen to agree with the calculated condition

$$\frac{dy}{dx} = \frac{-\tan \theta}{1 + 2 \tan^2 \theta}$$

Differentiation shows this to have a maximum value at a dip of 35°16'.

Fig. 9 presents the actual path taken by a signal incident vertically at the bottom of the ionosphere in the northern hemisphere. Height zero is the base of the parabolically ionized region and height 100 is the level of maximum ionization. The curves were obtained by graphical integration of the curves of Figs. 6, 7, and 8.

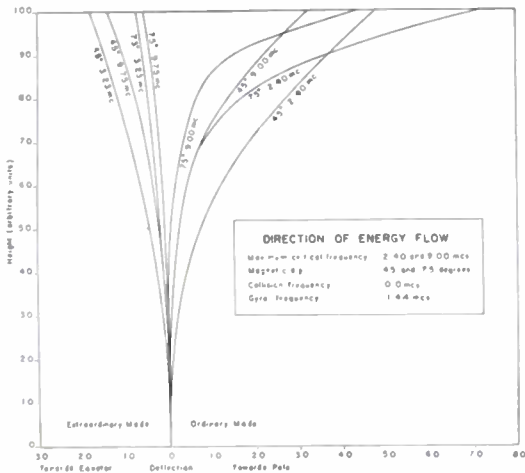

Fig. 9—The ray paths obtained by graphical integration of the slopes of Figs. 6 through 8.

They are drawn to the same scale but it must be noted that this scale is arbitrary. Ordinary and extraordinary critical frequencies for a given condition of ionization are paired so that the total horizontal separation of these modes on reflection at the same level of maximum ionization may be seen.

At a magnetic dip of 75° when the maximum ionization corresponds to a critical frequency of 2.4 Mc the ordinary wave is deflected north a distance 72 per cent of the half thickness of the ionized region. The extraordinary wave is deflected south a distance 7.5 per cent of this half thickness so that the total separation on reflection is 79.5 per cent. When the ionization is increased so that the ordinary critical frequency is 9 Mc, the total separation is reduced to 49.5 per cent.

At a dip of 45° when the ordinary critical frequency is 2.4 Mc, the total separation on reflection is 66.5 per cent and when the critical frequency is increased to 9 Mc, the total separation falls to 47 per cent.

The manner in which the lateral displacement of each mode depends on the inclination of the magnetic field is shown in Fig. 10 for the case of zero collision frequency.

The ionization of the parabolic region has been chosen so that the highest frequency reflected is 10 Mc for both

modes. Consequently, $\omega_m = \omega$ for the ordinary mode and $\omega_m = (1 - h)^{1/2} \omega$ for the extraordinary mode.

The deflection of the ordinary mode increases steadily until the magnetic field is vertical. The deflection of the extraordinary mode, however, reaches a maximum at an approximate dip of 31° as might be expected from the maximum at a dip of 35°16' already found for the slope.

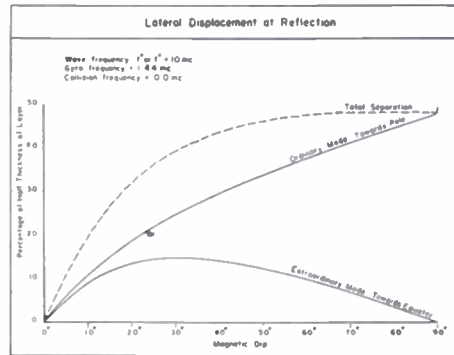

Fig. 10—The lateral displacement on reflection as a function of magnetic dip.

It will be noticed that the deflection curve for the ordinary mode shows a sharp upturn very near 90°. This is a consequence of the sharp increase in the slope very near the reflection level when the magnetic inclination is high.

However the "slowly varying" theory used does not adequately treat the transition from transverse to longitudinal propagation at

$$\frac{h_T^2}{|h_L|g} = 2$$

near $\omega_0 = 1$.

The abrupt change to longitudinal propagation at zero collision frequency at the magnetic pole is the limiting case of this transition. Consequently, the deflection curve is not reliable near 90°.

Figs. 6 and 8 include the effect of absorption on the northward and southward slopes of the ordinary and extraordinary modes. The calculation has been made for a dip of 45° for the critical frequency pair, 2.4 and 3.23 Mc. A collision frequency of 2.4×10^{-2} Mc or 1.5×10^6 collisions per second was arbitrarily chosen.

The corresponding integrated deflection is reduced in the ordinary mode from 47.8 per cent to 46.8 per cent and in the extraordinary mode from 17.8 per cent to 17.5 per cent.

The westward components of the slope and integrated path for the ordinary and extraordinary modes are shown in Figs. 11 and 12. The extraordinary mode suffers the largest westward deflection, 5 per cent as compared with 1.5 per cent for the ordinary mode. It is of interest that the westward slope of the ordinary mode passes through a maximum below the level of maximum ionization.

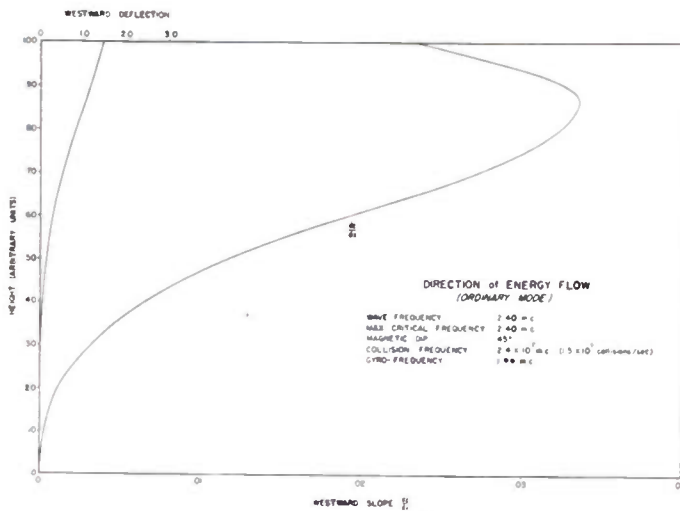

Fig. 11—The westward slope and ray path, resulting from collision, for the ordinary mode.

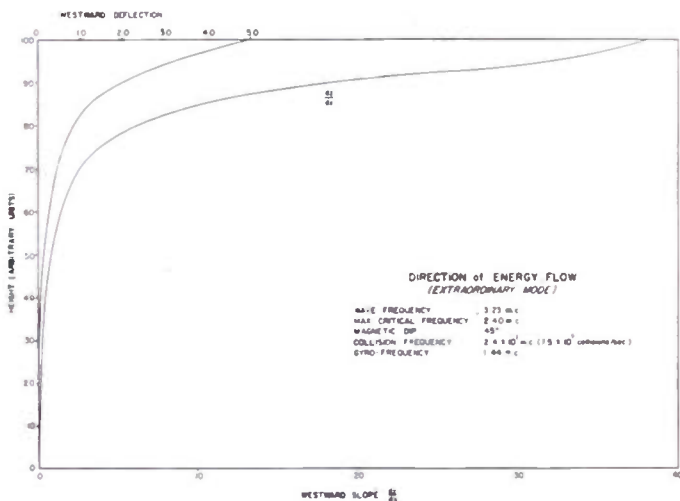

Fig. 12—The westward slope and ray path, resulting from collision, for the extraordinary mode.

MEASURED CRITICAL FREQUENCY DIFFERENCES

The horizontal separation of the points of reflection of ordinary and extraordinary modes can have a large effect on the measurable $f^x - f^o$ critical frequency difference on height-frequency records. The latitude gradient of F -layer critical frequencies varies with the time of day, season, sunspot number, and latitude. Typical latitude variation curves are given in the literature.⁹ It is usually (but not always) negative and its magnitude is normally greatest in the daytime and in the winter, and may be as large as 500 kc in 100 kilometers. Since the ordinary wave is deflected poleward and the extraor-

inary wave towards the equator, the effect of the usual latitude gradient of ionization is to increase the observed frequency difference. Values of gyro frequency and of the earth's field calculated from the $f^x - f^o$ frequency difference will then be too large.

We have seen that the percentage deviation from the vertical in terms of the half thickness decreases as the ionization increases. On the other hand, the magnitude of the latitude gradient of ionization is usually greatest in the daytime when the ionization is highest. Consequently, these two factors have opposing effects on the magnitude of the critical frequency difference.

However, there is another important factor affecting the $f^x - f^o$ frequency difference, namely, the variation in the thickness of the ionized region. Since the paths taken by the ordinary and extraordinary critical frequencies have been calculated for an arbitrary thickness, any variation in this thickness will produce a proportional variation in the horizontal deflections. The actual ionospheric distribution of ionization may depart considerably from the parabolic approximation but the effective half thickness is probably considerably greater in the day, when ionization is at its maximum, than at night. An increase in the half thickness from 100 km at night to 200 km in the daytime, other factors remaining constant, would increase the deflections by 100 per cent.

Measurements of $f^x - f^o$ critical frequency differences have been reported elsewhere¹⁰ which indicate a diurnal variation in apparent magnetic field at Clyde River, Baffin Land of over 10 per cent, with the maximum at noon. Similar results, to be detailed in another report,¹¹ have been obtained at Ottawa, Churchill, and Portage La Prairie, Manitoba. It is believed that these effects may be explained as due to a diurnal variation in the latitude of reflection of the ordinary and extraordinary modes in conjunction with the gradient of ionization with latitude.

It must be pointed out that the deflections calculated for plane waves in a "slowly varying" horizontally stratified medium cannot be accurately applied to an ionosphere having a latitude gradient. However it is believed that the normal latitude gradients in the ionosphere will not greatly change the deflections.

ACKNOWLEDGMENTS

In conclusion, I wish to thank David V. Dickson for his valuable co-operation. His was the tedious task of computing most of the polarization and deflection curves without which this paper would have been valueless.

⁹ "Ionospheric Radio Propagation," National Bureau of Standards Circular 462, U. S. Dept. of Commerce, Washington, D. C.; June, 1948.

¹⁰ J. C. W. Scott, "Magneto-ionic measurements at high latitudes," *Terr. Mag. Atmo. Elec.*, vol. 53, p. 109; June, 1948.

¹¹ J. C. W. Scott, "Longitudinal and transverse propagation in Canada," *Jour. Geophys. Res.*, vol. 56, p. 65; March, 1950.

Radiation from Circular Current Sheets*

W. R. LEPAGE†, SENIOR MEMBER, IRE, C. S. ROYS‡, SENIOR MEMBER, IRE, AND S. SEELY†, SENIOR MEMBER, IRE

Summary—An analysis of the radiation from a system of coplanar concentric circular current sheets, in which the current elements are perpendicular to the plane of the circles, is carried out. The current elements are of negligible length, and are continuous along the periphery of the circles. The formation of beams in the horizontal plane, and also in the vertical plane, are examined. The solution of the three-dimensional field is given in two forms: one as a Fourier series, and the other as a Bessel-Fourier series.

The solutions are adapted to show how a prescribed horizontal pattern may be synthesized. In one method the pattern is represented as a Fourier series, in the other it is represented as a Bessel-Fourier series. It is also shown that by combining these two types of solution, it is possible to synthesize simultaneously a pattern in both the vertical and horizontal planes.

INTRODUCTION

THE TYPE OF array here considered is illustrated in Fig. 1. In previous treatments of this type of array there has been interest in obtaining a gain in the vertical plane, while retaining unidirectional properties in the horizontal plane.¹⁻³ By a change in the phasing of the current elements, a beam can be formed in the horizontal plane. For certain applications, such as direction-finding and point-to-point communication, such an array offers useful properties. The basic solution is known for the simplest possible case of a horizontal beam formation.⁴ It is the purpose of the present paper to generalize the solutions for both the horizontal and vertical patterns, and to show how the results can be used to synthesize desired field patterns.

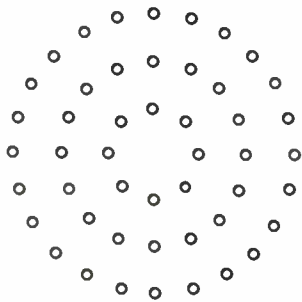

Fig. 1—An array of circularly disposed elements.

The analysis is idealized to the extent of assuming that each concentric ring of elements is replaced by a

* Decimal classification: R125.1. Original manuscript received by the Institute, November 29, 1949; revised manuscript received, May 9, 1950.

† Syracuse University, Syracuse, N. Y.

‡ Formerly, Syracuse University; now, University of Massachusetts, Amherst, Mass.

¹ H. Chiereix, "Antennas a Rayonnement Zenithal Reduit," *L'Onde Elect.*, vol. 15, p. 440; July, 1936.

² W. W. Hansen, and H. R. Woodyard, "A new principle in directional antenna design," *Proc. I.R.E.*, vol. 26, p. 333; March, 1938.

³ W. W. Hansen, and M. Hollingsworth, "Design of flat-shooting antenna arrays," *Proc. I.R.E.*, vol. 27, p. 137; February, 1939.

⁴ Stohr, "Compensated Circular Antenna Arrays," *Gesellschaft fur draht. Tele.*, Reproduced by U. S. Dept. Commerce Publication Board, PB 8922; 1946.

continuous cylindrical current sheet of vertical currents. In addition, they are assumed to be of infinitesimal height, thereby permitting the approximation that the contribution to the field of each current element is independent of the other portions of the current system. The analysis is based on the consideration of the system in a transmitting condition. The treatment is entirely one of deriving expressions for the field pattern for various types of current distributions. There is no consideration of how such distributions can be attained.

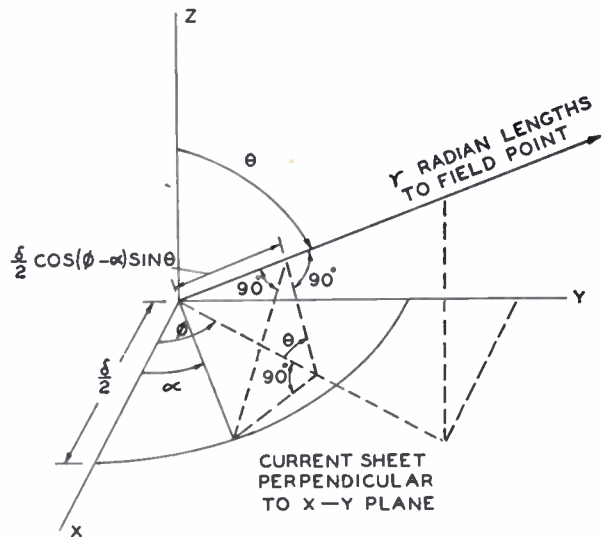

Fig. 2—Current sheet perpendicular to X-Y plane.

FUNDAMENTAL EQUATIONS

The co-ordinate system is illustrated in Fig. 2. All linear distances are in radian-length measure ($2\pi/\lambda$ times the actual length). The figure shows a single circular current sheet, which is typical of the many which may constitute the complete array. $\bar{I}(\alpha)$ is the complex expression for the current, in amperes per radian length of circumference. It is assumed that the array is symmetrical with respect to an imagined ground plane.

The distance from the center to the field point is greater than the distance from a point on the circle by the amount

$$\frac{\delta}{2} \sin \theta \cos (\phi - \alpha). \quad (1)$$

The field strength at a point in the far field is proportional to the integral

$$\bar{E}(\phi, \theta) = F(\theta) \frac{\delta}{2\pi} \int_0^{2\pi} \bar{I}(\alpha) e^{j(\delta/2) \sin \theta \cos (\phi - \alpha)} d\alpha. \quad (2)$$

Since multiplying constants are unimportant, the factors e^{-ir} and $1/r$ are not included, and the magnitude factor has been taken as $1/\pi$, to suit a later purpose.

FOURIER-SERIES REPRESENTATION OF CURRENT DISTRIBUTION

A general solution of (2) may be obtained by expressing the current in the Fourier series

$$\bar{I}(\alpha) = \sum_{n=-\infty}^{\infty} \bar{C}_n e^{jn\alpha} \quad (3)$$

It is to be emphasized that $\bar{I}(\alpha)$ is complex, in general. A substitution of this expression into (2), in accordance with the procedure shown in the Appendix, gives

$$\bar{E}(\phi, \theta) = F(\theta)\delta \sum_{n=-\infty}^{\infty} \bar{C}_n e^{jn\phi} J_n \left(\frac{\delta}{2} \sin \theta \right) \quad (4)$$

The solution given by (4) is completely general. The only restriction is the convergence of the series for both the current and the pattern.

BEAM-CO-PHASED DISTRIBUTION OF CURRENT

In beam antenna practice, the current elements are usually phased so as to give a common phase to the radiation from all elements along the direction of the main beam. The term "beam-co-phased" is to be used to describe this situation. Let the current elements of a single circular current sheet be phased beam-co-phasally, with the direction of the main beam taken along the $\phi=0, \theta=\theta_0$ direction. From (2) it is seen that the current distribution

$$\bar{I}(\alpha) = e^{-j(\delta/2) \sin \theta_0 \cos \alpha} \quad (5)$$

makes the integrand independent of (α) , when $\phi=0$ and $\theta=\theta_0$.

The solution can be extended to include modifications of this distribution, however. Equation (5) can be multiplied by any complex periodic function of (α) , which may in turn be represented by a Fourier series in complex form, giving

$$I(\alpha) = \sum_{n=-\infty}^{\infty} \bar{D}_n e^{jn\alpha} e^{-j(\delta/2) \sin \theta_0 \cos \alpha} \quad (6)$$

Equation (6) retains the same degree of generality as (3), but it is in a form to display deviations from the beam-co-phased law.

Equation (6) may be substituted into (2), and treated by the process shown in the Appendix. The result is

$$\bar{E}(\phi, \theta) = F(\theta)\delta \sum_{n=-\infty}^{\infty} \bar{D}_n e^{jn(\Delta+\pi/2)} J_n [\delta f(\phi, \theta)], \quad (7)$$

where

$$f(\phi, \theta) = \frac{1}{2} \sqrt{\sin^2 \theta + \sin^2 \theta_0 - 2 \sin \theta_0 \sin \theta \cos \phi} \quad (8)$$

and

$$\Delta = \tan^{-1} \frac{\sin \theta \sin \phi}{\sin \theta \cos \phi - \sin \theta_0} \quad (9)$$

This result is particularly interesting when the excitation satisfies the beam-co-phased law and has a sym-

metrical amplitude distribution. In this case,

$$A(\alpha) = \sum_{n=-\infty}^{\infty} D_n e^{jn\alpha} \quad (10)$$

is real, and the coefficients are real. With this simplification, the formula

$$E(\phi, \theta) = F(\theta)\delta \left\{ D_0 J_0 [\delta f(\phi, \theta)] + 2 \sum_{\substack{n=2 \\ \text{(even)}}}^{\infty} (-1)^{n/2} D_n \cos n\Delta J_n [\delta f(\phi, \theta)] \right\} \quad (11)$$

is obtained.

Another important simplification is possible, by confining consideration to the two patterns in the surfaces of $\theta=\theta_0$ and $\phi=0$. When $\theta=\theta_0; f(\phi, \theta_0) = \sin \theta_0 \sin \phi/2$, and $\Delta = (\phi+\pi)/2$, resulting in the pattern

$$E(\phi, \theta_0) = F(\theta_0)\delta \left\{ D_0 J_0 \left(\delta \sin \theta_0 \sin \frac{\phi}{2} \right) + 2 \sum_{\substack{n=2 \\ \text{(even)}}}^{\infty} D_n \cos \frac{n\phi}{2} J_n \left(\delta \sin \theta_0 \sin \frac{\phi}{2} \right) \right\} \quad (12)$$

When $\phi=0; f(\phi, \theta) = 1/2 (\sin \theta_0 - \sin \theta)$, and $\Delta=0$, giving

$$E(0, \theta) = F(\theta)\delta \left\{ D_0 J_0 \left[\frac{\delta}{2} (\sin \theta - \sin \theta_0) \right] + 2 \sum_{\substack{n=2 \\ \text{(even)}}}^{\infty} (-1)^{n/2} D_n J_n \left[\frac{\delta}{2} (\sin \theta - \sin \theta_0) \right] \right\} \quad (13)$$

If the current has a uniform value throughout the circle, and $\theta_0 = \pi/2$, further reductions are possible, giving

$$E\left(\phi, \frac{\pi}{2}\right) = F\left(\frac{\pi}{2}\right)\delta D_0 J_0 \left(\delta \sin \frac{\phi}{2} \right) \quad (14)$$

$$E(0, \theta) = F(\theta)\delta D_0 J_0 \left[\delta \sin^2 \left(\frac{\theta - \frac{\pi}{2}}{2} \right) \right] \quad (15)$$

SYNTHESIS OF A PATTERN IN THE SURFACE $\theta=\theta_0$

Both of these solutions lend themselves to the synthesis of a prescribed field pattern when θ is constant. Suppose that the given field pattern is specified as

$$\bar{H}(\phi, \theta_0) = H(\phi) e^{jH_0(\phi)} \quad (16)$$

The function $H(\phi)$ is the important one, since it represents the magnitude of the field pattern. Accordingly, the problem is to determine the current distribution in the array to yield a prescribed $H(\phi)$ function. Two cases are considered, depending on the form that is used for the current distribution. These are: (a) Fourier series representation of the field; and (b) Bessel-Fourier representation of a symmetrical field.

(a). *Fourier series representation of the field.* A combination of (3) and (4) provides the necessary information for the synthesis of the prescribed pattern. Equation (4) is a Fourier series representation of the field pattern, so the synthesis is accomplished by finding each \bar{C}_n in the equation

$$\bar{H}(\phi, \theta_0) = F(\theta_0)\delta \sum_{n=-\infty}^{\infty} \left[\bar{C}_n j^n J_n \left(\frac{\delta}{2} \sin \theta_0 \right) \right] e^{jn\phi}. \quad (17)$$

The quantity within the brackets is the n th Fourier coefficient in the series for $II(\phi)$. By applying the standard methods for obtaining the Fourier coefficients, it follows that

$$\bar{C}_n = \frac{1}{2\pi F(\theta_0)\delta j^n J_n \left(\frac{\delta}{2} \sin \theta_0 \right)} \int_0^{2\pi} II(\phi) e^{j[H_a(\phi) - n\phi]} d\phi. \quad (18)$$

This expression for the Fourier coefficients of the current distribution is significantly dependent upon the array diameter δ . If the Fourier series for $II(\phi)$ exists, the integral of (18) will become small for sufficiently large values of n . However, for a fixed argument, the Bessel function decreases rapidly with increasing order. This effect introduces a decreasing factor in the denominator which tends to make the series for $\bar{I}(\alpha)$ diverge. However, as the argument of the Bessel function increases, the value of J_n becomes zero less rapidly with increasing n . A sufficiently large value of array diameter is therefore necessary to ensure convergence of the series for the current distribution. It is not necessary to have the same circle for each harmonic of current distribution, in which case those circles carrying the higher order components of current must be sufficiently large. Since the function $II_a(\phi)$ is unimportant, it follows that the coefficients specified by (18) are not unique.

(b). *Bessel-Fourier representation of a symmetrical field.* Let $II_a(\phi)$ be zero and let $II(\phi)$ be symmetrical about $\phi=0$. Further, let it be written

$$II(\phi) = h \left(\sin \frac{\phi}{2} \right). \quad (19)$$

The synthesis of a pattern by this method requires a system of concentric rings. Each ring is excited beam-co-phasally with constant current amplitude. The direction of the co-phasal radiation is the same for each ring. Let δ_1, δ_2 , and the like, be the radian-length diameters of the successive circles, counting from the inside. Furthermore let the diameters be determined by the formula

$$\delta_k = \frac{b_k}{\sin \theta_0}, \quad (20)$$

where k takes on successive integral values. The constants designated by b_k are the roots of $J_0=0$, with the subscript k corresponding to the number of the root.

The current distribution is given by (6), except that only the single term with $n=0$ remains. The subscript

k is a ring number index, and N is the number of rings. The current distribution for the k th ring is

$$\bar{I}_k(\alpha) = D_{0k} e^{-j(b_k/2)\cos\alpha}. \quad (21)$$

Equation (21) provides the form for the solution. It is only necessary to sum N such solutions, one for each ring. The result is

$$H(\phi) = h \left(\sin \frac{\phi}{2} \right) \simeq F(\theta_0) \sum_{k=1}^N \delta_k D_{0k} J_0 \left(b_k \sin \frac{\phi}{2} \right). \quad (22)$$

This is a finite summation of terms of the Bessel-Fourier type. It is an approximate representation of the specified h function. The general coefficient D_{0k} is chosen to make (22) the Bessel-Fourier series of $h(\sin \phi/2)$. One of the possible formulas for this yields the relation⁵

$$D_{0k} = \frac{1}{F(\theta_0)\delta_k J_1(b_k)^2} \int_0^1 y h(y) J_0(b_k y) dy. \quad (23)$$

The number of terms required in the Bessel-Fourier series for the given field pattern depends, of course, on the sharpness of the desired beam. The sharper the beam, the greater will be the required number of terms, and hence the greater will be the diameter of the outside circle. This is in agreement with the known relationship between array dimensions and beam width.

TAPERING OF BEAM-CO-PHASAL EXCITATION TO MODIFY THE $\theta = \theta_0$ PATTERN

The general beam-co-phasal distribution offers beam-shape adjusting possibilities with a single circle. This requires the use of the series of (10), rather than the single term for $n=0$, as in the above example.

Equation (12) shows an order of Bessel function for each harmonic in the current distribution. An analysis of the effects is complicated by the cosine multiplier of the Bessel function. An adjustment of the pattern by manipulating the current amplitude distribution therefore must be done empirically.

The effect of tapering the excitation toward the side of the array can be demonstrated with this solution. Consider the specific example

$$A(\alpha) = \frac{1}{2} [1 + \cos 2\alpha] = \frac{1}{2} [1 + \frac{1}{2} e^{j2\alpha} + \frac{1}{2} e^{-j2\alpha}]. \quad (24)$$

From (12) it is evident that the field pattern is

$$E(\phi, \theta_0) = F(\theta_0)\delta \left[J_0 \left(\delta \sin \theta_0 \sin \frac{\phi}{2} \right) + \cos \phi J_2 \left(\delta \sin \theta_0 \sin \frac{\phi}{2} \right) \right]. \quad (25)$$

These functions are shown in Fig. 3 for the numerical case of $\delta = 10\pi$. It is seen that there is some cancellation of the side lobes.

⁵ G. N. Watson, "A Treatise on the Theory of Bessel Functions," chap. 18, Cambridge University Press, Cambridge, England, 2nd ed.: 1948.

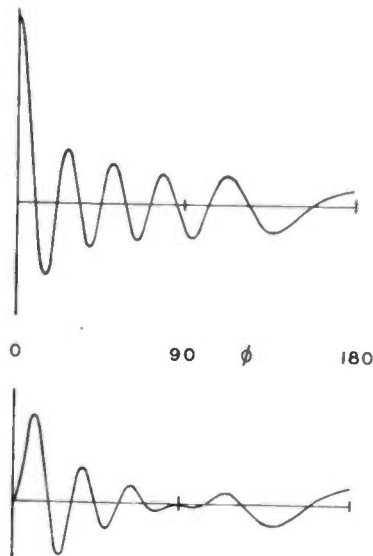

Fig. 3—Comparison of $J_0(10\pi \sin \phi/2)$ and $\cos \phi J_0(10\pi \sin \phi/2)$ functions.

SYNTHESIS OF HORIZONTAL AND VERTICAL PATTERNS

By allowing the array to consist of a sufficient number of rings, the preceding equations can be set up simultaneously to synthesize patterns in the $\theta = \theta_0$ and $\phi = 0$ surfaces. This is done by combining the Fourier series in ϕ , as expressed by (4), with a Bessel-Fourier series in θ , obtained by allowing δ to have a series of values for each value of n in (4).

Let the required patterns be

$$\bar{E}(\phi, \theta_0) = H(\phi) e^{jH_0(\phi)} \quad (26a)$$

$$E(0, \theta) = F(\theta) V(\sin \theta). \quad (26b)$$

Equation (4) may therefore be summed over a number of values of δ , for each value of n , in accordance with the formula

$$\bar{E}(\phi, \theta) \simeq F(\theta) \sum_{n=-M}^M j^n \bar{C}_n e^{jn\phi} \sum_{k=1}^{N_n} \delta_{nk} D_{nk} J_n \left(\frac{\delta_{nk}}{2} \sin \theta \right). \quad (27)$$

The n summation is given the limit M rather than ∞ , to avoid an array of infinite diameter. Let the k summation be considered first. For each value of n it will provide an approximation for the vertical pattern, if N_n is sufficiently large, and D_{nk} is given by the formula⁵

$$D_{nk} = \frac{2}{\left[J_{n+1} \left(\frac{\delta_{nk}}{2} \right) \right]^2} \int_0^1 V(y) y J_n \left(\frac{\delta_{nk}}{2} y \right) dy, \quad (28)$$

where $J_n(\delta_{nk}/2) = 0$ for each n and k . The same vertical pattern is obtained for each n , and when the summation is carried out over n , the final vertical pattern will be the sum of M components, each of identical form. This amounts only to a change in scale.

Recalling that each summation of k , up to N_n , is an approximation for $V(\sin \theta)$, (27) becomes

$$\bar{E}(\phi, \theta) \simeq F(\theta) V(\sin \theta) \sum_{n=-M}^M j^n \bar{C}_n e^{jn\phi}. \quad (29)$$

The \bar{C}_n coefficients can now be chosen to give the required function $H(\phi)$, by allowing M to be sufficiently large. \bar{C}_n is given by the usual formula

$$\bar{C}_n = \frac{1}{2\pi j^n F(\theta_0) V(\sin \theta_0)} \int_0^{2\pi} H(\phi) e^{j[H_0(\phi) - n\phi]} d\phi. \quad (30)$$

When the coefficients D_{nk} and \bar{C}_n are determined in accordance with (28) and (30), the field patterns in the prescribed surfaces are

$$E(\phi, \theta_0) \simeq F(\theta_0) V(\sin \theta_0) H(\phi) \quad (31a)$$

$$\bar{E}(0, \theta) \simeq F(\theta) V(\sin \theta) \left| \sum_{n=-M}^M j^n \bar{C}_n \right|. \quad (31b)$$

The ring of diameter δ_{nk} has a current distribution with amplitude and phase given by $\bar{C}_n D_{nk}$. It is noted that this array consists of $N_0 + N_1 + N_2 + \dots + N_M$ concentric rings of diameters δ_{nk} , where $1 \leq k \leq N_n$ and $0 \leq n \leq M$. Each ring is excited with a current distribution in accordance with only the n th harmonic, in contrast with the synthesis described by (29), for which all components appeared on a single circle. There are N_0 rings with uniform current, N_1 rings with the first harmonic, and so forth. The number of rings for each harmonic depends on the rate of convergence of the Bessel-Fourier series for the vertical pattern, for that harmonic.

APPENDIX

Equation (3) is substituted in (2), and the substitution $u = \alpha - \phi$ is made, giving

$$E(\phi, \theta) = \frac{F(\theta)\delta}{2\pi} \sum_{n=-\infty}^{\infty} \int_{-\phi}^{2\pi-\phi} \bar{C}_n e^{jn(\phi+u)} e^{j(\delta/2) \sin \theta \cos u} du.$$

The integrand is periodic in u , so both limits may be increased by ϕ , to give

$$E(\phi, \theta) = \frac{F(\theta)\delta}{2\pi} \sum_{n=-\infty}^{\infty} e^{jn\phi} \int_0^{2\pi} \bar{C}_n e^{jn u} e^{j(\delta/2) \sin \theta \cos u} du.$$

The integral is a form⁶ for the function $2\pi j^n J_n(\delta/2 \sin \theta)$. Equation (4) follows directly.

The current distribution given by (6), when substituted into (2), yields an exponent

$$\begin{aligned} jn\alpha + j \frac{\delta}{2} [\sin \theta \cos(\phi - \alpha) - \sin \theta_0 \cos \alpha] \\ = jn\alpha + j \sqrt{\sin^2 \theta + \sin^2 \theta_0 - 2 \sin \theta_0 \sin \theta \cos \phi \cos(\alpha - \Delta)}. \end{aligned}$$

The variable change $u = \alpha - \Delta$ is then used, as in the previous case.

⁶ E. Jahnke and F. Emde, "Tables of Functions," Dover Publications, New York, N. Y., p. 149; 1945.

High-Frequency Vibrations of Plates Made from Isometric and Tetragonal Crystals*

E. A. GERBER†, ASSOCIATE MEMBER, IRE

Summary—The paper deals with thin piezoelectric plates made from the isometric crystals, sodium chlorate and sodium bromate, and the tetragonal crystals, potassium dihydrogen phosphate and ammonium dihydrogen phosphate. Beveling of crystals is first described, briefly, as a method used for preparing single response crystal units. In the following section the paper discusses the possibilities of getting thickness controlled resonances. The two cuts (zxw) 45° and $(zxtw)$ $45^\circ/54^\circ 44'$ (notation according to the 1949 Standards of The Institute of Radio Engineers) give the strongest deformations. The measured frequency constants of numerous round bevelled blanks and their temperature coefficients agree in most cases with the values obtained from calculations based on data from other authors. The resistance, inductance, and quality factor of the equivalent electric circuits are measured. The concordance with calculated values is fairly good if the ratio crystal area/(electrode area)² is introduced into the formulas. The NaBrO_3 thickness modes have about the same quality factor as that of quartz, the quality factor of $\text{NH}_4\text{H}_2\text{PO}_4$ is about one order of magnitude smaller.

I. INTRODUCTION

THE ELASTIC and piezoelectric properties of the isometric crystals, sodium chlorate NaClO_3 and sodium bromate NaBrO_3 , and of the tetragonal crystals, potassium dihydrogen phosphate KH_2PO_4 and ammonium dihydrogen phosphate $\text{NH}_4\text{H}_2\text{PO}_4$, have been thoroughly investigated by Mason.^{1,2} The author, however, did considerable research in 1944 in an attempt to get good-quality thickness vibrators from these substances, and his work and findings are presented herewith. At that time, some of the elastic constants were determined; they agree, for the most part, with those published by Mason. It may be added that the work is not entirely completed, as it was terminated due to causes beyond the control of the author.

II. PREPARATION OF THE CRYSTAL PLATES

For all measurements given throughout the paper, various round plates with various diameter-to-thickness ratios were used. To avoid coupling with other modes, all plates were bevelled symmetrically using optical cups with radii of curvature between 25 and 50 millimeters. The width of the bevels lay between 10 and 20 per cent of the crystal diameter, thus leaving a small cylindrical part on the edges to prevent chipping. The beveling was carried out until all spurious responses in the neighborhood of the main response disappeared. Then the equivalent resistance reached a low value. The crystal re-

tained this value even by carrying on beveling, as long as it remained free of spurious responses. An example of the influence of the width of the bevel on the resistance is given in section VI. In some cases, it was not possible to get a single response crystal with one bevel; then another cup with a larger radius of curvature was applied.³

III. THE POSSIBILITIES OF GETTING THICKNESS MODES

As it is well known, NaBrO_3 and NaClO_3 belong to the class 2 3 of the isometric system, while KH_2PO_4 and $\text{NH}_4\text{H}_2\text{PO}_4$ belong to the class $\bar{4} 2 m$ of the tetragonal system. For these two classes, the matrices of the piezoelectric stress constants are:⁴

| Class $\bar{4} 2 m$ | | | | | | Class 2 3 | | | | | |
|---------------------|---|---|----------|----------|----------|-----------|---|---|----------|----------|----------|
| 0 | 0 | 0 | e_{14} | 0 | 0 | 0 | 0 | 0 | e_{14} | 0 | 0 |
| 0 | 0 | 0 | 0 | e_{14} | 0 | 0 | 0 | 0 | 0 | e_{14} | 0 |
| 0 | 0 | 0 | 0 | 0 | e_{36} | 0 | 0 | 0 | 0 | 0 | e_{14} |

If we have plates the thicknesses of which are parallel to the applied electric field, there appears upon first inspection that there is no possibility of obtaining thickness vibrations, for the deformations occur only in planes perpendicular to the direction of the field. However, by transforming the e_{ik} 's on rotated crystallographic axes, using the transformation formulas for Rochelle salt given in Cady's book,⁵ it can be seen that there are two possibilities for exciting thickness deformations:

1. The cut (zxw) with the Z' axis parallel to the thickness of the plate:⁶

$$\begin{aligned} e_{33}' &= e_{34}' = 0 \\ e_{35}' &= \frac{1}{2}(e_{14} + e_{36}) \sin 2\phi. \end{aligned} \quad (1)$$

The latter equation offers the possibility of obtaining shear vibrations. $\phi = 45^\circ$ is the preferred angle, if strong vibrations are desired.

* It may be worth while to remark, at this occasion, that for the same reason two or even three bevels have been used successfully in round AT cut quartz crystals. If one bevel did not give sufficient freedom from spurious responses or a smooth resistance-temperature curve, one or two more bevels have been applied. If a distortion occurred in the upper frequency range of the spectrum or in the upper range of the resistance-temperature curve, a bevel with a smaller radius of curvature was applied in most cases; for a distortion in the opposite part of the ranges, a larger radius of curvature proved to be helpful.

⁴ W. G. Cady, "Piezoelectricity," McGraw-Hill Book Co., New York, N. Y., p. 191; 1946.

⁵ See footnote reference 4, p. 202.

⁶ The crystal plate orientations and the piezoelectric relations, symbols, and units are chosen according to "IRE Standards on Piezoelectric Crystals, 1949," Proc. I.R.E. vol. 37, pp. 1378-1395; December, 1949.

* Decimal classification: R214.3. Original manuscript received by the Institute, July 11, 1949; revised manuscript received, February 21, 1950.

† Signal Corps Engineering Laboratories, Fort Monmouth, N. J.
¹ W. P. Mason, "The elastic, piezoelectric, and dielectric constants of potassium dihydrogen phosphate and ammonium dihydrogen phosphate," *Phys. Rev.*, vol. 69, pp. 173-194; March, 1946.

² W. P. Mason, "The elastic, piezoelectric, and dielectric properties of sodium chlorate and sodium bromate," *Phys. Rev.*, vol. 70 pp., 529-537; October, 1948.

2. The cut (zxw) $45^\circ/54^\circ 44'$ (Cady's L-cut⁷) with the Z' axis parallel to the thickness of the plate and the Y' axis taken in the XY plane:

$$\begin{aligned} e_{33}' &= \frac{2}{3\sqrt{3}}(2e_{14} + e_{36}) \\ e_{34}' &= 0 \\ e_{35}' &= \frac{1}{3}\sqrt{\frac{2}{3}}(e_{36} - e_{14}), \end{aligned} \quad (2)$$

e_{33}' gives longitudinal and e_{35}' shear vibrations. The above equations hold for class $\bar{4} 2 m$ and also for class $2 3$, if e_{36} is set equal to e_{14} .

IV. FREQUENCY OF THICKNESS VIBRATIONS

1. Theory

The theory of thickness vibrations of crystals has been worked out in the case of quartz by Koga⁸ and Bechmann,⁹ among others, in the case of Rochelle salt by Mason.¹⁰ We can transfer their results for our two crystal classes under consideration. Table I shows the result; it gives the frequency formulas for the different cuts and modes of vibration. In these formulas, the c_{ik} 's are the stiffness coefficients, l is the thickness of the plates, and ρ the density.

constant, ϵ^S permittivity which is measured when the strain is held constant. The indices of the different constants will be omitted, if not determined orientations are to be characterized); and (2) by a surface stress which diminishes the frequency by an additional amount depending upon the arrangement of the electrodes. Thus, the exact expression for the fundamental frequency of thickness vibrations is

$$f = \frac{1}{2l\rho^{1/2}} \left(c^E + \frac{4\pi e^2}{\epsilon^S} - \frac{32e^2t}{\pi\epsilon^S(t + \epsilon^S a)} \right)^{1/2} \quad (7)$$

where c^E is the stiffness coefficient for the electric field held constant and a the width of the total air gap. For a plated crystal ($a = 0$) (7) becomes

$$f = \frac{1}{2l\rho^{1/2}} \left(c^E + 0.19 \frac{4\pi e^2}{\epsilon^S} \right)^{1/2} \quad (8)$$

For a crystal with a large air gap, (7) is

$$f = \frac{1}{2l\rho^{1/2}} \left(c^E + \frac{4\pi e^2}{\epsilon^S} \right)^{1/2} = \frac{1}{2l\rho^{1/2}} (c^D)^{1/2} \quad (9)$$

The superscript D of the stiffness coefficient means that the normal component of the electric displacement is constant.

TABLE I

| Class | Mode | Cut | |
|---------------|---------------|---|---|
| | | (zxw) | (zxw) $45^\circ/54^\circ 44'$ |
| $\bar{4} 2 m$ | shear | $f = \frac{1}{2l} [(c_{44} \sin^2 \phi + c_{66} \cos^2 \phi)/\rho]^{1/2}$ (3) | Solution available only through trigonometric method. |
| | compressional | — | |
| $3 2$ | shear | $f = \frac{1}{2l} [c_{44}/\rho]^{1/2}$ (4) | $f = \frac{1}{2l} [(c_{11} - c_{12} + c_{44})/3\rho]^{1/2}$ (5) |
| | compressional | — | $f = \frac{1}{2l} [(c_{11} + 2c_{12} + 4c_{44})/3\rho]^{1/2}$ (6) |

For exact considerations, and especially for the substance, KH_2PO_4 and $\text{NH}_4\text{H}_2\text{PO}_4$, it is necessary to respect secondary piezoelectric effects. The stiffness coefficient for free thickness vibrations is changed by the piezoelectric effect in a double manner:^{11,12} (1) by a stress influencing the volume unit, which enlarges the stiffness coefficient by the amount $4\pi e^2/\epsilon^S$ (e piezoelectric stress

⁷ See footnote reference 4, p. 204.

⁸ I. Koga, "Vibration of piezoelectric oscillating crystal," *Phil. Mag.*, vol. 16, pp. 275-283; August, 1933.

⁹ R. Bechmann, "Über die Temperatur-Koeffizienten der Eigenschwing-piezoelektrischen Quarzplatten und Stäbe," *Hoch. und Elek.*, vol. 44, pp. 145-160; November, 1934.

¹⁰ W. P. Mason, "A dynamic measurement of the elastic, electric, and piezoelectric constants of Rochelle salt," *Phys. Rev.*, vol. 55, pp. 775-789; April, 1939.

¹¹ W. G. Cady, "The piezoelectric resonator and the effect of electrode spacing upon frequency," *Physics*, vol. 7, pp. 237-259; July, 1936.

¹² R. Bechmann, "Dickenschwingungen piezoelektrisch erregter kristallplatten," *Hoch. und Elek.*, vol. 56, pp. 14-21; July, 1940; See also footnote reference 4, p. 314.

2. Experimental Results

As we observe from (4), the frequency of NaBrO_3 and NaClO_3 (zxw) cut thickness vibrators is independent of the angle of cut; the strongest shear vibrations will be obtained for $\phi = 45^\circ$, according to (1). Various round plates with various diameter-to-thickness ratios were cut at this angle and the frequency constant measured using electrodes that rested freely upon the plate. The frequency constant is plotted against the diameter-to-thickness ratio in Fig. 1. The distribution of the single points may be caused by the variation in bevels. The increase of the frequency constant with smaller diameter-to-thickness ratios is like that of the AT-cut and BT-cut of quartz. Extrapolating the value of the frequency constant to a diameter-to-thickness ratio of about 20, we obtain, at room temperature, for NaBrO_3 1,076 kc mm, and for NaClO_3 1,095 kc mm. The values

or c_{44} and $s_{44} = 1/c_{44}$, calculated from these frequency constants with the aid of (4), check well with those found at room temperature by other authors. The frequency constants of plates cut at other angles of ϕ agree with that for $\phi = 45^\circ$; any variations being within the limits of error caused by differences in bevels.

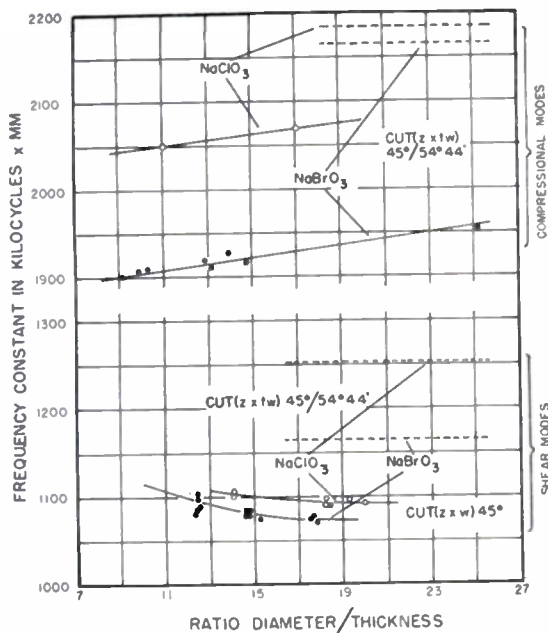

Fig. 1—Frequency constants of different thickness vibrations of NaBrO₃ and NaClO₃ crystals as a function of the ratio diameter/thickness.

Solid curves: Measured values.
Dashed curves: Calculated values.

Fig. 1 also shows the measured frequency constant for the compressional mode of the L cut for the two isometric crystals also plotted against the diameter-to-thickness ratio. Contrary to the behavior of the shear mode, the frequency increases with this ratio, as far as the few measured points can show. The two dashed lines on the top of the graph are values for the frequency constant of the compressional mode of the L cut, computed by (6) from Mason's values for s_{11} , s_{12} , and s_{44} . As we see, our values are 5.5 per cent (NaClO₃) and 10.5 per cent (NaBrO₃) smaller than those computed from Mason's measurements. The reason is not quite clear, but in every case, our measurements confirm Mason's results that the crystals have a negative s_{12} ratio. If we use Voigt's data for NaClO₃ (who found a positive value for s_{12}), we obtain a frequency constant of 1,500 kc mm, which differs from our value by 42 per cent.

The other two dashed lines in Fig. 1 show the frequency constant of the thickness shear vibration of the L cut, these two values being calculated from (5). This mode is not realizable; for e_{34} , and e_{35} , are equal to zero for class 2 3, according to (2), yet if the deviation from the exact L cut is only a few degrees, this mode appears with a relatively high activity according to our find-

ings. Fig. 2 shows measurements of the frequency constant of the thickness shear mode for the cut zxw of KH₂PO₄ and NH₄H₂PO₄. The crystal plates were prepared according to the rule outlined in section II. Some of the units were plated, and some were mounted in an air-gap holder. In all cases, the plates were held at three points on their circumference. The three solid curves in Fig. 2 are calculated from Mason's¹ values for c_{44} , c_{66}^D , and c_{66}^E with the aid of (2), (8), and (9). Since the difference between c_{66}^D and c_{66}^E is only 1.5 per cent in the case of KH₂PO₄, the two frequency curves for a plated crystal and an air-gap crystal coincide in this case in the drawing. As we observe, the measured values check well with the calculated values within the dispersion due mostly to the differences in bevels.

V. TEMPERATURE COEFFICIENT OF FREQUENCY

1. Theory

To obtain the temperature coefficient (TC) for small changes of the temperature, we differentiate the equations (3) and (4) partially in terms of the temperature. For obtaining exact values, we have to replace c_{66} in the case of a large air gap by c_{66}^D , according to (9), and in the case of a plated crystal by

$$\left(c_{66}^D - 0.81 \frac{4\pi e_{36}^2}{\epsilon_3^2 S} \right),$$

according to (8) in connection with (9). Then we obtain in the tetragonal system for a large air gap

$$\frac{1}{f} \frac{\partial f}{\partial T} = (\alpha_x - \alpha_z) \sin^2 \phi + \frac{\alpha_z}{2} + \frac{1}{2c} \left(\frac{\partial c_{44}}{\partial T} \sin^2 \phi + \frac{\partial c_{66}^D}{\partial T} \cos^2 \phi \right) \quad (11)$$

where $c = (c_{44} \sin^2 \phi + c_{66} \cos^2 \phi)$; and for a plated crystal

$$\frac{1}{f} \frac{\partial f}{\partial T} = (\alpha_x - \alpha_z) \sin^2 \phi + \frac{\alpha_z}{2} + \frac{1}{2c'} \left[\frac{\partial c_{44}}{\partial T} \sin^2 \phi + \left\{ \frac{\partial c_{66}^D}{\partial T} - 0.81 \frac{4\pi e_{36}^2}{\epsilon_3^2 S} \left(\frac{2}{e_{36}} \frac{\partial e_{36}}{\partial T} + \frac{1}{\epsilon_3^2 S} \frac{\partial \epsilon_3^2 S}{\partial T} \right) \right\} \cos^2 \phi \right] \quad (12)$$

where

$$c' = c_{44} \sin^2 \phi + \left(c_{66}^D - 0.81 \frac{4\pi e_{36}^2}{\epsilon_3^2 S} \right) \cos^2 \phi.$$

We obtain in the isometric system

$$\frac{1}{f} \frac{\partial f}{\partial T} = \frac{\alpha}{2} + \frac{2}{c_{44}} \frac{\partial c_{44}}{\partial T} \quad (13)$$

α_x , α_z are the thermal expansion coefficients in the tetragonal system, and α is the thermal expansion coefficient in the isometric system. They are equal to

$$\frac{1}{l} \frac{\partial l}{\partial T}$$

2. Experimental Results

As will be noted from (13), the TC of the (zxw) cut shear mode of the isometric crystals is independent of the angle of cut. The measured TC's are plotted in Table II. They represent, in the case of NaBrO₃, the average value of nine crystals; in the case of NaClO₃, the average value of three crystals. These, and all later data are measured between 0° and 50° C, in which

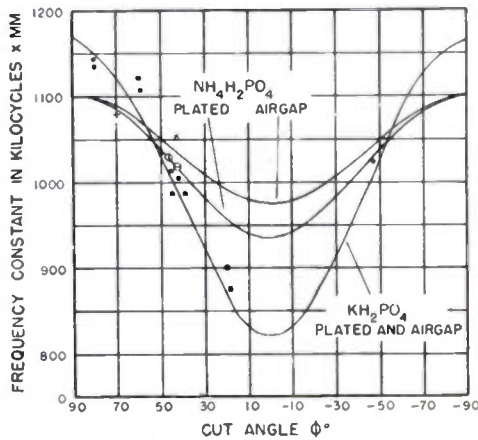

Fig. 2—Frequency constants of the KH₂PO₄ and NH₄H₂PO₄ thickness shear mode, cut (zxw), as a function of the angle of cut. Solid curves: Calculated from Mason's measurement of the stiffness coefficients. Dots: Observed values.

- -ratio diameter/thickness between 11.4 and 14, air gap
- -ratio diameter/thickness between 14.1 and 16, air gap.
- × -ratio diameter/thickness between 10 and 12 air gap, average of 4 plates.
- ⊕ -ratio diameter/thickness 13, plated, average of 15 plates, (790 kc, width of bevel 1.4 mm, radius of cup 20 mm).
- + -ratio diameter/thickness 29, plates, average of 5 plates.
- ⊖ -ratio diameter/thickness 32, plated, average of 6 plates.

TABLE II

| | NaBrO ₃ | NaClO ₃ | KH ₂ PO ₄ | |
|---|-----------------------|----------------------|---------------------------------|----------------------|
| | | | Gerber | Mason |
| $\frac{1}{f} \frac{\partial f}{\partial T}$ | $-3.14 \cdot 10^{-4}$ | $-3.3 \cdot 10^{-4}$ | see Fig. 3 | |
| α_z | $0.39 \cdot 10^{-4}$ | $0.43 \cdot 10^{-4}$ | $0.27 \cdot 10^{-4}$ | $0.27 \cdot 10^{-4}$ |
| α_z | | | $0.43 \cdot 10^{-4}$ | $0.46 \cdot 10^{-4}$ |
| $\frac{1}{c_{41}} \frac{\partial c_{41}}{\partial T}$ | $-6.67 \cdot 10^{-1}$ | $-7.0 \cdot 10^{-1}$ | $-4.1 \cdot 10^{-4}$ | $-3.9 \cdot 10^{-4}$ |
| $\frac{1}{c_{66}^D} \frac{\partial c_{66}^D}{\partial T}$ | — | — | $-6.0 \cdot 10^{-4}$ | $-7.6 \cdot 10^{-4}$ |

temperature range all derivatives have been constant enough. The values for the temperature coefficients of the stiffness coefficients, computed with the aid of (13), agree well with those measured by Mason,² as far as we can extract them from his graphs. Temperature coefficients of the L cut have not been measured.

In the case of KH₂PO₄, the temperature coefficients of the stiffness constants have been determined by measuring the temperature coefficient of the face shear vibration of xz, yz, and zy cut bars, according to a method, published first by Michailov,¹³ and used by Mason¹⁴ in his investigations of the crystals under consideration. The results are plotted also in Table II.

From these values,

$$\frac{1}{f} \frac{\partial f}{\partial T}$$

for the thickness shear vibration has been calculated for different cut angles ϕ by (11) for an air-gap holder, and by (12) for a plated crystal. In the latter case, the values for ϵ_{36} , ϵ_3^0 , and their temperature coefficients are taken from Mason's¹⁵ paper. The full curves A and B, of Fig. 3, show the results. The dashed curves C and D are cal-

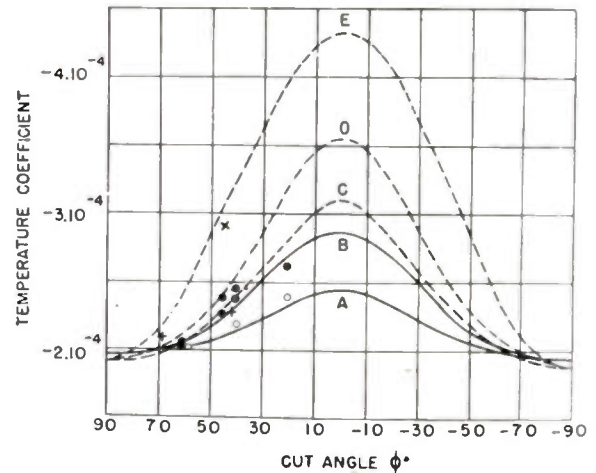

Fig. 3—Temperature coefficient of the KH₂PO₄ (curves A—D) and NH₄H₂PO₄ (curve E) thickness shear mode, cut (zxw). Curves A and B are calculated from the author's values, C and D from Mason's values. A and C are valid for a plated crystal, B and D for a crystal with a large air gap. Curve E is calculated from Mason's values, and is valid for a large air gap, the corresponding curve for a plated crystal coincides with B. The dots represent observations from different plates with ratios diameter/thickness between 11 and 16:

- KH₂PO₄ air gap plated
- NH₄H₂PO₄ ● × ⊕

culated from Mason's data, (see last row of Table II). Now, the TC of the thickness shear mode of different round bevelled crystals, plated, and with air gap has been measured. (Note the different points in Fig. 3.) They check relatively well with our calculated values,

¹³ G. Michailov, "The investigations of elastic vibration in a piezocrystal of Rochelle salt," *Techn. Phys. (USSR)*, vol. 3, pp. 652-661; 1936.

¹⁴ See footnote reference 1, p. 192.

¹⁵ See footnote reference 1, p. 183.

lit differ from those of Mason's paper, due by his larger value of

$$\frac{1}{c_{66}^D} \frac{\partial c_{66}^D}{\partial T},$$

(see Table II). The reason is not clear, because in the case of $\text{NH}_4\text{N}_2\text{PO}_4$, there is relatively good agreement with values obtained from three crystals, 677 kc ($\phi = 45^\circ$, air gap), 3,100 kc ($\phi = 45^\circ$, plated), and 3,340 kc ($\phi = 70^\circ$, plated), and with those calculated from Mason's paper (see Fig. 3, curve *E*). The TC measurement of the 3,100 and 3,340 kc crystal was extended to lower temperatures, and for the plated 45° cut, the expected zero temperature coefficient was reached at -90°C , but for a plated 70° cut, the frequency increase was linear to -90°C ; for in this case $\cos^2 \phi$ becomes too small to permit its factor (see (12)) to effect a larger influence on the temperature coefficient.

VI. RESISTANCE, INDUCTANCE, AND QUALITY FACTOR

In spite of the high temperature coefficients of the crystals under consideration, they may be useful for some purposes and, for this reason, it is very important to know about their equivalent electric constants; in accomplishing this we make use of the common expressions for *R* and *L*, given for instance in Cady's book,¹⁶ and valid for the air gap equal to zero:

$$L = \frac{\rho(fl)^3}{8e^2} \frac{A}{A_e^2} \frac{1}{f^3} \quad (14)$$

$$R = \frac{\pi\rho(fl)^3}{4e^2} \frac{A}{A_e^2} \frac{1}{f^2} \frac{1}{Q} \quad (15)$$

Q is the quality factor. Instead of the total area of the crystal *A*, the ratio A/A_e^2 , A_e being the area of the electrodes which is equal to the area of the flat part of the crystal in most cases, has been introduced into the formulas. As we will see later, we reach a better agreement with the measured values in this way. A/A_e^2 is used according to Bechmann⁹ who gives a solution for the thickness vibration of crystal plates with a finite electrode area. His theory is based on the assumption that the amplitude of vibration is uniform across the whole crystal plate which, of course, is also an approximation.

As a result of calculating the inductance and the resistance of all thickness modes of our four crystals under consideration, with the aid of equations (14) and (15), it was found that the two isomorphous crystals of the hexometric system on the one side, and the two isomorphous crystals of the tetragonal system on the other side differ by more than one order of magnitude in *L* and *R* of the shear mode. Because NaBrO_3 and $\text{NH}_4\text{H}_2\text{PO}_4$ have theoretically the lower resistance of each group, greater attention was devoted to these two crystals.

This relatively great difference has been proven by measurements. Some crystal plates are cut with differ-

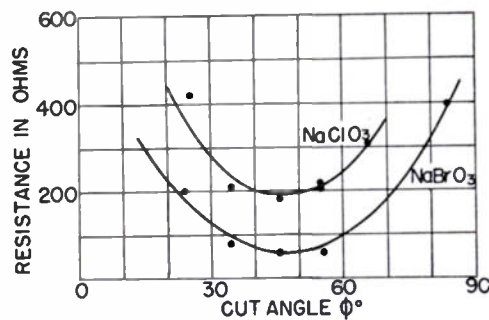

Fig. 4—Resistance of the thickness shear modes of NaClO_3 and NaBrO_3 . Frequency 1,085 kilocycles, diameter of the crystal 18 mm, diameter of the electrodes 15.5 mm.

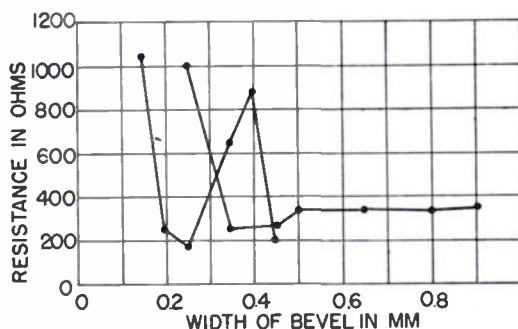

Fig. 5—Typical behavior of the resistance of the thickness shear mode as a function of the width of the bevel. NaClO_3 crystals, frequency 1,085 kc, diameter 18 mm, radius of the applied optical cup 30 mm.

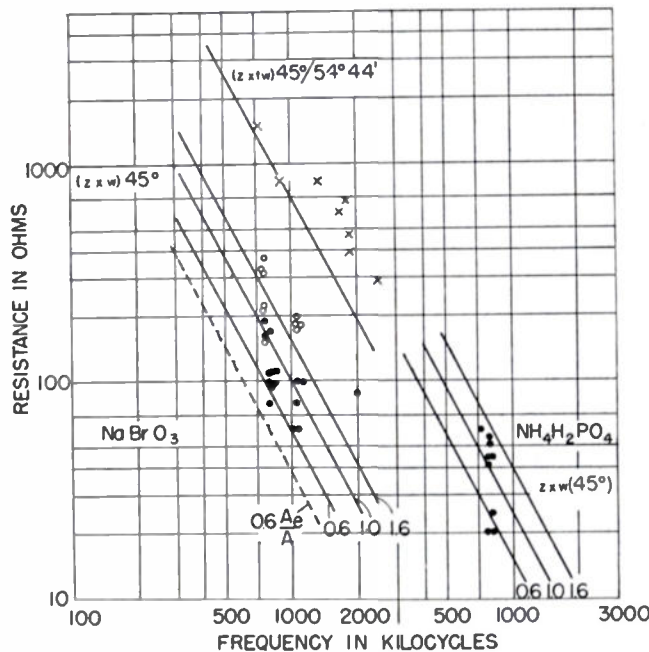

Fig. 6—Resistance of thickness modes of NaBrO_3 and $\text{NH}_4\text{H}_2\text{PO}_4$ crystals as a function of frequency. Parameter of the curves is the ratio $A/A_e^2 \text{ cm}^{-1}$. (*A* area of the plate, A_e area of the electrodes). The dots represent observations from plates with the following data:

- $0.6 < A/A_e^2 < 1.0$, } cut (z x w) 45°
- $1.0 < A/A_e^2 < 1.6$, }
- × $0.5 < A/A_e^2 < 1.0$, cut (z x t w) $45^\circ/54^\circ44'$.

¹⁶ See footnote reference 4, pp. 321-322.

ent angles ϕ . In the case of the isometric group (see Fig. 4), the resistance of NaBrO_3 crystals is very much lower, and the course of both curves is in agreement with equation (1), which requires the lowest value at $\phi = 45^\circ$. A comparison between the two phosphates gives a similar result: The average value of R for $\text{NH}_4\text{H}_2\text{PO}_4$ crystals, frequency 3,300 kc, diameter 10 mm, is 26 ohms; while four 3,100 kc KH_2PO_4 crystals of the same diameter showed an average of 130 ohms. As mentioned above, bevels have been used in every case, and enlarged until the resistance reached what is probably the lowest value obtainable. Fig. 5 shows a typical behavior of the resistance of two crystals with the same frequency and size due to changing the bevel. In Figs. 6, 7, and 8, there

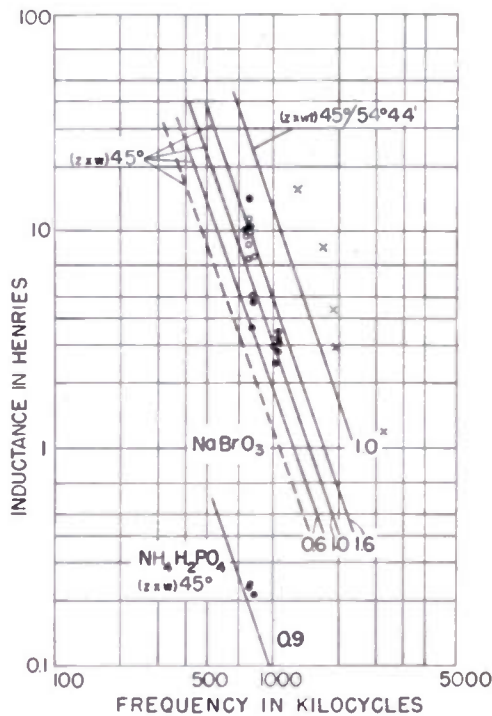

Fig. 7—Inductance of thickness modes of NaBrO_3 and $\text{NH}_4\text{H}_2\text{PO}_4$ crystals as a function of frequency. For notations refer to Fig. 6.

are plotted the measured values of R , L and $Q = \omega L/R$ of different crystals. They have different values of A and A_0 , diameters of the whole crystal lying between 2.2 and 1.0 cm, and the diameter of the electrodes between 1.7 and 0.9 cm. We have shown only three ranges for the values of A/A_0^2 , each characterized in the graphs by a different symbol, because of the confusion which will result from identifying with each measurement its own value for A/A_0^2 .

If we first observe Fig. 8, we see that the quality factor of the thickness modes of NaBrO_3 remains constant in the measured frequency range within the distribution to be expected, as it is in the case with quartz, according to Bechmann's¹⁷ measurements between 300 kc and 5,000 kc, and the author's¹⁸ measurements between 5,000 kc and 40,000 kc fundamental mode. Referring to Figs. 6 and 7, the straight lines represent the

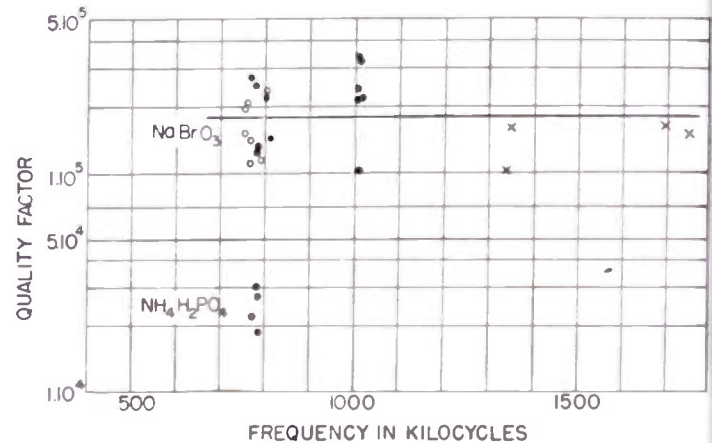

Fig. 8—Quality factor of NaBrO_3 and $\text{NH}_4\text{H}_2\text{PO}_4$ thickness shear modes. For the meaning of the different dots, see Fig. 6. The solid-line represents the average value of the NaBrO_3 measurements.

theoretical values for R and L , computed with the aid of formulas (14) and (15) for three different values of A/A_0^2 . If we compute R and L only by using the area of the electrode A_0 (which is equal to the area of the flat part of the crystal) or the total area of the crystal A instead of the expression A/A_0^2 , we will obtain lower theoretical values for L and R and, therefore, less agreement with the experimental data. The two dashed lines in Figs. 6 and 7 represent, for instance, the theoretical values corresponding to the size of $A/A_0^2 = 0.6$, but computed only with $1/A_0$ instead of A/A_0^2 . We obtain the value of $1/A_0$ by dividing $A/A_0^2 = 0.6$ by the average value of A/A_0 . The latter value lies between 1.3 and 1.7 for all measured crystals.

The resistance of the compressional mode of NaBrO_3 is higher than that of the shear mode by a factor of approximately 2.5. A study of the compressional mode of the other crystals has not been made.

¹⁷ R. Bechmann, "Eigenschaften von Quarzoszillatoren und Resonatoren im Bereich von 300 bis 5000 K Hz." *Hoch und Elek.*, vol. 59, pp. 97-105; April, 1942.

¹⁸ *FIAT Rev. of German Science, "Physics of Solids,"* vol. 9, 1939-1946, edited by Georg Joos, Part 2, p. 58.



Standards on Electron Tubes: Methods of Testing, 1950*

PART II

8. NONLINEAR CHARACTERISTICS

8.1 Detection Characteristics

The following tube characteristics are of interest in connection with large-signal detection.

8.1.1 Rectification Characteristic (SS)

In the general case of a tube of n electrodes, the connections are shown in Fig. 64. E is an alternating-current generator considered as having zero direct- and alternating-current impedance. All electrodes not entering directly in the measurements are maintained at steady and specific voltages.

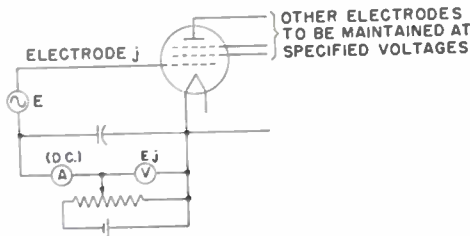

Fig. 64—Circuit arrangement for measuring rectification characteristic.

The average currents in an electrode circuit, as read by a direct-current instrument, are plotted as ordinates against values of the direct voltage E_j on the electrode as abscissas, for various values of E as a parameter; i.e., E is held constant for each graph.

8.1.2 Transrectification Characteristic (SS)

The transrectification characteristic is the graph between the average current in the circuit of an electrode, the direct voltage on that electrode, and the amplitude (or root-mean-square value) of an alternating voltage impressed on another electrode. The connections for this test for a tube of n electrodes are shown in Fig. 65. The electrode j and other electrodes are to be maintained at their specified values of direct voltage.

The values of direct voltage E_k in the electrode circuit are plotted as abscissas against the average of current

I_k in that circuit as ordinates for various values of alternating voltage E applied to the other electrode as a parameter; i.e., E is held constant for each graph.

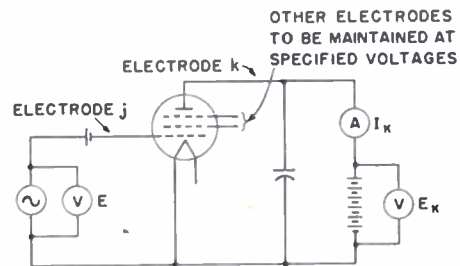

Fig. 65—Circuit arrangement for measuring transrectification characteristic.

8.2 Conductance for Rectification (SS)

Conductance for rectification is most simply determined from the slope of the graph showing the relation between the values of the average direct currents in the circuit of an electrode as ordinates, and the direct voltages in the circuit of the same electrode as abscissas, with a constant specified radio-frequency voltage applied to one or more of the electrodes.

A balance method for measuring conductance for rectification is also available. An application of this method to the measurement of the plate conductance for transrectification in a triode is shown in Fig. 66. In

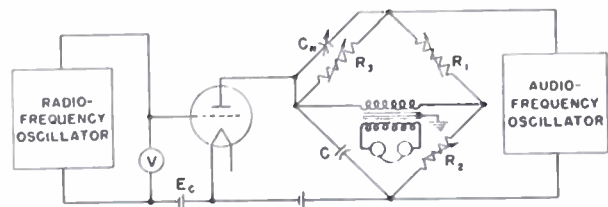

Fig. 66—Circuit arrangement for measuring (plate) conductance for rectification.

this case the voltage is applied to the grid.

$$g_p' = \frac{R_1}{R_2 R_3}$$

The plate resistance for rectification r_p' is the reciprocal of the plate conductance for rectification; i.e.,

$$r_p' = \frac{1}{g_p'} = \frac{R_2 R_3}{R_1}$$

* Reprints of this Standard, 50 IRE 7.S2 (Parts I and II), may be purchased while available from The Institute of Radio Engineers, 1 East 79 Street, New York 21, N. Y., at \$1.25 per copy. A 20 per cent discount will be allowed for 100 or more copies mailed to one address.

This Standard supersedes 38 IRE 7.S1, *Standards on Electronics: Methods of Testing Vacuum Tubes, 1938*, except Section H—Phototubes. Part I of this Standard appeared in the August, 1950, issue of the PROCEEDINGS.

In Fig. 66 capacitor C is a radio-frequency by-pass. C_n is necessary to balance the tube capacitance and the capacitance of C . The resistive elements of the bridge are balanced in the usual manner.

Although Fig. 66 shows only the measurement of plate conductance for transrectification of a triode, the method is also applicable to the measurement of conductance of any electrode for ordinary rectification or

transrectification. For multielectrode tubes, all electrodes not directly involved in the measurements should be maintained at constant and specified voltages.

8.2.1 Reference

Stuart Ballantine, "Detection at high signal voltages," *PROC. I.R.E.*, vol. 17, pp. 1153-1177; July, 1929.

9. POWER OUTPUT

The power output of a vacuum tube is dependent on the direct operating voltages applied to the various electrodes, on the external load impedance in the plate circuit, and on the magnitude of the exciting voltage applied to the control grid. In any case, the operating conditions are subject to the maximum safe values placed by the manufacturer on electrode voltages, electrode power dissipation, and space current drawn from the cathode.

For vacuum tubes normally used as class-A amplifiers under conditions such that the control grid is not driven appreciably positive with respect to the cathode, the power output is the power delivered to a resistive load with a sinusoidal input voltage applied to the grid. For tubes in which the control grid is driven positive as in class-B amplifier tubes as usually operated, special consideration must be given to the impedance in the grid circuit and its effect on harmonic distortion. Further consideration is given to amplifiers of this class in Section 8.2.

In general, where harmonic distortion is undesirable, the power output available in any particular application will increase with the permissible percentage of harmonics. The amount of distortion that may be tolerated varies greatly in different applications; consequently, there is no single criterion of permissible distortion acceptable in all cases.¹⁷ A reference to the available power output for sinusoidal input should be accompanied by a statement of the maximum percentage of distortion present at this power output or at lower values of power output within the operating range. This percentage of distortion is expressed in terms of the total distortion as defined in Section 9.1 below, or the individual harmonic components of output current may be expressed separately as percentages of the current of fundamental frequency. Usually, the second and third harmonics will

suffice, but higher-order terms should be given where they are of the same order of importance as the second and third harmonics.

9.1 Measurement of Harmonics (SS).

The total harmonic distortion is expressed by

$$D = \frac{(I_2^2 + I_3^2 + \dots + I_n^2)^{1/2}}{I_1}$$

where

I_1 is the amplitude of the fundamental, and

I_2, I_3, \dots, I_n are the amplitudes of the 2nd, 3rd, \dots , n th harmonics of the current in the load.

The distortion may be measured by a harmonic analyzer, of which several types have been described in the literature. When merely the value of D is desired, as in determining the undistorted output, those analyzers which measure the root-mean-square value of all harmonics present are preferable to those which measure the separate harmonics.

The method of Suits¹⁸ is a particularly good example of the type of analyzer which measures the harmonics separately. The Suits method requires only the simplest apparatus, and where laboratory facilities are limited this advantage may outweigh the disadvantages involved in the computation of D .

The Belfils analyzer^{19,20} utilizes an alternating-current Wheatstone-bridge balance for the suppression of the fundamentals, and is particularly useful for direct measurement of D . For maximum convenience, the frequency of the audio-frequency source should be very stable. This instrument can be operated so that it is direct reading by maintaining a constant input voltage.

In the McCurdy-Blye analyzer,²¹ low- and high-pass filters are used to separate the harmonics from the

¹⁷ C. G. Suits, "A thermionic voltmeter method for the harmonic analysis of electrical waves," *PROC. I.R.E.*, vol. 18, pp. 178-192; January, 1930.

¹⁹ G. Belfils, "Mesur du 'residu' des courbes de tension par la methode du pont filtrant," *Rev. Gen. d'Elec.*, vol. 19, pp. 526-529; April, 1926.

²⁰ Irving Wolff, "The alternating current bridge as a harmonic analyzer," *Jour. Opt. Soc. Amer.*, vol. 15, pp. 163-170; September, 1927.

²¹ R. G. McCurdy and P. W. Blye, "Electrical wave analyzers for power and telephone systems," *Jour. AIEE*, vol. 48, pp. 461-464; June, 1929.

¹⁷ Power output for which the total generated harmonics with sinusoidal excitation does not exceed five per cent has been conventionally called undistorted power output. The standardization of such a term is not recommended, since it involves a direct contradiction between its definition and the technical significance attached to it. Furthermore, the choice of five per cent as a criterion of distortion is wholly arbitrary. In some cases distortion of this magnitude is entirely permissible; in other cases it is far too large to be tolerated. It is believed that the method outlined of giving the percentage of harmonics with the power rating is preferable and not subject to ambiguity.

fundamental. This instrument is superior to the Belfils type in that the frequency of the source may vary somewhat without necessitating readjustment.

A differential analyzer especially designed for power-output work has been described by Ballantine and Cobb.²²

9.1.1 Precautions

The sinusoidal electromotive force applied to the control grid should be free from harmonics. This can be assured by the use of a low-pass filter (see Fig. 67).

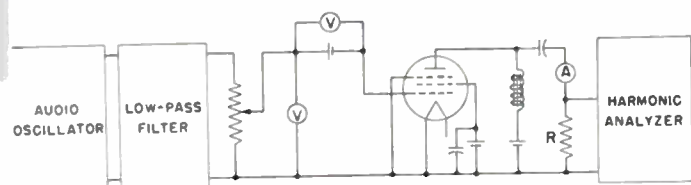

Fig. 67—Circuit arrangement for measuring undistorted power output of a pentode.

If an iron-cored choke is employed for shunt feed in the plate circuit (Fig. 67), care should be exercised in its selection or design to avoid the generation of harmonics in it due to the nonlinear and hysteretic behavior of the iron.

9.2 Measurement of Power Output (SS)

In the measurement of power output, use is made of well-established measurement technique. However, a

²² Stuart Ballantine and H. L. Cobb, "Power output characteristics of the pentode," *Proc. I.R.E.*, vol. 18, pp. 450-470; March, 1930.

number of general precautions should be observed and are given below.

9.2.1 Precautions

In class- A_1 amplification, the grid is not driven positive with respect to the cathode, hence the peak grid input voltage will be approximately equal to the grid bias.

The condition that no appreciable current shall flow in the grid circuit may require the peak grid input voltage to be slightly less than the grid bias, especially in filamentary tubes whose filaments are heated by alternating current.

When the grid is driven positive, the essential characteristics of the driving circuit should be specified.

The effects of the regulation of the power-supply voltages should be taken into consideration.

The effects of feedback due to common circuit elements should be considered.

9.2.2 References

E. W. Kellogg, "Design of non-distorting power amplifiers," *Jour. AIEE*, vol. 44, pp. 490-498; May, 1925.

J. C. Warner and A. V. Loughren, "The output characteristics of amplifier tubes," *Proc. I.R.E.*, vol. 14, pp. 735-758; December, 1926.

C. R. Hanna, L. Sutherlin, and C. B. Upp, "Development of a new power amplifier tube," *Proc. I.R.E.*, vol. 16, pp. 463-473; April, 1928.

10. ELECTRODE DISSIPATION

Three types of cooling are generally employed for vacuum-tube electrodes. These are radiation, liquid, and forced-air cooling. Methods for measuring power loss are different for each type.

10.1 Methods of Measuring Anode Dissipation (PO)

10.1.1 Radiation-Cooled Anodes

10.1.1.1 Optical-pyrometer Methods. This method is applicable only to radiation cooling where the anode is radiating in the visible spectrum under oscillating conditions. A pyrometer is used to measure plate temperature at the hottest point and at two other points having different temperatures. The tube is then operated statically with a relatively low direct anode potential, and with adequate alternating or positive direct grid voltage to reproduce as well as possible the dissipation pattern of the previous oscillating conditions. When the pyrometer readings at the chosen three points match the earlier data, the direct-current input to the anode gives a fair

measure of the anode dissipation under the oscillating condition. This method can be accurate to within a few per cent.

10.1.1.2 Thermocouple Method. The anode radiation may be collected from one side of the anode at a time by means of a conical tube having reflecting walls, and the energy focused on a thermocouple. If the anode is then supplied with direct-current power under static conditions to duplicate the previous thermocouple readings, the direct-current power supplied will be equivalent to the anode dissipation.

10.1.1.3 Calorimeter Method. The total power lost in the tube, including filament and grid loss, can be measured by immersing the tube in a circulated liquid and measuring the rate of flow and temperature rise of the liquid after the temperatures are stabilized. The power dissipated can then be calculated from the formula given in Section 10.1.2. In this method also, measured static inputs which result only in static dissipation may be

used to match the dynamic conditions. In design calculations it is usually assumed that the filament or heater power lost through the anode will be proportional to the ratio of the area of the anode to that of the anode plus its end openings.

10.1.2 Liquid-Cooled Anodes

The direct method of measuring anode dissipation of liquid-cooled anodes consists of measuring the flow of liquid through the cooling jacket and the temperature rise between inlet and outlet points. The total dissipation may be calculated from the formula: Power in kilowatts = $K \times$ gallons per minute \times temperature difference in degrees C. When the cooling liquid is water, $K = 0.264$. With other liquids, K is proportional to the specific heat and specific gravity of the liquid used. Since the filament or heater power alone may also be measured by this method, the net anode dissipation can be calculated. In this method, also, measured static inputs which result only in static dissipations may be used to match the dynamic conditions.

10.1.3 Forced-Air-Cooled Anodes

For forced-air cooling, quite satisfactory results may be obtained by a temperature-matching method. A temperature-responsive device is placed at some point in the cooling system. With a constant flow of air at constant inlet temperature, the indication of this device is noted under oscillating conditions. Direct-current power is then supplied to the anode under nonoscillating conditions to duplicate this indication. This power is equal to the anode dissipation under oscillating conditions. Various temperature-responsive devices may be used, provided they are not affected by radio-frequency fields.

10.1.3.1 Cooler-Temperature Matching Method. In this method, the temperature-indicating device is brought into intimate contact with the metal cooler attached to the anode. Under direct-current conditions, the anode voltage should be relatively low and the grid voltage positive in order to produce uniform heating.

10.1.3.2 Air-Temperature Matching Method. In this method the temperature-indicating device is placed in the outgoing air stream, which is preferably confined within a duct to prevent disturbing air currents. An insulated duct diverting a part of the outgoing air may also be used for this purpose. The indicating device may be, for example, one or more thermometers, one or more thermocouples connected in series, or a resistance-wire grid. With the latter, measurement of resistance gives an indication of temperature.

10.2 Methods of Measuring Grid Dissipation (PO)

The knowledge of dissipation is important in order to insure that the electrode is operated below the point at which primary emission becomes excessive.²³ The meth-

ods of measurement given here are applicable only at frequencies low enough so that electron transit time is negligible. It should be borne in mind that grid dissipation is a component of, but not the same as, grid driving power.

10.2.1 Direct Grid-Current Method

²⁴The grid dissipation can be calculated if peak alternating grid voltage is known. The product of the direct grid current and the peak positive excursion of the grid voltage with respect to the cathode is the approximate grid power dissipation. This method is subject to error if secondary emission is appreciable.

10.2.2 Graphical Integration Method

The grid dissipation can be calculated from the dynamic characteristic of the tube by graphical integration. This method also is subject to error if secondary emission is appreciable.

10.2.3 Liquid-Cooled Grids

With tubes having liquid-cooled grids, the rate of flow and temperature rise of the cooling medium will give the grid power loss under oscillating conditions in the method described under Section 10.1.2. Subtraction of the grid loss due to filament alone gives the grid dissipation under oscillation. Here also, measured static inputs which result only in dissipation may be used to match the dynamic conditions.

10.3 Operating Tests of Large High-Vacuum Diodes (PO)

This test is ordinarily made to determine arc-back incidence. It is made in a rectifier circuit that subjects each tube to the desired operating test conditions. One form of circuit is shown in Fig. 68. The operating conditions usually fix the filament voltage, peak inverse voltage or an equivalent transformer voltage, average and/or peak forward tube current, operating time, frequency, load circuit (ordinarily resistive), and the method of applying electrode voltages.

10.4 Radio-Frequency Operating Tests for Power-Output High-Vacuum Tubes (PO)

10.4.1 Power Output

The test for power output is made by operating the tube as a radio-frequency oscillator or as a radio-frequency amplifier. The value of the power output of the tube can be obtained by measuring the radio-frequency power delivered to a load, and correcting the result for circuit losses; or by measuring the total plate power input to the tube and subtracting the power dissipated in the tube. In addition, when an amplifier circuit

²³ I. E. Mourontseff and H. N. Kozanowski, "Grid temperature as a limiting factor in vacuum-tube operation," *Proc. I.R.E.*, vol. 21, pp. 447-454; March, 1936.

²⁴ H. P. Thomas, "Determination of grid driving power in radio-frequency power amplifiers," *Proc. I.R.E.*, vol. 21, pp. 1134-1142; August, 1933.

is used for testing, appropriate corrections must be made for feed-through power; when an oscillator circuit is used, correction must be made for excitation power.

Power output may be measured by devices such as lamp loads, calorimeters, or calibrated lengths of dissipative transmission line with a suitable sampling device to indicate power level.

10.4.2 Grid Driving Power

The grid driving power or excitation power of an amplifier tube may be measured by a substitution method

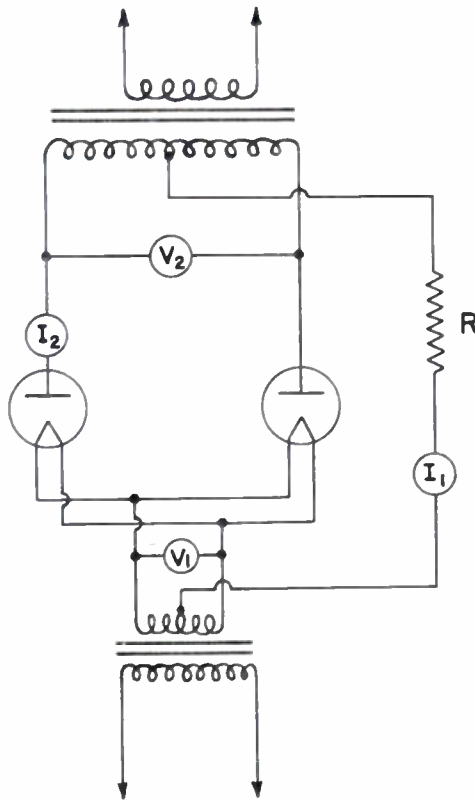

Fig. 68—Circuit arrangement for testing large high-vacuum diodes.

in which a calibrated load is substituted for the tube. The load is adjusted so that the same conditions are obtained in the driving circuit as with the amplifier tube connected. The power measured in this load will then be equivalent to the grid driving power of the amplifier tube.

Another method suitable for measuring the driving power of an amplifier tube at the higher frequencies is the use of a transmission line or waveguide as a power-measuring device. It is convenient to use a section of transmission line not shorter than one-half wavelength inserted between the driving source and the amplifier tube. If the maximum and minimum rms voltages, V_{\max} and V_{\min} respectively, are measured along the line, the power supplied to the amplifier is given by the formula

$$\text{Driving Power} = \frac{V_{\max} \times V_{\min}}{Z_0}$$

where Z_0 is the characteristic impedance of the line in ohms. The line must be sufficiently well-matched so that V_{\min} can be measured with the desired accuracy.

Still another method applicable to either an oscillator or an amplifier is the use of an oscillograph to measure the grid current and voltage and their phase relation at the input terminals of the tube. The average power can then be determined by graphical integration.

Grid driving power can also be determined for either an oscillator or an amplifier tube by measuring the direct component of grid current and the peak value of the grid driving voltage. The product of these quantities²⁴ gives an approximation of grid driving power if the dielectric and lead losses and the effects of transit time are negligible.

The power delivered to the input of the tube can be determined by subtracting the product of the direct grid current and the bias voltage from the grid driving power.

11. METHODS OF TESTING CATHODE-RAY TUBES

11.1 General Instructions

11.1.1 Scope

This section describes the methods of measurement of important characteristics of cathode-ray tubes. Methods of test used primarily for quality control of the product during manufacture are not included.

11.1.2 Reference to Methods of Testing Other Tubes

A number of the general electron-tube precautions and test conditions of Sections 1 to 7, *Standards on Electron Tubes: Methods of Testing, 1950*,²⁵ are applica-

²⁵ "Standards on electron tubes; methods of testing, 1950," *Proc. I.R.E.*, vol. 38, pp. 917-948; August, 1950.

ble to cathode-ray tubes, and should be observed in addition to those given below under this section, *Methods of Testing Cathode-Ray Tubes*.

11.1.3 Shielding and Insulation

11.1.3.1 Magnetic Shielding. Stray magnetic fields through a cathode-ray tube during tests can deflect and distort the beam sufficiently to give misleading test results. Fields through the tube near its screen will usually only shift the spot position, while fields through the mount assembly can distort, or even cut off the beam by decentering it in the focusing fields, and in the limiting apertures. Consequently, cathode-ray tubes under test should be carefully shielded from the earth's

used to match the dynamic conditions. In design calculations it is usually assumed that the filament or heater power lost through the anode will be proportional to the ratio of the area of the anode to that of the anode plus its end openings.

10.1.2 Liquid-Cooled Anodes

The direct method of measuring anode dissipation of liquid-cooled anodes consists of measuring the flow of liquid through the cooling jacket and the temperature rise between inlet and outlet points. The total dissipation may be calculated from the formula: Power in kilowatts = $K \times$ gallons per minute \times temperature difference in degrees C. When the cooling liquid is water, $K = 0.264$. With other liquids, K is proportional to the specific heat and specific gravity of the liquid used. Since the filament or heater power alone may also be measured by this method, the net anode dissipation can be calculated. In this method, also, measured static inputs which result only in static dissipations may be used to match the dynamic conditions.

10.1.3 Forced-Air-Cooled Anodes

For forced-air cooling, quite satisfactory results may be obtained by a temperature-matching method. A temperature-responsive device is placed at some point in the cooling system. With a constant flow of air at constant inlet temperature, the indication of this device is noted under oscillating conditions. Direct-current power is then supplied to the anode under nonoscillating conditions to duplicate this indication. This power is equal to the anode dissipation under oscillating conditions. Various temperature-responsive devices may be used, provided they are not affected by radio-frequency fields.

10.1.3.1 Cooler-Temperature Matching Method. In this method, the temperature-indicating device is brought into intimate contact with the metal cooler attached to the anode. Under direct-current conditions, the anode voltage should be relatively low and the grid voltage positive in order to produce uniform heating.

10.1.3.2 Air-Temperature Matching Method. In this method the temperature-indicating device is placed in the outgoing air stream, which is preferably confined within a duct to prevent disturbing air currents. An insulated duct diverting a part of the outgoing air may also be used for this purpose. The indicating device may be, for example, one or more thermometers, one or more thermocouples connected in series, or a resistance-wire grid. With the latter, measurement of resistance gives an indication of temperature.

10.2 Methods of Measuring Grid Dissipation (PO)

The knowledge of dissipation is important in order to insure that the electrode is operated below the point at which primary emission becomes excessive.²³ The meth-

ods of measurement given here are applicable only at frequencies low enough so that electron transit time is negligible. It should be borne in mind that grid dissipation is a component of, but not the same as, grid driving power.

10.2.1 Direct Grid-Current Method

²⁴The grid dissipation can be calculated if peak alternating grid voltage is known. The product of the direct grid current and the peak positive excursion of the grid voltage with respect to the cathode is the approximate grid power dissipation. This method is subject to error if secondary emission is appreciable.

10.2.2 Graphical Integration Method

The grid dissipation can be calculated from the dynamic characteristic of the tube by graphical integration. This method also is subject to error if secondary emission is appreciable.

10.2.3 Liquid-Cooled Grids

With tubes having liquid-cooled grids, the rate of flow and temperature rise of the cooling medium will give the grid power loss under oscillating conditions in the method described under Section 10.1.2. Subtraction of the grid loss due to filament alone gives the grid dissipation under oscillation. Here also, measured static inputs which result only in dissipation may be used to match the dynamic conditions.

10.3 Operating Tests of Large High-Vacuum Diodes (PO)

This test is ordinarily made to determine arc-back incidence. It is made in a rectifier circuit that subjects each tube to the desired operating test conditions. One form of circuit is shown in Fig. 68. The operating conditions usually fix the filament voltage, peak inverse voltage or an equivalent transformer voltage, average and/or peak forward tube current, operating time, frequency, load circuit (ordinarily resistive), and the method of applying electrode voltages.

10.4 Radio-Frequency Operating Tests for Power-Output High-Vacuum Tubes (PO)

10.4.1 Power Output

The test for power output is made by operating the tube as a radio-frequency oscillator or as a radio-frequency amplifier. The value of the power output of the tube can be obtained by measuring the radio-frequency power delivered to a load, and correcting the result for circuit losses; or by measuring the total plate power input to the tube and subtracting the power dissipated in the tube. In addition, when an amplifier circuit

²³ I. E. Mourontseff and H. N. Kozanowski, "Grid temperature as a limiting factor in vacuum-tube operation," *Proc. I.R.E.*, vol. 24, pp. 447-454; March, 1936.

²⁴ H. P. Thomas, "Determination of grid driving power in radio-frequency power amplifiers," *Proc. I.R.E.*, vol. 21, pp. 1134-1142; August, 1933.

is used for testing, appropriate corrections must be made for feed-through power; when an oscillator circuit is used, correction must be made for excitation power.

Power output may be measured by devices such as lamp loads, calorimeters, or calibrated lengths of dissipative transmission line with a suitable sampling device to indicate power level.

10.4.2 Grid Driving Power

The grid driving power or excitation power of an amplifier tube may be measured by a substitution method

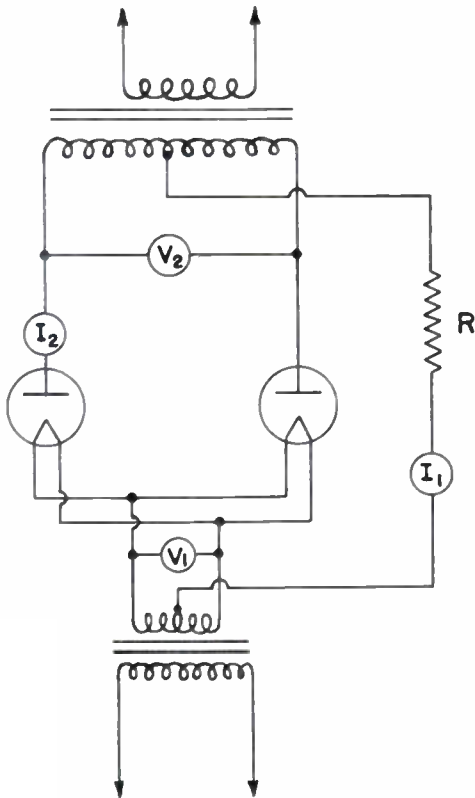

Fig. 68—Circuit arrangement for testing large high-vacuum diodes.

in which a calibrated load is substituted for the tube. The load is adjusted so that the same conditions are obtained in the driving circuit as with the amplifier tube connected. The power measured in this load will then be equivalent to the grid driving power of the amplifier tube.

Another method suitable for measuring the driving power of an amplifier tube at the higher frequencies is the use of a transmission line or waveguide as a power-measuring device. It is convenient to use a section of transmission line not shorter than one-half wavelength inserted between the driving source and the amplifier tube. If the maximum and minimum rms voltages, V_{\max} and V_{\min} respectively, are measured along the line, the power supplied to the amplifier is given by the formula

$$\text{Driving Power} = \frac{V_{\max} \times V_{\min}}{Z_0}$$

where Z_0 is the characteristic impedance of the line in ohms. The line must be sufficiently well-matched so that V_{\min} can be measured with the desired accuracy.

Still another method applicable to either an oscillator or an amplifier is the use of an oscillograph to measure the grid current and voltage and their phase relation at the input terminals of the tube. The average power can then be determined by graphical integration.

Grid driving power can also be determined for either an oscillator or an amplifier tube by measuring the direct component of grid current and the peak value of the grid driving voltage. The product of these quantities²⁴ gives an approximation of grid driving power if the dielectric and lead losses and the effects of transit time are negligible.

The power delivered to the input of the tube can be determined by subtracting the product of the direct grid current and the bias voltage from the grid driving power.

11. METHODS OF TESTING CATHODE-RAY TUBES

11.1 General Instructions

11.1.1 Scope

This section describes the methods of measurement of important characteristics of cathode-ray tubes. Methods of test used primarily for quality control of the product during manufacture are not included.

11.1.2 Reference to Methods of Testing Other Tubes

A number of the general electron-tube precautions and test conditions of Sections 1 to 7, *Standards on Electron Tubes: Methods of Testing, 1950*,²⁵ are applica-

ble to cathode-ray tubes, and should be observed in addition to those given below under this section, *Methods of Testing Cathode-Ray Tubes*.

11.1.3 Shielding and Insulation

11.1.3.1 Magnetic Shielding. Stray magnetic fields through a cathode-ray tube during tests can deflect and distort the beam sufficiently to give misleading test results. Fields through the tube near its screen will usually only shift the spot position, while fields through the mount assembly can distort, or even cut off the beam by decentering it in the focusing fields, and in the limiting apertures. Consequently, cathode-ray tubes under test should be carefully shielded from the earth's

²⁵ "Standards on electron tubes; methods of testing, 1950," *Proc. I.R.E.*, vol. 38, pp. 917-948; August, 1950.

field and from all stray magnetic fields, alternating and direct, such as those produced by transformers and solenoids. Devices producing strong fields should preferably be located at a distance from the tube. Magnetic shields need not totally enclose the tube, but should substantially eliminate all fields transverse to the axis through it, particularly through the mount. For electrostatically focused and deflected tubes, the shield may be a form-fitting sleeve open at the base and screen ends. For tubes requiring external focusing or deflecting magnets, the shield must also enclose the magnets, with sufficient clearance so that the desired fields through the tube are not affected by external shunting through the shield. Shields are preferably made of a high-permeability alloy.

11.1.3.2 Demagnetization of Mount Parts. Mount parts made of ferromagnetic materials may become magnetized and thus produce anomalous effects. If such effects are observed, the tube electrodes should be demagnetized.

11.1.3.3 Insulation. In testing cathode-ray tubes, care must be taken to insure that the operator is protected against high voltages and X rays. Insulation and spacing must be provided to prevent arcing and leakage that may change the operating conditions imposed on the tube, or give false current readings.

Leakage currents and charges on the external surface of the tube may also produce spot shifts and distortion of the screen patterns. Best stability of operation is attained when the tube is operated with its final anode near ground potential. If the tube is operated with the cathode near ground potential, the tube supports and any other object in contact with the screen end of the tube must be well insulated to prevent pattern shifting or distortion due to leakage currents through the tube envelope or along its surface.

11.1.4 Ambient Light

Several cathode-ray tube tests depend on measurement of light output from the tube screen, or on visual observations of the fluorescent or phosphorescent screen patterns. It is essential that the ambient light on the tube screen be kept low during these tests in order to avoid errors in light measurements and impairment of visual observation by reduction of contrast. Illumination should, in general, be kept small in comparison with the screen brightness being measured or observed.

11.1.5 Operating Conditions

11.1.5.1 Applied Voltages. The various voltages should be applied in the proper sequence to prevent screen burning and arc over.

The heater and control-electrode voltages should be applied first. After sufficient time has been allowed for the cathode to attain normal operating temperature, positive electrode voltages should be applied simultaneously or in the sequence of increasing magnitudes. In applying the voltages, care must be taken to insure that the maximum-rated voltages between electrodes

are not exceeded. The control-electrode voltage should always be of such value as to prevent screen burning during test.

11.1.5.2 Regulation. High-voltage power supplies are sometimes designed with poor regulation. If the regulation of the power supply used is such that any changes occur in the electrode voltages, they must be readjusted to the desired values.

11.1.5.3 Filtering. Alternating components in the source voltages may result in errors of measurement. These errors depend upon the relative magnitude of the alternating and direct components.

11.1.5.4 Focus. Improper focus adjustment of cathode-ray tubes may result in misleading data on such items as light output, line width, and color. The focusing field should, therefore, be adjusted for best focus in the center of the screen or for best over-all focus, depending upon the type of measurement to be made.

11.1.5.5 Focusing Coils or Focusing Magnets. Focusing coils or magnets are mounted on the tube neck in such a manner that the center of the air gap is at the recommended distance from the reference line. The focusing coil should be aligned to provide best over-all focus.

11.1.5.6 Deflecting Electrode Potentials. The zero-signal potential of the deflecting electrodes should be equal to the potential of the electrode through which the electrons pass just before entering the deflecting field. With tubes designed for balanced deflection, care should be taken to insure that the deflecting signals are balanced in order to minimize distortion.

11.1.5.7 Magnetic Deflecting Yokes. Magnetic deflecting yokes are ordinarily mounted on the neck in such a manner that the forward end of the coil is placed against the bulb on or near the reference line. Generally, the deflecting yoke should be concentric with the bulb neck. The maximum length of the deflecting yoke is determined by the maximum deflection angle for which a given cathode-ray tube is designed. The angle of deflection is inversely proportional to the square root of the accelerating voltage and directly proportional to the ampere turns, provided no part of the magnetic circuit becomes saturated.

Nonuniform fields in the beam cross section produce deflection defocusing. Nonuniform fields within the space through which the beam is deflected produce pattern distortion. Care should be taken in the selection of a deflecting yoke for cathode-ray tube testing to be sure that the yoke has been designed to minimize these defects.

11.2 Instructions for Test

For general instructions refer to Section 1.

11.2.1 Spot-Cutoff Voltage (Spot Cutoff)

The spot-cutoff voltage is determined by measuring the control electrode bias voltage for visual extinction of the undeflected focused spot. The ambient illumina-

tion should not exceed one foot-candle to insure reproducible results.

11.2.2 Measurement of Screen Brightness

To adjust screen brightness to a desired value for measurement, produce on the tube screen a raster as indicated for the tube type and adjust the control electrode bias for the desired screen brightness as measured with a photometer, corrected for the spectral response of the average eye. Because of the short persistence of most fluorescent screens, the light emitted from a small area of scanned raster shows fluctuations. These fluctuations are averaged by the eye to yield an apparent brightness. Some photometers such as the photo-voltaic cells do not average the light in the same way as the eye. Therefore, in order to minimize the effects of light fluctuations, when using a photocell photometer, the cell should be located a distance from the screen at least equal to the raster diagonal, and equipped with a baffling or lens system to limit the sighting angle within the raster frame. When properly baffled, the system responds to true brightness of the included scene. In addition, the photocell has some measure of unavoidable nonlinearity in its illumination-output characteristic which is influenced by the load resistance. A low-resistance microammeter should be used to minimize errors caused by this nonlinearity. For accurate measurements an illuminometer which makes use of the eye is recommended.

11.2.3 Leakage Currents

Leakage currents are those read in external circuits with the beam cut off and all electrode voltages applied. These currents are identified by the circuits in which they are read.

11.2.4 Electrode Currents

The current in the external circuit of each electrode is measured. Each current is identified by the circuit in which it is measured and should be corrected for leakage. It is usually not possible to measure screen current, because it may be combined with other currents.

11.2.5 Gas Content

The gas content may be determined by two methods. One makes use of certain electrodes as a modified ionization gauge (see Section 5.2.2) to determine the gas ratio. The other makes use of the presence of a cross on the screen of a gassy tube. The first method is usually applied to tubes having an isolated number-two grid, while the second method is used with tubes having deflecting plates.

11.2.5.1 Gas Ratio Test. The gas ratio is given by the equation $G = (N - L)/P$, where G = gas ratio, N = ion current, L = leakage current in the electrode circuit used to collect ions, and P = electron current which produces the ions. This ratio is customarily expressed in micro-

amperes per milliampere. The ion current is usually measured in the final or in the number-one anode circuit with that anode biased negatively with respect to the cathode, the number-two grid positively, and the number-one grid at cathode potential and without beam focusing or scanning. The leakage current is usually measured under the same conditions with the exception that the number-one grid is biased beyond cathode-current cutoff. The electron current is measured under the same conditions as for ion current with the exception that a positive voltage is applied to the final or to the number-one anode.

A commonly used value for the number-two grid is 250 volts. For electron-current measurements, 25 volts positive and, for ion current measurements, 25 volts negative are the customary values for the number-one anode potential.

11.2.5.2 Gas-Cross Method. With the normal operating voltages, with the scanning pattern produced by high beam current, and with number-one grid voltage near or at 0, the raster is observed. The appearance of a luminescent cross, the arms of which coincide with the deflecting axes, indicates the presence of gas. The relative brightness of the cross is a measure of the amount of gas present. This test is by nature qualitative, but is very convenient for control purposes and can be made semiquantitative by comparisons with standard tubes of known gas content.

11.2.6 Measurement of Cathode-Ray-Tube Capacitances

11.2.6.1 General. The direct interelectrode capacitances to be measured in a particular cathode-ray tube are usually listed on the individual data sheet. In general practice the following capacitances are the most important:

- (1) On all types, the capacitances between control grid and all other electrodes tied together.
- (2) On types with heater and cathode not internally connected, the capacitance between cathode and all other electrodes tied together.
- (3) On electrostatically deflected types, the capacitance between:
 - (a) deflection plate number one and deflection plate number two, all other electrodes grounded;
 - (b) deflection plate number three and deflection plate number four, all other electrodes grounded;
 - (c) deflection plate number one and all other electrodes, except deflection plate number two, which is grounded;
 - (d) deflection plate number two and all other electrodes, except deflection plate number one, which is grounded;
 - (e) deflection plate number three and all other electrodes, except deflection plate number four, which is grounded; and
 - (f) deflection plate number four and all other electrodes, except deflection plate number three, which is grounded.
- (4) On multigun and split-beam types, the capaci-

tances of each section, and additional capacitances between elements of the several sections.

(5) The capacitance between the internal and external conductive bulb coatings as discussed below.

Metal base sleeves and external conductive coatings should be grounded for all tests unless otherwise specified. For circuits and general precautions for capacitance measurements, see Section 7.1.

11.2.6.2 Measurement of Capacitance Between the Tube Coatings. Internal and external conductive coatings on portions of the bulb wall form a capacitor whose dielectric is the glass of the bulb. Measurement of its capacitance is complicated by the fact that the coatings may have high linear resistance. The measured capacitance of a capacitor having a high linear resistance of either or both coatings falls off at high frequencies, and increases with increase in number of contact points on the external coating. Therefore, it is desirable that data on capacitance of the tube coatings include the test frequency and the method of connecting to the external coating.

11.2.7 Focusing-Electrode Voltage of Electrostatic-Focus Types

11.2.7.1 Focusing-Electrode Voltage at Low Screen Current. The focusing-electrode voltage for best focus of the spot is read with the spot undeflected, and with the control-electrode bias voltage adjusted for a value of screen current low enough to avoid screen burning.

11.2.7.2 Focusing-Electrode Voltage at Recommended Operating Conditions. The focusing-electrode voltage for the best focus at the center of the pattern is read with the recommended pattern size scanned on the screen and with the control-electrode bias-voltage adjusted for a given value of brightness or current. If a scanned raster is used, care should be taken to adjust for the best center focus. If the spot is not circular, best focus means that adjustment which gives the best compromise values of resolution along both axes.

11.2.8 Focusing-Coil Current of Magnetic-Focus Types

All measurements of focusing-coil current are made with the gap of the focusing coil located at the recommended distance from the reference line at the junction of neck and bulb, and with the focusing coil properly aligned with respect to the electron-gun axis.

11.2.8.1 Focusing-Coil Current at Low Screen Current. The focusing-coil current for best focus of the spot is read with the spot undeflected and with the control-electrode bias voltage adjusted for a value of screen current low enough to avoid screen burning.

11.2.8.2 Focusing-Coil Current at Recommended Operating Conditions. The focusing-coil current for the best focus at the center of the pattern is read with the recommended pattern size scanned on the screen and with the control-electrode bias voltage adjusted for a desired value of screen brightness or current. If a scanned raster is used, care should be taken to adjust for best center focus. If the spot is not circular, best focus

means that adjustment which gives the best compromise values of resolution along both axes.

11.2.9 Deflection Factor of Electrostatic-Deflection Types

Either direct or alternating voltages may be used in measuring deflection factor of a pair of deflecting plates. The deflection factor is usually expressed in volts per inch. The difference in potential applied between the plates to produce a measured deflection of the spot in a direction perpendicular to the tube axis is measured.

If alternating voltage is used, the peak potential difference is measured by means of a peak voltmeter or suitably calibrated oscilloscope. If the alternating voltage is sinusoidal, it may be measured with an rms voltmeter, and the reading converted to peak voltage. If the alternating voltage is not sinusoidal, the use of an oscilloscope is advisable. It is recommended that the frequency of the alternating voltage used be in the audio-frequency range. If high frequencies are used, the frequency should be kept below the value at which transit time and lead reactance begin to increase the deflection factor.

To avoid screen burning during the measurement, the trace should be maintained at a reduced intensity by adjustment of the control-electrode voltage, or by application of an alternating voltage to the second pair of deflection plates.

11.2.10 Deflection Factor of Magnetic-Deflection Types

Either direct or alternating current may be used in measuring deflection factor of a cathode-ray tube. The deflection factor is usually expressed in amperes per inch. The current through the coils to produce a measured deflection of the spot in a direction perpendicular to the tube axis is measured.

If alternating current is used, the peak current is measured by means of a peak-current meter or suitably calibrated oscilloscope. If the current is not sinusoidal, the use of an oscilloscope is advisable. It is recommended that the frequency of the alternating current used be in the audio-frequency range. If high frequencies are used, the frequency should be kept below the value at which transit time and coil reactance begin to increase the deflection factor.

To avoid screen burning during the measurement, the trace should be maintained at a reduced intensity by adjusting the control-electrode voltage, or by passing a current through a second pair of deflecting coils.

11.2.11 Measurement of Large-Area Contrast

Maximum contrast of a television picture is the ratio of the values of brightness of the brightest and darkest parts of the picture. Detail contrast is the ratio of the values of brightness of adjacent picture elements. The maximum contrast is limited because light can reach the unexcited part of the screen from the excited part (1) by direct illumination (when the screen is on a concave surface), (2) by internal reflection from the tube walls and electrodes, and (3) by internal reflection from

the medium on which the screen is deposited, if this medium is transparent and the picture is viewed through the medium.

The maximum contrast depends on the type of picture being reproduced. In Fig. 69, for example, the

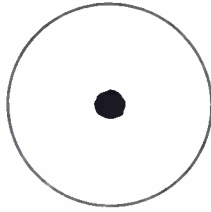

Fig. 69—Raster excitation for contrast measurement; center excited.

screen is excited directly only at the center. In Fig. 70 the screen is excited directly over the entire raster area except at the center. On the basis of the factors (1) to (3) above, the maximum contrast obtainable under the conditions of Fig. 70 will be considerably lower than that



Fig. 70—Raster excitation for contrast measurement; raster area except center excited.

of Fig. 69. The merit of a tube in terms of large-area contrast-reproducing capability may be determined by the following test:

A standard television raster of normal width and only half normal height is scanned, with the top or bot-

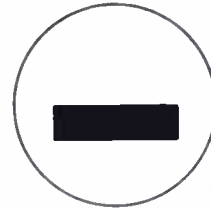

Fig. 71—Raster excitation for contrast measurement; half of raster area excited.

tom edge passing through the screen center, as indicated in Fig. 71. The large-area contrast is given by the formula

$$\text{Large-Area Contrast} = \frac{B_2 - B_0}{B_1 - B_0}$$

B_0 = brightness of the screen at any point with the beam suppressed.

B_1 = brightness near the center of the unexcited part of the screen.

B_2 = brightness near the center of the excited part of the screen.

Values of brightness B_1 and B_2 are measured with the grid bias adjusted for the maximum raster brightness attainable with the desired value of resolution in lines per picture height.

12. GAS TUBES

The characteristics of gas tubes differ radically from those of (high) vacuum tubes. Because the tube voltage drop is nearly independent of the magnitude of current conducted and the grid in general has no control after the discharge has started, the current through the tube is determined primarily by the applied voltage and the circuit impedance.

The precautions of Sections 1.1 and 1.3 are applicable, except that there is no recommended method of establishing equivalent datum points for ac and dc filament supplies.

12.1 Precautions for Testing Mercury-Vapor Tubes

Mercury vapor is often used in gas tubes. The pressure of the vapor in the tube affects the electrical characteristics and is a rapidly varying function of the condensed-mercury temperature.

In the testing of mercury-vapor tubes, due care must be taken to control condensed-mercury temperature in order to obtain reproducible results. In general, it may be expected that with increase of temperature the tube

voltage drop will decrease, the peak inverse voltage that the tube will withstand will decrease, and the critical grid voltage will become more negative.

It should be noted that the time required to attain the desired condensed-mercury temperature is usually longer than the cathode-heating time.

In testing the maximum peak inverse voltage or control characteristics, precautions must be taken to insure that no condensed mercury exists in the upper parts of the tube. This is generally accomplished by a preheating process in which only filament power is applied to the tube. The tube must be maintained in an upright position, away from air drafts, in order to prevent mercury from recondensing in the upper part of the bulb.

12.2 Hot-Cathode Gas-Tube Tests

For test methods see Section 2.1.

12.2.1 Filament or Heater Electrical Characteristic

12.2.1.1 Precaution. For tubes with high filament current, it may be necessary to correct for voltage drop

in the socket when the voltage is measured at the socket terminals.

12.2.2 Control Characteristic Tests

The critical grid voltage of a gas tube is a function of anode voltage, and is usually presented in the form of a curve with instantaneous anode voltage as ordinate. Data for plotting the curve are obtained as follows:

12.2.2.1 Critical Grid-Voltage Test. With voltage applied to the filament or heater, and with sufficient direct voltage applied to the control grid to prevent conduction, voltage is applied to the anode through a resistance that will limit the current during conduction to a suitable value. The grid series resistance is usually zero but in no case should be large enough to affect the test result. The control-grid voltage is gradually made more positive (or less negative) until anode conduction starts, at which time the critical grid voltage is observed. Where the critical grid voltage is positive, appreciable grid current may flow before conduction. The grid voltage must then be read at the grid terminal.

The condensed-mercury temperature of mercury-vapor tubes should be held to the desired value, which should be recorded with the results. This value is dependent upon operating conditions and tube structure, but is ordinarily between 20° and 50° C.

For tubes having shield grids, the shield-grid potential is an additional parameter, and should be held at a fixed value, usually zero.

12.2.2.1.1 Precaution. It may be desirable to use a small capacitor between each grid and the cathode to prevent possible anode-voltage surges from affecting the grid voltage.

12.2.2.2 Critical Anode-Voltage Test. With voltage applied to the filament or heater, the grid or grids, if any, are held at zero voltage and the anode voltage increased until conduction occurs. The value of anode voltage at this point is the critical anode voltage. Sufficient resistance must be inserted into the anode circuit to limit the current during conduction to a suitable value.

12.2.3 Emission Tests

In a tube of given design, tube voltage drop is primarily a function of emission. Lower tube voltage drop is, therefore, an indication of higher emission. The electron-emission quality of a gas tube is commonly tested by measurement of the tube voltage drop at an anode current sufficiently high to indicate cathode capability. This is sometimes done under conditions of continuous-current conduction. An intermittent-conduction method is more accurate because of the reduction of cathode heating by the arc current. Formation of a cathode spot, as indicated by a discontinuous reduction in the arc drop, indicates faulty cathode operation.

In these tests, any grids having separate terminals should be connected to the anode either directly or through a current-limiting resistor. The value of re-

sistance should be specified, since the tube voltage drop is affected by the current distribution between the grid and the anode.

Since the tube voltage drop in mercury tubes varies with vapor pressure, the permissible range of condensed-mercury temperature should be controlled within narrow limits.

12.2.3.1 Direct- and Alternating-Voltage Methods. With the desired voltage applied to the filament or heater, with an anode supply voltage sufficient to cause firing, and with the anode current limited to the desired value by a series resistor, the voltage drop is measured by a voltmeter if direct voltage is used, and by an oscillograph or other suitable means if alternating voltage is used. In the latter case, the voltage is read at the instant the current is at its peak value.

12.2.3.2 Intermittent Voltage Method. With the desired voltage applied to the filament or heater, with the anode current limited to a desired value by the circuit, and with the anode voltage to be applied intermittently at a repetition rate such that appreciable heating of the cathode does not occur, the tube voltage is measured by an oscillograph or other suitable means at the instant when the current has peak value. The anode current should increase smoothly and continuously to its peak value near the middle of the conduction period. The period of conduction should be of sufficient duration to insure that the tube is sufficiently ionized to make the measured tube voltage drop independent of the conduction period. In general, a period of 150 microseconds is adequate.

12.2.4 Grid-Current Tests

The critical grid current of a thyatron is a function of the anode voltage and includes positive-ion, electron, and leakage currents. The interelectrode-capacitance charging currents may also be of importance. These grid currents are usually of the order of microamperes. They are generally measured by reading the voltage drop across a resistor in series with the grid.

12.2.4.1 Critical-Grid-Voltage Method. With a specified anode voltage, the grid supply voltage is measured, a resistance R_0' being used in series with the grid, as shown in the circuit of Fig. 72. This voltage is denoted

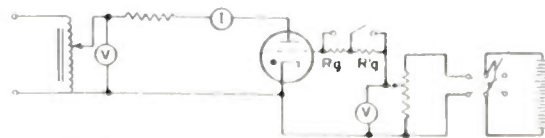

Fig. 72—Circuit arrangement for measuring critical grid current.

by E_{cc}' . The measurement is then repeated with a different resistance R_0 . The second measured voltage is denoted by E_{cc} . Since the grid voltage and current can be assumed to have the same values in both measurements, the grid current flowing just before conduction is

$$i_{cc} = \frac{E_{cc} - E_{cc}'}{R_0 - R_0'}$$

This test may be performed with either direct or alternating anode supply voltage. If alternating voltage is used, the frequency should be low enough so that the effect of tube and circuit capacitances can be neglected.

The primary electron emission from the grid is a function of the grid temperature. In order that the full value of total grid current may be measured, the grid must be heated by operating the tube at the desired values of anode current for an adequate time immediately before the measurements are made.

In this test, the shield grid is connected to the cathode. Other grid-current tests may be made with direct voltage on the shield grid.

12.2.4.1.1 Precaution. This method may be inaccurate if the positive-ion current to the grid resulting from the pre-conduction current in the thyatron is large compared to the electron-emission current from the grid, and if the resistance of R_g is too great.²⁶

12.2.5 Fault-Current Test (Surge-Current Test)

The ability of a tube to withstand a fault current without excessive damage is tested in a circuit in which the tube is connected in series with a high-current tube such as an ignitron, as shown in Fig. 73. By control of the ignitron, the desired peak value of half-wave current can be passed through the tube for a definite time.

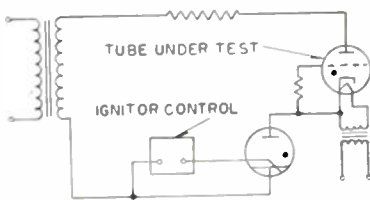

Fig. 73—Circuit arrangement for fault-current test.

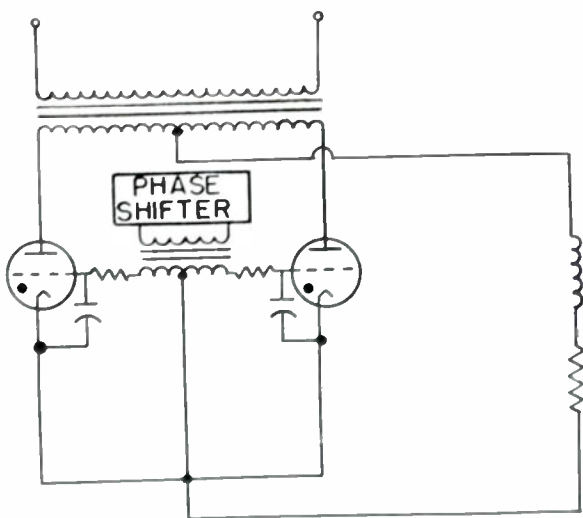

Fig. 74—Circuit arrangement for single-phase-rectifier operation test.

12.2.6 Operation Test

Gas tubes may be given an operation test by operating them in conventional rectifier circuits. Fig. 74 shows a typical full-wave single-phase circuit; Fig. 75 shows a typical three-phase zig-zag circuit as connected for thyatrons. In the testing of diodes, the grid circuits are eliminated.

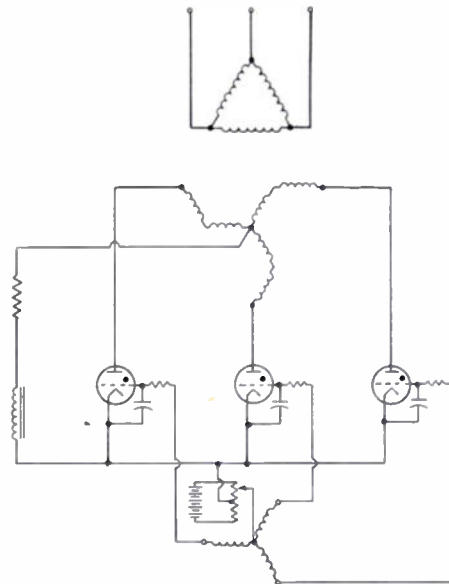

Fig. 75—Circuit arrangement for three-phase-rectifier operation test.

The tube is operated at a definite temperature for a definite time to observe the frequency of arc-back and whether grid control is lost.

The severity of the test depends upon a number of tube factors such as those illustrated in Fig. 76. These and other important factors are:

1. Peak anode current.
2. Peak inverse anode voltage.
3. Current at the beginning of commutation.
4. Inverse voltage immediately after commutation.
5. Commutating time.
6. Arc-back current.

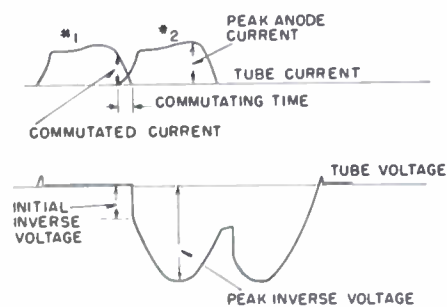

Fig. 76—Typical three-phase-rectifier wave forms.

The magnitude of these factors depends upon the following circuit parameters:

- a. Number of phases of the rectifier.
- b. Type of filtering circuit.
- c. Transformer impedance.

²⁶ H. W. French, "The operating characteristics of grid-controlled hot-cathode arcs or thyatrons. *Jour. Frank. Inst.*, vol. 221, pp. 83-102; January, 1936.

- d. Type of load circuit. (The power may be absorbed either by resistor or by a reverse-emf load. Examples of the latter are a battery, a capacitor, or a motor, which can augment the arc-back current.)
- e. Firing time in grid-controlled or ignitor-controlled tubes.

The correlation of test results may be difficult unless the tests are made under conditions that are identical with respect to the foregoing parameters.

For convenience, this test is often made with a full-wave single-phase rectifier operating into a resistance load, such as a water resistor. The influence of factors 3, 4, and 5 is then minimized. In order to make the test comparable in severity with a polyphase test, it is usually necessary to increase the test voltage.

12.2.6.1 "Cheater-Circuit" Test. It is possible to construct test circuits, called "cheater circuits," that will simulate the current and voltage wave forms of the circuit described in the last paragraph of Section 12.2.6. These circuits usually consist of high-current, low-voltage sources of power to supply the forward current through the tube under test, and high-voltage, low-current sources to apply inverse voltage after the end of the conduction period. Synchronous switching methods are used to switch from one source to another at the proper time in the cycle. The object of such circuits is to reduce the energy requirements and the equipment cost. This usually requires that the high-voltage source of power be of relatively small capacity and high impedance. The current through the tube on occurrence of arc-back is therefore relatively small. Under such conditions, it is possible that the rate of occurrence of arc-back may be reduced over that which would be obtained from a power source of lower impedance. By the use of sensitive arc-back indicators, the small reverse currents that flow when the tube arcs back can be indicated. Such a method of testing requires careful cor-

relation of test results with those obtained under actual service conditions.

Fig. 77 shows one form of "cheater circuit." The switching is done by a rotating commutator or by a suitable thyatron circuit.

12.2.7 Thermal Tests for Hot-Cathode Mercury Tubes

The operating temperature of a hot-cathode mercury-vapor tube, cooled by air convection, depends on the power generated in the tube and the efficiency of the air cooling. The latter depends on the ambient air temperature and on the air flow past the cooling surfaces of the tube.

The time required for the temperature of a tube to rise from a low ambient value to its minimum desired operating value depends on the filament power and on the ambient temperature. Tube arc losses are not involved, because the tube should not be allowed to conduct before it is heated to the minimum operating temperature.

In order to fix the conditions under which cooling efficiency is measured, it is necessary to establish the mounting method. A suggested arrangement is shown in Fig. 78. Baffles or other means should be used to prevent extraneous drafts.

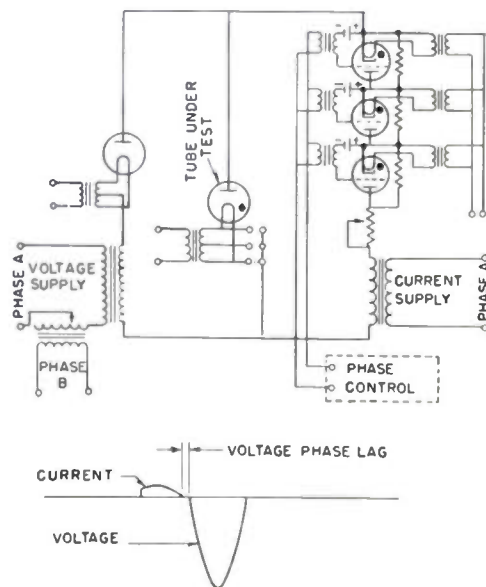

Fig. 77—Typical "cheater-circuit" rectifier test circuit.

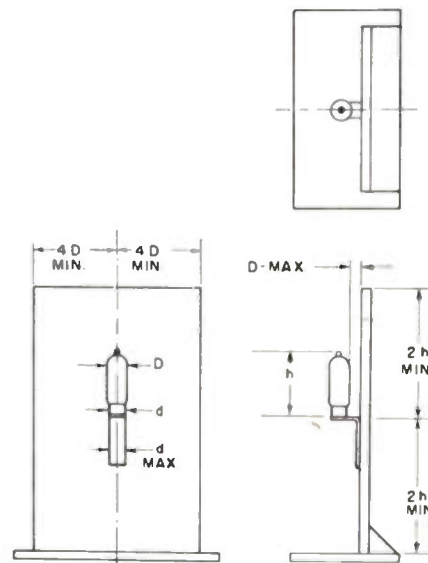

Fig. 78—Test mounting for mercury-vapor-tube temperature tests.

12.2.7.1 Method of Measuring Condensed-Mercury Temperature. The preferred method of measuring the condensed-mercury temperature is by means of a thermocouple in close contact with the tube in the region in which the mercury is condensing. The location of the thermocouple is usually immediately above the base of a glass tube or on the radiator of a metal tube. The thermocouple wire must be of small enough diameter (about 0.010 inch) to minimize error caused by heat conduction.

12.2.7.2 Test for Rate of Condensed-Mercury Temperature Rise. The condensed-mercury temperature of the tube is measured as a function of time, starting at the time the heater circuit is closed. The heater voltage

should be held constant, preferably at the lowest desired rated operating value. The data obtained may be plotted as a curve of temperature rise above ambient temperature versus time.

12.2.7.3 Test for Equilibrium Condensed-Mercury Temperature Rise. With the filament or heater voltage at the highest operating value and with maximum value of average anode current, the condensed-mercury temperature rise at equilibrium is measured for various ambient temperatures. The data obtained may be presented as a curve of condensed-mercury temperature versus ambient temperature.

12.2.8 Deionization-Time Test

For some time after a conduction period, the anode-cathode space of a gas tube contains a cloud of positive ions. The positive space charge of these ions neutralizes the potential of the grid and prevents it from exercising its control function. The positive-ion density is reduced by diffusion of ions to the tube walls and electrodes. The time from end of conduction until control is reestablished is called the deionization time. Deionization time is a function of a number of variables, among the more important of which are voltage and impedance of the grid circuit, anode current previous to extinction, anode voltage, and temperature of mercury tubes.

12.2.8.1 Inverter Method. The time necessary for deionization may be measured by connecting two of the tubes in an ac-commutated inverter circuit, as shown in Fig. 79. If preferred, one of the tubes to be tested may be used in this circuit, together with a tube of known characteristics.

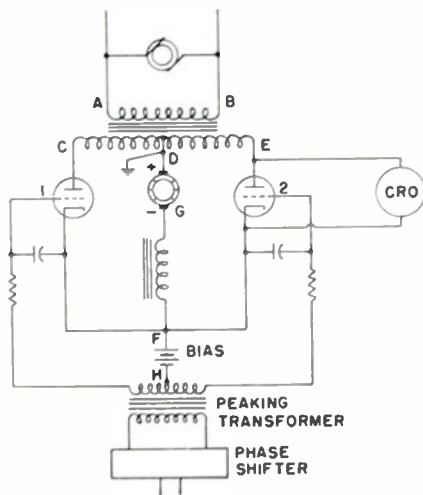

Fig. 79—Inverter circuit for measuring deionization time.

The test circuit is similar to a full-wave single-phase rectifier except that the load, a dc generator in this case, can cause current to flow through the tubes. Triggering pulses are applied to the grids of the tubes so that each tube fires a short time before the ac voltage on its anode becomes negative. The dc generator in combination with the smoothing reactor forces current through the tubes in opposition to the transformer voltage. Thus, during the greater part of the ac cycle, power flows from the generator to the ac source.

The operation of the circuit may be visualized by referring to the circuit of Fig. 79 and to the voltage and current wave forms in Fig. 80. Assume current to be flowing in tube #2 as shown in Fig. 80(c). Since the voltage drop in the tube is small relative to the applied voltages, the voltage of point *F* in Fig. 79 may be assumed to be equal to that at point *E* as long as tube #2 is conducting. From Figs. 80(a) and 79 it can be seen that with tube #2 conducting, the anode of tube #1 is positive with respect to its cathode during the latter

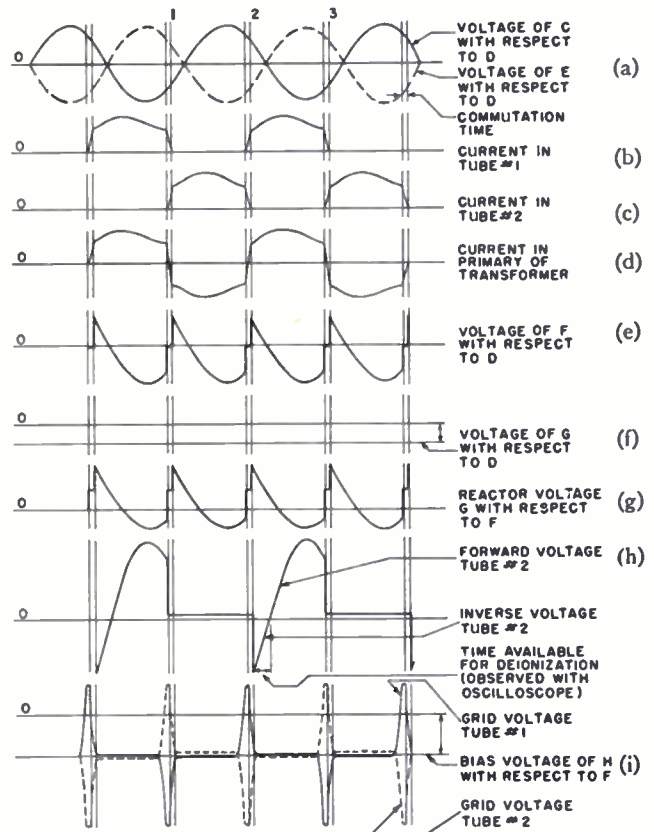

Fig. 80—Typical wave forms appearing in the inverter circuit for measuring deionization time.

portion of the conduction cycle of tube #2, and tube #1 is kept from conducting only because its grid bias is more negative than the critical value. At point 2 of Fig. 80(a), the grid of tube #1 is pulsed as shown in Fig. 80(i). Tube #1 immediately starts to conduct current. However, due to the leakage reactance of the transformer, current through the transformer secondary *DE* cannot stop instantly, and similarly the current through tube #1 and transformer winding *CD* cannot build up instantly. Therefore, for a finite period of time known as the commutation time, both tube #1 and #2 are conducting. Since point *C* of Fig. 79 is now positive and point *E* is negative, tube #1 continues to conduct and tube #2 is extinguished. The voltage from *F* to *D* across the inductance and generator is as shown in Fig. 80(e). It is the sum of the rectified ac voltage and dc generator voltage.

The voltage of the anode with respect to the cathode of tube #2, shown in Fig. 80(h), is then the voltage of *E* with respect to *D* minus the voltage of *F* with respect to *D*.

The method of adjustment of this circuit is as follows:

1. Set the dc bias at a specific value.
2. With the dc generator disconnected from the inverter, set the dc generator voltage to a value low with respect to its operating value.
3. Adjust the alternating voltage until a specific forward peak voltage is obtained.
4. Adjust the phase shifter to fire the tubes somewhat in advance of the desired phase.
5. Connect generators to the circuit and raise the alternating voltage until the tubes start to conduct an appreciable current.
6. Adjust the dc generator voltage and phase of firing together to obtain the desired average tube current. (Phasing later in the cycle or raising the anode current will change the inverse voltage and require adjustment of the generator voltage.)
7. Run for a specific time and note failures to commutate.
8. Repeat the test for longer or shorter times of negative anode voltage until a duration of negative anode voltage is established for the specified number of deionization failures per unit time.

The inverse and forward voltages on the tubes depend on the alternating voltage. The average amount of current flowing is a function of the direct voltage and of the angle of lag of the grid voltage at a given alternating anode voltage.

When a tube fails to deionize within the available deionizing time, the direct current rises to a high value. A circuit breaker must therefore be provided in the dc circuit to protect the tubes. A choke should be used to smooth the current and to decrease the rate of rise of direct current on deionization failure, and thus to prevent the direct current from increasing sufficiently to damage the tubes within the operating time of the circuit breaker.

Commutation failure may result from failure of arc initiation in one of the tubes. The initiating grid voltage should therefore be made sufficiently positive for an adequate time to insure reliable initiation of the arc.

12.2.8.2 Capacitor-Discharge Method. If a charged capacitor is connected so as to apply a negative voltage to the anode of a gas tube that is conducting, the discharge in the tube will cease. The current previously flowing through the tube now charges the capacitor in the opposite direction, causing the anode voltage to change from negative to positive at a rate dependent on the constants of the charging circuit. If the ion density decreases sufficiently during the time in which the anode is negative, the grid can prevent conduction when the tube voltage becomes positive.

Fig. 81 shows a circuit using this principle to measure deionizing time. The tube under test is conducting direct current of the desired value. The capacitor, which is connected in parallel with the load resistor, charges in such polarity that the terminal connected to the tube anode is negative. When the switch is closed the anode voltage becomes negative, and the discharge

therefore ceases. The capacitor then discharges through the load resistor. The wave form of voltage across the tube is shown in the figure. With this method, the de-

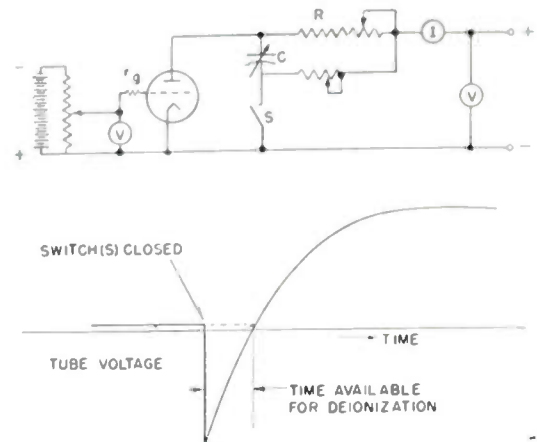

Fig. 81—Circuit arrangement for measuring deionization time by capacitor-discharge method.

ionization time is arbitrarily considered to be the time taken by the anode voltage to rise to a value equal to the tube voltage drop, with the capacitance adjusted to the smallest value at which the tube stops conducting a desired percentage of a number of trials. This deionization time can be calculated from the formula

$$t = RC \ln \frac{2E_{bb} - E_a}{E_{bb} - E_a}$$

where E_a is the tube voltage drop and E_{bb} is the supply voltage.

(Note—When the tube voltage drop is less than 10 per cent of the anode supply voltage, it may without serious error be assumed to be zero. The formula for deionization time then simplifies to $t = 0.7RC$.)

12.2.9 Thyatron Ionization-Time Test

With the filament or heater voltage at the desired value and the tube temperature adjusted to a value within the desired range, a voltage, either direct or alternating, is applied to the anode through a resistance. With the grid biased to a voltage substantially more negative (or less positive) than the critical grid voltage, an essentially rectangular pulse of voltage of variable duration is applied in the grid circuit. This pulse should be of such magnitude that the resultant grid voltage is less negative (or more positive) than the critical grid voltage by a specific amount and, when alternating anode voltage is used, should occur at the peak of the anode-voltage wave. Conduction should take place within the time of the pulse duration, as indicated by a cathode-ray oscillograph. The ionization time is the time from the application of the grid pulse to the time at which the tube voltage drop falls to a desired value.

12.2.9.1 Precaution. The time of rise of the applied pulse should be short compared with the ionization time to be measured.

12.3 Cold-Cathode and Voltage-Regulator Gas-Tube Tests

12.3.1 General Precautions

The characteristics of cold-cathode tubes are affected by several factors that are not, in general, common to other types of tubes. The more important factors are discussed in the following sections.

12.3.1.1 Illumination. The breakdown voltage and breakdown time of tubes not having an opaque coating may be markedly affected by the amount and nature of illumination. As illumination on the tube is increased, the breakdown voltage and breakdown time decrease. For consistent test results, it is advisable that all characteristics be determined in a range of illumination where the tube characteristics are not materially affected by the illumination.

Cold-cathode tubes in general have a memory effect with regard to illumination. With a sudden decrease in illumination, the effect of the previous higher value often tends to persist, but decreases with time.

12.3.1.2 Storage and Handling. When a tube is allowed to stand idle, breakdown time and breakdown voltage may increase. This effect is especially apparent when the tube is subsequently operated at low levels of illumination. After the tube passes current for a few seconds, the breakdown time and breakdown voltage will revert to approximately their original values. The maximum changes due to storage ordinarily take place in from twenty-four hours to one week.

12.3.1.3 Ambient Temperature. In tubes containing only inert gases, the effect of temperature changes on the tube characteristics is usually negligible.

12.3.1.4 Rapid Test Methods. Cold-cathode gas tubes may have comparatively long ionization and deionization times. In measuring such characteristics as breakdown voltage and transfer current, it is therefore necessary that the tube be allowed to come to ion equilibrium under the test conditions. Hence, in the use of automatic or rapid test methods, it is recommended that test voltages be applied for a period of not less than 0.1 second

12.3.1.5 Capacitance Effects. In the measurement of transfer current, major errors may be introduced if capacitance effects are ignored. Circuit capacitance between the starter and the cathode can supply an appreciable transfer current not indicated on the current meter. This current is caused by the discharge of this capacitance through the tube, the voltage falling by an amount equal to the difference between the breakdown voltage and the voltage drop of the starter. It is important, therefore, that this effect be eliminated in this test by placing the starter resistor adjacent to the starter.

12.3.1.6 Preconditioning Current. In order to eliminate the effect of storage on starter breakdown voltage in testing certain narrow-range tubes, a preconditioning current is sometimes required. It is recommended that this preconditioning of the electrode to be tested take place not more than 30 seconds prior to making the

test; that the value of the preconditioning current be at least 10 per cent of rated value of the tube; and that the preconditioning period be not less than 0.1 second and not more than 5 seconds.

12.3.2 Breakdown-Voltage Tests

12.3.2.1 Anode Breakdown-Voltage Test. All electrodes, except the anode, should be held substantially at cathode potential before breakdown. The anode circuit should contain a resistor having sufficient resistance to limit the current after breakdown to a suitable value. A positive anode voltage is applied and increased until the tube conducts current. The minimum value of voltage required to start conduction (breakdown) is measured.

12.3.2.2 Starter Breakdown-Voltage Test. This test is similar to that in Section 12.3.2.1, except that the anode and the starter are interchanged.

12.3.2.3 Voltage Regulator-Tube Breakdown Test. This test is similar to that in Section 12.3.2.1.

12.3.3 Anode-Voltage-Drop Tests

In three-electrode tubes, ordinarily both anode voltage drop and starter voltage drop are measured. When anode voltage drop is being measured, the starter may be allowed to float or may be connected to the cathode through sufficient resistance to limit the starter current to not more than 10 per cent of the anode current.

In measuring starter voltage drop, the anode should be approximately at cathode potential. The current to the anode should not exceed 10 per cent of the starter current.

12.3.3.1 Direct-Current Method. A positive direct potential is applied to the anode (or starter) through sufficient resistance to limit the current to the desired value. The anode-to-cathode (or starter-to-cathode) voltage drop is then measured.

12.3.3.2 Alternating-Current Method. An alternating voltage is applied to the anode (or starter) through sufficient resistance to limit the peak current to the desired test value. The anode-to-cathode (or starter-to-cathode) voltage drop is then measured at peak current with a cathode-ray oscillograph or by other suitable means.

12.3.4 Transfer-Current Test

A positive potential is applied to the anode through sufficient resistance to limit the current after breakdown to a suitable value. A positive voltage is applied to the starter through sufficient resistance to limit the starter current to less than the transfer value. The starter current is then gradually increased until conduction takes place to the anode. The starter current just prior to anode conduction is measured.

The starter resistor must be adjacent to the starter (see Section 12.3.1.5).

12.3.5 Voltage-Regulator-Tube Regulation Test

The difference between the maximum and the minimum anode voltage drop is determined as the anode current is varied over the desired range.

Contributors to the Proceedings of the I.R.E.

Alda V. Bedford (A'31-SM'46-F'50) was born in Winters, Tex., on January 6, 1904. He received the B.S. degree in electrical engineering from the University of Texas in 1925 and the M.S. degree in electrical engineering from Union College in 1929. While at the University of Texas he spent one summer with the Dallas Power and Light Company.



ALDA V. BEDFORD

In 1925 Mr. Bedford joined the General Electric Company, starting in the general engineering laboratory and later transferring to the testing department and the research laboratories, working on sound recording by film and disk, audio frequency amplifiers, loudspeakers, sound printers for film, and television. Since 1929 he has been employed in the RCA Laboratories, first on disk sound recording and then on television. He received a "Modern Pioneer" award from the National Association of Manufacturers in February, 1940, for inventions in television. In 1949 he received an RCA Laboratories award for "his concept of the by passed mixed highs principle in color television."



R. A. Erickson was born in Bryant, S. D., on September 12, 1923. After receiving the B.S. degree in physics from the South



R. A. ERICKSON

Dakota School of Mines and Technology in 1944, he was employed with the National Advisory Committee on Aeronautics at Langley Field, Va., which he left for service in the U. S. Navy in 1944. In 1946, he worked for Air Associates, Inc., in Los Angeles, Calif., and, from

1946 to 1949, he was engaged in graduate studies in physics at Texas A & M College. During this time, Mr. Erickson also did research for the Texas A & M Research Foundation. He is now at the Oak Ridge National Laboratory as a graduate fellow of the Oak Ridge Institute of Nuclear Studies, where he is engaged in research that will be applied toward fulfilling the Ph.D. dissertation requirements of the A & M College of Texas.



Eduard A. Gerber was born in Fuerth, Bavaria, Germany, on April 3, 1907. He received the Dipl. Phys. degree in 1930, and the Dr. Ing. degree in 1934, both from the Munich Technical University. In 1935 he joined the scientific staff of the Carl Zeiss Works, Jena, Germany, and was in charge

of the research and development work on piezoelectric crystals. Before he arrived in this country, he was one of the co-authors of the volumes on "Physics of Solids," of the *FIAT Review*, of German Science, published by the Military Government for Germany.



E. A. GERBER

on Piezoelectric Crystals.



Harry Grundfest was born on January 11, 1904, in Minsk, Russia. He received the B.A. degree in 1925, the M.A. in 1926, and the Ph.D. in biophysics in 1930, all from Columbia University. From 1929 to 1931 he was a National Research Council Fellow at the Laboratories of Biophysics, Columbia University, and the Johnson Foundation for Medical Physics, University of Pennsylvania. Dr. Grund-



H. GRUNDFEST

fest has taught at Columbia University, Cornell Medical College, and Swarthmore. From 1935 to 1945 he was associated with the Rockefeller Institute of Medical Research and, while on leave of absence during 1943 to 1945, he was a senior physiologist at the Ft. Monmouth Signal Laboratory and a special research associate on the Wound Ballistics Project at Princeton University.

Since 1945, Dr. Grundfest has been at the College of Physicians and Surgeons at Columbia University where he is primarily concerned with the electrophysiology of nerve and the nervous system.



Rudolf Guertler was born in Prerau, Austria, on September 29, 1894. He studied electrical engineering at the Technical University at Bruenn-Brno, where he was for a short time assistant lecturer in electrotechnology and electrical communication.



RUDOLF GUERTLER

radio transmitter laboratories.

In 1923, he was employed by the Telefunken Company, Berlin, where he carried out developmental work in the audio frequency and

He has published a number of papers and, in 1931, received the degree of Dr. Tech. from the Technical University of Bruenn.

Since 1938 Dr. Guertler has visited various countries, including Sweden, Belgium, Jugoslavia, and Persia, to carry out acceptance tests or experiments on transmitters installed by Telefunken.

Subsequently he worked with Austronic Engineering Laboratories in Melbourne, Australia, and in February, 1948, he joined the staff of the radio transmission division of Standard Telephones and Cables Pty. Ltd. in Sydney, Australia.



D. D. King (M'46) was born on August 7, 1919, at Rochester, N. Y. He received the A.B. degree in engineering sciences from



D. D. KING

Harvard College in 1942, and the Ph.D. degree in physics from Harvard University in 1946. He was a teaching fellow in physics and communication engineering in 1943, serving as a staff member of the pre-radar Officer's Training School at Cruft Laboratory, Harvard University. During 1945 he was a research associate at Cruft Laboratory. In 1946 he was appointed research fellow in electronics, and in 1947 assistant professor of applied physics at Harvard University.

Since 1948 Dr. King has been an associate professor of physics in the Institute for Co-operative Research of The Johns Hopkins University. He is a member of Sigma Xi and the American Physical Society.



Vincent R. Learned (S'38-A'40-SM'47) was born on January 21, 1917, in San Jose, Calif. He received the B.S. degree in electrical engineering from the University of California in 1938, after which he spent two years in the engineering department of the McClatchey Broadcasting Company, in Sacramento, Calif. From 1941 through 1942, he served as a teaching and research assistant at Stanford University, and



V. R. LEARNED

earned the Ph.D. degree there during the following year.

Since 1943, Dr. Learned has been employed by the Sperry Gyroscope Company, in Great Neck, N. Y., first as a project engineer on the development of Doppler radar systems and components, and since 1946 pri-

Contributors to the Proceedings of the I.R.E.

marily on the development of new klystron tubes. His work in these fields has resulted in four patents, with others pending. His present position is that of engineering section head for electron tube research.

Dr. Learned is a member of the American Physical Society, Sigma Xi, Tau Beta Pi, and Eta Kappa Nu.

❖

Wilbur R. LePage (SM'46) was born in Kearney, N.J., on November 16, 1911. He received the E.E. degree from Cornell University in 1933, the M.S. degree from the University of Rochester in 1939, and the Ph.D. degree from Cornell in 1941. He taught electrical engineering at the University of Rochester from 1933 to 1938, and also one term at Cornell in 1941. He worked in the Advanced Development Division



WILBUR R. LE PAGE

of RCA for part of 1941, and in 1942 went to the Radiation Laboratory of Johns Hopkins University, where he participated in the Proximity Fuze program during the war. He did part-time teaching for Purdue University while with RCA, and for Johns Hopkins University. In 1946 he went to the Stromberg Carlson Company as a senior research engineer. Since 1947 he has been associate professor of electrical engineering at Syracuse University.

Dr. LePage is a member of the American Institute of Electrical Engineers, Sigma Xi, Tau Beta Pi, Eta Kappa Nu, and Phi Kappa Phi.

❖

D. A. McLean was born on July 15, 1905, in Golden, Colo. He joined the staff of the Chemical Laboratories in 1929, immediately after receiving the B.S. degree in chemical engineering from the University of Colorado. For the following three years he was interested chiefly in problems of plasticity, viscosity, and the wetting of solids by liquids. While working on these problems, he contributed



D. A. McLEAN

to the theory of capillary penetration of liquids into fibrous solids. More recently he has been engaged in studies of dielectric breakdown and has given particular attention to paper capacitors.

Carl S. Roys (SM'45) was born in Shelburne, Mass., on July 30, 1898. He received the B.S. degree from the Worcester Polytechnic Institute in 1923. Subsequently, he was a graduate student at Union College, the University of Wisconsin, and Purdue University, receiving the M.S. E.E., and Ph.D. degrees from Purdue in 1929 and 1933, respectively. In 1924 he became an instructor in civil engineering at Union College, and in 1925, an instructor in the school of electrical engineering at Purdue University. He left there in 1942 with the rank of associate professor to become professor in charge of graduate instruction in electrical engineering at the Illinois Institute of Technology. Later he was professor of electrical engineering at Syracuse University and currently holds the same position at the University of Massachusetts, where he is specializing in transient analysis, industrial electronics, and electromagnetic engineering.



CARL S. ROYS

His industrial experience includes telephone transmitter development at the Western Electric Co. in New York, N. Y.; general test and synchronous machine design at the General Electric Co. in Schenectady; cathode-ray tube development at RCA Radio-tron; and electromagnetic radiation analysis at Electronics Park, Syracuse. During the war, he served as a general consultant for the Continental Electric Co. of Geneva, Ill., and has also served as a consultant for Eicor, Inc., of Chicago, since 1944.

Dr. Roys is a member of the American Institute of Electrical Engineers, the American Society of Engineering Education, the Radio Engineers Club of Chicago, Sigma Xi, Tau Beta Pi, Eta Kappa Nu, and Sigma Pi Sigma. While in Chicago, he was a member of various committees of the Chicago Section of The Institute of Radio Engineers and was chairman of the Education Committee in 1946. He is the author of several technical papers, is co-inventor of the electron switch for cathode-ray oscillographs, and has also been granted other patents on rotating machinery.

❖

For a photograph and biography of JOHN W. CLARK, see page 564 of the May, 1950, issue of the PROCEEDINGS OF THE I.R.E.

❖

For a photograph and biography of O. M. STUETZNER, see page 950 of the August, 1950, issue of the PROCEEDINGS OF THE I.R.E.

James C. W. Scott (M'47) was born at le Havre, France, on March 1, 1904. He graduated from the University of Washington with the degree of B.Sc. in physics. In 1930 he was employed by Bell Telephone Laboratories, Inc., where he did research work on copper-oxide rectifiers. In 1933 he returned to the University of Washington with a teaching fellowship to do graduate work in physics.



J. C. W. SCOTT

During the war, he joined the Royal Canadian Air Force and served overseas as a radar officer. He later was in charge of the Canadian east-coast chain of radar stations and started the radio propagation prediction section of the RCAF. At the end of the war, Mr. Scott retired from the Air Force with the rank of Squadron Leader to join the staff of the National Research Council of Canada. He transferred to his present position with the Defence Research Board in 1947 to take part in the organization of the new Radio Propagation Laboratory where he now holds the post of assistant superintendent.

He was secretary of the Canadian Radio Wave Propagation Committee, and is a member of the American Physical Society and the Canadian Association of Physicists.

❖

Samuel Seely (A'39-SM'45) was born in New York, N. Y., on May 7, 1909. He received the E.E. degree from the Polytechnic Institute of Brooklyn in 1931; the M.S. degree from Stevens Institute of Technology in 1932, and the Ph.D. degree in physics from Columbia University in 1936. He was a member of the staff of the department of electrical engineering at the School of Technology of the College of the City of New York from 1936 until 1946, but was on extended leave of absence at the Radiation Laboratory at the Massachusetts Institute of Technology from January, 1941, until January, 1946. He was associate professor of electronics at the Naval Postgraduate School at Annapolis, Md., from July, 1946, until February, 1947. He joined the staff of Syracuse University in February, 1947, as professor of electrical engineering.



SAMUEL SEELY

Dr. Seely is a member of the American Institute of Electrical Engineers, the American Physical Society, the American Society of Engineering Education, Tau Beta Pi,

Sigma Xi, and of the Papers Review Committee of the IRE. He is coauthor of the textbook, "Electronics," and author of "Electron Tube Circuits."

❖

Helmut Sommer (S'49) was born in Geislingen, Germany, on August 23, 1922. He received the B.S. degree in electrical engineering from Texas A & M College in 1944, and the Ph.D. degree from the same institution in 1950.



H. SOMMER

From 1943 to 1946, Dr. Sommer was on active duty with the U. S. Army Signal Corps. He attended the army electronics school at Harvard and M.I.T. He also saw service

in Europe with the Psychological Warfare Division, SHAEF, and with the U. S. Strategic Bombing Survey. Since August, 1946, he has been a captain in the ORC.

In 1946, Dr. Sommer returned to Texas A & M to enroll in the graduate school. From 1947 to 1948, he was the Westinghouse Fellow in mass spectrometry. In September, 1949, he joined the Atomic Physics Section of the National Bureau of Standards.

❖

J. R. Weeks was born on October 27, 1893, in Newark, N. J. After graduating from Sheffield Scientific School at Yale University in 1914 with the degree of Ph.B., he joined the student course of the Western Electric Company at Hawthorne. On completing this course, he transferred to the research department in New York City where he worked on the manufacture of the vacuum tubes for the Arling-



J. R. WEEKS

ton-Paris trans-Atlantic radio-telephone studies. During the first World War, he served in the Signal Corps. Since 1920 he has been associated with the apparatus development department of the Western Electric Co. He was first occupied with studies of insulations, principally of rubber for submarine cables, and during 1923 assisted in laying and testing the submarine telephone cable between San Pedro and Catalina Island. He then engaged in the design of loading and retardation coils for filters and networks, and later transferred to the development of capacitors. During the war he developed and supervised testing of capacitors of all types and varieties for the armed services.

Correspondence

Note on the Reactance-Tube Oscillator*

In the paper, "The Reactance-Tube Oscillator," which appeared in the November, 1949, issue of the PROCEEDINGS OF THE I.R.E.,¹ it was stated that a variation of the transconductance g_m of the oscillator tube changes the generated frequency f .

However, such an interpretation of that formula is not allowed for the following reasons. In the case of stationary oscillations, the problem of the "reactance-tube oscillator" leads to a complex equation, which can further be split up into two independent ones. By solving these equations, we get fixed values for the two unknowns f and g_m , which can never be altered, assuming that no other components of the oscillatory circuit are changed. This is easily understood in a more practical way, too. In an oscillator with grid leak bias we introduce an additional negative grid voltage with the intention of changing the transconductance of the tube. This tends to decrease the grid current and, consequently, the voltage drop in the grid leak, but the total grid voltage and therefore the transconductance remain the same. However, this decrease of grid current has two remarkable effects: an increase of grid cathode resistance, resulting in negligible frequency shift and some change in the amplitude of oscillations until the circuit stops oscillating; and the variation of the space charge between cathode and grid, which leads to new values of the grid cathode capacity. (In a

typical case we may have changes of several micromicrofarads.) This effect, which must not be confounded with the Miller effect, causes the observed frequency modulation.

In the ordinary circuit with a separate reactance tube, there are no restrictions—due to the oscillatory condition—with respect to the transconductance of the reactance tube.

In Switzerland, the "reactance-tube oscillator" has been in commercial use for years. Practical work with this circuit gave rise to these remarks. I hope they will be of interest to your readers.

ADOLF GIGER
Swiss Federal Institute of Technology
Zurich, Switzerland

and modulation frequencies. The modulating voltage e_m which is of much lower frequency than the output voltage, is obtained from a low resistance source such

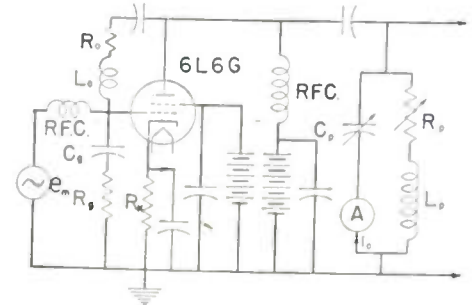

Fig. 1

The Reactance-Tube Oscillators*

Our recent paper, "The Reactance-Tube Oscillator,"¹ was so reduced in length for publication that some confusion has resulted. It is interesting to note that a somewhat similar circuit is in use in Switzerland, as stated in a recent letter by Adolf Giger. However, his circuit must be basically different from ours, if as he states, it uses grid leak bias, and depends upon variation of space charge to change the cathode-to-grid capacity and thus the frequency.

In the "reactance-tube oscillator," as shown in Fig. 1, the fixed part of the grid bias may be obtained by means of a cathode resistor R_k , by-passed for both oscillation

as a transformer secondary, so that there is no grid leak bias and operation is essentially class A. This modulating voltage varies the grid bias slowly enough that the expressions for the transconductance g_m in our original paper, derived for steady-state conditions, will hold approximately. Both the transconductance and the plate resistance r_p change as bias changes, but in opposite directions, so that the condition for oscillation remains satisfied. As we have shown, any changes in g_m result in a change in the frequency of oscillation, and thus the output frequency tends to follow the instantaneous amplitude of the modulating voltage.

V. C. RIDEOUT
HAN CHANG
The University of Wisconsin
Madison, Wis.

* Received by the Institute, January 19, 1950.
¹ H. Chang and V. C. Rideout, "The Reactance-tube oscillator," Proc. I.R.E., vol. 37, pp. 1330-1331; November, 1949.

* Received by the Institute, February 20, 1950.
¹ H. Chang and V. C. Rideout, "The reactance-tube oscillator," Proc. I.R.E., vol. 37, pp. 1330-1332; November, 1949.

Feedback and the Future of Sciences*

I was very interested to read the editorial "Feedback," by Parker in a recent issue of the PROCEEDINGS.¹ While agreeing with many of his conclusions, I disagree with others.

As an engineer whose interests combine radio with genetics, it seems to me that the principle of feedback offers much possibility for the future of the sciences.

In the very simple animal, with a nervous system, the signals received by the sense nerves are by an inherent reflex fed back to the motor nerves to cause the action which natural selection has retained as the one most suited to the survival of the animal. As the higher and higher animals are studied, the number of feedback paths is multiplied, and they become controlled by other senses. Ultimately, we reach a condition such as we find in man. Here, millions of feedback paths are provided, most of which pass through the conscious brain. This brain has storage (memory), multiple feedback paths, and a special unit that reassembles past experience and produces new motor actions or ideas (intelligence).

It is an interesting point that the most intelligent of beings cannot produce ideas that have no basis in previous experience. The brain is thus not creating an idea from nothing, but is, by utilizing existing material, in effect, a complex machine. It is, in my opinion, not complex because its fundamental ideas are complex, but rather that simple bases of action are present in such quantity as to baffle a casual observer.

Thus it would appear to be possible, by the assembly of millions of sub-units to build an artificial brain, and since we can find the weaknesses of our present brain, one even better than we now have. The component parts would be no more complex than many of the circuits that are in common use today. It may not be generally realized that the parts of the body operate similarly to electronic circuits. A muscle could be considered as millions of tubes biased at differing voltages beyond cutoff. As the nerve signal (bias voltage) increases, more and more conduct, thus giving a greater total output. A muscle does not even have the flexibility of the triode, its conduction is of the stop-start variety, there are no graduations of current in individual tubes.

Thus we could treat a man as a very complex machine, which is what he really is. Here genetics takes hold and shows that there are 3^{10,000}, or even more, designs for this machine, so that one design is seldom duplicated; and even when it is duplicated, in identical twins, the same environmental differences occur as do in the production of our simple machines. Which perhaps explains why the simple bases of life have taken so long to be related to human machines. Thus, in feedback as in chemistry, the organic and the inorganic tread almost side by side.

I do, however, disagree with Mr. Parker

in his application of feedback to proving that the politics of the U.S.A. are the best. Feedback probably applies here as in other fields, but our knowledge is so small that it is mere patriotism to use the principle to attempt to prove that one system of government is better than another. While patriotism is, to my mind, an essential of the evolution of mankind to the best advantage, it should be reserved for occasions where it is needed, and not used to bolster a scientific argument. This latter and dangerous idea is occurring in Russia today, and is tending to cause the downfall of science as we know it. I would not like it to be said that Mr. Parker, or any other writer in the PROCEEDINGS OF THE I.R.E., studies with his "heart" rather than his head, and for that reason, I feel that such theories should be left out of journals of such high scientific standards as the PROCEEDINGS. Its pages should be reserved for facts and, where theories are put forward, they should be free from personal bias, being ideas for factual development and criticism by readers.

It has been suggested to me that the British government system may be compared to the effects of natural selection on life. Natural selection has in effect produced a system that suits the people, within limits, and it is perhaps the best system that could be produced in such a period in such an environment. The above is very true, but it is also true from genetic study that natural selection produces a fair result from what is offered it, and that many better results are possible but were never tried, or were perhaps cast aside without trial. As a patriot, I would say that my country is the best. As a scientist I know that it is full of faults, and that it must be criticized with the head and, as far as I am consciously able, without personal or patriotic bias.

R. G. SILSON
25 Edinburgh Drive
Kirton, Boston
Lincs., England

Comment on "Psychical Physics"*

We have just run across a most unusual book, "Psychical Physics," by S. W. Tromp, a professor of geology at Fouad I University, in Cairo, Egypt.

Radio and radar engineers had known for some time that modulated radio waves annoyed and confused birds. Navy radar men sometimes noted headaches and temporary sterility effects after working near radar transmitters for long periods. As one radar engineer dryly commented after one of these observations, "It doesn't say anything about this on page 176, so you can forget about what you saw and felt—it simply doesn't exist." On occasion, this humorous observation appears to apply equally well to some of our modern sciences as well.

In recent years, psychologists have made some rather thought-provoking discoveries in the field of "extrasensory perception" (ESP) or psychic phenomena. They found

that games of chance appeared to be influenced by intense mental concentration and that results of telepathic tests could not be explained away by laws of probability or by coincidence.

Biologists found a series of brain electrical currents which correlated with thinking processes—insects smell by a system of infrared-ray radar; a bird's sense of direction is largely derived from the earth's magnetic and electrostatic fields and a keen sense of smell; an eye disease of racing horses, known as "moon blindness," varies in intensity with the phases of the moon; certain areas of barren land are produced by harmful radiations emanating from the earth; and positions of the planetary bodies have a definite gravitational effect upon animal and plant life.

Tromp's broad and searching work, which could have been titled "The Effects of Radiation and Energy Fields Upon Animal Sensory Systems," dismisses almost none of the many known psychic phenomena, combines them into a general classification of "psychical physics," and successfully analyzes most of them with a solid array of well-known laws drawn from many scientific fields. Parapsychic phenomena are shown to be keen animal senses possessed by certain highly sensitive humans which operate through the usual electrical, chemical, and energy-field laws.

The scope and implications of this book are highly intriguing when viewed in the light of Wiener's "cybernetics," the British "thinking" servo, and electronic computers. A future age may see electronic mechanisms serving man by automatically responding at a distance to the feeble signals produced by his mental and physical processes.

TED POWELL
5719 69th Lane
Maspeth, L. I., N. Y.

Nikola Tesla, Inventor*

The discussion article on inventors was instructive.¹ However, it always puzzled us as to why Nikola Tesla's name is generally absent in most discussions on radio pioneering work. This prophetic genius dabbled with radio waves in the 1890's, and about 1900 prophesied worldwide radio broadcasting, multiplex carrier communications, radio news and time broadcast, pocket receivers, selective tuning, and the like. According to a science editor of the New York *Herald Tribune's* editorial staff, (J. J. O'Neill), Tesla discussed navigation radar in an article written in 1900—just four years prior to Christian Hulsmeyer's historic radar patent (Br. Pat. #13,170). We refer you to the appendix section of Tesla's "Experiments with Alternating Currents of High Frequency and Potential," McGraw Publishing Co., New York, N. Y.; 1904, and to "The Problem Of Increasing Human Energy", vol. LX, No. 2, page 209, June 1900, *Century Illustrated Monthly Magazine*.

TED POWELL
24 Nassau Road
Great Neck, L. I., N. Y.

* Received by the Institute, January 31, 1950.

¹ Henry W. Parker, "Feedback," *Proc. I.R.E.*, vol. 37, p. 1235; November, 1949.

* Received by the Institute, January 16, 1950.

¹ S. W. Tromp, "Psychical Physics," Elsevier Publishing Co. (Holland), New York, N. Y., 549 pp.; 1949.

* Received by the Institute, June 21, 1950.

¹ I. E. Mouroumteff, "Who is the true inventor," *Proc. I.R.E.*, vol. 38, pp. 609-612, June, 1950.

Institute News and Radio Notes

TECHNICAL COMMITTEE AND PROFESSIONAL GROUP NOTES

The Standards Committee held a meeting on June 29, under the Chairmanship of J. G. Brainerd. The Standards on Wave Propagation: Definitions of Terms 1950, as submitted by the Wave Propagation Committee were approved. The "Preliminary Standard on Radio Receivers: Method of Measurement of Spurious Radiation-Frequency Modulation and Television Receivers," were approved as submitted by the Receivers Committee. This Standard will not be published in the PROCEEDINGS; however, it will be available to those who make inquiries at Headquarters. . . . The Sound and Reproducing Committee held a meeting on June 8, H. E. Roys, Chairman. R. E. Zenner was appointed to represent this Committee on the Annual Review Committee. A meeting of the Measurements and Instrumentation Committee was held on June 1, under the Chairmanship of Ernst Weber. Dr. Weber has requested each Subcommittee Chairman to make a survey of the groups concerned with the fields covered by his Subcommittee. He requested his Chairmen to list these groups and indicate the standardization work in progress. It is expected that the survey will aid in establishing sub-personnel and will prevent duplication of work. A report was given on the activities going on in all the subcommittees. Dr. Weber will serve as Chairman of the newly formed Joint Committee of IRE and AIEE on High-Frequency Measurements. This Committee is sponsoring a Conference on High-Frequency Measurements, scheduled for January, 1951, in Washington, D.C. The National Bureau of Standards will also be a sponsor in this Conference. F. J. Gaffney has been appointed Chairman of the Technical Program Committee and has requested that suggestions for papers be sent to him at Polytechnic Research and Development Company, Inc., 66 Court Street, Brooklyn, N. Y. Dr. Lyons (NBS) will serve as Chairman of the Local Arrangements Committee. The co-operation of IRE and AIEE Sections in the vicinity of Washington have been enlisted. There will be four half-day sessions for papers and it is intended that they will preferably be a review of new developments and the most recent trends, so that lively discussions can be initiated. Chairman Weber announced that the IRE Papers Procurement Committee has been disbanded and a request has been made to the Technical Committees and Professional Groups to bring good papers to the attention of the Technical Editor of the PROCEEDINGS, or to ask authors to submit their papers for publication. This would apply to tutorial papers and in particular to papers which are both practical and educational. . . . A meeting of the Navigation Aids Committee was held on June 26, under the Chairmanship of P. C. Sandretto. Work on definitions is progressing in this Committee. Copies of the *Proceedings of the Electronics Com-*

ponents Symposium which was held in Washington, D. C., on May 9, 10, 11, 1950, are now available from Trielectro Company, 1 Thomas Circle, Washington, D. C., for \$3.50 per copy. . . . The new membership of the Joint Technical Advisory Committee for the year July 1, 1950, to June 30, 1951, are: J. V. L. Hogan, Chairman; Ira J. Kaar, Vice-Chairman; L. G. Cumming, Non-Member Secretary; and Ralph Bown, Haraden Pratt, Philip F. Siling, T. T. Goldsmith, Jr., D. G. Fink, and D. B. Smith. . . . At the June 21 meeting of the Committee on Professional Groups, the newly revised Manual For Professional Groups was approved. A new Group which will be known as the Professional Group on Radio Telemetry has been formed. Interest in Professional Group activities continues to run high

ELECTRONICS CONFERENCE PLANS VARIED TECHNICAL PROGRAM

Industrial electronic applications will be featured in the eighteen technical sessions of the National Electronics Conference to be held from September 25 to 27, at the Edgewater Beach Hotel, in Chicago, Ill. On Monday, September 25, the opening session at 10:00 A.M. is entitled "Microwaves and Antennas," and will be followed by meetings on "Magnetic Amplifiers," and "Dielectric Heating." The afternoon sessions for Monday will be on the following subjects: "Time-Position Measurement," "Circuits," and "Tube Technology."

On Tuesday, September 26, morning technical sessions will include: "Television," "Inspection and Control," and "Exploration and Navigation." Afternoon meetings will feature "Research Instrumentation," "Computers," and "Electroacoustics."

A session on "Oscillography" will open the Conference on Wednesday morning, followed by sessions concerning "Control Instrumentation" and "Nucleonics." The subject of "Industrial Control" will be discussed at the first afternoon session, after which "Signal Generators and Analysers" and "Nucleonics" will be presented.

The opening of the Conference on Monday, September 25, will be high lighted at the luncheon in the Marine Dining Room of the Edgewater Beach Hotel, when Wayne Coy, Chairman of the Federal Communications Commission will make an address. Mr. Coy will be introduced by Dr. W. L. Everitt, Dean of Engineering at the University of Illinois.

The subject "Is the Engineer Slipping?" will be discussed in a talk by E. A. McFaul, formerly of Northwestern University, at the Tuesday luncheon. Mr. McFaul will be introduced by Titus LeClair, of the Commonwealth Edison Company. Mr. LeClair is the National President of the AIEE. There will be an Old Timers' Night dinner in the Ball Room of the Hotel on Tuesday evening at 7:00 P.M.

John V. L. Hogan, President of the Interstate Broadcasting Company, Inc., and Radio Inventions, Inc., will speak on "What's Behind the IRE?" at the luncheon on Wednesday, introduced by Raymond F. Guy, National Broadcasting Company, and 1950 IRE President.

FIRST CALL! AUTHORS FOR IRE NATIONAL CON- VENTION!

E. Weber, Chairman of the Technical Program Committee for the 1951 IRE National Convention, to be held March 19-22, requests that prospective authors submit the following information:

1. Name and address of author
2. Title of paper
3. A 100-word abstract and additional information up to 500 words (both in triplicate) to permit an accurate evaluation of the paper for inclusion in the Technical Program.

Please address all material to E. Weber, Microwave Research Institute, Polytechnic Institute of Brooklyn, 55 Johnson Street, Brooklyn 1, N. Y. The deadline for acceptance is November 20, 1950. Your prompt submissions will be appreciated.

Calendar of COMING EVENTS

IRE West Coast Convention of 1950, Municipal Auditorium, Long Beach, Calif., September 13-15

Instrument Society of America Meeting, Memorial Auditorium, Buffalo, N. Y., September 18-22

National Electronics Conference, Chicago, Ill., September 25-27

National Academy of Sciences meeting, G. E. Research Laboratory, Schenectady, N. Y., October 9-11

IRE-AIEE Conference on Electronic Instrumentation in Nucleonics and Medicine, Hotel Sheraton, New York, N. Y., October 23-25

Audio Fair, Sponsored by Audio Society of America, Hotel New Yorker, New York, N. Y., October 26-28

Radio Fall Meeting, Syracuse, N. Y., October 30, 31, November 1

UNITED STATES AIR FORCE RESERVE OFFERS VARIOUS COMMISSIONS

Individuals without prior military service may now be commissioned in the U. S. Air Force Reserve, provided that they fulfill certain qualifications listed below. Former officers of the Army, Navy, and Air Force may be appointed or re-appointed in the Air Force Reserve, and subsequently, request active duty. Former airmen who do not have reserve status may be enlisted in the Reserve in their former grades and volunteer for active duty in those grades. The following opportunities are open to individuals without prior military service, former personnel of the Armed Forces of the United States, and all members of the Air Force of the United States (seeking appointment in a grade higher than that presently held), except regular commissioned officers of the USAF and USAFR or ANGUS officers on extended active duty in an Air Force of the United States. Officers holding commission in the Reserve Forces of the Army of the United States, Navy, Marine Corps, Coast Guard, Coast Geodetic Survey, and Public Health Service may not apply for appointment in the USAFR under the provisions of Air Force Regulation 45-15, September 23, 1949, until they have obtained a conditional resignation from their commissions.

1. *Communications Specialists*—Applicant must possess a college degree in electrical, communications, or radio engineering with a minimum of two years of progressive responsible experience with industry in the communication and/or electronics field in any combination of the following: the installation, maintenance, and repair of airborne and/or ground communications equipment involving experience in wire and radio communications, electronics, engineering, miscellaneous electrical and/or telecommunications engineering, including telegraph, telephony, cable, alarm and signal systems, traffic controls and their equipment such as switchboards, dial system, teletypewriters and facsimile transmitters and/or installation, management and operation of radio stations, telephone systems and navigational aids or systems. The applicant must currently be employed in one of the above specialties.

2. *Design and Development Officer*—Applicant must possess a college degree within one of the following or associated fields, with civilian experience to demonstrate that he has acquired a thorough knowledge of the physical and mathematical sciences underlying that field. A minimum of one year's experience is required, and the applicant must be working in the field for which applying at the time of application.

- Electronics Nuclear Physics
- Geophysics Metallurgy
- Engineering Basic physical sciences

3. *Photographic Equipment Engineer*—Applicant must possess a college degree in engineering with a minimum of three years' experience in the design, manufacture, or repair of cameras, or in the manufacture of optical instruments.

4. *Production Inspection Officer*—Applicant must possess a college degree in the field of mechanical, electrical, or chemical

engineering with a minimum of two years' civilian experience in industrial design production.

5. *Special Investigations Technical Officer*—Applicant must possess at least a bachelor degree in the engineering or physical science field and a minimum of two years' experience in any one of the fields listed below:

- Electrical and sound engineering
- Analytical chemistry

AGE REQUIREMENTS—All applicants must have passed their twenty-first birthday and on the date of appointment must not have reached the birth date indicated below for the grade for which applying.

| | |
|-------------------------|----|
| Second Lieutenant..... | 28 |
| First Lieutenant..... | 33 |
| Captain..... | 37 |
| Major..... | 45 |
| Lieutenant Colonel..... | 51 |
| Colonel..... | 56 |

Interested applicants may write to Military Liaison Committee, 1 East 79 Street, New York 21, N. Y., for further information, including names and locations of officers to whom application should be made, application blanks, etc. Many other opportunities, not listed, are offered to technical and professional specialists. If your specialty is not covered by the above list, write for further information, giving full details.

ISO WILL HOLD 1952 GENERAL ASSEMBLY IN UNITED STATES

The International Organization for Standardization has accepted an invitation to hold its General Assembly in the United States. Delegates of the 29 countries that are members of the ISO will be guests of the American Standards Association. As the U. S. member, the ASA presents the viewpoint of U. S. groups on standards that come before the ISO for international consideration. More than 100 national technical societies and associations, and some 1,700 leading industrial firms are ASA members.

Seventy-one international technical committees are working to bring about agreement on definitions, terminology, specifications, dimensions, and test methods in the national standards of the member countries to increase understanding and easier interchange of products.

Countries now members of the ISO are: Australia, Austria, Belgium, Brazil, Canada, Chile, Denmark, Finland, France, Hungary, India, Israel, Italy, Mexico, Netherlands, New Zealand, Norway, Poland, Portugal, Switzerland, Sweden, Czechoslovakia, Union of South Africa, United Kingdom, Uruguay, United States of America, Union of Soviet Socialist Republics, and Yugoslavia.

RADIO, TV, ELECTRONICS EXHIBIT WILL BE HELD IN PHILADELPHIA

The second annual Radio, Television and Electronics Exhibit sponsored by the Philadelphia Radio Service Men's Association will be held at Philadelphia's Broad-

wood Hotel from September 25-27, for the purpose of acquainting servicemen, dealers, and others in the servicing industry with the newest developments in electronics. Many important educational seminars and lectures will be held during the daily sessions, which will begin at 7:00 P.M., September 25, and run from 10:00 A.M. to 10:00 P.M. on September 26 and 27.

Activities of the first evening will be concentrated on an introductory program with addresses by key industrial figures and civic officials, plus the opening of the many trade displays which will hold prominent positions in the main ballroom of the Broadwood Hotel.

An invitation to attend the show has been extended to all organizations and servicemen. Tickets of admission will be distributed by all Parts and Radio Distributors.

NATIONAL BUREAU OF STANDARDS HAS 50-MILLION VOLT BETATRON

A 50-million volt betatron, designed and constructed by the General Electric Company, has been installed in the National Bureau of Standards' new betatron laboratory, extending the Bureau's high-energy research into the region from 2 to 50 million electron volts. For work at even higher energies, a 180-million volt synchrotron, now being completed by General Electric, will be installed at the Bureau next year.

The NBS research program with these machines has four main aspects: the investigation of shielding and protection against high-energy radiations, the medical applications of these radiations, their industrial applications, and their basic physical properties.

X-rays with energies between 10 and 70 million volts are now widely used in the medical treatment of deep-seated tumors. These high-energy radiations are directed to burn out a pinpoint of afflicted tissue deep within the human body without damaging the surrounding area, but proper protective precautions are of the greatest importance—both to the patient and to the radiologist administering the treatment. The new betatron research program will fill the need for standards of protection in the higher regions now available to medicine.

Components Conference Papers Available

Papers delivered at the IRE-AIEE-RMA Conference on Improved Quality Electronic Components held in Washington, D. C., on May 9-11, 1950, have been published together in a proceedings of the conference which may be obtained from Trielectro Company, 1 Thomas Circle, Washington, D. C.

Industrial Engineering Notes¹

TELEVISION NEWS

Production of home radio receivers, including portables, increased in May as television set production dropped slightly below the record level of the past two months, according to RTMA member-company reports. May production of home radios by RTMA member-companies totaled 693,592 sets, compared with 648,352 receivers of this type produced in the preceding month. RTMA member-companies also reported the manufacture of 206,464 automobile radios in May. Television set production in May amounted to 376,227, compared to 420,026 sets in April. The average weekly rate of TV set production in May at 94,057 sets per week was only 10 per cent under the April rate. Radio receivers equipped for FM reception totaling 86,405 were reported to RTMA in May. In addition, 30,582 TV receivers produced contained FM facilities. . . . Michigan State College has filed a petition with the FCC for reallocation of television channel No. 12 from Grand Rapids to East Lansing, Mich. If this were not granted, the College asked that some other channel which the FCC should deem suitable for that location be granted. Recently the State Board of Agriculture appropriated \$100,000 for installation of a TV studio and authorized the College to apply for a station. . . . Sales of television receivers to dealers in TV broadcasting areas during April are estimated at 369,000, according to a tabulation released by RTMA. The April report shows set shipments by manufacturers to dealers in 36 states and the District of Columbia. The estimate includes shipments by nonmembers as well as RTMA member-companies. TV set shipments during the first four months of 1950 are estimated at 1,925,000 by RTMA.

FCC ACTIONS

Television broadcasting and manufacturing interests have strongly opposed the petition of the Bell Telephone Laboratories, Inc., for assignment of the 470- to 500-Mc band to broad-band mobile telephone service. The hearing before the FCC on the mobile request was completed with indications that the Commission would not act on the request until after it completes the forthcoming uhf allocation hearing. It was also indicated that the two questions are so related that the FCC decisions will be handled down simultaneously. . . . The Multiplex Development Corp., of New York, N. Y., has been granted authority to operate a developmental broadcast station, for a period of 90 days, for the purpose of field testing its newly developed multiplex system. The proposal involves the simultaneous transmission of one or more multiplexed aural FM programs concurrently with the emission of the main aural program without impairing the quality of the main program

¹ The data on which these NOTES are based were selected, by permission, from *Industry Reports*, issues of June 12, June 16, June 23, and June 30, published by the Radio Manufacturers Association, whose helpful attitude is gladly acknowledged.

within the audio-frequency range between 30 and 15,000 cycles, and without exceeding the presently assigned channel widths of FM broadcast stations. . . . The FCC has proposed to amend its rules governing the Citizens Radio Service to permit the operation of these stations by any person authorized to do so by the station licensee where manually operated telegraphy transmitting by any type of the Morse Code is not involved. This would, for example, permit operation of radio-controlled devices, such as model aircraft equipment, the FCC said. . . . Completion of the American Telephone and Telegraph Company's proposed transcontinental microwave relay system is authorized in grants made by the FCC. Chief among these are construction permits for 55 microwave relay stations to bridge the present gap between Omaha and San Francisco. This final link is scheduled to be completed by January 1, 1952. It will provide four microwave channels, two of which will be used for television circuits, one in each direction. The other two channels will carry telephone traffic. Construction of the New York-Chicago portion of the cross-country microwave route is virtually completed, and is expected to be available for intercity TV network service in the near future. The Chicago-Omaha section, under construction, is planned to be ready for operation by April, 1951. As in the case of the coaxial cable, microwave relay can be used to augment TV network broadcast operation. The two facilities can be interconnected. . . . The estimated construction costs involved in today's microwave relay grants total \$20,400,000 of which amount \$17,900,000 is for the Omaha-San Francisco link, and \$2,500,000 for additional equipment in the Chicago-Omaha section. This will bring the indicated cost of the completed transcontinental microwave system to \$37,590,000. . . . Detailed technical information on RTMA's activities with respect to interference problems caused by oscillator radiation from FM receivers was filed with the FCC by W. R. G. Baker, Director of the RTMA Engineering Department. The information was in reply to an FCC request for assistance in eliminating an air traffic hazard in the vicinity of Crawfordsville, Ind. Dr. Baker also sent a letter to members of the RTMA Board of Directors, pointing out that the problem was one for individual set manufacturers and urged them to instruct their engineers to give the matter immediate attention. . . . The FCC amended its rules to establish a new class of commercial radio operator license designed to meet the need for a non-technical radio-telephone operator license intermediate between the second class and restricted operator's license. Among the stations included in the scope of authority of the new radio-telephone third class operator permit are low-power noncommercial educational FM broadcast stations (10 watts or less). . . . The number of radio and TV broadcast station authorizations issued by the FCC in the United States and its possessions totalled 3,226 as of June 7. The grand total included 2,295 AM stations, 740 commercial FM outlets, 82 noncommercial educational FM stations, and 109 television stations.

RADIO AND TELEVISION NEWS ABROAD

It is estimated that another year will pass before television broadcasting is available in Germany, according to a report to the U.S. Department of Commerce. At that time, the report says, TV apparatus will have to be imported from abroad. Imports of radio receivers into the Union of South Africa in 1949 totaled 57,474 units valued at 538,514 pounds of which 11,396 sets valued at 114,054 pounds were from the United States. Imports of valves totaled 407,556 units at 77,091 pounds during the year. United States manufacture supplied 214,472 tubes at 32,701 pounds. . . . Production of radio receiving sets in Switzerland in 1949 totaled 56,500 to surpass the output of 1948 and 1947, according to a report from the U.S. Embassy at Berne. Sales, however, slackened so that at least 15,000 sets produced during the year were still in stock. . . . There were an estimated 12,335,088 radio licenses in force in the British Isles at the end of April, according to information received by the U. S. Department of Commerce. Of this total, 360,265 were television receivers. A German request to use radar on merchant vessels has been granted by occupation authorities. The first radar facilities have been installed on a merchant ship and others are expected to be granted in the near future. . . . There are approximately a dozen radio stations in South Korea and 317,000 sets in use, according to information obtained by RTMA from the U. S. Department of Commerce. Only 2,462 of the Korean radio receivers are capable of short-wave reception, according to Commerce information. At the time of liberation from the Japanese there were 10 radio stations operating in South Korea, and the transmitting equipment was of Japanese manufacture copied from German or U.S. models, the department said. . . . The British Radio Industry Council has informed the Postmaster-General that it is prepared to finance the installation of temporary apparatus to establish a cross-channel link for the exchange of TV programs with France at the earliest possible date. A memorandum from the Council, according to information received by the U.S. Department of Commerce, urges that immediate steps be taken in co-operation with French organizations to establish the means for an interchange of TV programs.

MAN-HOUR REPORT IS ISSUED ON RADIO INDUSTRY BY LABOR

The Bureau of Labor Statistics, U.S. Department of Labor, has published a comprehensive report entitled "Trends in Man-Hours Expended Per Unit, Home Radio Receivers." The 56-page study covers the years 1939 to 1947 and is one of a series of reports of various industries compiled in the Bureau's Branch of Productivity and Technological Developments. The report has been under preparation at the Bureau for two years, with the aid of industry and RTMA.

Copies of the Labor Department study are available upon request from the Division of Manpower and Productivity of the Bureau of Labor Statistics, U.S. Department of Labor, Washington 25, D.C.

R. C. SPRAGUE ELECTED HEAD OF NEWLY REORGANIZED RMA

Robert C. Sprague, president of the Sprague Electric Company and long active in RMA affairs, was elected president and chairman of the RMA Board of Directors at the conclusion of the 26th annual convention held in June at the Stevens Hotel, in Chicago, Ill. His election followed membership approval of amendments to the RMA By-Laws authorizing the Board of Directors to effect a broad-scale reorganization of the Association.

Mr. Sprague, who has been a director of RMA since 1943, succeeds R. C. Cosgrove, who completed his fourth term as president of RMA. Mr. Sprague is a former chairman of the RMA Parts Division, and was particularly active in association and industry affairs during the war and the reconversion period. He was formerly chairman of the OPA Industry Advisory Committee of the Radio Parts Industry and a member of the WPB Advisory Committee on Electric Condensers. More recently, he has been directing an educational program for dealers and servicemen in his capacity as chairman of the RMA "Town Meetings" Committee.

RMA members at the annual membership meeting voted to change the name of the Association to Radio-Television Manufacturers Association, in recognition of the growing importance of television to the industry. The change in name becomes effective upon filing of necessary amendments to RMA's Illinois incorporation charter.

All amendments to the RMA By-Laws proposed by the RMA Organization and Services Committee, of which Director J. J. Kahn was chairman, were adopted at the membership meeting, but with the specific condition that the proposed new scale of maximum dues will not become operative until after an acceptable reorganization plan is developed and adopted by the RMA Board of Directors.

President Sprague will shortly appoint a new RMA Reorganization Committee to continue the examination of the RMA structure and services initiated during the past year by the RMA Organization and Services Committee.

The authorized reorganization plan provided in the revised By-Laws makes possible the election of a full-time salaried president of RMA whenever the Board of Directors so desires. It also creates a new office of chairman of the board and re-defines the duties of various Association officials and readjusts the dues scale. The RMA constitution is repealed in its entirety as unnecessary under the present Illinois charter.

Five new directors and nine former directors were elected Thursday morning at annual meetings of the five Divisions. Chairmen of the five Divisions and vice-presidents representing each Division also were elected.

Leslie F. Muter of Chicago, was re-elected treasurer of the Association for his fourteenth term. The Board also reappointed W. R. G. Baker of Syracuse, as Director of the RMA Engineering Department and John W. Van Allen of Buffalo as General Counsel, the latter for his 24th year.

The five new directors of RMA are: Robert S. Bell, assistant to president, Packard-Bell Co., Los Angeles, Calif.; John W. Craig, vice-president and general manager, Crosley Division, Avco Mfg., Corp., Cincinnati, Ohio; Robert C. Tait, president, Stromberg Carlson Co., Rochester, N.Y.; R. G. Zender, vice-president, Lenz Electric Manufacturing Co., Chicago; and R. S. Perry, sales manager, Federal Telephone and Radio Co., Clifton, N.J.

The nine former directors who were re-elected are: E. Alschuler, president, Sentinel Radio Corp., Evanston, Ill.; G. M. Gardner, chairman, Evans-Gardner & Co., Chicago; H. L. Hoffman, president, Hoffman Radio Corp., Los Angeles; H. C. Mattes, executive vice-president, Belmont Radio Corp., Chicago; R. E. Carlson, vice-president, Tung-Sol Lamp Works, Inc., Newark, N.J.; H. J. Hoffman, vice-president, Machlett Laboratories, Inc., Springdale, Conn.; Ray F. Sparrow, vice-president, P. R. Mallory and Co., Inc., Indianapolis; Arie Liberman, president, Talk-A-Phone Co., Chicago; and President Sprague.

The Board of Directors, upon recommendation of the Set Division Executive Committee, appropriated funds to publish and distribute the results of a survey of the effects of television on public attendance at sports events. The survey was conducted by Jerry N. Jordan of Philadelphia, in connection with graduate work at Princeton University. The report, which is entitled "Long Range Effect of Television and Other Factors on Sports Attendance," has been widely approved for its factual analysis of the subject. RMA plans to distribute it widely to sports organizations, colleges and universities, broadcasters, television manufacturers, and other interested parties.

The RMA Industry Statistics Committee was authorized by the Board of Directors to eliminate the weekly detailed statistics on production of television and radio receivers by RMA members and to substitute a simplified report projected for the industry. The detailed tabulations, however, will be continued on a monthly basis. The Parts Division Executive Committee approved a new statistical service for Parts Division members which will provide monthly information on dollar sales volume of parts manufacturers compared with similar months in the previous year.

U.S. SUPREME COURT ISSUES IMPORTANT PATENTS' RULING

A ruling of far-reaching importance to the radio industry was issued by the U.S. Supreme Court in June, when it upheld the right of Hazeltine Research, Inc., to recover royalties from the Automatic Radio Manufacturing Co., Inc., under the former company's licensee agreement.

Both the District Court and the Court of Appeals had previously ruled in favor of Hazeltine in its suit to collect the minimum royalty under its agreement, for an accounting of other sums due, and for other relief.

The questions for determination, the Supreme Court said, are whether a misuse of patents has been shown, and whether the petitioner may contest the validity of the licensed patents, in order to avoid its obliga-

tions to pay royalties under the agreement.

The decision of the Court broke these questions down and answered them in the following manner:

"It is insisted that the license agreement cannot be enforced because it is a misuse of patents to require the licensee to pay royalties based on its sales, even though none of the patents are used." . . . The Court declared: "We cannot say that payment of royalties according to an agreed percentage of the licensee's sales is unreasonable. Sound business judgment could indicate that such payment represents the most convenient method of fixing the business value of the privileges granted by the licensing agreement. We are not unmindful that convenience cannot justify an extension of the monopoly of the patent. But as we have already indicated, there is in this royalty provision no inherent extension of the monopoly of the patent. Petitioner cannot complain because it must pay royalties whether it uses Hazeltine patents or not."

In ruling on whether Automatic Company could contest the validity of patents it used under the licensing agreement, the Court held that the following general rule applied: "The general rule is that the licensee under a patent license agreement, may not challenge the validity of the licensed patent in a suit for royalties due under the contract."

The court decision also noted that the "mere accumulation of patents, no matter how many, is not in and of itself illegal."

The dissenting opinion of Justice Douglas and Justice Black held that "a plainer extension of a patent by unlawful means would be hard to imagine." It contended that the patent owner used the patents to "bludgeon his way into a partnership with this licensee, collecting royalties on unpatented as well as patented articles."

D. B. SMITH IS NAMED VICE-DIRECTOR OF RMA ENGINEERING DEPARTMENT

David B. Smith, vice-president of Philco Corp., has been named vice-director of the RMA Engineering Department by Director W. R. G. Baker. Mr. Smith has long been active in the affairs of RMA, and many times has represented the Association before the Federal Communications Commission and other government agencies.

Dr. Baker also reappointed Virgil M. Graham, of Sylvania Electric Products Inc., as associate director. Mr. Graham has assisted in directing the RMA Engineering Department since the early thirties.

NBS ELECTRONIC COMPUTER IS DEMONSTRATED TO GOVERNMENT

SEAC, a high-speed, general-purpose, automatic electronic computer, which was designed and constructed in 20 months by the National Bureau of Standards, has been demonstrated before high government and military officials.

The project was sponsored by the Office of the Comptroller, Department of the Air Force, and is being operated by the Bureau of Standards to provide a fast and powerful computational tool for the Air Force and for the solution of important, unsolved general scientific and engineering problems.

IRE People

Arthur Bessey Smith (M'34-SM'43), vice-president of Automatic Electric Laboratories, Inc., was awarded the honorary degree of doctor of engineering in recognition of his many contributions in the field of communications at the seventy-ninth annual commencement of the University of Nebraska. Dr. Smith, who was graduated from the University of Nebraska in 1901, for many years was chief research engineer of the Automatic Electric Company, Chicago, Ill.



ARTHUR B. SMITH

The citation accompanying his degree reads: "Designer and inventor of circuits and devices used in telephony. Pioneer in the field of communication. One-time teacher at Purdue University. Organizer of industrial training course for young engineering employees. Member of international committees on acoustics, and standardization of electrical terms, definitions, abbreviations, and symbols. Author of technical papers. Active member of technical societies. Guide and counsellor to researchers. Inspiration to young engineers."

During the early years of his career, he worked for various telephone companies in Nebraska, Iowa, and New York, later going to Purdue University, where he taught telephone engineering during the period 1905 to 1909.

Dr. Smith, who joined Automatic Electric Company in 1909 as assistant to the sales manager, was transferred shortly afterwards to the Development and Research department as head of the research group. In 1912, he established the Automatic Electric Training School, of which he is now the director. It was during this period also that he collaborated with W. Lee Campbell in the preparation of the first general treatise devoted exclusively to "Automatic Telephony." He has also authored other works in the same field, as well as a large number of technical papers and articles on telephone switching, transmission, and allied topics.

In 1926, Dr. Smith received the degree of doctor of philosophy in physics from Northwestern University, based on his investigation of the phenomena underlying the slow acting relay.

Dr. Smith is currently serving on one of the committees of the American Standards Association engaged in revising the American Standard Electrical Terms.

❖

John Milton Miller (A'17-F'20) has been appointed as special consultant to E. O. Hurlburt, director of research, at the Naval Research Laboratory, Washington, D. C. He will serve as consultant in the field of electronic research and development.

Dr. Miller, who has been superintendent of Radio Division I at NRL since 1945, is a native of Hanover, Pa. He was graduated from Yale University, and received the degree of doctor of philosophy in physics in 1915. From 1907 to 1919 he was a physicist with the National Bureau of Standards; from 1919 to 1923, a radio engineer at the Radio Laboratory, Air Station, Navy Department at Anacostia. In 1923, he joined the Naval Research Laboratory as a radio engineer.

During the period from 1925 to 1936 he was in charge of radio receiver research at the Atwater Kent Manufacturing Company, Philadelphia, Pa., and from 1936 to 1940 he was assistant head of the research laboratory for the RCA Radiotron Company.

He returned to NRL in 1940 as associate superintendent of the Radio Division, becoming superintendent of Radio Division I in July, 1945. Dr. Miller, who has served as a patent expert with the Federal Government, has invented fundamental circuits for quartz crystal oscillators, used universally today for frequency stabilization, and has helped to perfect crystals cut to have zero temperature coefficient. With Louis A. Gebhard, superintendent of Radio Division II at NRL, he designed the first high-powered crystal controlled radio transmitter.

The author of numerous scientific papers in the field of radio, Dr. Miller was awarded the Distinguished Civilian Service Award in 1945 for "initiation of the development of a new flexible frequency cable urgently needed in radio and radar equipment which, through his related developments of techniques for the mass production and inspection of such cable, not only met a universal need in the Armed Forces, but solved a desperate material shortage in the United States in World War II."

J. A. Hutcheson, (A'28-M'30-SM'43-F'48), director of research, Westinghouse Electric Corporation, Pittsburgh, Pa., will become chairman of the Committee on Ordnance, Research and Development Board. Dr. Hutcheson has served the committee as a consultant for the past two years.

He joined the Westinghouse Corporation shortly after his graduation in 1926 from the University of North Dakota, and has been director of research since March, 1948. During the war he supervised the engineering of all the radio communication and radar equipment produced by Westinghouse for the armed forces.



J. A. HUTCHESON

During his early association with Westinghouse, Dr. Hutcheson designed new types

of equipment for the fast-growing radio industry, both for the armed forces and for commercial stations. During 1932 and 1933 he designed the modulation system for the 500-kw radio broadcasting transmitter at WLW, Cincinnati, Ohio, then the most powerful kind in the world.

When development of atomic energy shifted to peacetime application, Dr. Hutcheson became chief advisor to a group formed to co-ordinate and advance all atomic energy research within the Westinghouse Corporation.

❖

John A. Green (S'39-A'42-M'45-SM'46) has established the John A. Green Company, manufacturers' representatives, and the



JOHN A. GREEN

Equipment and Service Company, consulting engineers and electrical manufacturers, at 6815 Oriole Drive, Dallas, Texas. For nine years Mr. Green has been an electrical engineer with the Collins Radio Company, Cedar Rapids, Iowa, and for the past several years has been head of that Company's broadcast engineering department.

Mr. Green, who was graduated from Purdue University, is also a member of the American Institute of Electrical Engineers and of the American Petroleum Institute, and is a licensed professional engineer in the State of Oklahoma.

The John A. Green Company will represent several well-known manufacturers as their sales engineer in the States of Texas, Oklahoma, Arkansas, Louisiana, and New Mexico. The Equipment and Service Company will devote its services to industrial, electronic, broadcast, and electrical engineering problems.

❖

Loren B. Harrell (A'43), founder and president of Harrell, Atcheson and Adams, Inc., passed away recently after a short illness. He was thirty-nine years old.

Prior to his organization of the aforementioned firm, he had been engaged in radio distribution and engineering in Florida. During the war he served as a radio engineer with the Signal Office, Fourth Service Command, first organizing and supervising the pre-radar training schools at Fort McPherson, Ga. He was then assigned to work with air-ground radio facilities throughout the Command.

IRE People

Beatrice A. Hicks (S'42-A'44) of Upper Montclair, N. J., was elected president of the Society of Women Engineers at the annual convention held in May. Born in New Jersey in 1919, Miss Hicks obtained the B.S. degree in chemical engineering from Newark College of Engineering in 1939, and the M.S. degree in physics from Stevens Institute of Technology in 1949.



BEATRICE A. HICKS

From 1939 until

1942, she was a research worker at Newark College of Engineering. In 1942 she joined the Western Electric Company at Kearny, N. J. After some months spent in test set design, she transferred to work in quartz crystal production and contributed substantially to dimensional development. In 1945 Miss Hicks joined Newark Controls, Bloomfield, N. J. She is now chief engineer and vice-president of this concern, engaged in the manufacture of liquid level controls and other similar devices.

Miss Hicks, who is the wife of R. D. Chipp (A'34-SM'43), is also a member of the American Society of Heating and Ventilating Engineers, the Society of Women Engineers, and is a registered professional engineer in the States of New York and New Jersey.



Finley W. Tatum (A'43-SM'47) has been promoted to the rank of professor of electrical engineering in the School of Engineering, Southern Methodist University, Dallas, Texas. Professor Tatum joined the faculty of Southern Methodist University in 1947. Formerly he had been an engineering supervisor for the American District Telegraph Company in New York, N. Y.



Francis X. Rettenmeyer (A'26-M'29-SM'43-F'44) has recently joined the Philco Corporation as executive engineer to assist in the engineering administration of the Company's Government and industrial electronics program, according to an announcement by Leslie J. Woods, vice-president—director of engineering and research.



F. RETTENMEYER

Mr. Rettenmeyer was graduated from the University of Colorado with the B.S.E.E. degree in 1922, and received the M.S. degree in physics and mathematics from Columbia University in 1925. He was associated with the

Bell Telephone Laboratories for the next ten years, and advanced to the position of engineer in charge of receiver and navigation equipment design. During the next decade he was with RCA, as chief receiver engineer in the home instrument division. For the period 1945-1950, he has been chief engineer for Federal Radio and Telegraph Company. In his new position with Philco, Mr. Rettenmeyer will assist in the administration of electronic research and development projects for various departments of the armed services, and also of such industrial equipment as the microwave relays for television and communications which Philco is now supplying to major industrial customers.



Alexander M. Lewyt (SM'46), president and general manager of the Lewyt Corp., Brooklyn, N. Y., is one of the 1950 winners



A. M. LEWYT

of the Horatio Alger Award given annually by the American Schools and Colleges Association to leaders in American business, who symbolize the American tradition of overcoming handicaps and achieving success through industry, sacrifice, and ethics. His company manufactures the Lewyt vacuum cleaner, and employs 1,500 people on multimillion dollar electronic contracts for the government and private contractors. Mr. Lewyt studied electrical and mechanical engineering courses at various institutions including Pratt Institute, Columbia University, and New York University.

Mr. Lewyt joined his father in the business 20 years ago and assumed the entire responsibility in 1935.



Charles N. Kimball (A'34-M'40-SM'43) has been elected president of Midwest Research Institute, Kansas City, Mo. He is a graduate of Northeastern University and received the doctor of science degree from Harvard in 1934.

Upon his graduation he became a tube development engineer with the National Union Radio Corporation. In 1935, he joined the License Division Laboratories of the Radio Corporation of America in New York, N. Y., where he worked on television, frequency modulation, and special communication studies.

Dr. Kimball was vice-president in charge of engineering at Aireon Manufacturing Corp. in Kansas City from 1940 through 1946, during which period he was a member of the Board of Directors. He supervised work on many projects, including radar

countermeasure equipment and underwater sound techniques.

During 1947 and 1948 he worked on instrumentation problems in the food processing industries, with the C. J. Patterson Company of Kansas City.

From 1948 until June 1, when he assumed his new position, he was technical director for Bendix Aviation Corporation's Research Laboratories in Detroit.

Dr. Kimball, who is the author of several papers on television and electronics, also holds patents in these fields. He is a member of Tau Beta Pi, the Harvard Engineering Society, the American Association of Cereal Chemists, and the Institute of Aeronautical Sciences. He is a former officer of the Kansas City Section of the IRE.

At Midwest Research Institute, founded in 1945 as a nonprofit organization to promote research and stimulate industry throughout the middle west, Dr. Kimball is responsible for the integration of all facilities of the organization's activities, and plays an important part in contacts between the institute and its trustees, civic and industrial leaders and sponsors of research projects.



Winfield W. Salisbury (SM'44-F'47), director of research for the Collins Radio Company, Cedar Rapids, Iowa, was awarded



W. W. SALISBURY

the honorary degree of doctor of science from Cornell College, Mount Vernon, Iowa, at the annual commencement.

Mr. Salisbury was born at Carthage, Ill., on December 27, 1903. He was graduated from the University of Iowa with the A.B. degree in 1926 and served as a

teaching fellow at the University of California during 1927 and 1928.

For the following nine years he was a consulting engineer and then in 1937 joined the U. S. Department of Labor as an employment analyst. From 1938 until 1941 Mr. Salisbury was a member of the staff of the Radiation Laboratory, University of California. Then he became group leader of Group A and co-ordinator of groups A, Q and R, Radio Research Laboratory at Harvard University after a year at MIT. He was manager of the high power division of Harvard's Radio Research Laboratory during 1943 through 1945, engaged in work on microwaves, ion sources, cyclotron engineering, and ultrasonics.

Mr. Salisbury is a Fellow of the American Physical Society, member of the New York Academy of Sciences, member of the Society of Sigma XI, Fellow of the American Association for the Advancement of Science, member of the American Astronomical Society, and of the Association of Atomic Scientists.

Books

Radio Operating, Questions and Answers by J. L. Hornung

Published (1950) by McGraw-Hill Book Co., Inc., 330 West 42 St., New York 18, N. Y. 539 pages +4-page index +xii pages +22-page appendix. 133 figures. 5x7 $\frac{1}{2}$. \$5.00.

This is the tenth edition of a "Questions and Answers" book on radio which has been of real use to radio students in recent years. The text is readable, and is as complete as the coverage of books of this type can well be. The book is of particular use to radio amateurs who desire to check the extent of and accuracy of the knowledge they have acquired through practice. It is of use to technical school graduates who desire to make sure that specialization in school has not deprived them of a rounded fund of knowledge.

The author of the book is aware that radio theory and operation in its various phases cannot be successfully mastered by the use of a questions-and-answers book alone, and recommends that students complete a course in basic theory in a reputable correspondence or residence school. Radio applications have expanded so that there are a great number of avenues of employment. Engineers and technicians moving from one type of position to another usually find it of advantage to "brush up" on the technical requirements of the new job. In this situation the questions-and-answers book is helpful in disclosing shortcomings, shortcomings which may be made up by mastering the answers as herein given, or by studying more advanced textbooks which contain the special knowledge of immediate interest.

This 1950 edition of Hornung's book contains answers to FCC examination questions in Elements 1, 2, 3, 4, 5, 6. Element 7, released by the FCC, effective January 3, 1950, embodies a total of 266 questions dealing with rules and regulations. There are included also 46 special problems dealing with the more complex questions given in the widely distributed FCC Guide.

In a future edition of this work, the reviewer would like to see incorporated specific, detailed information about railroad and mobile radio. This general application of radio is becoming a major field, entitled to direct treatment by technical writers.

DONALD MCNICOL
25 Beaver St.
New York, N. Y.

Electronics in Engineering by W. Ryland Hill

Published (1949) by McGraw-Hill Book Co., Inc., 330 W. 42 St., New York 18, N. Y. 265 pages +4-page index +3-page appendix +viii pages. 184 figures. 9x6. \$3.50.

The author of this text has set himself the difficult task of writing for the non-electrical student of engineering, and has succeeded rather well. The book is largely descriptive, and the author has not spared words where needed to avoid student difficulty in understanding the material. This is especially illustrated by the sections on triode characteristics and load-line analysis.

At the same time mathematics is introduced at critical points to show to the student that a quantitative background does exist.

The usual basic tube types are covered, and a short qualitative discussion of the underlying physical processes is given. The material chosen runs the gamut from poly-phase rectifiers to oscillators, modulators, and photoelectric devices. In addition, several chapters given over to tube applications of types encountered in colorimeters, ph meters, counters, and temperature measurement. The material on the vacuum-tube voltmeter also seems incomplete considering the broad present use of the device.

As in many efforts to reduce rigorous material to a nonmajor level, certain inaccuracies creep in through generalizing of statements. Several of these include the implication that the work function energy is due to overcoming only the image forces; that tube input capacities are due to the geometric capacities only, no indication being given of the Miller effect; and that modulation over 100 per cent is desirable as in Fig. 13.2.

The publisher states on the jacket that "problems are worked out in the text to illustrate the discussion." The reviewer was able to find only three such problems, and this seems hardly a sufficient number to justify an advertising statement.

It is unfortunate that the publisher has seen fit to further perpetuate the nonstandard circuit symbol for the capacitor, which was declared obsolete in 1946 by the ASA.

J. D. RYDER
University of Illinois
Urbana, Ill.

New Publications

Management of Industrial Research is a selected and annotated bibliography of books and articles, which is available to the public free of charge, and is published by Arthur D. Little, Inc., Cambridge 42, Mass.

It has been prepared from the viewpoint of the research director and those in charge of research policy, and has been made publicly available because of the interest shown by many organizations in a fundamental review of their research policies, objectives, procedures and programs.

Among the chapter headings of the bibliography are the following: General References; Organization; Control; Research Program; and Research Laboratory.

Facsimile by Charles R. Jones

Published (1949) by Murray Hill Books, Inc., 232 Madison Ave., New York 16, N. Y. 401 pages +8-page index +10-page glossary +xvii pages. 223 figures. 6x9. \$6.00.

The book "Facsimile" in the author's words has been written to assemble between two covers as much as possible of the available information on modern facsimile

methods and systems in this country. He points out that emphasis has been placed on the methods and devices, rather than on theory. The book is divided into four parts: What Facsimile Is; How Facsimile Works; Present-Day Facsimile Methods; and Servicing. In describing what facsimile is, he gives a short resume of the history of facsimile and a very brief description of modern facsimile systems.

He also describes the many ways in which facsimile may be used. He points out the economical considerations and problems involved in facsimile broadcasts. A two-page illustration showing an example of facsimile news broadcasting is very discouraging, hard to read, and blurred. I have seen much better facsimile receptions, and I think more care should have been used in picking out the illustration.

Part 2 describing how facsimile works tells of the many processes used in transmitters and receivers. Facsimile synchronization and phasing is discussed very briefly. Tape facsimile standards are also discussed. These two parts cover less than one-half of the book.

Part 3 is a catalog description with some operating details of the different types of equipment made by the various facsimile manufacturers. In fact, Chapter 12 is devoted to a list of the various facsimile manufacturers and addresses, affiliations, and activities. It seems to me that more space ought to have been devoted to the basic principles, rather than to the detail descriptions of the equipments that each of these manufacturers make.

In part 4 which is "Servicing" there are four pages of general descriptions of the various items that have to be considered when servicing. The other 30 pages are excerpts from servicing notes which should be available from the manufacturer. Most of these notes are meaningless, unless the equipments were available. For instance, on page 383 item 7 reads "Auxiliary side plate (plate 3, #14): remove the four 10x32 flat head screws on the inside. Do not remove the four screws which hold the auxiliary plate spacer to right side plate."

From the contents of the book and the aims of the author it seems to be a general introduction of facsimile which should meet the needs of someone who required a broad outline of the field of facsimile. For this purpose the first half of the book is excellent. However, the second half of the book could have been condensed into about one-fourth of its length, if the author had chosen only examples of the different basic types of facsimile and perhaps mentioned the others. The service notes are of interest to those who might want to write service notes for facsimile equipment; otherwise the perusal of these notes is boring and meaningless.

NATHAN MARCHAND
Sylvania Electric Products Inc
Physics Laboratory
P.O. Box No. 6, Bayside, L. I., N. Y.

Sections*

| Chairman | | Secretary | Chairman | | Secretary |
|--|--|--|---|-----------------------------------|---|
| J. S. Hill Box 298 Hudson, Ohio | AKRON (4) | R. L. Burtner Goodyear Aircraft Corp. 1210 Massilian Rd. Akron, Ohio | R. J. Pierce 1026-12 Ave. Honolulu, T. H. | TERRITORY OF HAWAII (7) | R. R. Hill Mutual Tel. Co. Box 2200 Honolulu 5, T. H. |
| W. J. Miller 1074 Springdale Rd. Atlanta, Ga. | ATLANTA (6) Sept. 15-Oct. 20 | D. B. Buchanan 5130 Powers Ferry Rd. Atlanta, Ga. | G. K. Miller 1622 W. Alabama Houston 6, Texas | HOUSTON (6) | Wayne Phelps 26 N. Wynden St. Houston 19, Texas |
| J. W. Hammond 4 Alabama Ct. Towson 4, Md. | BALTIMORE (3) | C. E. McClellan Westinghouse Elec. Corp. 2519 Wilkens Ave. Baltimore, Md. | G. H. Fathauer 4125 E. 10 St. Indianapolis 1, Ind. | INDIANAPOLIS (5) | J. H. Schultz Indianapolis Elec. School 312 E. Washington St. Indianapolis 4, Ind. |
| J. Petkovsek 1015 Ave. E. Beaumont, Texas | BEAUMONT- PORT ARTHUR (6) | C. B. Trevey 2555 Pierce St. Beaumont, Texas | F. M. Ashbrook 111-A Ellis China Lake, Calif. | INYO KERN (7) | D. L. Ewing 309-B Fowler China Lake, Calif. |
| W. H. Hauser WBZ, WBZ-FM, WBZ- TV 1170 Soldiers Field Rd. Boston, Mass. | BOSTON (1) | F. D. Lewis General Radio Co. 275 Massachusetts Ave. Cambridge, Mass. | C. F. Heister Fed. Com. Comm. 838 U. S. Court House Kansas City 6, Mo | KANSAS CITY (5) | Mrs. G. L. Curtis 6005 El Monte Mission, Kan. |
| M. J. Kobilsky Fabrica Argentina De Prod. Vedia Y AR. Forest Buenos Aires, Argentina, S.A. | BUENOS AIRES (1) | H. T. Magno Mirasol 451 Buenos Aires, Argentina, S.A. | G. L. Foster Spartan of Canada London, Ont., Canada | LONDON, ONTARIO (8) | G. R. Hosker Richards-Wilcox, Co. Ltd. London, Ont., Canada |
| K. R. Wendt Colonial Radio Corp. 1280 Main St. Buffalo 9, N. Y. | BUFFALO-NIAGARA (4) Sept. 20-Oct. 18 | H. G. Kuhn 211 Frankhauser Rd. R.F.D. #3 Williamsville, N. Y. | R. L. Sink Consolidated Eng. Co. 620 N. Lake Ave. Pasadena 4, Calif. | LOS ANGELES (7) | W. G. Hodson 524 Hampton Rd. Burbank, Calif. |
| D. B. Harris 2003 Glenway Dr. Cedar Rapids, Iowa | CEDAR RAPIDS (5) | J. L. Hollis 2900 E. Ave. N.E. Cedar Rapids, Iowa | S. T. Fife Univ. of Louisville Louisville, Ky. | LOUISVILLE (5) | I. W. Lyle Route 3 Jefferson Town, Ky. |
| Kipling Adams General Radio Co., 920 S. Michigan Ave. Chicago 5, Ill. | CHICAGO (5) | R. M. Krueger Am. Phenolic Corp. 1830 S. 54 Ave. Chicago 50, Ill. | H. F. Loeffler Wisconsin Tel. Co. 845 N. 35 St. Milwaukee 8, Wis. | MILWAUKEE (5) | D. E. Mereen Western Sound & Elect. Lab. 805 S. Fifth St. Milwaukee 4, Wis. |
| A. B. Bereskin 452 Riddle Rd. Cincinnati 20, Ohio | CINCINNATI (5) | W. B. Shirk 6342 Hamilton Ave. Cincinnati 24, Ohio | J. C. Bernier Ecole Polytechnique 1430 St. Denis Montreal, Que., Canada | MONTREAL, QUEBEC (8) | N. R. Olding Canadian Broad. Corp. Box 6000 Montreal, Que., Canada |
| J. B. Epperson Scripps-Howard Radio Box 228 Berea, Ohio | CLEVELAND (4) Sept. 28-Oct. 26 | J. L. Hunter John Carroll Univ. Cleveland, Ohio | T. S. Church 3325 49th Loop Sandia Base Branch Albuquerque, N. M. | NEW MEXICO (7) | B. J. Bittner 3110 42 Pl. Sandia Base Branch Albuquerque, N. M. |
| G. E. Mueller Elec. Eng. Dept. Ohio State Un. Columbus, Ohio | COLUMBUS (4) Sept. 8-Oct. 13 | W. F. Rite 95 E. Ninth Ave. Columbus, Ohio | H. F. Dart 33 Burnett St. Glen Ridge, N. J. | NEW YORK (2) | Earl Schoenfield W. L. Maxson Corp. 460 W. 34th St. New York 1, N. Y. |
| Lawrence Grew S. N. E. Telephone Co. New Haven, Conn. | CONNECTICUT VALLEY (1) | John Merrill 16 Granada Terr. New London, Conn. | C. M. Smith Radio Station WMIT 419 N. Spruce St. Winston Salem, N. Car. | NORTH CAROLINA- VIRGINIA (3) | V. S. Carson Elec. Eng. Dept. N. C. State College Raleigh, N. Car. |
| J. H. Homsy 6022 Vanderbilt Dallas, Texas | DALLAS-FORT WORTH (6) | R. A. Arnett Box 7166 Dallas, Texas | M. W. Bullock Capital Broadcasting Co. 501 Federal Securities Bldg. Lincoln 8, Neb. | OMAHA-LINCOLN (5) | C. W. Rook Dept. of Elec. Eng. Univ. of Nebraska Lincoln, Nebr. |
| C. J. Marshall 2412 Rosewood Ave. Dayton 9, Ohio | DAYTON (5) | R. W. Ittelson 551 Daytona Pkwy. Dayton, Ohio | J. T. Henderson 11 Primrose St. Ottawa, Ont., Can. | OTTAWA, ONTARIO (8) | E. L. R. Webb National Res. Council Sussex St. Ottawa, Ont., Canada |
| W. E. Clynch 3900 Decatur St. Denver 11, Colo. | DENVER (5) | R. E. Swanson 1777 Kipling St. Denver 15, Colo. | C. A. Gunther E.D., E.P.D. Bld. 10-7 RCA Victor Div. Camden, N. J. | PHILADELPHIA (3) Oct. 5 | C. M. Sinnett Adv. Dev. Sec. RCA Victor Div. Camden, N. J. |
| G. A. Richardson Dept. of Elec. Eng. Iowa State College Ames, Iowa | DES MOINES- AMES (5) | A. D. Parrott Northwestern Bell Tel. Co. 604-Ninth St. Des Moines 9, Iowa | W. H. Hamilton Westinghouse Res. Labs. East Pittsburgh, Pa. | PITTSBURGH (4) Sept. 11-Oct. 9 | V. G. Shaw Farmer's Eng. & Mfg. Co. 549 Brushton Ave. Pittsburgh, Pa. |
| N. C. Fisk 3005 W. Chicago Ave. Detroit 6, Mich. | DETROIT (4) Sept. 15-Oct. 20 | P. L. Gundy 55 W. Canfield Ave. Detroit, Mich. | F. E. Miller 3122 S.E. 73 Ave. Portland 6, Ore. | PORTLAND (7) | Henry Sturtevant 8211 S.W. Westgard Ave. Portland 19, Ore. |
| W. J. Peterson 322 E. Allegheny Ave. Emporium, Pa. | EMPORIUM (4) | W. R. Rolf 364 E. Fifth St. Emporium, Pa. | L. J. Giacioletto RCA Laboratories Princeton, N. J. | PRINCETON (3) | W. H. Surber School of Engineering Princeton University Princeton, N. J. |
| R. E. Mow Eng. Dept. General Elec. Co. Owensboro, Ky. | EVANSVILLE- OWENSBORO | H. W. A. Chalberg 316 E. Ninth St. Owensboro, Ky. | J. A. Rodgers Huntington Hills Rochester, N. Y. | ROCHESTER (4) | J. C. O'Brien 283 Malden St. Rochester 13, N. Y. |
| B. H. Ratts 2506 Terrace Rd. Ft. Wayne 3, Ind. | FORT WAYNE (5) | R. B. Jones 4322 Arlington Ave. Ft. Wayne, Ind. | | | |

* Numerals in parentheses following Section designate Region number.

Sections

| Chairman | | Secretary | Chairman | Secretary |
|---|---------------------------------|--|--|---|
| N. D. Webster 515 Blackwood N. Sacramento, Calif. | SACRAMENTO (7) | J. R. Miller 3991 3rd Ave. Sacramento, Calif. | H. W. Wells Carnegie Inst. of Wash. 5241 Broad Branch Rd. N.W. Washington, D. C. | WASHINGTON (3) Mark Swanson 8704 Maywood Ave. Silver Spring, Md. |
| L. A. Mollman Union Electric Co. 12 and Locust Sts. St. Louis 1, Mo. | ST. LOUIS (5) | H. G. Wise 1705 N. 48 St. E. St. Louis, Ill. | Richard Blythe Dept. of Physics Bucknell Univ. Lewisburg, Pa. | WILLIAMSPORT (4) Sept. 27-Oct. 24 R. C. Walker Box 414, Bucknell Univ. Lewisburg, Pa. |
| C. R. Evans Radio Station KSL Salt Lake City, Utah | SALT LAKE (7) | E. C. Madsen Dept. of Elec. Eng. University of Utah Salt Lake City, Utah | SUBSECTIONS | |
| F. E. Brooks 143 Eng. Bldg. University of Texas Austin, Texas | SAN ANTONIO (6) | A. H. La Grone Box F University Sta. Austin 12, Texas | Chairman | Secretary |
| E. W. Thatcher 2661 Poinsettia Dr. San Diego 6, Calif. | SAN DIEGO (7) Sept. 5-Oct. 3 | J. P. Day 3565 Ingraham St. San Diego 9, Calif. | C. E. Houston Dept. of Elec. Engr. Texas Tech. College Lubbock Texas | AMARILLO-LUBBOCK (6) (Dallas-Ft. Worth Subsection) |
| R. A. Isberg Radio Station KRON 901 Mission St. San Francisco, Calif. | SAN FRANCISCO (7) | A. R. Ogilvie Remler Co., Ltd. 2101 Bryant St. San Francisco, Calif. | F. T. Hall Dept. of Elec. Engr. Pennsylvania St. College State College, Pa. | CENTRE COUNTY (4) (Emporium Subsection) |
| S. D. Bennett 3437-36 Ave. W. Seattle 99, Wash. | SEATTLE (7) | J. E. Mason 2318 Tenth St. Bremerton, Wash. | A. H. Sievert Canadian Westinghouse Co. Hamilton, Ont., Canada | HAMILTON (8) (Toronto Subsection) |
| H. L. Thorson General Elec. Co. Bldg. 269 Schenectady, N. Y. | SCHENECTADY (2) | J. D. Cobine General Elec. Res. Lab. The Knolls Schenectady, N. Y. | S. K. Waldorf Penn. Water & Power Co. Fulton Bank Bldg. Lancaster, Pa. | LANCASTER (3) (Philadelphia Subsection) |
| L. R. Fink 416 Cherry Rd. Syracuse 9, N. Y. | SYRACUSE (4) | Samuel Seely Dept. of Applied Science Syracuse University Syracuse, N. Y. | O. M. Dunning Hazelton Elec. Corp. 5825 Little Neck Pkwy. Little Neck, L. I., N. Y. | LONG ISLAND (2) (New York Subsection) |
| M. W. Keck 2231 Oak Grove Pl. Toledo, Ohio | TOLEDO (4) | E. V. Birk 723 Ledge Ave. Toledo 9, Ohio | A. C. Beck Bell Telephone Labs. Holmdel, N. J. | MONMOUTH (2) (New York Subsection) |
| T. J. Millen Philco Corp. of Canada, Ltd. 1244 Dufferin St. Toronto, Ont., Canada | TORONTO, ONTARIO (8) | G. E. McCurdy McCurdy Radio Ind. 33 Melinda St. Toronto, Ont., Canada | A. W. Parkes, Jr. Aircraft Radio Corp. Boonton, N. J. | NORTHERN N. J. (2) (New York Subsection) |
| W. G. Pree 2500 W. 66 St. Minneapolis, Minn. | TWIN CITIES (5) | O. A. Schott 4224 Elmer Ave. Minneapolis 16, Minn. | George Weiler 1429 E. Monroe South Bend, Ind. | SOUTH BEND (5) (Chicago Subsection) |
| | | | R. M. Wainwright Elec. Eng. Department University of Illinois Urbana, Ill. | URBANA (5) (Chicago Subsection) |
| | | | R. D. Cahoon C.B.C. Winnipeg, Man., Canada | WINNIPEG (8) (Toronto Subsection) |

Professional Groups

| | Chairman | | Chairman |
|------------------------------------|---|---|---|
| ANTENNAS AND PROPAGATION | Newbern Smith National Bureau of Standards Washington 25, D. C. | CIRCUIT THEORY | J. G. Brainerd University of Pennsylvania Philadelphia, Pa. |
| AUDIO | Leo L. Beranek Massachusetts Institute of Technology Cambridge 39, Mass. | INSTRUMENTATION | Ernst Weber Polytechnic Institute of Brooklyn Brooklyn, N. Y. |
| BROADCAST AND TELEVISION RECEIVERS | Virgil M. Graham Sylvania Electric Products Inc. 40-22 Lawrence St. Flushing, L. I., N. Y. | NUCLEAR SCIENCE | Harner Selvidge Bendix Aviation Corporation Fisher Building Detroit 2, Mich. |
| BROADCAST TRANSMISSION SYSTEMS | Lewis Winner Bryan Davis Publishing Co., Inc. 52 Vanderbilt Ave. New York 17, N. Y. | QUALITY CONTROL | R. F. Rollman Allen B. DuMont Laboratories 1000 Main Ave. Clifton, N. J. |
| | | VEHICULAR AND RAILROAD RADIO COMMUNICATIONS | A. B. Buchanan 2000 Second Ave. Detroit 26, Mich. |

Abstracts and References

Prepared by the National Physical Laboratory, Teddington, England, Published by Arrangement with the Department of Scientific and Industrial Research, England, and *Wireless Engineer*, London, England

NOTE: The Institute of Radio Engineers does not have available copies of the publications mentioned in these pages, nor does it have reprints of the articles abstracted. Correspondence regarding these articles and requests for their procurement should be addressed to the individual publications and not to the IRE.

| | |
|--|------|
| Acoustics and Audio Frequencies..... | 1107 |
| Antennas and Transmission Lines..... | 1108 |
| Circuits and Circuit Elements..... | 1109 |
| General Physics..... | 1110 |
| Geophysical and Extraterrestrial Phenomena..... | 1111 |
| Location and Aids to Navigation..... | 1111 |
| Materials and Subsidiary Techniques..... | 1111 |
| Mathematics..... | 1112 |
| Measurements and Test Gear..... | 1113 |
| Other Applications of Radio and Electronics..... | 1114 |
| Propagation of Waves..... | 1115 |
| Reception..... | 1116 |
| Stations and Communication Systems..... | 1116 |
| Subsidiary Apparatus..... | 1116 |
| Television and Phototelegraphy..... | 1116 |
| Transmission..... | 1117 |
| Tubes and Thermionics..... | 1117 |
| Miscellaneous..... | 1120 |

The number in heavy type at the upper left of each Abstract is its Universal Decimal Classification number and is not to be confused with the Decimal Classification used by the United States National Bureau of Standards. The number in heavy type at the top right is the serial number of the Abstract. DC numbers marked with a dagger (†) must be regarded as provisional.

ACOUSTICS AND AUDIO FREQUENCIES

| | |
|--|------|
| 016:534 | 1838 |
| References to Contemporary Papers on Acoustics—A. Taber Jones. (<i>Jour. Acoust. Soc. Amer.</i> , vol. 22, pp. 197-205; March, 1950.) Continuation of 1047 of June. | |
| 534.23 | 1939 |
| Transient Radiation from Sound Sources, and Related Problems—J. Brillouin (<i>Ann. Télécommun.</i> , vol. 5, pp. 160-172 and 179-194; April and May, 1950.) A mathematical introduction outlines the methods of the symbolic calculus used, indicated ways of representing discontinuities and shows how two polynomials, derived from Bessel functions and used in the calculations, can be evaluated. Formulas are derived for the flux and the densities of the radiated and nonradiative energy for the steady state, and examples are calculated for a pulsating and an oscillating sphere. Corresponding general formulas are derived for the waves outside the source under transient conditions. The existence of discontinuities in the wave front and in the end of the wave train is noted. Discussion of sinusoidal radiation shows the importance of the transient waves, for which the ratio of the initial amplitude (of pressure of radial velocity) to that of the steady-state wave increases very rapidly when the radius of the source tends toward zero. Calculations are again made for the pulsating and the oscillating sphere. General formulas are obtained for a rigid sphere subjected to an external force and the two cases of (a) unit impulse and (b) a sinusoidal force are considered. Various diffraction effects are discussed with particular reference to the acoustic properties of surfaces with semicylindrical or hemispherical bosses, which act as virtual sources when sound waves reach them. Conclusions stress the importance | |

The Annual Index to these Abstracts and References, covering those published in the PROC. I.R.E. from February, 1949, through January, 1950, may be obtained for 2s. 8d. postage included from the *Wireless Engineer*, Dorset House, Stamford St., London S. E., England. This index includes a list of the journals abstracted together with the addresses of their publishers.

of the transient waves, which in certain cases are the only ones to be observed.

| | |
|--|------|
| 534.24 | 1840 |
| Phase Distortion of Acoustic Pulses Obliquely Reflected from a Medium of Higher Sound Velocity—A. B. Arons and D. R. Yennie. (<i>Jour. Acoust. Soc. Amer.</i> , vol. 22, pp. 231-237; March, 1950.) Since phase shift at reflection depends only on the acoustic parameters of the reflecting interface and the angle of incidence, and is independent of the frequency of the incident wave train, it is to be expected that pulses of arbitrary shape will be subjected to distortion upon reflection. The expected shape of the pressure wave reflected from a semisolid sea bottom at angles exceeding the critical angle of total reflection is derived for the exponentially decaying shock waves produced in underwater explosions, and agrees well with observed pressure/time curves of the first and successively higher-order reflections. | |
| 534.24 | 1841 |
| On the Non-Specular Reflection of Sound—V. Twersky. (<i>Phys. Rev.</i> , vol. 78, pp. 332-333; May 1, 1950.) Summary of American Physical Society 1950 Annual Meeting paper N2. The reflection of plane waves by rigid, nonabsorbent surfaces with bosses is analyzed. | |
| 534.632:681.81 | 1842 |
| A Stroboscopic Tuner for Musical Instruments—A. Douglas. (<i>Electronic Eng.</i> vol. 22, pp. 178-180; May, 1950.) The apparatus consists of a series of twelve rotating disks, each printed with seven concentric rings of alternate black and white segments, the number of segments increasing successively by a factor of 2 from center to edge; all twelve are suitably geared together and driven by a common motor. They cover a frequency range of 31-4,000 cps by semitone intervals. The motor is driven from a tuning fork whose frequency is adjustable over a limited range. The disks are illuminated by neon tubes which are energized, through a microphone and amplifier, by the note emitted by the instrument being tuned, which is thus readily compared with the standard fork frequency. | |
| 534.78 | 1843 |
| The Intelligibility of Interrupted Speech—G. A. Miller and J. C. R. Licklider. (<i>Jour. Acoust. Soc. Amer.</i> , vol. 22, pp. 167-173; March, 1950.) It is easy to understand noise-free speech provided the interruptions (blanks) occur more than 10 times per second. With interrupting noise, if the ratio of average speech power to average noise power is constant, intelligibility is independent of interrupting frequency if > 200 per second. Interrupted masking noise has least effect if interruption frequency is about 15 per sec. When interrupted speech and interrupted noise alternate at fre- | |

quencies below 10 per sec, the noise does not impair intelligibility.

| | |
|---|------|
| 534.78:621.395 | 1844 |
| The Perception of Speech and Its Relation to Telephony—H. Fletcher and R. H. Galt. (<i>Jour. Acoust. Soc. Amer.</i> , vol. 22, pp. 89-151; March, 1950.) A very comprehensive survey of articulation tests carried out mainly at the Bell Telephone Laboratories and partly at Harvard University. Four sets of data are considered and analyzed, covering the years 1919-1925, 1928-1929, 1935-1937, and 1944-1945 (effect of intense noise on intelligibility). "Functions are developed which permit the calculation of articulation index and hence of articulation for communication systems which include a wide range of response/frequency characteristics and of noise conditions, as well as several special types of distortion." | |
| 534.833.1 | 1845 |
| Transmission of Reverberant Sound through Double Walls—A. London. (<i>Jour. Acoust. Soc. Amer.</i> , vol. 22, pp. 270-279; March, 1950; <i>Jour. Res. Nat. Bur. Stand.</i> , vol. 44, pp. 77-88; January, 1950.) The transmission of reverberant sound through a double wall, consisting of two identical single walls coupled by an air space, is investigated both theoretically and experimentally. A theory is developed which gives good agreement with experiment. | |
| 534.845.1:534.846.5 | 1846 |
| The Determination of Reverberant Sound Absorption Coefficients from Acoustic Impedance Measurements—A. London. (<i>Jour. Acoust. Soc. Amer.</i> , vol. 22, pp. 263-269; March, 1940.) A method of predicting the reverberation time of a room from measurements of the absorption coefficient of small samples of the material lining it, when these are used to terminate an acoustic impedance tube. The coefficient for normal incidence measured thereby can be related accurately to the random-incidence case of the room by an empirical statistical treatment. | |
| 534.86:621.396.712 | 1847 |
| Developments in Studio Design—L. L. Beranek. (<i>Proc. I.R.E.</i> vol. 38, pp. 470-474; May, 1950.) 1949 IRE National Convention paper. Discussion with particular reference to acoustic properties and studio construction methods used in Broadcasting House, Copenhagen, and Broadcasting House, Oslo. | |
| 621.395:534.78 | 1848 |
| A Reference Telephone System for Articulation Tests—J. Swaffield and R. H. de Wardt. (<i>P. O. Elec. Eng. Jour.</i> , vol. 43, Part 1, pp. 1-7; April, 1950.) Describes equipment supplied by the British Post Office and installed in the CCIF laboratory, Geneva, for developing and maintaining the proposed new international | |

standards of telephone transmission based on articulation measurements. The equipment consists of a microphone-amplifier-receiver chain having the same transmission characteristics as a 1-m free-air path. Provision is made for the insertion of the telephone circuit under test and for the comparison of the attenuation and noise produced with that of a standard attenuator and noise generator. Apparatus is provided for measuring the speech voltage and the sensitivity or gain of all the elements in the chain, including the microphones and receivers.

621.395.61 1849

Miniature Condenser Microphone—J. K. Hillard. (*Jour. Soc. Mot. Pic. Eng.*, vol. 54, pp. 303-314; March, 1950.) Description of microphone Type 21B, which has a high output level and a uniform frequency response. Its advantages over larger and heavier microphones are enumerated and placing and pickup techniques suitable for motion-picture sound recording are discussed. See also 1319 of July.

621.395.61 1850

The "Bantam" Mike—KB-20—L. J. Anderson and L. M. Wigington. (*Broadcast News*, no. 58, pp. 14-17; March and April, 1950.) An abstract of another account is given under 805 of May.

621.395.623.7 1851

The Acoustical Impedance of Closed Rectangular Loudspeaker Housings—W. F. Meeker, F. H. Slaymaker, and L. L. Merrill. (*Jour. Acoust. Soc. Amer.*, vol. 22, pp. 206-210; March, 1950.) Morse's method for calculating pressure distribution in rooms is applied to finding the impedance presented to the back of a small loudspeaker by its rigid housing. In a typical case the impedance passes from negative to positive at about 70 cps, when the maximum linear dimension of the enclosure is $< \lambda/7$. Experiments show that the results depend also on the loudspeaker diaphragm dimensions.

621.395.623.7:621.3.018.8 1852

Transients and Loudspeaker Damping—J. Moir. (*Wireless World*, vol. 56, pp. 166-180; May, 1950.) Some conflicting theories on optimum amplifier output impedance are investigated experimentally. Little or no improvement of loudspeaker transient response is obtained by reducing the amplifier output impedance below 10 to 20 per cent of the voice-coil impedance. At high frequencies this improvement may be offset because a low output impedance gives a low acoustic output, since the impedance of the voice coil increases with frequency.

621.395.625.2:621.395.667 1853

Tone Control with RC Networks in Sound-Recording Technique—A. Lennartz. (*Funk. und Ton.*, vol. 5, pp. 169-181; April, 1950.) Taking 1,000 cps as the reference frequency, and the level at this frequency as reference level, four basic types of correction are defined viz., bass boost, bass cut, top boost, and top cut; these may be combined as required. Examples of circuits are shown and approximate formulas are derived for component values.

621.395.625.3 1854

Magnetic Recording and Its Application in the South African Broadcasting Corporation—E. J. Middleton. (*Trans. S. Afr. Inst. Elec. Eng.*, vol. 41, pp. 41-52; February, 1950.) Basic principles are outlined; an account is given of problems encountered in practice, and the main advantages and disadvantages of the system for a broadcasting service are indicated. At present 90 per cent of the SABC studio recording is done on disks, but the use of magnetic

tape is steadily increasing; for outside work, tape is rapidly superseding disk recording.

621.395.625.6 1855

Increased Noise Reduction by Delay Networks—J. R. Whitney and J. W. Thatcher. (*Jour. Soc. Mot. Pic. Eng.*, vol. 54, pp. 295-302; March, 1950.) Increased signal-to-noise ratio in optical sound-film recording is achieved by the use of networks which delay the application of sound currents to the modulator until after the noise-reduction bias current has been partially cancelled. Noise reductions as high as 30 db have been tried successfully and reductions of 15 db have frequently been used in practice.

681.85 1856

Applications of Dynamic Analogies to Cutters and Reproducers for Disks—G. Bouchier. (*Radio Franç.*, no. 4, pp. 9-16; April, 1950.) Problems relating to disk recorders and reproducers are treated by analogy with the corresponding problems in electrical circuitry, L taking the place of moment of inertia, C of compliance, and R of mechanical resistance; the angular velocity of the stylus is then represented by current. The response at different frequencies is calculated for a magnetic lateral cutter and pickup with different degrees of mechanical damping; results are shown in tables and graphs.

534.6 1857

Acoustic Measurements [Book Review]—L. L. Beranek. Publishers: John Wiley and Sons, Inc., New York, N. Y. 1949, 896 pp., \$7.00. (*Proc. I.R.E.*, vol. 38, p. 578, May, 1950; *Rev. Sci. Instr.*, vol. 21, p. 387; April, 1950.) The author "has made a valuable addition to our technical literature and his reference volume should have a long life in the libraries of all engineers whose work touches on sound measurements."

ANTENNAS AND TRANSMISSION LINES

621.3.09 1858

Propagation of Electromagnetic Disturbances along Thin Wire in a Horizontally Stratified Medium—B. L. Coleman. (*Phil. Mag.*, vol. 41, pp. 276-288; March, 1950.) "For a thin wire buried at finite depth in a semi-infinite homogeneous medium and subject to a disturbance at a given frequency, there exists an exponential attenuation of the current in the wire with a propagation constant equal to that of the medium. This result is extended to a medium with a number of layers, and to a wire lying in an interface."

621.3.08:621.385.029.63/64 1859

Experimental Study of the Propagation along a Delay Line in the Form of a Helix—M. Jessel and R. Wallauschek. (*Ann. Télécommun.*, vol. 3, pp. 291-299; August and September, 1948.) An investigation of the effect of variation of the following factors: (a) the material of the conductor (Cu, Fe, steel, and chrom alloys); (b) the diameter of the wire (0.33 to 0.7 mm); (c) the pitch of the helix; (d) wavelength; and (e) the diameter of the helix. Other factors affecting attenuation are considered. The method of measurement is described; experimental results are shown graphically.

621.392.26†:621.3.09 1860

Electromagnetic Waves in Rectangular Waveguides—K. S. Knol. (*Tijdschr. ned. Radiogenoot.*, vol. 15, pp. 53-74; March, 1950.) In Dutch, with English summary.) A résumé of waveguide theory is given. Brillouin's method for rectangular waveguides is treated in some detail and the solution of Maxwell's equations for the interior of a waveguide is found by considering the superposition on the

incident wave of the three reflected waves resulting from the rectangular construction. An attenuator is described which uses a coaxial line of adjustable length within a waveguide excited at a wavelength much greater than the critical value.

621.392.26†:621.3+09 1861

A Model for Studying Electromagnetic Waves in Rectangular Wave Guides—K. S. Knol and G. Diemer. (*Philips Tech. Rev.*, vol. 11, pp. 156-163; November, 1949.) A rubber-membrane model is described.

621.392.26†:621.3.09 1862

Mode Conversion Losses in Transmission of Circular Electric Waves through Slightly Non-Cylindrical Guides—S. P. Morgan, Jr. (*Jour. Appl. Phys.*, vol. 21, pp. 329-339; April, 1950.) A general expression is derived for the effective attenuation owing to mode conversions in a deformed section of waveguide. In the special case of elliptical deformation the theory gives results in agreement with experiment. The effects of random distortions in a long waveguide are analyzed and typical examples of the magnitude of the loss are given.

621.396.67 1863

Antifading Broadcast Antenna—H. Brueckmann. (*Electronics*, vol. 23, pp. 82-85; May, 1950.) In the case of base-fed towers the progressive wave along the antenna gives rise to high-angle radiation which results in fading due to interference between ground and sky waves. The antenna here described is composed of insulated sections and fed at the insulator, some way up, so that the effects of the progressive waves in the two sections cancel one another, giving an enlarged service area. The performance of such an antenna at Radio Frankfurt, operating on 1195 kc, was measured and some results are tabulated.

621.396.67:621.317.79 1864

Ripple Tank for Phase-Front Visualization—(See 1979.)

621.396.67:621.397.5 1865

High-Gain and Directional Antennas for Television Broadcasting—L. J. Wolf. (*Broadcast News*, pp. 46-53, March and April, 1950.) Illustrated description of the RCA Supergain antenna, with diagrams showing typical radiation patterns and installations with different combinations of the radiating elements.

621.396.67.012 1866

Radiation Characteristics of a Turnstile Antenna in a Cylindrical Shield—D. S. Saxon, A. Baños, Jr., and L. L. Bailin. (*Phys. Rev.*, vol. 78, p. 327; May, 1950.) Summary of American Physical Society 1950 Annual Meeting paper HA5. The antenna investigated consists of crossed wires excited in quadrature. The axis of the shield is perpendicular to the plane of the antenna; it is open at one end, and its diameter is a fraction of the driving wavelength. Excitation of an infinitely long circular waveguide is considered, and conditions under which only the dominant (TE_{11}) mode is important are determined; the radiation problem is then treated as one in which a semi-infinite circular guide, excited by a TE_{11} mode, radiates into free space. Using a solution obtained by Levine and Schwinger (not yet published) values of reflection coefficient and gain function have been computed. Results are compared with those found experimentally and by the Kirchhoff method.

621.396.67.012 1867

On the Radiation Patterns of Dielectric Rods of Circular Cross Section—C. W. Horton, F. C. Karal, and C. M. McKinney. (*Phys. Rev.*,

vol. 78, pp. 327-328; May 1, 1950.) Summary of American Physical Society 1950 Annual Meeting paper HA6. Theoretical patterns are calculated for different diameters, lengths, and modes of excitation, the fields in the radiators being assumed the same as in an infinitely long dielectric guide. Correction is made for finite rod length by substituting an equivalent rod of smaller diameter with dielectric constant such that the wavelength of the guided wave is unchanged. In a particular case studied good agreement was found between theory and experiment.

621.396.677 1868

Theory and Application of Transit-Time Compensators in Transmitters and Receivers of Beamed Electromagnetic Waves—H. Stenzel. (*Fernmeldelech. Z.*, vol. 3, pp. 94-100 and 125-132; March and April, 1950.) By analogy with the principle of compensation as applied to a ship's sound-detection apparatus, general formulas are derived for the characteristics of compensated electromagnetic radiating systems. The use made of transit-time networks in the strip and the cylinder compensator is described. Straight-line grouping and circular grouping of radiators is investigated. The grouping characteristic of arbitrary arrangements of radiators is investigated experimentally, using a cathode-ray tube as indicator. With quarter-circle grouping of the radiators a direct indication of signal bearing can be obtained on a cathode-ray oscilloscope by application of the sum-and-difference method of acoustics.

621.396.677.029.6 1869

Directional Antenna Systems at Microwave Frequencies—C. A. Rosencrans. (*Broadcast News*, no. 58, pp. 28-35; March and April, 1950.) Discussion of the practical solution of various problems associated with the design and installation of microwave radio links.

CIRCUITS AND CIRCUIT ELEMENTS

621.3.016.35:621.392.5 1870

The Nyquist Criterion of Stability—J. C. West. (*Electronic Eng.*, vol. 22, pp. 169-172; May, 1950.) A semigraphical demonstration for the case of feedback systems.

621.314.2:621.3.017 1871

Current Density and Permissible Heating in Small Transformers—U. Finkbein. (*Funk. und Ton.*, vol. 4, pp. 182-192; April, 1950.) The loading of a transformer is limited only by the permissible heating, which depends on the current density. Since the same laws hold for the steady flow of heat as for the steady flow of electricity, the calculations for the former case may be made by constructing equivalent circuit diagrams in which the values of the equivalent resistances are found from consideration of the conduction, convection, and radiation processes. For heating due to copper and iron losses the equivalent circuit is a quadripole. For low-power transformers the current density may be allowed to reach 6 per mm², but for powers of about 2 kva it should not exceed about 1 per mm².

621.314.2.083:621.317.612 1872

On the Measurement of the No-Load Losses of Small 50-c/s Transformers—Medina. (See 1967.)

621.314.3† 1873

Analysis of Transients and Feedback in Magnetic Amplifiers—W. C. Johnson and F. W. Latson. (*Elec. Eng.*, vol. 69, pp. 353-359; April, 1950.) AIEE 1950 Winter General Meeting paper. The steady-state characteristics of a saturable reactor can be used to determine the effect of feedback on the properties

of the reactor. The equivalent control circuits for saturable reactors are discussed and formulas are derived for computing the performance of certain types of magnetic amplifier.

621.318.4.011.3 1874

Inductance of Toroidal Coils—R. Cazenave. (*Rev. Gén. Elec.*, vol. 59, pp. 169-174; April, 1950.) The inductance is greater than the approximate value calculated from elementary theory. For maximum inductance the greatest dimension of the winding cross section should be perpendicular to the axis of the toroid. Suitable formulas are given for coils of various cross sections commonly used.

621.318.42+621.314.2 1875

Inductors and Transformers for High Frequencies—P. M. Prache. (*Câbles and Trans.* (Paris), vol. 4, pp. 89-125; April, 1950.) The dynamic effect on the core of the electromotive force generated by the variation of the magnetic field is not negligible at relatively high frequencies. This magnetodynamic propagation is analyzed for metal-strip, wire, and dust cores. Its effect is to concentrate the magnetic flux towards the outer surface of the core; this "magnetic skin effect" causes a reduction of the apparent permeability and the *Q* of an inductor. The variation of the reduction coefficient with frequency is calculated for the different types of core considered. The effect on the windings is dealt with similarly, calculations being made of the changes of inductance, distributed capacitance, resistance, and loss caused by leakage of current between turns and between winding and core. The various parameters and their variation with frequency are determined in the two cases. Numerous experimental results confirm the theory.

621.392 1876

Method of Determining the "Trees" ["arbres"] of a Network—J. Lantieri. (*Ann. Télécommun.*, vol. 5, pp. 204-208; May, 1950.) The term "tree" is applied to an open-circuit combination of the branches of a network including all the junctions. Any network has a representative geometrical configuration defined by a matrix. The solution of certain network problems can be simplified by the use of matrix calculus, which is here applied to determine (a) the nature and number of the "trees" in the Carey-Foster bridge, (b) the admittance of a passive 2-pole network with no mutual impedance, and (c) the voltage across the second diagonal of a Wheatstone bridge.

621.392:681.142 1877

Diode Coincidence and Mixing Circuits in Digital Computers—Tung Chang Chen. (See 1958.)

621.392.5/.6 1878

Construction of Quadripoles and Multipoles with Given Frequency Characteristics—V. A. Taft. (*Bull. Acad. Sci.* (URSS), no. 2, pp. 216-232; February, 1950. In Russian.) Methods are indicated for constructing passive quadripoles and multipoles (for certain particular cases) with given frequency characteristics, and the necessary and sufficient conditions for their construction to be possible are established. The problem of the construction of circuits from passive elements *R*, *L*, *C*, and *M*, which would be equivalent to a given system of ordinary differential equations is also discussed. This question is of practical importance in the design of electrical calculating machines. The methods developed can be used for constructing networks with given properties if the impedance (or admittance) function satisfies the conditions of realization and is expressed in the form of rational fractions. Otherwise the given relations must be first approximated by rational fractions.

621.392.5 1879

Complementary Note on the Synthesis of Passive, Resistanceless Four-Poles—B. D. H. Tellegen. (*Philips Res. Rep.*, vol. 4, pp. 366-369; October, 1949.) Continuation of 2745 of 1949. By removing a pole at a finite value of the frequency a passive resistanceless quadripole of order *n* can be split up into two quadripoles, one of the second order and one of order (*n*-2).

621.392.5 1880

Reciprocal Aspects of Transient and Steady-State Concepts—W. J. Kessler. (*Elec. Eng.*, vol. 69, pp. 319-321; April, 1950.) "The transient response of a network can be defined in steady-state terms, and the steady-state behavior can be described in transient terms. The steady-state behavior is usually defined in terms of amplitude and frequency while the transient behavior is defined in terms of amplitude and time. Therefore, the transient and steady-state responses are regarded as nothing more than alternative viewpoints of network behavior when it is expressed in the time domain or the frequency domain respectively."

621.392.52 1881

Phase-Shift Band-Pass Filters—D. H. Pickens and J. N. Van Scoyoc. (*Electronics*, vol. 23, pp. 96-99; May, 1950.) The phase shift of a bridged-T network changes by 180° as the frequency passes through its null value. By subtracting the output of such a network from that of a similar one with a different null frequency, frequencies between the null frequencies can be transmitted and those outside this band are cancelled. Readily available components can be used, even at low audio frequencies. Circuits for the differential combination of the two outputs are described.

621.392.6.029.63+621.317.336./34 1882

Theory and Technique of Multipole Networks at Ultra-High Frequencies—G. Goudet and H. Jassin. (*Onde Elec.*, vol. 30, pp. 178-194 and 223-226; April and May, 1950.) The theory is reduced to a general form applicable to uhf and lower frequencies by consideration of normalized impedance and electric and magnetic intensities and by application of matrix calculus. The multipole network may be terminated by any form of waveguide or transmission line. The second part of the paper describes a method of measurement at about 3 kMc of the impedance, attenuation, and wave-propagation velocity of coaxial cables. A method is also given for measuring the transmission and reflection coefficients of coaxial plug connectors. Typical results are given.

621.396.6+621.317.7+621.38.001.8 1883

Physical Society's Exhibition—(*Wireless Eng.*, vol. 27, pp. 158-163; May, 1950; *Wireless World*, vol. 56, pp. 171-175; May, 1950; *Instr. Practice*, vol. 4, pp. 237-249; March, 1950; *Elec. Times*, vol. 117, pp. 503-510; March 30, 1950; *Engineer* (London), vol. 189, pp. 397-398, 411-415 and 444-448; March 31, and April 7 and 14, 1950; *Engineering* (London), vol. 169, pp. 377-380 and 401-404; April 7 and 14, 1950.) Electronic equipment for research and measurement shown at the exhibition held in London from March 31 to April 5, 1950.

621.396.615 1884

Frequency and Amplitude Stability of the Cathode Coupled Oscillator—P. G. Sulzer. (*Proc. I.R.E.* vol. 38, pp. 540-542; May, 1950.) The effects of supply-voltage variations are calculated, and the theoretical results are confirmed by experiment. Cathode-coupled oscillators can have excellent frequency stability.

621.396.615.14+621.396.645 1885

Annular Circuits for High-Power, Multiple-Tube, Radio-Frequency Generators at Very-High Frequencies and Ultra-High Frequencies—D. H. Preist. (PROC. I.R.E., vol. 38, pp. 515-520; May, 1950.) 1949 I.R.E. National Convention paper. A resonator is used which consists of a thick cylinder inserted between an axial and an outer conductor which are electrically connected. The inner and outer conductors are excited in antiphase to the thick cylinder. This construction makes possible multi-tube power amplifiers having the same upper frequency limit and efficiency as a single tube, and also permits the use of a coaxial output line without coupling probes or loops.

621.396.615.17 1886

The Multivibrator and Its Recent Developments—J. Moline. (*Radio Franç.*, pp. 17-21 and 16-20; April and May, 1950.) Discussion of variants of the basic circuit, including flip-flop and scale-of-two circuits and a generator of square waves.

621.396.615.17.029.4 1887

Rectangular Wave Generator for Biological Studies—J. W. Moore. (*Electronics*, vol. 23, pp. 122-190; May, 1950.) Description of a circuit comprising multivibrator, univibrator, clipper and power amplifier, which has been used for over two years to produce negative pulses at repetition rates of $\frac{1}{2}$ to 400 cps with pulse durations of 20 μ seconds to 1.5 seconds.

621.396.645:539.16.08 1888

Linear Amplifiers—M. A. Schultz. (PROC. I.R.E., vol. 38, pp. 475-485, May, 1950.) The requirements of an amplifier for use with an ionization chamber in nuclear research are that it shall have an adjustable rise time characteristic (0.1 to 20 μ second) to handle a wide range of pulse widths and shall have a linear response to random pulses within the amplitude range 10 μ v-50 mv. The amplifier must also be capable of handling small pulses in the presence of large pulses and vice versa. Noise, bandwidth, and overload considerations are discussed and practical circuits described.

621.396.645.35 1889

The Construction and Operation of a Highly Sensitive Direct-Voltage Amplifier—H. Boucke and H. Lennartz. (*Funk. und Ton.*, vol. 4, pp. 161-168; April, 1950.) Discussion of the modifications necessary to Kerkhof's design (1387 of 1943) to overcome such difficulties as insufficient amplification, changing of bridge balance during long warming-up period, residual voltage at the output. Measures taken include increasing the selectivity of the high-frequency circuits, introducing hum filters, and careful screening.

621.397.645 1890

Wide-Band Chain Amplifier for TV—Tyminski. (See 2048.)

621.392 1891

Communication Circuit Fundamentals [Book Review]—C. E. Smith. Publishers: McGraw-Hill Book Co., New York, N. Y., 401 pp., \$5.00. (*Radio and Telev. News, Radio-Electronic Eng. Sup.*, vol. 14, p. 28; April, 1950.) "The second of four books designed for a complete course in radio and communication engineering." The first book, "Applied Mathematics for Radio and Communication Engineers," was noted in 112 of 1946.

621.392 1892

Matrix Analysis of Electric Networks [Book Review]—P. Le Corbeiller. Publishers: Harvard University Press and John Wiley and Sons, Inc., N. Y., 1950, 108 pp., \$3.00 (PROC. I.R.E., vol. 38, p. 576; May, 1950. *Rev. Sci.*

Instr., vol. 21, p. 381; April, 1950.) "The first of a series of monographs on applied science to be published by Harvard University in order to make the results of University research available to a wider audience than would be reached by individual professional journals. . . Its purpose is to offer a simplified and gradual approach to Kron's method of analysis of stationary electric networks. . . It can be highly recommended to all radio engineers who want to keep in touch with modern advances in network theory."

GENERAL PHYSICS

501+53 1893

A Sampling of 1949 Books—(*Jour. Appl. Phys.*, vol. 21, pp. 352-368; April, 1950.) Brief individual comments are given on a selected list of new books noted during late 1948 and 1949, mostly in the fields of mathematics, physics, radiocommunications, and electronics.

534.24+535.312]:519.3 1894

A Variational Principle for the Computation of Reflection Coefficients—G. Toraldo di Francia. (*Phys. Rev.*, vol. 78, p. 298; May 1, 1950.) Previously used for computing phase shifts and transmission cross sections, this principle is here applied to the calculation of the reflection coefficient of a potential barrier. See also 1052 of June (Levine).

535.13 1895

General Operator Field Equations Derived from a Variation Principle. Construction of "Divergence-Less" Four-Vector Operator—C. Gregory. (*Phys. Rev.*, vol. 78, p. 479; May 15, 1949.)

535.222 1896

A Measurement of the Velocity of Light—R. A. Houstoun. (*Nature* (London), vol. 164, p. 1004; December 10, 1949.) A quartz crystal is substituted for the toothed wheel used in Fizeau's method of measurement and in an alternating electric field acts as an intermittent diffraction grating. The light in the first-order spectrum is interrupted 200 times as rapidly as by Fizeau's toothed wheel. Light, after passing through the quartz, travelled a distance of about 39 m and was then reflected back through the quartz to the eye of the observer. For a particular path length the intensity has a minimum value. The velocity deduced, when reduced to vacuum, is 299,775 kms. Measurement accuracy is about the same as that of other recent determinations, but could be increased 10 times with a tenfold increase of range. A full account of the work will be published elsewhere. See also 42 of 1939, 3244 of 1941 and 2010 below.

535.42+534.26 1897

On the Theory of Diffraction by an Aperture in an Infinite Plane Screen: Part 2—H. Levine and J. Schwinger. (*Phys. Rev.*, vol. 75, pp. 1423-1432; May 1, 1949.) In part 1 (83 of February) the problem of diffraction of a scalar plane wave was dealt with by a variational principle in which the aperture was regarded as coupling the two half spaces on opposite sides of the screen. In part 2 a different variational principle is developed by considering the screen as an obstacle to the propagation of the wave. Calculated values of transmission coefficient are shown graphically against the ratio aperture radius/ λ for the particular case of circular aperture and normal wave incidence. Results are compared with exact values calculated by Bouwkamp; degree of approximation is good.

535.42 1898

Diffraction by a Cylindrical Obstacle—C. H. Papas. (*Jour. Appl. Phys.*, vol. 21, pp. 318-325; April, 1950.) The diffraction of a plane

wave by an infinitely long perfectly conducting cylinder whose axis is parallel to the electric vector is treated by the variational method of Levine and Schwinger (83 of February and 1897 above) which avoids the difficulties of earlier methods. The scattering cross sections for wavelengths large and small with respect to the radius a of the cylinder are computed and shown graphically. The cross section approaches the value $4a$ as $Ka(+2\pi/\lambda)$ approaches infinity.

537.226.001.11 1899

Properties of Slow Electrons in Polar Materials—H. Fröhlich, H. Pelzer, and S. Zienau. (*Phil. Mag.*, vol. 41, pp. 221-242; March, 1950.) Energy problems in the interaction between an electron and a continuous dielectric medium are investigated theoretically by a variational method.

537.311.5:621.3.015.3 1900

Density Distribution of Transient Currents in Conductors—L. M. Vallesco. (PROC. I.R.E., vol. 38, p. 563; May, 1950.) Analysis of the distribution of an exponential-decay-current and of a pulse current.

537.525 1901

The Collection of Positive Ions by a Probe in an Electrical Discharge—R. L. F. Boyd. (*Proc. Roy. Soc. A*, vol. 201, pp. 329-347; April 26, 1950.) The Langmuir probe method for determining electron temperature gives anomalous results when applied to positive ions. The theoretical aspects of the collection of positive ions are discussed; the conclusions were tested in experiments using a special probe in an argon discharge. The probe consisted of a plane Pt foil screened by a fine wire grid whose potential could be adjusted separately; this device permitted the probe current to be separated into its electron and ion components.

537.581 1902

Convenient Methods for Thermionic Emission Calculations—H. F. Ivey and C. L. Shackelford. (*Phys. Rev.*, vol. 78, p. 356; May 1, 1950.) Summary of American Physical Society 1950 Annual Meeting paper EP24. Four simple methods are presented by which any one of the quantities Φ , A , T , J in Richardson's equation can be found if the others are known. In the first method, the equation is reduced to a simple form involving T only in the exponential term. Two other methods are graphical, and the fourth uses an abac. The accuracy is discussed in each case.

538.082.74:538.653.11 1903

On the Propagation of Large Barkhausen Discontinuities in Ni-Fe Alloys—L. J. Dijkstra and J. L. Snoek. (*Philips Res. Rep.*, vol. 4, pp. 334-356; October, 1949.) "The propagation of the Bloch boundary between two macrodomains under the influence of an external magnetic field H is investigated for Ni-Fe wires of the composition 60-40 and 50-50 subjected to a tensile stress. The quantities involved are the axial rate of propagation v and the effective length λ of the discontinuity. . . A review is given of the various factors determining the shape of the boundary and the rate of propagation v . The experimental results lead to the concept that the movement of the Bloch boundary is impeded by two causes of different origin, one being the eddy-current effect, the other probably a spin-relaxation effect."

538.569.4+[621.396.11:535.312 1904

Absorption and Reflexion of U.H.F. Waves (300-500 Mc/s) by Sea Water—S. K. Chatterjee and B. V. Sreekantan. (*Indian Jour. Phys.*, vol. 23, pp. 273-279; June, 1949.) A parallel beam was passed through a solution simulating sea water. Intensity measurements indicated

maximum absorption at 380 Mc and very little variation of the reflection coefficient over the frequency range investigated. Dielectric constant and conductivity increased with frequency. See also 1921 of 1949.

538.569.4 1905
A Square-Wave Modulation Method for Microwave Spectra—T. R. Hartz and A. van der Ziel. (*Phys. Rev.*, vol. 78, p. 473; May 15, 1950.) The double-modulation method used by Gordy and Kessler (3125 of 1949) and Watts and Williams (1017 of 1948) is modified, with consequent improvement of sensitivity, by substituting a 50-kc square-wave voltage of 10 v or more for the sinusoidal radio-frequency modulation applied in conjunction with low-frequency sawtooth voltage to the klystron reflector.

539.234:537.581 1906
The Use of Radioactive Sr in some Thermionic Experiments on Thin Films—H. W. Allison and G. E. Moore. (*Phys. Rev.*, vol. 78, pp. 354-355; May 1, 1950.) Summary of American Physical Society 1950 Annual Meeting paper EP15. Electron emission measurements made by a tracer method at low temperatures on films of Sr and SrO 1-10 molecules thick evaporated on to tungsten ribbons indicate thermionic activity comparable with that of BaO-SrO cathodes. The technique is described and quantitative results given.

GEOPHYSICAL AND EXTRATERRESTRIAL PHENOMENA

523.53:621.396.9 1907
On Meteor Speed Measurements by the Radio Doppler Method at Low Frequencies—D. D. Cherry and C. S. Shyman. (*Phys. Rev.*, vol. 75, pp. 1441-1442; May 1, 1949.) Measurements were made during the Geminid shower of December 11, 1948, at 30.66 Mc and 12.8625 Mc simultaneously. Results are compared; the frequency used does not appear to affect the value of velocity found.

523.72:621.396.822 1908
Investigations of Radio-Frequency Radiations from the Sun during the Total Solar Eclipse of 20th May, 1947—S. E. Khaykin and B. M. Chikhachev. (*Bull. Acad. Sci. (URSS)*, vol. 12, pp. 38-43; January and February, 1948. In Russian.) See 1135 of June.

523.72:621.396.822 1909
The Growth of Circularly Polarized Waves in the Sun's Atmosphere and Their Escape into Space—V. A. Bailey. (*Phys. Rev.*, vol. 78, pp. 428-443; May 15, 1950.) The theory of plane waves in an ionized medium pervaded by static electric and magnetic fields (2785 of 1949) predicts wave amplification and consequent noise in certain frequency bands. For given frequency and electron drift velocity two independent trios of waves are produced, having circular and mutually opposed polarization. The conditions are established under which a growing flux of energy carried by the waves can pass normally through the boundary between two ionized media, and the theory is applied to show that powerful waves can arise from growth of random transverse perturbations above sunspots and that these waves can escape into space; observations of solar noise are correlated with these phenomena. The ultimate intensity attainable by such a perturbation is discussed.

523.745:550.385 1910
Geomagnetic Storms and Solar Activity 1949—H. W. Newton. (*Observatory*, vol. 70, pp. 84-86; April, 1950.) Geomagnetic activity was on the whole higher than during 1948, sunspot frequency about the same. Data are

tabulated for magnetic storms recorded at Abinger.

523.75 1911
The Solar Flare of 1949 November 19—M. A. Ellison and M. Conway. (*Observatory*, vol. 70, pp. 77-80; April, 1950.) A short account of the development and spectrum of this flare, which was associated with the largest changes of cosmic-ray and neutron intensity ever recorded. The sky-wave signal disappeared abruptly on the three Decca frequencies (70, 113, and 127 kc) and did not reappear until about 5 hours later. There was a simultaneous enhancement of atmospherics recorded on a frequency of 22 kc and also a fadeout of signals in the frequency range 5 to 20 Mc.

551.52 1912
Physics and the Atmosphere—G. M. B. Dobson. (*Proc. Phys. Soc. (London)*, vol. 63, pp. 252-266; April 1, 1950.) Text of the fifth Charles Chree Address, given on November 4, 1949. Includes an account of investigations of atmospheric ozone.

551.510.5:546.21 1913
The Distribution of Atomic and Molecular Oxygen in the Upper Atmosphere—H. E. Moses and Ta-You Wu. (*Phys. Rev.*, vol. 78, p. 333; May 1, 1950.) Summary of American Physical Society 1950 Annual Meeting paper N7. From the usual steady-state gas conditions, together with an appropriate form of the barometric equation, theoretical calculations are made of the number density of O_2 and O and of the temperature, all as functions of height, the temperature and its gradient being known at one height. According to these calculations, dissociation of O_2 is not complete till about 200 km, and the maximum number density of O , occurring at about 100 km, is about $10^{11}/cm^3$, which is considerably less than estimated by previous workers.

551.510.535 1914
On Investigations of the F_2 Layer of the Ionosphere during the Total Solar Eclipse of 20th May, 1947—Ya. L. Al'pert. (*Bull. Acad. Sci. (URSS)*, vol. 12, pp. 44-48; January and February, 1948. In Russian.) See 1147 of June.

551.510.535 1915
On the Frequency of Occurrence and the Structure of the E_1 Layer of the Ionosphere—W. Becker and W. Dieminger. (*Naturwiss.*, vol. 37, pp. 90-91; February, 1950.) The reflection heights of the ordinary and extraordinary rays at the E_1 , E_2 , and E_3 layers are more clearly identified by the use of high-power equipment (see 892 of May). Two typical records obtained at the Max Planck Institute for Ionosphere Research are reproduced. Mean values of limiting frequencies for and heights of the E_2 layer at half-hourly intervals for August, 1949, are tabulated and discussed. The slight thickness of the E_2 layer makes it probable that its existence is due to neutral corpuscles radiated by the sun. The sporadic- E layer should be distinguished according to its height and uniformity and the time of day.

551.510.535:621.396.11 1916
Radio Wave Propagation in a Curved Ionosphere—Kelso. (See 2013.)

LOCATION AND AIDS TO NAVIGATION

621.396.9:523.53 1917
On Meteor Speed Measurements by the Radio Doppler Method at Low Frequencies—Cherry and Shyman. (See 1907.)

621.396.933 1918
Traffic Handling Capacity of 100 Chan-

nel Distance-Measuring-Equipment (DME) Standardized by R.T.C.A. SC-40 and I.C.A.O.—C. J. Hirsch. (*Proc. Radio Club Amer.*, vol. 27, pp. 3-25; 1950.) Normal operation of the equipment is discussed. Decreased efficiency may result from (a) transponder dead time, which occurs after each reply is transmitted, and (b) "bunching" of pulses from different pairs causing spurious replies by the transponder. An analysis of the characteristics determines how the time of initial search for a transponder reply and the memory of previous replies are affected by the number of interrogations received by a transponder. Results of actual tests confirm that the equipment satisfactorily complies with ICAO specifications. See also 365 of March.

621.396.933 1919
Principles Common to Certain Systems of Radio Navigation, and Study of a Particular Case: the Raydiat System—J. Rabier. (*Ann. Télécommun.*, vol. 5, pp. 137-142; April, 1950.) Discussion of systems depending on knowledge of the velocity of propagation of em waves. The Raydiat system was noted in 3131 of 1947.

621.396.933 R.T.C.A. 1920
The Radio Technical Commission for Aeronautics—Its Program and Influence—J. H. Dellinger. (*Proc. I.R.E.*, vol. 38, pp. 468-470; May, 1950.) 1949 IRE National Convention paper.

621.396.9 1921
Frequency—Modulated Radar [Book Review]—D. G. C. Luck. Publishers: McGraw-Hill Book Co., New York, N. Y., 466 pp., \$4.00, 1949. (*Electronics*, vol. 23, p. 132; May, 1950.) Written originally as a U. S. Navy report, this book deals with basic theory, design, and applications. Military systems take up a substantial portion, and some of the equipment discussed was not completed until after the war. For certain single-target problems, FM has advantages over pulse radar; for multi-target problems, further development is required.

MATERIALS AND SUBSIDIARY TECHNIQUES

531.787.9 1922
The Pirani Effect in a Thermionic Filament as a Means of Measuring Low Pressures—L. Spiers and W. P. Jolly. (*Brit. Jour. Appl. Phys.*, vol. 1, pp. 132-133; May, 1950.) Measurements on the tungsten filament of a simple ionization gauge showed that as the pressure P is reduced the filament-heating voltage required to maintain a given filament emission—90 μ in the particular case considered—falls. When the gas used is hydrogen, the relation between heating voltage and log P is linear. Advantages of a gauge of this type are enumerated.

535.215 1923
Photoconductivity of Lead Sulphide—L. Genzel and H. Müsser. (*Zeit. für Phys.*, vol. 127, pp. 194-200; January, 1950.) Previous work on the internal photoeffect of PbS in the infrared region is extended towards shorter waves; experimental results are discussed.

535.215.4:546.289 1924
Photoelectric Effects in Germanium—B. J. Rothlein and F. A. Stahl. (*Sylvania Technologist*, vol. 3, pp. 8-11; April, 1950.) Theoretical and experimental results on the photosensitivity of Ge in the wavelength range 0.5-2 μ are reviewed and the relation of the photosensitivity to the properties of the surface layers of the semiconductor is discussed. An ac photo switch is described in which the power supplied to a

dissipative load is controlled by an infrared beam.

537.581+537.324 1925

Refractory Thermocouples and Emissivity Determination—F. H. Morgan. (*Phys. Rev.*, vol. 78, p. 353; May 1, 1950.) Summary of American Physical Society 1950 Annual Meeting paper EP9. The thermoelectric power was investigated for thermocouples of W/Ta, W/Mo, Ta/Mo, and W/W-Mo up to temperatures of 3,000° C or near. The curve found for W/Ta, which was checked, differed from that previously recorded. Using these thermocouples, the spectral emissivity of thoria and other cathode materials was easily found.

537.581:546.92 1926

Effect of Impurities on Thermionic Emission from Platinum—A. Ertel. (*Phys. Rev.*, vol. 78, pp. 353-354; May 1, 1950.) Summary of American Physical Society 1950 Annual Meeting paper EP10. An account of measurements of thermionic work function and emission constant for No. 1 grade and CP platinum. The former contained an electropositive impurity which, on receiving heat treatment, was "cleaned up" at 1,850°-1,930° K; the latter contained both a similar impurity and another which yielded violent bursts of emission at 900°-1,100° K. Spectroscopic and X-ray diffraction analyses were also made.

537.581:666.76 1927

Certain Refractory Compounds as Thermionic Emitters—D. L. Goldwater and R. E. Haddad. (*Phys. Rev.*, vol. 78, p. 353; May 1, 1950.) Summary of American Physical Society 1950 Annual Meeting paper EP8. Some nitrides, borides, and carbides are investigated and compared with thoria.

537.582:546.3 1928

A Preliminary Study of the Work Function of Contaminated Metal Surfaces—P. H. Miller, Jr., and B. J. Rothlein. (*Phys. Rev.*, vol. 78, p. 354; May 1, 1950.) Summary of American Physical Society 1950 Annual Meeting paper EP13. An electron beam is passed between a reference plate and the test surface (Ta, Zr, or W); changes of work function produce field changes causing deflection of the beam. Changes of 0.05 v can be measured.

538.221 1929

Symposium of Papers on Ferromagnetic Materials—(PROC. I.R.E., Part II, vol. 97, pp. 118-274; April, 1950.) Summaries are given of all the papers presented during the four sessions on November 7 and 8, 1949, together with the full text of those not published hitherto.

538.221 1930

g-Factors in Ferrite Materials—H. G. Beljers and D. Polder. (*Nature* (London), vol. 165, p. 800; May 20, 1950.) Microwave absorption measurements, using 3.2-cm waves, for ferrites containing various proportions of NiO and ZnO give g-factors near 2, in agreement with theory.

538.221 1931

Magnetization in Ferrites—E. W. Gorter. (*Nature* (London), vol. 165, pp. 798-800; May 20, 1950.) A study of the saturation magnetization of various ferrites with spinel structure.

538.221 1932

Anomalous Behavior of the Dielectric Constant of a Ferromagnetic Ferrite at the Magnetic Curie Point—F. G. Brockman, P. H. Dowling, and W. G. Stenbeck. (*Phys. Rev.*, vol. 75, p. 1440; May 1, 1949.)

546.841-3+666.76 1933

Notes on Thoria and Other Refractory

Materials—L. J. Croning. (*Phys. Rev.*, vol. 78, p. 352; May 1, 1950.) Summary of American Physical Society 1950 Annual Meeting paper EP1. The chemistry of Th compounds is complex; thoria may contain over 3 per cent impurities, and the specific surface of samples from different sources varies enormously. Experimental work is described on the reaction of thoria with metals, the secondary/primary emission ratio of directly heated thoria cathodes, and the evaporation of a large variety of refractory materials.

546.841-3:621.3.011.2 1934

Electrical Conductivity of Sintered Thoria—W. E. Danforth and F. H. Morgan. (*Phys. Rev.*, vol. 78, p. 353; May 1, 1950.) Summary of American Physical Society 1950 Annual Meeting paper EP6. The thoria was studied in vacuo, at temperatures up to 1,800° C. Specimens were subjected to currents up to several amperes per cm²; the resistance variation is essentially linear over this range and may be as low as 1 ohm-cm at 1,200° C after prolonged passage of 10 a/cm². Exposure to atmospheric pressure causes deactivation. The effect of activation procedures on resulting activation energies is discussed.

546.841-3:621.385.032.216 1935

Rate of Disappearance of Thoria from Coated Filaments—E. Shapiro. (*Phys. Rev.*, vol. 78, p. 352; May 1, 1950.) Summary of American Physical Society 1950 Annual Meeting paper EP2. Dependence of the rate on temperature and emission was studied. A formula is given for the range 2,050°-2,250° K, over which the rate is not affected by the current being taken.

546.841-3:621.385.032.216 1936

Thermal Emissivity Changes of Thoria-Coated Tungsten Filaments—O. A. Weinreich. (*Phys. Rev.*, vol. 78, pp. 352-353; May 1, 1950.) Summary of American Physical Society 1950 Annual Meeting paper EP3: An investigation with particular reference to the effects of processing. In some cases the changes observed can be correlated with changes of thermionic emission. Emissivity of fresh coatings was increased by high-temperature flashing and by electron bombardment.

621.315.57:666.3:621.385.032.21 1937

Ceramic Heaters and Cathodes for Electron Tubes—Palumbo. (See 2065.)

621.315.59:546.28 1938

Nucleon-Bombarded Silicon—K. Lark-Horovitz, M. Becker, R. E. Davis, and H. Y. Fan. (*Phys. Rev.*, vol. 78, p. 334; May 1, 1950.) Summary of American Physical Society 1950 Annual Meeting paper OA1. The effect of bombardment on resistivity is investigated experimentally.

621.315.59:546.289 1939

Impedance Characteristics of Grain Boundaries in High Resistivity N Type Germanium—N. H. Odell and H. Y. Fan. (*Phys. Rev.*, vol. 78, p. 334; May 1, 1950.) Summary of American Physical Society 1950 Annual Meeting paper OA2.

621.315.59:546.289 1940

D.C. Characteristics of High Resistance Barriers at Crystal Boundaries in Germanium—W. E. Taylor and H. Y. Fan. (*Phys. Rev.*, vol. 78, no. 3, p. 335; May 1, 1950.) Summary of American Physical Society 1950 Annual Meeting paper OA5.

621.315.59:621.385.2:621.314.632:537.311.33 1941

D.C. Characteristics of Silicon and Germanium Point Contact Crystal Rectifiers: Part

2—The Multicontact Theory—V. A. Johnson, R. N. Smith, and H. J. Yearian. (*Jour. Appl. Phys.*, vol. 21, pp. 283-289; April, 1950.) An extension of the diode theory which accounts for the observed characteristics of these rectifiers.

621.315.612.4 1942

The Ferro-Electricity of Titanates—G. H. Jonker and J. H. van Santen. (*Philips Tech. Rev.*, vol. 11, pp. 183-192; December, 1949.) Discussion of the analogy between ferromagnetic phenomena and the piezoelectric properties of Rochelle salt, KH₂PO₄, and BaTiO₃. Outlines of a theory applicable to titanate dielectrics are given.

621.318.323.2:538.114 1943

Magnetic After-Effect in Laminated Cores in Weak Alternating Fields—R. Feldtkeller. (*Ferromagnet. Z.*, vol. 3, pp. 112-117; April, 1950.)

621.795:621.385.833 1944

A Lapping Technique to Improve the Image Quality of Electron Microscope Lenses—F. A. Hamm. (*Jour. Appl. Phys.*, vol. 21, pp. 271-278; April, 1950.)

533.5+531.788 1945

Vacuum Equipment and Techniques [Book Review]—A. Guthrie and R. K. Waklerling (Eds.). Publishers: McGraw-Hill Book Co., New York, N. Y., 242 pp., \$2.50, 1949. (PROC. I.R.E., vol. 38, p. 578; May, 1950; *Rev. Sci. Instr.*, vol. 21, p. 38; April, 1950.) Concerned primarily with the development of equipment at the University of California Radiation Laboratory. "While . . . the volume does not cover fully all problems likely to be encountered in vacuum processes, . . . workers in high-vacuum electronics should find it to be well worth their attention."

535.37 1946

An Introduction to the Luminescence of Solids [Book Review]—H. W. Leverenz. Publishers: John Wiley and Sons, Inc., New York, N. Y., 471 pp., \$12.00, 1950. (PROC. I.R.E., vol. 38, p. 577; May, 1950; *Rev. Sci. Instr.*, vol. 21, p. 382; April, 1950.) ". . . the author has wisely chosen to describe phosphors generally in terms of preparations, compositions, structures, and physical characteristics, using individual phosphors to illustrate each feature. In this way, a co-ordinated view of the entire subject is obtained, without sacrificing the utility of adequate descriptions of interesting and useful phosphors. . . . Much of the author's original work is presented in this volume, together with extensive references to the available literature (the bibliography contains over 1,000 references). . . . it will be invaluable . . . in training future specialists and in aiding scientists who wish to refresh and increase their knowledge of solid matter and its interactions with radiations. . . ."

621.318.2 1947

Abriss der Dauermagnetkunde (Permanent Magnet Technology) [Book Review]—J. Fischer. Publishers: Springer Verlag, Berlin, Germany, 248 pp., 36 DM or 39 DM (linen bound). (*Electrician*, vol. 144, p. 1205; April 14, 1950.) A comprehensive treatise intended for students and engineers interested in permanent magnets of any size and application.

MATHEMATICS

517.512.2 1948

The Summation of Fourier Series by Operational Methods—L. A. Pipes. (*Jour. Appl. Phys.*, vol. 21, pp. 298-301; April, 1950.) A method using Laplace transforms is described by means of which graphical representations can easily be obtained of certain functions de-

ned by Fourier series and of practical importance.

- 681.142** 1949
The Electronic Isograph for Roots of Polynomials—B. O. Marshall, Jr. (*Jour. Appl. Phys.*, vol. 21, pp. 307-312; April, 1950.) A polynomial $f(z) = \sum a_n \cdot z^n$ can be represented by $\sum a_n r^n \cos n\theta + j \sum a_n r^n \sin n\theta$ and a root occurs when these two terms are simultaneously zero. $\sin n\theta$ and $\cos n\theta$ are generated by a commutator, and potentiometers control the amplitudes corresponding to the coefficients (a_n). The sums of the cos and sin terms are applied to the λ and y plates respectively of an oscillograph, and r is varied by another potentiometer until the trace passes through the origin, indicating one of the roots; θ is determined by a stroboscopic device. Polynomials of degree 10 or less can be dealt with. Various applications are discussed.
- 681.142** 1950
Principle and Realization of a Mathematical Machine, the "Operateur Mathématique Electronique" (O.M.E.)—B. A. Sokoloff. (*Ann. Télécommun.*, vol. 5, pp. 143-159; April, 1950.) A detailed account of equipment noted in 1443 of July (Raymond)—Type OME 111.
- 681.142** 1951
An Analog Computer—J. G. Bayly. (*Rev. Sci. Instr.*, vol. 21, pp. 228-231; March, 1950.) An integrator capable of solving equations of the form $dx/dt = -\lambda x + f(t)$.
- 681.142** 1952
High Speed Digital Computers—L. N. Ridenour. (*Jour. Appl. Phys.*, vol. 21, pp. 263-270; April, 1950.) An elementary survey of present developments and future trends.
- 681.142** 1953
A Dynamically Regenerated Electrostatic Memory System—Eckert, Lukoff, and Smoliar. (See 2005.)
- 681.142:517.946.8** 1954
Solution of Partial Differential Equations with a Resistance Network Analogue—G. Liebmann. (*Brit. Jour. Appl. Phys.*, vol. 1, pp. 92-103; April, 1950.) A more extended account of the network and iteration method noted in 3460 of 1949. The network described is axially symmetrical, with 60 meshes in the z direction and 20 in the r direction, and has 50 current-feeding points. Accuracies to within 1 part in 10^2 - 10^4 can be attained much more quickly than by numerical methods of field plotting, and semiskilled operators can handle the equipment satisfactorily.
- 681.142:517.946.8** 1955
The Analog Solution of Simultaneous Partial Differential Equations by Means of Passive and Active Electrical Networks—J. H. Green, Jr., and V. B. Corey. (*Phys. Rev.*, vol. 78, p. 328; May 1, 1950.) Summary of American Physical Society 1950 Annual Meeting paper HA7.
- 681.142:621.3.016.352** 1956
Stabilization of Simultaneous Equation Solvers—G. A. Korn. (*Proc. I.R.E.*, vol. 38, p. 514; May, 1950.) Discussion on 3348 of 1949.
- 681.142:621.385.032.212** 1957
The Dekatron—Bacon and Pollard. (See 2066.)
- 681.142:621.392** 1958
Diode Coincidence and Mixing Circuits in Digital Computers—Tung Chang Chen. (*Proc. I.R.E.*, vol. 38, pp. 511-514; May, 1950.) "Basic circuits utilizing germanium diodes in electrically pulsed systems are described. The

circuits are of the following types; (a) coincidence circuits—output signal occurs only when all the inputs receive signals simultaneously; (b) mixing circuits—output signal occurs when any one of the inputs receives a signal. The analyses of transient response of the output signal and input impedance are given." Pulse-repetition rates up to several Mc and rise- and fall-times of 0.05 μ s are possible.

- 681.142:794.1** 1959
Programming a Computer for Playing Chess—C. E. Shannon. (*Phil. Mag.*, vol. 41, pp. 256-275; March, 1950.) Full text of the paper noted in 1703 (f) of 1949. Has theoretical interest in relation to more practical problems such as those concerning machines for designing filters and switching circuits.

MEASUREMENTS AND TEST GEAR

- 537.291.082.1** 1960
A Dynamic Electron Trajectory Tracer—J. W. Clark and R. E. Neuber. (*Proc. I.R.E.*, vol. 38, pp. 521-524; May, 1950.) Electrode structure in sheet-rubber model is made to oscillate vertically, thus simulating the effect of applied radio-frequency voltage.
- 621.3.018.4(083.7):621.396.615.17/.18**
+ **621.317.761** 1961
Frequency Generation and Measurement—H. J. Finden. (*Electronic Eng.*, vol. 22, pp. 220-226; June, 1950.) Illustrated description of a frequency synthesizer covering the range 1 kc-1 Mc in 1-kc steps in a decade arrangement, and delivering 0.1 v into a 100- Ω load. A standard controlling frequency of 100 kc is obtained from a crystal maintained at 60° C; this is fed to amplifier and multivibrator circuits to produce oscillations at 1 kc, 10 kc, 100 kc, and 1 Mc, respectively, the lowest of these determining the minimum size of the variation step. The procedure for generating a required frequency, by selecting and combining appropriate harmonics, is given in detail.
- 621.317:061.3** 1962
Instruments and Measurements Conference, Stockholm, 1949—(*Instr. Practice*, vol. 4, pp. 25-33; November, 1949.) Titles and authors are given of all the papers presented, with abstracts of those in English.
- 621.317.336/34+621.392.6.029.63** 1963
Theory and Technique of Multipole Networks at Ultra-High Frequencies—Goudet and Jassin. (See 1882.)
- 621.317.35:621.314.2.029.3** 1964
Test Methods for High Quality Audio Transformers—E. B. Harrison. (*Tele-Tech*, vol. 9, pp. 40-41... 65; March, 1950.) Square-wave inputs are applied at seven frequencies in the range 20 cps-20 kc. The effect of winding resistance, leakage inductance, and reflected primary impedance on the output waveform is discussed. Results obtained at the different frequencies with five commercial transformers are illustrated.
- 621.317.373:621.317.755** 1965
Phase-Angle Measurements Using a Cathode-Ray Tube—F. A. Benson and A. O. Carter. (*Electronic Eng.*, vol. 22, pp. 238-242; June, 1950.) A discussion of errors in cathode-ray oscillograph measurements due to trace width and presence of harmonics.
- 621.317.39:548.0:537.228.1** 1966
An Arrangement for Indicating Piezoelectricity of Crystals—W. G. Perdok and H. van Suchtelen. (*Philips Tech. Rev.*, vol. 11, pp. 151-155; November, 1949.) Describes apparatus of improved sensitivity, for detecting piezoelectric effects in small fragments of crystal. These are placed between two flat electrodes connected in parallel with the tuning circuit of an oscillator which is tuned manually through the range 300 kc-30 Mc and at the same time modulated on frequency at 100 cps by means of a vibrating capacitor. The dip in the amplitude of oscillation when tuning through a crystal resonance is detected by a separate tube and produces an audible rattle in a loudspeaker.
- 621.317.612:621.314.2.083** 1967
On the Measurement of the No-Load Losses of Small 50-c/s Transformers—L. Medina. (*Elektrotech. und Maschinenb.*, vol. 67, pp. 99-104; April, 1950.) Two methods are described, both giving accurate results. In the first method the losses are determined for the value of a resistor substituted for the transformer winding shunted by a capacitor adjusted to give a minimum total current through the combination, the resistor being adjusted to obtain the same current. An amplifier tuned to 50 cps ensures adequate sensitivity for operating a moving-coil meter or cathode-ray indicator. The test transformer is fed from 50-cps mains through an autotransformer and an isolating transformer with an earthed screen between the windings. The second method uses a simple resonance bridge. Typical results are tabulated. Complete circuit details of the tuned amplifier are given. See also 180 of 1947.
- 621.317.7+621.396.6+621.38.001.8** 1968
Physical Society's Exhibition—(See 1883.)
- 621.317.72** 1969
A Millivoltmeter for a Large Range of Frequency and Voltage—H. te Gude. (*Funk. und Ton.*, vol. 4, pp. 201-204; April, 1950.) Details of the design of an instrument intended for measurements on broadcast receivers and transmitters, and comprising a 6-stage amplifier, crystal detector, moving-coil meter, and capacitive attenuator. Frequency range is 1 kc-30 Mc; the 11 voltage ranges extend from 1 mv to 1,000 v full scale.
- 621.317.725** 1970
VTVM Circuits—M. C. Selby. (*Electronics*, vol. 23, pp. 110-111; May, 1950.) A tabulated survey of basic tube-voltmeter circuits.
- 621.317.725** 1971
Negative-Feedback Direct-Voltage Valve Voltmeters—W. Geyger. (*Arch. Tech. (Messing)*, no. 170, pp. T31-T33; March, 1950.) An asymmetric single-triode bridge circuit with heavy negative feedback, the adjustment of which provides 4 ranges between 2 and 200 v without affecting the current drawn from the battery supply. Results of measurement are practically independent of alterations of tube characteristics and supply voltage fluctuations. Two-tube push-pull circuits are also shown, one battery-operated and the other supplied from alternating-current mains.
- 621.317.733** 1972
High-Frequency Bridge of the Société Anonyme de Télécommunications for the Measurement of [Cable] Impedance Deviations—G. Fuchs and P. Fenouillet. (*Cables and Trans. (Paris)*, vol. 4, pp. 126-132; April, 1950.) Direct-reading instrument operating over the range 50 kc-10 Mc and giving the real and imaginary parts of impedances near 75 Ω to within 1 part in 1,000.
- 621.317.733** 1973
A Method of Decreasing the Effect of Earth Admittances in A. C. Bridges—G. H. Rayner and R. W. Willmer. (*Jour. Sci. Instr.*, vol. 27, pp. 103-104; April, 1950.) The bridge screen is connected to the cathode of a cathode follower, so that its potential follows that of the grid, which is connected to one of the detector

terminals and thus has a negligible admittance to earth. The balance condition of the bridge is satisfied although the detector terminals are not at earth potential. Precautions taken to ensure a high input impedance for the cathode follower are described in detail.

621.317.733:621.317.794 1974

A Bolometer Bridge for Standardizing Radio-Frequency Voltmeters—M. C. Selby and L. F. Behrent. (*Jour. Res. Nat. Bur. Stand.*, vol. 44, pp. 15-30; January, 1950.) The equipment described can be used to measure voltages between 20 mv and 1.9 v at frequencies below 700 Mc to an accuracy within ± 1 per cent. The equipment may also be used for the direct measurement of radio-frequency, generator voltages, as a standard of radio-frequency impedance, and for accurate power measurement from 20 μ w to 100 mw. Factors limiting the range of voltage measurement are described, and various independent methods are given by which the measured voltage can be checked.

621.317.733:621.396.611.21:621.3.012.8 1975

Measurement of the Equivalent Electrical Circuit of a Piezoelectric Crystal—A. C. Lynch. (*Proc. Phys. Soc. (London)*, vol. 63, pp. 323-331; May 1, 1950.) The value of the equivalent capacitance is deduced from measurements of the effective series capacitance of the crystal at two frequencies symmetrically disposed about the resonance frequency and differing from it by 0.5-5 per cent. A substitution Schering bridge reading to 0.001 pF is used, connected so as to exclude effects of stray capacitance to earth. With a single resonance frequency the equivalent circuit parameters are measured to within 0.1 per cent and the piezoelectric coefficient calculated to within 0.5 per cent. When there is more than one resonance mode the equivalent circuits for each can be deduced by successive approximations.

621.317.756.089.6:621.396.662 1976

Design Analysis of a TM-Mode Piston Attenuator—A. B. Giordano. (*Proc. I.R.E.*, vol. 38, pp. 545-550; May, 1950.) 1948 I.R.E. National Convention paper. The design of a system consisting of coaxial input and output sections separated by a cylindrical waveguide section operating below cut-off is described. The attenuation, input impedance, and voltage SWR are calculated and evaluated numerically for a model designed to operate at 10-cm wavelength. The calculations agree well with experimental measurements for coupling separations ≥ 0.5 cm.

621.317.772:621.396.11 1977

A Method of Simulating Propagation Problems—Iams. (*See 2014.*)

621.317.784 1978

Absolute Measurement of Microwave Power by Radiation Pressure—A. L. Cullen. (*Nature (London)*, vol. 165, p. 726; May 6, 1950.) Using the method previously described (1727 of 1949) the deflection observed with a 9.1-cm magnetron transmitter giving 1- μ s pulses with a recurrence frequency of about 1 kc corresponded to a force of 0.014 dyne, equivalent to a power of 36 w, as compared with 32 w measured simultaneously but independently by a balanced calorimeter method. Projected further work with the apparatus evacuated may eliminate disturbing effects possibly due to heating.

621.317.79:621.396.67 1979

Ripple Tank for Phase-Front Visualization—J. D. Fahnestock. (*Electronics*, vol. 23, pp. 120 and 122; May, 1950.) An analogue method of determining phase fronts associated with antenna systems. Magnetically driven pin

points, representing the antennas, are actuated by an audio oscillator and produce water ripples. These are viewed as a stationary pattern on a ground glass screen above the tank, a synchronously controlled, stroboscopic light source being used.

621.396.615 1980

Wide-Range Frequency-Modulated Oscillator—P. M. Milner. (*Electronics*, vol. 23, pp. 118, 144-164; May, 1950.) A reactance tube is used as modulator, frequency variation being achieved by varying modulator grid voltage, without introducing frequency multiplication or conversion. From 15 Mc to 40 Mc the frequency dependence on modulator grid voltage (from 0 to 2.8 v) is linear to within ± 1 per cent, and the output is 1 v rms within ± 5 per cent.

OTHER APPLICATIONS OF RADIO AND ELECTRONICS

534.321.9.001.8 1981

Summarized Proceedings of Symposium on Applications of Ultrasonics—G. Bradfield. (*Proc. Phys. Soc. (London)*, vol. 63, pp. 305-322; May 1, 1950.) This symposium, held on February 18, 1949, included surveys of recent advances in (a) the investigation of the fundamental structure of matter, (b) telecommunication and allied applications, and (c) the use of mechanical forces set up by intense waves.

539.16.08 1982

On the Velocity of Discharge Propagation in Externally Quenched Geiger Counters—C. Balakrishnan and J. D. Craggs. (*Proc. Phys. Soc. (London)*, vol. 63, pp. 358-366; April 1, 1950.) A new method for measuring this velocity is described. The results obtained with argon, hydrogen, and neon are shown in graphs and tables, and discharge-propagation mechanisms are discussed briefly.

539.16.08 1983

On the Temperature Dependence of Counter Characteristics in Self-Quenching Geiger-Müller Counters—O. Parkash and P. L. Kapur. (*Proc. Phys. Soc. (London)*, vol. 63, pp. 457-461; May 1, 1950.)

539.16.08 1984

A Study of Plateau Slopes in Self-Quenching Geiger-Müller Counters—S. C. Brown and C. Maroni. (*Rev. Sci. Instr.*, vol. 21, pp. 241-244; March, 1950.)

539.16.08 1985

Time Lags in Geiger Counters—A. R. Laufer. (*Rev. Sci. Instr.*, vol. 21, pp. 244-251; March, 1950.)

539.16.08 1986

The Electric Field in a Geiger Counter—A. R. Laufer. (*Rev. Sci. Instr.*, vol. 21, pp. 252-254; March, 1950.)

539.16.08:621.315.59 1987

A Germanium Counter—K. G. McKay. (*Phys. Rev.*, vol. 76, p. 1537; November 15, 1949.) Bombardment of the barrier region of a Ge crystal under a point contact by an α particle produces free electrons and positive holes in the barrier region, which are then swept out by the barrier field aided by the applied field. This effect is applied in a counter using N-type high-back-voltage Ge with a phosphor-bronze point contact. Connected to an amplifier covering the range 100 kc-15 Mc, this acted as an efficient counter for α particles. The fast rise and recovery times, small sensitive volume, and ability to discriminate against β particles are advantageous in certain applications.

539.16.08:621.396.645 1988

Linear Amplifiers—Schultz. (*See 1888.*)

620.179.16 1989

Ultrasonic Testing of Gas Turbine Disks—A. R. Laufer. (*Metal Progress*, vol. 57, pp. 468-472; April, 1950.) Flaw detection using a frequency of 2.25 Mc.

621.316.74:621.385.38 1990

A Continuously-Operating Thyatron Temperature-Control Device—Aumont. (*See 2032.*)

621.316.74.076.7 1991

Electronic Temperature Control. (*Overseas Eng.*, vol. 23, pp. 352-353; May, 1950.) A description of commercial control equipment for gas- or oil-fired furnaces. Variation of temperature causes movement of a metal vane between two coils, thus changing their inductance and operating a sensitive relay controlling the opening of the fuel tube.

621.317.083.7 1992

Analysis of Errors in a Phase-Shift Angle Telemetry System—J. V. Harrington. (*Proc. I.R.E.*, vol. 38, p. 495; May, 1950.) Summary of thesis.

621.317.39 1993

An Electrical Displacement Meter—A. Douglas. (*Electronic Eng.*, vol. 22, pp. 215-219; June, 1950.) The design and operation of available mains-frequency em gauges for measuring small physical displacements are discussed, and their shortcomings pointed out. The nonresonant-bridge type has low sensitivity, and while the resonant-bridge type is better in this respect it is difficult to stabilize. A bridged-T circuit was therefore used, having a common point to which the ac source (a Colpitts oscillator at 20 kc) coil and detector could be earthed. Various practical applications of the instrument are mentioned. A more detailed paper on the subject, by the author and H. Ford, is published as Special Report No. 34 of the Iron and Steel Institute.

621.365.54† 1994

Radio-Frequency Heating in the Fabrication of Precision Machines and Apparatus—A. Leemann. (*Microtecnic (Lausanne)*, vol. 4, pp. 33-36; January and February, 1950.) Advantages of the rf method and practical arrangements for heating small parts are discussed.

621.365.54† 1995

Heating by High-Frequency Fields—E. C. Witsenburg. (*Philips Tech. Rev.*, vol. 11, pp. 165-175; December, 1949.) A formula is derived for the heating-coil efficiency, from which it appears that in simple cases the best results are obtained when the frequency is high enough to ensure that the penetration depth is not greater than about $\frac{1}{2}$ the diameter of the object being heated.

621.38:621.944 1996

Electronic Mill Control—(*Flec. Times*, vol. 117, pp. 699-701; April 27, 1950.) GEC equipment installed 10 years ago in the cold-rolling section of Richard Thomas and Baldwin's Ebbw Vale works is described. It is designed to ensure constant tension in the strip while the latter is uncoiled, rolled, and recoiled, and its use enables a thick-sheet mill to produce thicknesses suitable for tin plate.

621.39.001.8+621.396.6+621.317.7 1997

Physical Society's Exhibition—(*See 1883.*)

621.38.001.8 1998

Electronics Symposium 1949—(*Instr. Practice*, vol. 3, pp. 570-571; October, 1949.) Summaries are given of the following papers presented at the symposium organized by the Electronics Group of the Scientific Instrument

Manufacturers' Association, London, 2nd-4th Nov. 1949:

- Electronic Instrumentation in Atomic Research—D. Taylor.
 Electronic Amplifiers—D. L. Banks.
 Magnetic Amplifiers—A. V. Herningway.
 Some Recent Improvements in Electronic Measuring Techniques—C. H. W. Brooks-Smith and J. A. Colls.
 The Measurement of Some Transient Phenomena—H. A. Dell.
 An Industrial Servomechanism—P. H. Briggs.
 Cooperative Research at B.S.I.R.A.—A. J. Maddock.

See also 708 of April.

621.383:621-426:771.37 1999
Automatic Exposure Control—G. Bruck, J. Higgins, and J. Ward. (*Electronics*, vol. 23, pp. 74-78; May, 1950.) A photoelectric servo device for aperture control on motion-picture and television cameras in antenna work at speeds over 500 mph.

621.384:621.1† 2000
An Open-Type 800-kV Van de Graff Generator—P. Ohlin and O. Beckman. (*Ark. Mat. Astr. Fys.*, vol. 1, pp. 323-327; October 22, 1949. In Swedish.) General description of the generator and associated accelerator recently constructed at Uppsala.

621.385.83 2001
Electron Optics at High Frequencies and at Relativistic Velocities—D. Gabor. (*Rev. d'Optique*, vol. 29, pp. 209-231; April, 1950. In English.) When dc and ac fields are considered simultaneously, it is more convenient to represent the field by vector potentials and anti-potentials, particularly for systems with axial symmetry. The equations of motion including the relativistic term are considered for an electron, and the conditions for space and phase focusing are established. The results are applied to the case of a linear accelerator and it is concluded that only field-lenses with Alvarez windows will allow stability to be attained in practice.

621.385.833 2002
Note on Potentials Derived from Axial Values in Electron Optics—F. Berz. (*Phil. Mag.*, vol. 41, pp. 209-220; March, 1950.) "The determination of electrode systems which produce a precalculated distribution along the optic axis is examined. It is shown that an analytic potential distribution is completely determined when its values along any arbitrarily small interval on the axis are exactly known. On the other hand if, as usual, the value of the potential along a finite stretch of the axis is prescribed within arbitrarily small but finite limits, this is compatible with an infinity of different potential distributions which can be constructed without any singularity at finite distances, and which can assume prescribed values at any number of points outside the axis of symmetry."

621.385.833 2003
Laboratory Modifications in the R.C.A. Model EMC Electron Microscope—S. G. Ellis. (*Rev. Sci. Instr.*, vol. 21, pp. 255-257; March, 1950.) The modifications described are capable of being carried out in any laboratory machine shop, and increase the resolving power nearly to its ultimate value, about 50 Å.

621.398:538.74 2004
The Admiralty Transmitting Magnetic Compass—A. Hine. (*Instr. Practice*, vol. 3, p. 456; August, 1949.) A brief survey of the function and possible uses of the instrument. The principle is that of a Wheatstone bridge using the liquid in the master compass as a

resistance path between electrodes mounted on the card and in the bowl. The voltage developed between two points on the bridge depends on the compass setting and is used, after amplification, to operate follow-up equipment feeding as many repeaters as required.

681.142 2005
A Dynamically Regenerated Electrostatic Memory System—J. P. Eckert, Jr., H. Lukoff, and G. Smoliar. (*Proc. I.R.E.*, vol. 38, pp. 498-510; May, 1950.) 1949 IRE National Convention paper. The fundamental theory is discussed of the processes by which charge patterns representing binary numbers are stored on the screen of a cathode-ray tube in an electrostatic "memory" system. The influence of cathode-ray tube parameters and of associated circuits is analyzed. Experiments with different systems show that the binary digits, 1 and 0, are best represented by a dot and a circle, the circle being produced by whirling the spot at a high radio frequency.

621.38/.39 2006
Advances in Electronics: vol. 2 [Book Review]—L. Marton (Ed.). Publishers: Academic Press, New York, N. Y. 378 pp., \$7.60, 1950. (*Electronics*, vol. 23, pp. 134-135; May, 1950.) Includes 8 new monographs dealing with electron focusing, cathodoluminescence, breakdown in dielectrics, microwave magnetrons, ferromagnetic phenomena and spectroscopy. (vol. 1: 2889 of 1949.)

621.38:539.17 2007
Electronics: Experimental Techniques [Book Review]—W. C. Elmore and M. L. Sands (Eds.). Publishers: McGraw-Hill Book Co., New York, N. Y., 417 pp., \$3.75, 1949. (*Electronics*, vol. 23, pp. 136-142; May, 1950.) National Nuclear Energy Series, Division V, vol. 1. "This is not a treatise on experimental electronic techniques; it is a volume describing in detail a series of excellent devices which have been designed, tested and modified until they meet satisfactorily many of the needs of the nuclear physicist." This volume covers the work done at the Los Alamos Laboratories. "The usefulness of this book and its permanent value would have been greatly enhanced if . . . a more complete treatment had been given of the basic circuit elements . . ."

621.38.001.8 2008
A Symposium on Electronics [Book Review]—A. G. Peacock (Ed.). Publishers: Chapman and Hall, London, England, 199 pp., 16 s. (*Brit. Jour. Appl. Phys.*, vol. 1, p. 110; April, 1950.) A collection of ten papers read at the first symposium on electronics, held in London in 1948; applications in research and industry are dealt with. See also 1145 of 1949.

PROPAGATION OF WAVES

538.566 2009
The Radiation from a Magnetic Dipole in a Spherically Symmetrical Stratified Medium—G. Eckart. (*Ann. Télécommun.*, vol. 5, pp. 173-178; May, 1950.) Primary radiation over a curved earth is considered for the case in which the dielectric constant is a function of the radius r of the form $\epsilon = \alpha + \beta/r$. The equation derived for waves with the Fitzgerald potential Π is solved by separation of the variables and a solution is expressed in terms of Green's functions. A second solution for a homogeneous medium under particular conditions is derived. From the two solutions a theorem on hypergeometric functions is deduced. The physical interpretation of the results is briefly discussed.

621.396.11+535.222 2010
Velocity of Light and of Radio Waves—

L. Essen. (*Nature* (London), vol. 165, p. 821; May 20, 1950.) Houston's recent measurement of the velocity of light (1896 above) is noted as being in close agreement with the commonly accepted value of 299,776 km and not with other recent determinations by both radio and optical methods. Further careful measurements are needed to establish the value of the velocity. See also 1751 of August.

621.396.11 2011
On the Propagation of Medium Waves over Inhomogeneous Ground—J. Grosskopf. (*Fernmeldelech. Z.*, vol. 3, pp. 118-121; April, 1950.) The decrease in field strength in propagation over ground having different dielectric and conductivity constants along the propagation path, as in the case of successive stretches of land and sea, may be determined by a graphical method from the measured or estimated values of the ground constants, an appropriate modification of the formula for numerical distance being applied. The kinks in the field-strength/distance curve which correspond to land/sea boundaries are interpreted quantitatively. See also 2122 of 1944.

621.396.11:535.312†+538.569.4 2012
Absorption and Reflexion of U.H.F. Waves (300-500 Mc/s) by Sea Water—Chatterjee and Sreekantan. (See 1904.)

621.396.11:551.510.535 2013
Radio Wave Propagation in a Curved Ionosphere—J. M. Kelso. (*Proc. I.R.E.*, vol. 38, pp. 533-539; May, 1950.) "Using a double parabola approximation to the Chapman distribution of electron density as a function of height, and the assumption of a curved-ionosphere, curved-earth geometry, analytic expressions are obtained for the true height of reflection, ray path, reflection coefficient, ground range, and group path. Graphical results are given for the maximum usable frequency factor. Where possible, the above results are compared with results obtained by assuming a plane ionosphere."

621.396.11:621.317.772 2014
A Method of Simulating Propagation Problems—H. Iams. (*Proc. I.R.E.*, vol. 38, pp. 543-545; May, 1950.) 1949 IRE West Coast Convention paper. Problems relating to reflection, refraction, or scattering can be simulated by propagating cm waves in a large sheet of low-loss dielectric material, conditions being varied by embedding objects in the sheet, altering its thickness, or coating its surface. One surface of the sheet is then scanned with the probe of a phase-front plotter.

621.396.81 2015
U.H.F. Coverage in Pittsburgh—R. N. Harmon. (*FM and Telev.*, vol. 10, pp. 14-17; May, 1950.) A field-strength survey has been made by Westinghouse Radio to determine whether the method of calculation proposed by the FCC for very hilly country is satisfactory. Considerable disagreement was found between the theoretical and the observed results.

621.396.81 2016
Microwave Angle Separation on a Two and One-Half Mile Overwater Path—A. W. Stratton and A. H. LaGrone. (*Jour. Appl. Phys.*, vol. 21, pp. 188-193; March, 1950.) Three methods were used to measure the angular separation between the direct and water-reflected waves in transmissions across Lake Buchanan, Texas, using a wavelength of 3.2 cm. The separation was $<0.5^\circ$ and the two intensities were nearly equal. The first method depends on measurements of the relative phases and signal strengths at three vertically spaced antennas. The second method requires the relative phases at two antennas

and the signal strengths relative to the maximum and minimum signal from a height/gain curve. The third method requires a signal-strength record as the axis of a large parabolic antenna is tilted in the vertical plane containing the incoming rays. The first method is quick and, in general, accurate; the second is the most accurate, but the necessary height/gain measurements limit its usefulness.

621.397.81 2017
WTTG Field-Strength Survey—Wakeman. (See 2050.)

RECEPTION

621.396.621:621.396.822 2018
Design Factors in Low-Noise-Figure Input Circuits—M. T. Lebenbaum. (Proc. I.R.E., vol. 38, p. 539; May, 1950.) Correction to paper abstracted in 1504 of July.

621.396.621 2019
The Technique of Radio Design [Book Review]—E. E. Zepler. Publishers: Chapman and Hall, London, England, 2nd ed., 394 pp., 25s, 1949. (*Electronics Eng.*, vol. 22, p. 254; June, 1950; *Tele-Tech*, vol. 9, p. 67; April, 1950; *Jour. Sci. Instr.*, vol. 27, p. 112, April, 1950.) This book, originally published in 1943, deals with the development and testing of all types of radio receiving apparatus, and embodies the first-hand experience gained during many years by a designer in a large works laboratory.

621.396.621 2020
Recent Advances in Radio Receivers [Book Review]—L. A. Moxon. Publishers: Cambridge University Press, London, England, 183 pp., 18s, 1949. (*Brit. Jour. Appl. Phys.*, vol. 1, p. 110; April, 1950.) One of a series of monographs on radio technique. The treatment is essentially physical, and the problem of receiver noise gets particular attention, the book being concerned mainly with receivers for radar and communications.

STATIONS AND COMMUNICATION SYSTEMS

621.395.47+621.396.86 2021
An Improved Speech Inverter System—L. L. Koros. (*Electronics*, vol. 23, pp. 86-89; May, 1950.) Details with diagrams are given of a privacy circuit for radio or line telephony using an audio-frequency inversion carrier modulated by the speech input and also controlled in accordance with its average level. An RC equalizer network corrects frequency response. Distortion and background noise levels are low.

621.395.6:621.395.44 2022
Carrier-Current and Pilot-Signal Generators Standardized by the Administration Française des P.T.T. for 600-Channel Telephony Links—H. Dumas and P. Moll. (*Câbles and Trans.* (Paris), vol. 4, pp. 150-179; April, 1950.) Illustrated description of the terminal equipment on the Paris-Toulouse-Brive-Bordeaux circuit. Bandwidth is 4 kc. Basic frequencies of 4, 12, and 124 kc are derived from a 4-kc master oscillator and provide, respectively, 12 channels between 60 and 108 kc, 60 channels between 312 and 552 kc, and 600 channels between 60 and 2,540 kc, or 960 channels between 60 and 4,028 kc. Pilot signal frequencies are 60, 300, and 2,604 kc. Precautions taken against breakdown include triplification of the master-oscillator unit and duplication of the harmonic-generator-filter-amplifier chain; these are interchanged periodically.

621.396.41:621.396.97 2023
Multiplex Broadcasting—E. A. Brettingham-Moore. (*Proc. I.R.E.* (Australia), vol. 11,

pp. 55-62; March, 1950.) The present overcrowding of the 540-1,500 kc band in the Sydney area has made it essential to consider the use of new channels. United States experience in the uhf band using pulse-time-division and frequency-division multiplex was reviewed, and it was decided that equally good results should be attainable by use of frequency-division multiplex in the 100-Mc band. An experimental 2-channel system is described operating on a main carrier of 91 Mc, modulated on frequency by two AM subcarriers of frequencies 570 and 650 kc. The inherent economies of multiplex systems are pointed out.

621.396.619.16 2024
The Use of Modulation Converters in Pulse Multiplex Equipment—G. Potier. (*Onde Elec.*, vol. 30, pp. 195-199; April, 1950.) Discussion of the principles of converting one type of pulse modulation to another type, particularly as applied to a PTM transmission system in which PAM is used initially. This reduces the number of tubes required and limits the effects of overmodulation. General descriptions are given of a sawtooth waveform generator operating as a converter and a method of receiving PPM signals with equipment designed for PTM.

621.396.65:621.396.619.16 2025
An Installation for Multiplex-Pulse Modulation—C. J. H. A. Staal. (*Philips Tech. Rev.*, vol. 11, pp. 133-144; November, 1949.) The requirements which have led to the use of multiplex (time-sharing) PM cm-wave equipment in certain radio links for telephone services are discussed. An 8-channel PTM system is described, with detailed discussion of the channel-selection circuits. An original feature of the receiver is the use of a tube, with secondary-emission cathode in an anode-follower circuit to convert the received pulse samples of the audio waveform into a stepped replica of the waveform itself.

621.396.65:621.397.5 2026
Television Radio-Relay Links—A. H. Mumford and C. F. Booth. (*P.O. Elec. Eng. Jour.*, vol. 43, part 1, pp. 23-35; April, 1950.) A survey of the problems governing the choice of the system to be used in a television relay radio link and a statement of the requirements which have to be met, with brief details of an experimental 200-Mc single-frequency link between London and Cardiff and a full description of the London-Birmingham relay system. See also 471 of March.

621.396.712:534.86 2027
Audio-Frequency Equipment for Broadcasting Services—J. E. Telfer. (*Proc. I.R.E.*, (Australia), vol. 11, pp. 107-123; May, 1950.) Studio design is discussed and the special features of suitable equipment are described, including that of typical control rooms. A summary of permissible tolerances in frequency response, distortion, signal-to-noise ratio, and crosstalk level is given.

621.396.712:534.85 2028
Developments in Studio Design—Beranek. (See 1847.)

SUBSIDIARY APPARATUS

621-526 2029
Analysis of a Sampling Servo Mechanism—K. S. Miller and R. J. Schwarz. (*Jour. Appl. Phys.*, vol. 21, pp. 290-297; April, 1950.)

621-526 2030
Theory of Nonlinear Servomechanisms—J. R. Dutilh. (*Radio Franç.*, no. 5, pp. 1-7; May, 1950.)

621.316.74 2031
A Thermostat Control Unit—H. A. Voden. (*Jour. Soc. Chem. Ind.* (London), vol. 69, pp. 51-52; February, 1950.) A thermistor is used as the sensing element. The output from the thermistor bridge network, after amplification, provides grid-voltage control of the current in a gas-filled triode, the anode circuit of which contains the heating element. Temperature fluctuations are $<0.01^\circ$ in the range 20° - 70°C and $<0.025^\circ$ up to 120°C .

621.316.74:621.385.38 2032
A Continuously-Operating Thyatron Temperature-Control Device—R. Aumont. (*Rev. Gen. Elec.*, vol. 59, pp. 175-178; April, 1950.) A bridge circuit is described in which the unbalanced voltage produced by the temperature variation is applied, after amplification, to the thyatron grid. Arrangements are provided for ensuring the correct phase relation between this and the invariable component of the grid voltage. The thyatron supply is taken from a separate source, this being important where high power is handled. A large temperature range is covered by simple adjustments.

TELEVISION AND PHOTOTELEGRAPHY

621.397.5:621.396.65 2033
Television Radio-Relay Links—Mumford and Booth. (See 2026.)

621.397.5:621.396.67 2034
High-Gain and Directional Antennas for Television Broadcasting—Wolf. (See 1865.)

621.397.5:621.317] (083.747 2035
Standards on Television: Methods of Measurement of Television Signal Levels, Resolution, and Timing of Video Switching Systems, 1950—(Proc. I.R.E., vol. 38, pp. 551-561; May, 1950.) IRE Standard 23.S1 outlining suitable methods.

621.397.6 2036
Commercial Television at UHF—J. H. Bat-tison. (*Tele-Tech*, vol. 9, pp. 48 . . . 69; March, 1950.) For an abstract of another account see 1795 of August (Guy, Seibert, and Smith).

621.397.6 2037
High-Performance Television Monitors—J. E. B. Jacob. (*Jour. Brit. I.R.E.*, vol. 10, pp. 158-175; April, 1950.) A performance specification is outlined which should be met by a transmission station vision monitor. The use of stereographic projection to minimize picture distortion and of spot wobbling to render the line structure less visible is recommended. A monitor designed for the BBC and incorporating most of the features discussed is described.

621.397.6 2038
Television Synchronizing Generator—G. Zaharis. (*Electronics*, vol. 23, pp. 92-95; May, 1950.) "Standard synchronizing, blanking, horizontal, and vertical driving signals are obtained from a generator based upon binary counters without variable controls. Synchronizing-signal parameters are fixed by circuit configuration rather than by RC or charge-accumulation circuits. Stability is high and independent of power supply regulation." Circuit diagrams of the whole system are included.

621.397.6 2039
Synchronization for Colour Dot Interlace in the R.C.A. Colour Television System—(*Jour. Brit. I.R.E.*, vol. 10, pp. 128-136; April, 1950.) Synchronization problems are discussed and means of obtaining color-dot interlacing with a simplified receiver construction are outlined. A modification of the horizontal synchronizing pulse is required but this does not

affect the operation of monochrome receivers. The necessary alterations to present transmitter equipment are described.

- 621.397.611.2 2040
The Vidicon Photoconductive Camera Tube—P. K. Weimer, S. V. Forgue, and R. R. Goodrich. (*Electronics*, vol. 23, No. 5, pp. 70-73; May, 1950.) 1950 IRE Convention paper. Photoconductive and photoemissive targets for television pickup tubes are compared. A tube one inch in diameter and six inches long, with a photoconductive target, is described and its operating characteristics and sensitivity are given. Simplicity of design, high sensitivity, and good resolution make it suitable for industrial applications as well as for broadcasting use.
- 621.397.611.2 2041
Television Camera Tubes—(*Wireless World*, vol. 56, pp. 162-165; May, 1950.) A short illustrated account of the operation of image orthicons and discussion of manufacturing problems.
- 621.397.611.2 2042
The Marconi Mobile Camera Chain—(*Jour. Telev. Soc.*, vol. 5, pp. 363-366; December, 1949.) The equipment comprises camera, electronic viewfinder, camera control and preview monitor, and regulated power supply. The characteristics of the various units are summarized and a short explanation of the operating principles and construction of the Type-5655 image orthicon is given.
- 621.397.62 2043
Deflector Coil Characteristics—W. T. Cocking. (*Wireless World*, vol. 56, pp. 95-97, 147-151, and 176-179; March-May, 1950.) A discussion of the performance of the main types, with special reference to their efficiency: the most efficient deflector coil is the one that produces the least external field for a given internal field. For reasonable efficiency an iron circuit is essential: the two basic forms are the iron-ring and the iron-core; a hybrid version in which the iron acts as ring for the line coils and core for the frame coils has also been used. Tables are given showing LI^2 , R/L , and RI^2 for a number of radar coils and for a set of specially made coils. From comparison of experimental results the iron-ring type with bent-up end coils is best for both line and frame scan.
- 621.397.62 2044
More about Spot Wobble—T. C. Nuttall. (*Wireless World*, vol. 56, pp. 189-191; March, 1950.) Explanation of the way in which spot wobble operates and discussion of its application to improve the recording of television pictures on film, to reduce screen-saturation effects in high-power cathode-ray tubes for large-screen projection, and to remove lininess from large, bright, directly viewed television pictures. See also 1541 of July (Hallows).
- 621.397.62:535.88 2045
A 15 by 20-Inch Projection Receiver for the R.C.A. Colour Television System—(*Jour. Brit. I.R.E.*, vol. 10, pp. 137-151; April, 1950.) A detailed description is given of an improved receiver in which conventional radio-frequency, intermediate-frequency and audio-frequency circuits are used and a reflector system replaces the refractive system previously used, greater brightness being obtained. Picture reproduction is effected by means of separate green-, red-, and blue-phosphor projection tubes suitably located with respect to a pair of crossed dichroic mirrors, a 45° mirror, and a viewing screen. A sampling procedure is used for sequential operation of the three tubes. Detailed circuit diagrams are given.
- 621.397.62:621.396.662 2046
Broad-Band Television Tuners—A. Newton. (*Electronics*, vol. 23, pp. 102-106; May, 1950.) An intermediate frequency above 30 Mc is chosen, so that the image spectrum falls well outside the television bands; the radio-frequency stage can then be designed to have a single pass band wide enough to accept all the television channels and sufficiently selective to reject all image signals. Station selection is accomplished by tuning the local oscillator only, and the intermediate-frequency selectivity eliminates adjacent channel interference. Various alternative circuits are compared from the point of view of gain and noise.
- 621.397.621.2:535.371.07]:535.88 2047
The "Double-Layer" Projection Tube Screen for Television—M. Sadowsky. (*PROC. I.R.E.*, vol. 38, pp. 496-498; May, 1950.) 1949 IRE Electronic Conference paper. An account of the development of a screen with good efficiency and little color shift with change of beam current.
- 621.397.645 2048
Wide-Band Chain Amplifier for TV—W. V. Tyminski. (*Radio and Telev. News, Radio-Electronic Eng. Supp.*, vol. 14, pp. 14-16, 29; April, 1950.) A description of an amplifier with a bandwidth of 200 Mc, covering all television and FM bands and suitable for connecting several receivers to a single antenna system. The amplifier is analogous to a lumped-constant transmission line of characteristic impedance 180 ohms, in which some components are tubes. A gain of 9 db is obtained from an amplifier stage with six tubes. Further gain is best obtained by arranging two or more stages in cascade. See also 594 and 595 of March (Kennedy and Rudenberg).
- 621.397.7 2049
Bridgeport U.H.F.-TV Test Results—R. F. Guy. (*FM and Telev.*, vol. 10, pp. 11-13; May, 1950.) A first report of results obtained in 1,000 hours of operation.
- 621.397.81 2050
WTTG Field-Strength Survey—R. P. Wakeman. (*Tele-Tech.* vol. 9, pp. 27-29, 70; March, 1950.) Continuous field-strength measurements along eight roughly equispaced radials, with the transmitter as center, show the distribution to be normal for 10 representative distances up to 40 miles. The standard deviation decreases systematically with increase of distance from the transmitter; the Ad Hoc Committee, owing to lack of evidence, assumed no such variation.
- 621.397.82:621.326 2051
Interference from Incandescent Lamps—W. S. Mortley. (*Electronic Eng.*, vol. 22, p. 206; May, 1950.) Comment on 771 on April (D.G.F.).
- 621.397.828 2052
Some Devices for Reducing the Effects of Fading and Interference: Part 2—D. McMullan. (*Jour. Telev. Soc.*, vol. 5, pp. 339-348; December, 1949.) Means of reducing the effect of impulsive interference are discussed. These include limiting "black spotting," and a scheme in which the scanning spot is maintained at the brightness it had immediately prior to the interference. The circuit of such an interference suppressor interposed between the video amplifier and cathode-ray tube is given. The effect of fluctuation noise on synchronization and means of improving synchronization are described. The use of agc to minimize flutter due to aircraft and the use in future of a negative-modulation system are advocated. Part 1: 1278 of June.
- 621.397.828:621.396.61 2053
Eliminating TVI in your Ten-Meter Transmitter—S. Kupferman. (*CQ*, vol. 6, pp. 18-21 . . . 54; May, 1950.) An account of practical measures taken by an amateur to prevent his set from causing interference in nearby television receivers.
- TRANSMISSION**
- 621.396.61:621.397.828 2054
Eliminating TVI in your Ten Meter Transmitter—Kupferman. (See 2053.)
- VACUUM TUBES AND THERMIONICS**
- 621.327.43.032.216 2055
A Study of Cathode Behavior in Fluorescent Lamps—E. F. Lowry, E. L. Mager, and H. H. Homer. (*Phys. Rev.*, vol. 78, p. 355; May 1, 1950.) Summary of American Physical Society 1950 Annual Meeting paper EP21. Addition of about 5 per cent of ZrO_2 to the usual oxides of a cathode coating increased life by nearly 200 per cent to 7,500 hours rating, and greatly reduced production of spots and rings of discoloration on the tube wall. If ZrO_2 is added in excess, the blackening is greater than when it is not used at all.
- 621.383 2056
Investigations of the Pulse-Distribution of an R.C.A. Multiplier Phototube—R. Westöb and T. Wiedling. (*Ark. Mat. Astr. Fys.*, vol. 1, part 4, pp. 269-280; October 22, 1949. In English.)
- 621.385:621.326.662.6 2057
Investigation of Contaminants in Vacuum Tubes—P. D. Williams. (*Phys. Rev.*, vol. 78, p. 353; May 1, 1950.) Summary of American Physical Society 1950 Annual Meeting paper EP7. Mass-spectrometer studies have been made to identify volatile substances released at processing temperatures by glasses, ceramics, and quartz.
- 621.385:621.396.61 2058
A Survey of Modern Radio Valves: Part 4—Transmitting Valves for Use up to 30 Mc/s—K. D. Bomford and A. H. F. Hunt. (*P.O. Elec. Eng. Jour.*, vol. 43, part 1, pp. 10-15; April, 1950.) A discussion of design and construction, with particular reference to materials used and means adopted for dissipating heat during operation. Part 3: 1291 of June.
- 621.385.029.63/.64 2059
A Low-Noise Traveling-Wave Tube—S. W. Harrison. (*Sylvania Technologist*, vol. 3, pp. 12-16; April, 1950.) The design described was developed as the result of research on noise reduction. Reconsideration of theory of operation and allowance for both velocity and current fluctuations in the beam entering the helix led to a reduction of helix operating potential and beam current, the electron gun being modified to produce a "smooth" parallel beam. The operating characteristics are, for a helix potential of 650 v and a beam current of 140 μ a: gain 25 db, noise figure 14 db, bandwidth 800 Mc centered on 3,000 Mc. The method of noise measurement is described in some detail.
- 621.385.029.63/.64 2060
Development of Travelling-Wave Amplifiers with a Helical Coil; General Results—A. Blanc-Lapierre and M. Kuhner. (*Ann. Télécommun.*, vol. 3, pp. 259-264; August and September, 1948.) Relevant problems of electron optics, interaction between field and electron beam, measurement of attenuation and velocity of propagation along the helix, and matching methods, are discussed. Measurements were made on tubes with helices of different material and dimensions. Construction of the final type is described in detail; two

variants of this were made, (a) with a helix of 5.8 mm diameter, of 0.5 mm Armco wire, (b) with a helix of smaller diameter. Both operate at 1,500 v, with a bandwidth of the order of 100 Mc centered at 3,000 Mc. For low inputs the gain of (a) is 12-15 db; that of (b) about 20 db.

621.385.029.63/64 2061

Interaction Phenomena in the Travelling-Wave Valve: Theory and Experimental Verification—P. Lapostolle. (*Ann. Télécommun.*, vol. 3, pp. 265-290; August and September, 1948.) The theory given in the first part takes account of the complete distribution of the em fields in the beam and is applicable to any delay line. It indicates that the gain of the tube increases with current and tends to a limit which is a function of the diameter of the beam and the nature of the line. The essential characteristics of a tube may be predetermined experimentally by measuring the deceleration of the wave produced when the beam is replaced by a dielectric rod; this measurement can be performed in air. Gain and saturation level are calculated. In the second part, this theory is applied to the helix type tube, the helix being replaced by a helically conducting metal cylinder, for which the calculations are simpler. Experimental results are given which confirm the theory in respect of propagation characteristics, gain, and power. Characteristic impedance and attenuation are calculated for the helix circuit.

621.385.029.63/64 2062

Experimental Determination of the Characteristics of Travelling-Wave Amplifiers: Results Obtained—R. Wallauschek. (*Ann. Télécommun.*, vol. 3, pp. 300-308; August and September, 1948.) The measurement apparatus, comprising a calibrated generator and 2 watt-meters for input and output power, is described, the coupling arrangements being particularly considered. Measurements were made of the attenuation, gain, output power, etc. of the two tubes noted in 2060 above. Limiting power for linear operation was 130 and 60 mw, gain 11.5 and 21 db, noise factor 24 and 25 db, respectively.

621.385.029.63/64:621.3.09 2063

Experimental Study of the Propagation along a Delay Line in the Form of a Helix—Jessel and Wallauschek. (See 1859.)

621.385.029.63/64:621.396.615.141.2 2064

The Magnetron-Type Traveling-Wave Amplifier Tube—R. R. Warnecke, W. Kleen, A. Lerbs, O. Döhler, and H. Huber. (*Proc. I.R.E.*, vol. 38, pp. 486-495; May, 1950.) The low efficiency obtainable with traveling-wave amplifiers is due to the fact that only the energy corresponding to the difference between the electron velocity and the wave velocity can be extracted from the beam. This difference is of necessity small. A new tube is described in which a magnetic field constrains a ribbon-shaped electron beam to travel at right angles to a static electric field. A traveling wave on a delay line parallel to the beam bunches the beam in width and extracts energy from it. Measurements on experimental tubes of this type substantiate the theory, although the high efficiency and power output possible have not been reached in the early designs.

621.385.032.21:621.315.57:666.3 2065

Ceramic Heaters and Cathodes for Electron Tubes—T. R. Palumbo. (*Phys. Rev.*, vol. 78, p. 356; May 1, 1950.) Summary of American Physical Society 1950 Annual Meeting paper EP27. Prefired rods of a ceramic such as Al_2O_3 are exposed to a hydrocarbon atmosphere, e.g., methane, at 700°-900°C; a ceramic/carbon compound results which is

conductive and has a negative resistance coefficient and high current-carrying capacity; these conductive ceramics are used for tube cathodes or cathode heaters.

621.385.032.212:681.142 2066

The Dekatron—R. C. Bacon and J. R. Pollard. (*Electronic Eng.*, vol. 22, pp. 173-177; May, 1950.) A range of multielectrode cold cathode tubes, on octal or miniature bases, has been designed for use in electronic counting and computing machines. The three types at present designed are: (a) a scale-of-ten tube on octal base, for direct viewing, (b) a miniature scale-of-ten tube on a B7G base for frequency division or gate operation, (c) a tube of similar size to that of (a), with multiple connections for obtaining any of several scaling factors. The action of these tubes resembles in some respects that of the tube described by Lamb and Brustman (266 of February). A cathode glow discharge on one of a set of interconnected cathodes arranged around a central anode is caused to transfer from one position to the next by the application of controlling pulses to auxiliary intermediate electrodes. The transfer cycle may be clockwise or counterclockwise at will. Simple circuits for operating the tubes are described. A maximum counting rate of the order of 600 cycles per second is recommended, but greatly increased operating speeds are envisaged.

621.385.032.216 2067

The Potential Distribution in Pulsed Oxide-Coated Cathodes and Its Consequences for the Velocity Distribution of the Emitted Electrons—R. Loosjes, H. J. Vink, and C. G. J. Jansen. (*Jour. Appl. Phys.*, vol. 21, pp. 350-351; April, 1950.) Continuation of investigations noted in 2414 of 1948 and 491 and 1302 of 1950. Electron emission velocity was examined by an electrostatic deflection method. The velocities were in most cases more or less concentrated in two or sometimes three groups instead of being continuously distributed. The reason for this is not yet understood.

621.385.032.216 2068

The Electronic Temperature of Oxide Cathodes: Methods of Measurement and Results—R. Champelx. (*Le Vide* (Paris), vol. 5, pp. 763-768; March, 1950.) The usual method of calculating the electronic temperature T is to make use of the residual-current/voltage curve, the analytical expression of which is an equation analogous to that of Boltzmann. Because of possible errors in the measurements on which this curve is based, the value of T is liable to an error of 5-10 per cent. A more accurate and rapid method is described in which T is deduced from the internal resistance of the diode formed by the cathode and grid or anode, which is measured by connecting the tube, in a phase-compensation bridge circuit; possible errors are <2 per cent. Results show that T is always higher than the thermodynamic temperature and the difference is greater the lower the temperature and the better the cathode is activated. The results are interpreted by assuming a reflection coefficient which is the greater the lower the electron velocity. See also 1303 of June.

621.385.032.216 2069

Preparation of Thoria Cathodes by Cathodoporesis—G. Mesnard and R. Uzan. (*Le Vide* (Paris), vol. 5, pp. 769-776; March, 1950.) A carefully cleaned tungsten wire of diameter 0.15 mm, acting as the cathode of the system, is suspended along the vertical axis of a cylindrical anode of diameter 5 cm immersed in a bath of absolute alcohol with pure thoria in suspension and/or thorium nitrate with a little

water. Illustrations are given of the coating on the wire after exposure for different periods in the six baths used and for various currents. Factors affecting the adherence and character of the deposit are discussed.

621.385.032.216 2070

An Investigation of Magnesium as an Additive to the Nickel Base of an Oxide Cathode—R. Forman and G. F. Rouse. (*Phys. Rev.*, vol. 78, p. 355; May 1, 1950.) Summary of American Physical Society 1950 Annual Meeting paper EP18. Techniques for adding Mg to electrolytic Ni were developed and the rate of diffusion of the Mg through the Ni was studied. The thermionic properties of different cathodes were compared in a planar double diode. Under certain conditions cathodes activate more rapidly on a Ni base than on a Mg-Ni base.

621.385.032.216:537.533 2071

On the Interpretation of Conduction and Thermionic Emission of Ba-SrO Cathodes—F. K. du Pré, R. A. Hutner, and E. S. Rittner. (*Phys. Rev.*, vol. 78, pp. 567-571; June 1, 1950.) "A new semiconductor model for (Ba-Sr)O cathodes is proposed comprising a conduction band, donor levels, acceptor levels, and a full band. The combination of this model with the Vink-Loosjes concept of conduction by an electron gas in the pores of the oxide coating appears to explain in a natural way many of the existing experimental facts pertaining to the conductivity and thermionic emission of these cathodes."

621.385.032.216:[537.582+621.3.011.2 2072

Thermionic Emission, Conductivity, and Contact Potential Difference Measurements—W. J. Price. (*Phys. Rev.*, vol. 78, p. 354; May 1, 1950.) Summary of American Physical Society 1950 Annual Meeting paper EP14. Description of a special vacuum tube and method devised for investigating all three properties for the same cathode. Thoria-coated cathodes were studied; conductivity was proportional to thermionic emission over a considerable temperature range and for widely different conditions of activation. The change in work function following activation was found the same by thermionic-emission measurements and by contact-potential measurements.

621.385.032.216:537.583 2073

Thermionic Properties of Dense Oxide Cathodes—J. A. Burton, H. E. Kern, and R. T. Lynch. (*Phys. Rev.*, vol. 78, p. 355; May 1, 1950.) Summary of American Physical Society 1950 Annual Meeting paper EP20. Variation of thermionic properties with cathode temperature and with anode voltage applied for periods ranging 1 μ s to 1,000 sec was investigated by means of test diodes. Results are compared with those to be expected from an ideal diode of similar geometry under various conditions. For pulses short enough for decay effects to be negligible, the observed slopes of Schottky plots agree closely with those to be expected for a patch-free surface.

621.385.032.216:546.74 2074

Effects of Controlled Impurities in Nickel Core Metal on Thermionic Emission from Oxide-Coated Cathodes—H. Jacobs, G. Hees, and W. Crossley. (*Phys. Rev.*, vol. 78, p. 356; May 1, 1950.) Summary of American Physical Society 1950 Annual Meeting paper EP28. An investigation of the suitability of 18 Ni alloys as cathode bases. The best are Al-Ni, Cr-Ni, Mo-Ni, Th-Ni; the poorest are B-Ni, Be-Ni, Fe-Ni.

621.385.032.216:[546.841+3+546.719 2075

Thermionic Emitting Properties of Thoria-

Rhenium—G. A. Espersen. (*Jour. Appl. Phys.*, vol. 21, p. 261; March, 1950.) Cathode rods containing equal amounts of thorium and rhenium gave an emission of about 55 ma/cm² at 1,630°K and 1.2 a/cm² at 2,040°K, the corresponding values for a similar thorium-tungsten rod being 0.2 ma/cm² and 0.88 a/cm². After 150 hours test at 2,040°K the material deposited inside the glass envelope was greater for the thorium-tungsten cathodes.

621.385.032.216:546.841—3 2076

Experimental Use of Thorium Cathodes in High-Voltage Rectifier Tubes—S. T. Yanagisawa and T. H. Rogers. (*Phys. Rev.*, vol. 78, p. 353; May 1, 1950.) Summary of American Physical Society 1950 Annual Meeting paper EP4. The effect on the cathodes of very high back voltage was investigated by incorporating them in high-voltage rectifiers for X-ray work. Cathode life, emission efficiency, and the effect of thorium evaporation in particular were examined. The results indicate that thorium cathodes may be used in tubes, rated up to 110 kv peak.

621.385.032.216:546.841—3 2077

Base-Metal Effects in Thorium-Coated Filaments—H. Nelson. (*Phys. Rev.*, vol. 78, p. 353; May 1, 1950.) Summary of American Physical Society 1950 Annual Meeting paper EP5. Factors studied were: adhesion of thorium to the base metals W, Mo, Ta, and Pt, ease of activation, and final level of thermionic emission. Pt was best for adhesion but least satisfactory for activation. The final emission level, reached at 1,900°K, was about 5 a/cm² for W, Mo, and Ta.

621.385.032.216:621.3.011.2 2078

Electrical Conductivity of Oxide Cathode Coatings—D. A. Wright. (*Phys. Rev.*, vol. 78, p. 355; May 1, 1950.) Summary of American Physical Society 1950 Annual Meeting paper EP16. Conductivity measurements and Hall-effect measurements on activated coatings give results of which the former are and the latter may be in agreement with the Vink-Loosjes theory. P-type conductivity is not found in well-activated coatings, but develops when emission is drawn under nonactivating conditions; it is due to oxidizable impurities. The importance of surface phenomena is emphasized, these are associated with electron or hole movement rather than ion movement.

621.385.032.216:621.385.2 2079

Diode Studies of Oxide-Coated Cathodes—H. E. Kern and R. T. Lynch. (*Phys. Rev.*, vol. 78, p. 355; May 1, 1950.) Summary of American Physical Society 1950 Annual Meeting paper EP19. A description of the Bell Laboratories planar test diode, with a summary of standard procedures for applying and testing cathode coatings.

621.385.032.216:621.385.2:537.583 2080

The Decay and Recovery of the Pulsed Emission of Oxide-Coated Cathodes—R. M. Matheson and L. S. Nergaard. (*Phys. Rev.*, vol. 78, pp. 355–356; May 1, 1950.) Summary of American Physical Society 1950 Annual Meeting paper EP22. The cathodes were investigated in cylindrical diodes with anode-cathode spacing 0.019 inch. Observations of decays are noted. I/V characteristics obtained by use of short sampling pulses are compared with computed ideal characteristics; it is not possible to distinguish definitely between the effects of variation of emission and of internal cathode impedance; further studies on this aspect are in progress.

621.385.032.216:621.385.2:537.584 2081
A "Figure of Merit" and a "Quality Ratio" for D.C. Emission from Oxide-Coated Cathodes

—C. D. Richard, Jr. (*Phys. Rev.*, vol. 78, p. 356; May 1, 1950.) Summary of American Physical Society 1950 Annual Meeting paper EP25. Tests with oxide-coated cathodes in diodes are considered, where E_f/I_g curves serve as criteria. The "figure of merit" is the slope of a tangent to the "knee" of the curve, and the "quality ratio" is the ratio of figure of merit for the test specimen to that for a control specimen. Correlation with visual comparison of curves and with actual performance is good.

621.385.032.216:621.385.2:537.583 2082

Determination of Oxide Cathode Performance in Diode Tubes Through Figures of Merit—T. H. Briggs. (*Phys. Rev.*, vol. 78, p. 356; May 1, 1950.) Summary of American Physical Society 1950 Annual Meeting paper EP26. The criteria "figure of merit" and "quality ratio" proposed by Richard (2081 above) are useful for assessing variation of cathode activity with time and with chemical composition. A relation which may be significant for thermionic-emission theory has been found between the figure of merit and ratings proposed by Cardell and others for low-field and pulsed emission.

621.385.032.216.001.4 2083

Life Tests of Oxide-Coated Cathodes—An Engineering Report—J. O. McNally. (*Phys. Rev.*, vol. 78, p. 356; May 1, 1950.) Summary of American Physical Society 1950 Annual Meeting paper EP23. The development over a period of years of long-life cathodes is described, and the influence of operating temperature and current density is discussed.

621.385.1:621.396.822 2084

Noise Spectra from Vacuum Tubes at Ultra Low Frequencies—R. W. Bogle. (*Phys. Rev.*, vol. 78, p. 354; May 1, 1950.) Summary of American Physical Society 1950 Annual Meeting paper EP12. Noise measurements were made on a variety of tubes, including both commercial and specially constructed types, and using all the common emitting materials, over the range 0.01–10,000 cps. Observed results were in disagreement with the requirements of Johnson's flicker-effect theory in that there was no simple inverse proportionality of noise voltage to frequency and no sure evidence of flattening of the curve below a certain frequency point.

621.385.15 2085

New Multiplier Phototubes of High Sensitivity—A. Sommer and W. E. Turk. (*Jour. Sci. Instr.*, vol. 27, pp. 113–117; May, 1950.) High cathode sensitivity and high multiplication factor are combined with high signal-to-noise ratio. In one type the photocathode consists of a circular semitransparent deposit about 1 cm diameter in the center of a flat window. This type of tube is particularly suitable for scintillation counting.

621.385.2 2086

Measurements on Total-Emission Conductance at 35-cm and 15-cm Wavelength—G. Diemer and K. S. Knol. (*Philips Res. Rep.*, vol. 4, pp. 321–333; October, 1949.) Results of measurements for a wide range of anode voltages and saturation currents are given. The tube used was an experimental disk-seal diode with a cathode-anode distance of about 15 μ . Values of the electronic capacitance are also given. The experimental results do not at all agree with the linear-field theory proposed by Thomson (3554 of 1948). For the space-charge-limited region the total-emission conductance did not play an important part relative to the conductance due to the transconductance; this

may probably be explained by the screening effect of the space charge.

621.385.2 2087

Note on Total Emission Damping and Total Emission Noise—A. van der Ziel. (*Proc. I.R.E.*, vol. 38, p. 562; May, 1950.) Expressions are derived for a diode at uhf. The result for the damping is the same as that given by Begovich (2959 of 1949) but in a slightly different notation. See also 2098 of 1949 (Freeman).

621.385.2/.3]:621.315.59:546.815.221 2088

Crystal Diode and Triode Action in Lead Sulphide—H. A. Gebbie, P. C. Banbury, and C. A. Hogarth. (*Proc. Phys. Soc.*, vol. 63, p. 371; May 1, 1950.) With diode connection, rectification ratios of 2,000:1 at 1.5 v have been observed, and with triode connection voltage amplification factors up to 25 and power gains of about 4. Other resemblances between the behavior of PbS and Ge are mentioned. A full report of the investigations will be published later.

621.385.2:621.315.59 2089

Magnetically Biased Transistors—C. B. Brown. (*Phys. Rev.*, vol. 76, pp. 1736–1737; December 1, 1949.) A transverse magnetic field concentrates the hole current near the surface, reducing the average path length and resulting in less phase dispersion. Graphs indicate the improvement of characteristics and show that the upper frequency limit for $\alpha > 1.5$ (α -slope of collector-current/emitter-current curve) increased from 2 to 10 Mc for a typical unit when a field of 6,900 gauss was applied.

621.385.2:621.315.59:621.314.632 2090

D.C. Characteristics of Silicon and Germanium Point Contact Crystal Rectifiers. Part 1—Experimental—H. J. Yearian. (*Jour. Appl. Phys.*, vol. 21, pp. 214–221; March, 1950.) Typical dc current-voltage characteristics obtained for Si and Ge crystal rectifiers are described. A survey of published theories shows that none of them will account for the principal features of the observed characteristics. An obvious discrepancy occurs in the case of the forward characteristic, where the current rise with increasing voltage is much less than indicated by theory. Conditions which a satisfactory theory must meet are outlined.

621.385.2:621.315.59:621.314.632:537.311.33 2091

D.C. Characteristics of Silicon and Germanium Point Contact Crystal Rectifiers. Part 2. The Multicontact Theory—Johnson, Smith, and Yearian. (*See* 1941.)

621.385.2:621.396.822 2092

On the Retarding-Field Current in Diodes—R. Fürth and D. K. C. MacDonald. (*Proc. Phys. Soc.*, vol. 63, pp. 300–302; April 1, 1950.) A development of an earlier theoretical treatment (4088 of 1947) of the space-charge distribution in a cylindrical diode under retarding-field conditions. The views expressed by Bell (2960 of 1949) on the effective cathode temperature in cylindrical diodes are shown to be theoretically unsound and to have been based on operation at a current above the limiting value.

621.385.3 2093

New Super-Power Beam Triode Provides Output of 500,000 Watts—(*Broadcast News*, no. 58, pp. 8–9; March and April, 1950.) Illustrations and a few details of the RCA Type 5831 transmitting tube, 48 independent triodes are arranged symmetrically within a cylindrical housing, the individual filament and grid rods being tungsten rods 8 inches long supported

at both ends in V notches. The construction enables a simple water-cooling system to be used.

621.385.3 2094

Microphonism in the Dynamically Operated Planar Triode—J. A. Wenzel and A. H. Waynick. (PROC. I.R.E., vol. 38, pp. 524-532; May, 1950.) The effect of sinusoidal transverse oscillation of each electrode on the anode current of a planar triode is discussed theoretically. The case of simultaneous variation of the grid voltage is considered and it is shown that microphonic anode currents result at the sum and difference frequencies of the electrical and mechanical excitation. Experimental verification of the theory and a method of reducing microphony in audio amplifiers are described.

621.385.4.01 2095

The Computation of Electrode Systems in Which the Grids Are Lined Up—J. L. H. Jonker. (*Philips Res. Rep.*, vol. 4, pp. 357-365; October, 1949.) Formulas are developed for the paths of the electrons and the position of the focus in a system of electrodes in which the grids are aligned. These formulas are applied to the calculation of a planar arrangement with prescribed characteristics, and with zero screen-grid current when the control grid is at zero potential.

621.396.615.14 2096

Technology of Electronic Valves used for U.H.F.—R. Suart. (*Radio Franç.*, no. 4, pp. 1-9; April, 1950.) Illustrated description of the principles and construction details of the klystron, magnetron, and disk-seal triode.

621.396.615.141.2 2097

A Toroidal Magnetron—O. Buneman. (*Proc. Phys. Soc.*, vol. 63, pp. 278-288; April 1, 1950.) The design described, for which the name "torotron" is proposed, has a ring cathode lying within a concentric toroidal anode having radial resonator slots. The electric field is radial and the magnetic field, which may be produced by a heavy current in the cathode, circles around the cathode. The electrons travel at right angles to these crossed fields, i.e., along the cathode. Theoretical calculations for the static and operating conditions are given and compared with those for a conventional magnetron. It seems likely that the proposed form would operate satisfactorily at high powers with good efficiency and mode stability.

621.396.615.141.2.032.21: [537.533.8+537.581 2098

Thermionic and Secondary Emission Properties of Magnetron Cathodes and their Influence on Magnetron Operation—R. L. Jepsen. (*Phys. Rev.*, vol. 78, p. 354; May 1, 1950.) Summary of American Physical Society 1950 Annual Meeting paper EP11. Magnetrons with secondary-emission cathodes exhibit on the V/I performance chart a "maximum-current

boundary" which can be understood by considering only stable thermionic and secondary-emission properties of the pure metals of which the cathodes are composed. When the current is low, back bombarding power increases rapidly as anode current decreases; the electron interaction causing this is not yet understood.

621.385+621.396.6 2099

Fundamentals of Vacuum Tubes [Book Review]—A. V. Eastman. Publishers: McGraw-Hill Book Co., New York, N. Y., 3rd ed. 600 pp., \$5.50, 1949. (PROC. I.R.E., vol. 38, p. 450; April, 1950.) "Intended primarily for the use of senior electrical students. . . . The main emphasis appears . . . to be directed more particularly to the uses of vacuum tubes than to the physical properties of the tubes themselves. . . . The subject of special tubes and circuits for ultra-high-frequency uses has been omitted as demanding either a seriously curtailed treatment or an undesirably long book."

MISCELLANEOUS

519.283:658.562:621.397.62 2100

Quality Control in TV Receiver Production—L. Lutzker. (*TV Eng.*, vol. 1, pp. 6-9, 37; February, 1950.) Description of the introduction of a statistical technique and sampling inspection into a particular production line, with a consequent reduction in production costs.

538.56.029.6 2101

Technique and Applications of Ultra-Short Waves—J. Franeau. (*IIF* (Brussels), nos. 4 and 5, pp. 91-102 and 143-148; 1949. In French.)

539 2102

Rutherford Memorial Lecture (1948)—E. Marsden. (*Proc. Phys. Soc.*, vol. 63, pp. 305-322; April 1, 1950.) Rutherford's early background and fundamental work on radioactivity and the atom, described by one who studied under him.

621.317.2 2103

The "Laboratoire Central d'Électricité", 1882-1949. The New Laboratory at Fontenay-aux-Roses—L. Sartre. (*Rev. Gén. Élec.*, vol. 59, pp. 5-22; January, 1950.) A review of the development of the LCE which in 1942 became the "Laboratoire central des Industries électriques" and subsequently occupied vast new buildings near Paris. The work undertaken in this new laboratory includes the maintenance of national electrical standards and the calibration and testing of electrical instruments and materials. The installations and test equipment in the different sections are described, with numerous photographs.

621.385.001.4:519.283 2104

Statistical Evaluation of Life Expectancy of Vacuum Tubes Designed for Long-Life Operation—E. M. McElwee. (*Sylvania Technologist*,

vol. 3, pp. 16-20; April, 1950.) Full text of paper noted in 1559 of July (no. 20).

621.392 (Cauer) 2105

In Memoriam, Wilhelm Cauer—Nai-Ta Ming. (*Elektrotechnik* (Berlin), vol. 2, pp. 158-159; May, 1948.) Short account of Cauer's life and work, with lists of published and unpublished papers.

621.396 2106

Radio Progress during 1949—(PROC. I.R.E., vol. 38, pp. 358-390; April, 1950.) A comprehensive report, including over 800 references, based on material compiled by the 1949 Annual Review Committee of the Institute of Radio Engineers. The various sections deal with antennas and waveguides, audio techniques, network and circuit theory, electroacoustics, tubes and solid-state devices, electronic computers, facsimile, industrial electronics, modulation systems, navigation aids, nuclear science, piezoelectric crystals, radio transmitters, railroad and vehicular communications, receivers, research, sound recording and reproducing, symbols, television systems, video techniques and television, wave propagation.

621.396 2107

The Tron Family—W. C. White. (*Electronics*, vol. 23, pp. 112, 114; May, 1950.) An explanatory list of over 200 words ending with "tron." For an earlier list see 2302 of 1947.

621.396:061.3 2108

1950 [Australian] I.R.E. Radio Engineering Convention, Melbourne, May 3rd-6th—*Proc. I.R.E.* (Australia), vol. 11, pp. 124. . . 140; May, 1950.) Summaries are given of 29 technical papers presented at the convention.

621.396.6 2109

I.R.E. Convention Exhibits herald New Equipment—(*Tele-Tech*, vol. 9, pp. 32-34; March, 1950.) Illustrated descriptions of new electrical and radio products.

621.3 2110

Elektrotechnik des Rundfunktechnikers. Teil 1: Gleichstrom. (Electrotechnics for the Radio Technician. Vol. 1: Direct Current) [Book Review]—J. Kammerloher. Publishers: Deutscher Funk-Verlag. (*Elektrotechnik* (Berlin), vol. 4, p. 63; February, 1950.) A recommended book written by a professional teacher with the minimum amount of higher mathematics. The contents include: fundamental laws of the dc circuit in free space; the electric field; the magnetic field; phenomena of extended circuits; recurrent networks.

621.3 2111

Lehrbuch der Elektrotechnik. Vol. 1. [Book Review]—G. Oberdorfer. Publishers: Leibnizverlag, Munich, 5th edn, 502 pp. (*Elektrotechnik* (Berlin), vol. 4, p. 63; February, 1950.) "Can be well recommended to all earnest students."



FOR PLUS VALUES

Specify G-E Ignitrons

GL-5551/FG-271



GL-5822

GL-5551/FG-271

One of the most widely used G-E ignitrons—an established favorite in the welding industry. With max kva demand 600, the average anode current is 30.2 amp. Max average anode current of 56 amp checks with a kva demand of 200. . . Other popular G-E ignitrons for resistance welding are the GL-5550/GL-415, GL-5552/FG-235-A, and GL-5553/FG-258-A. Ratings sent promptly on request.

GL-5822

Newest of the G-E ignitron line, and expressly designed for the rapidly growing 3-phase welding field. Peak voltage forward and inverse is 1,200 v, with peak and avg anode currents of 1,500 and 20 amp, or 420 and 70 amp . . . or 1,500 v, with currents of 1,200 and 16 amp, or 336 and 56 amp. Straight-line interpolation on log-log paper is allowed between similar current points. . . Other G-E ignitrons for 3-phase welding are the GL-5554/FG-259-B and GL-5555/FG-238-B. Ratings gladly furnished.

- More tube-design know-how! General Electric pioneered electronic controls for welding.
- More precise G-E manufacture, using highest-grade materials.
- More step-by-step tube inspections—more top-rating final tests before the product reaches your hands.

EXPERIENCE is the best guide to dependable tube design. Because electronic welding control is a G-E "first," General Electric experience excels. Twenty years ago—to name but one example of leadership—the first electronic welder used in the automotive industry was built by General Electric. Thousands of similar welders speed car and truck production today.

Backed by this big fund of practical welding knowledge, G-E control ignitrons should lead in quality. And they do!

A check of component materials, shows instance after instance of choice based solely on quality. Precision manufacture shapes these selected materials into sturdy, long-serving G-E ignitrons which—having passed a series of rigid inspections—then are subject to extensive tests under actual welder conditions at max ratings.

G-E ignitrons are *right* when you install them, and they stay right! Let expert G-E tube engineers work with you on their application. Wire or write *Electronics Department, General Electric Company, Schenectady 5, New York.*

GENERAL ELECTRIC

Presenting the **NEW**
Astatic TV and FM Boosters
Models BT-1 and BT-2

Astatic raised tremendously the level of improved TV reception through pre-amplification of signal, when it developed its famous deluxe model AT-1 Booster with exclusive variable gain control and dual tuning. Now Astatic brings another great advancement to the progress of TV enjoyment—with two low-cost boosters that equal, to all practical purposes, the primary function of the highest priced units. Never before has so much quality been incorporated in a booster to sell at so low a price. Why not get the complete details? Write today.

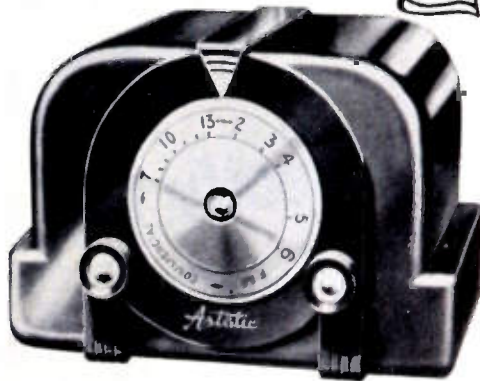

Booster Model BT-2
List Price \$32.50

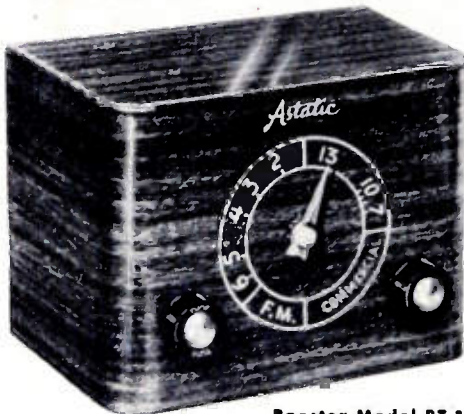

Booster Model BT-1
List Price \$29.95

**Only ASTATIC offers
as complete a choice of
BOOSTER MODELS**

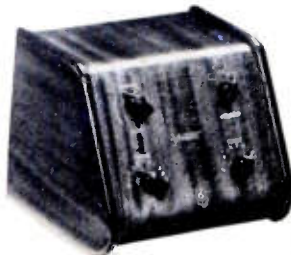

Booster Model AT-1
List Price \$49.50

Increasing numbers of TV set owners will still want the finest Booster that money can buy—and that means Astatic's deluxe Models AT-1 and AT-1B, with rich furniture finish mahogany or blond wood cabinet, exclusive and variable gain control, dual tuning and powerful four-tube operation.

**LOOK AT THE AMAZING
QUALITY FEATURES IN
THESE LOW-PRICED
BOOSTERS**

- 1 Employ Mallory Inductuner for continuous variable tuning.
- 2 High gain, very uniform on both high and low channels.
- 3 Simplified controls—single tuning knob with continuous tuning through both TV and FM bands.
- 4 Band width adequate over entire range.
- 5 Low noise design and construction.
- 6 No shock hazard to user.
- 7 Off-on switch for easily cutting in and out of circuit.
- 8 Selenium rectifier.
- 9 Use single 6AK5 Tube.
- 10 Provide for either 72 ohm or 300 ohm impedance input and output.
- 11 Model BT-2 has handsome, dark brown plastic cabinet.
- 12 Model BT-1 has metal cabinet in rich mahogany woodgrain finish.
- 13 Large dial face is easy to see in tuning.
- 14 Model BT-2 has recessed pilot light to show when booster is on.

THE Astatic CORPORATION
CONNEAUT, OHIO
IN CANADA: CANADIAN ASTATIC LTD. TORONTO, ONTARIO



BALTIMORE

"The Omegatron and Measurement of Atomic Constants," by J. A. Hipple, National Bureau of Standards; May 10, 1950.

"An Experimental Harbor Radar Installation," by R. H. Foy, Westinghouse Electric Corporation; Election of Officers; June 14, 1950.

BEAUMONT-PORT ARTHUR

Business Meeting; June 16, 1950.

BUENOS AIRES

"Information Coding," by P. J. Noizeux; Business Meeting; April 21, 1950.

"The Industrialized Television," by J. P. Calvelo; Business Meeting, May 19, 1950.

"Teleprinting on Radio," by H. C. A. van Duuren; June 2, 1950.

CINCINNATI

Student Paper Competition; June 1, 1950.

"Education and Training in Industry," by E. D. McConnell, Gruen Watch Company; Election of Officers; June 20, 1950.

CONNECTICUT VALLEY

Family Outing; June 10, 1950.

DALLAS-FORT WORTH

"Radio Communication in the Petroleum Industry," by Jerry Stover, Communication Engineering Company; June 20, 1950.

EMPORIUM

"Analog Computers," by H. R. Hegbar, Good-year Aircraft Corporation; June 20, 1950.

EVANSVILLE-OWENSBORO

"Television Receiver Circuits," by Bernard Parmet, Motorola, Inc.; June 21, 1950.

HAWAIIAN

"Symposium on Modern Electronic Test Equipment," by R. S. Willard, Mutual Telephone Company, Mr. Bostwick and Mr. Chittenden, CAA, Hnl., and C. R. Gilmartin, Hawaiian Airlines; June 27, 1950.

"Power and Audio Transformer Design Considerations," by Fred Mason, Pearl Harbor Shipyard; July 12, 1950.

MILWAUKEE

Business Meeting; April 6, 1950.

"Recent Progress in Ferromagnetism," by Charles Kittel, Bell Telephone Laboratories; April 19, 1950.

"A New Approach to Loudspeaker Design," by Howard Southers, Electro-Voice, Inc; June 23, 1950.

SALT LAKE

"Acoustic Qualities Necessary for Music Enhancement and Understandability in Speech," by C. R. Evans, Radio Station KSL; June 1, 1950.

SAN DIEGO

"Basic Principles of Digital Computers," by R. G. Nye, U. S. Navy Electronics Laboratory; June 6, 1950.

"Shipborne Radar Design Considerations," by I. L. McNally, U. S. Navy Electronics Laboratory; July 11, 1950.

SAN FRANCISCO

"Color Television," by George Sleeper, Color Television, Inc; May 22, 1950.

"Modern Methods in Electrical Communication," by Ralph Bown, Bell Telephone Laboratories; May 25, 1950.

(Continued on page 35A)



(Continued from page 34A)

"Electrical Measurement of Microsecond-Duration Dynamic Strains," by Lester Roberts, Graduate Student, Stanford University. "The Electro-Optical Shutter," by Timothy Murphy, Student, Santa Clara University, and "An Ultra-Low Frequency Sine Wave Oscillator," by Kenneth Kiser, Graduate Student, University of California; June 7, 1950.

SEATTLE

"An Analysis of Several Propagation Surveys in the VHF Region for Industrial Communication," by W. J. Reed, Boeing Airplane Company; June 15, 1950.

WASHINGTON

"Atomic Time and Frequency Standards," by Harold Lyons, CRPL/NBS; June 12, 1950.

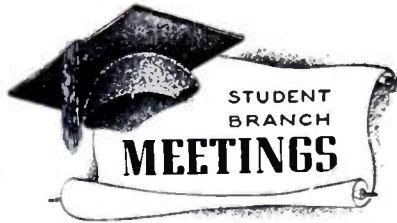

ALABAMA POLYTECHNIC INSTITUTE, IRE BRANCH
Business Meeting; June 26, 1950.
Film: "Frequency Modulation"; Business Meeting; July 10, 1950.

UNIVERSITY OF DAYTON, IRE BRANCH

"Number Systems," by Roy Hearsom, National Cash Register Company; May 2, 1950.
"Electronic Civil Service Employment," by Ken Bornhorst, Albert Chong, and James Dapper, Students, University of Dayton; May 9, 1950.
"Electronic Civil Service Employment," by Ken Bornhorst, Albert Chong, and James Dapper, Students, University of Dayton; May 16, 1950.
Election of Officers; May 23, 1950.

FENN COLLEGE, IRE BRANCH

"Navigational Aids on the Great Lakes," by Zenn Zenon, Student, Fenn College; June 30, 1950.

MARQUETTE UNIVERSITY, IRE-AIEE BRANCH

Business Meeting; Election of Officers; June 29, 1950.

MISSISSIPPI STATE COLLEGE, IRE BRANCH

Business Meeting; Election of Officers; May 18, 1950.

SAN JOSE STATE COLLEGE, IRE BRANCH

Election of Officers; June 16, 1950.

STANFORD UNIVERSITY, IRE-AIEE BRANCH

Field Trip through Westinghouse Company; May 5, 1950.
Student Paper Contest; May 12, 1950.
Field Trip through Newark Power Sub-Station; May 19, 1950.
"A Review of Stanford Electronics Laboratory," by Karl Spangenberg, Faculty, Stanford University; Election of Officers; May 31, 1950.

UNIVERSITY OF TEXAS, IRE-AIEE BRANCH

Technical Paper Contest; Film: "Television and How it Works"; February 6, 1950.
"Principles and Use of the Transistor," by Dr. Watson, Faculty, University of Texas; February 27, 1950.
"Servomechanism," by A. R. Teasdale, Jr., Faculty, University of Texas; March 6, 1950.
"Computer," by Cyril Hoyler, Radio Corporation of America; March 23, 1950.

CHECK "Proof of Performance" with these **PROVED B&W** PERFORMERS

For those "proof-of-performance" tests required by the FCC, here's a combination that will enable you to comply with the least amount of time . . . trouble . . . and money!

AUDIO OSCILLATOR MODEL 200 \$115

Provides a low distortion source of audio frequencies between 30 and 30,000 cycles. Self-contained power supply. Calibration accuracy $\pm 3\%$ of scale reading. Stability 1% or better. Frequency output flat within 1 db, 30 to 15,000 cycles.



DISTORTION METER MODEL 400 \$140

For fundamentals from 30 to 15,000 cycles measuring harmonics to 45,000 cycles; as a volt and db meter from 30 to 45,000 cycles. Min. input for noise and distortion measurements .3 volts. Calibration: distortion measurements ± 5 db, voltage measurements $\pm 5\%$ of full scale at 1000 cycles.



LINEAR DETECTOR MODEL 404 \$85

Provides combined RF detector and bridging transformer unit for use with any distortion meter. RF operating range: 400 kc to 30 mc. Single ended input impedance: 10,000 ohms. Bridging impedance 6000 ohms with 1 db insertion loss. Frequency is flat from 20 to 50,000 cycles.



SINE WAVE CLIPPER MODEL 250 \$10

Speeds accurate analysis of audio circuits by providing a test signal for examining transient and frequency response . . . at a fraction of the cost of a square wave generator. Designed to be driven by an audio oscillator.



SEE YOUR DEALER OR WRITE TODAY
FOR COVERING LITERATURE, DEPT. PR-90

BARKER & WILLIAMSON, Inc.
237 Fairfield Avenue Upper Darby, Penna.

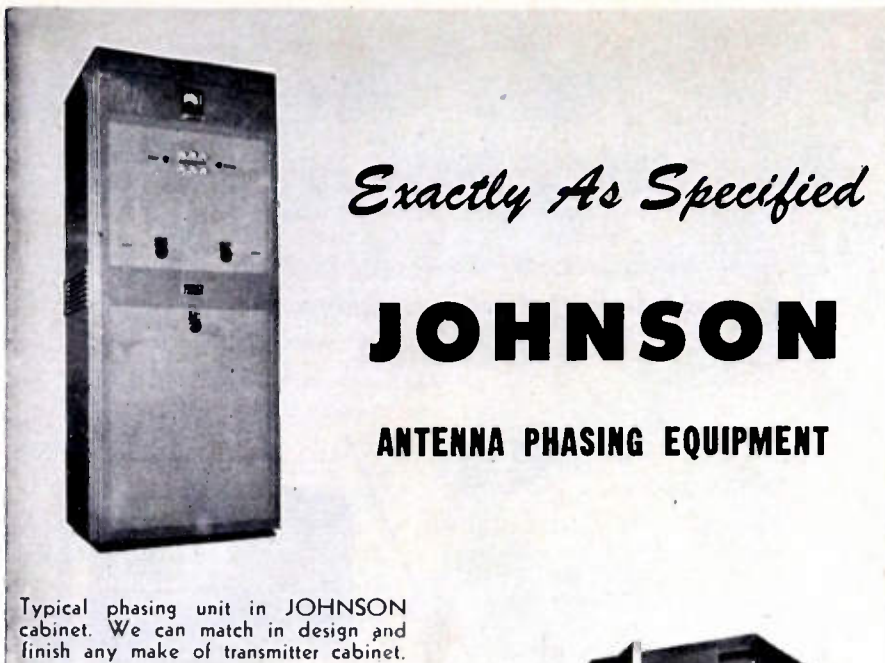

Exactly As Specified

JOHNSON

ANTENNA PHASING EQUIPMENT

Typical phasing unit in JOHNSON cabinet. We can match in design and finish any make of transmitter cabinet.

is an outstanding characteristic of Careful attention to specifications JOHNSON Antenna Phasing Equipment. It is made possible principally because each installation is individually designed. There are no "standard units" which must be adapted, no need of compromises with good engineering. You get what your consultant specifies!

Does this cost a lot? Emphatically no! Because JOHNSON manufactures nearly every component in an adequate variety of ratings and types, our engineers have available just the right material for any application. The cost is no more—frequently it is lower than less flexible, less generously rated equipment.

The same appreciation of technical and economic requirements is evident in other related JOHNSON equipment such as: coaxial line, phase sampling loops, isolation filters, tower lighting filters, RF contractors, pressurized capacitors, variable inductors and open wire line supports.

For detailed information on any of these products write:

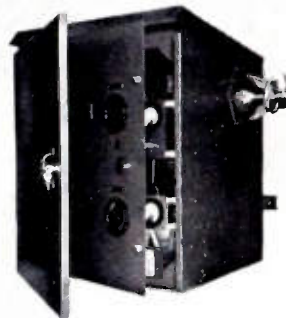

Weatherproof antenna coupling unit. Features an interior door which remains closed during adjustments.

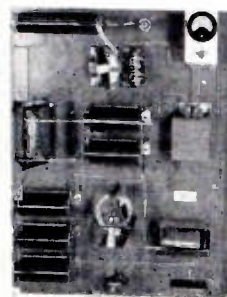

Panel mounted coupling network saves money where a tuning house is used. Every major component but the meter is JOHNSON built.



JOHNSON . . . a famous name in Radio!
E. F. JOHNSON CO., WASECA, MINNESOTA



The following transfers and admissions were approved and will be effective as of September 1, 1950:

Transfer to Senior Member

- Babillus, J., 1381 Elmhurst Dr., N.E., Cedar Rapids, Iowa
- Bowler, G. E., 7951 Stewart Ave., Los Angeles 45, Calif.
- Farmer, E. W., 174 Montee Sanchie, Ste. Therese de Blainville, Que., Canada
- Fox, J., 7 Spring Terr., Red Bank, N. J.
- Gruenberg, E. L., 20 Bethune St., New York 14, N. Y.
- Hollenberg, A. V., Bell Telephone Laboratories, Inc., Murray Hill, N. J.
- Jones, C. H., 3857 Greensburg Pike, Pittsburgh 21, Pa.
- Jones, W. J., 319 Covent Ave., New York 34, N. Y.
- Kibler, P. J., 8937 Yorktown Ave., Los Angeles 45, Calif.
- Ley, G. S., 110 Mt. Lebanon Blvd., Pittsburgh 16, Pa.
- Lyon, J. A. M., Department of Electrical Engineering, Northwestern University, Evanston, Ill.
- Nelson, A. B., 618 Burlington Ave., Bristol, Conn.
- Norlund, R. J., 214 E. Second St., Xenia, Ohio
- Raburn, L. E., 1012 St. James Blvd., Evansville, Ind.
- Sather, O. J., 755 Hartwell St., Teaneck, N. J.
- Schneberger, R. J., Westinghouse Research Laboratories, E. Pittsburgh, Pa.
- Scott, G. H., Engineering Hall, University of Arkansas, Fayetteville, Ark.
- Sherman, J. B., Electrical Engineering Department, The Cooper Union, Cooper Sq., New York 3, N. Y.
- Spencer, R. C., 247 Park Ave., Arlington 74, Mass.
- Story, T. H., 2831 Cove Rd., Merchantville 8, N. J.
- Sullivan, A. H., Jr., 2812 Hillside Ave., Dayton 9, Ohio
- Westneat, A. S., Jr., R.F.D. 1, Box 287, Princeton, N. J.
- Wolf, L. J., 210 New Jersey Ave., Collingswood 7, N. J.

Admission to Senior Member

- Mapes, C. M., 195 Broadway, New York 7, N. Y.
- Molloy, C. T., Bell Telephone Laboratories, Inc., Murray Hill, N. J.
- Petersen, R. P., 3013-31 Pl., Sandia Base Branch, Albuquerque, N. Mex.
- Rantzen, H. B., Rm. CA-025A, United Nations, Lake Success, N. Y.
- Rumsey, V. H., 2214 Jarvis Rd., Columbus 12, Ohio
- Weiss, R. A., Box 25, Ocean St., Highlands, N. J.

Transfer to Member

- Benner, A. H., Box 618, State College, Pa.
- Burnett, K. H., 42 Oakland St., W. Springfield, Mass.
- Busse, C. C., 8 Warriors Rd., Pittsburgh 5, Pa.
- Chatterjee, A. K., Birla Engineering College, Pilani, Jaipur State, India
- Coburn, E. D., Box 1527, Beaumont, Tex.
- Das, J., Technical Maintenance Officer, West Command Signal Regt., New Delhi, India
- Ellison, G. C., Jr., 11310 S.E. Market St., Portland 16, Ore.
- Graustein, W. W., Jr., 20 Edward Rd., Watertown, Mass.
- Hopkins, R. U. F., 4003 Atascadero Dr., San Diego 7, Calif.
- Hummer, J. L., Electrical Engineering Department, Rhode Island State College, Kingston, R. I.

(Continued on page 38A)

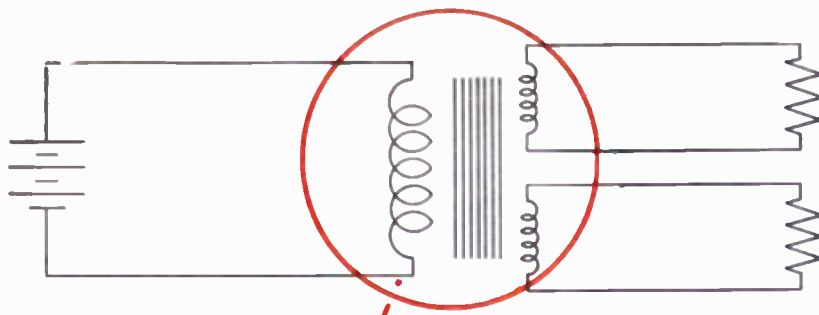

a **DC** transformer?

Certainly...

Bendix Specialized Dynamotors are made for the Job!



Whenever DC power is required at other than the supply voltage, Bendix* Specialized Dynamotors function as DC transformers. They can be wound for any input or output voltage between 5 and 1200 volts, and they can deliver power up to 500 watts. Multiple outputs can be supplied to correspond with several secondaries on transformers, and their output voltages can be regulated within close limits regardless of input voltage or load variations. Bendix Specialized Dynamotors are tailored to the exact requirements of each application by the design of the windings used in standardized frames. This reduces the cost, size and weight to an absolute minimum, consistent with the operational requirements. Compliance with Government specifications is assured by the choice and treatment of materials and the basic design. *A complete description of your requirements will enable our engineers to make concrete recommendations . . . All orders are filled promptly and at moderate cost.*

*REG. U. S. PAT. OFF.

**RED BANK DIVISION OF
BENDIX AVIATION CORPORATION**

RED BANK, NEW JERSEY

Expert Sales: Bendix International Division, 72 Fifth Avenue, N. Y. 11, N. Y.

Write for this colorful and informative book
—it's free. You'll find it loaded with facts
and figures about all types of dynamotors.



Really Smooth—Outstandingly Quiet—Fully Dependable

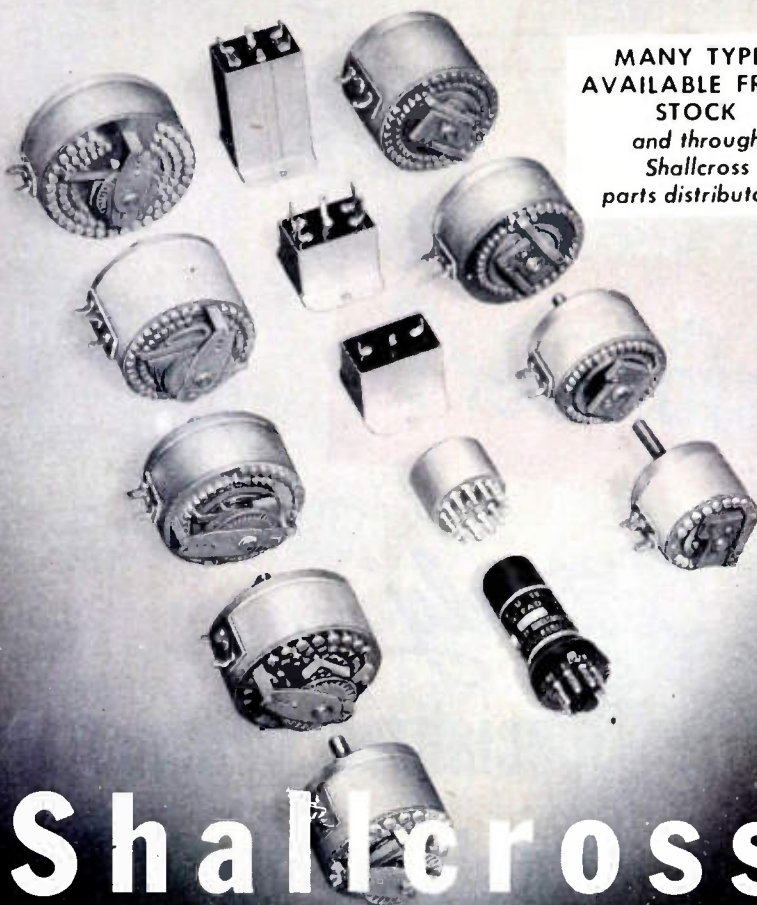

**MANY TYPES
AVAILABLE FROM
STOCK
and through
Shallcross
parts distributors**

Shallcross *Precision* **ATTENUATORS**

ALL STANDARD FIXED AND
VARIABLE TYPES

•
LADDER AND BALANCED
LADDER CONTROLS

•
"T" CONTROLS

•
BALANCED "H" CONTROLS

•
POTENTIOMETERS

•
VARIABLE IMPEDANCE
MATCHING NETWORKS

•
V.U. METER RANGE
EXTENDING ATTENUATORS

•
STANDARD AND SPECIAL
FIXED PADS

•
SPECIAL NETWORKS

Perhaps you've noticed how frequently Shallcross attenuators now appear in the finest audio or communications equipment? Or how often they are chosen for replacement purposes?

There's a reason! Improved design, materials and production techniques have resulted in a line that sets new, higher standards of attenuation performance for practically every audio and communications use.

Shallcross Attenuation Engineering Bulletin 4 gladly sent on request.

Shallcross Manufacturing Co.
Dept. PR-90 Collingdale, Pa.

RESISTORS — INSTRUMENTS — SWITCHES — ATTENUATORS



(Continued from page 36A)

Jones, R. W., Box 283, Naval Base, S. C.
Klopfenstein, R. W., 27 E. 10 Ave., Runnemede, N. J.
Lee, H. E., 2031 Thomas Ave., San Diego 9, Calif.
Pace, R. A., Civil Aeronautics Administration, Annette, Alaska
Ray, H. A., Jr., 1052 Warner Bldg., Washington, D. C.
Stokes, B. C., 29 Vanderbilt Ave., Floral Park, N. Y.
Triman, E. L., 5349 N. Oriole Ave., Chicago 51, Ill.
Valach, C. F., 2502 Elmwood Ave., Berwyn, Ill.
Webb, E. E., 718 E. Melton St., Longview, Tex.

Admission to Member

Brown, J. S., West Ealing, 16 Douglas Gardens, London, England
Chrisman, D. W., 515 S. Wellesley Ave., Albuquerque, N. Mex.
Gage, G. H., Jr., 1332 Claranette Ct., Owensboro, Ky.
Kirkby, R. L., RCAF Station, Clinton, Ont., Canada
Knowlton, K. R., 844 Kingston Rd., Toronto 8, Ont., Canada
Lord, W. P., 60 Neptune St., San Antonio, Tex.
Lovell, R. E., c/o La Villite, Alamogordo, N. Mex.
Martin, E. J., Physics Laboratories, Sylvania Electric Products Inc., Box 6, Bayside, L. I., N. Y.
Noe, J. B., 3125-40 St., Sandia Base, Albuquerque, N. Mex.
Parke, N. G., III, Independence Ct., Concord, Mass.
Peck, D. G., c/o Telecommunication Department, Kuantan, Pahang, Malaya
Pfund, E. T., Jr., 190 Oakland Ave., Methuen, Mass.
Prescott, R. S., 6 Forest St., Lexington 73, Mass.
Robinson, H. E., 867 N. Abingdon St., Arlington, Va.
Saunders, M. E., 1041 W. 53 Ave., Vancouver, B. C., Canada
Sodhi, S. S., 15, Bachumal Bldgs., Chunamandi, Paharganj, New Delhi, India
Surdam, E. L., 1002 Terminal Sales Bldg., Portland 5, Ore.
Torn, L. J., Airborne Instruments Laboratory, Inc., 160 Old Country Rd., Mineola, L. I., N. Y.
Townley, R. C., 155 Gold St., N. Arlington, N. J.
Tripp, A. L., 9 Chico Ct., S. San Francisco, Calif.
Valder, F. L., 43 Hqpton Rd., Streatham, London S.W. 16, England
Weed, A. C., Jr., 5311 Dorchester Ave., Chicago 15, Ill.
Wilcox, R. B., 78 Waban Park, Newton 58, Mass.

The following elections to Associate grade were approved and will be effective as of August 1, 1950:

Abell, V. F., Solomons, Md.
Agrawal, C., All India Radio, Queens Rd., Bombay, India
Alegria, M. G. S., C.P. 1229-CFL, Luanda, Angola, Portuguese West Africa
Barnett, K. G., 348 Hawthorne St., Glendale 4, Calif.
Boden, E. H., General Delivery, Emporium, Pa.
Bonnett, J. D. W., 815 W. 25 Ave., Vancouver, B. C., Canada
Bosted, N. P., 1022 N. Negley Ave., Pittsburgh, Pa.
Boulder, A. G., 4449-14 St., Canton, Ohio
Canto, L., Barnard Hall, North Brothers Island, New York, N. Y.
Caro, D. E., Physics Department, The University, Edgbaston, Birmingham 15, England
Chun, H. W. M., 1246 Matluck Ave., Honolulu 24, T. H.
Crossland, O. C., 246 Hable St., Denver-Harbor, Houston, Tex.

(Continued on page 39A)



(Continued from page 38A)

- Culbertson, H. B., 2307 Village Way, Dallas, Tex.
- Ellis, G. A., 5931 Thekla St., St. Louis 20, Mo.
- Emerson, W. P., 50 School St., Lexington 73, Mass.
- Fitzgerald, M. W., 1019 W. 19 St., N. Vancouver, B. C., Canada
- Foster, C. P., Jr., 609 MacArthur, Redwood City, Calif.
- George, H. A., Box 384, Bayville, L. I., N. Y.
- Gerdes, C. V., Monsanto Chemical Company, 1515 Nicholas Rd., Dayton 7, Ohio
- Hatchl, S., 1112 Jackson Blvd., Houston 6, Tex.
- Hawk, J. M., 3009 Wood St., Ames, Iowa
- Heising, C. R., Bldg. 63, General Electric Company, Lynn, Mass.
- Hembise, P. M., Sneach Pond Rd., Manville, R. I.
- Hepburn, J. T., 1149 Cortell Rd., N. Vancouver, B. C., Canada
- Hilton, B. C., Canadian Broadcasting Corporation, 701 Hornby St., Vancouver, B. C., Canada
- Holmes, G. A., 754 Carroll St., Akron 5, Ohio
- Holmgren, J. D., 385 S. Greenwood Ave., Pasadena 10, Calif.
- Horan, W. H., 10 Brooks St., S. Natick, Mass.
- Itenson, V. A., 1050 LeRoi St., Vancouver, B. C., Canada
- Jones, D. T., 3576 Anzio Dr., Vancouver, B. C., Canada
- Kent, N. S., 1607 W. 58 St., Vancouver, B. C., Canada
- Lee, F. G., 2549 1/2 S. Spaulding Ave., Los Angeles 16, Calif.
- Lisiecki, M., 1252 Greystone Rd., Baltimore 27, Md.
- Marini, J. W., 2603 Southern Ave., S.E., Washington, 20, D. C.
- Martin, H. R., 1621 S. Bloomington, Streator, Ill.
- Mayeda, T. A., 4800 Georgia Ave., N.W., Washington 11, D. C.
- Neveroski, F., 202 N. Howard Ave., Vancouver, B. C., Canada
- Oliver, W., 1 Moorlands Grove, Morecamre, Lancs., England
- Oltman, H. G., Jr., 636 Fairway Dr., Albuquerque, N. Mex.
- Oshokoya, S. O., 68 Kadara St., Ebute-Metta, Nigeria, West Africa
- Peterson, R. W., 3919 Dalton Ave., Los Angeles 37, Calif.
- Pierce, J. R., 1075 N. Eighth, Las Cruces, N. Mex.
- Pye, R. M., 3671 Point Grey Rd., Vancouver, B. C., Canada
- Quackenbush, E. C., 664 Downer Pl., Aurora, Ill.
- Rayment, C. V., 52 Cooper St., Ottawa, Ont., Canada
- Riddell, A. I., 360 E. 16 St., N. Vancouver, B. C., Canada
- Rosenstein, G. M., 338 Wellesley Rd., Philadelphia 19, Pa.
- Russo, L. J., Jr., 178 Grove St., N. Plainfield, N. J.
- Schneiderman, M., 45 Martin Ave., Clifton, N. J.
- Souch, W. F., Canadian Marconi Company, 149 Portage Ave., E., Winnipeg Man., Canada
- Sullivan, H. B., 2419 Hulseman Ter., Philadelphia, Pa.
- Teasdale, A. R., Jr., Electrical Engineering Department, University of Texas, Austin, Tex.
- Tripp, H. H., 825 W. Eighth Ave., Vancouver, B. C., Canada
- Turchan, P. J., 1714 S. Desplaines St., Chicago 16, Ill.
- Walsh, J. D., USAFIT, MCLI, Box 3336, Wright-Patterson AFB, Dayton, Ohio
- Warren, D. S., 750 Hillside Ave., Plainfield, N. J.
- Weeks, J. P., 1139 National Ave., Memphis, Tenn.
- Wilson, C. M., 514 W. Keith Rd., N. Vancouver, B. C., Canada
- Woodson, M. P., 601 19 St., N.W., Washington 6, D. C.

New UP-TO-THE-MINUTE FACTS AND DATA...

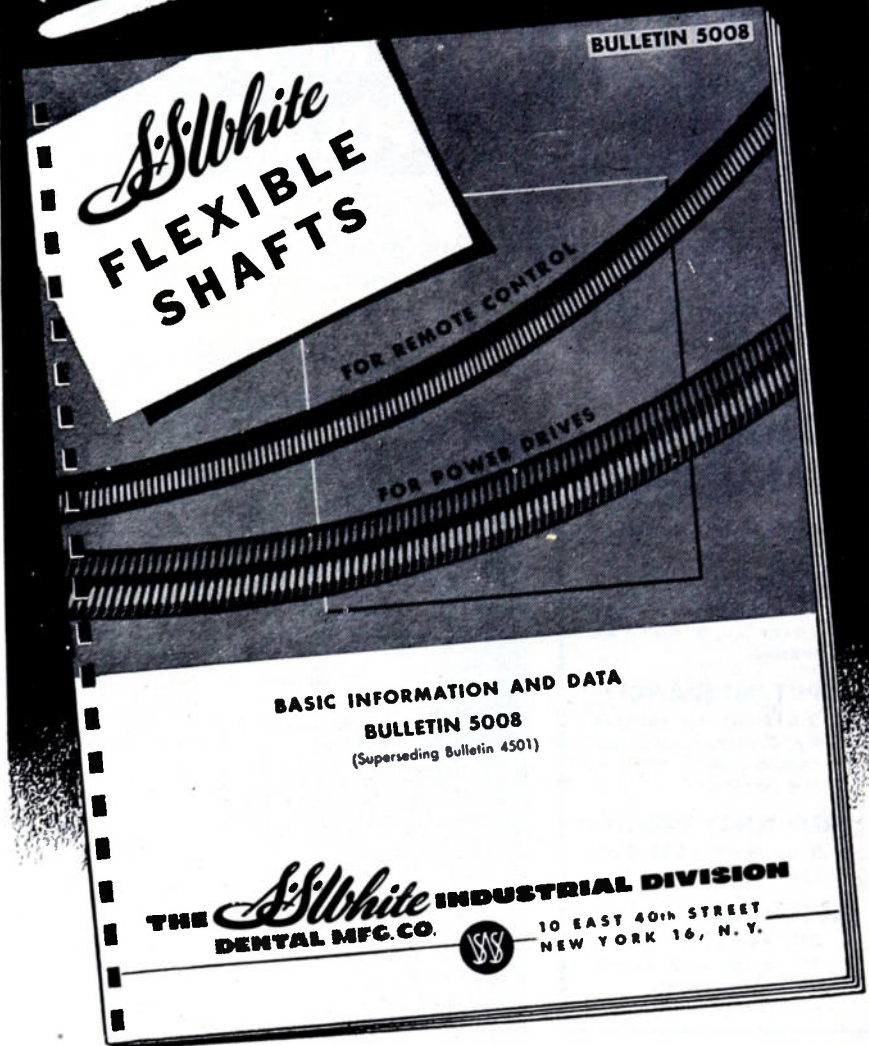

BULLETIN 5008 Just off the press!

Flexible shafts—the very latest information and engineering data on power drive and remote control flexible shafts and casings, brought up to date to include latest developments.

It also tells you how to select shafts and casings for specific applications and how to work out the necessary details.

Write for a free copy today.

THE Sillwhite INDUSTRIAL DIVISION
DENTAL MFG. CO.  Dept. G, 10 East 40th St.
NEW YORK 16, N. Y.

Announcing...

IMPROVEMENTS IN THE

BALLANTINE BATTERY OPERATED ELECTRONIC VOLTMETER

Achieving a tenfold increase in sensitivity, higher input impedance, improved low frequency response and substantial reduction in size and weight.



VOLTAGE RANGE:

100 microvolts to 100 volts in 6 decade ranges.

INPUT IMPEDANCE:

2.2 megohms shunted by 8 mmfd on high ranges and 15 mmfd on low ranges.

FREQUENCY RANGE:

2 cycles to 150,000 cycles.

ACCURACY:

3%, except 5% below 10 cycles and above 100,000 cycles.



- Available multipliers, amplifiers and shunts extend further the range and usefulness.
- Can also be used as a pre-amplifier with maximum gain of 60 DB.
- Features the well-known Ballantine logarithmic voltage and uniform DB scales.
- Battery life over 150 hours.

MODEL 302B

Size: 6 $\frac{1}{4}$ " x 7 $\frac{1}{2}$ " x 12 $\frac{3}{4}$ "

Weight: 17 lbs.

Price complete with cover and batteries: \$215.

For further information on the Ballantine Model 302B and other Ballantine Sensitive Electronic Voltmeters and accessories measuring up to 5.5 megacycles, write for catalogue.

BALLANTINE LABORATORIES, INC.

102 FANNY ROAD, BOONTON, NEW JERSEY



News—New Products

These manufacturers have invited PROCEEDINGS readers to write for literature and further technical information. Please mention your I.R.E. affiliation.

(Continued from page 30A)

Null Detector and VTVM

The Freed Transformer Co., 1718-36 Weirfield St., Brooklyn (Ridgewood) 27, N. Y., is now delivering their new null detector and vacuum-tube voltmeter, No. 1210.

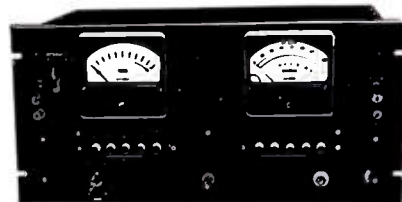

This unit has been designed for ac bridge measurements. It provides simultaneous measurement of the voltage across the unknown and the balance of the bridge. This vacuum-tube voltmeter has a sensitivity of 0.1, 1, 10, and 100 volts. The input impedance is 50 megohms shunted by 20 μ f. The frequency range is from 20 cps to 20,000 cps. Null detector—gain 94 db. It has selective circuits for 60-400-1,000 cps and a frequency range of 20 to 30,000 cps.

New Audio Amplifiers

The Altec Lansing Corp., 1161 N. Vine Street, Hollywood 38, Calif., has announced a new series of amplifiers designed specifically for use with the Altec miniature condenser microphone. By newly developed circuits, these amplifiers eliminate the need for several elements now necessary in microphone amplifier systems. With this new circuit, power for the condenser microphone impedance matching tube is obtained from the amplifier rectifiers. No input transformers or input matching transformers are required.



First of the new series is the A-332A amplifier, an 18-watt portable public address unit. Three inputs are provided, two for the miniature condenser microphone, and one for variable reluctance phonograph pickup. Each of the three channels is provided with independent gain and bass controls. A high-frequency droop control is provided for all input channels. When more than 18 watts of power is required, the A-332A may be used to drive the 75-watt A-247B Amplifier.

(Continued on page 42A)



Pan American pioneers radiotelephone network

... equipment by COLLINS

WHEN Pan American World Airways opened a route into the Middle East in 1947, all en route plane-ground communications had to be performed by radiotelegraph—the dot-dash system. A radiotelephone network, like that used on the United States airways, did not exist overseas.

Today, through the initiative of Pan American, messages can be exchanged immediately by radiotelephone between Clipper pilots and ground radio-operators over every foot of the Clipper routes from New York to Basra, Iraq, and from New Delhi, India, eastward round the world to San Francisco.

To accomplish this extensive pioneering job, Pan American has invested three years of work and a large sum of money. This airline has negotiated permission for radio stations with foreign governments, and has installed these stations at a number of points in Europe and Asia. Pilots and ground personnel have been trained for the new operation, and the Clippers' radio installations have been modified from radiotelegraph to radiotelephone.

The major radio units chosen by Pan American World Airways for this purpose, and for the Caribbean area, are Collins high frequency ground station and airborne transmitters and receivers. In-

cluded are Collins 231D 3.5/5 kilowatt Autotune[®] transmitters, 16F 300/500 watt Autotune[®] transmitters and 51N receivers on the ground, and 18S transmitter-receivers in the air.

To complete the modernization of its ROUND THE WORLD system, Pan American has installed Collins 231D and 16F transmitters, and 51N receivers, in route stations at Santa Maria, Lisbon, London, Munich, Vienna, New Delhi, Calcutta, Bangkok, Manila, Honolulu, Los Angeles, San Francisco and Seattle; a 16F transmitter and 51N receivers at Vienna; a 16F transmitter at Damascus; and 51N receivers at Rome.

Additionally, a great improvement in ground radiotelephone service was made at Munich. There, VHF communications were relocated from the airport to the top of 10,000-foot Mount Zugspitze in the Bavarian Alps, whence a Collins 3000A very high frequency transmitting and receiving installation increases the effective operating radius from 50 to 250 miles, covering an area from Luxemburg to Milan, Italy.

This pioneering by Pan American World Airways is in the best tradition of American free enterprise. Collins is proud to have been chosen to play a part.

® REG. U.S. PAT. OFF.

IN RADIO COMMUNICATIONS, IT'S . . .



COLLINS RADIO COMPANY, Cedar Rapids, Iowa

11 W. 42nd Street, NEW YORK 18

2700 W. Olive Avenue, BURBANK

what's the REAL PROBLEM?

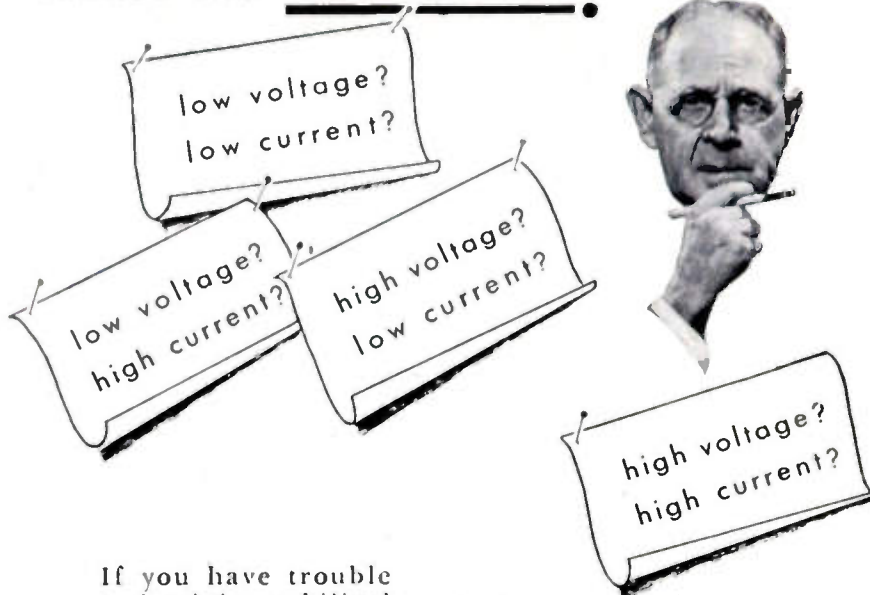

If you have trouble maintaining stabilized DC Voltage under changing Load conditions, it's time to investigate the Sorensen line of Nobatrons.

- **Common Nobatron Specifications:** Regulation Accuracy 0.2% from 0.1 load to full load; Ripple Voltage 1%; Recovery time 0.2 seconds under most severe load or input conditions; 95-130 VAC single phase 50-60 cycles; Adapter available for 230 VAC operation.
- **Ratings**
 Nobatron — 6, 12, 28, 48, 125 volts from 5-350 amperes
 B-Nobatron — 325, 500, 1000 volts — 125 ma.; 300 ma. & 500 ma.
 DC Standards — 2, 6, 15, 25, 50, 75, 150, 300 volts — 15, 30 and 50 ma.
- **Problems?** Sorensen Engineers are always at your service to help solve unusual applications.
- **Sorensen manufactures:**
 AC line regulators 60 and 400 cycles; Regulated DC Power Sources, Electronic Inverters; Voltage Reference Standards; Custom Built Transformers; Saturable Core Reactors.

WRITE TODAY For Catalog B1049 For The Complete Line And Prices.



Sorensen and company, inc.
 375 FAIRFIELD AVE. • STAMFORD, CONN.

MANUFACTURERS OF AC LINE REGULATORS, 60 AND 400 CYCLES; REGULATED DC POWER SOURCES; ELECTRONIC INVERTERS; VOLTAGE REFERENCE STANDARD; CUSTOM BUILT TRANSFORMERS; SATURABLE CORE REACTORS

TYPICAL DC SOURCES



MODEL 325B
0-325 volts; 125 ma.



MODEL VS-50-50
50 volts @ 50 ma.



MODEL E-6-15
6 volts; 1.5-15 amperes

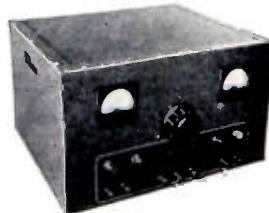

MODEL 500 B
0-500 volts; 300 ma.

News—New Products

These manufacturers have invited PROCEEDINGS readers to write for literature and further technical information. Please mention your I.R.E. affiliation.

(Continued from page 40A)

350-Watt Isolation Transformer

A new isolation testing transformer has been announced by Standard Transformer Corp., 3580 Elston Ave., Chicago 18, Ill., maker of Stancor transformers and related components. This new unit is rated at 350



watts and is large enough to handle almost any TV or radio receiver on test. It may also be used to correct a high or low line voltage. Three standard receptacles provide output voltages of 105-, 115-, and 125-, with 117 volts, ac. from the line.

Sub-Audio Coils

United Transformer Co., 150 Varick St., New York 13, N. Y., has specialized for many years in the manufacture of stable Hi-Q coils for audio and supersonic frequency work. They have now developed and make available to customers' specifications Hi-Q coils for subaudio frequencies.



These coils have Hi-Q and stable characteristics for frequencies from 0.1 to 10 cps. A typical unit provides an inductance of 300,000 hys. with Q of 10 at 0.15 cps and Q of 30 at 0.5 cps. This coil is designed for a 1 volt ac-0.1 ma dc circuit.

(Continued on page 44A)

Miniaturization Specialist Capacitors—

1000 to the Pound!

AEROVOX MICRO-MINIATURES

(TYPE P83Z AEROLITE* CAPACITORS)

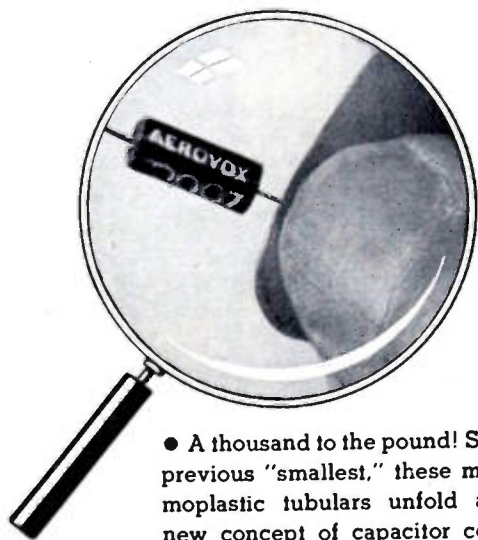

● A thousand to the pound! Smaller than previous "smallest," these molded thermoplastic tubulars unfold an entirely new concept of capacitor construction.

The smaller physical sizes are directly attributed to the latest metallized-paper technique which combines both dielectric and electrodes in a single winding strip. Unusually strong lead connections to capacitor section. Since capacitance is predetermined mechanically in the initial processing, it is no longer necessary to rely on the human element for capacitance control.

Type P83Z Micro-miniatures are particularly applicable to that portion of the electronic field where low capacitance paper capacitors and high-capacity disk capacitors are now being used.

*Trade-mark

Featuring . . .

Two sizes: 3/16" d. x 7/16" l.; 1/4" d. x 9/16" l.
200, 400 and 800 rated voltage; 300, 600 and 900 test voltage.
Hyvol K impregnated in humidity-resistant molded thermoplastic case.
Operating temperature from -15°C. to +85°C. without derating.
Power factor less than 1% when measured at or referred to frequency of 1000 cps and ambient temperature of 25°C.
Life test: 1000 hours at 1.25 times rated voltage in ambient temperature at 85°C.
Insulation resistance of 25,000 megohms or greater, measured at or referred to temperature of 25°C. Insulation resistance at 85°C., 800 megohms or greater.

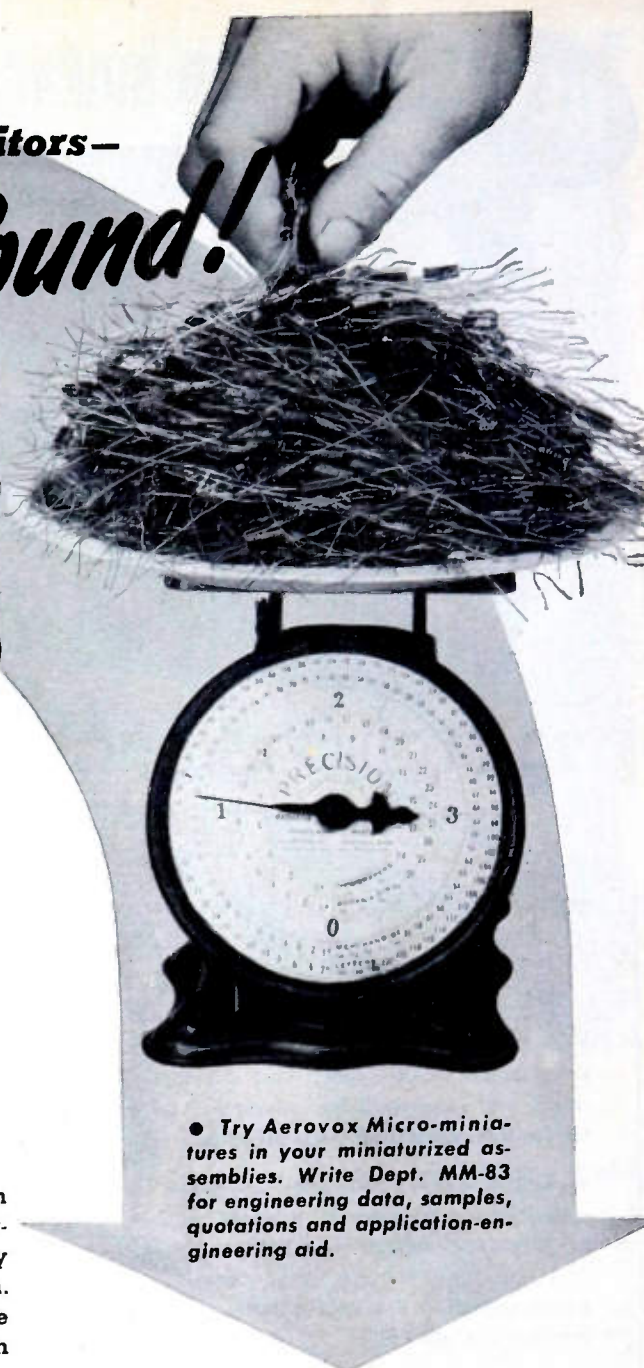

● Try Aerovox Micro-miniatures in your miniaturized assemblies. Write Dept. MM-83 for engineering data, samples, quotations and application-engineering aid.



FOR RADIO-ELECTRONIC AND INDUSTRIAL APPLICATIONS

AEROVOX CORPORATION, NEW BEDFORD, MASS., U. S. A.

Sales Offices in All Principal Cities • Export: 41 E. 42nd St., New York 17, N. Y.

Cable: AEROCAP, N. Y. • In Canada: AEROVOX CANADA LTD., Hamilton, Ont.

NEW!

STANDARD SIGNAL GENERATOR

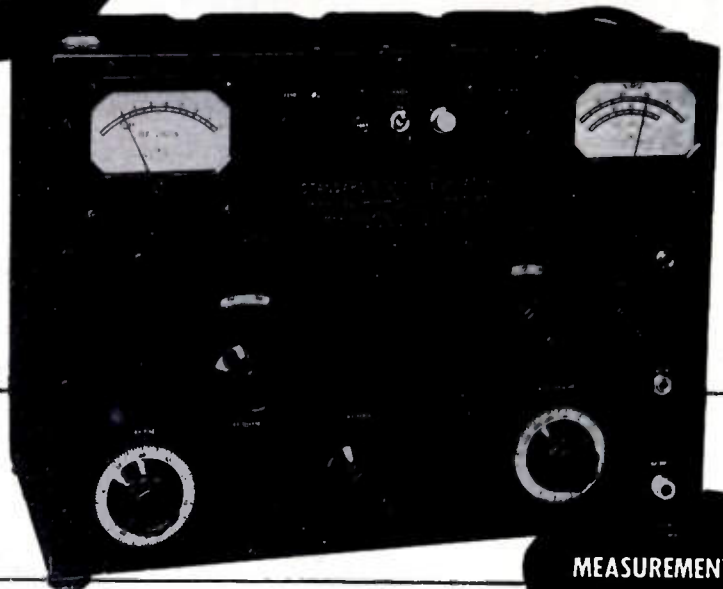

MEASUREMENTS
Model 82

20 CYCLES TO 50 MC. IN ONE INSTRUMENT!

THIS new *Laboratory Standard* is designed for the extremely wide frequency coverage of 20 cycles to 50 megacycles, employing two specially designed oscillators.

A low frequency oscillator, in the range from 20 cycles to 200 kilocycles, provides continuously variable, metered output from 0 to 50 volts across 7500 ohms. This is sufficient for most measurements at audio and supersonic frequencies. It may also be used as the modulator for the radio frequency oscillator.

A radio frequency oscillator covers the range from 80 kilocycles to 50 megacycles. It provides metered output, continuously variable with an improved mutual inductance type attenuator, from 0.1 microvolt to 1 volt. This voltage range makes possible most receiver measurements including the determination of a.v.c. characteristics and interference susceptibility.

SPECIFICATIONS:

Frequency Range: 20 cycles to 50 megacycles. (20 cycles to 200 kilocycles in four ranges; 80 kilocycles to 50 megacycles in seven ranges; plus one blank range.)

Frequency Calibration: Direct reading dial, individually calibrated for each range.

Frequency Accuracy: 20 cycles to 200 kilocycles, accurate to $\pm 5\%$. 80 kilocycles to 50 megacycles, accurate to $\pm 1\%$.

Output Voltage and Impedance: 0 to 50 volts across 7500 ohms from 20 cycles to 200 kilocycles. 0.1 microvolt to 1 volt across 50 ohms over most of the range from 80 kilocycles to 50 megacycles. [Improved mutual inductance type attenuator.] The output voltage or impedance of either range can be changed by the use of external pads.

Modulation: (80 KC—50 MC range) Continuously variable from 0 to 50% from 20 cycles to 20 kilocycles by internal low frequency oscillator or external source.

Harmonic Output: Less than 1% from 20 cycles to 20 kilocycles; 3% or less from 20 kilocycles to 50 megacycles.

Leakage and Stray Field: Less than 1 microvolt from 80 kilocycles to 50 megacycles.

Power Supply: 117 volts, 50 to 60 cycles. 75 watts.

Dimensions: 15" high x 19" wide x 12" deep, overall.

Weight: 50 lbs.

MEASUREMENTS CORPORATION

BOONTON



NEW JERSEY

News—New Products

These manufacturers have invited PROCEEDINGS readers to write for literature and further technical information. Please mention your I.R.E. affiliation.

(Continued from page 42A)

Hermetically Sealed Panel Meter

Marion Electrical Instrument Co., Manchester, N. H., announces a new $4\frac{1}{2}$ -inch instrument which brings the features of the Marion hermetic line to users who require a $4\frac{1}{2}$ -inch meter. A solder-type zero adjuster provides adjustment without breaking the hermetic seal. A rubber gasket is included for use as a pressure seal for panel mounting.

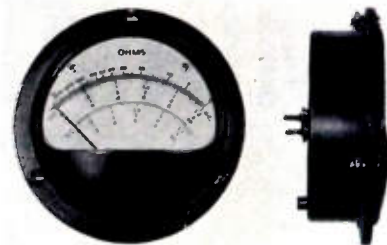

Extremely compact, this new meter has a depth of $1\frac{1}{8}$ inches from front of panel to allow more freedom in installation. This type is now offered in a wide variety of standard ranges. Either 1 or 2 per cent accuracy rating available. Dials are standard or specially calibrated, depending on requirements.

New Locked-Flange Bobbins for Coils

Precision coil bobbins with a new plastic-coated core, and the flanges locked in place on this core by the plastic are being marketed by Precision Paper Tube Co., 2045 W. Charleston St., Chicago 47, Ill. Thus, wire cannot be crowded on the bobbin, nor become loosened, as it does when loose flanges slide along the tube, or off it.



The manufacturer states that the new plastic-coated core makes the coil bobbins 15 to 20 per cent stronger, yet light in weight. It also increases the bobbins' insulating qualities and moisture resistance, and has excellent heat-dissipating qualities. Spiral-wound, this core can be made any size, any shape—round, square, or rectangular—and to any ID or OD with close tolerances.

(Continued on page 46A)

Exclusive
G.P.L. Development

LEADERS IN

Professional Quality Projection for 16 mm. Film

*Telecast Projectors with the Basic Features
and Performance Reliability of the Famous
Simplex Theatre Projectors*

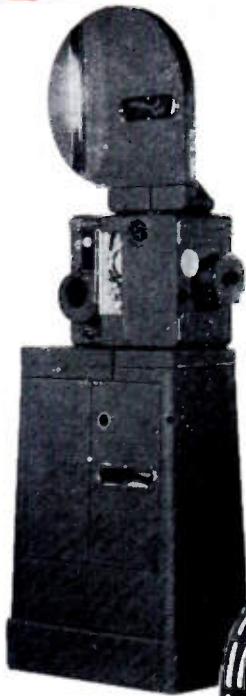

Clearer Pictures ... Finer Sound

from ANY Film in your Studio

The G.P.L. Model PA-100 is a heavy-duty studio film chain projector, for use with either iconoscope or image orthicon, which sets new standards of ruggedness and projection quality. The professional sprocket type pull-down is quiet and trouble free. It provides a vertical stability of better than 0.2%. Tests show more than 1,000 passages without noticeable film wear. The high quality optical system resolves better than 90 lines per mm., with the screen so uniformly illuminated that corner brightness is at least 90% of center.

- The sound system provides a frequency response truly flat to 7,000 cps, with flutter less than 0.2%.
- An enclosed, 4,000 foot film magazine provides for 110 minutes of projection—an entire feature.
- The film gate and optical and sound components are instantly removable.



A Portable that Pays for Itself in the Field

The G.P.L. General Utility Projector (PA-101) works directly with image orthicon studio or field cameras to provide new economy and convenience in your operations. For the small station, it provides the same quality as conventional iconoscope film chain equipment, using regular studio cameras. For large stations, its portability and high performance permit great flexibility, such as picking up commercials at remotes—games, sporting events, etc., without requiring studio standby facilities for this purpose.

It has the same performance features as the PA-100 except that a fast intermittent shutter provides illumination in relatively broad pulses at 120 cycles per second. This means that the projected picture may be picked up by a standard image orthicon camera without special phasing facilities. The projector weighs only 65 lbs. with case.

**WRITE, WIRE OR PHONE
FOR DETAILS ...**



TV Camera Chains • TV Film Chains
TV Field and Studio Equipment
Theatre TV Equipment

General Precision Laboratory

INCORPORATED

PLEASANTVILLE

NEW YORK

THE NEW CLARKSTAN

ARMS

WITH THE "SLIDE-IN" CARTRIDGE HOLDER

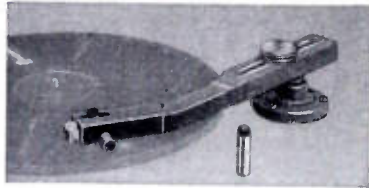

USES ANY TYPE CARTRIDGE

Never before such fine quality professional transcription and record arms designed to use any cartridge of your choice. Slotted so you need only slide the cartridge into the arm and a twist of the thumb screw secures the cartridge in place. No soldering. Positive electrical contact is maintained by a spring loaded plunger. A quick-acting weight adjustment and height adjustment for all turntable conditions gives accurate balance and proper needle force. These fine quality professional arms are the best yet for LP Microgroove and standard discs. Model 213G plays records up to 12" in diameter. Model 212G plays transcriptions up to 17" in diameter. See your jobber or write for Bulletin No. 173-4A.

WIDE RANGE RV PICKUP

Clarkstan RV wide range variable reluctance cartridge for best reproduction of LP Microgroove and standard records. Instantaneously replaceable and interchangeable needles permit use of a variety of styli. Frequency response to above 12,000 cps. Needle force 5-7 grams for LP Microgroove, as low as 10 grams for conventional records. Output 60 millivolts. High Impedance—5—50—250 and 500 ohm models available. 1/2" mounting centers. Supplied with sapphire stylus. Net price (cartridge only with standard sapphire stylus) \$15.00. See your jobber or write for Bulletin No. 141-4A.

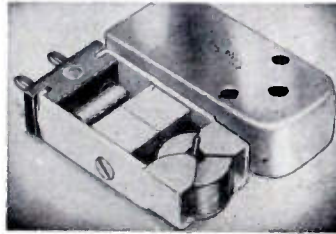

CLARKSTAN AUDIO SWEEP FREQUENCY TRANSCRIPTIONS



An entirely new method of making instantaneous frequency response runs. Audio Sweep Frequency Transcriptions embody all correction factors in the original recording which eliminates the need for charts and graphs. When used with an oscilloscope, the Audio Sweep Frequency Transcriptions (sweep rate 20 times per second) provide an instantaneous response measurement so a few quick adjustments on a circuit complete the job. Used extensively for testing audio amplifiers, loud speakers, microphones, acoustical networks, electrical filter networks, etc. Broadcast engineers can make frequent quick checks of transmission systems and components. Used for production testing. Locates distortion. Excellent for laboratories as well as FM stations, motion picture studio and theatre sound equipment. See your jobber or write for Bulletin No. 1044.

STEADY STATE FREQUENCY RECORDS

Clarkstan now offers three new test records which for the first time conform to exact specifications, permitting the user to work in known quantities. The reproduction of these fine test records involves no polishing and employs the very latest techniques which insure exact duplication of the original recordings in each pressing. Complete specifications of the original recordings are furnished. See your jobber or write for Bulletin No. 1811.



MICROSCOPE GROOVE ANALYZER

Low cost, medium power microscope with built-in light and reticle. Designed expressly for the phono record recorder. The illumination is optimum for observing the condition of the groove and the number of lines per inch and depth of cut. Has flat field, excellent optics—can be used with glasses (eyepoint is 1" above top). Both 20x and 40x provided in one microscope. Reticle for direct measurement by .002". Complete with lacquered wooden carrying case with sliding cover. Focusing is accomplished by means of friction sliding tube. Is easy and positive. Net price \$22.50. See your jobber or write for Bulletin No. 185.

CLARKSTAN KNOBS

Attractive one-piece knobs accurately machined from DURAL add the professional appearance to control panels and all types of test equipment. All knobs have fluted sides and have screw-type mounting for round or flat shafts to fit standard 1/4" shafts. Back of all knobs recessed 3/4" diameter by 5/64" deep to accommodate panel bushing nut. Made in following diameters: 1/2"—1 1/4"—1 1/2"—2" with or without pointer. See your jobber or write for Bulletin No. 182A.



CLARKSTAN
CORP.

ELECTRONICS DIVISION 2R

11921 WEST PICO BOULEVARD
LOS ANGELES 64, CALIFORNIA

News—New Products

These manufacturers have invited PROCEEDINGS readers to write for literature and further technical information. Please mention your I.R.E. affiliation.

(Continued from page 44A)

New Series of Relays

Recommended for applications where humidity or dust conditions present a hazard to continuous operation are the hermetically sealed relays recently introduced by the Guardian Electric Manufacturing Co., 1621 W. Walnut St., Chicago 12, Ill.

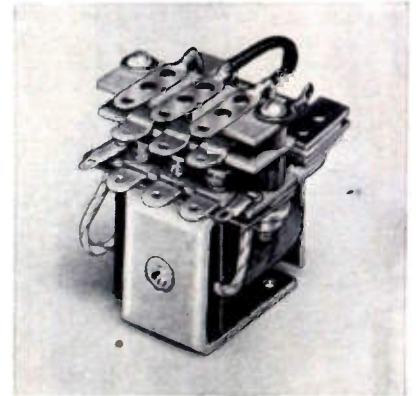

These units are available in four standard mounting arrangements—the lug header type, Army-Navy connector type, octal plug type, and the screw terminal type. A wide variety of contact combinations and operating voltage ranges are available in the units now offered by this company as standard hermetically sealed equipment. The relay is shown above, below it is shown hermetically sealed.



Among the relays listed in the new Guardian Catalog 5-H are the well-known radio, telephone, and aircraft type relays. Through the development of a new method of sealing and the use of aluminum containers, the weight of these units is far less than those previously offered to industry. Included in the current catalog is technical information concerning the performance of units conforming to requirements of the ANK-20b and the 10-G vibration tests. Write for a copy of the catalog 5-H with information on hermetically sealed relays.

(Continued on page 48A)

What's Your
PANEL INSTRUMENT
Problem?



Simpson
ENGINEERS WILL HELP YOU
Solve It!

No matter what your panel instrument problem is, Simpson Electric Company engineers will be glad to help you solve it. Every day they are confronted with individual design problems.

Behind every Simpson instrument is a world-wide reputation for quality. Simpson movements have greater ruggedness and accuracy, because of the full bridge-type construction and soft iron pole pieces.

When Simpson helps you with your problem, you benefit from this world-wide reputation and the years of experience of Simpson engineers.

Let Simpson engineers help you with your next instrument problem and for your standard instrument requirements take advantage of our large stock, available for immediate delivery.



SIMPSON ELECTRIC COMPANY

5200-18 WEST KINZIE STREET, CHICAGO 44, ILLINOIS
IN CANADA: BACH-SIMPSON, LTD., LONDON, ONTARIO

you need these FOUR...

no more!



THE BLUE ZEPHYR BELL LAMP
Ideal for over-all illumination. Light-weight, sturdy construction. 750 to 2000 watt, range in P. S. 52, 1000-hr. globe. Folding leg stand, and diffuser. Blue wrinkle finish.

①



②

THE BLUE ZEPHYR BABY
A full size 750 watt Baby Spot that is interchangeable from the auxiliary stand to the Blue Comet Boom (as shown above). Contains all the features and accessories of the Blue Zephyr Junior, shown below. Blue wrinkle finish.

③

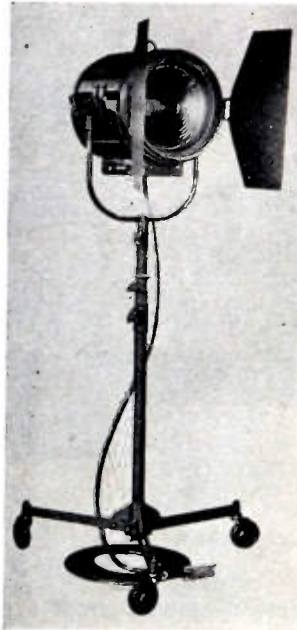

THE BLUE ZEPHYR JUNIOR
The finest in modern lighting equipment. Lamp head features include interlocking ventilation channels, direct-action focusing with graduated scale. Attached rotating barn doors and full-size diffuser frame. Stand has folding legs with rubber-tired ball-bearing casters. Adjustable from 51 inches to 113 inches. Blue wrinkle finish.

④

THE BLUE COMET BOOM
Stand extends to 8 feet-10 inches; has air brake for ease in lowering. Boom arm adjustable from 5 feet-4 inches to 8 feet-1 inch. Positive locking fittings. Boom and stand fold flat for compact handling. Flexible, quiet. Blue wrinkle finish.

WRITE TODAY FOR OUR NEW CATALOGUE ON LIGHTWEIGHT LIGHTING



MOLE-RICHARDSON CO.

937 NORTH SYCAMORE AVENUE
HOLLYWOOD 38, CALIFORNIA

News New—Products

These manufacturers have invited PROCEEDINGS readers to write for literature and further technical information. Please mention your I.R.E. affiliation.
(Continued from page 46A)

Stabilized DC Indicating Amplifier

Multi-purpose stabilized dc indicating amplifiers just announced by Leeds & Northrup Co., 4934 Stenton Ave., Philadelphia 44, Pa., are useful for low-level dc measurements as direct-reading microvoltmeters or micromicroammeters; as recorder pre-amplifiers to extend the range of standard Speedomax recorders; and as high-sensitivity, short-period null detectors in place of galvanometers. Amplifiers are supplied either as voltage or current type, with choice of zero-left or zero-center built-in 4-inch indicating meter.



Both gain and zero point are so highly stabilized by a combination of ac amplification and dc null-balance feedback that trimmer controls are unnecessary. Without impairing performance, the voltage amplifier can be used with sources up to 10,000 ohms resistance, and the current type with sources of 100,000 ohms and higher.

Basic range of the voltage amplifier is 0 to 50, or -25 to +25 microvolts, with scale multipliers of 1, 2, 4, 10, 20, and 40; of the current amplifier, 0 to 1,000 or -500 to +500 μ a, with multipliers of 1, 2, 5, 10, 20, 50, 100, 200, 500, 1,000, and 2,000. Response time of both models is 2 to 3 seconds. Output at recorder connector for full-scale input on any range is 10 mv at output impedance of 500 ohms.

For convenience in null balance measurements, the indicating meter can be switched to non-linear response.

For full details, write to the manufacturer.

400 CPS Chopper

A 400-cps chopper is now being offered to the industry by Airpax Products Co., 1024 Greenmount Ave., Baltimore 2, Md. This component is offered at 6, 12, 26, 32, and 120 volts dc, or 120 volts ac.

The manufacturer claims that life tests of between 3,000 and 6,000 hours have been recorded. However, it is being marketed with an expected life of 1,000 hours or better.

When an external 0.04 μ f capacitor is in series with the coil, the chopped output is in phase with the driving signal. The capacitance tolerance is not critical. Without correction the output lags approximately 65°. The chopper is adjusted for the frequency range of 380 to 420 cps.

(Continued on page 56A)

setting **new** standards
for
electrical instruments



MARION RUGGEDIZED METERS

This amazing new family of Marion ruggedized electrical indicating instruments sets new standards of quality and accuracy in electrical measurement. Marion "Ruggedized" instruments give better performance in *any* application. Use them with confidence even where you never before dared use "delicate instruments." They exceed all JAN-I-6 requirements, are *hermetically sealed* and completely interchangeable with existing JAN 2½" and 3½" types.

Marion Ruggedized instruments perform perfectly under critical conditions of shock, vibration, mechanical stress and strain. Hermetic sealing makes them impervious to weather and climate.

When you want the *best* in meters for any application—from bulldozers to Geiger Counters—insist on Marion, the name that means the most in meters.

Send for our booklet on Marion Ruggedized Instruments. Marion Electrical Instrument Company, 407 Canal Street, Manchester, New Hampshire.

MARION MEANS THE MOST IN METERS

Canadian Representative: Astral Electric Company, 44 Danforth Road, Toronto, Ontario, Canada
Export Division: 458 Broadway, New York 13, U.S.A., Cables MORHANEX



Manufacturers of
Hermetically Sealed
Meters Since 1944



marion meters

SCIENTISTS AND ENGINEERS

for
challenging research and advanced
development in fields of

RADAR
GYROSCOPES
SERVOMECHANISMS
MECHANICAL SYSTEMS
ELECTRONICS CIRCUITS
APPLIED PHYSICS AND MATH
PRECISION MECHANICAL DEVICES
ELECTRICAL SYSTEM DESIGN
GENERAL ELECTRONICS
INSTRUMENTATION
MICROWAVES
COMPUTERS
AUTOPILOTS

*Scientific or engineering
degree and extensive technical
experience required.*

WRITE:
Manager, ENGINEERING PERSONNEL
BELL AIRCRAFT CORPORATION
P.O. Box 1, Buffalo 5, N.Y.

Senior Electronic Circuit Physicists

for advanced Research and
Development

Minimum Requirements:

1. M.S. or Ph.D. in Physics or E.E.
2. Not less than five years experience in advanced electronic circuit development with a record of accomplishment giving evidence of an unusual degree of ingenuity and ability in the field.
3. Minimum age 28 years.

RESEARCH AND
DEVELOPMENT
LABORATORIES
Hughes Aircraft Company
Culver City, California



The following positions of interest to I.R.E. members have been reported as open. Apply in writing, addressing reply to company mentioned or to Box No. ...

The Institute reserves the right to refuse any announcement without giving a reason for the refusal.

PROCEEDINGS of the I.R.E.
1 East 79th St., New York 21, N.Y.

TELEVISION ENGINEERS

Television engineers with at least 3 years resign experience, preferably electrical engineering, as production engineer for nationally known radio and TV manufacturer located in upper New York state. Box 612.

ANTENNA ENGINEER

Long Island laboratory has an opening that is unusually suitable for an engineer who prefers a small company, is interested in specializing in VHF and microwave antennas and who has carried real responsibility in this or closely related field. Box 614.

ACOUSTIC ENGINEER

For research and design on loudspeakers and microphones. Must have a thorough background in acoustics, audio and measuring techniques, with a minimum of 5 years laboratory or practical design experience on loudspeakers or transducers. Progressive manufacturer in New York suburban area. Send complete resume and state salary requirements. Box 415.

RADIO ENGINEER

Electrical or radio engineer, must have development experience in audio frequency circuit design. Acoustical experience also helpful. State experience, age, salary desired. Box 616.

ELECTRONIC ENGINEER

At least 5 years post-college experience in development DC amplifier, digital computers, pulse and servo design. Established company. Classified work. New York City. Box 617.

PROFESSOR

Professor of communications engineering needed for fall 1950 southeastern university. Will be in charge of graduate work and research activities. \$6.50 for nine months with extra income for summer teaching, or sponsored research. Must have Ph.D. or D.Sc. degree. Write Box 618.

JUNIOR ELECTRICAL ENGINEER

Attractive opportunity for junior electrical engineer with manufacturer of UHF equipment. Preferably a man with one or two years experience. Reply to Box 619.

PROJECT RADIO ENGINEER

To take responsible charge of design of radio communications systems between Hawaiian Islands. Experience in VHF and microwave links design desirable. College training or equivalent necessary. Live in Honolulu. Contact Mutual Telephone Co. Box 2200, Honolulu, T.H.

(Continued on page 51A)

ELECTRONIC ENGINEERS

BENDIX RADIO DIVISION
Bendix Aviation Corporation

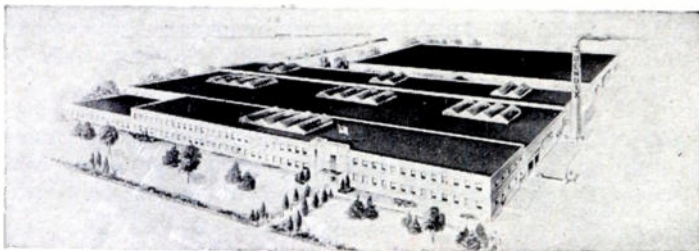

PRODUCTION DESIGN RESEARCH

Bendix Radio Division, a leader in the field of high quality radar and communications equipment, has positions for engineers experienced in the design and development, for production, of radio and radar equipment or electronic research.

Positions are available at all salary levels.

Good advancement opportunities, air-conditioned plant in suburban location, excellently equipped laboratories, technical library, large experimental engineering model shop.

Housing and rentals in Baltimore are plentiful.

Interviews will be held in Baltimore, Chicago and New York. Please send resume of experience promptly to:

MR. W. L. WEBB, Director Engineering and Research
BENDIX RADIO DIVISION
Bendix Aviation Corporation • Baltimore 4, Maryland

RESEARCH ENGINEERS ELECTRICAL ENGINEERS AND PHYSICISTS

THE FRANKLIN INSTITUTE LABORATORIES FOR RE- SEARCH AND DEVEL- OPMENT

Have opening for personnel with 2-10 years experience. Advanced degrees are desirable in certain of the positions. Fields of interest covered are: Mathematical Analysis of Physical Problems, Statistical Theory of Communications, Electromagnetic Theory, Circuit Analysis, Servomechanism Theory, Electrical Computing, Advanced and Fundamental Circuit Development, Radar and Pulse Circuits, Supervision of Operation of G.C.A. or Tracking Radar, Air Traffic Control, Air Navigation, Automatic Controls, Industrial or Marine Power Drives, and Electrical Machinery.

Send resume of education and experience, salary requirements and a photograph to:

Personnel Department
THE FRANKLIN INSTITUTE
Philadelphia 3, Pennsylvania

PHYSICISTS AND ENGINEERS

You can find plenty of positions where you will work on minor improvements on radar, telemetering systems, and other conventional devices. However, you will find very few positions where you can break ground in new fields having tremendous significance. This you can do at the JACOBS INSTRUMENT COMPANY, whose entire effort is devoted to pioneering activities in new fields that it has opened up itself. One of these fields, for example, is that of ultra-high speed, ultra-compact digital computers and controllers. This company's JAINCOMP family of computers dominates this field. Other equally important fields are being developed. Engineers and physicists with sound backgrounds and experience in the design of advanced electronic circuits or precision mechanical instruments may qualify, also individuals with good backgrounds in applied physics. A few openings exist for outstanding junior E. E.'s and physicists, also experienced technicians; applicants for these positions must apply in person.

JACOBS INSTRUMENT CO.

4718 Bethesda Ave.
Bethesda 14, Maryland



(Continued from page 50A)

ENGINEER

Chief systems test engineer with practical experience in electro-mechanical and hydraulic systems to direct systems testing on guided missiles. Familiarity with production testing techniques and test equipment in above fields is desirable. Excellent opportunity for someone who can organize a rapidly expanding facility. Direct inquiries to Manager, Engineering Personnel, Bell Aircraft Corp., P. O. Box 1, Buffalo, N.Y.

SPECIFICATION WRITERS

Specification writers capable of clear, concise technical description of the design, construction and testing of missile and electronic equipment. Knowledge of military specifications and familiarity with aircraft and electronic components is essential. Direct inquiries to Manager, Engineering Personnel, Bell Aircraft Corp., P.O. Box 1, Buffalo 5, N.Y.

ENGINEER

Engineer, electrolytic capacitor, at least 5 years experience in design and development. Write resume of experience and salary expected. Box 620.

RADIO ENGINEER

Radio engineer wanted by prominent Chicago electronic manufacturer to design and supervise manufacture of full line of commercial amplifiers. Must have engineering degree or equivalent and minimum of 2 years design experience in commercial P.A. systems. Give details including age, education, experience, reference, availability and salary expected. Box 621.

ENGINEER

Excellent opportunity for engineer to apply microwave measurements and techniques to development and manufacture of magnetrons and klystrons. Pulse circuit knowledge also valuable. B.S. degree and experience or advanced degree with heavy concentration on above required. State salary expected and qualifications. Location New York City. Box 622.

CIRCUITS ENGINEER

Rapidly expanding company in instrumentation field has opening for senior engineer. Prefer man with masters degree and 4 or more years of experience in design of pulsing circuits, VHF and UHF. Excellent opportunity for man who can meet requirements. Location Brooklyn. Send complete resume to Box 623.

PHYSICIST

Physicist for fundamental electron tube research. Should be familiar with techniques of producing photo-electric, secondary emissive and fluorescent screens, experience with electron-optics, physical optics and solid state physics an advantage. Box 624.

SALESMAN

Salesman to organize and promote sales of high quality radio resistors now being produced by a company well established in radio and electrical component industry. Give summary of experience and availability in reply. Box 625.

(Continued on page 52A)

ELECTRONICS TECHNICIANS

for

RADAR, COMMUNICATIONS, TELEVISION RECEIVERS

Needed by

RCA Service Co., Inc.

A Radio Corp. of America
Subsidiary for U.S. & Overseas

Requirements:

- Good Character
- Training in Installation or Maintenance of Radar, Communication or Television
- Give Full Details of Practical Experience

QUALIFIED CANDIDATES WILL BE
INTERVIEWED PROMPTLY

Compensation:

Up to \$7,000.00 a Year to Start. For Overseas Assignment, With Periodic Review of Base Salary Thereafter Made Up of—

- Base Salary
- Overseas Bonus
- Actual Living & Other Expenses
- Accident, Hospitalization and Life Insurance
- Vacation & Holiday Pay

Qualified technicians seeking connection with leading company having permanent program for installation and service of military equipment, AM, FM, TV transmitters and receivers, and electronic devices, such as electron microscopes, mobile and microwave communications, theatre TV, write full history to:

RCA SERVICE COMPANY, INC.

Camden 2, New Jersey

Positions available for

SENIOR ELECTRONIC ENGINEERS

with

Development & Design
Experience

in

**MICROWAVE RECEIVERS
PULSED CIRCUITS
SONAR EQUIPMENTS
MICROWAVE
COMMUNICATIONS
SYSTEMS**

Opportunity For Advancement
Limited only by Individual
Ability

Send complete Resume to:
Personnel Department

MELPAR, INC.
452 Swann Ave.
Alexandria, Virginia

ENGINEERS RESEARCH AND DEVELOPMENT

Career Positions
for

Top Engineers and Analysts

**SENIOR ELECTRONICS AND
ELECTRONICS ENGINEERS**—
B.S. or M.S. degree; 2 to 7 years
experience in radar, television, pulse,
video or display circuit design.

**DIGITAL COMPUTER DESIGN
ENGINEERS**

**AUTOMATIC TELEPHONE
SWITCHBOARD DESIGN EN-
GINEER**

**SENIOR ELECTRO-MECHANICAL
ENGINEERS**—Degree and at
least 4 years experience in servo-
mechanism analogue computers, spe-
cial weapons or system design.

For Interview
Contact Martin Representative Attending
I.R.E. West Coast Convention
September 13-15
Long Beach, California
or

Submit detailed resume to:

THE GLENN L. MARTIN COMPANY
Employment Department
Baltimore 3, Maryland



(Continued from page 51A)

ASSISTANT PROFESSOR AND INSTRUCTOR

Strong eastern college has opening for Assistant Professor and Instructor in electrical engineering. Master of Science in electrical engineering is required, and industrial experience is desirable. Send resume of qualifications, references and salary required. Box 626.

PHYSICISTS & ENGINEERS

Cornell Aeronautical Laboratory, an affiliate of Cornell University, has permanent positions open in fields of pure and applied physics for men of project engineer caliber with advanced degrees and experience in physics, applied mathematics, electronics, and mechanical instrument design. The position of our laboratory is between those of universities and commercial research institutes, and combines, we believe, many of the traditional advantages of both. Inquiries confidential; address Mr. Nathaniel Stimson, Dept. R, Cornell Aeronautical Lab. P.O. Box 235, Buffalo 21, N.Y.

ENGINEER

Well known German radio manufacturer has immediate opening for engineer with design and development experience in FM-TV equipment. Factory situated in mountainous part of Southern Germany (US Zone) with pleasant living conditions (summer and winter sports). German language desirable. Please write to Z.G. 931, ANNONCEN-EXPEDITION CARL GABLER GMBH, Munich, Germany.

ELECTRONIC PHYSICIST

Electronic Physicist for research and development work on instrumentation problems with major petroleum refiner. Degree in physics essential, M.S. or Ph.D. preferred. Must have a minimum of 5 years' research experience on a variety of electronic problems and demonstrated ability to develop new and ingenious electronic devices. Age 28-40. Location Chicago. Salary dependent upon training and experience. Reply in confidence giving full details to Box 627.



NATIONAL UNION RESEARCH DIVISION

Electrical Engineers and Physicists are needed for research on Cathode Ray, Subminiature, Secondary Emission and other types of Vacuum Tubes.

Permanent interesting positions are available in the following fields:

Tube design & development
Tube processing
High vacuum systems
Solid state physics
Electron optics
Phosphorescence

Men qualified in any of the above are invited to send their resumes to:

Divisional Personnel Manager
National Union Research Division
350 Scotland Rd., Orange, N.J.

RCA VICTOR Camden, N. J. Requires Experienced Electronics Engineers

RCA's steady growth in the field of electronics results in attractive opportunities for electrical and mechanical engineers and physicists. Experienced engineers are finding the "right position" in the wide scope of RCA's activities. Equipment is being developed for the following applications: communications and navigational equipment for the aviation industry, mobile transmitters, microwave relay links, radar systems and components, and ultra high frequency test equipment.

These requirements represent permanent expansion in RCA Victor's Engineering Division at Camden, which will provide excellent opportunities for men of high caliber with appropriate training and experience.

If you meet these specifications, and if you are looking for a career which will open wide the door to the complete expression of your talents in the fields of electronics, write, giving full details to:

Notional Recruiting Division
Box 950, RCA Victor Division
Radio Corporation of America
Camden, New Jersey

20

Years
of
**ENGINEERING
LEADERSHIP**

in the
**SPECIALTY
TRANSFORMER
FIELD**

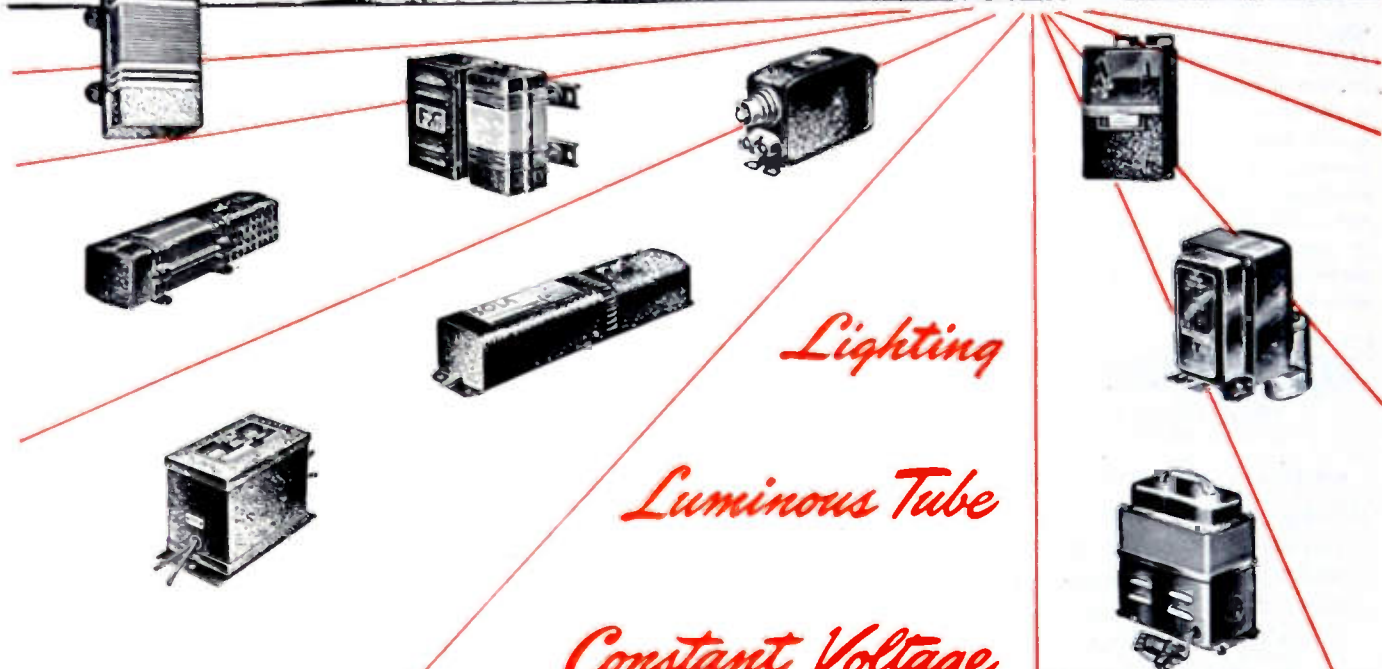

Lighting

Luminous Tube

Constant Voltage

SOLA TRANSFORMERS

Transformers for: Constant Voltage - Fluorescent Lighting - Cold Cathode Lighting - Airport Lighting - Series Lighting - Luminous Tube Sign
Oil Burner Ignition - X-Ray - Power - Controls - Signal Systems - etc. - SOLA ELECTRIC COMPANY, 4633 W. 16th Street, Chicago 30, Illinois

THE WIDE BAND POCKETSCOPE

®

BY WATERMAN



MODEL
S-14-B

Wt. 14 lbs.
12" x 6" x 7"

Another Waterman **POCKETSCOPE** confirming the obsolescence of conventional oscilloscopes. Characterized by wide band amplifier fidelity without peaking as well as amazing portability. S-14-B **POCKETSCOPE** is ideal for laboratory and field investigation of transient signals, aperiodic pulses, or recurrent electrical wave forms.

Vertical channel: 50mv rms/inch, with response within -2DB from DC to 700KC, and pulse rise of 0.35 μ s. Horizontal channel: 0.3v rms/inch with response within -2DB from DC to 200KC, and pulse rise of 1.8 μ s. Non-frequency discriminating attenuators and gain controls, with internal calibration of trace amplitude. Repetitive or trigger time base, with linearization, from 1/2cps to 50KC, with \pm sync. or trigger. Trace expansion. Filter graph screen. Mu metal shield. And a host of other features.

WATERMAN PRODUCTS CO., INC.

PHILADELPHIA 25, PA.
CABLE ADDRESS: POKETSCOPE

WATERMAN PRODUCTS INCLUDE:

| | |
|-------------------------|--------------------|
| S-10-B GENERAL | POCKETSCOPE |
| S-11-A INDUSTRIAL | POCKETSCOPE |
| S-14-A HI-GAIN | POCKETSCOPE |
| S-15-A TWIN TUBE | POCKETSCOPE |
| S-21-A LINEAR TIME BASE | |

Also **RAKSCOPES**, LINEAR
AMPLIFIERS, RAYONIC® TUBES
and other equipment



★ ★



★ ★

Positions Wanted By Armed Forces Veterans

In order to give a reasonably equal opportunity to all applicants, and to avoid overcrowding of the corresponding column, the following rules have been adopted:

The Institute publishes free of charge notices of positions wanted by I.R.E. members who are now in the Service or have received an honorable discharge. Such notices should not have more than five lines. They may be inserted only after a lapse of one month or more following a previous insertion and the maximum number of insertions is three per year. The Institute necessarily reserves the right to decline any announcement without assignment of reason.

ELECTRONIC ENGINEER

B.S.E.E. June 1950, University of Missouri. Age 26, top one-eighth of class, Eta Kappa Nu. 3 years research laboratory technician, 2 years broadcast Chief Engineer, active HAM. Interested in development, design or application. Box 430 W.

INSTRUCTOR

B.S. and M.S. in E.E. Desires teaching position in electrical engineering. Available September 1950. Member Phi Kappa Phi, Eta Kappa Nu, Tau Beta Pi. 1 year teaching experience as full time instructor. Age 24. Married. Box 442 W.

ELECTRONIC ENGINEER

B.S. in physics, June 1950, John Carroll University. Age 23. 1 year experience as Navy radio technician and 6 years radio repair part time. Desires position in development or research. Box 443 W.

JUNIOR ENGINEER

B.S.E.E. June 1950, New York University. Desires position preferably in electronics or communication fields. 3 years Army experience as aircraft mechanic with some work on radar equipment installation and maintenance. Age 29, married, one child. Box 444 W.

COMMUNICATIONS TEACHER

Assistant Professor in electrical engineering department of southern university desires similar position in east or north, teaching electronics and communications principles. B.S., M.A., M.S.E.E. (1948), University of Illinois 4 years' teaching Signal Corps schools. 8 months research on electronic timing. Age 30, married, 2 children. Eta Kappa Nu, Sigma Xi. Box 445 W.

LIAISON ENGINEER

Age 31, qualified to establish liaison group for coordinating production and design. B.S.E.E. (Night School), 3 1/2 years on development of PTM systems, 2 1/2 years electronic piece part production, 2 1/2 years systems installation and engineering, 2 years 1st class wireman and mechanic, 20 months as RTIC in Navy. Box 447 W.

(Continued on page 55A)

PROJECT ENGINEERS

Real opportunities exist for Graduate Engineers with design and development experience in any of the following: Servo-mechanisms, radar, microwave techniques, microwave antenna design, communications equipment, electron optics, pulse transformers, fractional h.p. motors.

SEND COMPLETE RESUME TO
EMPLOYMENT OFFICE.

SPERRY GYROSCOPE CO.

DIVISION OF
THE SPERRY CORP.
GREAT NECK, LONG ISLAND

RESEARCH DEVELOPMENT ENGINEERING

A progressive electronic research and development organization, contemplating expansion of personnel and facilities in an Eastern research center, is interested in contacting qualified engineering and scientific personnel experienced in electronics, physics, mechanics and administration.

Send complete resumes

to

THE APPLIED SCIENCE
CORPORATION OF PRINCETON
P.O. BOX 44 PRINCETON, N.J.

Positions Wanted

(Continued from page 54A)

ELECTRONIC ENGINEER

Electronic engineer, graduated M.I.T. 1943 with B.S. and M.S. degrees, specializing in pulse communications systems. Desires permanent position. Box 448 W.

ELECTRICAL ENGINEER

B.S.E.E. June 1950, Newark College of Engineering, top 10%. Tau Beta Pi. Navy ETM; Reserve AETM. Age 23. Single. Summer experience wiring and drafting. Well qualified for position in development of electronic equipment. Box 449 W.

JUNIOR ENGINEER

B.E.E. Cooper Union, majored in electronics, graduated June 1950. Military service work on automatic pilots, amplifiers, gyros, etc. for 1 year. Also 1 year of work on aircraft transmitters and receivers as technician. Amateur Radio Class A license for past 6 years. Desires position in electronics or electro-mechanical field. Age 24. Box 450 W.

ELECTRICAL ENGINEER

Recent graduate of leading Canadian university. B.Sc.E.E. 5 years as radar technician in Air Force. Practical electrical background. Married, veteran. Interested in production of sales. Location secondary. Available immediately. Box 451 W.

ENGINEER

B.S.E.E. June 1950. New Mexico A. & M., communications major. 3 years experience Air Force radio and radar mechanic. Age 34, married, 1 child. Speak, understand and write Spanish. Would accept job in Latin America. Box 458 W.

COMMUNICATIONS ENGINEER

B.S.E.E. University of Michigan, February 1950. Age 25, married, 2 children. 3 years Navy aircraft radio operator and maintenance. Desires communications, electronics, or sales work anywhere in U.S. Box 459 W.

STATISTICAL QUALITY CONTROL ENGINEER

B.S.E.E. MIT, plus statistical quality control, mathematics statistics, methods, accounting and time study at Columbia. Experience: 4 years industrial field coordination engineer; 4 years inspection administration, Lt. Commander. Desires position as liaison with production, inspection, engineering and sales for quality div. Member ASQC. Box 460 W.

ENGINEER

M.S.E.E., MIT, Tau Beta Pi, Sigma Xi. Age 29. 2 years experience in radar while in service. 3 years experience in microwave measurements and developments. Desires electrical engineering teaching position in midwest. Box 461 W.

SALES OR APPLICATION ENGINEER (JR.)

B.E.E. June 1950, Pratt Institute; age 24; married. Former AETM 3/c, radio and radar service in U. S. Navy. Interested in sales or application. Hard, willing worker. Any location in U.S. or Alaska. Resume. Box 462 W.

(Continued on page 56A)

New Type 2A TAP SWITCHES

HAVE A CONSTANT CONTACT RESISTANCE OF
ONLY 1 or 2 MILLIOHMS!

These high quality switches with up to 24 contacts were specifically developed to meet the need for rugged precision instrument switches that have longer operating life and are economical components in competitively priced electronic instruments and military equipment.

Write for Technical Bulletin No. 28.

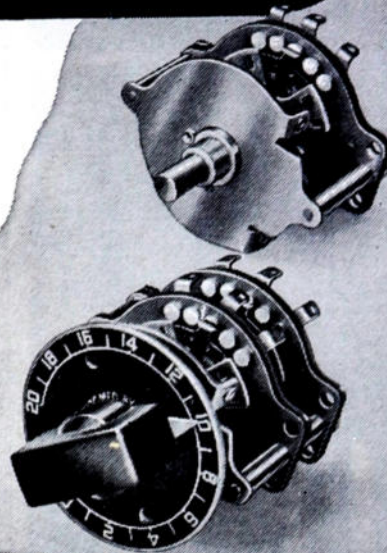

TECH LABORATORIES PALISADES PARK
NEW JERSEY

Pioneer in Radio Engineering Instruction Since 1927

CAPITOL RADIO ENGINEERING INSTITUTE

An Accredited Technical Institute

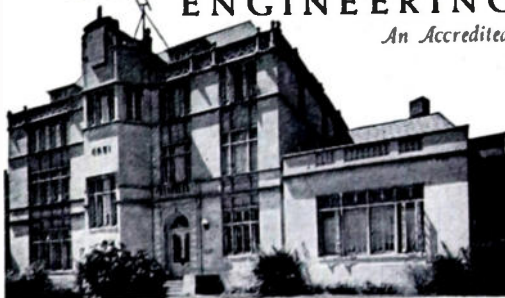

ADVANCED HOME STUDY AND RESIDENCE COURSES IN PRACTICAL RADIO-ELECTRONICS AND TELEVISION ENGINEERING
Request your free home study or resident school catalog by writing to:

DEPT. 269B
16th and PARK ROAD, N.W.,
WASHINGTON 10, D.C.
Approved for Veteran Training

Engineers— Physicists

SENIORS

- What do you want in a position?
- What are your aims and ambitions?

The W. L. Maxson Corporation offers special opportunities if you are heavily experienced in research and development on radar, computers and associated equipment.

Please address your job requirements and résumé to A. Hoffsommer for individual attention.

THE W. L. MAXSON CORPORATION
460 W. 34th Street
New York 1, N.Y.

PEAK Attenuation Efficiency

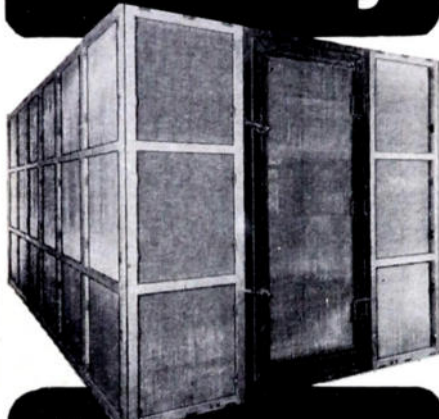

ACE Custom-Built
SCREEN ROOMS

COVER THE ENTIRE RADIO FREQUENCY SPECTRUM

Tests and evaluations of present-day electronic equipment call for reducing the area background level of radio interference to a far greater extent than is possible with any ordinary screen room or shielded enclosure. Specialists in this exacting field since the early days of World War II, ACE offers both the know how and the production facilities. Attenuations of 140db.—and higher—at frequencies as low as 0.15 and as high as 10,000 mc. are readily obtainable in our custom-built rooms. Put your screening problem up to ACE. Write, wire or 'phone for details.

STANDARD "CELL TYPE" SCREEN ROOMS

Nine out of ten laboratory or production shielding problems can be solved fast and economically by ACE pre-built "cell-type" screen rooms. Minimum attenuations as high as 100 db. are obtained from 0.15 to 1000 mc. Easy to erect, enlarge or move. Fully proved. Low in price. Write for data bulletin.

**ACE ENGINEERING
& MACHINE CO., Inc.**

3644 N. Lawrence Street

PHILADELPHIA 40, PA.

REgent 9-1019

Positions Wanted

(Continued from page 55A)

ELECTRONIC ENGINEER

B.E.E. June 1950, upper fifth, Syracuse University. Married, 1 child. Experience in radio, radar and antenna research. Interested in television, electronics, radio communication. Location anywhere in U. S. Box 467 W.

JUNIOR ENGINEER OR LABORATORY TECHNICIAN

Speciality precision instruments. 5 years experience on development of photoelectric instruments, electrocardiographs, timers, pulse transmitters and control systems. 3 years engineering college at Pratt Institute and New York University. Desires position in design or development work. Box 468 W.

COMMUNICATIONS ENGINEER

7 years experience in communications and VHF control systems in CAA and Army. 2 years at supervisory level. Graduate C.R.E.I. Married. Age 26. Interested in VHF-UHF design or development. Location immaterial. Available Sept. 15. Box 469 W.

ENGINEER

B.A. New York University, physics and psychology majors; graduate RCA Institute; age 33; 6 years broadcast engineering, 4 years teaching physics, both with administrative responsibilities. Seeks position in engineering administration, New York City location to permit continuing graduate study. Available Oct. 1. Box 470 W.

ELECTRONICS ENGINEER

B.S. Applied Physics. Graduated U.C.L.A. August 1950. 3 years as Army electronic technician. Desires position in industrial electronics with good future. Prefer west coast. Married. Age 26. Box 471 W.

ELECTRICAL ENGINEER

B.S.E.E. June 1950, Polytechnic Institute of Brooklyn. Age 26, single. F.C.C. radio phone license. 3 years electronic experience including design, construction and testing; 6 months radio repairman in Air Corps. Interested in sales, service, development or broadcast engineering. Resume on request. Box 472 W.

JUNIOR ELECTRONIC ENGINEER

B.S.E.E. June 1950, New York University. Age 23, single. 14 months Army. Attended Signal Corps school. 5 years radio and some television set repair part time. Desires communication or electronic work anywhere in U. S. Box 473 W.

ENGINEER

B.E.E.; M.E.E. August 1950, Syracuse University. Age 23, single. Communications major. 1 year Navy electronics technician, 1 year laboratory instructor. Tau Beta Pi, Pi Mu Epsilon, Sigma Pi Sigma. Desires communications work. Salary and location secondary. Box 474 W.

PHYSICISTS AND SENIOR RESEARCH ENGINEERS

POSITIONS NOW OPEN

Senior Engineers and Physicists having outstanding academic background and experience in the fields of:

- Microwave Techniques
- Moving Target Indication
- Servomechanisms
- Applied Physics
- Gyroscopic Equipment
- Optical Equipment
- Computers
- Pulse Techniques
- Radar
- Fire Control
- Circuit Analysis
- Autopilot Design
- Applied Mathematics
- Electronic Subminiaturization
- Instrument Design
- Automatic Production Equipment
- Test Equipment
- Electronic Design
- Flight Test Instrumentation

are offered excellent working conditions and opportunities for advancement in our Aerophysics Laboratory. Salaries are commensurate with ability, experience and background. Send information as to age, education, experience and work preference to:

NORTH AMERICAN AVIATION, INC.

Aerophysics Laboratory
Box No. N-4, 12214 South Lakewood Blvd.
Downey, California

News—New Products

These manufacturers have invited PROCEEDINGS readers to write for literature and further technical information. Please mention your I.R.E. affiliation.

(Continued from page 48A)

Recent Catalogs

• • • A fifteen-page folder in color describing the services and products of **Hermetic Seal Products Co.**, 29-37 S. Sixth St., Newark 7, N. J. They offer multiple headers—terminals in all shapes.

• • • 1950 Catalog 20-A, which describes all the instruments which **Hewlett-Packard Co.**, 395 Page Mill Rd., Palo Alto, Calif., regularly manufactures. Sales, service, and prices are quoted in the booklet.

• • • 1950 Catalog K, with a complete line of industrial, laboratory, and prospecting nuclear measurement equipment, is available on request from **Nuclear Instrument & Chemical Corp.**, 223 W. Erie St., Chicago 10, Ill.

• • • A new edition, the seventh, of the **Stancor** television catalog and replacement guide, Form 338, is available from **Standard Transformer Corp.**, 3580 Elston Ave., Chicago 18, Ill.

(Continued on page 59A)

HERE'S USEFUL AND
IMPORTANT INFORMATION
FOR You!

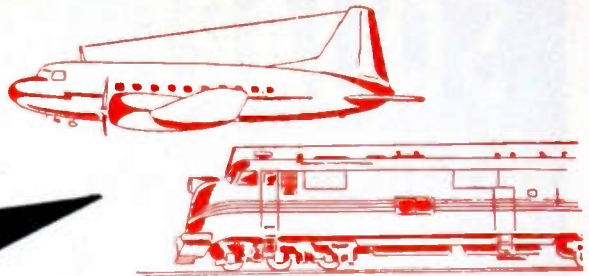

| Type | Description | Typical Service | Prototype | Construction | Heater | | Plate | | Grid | Screen | | Amp. Factor | Mut. Cond. |
|----------|------------------------|--------------------------------|-----------|-----------------|--------|-------|--------------------------------|------|------------------------|--------|-----|-------------|----------------------------|
| | | | | | Volts | Amps. | Volts | Ma. | Volts | Volts | Ma. | | |
| 2C50 | Dual Power Triode | Aircraft Control Equip. | — | Bantol | 12.6 | 0.3 | 300 | 12.5 | -24 | — | — | 9.5 | 1750 |
| 2C52 | Dual Amplifier Triode | Aircraft Control Equip. | — | Bantol | 12.6 | 0.3 | 250 | 1.3 | -2 | — | — | 90 | 1900 |
| 6AK5W | Pentode RF Amplifier | Military Ruggedized | 6AK5 | 7 pin miniature | 6.3 | 0.175 | 120 | 7.5 | Rk 200 | 120 | 2.5 | — | 5000 |
| 6AL5W | Dual Diode | Military Ruggedized | 6AL5 | 7 pin miniature | 6.3 | 0.3 | Max. Peak Inv. 330 Volts Max. | | to 9 ma. dc. per plate | | | | |
| 6A56W | Pentode RF Mixer | Military Ruggedized | 6A56 | 7 pin miniature | 6.3 | 0.175 | 120 | 5.2 | -2 | — | — | — | 3200 |
| 6C4W† | RF Power Triode | Military Ruggedized | 6C4 | 7 pin miniature | 6.3 | 0.15 | 250 | 10.5 | -8.5 | — | — | 17 | 2200 |
| 6J5WGT | General Purpose Triode | Military Ruggedized | 6J5GT | Bantol | 6.3 | 0.3 | 250 | 9 | -8 | — | — | 20 | 2600 |
| 6J6W† | Dual AF-RF Triode | Military Ruggedized | 6J6 | 7 pin miniature | 6.3 | 0.45 | 100 | 8.5 | Rk 50 | — | — | 38 | 5300 |
| 6SA7WGT† | Pentagrid Converter | Military Ruggedized | 6SA7GT | Bantol | 6.3 | 0.3 | 250 | 3.5 | Rg 20000 | 100 | 8.5 | — | 450 Conv. Cond. 1650 |
| 6SJ7WGT† | Pentode RF Amplifier | Military Ruggedized | 6SJ7GT | Bantol | 6.3 | 0.3 | 250 | 3.0 | -3 | 100 | 0.8 | — | 2600 |
| 6SN7WGT | Dual Triode | Military Ruggedized | 6SN7GT | Bantol | 6.3 | 0.6 | 250 | 9.0 | -8 | — | — | 20 | 2600 |
| 6X4W | Fullwave Rectifier | Military Ruggedized | 6X4 | 7 pin miniature | 6.3 | 0.6 | Max. Peak Inv. 1250 Volts Max. | | to 70 ma. dc. | | | | |
| 12J5WGT | General Purpose Triode | Military Ruggedized | 12J5GT | Bantol | 12.6 | 0.15 | 250 | 9 | -8 | — | — | 20 | 2600 |
| CK5654 | Pentode RF Amplifier | Commercial Aircraft Ruggedized | 6AK5W | 7 pin miniature | 6.3 | 0.175 | 120 | 7.5 | Rk 200 | 120 | 2.5 | — | 5000 |
| CK5670 | Dual Triode | Commercial Aircraft Ruggedized | 2C51 | 9 pin miniature | 6.3 | 0.35 | 150 | 8.2 | Rk 240 per sect | — | — | 35 | 5500 |
| CK5686 | AF-RF Output Pentode | Commercial Aircraft Ruggedized | — | 9 pin miniature | 6.3 | 0.35 | 250 | 27 | -12.5 | 250 | 5 | — | 3300* |
| CK5694 | Dual Power Triode | Industrial AF Amplifier | 6N7G | Standard glass | 6.3 | 0.8 | 294 | 7 | -6 | — | — | 35 | 3200 |
| CK5725 | Pentode RF Mixer | Commercial Aircraft Ruggedized | 6A56W | 7 pin miniature | 6.3 | 0.175 | 120 | 5.2 | -2 | 120 | 3.5 | — | 3200 |
| CK5726 | Dual Diode | Commercial Aircraft Ruggedized | 6AL5W | 7 pin miniature | 6.3 | 0.3 | Max. Peak Inv. 330 Volts Max. | | to 9 ma. dc. per plate | | | | |
| CK5749† | Pentode RF Amplifier | Commercial Aircraft Ruggedized | 6BA6 | 7 pin miniature | 6.3 | 0.3 | 250 | 11.0 | Rk 68 | 100 | 4.2 | — | 4400 |
| CK5750† | Pentagrid Converter | Commercial Aircraft Ruggedized | 6BE6 | 7 pin miniature | 6.3 | 0.3 | 250 | 2.6 | 1.5 | 100 | 7.5 | — | 475 Conv. Cond. 1200 |
| CK5751† | Dual High Mu Triode | Commercial Aircraft Ruggedized | — | 9 pin miniature | 6.3‡ | 0.35 | 250 | 1.1 | -3 | — | — | 70 | 1200 |
| CK5814† | Dual Medium Mu Triode | Commercial Aircraft Ruggedized | — | 9 pin miniature | 6.3‡ | 0.35 | 250 | 10.5 | -8.5 | — | — | 17 | 2200 |

† Sample quantities available late in 1950

* 2.7 watts Class A output, 10 watts Class C input power to 160 mc.

‡ Series heater rating 12.6 volts, 0.175 amps.

Note: All dual section tube ratings are for each section.

RAYTHEON Makes All These Tough Service Tubes
— and tens of thousands of them are daily
demonstrating their superior reliability and
stamina in commercial aircraft, industrial
and military service.

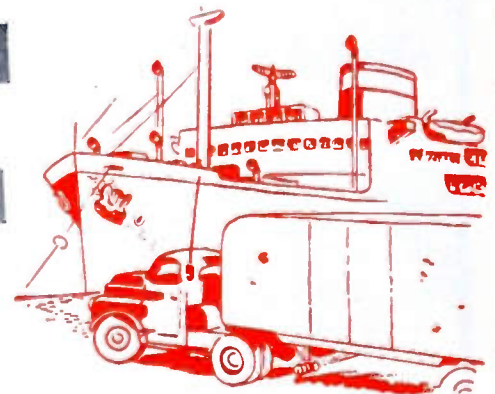

These Raytheon tubes are engineered and manufactured specifically for critical services where a single tube failure may lead to serious loss of life or dollars. We are interested in developing additional types for your tough service applications.

Over 300 Raytheon Special Purpose Tube distributors are ready to serve you on the above types. Application information on these tubes is available at Newton, Chicago and Los Angeles.

RAYTHEON

Excellence in Electronics

RAYTHEON MANUFACTURING COMPANY

SPECIAL TUBE SECTION - Newton 38, Massachusetts

SUBMINIATURE TUBES-SPECIAL PURPOSE TUBES-MICROWAVE TUBES-CATHODE RAY TUBES-RECEIVING TUBES

SQUARE WAVES

PRECISION GENERATORS by TEKTRONIX

Leading manufacturers now recognize that frequency and transient response measurements are most easily made by square wave testing techniques. This method is widely used on production line testing and adjusting of wideband amplifier, filter and attenuator circuits.

LABORATORY UTILITY

- **FREQUENCY RANGE:**
25 cps—1 mc, continuously variable.
- **FREQUENCY METER:**
Direct reading, accurate to 3% of full scale.
- **RISE TIME:**
.02 μ sec. for 93 ohm load.
- **OUTPUT AMPLITUDE:**
15v across 93 ohm external load.
160 ma maximum available for external load.
- **SYNC INPUT AND OUTPUT CONNECTIONS.**
- **WEIGHT: 35 lbs.**



TYPE 105
SQUARE WAVE GENERATOR \$395.00

ASSEMBLY LINE EFFICIENCY

- **FOUR FIXED FREQUENCIES:**
LF—50 cps, 1 kc.
HF—100 kc, 1 mc.
- **RISE TIME:**
LF—3 μ sec.
HF—.02 μ sec.
- **OUTPUT AMPLITUDE:**
LF—0 to 50v, continuously variable
in 9 ranges. Accuracy 2%
of full scale. Useful as a volt-
age calibrator.
HF—0 to 5v.
- **WEIGHT: 21 lbs.**

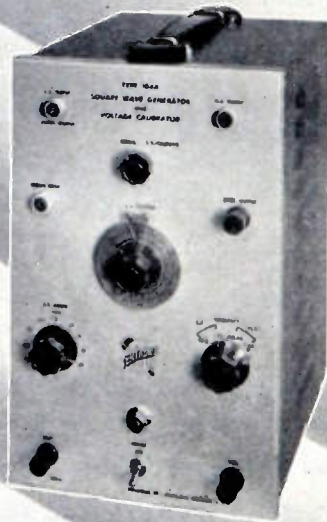

TYPE 104A
SQUARE WAVE GENERATOR
\$195.00

Prices f.o.b. Portland, Oregon.

Both of these instruments feature coaxial outputs, fully regulated DC power supplies, electrically welded aluminum alloy construction and many other characteristics by which Tektronix has become known and accepted throughout the world.



TEKTRONIX, INC.

712 S.E. Hawthorne Blvd. Portland 14, Ore.

New Miniature Insulated Terminals

to help your
miniaturization program

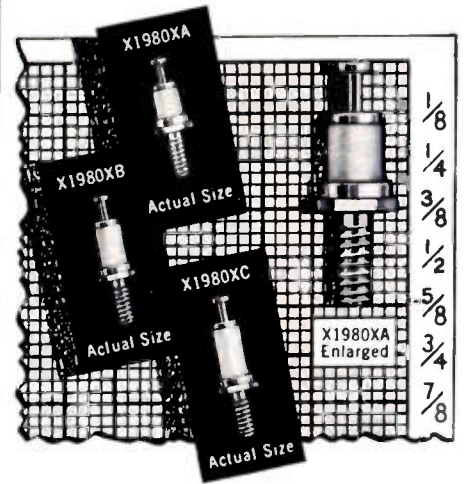

Featuring extremely small size combined with excellent dielectric properties, three new miniature insulated terminals are now available from CTC.

Designed to meet the requirements of the miniaturization programs now being carried out by manufacturers of electrical and electronic equipment, the terminals come in three lengths of dielectric and with voltage breakdown ratings up to 5800 volts. In addition, they have an extremely low capacitance to ground.

The X1980XA is the smallest terminal, having an over-all height of only three-eighths of an inch including lug. Insulators are grade L-5 ceramic, silicone impregnated for maximum resistance to moisture and fungi.

All terminals have hex-type mounting studs with 3/48 thread or .141" OD rivet style mounting. Mounting studs are cadmium plated, terminals are of bright-alloy plated brass.

Write for additional data.

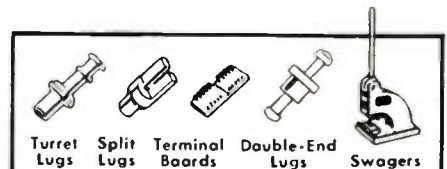

custom or standard the
guaranteed components

CAMBRIDGE THERMIONIC CORP.
456 Concord Ave., Cambridge 38, Mass.
West Coast Stock Maintained By: E. V. Roberts,
5014 Venice Blvd., Los Angeles, California

News—New Products

These manufacturers have invited PROCEEDINGS readers to write for literature and further technical information. Please mention your I.R.E. affiliation.

(Continued from page 56A)

•••Cleveland Electronics, Inc., 6622 Euclid Ave., Cleveland 3, Ohio, is offering a radio and TV replacement speaker catalog, #127M. Also featured are the new Cletron weather proof speakers and TV lightning arrestors. Write to Bill Allen at Cleveland.

Liquid Nuclear Set

To simplify laboratory work with solutions containing radioactive materials, Nuclear Instrument and Chemical Corp., 229 W. Erie St., Chicago 10, Ill., announces the availability of a special set of equipment which speeds up such counting work.

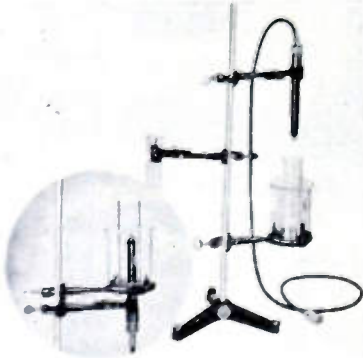

In addition to standard laboratory pieces, such as ring stand and necessary clamps, the set also includes a special Marinelli-type beaker and a support on which the beaker can be mounted. A plug-in type counter is provided with the set over which the Marinelli beaker can be placed.

As part of this set, a test tube of correct size is also provided so that the Geiger tube may be used as a dip counter. For beta counting the test tube is filled with 20 cc of the active liquid which then covers the sensitive area of the counter.

This counter is all glass and is easily decontaminated. The Marinelli beaker may be used only for gamma counting, since a heavy glass wall is interposed between the liquid and the counter. The advantage of this method is that the counter is not contaminated in any way and, therefore, many solutions may be checked without the necessity for cleaning the counter each time.

New Servo Amplifier

A new servo amplifier just developed by the Transcoil Corp., 107 Grand St., New York 13, N. Y., enables servo design-

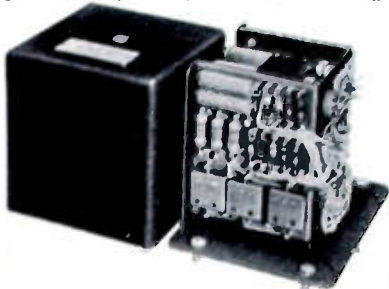

ers to have a complete servo loop, meeting the requirements of the system under

(Continued on page 60A)

Airtron

DESIGNS AND PRODUCES

Flexible and Rigid

WAVEGUIDE

COMPONENTS

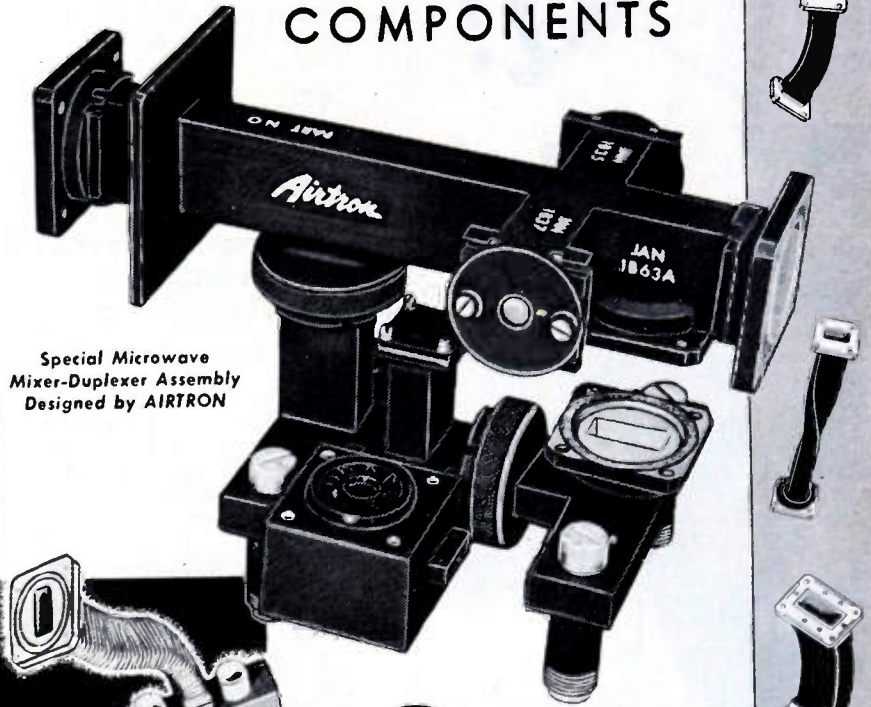

Special Microwave Mixer-Duplexer Assembly
Designed by AIRTRON

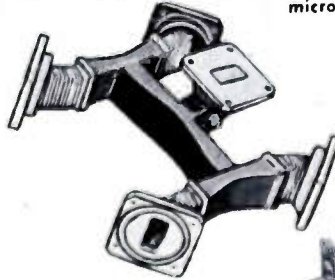

From the smallest waveguide component to complete transmission systems... from the first "doodle" memo or blueprint to the finished precision product... make AIRTRON your FIRST source for all types of microwave plumbing. Unique in background, technical savvy, plant facilities and the WILL to SERVE, this organization is prepared to engineer and manufacture your staple or special requirements in:

- Mixers
- Duplexer Assemblies
- Magic Tees
- Waveguide Switches
- Elbow Bends
- Elbow Miters
- Twisted Sections
- Rigid Twists
- Choke Fittings
- Flexible Waveguides
- Straight Section
- Rotary Joints

Send for AIRTRON
Engineering Data on
Microwave Plumbing



Airtron

INC.

105 East Elizabeth Ave., Linden, New Jersey

BRANCH OFFICES

Baltimore Los Angeles New York
Boston St. Louis Dallas Dayton

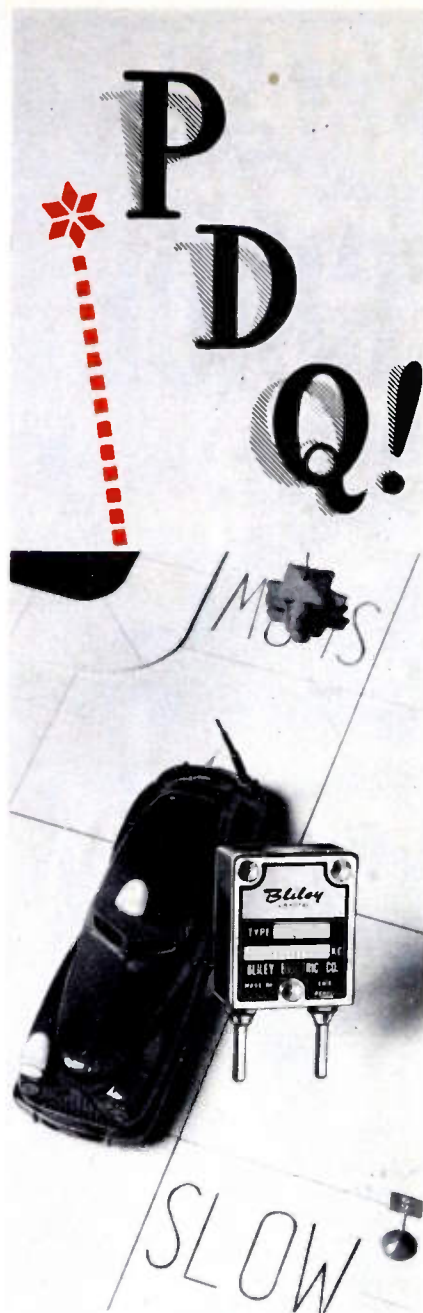

Shown:
Bliley type MC-7

POLICE SERVICES DEMAND QUALITY!

Yes, all mobile services demand dependable crystal performance. Bliley engineering skill plus craftsmanship throughout production is quality. Your frequency control will be better with Bliley, the top choice for 20 years.

Bliley
CRYSTALS

BLILEY ELECTRIC COMPANY
UNION STATION BUILDING
ERIE, PENNSYLVANIA

News—New Products

These manufacturers have invited PROCEEDINGS readers to write for literature and further technical information. Please mention your I.R.E. affiliation.
(Continued from page 59A)

study, in only a fraction of the time previously necessary to build these circuits.

Developed to form a complete package with Transicoil control motors, gear trains, and motor generators, the new servo amplifier is designed to drive a control motor wound for plate-to-plate operation. As such, it operates with a wide variety of ac transmission elements such as autosyns and both resistive and inductive potentiometers. In carrier frequency loops, the amplifier provides all the circuitry needed in the error signal path.

Types available include a laboratory model, and one for production, both made to meet the requirements of the application. A four-page folder providing details is available upon request.

Weatherproof Driver Unit Features Line-Matching Transformer

Specifically designed as an all-purpose driver unit for speech and music, the new Model PM-708TR, just released by Racon Electric Co., Inc., 52 E. 19 St., New York 3, N. Y., features a built-in 25-watt vacuum impregnated line matching transformer. Available impedances: 15, 500, 1,000, 1,500, 2,000 ohms.



In the manufacture of this driver unit only Alnico V magnets and Arnico magnetic iron are used. To prevent corrosion, all soft steel parts are doubly plated. An automatic electromagnetic switch employed in the magnetizing process insures maximum flux density in the gap and a high degree of uniformity.

The voice coil is wound with aluminum wire for greatest efficiency and coil terminals are welded instead of soldered. The voice coil lead is a strip of fatigue-resistant beryllium copper to withstand abnormal diaphragm excursion. The voice coil suspension is made of bakelized linen firmly cemented to the phenolic diaphragm with a thermo-setting plastic. Induction heating bakes the diaphragm voice coil suspension and voice coil into an unbreakable bond.

(Continued on page 62A)

PRECISION ELECTRONIC SYSTEMS

SENSING

RADIO DIRECTION FINDING

INSTRUMENTS

SERVOSCOPE

SERVOBOARD

CONTROL

THERMISTOR BOLOMETERS
PRE-AMPLIFIERS
POWER SUPPLIES
SELECTIVE AMPLIFIERS

Write today for complete information

SERVO

CORPORATION OF AMERICA

NEW HYDE PARK, N. Y.

You can use a battering ram to make it fit...



BUT it's simpler to design the radio around the battery!

Regardless of what size portable radio you are designing, you'll find compact, long-lasting "Eveready" batteries to fit it. "Eveready" brand batteries give longer playing life. They are the accepted standard for portable radios. Users can get replacements everywhere — they *prefer* portables that use "Eveready" batteries.

CONSULT OUR BATTERY ENGINEERING DEPARTMENT
FOR COMPLETE DATA ON "EVEREADY" BATTERIES

"Eveready", "Mini-Max", "Nine Lives"
and the Cat Symbol are trade-marks of

NATIONAL CARBON DIVISION
UNION CARBIDE AND CARBON CORPORATION
30 East 42nd Street, New York 17, N.Y.

EVEREADY
TRADE-MARK
RADIO BATTERIES



● The No. 753 "Eveready" "A-B" battery pack provides plenty of power for compact "pickup" portables. For smaller portables, we recommend "Eveready" No. 950 "A" batteries and the No. 467 "B" battery.

District Sales Offices: Atlanta, Chicago, Dallas, Kansas City, New York, Pittsburgh, San Francisco

Specify CP TEF-LINE SUPER TRANSMISSION LINE

A new transmission line based upon a new plastic—TEFLON

CP TEF-LINE transmission line, utilizing DuPont Teflon insulators, greatly reduces high frequency power losses. Furthermore, operation of transmission line at frequencies heretofore impossible owing to excessive power loss now becomes easily possible. For TV, FM and other services utilizing increasingly high frequencies, TEF-LINE by CP is a timely and valuable development worthy of investigation by every user of transmission line.

ONE-PIECE INNER CONDUCTOR

Seal-O-Flange Tef-Line is made of a single piece of copper tubing. Teflon disks are distributed to provide positive, permanent positioning.

COPPER INNER CONDUCTOR OF A TEF-LINE SEAL-O-FLANGE TRANSMISSION LINE SHOWING A ONE-PIECE TEFLON INSULATING DISK FITTING INTO DEPRESSION FORMED IN THE TUBE WALL.

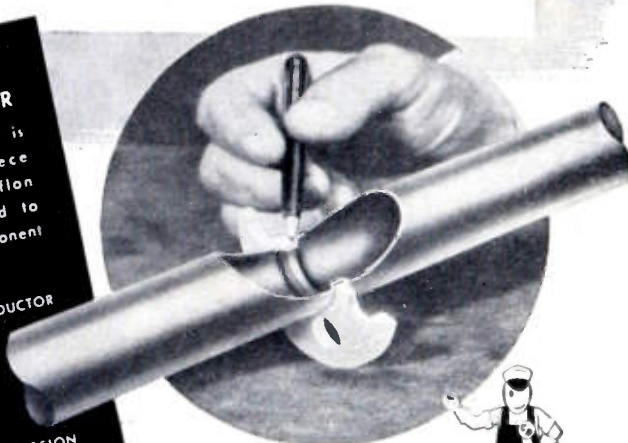

CP SUPER TEF-LINE IS AVAILABLE NOW!

Tef-Line can be delivered immediately in three standard sizes— $\frac{7}{8}$ ", $1\frac{1}{8}$ " and $3\frac{1}{8}$ ". With the exception of elbows and gas stops, the new Seal-O-Flange Super Transmission Line is interchangeable with all other CP fittings including end seals, tower hardware, flanges, "O" rings, inner conductor connectors and miscellaneous accessories.

Check your transmission line requirements with the new CP TEF-LINE BULLETIN which is available on request. If you need help in planning installations, our engineers will be happy to talk over specific problems at your convenience.

- TOWER HARDWARE
- AUTO-DRY-AIRE DEHYDRATORS
- LO-LOSS SWITCHES
- COAXIAL DIPOLE ANTENNAS
- SEAL-O-FLANGE TRANSMISSION LINE

Communication Products Company, Inc.

KEYPORT  NEW JERSEY

News—New Products

These manufacturers have invited PROCEEDINGS readers to write for literature and further technical information. Please mention your I.R.E. affiliation.

(Continued from page 60A)

Subminiature Relays

Potter & Brumfield, Princeton, Ind., now offer their subminiature telephone type series MT relays, fitted with from one to four model 1SM1 microswitches. This gives an assembly $1\frac{1}{8}$ inches \times $1\frac{1}{4}$ inches \times $\frac{1}{8}$ inch with contacts up to 4 form C (4PDT) rated at 5 amperes, 115 v 60 cps resistive load, or 3 amperes at 24 v



dc. Maximum inrush 12 amperes for $\frac{1}{2}$ second. This relay is said to withstand better than 50 G. vibration.

(Continued on page 63A)

NOW!

SPEED UP ALL SOLDERING WITH

UNGAR

FEATHER-LIGHT SOLDERING PENCILS WITH

HI-HEAT TIPS

INCREASED WATTAGE



For use with No. 776 Handle & Cord Set

Stop wrestling with big irons. New HI-HEAT TIPS in your Ungar Electric Soldering Pencil produce a really versatile tool that'll perform on a par with the big, bulky 100-150 watt irons. If you can't get immediate delivery, please be patient, for production hasn't yet caught up with demand. Ask your supplier for No. 1236 Pyramid or No. 1239 Chisel. List price, \$1.25 each.

Ungar

ELECTRIC TOOL CO., Inc.
LOS ANGELES 54, CALIFORNIA

News—New Products

These manufacturers have invited PROCEEDINGS readers to write for literature and further technical information. Please mention your I.R.E. affiliation.

(Continued from page 62A)

The ISM1 microswitch is molded bakelite enclosed, thus protecting the contacts and springs from most environment conditions. Extremely compact size and high vibration resistance make this assembly particularly applicable to rocket, missile and aircraft installations. The relay may be used unshoused or hermetically sealed in the model "M" deep drawn steel can 1 inch \times 1 $\frac{1}{8}$ inches \times 2 $\frac{3}{8}$ inches high. The hermetically sealed assembly can be fitted with either plug-in or solder terminals, with high dielectric glass insulation. Actuating coils for either ac or dc are available.

The microswitches are so mounted that the differential lever action of the armature permits lower coil power and fast positive operation.

(Continued on page 66A)

We will be grateful if you will mention PROCEEDINGS of the I.R.E. when writing to our advertisers.

Centralab

Division of GLOBE-UNION INC.
Milwaukee

The
First Name
in
Ceramic
Electronic
Components

TIC

INSTRUMENTS THAT BELONG IN *Your* LABORATORY

TIC Type 310-A Z-Angle Meter — 30 to 20,000 c.p.s.

Measures impedance directly in polar coordinates as an impedance magnitude in ohms and phase angle in degrees $Z \pm \theta$. Measures, with equal ease, pure resistance, inductance, capacitance or complex impedances comprised of most any RLC combinations. Range: Impedance (Z), 0.5 to 100,000 ohms; Phase Angle (θ), $+90^\circ$ (X_L) through 0° (R) to -90° (X_C). Accuracy: Within $\pm 1\%$ for impedance and $\pm 2^\circ$ for phase angle. Price: \$425.00.

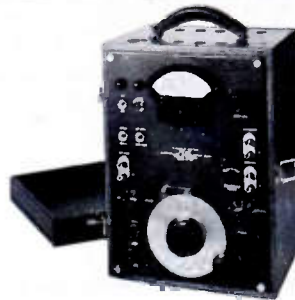

TIC Type 311-A R-F Z-Angle Meter for radio frequencies — 100 kc to 2 mc.

Simplifies laboratory and field impedance and phase angle measurements. Ideal for checking impedance of coils, transformers, coupling networks, lines, filters, antennas, etc. Direct-reading Impedance Range: 10 to 5,000 ohms up to 200 kc, and 10 to 1,000 ohms at 1 mc. Phase Angle: $+90^\circ$ (X_L) through 0° (R) to -90° (X_C). Accuracy: Impedance to within $\pm 3\%$, and phase angle $\pm 4^\circ$. Price: \$350.00.

TIC Type 410-A R-F Oscillator — 100 kc to 10 mc. (Special models 46.5 kc to 4.65 mc available.)

Power oscillator for use as bridge driver and general laboratory measurements. Features: High stability, high output (approximate 30 volts), 50-60 Ω output impedance, expanded frequency scale, direct reading output voltmeter, compact design. Price: \$350.00.



TIC Type 320-A Phase Meter — frequency range 20 cycles to 100 kc.

The first commercially available all-electronic instrument that directly measures the phase angle between two voltages in a simple operation. Ideally suited to applications in such fields as audio facilities, ultrasonics, servomechanisms, geophysics, vibrations, acoustics and many others.

Phase angle readings made directly without balancing . . . stable at frequencies as low as 2 to 3 cycles. Voltage range: 1 to 170 peak volts. Terminals for recorder . . . choice of relay-rack or cabinet mounting. Price \$475.00. Cabinet \$20.00.

TIC Type 110 Slide-Wire Resistance Box

Convenient combination consisting of precision decade resistor and continuously adjustable slide-wire which provides smooth, continuous variation of resistance between decade steps (permits adjustment of resistance to one part in 10,000). For most applications, eliminates need for more elaborate multi-dial decade boxes. Ideal for student and general laboratory use. Decade resistance cards adjusted to within $\pm 0.1\%$ of nominal values, and slide-wire resistors direct-reading to within 1% of their maximum values. Cast aluminum cabinet. All resistance elements completely enclosed. Suitable for use at audio and ultrasonic frequencies. Type 110-A, range 0-11,000 ohms: \$42.50. Type 110-B, range 0-110,000 ohms: \$45.00.

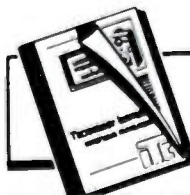

Technical catalog—yours for the asking. Contains detailed information on all TIC Instruments, Potentiometers and other equipment. Get your copy without obligation—write today.

TIC TECHNOLOGY INSTRUMENT CORP.

1058 Main Street, Waltham 54, Massachusetts

Engineering Representatives Cleveland, Ohio PProspect 6171
Chicago, Ill.-Uptown 8-1141 Boonton, N.J.-Boonton 8-3097 Rochester, N.Y.-Genesee 3547M
Cambridge, Mass.-ELiot 4-1751 Canaan, Conn.-Canaan 649 Hollywood, Cal.-Hollywood 9-6305
Manhasset, N.Y.-Manhasset 7-3424 Dayton, Ohio-Michigan 8721

MICROWAVE TEST EQUIPMENT

PULSE EQUIPMENT

- G.E.K.—2745\$39.50
- G.E.K.—2744-A, 11.5 KV High Voltage, 3.2 KV Low Voltage @ 200 KW oper. (270 KW max.) 1 microsec. or 1/4 microsec. @ 600 PPH\$39.50
- W.E. #D186173 111-Volt input transformer, W.E. Impedance ratio 50 ohms to 900 ohms. Freq. range: 10 kc to 2 mc. 2 sections parallel connected, potted in oil\$36.00
- W.E. KN 9800 input transformer. Winding ratio between terminals 3-5 and 1-2 is 1:1.1, and between terminals 6-7 and 1-2 is 2:1. Frequency range: 380-520 c.p.s. Permalloy core\$6.00
- G.E. K2450A, Will receive 13 KV, 4 micro-second pulse on pri., secondary delivers 14KV. Peak power out 100KW Q.E.\$34.50
- TR10 Modulator X Band\$350.00
- 80-4 Radio Thyatron\$420.00
- 8CH-268 Keyer Units\$95.00
- 151B Tubes\$12.00
- 705A Tubes\$2.80
- 705 Sockets\$1.70

Complete line of high voltage pulse transformers, networks and dual lines.

ARMY-NAVY TEST SETS

- TS-226A/AP Power Meter.
- TS62/AP 3 centimeter precision echo box.
- TS36/AP 3 centimeter Thermistor Bridge—Power Meter.
- TS89/AP Voltage divider.
- TS268/U Crystal checker for IN23 type crystals etc.
- CW-60ABM 10 Centimeter Wavemeter. Coaxial type micrometer adjust cavity, Resonance Indicating meter, carrying case (similar to TS117/GP)
- TS235/UP High Power Load, "L" band (1000 mcs.)
- LU-1 Freq. Meter and Test OSC. Type CRV-00ACL

23,000 TO 27,000 MC. BENCH TEST PLUMBING 1/2" x 1/4" WAVEGUIDE

- PRECISION SLOTTED LINE, DeMornay Budd type 337, complete with adjustable probe and crystal output, Square flanges.\$400.00
- PRECISION SLOTTED LINE, Adjustable probe. Humble Oil type, CPK-211H\$200.00
- DIRECTIONAL COUPLER-WAVEMETER MOUNT, 12DB\$60.00
- PRECISION VARIABLE ATTENUATOR, mfg. Bernard Rice\$90.00
- TUNABLE CRYSTAL MOUNT, DB423 less tuning plunger\$30.00
- FLAP ATTENUATOR, DB405 10DB attenuation\$26.00
- LOW POWER LOAD\$20.00
- SCRIBW TUNER\$25.00
- SHUNT TEE\$35.00
- WAVEGUIDE LENGTHS, 2" to 6" long, gold-plated with circular flanges and coupling nuts\$2.25 per inch
- AP-34 Rotating Joint\$49.50
- Right Angle Bend E or H Plane, specify combination of couplings desired\$12.00

- 45° Bend E or H Plane, Choke to cover\$12.00
- Directional coupler CU-103/APB32\$49.50
- Mitered Elbow, cover to cover\$4.00
- TR-ATIS Section, choke to cover\$4.00
- Flexible Section 1" choke to choke\$5.00
- "B" Curve Choke to cover\$4.50
- Adaptor, round to square cover\$5.00
- Feedback to Parabola Horn with pressurized window\$27.50
- Low Power Load, less cards\$18.50
- K Band Mixer Block\$45.00
- Waveguide 1/2 x 1/4"\$1.00 per ft.
- Circular Flanges\$1.50
- Flange Coupling Nuts\$1.50
- Slotted line, DeMornay Budd #397, new\$450.00
- 80° Twist\$10.00
- "K" Band Directional Coupler CU104/APB-34 20 DB\$49.50 ea.
- K BAND 2K33 w/cav\$18.00
- 3J31 Magnetrons\$55.00

- TVN-9HU Power Supply, M.I.T. Rad. Lab.
- TVN-85E Klystron Power Supply, M.I.T. Rad. Lab.
- CS60ABW Watt Meter—Wavemeter, 3 centimeter.
- AP3 Receiver—1000 to 6000 mcs.
- AN/CPN-8—10 centimeter 40 kw. output RF package. Includes magnetron oscillator, complete modulator, complete receiver, complete signal and power analyzer with 5" scope. 115V AC input.

TEST EQUIPMENT

- Dehydrator Unit CPD 10137 Automatic cycling.
- Compressor to 60 lbs. Compl. for Radar XSMN. Line New\$425.00

8500 Mc. to 9600 Mc. Bench Test Plumbing 1" x 1 1/2" WAVEGUIDE

- SLOTTED LINE, Complete with adjustable probe, crystal output, precision vernier adjust, Humble oil type\$220.00
- KLYSTRON MOUNTS, DeMornay Budd type DB380 for 2K25 etc. includes tunable termination\$70.00
- VARIABLE ATTENUATOR, DeMornay Budd type DB385, Maximum attenuation 35DB.\$120.00
- VARIABLE STUB TUNER, DB356, 180 degree phase shifting capability\$70.00
- FLAP ATTENUATOR, DB385, Maximum Attenuation 10DB\$25.00
- MAGIC TEE, DB339\$42.00
- WAVE GUIDE TO TYPE "N" ADAPTOR, DB377\$15.00
- LOW POWER TERMINATION, DB381\$18.50
- UNI-DIRECTIONAL COUPLER, DB390, 23DB type "N" output\$18.50
- PICK UP HOHN, Type "N" output\$4.50
- WAVEMETER, 8500 to 9400 mcs. with calibration, Micrometer adjust head, Reaction type\$85.00
- WAVEGUIDE LENGTHS, Plated and fitted with couplings available in 6", 12", 24", 30", 60" sections\$2.00 per ft.
- 90 DEGREE ELBOWS, E or H plane, 2 1/2" radius\$12.50
- MITERED ELBOWS, E or H plane\$10.00
- 45 DEGREE OFFSET ELBOWS, E or H plane\$10.00
- 90 DEGREE TWIST, 6" long\$8.00
- BULKHEAD FEED—THRU ASSEMBLY\$15.00
- PRESSURE GAUGE SECTION, 15lb. gauge and press. nipple\$10.00
- PRESSURE GAUGE, 15 lbs.\$2.50
- CRYSTAL MOUNT, IN23 type crystal holder\$17.50
- DUAL OSCILLATOR-BEACON MOUNT, P/O AP510 Radar for mounting two 723A/B kly-

- strons with crystal mts, matching slugs, shields\$42.50
- DUAL OSCILLATOR MOUNTS, (Back to back) with crystal mount, tunable termination, attenuating slugs\$18.50
- KLYSTRONS 723AB\$12.00
- Directional Coupler, UG-40/U Take off 20 DB\$17.50
- Directional coupler, AP5-6 type "N" take off 20 DB calibrated\$17.50
- Broad Band Directional coupler, type "N" take off choke to cover, 23 DB calibrated\$18.50
- Flexible Section 18" long\$12.00
- Rotary Joint Choke to Choke\$10.00
- 2K25/723 AB Receiver local oscillator Klystron Mount, complete with crystal mount, iris coupling and choke coupling to TR\$22.50
- TR-ATR Duplexer section for above\$38.50
- 723AB Mixer-Beacon Dual Oscillator Mount Matching slugs and tunable termination, new\$24.50

1 1/4" x 3/8" WAVEGUIDE

- SLOTTED LINE, Complete with adjustable probe, crystal output, precision vernier adjust, Humble Oil type\$225.00
- TUNABLE TERMINATION, Precision adjust\$65.00
- LOW POWER TERMINATION\$25.00
- MAGIC TEE\$45.00
- TRANSITION, 1 1/4" x 3/8" to 1" x 1/2"\$19.50
- OSCILLATOR MOUNT, for four 723AB klystron\$38.50
- 90 DEGREE ELBOWS, E or H plane\$12.50
- WAVEGUIDE LENGTHS, Cut to size and supplied with 1 choke, 1 cover, per length\$2.00 per ft.
- WAVEMETER: Absorption type, Precision micrometer adjust. Very high Q\$150.00

| MAGNETRONS | | KLYSTRONS | |
|------------|-------|-----------|-----------|
| 2J27 | 2J62 | 723A | 2K42 |
| 2J31 | 3J31 | 707B | W/Cavity |
| 2J21-A | 3J31 | 417A | 2K22 |
| 2J22 | 5J30 | 2K41 | 726B |
| 2J26 | 714AY | 2K26 | 2K55 726C |
| 2J32 | 718DY | | |
| 2J37 | 720BY | | |
| 2J38 | 720CY | | |
| 2J39 | 725-A | | |
| 2J40 | 730-A | | |
| 2J49 | 728 | | |
| 2J34 | 700 | | |
| 2J61 | 706 | | |

| MAGNETRON MAGNETS | | | |
|-------------------|------------|------------|---------|
| Gauss | Pole Diam. | Spacing | Price |
| 4850 | 3/4 in. | 3/4 in. | \$ 8.90 |
| 5200 | 2 1/2 in. | 3/4 in. | \$17.50 |
| 1300 | 1 1/2 in. | 1 5/16 in. | \$12.50 |
| 1860 | 1 1/2 in. | 1 1/2 in. | \$14.50 |

Electromagnets for magnetrons\$24.50 ea.
 GE Magnets type MT765115, GI Distance Between pole faces variable, 2 1/16" (1900 Gauss) to 1 1/2" (2200 Gauss) Pole Dia. 1 1/2". New Part of SCLT 584\$34.50

| THERMISTORS | | VARISTORS | |
|------------------------------------|--------|-----------|--------|
| D-167332 (tube) | \$.95 | D-170225 | \$1.25 |
| D-170396 (head) | \$.95 | D-167176 | \$.95 |
| D-167613 (button) | \$.95 | | |
| D-168549 | \$.95 | | |
| D-164699 for MTG in "X" band Guide | \$.95 | | |
| D-165593 | \$.95 | | |
| D-98836 | \$2.00 | | |
| D-161871A | \$2.85 | | |
| D-171121 | \$.95 | | |
| D-162356 (308A) | \$1.50 | | |
| D-163357 | \$2.00 | | |
| D-99946 | \$2.95 | | |

- 6000 Mc. to 8500 Mc. Bench Test Plumbing 1 1/4" x 3/8" WAVEGUIDE
- KLYSTRON MOUNT, DB356 complete with shield and tunable termination\$125.00
- FLAP ATTENUATOR, DB361\$45.00
- PRECISION WAVEMETER, DB358, Micrometer adjust head\$190.00
- VARIABLE STUB TUNER\$90.00
- WAVEGUIDE TO TYPE "N" ADAPTER\$18.50
- WAVEMETER TEE, DB352\$32.50
- SLOTTED LINE, DB354 Precision vernier adjust, less probe\$320.00
- MAGIC TEE\$80.00
- DIRECTIONAL COUPLER, Two hole 25DB coup-

- ling, type "N" output\$25.00
- PRECISION CRYSTAL MOUNT, Equipped with tuning slugs and tunable termination\$125.00
- TUNABLE TERMINATION, Precision adjust\$70.00
- LOW POWER LOAD\$35.00
- 4000 to 6000 mcs. Bench Test Plumbing 2" x 1" WAVEGUIDE
- SLOTTED LINE, DeMornay type 332 complete with probe, etc.\$600.00
- FLAP ATTENUATOR\$48.00
- VARIABLE STUB TUNER AND LOW POWER TERMINATION\$48.00
- WAVEMETER TEE\$48.00

- ADAPTERS: Choke to choke\$18.00
- Cover to cover\$14.00
- Choke to cover\$18.00
- WAVEGUIDE TO TYPE "N" ADAPTER\$45.00
- DIRECTIONAL COUPLER, Two hole type, "N" output\$48.00
- KLYSTRON MOUNT, Equipped with tunable termination and micrometer adjust, klystron antenna tuning\$110.00
- CRYSTAL MOUNT, Equipped with tunable termination and micrometer adjust crystal tuning\$125.00
- TUNABLE TERMINATION, Precision adjust\$90.00

3000 MC BENCH TEST PLUMBING

- TEST EQUIPMENT**
- 10 CM Wavemeter WE type B435490 Transmission type, Type N Fittings, Vee-der Root Micrometer dial, Gold Plated W/Calib. Chart P/O Free. Meter X86404A New\$99.50
- AS14A/AP-10 CM Pick up Dipole with "N" Cables\$4.50
- R. F. EQUIPMENT**
- INTR. LIGHTHOUSE ASSEMBLY, Part of RT-39 APG & APG 15, Receiver and Trans Cavities w/assoc. TR Cavity and Type N CILG. To Revr. Uses 2C40, 2C43, 1B27, Tunable APG 2400-2700 MCS, Silver Plated\$49.50
- Beacon Lighthouse cavity 10 cm with miniature 28 volt DC FM motor, Mfg. Bernard Rice\$47.50 ea.
- S. BAND**
- 90° Twist, circular cover to circular cover\$25.00
- Magnetron to Waveguide Coupler with 721A Duplexer Cavity, gold-plated\$45.00
- 721A TR Box complete with tube and tuning plungers\$12.50
- McNally Klystron Cavities for 707B or 2K28, Three types available\$4.00
- F-29/SPH-2 Filters, Type "N", Input and output\$12.50

- 726 Klystron Mount, Tunable output, to type "N" complete, with socket and mounting bracket\$12.50
- WAVEGUIDE TO 3/8" RIGID COAX "DOOR-NOB" ADAPTER, CHOKE FLANGE, SILVER PLATED BROAD BAND\$32.50
- WAVEGUIDE DIRECTIONAL COUPLER, 27 db. Navy type CABV-47AAN, with 4 in. slotted section\$32.50
- SQ. FLANGE to rd choke adapter, 18 in. long OA 1 1/2 in. x 3 in. slide, type "N" output and sampling probe\$27.50
- AN/APR5A 10 cm antenna equipment consisting of two 10 cm waveguide sections, each polarized, 45 degrees\$75.00 per set
- POWER SPLITTER: 726 Klystron input dual "N" output\$5.00
- 10 CM FEEDBACK DIPOLE ANTENNA, in lucite ball, for use with parabola 3/8" Rigid Coax Input\$8.00
- 721A TR cavities, heavy silver plated\$2.00 ea.
- 3/8" RIGID COAX**
- Magnetron Coupling with TR Loop, gold-plated with probe, etc.\$7.50
- Sperry Rotating Bend, pressurized\$22.50
- 5 Ft. Lengths Stub Supported, sold-plated, per length\$7.50
- Short Right Angle Bends (for above)\$2.50

- GENERAL TEST EQUIPMENT**
- Multi Frequency Generator, American Time Product type SC-16, Frequency 10 to 100, Precision Standard "Watch-Master"\$14.00
- UHF Signal Generator R.C.A. type 710A 370 to 560 mcs.\$18.00
- Wheatstone Bridge, Industrial Instruments type IN-1\$18.00
- FM Signal Generator, Boonton Radio type 155A Freq. range 1 to 10 mcs, 38 to 50 mcs. Condenser Weld Power, Cap. 56 mfd, max. max. chg. 1500 Volts\$18.00
- Frequency Meter, Lavole Model 105-300 to 600 mcs.\$18.00
- Megohm Bridge, Industrial Instruments type MB. Visual Alignment Signal Generator, General Electric-0 to 60 mcs.\$18.00

- NEW TEST EQUIPMENT IN STOCK**
- I-185A Oscillator
- I-158 Range Calibrator
- I-223 Range Calibrator
- BC 438 Freq. Meter
- RF Preamp.
- G.R. Capacity Brgd. #216
- G.R. Unit G-20 Shunt #229
- G.R. 100 SL Aud. On #213
- TS226A/AP Pwr. Mir. O-1000 W.
- Sig. Gen. #804 8-330 MC
- I83J Dynamotor Test set

QCQ2 SONAR

ECHO RANGING AND LISTENING EQUIPMENT

Use: Medium ASW ships.
Keying interval, 1,000, 2,000, 4,000, 8,000 yards, and manual.
Projector. Magnetostrictive, permanent magnet polarization, resonant frequency about 25 kc.
Transmitting system. The electron tube driver oscillator and two amplifier stages are contained in the receiver chassis; the variable tuning condenser being ganged with the receiver tuning condensers in order to give uni-control of receiver and driver tuning. In another chassis are located the output tubes and the high voltage rectifier. Sweep frequency modulation is provided, giving a shift from 400 cycles below to 600 cycles above the operating frequency during the transmission.
Receiving system. The receiver is of the tuned-radio-frequency type. It includes time varied gain, to reduce the volume of reverberations immediately following the transmission, and has a "Flat-Peak" audio filter, and an adjustable BFO to give an audible note above or below 800 cycles.
Keying and indicating system. Keying is mechanical; cams in the indicator unit determine the pulse length and keying interval. Ranges are indicated by the flash of a neon lamp.
Complete sets available less hoist. Also stacks alone.

QBF and QJA SONAR

ECHO RANGING AND LISTENING EQUIPMENT

Use. Large ASW ships.
ABF may be converted by field modifications, to QJA available.
Keying interval, 1,000, 2,000, 3,000, 4,000, 5,000 10,000 yards and manual.
The electrical train system consists of a handwheel on the stack which selects, by commutation, three voltages from the secondary of a transformer-like device called a Commutator Transmitter.
Projector. The projector is of the Rochelle salt crystal type with a single element used for both listening and ranging. The frequency is 22 to 28 kc.
Transmitting system. The receiver-driver oscillator unit contains two electron tube oscillators, one fixed at about 150 kc and one tunable over the range from 160 to 180 kc. The outputs of the two are mixed, producing a difference frequency, which is then fed to the driver-amplifier unit and thus to the projector.
Receiving system. The receiver is a superheterodyne type covering the range from 10 to 30 kc.
Keying and indicating system. Ranges are indicated by the flash of a neon lamp which revolves at a constant speed, driven by a synchronous motor.

QCU, QCU-1 SONAR

ECHO RANGING AND LISTENING EQUIPMENT

Use. Small ASW Ships.
Intended to be used as a replacement for the obsolete WEA-1 equipment the old hoist.
Keying interval, 1,000, 2,000, 4,000, 8,000 yards and manual.
Training is electrical, controlled by a hand crank at the remote station.
Projector. Magnetostrictive, permanent magnet polarization, resonant frequency about 25 kc split for BDI.
Transmitting system. The electron tube driver oscillator and two amplifier stages are contained in the receiver chassis; the variable tuning condenser being ganged with the receiver tuning condensers in order to give uni-control of receiver and driver tuning. In another chassis are located two type 811 output tubes and two type 836 high voltage rectifier tubes. Sweep frequency modulation is provided, giving a shift from 400 cycles below to 600 cycles above the operating frequency during the transmission.
Receiving system. The receiver is of the tuned radio frequency type. It includes time varied gain, to reduce the volume of reverberations immediately following the transmission, and has a "Flat-Peak" audio filter, and an adjustable BFO to give an audible note, above or below 800 cycles.

QCS, QCS-1, QCT-1 SONAR

ECHO RANGING AND LISTENING EQUIPMENT

Use. ASW ships.
Keying interval (original)—1,000, 2,000, 5,000, 10,000 yards and manual, (field modification added 3,000 and 4,000 yards)
Transmitting system. The driver-rectifier unit contains an electron-tube oscillator tunable over the range of 17 to 25.5 kc, and electron-tube amplifier and a rectifier power supply.
Receiving system. The superheterodyne receiver covers the range from 13 to 37 kc and may be connected by a selector switch to either the "QCQ" or the "JK" face of the projector. It has separate audio amplifiers for the range indicator lamp and for the loudspeaker. The audible note may be adjusted over the range from 0 to 1600 cycles.
Three degrees of I-f selectivity, and two of audio are provided by selector switches connected to filters.
Keying and indicating system. Keying is mechanical; cams driven by the range indicator disc shaft determine the pulse strength and keying interval.

Complete 3 CM Radar System Equipment

40 KW peak transmitter, pulse modulator, receiver, using 723AB, power supply operating from 115V 800 Cycle, antenna system. Complete radar set neatly packaged in less than 16 cubic feet, all tubes, in used but excellent condition—\$350.00. This price for laboratories, schools, and experimental purposes only.

High Voltage Power Supply

15 KV at 30 Ma OC. Bridge Rectifier, Western Electric . . \$125.00

RADIO SYSTEMS

TAJ 500 Watt Low Frequency Transmitter 150-550KC CW-MCW.
TBK 500 Watt High Frequency Transmitter 2-18 MC. A1, A2, A3, Emission Mfg. by RCA.
White Radio Telephone Model :WRMSS—ship to ship—ship to shore—small airports—mines—plantations—inter island—ranges 10 channels fit tuned rec. & xmitter. Xmitter. pwr. output in excess of 100W unmodulated into antenna of 18Q & 100 MMF. Freq. Range 2-12 MC. Can be modified to increase range. Xtal controlled. 110V 60 cy or 220V 60 or 25 cy. Meas. 24" H x 10" WX 14" D. 125 lbs. Write or phone for data.

FM STATION

Kilowatt Amplifier
Model 4BT2A1 Type BT2A Serial RC25
250 Watt Exciter
Model 4BT1A1 Type 3T1A Serial CC833
Station Monitor
Model 4BM1A1 Type BM1A Serial WC268
Power Supply
Model BPF2A1 Type BF2A Serial WC547
Transmitter Console
Model 4BC3A1 Type BC3A Serial WC5
Type BK-2A Two Bay Circular Antenna with Mast, Transmission Line, Klystrons and Matchers.
100 Feet of 1/4 coax. transmission line including 90° elbows
Dehydrator for transmission line.
Desk and Chair for transmitter console.
Write or Phone for Data and Price.

APS-2

10 cm. airborne radar set designed for navigation and high altitude bombing. The antenna rotates through 360 degrees. Presentation is PPI and A Scope. The following units of the set are supplied: Antenna, transmitter-receiver, modulator, indicator, 24VDC input power unit. New with all tubes, incl. 714AY magnetron. 417A klystron.

APS-3

3 cm. airborne radar set designed for intercept of enemy aircraft and nominal navigation. Antenna in sector scan. magnetron operates the set at 45kw. Complete sets available with all tubes incl. magnetron and 723AB klystrons. Both new and used condition.

APS-4

cm. airborne radar set designed for sector scan search, mapping and navigation. Entirely enclosed in a streamlined housing for optional mounting on aircraft bomb rack, or on nose of large bombers. Complete sets with indicator equipment, and power unit ready for installation.

APS-6

3 cm. Night Flihter radar with pencil beam antenna. Transmitter-receiver packages and antennas available in equal to new condition.

APS-6A

3 cm. airborne radar RF package. 45kw. using 725A magnetron. IF strip using 6AK5's, 723AB beacon and local oscillator.

APS-10

3 cm. airborne radar using 2J42 magnetron. Modulator decks and low voltage power supply, only, available. less tubes. Beacon—local oscillator klystron mounts are available.

APQ-13

3 cm. airborne radar complete RF package in excellent condition including all tubes.

APS-15

3 cm. airborne radar designed for high altitude bombing, navigation, intercept of enemy aircraft, weather forecasting. Antenna rotates 360 degrees. Presentation is PPI and A Scope. The following units are supplied: Antenna, transmitter-receiver, modulator, indicator, slant-range computer. 24VDC input power unit. New with all tubes including 45kw 725A magnetron. 723AB local oscillator-beacon.

CPN-8

10 cm Navigation Beacon ground station. Complete and partial installations available. High power beacon of long range capability. Complete power, frequency, operation analyzer (5" scope) included.

CXBR

10 cm. M.I.T. navigation beacon equipment, complete, in excellent condition.

FD MARK IV

800 mc. gunlaying radar w/g. and designed by Western Electric for battleships. Complete consoles available with all tubes including 700A magnetron and modulator thyratron.

MARK 10

10 cm. gunlaying radar, complete, for automatic firing of guns as antenna tracks target. 250 KW.

SA

200 cm. Air Search Radar especially designed for shipboard of mobile installation. Ideal for ground intercept and control of aircraft. PPI 7" indicator. Long range.

SD

200 cm. radar similar to SA but designed for installation on submarines. New.

SE

10 cm. shipboard Surface Search radar, using thyratron modulator. Complete installation available including spare parts. "A" scope presentation. 250 KW.

SF-1

10 cm. shipboard Surface Search radar with PPI and A scope. Used for navigation and target range information on naval vessels. 250 KW.

SG

10 cm. shipboard Surface Search radar with PPI and A scope. Heavy, rugged equipment designed for large naval and merchant vessels. 250 KW.

SJ-1

10 cm. radar designed for installation of Submarines. Equipped with PPI and A scope. Complete installations.

SL

10 cm. radar designed for Surface Search on shipboard. PPI indicator console.

SN

10 cm. portable radar. Lightweight, easily transportable complete radar installation using lighthouse tubes with a 25 mile maximum range. 115 V AC operation.

SO-1

10 cm. shipboard radar for navigation of all types of vessels. 4, 20, and 80 miles range. PPI indicator. Large antenna. 115 V DC input.

SO-8

Same as SO-1 but with a lightweight antenna.

SO-13

Same as SO-1 but with a lightweight antenna, 28 V DC input. Designed for PT boat installation.

SCR-518

Radar altimeter using pulse-echo-time principle. 400 mc. 28 V DC input. CH tube altitude indication.

SCR-520

Airborne radar RF package, 10 cm., complete with pulser, 714AY magnetron.

SCR-533

IFF/Air Search trailer, complete, 500mc operation, A scope.

SCR-663

Sperry searchlight training, aircraft tracking ground installation. Used condition.

TPS-2

1000 mc. portable early warning system. Bed spring antenna. Complete with portable gasoline generator.

UPN-2

10 cm. portable beacon equipment.

SQ

10 cm. portable radar designed for use on landing barges and beach heads. PPI, B. A indication on 3" scope. 115V AC operation.

MORE TEST EQUIPMENT Phone or write for information
TB 36, 110AP, 35, 62, 108, 102, 111, 34, 104, 45, 102, 33, 107, 10

RADAR
RADAR
RADAR
RADAR

R

A

D

A

R

SONAR
SONAR
SONAR
SONAR

COMMUNICATIONS EQUIPMENT CO.

131 Liberty Street, New York, N.Y.

Dept. 19

P. J. Pflsner

Phone Digby—9-4124

TWO NEW TWIN POWER SUPPLIES

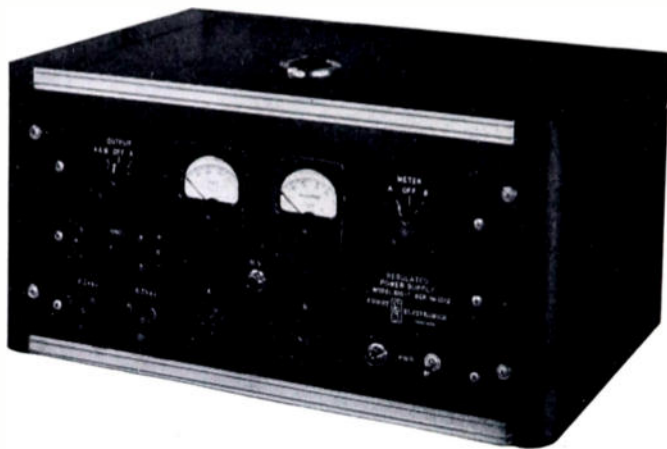

MODEL 610-F

- Precise Electronic Regulation.
- 2 Independent Sources of Power.
- 0-325 V.D.C. at 0-100 Milliampers. Continuously Adjustable.
- 0-325 V.D.C. at 0-200 Mils of the Sources are Combined.
- Both D.C. Outputs Metered for Voltage or Current.
- A.C. Ripple Less than 10 Millivolts.

MODEL 1210

- Precise Electronic Regulation.
- 2 Independent Sources of Power.
- 0-500 V.D.C. at 0-150 Milliampers. Continuously Adjustable.
- 0-500 V.D.C. at 0-300 Mils if the 2 Sources are Combined.
- Both D.C. Outputs Metered for Voltage or Current.
- 6.3 or 12.6 V.A.C. Outputs Provided.
- A.C. Ripple Less Than 10 Millivolts.

Also available with regulated bias output.

Furst Twin Power Supplies double the usefulness of a single unit at considerable saving in space and cost. Write for complete specifications on these and other Furst Twin Power Supply Models.



FURST ELECTRONICS

10 S. Jefferson St., Chicago 6, Ill.

**FOR BETTER PERFORMANCE
BETTER BUY**

Acme Electric

TRANSFORMERS

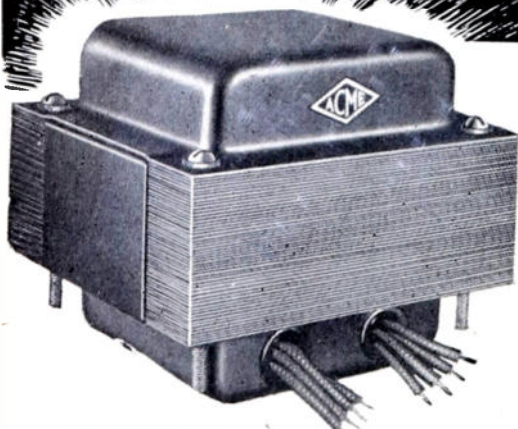

ACME ELECTRIC CORPORATION

• 449 Water St., Cuba, N.Y., U.S.A.

Acme Electric
TRANSFORMERS

You write the specifications and Acme engineers will design a transformer with the exact output characteristics to provide "top" performance for your product. And remember, in addition to quality performance, Acme also can provide quantity production in custom designed electronic transformers.

News—New Products

These manufacturers have invited PROCEEDINGS readers to write for literature and further technical information. Please mention your I.R.E. affiliation.

(Continued from page 63A)

Variable Electronic Filter

Spencer-Kennedy Laboratories, Inc., Dept. IR, 186 Massachusetts Ave., Cambridge 39, Mass., has a new Model 300 variable electronic filter. Due to a new and patented circuit, it has the unusual specification of a continuously variable cutoff within the frequency range of 20 cps to 200 kc. With an attenuation rate of 18 db per octave, it is analogous in performance characteristics to the Constant-K inductance capacitance filter.



A range switch selects the type of section desired, high-pass or low-pass, as well as four-decade frequency ranges. Several filters can be cascaded so that attenuation rates of 36-, 54-, etc. db per octave can be realized. Sections can be combined to make a variable band-pass filter.

Light in weight, compact in construction, and including a regulated power supply the Model 300 variable electronic filter has many uses in the movie, radio broadcasting, television, and sound recording industries.

Multipurpose Transmission Test Set

In addition to measuring the electrical characteristics of telephone lines and equipment the new multipurpose transmission test set developed by Shallcross Manufacturing Co., 520 Pusey Ave., Colling-

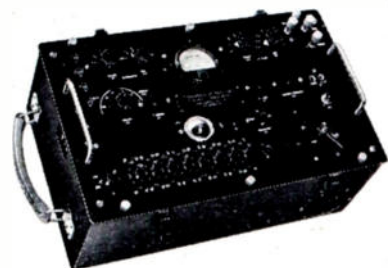

dale, Pa., may be used for efficiency tests on local and common battery telephone

(Continued on page 67A)

News—New Products

These manufacturers have invited PROCEEDINGS readers to write for literature and further technical information. Please mention your I.R.E. affiliation. (Continued from page 66A)

lines and sets, carbon microphones, receivers, and magnetic microphones, and to test capacitors, generators, ringers, insulation resistance, dials, and continuity. Key switches and dials are used to select and control the test circuits. The 693 Transmission Test Set is powered by external batteries. It features compact, substantial construction and is fully portable.

Improved Coil Winding Machine

An improved coil winding machine, Model 125, that winds coils and solenoids up to 8 inches in length instead of 6 inches,

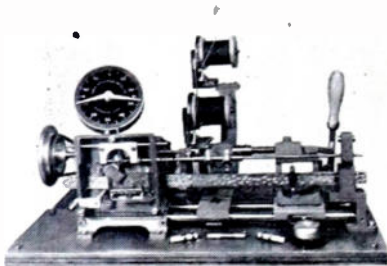

has just been announced by George Stevens Mfg. Co., Inc., 6022 N. Rogers Ave., Chicago 30, Ill.

(Continued on page 68A)

HIGHEST QUALITY ELECTRONIC COMPONENTS

Large Quantities in Stock for Immediate Delivery

RELAYS TUBES
TRANSFORMERS CHOKES
VOLUME CONTROLS RECTIFIERS
WIRE & CABLE TUBE SOCKETS
RESISTORS (WIRE WOUND, CARBON, etc.)

CONDENSERS (MOLDED, CERAMIC, OIL FILLED, etc.)

SWITCHES (TOGGLE, MINIATURE, WAFER, etc.)

All standard brands, inspected and guaranteed by Wells Sales.

Manufacturers: Write for complete Electronic Catalog and prices.
Dept. P

WELLS SALES, INC.

320 N. LA SALLE ST.
CHICAGO 10, ILL.

40 MC TO 220 MC TV AMPLIFIERS



SPECIFICATIONS

- BANDWIDTH
40 MC — 220 MC
- IMPEDANCE
52, 72, and 93 ohm unbalanced, 300 ohm balanced
- GAIN 20 db
- OUTPUT VOLTAGE
4 volts RMS Maximum
- RESPONSE
± 2 db over bandwidth
- PRICE
\$200.00 f.o.b. Cambridge, Mass.

With the Model 212TV Amplifier—SKL — introduces for the first time a single broad band booster capable of amplifying all 13 television channels simultaneously. Because of its stability and reliability — a tube failure means only a slight loss of gain, not amplifier failure — the Model 212TV Amplifier can be safely left unattended for long periods of time. Its low noise level, high output, and low impedance make the Model 212TV Amplifier ideal for television distribution systems in hotels, apartment houses, sales rooms and television stations and manufacturers' plants.

Write today for further information

SKL SPENCER KENNEDY LABORATORIES, INC.
186 MASSACHUSETTS AVE., CAMBRIDGE 39, MASS.

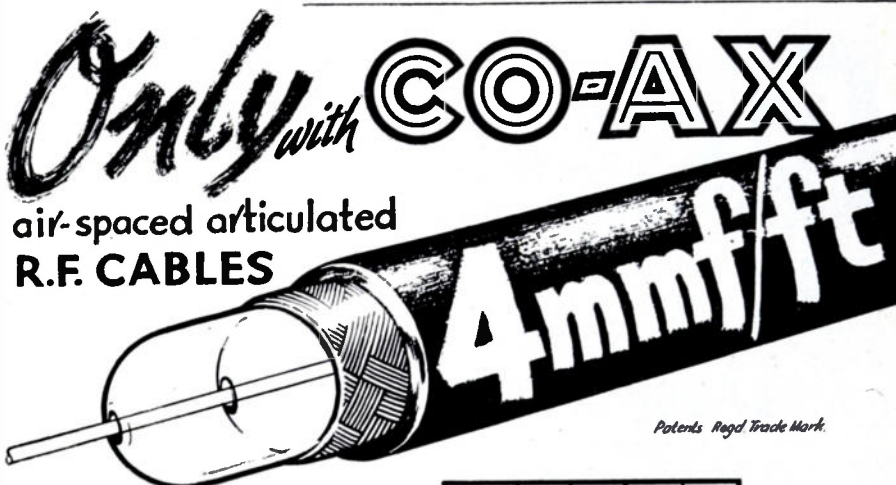

Patents Regd Trade Mark.

THE LOWEST EVER CAPACITANCE OR ATTENUATION

We are specially organised to give SPOT DELIVERIES TO U.S.A Cable your rush order for shipment by air freight. Settlement by your own \$ check

TRANSRADIO LTD
CONTRACTORS TO H.M. GOVERNMENT
13 BA CROMWELL ROAD - LONDON SW7 ENGLAND
CABLES: TRANSRAD LONDON.

| LOW ATTEN TYPES | IMPED OHMS | ATTEN db/100ft of 100 Mc. | LOADING μ v | O.D." |
|-----------------|---------------|---------------------------|-----------------------|-------|
| A1 | 74 | 1.7 | 0.31 | 0.36 |
| A2 | 74 | 1.3 | 0.24 | 0.44 |
| A34 | 73 | 0.6 | 1.5 | 0.88 |
| LOW CAPAC TYPES | CAPAC mmf/ft. | IMPED OHMS | ATTEN db/100ft/100Mc. | O.D." |
| C1 | 7.3 | 150 | 2.5 | 0.36 |
| PC1 | 10.2 | 132 | 3.1 | 0.36 |
| C11 | 6.3 | 173 | 3.2 | 0.36 |
| C2 | 6.3 | 171 | 2.15 | 0.44 |
| C22 | 5.5 | 184 | 2.8 | 0.44 |
| C3 | 5.4 | 197 | 1.9 | 0.64 |
| C33 | 4.8 | 220 | 2.4 | 0.64 |
| C44 | 4.1 | 252 | 2.1 | 1.03 |

HIGH POWER FLEXIBLE

PHOTOCELL CABLE

V.L.C. ★

★ Very Low Capacitance cable.

COSSOR
for **QUALITY**

WHEN TIMING COUNTS . . .
you can count on
Cossor Twin Beam Scopes

UNIQUE twin beam flat face tube permits EXACT time comparison of two waveforms without phase or frequency error. Beams are independent vertically and locked in horizontal direction, can be separated, superimposed or crossed for any comparative test . . . and . . .

Model 1035 TWIN BEAM SCOPE (illustrated) offers these additional features: DIRECT time measurement on calibrated controls from 150 millise. to 1 microsec. DIRECT voltage measurement on each beam from 500 volts to 1 millivolt.

Recurrent or triggered sweeps from 150 millise. to 5 microsec. High gain, wide-band amplifier, -3 db. at 7 Mc.

Write for details on Model 1428 Scope Camera for still or moving film records.

All instruments and spares in stock New York.

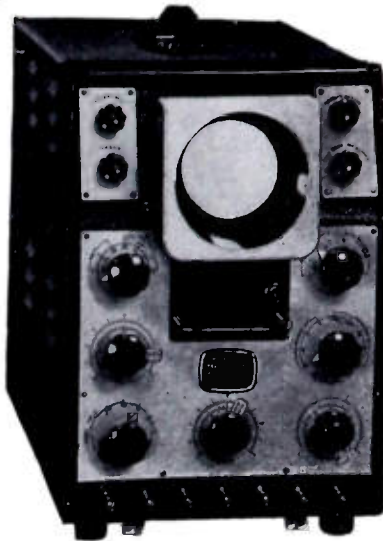

\$465 fob Halifax
\$650 fob New York

COSSOR (CANADA) LIMITED
301-303 Windsor Street, Halifax, N. S.
BEAM INSTRUMENTS CORPORATION
Room 907, 511 5th Avenue, New York 17, N. Y.

News—New Products

These manufacturers have invited PROCEEDINGS readers to write for literature and further technical information. Please mention your I.R.E. affiliation.

(Continued from page 67A)

The new model is mounted on rods instead of a cast iron base. The rods make possible better alignment and more flexibility because the tailstock now can be moved back and forth as well as from side to side. Also, the tension bracket may now be moved to any position to suit the winding arbor.

The new model's tailstock handle is now vertical, permitting it to be moved by the operator's elbow and leaving the operator's hand free. The vertical tailstock handle can also be easily adapted to a foot pedal. Bushings for the cam follow rod are hardened and ground, instead of oilite.

Cam, gears, and idler forming the pattern are now enclosed in front by a clear plastic window, keeping them in plain sight of the operator at all times. The traverse rack is driven by change gears and idler enclosed in back of the head. The traverse rack has an adjustable stop to insure return to identical starting position.

Model 125 also winds progressive universal coils up to 4 inches in length and 3 inches in diameter, universal coils up to $\frac{3}{4}$ inch in width, and If coils. The Model 125 winds wire from 20 to 44 gauge. Cams are stocked from $\frac{1}{4}$ inch to $\frac{1}{8}$ inch in decrements of $\frac{1}{16}$ inch. Sizes larger than $\frac{1}{4}$ inch or less than $\frac{1}{8}$ inch are made upon special order.

(Continued on page 70A)

E-I HERMETIC SEALING COMPONENTS

ENGINEERS, DESIGNERS, PURCHASING AGENTS! SAVE TIME AND EFFORT

with the **E-I**
SAMPLE KIT!

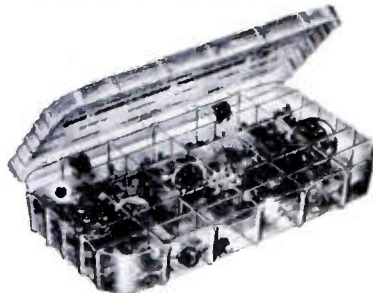

New designers kit contains 81 standard terminals and 11 different headers. These mass produced, economy-priced standard parts solve practically all problems requiring hermetic sealing. Transparent case with labeled bins makes it easy to select the correct component for your needs. The E-I SAMPLE KIT is available at the nominal price of \$10.00. Send check with order or request the free E-I illustrated brochure today!

Write for these descriptive bulletins:

849 - Hermetically Sealed Terminals
850 - Hermetically Sealed Multiple Headers
851 - Gasket Type Bushings



ELECTRICAL INDUSTRIES
INCORPORATED
44 SUMMER AVENUE • NEWARK 4, N. J.

ALLISON RADAR

FOR
MULTI-ENGINED AIRCRAFT

Military • Airline • Executive
MODELS E ES ESB
58-65 LBS. OVERALL WEIGHT

1. Long range. 80-150 miles.
2. Exclusive scanning method.
3. Compact. Sturdy.
4. Easy to operate. Pilot control.
5. Simplicity of maintenance.
6. Gyro-stabilized.
7. JAN components.
8. RACON beacons.

ALLISON RADAR SALES CORP.

Exclusive Manufacturers' Distributors
ALINE RHONIE, President
11 West 42nd St., New York 18
PEnn 6-5811-12

NEW All-Metal...
All-Weather
MOUNT

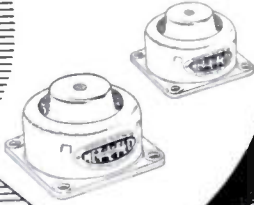

COMPLETE and BALANCED PROTECTION

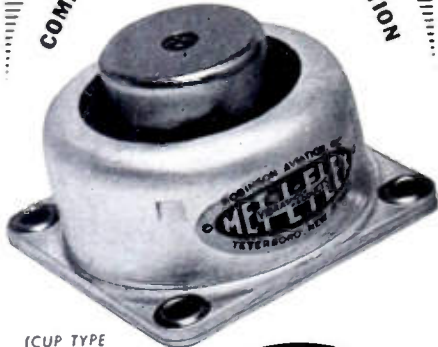

(CUP TYPE
MODEL #7002)



All-metal — all-weather cup type shock mounts provide vibration isolation and shock absorption through the widest possible range of operating conditions.

These unit mounts and mounting systems are absolutely uniform—no organic materials—stable characteristics from -90°C. to +175°C.—wide load tolerance—built-in damping for reduced amplification at resonance.

If you have an electronic or delicate equipment mounting problem, you will probably find Robinson is the answer.

Write Dept. 804
Write for MET-L-FLEX
Data Sheets



ROBINSON AVIATION INC.
TETERBORO, NEW JERSEY
Vibration Control Engineers

CABINETS • CHASSIS • PANELS • RACKS

Planning ELECTRONIC EQUIPMENT?
Investigate the ECONOMIES
of PAR-METAL HOUSINGS!

We manufacture Metal Housings for every purpose — from a small receiver to a deluxe broadcast transmitter. And the cost is low!

Because we specialize in the Electronics field, Par-Metal Products excel in functional streamlined design, rugged construction, beautiful finish, and economy.

Remember, Par-Metal equipment is made by electronic specialists, not just a sheet metal shop.

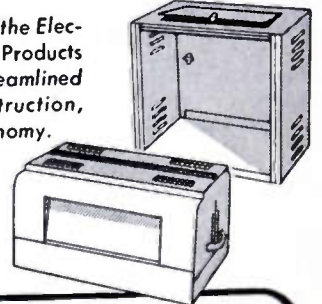
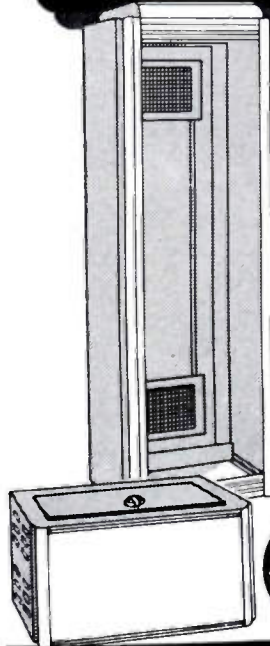

PAR-METAL

PRODUCTS CORPORATION

32-62 — 49th ST., LONG ISLAND CITY 3, N. Y.

Export Dept.: Roche International Corp.

13 East 40 Street, New York 16, N. Y.



WRITE FOR CATALOG!

Bolometer Amplifier...

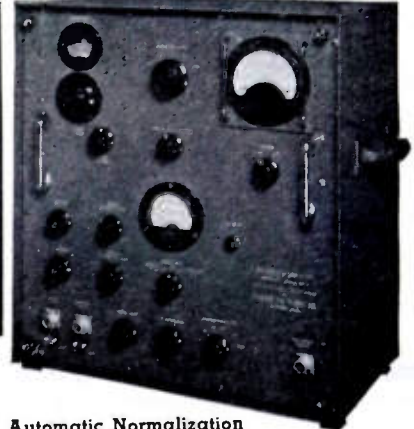

- Variable Bandwidth
- Tunable Frequency Range
- Voltage Ratio Expander
- Automatic Normalization
- Self Contained Metering
- Recorder Output

USES

The P & B Bolometer Amplifier Model 100 is a quality amplifier designed for use in connection with making electrical measurements of antennas and associated radio-frequency systems. Standing wave ratios may be quickly determined on either a linear or expanded indicating scale.

The tunable, variable bandwidth, band-pass characteristics of the amplifier makes it useful where conditions might render other test equipment useless.

Built to Navy Specifications for research and production testing.

Ask for Bulletin L-100

CHARACTERISTICS

- Frequency range—400 cycles—5000 cycles (± 3% calibration accuracy)
- Bandwidth—(1/2 voltage) 6, 12, 22, 50, 100 and 300 cycles
- Input Voltage Range
 - Signal Channel—10⁻²—10⁻⁷ volt.
 - Monitor Channel—10⁻²—10⁻⁵ volt.
 - Expander Operation—10⁻²—10⁻⁵ volt.
- Input Impedance—250 to 350 ohms.
- Meter—logarithmic scale with 100 db decade.
- Recorder Output—.01—100 volts @ .01 w. max. (undecaded)
- Normalization—output voltage holds within ±1/4 db for input changes of ±5 db to both channels.
- Bolometer Bias—adjusted in steps of 2% current change over range of 2.1.
- Voltage Ratio Expander—8th power expansion.

PICKARD & BURNS, INC.

240 Highland Avenue

Needham 94, Massachusetts



when you need resistors—

IT WILL PAY YOU TO
CONSULT THE NEW

IN-RES-CO CATALOG

Included are complete descriptions and specifications on wire wound resistors of all types and sizes. Each is precision wound to close tolerance, and many feature special moisture-proofing to assure proper functioning under severest climatic conditions. INRESCO Resistors—available for IMMEDIATE DELIVERY—are supplied in standard or custom types to meet the most unusual design or operational requirements, and are offered at prices that benefit from mass production facilities. A copy of the new INRESCO catalog will be helpful; write for it today. Prices, samples and estimates promptly on other than standard resistors.



INSTRUMENT RESISTORS COMPANY

1036 COMMERCE AVE., UNION, N. J.

Wire Wound
Resistors for Every Use
in Electronics and
Instrumentation

You Are Invited to Attend the Second Annual AUDIO FAIR

at the

Hotel New Yorker, New York City, October 26, 27, 28, 1950



The event of utmost interest and importance to Broadcast Engineers, Recordists, Sound-on-Film Men, Public Address Men, Audio Hobbyists and Distributors and Dealers.

Presenting again, under one roof, an industry-wide display and demonstration of the latest and best of audio equipment, components and accessories.

Free Registration Banquet Thurs., Oct. 26, 7:30 P.M.

Sponsored by the AUDIO engineering society

in conjunction with it's

ANNUAL MEETING AND CONVENTION

ONE OF OUR PRECISION PRODUCTS

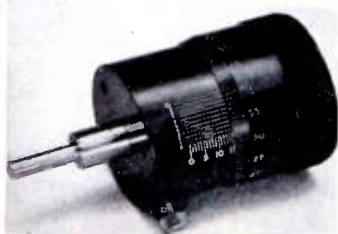

SPECIAL MICROMETER HEAD

- Invar nut and spindle (Hard chrome plated)
- Anti-back lash screw thread
- Readable in either direction of rotation to .00005

MANUFACTURERS THREAD GRINDING, INC.

P. O. Box 66

EATONTOWN, N. J.

ASBURY PARK 1-1019

News—New Products

These manufacturers have invited PROCEEDINGS readers to write for literature and further technical information. Please mention your I.R.E. affiliation.

(Continued from page 68A)

New Microphone

An advance in microphone engineering is claimed by The Astatic Corporation, Conneaut, Ohio, with announcement of a newly perfected unit, the Synabar, Model DR-10 microphone.



Outstanding feature of the Synabar, which is an unidirectional cardioid crystal type, is the use of a special sintered metal to cancel out 15 db front to back. This feature is an achievement for effectiveness in making a new microphone dead to the sound from rear, it is claimed.

The clear-toned performance of the Synabar does not diminish through long service life, thanks to added ruggedness of the advanced construction, the manufacturer declares. Excellent frequency range, from 50 to 10,000 cps, is further enhanced by a response selector switch, which provides choice of ideal pickup characteristics for either crisp voice or general voice and music.

A high impedance microphone, the Synabar has an output level of -54 db. Its crystal element has a special metal-seal protection against moisture or dryness. The finish is satin chrome and the unit is furnished with 20 feet of single conductor shielded cable and detachable concentric cable connector. Available in models with or without off-on switch.

Multichannel Sampling Switch

The Applied Science Corporation of Princeton, Princeton, N. J., announces the development of a high-speed multichannel sampling switch.

The device illustrated is an ASCOP Model 1-30-30S. The motor and switch are designed as a single packaged unit weighing 53 ounces. Over-all dimensions are 5 inches long X 3 1/2 inches wide X 3 1/2 inches high.

(Continued on page 73A)



In only 1 SECOND!
COMPLETE
AUDIO WAVEFORM ANALYSIS
with the
AP-1 PANORAMIC
SONIC ANALYZER

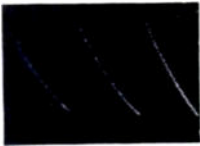

Oscillograph of waveform to be analyzed

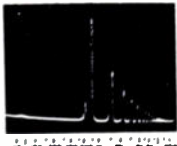

Panoramic Sonic Analysis of the same wave

Provides the very utmost in speed, simplicity and directness of complex waveform analysis. In only one second the AP-1 automatically separates and measures the frequency and amplitude of wave components between 40 and 20,000 cps. Optimum frequency resolution is maintained throughout the entire frequency range. Measures components down to 0.1%.

- Direct Reading
- Logarithmic Frequency Scale
- Linear and Two Decade Log Voltage Scales
- Input voltage range 10,000,000:1

AP-1 is THE answer for practical investigations of waveforms which vary in a random manner or while operating or design constants are changed. If your problem is measurement of harmonics, high frequency vibration, noise, intermodulation, acoustics or other sonic phenomena, investigate the overall advantages offered by AP-1.

Write NOW for complete specifications, price and delivery.

See us in Booth 428 at the Fifth National Instrument Exhibit, Buffalo, N.Y., September 18-22, 1950.



H

IS FOR **H**ORNET

CLASS H

HIGH VOLTAGE

KNOW How

AND THEY MAKE AN H OF A DIFFERENCE

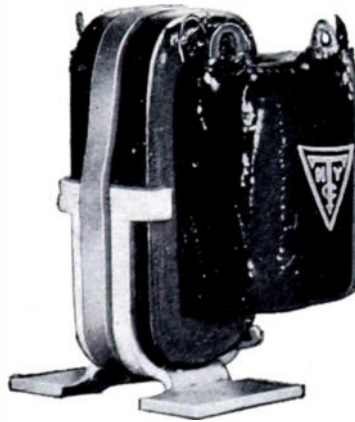

HORNET Transformers provide minimum size, maximum efficiency and greatest life expectancy in transformers for portable and airborne equipment.

Because they are manufactured of newly developed Class H materials — silicones, fiberglass and special steels — HORNET miniature transformers can be operated at temperatures far in excess of the so-called "normal range."

Compare These Typical Volume and Weight Figures

| PLATE TRANSFORMER: Primary 115V., 380/1600cps. Secondary 860V. C.T. 70 MA-RMS, 60 V.A. (85 deg.C. ambient, 50,000 ft. alt.) | | | | | |
|---|-------------------------|-----------------|-------------------------|---------------|-------------------------|
| | Max. Oper. Temp. Deg.C. | Volume Cu. Ins. | Relative Volume Percent | Weight Pounds | Relative Weight Percent |
| Hermetically Sealed (Class A insulation) | 105 | 21.3 | 100 | 2.0 | 100 |
| Open Construction (Class A insulation) | 105 | 11.0 | 54.2 | 1.2 | 60 |
| HORNET (Class H insulation) | 200 | 6.5 | 30.5 | .33 | 16.5 |

The HORNET represents a combination of ingenious design, modern materials, and radically different manufacturing techniques which opens vast new fields in transformer construction and application.



Send for your copy of Bulletin B-300, containing detailed size, weight and rating information on Hornet Transformers and Reactors.



NEW YORK
TRANSFORMER CO., INC.
 ALPHA, NEW JERSEY



SMALL
PARTS
Cost less when made by
MULTI-SWAGE

The economy way to get
a million small parts
similar to these —

Examine the tubular and solid metal parts shown here twice size. If you use anything similar . . . in quantities of over a million . . . important savings can be yours. Send us the part and specs. Our quotation will show why the Bead Chain Company's MULTI-SWAGE Process has long been known as the most economical method of making electronic tube contact pins, terminals, jacks and sleeves. And, why more and more users of mechanical parts (up to 1/4" dia. and to 2" length) employ our facilities. WRITE for Data Bulletin.

B THE BEAD CHAIN MANUFACTURING CO.,
Tr. Mark 88 MOUNTAIN GROVE ST., BRIDGEPORT 5, CONN.

Test Equipment
FOR
RADAR and PULSE APPLICATIONS

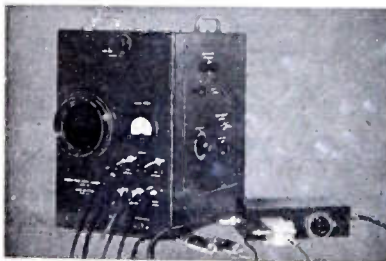

MODEL 705 WOBULATOR

Swept signal output with center frequency adjustable from 2 to 500 mc.
Continuous swept output adjustable from 0 to 100 mc./sec. with 0.1 volt output at 50 ohms.
Internally synchronized scope with detectors and amplifiers.
High and low impedance shielded traveling detectors.
Output designed for making response measurements at 3000 mc., IF frequencies, and Video.

MODEL 708 SPECTRUM ANALYZER

Frequency range—8500 mc to 9600 mc.
Receiver—Double conversion superheterodyne.
IF bandwidth—approximately 10 kc.
Sweep frequency—10 cps to 25 cps.
Minimum frequency dispersion—1 mc/inch.
Maximum frequency dispersion—10 mc/inch.
Signal input attenuator—100 db linear.
Power—115V or 230V, 50 cps to 800 cps.

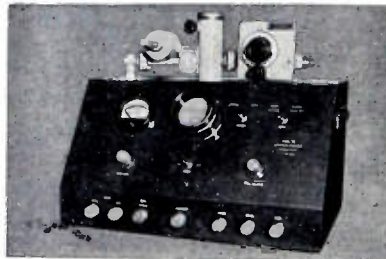

Gold Plated
TUNGSTEN
and
MOLYBDENUM
GRID WIRE



Made to meet your specifications . . . for gold content, diameter and other requirements.

Write for details and list of products



SIGMUND COHN CORP.
44 GOLD ST. NEW YORK

Write for complete technical data

Canoga Corporation

14315 Bessemer St., Van Nuys, Calif. • Box 361

News—New Products

These manufacturers have invited PROCEEDINGS readers to write for literature and further technical information. Please mention your I.R.E. affiliation.

(Continued from page 70A)

The synchronous driving motor is rated at 1,800 rpm, 115 volt single phase, 60 cps. Since the switch is driven directly by the motor shaft at a rate of 30 revolutions per second, sampling of all 30 "break-before-make" channels is in synchronism with the ac line voltage. This synchronous switching is ideally suited for the display of the sampled information on a C-R oscillograph.



ONE INCH

The 30 active contact pins are connected to terminal lugs to facilitate wiring by the user.

A similar unit is available with all 60 contacts made accessible. With its shorting-type wiper, this device features great versatility in possible switching arrangements.

(Continued on page 75A)

HICKOK

Laboratory

MODEL

TUBE TESTER



MODEL 539

Especially Accurate

- Dynamic Mutual Conductance . . . Readings in Micromhos.
- Permits choice of 3 A.C. signals, .25, .5, and 2.5 volts.
- Vernier adjustment permits accurate setting of grid voltage.
- Optional self-bias arrangement.
- Provision for insertion of plate milliammeter for measuring plate current.
- Separate A.C. meter measures line voltage at all times.
- D.C. grid bias and D.C. plate and screen voltages.
- Tube life and gas test for accurate matching of tubes.
- Tests all tubes normally encountered in all phases of electronic work.
- Designed with professional accuracy for engineers and engineering technicians.

See the Model 539 at your jobbers or write for additional information today!

The HICKOK ELECTRICAL INSTRUMENT COMPANY

10551 Dupont Ave., Cleveland 8, O.

1910 *Our 40th Anniversary* 1950

DYNAMIC D-33



Betty Adams
Star of Lippert Productions

Truly AN American BEAUTY

Providing full vision for artist and audience, this new American Dynamic D-33 Microphone is attractively finished in Gold and Black and efficient for all Audio pickup. Easily mounted on stand or for suspension use. Quickly detachable for hand use. Omnidirectional pickup. No pre-amplifier required. Weight, 7 oz. Equipped with Cannon "Latch Lock" plug and 25 ft. two conductor shielded cable. Impedance; 30-50 and 250 ohms. Available in all popular impedances.

American's New Floor Stand adds greater versatility for your staging. Angle adjustment . . . Silent, positive fingertip control . . . Upper rod and fittings polished chrome. Lower rod and angle adjustment, satin black. Microphone mounting, standard $\frac{3}{8}$ " x 27 thread.

WRITE FOR CATALOG

American Microphone Co.

370 S. Fair Oaks Avenue, Pasadena 1, Cal.



Stable at temperatures from -70° to +400° F.



The non-melting silicone insulating and water-proofing compound for ignition systems and electronic equipment.

DC 4 COMPOUND MEETS ALL REQUIREMENTS OF AN-C-128a

DC 4 is highly resistant to oxygen, ozone, hydrogen peroxide and to deterioration caused by corona discharge. It is more water repellent than paraffin or waxes.

POWER FACTOR, up to 10 megacycles . . . 0.001
VOLUME RESISTIVITY, ohm centimeters . . . 10¹²
DIELECTRIC STRENGTH, volts/mil . . . 500

For more information about Dow Corning 4 Compound; Dow Corning 200 Fluids as liquid dielectrics; DC 1208, the water repellent for glass and ceramics; Silastic, the Dow Corning Silicone rubber for use at -100° to 500° F; Dow Corning Silicone (Class H) Electrical Insulating Varnishes and Resins.

For more data phone or write

Dow Corning
FIRST IN SILICONES

DOW CORNING CORPORATION

MIDLAND, MICHIGAN

Atlanta • Chicago • Cleveland • Dallas

Los Angeles • New York

Canada: Fiberglas Canada, Ltd., Toronto

Great Britain: Albright and Wilson, Ltd., London

MORE GEO. STEVENS COIL WINDING EQUIPMENT IS IN USE THAN ALL OTHER MAKES COMBINED!

- **MORE OUTPUT . . . LOWER COSTS . . .** from EXCLUSIVE SPEED FEATURE. Universal motors permit variable speeds without changing belts and pulleys. Coil design permitting, speeds as high as 7500 RPM are not uncommon.
- **PORTABILITY.** Conveniently carried from place to place. Machines come mounted on bases to constitute one complete unit.
- **MUCH LOWER ORIGINAL COST.** The same investment buys more GEO. STEVENS machines than any other coil winding machines.
- **LONG LIFE.** Most of the original

GEO. STEVENS machines bought 14 years ago are still operating daily at full capacity.

- **MUCH FASTER CHANGING OF SET-UPS** than any other general purpose coil winding machine. Quickly changed gears and cams save time between jobs.

- **VERY LOW MAINTENANCE.** Replacement parts are inexpensive, can be replaced in minutes, and are stocked for "same day" shipment, thus saving valuable production time.

- **EASIEST TO OPERATE.** In one hour, any girl can learn to operate a GEO. STEVENS machine.

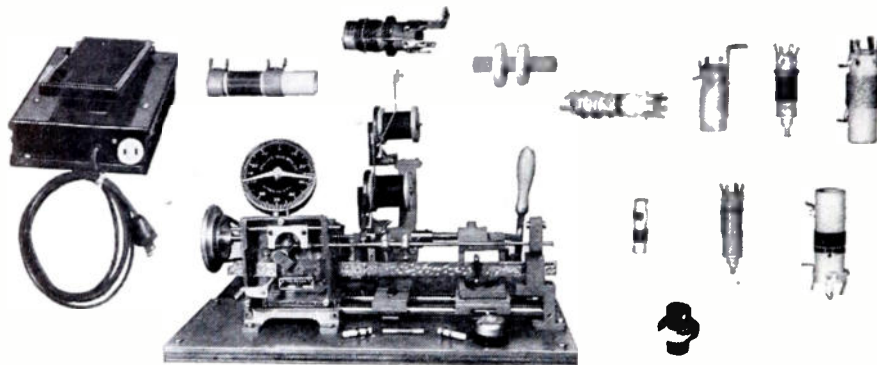

Progressive universal winding machine, Model 125, handles space wound coils and solenoids up to 8" in length, progressive universal coils up to 4" in length and 3" in diameter, universal coils up to 3/4" in width, and I.F. coils. Winds wire from 20 to 44 gauge. Cams are stocked from 3/4" to 1/16" in decrements of 1/64". Sizes larger than 3/4" or less than 1/64" are made upon request.

Cam, gears and idler forming the pattern are enclosed in front. Traverse rack is driven by change gears and idler enclosed in back of the head. The traverse rack has an adjustable stop to insure return to identical starting position. Large ball bearings on head stock spindle give long life and easy running. Ball bearing tailstock with spring tension lever permits quick change of coil forms.

Standard equipment: 1/4 H.P. universal motor, foot operated speed controller, V belt drive, and double spool carrier with two adjustable oilite bearing tensions to control wire during winding.

Dial Counter (Model 50 or 51) with 6" full vision clock dial, accurately registers all turns.

There is a GEO. STEVENS machine for every coil winding need. Machines that wind ANY kind of coil are available for laboratory or production line. . . . Send in a sample of your coil or a print to determine which model best fits your needs. Special designs can be made for special applications. Write for further information today.

World's Largest Manufacturer of Coil Winding Machines

REPRESENTATIVES

Frank Tatro
6022 No. Rogers Ave., Chicago 30, Illinois
Ralph K. Reid
1911 W. 9th St., Los Angeles 6, California
R. F. Staff & Co.
1213 W. 3rd St., Cleveland 13, Ohio

GEO. STEVENS

MFG. CO., INC.

Pulaski Road at Peterson
Chicago 30, Illinois

Dependable
PERFORMANCE
at
LOWER COST



TOWER LIGHTING EQUIPMENT

H & P lighting equipment, consistently specified by outstanding radio engineers, is furnished as standard equipment by most leading tower manufacturers.

300 MM CODE BEACON

Patented ventilator dome circulates the air, assures cooler operation, longer lamp life. Concave base with drainage port at lowest point. Glass-to-glass color screen supports virtually eliminate color screen breakage. Neoprene gaskets throughout. CAA approved



MERCURY CODE FLASHER

Lifetime-lubricated ball bearings. No contact points to wear out. Highest quality bronze gears. Adjustable, 14 to 52 flashes per minute

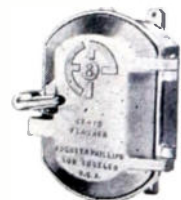

SINGLE and DOUBLE OBSTRUCTION LIGHTS

Designed for standard A-21 traffic signal lamps. Prismatic globes meet CAA specifications.



"PECA" SERIES PHOTO-ELECTRIC CONTROL

Turns lights on at 35 f.c.; off at 58 f.c., as recommended by CAA. High-wattage industrial type resistors. Low-loss circuit insulation.

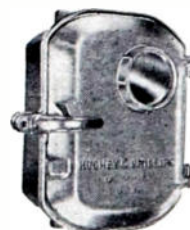

ALSO COMPLETE LIGHT KITS FOR A-2, A-3, A-4 and A-5 TOWERS
PROMPT SERVICE and DELIVERY

First-day shipments out of stock. Immediate attention to specifications and unusual requirements

WRITE OR WIRE FOR CATALOG AND DETAILED INFORMATION

HUGHEY & PHILLIPS

TOWER LIGHTING DIVISION

326 N. LA CIENEGA BLVD.
LOS ANGELES 48, CALIF.
60 E. 42ND ST. NEW YORK 17, N. Y.

News—New Products

These manufacturers have invited PROCEEDINGS readers to write for literature and further technical information. Please mention your I.R.E. affiliation.

(Continued from page 73A)

Recent Catalog

••• An 8-page booklet, entitled "Installation Instructions and Suggested Uses for Stephens Tru-Sonic High-Fidelity Audio Equipment," may be obtained by writing to Stephens Mfg. Corp., 8538 Warner Dr., Culver City, Calif.

Remote Radio Pickup and Mobile Transmitter Link Equipment

Radio Engineering Laboratories, Inc., 36-40 37 St., Long Island City, L. I., N. Y., are now producing the new REL Model 695, 50 watt, 153-Mc FM remote pickup equipments. A 12-volt dc power supply unit is available for pickup truck operation. This equipment is of interest to broadcasters, not only for regular program pickup use but for emergency broadcasts because the program can be on the air as soon as the pickup truck gets its microphones to the site of the remote. Another use is as an emergency studio to transmitter link to replace normal facilities during temporary failures due to storm or other causes.

(Continued on page 77A)

SURVEY OF MODERN ELECTRONICS

By Paul G. Andres

Illinois Institute of Technology

Sept., 1950 522 pages 380 illus. \$5.75

GIVES TESTED MATERIAL USED BY MANY MANUFACTURERS

Emphasizes the practical application of electronic principles in industry today. States vacuum tube fundamentals. Gives use of all types in communication, instrumentation, control, induction and dielectric heating. Covers proximity fuse, automatic pilot, radar, and many other modern devices. Draws data, circuits, and illustrations from nearly every manufacturer in the field.



APPROVAL COUPON

JOHN WILEY & SONS, INC., DEPT. PI-950
440 Fourth Ave., New York 16, N.Y.

Send me, on 10 days' approval, Andres' Survey of Modern Electronics. Either I will remit \$5.75 plus postage, or I will return book postpaid.

Name

Address

City Zone State

Employed By

(Offer not valid outside U.S.)

FROM THE SMALLEST TO THE LARGEST YOU'LL DO BETTER WITH BUD

MINIBOXES



There are thousands of uses in the fields of radio and electronics for these new boxes. They are made from heavy gauge aluminum. The design of the box permits installation of more components than would be possible in the conventionally designed box of the same size. It is of two piece construction, each half forming three sides. The flange type construction assures adequate shielding. Available in etched aluminum finish and gray hammerloid finish.

| Catalog Number | Gray | Etched | Length | Width | Height | Dealer Cost |
|----------------|---------|--------|--------|--------|--------|-------------|
| CU-2100 | CU-3000 | 2 1/4" | 2 1/4" | 1 1/2" | \$.50 | |
| CU-2101 | CU-3001 | 3 1/4" | 2 1/2" | 1 1/2" | .50 | |
| CU-2102 | CU-3002 | 4" | 2 1/2" | 1 1/2" | .50 | |
| CU-2103 | CU-3003 | 4" | 2 1/2" | 2 1/4" | .70 | |
| CU-2104 | CU-3004 | 5" | 2 1/2" | 2 1/4" | .72 | |
| CU-2105 | CU-3005 | 5" | 4" | 3" | .72 | |
| CU-2106 | CU-3006 | 5 1/4" | 3" | 2 1/4" | .78 | |
| CU-2107 | CU-3007 | 6" | 3" | 4" | .81 | |
| CU-2108 | CU-3008 | 7" | 5" | 3" | 1.05 | |
| CU-2109 | CU-3009 | 8" | 6" | 3 1/2" | 1.68 | |
| CU-2110 | CU-3010 | 10" | 6" | 3 1/2" | 1.80 | |
| CU-2111 | CU-3011 | 12" | 7" | 4" | 2.34 | |
| CU-2112 | CU-3012 | 17" | 5" | 4" | 2.76 | |
| CU-2113 | CU-3013 | 10" | 2" | 1 1/2" | .78 | |
| CU-2114 | CU-3014 | 12" | 2 1/2" | 2 1/2" | .96 | |
| CU-2115 | CU-3015 | 4" | 2" | 2 1/2" | .60 | |
| CU-2116 | CU-3016 | 4 1/4" | 2 1/4" | 1 1/4" | .66 | |

Prices 10% higher west of the Mississippi River

ADD-A-RACK SERIES



It has always been necessary to buy special racks without louvers on one side to obtain a maximum of panel space with a minimum of floor space. Now, you no longer need to buy a whole new cabinet when you want additional panel space. Through our new and exclusive Add-a-Rack series, BUD not only offers additional racks at a lower cost, but provides you with a sturdier, better looking assembly.

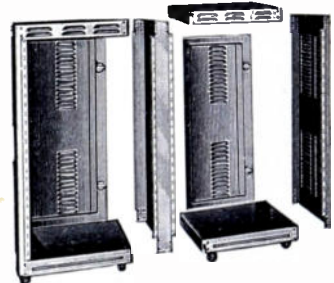

The illustration above at left shows two Add-a-Rack cabinets assembled together. The illustration above at right shows the unique and ingenious method of adding a unit to your present equipment. Instead of buying an entire new outfit, you purchase only four parts: (1) a door, (2) a top, (3) a bottom and (4) an Add-a-Rack coupling unit. The right (or left) hand side of your present relay rack is removed and replaced by the Add-a-Rack coupling unit; next, a top and bottom is fastened into place, and the side taken from the first rack is fastened onto the second rack which has been added. Place the additional door into position and you have two racks properly and efficiently coupled together.

In the same simple way, more racks can be added at any time and every one will be in a CONTINUOUS ONE-PIECE assembly.

This series is available in two ways: (1) a double unit consisting of two racks and the Add-a-Rack coupling unit. (2) Add-a-Rack unit, consisting of a door, a top, a bottom and an Add-a-Rack coupling unit. These units are furnished with all necessary assembling and panel mounting hardware.

BUD RC-7756 Casters will fit this unit. Casters are not included in price of cabinet.

| Add-a-Rack Unit | To Add-a-Rack to | Overall Height | Panel Space | Dealer Cost |
|-----------------|------------------|----------------|-------------|-------------|
| AR-1778 | CR-1774 | 46 1/16" | 36 3/4" | \$26.25 |
| AR-1775 | CR-1771 | 47 5/16" | 42" | 32.50 |
| AR-1776 | CR-1772 | 66 9/16" | 61 1/4" | 40.75 |
| AR-1777 | CR-1773 | 82 5/16" | 77" | 48.00 |

Complete unit, consisting of the knocked-down parts necessary for two relay racks coupled together.

| CR-1779 | two coupled relay racks same size as CR-1774 | Dealer Cost |
|---------|--|-------------|
| CR-1779 | two coupled relay racks same size as CR-1774 | \$54.75 |
| CR-1780 | two coupled relay racks same size as CR-1771 | 67.95 |
| CR-1786 | two coupled relay racks same size as CR-1772 | 83.05 |
| CR-1799 | two coupled relay racks same size as CR-1773 | 98.40 |

Prices are 10% higher west of the Mississippi River.

The above are only a few of our standard items. Send for catalog for complete information. We welcome the opportunity of quoting from your blue prints on special steel or aluminum housings.



BUD RADIO, INC.

2110 EAST 55TH STREET

CLEVELAND 3, OHIO

THE RADIO ENGINEERING SHOW



Dates: March 19-22, 1951

Monday through Thursday

Place: Grand Central Palace,
New York City

at Lexington Ave. and 46th St.

Plan to Come!

252 Exhibits—17,689 Attended in 1950

JUST PUBLISHED!

A definitive new work on the theory and relative merits of the traveling-wave tube, and its importance to present-day communications and the entire field of microwave electronics.

TRAVELING WAVE TUBES

By J. R. PIERCE, Ph.D.

Member of the Technical Staff
Bell Telephone Laboratories, Inc.

BEGINNING with a clear and simple description of the traveling-wave tube and a simple exposition of its theory, this book treats in a unified manner problems such as those of circuit impedance, loss, gain, power, and noise in traveling-wave tubes.

In presenting this well-rounded treatment, the author has provided much new material in addition to using previously published information, and he has applied to both a common notation and uniform development.

The first chapter is introductory, showing the nature of traveling-wave tubes, their advantages and disadvantages, and in general their place in present-day communications and the trend of their development. Then follows the description of the tube itself, and a concise, specialized analysis of its operation. Following chapters discuss slow-wave circuits and give a qualitative and quantitative idea of their nature and limitations. Then, simplified equations for the overall behavior of the tube are introduced and solved, and matters such as overall gain, insertion of loss, a-c space-charge effects, noise figure, field analysis of operation and transverse field operation are considered. Power output is discussed, and in the final chapters brief treatments are given of two closely related types of tube—the traveling-wave magnetron amplifier and the double-stream amplifier. Appendices treat various detailed points and contain in easily usable form, material necessary for calculating gain of traveling-wave tubes. In sum, this book provides the broad coverage of principles and the necessary treatment of details for those planning to work with traveling-wave tubes.

EXAMINE THIS BOOK FREE

Use the convenient order form below to obtain an examination copy of this important new work.

----- **Please cut out and mail** -----

D. Van Nostrand Company, Inc. Publishers
250 Fourth Avenue, New York 3, N.Y. Since 1848

Please send me a copy of "Travelling Wave Tubes." Within ten days I will either return the book or send you \$4.50, plus a few cents postage.

Name.....
Address.....
City.....Zone.....State.....
IRE-950



FOR SUPERIOR PAPER-DIELECTRIC CAPACITORS

Permanol

G-H "Custom-manufactured" capacitors treated with this highly effective impregnant insure

Utmost protection against voltage breakdown . . .

Maximum stability under adverse climatic conditions

Low power-factor change with frequency . . .

Permanent, non-ageing characteristics . . .



can supply you with PERMANOL treated capacitors to your own specifications. Any reasonable capacity, tolerance or working voltage . . . any size or type of container . . . small or production quantities.

One of the best equipped capacitor manufacturing plants on the Pacific Coast

GIRARD-HOPKINS

1000 40th Avenue, Oakland 1, Calif.

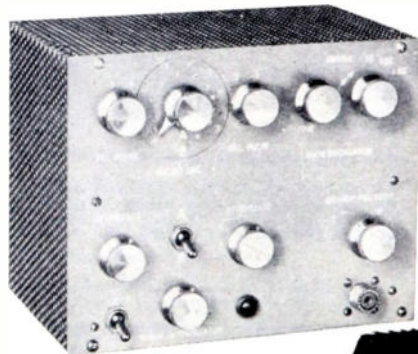

BRIEF SPECIFICATIONS

PULSE DURATION individually adjustable from 0.15 to 1.5 microseconds; **RISE TIME** is .05. **DECAY TIME** 0.10 microseconds. **SPACING** between pulses variable from -0.5 to +3 microseconds. **REPETITION RATE** adjustable in 3 ranges, 1 to 10, 10 to 100 and 100 to 1000 cycles; can be externally triggered. **OUTPUT IMPEDANCE** approximately 400 ohms, maximum output voltage, -200 v. **CONTROL CALIBRATION ACCURACY** ± 5% over entire range.

THE *Berkeley*
MODEL 902
DOUBLE PULSE GENERATOR

TYPICAL PULSE COMBINATIONS



The Berkeley Double Pulse Generator produces two pulses individually controllable in width, amplitude and time relation to each other. Pulse amplitude is individually adjustable without cross effect from 0 to +50 v. and 0 to -200 v. A fine control, plus a 10 to 1 step attenuator permits varying the amplitude of both pulses after mixing.

TYPICAL APPLICATIONS...Resolution tests of high speed scaling circuits, response simulation of scintillation and proportional counters, evaluation of electronic gate and switch response, TV equipment testing, characteristic checks of wide band amplifiers, etc.

COMPLETE INFORMATION is yours for the asking; please request Bulletin E-902.

Berkeley Scientific Company

SIXTH & NEVIN AVENUE • RICHMOND, CALIFORNIA

The New STAVER MINI-SPRING

TRADE MARK REG. AND PAT. PEND.

A quality Tube Guard that is Bargain Priced

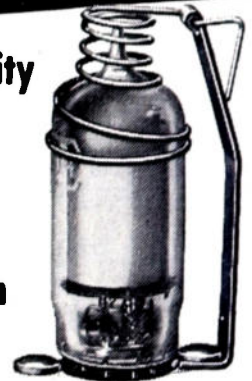

Gives support two ways—Keeps pressure downward and gives sideway support. The spring action is constant and resilient permanently. Send for catalog sheet.



News—New Products

These manufacturers have invited PROCEEDINGS readers to write for literature and further technical information. Please mention your I.R.E. affiliation.

(Continued from page 75A)

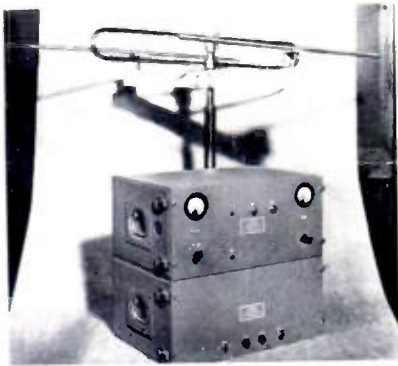

The photograph shows the ac power supply and the transmitter, and the antenna which usually is mounted atop the pickup truck during operation.

Wide-Band Decade Amplifier

Type 500-A wide-band decade amplifier has been developed by **Technology Instrument Corp.**, 1058 Main St., Waltham, Mass., for general laboratory use and for special applications requiring zero phase shift on high stability of gain. To increase the general utility of the amplifier, compact construction, cabinet or rack mounting, and ac operation from a self-contained power supply have been incorporated in the design.



Input impedance is high enough to permit measurements in most circuits without upsetting normal conditions.

Output impedance is low enough to permit operation into a wide range of loads without causing a variation from the indicated gain of 10,000 or 1,000 times.

Maximum output of 20 v on any gain setting insures sufficient amplitude for the operation of most devices used in conjunction with general purpose laboratory amplifiers.

Zero phase shift from 20 cps to 100 kc (all instruments adjusted as close as practical to zero—some might exhibit an error of 2° unless requested otherwise) makes possible the extension of phase measurements of 5-mv levels, when used with TIC Type 329 phase meter.

Gain stabilized by feedback, so that it is constant with line voltage or tube changes.

(Continued on page 78A)

HE CHOSE

Magnecorder



WIBA

FOR FIDELITY

No other recorder offers such high fidelity at such a low price! Frequency response 50-15 kc \pm 2 db. Signal-noise ratio: 50 db. Flutter less than 0.3%. Meets N.A.B. standards.

FOR FLEXIBILITY

For delayed studio or network broadcasts, a Magnecorder can be mounted in a rack or console cabinet. For remotes, slip it into its really portable cases. Amplifiers for every purpose—single or multi-channel.

FOR FEATURES

Magnecord sets the pace! New or old, your Magnecorder can have 3 heads (separate erase, record, and playback heads) to permit monitoring from the tape. 3 speeds (15", 7½" and 3¾" — up to an hour on a 7" reel) now available on both PT6 and PT63 equipment. Magnecorders are fail-safe, sturdy! Features to fit your every need.

MAGNECORDER

Professional Tape Recorders Fit every purpose — every purse!



PT6 SERIES
— world's most widely used professional tape recorder.



PT63 SERIES
— 3 heads to erase, record, and monitor from the tape.



PT7 SERIES
— A complete console for only \$950.00. Models for portable or rack mount also available. Outstanding features and flexibility.

Write for NEW CATALOG

MAGNECORDER, Inc. Dept. P9
360 N. Michigan Ave., Chicago 1, Ill.
Send me latest catalog of Magnecorder equipment.

Name.....
Company.....
Address.....
City..... State.....

PROFESSIONAL CARDS

LESTER W. BAILEY
Registered Patent Agent
Senior Member IRE
PATENT OFFICE PRACTICE specializing in
ELECTRONICS MECHANICS
RADIO
LINCOLN-LIBERTY BUILDING
PHILADELPHIA 7
Broad & Chestnut Streets Rittenhouse 6-3267

ALFRED W. BARBER
LABORATORIES
Specializing in the Communications Field and
in Laboratory Equipment
Offices, Laboratory and Model Shop at:
32-44 Francis Lewis Blvd., Flushing, L.I., N.Y.
Telephone: Independence 3-3306

HAROLD J. BROWN
Vibrators
Vibrator Power Supplies
Electrical Contact Systems
Mattapoisett, Mass.

W. J. BROWN
International Electronics Consultant
AT PRESENT IN GREAT BRITAIN
Will undertake assignments for American or
British Clients. Please address inquiries to 11
Public Square, Cleveland 13, Ohio.
TO 1-6498 FA-1-0030

EDWARD J. CONTENT
Acoustical Consultant
Functional Studio-Theater Design
FM — Television — AM
Audio Systems Engineering
Roxbury Road Stamford 3-7459
Stamford, Conn.

CROSBY LABORATORIES, INC.
Murray G. Crosby & Staff
Radio-Electronic Engineering,
Research & Development
FM, Communications, TV
Test Equipment
Offices, Laboratory & Model Shop at:
126 Herricks Rd., Mineola, N.Y.
Garden City 7-0284

Richard B. Schulz
Electro-Search
Radio-Interference Reduction;
Development of
Interference-Free Equipment,
Filters, Shielded Rooms
515 W. Wyoming Ave., Philadelphia 40, Pa.
Gladstone 5-5353

ELK ELECTRONIC LABORATORIES
Jack Rosenbaum
Specializing in the design and
development of
Test Equipment for the communications,
radar and allied fields.
333 West 52nd St. Telephone:
New York 19, N.Y. PLAZA 7-0520

WILLIAM L. FOSS, INC.
927 15th St., N.W. REpublic 3883
WASHINGTON, D.C.

PAUL GODLEY CO.

Consulting Radia Engineers
P.O. Box J. Upper Montclair, N.J.
Offs & Lab.: Great Notch, N.J.
Phone: Montclair 3 3000
Established 1926

HERMAN LEWIS GORDON

Registered Patent Attorney
Patent Investigations and Opinions
Warner Building 100 Normandy Drive
Washington 4, D.C. Silver Spring, Md
National 2497 Shepherd 2433

HOGAN LABORATORIES, INC.

John V. L. Hogan, Pres.
APPLIED RESEARCH, DEVELOPMENT,
ENGINEERING
Est. 1929. Exceptionally competent staff. Elec-
tronics, Optics, Mechanisms, Facsimile Com-
munication, Electro-sensitive recording media,
Instrumentation.
155 Perry Street, New York 14 CHelsea 2-7855

MEASUREMENTS CORP.

RESEARCH & MANUFACTURING
ENGINEERS
Harry W. Houck Jerry B. Minter
John M. van Beuren
Specialists in the Design and
Development of Electronic Test Instruments
BOONTON, N.J.

PICKARD AND BURNS, INC.

Consulting
Electronic Engineers
240 HIGHLAND AVE.
NEEDHAM, MASS.

PAUL ROSENBERG ASSOCIATES

Consulting Physicists
Main office: Woolworth Building,
New York 7, N.Y.
Cable Address Telephone
PHYSICIST WOrth 2-1939
Laboratory: 21 Park Place, New York 7, N.Y.

SERVO CORPORATION OF AMERICA

Henry Blackstone, President
Consultants on
Electronic Control Problems
for Industry
New Hyde Park Long Island, N.Y.

TECHNICAL MATERIEL CORPORATION

COMMUNICATIONS CONSULTANTS
RADIOTELETYPE • FREQUENCY SHIFT
INK SLIP RECORDING • TELETYPE NETWORKS
121 Spencer Place, Mamaroneck, N.Y.

WHEELER LABORATORIES, INC.

Radio and Electronics
Consulting — Research — Development
R-F Circuits — Lines — Antennas
Microwave Components — Test Equipment
Harold A. Wheeler and Engineering Staff
Great Neck, N.Y. Great Neck 2-7806

News—New Products

These manufacturers have invited PROCEEDINGS readers to write for literature and further technical information. Please mention your I.R.E. affiliation.

(Continued from page 77A)

Two-Pole Mercury Plunger Relays

Ebert Electronics Corp., 185-09 Jamaica Ave., Hollis 7, L. I., N. Y., announces the release of its new two-pole mercury plunger relays. Based on many years of experience producing a single-pole mercury relay of unusual reliability (10,000,000 operations without failure), a new design has been developed incorporating two of the standard EMT tubes in one coil structure. This produces an efficient arrangement for loads up to 35 amperes 115 v ac, or 25 amperes 200 v ac with minimum size and cost.

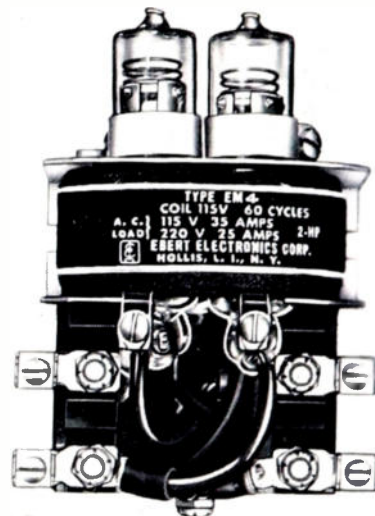

The over-all dimensions of the two-pole relay (Type EM-4) are 4 $\frac{3}{8}$ inches high by 3 $\frac{3}{8}$ inches wide by 2 $\frac{1}{4}$ inches deep. It is available with contacts normally open or normally closed. For special applications it is also manufactured with one contact normally open, the other normally closed. This permits instantaneous switch from one circuit to another.

The reliability of these relays lies in the hermetic, dustproof structure, based on heavy tungsten contacts in a hydrogen-filled glass tube. Contact is made from mercury to mercury when the internal magnetic plunger is energized.

We will be grateful if you will mention PROCEEDINGS of the I.R.E. when writing to our advertisers.

INDEX AND DISPLAY ADVERTISERS

| | |
|-------------------------|-----|
| Section Meetings | 34A |
| Student Branch Meetings | 35A |
| Membership | 36A |
| Positions Open | 50A |
| Positions Wanted | 54A |
| News-New Products | 30A |

| | |
|-------------------------------|-----|
| Electro-Motive Mfg. Co., Inc. | 21A |
| Electro-Search | 78A |
| Elk Electronic Laboratories | 78A |
| W. L. Foss | 78A |
| Franklin Institute | 51A |
| Freed Transformer Co., Inc. | 29A |
| Furst Electronics | 66A |

| | |
|-----------------------------------|----------|
| Simpson Electric Co. | 47A |
| Sola Electric Co. | 53A |
| Sorenson & Co., Inc. | 42A |
| Spencer-Kennedy Labs. | 67A |
| Sperry Gyroscope Co. | 23A, 54A |
| Sprague Electric Co. | 4A |
| Stackpole Carbon | 12A |
| Staver Co. | 76A |
| Geo. Stevens Mfg. Co., Inc. | 74A |
| Stoddart Aircraft Radio Co. | 19A |
| Sylvania Electric Products Co. | 18A |
| Tech Laboratories | 55A |
| Technical Materiel Corp. | 78A |
| Technology Inst. Corp. | 63A |
| Tektronix, Inc. | 58A |
| Transradio Ltd. | 67A |
| Truscon Steel Co. | 8A |
| Ungar Electric Tool Co., Inc. | 62A |
| United Transformer Co. | 17A |
| D. Van Nostrand Co. | 76A |
| Waterman Products | 54A |
| Wells Sales, Inc. | 67A |
| Wheeler Labs. | 78A |
| S. S. White Dental Mfg. Co., Inc. | 39A |
| John Wiley & Sons, Inc. | 75A |

DISPLAY ADVERTISERS

| | |
|------------------------------------|---------------------------|
| Ace Engineering & Machine Co. | 56A |
| Acme Electric Corp. | 66A |
| Aerovox Corporation | 43A |
| Airtron, Inc. | 59A |
| Allen-Bradley Co. | 28A |
| Allison Radar Sales | 68A |
| American Lava Corp. | 9A |
| American Microphone Co. | 73A |
| Amperex Electronic Corp. | Cover II |
| Applied Science Corp. of Princeton | 54A |
| Arnold Engineering Co. | 6A |
| Astatic Corp. | 34A |
| Audio Engineering Society | 70A |
| L. W. Bailey | 78A |
| Ballantine Laboratories, Inc. | 40A |
| Barker & Williamson | 35A |
| Bead Chain Mfg. Co. | 72A |
| Bell Aircraft Corp. | 50A |
| Bell Telephone Labs. | 2A |
| Bendix Aviation (Radio Div.) | 50A |
| Bendix Aviation (Red Bank Div.) | 37A |
| Berkeley Scientific Co. | 76A |
| Bliley Electric Co. | 60A |
| H. J. Brown | 78A |
| W. J. Brown | 78A |
| Bud Radio, Inc. | 75A |
| Cambridge Thermionic Corp. | 58A |
| Canoga Corp. | 72A |
| Capitol Radio Engineering Inst. | 55A |
| Centralab | 63A |
| Clarkstan Corp. | 46A |
| Cleveland Container Co. | 5A |
| Sigmund Cohn Corp. | 72A |
| Collins Radio Co. | 41A |
| Communication Products Co. | 62A |
| Communications Equipment Co. | 64A & 65A |
| Cornell-Dubilier Electric Corp. | Cover III |
| Cossor Ltd. | 68A |
| Crosby Labs. | 78A |
| Dow Corning Corp. | 58A |
| Allen B. DuMont Labs. | Facing 16 & 17A, 20A, 27A |
| Eitel-McCullough, Inc. | 14A |
| Electrical Industries Inc. | 68A |
| Electrical Reactance Corp. | 13A |

| | |
|------------------------------------|--------------------|
| General Electric Co. | 10A, 11A, 15A, 33A |
| General Radio Co. | Cover IV |
| General Precision Laboratories | 45A |
| Girard-Hopkins Inc. | 76A |
| Paul Godley Co. | 78A |
| H. L. Gordon | 78A |
| Hewlett-Packard Co. | 3A |
| Hickok Electrical Inst. Co. | 73A |
| Hogan Laboratories | 78A |
| Hughes Aircraft Co. | 50A |
| Hughey & Phillips | 74A |
| Instrument Resistors | 70A |
| Jacobs Inst. Co. | 51A |
| J. F. D. Mfg. Co. | 22A |
| E. F. Johnson Co. | 36A |
| Lambda Electronics | 79A |
| Lavoie Labs. | 31A |
| Magnecord Inc. | 77A |
| P. R. Mallory & Co., Inc. | 7A |
| Manufacturers Thread Grinding Inc. | 70A |
| Marion Electrical Inst. Co. | 49A |
| Glenn L. Martin Co. | 52A |
| W. L. Maxson Corp. | 55A |
| Measurements Corp. | 44A, 78A |
| Melpar Inc. | 52A |
| Mole-Richardson Co. | 48A |
| Mycalex Corp. of America | 16A |
| National Carbon Co. | 61A |
| National Union Radio Corp. | 52A |
| North American Aviation, Inc. | 56A |
| Ohmite Mfg. Co. | 25A |
| Panoramic Radio Products | 71A |
| Par-Metal Products | 69A |
| Pickard & Burns Inc. | 69A, 78A |
| Potter Instrument Co. | 26A |
| Radio Corp. of America | 32A, 52A, 80A |
| RCA Service Co. | 51A |
| Raytheon Mfg. Co. | 57A |
| Robinson Aviation Inc. | 69A |
| Paul Rosenberg Assoc. | 78A |
| Servo Corp. of America | 78A, 60A |
| Shallcross Mfg. Co. | 38A |
| Sheldon Electric Co. | 24A |

ELECTRONICALLY REGULATED LABORATORY POWER SUPPLIES



RACK MODEL 32

• STABLE
• DEPENDABLE
• MODERATELY PRICED
•

STANDARD
RACK
MOUNTING
PANEL SIZE
10 1/2" x 19"
DEPTH 9"
WEIGHT 38 LBS

- INPUT: 105 to 125 VAC, 50-60 cy
- OUTPUT #1: 200 to 325 VDC at 300 ma regulated
- OUTPUT #2: 6.3 Volts AC CT at 5A unregulated
- OUTPUT #3: 6.3 Volts AC CT at 5A unregulated
- RIPPLE OUTPUT: less than 10 millivolts rms

For complete information write for Bulletin G-2



LAMBDA ELECTRONICS
CORPORATION
CORONA NEW YORK

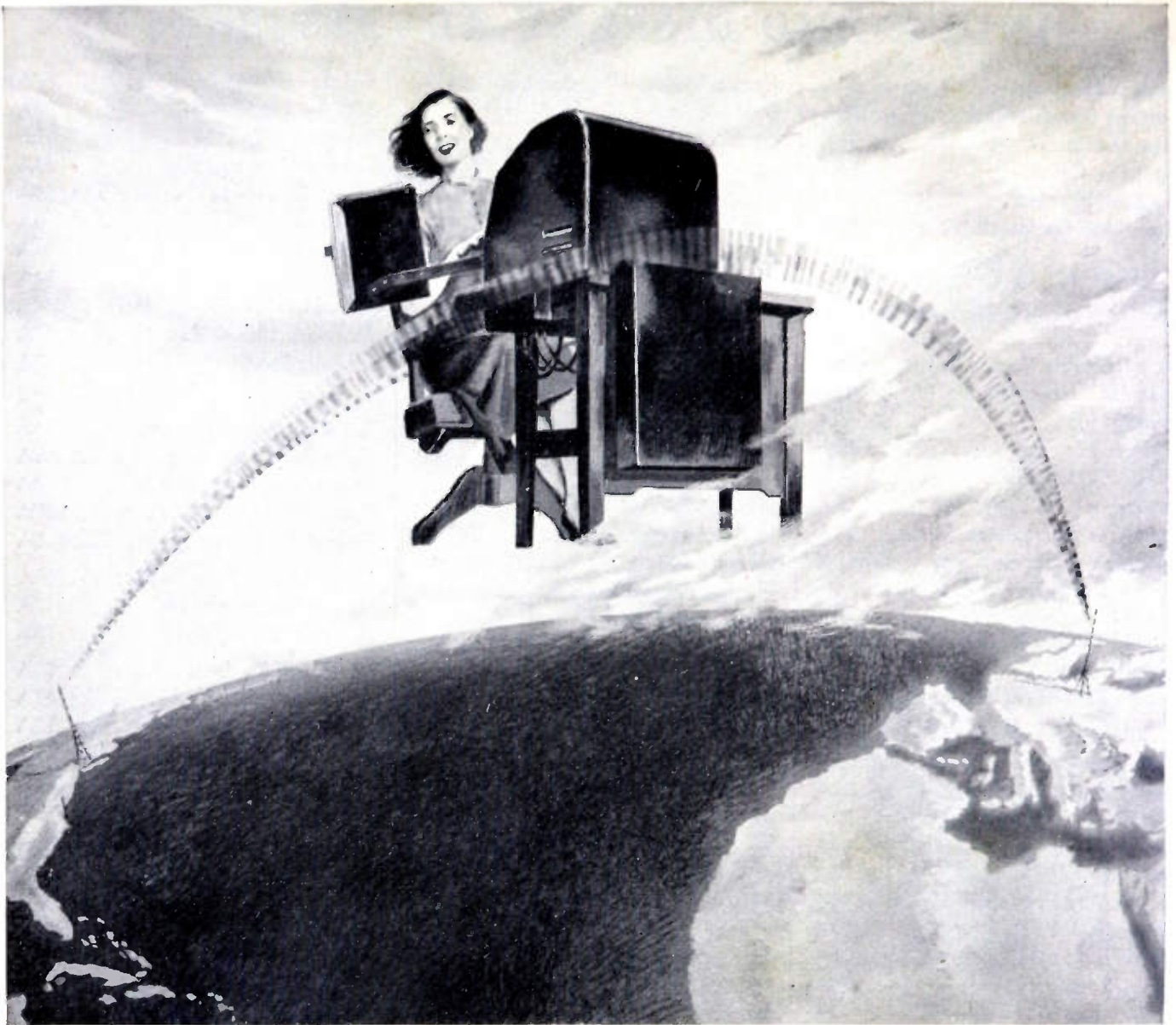

New RCA overseas teleprinter service by radio, first open to the public, now links New York and Holland.

Now "Flying Stenographers" span the sea!

You are familiar with *teleprinter* service which delivers a typed message, by wire, at high speed. Now this useful service takes to the air on a person-to-person basis, and is spanning the Atlantic Ocean by radio!

This new achievement, called TEX, was developed by RCA engineers and European experts. Its heart is an amazing machine that thinks in code, detects errors which may have come from fading or static—and automatically insists on a correction!

If, when RCA's "TEX" is at work, a letter becomes distorted, the receiving instrument rejects the character and sends back a "Repeat, please" signal in fractions of a second—then repeats it until a correct signal is received. Like other RCA advances in radio, television, and electronics, RCA's TEX system helps make radio waves more useful to all of us—and in more ways!

* * *

See the newest in radio, television, and electronics at RCA Exhibition Hall, 36 West 49th St., N. Y. Radio Corporation of America, Radio City, New York 20, N. Y.



RCA Research and pioneering provide a basis for the superiority of RCA Victor television receivers—the best buy on the 1950 market.



RADIO CORPORATION of AMERICA

World Leader in Radio — First in Television

they

may

look

alike,

but:

there

is

only

one

C-D

COMPACT! DEPENDABLE!

Best... by Field Test

Type BBR MINIATURE ELECTROLYTIC CAPACITORS

anode risers connected
directly to outer leads

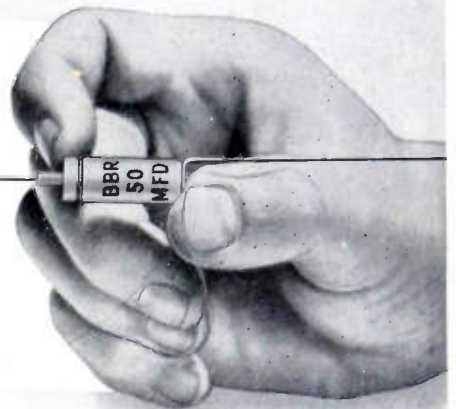

... new construction eliminates shorts to the container!

Another C-D first! Positive lead, of round aluminum wire, is clamped to special aluminum center piece providing continuous metallic contact from foil to terminal lead. No foreign material sandwiched between inner and outer leads—a consistent cause of floating opens and high resistance contacts. Also eliminates shorts in container. Other features are:

High-purity aluminum electrodes—low electrical leakage! Cellulose-acetate wrap prevents "contamination" during assembly! Electrolyte centrifuged into container—fills

section completely; provides reserve fluid for many years' use! Rubber bakelite insulation washer permits perfect seal! Stable electrolyte—a C-D exclusive—permits long shelf and operating life!

For further information on these and other C-D electrolytics, write for catalog. CORNELL-DUBILIER ELECTRIC CORPORATION, Dept. M-9-0 South Plainfield, New Jersey. Other plants in New Bedford, Brookline and Worcester, Mass.; Providence, R. I.; Indianapolis, Ind., and subsidiary, The Radiart Corp., Cleveland, Ohio.



CONSISTENTLY DEPENDABLE

CORNELL-DUBILIER

CAPACITORS • VIBRATORS • ANTENNAS • CONVERTERS



SPECIAL TERMINAL BOXES for V-5 and V-10 VARIACS*

VARIAC users have frequently asked for special terminal boxes for facilities impossible to fit in the space provided by the standard "T" terminal box regularly used with all V-5MT, V-5HMT, V-10MT and V-10HMT VARIACS.

We now stock a new, larger rectangular terminal box with sufficient room for almost any special terminal arrangement desired. Unlike the standard "T" box, the new box has a removable cover for easy access to its interior.

The boxes for the V-5 and V-10 series are identical and can be put on existing VARIACS by the customer with no difficulty. Both V-5 and V-10 VARIACS are now stocked with the new terminal cases.

Two boxes are available. The "TC" unit, a plain box with four BX or conduit knockouts and a blank cover, and the "TE" box equipped with a 3-wire outlet, cord and 3-terminal plug and a two-pole switch.



V-5MTE

VARIACS WITH SPECIAL WINDINGS

We receive many requests to modify the winding on VARIACS to furnish output voltages or voltage ranges different from the standard models, or to provide special input or output tap arrangements.

Where the quantities involved are sufficiently large to warrant special production, at a price reasonably low, we welcome your inquiries for VARIACS of this type.

When requesting quotations for these VARIACS please supply complete information to facilitate our prompt reply.

*Trade Name ©



V-10MTC

SPECIFICATIONS

V-5MTC

Dimensions of ALL Boxes: 2 7/8" wide, 3 3/4" high, 2" deep.

| TYPE | DESCRIPTION | PRICE |
|---------|---|---------|
| V-5MTC | V-5 VARIAC with 4 knockouts in box | \$24.00 |
| V-5MTE | V-5 VARIAC with 3-wire outlet box, 3-wire cord and plug, 2-pole switch | 33.50 |
| V-10MTC | V-10 VARIAC with 4 knockouts in box | 39.00 |
| V-10MTE | V-10 VARIAC with 3-wire outlet box, 3-wire cord and plug, 2-pole switch | 48.50 |

BASIC BOXES

| | | |
|--------|--|---------|
| TC BOX | Plain box with 4 BX knockouts, blank cover | \$ 3.50 |
| TE BOX | 3-wire outlet, 3-wire cord and plug, 2-pole switch | 13.50 |



GENERAL RADIO COMPANY

Cambridge 39,
Massachusetts

90 West St., New York 6 920 S. Michigan Ave., Chicago 5 1000 N. Seward St., Los Angeles 38