

# Proceedings



of the I·R·E

**A Journal of Communications and Electronic Engineering**

**May, 1950**

Volume 38

Number 5

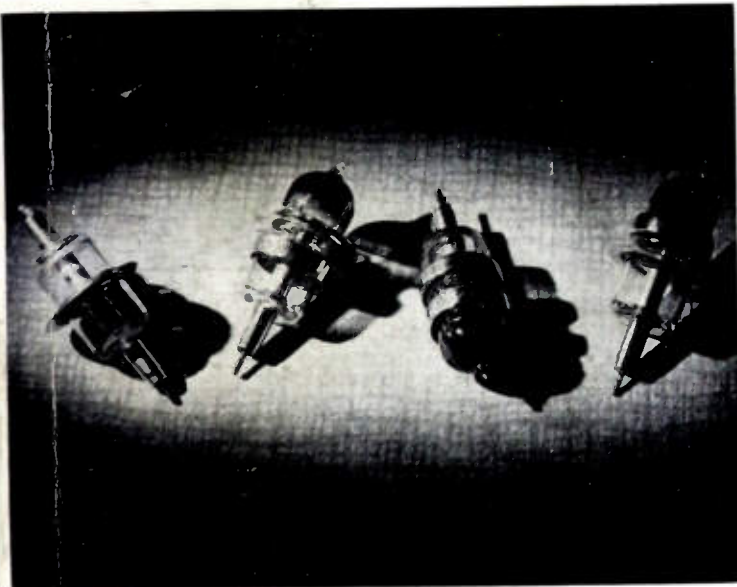

*Sylvania Electric Products Inc.*

## **ELECTRICAL PERFORMANCE BASED ON GEOMETRICAL COMPRESSION**

The planar grids in these triodes contribute to their operation up to frequencies of 3,000 megacycles per second.

The IRE Standards on Television: Methods of Measurement, of Television Signal Levels, Resolution, and Timing of Video Switching Systems, 19, appear in this issue.

### PROCEEDINGS OF THE I.R.E.

Radio Technical Commission for Aeronautics  
Developments in Studio Design  
Linear Amplifiers  
Magnetron-Type Traveling-Wave Tube  
Errors in a Telemetry System (Abstract)  
"Double-Layer" Projection Tube TV Screen  
Electrostatic Memory System  
Digital Computer Coincidence and Mixing Circuits  
Annular Circuits for VHF and UHF Generators  
A Dynamic Electron Trajectory Tracer  
Microphonism in a Planar Triode  
Propagation in a Curved Ionosphere  
Stability of the Cathode-Coupled Oscillator  
Simulating Propagation Problems  
TM-Mode Attenuator Design  
IRE Standards on Television  
Abstracts and References

TABLE OF CONTENTS, INDICATED BY BLACK-AND-WHITE  
MARGIN, FOLLOWS PAGE 32A

# The Institute of Radio Engineers



# NEW and *preferred* AMPEREX tubes

for **COMMUNICATIONS** and  
**INDUSTRIAL Applications**

High Frequency • High Power • Proven Life

*preferred*

**FOR HIGH FREQUENCY OPERATION to 150 Mc.**

*preferred*

**FOR GREATER EFFICIENCY**

High Pervience • Thoriated Filaments •  
Low Filament Inductance • Specially Coated Grids •  
Low Grid Lead Inductance

*preferred*

**ESPECIALLY IN GROUNDED GRID CIRCUITS—**

Minimized Filament-Plate Capacitance

*preferred*

**FOR ECONOMY**

Low Initial Cost • Low Operating Cost

**Types**  
**492/5757 and 492-R/5758**  
(water cooled) (air cooled)

|                                    |      |
|------------------------------------|------|
| Filament — Thoriated Tungsten      |      |
| Voltage .....                      | 5.0  |
| Current (Amps.) .....              | 110  |
| Amplification Factor .....         | 28   |
| Maximum Ratings —                  |      |
| Class "C" Telegraphy               |      |
| Plate Voltage .....                | 7500 |
| Plate Current (Amps.) .....        | 2    |
| Plate Dissipation (Kw.) .....      | 5    |
| Typical Power Output (Kw.) .....   | 8.5  |
| Frequency (Mc.) .....              | 100  |
| Efficiency .....                   | 75%  |
| Inter-electrode Capacitances (mmf) |      |
| Grid-Plate .....                   | 21   |
| Grid-Filament .....                | 30   |
| Plate-Filament .....               | 0.6  |

Detailed characteristic sheets available on request

**NEW!**

**TYPE**  
**501-R/5759**



Write for  
descriptive  
data sheets

**TYPE**  
**502-R/5761**



re-tube with  
**AMPEREX**

**AMPEREX ELECTRONIC CORP.**

25 WASHINGTON STREET, BROOKLYN 1, N. Y.

In Canada and Newfoundland: Rogers Majestic Limited  
11-19 Brentcliffe Road, Leaside, Toronto, Ontario, Canada

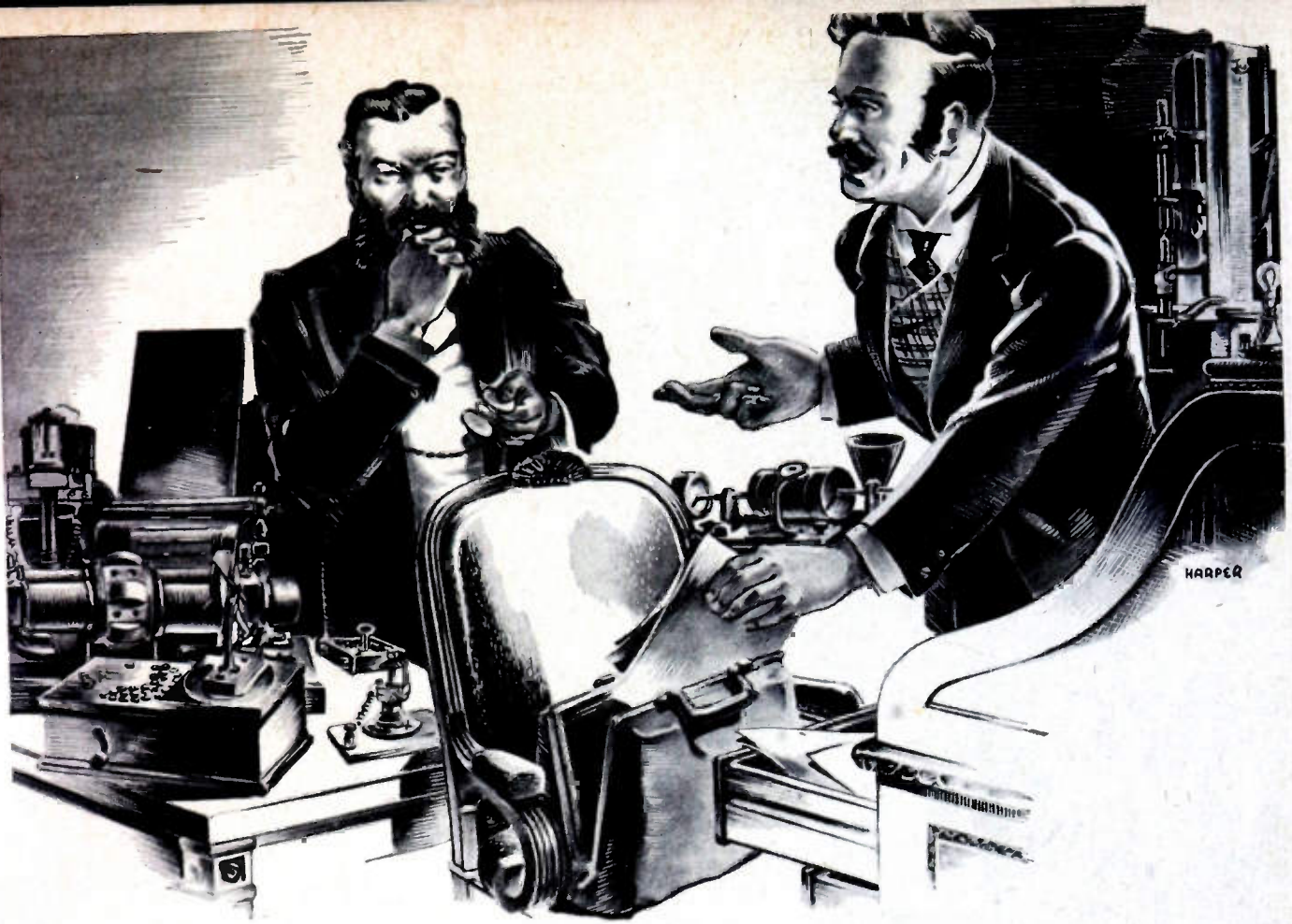

## The mistaken young man who quit the patent office . . .

Back in the 1880's, a young man quit the patent office. It was a perfectly good job except for one thing: There wasn't any future in it. You could, as he explained, walk through the place and see for yourself that just about every possible thing had been invented.

He was, of course, just as wrong then as he would be today almost seventy years later. In a world where nothing is impos-

sible and many things are still unknown, progress is limited largely by lack of imagination.

In electronics alone, a "normal" quarter of a century's development has been crowded into the past half dozen years. And patent requirements of this single industry probably equal the total work of the patent office when this mistaken young fellow resigned.

# SPRAGUE

**SPRAGUE ELECTRIC COMPANY**  
North Adams      Massachusetts

PIONEERS IN

ELECTRIC AND ELECTRONIC DEVELOPMENT

Sprague Telecaps<sup>®</sup>, the first truly practical phenolic molded paper tubulars, introduced a new era in trouble-free small capacitor performance, whether under "normal" or exceptionally difficult operating or "shelf" conditions.

<sup>®</sup>T.M. registered

Revolutionary new dry electrolytic capacitors to match television's exacting needs are another Sprague pioneering development. Conservatively rated up to 450 volts at 85°C., these long-life electrolytics are outstandingly stable.

Sprague Subminiature Paper Capacitors, hermetically sealed in metal cases with glass-to-metal solder-seal terminals, are designed to be as good as, and often better than, larger units.

PROCEEDINGS OF THE I.R.T.E. April, 1950, Vol. 38, No. 5. Published monthly by The Institute of Radio Engineers, Inc., at 1 East 79 Street, New York 21, N.Y. Price \$2.25 per copy. Subscriptions: United States and Canada, \$18.00 a year; foreign countries \$19.00 a year. Entered as second class matter, October 26, 1927, at the post office at Menasha, Wisconsin, under the act of March 3, 1879. Acceptance for mailing at a special rate of postage is provided for in the act of February 28, 1925, embodied in Paragraph 4, Section 412, P. L. and R., authorized October 26, 1927.

Table of Contents will be found following page 32A

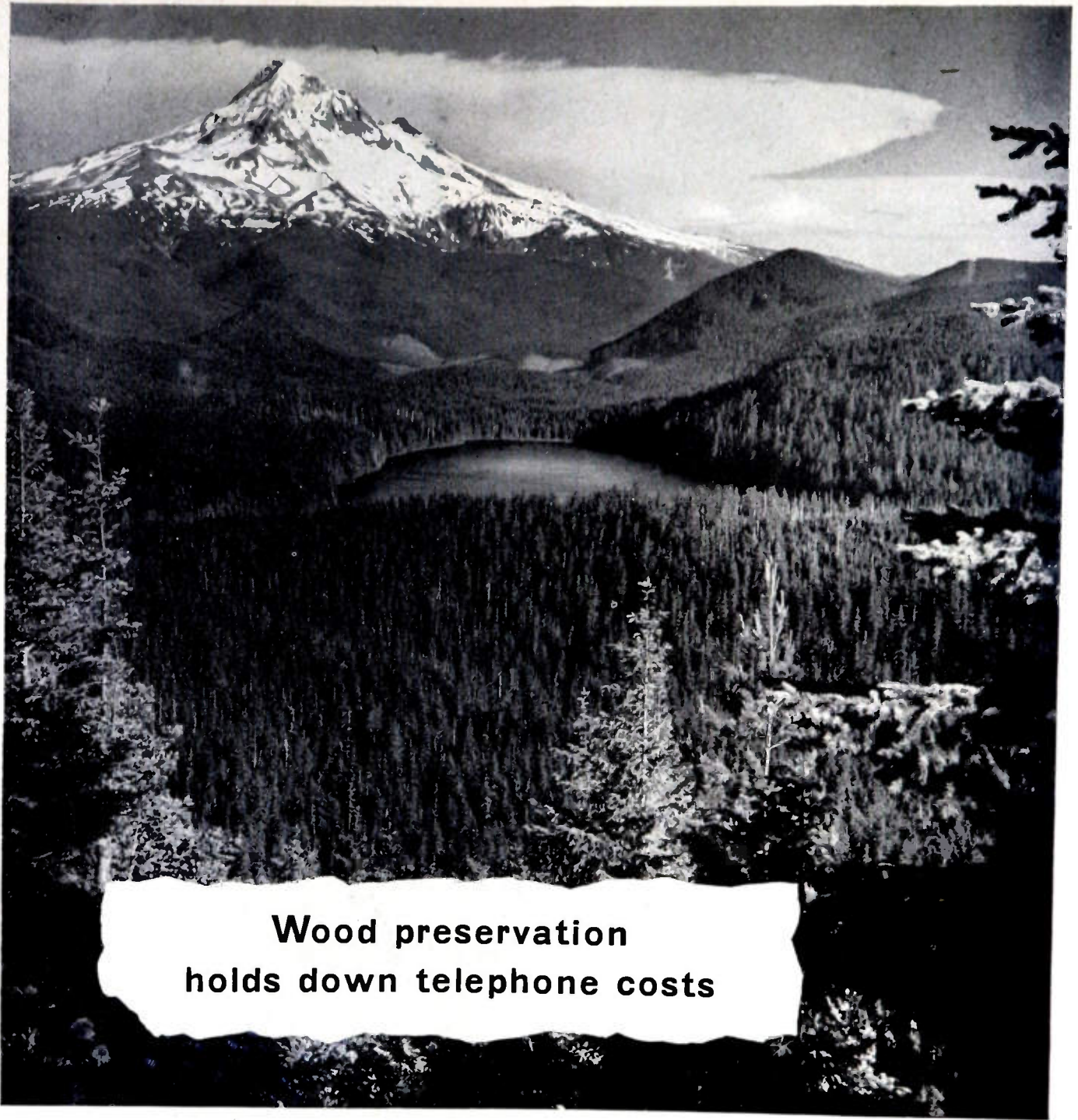

## Wood preservation holds down telephone costs

Poles are a substantial part of the plant that serves your telephone; making them last longer keeps down repairs and renewals that are part of telephone costs. So Bell Laboratories have long been active in the attack on wood-destroying fungi, the worst enemies of telephone poles.

Better, cleaner creosotes and other preservatives have been developed in co-operation with the wood-preserving industry. Research is now being carried out on greensalt—a new, clean, odorless

preservative. Even the products of atomic energy research have been pressed into service—radioactive isotopes are used to measure penetration of fluids into wood.

Treated poles last from three to five times as long as untreated poles. This has saved enough timber during the last quarter century to equal a forest of 25,000,000 trees. More than that, wood preservation has enabled the use of cheaper, quickly growing timber instead of the scarcer varieties.

This and other savings in pole-line

costs, such as stronger wires which need fewer poles, are some of the reasons why America's high-quality telephone service can be given at so reasonable a cost. It is one of today's best bargains.

**BELL TELEPHONE  
LABORATORIES**



*Exploring and Inventing, Devising and Perfecting, for Continued  
Improvements and Economies in Telephone Service.*

ZERO TO  
500 VOLTS  
AT  
200 MA



New **hp** Model 712A  
HIGH REGULATION POWER SUPPLY \$250

f. o. b. factory

**SPECIFICATIONS**

**OUTPUT VOLTAGES:**

- DC. High voltage. 0-500 volts (without switching) 200 ma. maximum load.
- DC. Bias voltage. 0-150 volts, 5 ma. maximum load.
- AC. Unregulated. 6.3 volts at 10 amps maximum load.

**REGULATION:**

- H.V. Better than 1/2% from no load to full load, 20 to 500 volts; or for line voltage, 105 to 125 volts.
- Bias. Better than 1% from no load to full load at maximum output voltage. Regulation at any other voltage depends on setting of voltage control. Internal impedance may be as high as 25,000 ohms.

**METERS:**

- Current Meter. 0-200 ma. (High voltage only.)
- Voltmeter. 2 ranges - 0-500 and 0-150 volts. Meter range may be switched to facilitate reading of high voltage output. 0-150 volt range may be switched to read bias output voltage.

**HUM:** Less than 8 mv.

**TERMINALS:**

- Either positive or negative high voltage terminal may be grounded. Positive terminal of bias supply is permanently connected to negative high voltage terminal.

**INPUT POWER:**

- Approximately 400 watts maximum at 105-125 volts, 50/60 cycles.

**OVERLOAD PROTECTION:**

- Load and line separately fused. Fuses available on front panel.

**MOUNTING:**

- Relay Rack Panel. Finish, -hp- grey. Detachable end pieces with hinged handles for table use, \$5.00 per pair.

**SIZE:** 10 1/2" x 19", 13" deep. Weight 60 lbs. Shipping weight 85 lbs.

**PRICE:** \$250.00 f.o.b. Palo Alto, California. Data Subject to Change Without Notice.

Continuously variable plate and bias voltages.

High stability, 1/2% regulation.

For laboratory, production work or industrial use, the new -hp- Model 712A is one of the most economical, convenient and broadly useful power supplies you can buy. It provides continuously variable regulated plate and bias direct current, as well as a 10 ampere, 6.3 volt alternating current for filament supply. It is a particularly useful power source for small transmitters, constant frequency oscillators, temporary set-ups or "breadboard" layouts. In nearly every application,

General purpose ac filament voltage.

Separate voltage and current meters.

the instrument's ease of operation and ability to meet many different power requirements saves valuable engineering time.

**CONSERVATIVE RATING**

The design of -hp- Model 712A is such that tubes operate well below manufacturer's rating, even under conditions of low output voltage and high current. Transformers are conservatively rated and only oil-filled condensers are employed to insure long, trouble-free service even under extreme operating conditions.

For details and demonstration, see your local Hewlett-Packard representative or write direct to the factory.

**HEWLETT-PACKARD COMPANY**

2057D Page Mill Road • Palo Alto, California

Export: FRAZAR & HANSEN, Ltd., 301 Clay Street, San Francisco, Calif., U. S. A. Offices: New York, N. Y. and Los Angeles, California

2087

**hp** laboratory instruments  
FOR SPEED AND ACCURACY

**Attenuators**

Electronic Tachometers  
Microwave Power Meters  
Tunable Bolometer Mounts  
Slotted Lines  
Standing Wave Indicators  
Low Pass Filters

**-hp- PRODUCTS:**

VHF and UHF Signal Generators  
Voltage Dividers, Multipliers and Shunts  
Electronic Frequency Meters  
FM and TV Broadcast Monitors  
Regulated Power Supplies  
Audio Frequency Oscillators

Audio Signal Generators  
Vacuum Tube Voltmeters  
Frequency Standards  
Square Wave Generators  
Wave Analyzers  
Distortion Analyzers  
Amplifiers



PRODUCED BY THE MILLIONS



HI-Q  
Engineering  
Laboratory



HI-Q Components

*-Under keenly competent engineering supervision*

# HI-Q COMPONENTS

Capacitors  
Trimmers • Choke Coils  
Wire Wound Resistors

**BETTER 4 WAYS**

- ✓ PRECISION
- ✓ UNIFORMITY
- ✓ DEPENDABILITY
- ✓ MINIATURIZATION

● The engineering laboratory is the alert guardian of **HI-Q** quality. No component can be put into production until it has proven that it meets **HI-Q's** exacting standards to the complete satisfaction of these technicians. It is their further responsibility to see that standards are rigidly maintained during production runs. In addition, **HI-Q** engineers are always available to work with your engineers in the development of components to meet your specific needs. Feel free to call on them whenever and as often as you see fit.

*Don't miss the brand new **HI-Q** Datalog. If you haven't received your copy, write to-day.*

JOBBERS — ADDRESS: 740 Belleville Ave., New Bedford, Mass.

# HI-Q

*Electrical Reactance Corp.*  
FRANKLINVILLE, N. Y.

SALES OFFICES: New York, Philadelphia,  
Detroit, Chicago, Los Angeles

PLANTS: Franklinville, N. Y., Jessup, Pa.,  
Myrtle Beach, S. C.

EXPORT ADDRESS: 41 E. 42nd St., New York 17, N. Y., U. S. A.

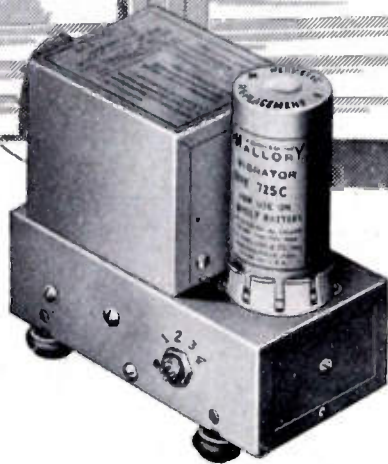
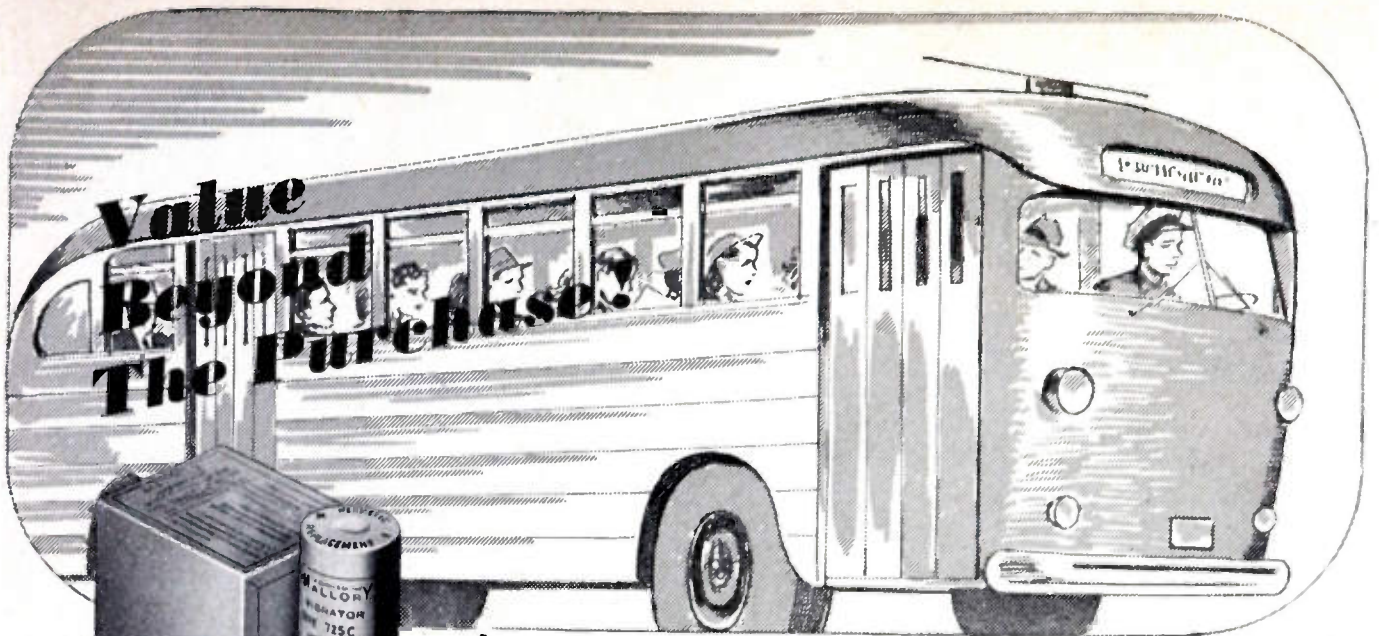

## MALLORY VIBRATORS

Mallory Vibrators and Vibrapack power supplies are based on exclusive design and manufacturing methods that assure long, trouble-free service. Send the details of your application. Get Mallory's recommendation on the Vibrator or Vibrapack power supply best suited to your needs.

## Mallory Vibrapacks\* Replace Costly Power Supply System *Effect Tremendous Savings!*

In one typical case, a simple and inexpensive circuit modification, developed by Mallory, made it possible for a manufacturer of mobile radio receivers to substitute Vibrapacks for a costly and less efficient power supply system. The conversion saved this Mallory customer \$40,000 in the first year! In addition, thousands of dollars are being saved in maintenance costs. Servicing the old system required hours of labor . . . the new one requires only occasional replacement of the vibrator.

When you buy Mallory vibrator equipment you benefit by a winning combination of dependability, economical performance and creative engineering.

*That's value beyond the purchase!*

And whether your problem is electronic or metallurgical, what Mallory has done for others can be done for you!

### Vibrators and Vibrapack Power Supplies

P. R. MALLORY & CO., Inc.  
**MALLORY**

P. R. MALLORY & CO., Inc., INDIANAPOLIS 6, INDIANA

#### SERVING INDUSTRY WITH

|                    |           |
|--------------------|-----------|
| Capacitors         | Contacts  |
| Controls           | Resistors |
| Rectifiers         | Vibrators |
| Special            | Power     |
| Switches           | Supplies  |
| Resistance Welding | Materials |

*\*Reg. U.S. Pat. Off.*





QUALITY . . . Plus ADAPTABILITY

## CLEVELAND

COSMALITE\* AND CLEVELITE\* SPIRALLY LAMINATED PAPER BASE PHENOLIC TUBES

Cosmalite is known for its many years of high quality performance. Clevelite is the new improved tubing designed to meet more exacting specifications.

"Cleveland" has an enviable record of service and dependability. Your orders receive prompt attention. Deliveries are made in time for your production schedules.

For the best . . . "Call Cleveland." Samples on request.

\*Trade Marks

Of Proven Performance in the Radio and Television fields.

Excellent for Motors, Relays, Transmitters, Fans, Controls, Switches, Bobbins, and many others.

*The* **CLEVELAND CONTAINER Co.**  
6201 BARBERTON AVE. CLEVELAND 2, OHIO

PLANTS AND SALES OFFICES at Plymouth, Wisc., Chicago, Detroit, Ogdensburg, N.Y., Jamesburg, N.J.  
ABRASIVE DIVISION at Cleveland, Ohio  
CANADIAN PLANT: The Cleveland Container, Canada, Ltd., Prescott, Ontario

REPRESENTATIVES

CANADA  
METROPOLITAN }  
NEW YORK }  
NEW ENGLAND }

WM. T. BARRON, EIGHTH LINE, RR #1, OAKVILLE, ONTARIO  
R. T. MURRAY, 614 CENTRAL AVE., EAST ORANGE, N.J.  
E. P. PACK AND ASSOCIATES, 968 FARMINGTON AVE.  
WEST HARTFORD, CONN.



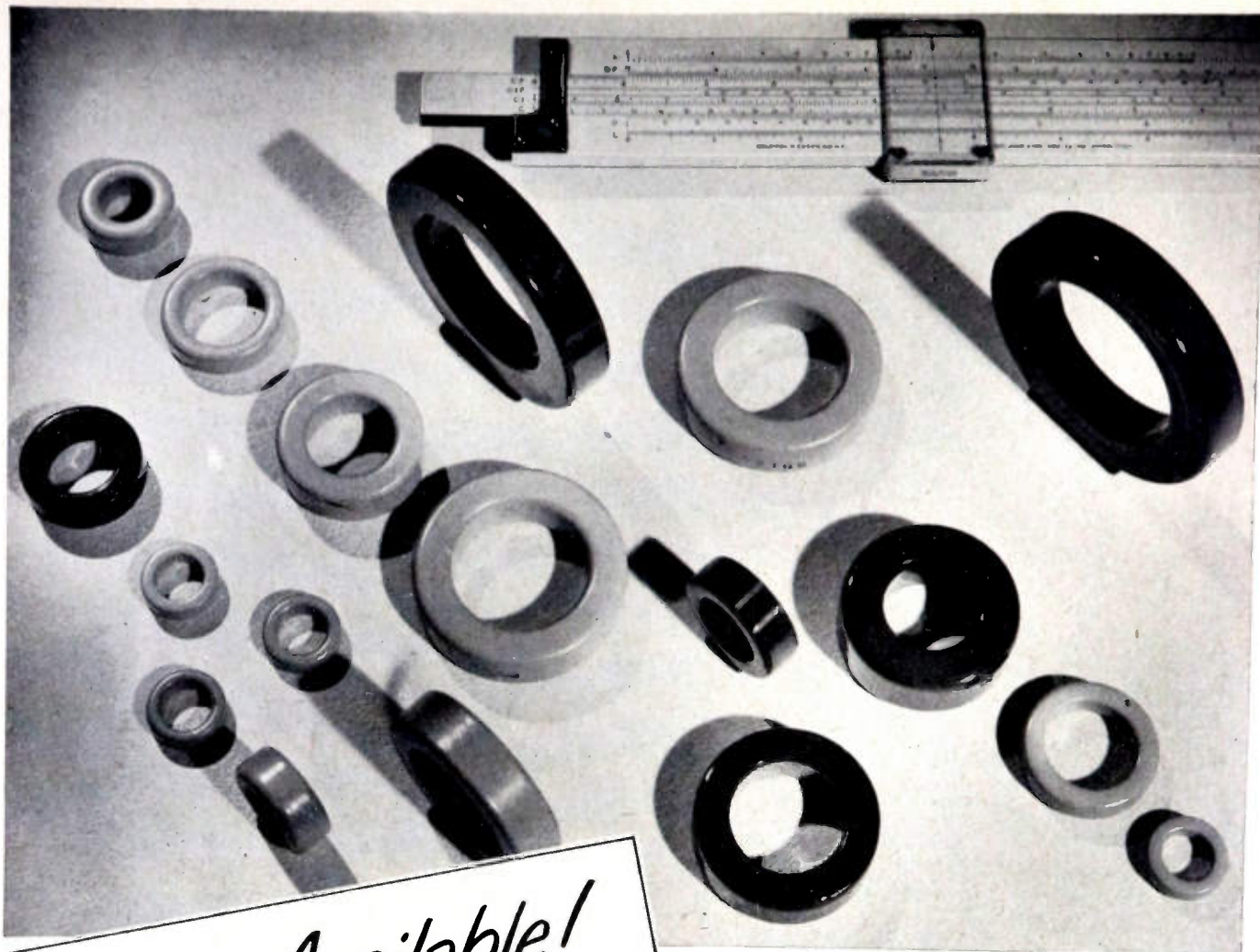

*Now Available!*  
**MOLYBDENUM PERMALLOY  
 POWDER CORES\***

**HIGH Q TOROIDS** for use in  
 Loading Coils, Filters, Broadband  
 Carrier Systems and Networks—  
 for frequencies up to 200 K C

**COMPLETE LINE OF CORES  
 TO MEET YOUR NEEDS**

- ★ Furnished in four standard permeabilities—125, 60, 26 and 14.
- ★ Available in a wide range of sizes to obtain nominal inductances as high as 281 mh/1000 turns.
- ★ These toroidal cores are given various types of enamel and varnish finishes, some of which permit winding with heavy Formex insulated wire without supplementary insulation over the core.

For high Q in a small volume, characterized by low eddy current and hysteresis losses, ARNOLD Moly Permalloy Powder Toroidal Cores are commercially available to meet high standards of physical and electrical requirements. They provide constant permeability over a wide range of flux density. The 125 Mu cores are recommended for use up to 15 kc, 60 Mu at 10 to 50 kc, 26 Mu at 30 to 75 kc, and 14 Mu at 50 to 200 kc. Many of these cores may be furnished stabilized to provide constant permeability ( $\pm 0.1\%$ ) over a specific temperature range.

*\* Manufactured under licensing arrangements with Western Electric Company.*

W 40 2930

**THE ARNOLD ENGINEERING COMPANY**  
 SUBSIDIARY OF ALLEGHENY LUDLUM STEEL CORPORATION  
 147 EAST ONTARIO STREET, CHICAGO 11, ILLINOIS



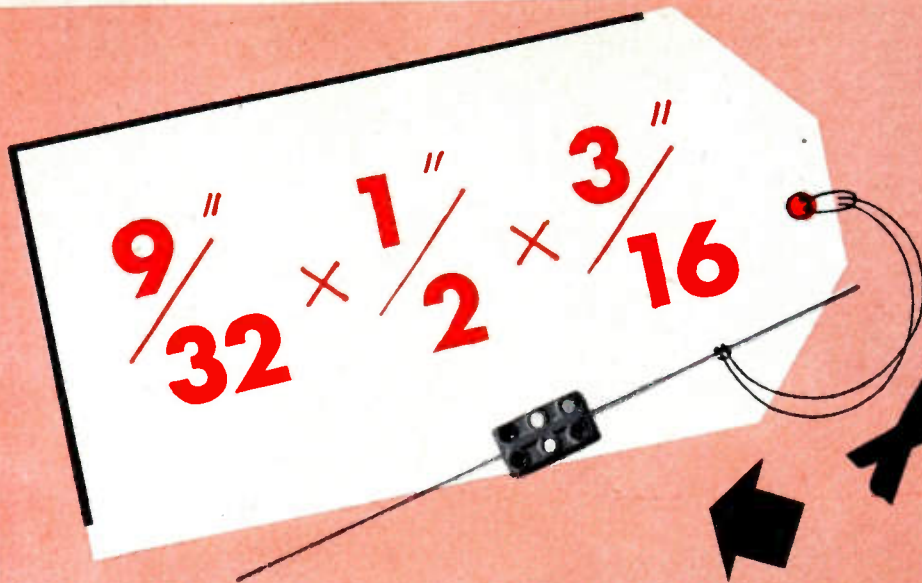

**ACTUAL  
SIZE**

**EL-MENCO CAPACITOR - CM-15**

*Miniature*

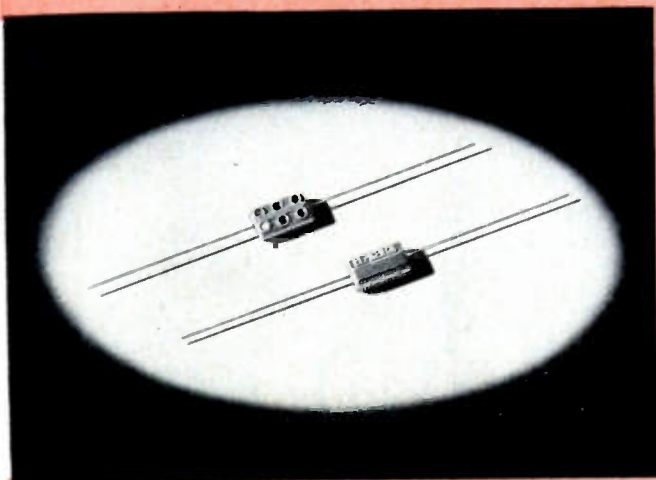

**CM 15 MINIATURE CAPACITOR**

Actual Size  $9/32'' \times 1/2'' \times 3/16''$   
 For Television, Radio and other Electronic  
 Applications  
 2 — 420 mmf. cap. at 500v DCw  
 2 — 525 mmf. cap. at 300v DCw  
 Temp. Co-efficient  $\pm 50$  parts per million  
 per degree C for most capacity values.  
 6-dot color coded.

**MANUFACTURERS WHO MAINTAIN  
 REPUTATIONS for high-quality  
 electrical equipment, demand  
 and get high-quality  
 El-Menco capacitors.**

**THE  
 ELECTRO MOTIVE MFG. CO., Inc.**  
 WILLIMANTIC CONNECTICUT



*Write on your  
 firm letterhead for  
 Catalog and Samples*

**MOLDED MICA** **El-Menco** **MICA TRIMMER**  
**CAPACITORS**

FOREIGN RADIO AND ELECTRONIC MANUFACTURERS COMMUNICATE DIRECT WITH OUR EXPORT DEPT. AT WILLIMANTIC, CONN. FOR INFORMATION.  
**ARCO ELECTRONICS, INC.** 135 Liberty St., New York, N. Y. - Sole Agent for Jobbers and Distributors in U.S. and Canada



# Designers

where  
timing  
is  
everything

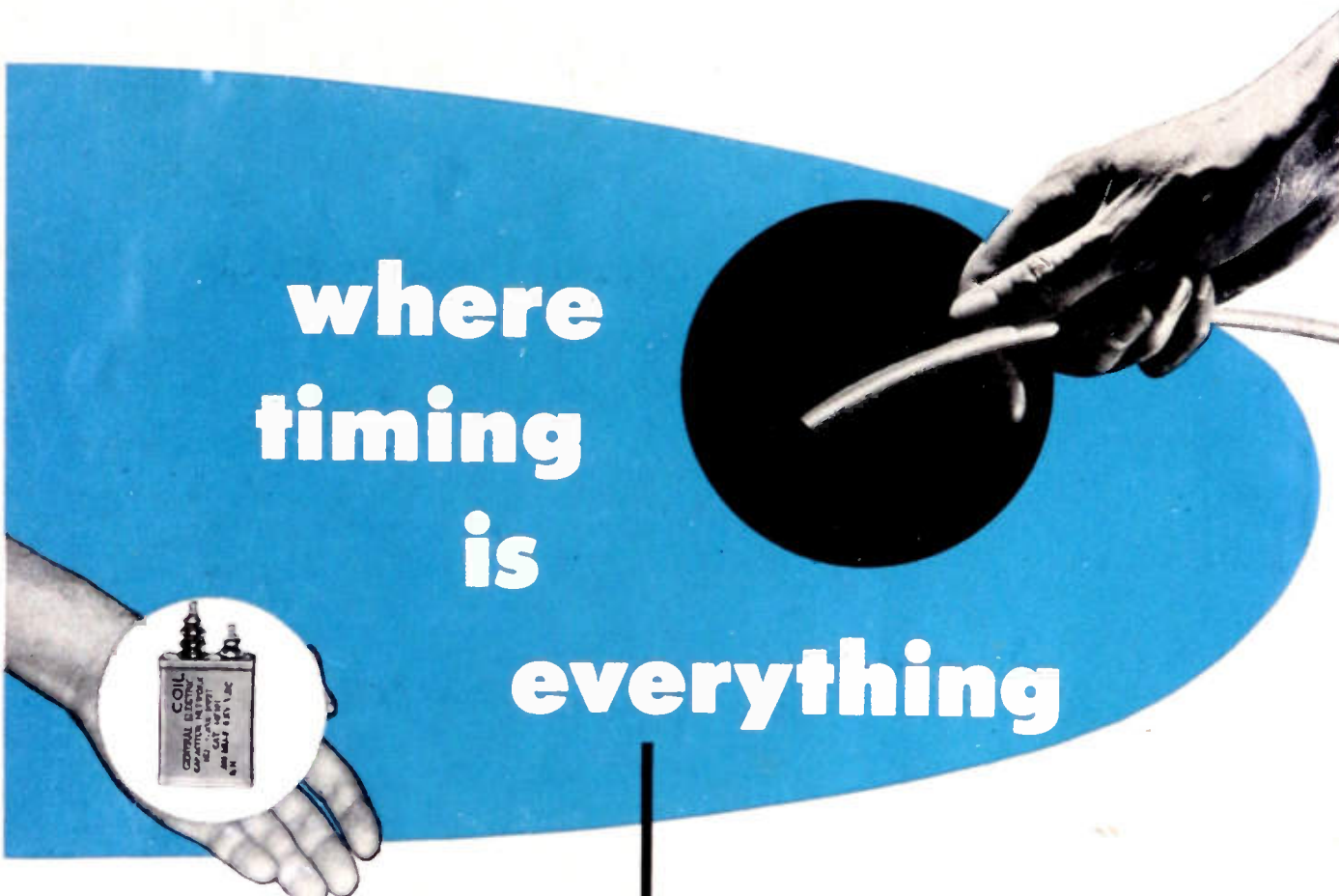

### NEW! MIDGET, HIGH-TEMPERATURE PULSE-FORMING NETWORKS

Here's a new, extremely compact and lightweight capacitor pulse-forming network that will operate at temperatures up to 120° C! With a volume of 6 cubic inches, it's just about one third the size of a conventional network with the same rating (6E2-.5-2000-50-P2T).

The life expectancy of this 6-kv unit ranges from 3.5 hours at 80° C ambient to 1 hour at 110°. A second new network twice this size has a life of about 330 hours at 100° C—9 hours at 120° C. If you want more data on these new units, write *Capacitor Sales Division, General Electric Company, Pittsfield, Mass.*

### DELAY LINES—BY THE FOOT

These G-E delay lines provide a means for delaying signals with a band-width up to 2-megacycles for any time interval from .25 to 10.00 microseconds. They are available in bulk form in lengths up to 100 feet—delay equals approximately 1/2 microsecond per foot. Characteristic impedances of 1100 and 400 ohms per foot are available. Since the line is very flexible, it may be bent into 4-inch diameter coils.

Ordering line in bulk form makes it possible for you to cut it to the exact length required for your particular application. For complete ratings and specifications, see Bulletin GEC-459.

GENERAL  ELECTRIC

# Digest

## TIMELY HIGHLIGHTS ON G-E COMPONENTS

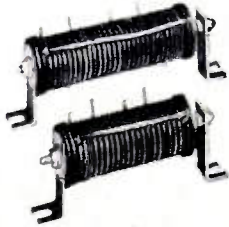

### MORE COMPACT RECTIFIER STACKS

If your requirements call for compact selenium stacks for operation in cramped quarters, these new, higher-voltage G-E selenium cells may be your answer. Their 18-volt d-c output means you can design stacks which are about 25% smaller than possible with 12-volt cells. The improved aging characteristics of these cells is made possible by a new G-E evaporation process which deposits selenium on aluminum with greater uniformity. Stacks are available with rated outputs of 18 to 126 d-c volts at 0.15 to 1.20 amperes with inputs of 23 to 180 a-c volts. See Bulletin GEA-5280.



### TIME METERS—TO CHECK TUBE LIFE

G-E time meters, with dependable Telechron\* motor drive, are especially useful in recording the operating time of radio transmitters or other electronic devices so that tubes may be replaced before they fail. They record operating time in hours, tenths of hours, or minutes, and are supplied for 11-, 115-, 230-, or 460-volt operation. The case is of molded textolite to harmonize with other G-E 3½-inch instruments mounted on the same panel. You'll find more description along with dimensions and pricing information in Bulletin GEC-472.

\*Reg. U.S. Pat. Off.



### NEW! WATER-FLOW INTERLOCK

This new G-E flow interlock provides sure protection against overheating in water-cooled components such as tubes, transformers, and dynamotors. Its function is to open the electrical circuit when water flow is lower than a preset minimum and close it when flow is above this point.

Adjustment can be made to actuate the electrical contact for any flow between 1 gallon per minute and 4 gallons per minute. The cut-in, cut-out differential of the unit is 0.2 gpm. The electrical circuit is rated at 10 amperes at 125 volts a-c, 5 amperes at 250 volts a-c and 3 amperes at 460 volts a-c. Maximum water-line pressure rating is 125 pounds per square inch. The unit is bronze with standard ½-inch fittings and is easy to install and adjust. For further description see Bulletin GEC-411.



### NEW! BATTERY-OPERATED VTVM

This new G-E battery-operated electronic voltmeter combines the portability of an ordinary low-sensitivity multimeter with the high sensitivity and versatility of a line-voltage-operated vacuum-tube voltmeter.

Its weight is only 4 pounds (with batteries), its size—3"x6"x8", but it measures a-c and d-c voltage in 7 ranges from 0-1 to 0-1000 volts, d-c current in 4 ranges from 0-1 to 0-1000 milliamperes, resistance in 5 ranges from 100 ohms to 10 megohms, mid-scale value.

D-c input impedance is 11 megohms on all ranges. A-c input impedance is 0.5 megohm shunted with 20 mmf on all ranges. Frequency response is flat within 5 per cent up to 15,000 cycles on all up to and including the 0-100-volt range. More data in Bulletin GEC-622.

General Electric Company, Section B667-5  
Apparatus Department  
Schenectady 5, N. Y.

Please send me the following bulletins:

(Indicate:  for reference only;  for planning an immediate project)

- |   |   |
|---|---|
| <input type="checkbox"/> GEA-5280 Selenium rectifiers | <input type="checkbox"/> GEC-472 Time meters          |
| <input type="checkbox"/> GEC-411 Flow Interlock       | <input type="checkbox"/> GEC-622 Electronic voltmeter |
| <input type="checkbox"/> GEC-459 Delay lines          |   |

NAME .....

COMPANY .....

ADDRESS .....

CITY ..... STATE .....

# WOW-TV-Land is a Big Market

## Served through a Truscon Radio Tower



Radio Station WOW-TV Omaha, Nebraska, serves a market of 764,400 people with total retail sales of nearly a billion dollars.

No other station covers the area comprising the rich, urban and rural market known as WOW-TV-Land. For this exclusive and effective coverage, WOW-TV uses a Truscon Self-Supporting Radio Tower 392 feet high, with an RCA double antenna for FM and TV giving an overall height of 500 ft.



*Another*  
**TRUSCON**  
**TOWER OF STRENGTH**  
**500 FT.**  
**HIGH**  
**OVERALL**

- The characteristics of terrain and meteorological conditions which are individual with WOW-Land received special consideration when Truscon radio engineers designed this handsome tower. Truscon offers a world-wide background of experience to call upon in fitting Radio Towers to specific needs. Whether your own plans call for new or enlarged AM, FM or TV transmission, Truscon will assume all responsibility for tower design and erection . . . tall or small . . . guyed or self-supporting . . . tapered or uniform in cross-section. Your phone call or letter to our home office in Youngstown, Ohio—or to any convenient Truscon District Service Office—will rate immediate, interested attention . . . and action. There is no obligation on your part, of course.

### TRUSCON STEEL COMPANY

YOUNGSTOWN 1, OHIO

Subsidiary of Republic Steel Corporation

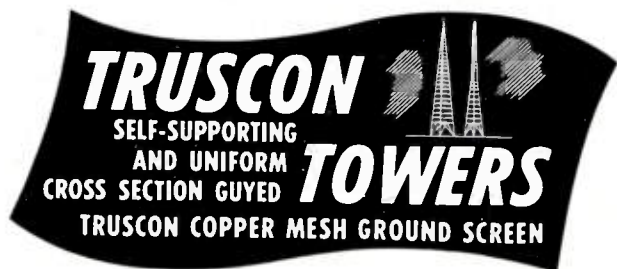

# You can use black magic to make it fit...

"SEEMS LIKE  
THERE OUGHT  
TO BE AN  
EASIER WAY!"

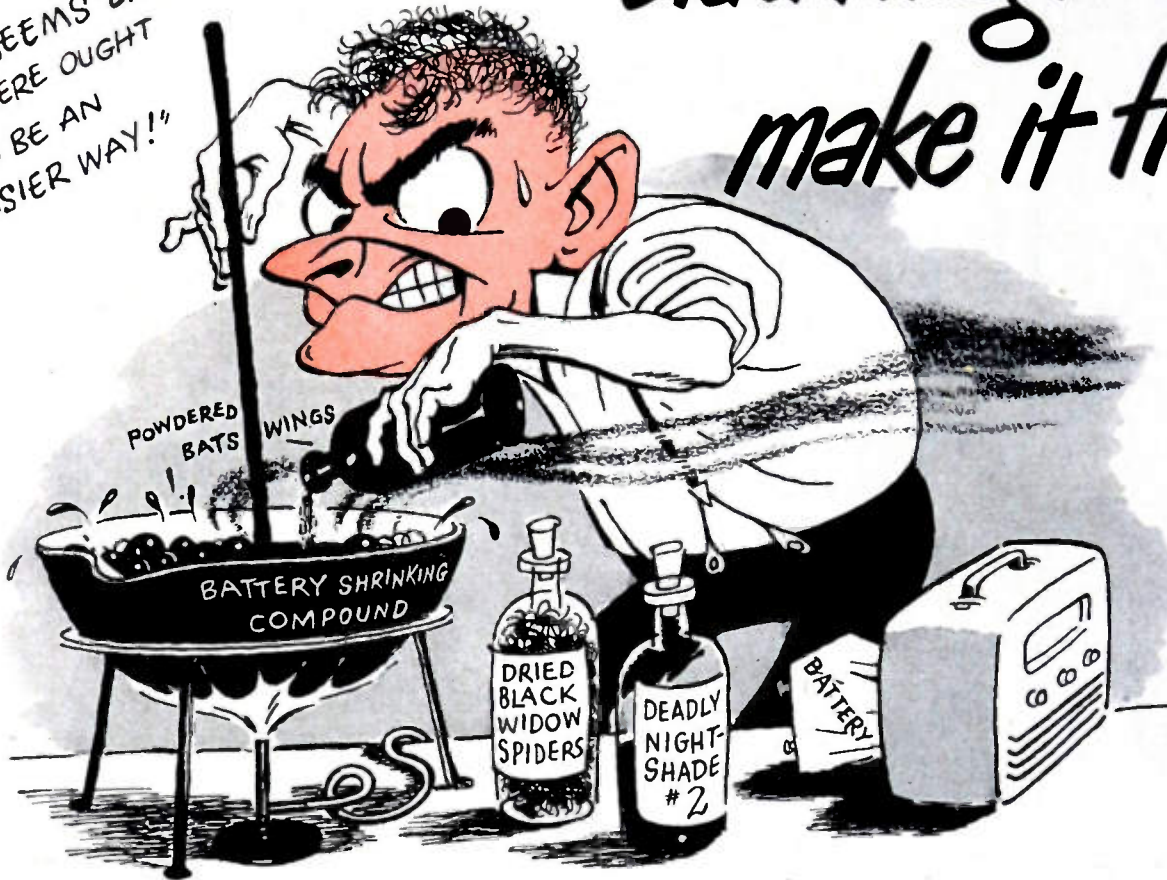

**BUT** it's simpler  
to design the  
radio around  
the battery!

There's no black magic about "Eveready" brand radio batteries. They are specified by many leading radio designers because they provide the utmost in performance, and can be readily obtained by the users when replacements are necessary.

Design your portable receivers around "Eveready" radio batteries! These powerful, long-lasting batteries come in a complete range of sizes to fit virtually any design you may have in mind. Call on our Battery Engineering Department for complete details.

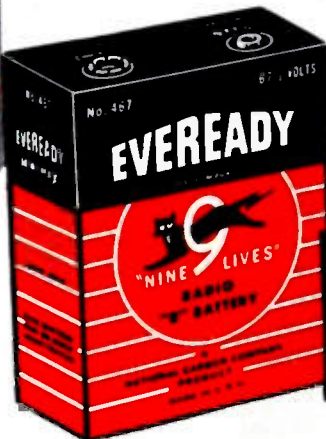

"Eveready" No. 950 "A" batteries and the No. 467 "B" battery make an ideal combination for small portable receivers.

"Eveready", "Mini-Max", "Nine Lives" and the Cat Symbol are trade-marks of  
**NATIONAL CARBON DIVISION**  
UNION CARBIDE AND CARBON CORPORATION  
30 East 42nd Street, New York 17, N. Y.

District Sales Offices: Atlanta, Chicago, Dallas,  
Kansas City, New York, Pittsburgh, San Francisco

**EVEREADY**  
TRADE-MARK  
RADIO BATTERIES

# It is Our Privilege to serve the Leaders

**THIS FREE BOOK** — fully illustrated, with performance charts and application data — will help any radio engineer or electronics manufacturer to step up quality, while saving real money. Kindly address your request to Dept. 16.



## ANTARA® PRODUCTS

**GENERAL**  
**GA** NILINE & FILM CORPORATION

444 MADISON AVENUE  
NEW YORK 22, N. Y.

# G A & F® Carbonyl



**Manufacturers of**

**CARBONYL IRON POWDER CORES**

*( THE CORE IS THE HEART OF THE CIRCUIT )*

**Aladdin Radio Industries, Inc.**  
*Chicago, Illinois*

**Henry L. Crowley & Company, Inc.**  
*West Orange, New Jersey*

**Delco Radio Division**  
*General Motors Corporation*  
*Kokomo, Indiana*

**Lenkurt Electric Co., Inc.**  
*San Carlos, California*

**Magnetic Core Corporation**  
*Ossining, New York*

**National Moldite Company**  
*Hillside, New Jersey*

**Powdered Metal Products Corporation**  
*of America*  
*Franklin Park, Illinois*

**Pyroferric Company**  
*New York, New York*

**Radio Cores, Inc.**  
*Oak Lawn, Illinois*

**RCA Victor Division**  
*Radio Corporation of America*  
*Camden, New Jersey*

**Speer Resistor Corporation**  
*St. Marys, Pennsylvania*

**Stackpole Carbon Company**  
*St. Marys, Pennsylvania*

**Iron Powders . . .**



*A page from the note-book of Sylvania Research*

## Better Tubes through Research in filamentary wire

**S**YLVANIA'S continuous research means better electronic tubes. For example, with the special research tool shown at the right the minute stretch or "creep" of filament wires is studied under the same conditions of temperature, vacuum and pressure found in electronic tubes. Using this instrument, Sylvania engineers have uncovered many new facts about filamentary alloys. From studies such as this Sylvania is able to give you better tubes of longer life and higher quality.



*This vacuum "creep" furnace is a typical example of Sylvania's ingenuity in research for better and still better products.*

# SYLVANIA ELECTRIC

RADIO TUBES; TELEVISION PICTURE TUBES; ELECTRONIC PRODUCTS; ELECTRONIC TEST EQUIPMENT; FLUORESCENT LAMPS, FIXTURES, SIGN TUBING, WIRING DEVICES; LIGHT BULBS; PHOTOLAMPS; TELEVISION SETS

# COMPONENTS FOR EVERY APPLICATION



**LINEAR STANDARD**  
High Fidelity Ideal



**HIPERM ALLOY**  
High Fidelity . . . Compact



**ULTRA COMPACT**  
Portable . . . High Fidelity



**OUNCER**  
Wide Range . . . 1 ounce

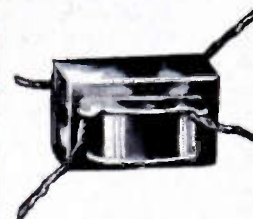

**SUB OUNCER**  
Weight 1/3 ounce



**COMMERCIAL GRADE**  
Industrial Dependability



**SPECIAL SERIES**  
Quality for the "Ham"



**POWER COMPONENTS**  
Rugged . . . Dependable



**VARITRAN**  
Voltage Adjustors



**MODULATION UNITS**  
One watt to 100KW



**VARIABLE INDUCTOR**  
Adjust like a Trimmer



**TOROID HIGH Q COILS**  
Accuracy . . . Stability



**TOROID FILTERS**  
Any type to 300KC



**MU-CORE FILTERS**  
Any type 1/2 - 10,000 cyc.

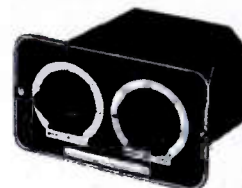

**EQUALIZERS**  
Broadcast & Sound



**PULSE TRANSFORMERS**  
For all Services



**HERMETIC COMPONENTS**  
Ceramic Terminals



**HERMETIC COMPONENTS**  
Glass Terminals



**GRADE 3 JAN**  
Components



**CABLE TYPE**  
For mike cable line

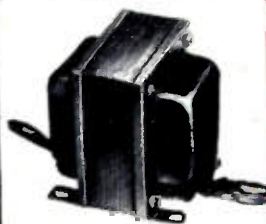

**VERTICAL SHELLS**  
Husky . . . Inexpensive



**REPLACEMENT**  
Universal Mounting



**STEP-DOWN**  
Up to 2500W . . . Stock



**LINE ADJUSTORS**  
Match any line voltage

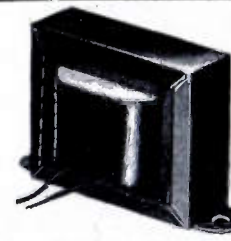

**CHANNEL FRAME**  
Simple . . . Low cost

*United Transformer Co.*  
150 VARICK STREET NEW YORK 13, N. Y.  
EXPORT DIVISION: 13 EAST 40th STREET, NEW YORK 16, N. Y. CABLES: "ARLAB"

# ANNOUNCING

EIMAC TUBE TYPE

# 2C39A\*



PLANAR CONSTRUCTION  
HIGH-MU TRIODE



## GENERAL CHARACTERISTICS

### ELECTRICAL

Cathode: Coated Unipotential  
 Heater Voltage - - - 6.3 volts  
 Heater Current - - - 1.0 amperes  
 Amplification Factor (Average) - - - 100  
 Direct Interelectrode Capacitances (Average)  
 Grid-Plate - - - 1.95  $\mu$ fd.  
 Grid-Cathode - - - 6.50  $\mu$ fd.  
 Plate-Cathode - - - 0.035  $\mu$ fd.

Transconductance  
 ( $i_b = 70$  ma.,  $E_b = 600$  v.) (Average) 22,000  $\mu$ mhos

### RADIO FREQUENCY POWER AMPLIFIER

Class-C FM Telephony or Telegraphy  
 (key-down conditions, 1 tube)

#### Maximum Ratings

|                                |       |                 |
|--------------------------------|-------|-----------------|
| D-C Plate Voltage              | - - - | 1000 Max. Volts |
| D-C Cathode Current            | - - - | 125 Max. Ma.    |
| D-C Grid Voltage               | - - - | -150 Max. Volts |
| Peak Positive R-F Grid Voltage | - - - | 30 Max. Volts   |
| Peak Negative R-F Grid Voltage | - - - | -400 Max. Volts |
| Plate Dissipation              | - - - | 100 Max. Watts  |
| Grid Dissipation               | - - - | 2 Max. Watts    |

The new Eimac 2C39A triode is the culmination of over five years of research and application engineering. It is the outgrowth of earlier types 2C38 and 2C39.

Its high performance standards make it the standout triode for VHF and UHF CW service, pulse service and aircraft navigational systems.

As a power amplifier, oscillator, or frequency multiplier, this small high-mu triode exhibits excellent characteristics from low frequencies to above 2500 megacycles.

Let us send you complete data and application notes on the new Eimac 2C39A triode . . . then consider the advantages it offers in the design of compact, moderate power-output equipment.

*\*Conforms with newly issued JAN specifications.*

**EITEL-McCULLOUGH, INC.**  
**San Bruno, California**

Export Agents: Frazer & Hansen, 301 Clay St., San Francisco, California

Follow the Leaders to

*Eimac*  
**TUBES**

The Power for R-F

## Another Engineering Achievement by Eimac

# The Right Switches... at the Right Price...

to modernize your product and  
to enhance its "saleability"

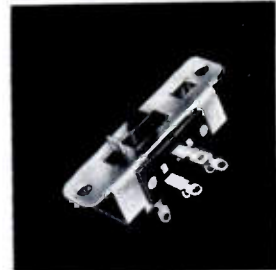
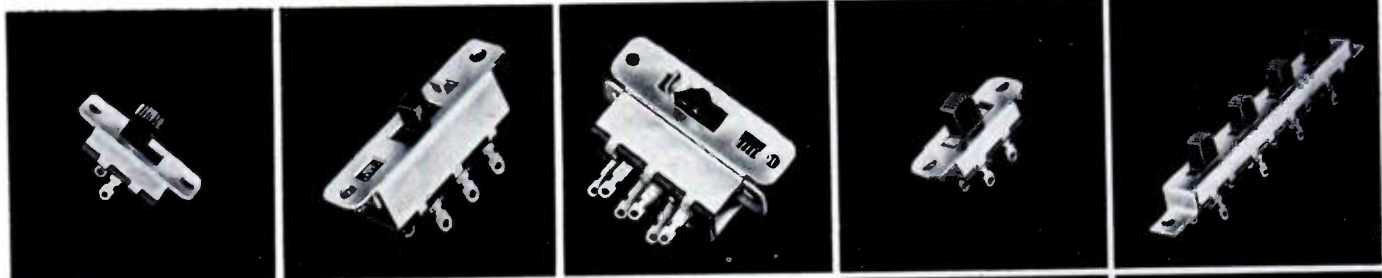

**NEW!**  
Two slide switches rated  
1 ampere at 125 volts DC  
3 amperes  
at 125 volts AC

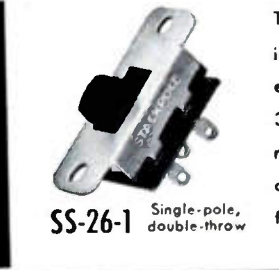
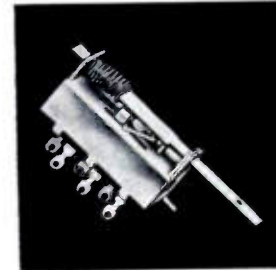
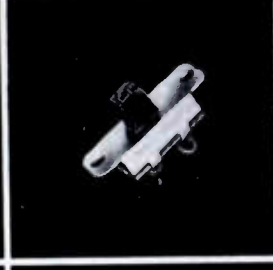

These sturdy little switches are  
ideal for appliances, toys and  
electrical equipment requiring  
3-ampere switch contact car-  
rying capacity. Both are Un-  
derwriters approved. Write  
for SS-26 Switch Bulletin.

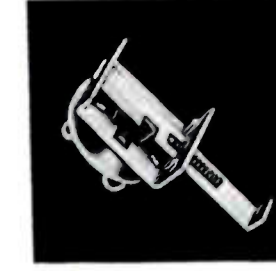
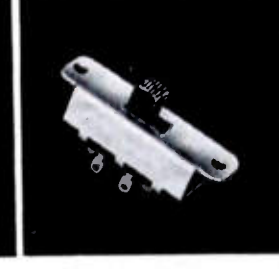
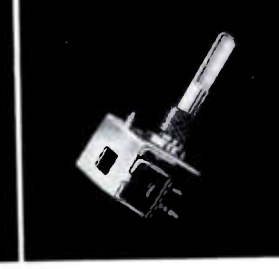
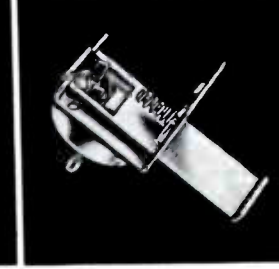
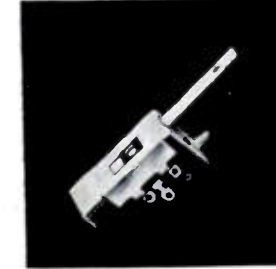
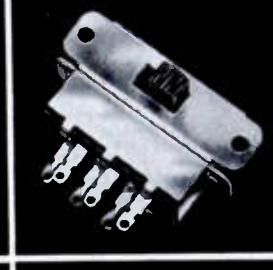
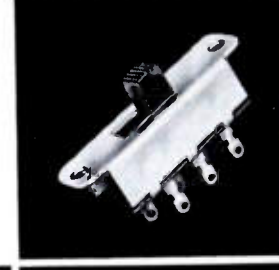

**LINE OR SLIDE ACTION**  
**Dozens of Contact Arrangements**

Inexpensive types are available for practically any switching  
requirement and at prices that will please you. Samples to speci-  
fications on request to quantity users. Write for Stackpole Switch  
Bulletin RC7C.

Fixed and Variable Resistors  
Iron Cores • Alnico II Perma-  
nent Magnets ...

ELECTRONIC COMPONENTS DIVISION,  
**STACKPOLE CARBON CO. St. Marys, Pa.**

... and hundreds of molded  
iron powder, metal, carbon  
and graphite products.

# STACKPOLE

# Sheldon LIFE TESTS *Insure*

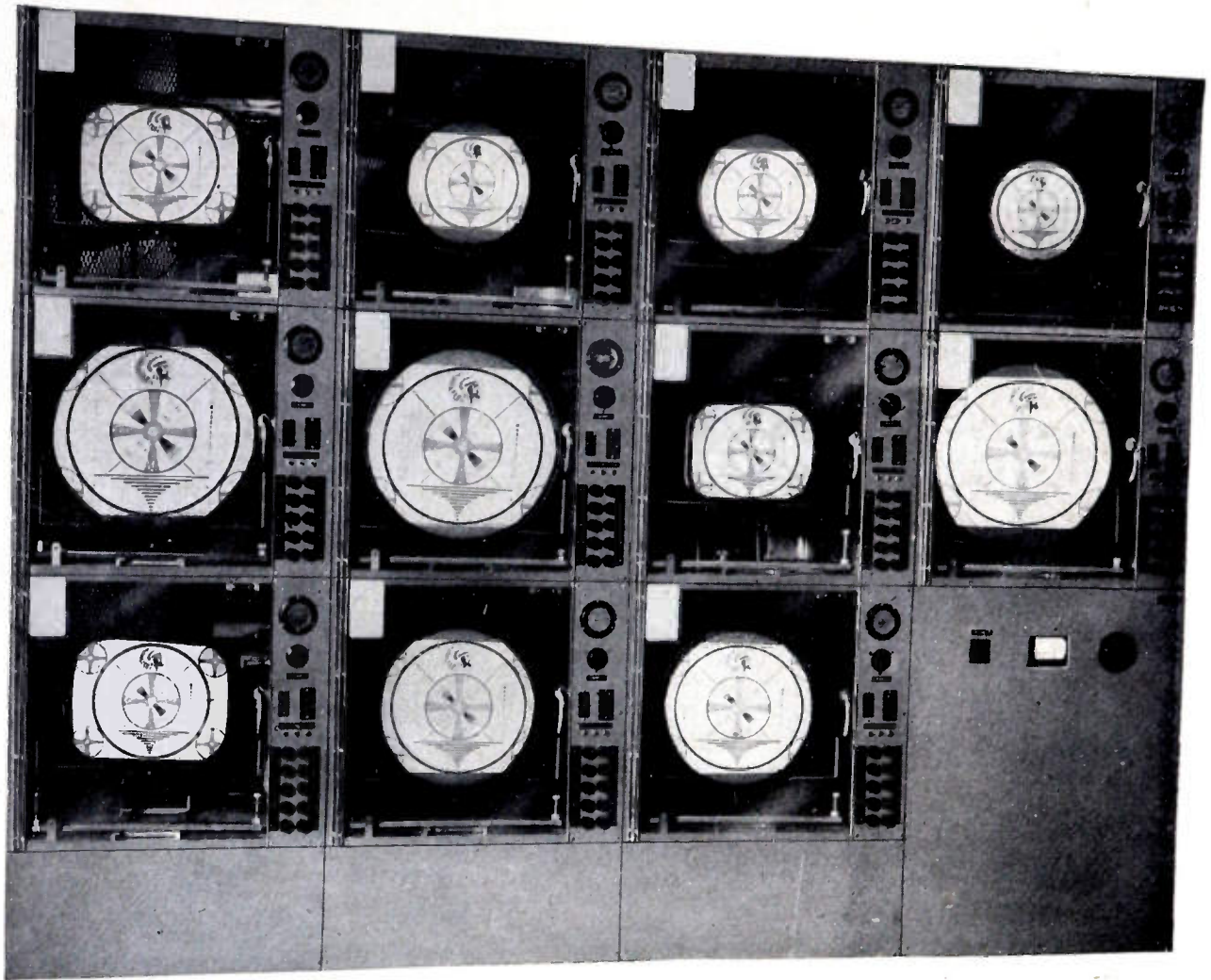

## CONSISTENT PICTURE TUBE PERFORMANCE

Each Sheldon "Telegenic" Picture Tube is subjected to 23 specific quality-control tests and inspections before shipment. As a "guardian" over all tube production, a percentage of Sheldon Picture Tubes are picked at random from each "run." They are put on life-test in the specially-designed equipment shown above. Each tube is operated under identical electrical and

mechanical conditions. The resulting, automatically-recorded data is another aid to Sheldon engineers in maintaining the consistently outstanding quality of Sheldon Telegenic Picture Tubes.

That is why, when you specify Sheldon, you get the BEST in television picture tubes.

Write for Sheldon's new "General Characteristics and Dimensions" Wall Chart on its complete line of 24 picture tubes . . . crystal face, velour black, round, rectangular, all-glass and glass-metal types.

**Sheldon**  
NATURAL IMAGE



SOFT GLOW  
Picture Tube

## SHELDON ELECTRIC CO.

*Division of Allied Electric Products Inc.*

68-98 Coit Street, Irvington 11, N. J.

Branch Offices & Warehouses: CHICAGO 7, ILL., 426 S. Clinton St. LOS ANGELES 26, CAL., 1755 Glendale Blvd.

SHELDON TELEVISION PICTURE TUBES • CATHODE RAY TUBES • FLUORESCENT STARTERS AND LAMP HOLDERS • SHELDON REFLECTOR & INFRA-RED LAMPS  
PHOTOFLOOD & PHOTOSPOT LAMPS • SPRING-ACTION PLUGS • TAPMASTER EXTENSION CORD SETS & CUBE TAPS • RECTIFIER BULBS

→ VISIT SHELDON'S BOOTH NO. 201 & DISPLAY ROOM NO. 632, PARTS DISTRIBUTOR SHOW, MAY 22-25, STEVENS HOTEL, CHICAGO ←

# Cross it Out!

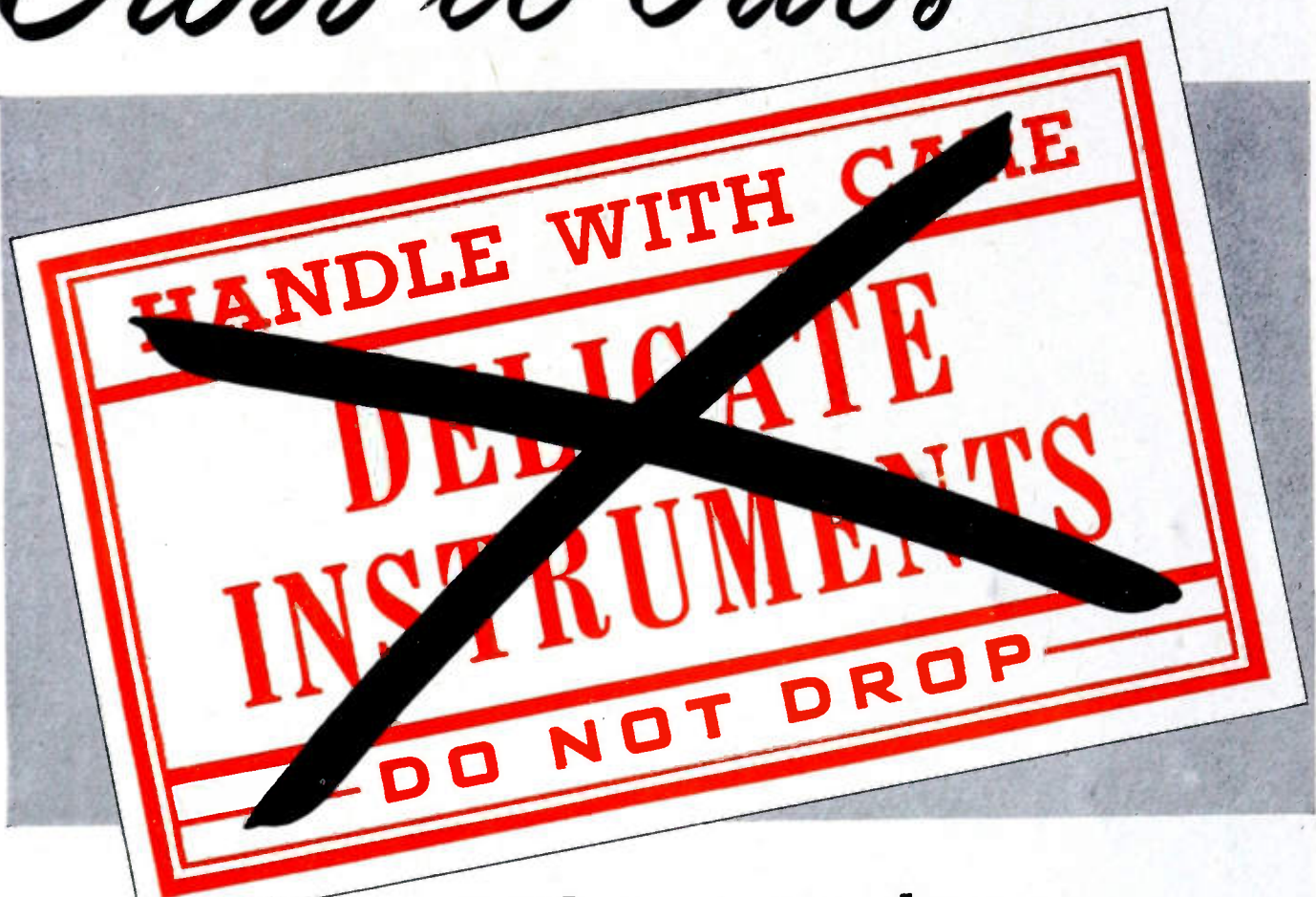

## with new marion **ruggedized** instruments

The new Marion Ruggedized meters (Hermetically Sealed) now give you an exceptionally accurate and sensitive means for electrical measurement and indication — under extreme conditions of Shock, Vibration, Mechanical Stress, Strain, Weather Conditions and Climate. This whole new family of Ruggedized Panel instruments gives you new freedom of application. You can use them where you have never before dared use "delicate instruments." What's more, they meet the dimensional requirements of JAN I-6 and are completely interchangeable with existing standard JAN 2½" and 3½" types.

When you need ruggedized meters for rugged applications; when you need special meters for special applications; when you need *better* meters for *any* application . . . call on Marion — the name that means the *most* in meters.

Send for your free copy of our booklet on the New Marion Ruggedized Instruments today. Marion Electrical Instrument Company, 407 Canal Street, Manchester, New Hampshire.

**MARION MEANS THE MOST IN METERS**

Canadian Representative: Astral Electric Company, 44 Danforth Road, Toronto, Ontario, Canada  
Export Division: 458 Broadway, New York 13, U.S.A., Cables MORHANEX



Manufacturers of  
Hermetically Sealed  
Meters Since 1944



# marion meters

Copyright, 1950 Marion Electrical Instrument Co.

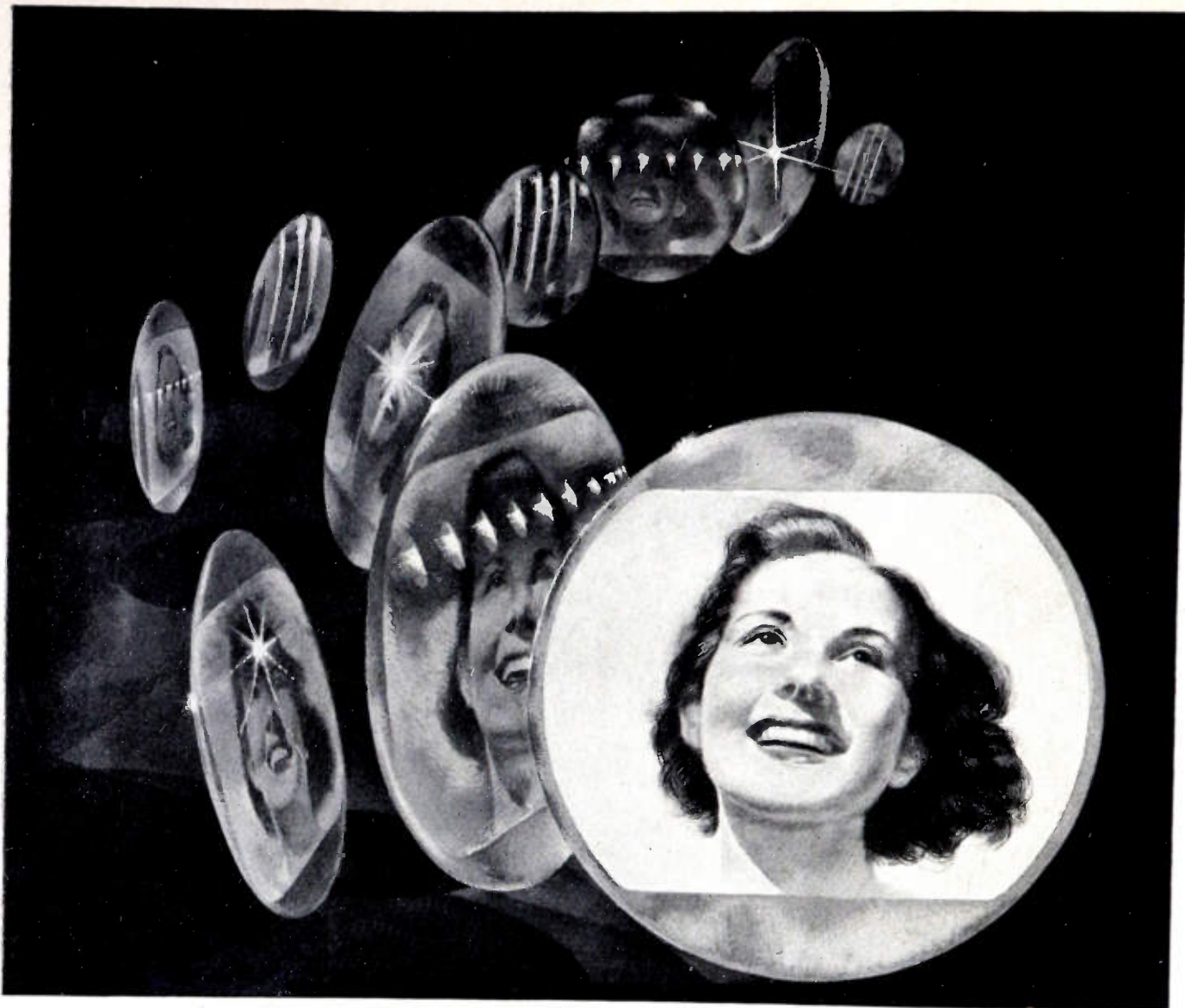

New-type glass for RCA television picture tubes filters unwanted light, to give sharper, clearer images.

*Wayward light is disciplined—for better television!*

Now television pictures gain still greater contrast and definition—through research originally initiated by scientists at RCA Laboratories.

Their discovery: That wandering light waves inside a picture tube—and even more important, *inside the glass itself*—may cause halation and blur an image's edges. But, by introducing light-absorbing materials into the glass, the wayward flashes are disciplined, and absorbed, so that only the light waves which actually make pictures can reach your eyes!

Glass companies, following this research, developed a new type of faceplate glass for RCA . . . Filterglass. Minute amounts of chemicals are added while the glass is being made, and give it, when the picture tube is inactive, a neutral gray tone. In action, images are sharper, clearer—with more brilliant contrast between light and dark areas. Reflected room light is also reduced.

\* \* \*

See the latest in radio, television, and electronics at RCA Exhibition Hall, 36 W. 49th St., N. Y. Admission is free. Radio Corporation of America, RCA Building, Radio City, N. Y.



Filterglass faceplates give you more brilliant pictures on today's RCA Victor television receivers.



**RADIO CORPORATION of AMERICA**

*World Leader in Radio — First in Television*



# WE CAN DO EVERYTHING BETTER THAN THEY CAN!

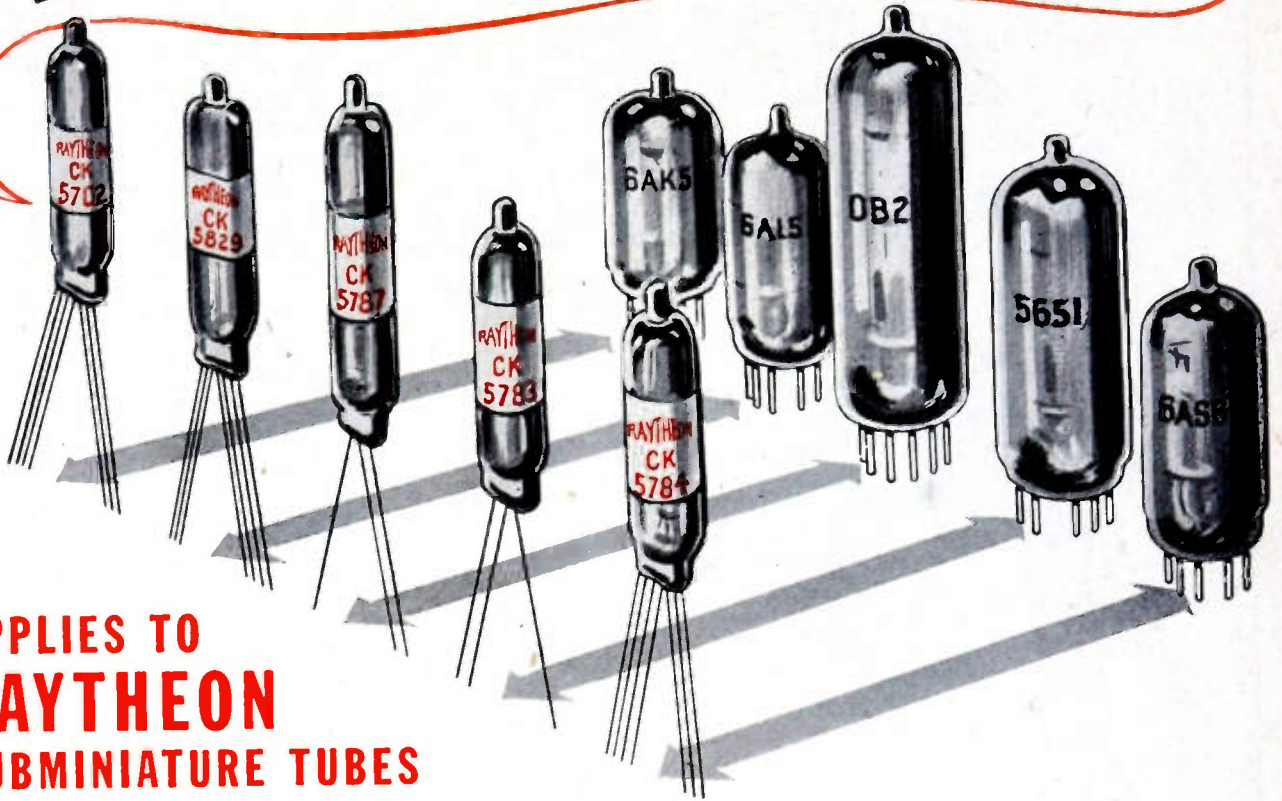

## APPLIES TO RAYTHEON SUBMINIATURE TUBES

RAYTHEON, and *only* Raytheon, SUBMINIATURES can sing that song loud and clear, as hundreds of users have already found out to their great satisfaction and profit. Compare them with their larger tube counterparts rating by rating — performance for performance.

Quality control, unequalled precision methods and experience in the making of long life tubes account for the fact that

RAYTHEON Subminiatures do the job of the bigger tubes just as well *if not better*.

RAYTHEON Subminiature Tubes simplify your design and production problems — increase product convenience and stability — are readily available from stock.

Here are a few of the many types:

This chart gives you at a glance the characteristics of representative Raytheon Subminiature Tubes

| Type No.                    | Remarks   | Maximum Diameter inches | Maximum Length inches | Filament Or Heater Volts | Ma. | Mutual Conductance umhos | Power Output mW  | TYPICAL OPERATING CONDITIONS |                 |              |      |            |                         |
|-----------------------------|---|-------------------------|-----------------------|--------------------------|-----|--------------------------|--|------------------------------|-----------------|--------------|------|------------|-------------------------|
|                             |   |                         |                       |                          |     |                          |  | Plate Volts                  | Ma.             | Screen Volts | Ma.  | Grid Volts |                         |
| <b>HEATER CATHODE TYPES</b> |   |                         |                       |                          |     |                          |  |                              |                 |              |      |            |                         |
| CK5702/CK605CK              | Characteristics of 6AK5   | 0.400                   | 1.5                   | 6.3                      | 200 | 5000                     |  | 120                          | 7.5             | 120          | 2.5  |            | 0                       |
| CK5703/CK608CK              | Triode, UHF Oscillator, 1/2 watts of 500 Mc                       | 0.400                   | 1.5                   | 6.3                      | 200 | 5000                     |  | 120                          | 9.0             |              |      |            | 0                       |
| CK5704/CK6088R              | Diode, equivalent to one-half 6AL5                                | 0.315                   | 1.5                   | 6.2                      | 150 |                          |  | 150cc                        | 9.0             |              |      |            |                         |
| CK5744/CK619CK              | Triode, High mu.  | 0.400                   | 1.5                   | 6.3                      | 200 | 4000                     |  | 250                          | 4.0             |              |      |            | 0                       |
| CK5784                      | Characteristics of 6AL5   | 0.400                   | 1.5                   | 6.2                      | 200 | 2200                     |  | 120                          | 5.2             | 120          | 2.5  |            | 0                       |
| CK5829                      | Similar to 6AL5   | 0.200x0.400             | 1.5                   | 6.3                      | 150 |                          |  | 117cc                        | 5.0 per section |              |      |            |                         |
| <b>FILAMENT TYPES</b>       |   |                         |                       |                          |     |                          |  |                              |                 |              |      |            |                         |
| 1AD4                        | Shielded RF Pentode — High Gm                                     | 0.300x0.400             | 1.5                   | 1.25                     | 100 | 2000                     |  | 45.0                         | 3.0             | 45.0         | 0.8  |            | 0                       |
| CK571AR                     | 10 ma. Filament electrometer tube, Ig = 2x10 <sup>-11</sup> amps. | 0.285x0.400             | 1.5                   | 1.25                     | 10  | 1.61                     |  | 10.5                         | 0.20            |              |      |            | -3.0                    |
| CK571AR                     | Triode, High frequency output                                     | 0.300x0.400             | 1.5                   | 1.25                     | 200 | 2000                     |  | 90.0                         | 11.0            |              |      |            | -4.0                    |
| CK574AR                     | Shielded Pentode RF Amplifier                                     | 0.290x0.390             | 1.25                  | 0.625                    | 20  | 371                      |  | 22.5                         | 0.125           | 22.5         | 0.04 |            | -0.625                  |
| CK5672                      | Output Pentode  | 0.285x0.385             | 1.5                   | 1.25                     | 50  | 625                      | 60.0   | 67.5                         | 2.75            | 67.5         | 1.1  |            | -6.25                   |
| CK5676/CK516AR              | Triode, UHF Oscillator for radio use                              | 0.300x0.400             | 1.5                   | 1.25                     | 120 | 1600                     |  | 135.0                        | 4.0             |              |      |            | -8.0                    |
| CK5677/CK5684X              | Triode, UHF Oscillator for radio use                              | 0.300x0.400             | 1.5                   | 1.25                     | 60  | 650                      |  | 135.0                        | 1.9             |              |      |            | -8.0                    |
| CK5679/CK569AR              | RF Pentode  | 0.300x0.400             | 1.5                   | 1.25                     | 50  | 1100                     |  | 67.5                         | 1.8             | 67.5         | 0.48 |            | 0                       |
| CK5697/CK570AR              | Electrometer Triode Max. grid current 5x10 <sup>-11</sup> amps.   | 0.285x0.400             | 1.25                  | 0.625                    | 20  | 1.51                     |  | 12                           | 0.22            |              |      |            | -3.0                    |
| CK5785                      | High voltage rectifier  | 0.285x0.400             | 1.5                   | 1.25                     | 15  |                          |  |                              | 0.1             |              |      |            | inverse peak 3500 volts |
| <b>VOLTAGE REGULATORS</b>   |   |                         |                       |                          |     |                          |  |                              |                 |              |      |            |                         |
| CK5763                      | Voltage reference tube — like 5651                                | 0.400                   |                       | 1.63                     |     |                          | Operating voltage 65. Operating current range 1.5 to 3.5 ma. |                              |                 |              |      |            |                         |
| CK5767                      | Voltage regulator   | 0.400                   |                       | 2.06                     |     |                          | Operating voltage 100. Operating current range 5 to 25 ma.   |                              |                 |              |      |            |                         |

**RAYTHEON**

Excellence in Electronics

**RAYTHEON  
MANUFACTURING  
COMPANY**

SPECIAL TUBE SECTION  
Newton 38, Massachusetts  
SUBMINIATURE TUBES  
GERMANIUM DIODES  
and TRIODES  
RADIATION COUNTER TUBES  
RUGGED, LONG LIFE TUBES

# Announcing

## NEW MEMBER OF THE

# MYCALEX FAMILY

## 9 Pin Miniature Tube Sockets

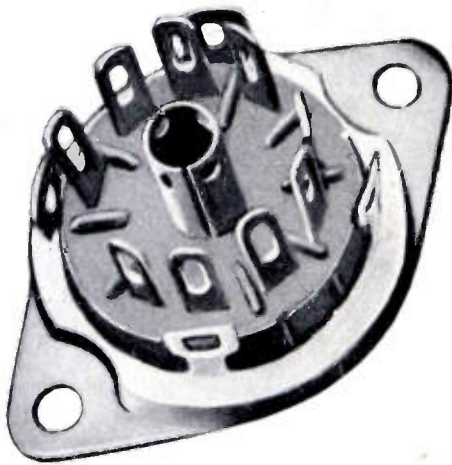

Enlargement of the new 9 (NOVAL) pin miniature tube socket.



Above: Complete 9 pin miniature socket.  
Below: Precision moldings in MYCALEX actual size two views.

We are proud to announce the addition of a 9 pin (NOVAL) miniature tube socket to the MYCALEX line. It has all the electrical characteristics of the widely used MYCALEX 410 and 410 X 7 pin tube sockets and fully meets RMA standards.

The NOVAL is injection molded and produced in two qualities to satisfy different requirements.

Write us today and let us quote you prices on your particular requirements. We will send you samples and complete data sheets by return mail. Our engineers are at your disposal and would be glad to consult with you on your design problems.

MYCALEX 410 for applications requiring close dimensional tolerances. Insulation loss factor of .015 (at 1 MC) yet compares favorably in price with mica filled phenolics.

MYCALEX 410X for applications where general purpose bakelite was acceptable but with an insulation loss factor of only .083 (at 1 MC). Prices compare with lowest quality insulation materials.

### Mycalex Tube Socket Corporation

"Under Exclusive License of Mycalex Corporation of America"

30 Rockefeller Plaza, New York 20, N. Y.



## MYCALEX CORP. OF AMERICA

"Owners of 'MYCALEX' Patents"

Executive Offices: 30 Rockefeller Plaza, New York 20, N. Y.

Plant and General Offices: Clifton, N. J.

# FREED

## TRANSFORMERS & INSTRUMENTS

"PRODUCTS OF EXTENSIVE RESEARCH"



NO. 1060 VACUUM  
TUBE VOLTMETER



NO. 1030 LOW  
FREQUENCY "Q"  
INDICATOR



HIGH FIDELITY  
OUTPUT  
TRANSFORMERS



DISCRIMINATORS



FILTER CHOKES



NO. 1140 NULL  
DETECTOR



NO. 1020 DIRECT  
READING  
MEG OHMMETER



HERMETICALLY  
SEALED COMPONENTS



TOROIDAL INDUCTORS



HI-Q MINIATURE  
TOROIDAL INDUCTORS



NO. 1210 NULL  
DETECTOR & VACUUM  
TUBE VOLTMETER



NO. 1162 DECADE  
INDUCTOR



SUB-MINIATURE HI-Q  
HERMETICALLY  
SEALED  
INDUCTORS



SUB-MINIATURE  
HERMETICALLY  
SEALED  
TRANSFORMERS



SPECIAL  
TRANSFORMERS



NO. 1050 UNIVERSAL  
BRIDGE



NO. 1010 COMPARISON  
BRIDGE



STEPDOWN  
TRANSFORMERS



CHOKES



POWER  
TRANSFORMERS



NO. 1040 VACUUM  
TUBE VOLTMETER



NO. 1110  
INCREMENTAL  
INDUCTANCE BRIDGE



FILAMENT,  
TRANSFORMERS

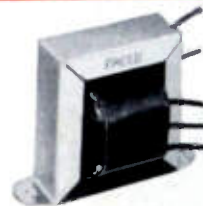

OUTPUT  
TRANSFORMERS



AUDIO  
TRANSFORMERS

SEND FOR LATEST CATALOG!

# FREED TRANSFORMER CO., INC.

DEPT. MP 1718-36 WEIRFIELD ST., (RIDGEWOOD) BROOKLYN 27, NEW YORK

SMALLER THAN PREVIOUS "SMALLEST"...

PREDETERMINED ACCURACY...

REMARKABLE STABILITY...

EXCEPTIONAL CHARACTERISTICS...

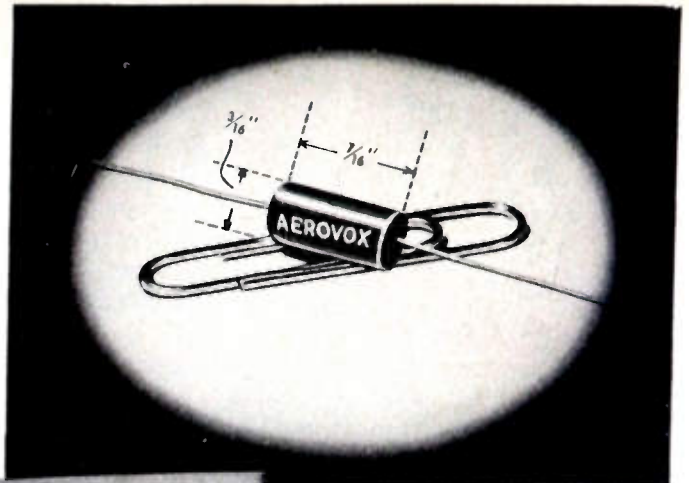

**AEROVOX**

# MICRO-MINIATURES

(TYPE P83Z AEROLITE® CAPACITORS)

• Smaller than a paper clip! Only 3/16" dia. by 7/16" long! Yet rugged, accurate, stable, exceptional.

Such is the story of Aerovox Micro-miniatures (Type P83Z Capacitors). Smaller physical size directly due to radically new *metallized dielectric*—a distinct departure from conventional foil-paper and previous metallized-paper constructions. Dielectric and electrodes combined in *one element*. Smallest capacitor available for capacitance range.

Aerovox Micro-miniatures are particularly applicable to radio-electronic miniaturization calling for high-frequency and by-pass coupling.

• Try Aerovox Micro-miniatures in your miniaturized assemblies. Write Dept. FD-450 for engineering data, samples, quotations, and application engineering aid.

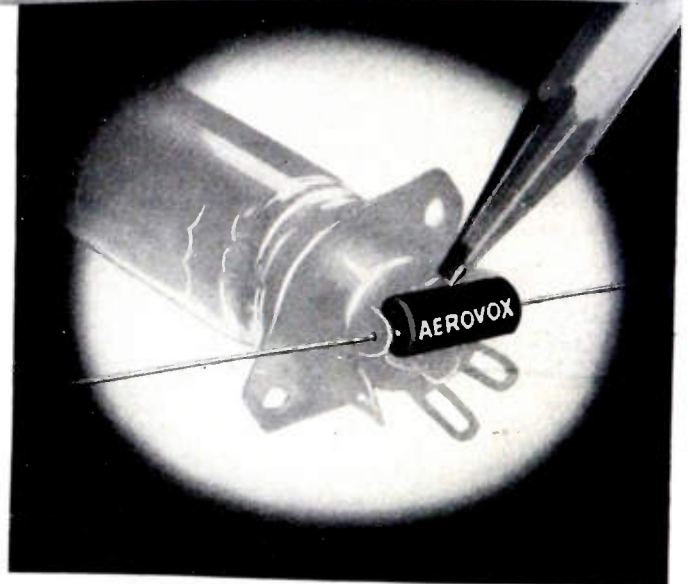

## F E A T U R I N G . . .

One size for all ratings—3/16" dia. by 7/16" long.

Hyvol K impregnated in humidity-resistant molded thermoplastic cases.

Operating temperature range from -15° C. to +85° C. without derating.

Power factor less than 1% when measured at or referred to frequency of 1000 cps and ambient temperature of 25° C.

Insulation resistance of 25,000 megohms or greater, measured at or referred to temperature of 25° C. Insulation resistance at 85° C., 500 megohms or greater.

Very high self-resonant frequency, due to remarkably small length of unit.

Life test: 1000 hours at 1.25 times rated voltage in ambient temperature at 85° C.

Meets humidity resistance requirements of RMA (REC-118, section 2, paragraph 2.38) for paper tubulars.

Meets RMA heat resistance test at 85° C. (REC-118, section 2, paragraph 2.39).

In 400 VDC (.0005 to .003 mfd.) and 200 VDC (.005 and .01 mfd.)

Other capacitance and voltage ratings will be made available in near future.

\*Trade-mark

CAPACITORS • VIBRATORS • TEST INSTRUMENTS



*For Radio-Electronic and Industrial Applications*

AEROVOX CORPORATION, NEW BEDFORD, MASS., U. S. A. • Sales Offices in All Principal Cities  
Export: 17 E. 42nd St., New York 17, N. Y. • Cable: AERDCAP, N. Y. • In Canada: AEROVOX CANADA LTD., Hamilton, Ont.

# This is what it takes to make good electronic equipment . . .

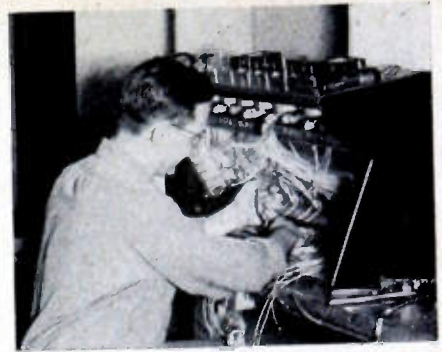

**Console Assembly.** Skilled workmanship that is assured by having experienced employees, trained to build equipment just one way — the very best.



**Welding aluminum by the inert arc method.** Modern processes that save time and at the same time assure better construction. By these means savings are made and passed on in the form of high quality products.



**Checking tolerances on production machined parts.** Precision testing at every step of manufacturing to be sure each part meets specifications and will perform at top efficiency in the finished product.

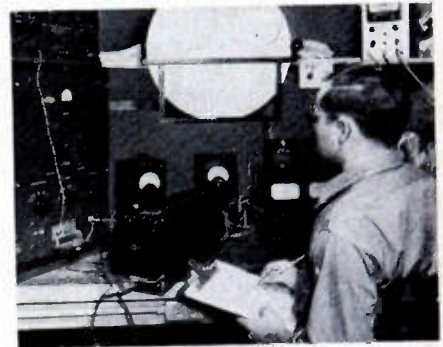

**Taking performance data on an airborne navigation receiver.** Final test of the complete product using the latest and best apparatus known. This assures the finest overall performance.

The Collins main plant in Cedar Rapids consists of modern structures containing 240,000 square feet of floor space. It is designed for the most efficient office, engineering and manufacturing operation. The Collins management, organization and facilities are devoted entirely to the designing and manufacturing of radio communication equipment.

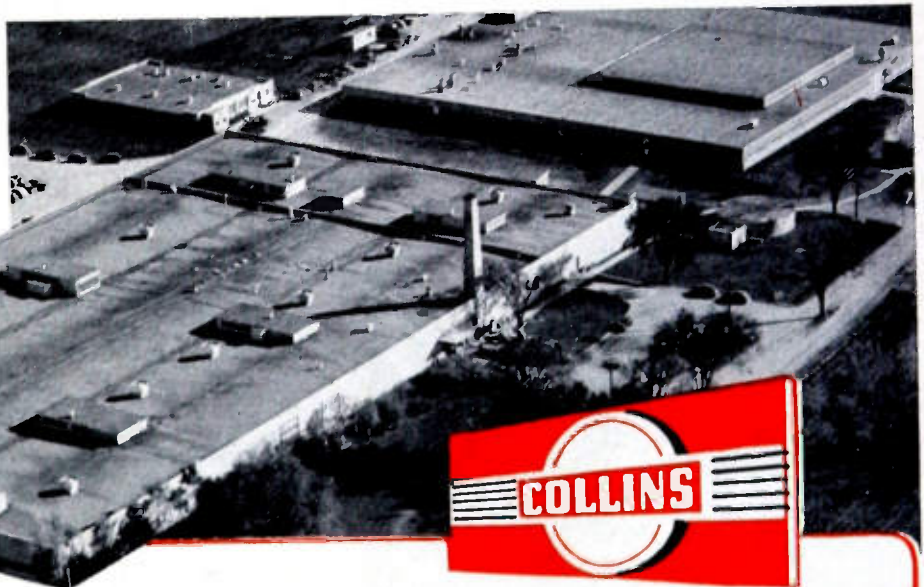

**COLLINS RADIO COMPANY, Cedar Rapids, Iowa**  
11 West 42nd St., NEW YORK 18      2700 West Olive Ave., BURBANK

# THE ONE 3-INCH TUBE

--- combining these modern features ---

## for "HAIR-LINE" performance

◆ Here is the modern achievement in a compact, three-inch cathode-ray tube providing the brilliant, "hair-line" trace long desired for best performance of portable oscillographs and industrial cathode-ray monitoring devices.

With performance at the highest premium, the special features of the DuMont Type 3RP-A have been combined to make high sensitivity compatible with short overall length; and to obtain a fine trace free from the distortions usually found in short tubes as sensitive as the Type 3RP-A.

Because of the new, ingenious design of the vertical deflection plates of the Type 3RP-A, the position of the cathode-ray beam does not affect deflection sensitivity, thereby substantially eliminating pincushioning and trapezoidal distortions.

New production techniques are applied for the first time to the commercial production of three-inch cathode-ray tubes to obtain a flat face which provides more usable screen area, eliminates parallax distortion, and carries through the high performance standard set by the advanced design of the Type 3RP-A electron gun.



**COMPACT DESIGN . . .**  
Maximum length of 9 1/8 inches plus high sensitivity.

**BALANCED DEFLECTION . . .**  
For uniform spot focus maintained over the entire trace.

**CURVED DEFLECTION PLATES . . .**  
For uniform deflection sensitivity.

**FLAT FACE . . .**  
For more usable screen area with minimized parallax distortion.

**"HAIR-LINE" TRACE . . .**  
Provided by small spot and fine focus.

### Electrical Data

|                   |                   |
|-------------------|-------------------|
| Heater Voltage    | 6.3 Volts         |
| Heater Current    | 0.6 ± 10% Amperes |
| Focusing Method   | Electrostatic     |
| Deflecting Method | Electrostatic     |
| Phosphor          | P1                |
| Fluorescence      | Green             |
| Persistence       | Medium            |

### Typical Operating Conditions

|   |                              |                               |
|---|------------------------------|-------------------------------|
| For Anode No. 2 Voltage of                      | 1,000                        | 2,000 Volts                   |
| Anode No. 1 Voltage for focus                   | 165 to 310                   | 330 to 620 Volts              |
| Grid No. 1 Voltage                              | -22.5 to -67.5               | -45 to -135 Volts             |
| Deflection Factors:                             |                              |                               |
| D1D2  | 73 to 99                     | 146 to 198 Volts D-C per Inch |
| D3D4  | 52 to 70                     | 104 to 140 Volts D-C per Inch |
| Anode No. 1 Voltage for focus                   | 16.5% to                     | 31% of Eb2 Volts              |
| Grid No. 1 Voltage                              | 2.25% to                     | 6.75% of Eb2 Volts            |
| Anode No. 1 Current for any operating condition | -15 to +10                   | Microamperes                  |
| Spot Position (Undelected)                      | Within 15 Millimeters square |                               |

# DUMONT

for

# Oscillography

ALLEN B. DUMONT LABORATORIES, INC., INSTRUMENT DIVISION, 1000 MAIN AVENUE, CLIFTON, NEW JERSEY

# OHMITE

## World's Largest Stock of



**RHEOSTATS**

**TAP SWITCHES**

**RESISTORS**

### Ready for IMMEDIATE Shipment

For fast delivery, rely on Ohmite. Stock orders are usually shipped out the same day received. Special orders, too, are scheduled and shipped promptly.

How can Ohmite do it? First, they have developed an efficient, tightly geared order system which short-cuts red tape.

But more important is Ohmite's enormous stock of rheostats, resistors, and tap switches—believed to be the largest and most complete maintained anywhere in the world.

Specify Ohmite for Dependability . . . and **PROMPT DELIVERY!**

OHMITE MFG. CO.  
4861 Flournoy St.  
Chicago 44, Ill.

*25th Anniversary*

1925-1950

**RUSH  
SERVICE  
ON SPECIAL  
ORDERS, TOO**

*Be Right with*

# OHMITE

Eng. U. S. Pat. Off.

**RHEOSTATS**

**RESISTORS**

**TAP SWITCHES**

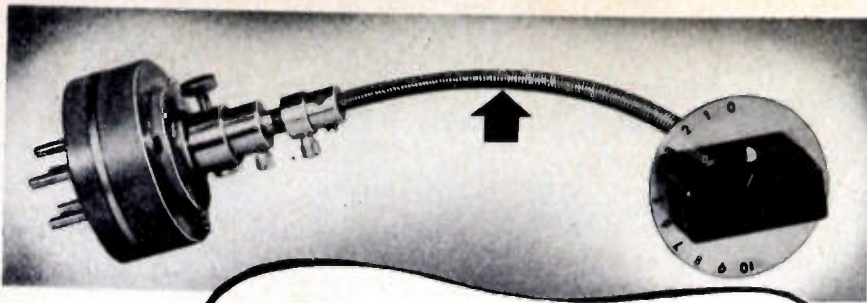

**S.S. WHITE FLEXIBLE SHAFTS  
PROVIDE "FEATHER-TOUCH"  
TUNING OF VARIABLE ELEMENTS**



**"PROVE IT YOURSELF"**

Make this convincing test of the smoothness and sensitivity of S.S. White remote control flexible shafts. It's called the "Loop Test."

Take an S.S. White remote control shaft—the type that's commonly used to connect variable elements to their control knobs in electronic and radio equipment. Loop it in the manner shown at the right. Then, with the loop resting on a flat surface, rotate the shaft with the fingers.

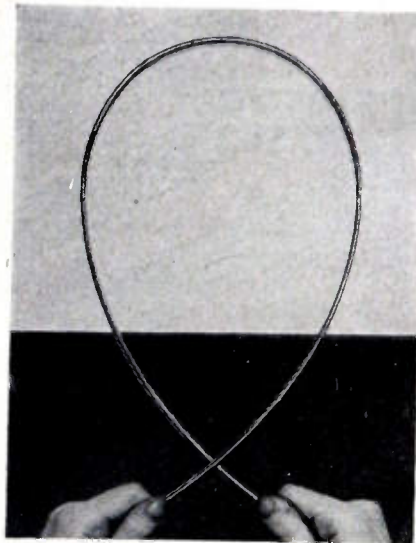

Note how smooth and easy it turns. This responsive jump-free action tells the story of the sensitive, accurate tuning you get with S.S. White flexible shafts. The reason, of course, is that these shafts are engineered and built specifically for remote control with deflection and backlash held to a minimum.

**SEND FOR BULLETIN 4501**

*It gives basic facts about flexible shafts and their selection and application. Write for free copy today.*



**S.S. WHITE INDUSTRIAL**  
THE S. S. WHITE DENTAL MFG. CO. DEPT. G 10 EAST 40th ST., NEW YORK 16, N. Y.



FLEXIBLE SHAFTS AND ACCESSORIES  
MOLDED PLASTICS PRODUCTS—MOLDED RESISTORS

*One of America's AAA Industrial Enterprises*

**News—New Products**

These manufacturers have invited PROCEEDINGS readers to write for literature and further technical information. Please mention your I.R.E. affiliation.

**Ceramic Coil Forms**

Two new ceramic coil forms, designed to fit into small or difficult places, have just been announced by Cambridge Thermionic Corp., 456 Concord Ave., Cambridge 38, Mass.



Coded LS-5 and LS-6, these forms are silicone impregnated ceramic. LS-5 is 1 1/2 inch in height (mounted) 3/8 inch in diameter; LS-6 is 13/16 inch in height and 5/16 inch in diameter. Ring terminals are adjustable. Both have a spring lock for the slug, and are available with high-, medium- or low-frequency slugs.

**Two New Regulated Power Supplies**

Two new Models 1110 and 1110-A, regulated power supplies, able to deliver 1/2 kilowatt dc maximum, are being manufactured by Furst Electronics, 12 S. Jefferson St., Chicago 6, Ill.



Output varies less than 5 volts for line voltage variations between 105 and 125 volts ac. Internal impedance is 10 ohms or less. The ac ripple is less than 20 mv. Model 1110 delivers 175-1,000 volts at 0.50 ampere. Model 1110-A delivers 175-1,500 volts 0.33 amperes.

*(Continued on page 19A)*



# PRECISION ATTENUATION to 3000 mc!

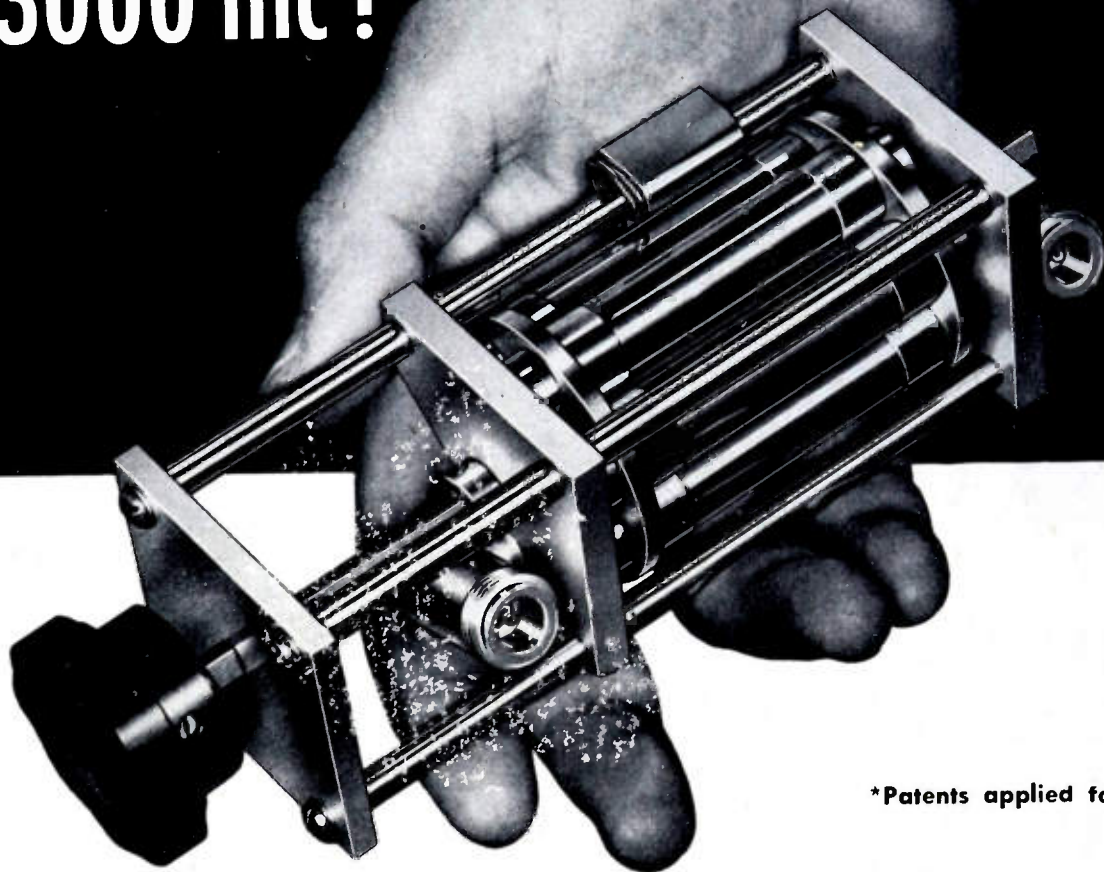

\*Patents applied for

Inquiries are invited concerning single pads and turrets having other characteristics

- VSWR less than 1.2 at all frequencies to 3000 mc.
- Turret Attenuator\* featuring "Pull — Turn — Push" action with 0, 10, 20, 30, 40, 50 DB steps.
- Accuracy  $\pm .5$  DB, no correction charts necessary.
- 50 ohm coaxial circuit. Type N connectors.

**STODDART AIRCRAFT RADIO CO.**  
6644 SANTA MONICA BLVD., HOLLYWOOD 38, CALIFORNIA  
Hillside 9294

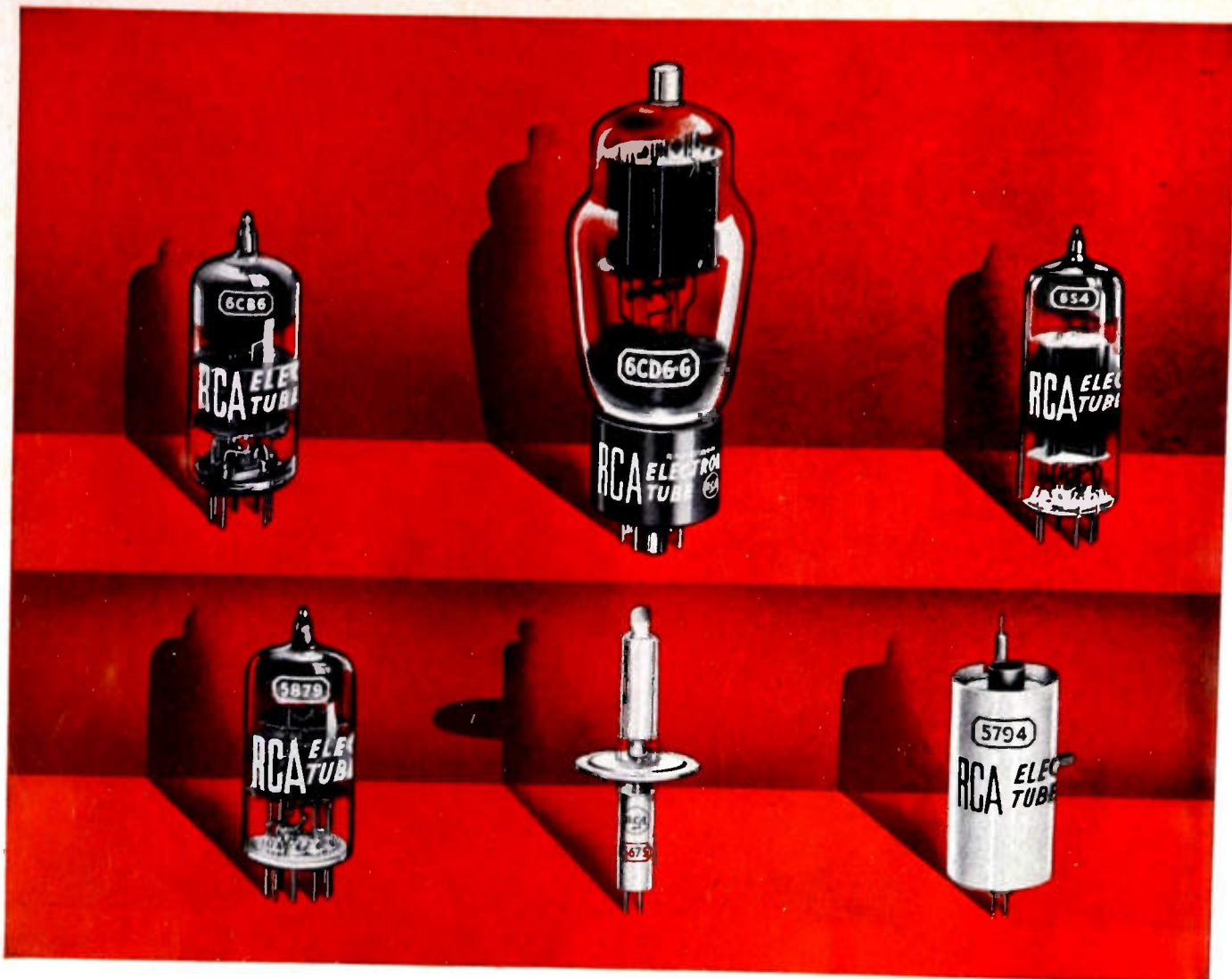

The Fountainhead of Modern Tube Development is RCA

## DEVELOPED BY **RCA** . . . symbols of RCA's engineering leadership

The tubes illustrated, and described in the adjoining columns, are a few of the more recent types designed by RCA engineers. Each represents a distinct advancement over previous comparable types . . . either by virtue of its improved performance or its contribution to the simplification of circuit design.

These tubes . . . and other new RCA tubes like them . . . provide wide design latitudes . . . aid in reducing equipment manufacturing costs. They can be used with confidence in new circuit designs.

In the future, as in the past, the vast engineering resources of RCA will be directed toward the development of tubes best suited to meet the cost and performance requirements of equipment designers.

**RCA-6CB6 Sharp-Cutoff Pentode.** A miniature type, designed for use as an i-f amplifier operating at frequencies in the order of 40 Mc., or as an r-f amplifier in vhf television tuners. Its transconductance is 6200 micromhos.

**RCA-6CD6-G Horizontal-Deflection Amplifier.** For 16GP4 systems, and for other similar wide angle systems, it makes possible the design of efficient horizontal-deflection circuits in which the plate voltage for the tube is supplied in part by the circuit and in part by the power supply.

**RCA-654 Vertical-Deflection Amplifier.** A high-perveance miniature triode of the heater-cathode type. In suitable circuits it will deflect fully a 16GP4 or similar kinescopes having a deflection angle of 70 degrees and employing an anode voltage up to 14,000 volts.

**RCA-5879 Sharp-Cutoff Pentode.** Of the 9-pin miniature type, the 5879 is designed

for a-f applications where reduced microphonics, noise, and hum are essential. It is especially useful in the input stages of medium-gain amplifiers.

**RCA-5675 "Pencil-Type" Triode for UHF.** Employs double-ended coaxial-electrode structure, for use in grounded-grid circuits. As a local oscillator, it will deliver 475 milliwatts at 1700 Mc. and about 50 milliwatts at 3000 Mc.

**RCA-5794 Fixed-Tuned Oscillator Triode.** Designed for Radiosonde Service, the 5794 employs two resonators integral with the tube. The output resonator is tuned to 1680 Mc. by means of an adjusting screw. The useful power output is in the order of 500 milliwatts.

For data on any of the tubes described above, write RCA, Commercial Engineering, Section E47R, Harrison, N. J.



**RADIO CORPORATION of AMERICA**  
ELECTRON TUBES

HARRISON, N. J.

# PROCEEDINGS OF THE I.R.E.

Published Monthly by

The Institute of Radio Engineers, Inc.

## BOARD OF DIRECTORS, 1950

Raymond F. Guy  
*President*

R. A. Watson-Watt  
*Vice-President*

D. B. Sinclair  
*Treasurer*

Haraden Pratt  
*Secretary*

Alfred N. Goldsmith  
*Editor*

B. E. Shackelford  
*Senior Past President*

Stuart L. Bailey  
*Junior Past President*

### 1950

Ben Akerman  
W. R. G. Baker  
T. H. Clark  
J. V. L. Hogan  
T. A. Hunter  
H. E. Kranz  
F. H. R. Pounsett  
J. E. Shepherd  
J. A. Stratton

### 1950-1951

A. V. Eastman  
W. I. Everitt  
D. G. Fink  
F. Hamburger, Jr.  
H. J. Reich  
J. D. Reid

### 1950-1952

W. R. Hewlett  
J. W. McRae

Harold R. Zeamans  
*General Counsel*

George W. Bailey  
*Executive Secretary*

Laurence G. Cumming  
*Technical Secretary*

Changes of address (with advance notice of fifteen days) and communications regarding subscriptions and payments should be mailed to the Secretary of the Institute, at 450 Ahnaip St., Menasha, Wisconsin, or 1 East 79 Street, New York 21, N. Y.

All rights of republication, including translation into foreign languages, are reserved by the Institute. Abstracts of papers with mention of their source, may be printed. Requests for republication privileges should be addressed to The Institute of Radio Engineers.

VOLUME 38

May, 1950

NUMBER 5

## PROCEEDINGS OF THE I.R.E.

|   |     |
|---|-----|
| Chicago Section 25th Anniversary—Officers .....   | 466 |
| Thoughts on the Humanitarian Responsibilities of Engineers .....  | 467 |
| 3606. The Radio Technical Commission for Aeronautics—Its Program and Influence .....  | 468 |
| 3607. Developments in Studio Design .....   | 470 |
| 3608. Linear Amplifiers .....   | 475 |
| 3609. The Magnetron-Type Traveling-Wave Amplifier Tube .....  | 486 |
| 3610. (Abstract) Analysis of Errors in a Phase-Shift Angle Telemetry System .....   | 495 |
| 3611. The "Double-Layer" Projection Tube Screen for Television .....  | 496 |
| 3612. A Dynamically Regenerated Electrostatic Memory System .....   | 498 |
| 3613. Diode Coincidence and Mixing Circuits in Digital Computers .....  | 511 |
| 3417. Discussion on "Stabilization of Simultaneous Equation Solvers" by G. A. Korn .....  | 514 |
| 3614. Annular Circuits for High-Power, Multiple-Tube, Radio-Frequency Generators at Very-High Frequencies and Ultra-High Frequencies .....        | 515 |
| 3615. A Dynamic Electron Trajectory Tracer .....  | 521 |
| 3616. Microphonism in the Dynamically Operated Planar Triode .....  | 524 |
| 3617. Radio-Wave Propagation in a Curved Ionosphere .....   | 533 |
| 3551. Correction to "Design Factors in Low-Noise Figure Input Circuits" .....   | 539 |
| 3618. Frequency and Amplitude Stability of the Cathode-Coupled Oscillator .....   | 540 |
| 3619. A Method of Simulating Propagation Problems .....   | 543 |
| 3620. Design Analysis of a TM-Mode Piston Attenuator .....  | 545 |
| 3621. Standards on Television: Methods of Measurement, of Television Signal Levels, Resolution, and Timing of Video Switching Systems, 1950 ..... | 551 |
| Correspondence:   |     |
| 3622. Note on Total Emission Damping and Total Emission Noise .....   | 562 |
| 3623. Density Distribution of Transient Currents in Conductors .....  | 563 |
| 3624. Principles of Radar .....   | 563 |
| Contributors to the PROCEEDINGS OF THE I.R.E. ....  | 564 |

## INSTITUTE NEWS AND RADIO NOTES SECTION

|   |     |
|---|-----|
| Technical Committee Notes .....   | 567 |
| 1950 IRE Convention and Show Unqualified Success .....                                  | 569 |
| Industrial Engineering Notes .....  | 571 |
| The Chicago Section Silver Anniversary .....  | 572 |
| IRE People .....  | 574 |
| Sections .....  | 575 |
| Books:  |     |
| 3625. "Matrix Analysis of Electric Networks" by P. Le Corbellier .....                  | 576 |
| 3626. "The Characteristics of Electrical Discharges in Magnetic Fields" .....           | 576 |
| 3627. "Introduction to the Luminescence of Solids" by H. W. Leverenz .....              | 577 |
| 3628. "Communication Circuit Fundamentals" by Carl E. Smith .....                       | 577 |
| 3629. "Vacuum Equipment and Techniques" edited by A. Guthrie and R. K. Waklerling ..... | 578 |
| 3630. "Fundamentals of Radio-Valve Techniques—Book I" by J. Deketh .....                | 578 |
| 3631. "Acoustic Measurements" by Leo L. Beranek .....                                   | 578 |
| 3632. "Terrestrial Radio Waves. Theory of Propagation" by H. Bremmer .....              | 578 |
| 3633. Abstracts and References .....  | 579 |
| News—New Products .....   | 30A |
| Section Meetings .....  | 37A |
| Student Branch Meetings .....   | 40A |
| Advertising Index .....   | 71A |
| Membership .....  | 43A |
| Positions Open .....  | 50A |
| Positions Wanted .....  | 52A |

## EDITORIAL DEPARTMENT

Alfred N. Goldsmith  
*Editor*

E. K. Gannett  
*Technical Editor*

Mary L. Potter  
*Assistant Editor*

## ADVERTISING DEPARTMENT

William C. Copp  
*Advertising Manager*

Lillian Petranek  
*Assistant Advertising Manager*

## BOARD OF EDITORS

Alfred N. Goldsmith  
*Chairman*

## PAPERS REVIEW COMMITTEE

George F. Metcalf  
*Chairman*

Responsibility for the contents of papers published in the PROCEEDINGS OF THE I.R.E. rests upon the authors. Statements made in papers are not binding on the Institute or its members.



## Chicago Section 25th Anniversary—Officers

E. H. Schulz (A'38-SM'46), chairman of the electrical engineering department of the Armour Research Foundation, was born in Lockhart, Texas, on October 30, 1913. He was graduated from the University of Texas with the B.S. degree in electrical engineering in 1935 and the M.S. degree in 1936. He received the Ph.D. degree from the Illinois Institute of Technology.

Dr. Schulz taught electrical engineering at the University of Texas from 1936 to 1942. In 1942 he joined the staff of the Illinois Institute of Technology, where he taught senior and graduate courses in radio engineering and was connected with the war training program. He transferred to the Armour Research Foundation in 1946 as assistant chairman of the electrical engineering department, and later was appointed chairman. He was responsible for industrial and government projects on electronic instrumentation and control, communications, vacuum tubes, and electrical machines and devices.

Kipling Adams (A'41-M'46), Chicago District office manager for the General Radio Company, was born in Haverhill, Mass., on December 19, 1908. He attended Massachusetts Institute of Technology for about three years, and took special courses at Harvard University.

Joining General Radio Co., at Cambridge in 1934, Mr. Adams started in their Standardizing Laboratory. He was made assistant service manager in the service department in 1936. After a three weeks' service visit to Chicago in 1945, he was appointed Chicago District office manager, and moved to Chicago in January, 1946. His responsibilities include both sales and engineering, and his territory covers thirteen states.

Mr. Adams was active in the Boston Section of the IRE before 1946. He has expanded his activities since joining the Chicago Section and has served on the Membership, Arrangements, Publicity, Program, Ways and Means, Engineer Status and the Silver

LeRoy Clardy (A'44-M'50), head of the Instrumentation Division of the Research Laboratories of Swift and Company, was born on July 16, 1910, in Fort Worth, Texas. He received the B.S. degree in 1931, and later the M.S. degree from Texas Christian University.

Mr. Clardy was a chemist in the Chemical Laboratory of Armour and Co., Fort Worth, Texas, from 1934 until he joined Terrell's Laboratories as chief chemist in 1936. He joined the Research Laboratories of Swift and Co. in Fort Worth in 1937, and transferred to Chicago to the Physics and Physical Chemistry Division in 1943. He was made head of the Instrumentation Division in 1949. He is responsible for research in the application of electronics and electronic devices and in the development of instruments for the meat packing industry.

**E. H. Schulz, Chairman**

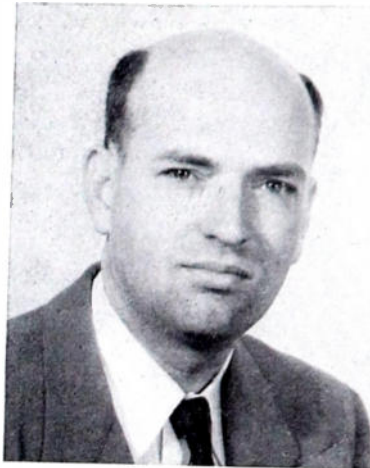

Co-author of the book, "Experiments in Electronics and Communication Engineering," and author of several technical papers, Dr. Schulz has served on a number of Chicago Section Committees, including the Chairmanship of the Meetings and Papers Committee. He served on the IRE Committee on Education for three years. He is a member of the AIEE and Sigma Xi.

Anniversary Committees.

Mr. Adams was Vice-Chairman of the Chicago Spring Conference in 1947, Recording Secretary during 1947-1948, Secretary-Treasurer in 1948-1949, and now is Vice-Chairman. He is actively associated with the National Electronics Conference, having served on the Publicity and Exhibits Committees.

**Kipling Adams, Vice-Chairman**



**LeRoy Clardy, Sec.-Treas.**



He has served as Chairman of the Arrangements Committee, and was Chairman of Procedures Committee during the period in which the Procedures Manual was written. In addition to his association with the IRE, he is a member of ISA, ACS, and is a Registered Professional Engineer in the State of Illinois.

Technically skilled people have brought to the world a myriad of new devices and operations. These have had a profound influence on the life of man. Usually that influence has been helpful. But sometimes it has been alarming, or even menacingly destructive.

Engineers have been trained to think clearly, comprehensively, and dependably within their special fields. Can they transfer their thinking ability to social, political, and economic realms? If so, great good might result.

This question is ably discussed in the following guest editorial by an engineer and editor of long and successful experience, who is a Past President of The Institute of Radio Engineers and a present member of its Editorial Administrative Committee—*The Editor*.

## Thoughts on the Humanitarian Responsibilities of Engineers

DONALD McNICOL

When accredited columnists who have wide coverage of news through the daily press devote space to criticism of engineers and scientists, it is obvious that, even though obscure, a question is posed. The most profound of the columnists take issue with the expressed views of scientists (for instance, such as those given at the United Nations first science conference in 1949) that humanity, rather than the scientists themselves, should answer for "the danger and immorality of the irresponsible behavior that has marked the conduct of international affairs."

Columnists reason that the race for the control of raw materials, lacking which scientific progress must slow down, is a primary cause of war, and one prominent columnist declares, "I have never yet heard a scientist advocate that it would be better to slow down technological progress in favor of peace and humanity. To suggest anything of the kind induces howls from the scientists that humanity is standing in the path of progress." And thoughtful editors ask: "Progress toward what?" Conscientious news writers wonder whether scientists are not becoming an isolated segment of society, and if so whether this is due to predilection, or to force of circumstances.

It is but common sense to state that scientists and engineers in their own minds understand that they are identifiable with "humanity" as are non-scientists and non-engineers. Because of what has come to pass during the past half century in the way of science and invention, some thinkers conclude that the pace has been so swift that science has been elevated over philosophy and religion. If it has come to pass that the world now is in the hands of those who know "how" but not "why," caution suggests that a mental pabulum be sought after and prescribed which might be expected to divert the often-feared headlong flight of mankind, away from any abyss imaginable. In the early decades of the present century general literature abounded in optimism and confidence, and the belief that mankind could resolve life's problems through the powers of reasoning. Beginning a few years ago the front pages and the microphones have chronicled a miscellany of alarms, truths, half truths and "I predicts" which, certainly as a by-product, have served to invalidate the adequacy of reason.

In earlier years, the daily reading fare consisted mainly of news about day-to-day domestic affairs. Now the press and radio deal with world problems, and with domestic problems mainly as these are determined by world problems.

The present writer believes that no other segment of society is better qualified to contribute toward desirable solutions to most of the difficulties which harass mankind than are the scientists and engineers. As have numerous others, I gather from pronouncements from Government, from educators, from industry, from labor, that a cry is being sounded for help: help of the order envisioned in the words of an American statesman of international prominence, expressed late in January, 1950:

"... the greater tragedy is that seemingly our national ideals no longer inspire the loyal devotions needed for their defense."

To conclude: The times call for patriotism and for realism, with perhaps less of the Machiavelian practices. Engineers of experience and accomplishment could, to national and international advantage, be substituted for appointees of limited experience and academic schooling only.

# The Radio Technical Commission for Aeronautics— Its Program and Influence\*

J. H. DELLINGER†, FELLOW, IRE

**Summary**—This paper describes the work of the Radio Technical Commission for Aeronautics (RTCA) as of March, 1949, the time of its presentation before the 1949 IRE Convention. The author's response to the word "influence" in the title given him is simply that the influence of an organization is proportional to the service it renders. As the RTCA exists solely to render service, it does have potential influence. The paper explains something about the service which the organization provides.

**A**VIATION RADIO is a complex field, both in respect to the methods and devices used and in respect to the interests affected. The RTCA is a means of dealing with both types of complexity. To bring about true co-ordination and assure harmonious progress, this body was created with representation from all interests concerned. It is thus a means of unifying the thinking and planning of all interested agencies, both government and nongovernment. My purpose is to tell you how it is organized and something of the work it does. I hope I can aid you to envisage the role which it plays in promoting progress along such lines, for example, as are dealt with in the other papers of this symposium.

It was originally established in 1935, when the Department of Commerce invited all United States agencies, both within and without the government, concerned with the development, application, and use of radio in aeronautical operations to form an organization for the co-ordination of effort. The organization was to have no enforcing authority of itself but would be effective through including enforcing agencies in its membership. It was promptly established and has continued to function as originally envisaged. It is the only body which includes and gives a voice to, all organizations concerned, both within and without the government.

It operates through four subsidiary entities: the Assembly, the Executive Committee, the Secretariat, and the Technical or Special Committees.

The Assembly is composed of United States organizations identified with aeronautical telecommunication. The Assembly directs the RTCA through the establishment of broad policies and operating procedures. It meets twice a year, ordinarily in Washington, D. C.

The Executive Committee comprises one representative from each of the following: the Departments of State, Treasury (Coast Guard), Army, Navy, Air Force, and Commerce (CAA), the Federal Communications Commission, Civil Aeronautics Board, and Aeronautical Radio, Inc., Aircraft Owners and Pilots Association, Air Line

Pilots Association, Air Transport Association of America, and Radio Manufacturers Association; and a Chairman, Vice-Chairman, and Secretary. The Executive Committee meets monthly and manages the affairs of RTCA in conformity with the policies established by the Assembly.

The Secretariat includes an Executive Secretary and assistants. The costs are defrayed by prorated assessments among the member organizations represented upon the Executive Committee. In general, the government organizations contribute offices, office furniture and equipment, supplies, and personnel who are assigned to the Secretariat. The nongovernment organizations contribute funds required for part of the personnel and the defrayment of operating expenses.

The technical work of RTCA is performed by Special Committees which are established by the Executive Committee. Each Special Committee is given a specific directive and is dissolved upon the acceptance of its report by the Executive Committee. The procedure of designating Special Committees to handle specific problems rather than the allocation of general problems to standing committees has evolved from experience. It has contributed greatly to the expeditious handling of the work of RTCA for the following reasons: (1) It permits the appointment to Committee membership of persons who are especially qualified to deal with the specific matter under consideration, and (2) it imposes the minimum burden upon the time of the Committee members.

As RTCA has a wide membership, the members of Technical Committees are principally from its member organizations. However, in any specific study, the RTCA invites the participation of persons from all agencies known to be affected by the conclusions reached. In most cases, despite the difficulties and complexity of many of the subjects, unanimous agreement is attained. This is only possible in many cases as the result of long and hard work. Apparently the combination of real work and participation by all interested agencies is a formula capable of solving refractory problems.

In general, a Special Committee is appointed for each problem the RTCA is asked to handle. The problems come to RTCA both from its members and from other organizations. Examples of sources of requests to make studies and recommendations are the Air Co-ordinating Committee, the Telecommunications Co-ordinating Committee, the Civil Aeronautics Administration, the military establishment's Aeronautical Board, State Department, Radio Manufacturers Association, Air Transport Association, and Federal Communications Commission.

After a recommendation is finally approved by the Executive Committee, it is sent to each agency, government or other-

wise, concerned with its subject matter. These agencies include the ones listed above, the various member agencies of RTCA, special commissions or boards formed by the President or other authority for particular tasks, and Congress. The recommendations are in some cases used by the State Department as a basis for the position taken by United States delegations in international conferences.

During the recent World War, RTCA was necessarily inactive; comprehensive planning had to give way to the immediate tasks of all personnel in their war activities. At the end of the war the member agencies made a careful and specific determination that RTCA should be reactivated and streamlined for efficient action. Also, early in 1946, the Aeronautical Board, a policy body of the Departments of War and Navy, took cognizance of the need for complete co-ordination of the installation and use of electronic aids to air navigation, communication, and traffic control, and requested the RTCA to adapt its organization to the expeditious determination of combined civil and military programs of aids to navigation and traffic control.

RTCA agreed to undertake the discharge of these responsibilities and immediately took steps to revise its Constitution, making it more specific and workable; also a full-time, paid secretariat was established.

About this same time (1946), pressure was developing from many directions for the formulation of a national program of aids to air navigation, traffic control, communication, and landing. I do not need to describe to this audience the conditions which cry out for such a program. The seriousness of the disorganization of air services by weather is common knowledge. The presidents of all the airlines wrote to the RTCA requesting a study of the problem, particularly a determination of what could be done soon. The President appointed an Air Policy Commission. Congress appointed an Aviation Policy Board. Military committees were formulating the problem.

It finally became clear that the RTCA could function in this situation when, on April 28, 1947, the government's Air Co-ordinating Committee formally requested the RTCA to undertake a study and develop a recommended program for the safe control of the expanding air traffic. In compliance with this request, the RTCA immediately established its Special Committee 31 (SC31) to tackle the whole problem of air traffic control, including necessary communication and navigation and landing aids, and prepare a complete program for a national system, taking account of the requirements of every type of flying. Before the work was done, over 10,000 man-hours of the best type of co-operative committee work had been completed. It was necessary to draft the best brains in many technical fields, and

\* Decimal classification: R005XR520. Original manuscript received by the Institute, January 11, 1950. Presented, Symposium on Radio Aids to Navigation, 1949 National IRE Convention, New York, N. Y., March 9, 1949.

† Radio Technical Commission for Aeronautics, Washington, D. C.

the list of participants in the SC31 achievement is a Who's Who of aviation radio. The report was issued in final form on May 12, 1948. That the planning job was successful is clear from its unanimous endorsement by such bodies as the Air Co-ordinating Committee (ACC), the military's Research and Development Board (RDB), the President's Air Policy Commission, and the Congressional Aviation Policy Board.<sup>1</sup>

The planned system is called the "common system" because it provides for those needs which are common to all users—air transport, military, private flying, etc.

A special organization has been set up to implement the program. It includes a new government body, the Air Navigation Development Board (ANDB), closely co-ordinated with the Air Navigation Panel of the ACC, and with the military's Research and Development Board. All these bodies, and the various other agencies concerned, take the SC31 program as a guide plan but not an inflexible directive. We thus avoid the trap of a fixed, unchangeable program which would ignore the realities of progress. We visualize an orderly development from what we have today to the completely automatic navigation and traffic control system envisaged for about 1963, for which only objectives are stated at this time. These objectives flow from a severe but inescapable set of requirements. The system will make full use of such advances as occur in radar, television, electronic computing machines, and other technical fields. Some of the devices required for the ultimate system are not yet in existence, as Mr. Rentzel has said, but are known to be realizable. Some do exist and are in use now.

The program makes full provision for orderly transition from the practices of today to the ultimate system of fourteen years hence. In particular, in order to make a large portion of the benefits of the ultimate system available as soon as possible, it was decided to proceed in two steps. The first step will be the "transition program," which can be brought into general use by about 1953. For this the devices are in considerable measure already available. The supply and utilization of the devices has begun. The full implementation of the transition program awaits the making of money available, completion of development on some parts of the system, and delivery of equipment in the necessary quantity. The transition program is so planned that much of it will be preserved for smooth incorporation into the ultimate system.

The principal initial task of SC31 was to choose between many possible means of constructing a basic system. This was accomplished by first working out a realistic statement of the requirements of an adequate system. The set of requirements pointed the way to the nature of the required system. It was found also that substantial benefit would accrue through such partial realization of the system as would be possible in five years; thus, the transition system.

Facilities on the ground and in the airplane are to supplement and check one another.

The essential navigational data are primarily air-derived while the data for traffic control are primarily ground-derived. The system provides identification of all airplanes, provides means for collision prevention, and includes a private communication line between each airplane and the ground. The system is of the polar co-ordinate or R-theta type.

The transition system, now being implemented and to be completed by 1953, includes:

1. Omnirange stations; giving courses in every direction extending radially from the station.
2. Distance measuring equipment (DME); providing a dial indication of distance from the airplane to the ground station.
3. Automatic course line computer; by which any desired course, not limited to the radials from the station, is continuously indicated.
4. Instrument landing system (ILS); by which a crossed-pointer instrument gives guidance horizontally and vertically for blind landings.
5. Improved approach lights; guiding the final phases of low approach and landing.
6. Precision approach radar; to complement and monitor the instrument landing system.
7. Radar surveillance; giving a continuous indication on a radar screen, to air traffic controllers, of the position of all aircraft.
8. Vhf communication equipment; for two-way voice communication.
9. Airborne transponder and private line; to give the airplane's identification and altitude and to exchange information and traffic control signals between ground and air.

All of these elements, improved, will be carried over into the ultimate system, estimated to be in operation throughout the country by 1963. The ultimate system will comprise additional features such that all airplanes, after filing their flight plans, will be automatically assigned a flight path and time, and will have full information for all details of flight at every instant from takeoff to completion of landing. Specialized traffic control equipment and specialized airspace separation equipment, utilizing automatic computing devices, will watch over the airspace at all times to eliminate collision hazards and to inform all pilots of any needed changes in course or speed. These aids will reach the pilot via a map-like picture on his instrument panel which will enable him to monitor the traffic in his vicinity and check his navigational data.

This program represents the major project handled by the RTCA to date. While comprehensive, there is no thought that it closes the book on aviation radio progress. It just happened that the need had grown so serious, and the prospective investment was so large, that an agreed basic program for a considerable number of years ahead was necessary. But there is no thought of neglecting the facts of rapid technological movement and obsolescence. The program itself has this vividly in view, and indeed has

the very objective of stimulating, rather than freezing progress. The way is left open for full utilization of all our cumulative resources of science, inventiveness, and industrial efficiency.

To round out the picture of the role of RTCA, I will mention briefly a few of its recent and current projects other than SC31.

In accordance with a request from the War Department in 1946, Special Committee 1 studied the relative merits of simplex and crossband communication in the 108 to 132-Mc band. The recommendations of this Committee are now recognized as standard communication procedures by all United States aeronautical organizations.

Special Committee 4, upon request of the Federal Communications Commission, was assigned the problem of studying frequency allocations in the 108- to 132-Mc band for the various classes of aeronautical services such as air navigation aids, air traffic control, emergency, airport utility, approach control, and air carrier and non-carrier communication. The frequency allocation plan developed by this Committee is now incorporated in the Rules of the Federal Communications Commission.

Following recommendations of the military's Aeronautical Board and the Air Co-ordinating Committee, Special Committee 8 in 1946 formulated a basis for United States policy relating to air navigation, communication, and traffic control. The report of this Committee established the United States position at the meetings of the International Civil Aviation Organization COT Division meetings in Montreal during October–November of 1946. To a major degree, this policy was accepted by the COT Division for international standardization of radio aids to air navigation, communication, and traffic control.

Special Committee 10 studied problems relating to air-sea distress communications. The findings of this Committee were utilized in the Third International Conference on Safety of Life at Sea held in London in 1948.

Special Committee 15 reviewed procedures for the reduction of precipitation static interference in aircraft. It analyzed the progress in this field and recommended procedures which had been found to be most effective.

Upon request from the Radio Manufacturers Association, Special Committee 20 developed standards relating to radio equipment form factors. These standards have been generally accepted by all United States operating and manufacturing agencies.

Special Committee 21, in conformity with a State Department request, developed performance specifications for 1,000-Mc distance measuring equipment. These specifications were accepted by all United States agencies and, later, by Great Britain. These specifications were considered for international standardization at the ICAO COM Division meetings which began in Montreal, Canada, on January 11, 1949.

Special Committee 22, in accordance with a request from Aeronautical Radio, Inc., developed a plan for the pairing of localizer, glide slope, and vhf omnirange frequencies. This plan has been accepted by the Civil Aeronautics Administration and is currently in use for the assignment of fre-

<sup>1</sup> On January 10, 1950, the President presented the Collier Trophy, symbolizing the greatest achievement in aviation in America during 1948, to the RTCA for the establishment of this program.

quencies employed by localizer, glide slope, and vhf omnirange facilities throughout the United States.

Special Committee 24, in accordance with a request from Aeronautical Radio, Inc. developed a standard nomenclature of air navigation terms and the elements of air navigation systems.

Special Committee 27, in accordance with a request from Air Transport Association of America, conducted a study of aeronautical frequency allocations above 400 Mc. With minor modifications, the frequency assignments recommended by this Special Committee were adopted by the International Telecommunications Union Conference held in Atlantic City in 1947.

Upon request of the Federal Communications Commission, Special Committee 29 developed equipment standards for airdrome control stations.

Special Committee 30 prepared a descriptive resume of United States planning in air navigation, traffic control, communication. This is primarily an educational document and has been given wide distribution both nationally and internationally.

Upon request of the Telecommunications Co-ordinating Committee, Special Committee 33 conducted a study of long-distance air navigation aids in the North Atlantic with particular reference to the operation of standard Loran. The recom-

mendations of this Committee were utilized at an international conference on navigation aids in Geneva, Switzerland, in January, 1949.

Upon request of the Air Co-ordinating Committee, Special Committee 34 studied simplex versus crossband operation as applied to international aeronautical air-ground communications. The recommendations of this committee were accepted as the United States position at the ICAO COM Division meetings of January and February, 1949, past, in Montreal, Canada.

Upon request of the Civil Aeronautics Administration, Special Committee 40 prepared standardized test procedures for the 1,000-Mc Distance Measuring Equipment and detailed specifications regarding the operating characteristics of the DME system. The United States has submitted these specifications for international standardization through ICAO.

Special Committee 45 developed air traffic control procedures for use during the transition period when both vhf omniranges and lf/mf four-course ranges are in operation. The procedures developed by this Committee have been accepted by the Civil Aeronautics Administration with initial application to the New York-Chicago airway.

Among subjects pending at the present time in Special Committees are the following:

Development of test procedures and standards for airborne lf, mf, hf, vhf, and pulse technique types of airborne radio equipment.

Radio Instrumentation.

Automatic Flight Control.

Standardization of Adjustment of Instrument Landing Systems and Visual-aural Range Facilities.

Standardization of Aircraft Equipment Control Panels.

Investigation of Television Station Interference to Marker Beacon Receivers.

Study of Performance Specifications of Automatic Course Line Computers.

#### CONCLUSION

I think I can do no better than conclude by expressing my admiration for the sincerity and enthusiasm with which the many people and organizations concerned are co-operating in carrying on this work. It is no easy matter to find common ground among many conflicting requirements and interests. The great need for, and inherent difficulty of, the solutions of these problems have evoked the determination to make the work a success. With continued co-operation of all concerned, we are assured that RTCA will continue to serve as a mechanism for progress on our common problems in aeronautical radio.

## Developments in Studio Design\*

LEO L. BERANEK†, SENIOR MEMBER, IRE

The appearance of this paper in the PROCEEDINGS OF THE I.R.E. is the result of the activities of the IRE Audio Professional Group.

**Summary**—This paper lists the essential design features that should be incorporated into a broadcast studio, and illustrates the manner in which certain European broadcasting houses have expressed these design features architecturally. The paper is comprised of five principal parts: I. Introduction; II. Design Criteria; III. Studio Shaping; IV. Control of Reverberation Time and Diffusion; and, V. Reduction of Transmitted Sound. Included in the text are curves of preferred reverberation times for studios, preferred reverberation time versus frequency characteristics, and means for providing necessary diffusion and absorption of the sound in a room.

### I. INTRODUCTION

**I**N THE PAST two decades broadcast and recording studio design has undergone rapid development, due to basic research in room acoustics and the practical experience of industry. Recently, the author had the opportunity to study studio design in several Euro-

pean countries. The purposes of this paper are, first, to state the essential design features that should be incorporated into a studio, and, second, to show how European broadcasters have met these acoustical design features architecturally.

### II. DESIGN CRITERIA

A broadcast studio should fulfill two major requirements: (1) It should form a good acoustic link between the microphone or microphones and the source of speech or music. (2) It should adequately exclude external noises.

These requirements are almost equal in importance. The first criterion is the more difficult to meet. In order to illustrate the procedure necessary to achieve good microphone-source coupling, let us analyze the situation in a small, rectangular studio.

A room is simply a cavity resonator of fairly large dimensions with many resonant (normal) frequencies. These normal frequencies are widely spaced at low frequencies, but become progressively more bunched at higher frequencies. We shall assume a rectangular studio

\* Decimal classification: R613.11. Original manuscript received by the Institute, September 2, 1949; revised manuscript received, February 13, 1950. Presented, 1949 IRE National Convention, New York, N. Y., March 7, 1949.

The information reported here was made possible through funds provided by the Office of Naval Research.

† Acoustics Laboratory, Massachusetts Institute of Technology, Cambridge, Mass.



with the dimensions  $25 \times 15 \times 10$  feet. This ratio of dimensions, 5:3:2, is one of several considered "optimum" in room acoustics. In the frequency range between 40 and 100 cps, calculations show that there are 20 possible resonant conditions (normal modes of vibration) for this room. Of these 20 modes, there are seven cases in which two or three modes of vibration have almost the same resonant frequencies. That is, there are actually only 11 resonant regions. For any given position of the source in the room, however, only a few of the normal modes of vibration will respond to the source, and the microphone will not be actuated by a particular mode of vibration unless it is located near a pressure maximum of that mode. As a result, only eight or nine resonant frequency regions couple the source to the microphone between 40 and 100 cps.

Within these frequency limits there are 17 keys on the piano, and of these only 12 fall within two cycles of a normal frequency. Therefore, less than half of the piano notes in this frequency region receive room support and some of the remainder will actually be suppressed. The situation will be even worse if the ratios of any two dimensions are integrally related. A major design requirement, therefore, is to increase the supporting effect of the room at the lower frequencies.

The avoidance of "booming" effects at the lower frequencies is another problem of major importance. Ordinary acoustical materials and seats do not absorb sound efficiently at low frequencies. Hence, if they are used to reduce the reverberation time, a very nonuniform response-versus-frequency characteristic will result. Some materials which absorb sound more efficiently at low than at high frequencies must be introduced into the room.

At the higher frequencies, the normal frequencies of the studio are so closely spaced that any note on the piano will excite a resonant mode of vibration. In this frequency region we must deal with a different effect called "flutter echo." The flutter echo is a transient vibration produced by reflection back and forth between two parallel walls. This effect is annoying to a listener because it imparts a rasping sound to speech and music. Hence, all parallel surfaces of any appreciable area must be eliminated.

The remaining criteria that must be established and met are (a) the shape of the sound decay curve at any given frequency, (b) the reverberation time at a reference frequency, and (c) the reverberation time versus frequency characteristic. In regard to item (a), the British Broadcasting Company concludes that when the studio is excited by a short (0.1 sec) pulse of a given frequency, the echoes from that pulse should reach the microphone at close regular intervals of time, and should be of such amplitude as to give an exponential decay.<sup>1</sup> The reverberation time in the reference frequency region, 500 to 1,000 cps, should be approximately that

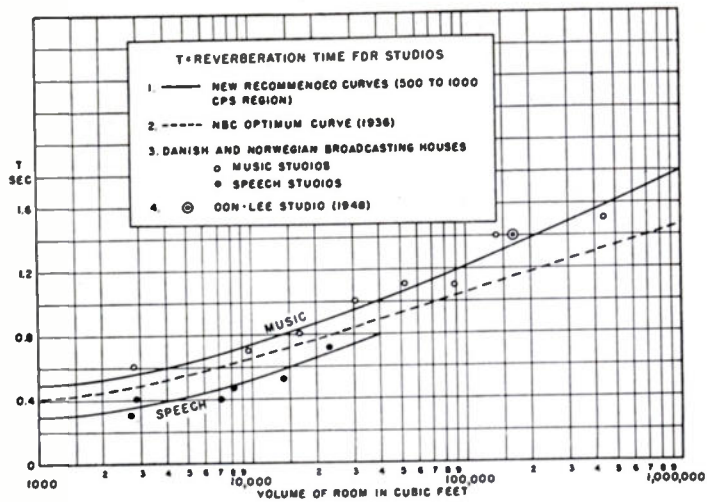

Fig. 1—Solid lines show curves for reverberation time in studios with normal furnishings and occupancy. Dashed curve shows curve published by National Broadcasting Company in 1936. Points show conformance of recent studios to these design criteria.

shown by one of the solid lines of Fig. 1.<sup>2,3</sup> The upper solid line applies for studios in which music is to be played; the lower solid line applies to studios for speech or drama. The small datum points plotted on this graph are for various studios of the Danish and Norwegian Broadcasting Systems and of the Don Lee Mutual Broadcasting System. Fig. 1 also shows a dotted line that represents the reverberation time recommended some years ago by the National Broadcasting Company.<sup>4</sup> The solid-line curves are based on controlled listening judgments made in the Danish and Don Lee Studios, and appear to be the best established curves available at this time.

There have been differences of opinion regarding the shape of the reverberation time ( $T$ ) versus frequency ( $f$ ) characteristic. It is generally agreed, however, that for speech the characteristic should be flat and the studio should be relatively dead. For music, the range of  $T$  versus  $f$  characteristics shown in Fig. 2 have been advocated. The most recent determination (curve 3) was made in the Danish Broadcasting House,<sup>3</sup> using three studios in which the reverberation characteristics could be varied over a wide range of shapes. Trained musicians listened to several types of orchestral compositions played over a loudspeaker and voted their preference. The unexpected result of this particular study is the hump in the curve at around 2,500 cps. Roop<sup>5</sup> and Bolt<sup>6</sup> show that for a room of 3,000 cubic feet the transmission irregularity is a maximum at some frequency below 800 cps. It may be that the ear has a preference for a more uniform curve of transmission irregularity versus fre-

<sup>2</sup> W. W. Carruthers and D. P. Loye, "Building to the acoustical optimum new Mutual-Don Lee broadcasting studios," *Jour. Acous. Soc. Amer.*, vol. 21, p. 428; July, 1949.

<sup>3</sup> P. V. Brüel, "Lydisolation og Rumakustik," Gumperts Forlag, Göteborg, Sweden, Fig. 240, p. 232; 1946.

<sup>4</sup> R. M. Morris and G. M. Nixon, "NBC studio design," *Jour. Acous. Soc. Amer.*, vol. 8, p. 81; October, 1936.

<sup>5</sup> R. W. Roop, "Frequency response fluctuations in rooms. I. Experimental investigation," *Jour. Acous. Soc. Amer.*, vol. 19, p. 728; July, 1947.

<sup>6</sup> R. H. Bolt and R. W. Roop, "Frequency response fluctuations in rooms. II. An approximate theory," *Jour. Acous. Soc. Amer.*, vol. 19, p. 729; July, 1947.

<sup>1</sup> Research Department Report No. B. 035, British Broadcasting Company, Engineering Division, 42 Nightingale Square, Balham, S.W. 12, England; October 14, 1948.

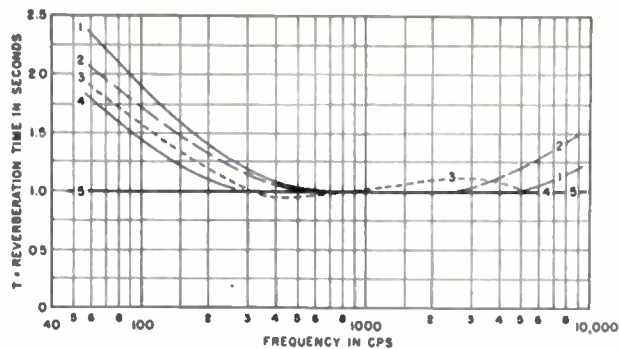

Fig. 2—Various recommended curves of reverberation time versus frequency for broadcast studios. (1) MacNair—1930; (2) Morris and Nixon—1936; (3) Danish Broadcasting studios for music; (4) Richmond and Heyda—1940; and (5) Békésy and others for speech studios. Curve 3 for music and the flat characteristic 5 for speech are recommended.

quency, and that greater absorption in the 500-cps region is a means of achieving this uniformity. Until contrary evidence is presented, the Danish reverberation characteristic for music studios will remain the most carefully determined. For speech studios, a flat characteristic is recommended.

In large broadcasting studios consideration must be given to the acoustical environment for the musicians. Experience in the United States, as well as in three European broadcasting houses, indicates that musicians desire audible reinforcement of their own music. Also, musicians in one part of an orchestra like to be able to hear the music of those in another part. Some type of low-ceilinged enclosure over the orchestra is necessary to achieve this result in large studios.

The isolation of a studio against external noise should at least meet the standards laid down by Nixon.<sup>7</sup> Nixon says the National Broadcasting Company has found that the maximum tolerable noise in studios, as measured by an American Standards Association sound level meter, is 25 db when read on meter scale A, 35 db on scale B and 45 db on scale C. Between any two studios an attenuation of 64 db or more should be provided. Some broadcasters, particularly in Norway, plan for noise levels 5 db lower than those just quoted and for attenuations greater than 75 db.

The studio should also be designed to reduce noise transmitted through the structure. In the case of pianos or other musical instruments that rest on the floor, a significant amount of sound will travel through the hard structure from one studio to another. To eliminate such transmission, a floating floor, and sometimes a completely floated studio, is necessary. Even airborne sounds will tend to enter the walls and travel through the structure to adjacent studios. If an attenuation in excess of 65–70 db is desired, the entire studio must be floated.

### III. STUDIO SHAPING

To provide for better coupling between the microphones and the source of sound at low frequencies, the studio should be shaped so that no two walls are paral-

lel. Nonparallelism is accomplished by simply splaying or slanting the side walls and the ceiling. One design of this type is shown in Fig. 3. A similar floor plan is found in the Norwegian Studios in Oslo. In these studios, no parallel walls exist. In the case of some of the Norwegian studios, nonparallelism is achieved by slanting the side walls so that the room is narrower at the ceiling than at the floor.

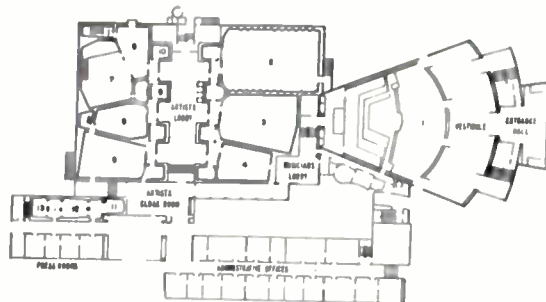

Fig. 3—Plan view of the Copenhagen Broadcasting House.

Splayed or skewed walls tend to shift some of the normal frequencies upward and some downward from their values in a simple rectangular room. In most cases, this shifting results in spreading the normal frequencies and gives a more even distribution along the frequency scale. Also, beats are produced when a number of modes of vibration die out simultaneously. A vibrato effect results. A string instrumentalist or a vocalist always strives to produce this effect. If the spacing of the modes of vibration along the frequency scale is uniform, the vibrato effect will be more uniform for different tones. There is another desirable effect. Skewed walls introduce more randomness into the distribution of the sound field in the room. Hence, fewer positions exist in the room at which extreme sound pressure variations occur as the frequency is varied. Therefore, the difficulties of finding a good location for the microphone decreases as the room becomes more and more irregular in shape.

The most desirable amount of splaying has never been determined. The answer to this question is partly economical and partly psychological. It is common practice to splay a wall by not less than one foot in each twenty feet of length. The Scandinavian studios in Fig. 3 are splayed considerably more than this in many cases.

Additional fine scale irregularity on flat splayed walls is also desirable. This may be accomplished either by obvious "bumps" of a variety of sizes or by choice and arrangement of the acoustical absorbing materials necessary in the room. In the Norwegian studios in Oslo this fine scale irregularity has been introduced as part of the absorbing panels. This treatment will be discussed further in the next section.

The ceiling and floor of the room should be nonparallel, if possible. If this cannot be done, then a number of triangular splays or polycylindrical diffusers of a variety of sizes may be placed on the ceiling. Another solution is to build a number of box-shaped reflecting boards with sloping surfaces, arranged to face in random directions.

<sup>7</sup>G. M. Nixon, "Acoustic problems in NBC studio design," *Electronics*, vol. 21, p. 85; May, 1948.

IV. CONTROL OF REVERBERATION TIME AND DIFFUSION

The reverberation time in a studio is controlled by the introduction of absorbing materials. As mentioned earlier, an audience and materials, such as carpets and seats, absorb far better at high frequencies than at low. Plywood panels, either flat or curved and backed by an air space, provide reasonably large low-frequency absorption. In some cases absorbing blankets are introduced into the air cavity. Panels used by Volkman<sup>8</sup> and Boner<sup>9</sup> consist of one or two sheets of thin plywood formed into convex, cylindrical surfaces. The plywood is backed by a wooden framework that breaks the panels into sections of various sizes, each having a different resonant frequency. When these panels are used in a room, a large number of different radii are chosen for the cylindrical elements in order to provide comparable diffusion over a wide range of frequencies. The diffusing effect of a cylinder is maximum when its diameter is roughly equal to one-half wavelength. Plywood panels appear to have an absorption coefficient as great as 0.5 at frequencies from 50 to 150 cps, decreasing to values as low as 0.05 above 1,000 cps. The 0.5 figure is obtained with two thin plywood layers, separated by small tufts of felt impregnated with glue. Flat sheets will absorb low-frequency sounds as effectively as curved ones, but they do not diffuse the sound at the higher frequencies.

The solutions to the low-frequency absorption problem employed by the Scandinavian broadcasting houses are particularly interesting. To provide this type of absorption, a number of forms of resonant absorbers are introduced into the studios. One type has the form shown in Fig. 4. Here, wall panels are constructed from a perforated facing backed by enclosed cavities. These cavities, and the holes into them, form Helmholtz resonators. In some cases the cavities are filled with

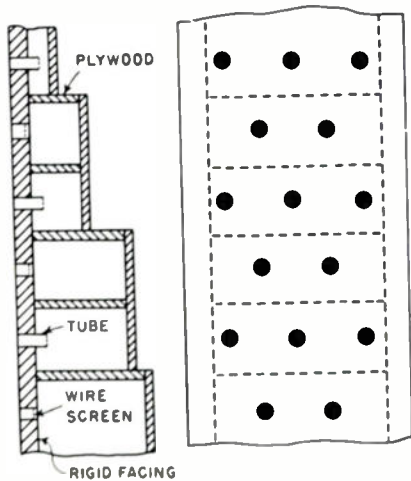

Fig. 4—Helmholtz acoustic resonators used in studios. The six resonators shown here have uniformly spaced resonances in the frequency region extending from 90 to 300 cps.

glass fibers or other absorbing material to broaden the resonance curve and to make the units absorptive over a wider frequency range. The six resonators shown in this figure have uniformly spaced resonances in the frequency region extending from 90 to 300 cps. In the case of the large studios of the Danish Broadcasting House, 250 plaster resonators, tuned to various frequencies below 100 cps, are distributed over the ceiling. Another type of acoustic unit for absorbing sound at low frequencies is shown in Fig. 5. Narrow slots are formed in a wood panel in front of an air space that contains an absorbing blanket. The absorption reaches a maximum that may be varied by adjusting the space behind the slot in the panel.

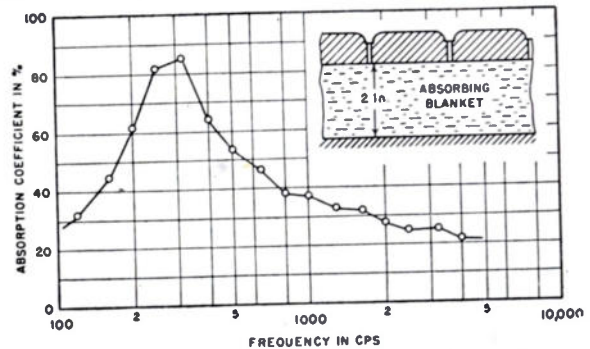

Fig. 5—Resonant structure and absorption curve for it. The structure is made of parallel slats separated slightly to produce resonance.

In the Norwegian Broadcasting House the panels are made of thin sheets of plywood which have narrow slots 3 inches long and 0.04 to 0.12 inch wide. There is one slot for each 1.6 square inch of the plywood board. The distance between the wall and the plywood panel varies from 2 to 12 inches in different parts of a studio. In the concert studio spacings up to 30 inches are used. With these absorbing surfaces placed at random positions on the walls, and with an appropriate choice of back spaces and slot widths for each studio, the No. 3 optimum reverberation time characteristic of Fig. 2 was approached. In some of the studios where higher reverberation times were desired, some of the panels were unperforated and the depth of the air space behind them was selected so as to vary the resonant frequency over a range from 50 to 150 cps.

Still another type of resonator is one which the Norwegians describe as a "pocket-resonator." Pocket resonators are tubes made from wood or wall board. They have cross-sectional dimensions of about 8×20 inches, and vary in length from 32 to 120 inches. The opening of the resonator which faces into the room, is filled with an acoustical blanket. The resonators act like damped organ pipes. Lengths are chosen to tune the resonator to particular frequencies where absorption is needed. When installed, they are placed behind a slotted panel and, hence, do not affect the over-all appearance of the room.

It is generally desirable to provide flexibility in the acoustical treatment to permit detailed tailoring of the reverberation time-frequency characteristic after completion of the studio. Two arrangements for doing this were used in the Danish Broadcasting House in Copen-

<sup>8</sup> J. E. Volkman, "Polycylindrical diffusers in room acoustical design," *Jour. Acous. Soc. Amer.*, vol. 13, p. 234; January, 1942.  
<sup>9</sup> C. P. Boner, "Performance of broadcast studios designed with convex surfaces of plywood," *Jour. Acous. Soc. Amer.*, vol. 13, p. 244; January, 1942.

hagen, and are shown in Fig. 6. There we see a hinged perforated panel that is backed with a thin layer of absorbing material. The panel may be moved forward so that the right-hand edge is flush with the front of the box, or it may be moved backward so as to eliminate the air space behind it completely. The variation in the absorption characteristic is indicated by the two curves beneath the sketch. The solid line is for maximum air space behind the absorbing layer.

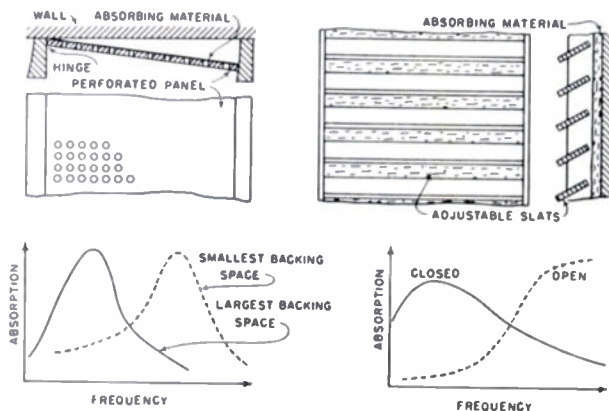

Fig. 6—Two structures for producing variable degrees of absorption. Curves of absorption coefficient versus frequency are shown below for the extreme positions of adjustment.

The arrangement on the right-hand side of Fig. 6 includes a series of adjustable shutters in front of an absorbing blanket. When the shutters are closed, only a small slit remains between adjacent louvers, and the absorption characteristic shown by the solid line beneath the sketch is obtained. When the shutters are opened, the absorption characteristic shown by the dotted line is obtained.

All such absorbing areas, whether adjustable or fixed, should be located in random positions on the walls and ceiling of the room. To enhance the appearance of the room an acoustically transparent facing may be provided.

Examples of the interior finishes and shaping described above are shown in Figs. 7 and 8. These photographs show studios 19 and 24, respectively, of the Norwegian Broadcasting House. The perforated facings in the rooms are illustrated. A splayed ceiling is shown in Fig. 7, and splayed ceiling and side walls are seen in Fig. 8. The pleasing appearance of the perforated facings is evident.

#### V. REDUCTION OF TRANSMITTED SOUND

No less important than the acoustic characteristics of the enclosure is the need for freedom from unwanted sounds. The most satisfactory procedure for achieving this effect is to build walls that have sufficient transmission loss to provide the necessary isolation for airborne noises, and to float the studio on resilient mountings to eliminate vibrations which might otherwise be transmitted through the structure. The idea of a floating studio is not new. Elaborate details have been worked out by several manufacturers in this country for floating the interior of small broadcasting studios.<sup>4</sup>



Fig. 7—Large-sized studio for music in the Norwegian Broadcasting House.



Fig. 8—Small-sized studio for speech and drama in the Norwegian Broadcasting House. The stair has three types (acoustically) of tread and the removable panels expose a gravel walk, a wood surface for tap dancing, and a marble surface for producing the sound of footsteps.

In the Norwegian Broadcasting House in Oslo each studio is made from poured concrete and rests on strips of live rubber. Canvas sleeves are used to break the continuity of the ventilating and cable ducts.

Doors to the studios preferably should be of a type which seal tightly around the edges. In the Danish studios an unusual door type is used. Around the edges of a 4-inch thick door, there is a cavity three inches wide and three inches deep. This cavity is filled with glass wool and covered with a perforated facing. The width of the slot between the door and the jamb is held to less than 0.04 inch. Sound traveling through this slot is absorbed in the glass wool lining. Best results are obtained by putting an offset in the jamb so that the sound will have to round a corner in traveling from the outside to the inside of the room.

#### ACKNOWLEDGMENT

The author wishes to thank the Danish and Norwegian Broadcasting Houses for their kindnesses in furnishing photographs and descriptions of their studios. The author is also grateful to R. B. Newman, who assisted in the preparation of the manuscript.

# Linear Amplifiers\*

M. A. SCHULTZ†, SENIOR MEMBER, IRE

**Summary**—The problems in the design of linear amplifiers are presented from the point of view of the radio engineer. Equations are given for the noise generated in the input circuits of these amplifiers for ideal cases. Typical amplifying circuits are presented, and the solutions of the design problems are illustrated by the circuit diagrams and performance of a commercial linear amplifier.

## INTRODUCTION

THE RADIO ENGINEER with his newly found knowledge in radar and television might look upon the nuclear instrumentation field as a logical one in which to employ his talents. This step follows because the nuclear field employs to a considerable extent the same pulse techniques that were exploited so successfully by the radio engineer during and after the war. One of the purposes of this article is to point out wherein the techniques and the experiences in the two fields are similar, yet different.

Obviously, the radio engineer must obtain some background in the nuclear field before he can successfully design apparatus for it. The linear amplifier is one nuclear device which the radio engineer can design and improve, once he understands the conditions under which the amplifier is to be used. First then, what is a linear amplifier to the nuclear physicist and engineer? A linear amplifier is an alternating-current amplifier intended for the amplifications of pulse signals which arise in detection instruments because of the disintegration of radioactive materials. These pulses, like the disintegrations, are completely random in time and usually random in amplitude. Instruments which detect these disintegrations can be built so that the output voltage from them is a measure of the energy of the disintegration. Therefore, the amplifier which receives its input from the detecting devices must not change the amplitude relationship of the various signals which enter it if the output of the amplifier is to be a true measure of the nuclear disintegration energy.

The problem of designing an amplifier for use with random pulses is different from that usually encountered in the communications field.<sup>1</sup> In television or radar work, discrete numbers are usually associated with repetition rates of pulses or pulse widths. These discrete numbers tie into considerations of frequency response and signal-to-noise ratios of receivers and amplifiers. The linear amplifier on the other hand might be called on to handle pulses having peak amplitudes anywhere from 10 microvolts to 50 millivolts. The impedance level

at which these pulses are generated is usually extremely high in the order of many megohms. The width of these pulses might vary from  $10^{-9}$  seconds to  $10^{-2}$  seconds, and any of these possible combinations of pulses may occur at a random time. The amplifier must then be extremely flexible in order to handle these pulses satisfactorily.

Fig. 1 shows a typical laboratory setup in which a linear amplifier might be used. An ionization chamber, proportional counter, or scintillation counter is used to convert the nuclear energy into pulses. All of these devices are similar in that pulses are generated at a high impedance level. These pulses are then amplified faithfully in amplitude by the linear amplifier system. The system usually includes a preamplifier and a main amplifier. The output of the amplifier then feeds an operating device or circuit.



Fig. 1—Typical experiment using linear amplifier.

These operating devices may be of several types, all of which might affect the design of the amplifier. The most common circuit employed following a linear amplifier is a pulse height discriminator. In simple terms, this is merely a circuit for passing all signals above a discrete amplitude. A pulse height discriminator is frequently built on the same chassis as the linear amplifier.

Other operating devices which are used are:

1. Oscilloscopes
2. Pulse height analyzers (for selecting only those pulses whose amplitudes lie between two discrete levels)
3. Time-coincidence or anti-coincidence circuits
4. Integrating circuits
5. Counting rate meters.

These circuits will be fully described in the other articles in this series.

Before attempting to lay down the requirements of a linear amplifier, it becomes necessary to examine closely the origin of the pulses and their form.

Fig. 2(a) shows a typical detector such as an ionization chamber connected to the grid of a vacuum tube. The ionization chamber contains a large number of gas molecules, and the passage of an energized particle through the chamber ionizes many molecules. Sufficiently high voltages are placed across the plates of the chamber to collect most of these ions. The charge which is liberated upon the collision of the energized particle

\* Decimal classification: R363.141. Original manuscript received by the Institute, January 16, 1950.

† Westinghouse Atomic Power Division, Pittsburgh, Pa.

<sup>1</sup> W. H. Jordan and P. R. Bell, "A general purpose linear amplifier," *Rev. Sci. Instr.*, vol. 18, pp. 703-705; October, 1947.

with the gas molecules is collected then on the chamber plates and produces a minute voltage step across the capacitance of the chamber. The input capacitance of the vacuum tube is effectively in parallel with the capacitance of the chamber, as is the grid leak resistor. In order that the maximum voltage should appear at the grid of the input tube, the grid leak resistor is made very large so that no charge leaks away during the time of ion collection.

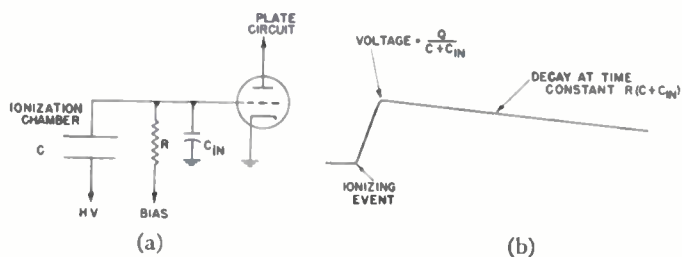

Fig. 2—(a) Detector input circuit. (b) Pulse shape at input grid.

When the chamber is filled with gases, such as argon or carbon dioxide, the negative ions are electrons. These electrons are collected by the chamber quite quickly, in the order of 1 microsecond. However, when gases such as air or chlorine are used, the negative ions are charged molecules. These molecules are collected slowly in the order of 100 to 1,000 microseconds. The electron collection case is the most frequently used at present.

During the pulse formation, the amplifier input appears to be capacitive, and the pulse shape appears as shown in Fig. 2(b).

#### OVER-ALL AMPLIFIER REQUIREMENTS

The requirements of the linear amplifier are determined then by the input pulses and the output operating devices. A good amplifier should meet certain requirements in the following categories.

##### A. Stability

Because it is desired to maintain a linear relationship between the energy of the input ionizing particle and the output voltage pulses from the amplifier, the stability of the gain of a linear amplifier is more important than the gain itself. The two principal causes of amplifier instability are, first, variation in the power supply voltages and, second, variation in components and tubes with respect to time and temperature. The variation of gain of power supply voltage can be minimized to a great extent by using highly regulated power supplies in both plate and filament supply. Stabilizations in the order of one-half per cent are commonly used. Negative feedback is used to offset the change of component values with time and temperature, and the more feedback that can be employed, the stabler the resulting amplifier. The types of circuits used to obtain this feedback will be described later.

##### B. Input and Output Voltages

The wide range of input voltages from 10 microvolts to 50 millivolts means that care must be taken to prevent the amplifier from overloading under large signal conditions. One type of experiment which is performed is to measure the number and heights of a series of large pulses originating from alpha particle or fission fragment disintegrations in the presence of a large number of smaller gamma-ray induced pulses. In this instance the larger pulses must not be blocked by the smaller ones building up.

Conversely, one might wish to measure small pulses in the presence of large ones. For example, in measuring the energy of beta rays, one would like to measure down to very low energies, but at the same time large pulses (high energy ones) overload the amplifier and may cause multiple small pulses. This condition limits the amplifier gain or the minimum setting of a pulse height selector.

Because the output of the amplifier must feed so many different types of circuits, it is desirable that the output impedance of the amplifier be as low as possible, yet the voltage output also be high. These two requirements cannot be met simultaneously without using large vacuum tubes. Commercial amplifiers have adopted the expedient of having two outputs. One output might be a low voltage low impedance output of about 5 volts at 50 ohms, and the second output might be at a higher voltage and impedance level of 100 volts at 1,000 ohms.

##### C. Gain

The gain of the linear amplifier depends on the measurement performed. This measurement will usually specify the bandwidth required. Typical gain figures of a commercial amplifier might be as given below:

1. Preamplifier gain                    10 to 100
2. Main amplifier gain                2,000 to 20,000.

As the techniques of improving these amplifiers with respect to signal-to-noise ratio become better known, the desire for more sensitivity on the part of various experimenters will conceivably push the over-all gain requirement to 3,000,000 to 4,000,000.

##### D. Linearity

The linearity of the amplifier amplitude response is particularly important. The operating device shown in Fig. 1 might be a multiple channel pulse height selector. In this case, the more channels that are used the better the linearity of the amplifier must be, in order to prevent a false output indication. Linearities of 0.5 per cent or better are often required.

It is usually possible to operate the early stages of the amplifier on a linear portion of their characteristics, but it is the output stages which cause most of the nonlinearity difficulties. If the amplifier is designed and used so that a discrete polarity of pulse can be made to occur

at a given output stage, this stage can be biased to obtain a maximum linear range. Negative feedback again is used to combat nonlinearity.

#### E. Frequency Response

The frequency response of the amplifier must be adjustable. This response may be determined by the signal-to-noise ratio or by other conditions, such as resolution. In discussing the response of an amplifier of this type, it is more customary to discuss the rise and decay time of pulses, rather than the frequency response, as the amplifier's main function is to amplify pulses. In general, the amplifier must be capable of passing frequencies from 30 cycles to 5 Mc. In the pulse notation the amplifier might have rise times adjustable from 0.1 microsecond to 20 microseconds and decay times of 50 microseconds to 0.2 microsecond. These rise times and decay times are obtained by manipulating a front panel selector switch which chooses a frequency response and corresponding gain of the amplifier. The parameters are occasionally adjusted so as to keep the noise output nearly constant.

#### F. Prevention of Spurious Counting

In operating devices such as pulse height discriminators, the amplifier should not introduce appreciable sources of error. These errors might be broken down into three main types, i.e., extra pulses, loss of pulses, or distortion of pulse amplitude.

1. *Extra Pulses.* In working the amplifier with low amplitude pulses, it is conceivable that noise bursts may arise which are greater in amplitude than the pulses being measured. These noise pulses may originate either externally or internally with respect to the amplifier. Microphonics are particularly good sources of extraneous counts in these wide-band high-gain amplifiers, employing high  $g_m$  tubes with small element spacing. Some manufacturers actually shock mount the tube sockets of the first few tubes of the circuit in an effort to reduce microphonics.

Insulator noise is also a common source of extraneous counts. Some of the insulators in the preamplifier are subjected to moderately high voltages and very small corona discharges can take place, especially at high humidities. Special care must be taken to coat these insulators. High voltage connectors from the preamplifier to the ionization chamber must also be designed for low noise output.

Electric motors and other sparking devices cause spurious pulses both by direct radiation into the amplifier and by conduction through the power lines. For accurate work, a power line filter is a necessity; and radio-frequency chokes should be built into the power supply leads of the amplifier. Direct radiation effects can be reduced by complete shielding of the amplifier.

Multiple ground connections between detector, preamplifier, main amplifier, and operating device are to be avoided whenever possible.

Another source of spurious counting in the output circuit may be caused by background pulses piling up. In some cases radiations of smaller energy than those which are being measured may be present in many times the quantity of the desired radiation. Occasionally, the probability of a large number of these random pulses piling up to give a pulse which could be recorded by the amplitude discriminator occurs. This effect may be minimized by using pulses of short duration. Electron collection in the ion chamber is a popular means of obtaining these short pulses.

2. *Loss of Pulses.* The amplifier must also not suppress any of the pulses which it is desired to measure. It is conceivable that a noise burst could come along in the proper phase to cancel out a desired pulse. This possibility and the possibility mentioned above of a spurious pulse entering the counting circuit usually can be eliminated by having large signal-to-noise ratios. A signal-to-noise ratio of about five to one is usually sufficient to eliminate this source of error. Another source of pulse suppression is due to the overloading of the amplifier. If an extremely large pulse comes along, it is possible that the large pulse might block one of the last stages of the amplifier, and thus one of the smaller normal size pulses might be lost during the time in which the amplifier is blocked. This condition can also be minimized by proper design, and circuits to prevent blocking are presented later in this article.

3. *Distortion of Pulse Amplitude.* If the pulse shape is distorted by the amplifier, then it is conceivable that a wrong output amplitude may operate the discriminator circuit. Noise riding through on top of a pulse might cause the discriminator to operate, even though the pulse itself is not large enough. Another type of distortion which may occur is a ringing overshoot following a large pulse which may or may not overload the amplifier. The ringing will appear as many small pulses.

#### PREAMPLIFIER

The preamplifier design is similar in philosophy to those used in radar equipments. It is usually mounted very closely to the radiation measuring device, and it is connected to the main amplifying section by means of a low impedance cable. Many special nuclear requirements may be asked of the preamplifier which might cause its physical shape to differ radically from radar preamplifiers. For example, it may be required to work in a high radiation field; or if it is being used near a nuclear machine such as a cyclotron, it might be required that the preamplifier operate in a high magnetic field. Generally speaking, though, the preamplifier is an impedance changing device to carry the pulse information from its high impedance source to the low impedance input of the amplifier proper.

The high voltage supply lead for the detecting device is usually brought in through the preamplifier. Voltages below 1,000 volts are handled in this manner; higher voltages might require separate connections.

The capacitance of the input signal lead from the detector should be kept as low as possible. The magnitude of the input signal is inversely proportional to the input circuit capacitance, and only a few feet of low capacitance coaxial cable can be tolerated.

The gain of the preamplifier is again a function of the measurement to be performed. When proportional counters or fission chambers are used as the detector element, very large pulses can be realized in their outputs. Then the preamplifier can have a gain of roughly one and be merely an impedance changer. For other types of detectors a gain of as much as 100 may be desirable.

The noise figure of the entire amplifier is governed by the circuit and components of the first few stages of the preamplifier. The design of these input circuits for low noise output is one of the fundamental problems in linear amplifiers. This problem differs somewhat from the problems in radio receiver work. A broad statement can be quoted from the radio engineers' bible,<sup>2</sup> "The ultimate limit of signal-to-noise ratio is obtained when the receiver bandwidth has the minimum possible value, and all the noise in the receiver output is caused by thermal agitation in the input circuit to the first tube." Let us examine the input circuit of the first stage of a linear amplifier to see how the receiver criterion holds for linear amplifiers.

From Fig. 2 the input circuit may be represented as shown in Fig. 3(a).

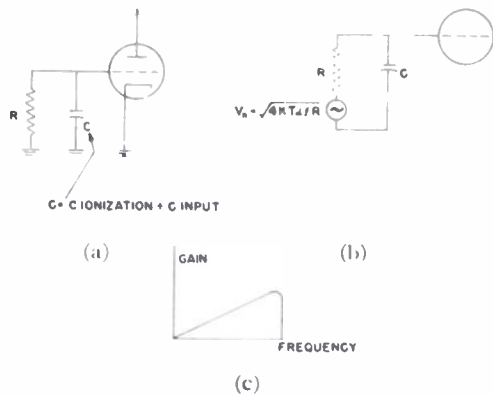

Fig. 3—(a) Input circuit. (b) Thermal noise equivalent circuit. (c) Idealized frequency response of amplifier having a discriminator circuit.

From the standpoint of thermal noise, this circuit may be considered as shown in Fig. 3(b).

The noise  $V_n$  is the root-mean-square thermal noise voltage originating in the resistor  $R$ . This voltage has been shown<sup>3</sup> to be

$$V_n = \sqrt{4kTdfR} \tag{1}$$

where  $K$  is Boltzmann's constant and  $T$  is the temperature in degrees kelvin. The thermal noise output voltage  $V_{out}$  then becomes

$$V_{out} = V_n \frac{\left(-j \frac{1}{\omega C}\right)}{R - j \frac{1}{\omega C}} \tag{2}$$

but in order to obtain the maximum signal from the ionization chamber,  $RC$  must be very large compared with the pulse width. Then if  $C$  is fixed and  $R \gg (1/\omega C)$  at any frequency within the pass band of the following amplifier,  $j(1/\omega C)$  can be neglected in the denominator,

$$V_{out} = V_n \frac{j \frac{1}{\omega C}}{R} = \frac{\sqrt{4kTdf}}{\sqrt{R}} j \frac{1}{\omega C} \tag{3}$$

As noise power is an important quantity for signal-to-noise considerations, the mean-squared voltage is of significance

$$\overline{V_{out}^2} = \frac{4kTdf}{R} \frac{1}{\omega^2 C^2} \tag{4}$$

Integrating this quantity over the amplifier pass band

$$\int_{f_2}^{f_1} \overline{V_{out}^2} df = \frac{KT}{RC^2\pi^2} \left(\frac{1}{f_1} - \frac{1}{f_2}\right) \tag{5}$$

and in wide-band amplifier work  $1/f_2 \ll 1/f_1$ .

Therefore, the average thermal noise power over the amplifier bandwidth becomes proportional to

$$\frac{KT}{RC^2\pi^2 f_1} \tag{6}$$

This result is significant in that the proper value of  $R$  for use with an ionization chamber has been previously shown to be very large; and from the standpoint of thermal noise reduction  $R$  should also be made very large. In fact because of this fortunate circumstance,  $R$  can be made large enough that thermal noise usually does not enter as a factor in the design of linear amplifiers. In the case of very slow amplifiers, that is, amplifiers for wide pulses having a low value of  $f_1$ , the thermal noise can become appreciable and must be considered.

As will be shown later, most amplifiers employ a differentiating network somewhere in the circuit. In the ideal case this differentiator modifies the over-all frequency response to appear as shown in Fig. 3(c). With a pass band of this type the thermal noise becomes

$$\frac{KT}{RC^2\pi^2} \left(\frac{f_2 - f_1}{f_2^2}\right) \tag{5a}$$

<sup>2</sup> F. E. Terman, "Radio Engineers Handbook," McGraw-Hill Book Co., Inc., New York, N. Y., p. 648; 1943.

<sup>3</sup> J. B. Johnson, "Thermal agitation of electricity in conductors," *Phys. Rev.*, vol. 32, p. 97; July, 1928.



which reduces to

$$\frac{KT}{RC^2\pi^2} \frac{1}{f_2}, \quad (6a)$$

when  $f_2 \gg f_1$ . It is interesting to note that the noise determining parameter has now become  $f_2$  rather than  $f_1$ . Thermal noise, however, is still comparatively unimportant as long as  $R$  is large.

It is necessary then to examine briefly the other sources of noise voltage in an input circuit. These other noises are the familiar shot effect noise, grid current noise, and flicker noise.

Shot noise arises from the fact that the electron emission from a cathode is in a large number of discrete units which are random in character. The plate current of the tube will therefore have superimposed upon it a random noise.

It has been shown<sup>4</sup> that this noise voltage can be defined roughly by

$$\overline{V_{\text{shot}}^2} = 4KT \frac{2.5}{g_m} (f_2 - f_1), \quad (7)$$

for the conditions generally found in a linear amplifier,

where  $K$  = Boltzmann's constant

$T = 290^\circ\text{K}$

$f_2$  = upper frequency cutoff

$f_1$  = lower frequency cutoff

$g_m$  = transconductance of the tube.

The factor 2.5 arises as an empirical space-charge reduction term.

From equation (7) it can be seen that in choosing a design, the highest  $g_m$  tube should be used. The shot noise also increases with the bandwidth of the amplifier; or from (7), the noise is a function of the upper frequency of the amplifier, as  $f_2$  is usually very much larger than  $f_1$ . It can also be shown<sup>4</sup> that triodes give less shot noise than pentodes, provided that the Miller effect can be tolerated.

For the case of the amplifier with the ideal triangular pass band caused by the differentiating network, the equation for the shot effect noise becomes

$$\overline{V_{\text{shot}}^2} = 4KT \frac{2.5}{g_m} \left( \frac{f_2^3 - f_1^3}{f_2^2} \right). \quad (7a)$$

Grid current noise arises from a superimposed random electron flow on the grid current. Grid current noise for the linear amplifier, ionization chamber input circuit combination may be shown to be roughly

$$\overline{V_{i_g}^2} = \frac{eI_g}{2\pi^2C^2} \left( \frac{1}{f_1} - \frac{1}{f_2} \right). \quad (8)$$

The corresponding differentiated case becomes

$$\overline{V_{i_g}^2} = \frac{eI_g}{2\pi^2C^2} \left( \frac{f_2 - f_1}{f_2^2} \right), \quad (8a)$$

when

$e$  = electronic charge =  $1.59 \times 10^{-19}$  coulombs

$I_g$  = the grid current

$C$  = the total input capacitance of the chamber and input circuit.

This equation indicates that a tube with low grid current should be used for lowest grid noise. Also the low-frequency cutoff point should be made as high as possible. Grid current refers to the total ionic and electron currents. It is usually desirable to bias the tube at a point where the ionic currents predominate as the electron current rises quite sharply as the grid approaches a positive voltage operating region. Tubes with very high vacuum, of course, would have low ionic grid currents.

Flicker noise is assumed to be caused by random variations in the cathode emitting surface giving rise to fluctuations in the anode current. This effect is usually not very large and can be given roughly by<sup>4</sup>

$$\overline{V_f^2} = 10^{-13} \ln \frac{f_2}{f_1}, \quad (9)$$

and for the amplifier with the differentiator

$$\overline{V_f^2} = 10^{-13} \left( \frac{f_2^2 - f_1^2}{f_2^2} \right). \quad (9a)$$

Here the noise is dependent only on the ratio of  $f_2$  to  $f_1$ , and not on the position of the band in the spectrum. Obviously, this ratio should be kept as small as possible.

In order for the reader to obtain a feel for the order of magnitude of these noise voltages, the following example is presented. Let us assume a linear amplifier working with an ionization chamber. The input tube is to be a 6AK5 having a  $g_m$  of 5,600. The total chamber and input capacitance is to be 30  $\mu\text{mf}$ ; the grid current =  $10^{-8}$  amps,  $f_1 = 10$  kc,  $f_2 = 1$  Mc. Then using equations (7), (8), and (9),

$V_{\text{shot}} = 2.67$  microvolts

$V_{i_g} = 3$  microvolts

$V_f = 0.68$  microvolts

$V_{\text{total}} = 4.1$  microvolts (noise voltages added in quadrature).

#### AMPLIFIER

The preamplifier connects directly to the main portion of the linear amplifier by means of a low impedance cable, and all of the bandwidth considerations can be made in the main amplifier.

The bandwidth of the amplifier again is a function of the type of experiment to be performed. In general, four considerations are apparent in the selection of the amplifier bandwidth. These are:

<sup>4</sup> A. B. Gillespie, "An Introduction to AC Amplifiers for Nuclear Physics Research," United Kingdom Atomic Energy Report AE-1010.

1. Signal-to-noise ratio
2. Resolution of pulses
3. Constancy of gain with particle collection time
4. Pulse background.

#### A. Signal-to-Noise Ratio

The approach to the problem of obtaining a good signal-to-noise ratio from the standpoint of reducing noise has just been treated in the preamplifier section. The reduction of noise calls for a reduction of bandwidth and naturally this bandwidth reduction affects the signal amplitude adversely. Methods for obtaining the optimum signal-to-noise ratio are complex<sup>4,5</sup> and beyond the scope of this paper. For experiments in which the pulse rise time is known, a general rule can be laid down which will result in the amplifier having a good signal-to-noise ratio close to the optimum one. First, the shot noise and the grid noise should be made approximately equal by methods other than juggling the bandwidth. To reduce shot noise, the input tube  $g_m$  might be increased. If the grid current noise is too large, proper selection of tubes and bias voltage can be helpful in causing a noise reduction. Define  $T$  as the pulse rise time,  $T_1$  as the time constant corresponding to a low-frequency  $RC$  band pass determining network, and  $T_2$  as the time constant corresponding to a high-frequency  $RC$  band pass determining network. These relationships are shown in Fig. 4.

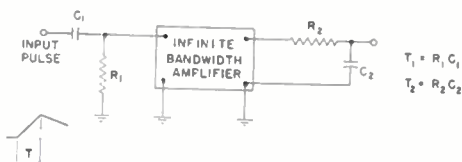

Fig. 4—Bandwidth reduction constants.

Then if these time constants are set so that  $T_1 = 0.5T$  and  $T_1/T_2 = 2$ , a good signal-to-noise ratio will result.

#### B. Resolution of Pulses

Good resolution permits high counting rates and also reduces the pile up of pulses. Short resolving time is important to separate the pulses completely from each other. This permits high counting rates and enables one to count, say, alpha particles or fission particles in the presence of a large gamma background. In coincidence experiments short pulses reduce the random coincidence rate, but leave the time coincidence rate unchanged. It is evident that the narrower these pulses are, the more accurate will be the time coincidence counting rate. This fact calls for the amplifier to faithfully reproduce the edges and top of the pulse. The condition is analogous to the similar problem in radar receivers when it is desired to separate one echo from another. It has been

shown<sup>6</sup> for maximum signal-to-noise ratio that the frequency response for the radar receiver should be the inverse of the pulse width. However, for better resolution radar receivers are built with bandwidths 1.5 to 10 times this value. A similar condition exists in linear amplifier design. In order to obtain good resolution the bandwidth should be made as wide as practical at the expense of signal-to-noise ratio.

#### C. Constancy of Gain with Particle Collection Time

The time of collection of ions in an ionization chamber will vary somewhat. This means that the rise times of the output pulses will not all be the same. The amplifier bandwidth again must be adjusted at the expense of signal-to-noise ratio to eliminate variations in amplitude as a function of rise time. An attempt should be made to eliminate variations in rise time by properly designing the geometry of the detecting chamber. If this cannot be done, a compromise must be made with signal-to-noise ratio. The best bandwidth is usually found by experiment.

#### D. Pulse Background

It has been mentioned that certain experiments call for the measurement of large pulses in the presence of a multitude of small ones. The background pulses will, in general, have the same time of rise and pulse width as the desired pulses. The probability of the smaller background pulses building up to a large pulse depends upon the width of the background pulses, assuming that the background pulses occur at a given mean rate. The amplifier then must not broaden the pulses, and consequently, it should again have as large a high-frequency cutoff as is consistent with a usable signal-to-noise ratio.

The past few paragraphs have indicated the operating procedure in setting up the bandwidth for use with a particular experiment. It should be pointed out also that in some instances it becomes desirable to reduce bandwidth from the indicated optimum because of microphonics and external noises. Here the procedure is to raise the low-frequency cutoff. Amplifiers which do not pass frequencies below 100 kc are usually not troubled with microphonics.

### DIFFERENTIATING NETWORKS

The ionization chamber and its associated networks are essentially an integrating device. In order to obtain some semblance of the original pulse of ionization, it is usually necessary to differentiate later in the circuit. The use of a differentiating network is familiar to radar engineers. In radar receiver work, a circuit known as FTC (Fast Time Constant) is switched into the video circuit in an effort to remove objectionable large block-

<sup>4</sup> W. C. Elmore, "Electronics for the nuclear physicist," *Nuclear Electronics*, vol. 2, pp. 16-23; March, 1948.

<sup>6</sup> Andrew V. Haefl, "Minimum detectable radar signal and its dependence upon parameters of radar systems," *Proc. I.R.E.*, vol. 34, pp. 857-862; November, 1946.

ing echoes. In linear amplifier design, a similar differentiating network is used.

The differentiation network is usually inserted between the preamplifier and the main amplifier. One might insert the differentiating network at the input of the preamplifier. This step would mean placing a small resistance across the detecting device. As has been shown previously, the low resistance is not desirable from the standpoint of signal to noise ratios. A loss in this ratio of about 20 db might result from the use of this low resistance. On the other hand, if the differentiator were placed near the output, the pile up of pulses might be so large that it would be most difficult to design circuits which would not overload. The junction of the preamplifier and the main amplifier then becomes a logical place to insert this network.

Differentiation is customarily performed in one of two manners; either a simple  $RC$  coupled circuit is used, or delay line coupling may be employed. Fig. 5 shows the

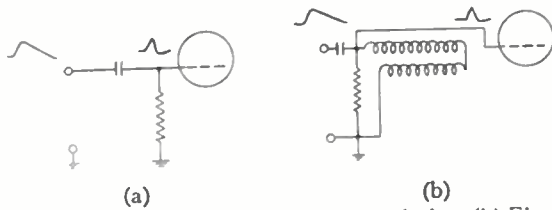

Fig. 5—(a) Elementary circuit for  $RC$  differentiation. (b) Elementary circuit for delay line differentiation.

elemental form of these circuits. The time constant of the  $RC$  network is usually of the order of magnitude of the rise time of the pulse. The input pulse to the differentiating network appears as is shown in Fig. 6(a). The output pulse looks similar to that of pulse  $B$  in Fig. 6. The advantage of delay line coupling over  $RC$  coupling is that the output pulse is a little steeper on the

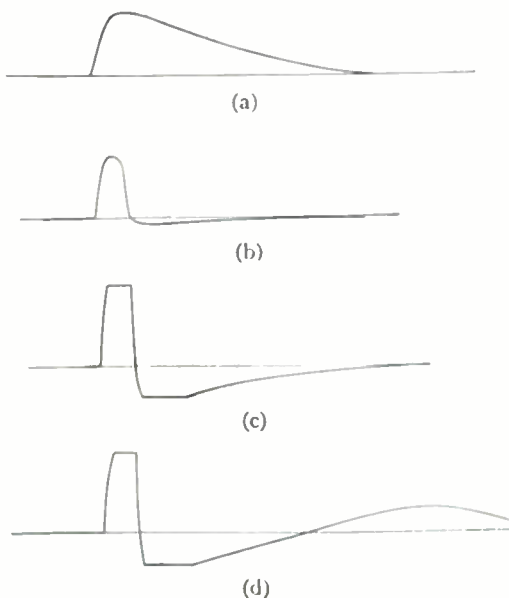

Fig. 6—(a) Typical input pulse. (b) Typical differentiated pulse. (c) Gracefully overloaded pulse. (d) Overloaded pulse from conventional amplifier circuit.

rear edge and is of constant width at the base. Certain types of pulse height discriminators are susceptible to variations in pulse width, and for accurate work with these discriminators, delay line coupling is required. Another advantage of the delay line coupling is that it is usually possible to obtain slightly better resolution, that is, to detect pulses closer to the rear edge of a preceding pulse. One disadvantage of the delay line type of coupling is that the noise output is increased a small amount. This comes about inherently in the method of production of the differentiated pulse. The delay line operates so that a pulse is sent down the line, and a reflected pulse is obtained from the line. This reflected pulse is added to the original pulse out of phase, and the sum of these two pulses forms the resulting differentiated pulse. However, the noise from the reflected pulse adds up in quadrature with the noise from the direct pulse.

The advantage of the  $RC$  differentiation is usually its simplicity. Only two circuit elements are involved, and the value of these elements can be changed easily to match the high-frequency cutoff of the amplifier. These functions are usually ganged in commercial amplifiers.

#### AMPLIFIER CIRCUITS

It now becomes of interest to examine the types of circuit configurations that are used in these amplifiers to obtain voltage gain. Simple direct circuits are rarely used in linear amplifiers because of their nonlinearity, instability, and tendency to overshoot. Conventional video-amplifier type of circuits with shunt or series peaking for high-frequency compensation are also seldom used. The types of amplifying circuit which appear most frequently in laboratory and commercial linear amplifiers are shown in Fig. 7. Circuit  $A$  of Fig. 7 shows a cathode-coupled amplifier-type of stage which is possibly the simplest circuit used. This circuit is familiar to radio engineers as an input circuit for oscilloscopes. In the linear amplifier usage, pairs of these tubes, as shown in the diagram, are coupled together to form a complete amplifier. The cathode-follower half of the amplifier has a low input capacitance, and the frequency range of the first gain producing tube can be extended. The total capacitance loaded onto the first tube plate circuit can be further minimized by the use of miniature twin triode tubes, such as the 12AX7. The connection from the plate to the grid can be made directly across the tube socket, and very little extra wiring capacitance introduced. These capacitance effects in this circuit are so small that the triode tubes can be used to frequencies of 4 and 5 Mc. The rise time can be made extremely fast as no large amounts of feedback are present. The difficulty with this amplifier lies in the fact that it soon becomes nonlinear; and although its stability is better than that of the single stage conventional amplifier, its stability does not compare with some of the more complex feedback type of circuits.

Circuit *B* of Fig. 7 shows a schematic diagram of a feedback pair type of amplifier section. This type of circuit will give better over-all performance than that of the previous amplifier at the expense of a little more complication. Previous circuits may be designed so that negative signals appear at the input terminals of the pair. The constants of the pair may then be adjusted so that, without too much loss in gain, the positive signal appearing at the second grid is limited to a value that does not cause grid current to flow. In addition to this effect, feedback reduces the overshoot of the interstage coupling circuit by a considerable factor from what it would be in the absence of feedback.<sup>7</sup> A reduction of six times in the amplitude of the overshoot is quite possible.

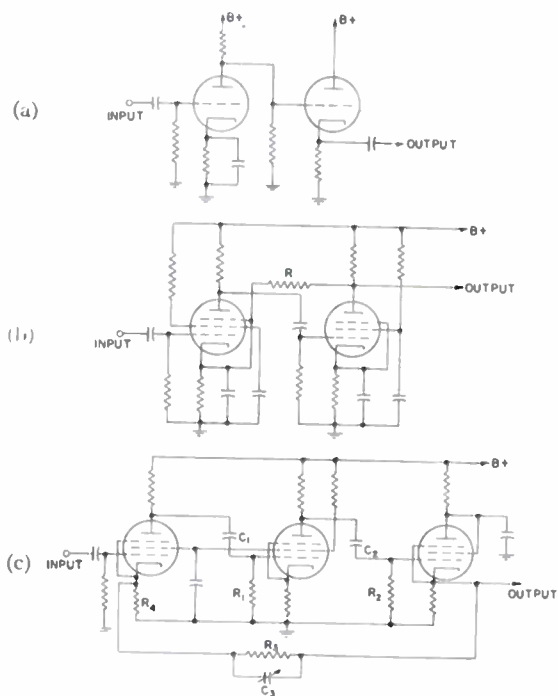

Fig. 7—Amplifier sections used in linear amplifiers. (a) Cathode-coupled. (b) Two-tube feedback pair. (c) Three-tube feedback pair.

By far, the most popular type of amplifier circuit for this service is the three tube feedback pair shown in Fig. 7(c).<sup>1</sup> This circuit has the advantages of high stability, good linearity, and reasonably fast rise time. The gain of the pair depends on the amount of feedback from the third cathode to the first one and is ordinarily adjusted to be between 20 and 100. It will be recalled that in feedback amplifier design, the gain  $= \mu / (1 + \mu\beta)$  where  $\mu$  is the gain of the system. Where  $\mu\beta$  is large compared to one, the gain is determined solely by  $1/\beta$ . This condition usually holds for this type of feedback pair and in Fig. 7(c) the gain is determined to an accurate degree by  $(R_3 + R_4)/R_1$ .

The design factors for stability of feedback amplifiers of this type are well known,<sup>8,9</sup> and it is sufficient to say

<sup>1</sup> G. E. Valley, Jr., and H. Wallman, "Vacuum Tube Amplifiers," McGraw-Hill Book Co., Inc., New York, N. Y., pp. 135-136; 1948.

<sup>8</sup> H. Nyquist, "Regeneration theory," *Bell Sys. Tech. Jour.*, vol. 11, p. 126; January, 1932.

<sup>9</sup> See pages 395-405 of footnote reference 2.

that good stability results when the gain falls off at both ends of the frequency range at a rate of 6 db/octave. This can be accomplished in this feedback pair by making  $R_1C_1 = R_3C_3$  in Fig. 7. In this manner the gains and phase shifts of these networks can be balanced and leaving the time constant of  $R_2C_2$  to determine the low-frequency cutoff. As a single  $RC$  network fortuitously has an approximate 6 db/octave dropoff, the stability criterion is realized.

Actually a 6-db/octave dropoff on the high-frequency end of the band does not give the sharpest rise time with the smallest overshoot. It has been shown<sup>10</sup> that a gaussian frequency dropoff, with the phase linear over the pass band, gives a very fast rise time with an overshoot of less than 2 per cent. The capacitor  $C_3$  is adjustable so that the best rise time with the smallest overshoot may be obtained from a given circuit. In linear amplifier practice this capacitor is usually adjusted by means of a good pulse generator and synchroscope. The adjustment of this parameter does not usually disturb the circuit stability.

It will be noted that  $180^\circ$  of phase shift is ultimately reached on the low-frequency side of the band because of the  $RC$  coupling networks and on the high-frequency side because of input, output, and stray capacitance. As the Nyquist<sup>8</sup> criterion calls for the gain to drop below unity before  $180^\circ$  phase shift is reached, the circuits as shown are quite stable. However, this stability can easily be upset by improper  $B+$  decoupling networks, or by improper loading of too much capacitance on the output.

If the pulse polarity can be specified, it is possible to bias the tubes in the pair in an asymmetrical manner and thus achieve a larger linear operating range for the pair. This step is taken for pairs used in the last stages of the amplifier.

#### AMPLIFIER OVERLOAD

The problem of amplifier overload is a serious one. Very wide pulse height distributions must be handled. The very large pulses will overload the amplifier if the gain is made large enough to examine the smallest pulses. These overloads produce large overshoots which obscure the smaller pulses. The overshoots are usually caused by grid current somewhere in the amplifier. Some form of overshoot occurs in any ac amplifier because of the necessary coupling elements. The overshoot, of course, can be reduced by having large time constant coupling circuits, and can be made single valued by making one of the coupling circuits have a much shorter time constant than the others. This step is taken by the differentiating network. Double differentiation, as in radar FTC circuits, can be avoided by making one other time constant of the circuit at least 100 times the shortest one. Then all of the rest of the time constants should be large compared to this second one. If no precautions

<sup>10</sup> See page 80 of footnote reference 7.

are taken along this line, the amplifier will have overshoots which will cross the baseline as many times as there are coupling circuits in the amplifier.

The manner in which a pulse overloads is of importance. Pulse *C* of Fig. 6 shows an overloaded pulse which has overloaded gracefully. By overloading gracefully is meant that the portions of the pulse near the base within the operating range of the amplifier are amplified successfully, and no additional wiggles or overshoots are introduced. Pulse *D* of Fig. 6 shows an overloaded condition which might exist in simple amplifiers. Here the overshoot crosses the base line and might possibly be interpreted as an additional pulse. These spurious overshoots, which are caused by grid currents charging up coupling condensers, can be avoided only by special care.

The simplest method which may be employed is not to permit the amplifier to draw grid current under any conditions. In certain amplifiers it may be possible to operate the last tubes in the circuit in such a manner that the large overloading pulses cause the grid to go negative. Series and shunt diode clipping is often employed to prevent the pulse peaks from becoming too large. Fig. 8 shows a simple type of shunt diode clip-

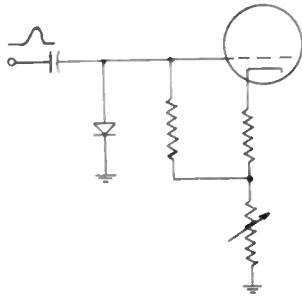

Fig. 8—Shunt diode clipping circuit.

ping. The pulse appears as a positive signal on the grid of the tube. The variable resistor is used to set a positive bias on the diode. When the pulse amplitude exceeds the bias level, the diode starts to conduct and load down the plate circuit of the previous tube. As the diode forward resistance is usually low compared with the previous plate circuit resistance, pulses of amplitude above the bias height are flattened off.

Another scheme, which is commonly used in radar receivers to prevent blocking, is to adjust the parameters in the plate and grid circuits so that the grid current cannot seriously affect the time constant. Fig. 9 shows two circuits which have effectively the same gain and the same time constants. Fig. 9(a) has the possibility of grid current flowing, charging up the coupling capacitor, and completely blocking the stage. Fig. 9(b), on the other hand, can have the 1 K resistor completely shorted, and yet only change the time constant by 5 per cent. Grid current blocking is then prevented. The disadvantage of the circuit of Fig. 9(b) is that the plate resistor must be held to a reasonably low value, hence the

coupling capacitor must be very large if a large time constant is to be achieved.

Another method of reducing charging current in the coupling capacitor is simply to eliminate the coupling capacitor and to direct couple some of the offending stages. One or more of these devices is used in the practical laboratory amplifier.

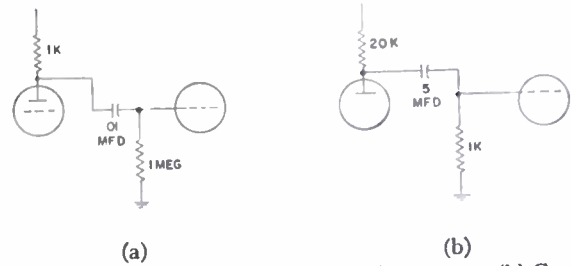

Fig. 9—Coupling circuits. (a) Conventional constants. (b) Constants to prevent grid current blocking.

### OUTPUT CIRCUITS

The requirements of an output circuit are that it have good linearity, low input capacitance, low output impedance, and a high output voltage. The cathode-follower circuit basically meets all of these requirements. Linearities of 1 per cent can be achieved with a carefully designed circuit. The input capacitance of a triode cathode follower circuit is  $C_{in} = C_{gp} + (1 - G)C_{gk}$  where  $G$  is the gain of the circuit,  $C_{gp}$  the plate to grid capacitance, and  $C_{gk}$  the grid to cathode capacitance. This capacitance can be made to be in the order of  $1.5 \mu\text{mf}$ , which is quite satisfactory. The output impedance of the triode cathode-follower circuit is approximately  $R_k / (1 + g_m R_k)$  where  $R_k$  is the cathode load resistance. This impedance is usually between 50 and 100 ohms. Output voltages of 100 volts are achieved in commercial amplifiers.

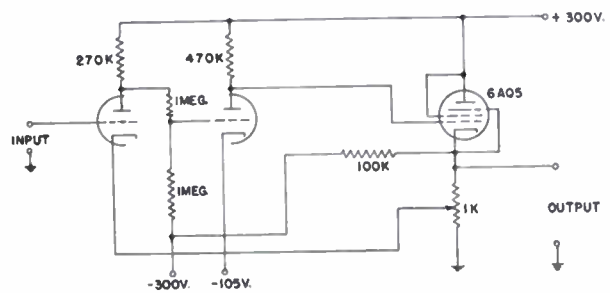

Fig. 10—Direct-coupled three-tube feedback pair output circuit.

In case one desires greater linearity of output at a lower impedance level than is obtainable from a cathode follower circuit, there are several other output circuits which may be used. All of these other circuits are multi-tube ones having none of the simplicities of the cathode follower. Fig. 10 shows the schematic diagram of a dc coupled three-tube feedback pair which has been used successfully for a fixed experiment requiring excellent linearity at a low impedance output. This circuit has a frequency response from 0 to 200 kc, and is used for

slow rising wide pulses. The 1,000-ohm potentiometer in the circuit is adjusted for an over-all circuit gain of one. Fig. 11 is a curve showing the linearity of this circuit. It will be observed that for input pulses in excess of 4 volts, the output follows faithfully to within 0.3 per cent. Although the circuit may be adjusted to make the linearity better at lower input voltages, the low inputs

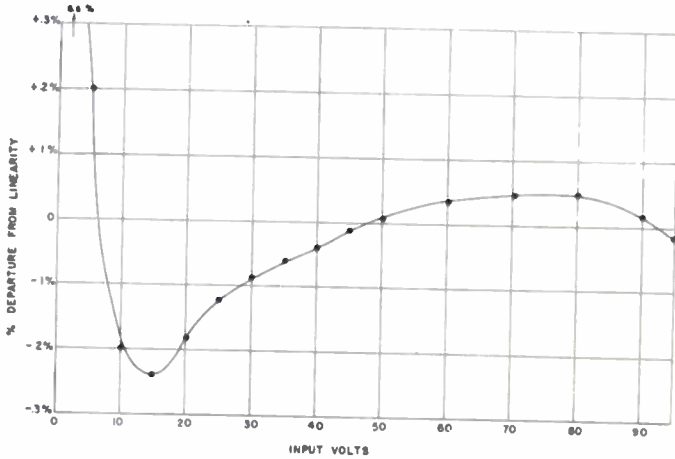

Fig. 11—Linearity of dc feedback pair as a function of input voltage.

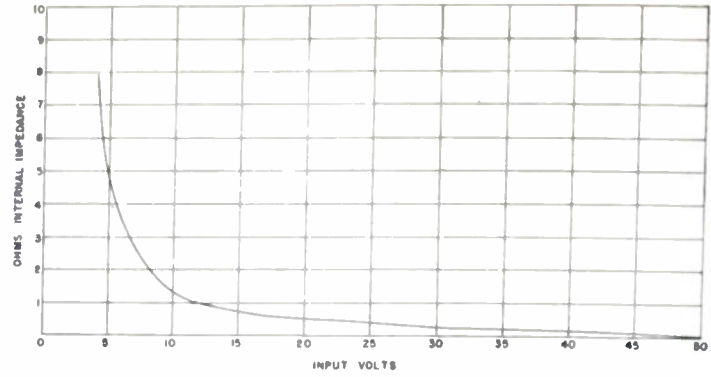

Fig. 12—Internal impedance of dc feedback pair as a function of input level.

are usually unimportant as they are masked by noise and are cut out by the discriminator.

Fig. 12 shows the internal impedance of this pair as a function of input level. Again, for signals above 4 volts, the impedance is always under 8 ohms, and for the higher voltages, impedances of a small fraction of an ohm are exhibited.

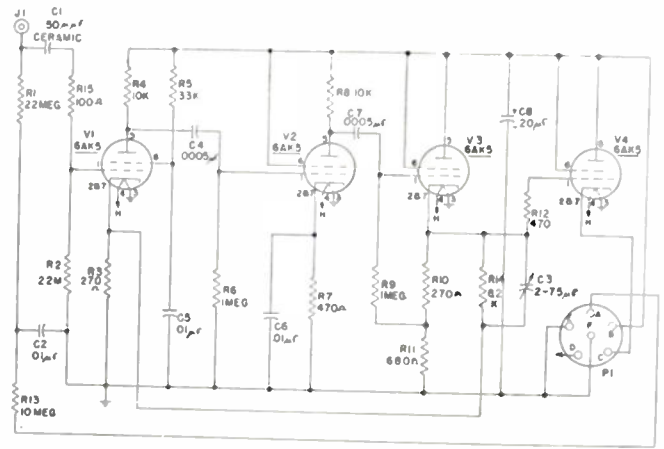

Fig. 13—Typical commercial preamplifier.

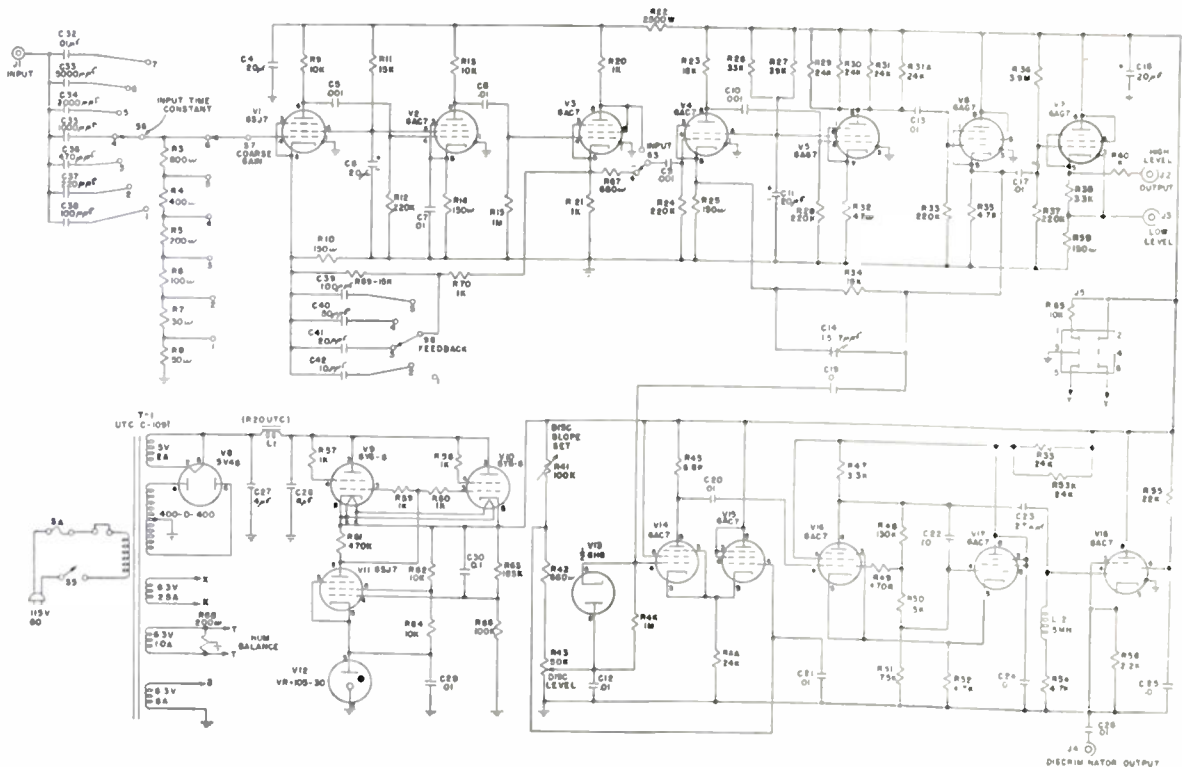

Fig. 14—Typical commercial linear amplifier.

## COMMERCIAL AMPLIFIER

Many of the principles just discussed are embodied in the commercial design of linear amplifiers. It is generally necessary for the commercial amplifier to be an extremely versatile instrument to fulfill the experimental uses to which it is put. Figs. 13 and 14 show the schematic diagrams of a typical commercial preamplifier and linear amplifier system.<sup>11</sup> The instrument described is based on the original AI amplifier described by Bell and Jordan. The amplifier is equipped with a pulse-height discriminator and has a high degree of stability. Front panel controls are provided which permit the time constant of the differentiating network to be varied from 0.16 to 16 microseconds. The rise time of the amplifier can be varied from 0.2 to 2 microseconds. The voltage amplification varies between 1,600 and 9,000, depending on the choice of input time constant and rise time. Thirty db of gain control is provided by means of a step attenuator.

The preamplifier consists of a three-tube feedback pair followed by a cathode-follower circuit. Means are provided to supply a dc voltage for the detecting element.

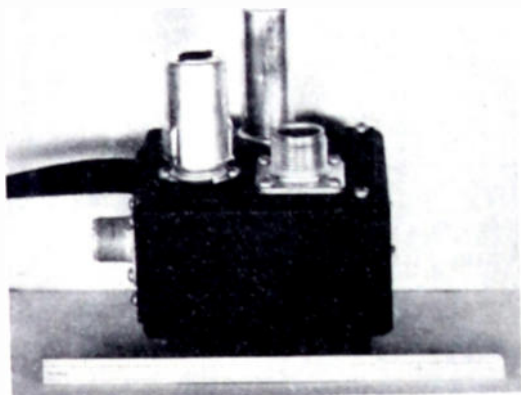

Fig. 15—Photograph of preamplifier.

Figs. 15, 16(a), and 16(b) show photographs of the preamplifier and amplifier, giving an idea as to the care that must be taken in the layout of the components. The units in their cases are completely shielded to avoid radiation pickup. Fig. 17 shows the linearity which may be obtained from this type of circuit. The nonlinearity is in the order of 1 per cent.

## ACKNOWLEDGMENTS

The author gratefully wishes to acknowledge the assistance of P. R. Bell and W. H. Jordan, of the Oak Ridge National Laboratories; D. Taylor, of the Atomic Energy Research Establishment, Harwell, England;

<sup>11</sup> Atomic Instrument Company, Boston, Mass., Preamplifier Model 205, Linear Amplifier Model 204-C.

L. W. Cronkhite, of the Atomic Instrument Company; and R. Durnal and W. Pagels of the Westinghouse Atomic Power Division, in the preparation of this paper.

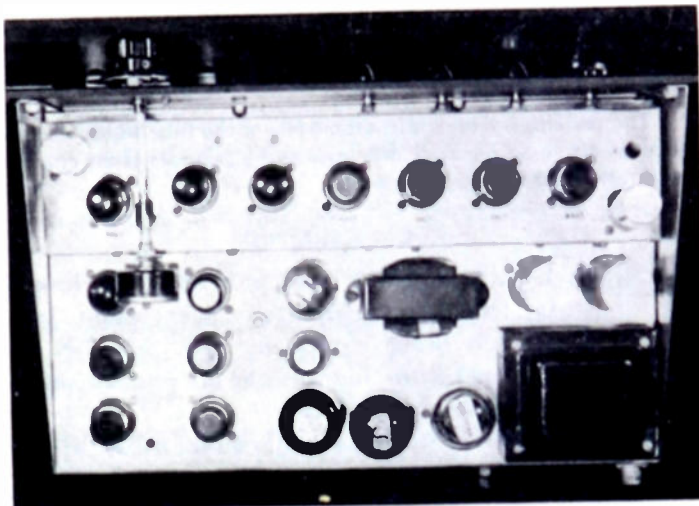

(a)

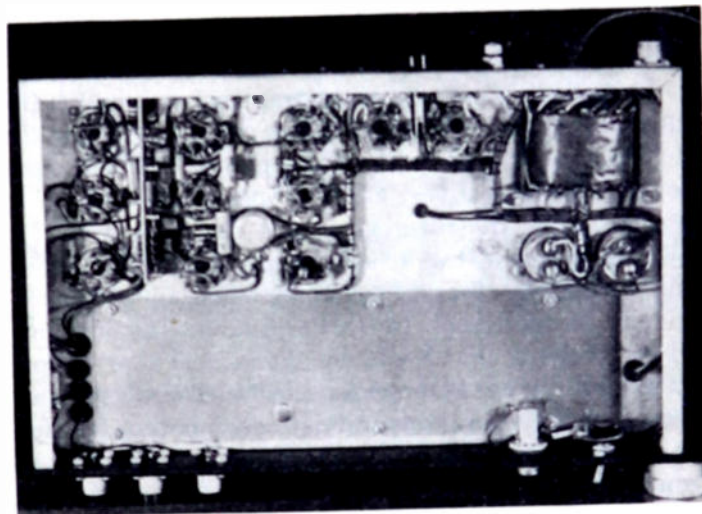

(b)

Fig. 16—(a) Top view of linear amplifier.  
(b) Bottom view of linear amplifier.

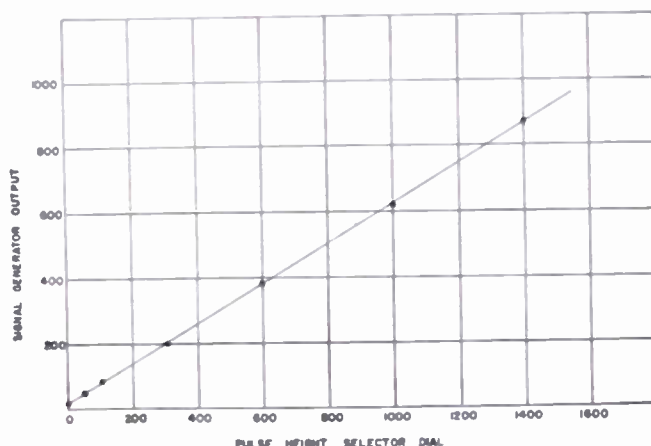

Fig. 17—Linearity of commercial amplifier.

# The Magnetron-Type Traveling-Wave Amplifier Tube\*

R. R. WARNECKE†, FELLOW, IRE, W. KLEEN†, A. LERBS†, O. DÖHLER†, AND H. HUBER†

**Summary**—This paper deals with the design and the static and dynamic behavior of a new, high-efficiency traveling-wave amplifier tube.

The preliminary experimental models of the tube whose characteristics are to be reported here involve the principle of the crossed, static electrical and magnetic fields.

## I. INTRODUCTION

HIGH-DEFINITION and color television broadcasts, frequency-modulated radar, radar jammers, and other equipment will probably require, in the near future, high-power microwave amplifier tubes with large bandwidths.

The principle of the traveling-wave tubes of the "Kompfner-Pierce" type suggests their use for amplifying signals occupying a wide frequency range, but the efficiency of the ordinary designs of tubes of this type is relatively small, of the order of the ratio of the real to the imaginary part of the propagation constant of the amplified wave.

In the helix structure of the traveling-wave tube, the current carried by the beam which can pass through the helix grows with the tension  $V_H$  applied to the helix; consequently, the real part of the propagation constant increases while the imaginary part decreases with  $V_H$ . With a radius of the helix corresponding to the maximum efficiency, the corresponding efficiency is approximately proportional to  $(\lambda^2 V_H)^{1/3}$  and, for instance, about 10 per cent at  $\lambda = 10$  cm,  $V_H = 2,500$  v, and about 25 per cent at  $\lambda = 40$  cm,  $V_H = 8,000$  v. These values are only first theoretical approximations, but the efficiency is effectively restricted because of the fact that only an energy corresponding to a relatively small difference between the velocity of the electron and the phase velocity of the wave is converted into electromagnetic energy.

It is apparently possible to get a somewhat higher efficiency compared to the values given above. For example, consideration has already been given for a long time to improving the energy exchange between an electron beam and the retarded wave of a helix by decreasing the pitch of the helix to conform with the decrease in the electron velocity as the energy is picked up from the stream;<sup>1</sup> but, as far as the authors are aware, it does not appear that this suggestion of decelerating the electrons to the highest possible degree in the radio-frequency field of the delay circuit has ever led to appreciable practical results. The reasons for this failure are, no doubt: the difficulty of introducing a

suitable change of structure; the difficulty of associating such a structure with the terminal elements of the circuit, which, in practice, are most unsuitable for obtaining large bandwidths; and also the reduced efficiency of the method when applied to high density beams of wide diameter, in the interior of which the electrons have appreciably different velocities in a same cross section.

An alternative method of increasing the efficiency of a traveling-wave tube of the "Kompfner-Pierce" type consists in using a collecting anode materially separate from the helix and raising this anode to a potential  $V_a$  lower than the helix potential  $V_H$ ; if the current caught by the walls of the retarding line is small, on account of the relatively small deceleration of the electrons by interaction with the wave, it is possible to apply a rather small potential to the collector, which naturally increases the total efficiency. For a given helix potential, the decrease of anode potential is limited, primarily, by the return of the electrons from the beam to the helix, which forms a virtual cathode due to the space charge, and also by the arrival in the helix field of the secondary electrons emitted by the anode and caught by the helix. Nevertheless, this method can lead to appreciable results. The efficiency can be considerably increased, particularly where the current carried by the beam has a relatively low density. According to the authors' experiments, for example, with a tube operating at 3,000 Mc, a beam current of 100 ma and a helix potential of 3,500 v, it is possible to obtain an efficiency of the order of 20 per cent for  $V_a < V_H$  instead of about 10 per cent with  $V_a = V_H$ .

Another way to increase the efficiency consists in using "hybrid" structures incorporating features of both the traveling-wave tube and velocity-modulated tubes. In these devices, electron bunches are formed by a delay circuit acting as a distributed buncher upon an electron beam. This beam is then caused to yield its kinetic energy to a resonator.<sup>2</sup> Devices of this kind have greater efficiencies than the ordinary "Kompfner-Pierce" tube. However, in spite of having greater bandwidths than the classical amplifier klystron, their practicability is limited by an unavoidable selective circuit.

In 1946, it was proposed by one of the authors, A. Lerbs, that using the interactions between electron beams moving through crossed magnetic and electric fields and a traveling-wave with an artificially reduced phase velocity would result in a highly efficient travel-

\* Decimal classification: R339.2. Original manuscript received by the Institute, January 31, 1950.

† Centre de Recherches, Compagnie Generale de Telegraphie Sans Fil, Paris, France.

<sup>1</sup> N. E. Lindenblad, United States Patent No. 2,300,052; application May 4, 1940.

<sup>2</sup> R. Warnecke, W. Kleen, O. Döhler, and H. Huber, "Groupe-ment électronique dans un tube à modulation de vitesse au moyen d'un organe à onde progressive," *Compt. Rend. Acad. Sci. (Paris)*, vol. 229, p. 648; October, 1949.

Application for French Patent No. 533,328, April 21, 1947.



ing-wave amplifier tube.<sup>3</sup> The result of this suggestion was the construction of the traveling-wave magnetron amplifier tube, the theory and early experimental behavior of which are described in the following account.

### II. THE SYSTEM

Fig. 1 is a schematic cross section of an idealized tube. Two conductors, 1 and 2, of an artificial line are so designed as to guide the wave in the direction  $+y$  and to retard its velocity below that of light. These conductors function as electrodes. Conductor 1 is called the cathode plate, and conductor 2 is to be referred to as the anode of the discharge space. That is, conductor 2 is positive with respect to 1. An electrostatic field  $E$  is applied between 1 and 2 and a constant magnetic field  $B$  is applied in direction  $z$ .

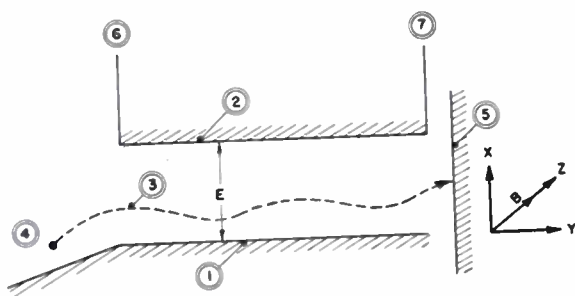

Fig. 1—Schematic cross section of an idealized traveling-wave magnetron tube.

A ribbon-shaped electron beam 3, emitted by cathode 4, travels between 1 and 2 in a direction perpendicular to both fields  $E$  and  $H$  (see Section IV). Cathode 4, negative with respect to 2, need not necessarily be at the same potential as electrode 1. At the output the beam is caught by collector 5. At the input the delay line is coupled to a generator by means of lead 6. The excited wave propagated towards  $+y$  is amplified by its interaction with the beam, and its power is yielded to the load coupled to the output line 7.

The similarity of this arrangement to the magnetron is obvious. If conductors 1 and 2 were to be incurred, if the line were closed, and if the surface of electrode 1 were coated with an emissive material, the system would represent a magnetron fitted with a delay line. It would behave in a manner quite similar to the multicavity magnetron.

The traveling-wave magnetron amplifier tube (TWMA), compared to the magnetron oscillator, is distinguished by the provision of special elements designed to eliminate feedback oscillations. Overreaching of the output end by the electrons and wave, and reflections back to the input end are avoided by proper shaping and screening and by the use of an attenuation in the line.

Quite simply, the TWMA is an amplifier magnetron in which oscillations are suppressed by eliminating the feedback that exists unavoidably in a magnetron oscillator.

<sup>3</sup> See R. Warnecke and P. Guénard, *Ann. Radioelec.*, vol. 3, p. 259; 1948, for a brief, early account of the theory of this tube.

### III. THE PRINCIPLE OF INTERACTION BETWEEN THE WAVE AND THE ELECTRON BEAM

The operational principle of the TWMA is the interaction of the electron beam with the transverse and longitudinal electric vectors of the traveling wave. The fact that the transverse vector is functional represents a considerable difference between the TWMA and the Kompfner-Pierce tube in which the transverse electric vector generally plays a negligible part and where amplification is practically due only to the longitudinal vectors. In the TWMA, consider the process of electron bunching and of energy transfer from the beam to the wave. (See Fig. 2.) It is assumed that steady-state,

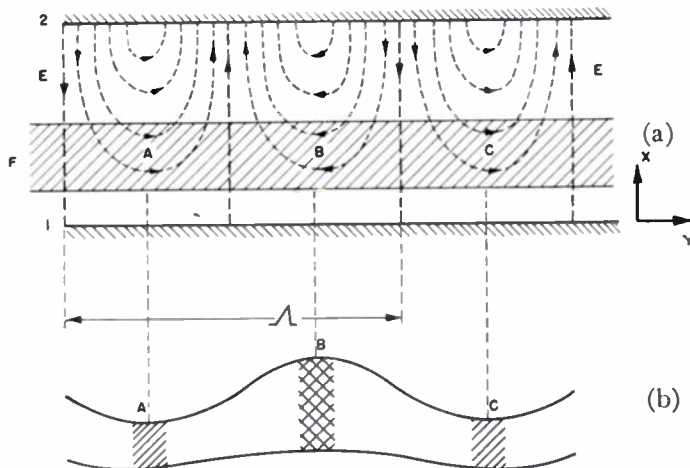

Fig. 2—Diagrammatic view showing the process of the electron bunching and of the energy transfer from the beam to the wave. The electrodes are numbered as in Fig. 1. (a) Plot of the electric lines of force inside the interaction space. (b) Shape of the beam acted upon by the wave.

straight trajectories run parallel to  $y$ . In the orthogonal fields  $E$  and  $B$ , the electron moves in a direction perpendicular to both fields at the mean velocity

$$v_y = v_0 = \frac{E_x}{B} = \frac{E}{B} \tag{1}$$

( $E$  in  $v/cm$ ,  $B$  in  $v/cm^2 = 10^8$  gauss).

According to (1), any disturbance in the transverse field  $E_x$  results in a variation in the velocity  $v_y$ , while a disturbance in the longitudinal field  $E_y$  leads to a displacement of the electron in direction  $x$ . A retarding field brings the electron closer to the anode; an accelerating field brings it closer to the cathode plate.

In Fig. 2(a) are plotted schematically the electric lines of force of the wave in the interior of the interaction space. The electron beam  $F$  travels at the same speed as the wave. The electrons located in a phase of the wave between  $A$  and  $B$  are in a transverse electric field that is directed towards the anode. They are therefore accelerated in direction  $y$ . Electrons between  $B$  and  $C$  are decelerated. Consequently, a bunching in the neighborhood of point  $B$  is effected in a radio-frequency field which has the direction  $-y$ . The electrons around  $B$  then approach the anode and are brought to a higher

dc potential, their velocity remaining that given by (1). An examination of the shape of the beam when acted upon by the wave shows (see Fig. 2(b)) that the width is increased at *B*, where bunching occurs, and decreased at *A* and *C* where the number of electrons is reduced.

Figs. 2(a) and 2(b) show qualitatively some very important properties of the TWMA and differences between it and the normal traveling-wave tube. These are:

A. In a linear traveling-wave tube the transfer of energy from the beam to the wave occurs only when the electron velocity is greater than the phase velocity of the forced wave. In the TWMA this transfer takes place when the two velocities are equal. This condition is of considerable importance.

B. In the ideal case, the energy transfer from beam to wave is accomplished by the displacement of electrons from a lower to a higher potential without altering the kinetic energy of the electrons. In the normal traveling-wave tube, electronic efficiency is determined by the deceleration of the electrons within a limited range of excess velocity. Electronic efficiency in the TWMA is not determined by that factor. In fact, the electronic efficiency may approach unity if, when no radio-frequency field is present the dc electron velocity is far smaller than the velocity corresponding to the anode voltage.

C. From the above description and from Fig. 2(b), it is seen that the beam cross section is alternately larger and smaller in accordance with the periodicity of the wave-length  $\lambda$  in the guide. This cross-section variation is in phase with the current variation. This leads to the assumption that in the TWMA there is at least a partial compensation for the repulsive forces developed by the hf space charge and for the debunching. That means the alternating components of the current density and the space charge are much smaller than the radio-frequency current.<sup>4</sup>

In view of the classical traveling-wave tube's serious efficiency loss due to the debunching caused by Coulomb's forces, the TWMA would seem to have another marked advantage.

It must be pointed out however, that the above inferences are made after examination of only a simply designed TWMA. The presence of a ribbon-shaped, straight beam in the absence of a radio-frequency field is assumed. This assumption requires further investigation as to whether it is feasible for practical purposes or which modifications must be made in the simple conceptions because of the limits set by the actually possible electron paths.

#### IV. SURVEY OF STEADY-STATE ELECTRON TRAJECTORIES

Consider the electron trajectories in homogeneous crossed fields while assuming there is no space charge. The negative plate is at a potential  $V_1 \leq 0$  relative to

<sup>4</sup> More accurately, the hf space-charge density is always zero—even in higher order approximations.

the cathode. The electron motion is governed by the differential equations

$$x = \frac{e}{m} (E - B\dot{y}) \tag{2}$$

and

$$\dot{y} = \frac{e}{m} B\dot{x} \tag{3}$$

whose solutions are with  $\dot{x} = 0$  at  $t = 0$

$$x = -\zeta(\cos \omega_m t - 1) + x_0 \tag{4}$$

and

$$y = \frac{E}{B} t - \zeta \sin \omega_m t + y_0 \tag{5}$$

where

$$\zeta = \pm \frac{\frac{E}{B} - \dot{y}_0}{\omega_m}, \quad \omega_m = \frac{e}{m} B. \tag{6}$$

After differentiation we have

$$\dot{y} = \frac{E}{B} - \zeta \omega_m \cos \omega_m t. \tag{7}$$

The first term,  $E/B$ , gives the well-known relationship for the mean velocity  $v_0$  of the electrons in crossed fields. Two limiting cases should be distinguished. These are:

A.  $\dot{x} = 0$  and  $\zeta = 0$ , straight-line beam, ideal optical system (see Fig. 3(a)): According to the relationships in (4) to (7), it is then required that

$$\dot{y}_0 = E/B \quad \dot{x}_0 = 0.$$

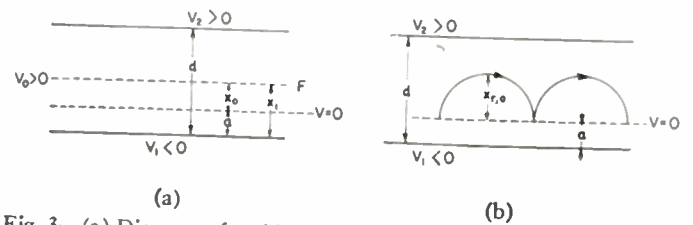

Fig. 3—(a) Diagram of an ideal optical system referring to the case of a straight-line beam. (b) Diagram illustrating the limiting case of cycloidal motion of the electrons.

In order to obtain a beam of the shape considered, therefore, the beam should enter the system parallel to electrodes 1 and 2 (see Fig. 3(a)) at a point where the potential is

$$V_0 = \frac{m}{2c} \left( \frac{E}{B} \right)^2 \tag{8}$$

i.e., at

$$x_0 = \frac{V_0}{V_2} (d - a). \tag{9}$$

For a given tube the value of  $V_0$  is predetermined by the propagation velocity of the delay line. Hence, the minimum values of  $V_2$  and  $B$  that would enable operation of a tube with an ideal optical system are

$$V_{2,\min}^{(i)} = V_0 \quad (10a)$$

$$B_{\min}^{(i)} = \sqrt{\frac{m}{2e} V_0} \frac{1}{d-a} = \frac{1}{2} \sqrt{\frac{2m}{e}} V_0 \frac{1}{d-a} = \frac{1}{2} B_{\text{crit}} \quad (10b)$$

where  $B_{\text{crit}}$  denotes the magnetic field of a plane magnetron with the anode voltage  $V_2 = V_0$ .

Under the conditions of (10a) and (10b) an electron beam that moves directly in front of the anode is obtained. Zero efficiency is then to be expected for the tube.

B. The other limiting case of electron trajectories is a cycloidal motion as found in a plane magnetron. (See Fig. 3(b).) In this tube the electrons leave the plane of cathode potential inside the interaction space with  $\dot{x}=0$ ,  $\dot{y}=0$  at points  $x=0$  and  $y=0$ . The crest of the trajectory is at

$$x_{r,0} = (d-a) \left( \frac{B_{\text{crit}}}{B} \right)^2 = \frac{\sqrt{\frac{8m}{e}} V_0}{B} \quad (11)$$

In flight the electron reaches its maximum energy at  $x = x_{r,0}$ . This maximum value is

$$W_{\text{max}} = eV_{\text{max}} = 2m \left( \frac{E}{B} \right)^2 = 4eV_0. \quad (12)$$

$V_0$  denotes the voltage equivalent to the phase velocity of the line, and  $V_{\text{max}}$  is increased by a factor 4 with respect to  $V_0$  for a straight beam. (See (8).)

By comparing the minimum value of  $V_2^{(m)}$  and  $B_2^{(m)}$  (the index  $m$  referring to a system with trajectories as found in a plane magnetron without space charge) to the corresponding values  $V_{2,\min}^{(i)}$  and  $B_{\min}^{(i)}$  found in the ideal system, (10a) and (10b), it follows that

$$V_{2,\min}^{(m)} = 4V_{2,\min}^{(i)} = 4V_0$$

$$B_{\min}^{(m)} = 4B_{\min}^{(i)}.$$

In the case of an ideal system, the values of the voltage and the minimum magnetic field are 4 times smaller than for the magnetron optical system.

By plotting the anode current  $I_2$  against  $B/B_{\text{crit}}$  (the value of  $B_{\text{crit}}$  derived from (10b)), we are provided with a crude method of evaluating the trajectory shapes. By checking the value of  $B/B_{\text{crit}}$  when  $I_2=0$ , we have a rough evaluation of the quality of the gun used. For a straight beam when  $I_2=0$ , the value of  $B/B_{\text{crit}}=1/2$ . For the magnetron optical system,  $B/B_{\text{crit}}=1$ . The cut-off of the characteristics may even be located at values

of  $B/B_{\text{crit}} > 1$  when velocity components  $\dot{y} < 0$  are to be found at the input of the tube.

In this discussion, however, only the limiting cases in a plane system are being considered. It should be borne in mind that space charges have been assumed to play no part in the processes of the TWMA. This hypothesis is justified as the current in the TWMA is dependent on the performance of a cathode that is located outside the interaction space. The construction is distinct from that of the magnetron. The views concerning the potential distribution and electron trajectories will very probably have to be modified when the influence of space charges exists at very high currents.

## V. SMALL-SIGNAL THEORY

The small-signal theory was established<sup>5</sup> under the following assumption:

$$\omega_m = \frac{e}{m} B \gg |j\omega + \Gamma v_0|$$

where

$\Gamma = \bar{\gamma} - j\bar{k}$  is the propagation constant of the wave in the direction of the beam

$\omega$  = the angular frequency

$v_0$  = electron velocity.

It was found that two waves are excited that are propagated in the direction of the beam. The imaginary parts of their propagation constants are equal and the real parts are equal but opposite in sign. One wave is attenuated, the other is amplified. The propagation velocities of the two waves are the arithmetical mean of the electron velocity  $v_0$  and the velocity of the free wave  $v_1$ —that is, the velocity of the wave in the absence of the beam. When  $v_0 = v_1$ , each wave receives half the input field produced by the generator. The gain can be expressed

$$G_{\text{db}} = 8.7\bar{\gamma}L + A, \quad (13)$$

where  $L$  = tube length; one finds  $A = -6$  db when  $v_1 = v_0$  and the line is without attenuation. Under optimum conditions, the expression

$$\bar{\gamma}_{\text{opt}} = \left[ \frac{k_0 d R_v(x_1) \coth(k_0 x_1)}{Z_0} \right]^{1/2} \quad (14)$$

is obtained with

$d$  = electrode spacing (Fig. 3)

$k_0 = \omega/v_0$

$I_0$  = current

$Z_0 = V_2 - V_1/I_0 (V_1 \leq 0)$

$x_1$  = the distance between the beam and the negative plate in the ideal optical system.

When considering systems having trajectories such as are found in the plane magnetron, and with the negative plate at the cathode potential, we must substitute for  $x_1$  in (14)

<sup>5</sup> J. Brossart and O. Döhler, "Les tubes à propagation d'onde à champ magnétique," *Ann. Radioléc.*, vol. 3, p. 328; October, 1948.

$$x_1 = a + \frac{x_{r,0}}{2} \quad (\text{see Fig. 3b and equation (11).})$$

$R_y(x_1)$ , the coupling field impedance at point  $x_1$ , is defined by

$$R_y(x_1) = \frac{E_y(x_1)E_y^*(x_1)}{2P} \quad (15)$$

where  $E_y^*(x_1)$  is the complex conjugate of the longitudinal field  $E_y$  at  $x_1$ , and  $P$  is the power guided by the line.  $R_y$ , a function of  $x_1$ , is determined by the dimensions of the delay line. (Approximate results are given in footnote reference 5.)

The gain therefore, is proportional to  $I_0^{1/2}$  and, for a given  $k_0$  it is inversely proportional to  $(V_2 - V_1)^{1/2}$ .

The maximum value of  $\tilde{\gamma}$ , as function of  $k_0d$ , is obtained when  $k_0d \simeq 2$ . This yields the order of the required magnetic field

$$B_{\text{RUBS}} \simeq \frac{2,700(V_2 - V_1)}{V_0\lambda}$$

when

$$\begin{aligned} V_2 - V_1 &= 4V_0 \\ \lambda &= 22 \text{ cm.} \end{aligned}$$

$B$  is of the order of 500 gauss.

At operating conditions other than the optimum, the relation  $\tilde{\gamma}/\tilde{\gamma}_{\text{opt}} = f(\mu)$ , is given in Fig. 4 with

$$\mu = \left(1 - \frac{v_0}{v_1}\right) \frac{k_0}{\tilde{\gamma}_{\text{opt}}}$$

The gain variation with  $\mu$ , which is the variation in voltage around its optimum value, is independent of the sign of  $\mu$ .

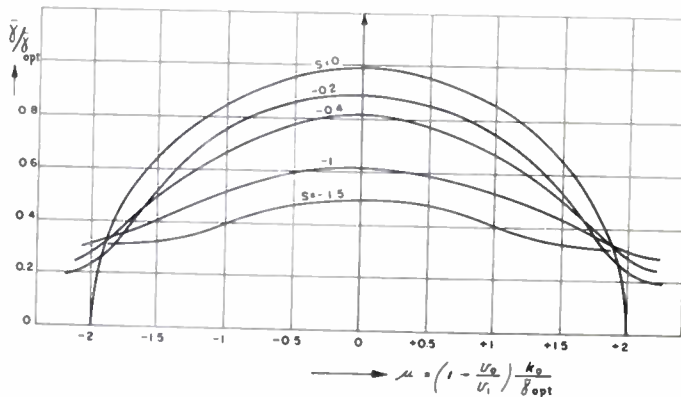

Fig. 4—Ratio of the propagation constant (real part) to the optimum value versus normalized value of the ratio of the beam velocity to the wave velocity for various line attenuations.

Fig. 4 also shows the influence of an attenuation in the line,  $\gamma = s\tilde{\gamma}_{\text{opt}} < 0$ . In first approximation, inserting an attenuation  $\gamma < 0$  results in decreasing  $\tilde{\gamma}_{\text{opt}}$  by  $|\gamma|/2$ .

If the condition  $\omega_m \gg |j\omega + \Gamma v_0|$  is not satisfied, two supplementary waves having their amplitude unaltered along the beam appear in addition to the two amplified

and attenuated waves. The initial conditions then, remain practically unchanged.

## VI. ELECTRONIC EFFICIENCY

The evaluation of the efficiency is based on energy considerations as in a preceding publication<sup>6</sup> for the magnetron. The merits of this viewpoint are further substantiated by a more accurate theory which will be published later.

The energy transfer to the wave is due to the approach of the electrons to the anode without variation in their speed. It follows that the electronic efficiency is

$$\eta_e = \frac{V_2 - V_{\text{max}}}{V_2} \quad (16)$$

where  $V_2$  is the anode potential and  $V_{\text{max}}$  is the maximum potential reached by the electrons along their steady-state trajectories. In the case of the ideal, straight beam optical system,

$$V_{\text{max}} = V_0 = \frac{m}{2e} \left(\frac{E}{B}\right)^2 \quad (17)$$

while for the magnetron system (see (12))

$$V_{\text{max}} = 4V_0. \quad (18)$$

The ideal system has, accordingly, a higher electronic efficiency. If, for example, the line delay is  $v_0/c = 1/20$  with  $V_0 = 625$  v and  $c$  = the velocity of light, and a value of 2,500 v is assigned to  $V_2$ , an efficiency of 75 per cent is found for the ideal system and an efficiency of zero per cent is found for the magnetron. This comparison, however, is not fully justified because the gain in the ideal system is smaller than that for the magnetron trajectories, the reason being that in the magnetron optical system the average trajectory is closer to the anode. If the two cases were referred to the same gain,  $V_2$  and  $B$  would decrease in the ideal system and the value found for the efficiency would be smaller than 75 per cent, but certainly greater than 50 per cent. An exact solution requires a better knowledge of  $R_y = f(x_1)$ . These figures show how significantly the trajectory shapes affect efficiency.

This energy point of view is only an approximation and would require a large-signal theory for its justification. One such theory laid down by Brossart and Döhler, shows that the electrons of a straight beam are not caught by the anode at a speed and with an energy corresponding to  $V_0$ , but rather to

$$V_0' = V_0 \left[ \left(1 + \frac{E_x(d)}{E}\right)^2 + \left(\frac{E_y(d)}{E}\right)^2 \right] \quad (19)$$

where  $E_x$  and  $E_y$  are the radio-frequency fields at the anode surface. We have  $(E_x(d)/E) \lesssim (2\tilde{\gamma}_{\text{opt}}/k_0) \ll 1$ . This small contribution made by  $E_x$  becomes obvious when it is seen that the bunching and the flight of the electrons to the anode takes place in a very small

<sup>6</sup> O. Döhler, "Sur les propriétés des tubes à champ magnétique constant," *Ann. Radioelec.*, vol. 3, p. 169; July, 1948.

transverse field. It can further be shown that  $(E_v(d)/E)^2$  is a negligible quantity compared to unity.

The above remarks, however, are valid only in the case of a straight beam in the steady state. It is not yet possible to judge the corrections that must be made for beams with epicycloidal trajectories. Intuitively it seems that the rotational energy of the electrons would increase in a radio-frequency field, resulting in a higher kinetic energy of the electrons at the anode and, consequently, in a lower efficiency.

This aspect of efficiency based on an energy viewpoint leads to valid results only with certain assumptions: The beam must enter the system in a region of a transverse focusing field at the input. The longitudinal field must be kept as small as possible at this point. If the beam were shot in toward the vicinity of the anode in a strong longitudinal field, the fraction of the electrons that finds itself at the input in an electric vector phase directed toward  $+y$ , would gain energy in the radio-frequency field and would move to the negative plate to be eventually caught by it. In order to avoid such an efficiency loss, the beam should enter the system at a point far from the anode. In this connection, some improvement might be brought about by arranging a variable delay line so that the radio-frequency field would be transverse at the input and longitudinal at the output.<sup>7</sup>

The large-signal theory shows that when electron absorption by the anode is neglected, the gain increases with the amplitude. This is evident since the electrons in the high-frequency field are approaching the anode. The absorption of the electrons by the anode surface is due to two distinct phenomena. First, there is the mechanism of interaction. Even with an ideal optical system an absorption takes place which results in a decrease in the gain. Secondly, when the dc trajectories are not straight lines, the absorption occurs in the vicinity of the input. This results in decrease in both gain and efficiency.

Parenthetically, the straight beam, considered more advantageous than cycloidal trajectories, corresponds to the electron motion in the magnetron. In the magnetron no epicycloidal trajectories for a field  $B \gg B_{crit}$  are possible because of the strong space charge. The steady-state trajectories are near-circles around the cathode. This is another reason for the high efficiency of the magnetron. The space charge in the magnetron, on the other hand, results in a fairly strong variation in  $E$  within a cross section of the discharge space and, therefore, in variations of the velocity  $E/B$ . This detrimental effect can be overcome in the TWMA where, according to measurements made so far, the influence of the space charge is rather small.

To summarize then, a high electronic efficiency can only be obtained by using a straight beam that enters the interaction space in the vicinity of the negative

plate at zero potential with respect to the cathode, and with the anode voltage as high as possible. The ratio  $E/B$  must equate the velocity of the free wave.

## VII. CIRCUIT AND OVER-ALL EFFICIENCY

The elimination of undesirable oscillations requires the introduction of an attenuation that is either lumped or distributed along the line. When a line of length  $L$  with a distributed attenuation  $\gamma < 0$  has at the input and output ends the mismatch  $R_e$  and  $R_a$ , respectively, the amplification stability is achieved only if

$$G_{db} < 8.7 \left| \gamma \right| L - A - (R_e + R_a) \quad (20)$$

where  $R_e$  and  $R_a$  are measured in "reflection decibels" and  $A$  is of the order of  $-6$  db. (See (13).) For a line provided with a lumped attenuating element that absorbs the whole of the impressed energy, (20) is valid also for both the ends  $L_1$  and  $L_2$ , of the line. The condition imposed by the inequality must not only be satisfied at the operating frequency, but in the entire band of finite amplification.

For practical purposes, in a distributed attenuation line  $R_e$  and  $R_a$  must be expected to be zero db owing to the impossibility of an ideal matching of the generator and the load over the entire range of electronic amplification. In a lumped-attenuation tube, at the first end  $R_e = 0$  db while  $R_a$  is fixed by the characteristics of the tapered attenuating element. At the other end, the situation is reversed with  $R_a = 0$  db and  $R_e$  being fixed by the attenuating element. The provision of an attenuation is mandatory and the over-all efficiency  $\eta_{tot}$  must decrease relative to the electronic efficiency  $\eta_e$  by

$$\eta_{tot} = \eta_e \eta_c$$

while the circuit efficiency  $\eta_c$  may be calculated by employing the same method as used for the linear traveling-wave tube.<sup>8</sup>

Consider a tube provided with a delay line whose extremities  $L_1$  and  $L_2$  are separated by an element that absorbs all the power impressed upon it and having an attenuation  $\gamma < 0$ . Then

$$\eta_c = \frac{1}{(1 + 4e^{-2\bar{\gamma}L_2}) \left[ 1 + \frac{|\gamma|}{\bar{\gamma}} (1 - e^{-2\bar{\gamma}L_2}) \right]} \quad (21)$$

This expression is simplified in the case of a tube with an evenly distributed attenuation of length  $L$  to read

$$\eta_c = \frac{1}{1 + \frac{|\gamma|}{\bar{\gamma}} (1 - e^{-2\bar{\gamma}L})} \quad (21a)$$

and for a purely lumped-attenuation tube to read

$$\eta_c = \frac{1}{1 + 4e^{-2\bar{\gamma}L_2}} \quad (21b)$$

<sup>8</sup> O. Döhler and W. Kleen, "Sur le rendement du tube à propagation sonde," *Ann. Radiolec.*, vol. 4, pp. 216-221; July, 1949. The factor  $|/1A^2|$  in equation (8) of this paper will assume a value of approximately 4 for the TWMA.

<sup>7</sup> Application for French Patent No. 564, 962, December 18, 1948.

Equation (21) should be regarded under the conditions of (20). For a stable amplification in a distributed-attenuation tube, the value of  $\eta_c$  would not greatly exceed 0.5 with  $|\gamma| \approx \bar{\gamma}$ . If  $\bar{\gamma} < |\gamma|$  then  $\eta_c$  is smaller than 0.5. The value for the circuit efficiency computed by means of (21) corresponds to that of the small-signal case. If the gain is decreased with the signal,  $\eta_c$  decreases also. This, of course, is due to the inverse relationship between  $\bar{\gamma}$  and the amplitude of the input signal.

In a lumped-attenuation tube the circuit efficiency may be materially higher than 0.5. From (21b), for example, we obtain

$$L_1 = L_2 \begin{cases} G = 10 \text{ db} & \eta_c \approx 75 \text{ per cent} \\ G = 20 \text{ db} & \eta_c \approx 90 \text{ per cent} \end{cases}$$

$$L_1 = L_2/2 \begin{cases} G = 10 \text{ db} & \eta_c \approx 85 \text{ per cent} \\ G = 20 \text{ db} & \eta_c \approx 95 \text{ per cent.} \end{cases}$$

These figures demonstrate the superiority of a lumped-attenuation. The extent to which  $L_2$  may be increased in order to increase  $\eta_c$  depends on how accurately the attenuating element can be matched.

Since over-all efficiency is given by the product  $\eta_c \eta_e$ , it is seen the best results could only be obtained at the cost of some compromise.  $\eta_c$  will be high if  $\bar{\gamma}$  is also high while the factors increasing  $\bar{\gamma}$  tend to diminish  $\eta_c$ . Decreasing the operating voltage and the magnetic field moves the beam closer to the positive electrode. As shown by experiment, a tube in which  $E/B$  is constant requires a fixed value of  $B$  for optimum efficiency. There is a corresponding behavior in the magnetron. But in the TWMA the maximum efficiency is more sharply defined because of the required high attenuation.

### VIII. EXPERIMENTAL RESULTS

The preceding principles and theories have been checked qualitatively with cylinder and plane-structure tubes. Fig. 5 shows a cylindrical tube having an external appearance similar to that of a magnetron. The delay line is a helix of rectangular cross section; the interaction

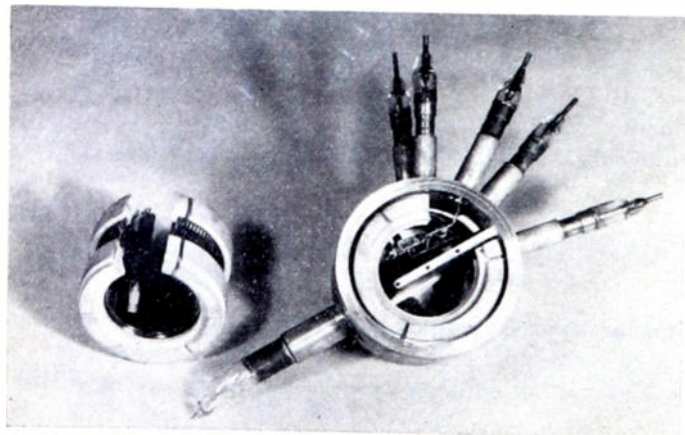

Fig. 5—View of a traveling-wave magnetron tube of cylindrical structure. The rectangular helix delay line and its holder are shown on the left.

space is situated outside the helix. In order to increase the attenuation, the tantalum helix wire is carburized. Shown lying beside the tube are the internal parts. The electrodes are mounted by means of two ceramic rings.

Fig. 6 shows a plane-structure tube before the glass envelope is sealed.



Fig. 6—View of a plane-structure tube before sealing the glass envelope.

In Fig. 7, the tube is mounted for testing between the magnet poles.

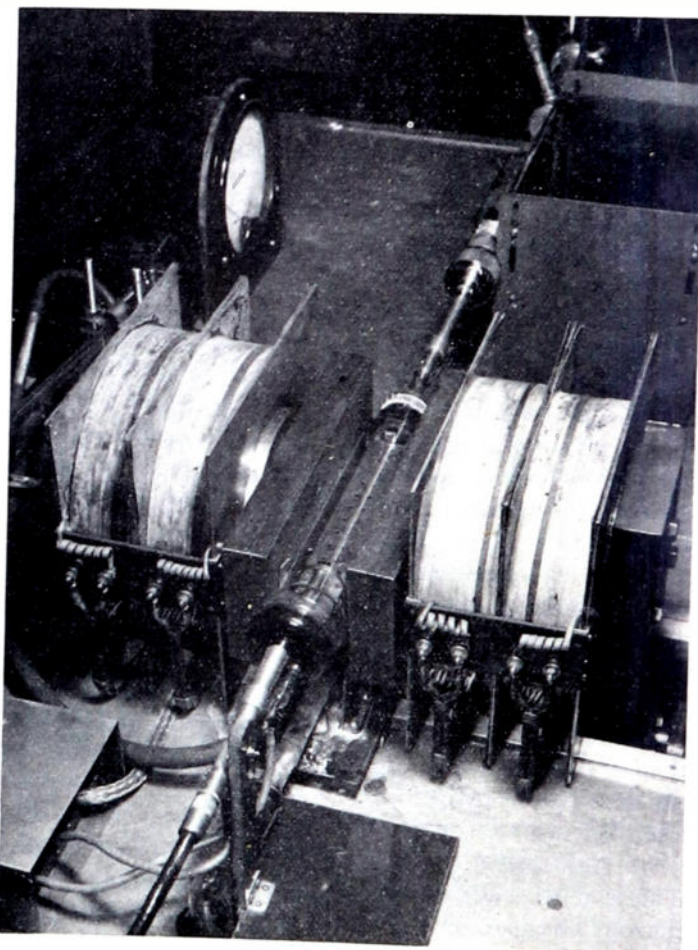

Fig. 7—Experimental mounting for testing purposes of the tube shown in Fig. 6.

In Fig. 8 are shown some measurements on a plane-structure TWMA, of the type shown in Fig. 6, that indicate the amplifying effect in the small-signal case. The ordinate is the ratio  $P_2/P_1$ .  $P_1$  is the power delivered at the output without the beam and  $P_2$  is the power with the beam. The abscissa  $B$  is the flux density. The line attenuation is 8 db. The line delay, meas-

ured beforehand, is  $c/v_1 = 22$ . This figure corresponds closely to the value of  $B$  that results in the maximum value of the ratio  $P_2/P_1$ . The other operating values are:

$$\begin{aligned} V_2 &= 2,000 \text{ v} \\ V_1 &= -600 \text{ v} \\ d &= 0.3 \text{ cm} \\ E/B &= 1.36 \times 10^9 \text{ cm/s.} \end{aligned}$$

When  $P_2/P_1 = 15.5$  db, oscillations start. (See Fig. 8.) Beside the main maximum value of  $P_2/P_1$ , a few secondary maximum values are found that are not yet quite satisfactorily explained.<sup>9</sup> Oscillations occur also at

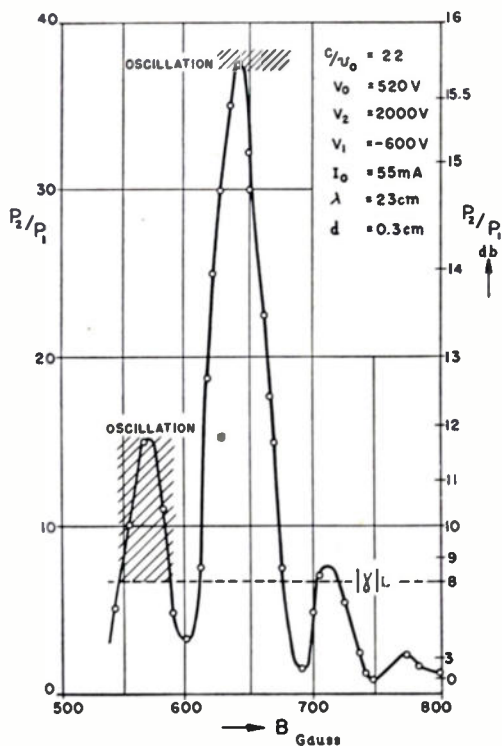

Fig. 8—Experimental data on a plane-structure tube. The ratio of the powers delivered with and without the beam is measured against the flux density.

$B < 580$  gauss and disappear when  $B$  is increased. For values of  $B$  lying between 590 and 635 gauss, and for values over 645 gauss, the tube is stable. Taking into account the line attenuation, the gain is

$$G \text{ db} = (P_2/P_1) \text{ db} - 8 \text{ db}$$

with the maximum value for the gain being approximately 7 db.

In a tube 20 cm long,  $\bar{\gamma} = (7 + 6/20) = 0.65$  db/cm approximately. By varying  $V_2$ ,  $V_1$ , and  $B$ , the maximum gain is always found for  $V_2 - V_1/B \approx 4$  v/gauss.

The incremental range of amplification is  $\Delta B/B \approx \pm 5$  per cent. It follows that the tube must be rather precisely constructed.

<sup>9</sup> The gain in terms of the voltage shows the same effect for the Kompfner-Pierce tube.

The ratio  $E/Bv_1$ , where  $v_1$  is the free wave velocity, should be constant within a few percent along the electron path. This is inferred from Fig. 4 where  $\bar{\gamma}$  becomes very small if  $\Delta(E/Bv_1)$  exceeds the value  $2(\bar{\gamma}_{opt}/k_0)$ . (The order of magnitude is  $\bar{\gamma} = 0.1 \text{ cm}^{-1}$ ). (See Fig. 8.)

A curve such as that in Fig. 8 is obtained for a number of tubes. For those with circular cross sections, the maximum gain is found for values of  $V_2 - V_1/(r_2 - r_1)B$  that vary a little with  $B$ . This is in accord with the theory.<sup>10</sup> In Fig. 9, the gain variation  $G/G_{max}$  ( $G_{max} \approx 3$  db) is plotted against  $V_1 < 0$ , that is,  $B$ , as the flux density is necessarily varied. The equipotential line and the electron trajectories approach the anode when  $-V_1$  is increased. It is difficult to collate these results to the theory because the variations in  $V_1$  and  $B$  result in alterations of the shapes of the trajectories. Also, the value of  $x_1$ , (14), that describes the mean distance be-

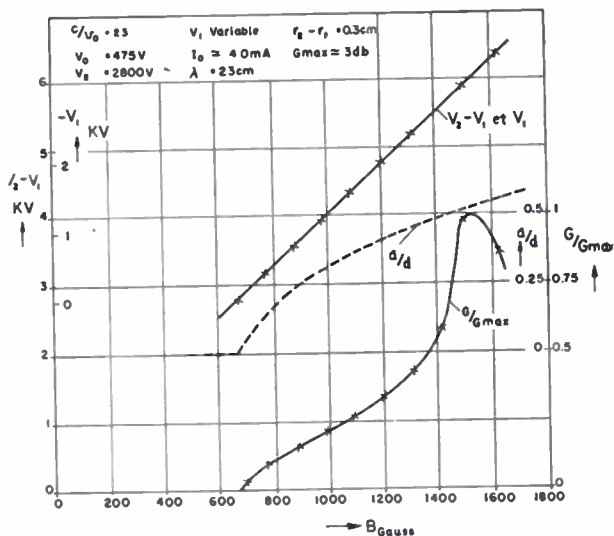

Fig. 9—Gain variation  $G/G_{max}$  ( $G_{max} = 3$  db) plotted against the flux density.

tween the trajectories and the electrode is not known accurately. It is seen however, that the gain is increased with the magnetic field until  $B \approx 1,500$  gauss in spite of the fact that the beam impedance also increases with the magnetic field. This results from an improvement in the trajectory's shape.

The extremely important influence that the shape has an efficiency was discussed in Sections VI and VII. The theoretical predictions made there are con-

<sup>10</sup> In a circular TWMA fitted with the cathode on the internal cylinder, the mean velocity of the electrons is

$$v_0 \approx \frac{V_2}{(r_2 - r_1)B} \left[ 1 - \frac{3}{4} \left( \frac{B_{crit}}{B} \right)^2 \left( \frac{r_2 - r_1}{r_1} \right) + \frac{1}{2} \frac{r_2 - r_1}{r_1} \right]$$

where  $r_1$  and  $r_2$  are the radii of the cathode cylinder and the anode respectively, and

$$B_{crit} = \frac{\sqrt{\frac{2m}{e} V_2}}{r_2 - r_1}$$

firmed by the experiments. In fact, the influence of trajectory shape appears even greater than predicted.

Trajectories that lower efficiency are accompanied by an electron absorption that occurs near the input end of the delay line. The absorption has two disadvantageous effects. It decreases the working current behind the point of absorption and it lowers the gain. The circuit efficiency is consequently decreased. (See (21a).)

Fig. 10 is the curve  $P_2=f(P_1)$  where  $P_1$  and  $P_2$  have the same meaning as in Fig. 8. The crosses are measured values. The curve  $\eta_{tot}$  is then plotted referring to an applied power  $I_0 V_2$ . With a helical attenuation of 5 db (that varies with the heat produced by the electron absorption), the curve  $G=P_2/P_1-5$  db is obtained for the gain. The decrease in gain with the signal is to be ascribed to the electron absorption caused by the trajectories. This is because the beam contains many electrons moving along epicycloidal paths. The maximum efficiency is 24 per cent. The circuit and electronic efficiency may be evaluated according to the above relationships on the basis of the measured values. The latter parameters are also shown in Fig. 10.

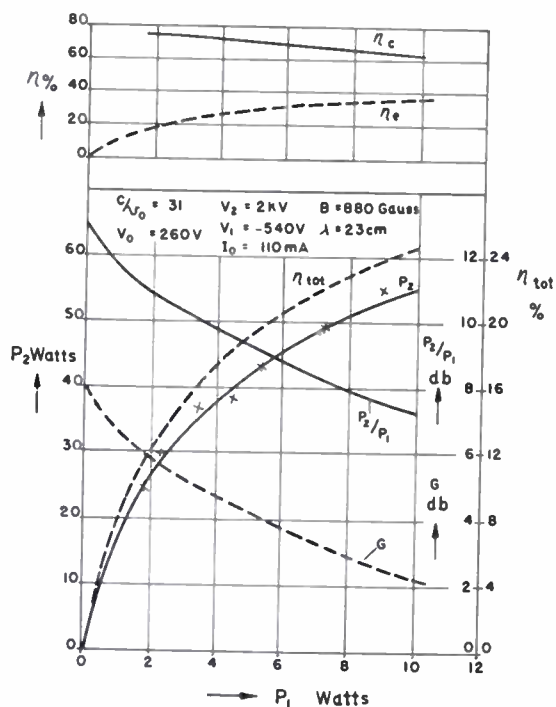

Fig. 10—Measured values  $\times$  of the power delivered with the beam in terms of the power delivered without the beam for the parameters shown. The graph gives also the over-all efficiency, and the circuit and electronic efficiencies against the applied power  $I_0 V_2$ .

The electronic bandwidths were found to be between 100 and 150 Mc. This value is apparently influenced by a certain amount of dispersion of the phase velocity of the flat helix.

Powers of approximately 200 w and an over-all efficiency of about 40 per cent have been obtained with tubes provided with optical systems producing nearly ideal trajectories.

## CONCLUSIONS

Theoretical results and the early experiments that substantiate the predictions of the theory justify an interest in the principles of the TWMA. The early designs are likely to be vastly improved—they by no means constitute the ultimate physical and technical possibilities embodied in the principle of operation.

The useful power of tubes having helical circuits in their delay lines, is limited primarily by the relatively small power that can be dissipated in such a structure. Another factor effecting the useful power is the quality of the gun. The power can be increased by a large factor by using a nearly ideal optical system so that electron interception is reduced to a bare minimum.

Evidently, massive delay lines, of the vane type, for example, would permit raising the power level. This is because the dissipation could be increased. Circuits such as these are particularly advantageous for tubes operating at high accelerating voltages. However, it seems that the high geometrical precision required for the design and construction of tubes with such circuits is difficult to achieve, when the delay factor (in reference to the velocity of light) exceeds 15.<sup>11</sup>

Circuits of the multivane or multicavity type offer the disadvantage of being pass-band circuits. They incur a high dispersion of the phase velocity and consequently, they have narrower bandwidths than helical circuits.

Delay lines equivalent to a chain of filters apparently provide a tighter coupling between the wave and the beam. As a consequence they have a higher gain and circuit efficiency than a helix.

In spite of the pass-band characteristics of vane-type structures, these systems offer much when compared to the possibilities of other microwave tubes. Furthermore, various expedients, the "rising sun" structure,<sup>12</sup> for example, might be incorporated proving of even greater usefulness than the simple recurrent structures.

The high applied powers made possible by the operating principle of the TWMA require important increases in the current. In this connection, the first factor to be taken into account is the structure of the electron gun. The current that can pass through the interaction space has an upper limit set by the space charge effects. This limit corresponds to the value of the anular current in the magnetron<sup>13</sup> and is approximately

$$I_{lim} = \frac{2\epsilon_0 V_2^2}{d^2 B} = 5 \cdot 10^{-6} \frac{V_2^{3/2}}{d} \frac{B_{crit}}{B}$$

When  $d=0.3$  cm,  $B_{crit}/B=1$ , and  $V_2=2.5$  kv, one has

<sup>11</sup> A greater delay is necessary for the TWMA than for an oscillator magnetron operated at the same voltage. Because of the greater space charge in the magnetron, the transverse electric field  $E$ , (hence, the electron velocity  $v_0=E/B$ ) at the anode is materially higher than that of the TWMA.

<sup>12</sup> Application for French Patent No. 563,911, November 26, 1948.

<sup>13</sup> O. Döhler, "Sur les propriétés des tubes a champ magnétique constant," *Ann. Radioélec.*, vol. 3, p. 29; January, 1948.



$I_{lim} \approx 2$  amp/cm, and when  $V_2 = 10$  kv,  $I_{lim} \approx 16$  amp/cm.

Because of space charge effects, high currents result in an electrostatic field that varies with  $x$  within the cross section of the interaction space. Therefore, the velocity  $v_0 = E/B$  will also vary within the cross section of the system. The interaction process in the TWMA then, becomes more like that in the magnetron where the space charge diminishes the cycloidal motion, which is favorable, and restricts the interaction to a limited part of the beam cross section. Effects of this nature may be involved when a tube is pulse-operated at very high peak powers. With high density currents, other interaction phenomena may appear between electron

streams moving in crossed electric and magnetic fields. The authors are not yet able to state whether or not these phenomena are favorable. Theoretically it appears that the function of the delay circuit in the TWMA may be performed by an electronic space charge and that the TWMA may be transformed into some kind of amplifier magnetron without circuit within the interaction range. This conception<sup>14</sup> seems likely to be of interest in the centimeter and decimeter regions.

<sup>14</sup> R. Warnecke, O. Döhler, and W. Kleen, "Amplification d'ondes électromagnétiques par interaction entre des flux électroniques se déplaçant dans des champs électrique et magnétique croisés," *Compt. Rend. Acad. Sci. (Paris)*, vol. 229, p. 709; January, 1949.

Application for French Patent No. 568,163, February 23, 1949.

## Analysis of Errors in a Phase-Shift Angle Telemetry System\*

JOHN V. HARRINGTON†, ASSOCIATE, IRE

THE FOLLOWING abstract gives the results of an investigation of errors in a phase-shift telemetry system.

In evolving a method to transmit angular position data, the selection of electrical phase angle to represent the desired data is a natural one, since there is a great deal of similarity between the two quantities. Since phase shift is a relative quantity, it is necessary to transmit a reference signal as well as a phase-shifted signal; and in order to transmit both of these on a common carrier, and to avoid angular ambiguities, the phase-shifted wave is transmitted at some integral multiple of the reference frequency. At the receiver, the frequency of the reference wave is multiplied prior to comparison with the phase-shifted signal. Minimum bandwidth is required when the integral multiple is 2, and it is with this particular system (which is perhaps the most common of all) that the following discussion of errors is concerned, although the analysis made for this case may be extended to others as well. This method has been successfully applied in plane-to-ground telemetry and in the relaying of shaft-position data in general.<sup>1,2</sup>

The receiver operates essentially as a comparison device and shifts the phase of the reference signal to match that of the incoming phase-shifted signal. Constant phase shifts in the transmission link, therefore, are

of no consequence, since they may be accounted for by an adjustment of the "zero setting" at the receiver. What are referred to as errors are not constant quantities, but are small deviations from the true or transmitted angular positions ( $\theta$ ), which deviations are functions of ( $\theta$ ) (static errors) or functions of the rate-of-change of  $\theta$  (dynamic errors). The principal sources of error for the system may be listed as follows:

1. Errors due to phase shifter.
2. Errors due to nonlinearity in transmission system.
3. Dynamic errors due to circuit time delay.
4. Phase variations due to random noise.
5. Errors due to multipath propagation.

The phase error arising from unbalance in the phase shifters is shown to follow a "second harmonic" distribution and is given by

$$\Delta\psi \approx q \sin 2\psi$$

where  $q$  = negative sequence unbalance ratio.

In a typical system the error from this source may be kept to within  $\pm 1$  degree.

The error due to system cross talk in the absence of compensation is found to be

$$\Delta\psi = B \frac{1 + 4\alpha^2}{\alpha} \cos \psi$$

where  $B$  = per cent second harmonic distortion.

$$\alpha = \frac{\text{amp of } 2\omega \text{ signal}}{\text{amp of } \omega \text{ signal}}$$

This has a minimum when  $\alpha = \frac{1}{2}$ , in which case

$$\Delta\psi = 4B \cos \psi.$$

Thus, a transmission system which is characterized by a 5 per cent second-harmonic distortion will give a phase error of 4(0.05)

(57.3) = 11.4 degrees. It is shown that this error can be reduced by the employment of compensatory techniques, although complete cancellation is not attainable, being prevented by the existence of higher-harmonic error distributions. Experimental verification of the relations derived in this section has been obtained.

Dynamic error due primarily to the slope of the phase characteristic in the  $2\omega$  channel filter is evaluated; it is only appreciable when  $2\omega$  and  $\omega$  are in the low audio-frequency range where the filter bandwidths are likely to be narrow, and further is only appreciable where  $\psi$  is to vary at rather high angular rates. In general, this error is given by the product of the rotation rate and the  $2\omega$ , time delay,  $t_d$ . For the constant "k" filters commonly used  $t_d = (229/\Delta f)$  in degrees per cycle.

The effect of random noise in causing uncertainty in or in limiting the accuracy of the basic system is analyzed. Probability distribution curves are presented for the phase of a sine wave plus noise, and from these it is shown that, for the random variation of phase to be almost entirely within the range  $\pm\theta$ , the rms signal-to-noise ratio  $a$  must be such that  $a \geq (115/\theta_1)$  where  $\theta_1$  is in degrees. The actual phase distribution function is given by:

$$P(\theta)d\theta = \frac{d\theta}{2\pi} \epsilon^{-a^2} [1 + \sqrt{\pi} a \cos \theta \epsilon^{a^2 \cos^2 \theta} [1 + \operatorname{erf}(a \cos \theta)]]$$

Thus, for  $\theta_1 = 5$  degrees,  $a$  must be greater than 23.

It is pointed out that the basic telemetry system will be of doubtful value when long-distance transmission is required, because of the distortion and error introduced by multipath propagation.

\* Decimal classification: 621.375.616. Original manuscript received by the Institute, February 4, 1949; abstract received, October 28, 1949.

The bulk of the material contained in this paper was presented to the Polytechnic Institute of Brooklyn in June, 1948, as a masters thesis.

† Air Force Cambridge Research Laboratory, Cambridge, Mass.

<sup>1</sup> L. N. Ridenour, "Radar System Engineering," McGraw-Hill Book Co., Inc., New York, N. Y., 1947.

<sup>2</sup> D. W. Moore, "Plane-to-ground telemetry," *Electronics*, vol. 18, pp. 125-128; November, 1945.

# The "Double-Layer" Projection Tube Screen for Television\*

MEIER SADOWSKY†

**Summary**—Problems involved in projection cathode-ray tube screens are discussed. The development of a screen with good efficiency and little color-shift with current change is described.

THE PROJECTION TUBE system of television makes possible a large image with a small cathode-ray tube. However, projection television not only requires a carefully designed optical system, but an intensely brilliant light source from the phosphor screen on the cathode-ray tube face.

To achieve a sufficiently bright screen image, high power input is required. However, the use of high voltage and high current entails special problems for the luminescent screen.

At low accelerating voltages, the brightness of a spot on a cathode-ray tube screen increases roughly as the square of the accelerating voltage, but as the potential is increased, a condition approaches where there is little gain in brightness because the screen reaches a limiting or "sticking" potential.<sup>1</sup>

This condition can be lessened or eliminated by increasing the secondary emission of the screen<sup>2</sup> or by providing an electrically conductive layer in contact with and parallel to the screen layer.<sup>3</sup>

The light output is also a function of the current input as indicated in the equation:<sup>4</sup>

$$L = (V - V_0)^n f(i)$$

where

$V$  = accelerating voltage

$V_0$  = "dead" or "threshold" voltage (varies with the phosphor)

$n$  = a constant that ranges in value from 1 to 3

$i$  = current density ( $f(i)$  is independent of  $V$ )

$L$  = light output (total luminous flux in lumens emitted by the excited phosphor).

For small current densities, the curves representing  $L$  as a function of  $i$  have the same trend for all values of  $V$  and are nearly straight lines. At higher values of  $i$ ,  $L$  tends toward maximum or saturation value with consequent decrease in screen efficiency (lumens output per watt input).<sup>5</sup>

\* Decimal classification: R583.6. Original manuscript received by the Institute, June 30, 1949; revised manuscript received, November 23, 1949. Presented, IRE Electronic Conference, Princeton, N. J., June 21, 1949.

† Philco Corporation, Lansdale, Pa.

<sup>1</sup> T. Soller, M. A. Starr, and G. E. Vallev, "Cathode Ray Tube Displays," sec. 16, McGraw-Hill, New York, N. Y.; 1948.

<sup>2</sup> A. Bramley, Pat. Pend., 1946.

<sup>3</sup> D. W. Epstein and L. Pensak, "Improved cathode-ray tubes with metal backed luminescent screens," *RCA Rev.*, vol. 7, pp. 5-11; March, 1946.

<sup>4</sup> P. Pringsheim and M. Vogel, "Luminescence of Liquids and Solids," p. 29, Interscience Publishers, Inc., New York, N. Y.; 1946.

<sup>5</sup> W. B. Nottingham, *Physics*, vol. 10, p. 73; 1939.

The value of the current density at which the fluorescence efficiency begins to decrease varies widely for different phosphors. It is much higher for silicate phosphors than for sulfide phosphors.

An all-sulfide screen, (e.g., blue ZnS:Ag, yellow ZnS:CdS:Ag) is more efficient than a mixed sulfide-silicate or all-silicate screen at low current densities.<sup>6</sup>

However, at high current densities, the saturation of the all-sulfide screen give a less efficient conversion of energy, thus limiting brightness.

An all silicate screen (e.g. blue CaMg (SiO<sub>3</sub>)<sub>2</sub>:Ti, yellow Zn<sub>8</sub>BeSi<sub>5</sub>O<sub>19</sub>:Mn) has been recently developed.<sup>7</sup> Though in use today, the blue silicate does not match the efficiency of the blue sulfide. Where it is not considered desirable to sacrifice brightness, the blue silicate cannot be used.

The only practical alternative, then, is a mixed screen with a yellow silicate (Zn<sub>8</sub>BeSi<sub>5</sub>O<sub>19</sub>:Mn) and a blue sulfide (ZnS:Ag). However, the difference in saturation values would cause a homogeneous screen of this type to shift in color as the current density rises beyond the saturation points of the blue sulfide, thus making the highlights yellow instead of white.

Under the auspices of the Philco Corporation, a research program was initiated a few years ago, at the National Union Radio Corporation Laboratories directed by Dr. Arthur Bramley, to try to eliminate or alleviate this problem.

It was early noticed that the addition of *fine-particle* beryllium oxide to the screen suspension raised the current value at which saturation occurred. In a long series of experiments, it was found that tubes screened in layers with the blue next to the face plate were more efficient than those where the yellow was deposited next to the face plate with the blue on top of it, or where the two components were well mixed. In order to obviate the expensive procedure of settling the layers separately, a synthesis and preparation program was carried out which developed an efficient fine-particle yellow silicate for use with a larger-particle blue sulfide. This permitted differential settling out of the suspension, resulting in a "layered" screen with the blue sulfide next to the glass, covered by fine particles of yellow silicate.<sup>8</sup>

D. Epstein of the RCA Laboratories has suggested that the reason for less color shift at higher currents of

<sup>6</sup> M. Sadowsky, "The preparation of luminescent screens," *Jour. and Trans. Electrochemical Soc.*, vol. 95, pp. 112-128; March, 1949.

<sup>7</sup> A. L. Smith, "Some new complex silicate phosphors containing calcium, magnesium and beryllium," *Jour. and Trans. Electrochemical Soc.*, vol. 96, pp. 287-296; November, 1949.

<sup>8</sup> A. Bramley, unpublished data.

the layered screen is that the fine-particle yellow silicate slightly diffuses the electron beam as it passes through it. Consequently, the *current density* of the beam impinging on the blue zinc sulfide is *less*. The saturation *value* remains the same for the sulfide, but it is not reached as readily because of the beam diffusion.<sup>9</sup>

In order to indicate the extent of the effects described above, the writer made a series of tubes embodying extremes of screen composition as indicated (each group consisted of 4 tubes).

*Group 1.*

Blue sulfide (ZnS:Ag) layer next to the glass, yellow silicate (Zn<sub>8</sub>BeSi<sub>6</sub>O<sub>19</sub>:Mn) settled on top of it 4 hours later.

*Group 2.*

Large-particle blue sulfide and small-particle yellow silicate settled together as in regular Philco production. (Blue settles out first.)

*Group 3.*

Blue sulfide and yellow silicate fairly well matched in particle size settled together.

*Group 4.*

Fine blue sulfide and fine yellow silicate settled together (well mixed screen), with fine layer of beryllium oxide on top of screen.

*Group 5.*

Yellow silicate next to the glass, blue sulfide settled on top of it 4 hours later.

Light output measurements were taken with a Weston Red Red, Eye Corrected Photronic Cell equipped with a Wratten 1 per cent transmission neutral density filter and Sensitive Research Milliammeter calibrated against a MacBeth Illuminometer. Measurements were made on a focused 2¼-X3-inch raster with photronic cell held against the face of the tube. The cell was in a fibre box with metal parts grounded to avoid charging of cell. Measurements at 25 kv, I<sub>b</sub> of 20, 100, 200µa.

Color measurements were made with a Hunter type<sup>10</sup> colorimeter using a Weston type 1 photronic cell without eye correcting Viscor filter and using three photovolt filters (green, blue, and amber). The transmission of the filters used compares favorably with the Corning filters actually used by Hunter, and the coefficients of the tristimulus equations have been set up to agree with the published tristimulus co-ordinates of the ICI Standard observer on Illuminants A and C.<sup>11</sup>

The accompanying curves show less color shift (Figs.

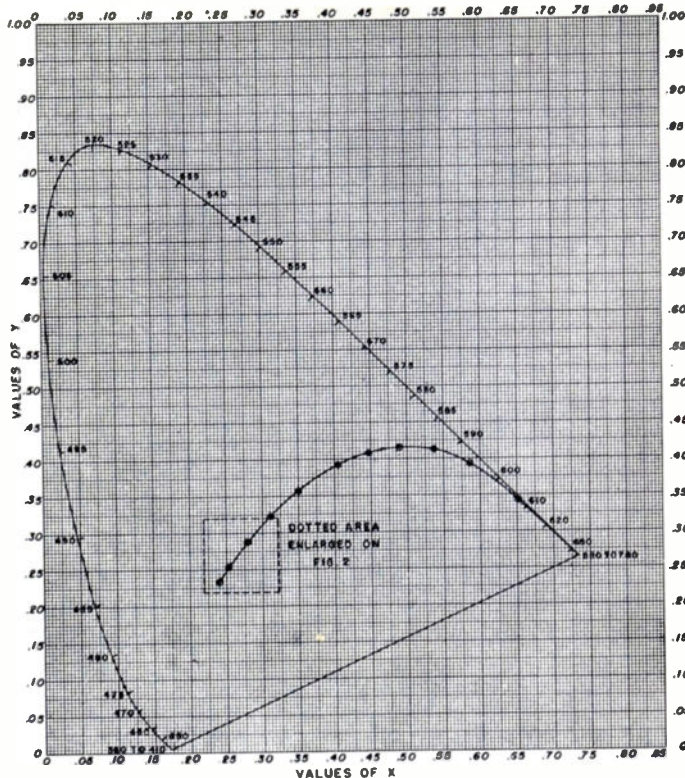

Fig. 1—Chromaticity diagram showing locus of black body radiation. (See footnote reference 11.)

1 and 2) and less efficiency drop (Fig. 3) at constant voltage, with increasing current density, where the sulfide phosphor is "protected" or covered by either a layer of small-particle silicate phosphor or by a layer of small-particle beryllium oxide. The greater color change and concomitantly greater drop in efficiency of Group 2

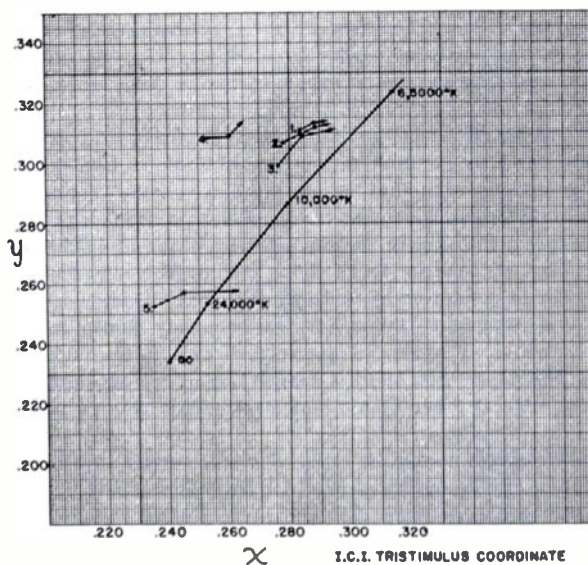

Fig. 2—Measurements at 25 kv; 20,100,200µa beam current. 2.25" X 3.00" raster size.

1. Blue layer 4 hours before yellow
2. Large blue, small yellow, settled together.
3. Blue and yellow, same size, settled together.
4. Small blue and yellow with BeO on top.
5. Yellow layer 4 hours before blue.

<sup>9</sup> D. W. Epstein, Oral communication.

<sup>10</sup> R. Hunter, "Photoelectric Tristimulus Colorimeter with Three Filters," Circular C429, National Bureau of Standards; July 30, 1942.

<sup>11</sup> A. C. Hardy, "Handbook of Colorimetry," The Technology Press, M.I.T., Cambridge, Mass., Chap. 7; 1936.

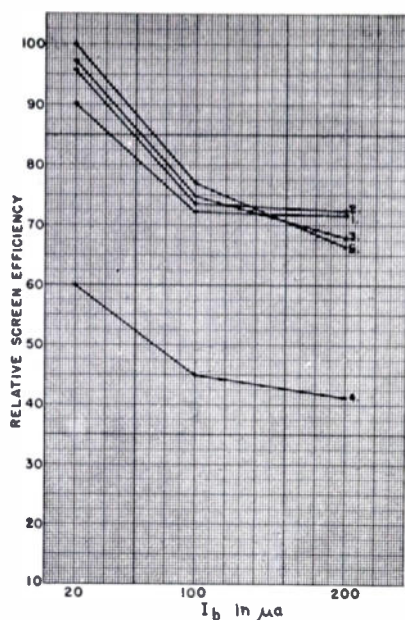

Fig. 3—1. Blue layer 4 hours before yellow.  
 2. Large blue, small yellow, settled together.  
 3. Blue and yellow, same size, settled together.  
 4. Small blue and yellow with BeO on top.  
 5. Yellow layer 4 hours before blue.

and, to a lesser extent, Group 5, indicate a greater saturation of the blue zinc sulfide phosphor.

(With the double layer screen, there is change in color with change in voltage. However, it is reasonably easy to regulate the voltage so that this does not become a problem.)

The screen developed for projection systems as exemplified by the present Philco TP-400A and TP-401A shows less color shift and better efficiency than previous projection tube screens. The system of differential deposition of screen components from the same suspension provides for maximum utilization of each and facilitates production of a good projection system.<sup>12</sup>

#### ACKNOWLEDGMENT

The author wishes to thank Miss Marian Magargal for taking the electrical measurements and making the color computations presented in this paper.

<sup>12</sup> A. Levy, U. S. patent number 2,475,330.

## A Dynamically Regenerated Electrostatic Memory System\*

J. P. ECKERT, JR.†, ASSOCIATE IRE, H. LUKOFF†, AND G. SMOLIAR†

**Summary**—In an electrostatic memory system, the words are stored as charge patterns on the screen of a cathode-ray tube. Memory is extended by a systematic regeneration process. All experiments were performed on a standard cathode-ray tube.

This paper discusses the fundamental theory behind electrostatic storage. The principal problem was that of finding a method for storing the charges such that two easily and reliably distinguishable states could be established at various points on the face of the tube. After experimenting with various patterns, a dot-circle combination was chosen as superior to all those tested. The dot, representing binary one, is generated by sharply focusing the beam on a spot. The circle is generated by imposing high-frequency sinusoidal electromotive forces, 90° apart, on the vertical and horizontal deflection plates. The paper then offers a comparison of the dot-circle pattern with the several other systems of electrostatic storage now under test.

The details of numerous experiments are given, together with a description of the apparatus used for test. The effects of phosphor type, gun structure, tube diameter, accelerating voltage, leakage, transients, and other factors affecting memory are discussed. The

concluding section of the paper describes the various types of large capacity high-speed memory designs which could be constructed from a reliable electrostatic memory tube.

#### I. INTRODUCTION

THIS PAPER describes a system for storing electrical impulses as charges on the screen of an ordinary cathode-ray tube. In order to extend the period of storage to many hours, a dynamic system of regeneration is provided. This system periodically examines and re-establishes the charges on the face of the tube before various deteriorating effects have made them illegible.

Work on an electrostatic memory system began nearly four years ago at the University of Pennsylvania by one of the authors and has been continued at the Eckert-Mauchly Computer Corporation. The principle of the regeneration circuit and the methods of scanning to provide this regeneration were known and understood at that time. The principal problem was that of finding a method for storing the charges such that two easily and reliably distinguishable states could be established at various points on the face of the tube. Preliminary

\* Decimal classification: 621.375.2XR138.31. Original manuscript received by the Institute, May 13, 1949; revised manuscript received, March 1, 1950. Presented, 1949 IRE National Convention, March 8, 1949, New York, N. Y.

† Eckert-Mauchly Computer Corp., Subsidiary of Remington Rand, Inc., Philadelphia, Pa.

tests indicated that a number of different types of charge patterns were satisfactory. However, one method was found which provided best results from almost every point of view, and this method formed the basis for the construction of a practical memory system.

Work very similar in nature to the developments described in this paper has been carried on in England under the direction of F. C. Williams of the University of Manchester. Some of his results are consistent with the results obtained in this country.

All results given in this paper are based on tests made with standard cathode-ray tubes. Certain special tubes are being studied and will probably be reported upon in the future. However, there are sufficient advantages in the standard cathode-ray tubes that special tubes will probably not be used in a memory for commercial digital computing equipment in the near future unless their performance is considerably improved.

*A. Basic Theory of Operation*

Fig. 1 shows a block diagram of an electrostatic memory system. An electrode has been attached to the screen of the cathode-ray tube upon which, by condenser action, charges are built up by the changes in the electrostatic charge on the inside surface of the screen of the tube. The charges on the electrode form the input signals to the amplifier. The amplifier must have a gain of several thousand.

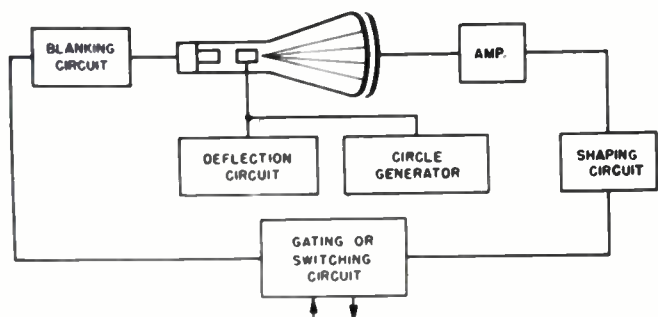

Fig. 1—Block diagram.

The output signals, after amplification, are passed through a shaping circuit and into the gating or switching circuit. Here, the information read from the face of the tube may be sent on to other circuits or may be restored on the tube screen or both. New information can be read in through the gating circuits to replace previous information. The blanking circuit controls the intensity grid of the cathode-ray tube.

The screen of the tube is considered to be divided into many small elementary areas of the order of 1/10 inch square. There may be several thousand elementary areas on the face of each tube. The deflection circuit controls the position of the beam, and thus determines that each unit of information is stored in the proper elementary area.

When a unit of information is to be retained for a long period of time, it must be regenerated periodically. Regeneration consists, first, of examining each ele-

mentary area to learn which charge pattern has been stored there; and second, of restoring the pattern to its original charge. Regeneration of an entire tube screen is done in a systematic fashion. The electrostatic memory is, therefore, a dynamic type like the mercury delay-line memory, but unlike the latter, can have a very short access time. This feature is one of the most important advantages of the electrostatic memory over the delay-line system.

*B. Charge Patterns*

Numerous charge pattern systems have been suggested. After extensive testing of many of these, a system using dots and circles as the two distinctive patterns was chosen as having the greatest reliability. The dot, representing a binary one, is formed by focusing the beam as sharply as possible in the center of an elementary area. The circle, representing zero, is formed by superimposing high-frequency sinusoidal electromotive forces phased 90° apart on the horizontal and vertical deflection systems. This is the purpose of the circle generator, shown in Fig. 1. The circle has a diameter 1½ to 3 times that of the focused dot, as shown in Fig. 2.

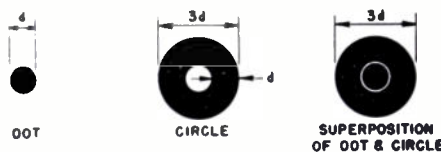

Fig. 2—Proportion of dot and circle.

*C. Reading and Writing Operation*

In order to learn what has been stored or remembered in one of the elementary areas, the fields between the deflection plates must be adjusted to such potentials that the beam will fall directly on the elementary area in question when the beam is turned on by applying a positive voltage to the intensity grid. When the beam reaches the screen, an output signal is developed on the electrode. The shape of this signal depends on both the

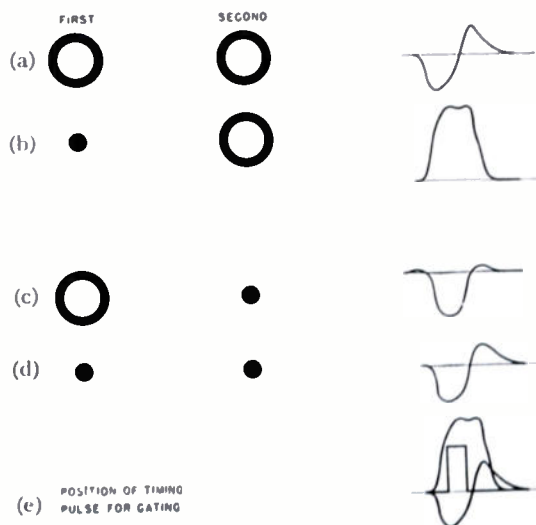

Fig. 3—Output signals.

reading pattern and the previously stored pattern. Each time the reading pattern is applied to the screen, the stored pattern is destroyed, or erased.

Suppose, for example, that a circular electron pattern is read by a second circle. The amplifier will produce a wave form like that shown in Fig. 3(a) (plotted as a function of time). If the first charge pattern is a dot and the second pattern a circle, the shape of the output voltage plotted as a function of time would appear as in Fig. 3(b). There is considerable distinction between these two electrical signals. If either signal is sampled, as shown in Fig. 3(e), a pulse is obtained only when a circle replaces a dot.

While unnecessary to the discussion of the operation of the device, Figs. 3(c) and 3(d) show the type of signal that is obtained if a dot replaces a circle and if a dot replaces another dot.

#### D. Secondary Electron Emission

The reasons for the development of the output signals shown involves an understanding of the behavior of the primary and the secondary electrons. The primary electrons are thrown on the insulating phosphor of the screen which, in turn, emits secondary electrons from the area under bombardment. Many of the secondaries, after leaving the screen, are drawn to the collector which is formed by the aquadag or conducting coating on the inner surface of the sides of the cathode-ray tube. The collector is at a high positive potential.

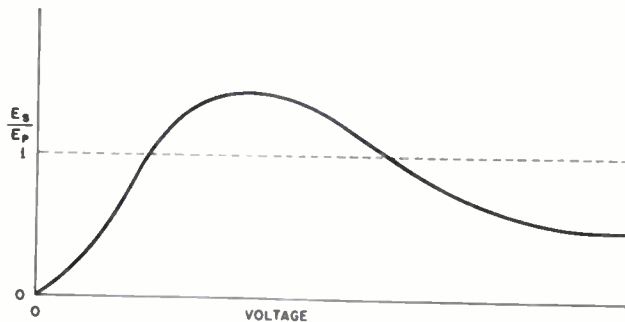

Fig. 4—Ratio of secondary electrons to primary electrons versus voltage.

Fig. 4 is a graph of the ratio of the number of secondary electrons to the number of primary electrons plotted versus voltage. The curve has a peak somewhere between 1,000 and 5,000 volts, depending upon the type of insulating surface used. For the phenomena of concern in this paper, the curve is mainly of interest in the section where it is substantially above one. Within this region of operation, the number of secondary electrons emitted by the area of the screen under bombardment is greater than the number of primary electrons which strike the screen. The most successful tests were those in which the operating voltages were within the range 1,500 to 10,000 volts.

Fig. 5 is a graph of the distribution of the secondary electrons as a function of the velocity at which they are emitted from the surface. Velocity is expressed as the

equivalent number of volts required to produce this velocity. Except for the few electrons emitted at the beam velocity, most of the electrons are emitted at a velocity of 6 to 15 volts. This velocity, of course, is quite low compared to the velocity of the striking beam which causes their emission.

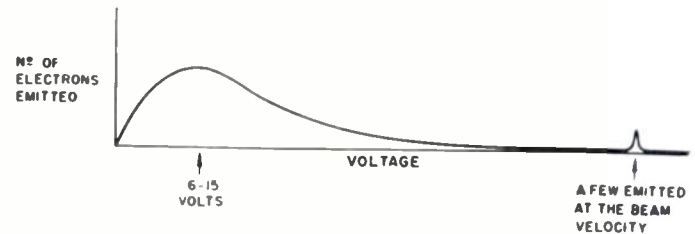

Fig. 5—Secondary electron emission versus velocity of emission in volts.

#### E. Theory of Electrostatic Storage

The dot-circle patterns form special potential distributions on the screen of a cathode-ray tube. Fig. 6 shows a cross section of a beam of electrons striking the phosphor screen. Secondary electrons are released in accordance with the principles just discussed. At first, most of the secondary electrons travel to and are collected by the collector. Some few secondary electrons may fall back on the surface of the screen. Since the beam has a velocity sufficient to make the number of secondaries greater than the number of primaries, the area under the beam reaches equilibrium when the number of electrons which leave the surface and the number which arrive become equal.

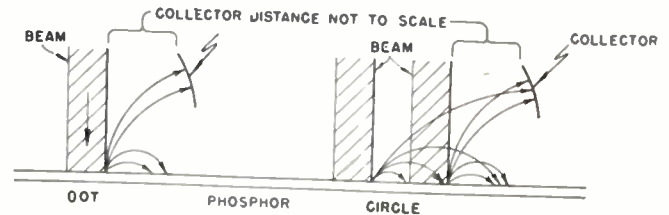

Fig. 6—Cross section of beam.

Figs. 7 and 8 shows two different curves of the potential distribution for the dot-circle patterns. Although much of the literature discusses Fig. 8, no really critical experiments known to the authors have positively proven the validity of either curve. The experience of the authors indicates that observed phenomena are equally well explained by either Fig. 7 or Fig. 8.



Fig. 7—Potential distribution.



Fig. 8—Alternate potential distribution

When electrons leave the surface of the screen, a positive signal is induced on the electrode. Conversely, as electrons fall on the screen, a negative signal is obtained.

Specifically, the amount of charge on the screen changes when either type of charge pattern is replaced by the other. When a circle replaces a dot, there is a net increase in positive charges. Conversely, when a dot replaces a circle, there is a net decrease of positive charges. Since the significant output signal is obtained when the larger pattern destroys the smaller, the two patterns chosen should therefore possess the greatest interfering periphery.

#### F. Output Signal

An explanation of the electrostatic phenomenon can be developed from the curves shown in Fig. 9. These curves are similar to those shown in Fig. 3 except that the value of the amplifier input resistance was reduced. The low frequency components were thus removed without impairing the highs.

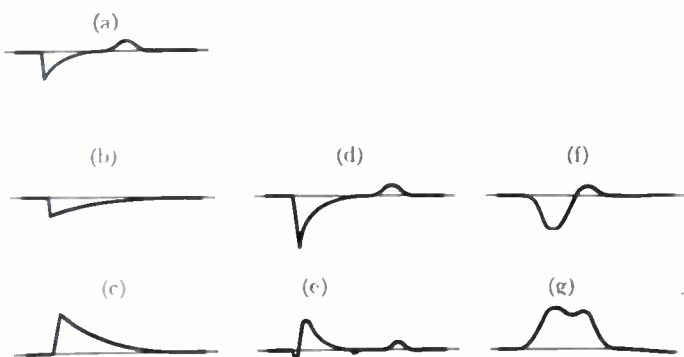

Fig. 9—Output signals.

Curve (a) of Fig. 9 is a signal obtained when the same pattern is used for reading as was previously stored in an elementary area. Since the transit time from gun to screen is about 1/100 microsecond, the initial negative kick of the signal is quite abrupt. The exponential decay to zero takes place as a result of the establishment of equilibrium by the secondaries, which takes considerably longer because the potential differences are much lower (being of the order of 6 to 10 volts), while the distances are comparable. Between 0.1 and 0.2 microsecond is required to establish equilibrium. Equilibrium results in a potential plateau under the bombarding beam from which as many electrons leave as arrive. When equilibrium has been established, the initial proportion of secondaries going to the collector has decreased and a larger number fall back on the neighboring areas of the surface. The rate at which the curve returns to zero, that is, reaches equilibrium, is a measure of the secondary electron emission.

From the time equilibrium is reached until the beam is turned off, there is a steady inward and outward flow of electrons to the screen maintaining a space-charge cloud between the spot and the collector. When the beam is turned off, the space charge is rapidly taken up by the collector. Since this negative space charge leaves the screen, a positive kick is induced in the electrode. All the other signals obtained contain curve (a) as a component. The components added to (a) to

produce the other signals are sudden rises with simple exponential declines.

Curve (b) of Fig. 9 represents the exponential component obtained when a relatively small pattern is placed on a larger pattern. Most of the secondaries are attracted to the surrounding positively charged area and reduce it to the screen potential. At that point equilibrium is reached and a larger proportion of the secondaries are attracted to the collector.

Curve (c) is obtained when a relatively large pattern is placed on a smaller one. The large positive kick occurs because at first most of the secondaries are drawn to the collector plate, in order to build up the potential plateau. Since the potential plateau of the dot is at about the potential of the collector and smaller in area, only a few of the secondary electrons are robbed from the flow to the collector. As the potential of the plateau nears that of the collector, the secondary flow to the collector diminishes and a greater number of secondaries fall back on the screen.

Thus, when a circle is put on a dot, there is a net outward flow of electrons, while there is a net inward flow of electrons when a dot is put on a circle. In either case, the net change in plateau area, and therefore the number of electrons to be exchanged in order to reach equilibrium, is the same.

Curve (d) is the sum of (a) and (b), while curve (e) is the sum of (a) and (c). Curves (f) and (g) are obtained by using a high load resistance on the amplifier input. (The scale of these two curves is different from that of the other curves.)

Fig. 10 is a photograph of an array of 1,200 spots taken on the face of a seven-inch cathode-ray tube.

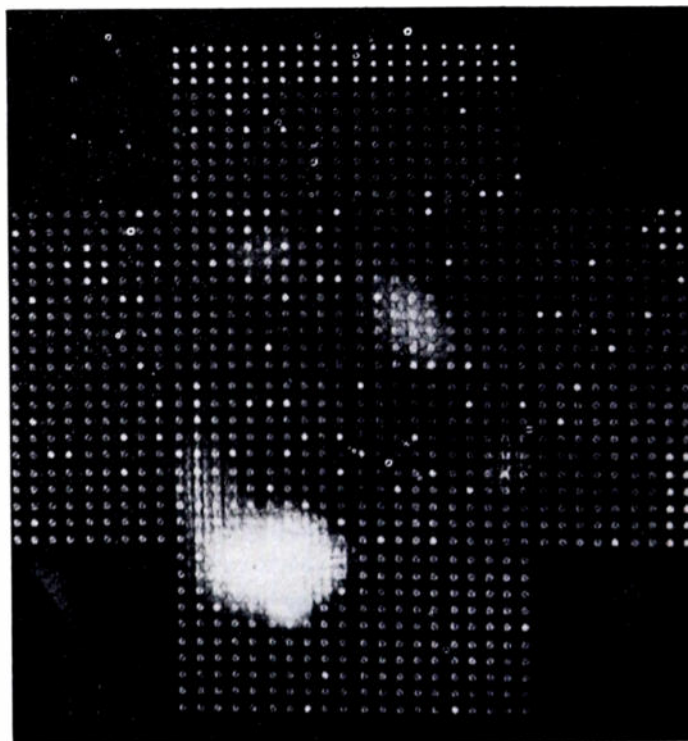

Fig. 10—Photograph of 1,200 spots.

### G. Deterioration or Destruction of Charge Patterns

Various factors tend to affect the storage process. Leakage of electrons through the volume of insulating material at the end of the tube will eventually destroy the charge patterns. Experiments have been made, however, which prove that loss through leakage is negligible. Deterioration over an interval of time many times longer than any contemplated regeneration period was not appreciable.

Redistribution is a term applied to the deteriorating effect produced on adjacent spots by secondary electrons which spray from a particular spot being read by the beam. The "redistribution ratio" is a measure of the number of times the reading beam may operate for a certain duration of time and at a certain distance from a spot before the signal which can be derived from that spot will have been degraded more than a specified percentage, say ten per cent.

Experimentation has shown that the degradation is not proportional to the number of times of reading but is proportional to the integrated time. For efficient operation a minimum duration satisfactory for reading and regenerating can be chosen.

In the course of the experiments carried on in England, small imperfections on the screen of the cathode-ray tube seemed to produce spurious signals. These were attributed to holes and possibly carbon particles in the phosphor. A small hole is supposed to produce a spurious signal because it exposes the glass which has different secondary emission characteristics than the phosphor. This type of imperfection was overcome in England by using a voltage such that the glass and phosphor have nearly the same secondary emission ratio. A voltage of about 1,500 volts was sufficient to fulfill these conditions.

Particles of carbon create another problem for this system. If a carbon imperfection is present on the screen, it has been learned in England that this too gives a spurious signal. Furthermore, it has been found that the size of the imperfection required to give difficulties may be considerably smaller than the dot used in the process. So far, no cathode-ray tubes have been encountered in the present experiments which give spurious signals with the dot-circle system of reading. While there is a slight variation in the size of output signals obtained in the circle-dot system as the reading operation moves across the tube screen, the size and shape are always sufficient to give a reliable memory.

The sensitivity of the dot-line system to screen imperfections seems to be a property of any system which sweeps the beam. Even though the imperfections may be smaller than the small pattern, the sharp edge of the beam detects them as the beam is swept across the screen. The resulting output signal contains these disturbances at the beginning of the signal where sampling normally occurs.

## II. COMPARISON OF THE VARIOUS SYSTEMS OF ELECTROSTATIC STORAGE

Several systems for operating electrostatic storage are illustrated in Fig. 11.

### A. Dot-Line System

The dot-line system, used in England by Williams, uses a dot for one pattern and a line for the other. The line and dot are superimposed as shown in the top line of Fig. 11. The line is analogous to the circle in the dot-circle system. The line is generated by sweeping the beam, not by moving the beam at high frequencies over an area. Furthermore, the position of the dot relative to the line is such that no initial distinction exists between the two patterns. Instead of an initially positive signal when the larger pattern reads the smaller, the output signal first goes negative and then positive, as the beam creates a larger positive area by continuing to sweep the area.

Such a system results in delay before the signal reaches its peak in the positive direction. A weak signal is obtained because the line only affects the interesting region around the dot in one dimension. There is not as large a change in plateau area as in the circle-dot system. Furthermore, the sweeping line does not cause this change in area to take place as rapidly as with the circle-dot system.

Greater accuracy or repeatability is required of the dot-line deflection system than for the dot-circle method. The exact location of the circle relative to the dot is not as critical as the line to the dot. The dot-line system has simplicity to recommend it.

### B. Dot-Wiggle System

An alternate dot-line system, line (b) in Fig. 11, was tested. The dot was produced in the usual fashion, but

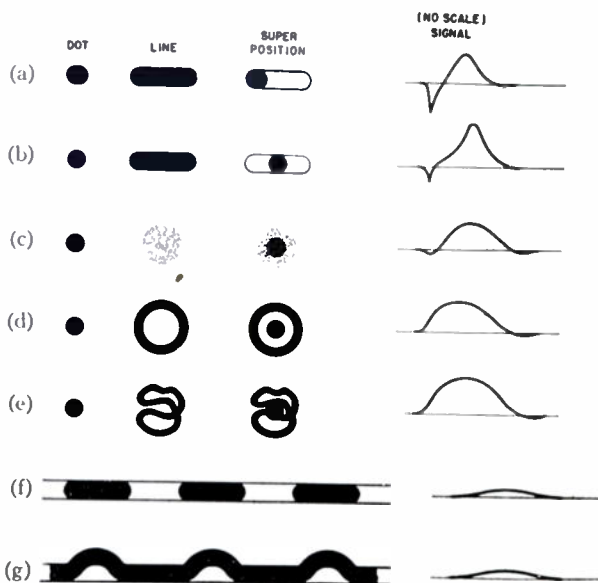

Fig. 11—Electrostatic storage systems. (a) Dot-line. (b) Dot-wiggle. (c) Dot-blur. (d) Dot-circle. (e) General system. (f) Broken-line. (g) Deflection.



the line was produced by superimposing a small, high-frequency signal on one of the deflection plates. This permitted a symmetrical superposition of the line on top of the dot rather than the one used in the first system described. It was believed that in this way the negative kick which precedes the signal obtained in the first system might be reduced and that the tolerance on the return of the deflection system in one dimension would be improved. The results of experimentation, however, indicated that the behavior of the dot-wiggle system was not, in general, greatly different from the dot-line system.

This can be understood if the system is considered as having the virtues of the dot-circle system in one dimension, but the disadvantages of the dot-line system in the other dimension. The conclusion, therefore, was that the dot-wiggle system appeared to have fewer virtues than the dot-circle system and was not appreciably simpler.

#### C. *Dot-Blur System*

A third system, line (c) in Fig. 11 which used a dot-blur pattern, was tested. The dot was created in the same manner as before, but a larger dot or blur was created around the dot by shifting the potential on the focus electrode. It was found that the focus electrode could be shifted either up or down to produce the defocusing. For certain types of guns this system was about as effective as the dot-circle system. However, for many of the types of guns which are presently used in cathode-ray tubes, the defocusing operation could not be done accurately. The focused dot did not always have the defocused area centered on it, and the edges of the defocused area did not always remain sharp. These defects pertain to the so-called Type "A" gun and make the dot-blur system inferior to the dot-circle system. It does retain the advantages of a large signal output and insensitivity to any minor inaccuracies in the return of the deflection system.

#### D. *Dot-Circle System*

Line (d) of Fig. 11 shows the dot-circle system already discussed. Larger signals are obtained in the dot-circle system than in any others tested because of the large ratio of the circle area to the dot area. The system still permits nearly as many spots to be stored in a given area as in the systems having the best space efficiency. The dot-circle system eliminates the initial negative kicks obtained with the line systems. This also contributes to a larger output signal and allows sampling to take place sooner and with greater time tolerance, resulting in an over-all faster system. The method is less sensitive to defects in the phosphor or signal plate because the beam is not swept. Any screen imperfections may affect the amplitude of the signal but not the shape. In particular, the critical initial portion of the signal is not changed by any screen imperfections. The dot-circle pattern allows greater inaccuracies in the deflection circuits when returning to read a spot than in

some other systems. The "time delay" associated with the dot-line system is absent, since the time needed to sweep the line is eliminated.

#### E. *General Shapes*

Line (e) of Fig. 11 shows some general shapes used. The results were more or less similar to those obtained with the dot and the circle. While the results of the dot-circle system seem to be a little better, tests for the general systems show that the exactness of the shape of the circle is not of critical importance. The advantage of high-frequency method of producing a circle is the relative simplicity of the standard equipment required to do it. The high frequencies can be superimposed on the deflection systems through small capacitors which do not otherwise interfere with the operation.

A final advantage to the high-frequency method is that the tube is used with the beam focused to a sharp spot in the manner in which it was intended. If later changes are made in gun design which affect the manner of focusing, the sensitivity of the focused element, or the manner in which the focusing is done, such changes will not affect the operation of the system as a whole. The circle-dot system is based upon the principle that the beam is always focused and the deflection system produces the various shapes.

#### F. *Broken-Line System*

Line (f) of Fig. 11 shows an early system first tried at the Moore School, University of Pennsylvania, before the work was undertaken at the Eckert-Mauchly Computer Corporation. This method, while giving a usable result, was not too satisfactory. Redistribution ratios of the order of 3 or 4 were about all that could be obtained for reasonable spacings. The dot-circle system for similar spacings gave redistribution ratios of many thousand.

#### G. *Deflection System*

Line (g) shows a deflection system used in radar. It is a variation of the system in line (f). The principle of operation is roughly the same as the broken line, and the defects that it suffers are of the same type, with slight improvement. Both systems, lines (f) and (g), require space at the beginning and end of each line for turning the beam on and off. This space is wasted, as is the time required for the starting and stopping operations.

The two deflection systems, lines (f) and (g), are suitable in a serial computer where they could be used to replace the mercury delay-line memory. Although the output signals are somewhat lower than other systems, the scanning rate can be three or four times faster.

Because both systems have low redistribution ratios they would not be suitable for a parallel computer. Since the parallel system requires the beam to return arbitrarily to any spot, the space at the beginning of each line would have to be allowed at each spot. This would

reduce the efficiency of the storage by as much as one half to two thirds.

### III. DESCRIPTION OF EXPERIMENTS AND RESULTS

This section describes the experiments and tests performed in the study of an electrostatic memory tube, giving the results and conclusions of each.

#### A. Phosphors Versus Voltage

The characteristics of the output signal of a cathode-ray tube used as an electrostatic memory are dependent upon the type of phosphor used. The secondary emission ratio varies with the type of phosphor and with the accelerating voltage. When using a cathode-ray tube for a memory, it is desirable to obtain the maximum number of spots on the screen, that is, best definition. Definition is improved by higher accelerating voltages; however, higher voltages decrease the secondary emission ratio, thus producing a drop in the output signal. The first problem, then, is to investigate the variation of output signal as a function of phosphor and accelerating voltage.

Four spots were placed on the screen at wide spacing so that the effects of redistribution were negligible. The writing sequence consisted of eight dots and then eight defocused dots, or blurs. Each spot was bombarded twice. The reason for the second return was to determine ease of erasure, which seems to be a function of the type of phosphor.

Readily available phosphors were checked. Specifically, these were P1, P2, P4, P5, P7 and P11. Since the object of these experiments was to obtain a cheap memory tube, none of the rarer phosphors was examined. Some of the untested phosphors are combinations of the available ones.

The accelerating voltage was varied from 200 to 10,000 volts. However, the complete range was not used on all phosphors because the output signals tended to drop off before reaching these limits. Fig. 12 shows a

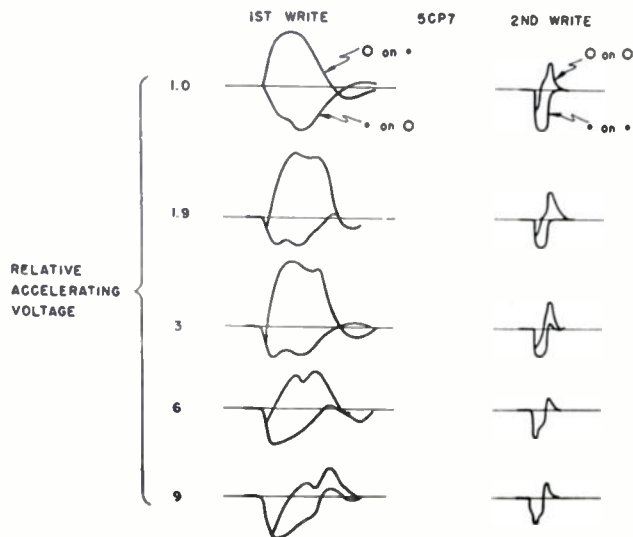

Fig. 12—Effect of accelerating voltage.

set of typical curves (First Write column) for the 5CP7 tube. The voltage values are relative.

The second column (Second Write) exhibits the erasure quality. A blur on a blur should produce a large negative pulse output. If the spot has not been thoroughly erased, a small negative pip, followed by a small positive pulse, occurs. At the lower voltages erasure is poor, while erasure becomes complete at higher voltages. Erasure is a function of other variables as well and is discussed later.

Table I shows the relative amplitudes of the output signals for various phosphors. The data were taken from curves similar to those in Fig. 12. The P1 phosphor is the best for a memory tube since it has high output signal at high accelerating voltages, good erasure,

TABLE I\*

| Accelerating Voltage | Phosphor |    |    |    |    |     |
|----------------------|----------|----|----|----|----|-----|
|                      | P1       | P2 | P4 | P5 | P7 | P11 |
| 200                  |          | 13 |    |    |    | 9   |
| 500                  | 14       | 22 | 14 |    | 20 | 19  |
| 950                  | 20       | 23 | 15 | 25 | 20 | 22  |
| 1,500                | 21       | 17 | 13 | 26 | 21 | 21  |
| 3,000                | 22       | 10 | 12 | 20 | 18 | 16  |
| 4,500                | 19       | 2  | 8  | 17 | 7  | 13  |
| 7,500                | 15       |    | 4  | 4  |    | 8   |
| 10,500               | 15       |    |    |    |    | 4   |

\* Units are relative output divisions.

low cost, and is very dense and free of holes and granular irregularities. The remaining experiments were made with P1 phosphor exclusively. The fine structure of P1 stems from the fact that the particles are ground—a procedure not as practical with many other phosphors due to the small allowable impurity content (of the order of 1/1000 of 1 per cent in these others, as compared to 1 per cent for P1).

#### B. Gun Structure

A number of different 5CP1 tubes were used in these experiments. Each gave results identical with the others. However, a 5CP1A was also tested, and it gave completely different results. The only difference between the two tube types was the gun structure. The 5CP1 uses a "triode" gun while the 5CP1A has the newer Type "A" gun. The "A" gun was designed to give less focus electrode current and better focusing. This feature, desirable for oscilloscopic purposes, is undesirable when it is necessary to produce a blur by defocusing. As a result, the 5CP1A compared poorly with the 5CP1 on output signal for dot-blur writing. The visual effect is shown in Fig. 13. Defocusing is accompanied by off-center deflection with the "A"-type gun as well as blurring of the edges.



Fig. 13—Triode versus "A" gun.

It was for the purpose of obtaining good results from the "A" gun that the circle-dot method was developed. As mentioned before, this method has the beam focused at all times but the large area figure is made by whirling the beam around a circular pattern. Thus, the focusing action of the "A"-type gun is not disturbed. Both methods were successful with the "triode" gun. Fig. 14 shows typical wave forms.

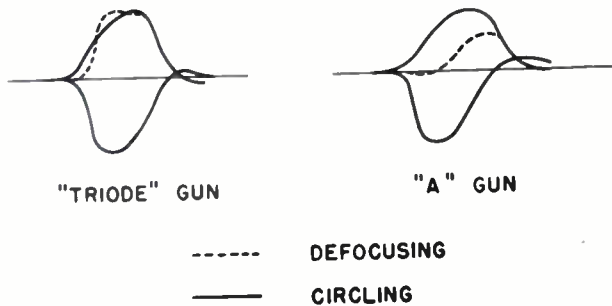

Fig. 14—Output waveshapes, defocusing vs. circling on triode and "A" gun.

The "A" gun was difficult to focus sharply over the entire area of the tube until an astigmatism control was added. This control provided a means for making the average potential of the deflecting plates equal to the potential of the second anode. Setting this control proved to be about ten times more critical with the "A" gun than with the "triode" gun.

### C. Tube Diameter

Intuitively, it might seem that memory capacity would be greatly increased by using a larger tube. A seven-inch tube should be able to store twice as many spots as the five-inch tube because the area of the former is nearly twice that of the latter. Upon examination, however, other factors which are not immediately apparent tend to deny this theory. Such factors as maximum deflection angle and increased spreading of the beam with distance tend to diminish the advantage of the seven-inch tube over the five-inch tube. Theoretically, for the same accelerating voltage and gun, and neglecting space charge and redistribution, the number of spots should not change with tube size. Actually, redistribution does not scale up proportionately as do other factors and, therefore, the larger tubes have some advantage over the smaller ones. Redistribution distances are changed but little and thus do not scale since the velocities of secondaries and the local field are not changed at the end of the tube.

The space efficiency for various diameter tubes was determined by operating each tube as a memory with 256 spots. The spot spacing in both the vertical and horizontal directions was decreased until the first detectable decrease in output signal was discovered (approximately 5 per cent).<sup>1</sup> This defines the limiting con-

<sup>1</sup> The spot spacing data are based upon two assumptions: (1) that a 5 per cent to 10 per cent decrease in output due to interference is tolerable; and (2) that the area for 256 spots can be used as a basis for extrapolating to the full tube area. Both assumptions must be examined more completely.

ditions caused by redistribution. The number of spots per unit area under these conditions is a measure of the space efficiency.

The space efficiency, however, can be influenced by the manner of deflection. Purely serial operations, as in television scanning, give the greatest space efficiency. The present methods were concerned with completely parallel operation in which a number of readbacks were made on one particular spot. Comparative data on this test are tabulated in Table II.

TABLE II

| Tube Diameter | Spots/In. <sup>2</sup> | Approximate Area (In. <sup>2</sup> ) | Extrapolated Total Spots Possible | Approximate Space Efficiency Relative to 3" Tube | Actual Increase in Spots |
|---------------|------------------------|--------------------------------------|-----------------------------------|--|--------------------------|
| 3"            | 320                    | 4.5                                  | 1,440                             | 100%   | —                        |
| 5"            | 141                    | 12.5                                 | 1,762                             | 44%  | 23%                      |
| 7"            | 102                    | 24.5                                 | 2,499                             | 32%  | 73%                      |

Although the space efficiency drops as the diameter is increased, there is an increase in the total number of spots. This indicates that the area changes faster than the effects of redistribution and defocusing.

### D. Effects of Accelerating Voltage on Signal Output, Redistribution, and Definition

The acceleration voltage plays an important role in the memory tube if a large number of spots are to be placed on the tube. Its lower limit is set by definition and secondary emission ratio, while its upper limit is set by insulation breakdown, secondary emission ratio, and decreased deflection sensitivity. The effect of an accelerating potential on secondary emission has been discussed previously. Definition, or sharpness of focus, improves with higher accelerating voltages because the velocity components perpendicular to the electron beam are made smaller compared to the main component which is directed toward the screen. Improved gun structures may correct this fault; for the present, higher voltage is the answer.

Memory tubes for computer work should provide a large number of readouts on one particular spot without causing loss of memory in nearby areas, that is, high redistribution ratios. Redistribution is not a linear function of readbacks, nor is it a linear function of the distance between spots. Redistribution changes extremely rapidly when the spot spacing is varied from one to two spot diameters; but it changes very little beyond that distance, indicating that the sprayed electrons have a sphere of influence with an abrupt boundary.

The magnitude of these effects was made the subject of an experiment. The variables were acceleration voltage, number of readbacks on a particular spot, spot spacing, and tube diameter. An output signal was produced by placing 256 spots on the screen as alternate fields of circles and dots. The spots adjacent to a selected spot were observed while the selected spot was read a large

number of times. The spacing was decreased in both directions until the first signs of signal deterioration were observed. The vertical and horizontal spacings were controlled independently. It was found that the two spacings are not equal for optimum conditions but seem to be a function of direction of deflection. This procedure was repeated with different acceleration voltages, various readback rates, and different diameter tubes.

The results are given in Table III. With lower accelerating voltages less than half the number of spots can be obtained.

TABLE III\*

| Accelerating Voltage | 3,300 Volts |     |       | 1,900 Volts |      |       |
|----------------------|-------------|-----|-------|-------------|------|-------|
|                      | 0           | 256 | 1,024 | 0           | 256  | 1,024 |
| Readbacks            |             |     |       |             |      |       |
| Tube Diameter        |             |     |       |             |      |       |
| 3"                   | 570         | 518 | 496   | 220         | 173  | 173   |
| 5"                   | 227         | 183 | 175   | 99          | 64   | 55    |
| 7"                   | 192         | 146 | 146   | 92          | 69.2 | 61.4  |

\* Units: Spot / Inch<sup>2</sup>.

### E. Magnetic Fields

Some of the secondary electrons from the bombarded screen return to the screen, and some go to the post accelerator. Since the positive output signal is caused by the electrons leaving the surface of the screen, it is possible that the signal could be increased by a magnetic field which would direct the secondary electrons toward the post accelerator.

The presence of the magnetic field produced a slight increase in the output signal, but the pattern was distorted. The redistribution ratio, which should also improve, only showed a slight improvement.

Another scheme for improving the signal output is to pulse the post accelerator with a positive potential, thereby attracting most of the secondary electrons. This scheme interfered with the equilibrium action and required a definite time out for pulsing. Neither of these methods seemed desirable since the improvement noted was so slight.

### F. Erase Time Study

Erase, writing, and reading represent the same operation in this electrostatic type memory tube. The beam erases what is already there and writes its latest shape each time the spot is read. Considerable interest is focused on the problem of determining the length of time the beam should stay on each spot. This time directly affects the basic repetition rate of the associated equipment and also determines the amount of redistribution on those neighboring spots within the sphere of influence. The results of these experiments seem to indicate that the beam should be kept on a spot until it has reached its equilibrium potential. This guarantees full output the next time the spot is called upon. The time required for a spot to reach full charge is a complicated

function of beam current, phosphor characteristics, accelerating voltage, spot diameter, time, and capacitance to surrounding areas.

It so happens that all the factors except time have been chosen on the basis of other considerations. Determination of erasure time can be made experimentally by observing the output signal while placing alternate frames of circles and dots on the screen, returning to each spot twice. The cathode-ray-tube grid unblank time can be lengthened until further increase produces no additional increase in signal amplitude. Fig. 15 shows the results of this test.

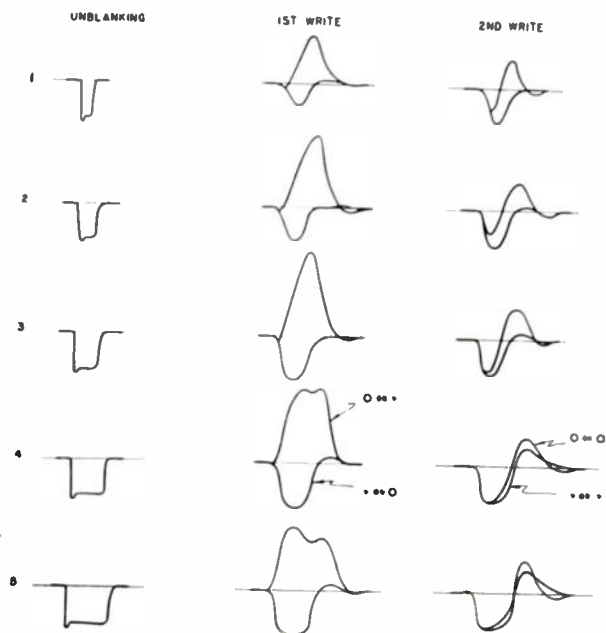

Fig. 15—Effect of length of writing period on output signal and erasure.

The experiment has been carried out with cathode-ray-tube grid wave forms which were steep compared to the rise time of the signal. It was expected that the signal amplitude would be related to the grid rise time since the output signal is obtained through the capacitively coupled signal plate. Apparently the coupling network time constant was long compared to the grid rise time because the only effect of this variation was an output signal delayed by the amount of the rise time. Obviously, if the grid-voltage rise time is made long enough, the poor low-frequency response of the signal-plate coupling network and amplifier will limit the signal. The effect of long cathode-ray-tube grid-voltage rise time is to slow down the memory. A compensating effect is the smaller amplifier necessary to drive the grid. A compromise between the two opposing factors must be reached. (0.2 to 0.25 microsecond rise was chosen.)

### G. Effect of Cathode-Ray Grid Voltage

Normally the grid voltage is at cutoff. When the deflection voltages have reached full amplitude, a positive signal is applied to the grid to turn the beam on. Complete cutoff (about  $-150$  volts at  $+3,000$  acceleration

voltage) is necessary until this time in order to prevent a faint beam from trailing across the screen. Electronic cutoff appeared in all cases coincident with visual cutoff.

Beam current in the tube is a function of grid voltage and hence affects the writing time. Therefore, a study was made of the effects of grid voltage variation. If the grid voltage is too low, the writing is poor and a small output signal is obtained. Conversely, if the grid voltage is too high, the positive signal output is decreased and redistribution is increased. The grid can be adjusted to optimum condition by observing the output signals. A typical test is shown in Fig. 16.

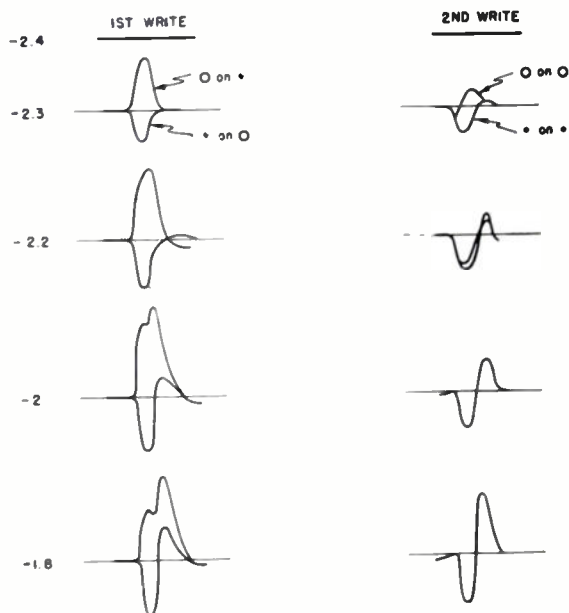

Fig. 16—Effect of grid voltage on output signal.

When used as a memory, a cathode-ray tube is operated at a higher negative bias than that normally used for good visual output. Fortunately, spot defocusing is small under these conditions. The grid bias must be accurate to within 5 volts if no change in output signal is to occur. This fact must be taken into account if direct-current restorers are used in the grid circuit.

## II. Input Circuit Design

The design of the input circuit and amplifier requires a knowledge of the frequency components present in the signal. In general, the time constant of the network should be lower than the rise time of the signal (between 0.2 and 0.4 microsecond) if the true wave shape is to be preserved. The signal-plate load resistance  $R_L$  should be computed so as to discharge the stray shunt capacity  $C_S$  which exists between signal plate and ground. If  $R_L$  is made too large,  $C_S$  will not be discharged completely before moving to another spot, resulting in loss of signal. If  $R_L$  is made too small, differentiation takes place through the signal plate to spot capacitance and  $R_L$ , resulting in a small, sharp output signal. The best compromise seems to be a  $R_L \cdot C_S$  time constant less than twice the memory repetition time. Inductive compensation can improve this condition.

With a value of  $R_L = 10K$  ohms, properly shunt compensated, a useful output of 5 to 15 millivolts is obtainable.

A method suggested for increasing the speed of the memory requires that the pickup plate be moved away from the screen in order to decrease the spot capacity. This scheme was tried and there was no significant or detectable increase at 3/16 inch. The amplitude remained practically constant. The fallacy lies in the fact that the capacity from collector to a spot does not change too much as the plate is moved away. Although the distance increases from the spot to the plate, the solid angle stays about the same due to the large diameter of the collector thus preventing the capacity from changing appreciably.

## I. Leakage Tests

Memory is possible only if the spots can hold their charge for a significant length of time. The factors which shorten the memory time of a spot are leakage and redistribution, the latter having been treated earlier. How much each factor contributes is a question which must be answered since it determines how often a spot must be regenerated.

The order of magnitude of leakage was determined by writing a line of dashes on the screen and moving the beam to another portion of the screen for an interval of time, and then reading back on the original line to produce an output signal. Any change in output signal with variation in length of interval indicates leakage. Observations were made at intervals of time up to 1/12 second, and no indications of leakage were evident. Longer intervals even up to several seconds showed only small changes and were therefore permissible. It would seem reasonable, therefore (if redistribution effects are negligible), to regenerate each spot every 100 milliseconds or less. Allowing 2 microseconds operating time for each spot, this requirement matches well with the timing of associated equipment.

## J. Transients

The interval between regenerations, that is, frame time, is influenced by the transients of the line supply. Such transients shift the beam by affecting the deflection and second anode voltage. For a given frame time, only a certain maximum rate of shift can be tolerated. If the displacement during each frame time is kept small (for example, less than 1/10 a spot diameter), the whole pattern can move slowly and still permit successful operation.

By making the power supply time constant longer than the regeneration interval, the voltages will change more slowly than the frame rate.

Under actual test, screen patterns jumped as much as  $\frac{3}{8}$  inch with line surges without affecting the memory pattern. It becomes difficult to provide the power supplies for larger memories with a long time constant, therefore shorter frame times improve the situation.

IV. THEORY OF OPERATION

A simple block diagram of the test equipment is shown in Fig. 17. The position of the beam is determined by the deflecting circuit which in turn is con-

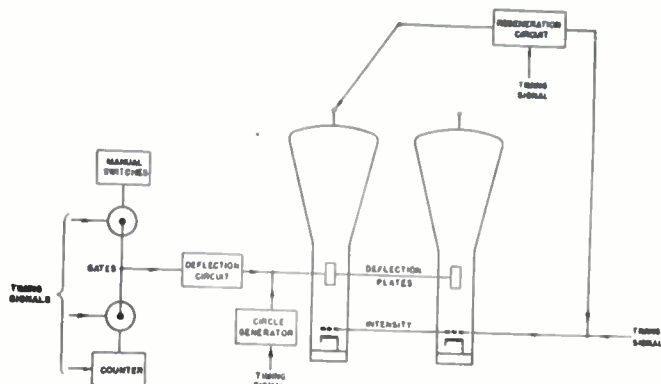

Fig. 17—Block diagram of test equipment.

trolled either by the manual switches or the counter. A spot or a circle can appear at any position depending upon the deflection signals and whether the circle generator is off or on. The signal picked up at the face of the tube is fed into the regeneration circuit. The beam is turned off and on by the timing signal and the output of the regeneration circuit.

The regenerative action is explained with the aid of the timing diagram, Fig. 18. In the diagram, the number 010011 is used as an example and the wave forms in various parts of the system are shown. The unblanking signal which controls the circle generator as well as the cathode-ray-tube beam produces a circle at the chosen area for the first half of each cycle. This circling produces the wave forms shown in the third line, depending upon whether a circle or dot had been the last previous form in that area. If a positive signal is obtained, it gates a clock pulse which sets the dot flip-flop. The flip-flop holds the beam on after the circle generator is turned off. The dot, or one, is thereby regenerated at that position.

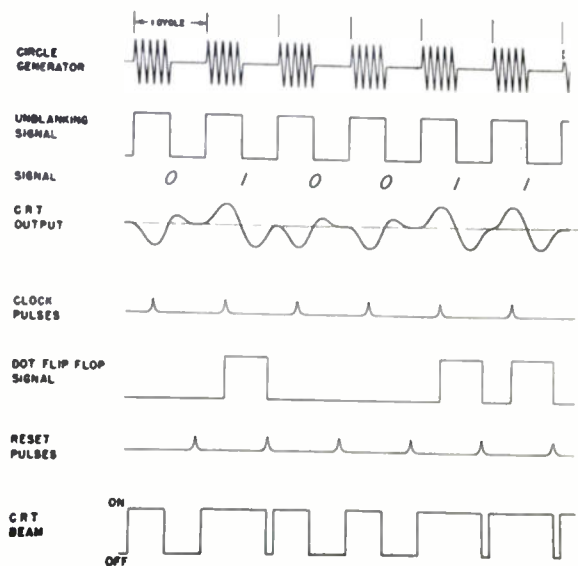

Fig. 18—Timing diagram of test equipment.

When the cathode-ray-tube output signal goes negative, the flip-flop is not set. The beam, therefore, goes off at the same time as the circle generator, leaving a circle on top of the original circle, thus regenerating the zero.

A. Regeneration Circuit

Extremely high computing speeds can be obtained by a parallel system consisting of several memory tubes. Each tube would have its own regeneration circuit but would be connected to a common deflection circuit. One of the binary digits of each stored word would be stored in each tube. A word could be selected in two to three microseconds and all of the digits would be presented simultaneously.

A detailed block diagram of the regeneration circuit is shown in Fig. 19. Clock gates, flip-flop, and unblanking signal have already been discussed in connection with the timing diagram, Fig. 18. Information is re-

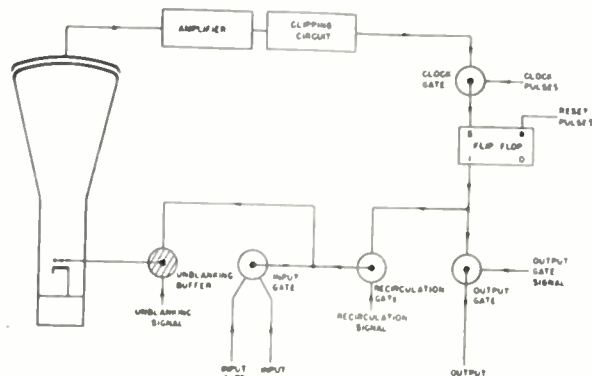

Fig. 19—Regeneration system.

moved from or inserted into the memory through the three gates in the lower right section of the diagram. For example, to put a dot (1) in any memory location, the input signal and the input gating signal are applied simultaneously to the input gate at the proper time. The output of this gate keeps the beam on after the circle generator has been turned off, thus putting a dot charge distribution on the tube.

The recirculation signal line normally permits signals to pass through the gate. To put a zero in any memory location, the recirculation gate must be blocked by a signal of the opposite polarity at the proper time.

Finally, to read out any stored signal, the output gate is opened and the signal appears on the output line. Obviously, reading out a signal does not of itself remove it from the memory. However, when such action is desired, information in the memory can be read out and simultaneously new information can be inserted by applying signals to all three gates.

B. Clipping Considerations

This memory system is based on the two different output signals obtained from the two charge distributions. For reliable operation the difference between the two signals must be well defined under all operating conditions.

For example, a positive signal gates a clock pulse. If the base line of the signal should shift, the circuit would pick up extra pulses or omit desired pulses. In other words, for best operation there should be no direct-current component in the signal at the point where it is sampled, that is, the clipping circuit.

Since the signal is obtained from an insulated plate, it originally contains no direct-current. Therefore, it is sufficient to maintain this condition through the amplifier and clipping circuit. To insure this condition, grid current must not flow in the amplifier.

The clipper uses the circuit of Fig. 20.  $R_1$  can be connected to some negative voltage which puts the second grid of the tube below cutoff. Then in the quiescent condition the upper diode draws current. Any positive pulse greater than the threshold value can turn on the gate. The threshold can be varied by changing the voltage to which  $R_1$  is returned. Since the circuit must distinguish between positive and negative signals,

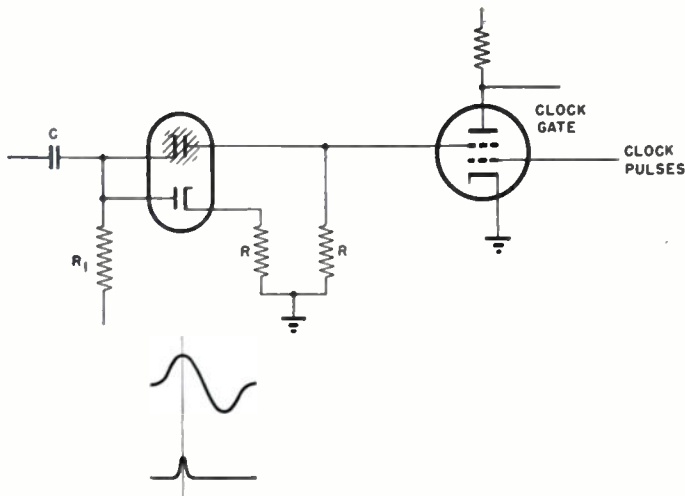

Fig. 20—Clipping circuit.

clipping action could also be obtained when the quiescent position of the second grid is zero or some positive voltage. Under these conditions, the negative signal must be enough to pull the grid down to cutoff and a positive signal to have no appreciable effect. In the laboratory model of the regeneration circuit, the threshold voltage was varied over a wide range to test the reliability of the circuit as well as to check the correctness of the chosen clipping level.

The output of the lower diode of the clipping circuit is used only to balance the impedance of the clipper as the instantaneous voltage changes. This prevents a change of charge on condenser  $C$  thus avoiding the base line shift discussed above.

### C. Deflection

Basically, for the purpose of this paper, a deflection circuit is a device which generates a voltage proportional to a number which is received in coded form. There are a number of different circuits which have this property, and each can be varied in a number of ways. The deflection circuit actually used in the laboratory model is shown in Fig. 21. Any spot position corresponds

to a particular combination of switching tubes turned off. These in turn operate the deflection tubes. The current through all conducting deflection tubes is equal. Therefore, each contributes voltage to the output which is proportional to its share of the anode load. The resistors shown in series with the plates of the upper deflection tubes are not logically necessary. They equalize as much as possible the plate voltage of all stages. The regulator tubes are part of the circuit which maintains constant current in each conducting deflection tube.

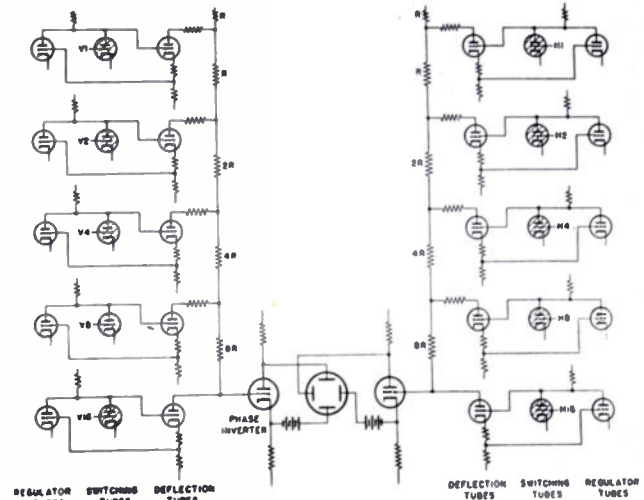

Fig. 21—Deflection circuit of test equipment.

## V. REGENERATION CONSIDERATION FOR A MEMORY SYSTEM

There are several different methods of regenerating an electrostatic memory system. These methods consider the timing and number of wires over which the regeneration occurs within a system or group of tubes. While there may be specific exceptions, a digital memory consists of a group of cathode-ray tubes. It is the presence of the group, rather than a single tube, which gives rise to the great variety of multiplexing or timing schemes and the different types of regeneration systems which may be used.

### A. Parallel System

The parallel system is probably the simplest system logically. Section IV of this paper dealt with an element of a parallel system. It is the fastest system and therefore, from the point of view of technique, may be considered the most highly developed system. It is not the simplest system from the standpoint of the amount of apparatus required, and it may be ruled out in a practical computing system where simplicity is more important than high speed.

If there are 50 of these systems, each can transmit and receive its information simultaneously from 50 independent circuits. These 50 circuits might correspond to 50 binary digits in an electronic digital computer. If the computer is decimal rather than binary, these digits would be considered in groups of four or five in order to make up the decimal digits. In the basic pattern of operation, the deflection circuits of all the cathode-ray

tubes in the system are tied to a set of common deflecting busses which would direct all the beams into the same region of the screen simultaneously.

The operation of such a system would be as follows. After deflecting the beams to the proper point in each tube, only one reading or writing operation is needed by the whole register. Such a system gives the ultimate in speed of operation because it uses multiple channels for transmitting all the intelligence at one time.

#### B. Regeneration Patterns in Parallel System

The fundamental limit on the speed of operation in a given channel is the cathode-ray tube phenomenon and not the amplifier and associated circuitry. A regeneration pattern must be used in the tube which allows a fairly good redistribution ratio in order to make the operation of a parallel system practical.

Assume that a cathode-ray tube contains approximately 1,000 spots which are regenerated in cycles consisting of two intervals. During the first cycle, any arbitrary spot is read and regenerated; during the second interval, one of the other spots on the tube is regenerated as part of a regular systematic regeneration procedure. In such a system, the condition of most interest would be that in which the same spot is read during all the arbitrary reading periods over a complete regeneration cycle without losing the spot next to the arbitrary spot through redistribution.

A condition exists in which the redistribution ratio must be at least 1,000 in order to have satisfactory operation of the memory. This pattern of regeneration utilizes 50 per cent of the operating time for the purpose of regeneration. In an actual computer, other operations may take place during the regeneration time.

#### C. Serial Operation

The serial system for regenerating memory tubes operates in a manner analogous to a regenerated mercury memory. From the point of view of the quantity of apparatus, the serial system uses about the simplest system. The apparatus setup for the serial system is like that in the parallel system except that it is a memory consisting of one tube. If there are more tubes, they are independently selected at different times.

In a simple serial system, the reading progresses systematically along the spots of the tube, starting, for example, in the upper left-hand corner of the spot pattern and counting along the spots of successive rows to the end of the pattern and then back to the beginning again. This is equivalent to the systematic regeneration cycle of a single channel of the parallel system. If it is desired to put in or take out a particular number, it is necessary to wait until this number is passing through the regenerating circuit and, at that time, the number is read out and the new number is read in.

Since the scanning process involved in this case is a purely systematic one and does not require any arbitrary steps from one point to another, the relatively elaborate jump-sweep system is replaced by the simple

step-charger system. Except for the fact that it produces small potential plateaus as steps, it is like a raster, similar to that used in television.

#### D. Serial Line System

A variation of the serial system, which we shall call the serial line system, is the one used by Williams. That system uses a perfectly systematic horizontal sweep with a step pattern. The vertical sweep, however, is a controlled sweep mentioned in connection with the parallel system. The serial line system uses a systematic scanning like the parallel scanning except that the element, instead of being considered a particular spot on the tube, is considered to be a particular line on the cathode-ray tube. For example, a  $32 \times 32$  array may be considered as 32 packages of 32 spots each—each line being taken as a package.

The mode of operation in this type of memory is such that one line is read systematically—say line 1. Then an arbitrary line is chosen. Then line 2 is read, and then some other arbitrary line is read; then line 3 is read, and so forth. In general, it is simply an extension of the separate spot principle into separate lines.

#### ACKNOWLEDGMENT

The authors wish to extend thanks to the various persons who have contributed to the preparation of this paper. In particular, they wish to express appreciation to C. Bradford Sheppard, of the engineering staff, who supplied some experimental results which were obtained during the early period of the electrostatic memory experiments; and to Joseph D. Chapline, Jr., for editorial assistance in the preparation of the manuscript.

#### BIBLIOGRAPHY

1. EDVAC Report No. 2, ONR, OCO, and Army Ordnance (sections covering deflection circuits); June 30, 1946.
2. A. Haeff, "Memory tube," *Electronics*, vol. 20, pp. 80-93; September, 1947.
3. A. Haeff, "The Memory Tube and Its Applications to Electronic Computation," *Mathematical Tables and Other Aids to Computation*, vol. 3, pp. 281-296; October, 1948.
4. J. A. Rajchman, "Selectron," *Mathematical Tables and Other Aids to Computation*, vol. 2, pp. 359-361; October, 1947.
5. R. A. McConnell, "Video storage by secondary emission from simple mosaics," *PROC. I.R.E.*, vol. 35, pp. 1258-1264; November, 1947.
6. B. Chance, et al., "Waveforms," MIT Radiation Laboratory Series, vol. 19, McGraw-Hill Book Co., New York, N. Y., chap. 21; 1949.
7. V. K. Zworykin, "Iconoscopes and kinescopes in television," *RCA Rev.*, vol. 6, pp. 60-84; July, 1936.
8. V. K. Zworykin and G. A. Morton, "Television," John Wiley and Sons, Inc., New York, N. Y.; 1940.
9. I. G. Maloff and D. W. Epstein, "Electron Optics and Television," McGraw-Hill Book Co., New York, N. Y.; 1938.



# Diode Coincidence and Mixing Circuits in Digital Computers\*

TUNG CHANG CHEN†, ASSOCIATE, IRE

**Summary**—Basic circuits utilizing germanium diodes in electrically pulsed systems are described. The circuits are of the following types:

1. Coincidence circuits—output signal occurs only when all the inputs receive signals simultaneously.
2. Mixing circuits—output signal occurs when any one of the inputs receives a signal.

The analyses of transient response of the output signal and the input impedance are given.

## I. INTRODUCTION

COINCIDENCE and mixing circuits, also known as gates and buffer circuits, respectively, occur frequently in many electronic devices and play an important role in electronic digital computers. A coincidence circuit produces an output when, and only when, all inputs are energized simultaneously. A mixing circuit combines several inputs without interaction into one output which is responsive to any one of the inputs. These circuits may be formed by using multiple control-grid vacuum tubes, tubes in parallel, or diodes.

The circuits, which are to be described, using germanium diodes are not amplitude sensitive, that is, the circuit operations depend only upon the presence or absence of signals provided the amplitudes are kept within a predetermined range. This property is desirable in most electronic digital computers and other similar applications.

In the following analysis and discussion it is assumed that the diodes are ideal except under the conditions where their back resistances cannot be neglected.

## II. COINCIDENCE CIRCUIT

A basic coincidence circuit of  $n$  inputs for positive pulses is shown in Fig. 1. All the voltages shown are referred to ground. All the input pulses are assumed to be rectangular with the same duration and equal amplitude and will occur at the same instant when there is a coincidence. The supply voltages are adjusted so that:

$$E_1 > E_o > E_2, \quad (1)$$

and

$$I_1 > I. \quad (2)$$

When there is no signal at any of the inputs, the clamping diode  $X_c$  and all the coupling diodes  $X_1, X_2, \dots, X_n$  are conducting; hence,  $e_o$  equals  $E_o$ . When there is a

pulse appearing at one of the inputs, taking input 1 as an example,  $X_1$  is cut off. Since  $I_1$  is greater than  $I$  the

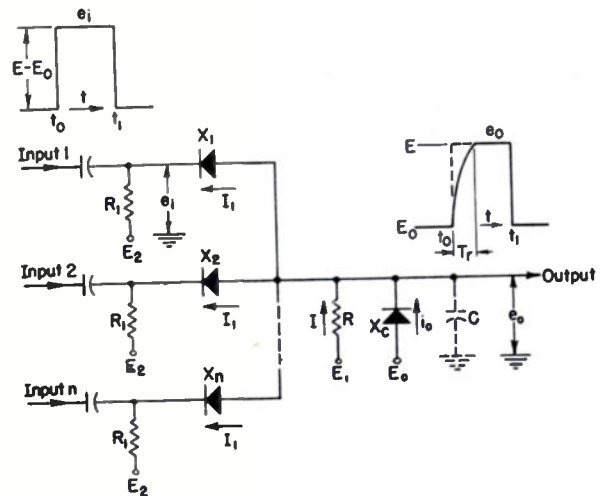

Fig. 1—Basic coincidence circuit for positive pulses.

clamping diode remains conducting, except when a coincidence of all the inputs occurs. With coincidence all the diodes are cut off and  $e_o$  rises exponentially with time constant  $RC$ , where  $C$  is the output capacitance including the capacitance of the diode  $X_c$ .

The rise time of the output pulse can be found to be:

$$T_r = RC \ln \frac{E_1 - E_o}{E_1 - E}. \quad (3)$$

If the voltage drop across  $R$  is large compared to the amplitude of the pulse, the rise time is approximately:

$$T_r = \frac{(E - E_o)C}{I}. \quad (4)$$

After the output voltage  $e_o$  has reached  $E$ , it follows the input voltage  $e_i$  exactly; because if  $e_o$  is greater than  $e_i$ , the clamping diode will begin to conduct. If the input pulses do not have the same duration and do not occur at the same instant, the output pulse only occurs in the overlapping part of all the input pulses and has an amplitude equal to the smallest of the inputs.

The purpose of using the clamping diode is threefold. First, it acts as a clamper or dc restorer to permit the use of capacitive coupling. Second, it keeps  $e_o$  constant, except when there is a coincidence, regardless of the number of inputs at which signals are present. If the clamping diode were not present, the maximum change in  $e_o$  in the absence of a coincidence would be:

$$\Delta e_o = \frac{R_1 E_1 + R E_2}{R_1 + R} - \frac{R_1 E_1 + n R E_2}{R_1 + n R} \quad (5)$$

\* Decimal classification: 621.375.2. Original manuscript received by the Institute, June 22, 1949; revised manuscript received, November 29, 1949.

† Formerly, Research Laboratory, Moore School of Electrical Engineering, University of Pennsylvania; now, Research Division, Burroughs Adding Machine Company, Philadelphia, Pa.

and this variation may have sufficient amplitude to give a false response when  $n$  is large. Third, the clamping diode eliminates leakage signals caused by the back resistance of the coupling diodes. The maximum leakage signal, which occurs when signals are applied to  $n-1$  inputs, is:

$$\Delta e_o' = \frac{(n-1)RR_1\Delta e_i}{(R+R_1)R_b + (n-1)RR_1} \quad (6)$$

for no clamping diode.  $R_b$  is the back resistance of a diode and  $\Delta e_i$  is the amplitude of the input pulses. With the clamping diode, the leakage signal will not occur until  $i_o$  becomes zero or:

$$\frac{(n-1)(E-E_o)}{R_b} = I_1 - I. \quad (7)$$

Under this condition the clamping diode is cut off. If the difference  $I_1 - I$  is large enough so that the clamping diode remains conducting for the highest pulse amplitude, no leakage will occur.

In the case where the total capacitances of the coupling diodes is comparable to the output capacitance, the output voltage changes abruptly to the value:

$$\frac{nC_x E}{C + nC_x}, \quad (8)$$

where  $C_x$  is the capacity of a coupling diode and the rise time is:

$$T_r' = (nC_x + C)R \ln \frac{E_1 - \frac{nC_x}{nC_x + C} E}{E_1 - E}. \quad (9)$$

If the voltage drop across  $R$  is large compared to the amplitude of the pulse, the rise time is approximately:

$$T_r' = \frac{CE}{I}. \quad (10)$$

Several types of input circuits are shown in Fig. 2 where the notations are identical with those used in Fig. 1. Input 1 is a capacitive coupled input. Inputs 2 and 3 are used for direct coupling which is sometimes necessary for gate signals of long durations. Input 2 should not be driven to a potential lower than  $E_o$  for then excessive current may exist in  $X_c$  and  $X_2$  in series, if the output impedance of the driving source is low. This limitation is avoided by the use of input 3, since diode  $X_3$  is cut off when the input voltage is less than  $E_o$ .

Input 4 is an inhibiting input. A coincidence of inputs, 1, 2, and 3 will give an output, except when a coinciding negative pulse is applied at input 4. Normally, diodes  $X_3$  and  $X_4$  are cut off and the presence of a negative pulse at the input makes the diode  $X_4$  conduct and inhibits the output. Diode  $X_3$  is merely used for clamping, while the series resistor  $R_2$  is used to limit the current through  $X_3$  and  $X_4$  during the negative pulse when the output impedance of the source is low.

It should be noted that if there is no signal existing at the inhibiting input for a considerable length of time the potential of point  $A$  is approximately midway between  $E$  and  $E_o$ , assuming the back resistance of diodes

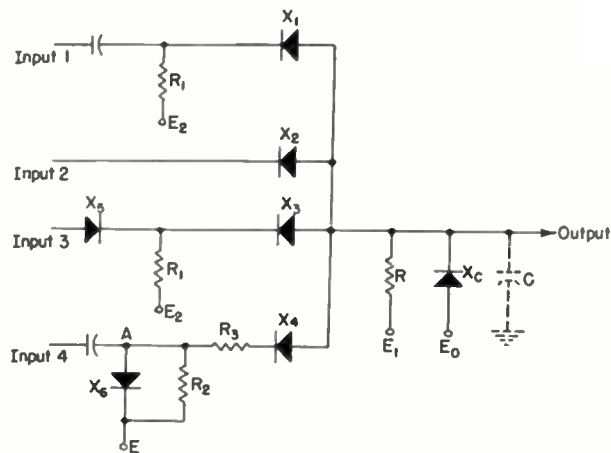

Fig. 2—Coincidence circuit for positive pulses with different types of inputs.

$X_4$  and  $X_3$  are equal and large compared to  $R_3$ . The output voltage, when it reaches the potential of point  $A$ , is affected by the output impedance of the inhibiting source. The shunt resistor  $R_2$ , having a resistance small compared to the back resistance of the crystal diode, maintains the potential of point  $A$  very close to  $E$  in the absence of inhibiting pulses.

Any combination of the inputs described above will form a coincidence circuit. The number of inputs is limited by the current capacity of the clamping diode  $X_c$ , since the current in the clamping diode, when no signal exists at any of the inputs, is:

$$i_o = (n-p)I_1 - I, \quad (11)$$

where  $n$  is the total number of inputs and  $p$  is the number of inhibiting inputs.

A coincidence circuit for negative pulses is identical with the one for positive pulses, except that all the diode connections are reversed and the relation of the various voltages is:

$$E_2 > E_o > E_1. \quad (12)$$

Positive pulses are required for the inhibiting inputs.

### III. MIXING CIRCUITS

A mixing circuit for positive pulses is shown in Fig. 3. The voltage  $E_2$  is negative with respect to  $E_o$  and all diodes are conducting in the absence of input pulses. The diodes  $X_2$ ,  $X_4$ , etc., are used for clamping. When a signal is applied to any one of the inputs, taking input 1 for example,  $X_2$  is cut off and  $X_1$  conducts more heavily. Other coupling diodes  $X_3$ , etc. are cut off when  $e_o$  rises above  $E_o$  and the output voltage  $e_o$  will follow the input voltage  $e_i$  exactly until time  $t_1$ . All the coupling diodes are cut off and  $e_o$  falls exponentially with time constant

RC. If the voltage drop across  $R_4$  is large compared to the amplitude of the pulse,  $I$  and  $C$  determine the fall time  $T_f$ . The number of inputs is limited by the required transient response of the driving source which sees a capacitance of  $C + (n-1)C_z$ , where  $C_z$  is the shunt capacitance of a diode.

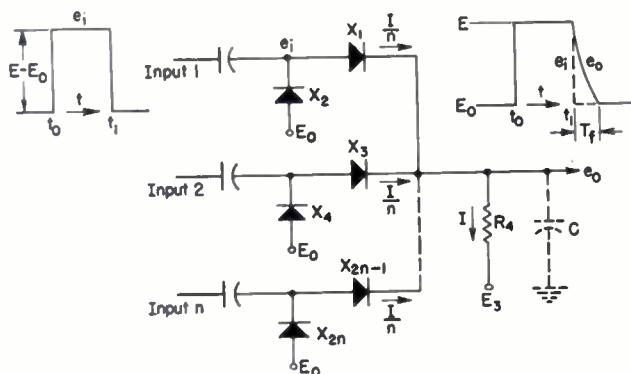
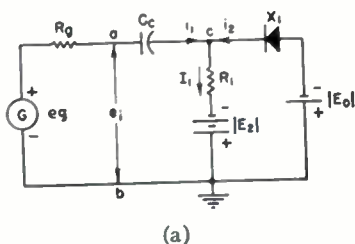

Fig. 3—Basic mixing circuit for positive pulses.

For direct-coupled input, the coupling capacitor and the clamping diode are omitted. When the inputs are a combination of direct- and capacitive-coupled inputs, it is desirable to shunt the clamping diodes with resistors having a low resistance compared to the back resistance of a diode for a similar reason as that described for the inhibiting input of a coincidence circuit.

IV. INPUT IMPEDANCE

The equivalent circuit of a driving source and one of the inputs of a coincidence circuit for positive pulses is shown in Fig. 4(a), where  $R_0$  is the internal resistance of the equivalent generator. It is assumed that the capaci-



(a)

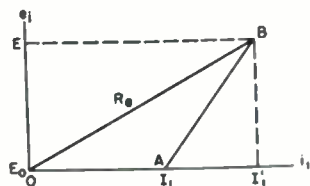

(b)

Fig. 4—(a) Equivalent input circuit of a coincidence circuit; (b) relation between input voltage and current.

tance of the coupling capacitor  $C_c$  is large so that the change in voltage across it is negligible during the pulse. For the quiescent state  $i_1$  is zero, and the potential at point  $c$  is  $E_0$ . When a pulse is generated by the source, both  $e_o$  and  $i_1$  are increasing. Since point  $c$  is clamped at  $E_0$ ,  $I_1$  remains constant and  $i_2$  decreases until  $X_1$  is cut off. The input resistance  $R_i$  across points  $a$  and

$b$  can be expressed by the function:

$$R_i = 0 \quad \text{for } 0 < i_1 < I_1$$

$$R_i = R_1 \quad \text{for } i_1 \geq I_1, \quad (13)$$

which is represented by the slopes of the broken line OAB in Fig. 4(b).

Letting  $e_i$  swing from  $E_0$  to  $E$ , the input resistance can be represented by an equivalent resistance  $R_e$  which will satisfy the conditions at the end points  $O$  and  $B$ . The equivalent resistance  $R_e$  can be written as:

$$R_e = \frac{E - E_0}{I_1'} = \frac{E - E_0}{E - E_2} R_1, \quad (14)$$

where  $R_e$  is a function of the amplitude of the pulse. Since the circuits are not amplitude sensitive, only the minimum pulse amplitude is to be considered. The equivalent input impedance is then a parallel combination of  $R_e$  and  $C_z$  which is the capacitance of crystal diode  $X_1$ . The back resistance of the diode is usually very large compared to  $R_e$  and can be neglected. The input impedance of a mixing circuit can be found in a similar way, and will not be repeated here.

V. APPLICATIONS

Coincidence circuits are commonly used for the following applications:

1. Reshaping of deteriorated pulses produced by the various components of electronic digital computers.
2. Selecting or inhibiting a certain one or groups of pulses from a pulse train.

Fig. 5 illustrates all the functions mentioned above. The pulse train at input 1 is reshaped by the standard

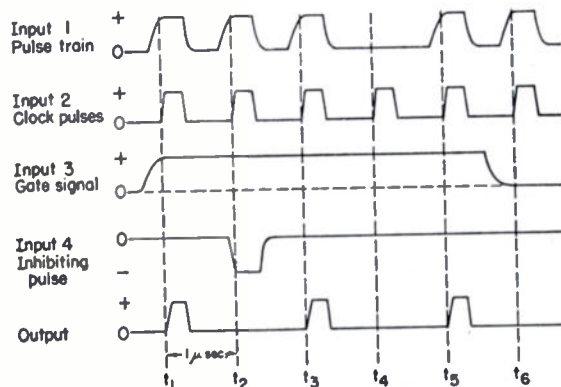

Fig. 5—Wave forms of a typical coincidence circuit for positive pulses.

timing or clock pulses at input 2 and a portion of the train is selected by the gate signal at input 3. The pulse at time  $t_2$  is deleted by the negative inhibiting pulse at input 4. Complete inhibition can be assured if the inhibiting pulse envelopes the clock pulse, regardless of the shape of pulses of the pulse train. These operations are accomplished by the use of one diode coincidence circuit, whereas many dual control-grid tubes and their associated components would be required if vacuum-tube circuits are employed.

Mixing circuits are used primarily for combining and isolating the outputs of several sources which may have different output impedances. The transient response of many vacuum tubes connected in parallel is greatly improved if they are isolated by a mixing circuit.

Since the diode coincidence and mixing circuits have negligible attenuation, they can be connected in tandem, provided that the output of the driving circuit is capable of sustaining the current required by the input of the driven circuit. These circuits have been extensively used in the EDVAC, an electronic digital computer developed at the Moore School of Electrical Engineering, University of Pennsylvania. In the EDVAC the diode coincidence and mixing circuits are designed for pulses of 0.3-microsecond duration at repetition rates as high as one megacycle with rise and fall times of 0.1 microsecond. These diode circuits can be designed to operate at pulse repetition rates of several megacycles and having rise and fall times of the order of 0.05 microsecond or less.

#### Discussion on

## “Stabilization of Simultaneous Equation Solvers”\*

G. A. KORN

**Lofti A. Zadeh:**<sup>1</sup> Dr. Korn's paper on “Stabilization of Simultaneous Equation Solvers” contains a few errors, possibly of a typographical origin, which distort the significance of his main result.

In the first place, equation (3) should read

$$\sum_{k=1}^n \left[ a_{ik} - \delta_{ik} \frac{(n+1)}{A} \right] x_k + b_i = 0,$$

and consequently (8) should be written as

$$\frac{n+1}{A(p)} = \lambda_i.$$

In the second place, Dr. Korn's assertion that the real parts of the  $\lambda_i$  never exceed unity, provided  $a_{ik}$  is positive definite and  $a_{ik} \leq 1$ , is incorrect. Actually, the real parts of the  $\lambda_i$  may be greater than unity, but the magnitudes of the  $\lambda_i$  will certainly be less than  $n+1$ .

Finally, in the statement of Dr. Korn's stability criterion (immediately following equation (10)),  $a$  should read  $|a|$  (magnitude of  $a$ ). In the corrected form the criterion loses much of its simplicity, since in order to ascertain whether the computer will be stable or not, it is necessary to vary not only the magnitude of  $a$  but also its phase.

A perfectly general and yet simple criterion for stability of a simultaneous equation solver can easily be obtained through the use of Nyquist's criterion. Thus, we can state that:

\* G. A. Korn, “Stabilization of simultaneous equation solvers,” *Proc. I.R.E.*, vol. 37, pp. 1000-1002; September, 1949.

<sup>1</sup> Columbia University, New York, N. Y.

#### ACKNOWLEDGMENT

The author is indebted to Samuel Lubkin for his contribution in the early stage of this development. The author also wishes to express his appreciation to R. E. Merwin, J. Chedaker, R. L. Snyder, G. W. Patterson, and H. J. Gray for their helpful criticisms of the manuscript.

#### BIBLIOGRAPHY

1. “Progress Report on The EDVAC,” University of Pennsylvania, Moore School of Electrical Engineering; June 30, 1946.
2. C. H. Page, “Digital computer switching circuits,” *Electronics*, vol. 21, pp. 110-118; September, 1948.
3. E. Baldinger, P. Huber, and K. P. Meyer, “High speed coincidence circuit used for multipliers,” *Rev. Sci. Instr.*, vol. 19, pp. 473-474; July, 1948.
4. C. F. West and J. E. DeTurk, “A digital computer for scientific applications,” *Proc. I.R.E.*, vol. 36, pp. 1452-1460; December, 1948.
5. T. K. Sharpless, “Design of mercury delay lines,” *Electronics*, vol. 20, pp. 134-138; November, 1947.
6. I. L. Auerbach, J. P. Eckert Jr., R. F. Shaw, and C. B. Shepard, “Mercury delay line memory using a pulse rate of several megacycles,” *Proc. I.R.E.*, vol. 37, pp. 855-861; August, 1949.
7. B. Chance, V. Hughes, E. F. MacNichol, D. Sayre, and F. C. Williams, “Waveforms,” p. 364; McGraw-Hill Book Co., New York, N. Y.; 1949.

A system of  $n$  equations

$$\sum_{k=1}^n a_{ik}x_k + b_i = 0$$

will have a stable solution if, and only if, the characteristic roots of  $a_{ik}$ , the  $\lambda_i$ , are such that the points  $(n+1)/\lambda_i$  are not enclosed by the Nyquist plot of  $A(p)$ .

In conjunction with the above criterion it is useful to note that when  $a_{ik}$  is positive definite and  $a_{ik} \leq 1$ , the points  $(n+1)/\lambda_i$  are located outside of the unit-circle in the right half of the complex plane.

**Granino A. Korn:**<sup>2</sup> The writer is grateful to Dr. L. Zadeh of Columbia University for his criticism of the paper on “Stabilization of Simultaneous Equation Solvers.”

With respect to Dr. Zadeh's first objection, it was considered fair enough to absorb the “mixing loss”  $1/n+1$  of the summing network into the gain  $A$  of the amplifier, so that equations (2) and (3) may be considered as correct. Under these circumstances the real parts of the  $\lambda_i$  will, indeed, be less than  $n+1$ , not one, and greater than zero.

In the statement of the stability criterion following equation (10),  $a$  should read  $|a|$  (typing error). The writer has, however, clearly stated below equation (10) that the phase as well as the magnitude of  $a$  must be varied. Dr. Zadeh's application of Nyquist's criterion is not self-evident but seems to be derived from the writer's equation (8).

<sup>2</sup> Curtiss-Wright Corporation, Columbus, Ohio.

# Annular Circuits for High-Power, Multiple-Tube, Radio-Frequency Generators at Very-High Frequencies and Ultra-High Frequencies\*

DONALD H. PREIST†, MEMBER, IRE

*Summary*—A new type of cavity suitable for excitation by a plurality of negative grid tubes in phase is described. In such a generator, which may be either an amplifier or an oscillator, the efficiency is independent of the number of tubes, and very large sizes are possible, limited only by the occurrence of unwarranted modes. This limit has not yet been reached in practice.

The upper frequency limit is the same as that for an individual tube in an optimum circuit. All forms of modulation may be used.

## I. INTRODUCTION

A CRITERION of effectiveness for a multiple-tube radio-frequency generator must take into account the following:

1. To what degree the multiple-tube generator with  $n$  tubes approaches the ideal result that the power output is  $n$  times that obtainable from a single tube, with the same efficiency as the single tube, at all frequencies up to the limiting frequency of the single tube, for all values of  $n$  greater than one.
2. To what degree the gain-bandwidth product of the generator, if an amplifier, approaches that for a single-tube amplifier.
3. To what degree the multiple-tube generator approaches the ideal as far as adjustment is concerned, namely, that the number of tuning controls and adjustments should be no greater than for a single-tube generator.
4. To what degree the operation of the multiple-tube generator deteriorates when one or more tubes fail. Presumably, the ideal generator would suffer a drop in output of  $1/n$ th for each tube failure without loss of efficiency, parasitic oscillations, or other undesirable results.
5. To what degree the characteristics of the tubes must approach uniformity.

Briefly, assessing the annular circuit on this basis, on the first count the ideal result has been obtained from every generator so far built; the largest number of tubes was fourteen.

The second property has not been measured completely to date, but may be deduced approximately as will be described.

The ideal adjustment condition is approached very closely.

The effects of tube failure are comparatively innocuous and closely approach the ideal.

\* Decimal classification: R355.912. Original manuscript received by the Institute, June 28, 1949; revised manuscript received, November 9, 1949. Presented, 1949 IRE National Convention, New York, N. Y., March 9, 1949.

† Eitel-McCullough, Inc., San Bruno, Calif.

Tubes picked at random have worked together satisfactorily in the generators so far built.

## II. THE NATURE OF THE ANNULAR CIRCUIT

Fig. 1 shows an annular transmission line compared with a coaxial line. The annular line has three elements; two are containing walls, connected electrically but separated mechanically, and the third is the "inner" or "live" conductor corresponding to the inner of the coaxial line.

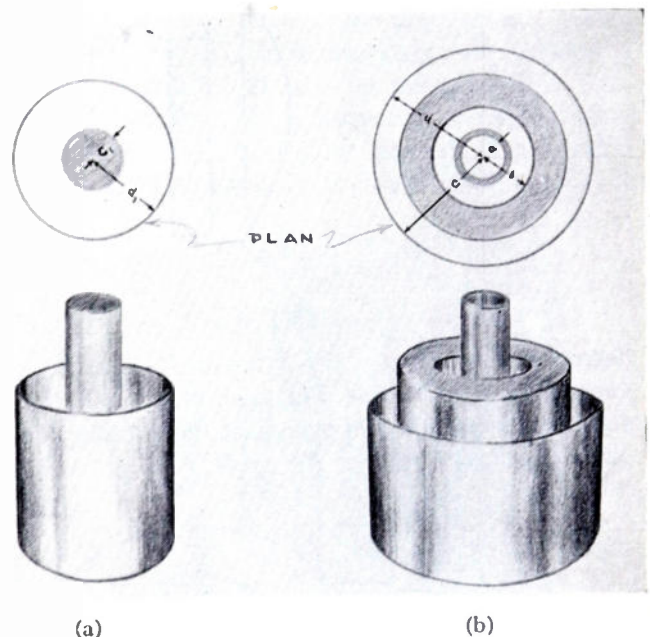

Fig. 1—(a) Coaxial line and (b) annular line.

The electrical properties of the annular line can be seen by inspection to be as follows:

$$Z_0 = \frac{1}{\frac{1}{138 \log \frac{b}{a}} + \frac{1}{138 \log \frac{d}{c}}}$$

for an air dielectric line, so that in the special case where

$$\frac{b}{a} = \frac{d}{c},$$

$$Z_0 = \frac{138}{2} \log \frac{b}{a}.$$

Thus the line is equivalent to two coaxial lines in parallel.

An interesting result of this in practice is that for a given minimum separation  $b-a$  or  $d-c$ , which is usually

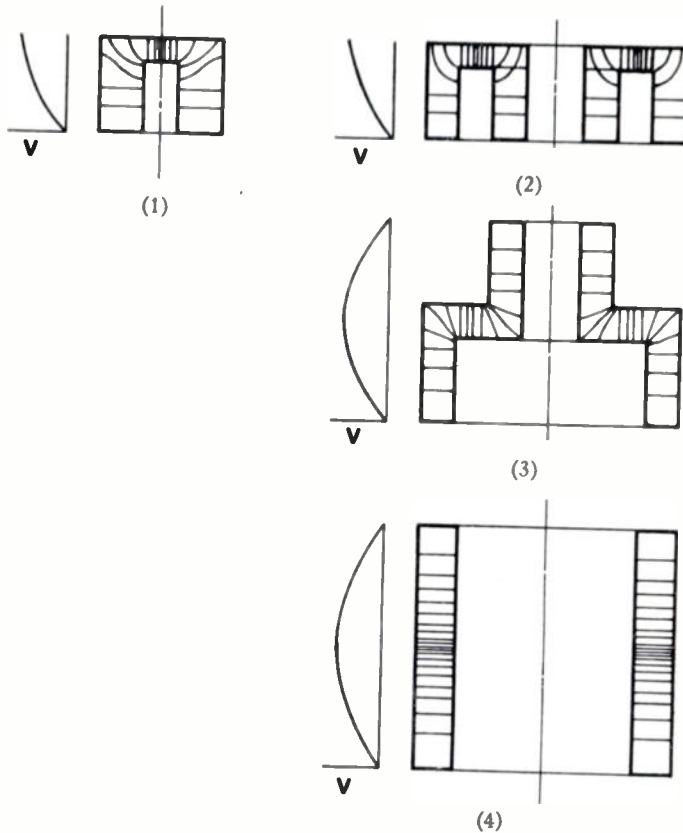

Fig. 2

determined by voltage breakdown or mechanical tolerances, the annular line will have about half the characteristic impedance of a coaxial line having the same outer diameter.

Before proceeding to methods of exciting such a line, and extracting power from it, let us look at Fig. 2 which shows an annular resonator. The simple case of a quarter-wave annular line shorted at one end is compared with a similar resonator of the orthodox coaxial type.

The successive pictures on the right of the figure show that the annular resonator is very nearly equivalent to a double-ended coaxial resonator half a wavelength long, or more exactly, to a double-ended resonator

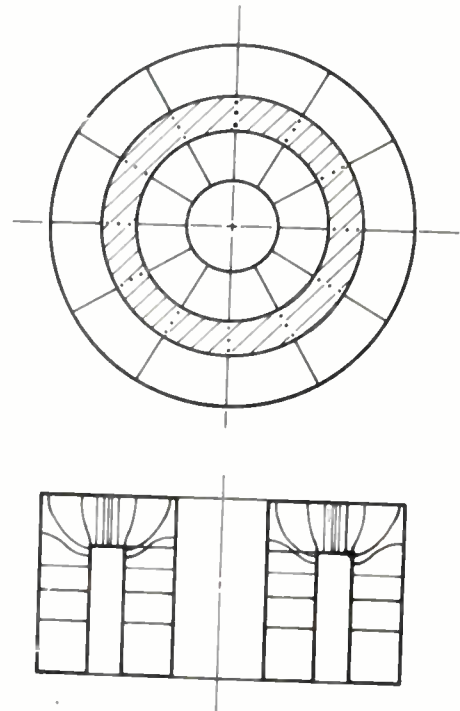

Fig. 3—TEM mode.

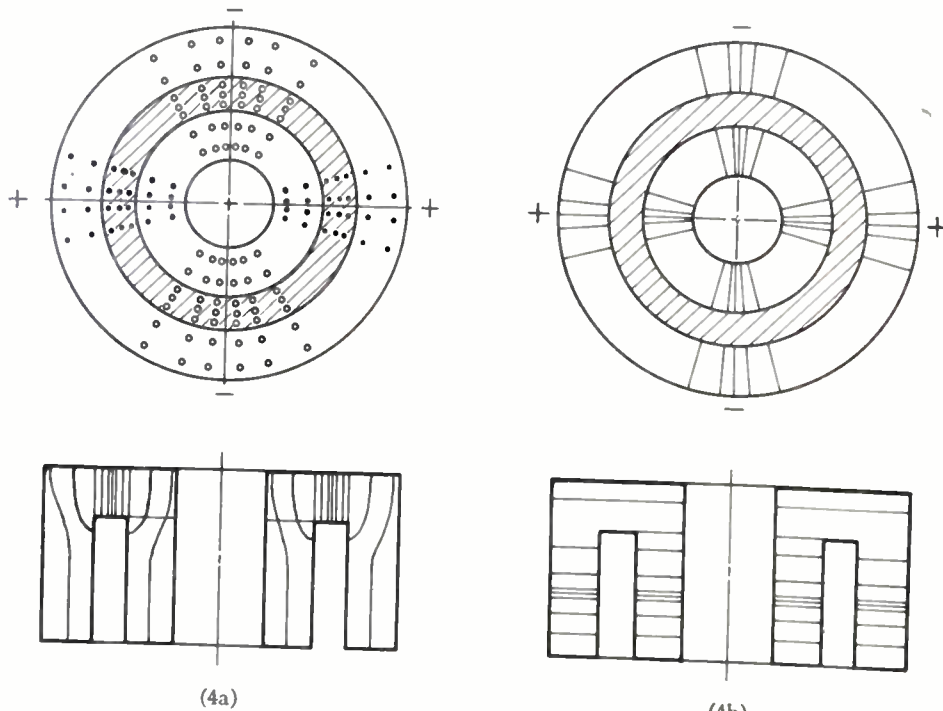

Fig. 4—(a)  $TE_{1,0,2}$  (rectangular ridge mode) and (b)  $TE_{2,1,1}$  (coaxial mode).

with a small shunting capacitance at the current node.

It may be deduced from this that the  $Q$  of an unloaded annular resonator will be about the same as that of a coaxial resonator of the same outside diameter and twice the length, assuming the same diameter ratios in both, i.e.,

$$\frac{d}{c} = \frac{b}{a} = \frac{d_1}{c_1}$$

for the coaxial line.

The principal modes which may be excited in such an annular resonator are shown in Figs. 3 and 4. In addition to the desired  $TEM$  mode in Fig. 3 there are others in Fig. 4 which are usually undesirable. Methods of suppressing these will be described later.

### III. APPLICATION TO MULTITUBE AMPLIFIERS

If we now consider how such a resonator may be excited, it will be clear that to preserve the symmetry of the radio-frequency field an annular exciting source is needed, especially at frequencies where the resonator is large compared with the wavelength. Now an approximation to an annular exciting source is a ring of coaxial-element vacuum tubes symmetrically disposed around the resonator, as shown in Fig. 5, with, for example, their grids connected to the outside end wall of the resonator and their anodes connected through suitable bypassing means to the "inner" conductor.

If the tubes are all driven as amplifiers, equally and in phase at the resultant resonant frequency of the combination of the resonator and the tubes, the  $TEM$  mode will be set up and the electric field will be symmetrical about the central axis.

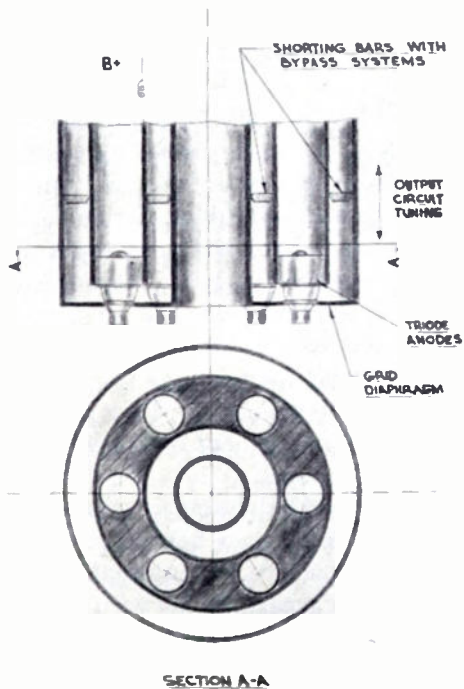

Fig. 5

The next part of the problem is to find a means of coupling into the resonator that will not disturb the symmetry of the radio-frequency field. Fig. 6 shows how this may be done very simply in the case of a multiple-tube grounded-grid amplifier. The inside part of the resonator is in effect bent back on itself, and becomes a coaxial line. The circumferential slot by which this is achieved may be varied in width as a variable capacitance-matching device, to control the standing-wave ratio on the coaxial line. By reversing the direction of power flow, an annular resonator may be excited from a coaxial source, as in the drive circuit. It will be noticed that the input driving power and the output load are supplied axially to the amplifier, with minimum disturbance to the symmetry of the radio-frequency field. Of course, it is possible to load and excite an annular resonator by means of loops or probes introduced at one or more points, but there are many disadvantages to this, especially at high power levels, and in generators that have to be tuned over a broad band. As the title of this paper bears special reference to high-power generators, it will be permissible to emphasize this somewhat. In a system of couplings using loops or probes, one is usually limited at a certain power level by flash-over. In the case of the probe, it

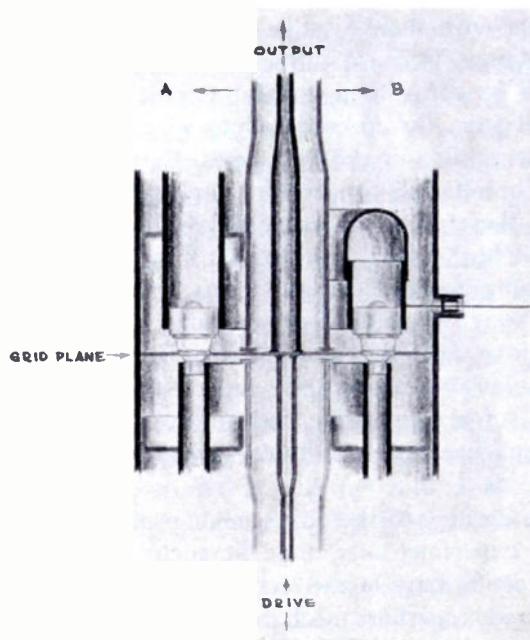

Fig. 6

will occur either between the probe and the inner conductor, or between the probe and the outer conductor. The latter effect is often found at frequencies where the length of the probe stem, or the radius of the probe, approaches a quarter of a wave length, which is often necessary in order to get a large enough coupling coefficient when using a large resonator.

In the case of loops, flashover occurs in a similar manner, especially when the length of the loop approaches a quarter wavelength.

The basic reason for this is that one is attempting to convey a certain amount of power through a small area, under conditions of severe mismatch. Now, in the annular circuit loaded symmetrically as shown above, the power is conveyed uniformly and symmetrically through a section having a large area, namely the area of the slot  $\pi dt$  for slot diameter  $d$  and aperture width  $t$ , so that the power density is lower than in the other systems, and, at the same time, it is clear that the degree of mismatch is much less. This system, then, is admirably suited to high power levels.

Many other geometrical forms are clearly possible in addition to the example in Fig. 6. The annular circuit may be designed around a tetrode unit with a little more complexity but without detracting from the properties of the circuit as described.

Considering now the attainable gain-bandwidth product of an annular amplifier, it has been found experimentally, as would be expected, that the gain is the same as that of a single tube. Bandwidth measurements have not been completed. Since, however, at ultra-high frequencies, even a single-tube amplifier will almost always be coaxial in form, an estimate of the bandwidth of an annular amplifier in comparison with a single-tube amplifier will be of interest. This may be based on the relative amounts of capacitance in the resonant circuits together with their relative foreshortening due to tube capacitance. Because the annular circuit is formed by essentially rotating a coaxial circuit about an offset parallel axis, the foreshortening would be expected to be very similar in the two cases. Experiment confirms this. The relative capacitance remains the determining factor, therefore. Inspection shows this to be about the same in both cases provided that the tubes in the annular amplifier are spaced closely enough, that is, less than about two diameters between centers. Hence, the bandwidth and the gain-bandwidth product of such an annular amplifier may be expected to be quite similar to that of a single-tube coaxial-line amplifier, for the same spacing between inner and outer conductors in both cases.

Turning now to the adjustment problem, it has been shown experimentally that in such an amplifier the two shorting bars in the output annular cavity may be connected together mechanically, giving one tuning control for the output circuit. The same may be done with the input circuit. The input and output coupling may be adjusted over quite a wide range by varying the capacitances of the slots using a simple telescopic joint adjustable externally. Thus, the number of controls is exactly the same as for a conventional grounded-grid amplifier using a single tube.

As an example of the kind of performance that can be obtained from an annular amplifier, a fourteen-tube amplifier using Eimac 2C39 triodes has generated a conservative 500 watts of cw output at a frequency of 1,000 megacycles and with a power gain of between

four and six times, depending on the adjustment. Tests at higher frequencies have not yet been concluded.

#### IV. APPLICATION OF THE ANNULAR CIRCUIT TO OSCILLATORS

The amplifier shown in Fig. 6 may be made into a self-excited oscillator by providing a suitable feedback system. In line with the emphasis on symmetry already observed, an axially symmetrical system would seem to be most desirable. Furthermore, from the standpoint of ease of operation over a wide frequency range, a broad-band system uncritical in adjustment with frequency is desirable also.

These two requirements have been met by what may be called the "grid-disc feedback system." Fig. 7 shows how the amplifier in Fig. 6 is converted to an oscillator, using this system.

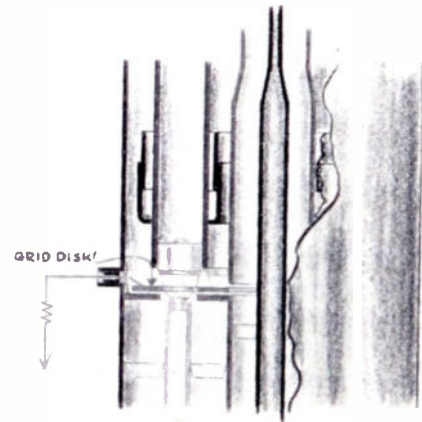

Fig. 7

It can be seen that the grids of the tubes, instead of being fixed to the deck or isolating diaphragm between the input and output circuits, are fixed to a flat annular disc arranged to be at the correct distance from the deck, with which it will form effectively a simple capacitance. Now it can be shown that the adjustment of this capacitance, in conjunction with the axial length of the grid-to-cathode circuit, will give control of feedback over a wide range, and that the amplitude and phase may be adjusted largely independently so as to satisfy all the requirements for efficient oscillation. Furthermore, the disc-to-deck capacitance may be left fixed over quite a high percentage tuning range without appreciable loss of efficiency. This system has been found flexible and convenient over a wide range of frequency and power level.

It has been found advantageous in such oscillators to use separate coaxial lines between each cathode and the deck, in cases where the internal grid-cathode reactance of the tube measured between the connectors is not uniform. By adjustment of these lines the anode currents may be made equal even with tubes having wide variations, and these adjustments are virtually independent of each other.



As an example of the performance of an annular oscillator, a fourteen-tube oscillator using Eimac 2C39 triodes has generated over 400 watts of cw output at 1,000 megacycles. Tests at higher frequencies are not yet concluded.

## V. CONTROL OF UNWANTED MODES

Let us now turn back to the problem of moding control, while bearing in mind the amplifier shown in Fig. 6.

As we saw in Fig. 4, there are possible modes other than the  $TEM$  mode which will be undesirable if we are trying to use the  $TEM$  mode. Now, it is a condition for the existence of any particular resonant mode of this kind that the circuit must be tuned to resonance for that mode, and that there must be the necessary amount of exciting energy provided. If the tuning conditions are simultaneously correct for more than one mode, the mode which will actually be excited depends on the relative amounts of excitation provided, and also on the comparative build-up times, or in other words, the effective  $Q$ 's for the various modes.

Bearing this in mind, let us examine the probability of occurrence of each of the unwanted families of modes in turn, and the means of suppressing them when they do occur.

Firstly, there is the  $TE_{1,0,p}$  mode, as in Fig. 4(a), in which the annular circuit may be considered as a rectangular waveguide of the ridge type, bent back on itself to form a closed loop. At a frequency dependent on the circumference of the loop, and on the loading due to the tubes, the circuit will resonate in the mode in which the electric field lines are parallel to the axis. There will be, in the general case, a variation of the strength of the field around the circuit, so that the end view of the electric field lines may be as shown in Fig. 4(a) for the case of  $TE_{1,0,2}$  where the circuit is two wavelengths around. Now the resonant frequency of this mode depends primarily on the circumference of the annulus and the loading, and only to a smaller degree on the axial length. If the amplifier has to work on a fixed frequency then, the problem of suppressing this mode may be resolved by arranging that the resonant frequency for the  $TE_{1,0,p}$  mode is removed sufficiently from the operating frequency. For an amplifier that has to be tuned over a wide frequency range however, there is the possibility that at one or more frequencies the  $TE_{1,0,p}$  modes may be excited. A large enough asymmetry of driving current from the tubes may presumably give sufficient excitation for this mode, that is to say, if the tube units are sufficiently nonuniform in characteristics. The theory of the ridge wave grid has been developed by Cohn<sup>1</sup> for nonresonant lines without discontinuous loading. The theory for an annular resonator loaded by vacuum tubes still remains to be worked out. It may be deduced from the work of Cohn,

however, that the cutoff frequency for the  $TE_{1,0,p}$  resonant mode we are considering will correspond to an annulus width  $d-a$  considerably less than half a wavelength, and probably in the region of one-quarter wavelength or less in a typical case. Now, at ultra-high frequencies where the tubes used are often large in diameter compared with a quarter wavelength, it will happen that  $d-a$  must be made considerably greater than one quarter, and usually around one half the lowest operating wavelength. Therefore, it is not usually possible to suppress these modes by arranging the circuit to be below cut-off, and the possibility of their existence has to be reckoned with.

Likewise, the related higher order modes of this family, such as  $TE_{2,0,p}$  and  $TE_{1,1,p}$  may exist under favorable circumstances.

The second unwanted mode family of special interest is the  $TE$  coaxial family, in which the electric field lines are transverse to the annulus axis. In this case, however, the resonant frequency is a steep function not only of the circumference but also of the axial length of the resonator. Furthermore, it is usually found that for a given axial length, the resonant frequencies for  $TE_{n,1,p}$  and  $TEM$  are separated enough for the  $TE$  mode never to be excited. In the rare cases where they may coincide unavoidably, it is possible to eliminate the  $TE$  mode by attention to the symmetry of the circuit.

There is one interesting difference between annular oscillators and annular amplifiers, and that is their relative susceptibility to unwanted modes. In the case of the amplifier already discussed, the unwanted resonant modes will occur only at certain frequencies where the circumference is favorable. In the case of the oscillator, oscillation may take place at a frequency determined by the circumference, if the feedback is correct for the ridge wave guide mode. It can be arranged, however, that the feedback will not be simultaneously correct for both the wanted and the unwanted mode, and, of course, the wanted mode needs to be favored only slightly in this respect for build-up of the unwanted mode to be prevented. This loose theory seems at any rate to be substantiated in practice, and all the annular oscillators so far constructed have been amenable in this respect.

Summing up the question of modeseperation in annular circuits, it may be said that in spite of the potential existence of two distinct families of unwanted  $TE$  modes, it seems possible to arrange that only the dominant  $TEM$  mode is excited, by building the circuit symmetrically, by avoiding the presence of discrete transverse conductors carrying radio-frequency current, and by using tubes with sufficiently uniform characteristics. These are simple precautions and do not involve the use of lossy elements. It may be added that in the largest annular generator so far built, which was five wavelengths in mean circumference, there has been no trouble with unwanted modes even when a large percentage of the tubes had their filaments turned off.

<sup>1</sup> S. B. Cohn, "Properties of ridge wave guide," Proc. I.R.E., vol. 35, pp. 783-789; August, 1947.

It has seemed advisable to go into the question of mode control in some small detail, because the possibility of unwanted modes appears to be the only factor likely to impose a fundamental limit on the size of an annular generator or on the number of tubes that may be used together by this method.

Since the size of ultra-high-frequency and microwave generators has so far usually been limited by the occurrence of unwanted modes, it seems very probable that the annular generator will suffer from a similar inherent limitation, especially in the case of the oscillator. However, this is a question of separating different families of modes which is relatively easy when compared with the separation of different modes of the same family as in the cavity magnetrons. Whether this latent limitation will every be reached in practice remains to be seen.

#### VI. THE EFFECTS OF TUBE FAILURE

Experiment has shown that an annular amplifier or oscillator will continue to work in the event of cathode emission failure of up to 75 per cent of the tubes, irrespective of their positions in the circuit. The efficiency decreases somewhat as the number of inoperative tubes becomes greater, but there is no spurious moding.

Grid emission or other phenomena causing abnormal electrode currents can be taken care of by overcurrent circuit breakers connected in the anode or cathode circuits of each tube.

A failure of vacuum may allow sparkover which can cause a complete shutdown until the faulty tube is replaced. This is true of a single-tube generator also.

The annular generator therefore, seems to be better off than the single-tube generator in that it can continue to work reasonably well in the event of tube failure, with the exception of failure of vacuum serious enough to cause sparkover.

#### VII. THE EFFECTS OF TUBE NONUNIFORMITY

Not enough experimental work or calculation has been done to warrant any conclusions being drawn on this important subject. However, the following results may be of significance.

Of the oscillators so far built, all have been equipped with individual cathode lines so that inequalities between tubes could largely be overcome. With tubes picked at random, no trouble has been observed due to tube nonuniformity.

The amplifiers so far made have not been fitted with any individual radio-frequency circuits to compensate for tube differences. So far, production tubes picked at random have given satisfactory results. With equal bias on all the tubes, variations in anode current of not more than  $\pm 25$  per cent about the average value were

observed, and, by adjusting the bias individually, the variation could be reduced to within 5 per cent, using 2C39 tubes on a frequency of 1,000 megacycles.

In view of the fact already noted that the efficiency of the generator does not change appreciably with a small number of the tubes in an entirely nonemitting state, it seems reasonable to assume that variations of reactance between tubes may be taken care of automatically to a large extent by the annular circuit leaving variations in electronic characteristics as the only possible source of inefficiency. This may be taken care of by individual adjustments of grid bias provided that the differences are not too great.

#### VIII. CONCLUSIONS

Referring to the criterion of effectiveness of a multiple-tube generator in Section I above and rating the annular generator on this basis, it appears that:

1. On the question of efficiency and power output versus frequency, it reaches the ideal in all examples so far built. Spurious moding has not been a problem in generators up to five wavelengths in circumference. At what level of size this will become serious is not easily predictable and requires experimental investigation.

2. A correctly designed annular amplifier may be expected to have the same power gain-bandwidth product as a single-tube coaxial-line amplifier. This has not yet been proved experimentally.

3. As far as adjustment of an annular amplifier is concerned the problem is no more difficult than in a single-tube amplifier with the possible exception that individual grid bias adjustments may be necessary if the tubes are sufficiently nonuniform in their characteristics. An annular oscillator under certain conditions may require  $n+1$  adjustable circuits for  $n$  tubes, but these adjustments are simple to make and take care of all usual variations in tube characteristics.

4. Tube failures on the whole will cause less of a problem than in a single-tube generator.

5. Nonuniformity of tubes may cause a problem in an annular amplifier if sufficiently great, although results obtained so far indicate that performance will be satisfactory with tubes having the normally high quality required for satisfactory operation at ultra-high frequencies.

#### IX. ACKNOWLEDGMENTS

The author wishes to thank the U. S. Army Evans Signal Laboratory for permission to publish the material in this paper. The circuit development described was carried out under the auspices of the Signal Corps.

The freely given help and advice obtained from the author's director and colleagues at Eitel-McCullough, Inc., deserve special and most cordial acknowledgment

# A Dynamic Electron Trajectory Tracer\*

JOHN W. CLARK†, MEMBER, IRE, AND RALPH E. NEUBER‡, ASSOCIATE, IRE

**Summary**—Simulated radio-frequency voltage is added to the familiar rubber sheet model for use in vacuum-tube design by causing an electrode structure to oscillate vertically. In this way information about the performance of large-signal, long-transit angle tubes can be obtained quickly and vividly. The scale factors work out that a few cycles per minute in the model can correspond to many hundreds of megacycles in the corresponding tube.

## INTRODUCTION

THE USE OF a gravitational analog as a tool in vacuum-tube design is almost as old as the vacuum-tube art itself. The analog may take the form of a plaster replica of the electric potential function in some structure of interest, or may be a thin elastic membrane stretched over a scale model of the tube electrodes. In any case, the fundamental fact on which the operation of such devices is based is that a sphere rolling freely under gravity will follow the same trajectory in a gravitational field as will an electron in the corresponding electric field. This method has long been used in the design of electron multiplier tubes and electron guns. For a detailed discussion of the theory of the static gravitational model, the reader is referred to Zworykin.<sup>1</sup> A critical study of some of the errors inherent in the rubber model appeared recently.<sup>2</sup>

The present paper describes a gravitational analog suitable for the design of microwave power tubes, i.e., of structures in which transit time effects are not negligible and in which the radio-frequency voltages are comparable in magnitude to the dc. The theoretical analysis of such structures is difficult in the extreme, even under greatly simplified assumptions. Accordingly, a mechanical analog is of great utility to the tube designer.

Since a vertical displacement in the model corresponds to a potential in the tube, it is possible to simulate a radio-frequency voltage by causing one or more of the electrode structures in the model to oscillate up and down. This permits one to observe transit-time dependent phenomena in a very graphic fashion, and to record them photographically for detailed analysis.

Hollmann<sup>3</sup> has made use of vertically oscillating electrodes on a rubber-diaphragm model to study the per-

formance of cathode-ray tubes at very high frequencies. The model to be described in the present paper could of course be used to study any type of long-transit-time tube; its principal use, however, has been in the design of the input space of the Resnatron, a microwave power tetrode.

It is appropriate at this point to emphasize two fundamental limitations of any gravitational model. First, it ignores space charge; thus one must confine himself to tubes in which space charge plays no controlling part in determining electron trajectories. Second, the rubber sheet model is essentially two dimensional. One can only set up on it structures which extend to infinity in the third dimension. Structures of cylindrical symmetry in which the electron paths run generally parallel to the axis of symmetry cannot be studied by gravitational analogs for this reason.

Let us now suppose we are interested in a structure which is essentially two-dimensional and in which space charge is not too important. Such a structure can be accurately modeled on the elastic sheet, and electron trajectories studied.

## FREQUENCY SCALE FACTOR

The relation between mechanical frequency in the model and electrical frequency in the actual tube structure can be calculated by the following simple argument. The velocity of a solid sphere which rolls on a surface is given by the energy equation:

$$1/2mv_m^2 + 1/2I\omega^2 = mgh, \quad (1)$$

where

- $m$  = the mass of the sphere
- $v_m$  = the velocity of its center of gravity
- $I$  = its moment of inertia
- $\omega$  = its angular velocity
- $g$  = the acceleration of gravity
- $h$  = the height through which it has fallen.

The moment of inertia of a sphere about an axis through its center is:

$$I = \frac{2}{5}mr^2 \quad (2)$$

if  $r$  is the radius of the sphere. If the sphere rolls without sliding, then

$$v_m = \omega r. \quad (3)$$

Combining these three equations and solving for  $v_m$ , we find

$$v_m = \sqrt{\frac{10}{7}gh}. \quad (4)$$

\* Decimal classification: R138. Original manuscript received by the Institute, September 26, 1949; revised manuscript received, January 11, 1950.

† Formerly, Collins Radio Company, Cedar Rapids, Iowa; now Varian Associates, San Carlos, Calif.

‡ Formerly, Collins Radio Company, Cedar Rapids, Iowa; now, Sylvania Electric Products Inc., Emporium, Pa.

<sup>1</sup> V. K. Zworykin, G. A. Morton, E. G. Ramberg, J. Hillier, and A. W. Vance, "Electron Optics and the Electron Microscope," John Wiley and Sons Inc., New York, pp. 418-422; 1945.

<sup>2</sup> G. B. Walker, "Factors influencing the design of a rubber model," *Proc. I.E.E.* (London), Part II, vol. 96, pp. 319-324; April, 1949.

<sup>3</sup> H. E. Hollmann, "Theoretical and experimental investigations of electron motions in alternating fields with the aid of ballistic models," *Proc. I.R.E.* vol. 29, pp. 70-79; February, 1941.

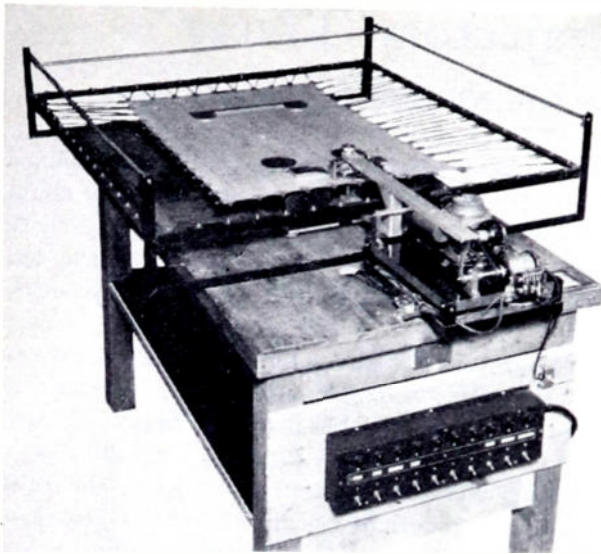

Fig. 1—The dynamic electron trajectory tracer.

This is the velocity of a ball in pure rolling which has fallen a distance  $h$  starting from rest. Correspondingly, it is of interest to calculate the velocity of an electron starting from rest. This follows at once from the energy equation.

The velocity of an electron which has been accelerated through  $V$  volts is:

$$v_e = \sqrt{2 \frac{e}{m} V}. \quad (5)$$

We are interested in the transit angle in radians. In the model,

$$\theta_m = \omega_m x_m / v_m = \omega_m x_m / \sqrt{\frac{10}{7} gh}. \quad (6)$$

In the vacuum tube,

$$\theta_e = \omega_e x_e / v_e = \omega_e x_e / \sqrt{2 \frac{e}{m} V}. \quad (7)$$

In (6) and (7), subscripts  $m$  refer to the model and subscripts  $e$  to the tube. The  $\theta$ 's are transit angles in radians required for the ball and the electron to traverse distance  $x_m$  and  $x_e$  respectively. The  $\omega$ 's are angular frequencies;  $\omega_m$  is the frequency with which an electrode in the model must oscillate in order to correspond to the frequency  $\omega_e$  in the tube. The  $v$ 's are the linear velocities as given in (4) and (5).

The model will accurately reproduce the conditions which prevail in the vacuum tube if the scale factors are so adjusted that  $\theta_m = \theta_e$ . This means that the transit angle in radians for the balls to go from one point to another in the model is exactly the same as that for the electrons to go between the corresponding points in the vacuum tube. Equating  $\theta_m$  to  $\theta_e$ , putting in  $f = \omega/2\pi$ , and rearranging, we find

$$f_m = \frac{\sqrt{\frac{5}{7} \frac{g}{e/m}} f_e}{\frac{x_m}{x_e} \sqrt{\frac{V}{h}}}. \quad (8)$$

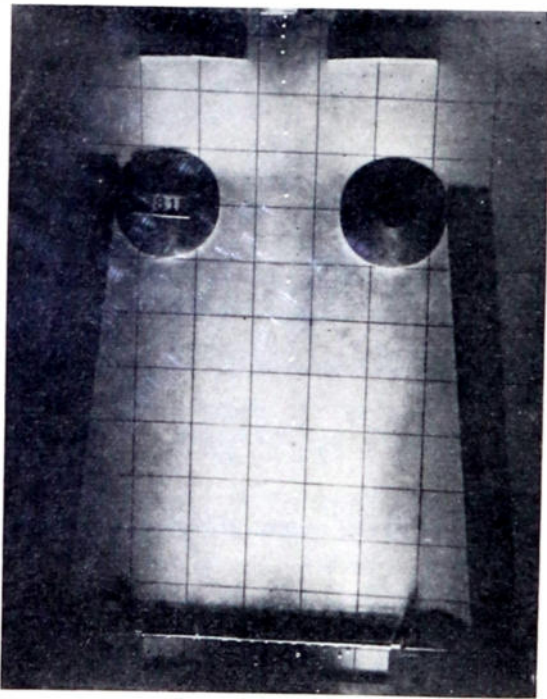

(a)

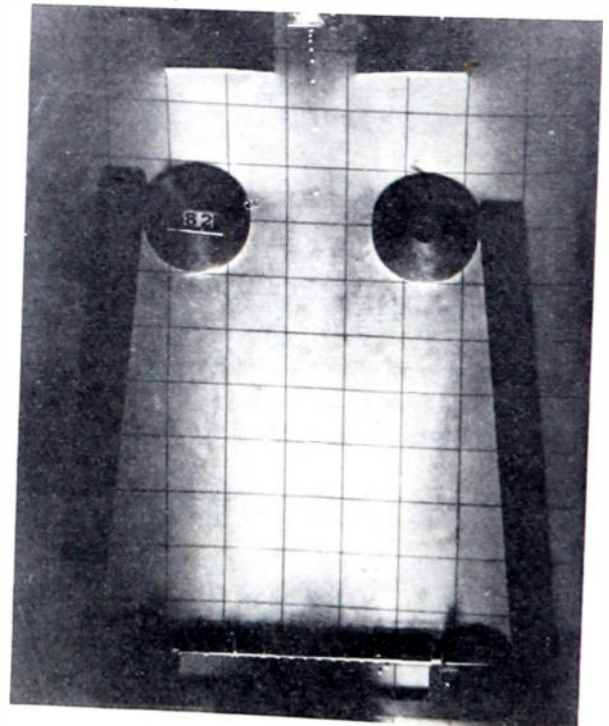

(b)

Fig. 2—Typical trajectories. Balls released at center of filament; plate and screen voltage 15 kv; control grid bias zero; peak rf voltage 1,640 volts (7/32"); illumination at 10° intervals. (a) Ball release phase 211° (81). (b) Ball release phase 216° (82).

The first factor in the numerator of (8) is a constant; the first factor in the denominator is the horizontal scale factor of the model; and the second factor in the denominator is the square root of the vertical scale factor. Inserting numerical values, the equation assumes the following simple form:

$$f_m = \frac{1200f_e}{A\sqrt{B}} \quad (9)$$

where

$f_m$  = the mechanical frequency in cycles per minute

$A$  = the horizontal scale factor ( $A = x_m/x_e$ )

$B$  = the vertical scale factor in Kv/cm

$f_e$  = the radio frequency in thousands of megacycles.

By sheer good fortune, the inter-relation between scale factors shown in (9) gives rise to relatively low mechanical frequencies. For instance, if  $A = 100$ , meaning that the model is 100 times as big as the tube, and if we use a vertical scale factor of 3 kilovolts to the centimeter, we find that a radio frequency of 3,000 megacycles corresponds to a mechanical frequency of 6.92 cycles per minute. Such a low frequency is, of course, very easy to generate and gives rise to no difficulties due to inertia effects.

### THE TRAJECTORY TRACER

Fig. 1 is a photograph of the dynamic electron trajectory tracer. The rubber sheet is stretched in an angle

iron framework. Uniform tension is assured by an arrangement of tiny pulleys which are attached to the sheet by rivets. The sheet is reinforced at the points of attachment by triangles of ordinary tire patch. This was suggested by L. A. Peterson.

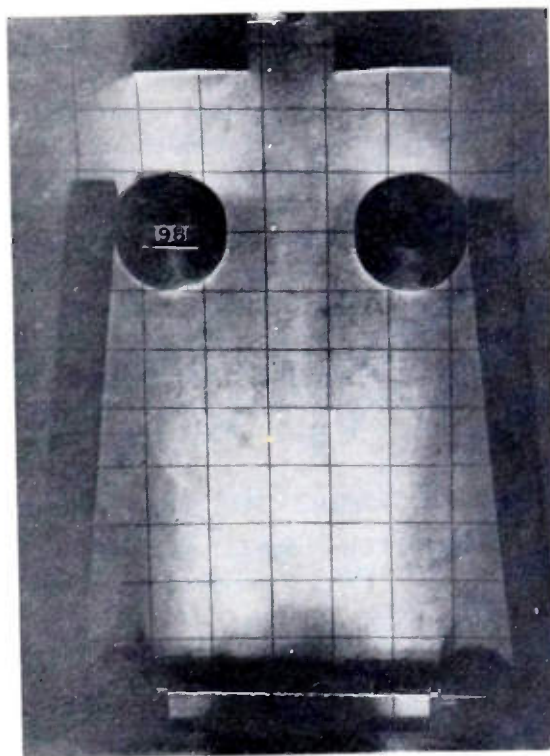

(b)

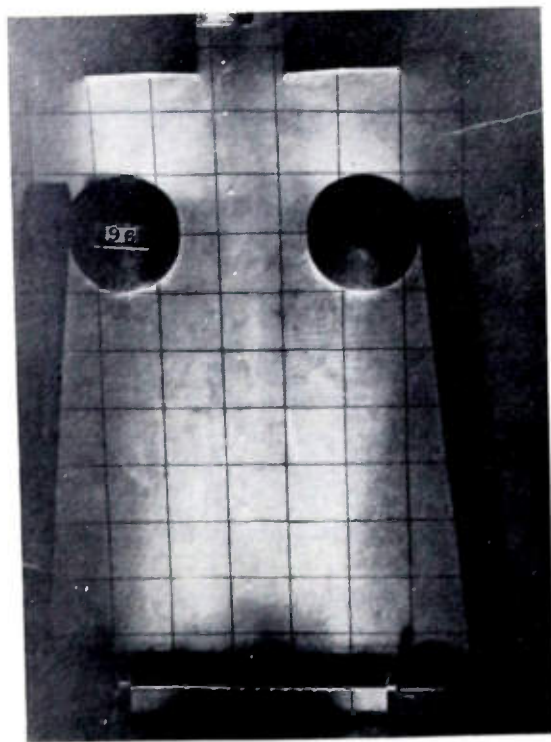

(a)

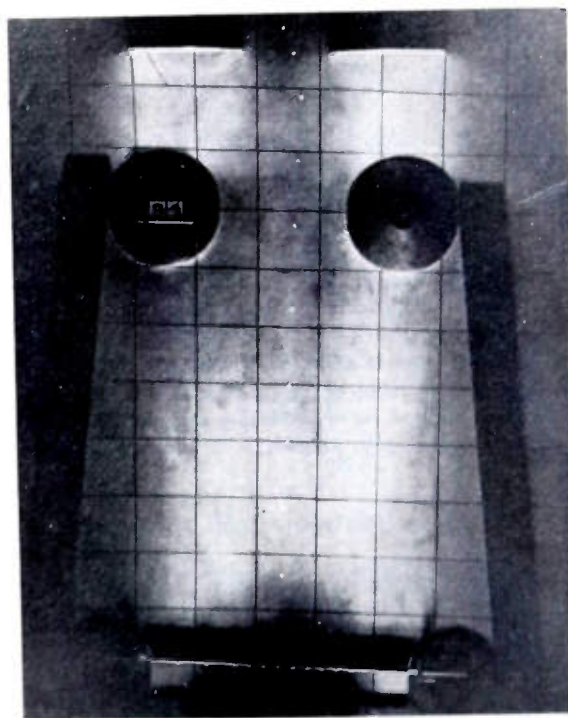

(c)

Fig. 3—Typical trajectories. Balls released at edge of filament; plate and screen voltage 15 kv; control grid bias zero; peak rf voltage 2,340 volts (5/16"); illumination at 10° intervals. (a) Ball release phase 0° (96). (b) Ball release phase 50° (98). (c) Ball release phase 207° (94).

In this model, the simulated radio-frequency voltage is applied to the "cathode"; i.e., to the ball-release mechanism. The ball-release mechanism is mounted on an oscillating arm which is driven by a small motor through a Graham variable speed transmission,<sup>4</sup> model 15MW20. The output speed of this device is continuously variable between 0 and 55 rpm.

Figs. 2 and 3 are typical examples of the performance of the dynamic electron trajectory tracer. A single ball is released in each photograph and is stroboscopically illuminated. Thus each photograph shows a series of dots which indicate the velocity, as well as the trajectory of the ball.

The structure under investigation is the 400-Mc resonatron which was developed during the war as a radar jamming device.<sup>5</sup> Only one of the 24 filaments is set up in the model. The ball-release mechanism with its electromagnet appears at the top of the photographs; the rectangular blocks immediately below it represent a por-

tion of the control grid. Two of the screen grid pipes are simulated by circular blocks. The tips only of the anode vanes appear at the bottom of the photographs, where a simple shutter arrangement prevents spent balls from rolling back onto the sheet.

This model is 25 times larger than the actual tube. The vertical scale factor is 15 kv to the inch. That is, in (9),  $A = 25$  and  $B = 5.9$  kv/cm. This gives a frequency in the model of 7.9 cycles per minute corresponding to 400 megacycles per second in the tube.

These pictures were selected from many to illustrate the sort of information most usefully derived from this apparatus. Such matters as the effect of ball-release phase, amplitude of grid drive, and grid bias on electron transit angle and on electron trajectories or focussing are clearly shown in these photographs. To evaluate these by calculation, even under greatly simplifying assumptions, would be prohibitively difficult.

#### ACKNOWLEDGMENTS

The authors wish to express their appreciation for the assistance of Leslie Gouak, who built most of the mechanisms described and aided in taking the stroboscopic photographs.

<sup>4</sup> Graham Transmissions, Inc., 3754 N. Holton St., Milwaukee 12, Wis.

<sup>5</sup> W. W. Salisbury, "The resonatron," *Electronics*, vol. 19, pp. 92-97, February, 1946.

## Microphonism in the Dynamically Operated Planar Triode\*

J. A. WENZEL†, STUDENT MEMBER, IRE, AND A. H. WAYNICK‡, SENIOR MEMBER, IRE

**Summary**—The theory of microphonism in planar triodes is extended to cover the practical case of simultaneous electrical and mechanical excitation. It is shown that, in addition to other components, microphonic plate current components result at the sum and difference frequencies of the two types of excitation for transverse motion of any of the three electrodes. Experiments providing verification of the theory, with a tube especially designed and constructed for this purpose are described. On the basis of the theory, (1) an electrical nondestructive method for determining which electrode of the tube is set into vibration at a given mechanical frequency is outlined, and (2) a method for considerably reducing the microphonic output of certain high-gain amplifiers of practical interest is described.

#### INTRODUCTION

MICROPHONISM in planar triodes under static electrical operating conditions has been the subject of two rather recent papers.<sup>1,2</sup> The case

of practical interest wherein the microphonic output under dynamic electrical operating conditions is determined has not been treated and is the subject of this paper.

The theoretical basis of the work follows closely the methods of the reference papers. It is shown that new terms are introduced in the expressions for the fluctuating plate current components when a tube is subjected to simultaneous electrical and mechanical excitation. For steady-state sinusoidal excitations, the new terms have the same form as those uniquely produced in frequency convertors. Consequently, they are called intermodulation terms.

The theoretical development leads to conclusions regarding methods whereby the electrode motions causing microphonism may be determined from electrical

\* Decimal classification: R262.9. Original manuscript received by the Institute, October 10, 1949; revised manuscript received, January 16, 1950.

† Ordnance Research Laboratory, The Pennsylvania State College, State College, Pa.

‡ Electrical Engineering Department, The Pennsylvania State College, State College, Pa.

<sup>1</sup> A. H. Waynick, "The reduction of microphonics in triodes," *Jour. App. Phys.*, vol. 18, pp. 239-245; February, 1947.

<sup>2</sup> V. W. Cohen and A. Bloom, "Microphonism in a subminiature triode," *Proc. I.R.E.*, vol. 36, pp. 1039-1048; August, 1948.

measurements. Methods of design or operation of amplifier systems with greatly reduced microphonic output are also suggested by the theory.

Experimental measurements with the aid of a tube especially developed for this purpose are then described. The resulting data are shown to validate the theory and support the conclusions reached.

#### THEORY OF THE PLANAR DYNAMICALLY OPERATED TRIODE

Consider the usual planar double-triode structure illustrated in Fig. 1. Here  $C$  is the cathode,  $G$  the grid, and  $P$  the anode structures, with the last two symmetrically placed with respect to the emitter. As far as

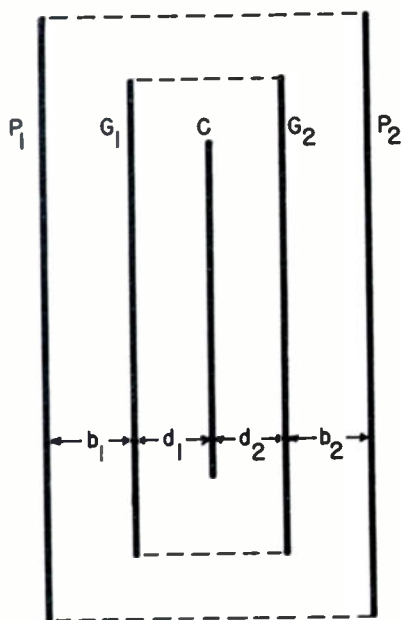

Fig. 1—Schematic representation of the planar double-triode section.

mechanical motion is concerned, the tube elements are considered to be rigid structures, and the motion of interest is that component of the interelectrode motion perpendicular to the electrodes and in the plane of the figure. Thus the tube may be considered as two single triode sections in parallel and is so denoted by referring to grid-cathode distances  $d_1$ ,  $d_2$  and plate-grid distances  $b_1$ ,  $b_2$ .

The space-charge-limited plate current of either triode section is given by Chaffee<sup>3</sup> as

$$I_p = \frac{2.336 \times 10^{-6} A (E_g + DE_p)^{3/2}}{d^2 (1 + D)} \quad (1)$$

where

$$D = 1/\mu \quad \text{and} \quad \mu = \frac{2\pi nb}{\log_e \frac{1}{2\pi nR}} = \frac{b}{K}$$

<sup>3</sup> E. L. Chaffee, "Theory of Thermionic Vacuum Tubes," McGraw-Hill Book Co., New York, N. Y., p. 147, eq. 114; 1933.

under the condition  $nR \ll 1$ . In these expressions

- $E_g$  = grid-cathode voltage
- $E_p$  = plate-cathode voltage
- $b$  = grid-plate distance
- $d$  = grid-cathode distance
- $R$  = radius of grid wires
- $n$  = number of grid wires per unit length
- $A$  = area of effective cathode surface.

It is evident that the plate current  $I_p = f'(E_p, E_g, d, b)$  for either triode section with  $n$ ,  $R$ , and  $A$  fixed. From practical considerations,  $E_p$  may be made constant. Further, quiescent and fluctuating components may be separated, with a slight change in notation, by writing  $E_g + \Delta E_g$ ,  $d + \Delta d$  and  $b + \Delta b$  as the instantaneous grid voltage, grid-cathode distance, and plate-grid distance; respectively. Here  $E_g$ ,  $d$ , and  $b$  indicate quiescent values and  $\Delta E_g$ ,  $\Delta d$  and  $\Delta b$  are the instantaneous magnitudes of the variations of the respective quantities from the quiescent values under dynamic electrical and mechanical conditions.

Considering the above, the plate current may be written

$$\begin{aligned} I_p &= F(E_g + \Delta E_g, d + \Delta d, b + \Delta b) \\ &= f(E_g, d, b) + \Delta E_g \frac{\partial f}{\partial E_g} + \Delta d \frac{\partial f}{\partial d} + \Delta b \frac{\partial f}{\partial b} \\ &\quad + \frac{1}{2!} \left[ (\Delta E_g)^2 \frac{\partial^2 f}{\partial E_g^2} + (\Delta d)^2 \frac{\partial^2 f}{\partial d^2} + (\Delta b)^2 \frac{\partial^2 f}{\partial b^2} \right. \\ &\quad + 2\Delta E_g \Delta d \frac{\partial^2 f}{\partial E_g \partial d} + 2\Delta E_g \Delta b \frac{\partial^2 f}{\partial E_g \partial b} \\ &\quad \left. + 2\Delta d \Delta b \frac{\partial^2 f}{\partial d \partial b} \right]; \end{aligned} \quad (2)$$

a Taylor's series expansion in these three variables to the second order. This applies to either section of the double triode configuration of Fig. 1,  $b$  and  $d$  being generic quantities.

Before applying the expansion (2) to equation (1) it is convenient to immediately consider certain factors. Considerable simplification may be obtained by restricting consideration to the high  $\mu$  approximation  $D = (1/\mu) \ll 1$  so that  $1 + D \cong 1$ . Under this restriction equation (1) becomes

$$I_p = \frac{c}{d^2} \left( E_g + \frac{KE_p}{b} \right)^{3/2}, \quad (1')$$

with  $c = 2.336 \times 10^{-6} A$ .

Further, following Cohen and Bloom,<sup>2</sup> the consideration of the tube structure of Fig. 1 as two single-triode sections permits dealing with the quiescent plate currents  $I_{p01}$ ,  $I_{p02}$  and instantaneous plate currents  $I_{p1}$ ,  $I_{p2}$  of the two sections separately. Hence, the magnitude of the total instantaneous variation of the sum of the plate currents from the quiescent value may be written

$$\Delta I_p = (I_{p1} - I_{p01}) + (I_{p2} - I_{p02}). \quad (3)$$

Applying the operations of (2) to (1)' and writing the result in the form of (3) yields

$$\begin{aligned} \Delta I_p = & \frac{3c}{2} (\Delta E_\theta) \left[ \frac{\alpha^{1/2}}{d_1^2} + \frac{\beta^{1/2}}{d_2^2} \right] \\ & - 2c \left[ \frac{(\Delta d_1)\alpha^{3/2}}{d_1^3} + \frac{(\Delta d_2)\beta^{3/2}}{d_2^3} \right] \\ & - \frac{3cKE_p}{2} \left[ \frac{(\Delta b_1)\alpha^{1/2}}{d_1^2 b_1^2} + \frac{(\Delta b_2)\beta^{1/2}}{d_2^2 b_2^2} \right] \\ & + \frac{3c}{8} (\Delta E_\theta)^2 \left[ \frac{\alpha^{-1/2}}{d_1^2} + \frac{\beta^{-1/2}}{d_2^2} \right] \\ & + 3c \left[ \frac{(\Delta d_1)^2 \alpha^{3/2}}{d_1^4} + \frac{(\Delta d_2)^2 \beta^{3/2}}{d_2^4} \right] \\ & + \frac{3cKE_p}{2} \left[ \frac{(\Delta b_1)^2 \alpha^{1/2}}{d_1^2 b_1^3} + \frac{KE_p (\Delta b_1)^2 \alpha^{-1/2}}{4d_1^2 b_1^4} \right. \\ & \left. + \frac{(\Delta b_2)^2 \beta^{1/2}}{d_2^2 b_2^3} + \frac{KE_p (\Delta b_2)^2 \beta^{-1/2}}{4d_2^2 b_2^4} \right] \\ & - 3c(\Delta E_\theta) \left[ \frac{(\Delta d_1)\alpha^{1/2}}{d_1^3} + \frac{(\Delta d_2)\beta^{1/2}}{d_2^3} \right] \\ & - \frac{3cKE_p}{4} (\Delta E_\theta) \left[ \frac{(\Delta b_1)\alpha^{-1/2}}{d_1^2 b_1^2} + \frac{(\Delta b_2)\beta^{-1/2}}{d_2^2 b_2^2} \right] \\ & + 3cKE_p \left[ \frac{(\Delta d_1)(\Delta b_1)\alpha^{1/2}}{d_1^3 b_1^2} + \frac{(\Delta d_2)(\Delta b_2)\beta^{1/2}}{d_2^3 b_2^2} \right], \end{aligned} \quad (4)$$

where

$$\alpha = E_\theta + \frac{KE_p}{b_1} \quad \text{and} \quad \beta = E_\theta + \frac{KE_p}{b_2}.$$

Attention is confined to sinusoidal variational quantities by setting  $\Delta E_\theta = C_E \sin \omega_E t$ ,  $\Delta d_1 = -\Delta d_2 = C_d \sin \omega_d t$ ,  $\Delta b_1 = -\Delta b_2 = C_b \sin \omega_b t$  where the displacement constraints follow from the rigid structures assumed in Fig. 1.

From (4) it is seen, under the above restrictions, that the incremental plate current is comprised of components: (1) at the fundamental and second harmonic of the grid electrical excitation frequency; (2) at the fundamental and second harmonic of the mechanical excitation frequencies; (3) at the sum and difference of the grid voltage and mechanical excitation frequencies and, for the steady-state case of interest; (4) at zero frequency.

The second harmonic and dc components arise from terms having coefficient factors such as

$$C_E^2 \sin^2 \omega_E t = \frac{C_E^2}{2} - \frac{C_E^2}{2} \cos 2\omega_E t.$$

The sum and difference components occur in terms having coefficient factors similar to

$$\begin{aligned} & C_E C_d \sin \omega_E t \sin \omega_d t \\ & = \frac{C_E C_d}{2} \cos (\omega_E - \omega_d) t - \frac{C_E C_d}{2} \cos (\omega_E + \omega_d) t. \end{aligned}$$

The dc terms require no further consideration, since they are removed by interstage coupling networks in cases of practical interest.

The interpretation of (4) is facilitated by considering the motion of each electrode of the tube separately. This is based on the experimentally proven, valid assumption that the microphonic output at a given mechanical driving frequency, for sinusoidal excitation, is frequently associated with the movement of one electrode. The theoretical curves given with the development are for a special tube, comprised of a single-triode section, which was constructed for this investigation and is described later. In view of this, each type of electrode motion is dealt with for both the single and double section case.

### CATHODE MOTION

#### Single Triode Section

Reference to Fig. 1 indicates that  $\Delta b = 0$  in the case of cathode motion, so that the only variables are  $\Delta d$  and  $\Delta E_\theta$ . Equation (4) reduces to

$$\begin{aligned} \Delta I_p = & \frac{c}{d^2} \left\{ \frac{3}{2} (\Delta E_\theta) \gamma^{1/2} + \frac{3}{8} (\Delta E_\theta)^2 \gamma^{-1/2} - \frac{2}{d} (\Delta d) \gamma^{3/2} \right. \\ & \left. + \frac{3}{d^2} (\Delta d)^2 \gamma^{3/2} - \frac{3}{d} (\Delta d) (\Delta E_\theta) \gamma^{1/2} \right\}, \end{aligned}$$

where  $\gamma$  is generic for either  $\alpha$  or  $\beta$ . For sinusoidal variations,  $\Delta d = C_C \sin \omega_C t$  and  $\Delta E_\theta = C_E \sin \omega_E t$ , this may be written

$$\begin{aligned} \Delta I_p = & K_{EE} C_E \sin \omega_E t - K_{EE} C_E^2 \cos 2\omega_E t \\ & + K_{CC} C_C \sin \omega_C t - K_{CC} C_C^2 \cos 2\omega_C t \\ & + K_{EC} C_E C_C \cos (\omega_E - \omega_C) t \\ & - K_{EC} C_E C_C \cos (\omega_E + \omega_C) t, \end{aligned} \quad (5)$$

where the dc terms have been neglected.

Equation (5) gives the magnitude, frequency, and phase of the variational components of plate current in terms of the electrical and mechanical excitation amplitudes and frequencies. For unit amplitudes of the variables,  $C_C$  and  $C_E$  unity, the  $K$  coefficients, which are functions of quiescent electrode potentials and interelectrode distances, give the magnitudes of the various terms and are hence useful in intercomparing the effects of various types of electrode motion. In (5) the coefficients have the values

$$\begin{aligned} K_E = & \frac{3c}{2d^2} \gamma^{1/2}, & K_{EE} = & \frac{3c}{16d^2} \gamma^{-1/2} \\ K_C = & -\frac{2c}{d^3} \gamma^{3/2}, & K_{CC} = & \frac{3c}{2d^4} \gamma^{3/2} \\ K_{EC} = & -\frac{3c}{2d^3} \gamma^{1/2} \end{aligned} \quad (6)$$

#### Double Triode

For the double triode the mechanical constraint describing cathode motion becomes  $\Delta d_1 = -\Delta d_2$ . Consider-



ing this, and the variable  $\Delta E_p$ , in (4) there results an expression formally identical to (5) in which the  $K$  coefficients have the values

$$\begin{aligned} K_E &= \frac{3c}{2} \left( \frac{\alpha^{1/2}}{d_1^2} + \frac{\beta^{1/2}}{d_2^2} \right), & K_{EE} &= \frac{3c}{16} \left( \frac{\alpha^{-1/2}}{d_1^2} + \frac{\beta^{-1/2}}{d_2^2} \right) \\ K_C &= 2c \left( \frac{-\alpha^{3/2}}{d_1^3} + \frac{\beta^{3/2}}{d_2^3} \right), & K_{CC} &= \frac{3c}{2} \left( \frac{\alpha^{3/2}}{d_1^4} + \frac{\beta^{3/2}}{d_2^4} \right) \\ K_{EC} &= \frac{3c}{2} \left( -\frac{\alpha^{1/2}}{d_1^3} + \frac{\beta^{1/2}}{d_2^3} \right). \end{aligned} \quad (7)$$

Perfect symmetry of the quiescent mechanical dimensions of the two triode sections is indicated by writing  $d_1 = d_2$  and  $b_1 = b_2$ . This leads to the relation  $\alpha = \beta$ . Entering these equalities in (7), and incorporating the result into a relation similar to (5), yields

$$\Delta I_p = K_E' C_E \sin \omega_{E} t - K_{EE}' C_E^2 \cos 2\omega_{E} t - K_{CC}' C_C^2 \cos 2\omega_C t,$$

where the primed coefficients have twice the value of corresponding coefficients in (6). Thus, for perfect symmetry, the fundamental displacement component and the intermodulation terms vanish while the coefficients of the remaining terms are double those of the corresponding single triode.

#### PLATE MOTION

##### Single-Triode Section

The mechanical constraint for plate motion in the single triode section is that  $\Delta d = 0$ . Consequently, considering  $\Delta b$  and  $\Delta E_p$ , equation (4) becomes

$$\begin{aligned} \Delta I_p &= K_E C_E \sin \omega_{E} t - K_{EE} C_E^2 \cos 2\omega_{E} t \\ &+ K_P C_P \sin \omega_P t - K_{PP} C_P^2 \cos 2\omega_P t \\ &+ K_{EP} C_E C_P \cos (\omega_E - \omega_P) t \\ &- K_{EP} C_E C_P \cos (\omega_E + \omega_P) t, \end{aligned} \quad (8)$$

when  $\Delta b$  is set equal to  $C_P \sin \omega_P t$ . In this relation the  $K$  coefficients have the values

$$\begin{aligned} K_E &= \frac{3c}{2d^2} \gamma^{1/2}, \\ K_{EE} &= \frac{3c}{16d^2} \gamma^{-1/2} \\ K_P &= -\frac{3c K E_p}{2d^2 b^2} \gamma^{1/2}, \\ K_{PP} &= \frac{3c K E_p}{4d^2 b^3} \left( \gamma^{1/2} + \frac{K E_p}{4b} \gamma^{-1/2} \right), \\ K_{EP} &= -\frac{3c K E_p}{8d^2 b^2} \gamma^{-1/2}, \end{aligned} \quad (9)$$

and are seen to be equal or analogous to those for cathode motion given in equations (6).

##### Double Triode

Applying the constraint  $\Delta b_1 = -\Delta b_2$  to (4) there re-

sults a relation having the form of (8) in which the  $K$  coefficients have the values

$$\begin{aligned} K_E &= \frac{3c}{2} \left( \frac{\alpha^{1/2}}{d_1^2} + \frac{\beta^{1/2}}{d_2^2} \right), \\ K_{EE} &= \frac{3c}{16} \left( \frac{\alpha^{-1/2}}{d_1^2} + \frac{\beta^{-1/2}}{d_2^2} \right), \\ K_P &= \frac{3c K E_p}{2} \left( -\frac{\alpha^{1/2}}{d_1^2 b_1^2} + \frac{\beta^{1/2}}{d_2^2 b_2^2} \right), \\ K_{PP} &= \frac{3c K E_p}{4} \left( \frac{\alpha^{1/2}}{d_1^2 b_1^3} + \frac{K E_p \alpha^{-1/2}}{4d_1^2 b_1^4} \right. \\ &\quad \left. + \frac{\beta^{1/2}}{d_2^2 b_2^3} + \frac{K E_p \beta^{-1/2}}{4d_2^2 b_2^4} \right), \\ K_{EP} &= \frac{3c K E_p}{8} \left( \frac{-\alpha^{-1/2}}{d_1^2 b_1^2} + \frac{\beta^{-1/2}}{d_2^2 b_2^2} \right). \end{aligned} \quad (10)$$

For perfect symmetry, as before,  $d_1 = d_2$ ,  $b_1 = b_2$  leading to  $\alpha = \beta$ . Incorporating (10) into a relation similar to (8) there results

$$\begin{aligned} \Delta I_p &= K_E' C_E \sin \omega_{E} t - K_{EE}' C_E^2 \cos 2\omega_{E} t \\ &- K_{PP}' C_P^2 \cos 2\omega_P t, \end{aligned}$$

in which the primed coefficients have twice the values of corresponding quantities in (9). It is evident that the same statements concerning cathode motion in the perfectly symmetrical double triode apply for plate motion.

#### GRID MOTION

##### Single-Triode Section

For grid motion the mechanical constraint becomes  $\Delta d_1 = -\Delta b_1$ . Writing  $\Delta d_1 = C_G \sin \omega_G t$ , and including  $\Delta E_p$ , equation (4) becomes

$$\begin{aligned} \Delta I_p &= K_E C_E \sin \omega_{E} t - K_{EE} C_E^2 \cos 2\omega_{E} t \\ &+ K_G C_G \sin \omega_G t - K_{GG} C_G^2 \cos 2\omega_G t \\ &+ K_{EG} C_E C_G \cos (\omega_E - \omega_G) t \\ &- K_{EG} C_E C_G \cos (\omega_E + \omega_G) t, \end{aligned} \quad (11)$$

in which the  $K$  coefficients of interest have the values

$$\begin{aligned} K_E &= \frac{3c}{2d^2} \gamma^{1/2}, & K_{EE} &= \frac{3c}{16d^2} \gamma^{-1/2}, \\ K_G &= \frac{-2c}{d^3} \gamma^{3/2} + \frac{3c K E_p}{2d^2 b^2} \gamma^{1/2} \\ K_{GG} &= \frac{3c}{2} \left( \frac{\gamma^{3/2}}{d^4} + \frac{K E_p}{2d^2 b^3} \gamma^{1/2} + \frac{(K E_p)^2}{8d^2 b^4} \gamma^{-1/2} \right. \\ &\quad \left. - \frac{K E_p}{d^3 b^2} \gamma^{1/2} \right) \\ K_{EG} &= \frac{3c}{2d^2} \left( -\frac{\gamma^{1/2}}{d} + \frac{K E_p}{4b^2} \gamma^{-1/2} \right). \end{aligned} \quad (12)$$

Comparing (11) with (5) and (8) indicates that the various frequencies of the plate current fluctuating com-

ponents are analogous for the three types of electrode motion. However, comparison of (6), (9), and (12) shows that, while the first two sets of relations are analogous, the latter appears to be quite different from the first two. Examination indicates that, as would be expected, the first- and second-order electrical signal frequency terms are the same in all of these equations. Further,

$$K_G = K_C + K_P,$$

$$K_{GG} = K_{CC} + K_{PP} - \frac{3cKE_p}{2d^3b^2} \gamma^{1/2},$$

$$K_{EG} = K_{EC} + K_{EP},$$

which express the relationship existing between the various mechanically derived components for the three types of motion. Grid motion is seen to be effectively a combination of the motions of the other two electrodes.

*Double Triode*

Application of the mechanical constraint relation  $\Delta d_1 = -\Delta b_1 = -\Delta d_2 = \Delta b_2$  to (4) yields an expression similar to (11) with  $K$  coefficient values

$$K_E = \frac{3c}{2} \left( \frac{\alpha^{1/2}}{d_1^2} + \frac{\beta^{1/2}}{d_2^2} \right),$$

$$K_{EE} = \frac{3c}{16} \left( \frac{\alpha^{-1/2}}{d_1^2} + \frac{\beta^{-1/2}}{d_2^2} \right),$$

$$K_G = \frac{-2c}{d_1^3} \alpha^{3/2} + \frac{3cKE_p}{2d_1^2b_1^2} \alpha^{1/2} + \frac{2c\beta^{3/2}}{d_2^3} - \frac{3cKE_p}{2d_2^2b_2^2} \beta^{1/2},$$

$$K_{GG} = \frac{3c}{2} \left[ \frac{\alpha^{3/2}}{d_1^4} + \frac{KE_p}{2d_1^2b_1^2} \left( \frac{1}{b_1} - \frac{2}{d_1} \right) \alpha^{1/2} + \frac{(KE_p)^2}{8d_1^2b_1^4} \alpha^{-1/2} + \frac{\beta^{3/2}}{d_2^4} + \frac{KE_p}{2d_2^2b_2^2} \left( \frac{1}{b_2} - \frac{2}{d_2} \right) \beta^{1/2} + \frac{(KE_p)^2}{8d_2^2b_2^4} \beta^{-1/2} \right],$$

$$K_{EG} = \frac{3c}{2} \left( -\frac{\alpha^{1/2}}{d_1^3} + \frac{KE_p}{4d_1^2b_1^2} \alpha^{-1/2} + \frac{\beta^{1/2}}{d_2^3} - \frac{KE_p}{4d_2^2b_2^2} \beta^{-1/2} \right). \tag{13}$$

Perfect double-triode symmetry,  $d_1 = d_2$ ,  $b_1 = b_2$  and  $\alpha = \beta$ , leads, as before, to the cancellation of the intermodulation and first-order vibrational terms. The remaining terms have twice the magnitude of their single-triode section counterparts. In this case, as in the previous cases studied, it is evident that perfect symmetry represents a limit and that the magnitudes of the various terms depend upon the degree of asymmetry. Evidently, the vanishing terms increase while the doubled terms decrease in magnitude as the asymmetry increases.

ANALYSIS OF SINGLE-TRIODE SECTION THEORY

Having shown the effects of considering the double triode as a limiting case, it is now convenient to confine

further attention to the single-triode section. In this paper only the theoretical curves for a special triode, the Sylvania SC-839-Z, are presented. Similar curves have been prepared for several commercial tube types, such as the 6A3, the triode section of the 6K8, etc., with corresponding results. The analysis is based on theoretical curves of the various  $K$  coefficients as a function of grid bias and for a practical fixed quiescent plate voltage. Furthermore, these curves represent the amplitudes of the various plate current components for the unit excitation amplitudes  $C_E = 1$  volt,  $C_C = 1$  mm. The arbitrary scale units used in plotting Figs. 2, 3, and 4 may be converted to absolute values by multiplying by the factor  $c/d^2$ .

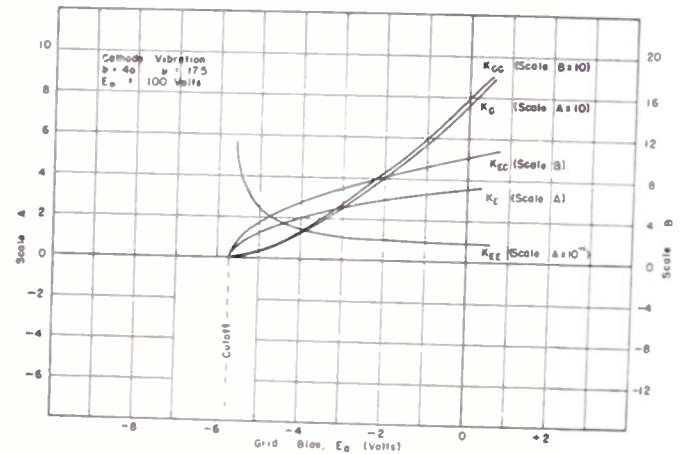

Fig. 2—Relative amplitudes of the plate current components for harmonic cathode vibration in the SC-839-Z single-triode section.  $C_E = 1.0$  volt,  $C_C = 1.0$  mm.

The coefficients for the case of cathode motion, (equations (6)), are shown in Fig. 2. They are plotted as a function of quiescent grid voltage. The latter is chosen as the independent variable from practical considerations. The fact that all coefficients remain positive is indicative of no change in phase of the plate current components as a function of grid bias.

For plate motion in the SC-839-Z the theoretical coefficients are obtained from (9) and are shown in Fig. 3.

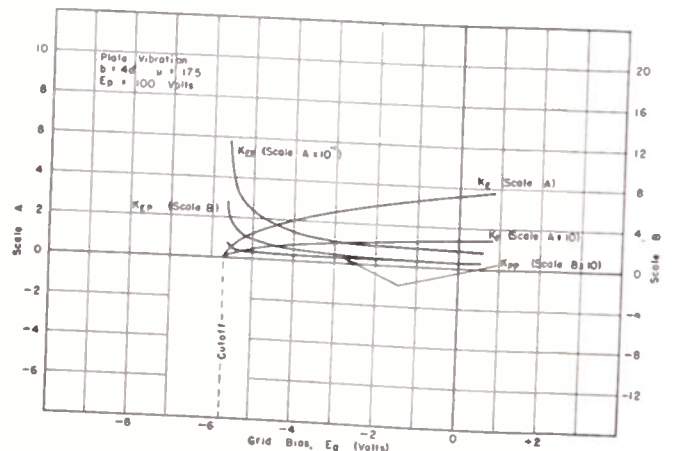

Fig. 3—Relative amplitudes of the plate-current components for harmonic plate vibration in the SC-839-Z single-triode section.  $C_E = 1.0$  volt,  $C_P = 1.0$  mm.

As is evident from the equations,  $K_E$  and  $K_{EE}$  are the same for both types of motion, the excitation remaining constant. However, the intermodulation and first- and second-order displacement coefficients follow entirely different curves as regards shape, slope, and magnitude.

Perhaps the most interesting results appear in Fig. 4; the coefficients for the case of grid motion. It will be noted that  $K_E$  and  $K_{EE}$  are the same as for the previous two types of electrode motion. However, the two displacement and the intermodulation coefficients for this case behave entirely differently from the analogous curves for the other types of motion. Perhaps the greatest difference of interest is that all of these coefficients pass through zero at one or more bias voltages and change sign. The latter implies a phase reversal at the bias for zero value of the coefficient. Also, the slopes and magnitudes of these curves are quite different from the previous cases. This may be utilized to advantage as will be discussed later.

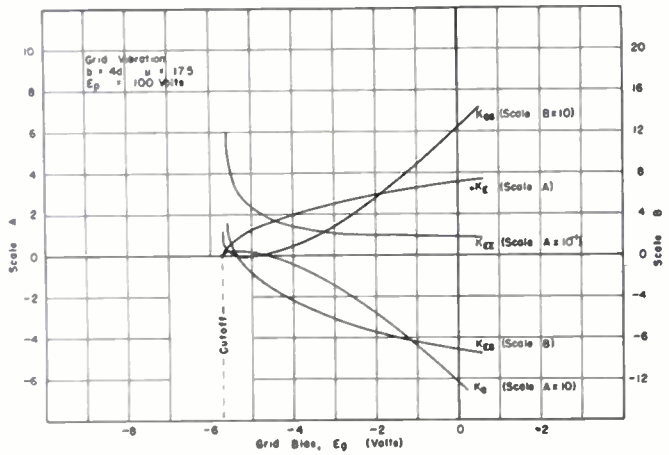

Fig. 4—Relative amplitudes of the plate-current components for harmonic grid vibration in the SC-839-Z single-triode section.  $C_E = 1.0$  volt,  $C_G = 1.0$  mm.

NORMALIZATION OF THE THEORETICAL CURVES

In practice the effects of microphonism are most usually encountered in high-gain voltage amplifiers. Here the factor of interest is the relative magnitude of the total microphonic output to the desired signal output. Consequently, it is useful to normalize the previous results by obtaining the ratio  $\Delta I_p / K_E C_E$ . This yields normalized coefficients,  $k$ 's, for the various components, and the excitation amplitudes are again chosen as unity.

The results of the normalization process are shown in Fig. 5 for cathode motion, Fig. 6 for plate motion, and Fig. 7 for grid motion. Each curve is essentially a noise-to-signal ratio plot for the given component. It is evident that the mathematical form of many of the normalized components is comparatively simple from the shapes of the curves.

CONCLUSIONS DRAWN FROM THE THEORY

The following conclusions can be drawn from the previous theory and curves. Since they form the basis

for the following experimental work, and lead to the conclusions of the paper, they are enumerated here:

- (1) For the small signal case of interest the fundamental and second harmonic grid signal frequency terms are independent of the type and amplitude of electrode motion.

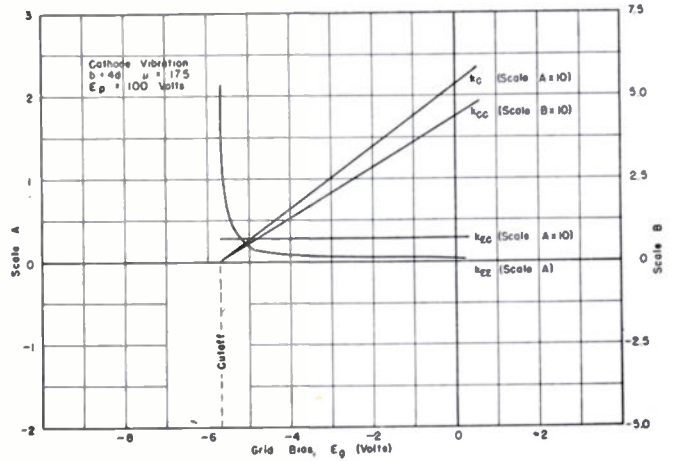

Fig. 5—Amplitudes of the plate-current components normalized with respect to  $K_E C_E$  for harmonic cathode vibration in the SC-839-Z single-triode section.  $C_E = 1.0$  volt,  $C_C = 1.0$  mm.

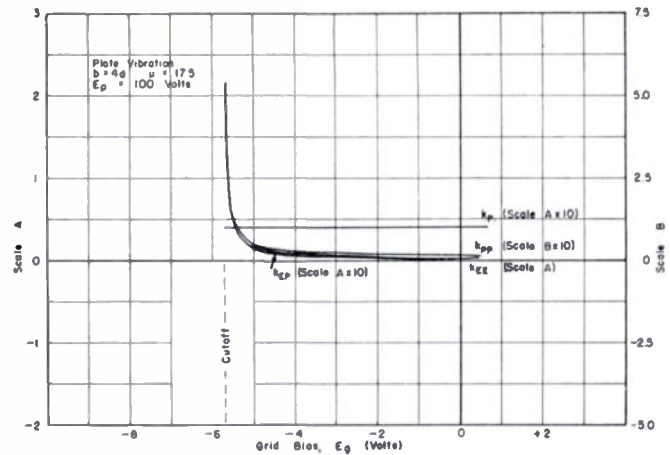

Fig. 6—Amplitudes of the plate-current components normalized with respect to  $K_E C_E$  for harmonic plate vibration in the SC-839-Z single-triode section.  $C_E = 1.0$  volt,  $C_P = 1.0$  mm.

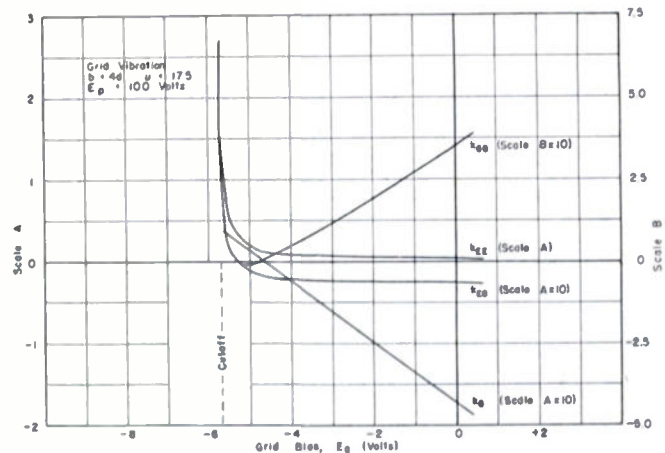

Fig. 7—Amplitudes of the plate-current components normalized with respect to  $K_E C_E$  for harmonic grid vibration in the SC-839-Z single-triode section.  $C_E = 1.0$  volt,  $C_G = 1.0$  mm.

(2) The variation of first-order microphonic effects with grid bias follows very different laws for motion of the three different electrodes. As the grid voltage becomes less negative,  $K_C$  increases concave upwards as in Fig. 2,  $K_P$  flattens off and increases but little as in Fig. 3, while  $K_G$  changes sign and passes through zero at a critical value of grid bias, Fig. 4. There is also appreciable difference in the various curves for both types of second-order effects involving mechanical motion. These differences become even more striking in the normalized curves of Figs. 5, 6, and 7.

(3) For the small-signal case and reasonable amplitudes of electrode motion, the intermodulation terms are very small, 30 to 40 db below the fundamental signal term for linear tube operation. This is not true for operation near cutoff.

### EXPERIMENTAL TUBES

The above theory was subjected to experimental verification with several commercial triodes, such as the 6A3, triode section of the 6K8, 6J6, etc. Most of these tubes have double-triode sections and, hence, the presence of mechanical displacement terms was indicative of asymmetry. It was determined that the great majority of the tubes tested, both as to type and quantity, at least to some degree, exhibited the phenomenon suggested by the theory.

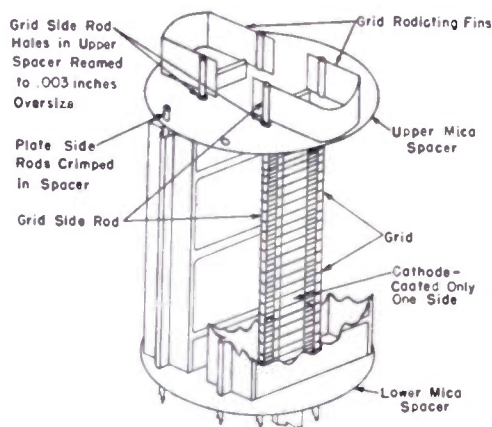

Fig. 8—Cutaway view of experimental triode, Sylvania SC-839-Z.

For the purposes of this paper, however, it is deemed adequate to describe the experimental results obtained with a special tube comprising a single-triode section. This tube was especially designed and constructed for this work.

The experimental planar single section triode has the Sylvania type number SC-839-Z. As indicated schematically in Fig. 8, the tube, which originally consisted of two unconnected double-triode sections, has been converted to two single-triode sections by coating the cathodes on one side only. Additional modification involved crimping of the plate side rods at the mica spacers to reduce possible plate motion and reaming the grid side rod holes in the spacers. The latter operation

was performed so that the grid might be relatively free to vibrate as a cantilever structure supported at the bottom and weighted at the top by the grid radiating fins. The spatial and electrical characteristics of the tube appear in Table I.

TABLE I  
ELECTRICAL AND SPATIAL CHARACTERISTICS  
OF THE SYLVANIA SC-839-Z

| Spatial Characteristics                               | Measured values    | Theoretical Values                    |
|---|--------------------|---------------------------------------|
| Grid-cathode distance, $d$                            | 0.360 mm           |                                       |
| Grid-plate distance, $b$                              | 1.416 mm           |                                       |
| Grid wires per unit length, $n$                       | 1.97 turns/mm      |                                       |
| Grid wire radius, $R$                                 | 0.028 mm           |                                       |
| Effective triode area, $A$                            | 65 mm <sup>2</sup> |                                       |
| Electrical Characteristics                            |                    | $E_p = 100$ volts<br>$E_G = -2$ volts |
| Amplification factor, $\mu$                           | 17.5               | 16.5                                  |
| Electrical transconductance, $s_p = K_g$              | 2.6 ma/volt        | 2.3 ma/volt                           |
| Mechanical transconductance for cathode motion, $K_C$ |                    | 46.4 ma/mm                            |
| Mechanical transconductance for plate motion, $K_P$   |                    | 13.6 ma/mm                            |
| Mechanical transconductance for grid motion, $K_G$    |                    | 32.8 ma/mm                            |

### EXPERIMENTAL ARRANGEMENT

The experimental arrangement involved equipment for simultaneously applying electrical and mechanical excitation to the tube. For comparison with the theory, sinusoidal excitations were required with known frequencies and known or constant amplitudes.

The schematic diagram of the electrical portion of the experimental arrangement is shown in footnote reference 1. Electrical signals of known frequency and amplitude were applied to the grid of the tube. Known and variable grid bias was available. The quiescent plate voltage was maintained constant by means of a plate voltmeter and adjustable plate power supply. A plate load of low dc resistance, but having a high impedance independent of plate current and nearly independent of frequency, was obtained by shunting a suitable choke with a fixed resistance. The output voltage across the plate load was amplified in a wide-band amplifier whose output, in turn, was observed with the aid of an oscilloscope and measured with an ac voltmeter or harmonic analyzer.

The tube was excited mechanically by means of a vibrator comprized of a modified dynamic speaker. The vibrator was designed for harmonic vibration, with load, over the frequency range of interest with a maximum amplitude of approximately 0.01 inch.

### EXPERIMENTAL PROCEDURE AND RESULTS

The experimental procedure involved placing the tube in the vibrator so that the resulting electrode motion would be perpendicular to the planes of the electrodes. For some fixed bias and plate voltage the frequency of the mechanical excitation was varied and the resulting

"microphonic" output of the tube recorded. These were limited to frequencies at which the output voltage was nearly sinusoidal, as observed with the aid of the oscilloscope, and for which the output amplitude was quite frequency dependent. The latter implies a mechanical resonance of one of the tube elements. For the SC-839-Z these resonances were found to occur over the frequency range 800 to 6,500 cps. The electrical signal was then applied to the grid and, for a given vibration frequency, the magnitudes of the various components of the "microphonic" output were measured with the harmonic analyzer. The frequency of the grid signal was chosen at some convenient value with respect to the mechanical excitation frequency so that the various components could be easily separated with the harmonic analyzer used. All of the following results refer to the SC-839-Z.

The first factor to be studied involves the use of the theory to determine which electrode is set into vibration as a result of mechanical excitation. These data were obtained from measurements on many tubes and are believed to be representative for this tube type. The procedure followed was to obtain measurements of the output voltage as a function of grid bias at the frequency of the mechanical excitation. This constitutes, essentially, a measurement of  $K_C$ ,  $K_P$  or  $K_G$ ; dependent upon the electrode set into vibration at this frequency. Equations (5), (8), and (11) indicate that the amplitudes of the terms associated with these coefficients are independent of the amplitude of the electrical grid signal, here set equal to zero. Reference to Figs. 2, 3, and 4 illustrates the fact that the amplitudes of the terms associated with these coefficients follow entirely different shaped curves whose characteristics may be used to determine which electrode is vibrating. These curve patterns are independent of the amplitudes of vibration of the various elements as long as a given amplitude is held constant during the measurements at a given frequency.

The results of such measurements for three different tube samples at three different frequencies appear in Fig. 9. Reference to the relevant curves of Figs. 2, 3,

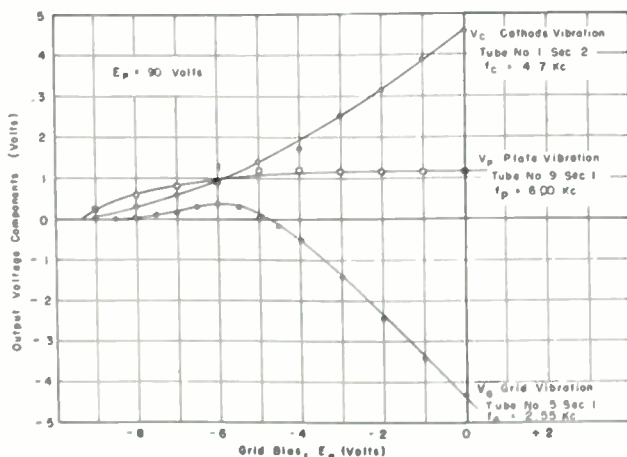

Fig. 9—Observed effects of grid bias variation on the output voltage component at the vibration frequency for cathode, plate, and grid resonances in the SC-839-Z.

and 4 indicates excellent agreement. The change in phase as  $V_G$ ,  $K_G$ , passes through zero was observed with the aid of an oscilloscope. It is concluded from these measurements that they may be utilized to determine the resonant mechanical frequencies of various electrode motions by a nondestructive electrical method.

The next factor to be considered is the measurement of the amplitudes of the various "microphonic" components when the tube is subjected to simultaneous electrical and mechanical excitation. While all of the theoretical curves were checked quite well, attention will be confined to the case of grid motion since this, in many ways, is the most interesting.

For these curves the frequency for the gravest mode of grid vibration was determined as outlined above. The electrical excitation was then applied and the amplitudes of the various output component frequencies were measured as a function of grid bias. Fig. 10 illustrates the results obtained for one tube. Comparison with Fig. 4 indicates excellent agreement with theory, the major discrepancies occurring near cutoff, as would be expected, due to the variation in  $\mu$  of the tube in this region.

These measurements appear to verify the theory both as regards to the shape of the curves and the relative magnitudes of the components. The relative magnitudes of the second-order components, and in particular  $V_{EG}$ , the intermodulation term, permit drawing certain conclusions which are believed to be of considerable importance in nonmicrophonic amplifier design for certain purposes. This will be discussed in the conclusion of the paper.

The normalization of the curves with respect to  $V_B$  is of interest in view of the discussion in connection with Fig. 7. The data of Fig. 10 have been normalized in this manner and the results appear in Fig. 11. The effect of amplification constant variation is emphasized here near cutoff, but good agreement with the theoretical curves is observed over most of the range of grid bias voltages.

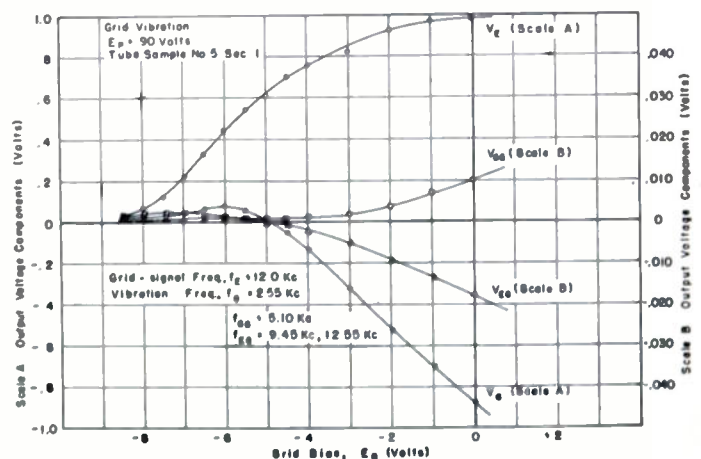

Fig. 10—Observed effects of grid bias variation on the output voltage components for grid vibration in the SC-839-Z.

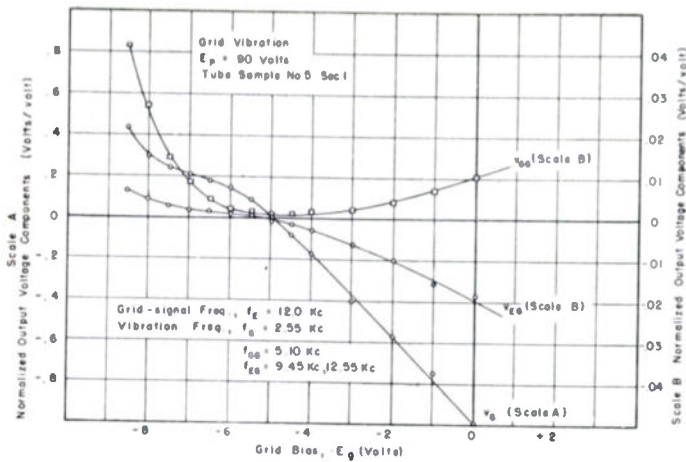

Fig. 11—Effects of grid bias variation on the output voltage components normalized with respect to  $V_E$  for grid vibration in the SC-839-Z.

### CONCLUSIONS

Aside from the obvious conclusions regarding the experimental verification of the theory there are several factors which appear to be of importance in the practical use of the work presented. These are enumerated below:

(1) The output component of the tube studied at the frequency of the grid signal, that is, the signal output of the tube, is completely independent of the mode or amplitude of electrode vibration within the practical limitation of small signal theory.

(2) Intermodulation between the electrical grid-signal and the mechanical vibration exists for all types of electrode motion over the entire operating range of the tube. The effect is second-order, however, and of negligible proportions for operation in the linear region of the tube characteristics. Theory predicts a considerable increase in the amplitude of the intermodulation components as cutoff is approached, but this condition is often not realized in practice because of the deviation of the tube amplification factor from its normally constant value.

(3) The output components, at the fundamental vibration frequencies, are readily distinguishable for the cases of harmonic cathode motion, plate motion, and grid motion when these components are measured at constant plate voltage over a range of grid bias values.

The third factor provides a simple method for identifying the principal vibrating electrode of a triode, at a given frequency, from purely external electrical measurements. For this purpose the tube is driven mechanically with constant amplitude at one of its resonant frequencies and the grid is held at zero ac potential. The output component at the frequency of vibration is measured as the grid bias is varied from zero to cutoff. Identification of the types of electrode motion is then made by comparing this result with the known patterns of variation of this component with grid bias as shown in Figs. 2, 3, 4, and 9.

This method may be used to establish the nature of

the various mechanical resonances of the tube, and should prove useful in tube development work where it is desirable to eliminate these resonances.

The first and second factors suggest a method for very considerably reducing the microphonic components in the output of amplifier systems where the intelligence to be amplified is of an audio-frequency character. Practical examples are found in strain gage, telemetering, and numerous other types of high-gain amplifier systems.

As is well known, nearly all microphonic components in the output of practical tubes have frequencies lying in the audio-frequency range. Thus, signal amplification in this frequency range will be subject to interference from microphonism in a great many applications of practical interest. An effective method for microphonic reduction is the rejection of the undesirable components of the plate current by use of a filter in the plate circuit tuned to the grid signal frequency. This, of course, requires that the grid signal frequency be far enough above the range of microphonic frequencies that neither the fundamental nor the second harmonic microphonic frequency component lies within the pass band of the filter.

If the intelligence to be amplified is of an audio-frequency character, both the carrier and the sidebands must be passed and the intermodulation components resulting from the motion of the electrodes will unavoidably also be passed. The success of the method thus hinges upon the fact that, within the linear operating region of the transfer characteristic, the intermodulation components are negligible. This has theoretically and experimentally been shown to be the case for normal amplitudes of vibration.

Based on the present theoretical and experimental work, a high gain amplifier system has been built in accordance with the above suggestion. Various types of input tubes have been utilized; including high gain pentodes of standard and miniature size. The amplifier was modified for either audio- or carrier-frequency operation at constant gain, and tests conducted under conditions of severe mechanical vibration. The reduction of microphonism by the above method was observed to be of the order of 30 to 40 db. Thus, the theory developed for a simple-triode structure, and verified with an experimental tube especially constructed for this purpose, has been found to be applicable to the more complicated tube types usually employed in high-gain amplifier systems.

### ACKNOWLEDGMENTS

We are greatly indebted to R. W. Slinkman and Sylvania Electric Products Inc., for designing and furnishing the special tubes for this work. One of the authors, J. A. W., is indebted to the Ordnance Research Laboratory for a Fellowship covering the period of the investigation.

# Radio Wave Propagation in a Curved Ionosphere\*

JOHN M. KELSO†

**Summary**—Using a double parabola approximation to the Chapman distribution of electron density as a function of height, and the assumption of a curved-ionosphere, curved-earth geometry, analytic expressions are obtained for the true height of reflection, ray path, reflection coefficient, ground range, and group path. Graphical results are given for the maximum usable frequency factor. Where possible, the above results are compared with results obtained by assuming a plane ionosphere.

All of these calculations are made under the usual restrictions of neglecting the earth's magnetic field and most of the effects of collisions of electrons with heavy particles.

## INTRODUCTION

THE CHAPMAN distribution<sup>1</sup> is generally accepted as representing the height variation of the electron density in the *E* and *F*<sub>1</sub> layers of the ionosphere. Hacke<sup>2</sup> has made a double parabola approximation to this distribution, and a single parabola approximation to the height variation of the product of electron density times the collision frequency. These approximations were applied to obtain analytic expressions for the true and group heights of reflection, and the reflection coefficient for a wave incident vertically on a deviating layer. For frequencies greater than about one half of the vertical incidence critical frequency, these results showed excellent agreement with those obtained by Jaeger<sup>3</sup> using numerical integration of the exact Chapman relations.

Hacke and Kelso<sup>4</sup> then extended this work to consider the case of oblique incidence on a plane ionosphere. The results obtained were independent of the geometry of the earth, and gave analytic expressions for the true and apparent heights of reflection, the ray paths, the range in the ionosphere, and for the reflection coefficient.

The present work extends the above, plane ionosphere, case to include the effects of both a plane and a curved earth; and then extends the entire treatment to the case of a spherical ionosphere concentric with a spherical earth. In addition to the quantities determined above, analytic expressions are given for the ground range and the group path as a function of frequency; and graphical results are given for the maximum usable frequency.

This work is done under the following restrictions: (1)

\* Decimal classification: R112. Original manuscript received by the Institute, June 23, 1949; revised manuscript received, December 19, 1949.

† Radio Propagation Laboratory, The Pennsylvania State College, State College, Pa.

<sup>1</sup> S. Chapman, "The absorption and dissociative or ionizing effect of monochromatic radiation in an atmosphere on a rotating earth," *Proc. Phys. Soc.*, vol. 43, pp. 698-706; May, 1947.

<sup>2</sup> J. E. Hacke, Jr., "An approach to the approximate solution of the ionosphere absorption problem," *Proc. I.R.E.*, vol. 36, pp. 724-727; June, 1948.

<sup>3</sup> J. C. Jaeger, "Equivalent path and absorption in an ionosphere region," *Proc. Phys. Soc.*, vol. 59, pp. 87-96; January, 1947.

<sup>4</sup> J. E. Hacke, Jr., and J. M. Kelso, "An approximate solution of the problem of path and absorption of a radio wave in a deviating ionosphere layer," *Proc. I.R.E.*, vol. 36, pp. 1477-1481; December, 1948.

all assumptions made for the Chapman distribution must hold; (2) the earth's magnetic field is neglected; (3) the angular operating frequency is assumed to be very much greater than the collision frequency throughout the region considered; (4) the absorption per vacuum wavelength is assumed to be small; (5) the electron density is assumed to be a function of radial (vertical) distance only; and (6) the Sellmeyer theory of dispersion is used.

## SUMMARY OF PREVIOUS RESULTS

It is well known that the electron density in a Chapman region is given by

$$N = N_m Ch(x) \tag{1}$$

where

$$Ch(x) = \exp 1/2 \{ 1 - x - \exp(-x) \} \tag{2}$$

$$x = (h - h_m) / H - \ln \sec \chi$$

*N*<sub>m</sub> = the maximum value of the electron density, occurring at *x* = 0

*H* = the "scale height" of the atmosphere in the region where the ionization is produced; division by *H* yields distances in "scale units," in which all distances are to be measured, unless otherwise specified

*h*<sub>m</sub> = the height at which *N* is a maximum when  $\chi = 0$

$\chi$  = the sun's angular distance from the zenith.

In the two previous papers, mentioned above, on the double parabola approximation, vertical distances were measured in *x* units down from the level of maximum ionization. In the present instance it is simpler to measure up from the bottom of the layer in *y* units, where

$$y = x - x_2 = 2.7811 + x. \tag{3}$$

(*x*<sub>2</sub> = -2.7811 is the bottom of the layer, i.e., the level at which the layer vanishes). In this notation, the distribution in (2) is approximated by the two parabolas

$$P_1(y) = 1 - (y - 2.7811)^2 / T^2,$$

$$y_1 = 1.4641 < y < y_m = 2.7811; \tag{4}$$

$$P_2(y) = A^2 y^2, \quad 0 < y < y_1. \tag{5}$$

In these equations *T* = 1.848, and *A* = 0.4792 are parameters adjusted to fit (2), *y*<sub>1</sub> is the negative point of inflection of the Chapman distribution, *y*<sub>m</sub> is the level of maximum ionization.

In the following work the region where the parabola *P*<sub>1</sub>(*y*) is used is called the "upper region"; the region where the parabola *P*<sub>2</sub>(*y*) is used is called the "lower region." When integration is needed to determine any quantity, it is necessary to consider three cases:

- Case (1) Quantity in the upper region; reflection in the upper region;
- Case (2) Quantity in the lower region; reflection in the lower region;
- Case (3) Quantity in the lower region; reflection in the upper region.

When reflection occurs in the upper region, the quantity is given by the sum of the results of Cases (1) and (3). This designation will be preserved throughout, and a corresponding numerical subscript will be attached to the symbol for the quantity being considered.

The index of refraction in a Chapman layer, under the present restrictions, is given by

$$\mu^2 = 1 - Ch(x)/R^2, \tag{6}$$

where  $R$  is the ratio of wave frequency to the vertical incidence critical frequency; and the absorption per unit path length is given by

$$k = K_m Ch(x)e^{-z}/(\mu R^2), \tag{7}$$

where

- $K_m = \nu_m/2c$
- $\nu_m$  = the value of the collision frequency,  $\nu$ , at  $x=0$
- $c$  = the velocity of light in free space.

The quantity  $Ch(x)e^{-z}$  may be approximated by the parabola,

$$Ch(x)e^{-z} = P_3(y) = b_0 + b_1y + b_2y^2, \quad y_3 < y < y_m, \tag{8}$$

where  $b_0 = -1.7162$ ,  $b_1 = 4.1236$ ,  $b_2 = -1.1696$ , and  $y_3 = 0.4821$  is the lower level at which the parabola  $P_3(y)$  vanishes.

The ratios

$$N/N_m = Ch(x) \quad \text{and} \quad N\nu/(N_m\nu_m) = Ch(x)e^{-z}$$

are plotted in Fig. 1 as functions of  $x$ . The parabolic approximations  $P_1(y)$ ,  $P_2(y)$ , and  $P_3(y)$  are shown dotted.

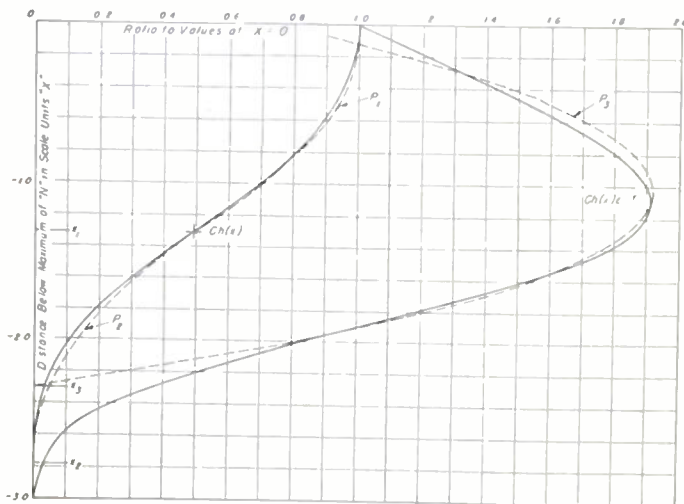

Fig. 1—Ion density and its product with collision frequency as functions of height in scale units below point of maximum ion density. Solid curves, Chapman distributions; dashed curves, parabolic approximations.

TRUE HEIGHT OF REFLECTION

The ionosphere is assumed to consist of uniform spherical shells, such that the electron density as a function of radial distance from the center of the earth follows the double parabola approximation given previously. Fig. 2 is a diagram of the trajectory of a ray through the curved ionosphere.

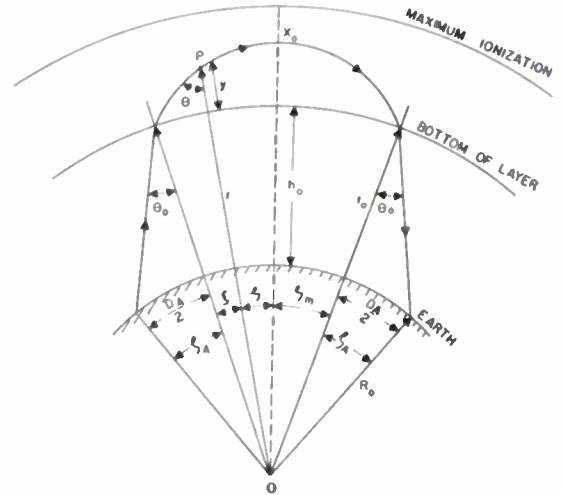

Fig. 2—Diagram showing ray path of a radio wave in a curved ionosphere concentric with a curved earth.

Here

- $R_0$  = the radius of the earth
- $h_0$  = the height of the bottom of the ionosphere layer
- $\zeta_m$  = the angular half range in the ionosphere
- $\theta_0$  = the angle of incidence on the layer.

If  $\mu$  is the index of refraction at any point  $P$ , at a distance of  $r$  from the center of the earth, where the ray makes the angle  $\theta$  with a radial direction, then Bouger's rule gives

$$\mu r \sin \theta = \mu_0 r_0 \sin \theta_0, \tag{9}$$

where the subscript  $_0$  refers to the bottom of the layer, so that  $r_0 = R_0 + h_0$ .

The condition for reflection is that the ray turn perpendicular to the radius at the "point of reflection"  $y_0$ , i.e.,  $\theta = 90^\circ$ . Applying this condition to (9), we get

$$\mu(y_0) = (\mu_0 r_0 \sin \theta_0)/r.$$

If the reflection occurs in the upper region, we may write  $\mu$  from (6), and obtain via (4) the following expression for  $y_0$ :

$$y_0 = 2.7811 - T \sqrt{1 - R^2 \left(1 - \frac{r_0^2}{r^2} \sin^2 \theta_0\right)},$$

$$y_1 < y_0 < y_m. \tag{10}$$

In (10),  $r = r_0 + y_0$ , and, consequently, (10) is not actually solved for  $y_0$ . A true solution would involve a quartic equation, and hence, for practical purposes, it has been found simpler to solve (10) by successive approximations. It should be noted here that it can be



shown<sup>5</sup> that there is a level  $x_m$ , lying below the level of maximum ionization, which gives the highest level at which reflections can occur for a particular value of  $R$ .

When reflection occurs in the lower region,  $0 < y < y_1$ , we approximate  $Ch(x)$  by  $P_2(y)$ , and obtain, as above,

$$y_0 = \frac{R}{A} \sqrt{1 - \frac{r_0^2}{r^2} \sin^2 \theta_0}, \quad 0 < y_0 < y_1; \quad (11)$$

where again we solve by successive approximations.

RAY PATHS

It has been shown by Forsterling and Lassen<sup>6</sup> that the angular distance  $\xi$  of the ray in the ionosphere can be approximated by the integral

$$\xi = \frac{\sin \theta_0}{r_0} \int_0^y \frac{dy}{\sqrt{(\alpha - \sin^2 \theta_0) + \left(\beta + \frac{2}{r_0} \sin^2 \theta_0\right) y + \gamma y^2}}, \quad (12)$$

if we define  $\alpha, \beta$  and  $\gamma$  by the relation

$$\mu^2 = \alpha + \beta y + \gamma y^2. \quad (13)$$

It is now useful to introduce the values of  $\alpha, \beta$ , and  $\gamma$  from the parabolic approximations  $P_1(y)$  and  $P_2(y)$ .

Case (1) Upper Region ( $y_1 < y < y_m$ ).

$$\xi_3 = \frac{\sin \theta_0}{r_0} \left[ -RT \ln \left\{ \frac{\sqrt{\alpha_1' + \beta_1' y_1 + \gamma_1' y_1^2} + y_1/RT + (1/2)RT\beta_1'}{\sqrt{\alpha_1' + \beta_1' y_0 + \gamma_1' y_0^2} + y_0/RT + (1/2)RT\beta_1'} \right\} + \frac{1}{\sqrt{-\gamma_2'}} \left\{ \sin^{-1} \left( \frac{2\gamma_2' y_1 + \beta_2'}{\sqrt{-q}} \right) - \sin^{-1} \left( \frac{2\gamma_2' y + \beta_2'}{\sqrt{-q}} \right) \right\} \right], \quad 0 < y < y_1 < y_0. \quad (19)$$

From equations (4) and (6) we obtain

$$\left. \begin{aligned} \alpha_1' &= \alpha_1 - \sin^2 \theta_0 = \frac{T^2 R^2 - T^2 + (2.7811)^2}{T^2 R^2} - \sin^2 \theta_0 \\ \beta_1' &= \beta_1 + \frac{2}{r_0} \sin^2 \theta_0 = \frac{-5.5622}{T^2 R^2} + \frac{2}{r_0} \sin^2 \theta_0 \\ \gamma_1' &= \gamma_1 = \frac{1}{T^2 R^2} \end{aligned} \right\} \quad (14)$$

It is useful to measure the angle of travel from the highest point of the trajectory  $y_0$ , so we make the change of variable

$$\zeta = \xi(y) - \xi(y_0).$$

Substituting (14) into (12), integrating from  $y_1$  to  $y$ , and evaluating  $\xi(y_0)$ , we obtain

$$\zeta_1 = \frac{RT \sin \theta_0}{r_0} \ln \left\{ \frac{\sqrt{\alpha_1' + \beta_1' y + \gamma_1' y^2} + y/RT + (1/2)RT\beta_1'}{\sqrt{\alpha_1' + \beta_1' y_0 + \gamma_1' y_0^2} + y_0/RT + (1/2)RT\beta_1'} \right\}, \quad y_1 < y_0 < y_m. \quad (15)$$

Because of the limit as the reflection height  $y_0$  approaches  $y_m$ , we are forced to use the negative square root in this equation. This same choice was required in the oblique incidence plane ionosphere case.

Case (2) Lower Region ( $0 < y_0 < y_1$ ).

From equations (5) and (6) we obtain

$$\left. \begin{aligned} \alpha_2' &= \alpha_2 - \sin^2 \theta_0 = \cos^2 \theta_0 \\ \beta_2' &= \beta_2 + \frac{2}{r_0} \sin^2 \theta_0 = \frac{2}{r_0} \sin^2 \theta_0 \\ \gamma_2' &= \gamma_2 = -A^2/R^2 \end{aligned} \right\} \quad (16)$$

Integrating and changing variable as in Case (1), we obtain

$$\xi_2 = \frac{\sin \theta_0}{r_0 \sqrt{-\gamma_2'}} \left[ \sin^{-1} \left\{ \frac{2\gamma_2' y_0 + \beta_2'}{\sqrt{-q}} \right\} - \sin^{-1} \left\{ \frac{2\gamma_2' y + \beta_2'}{\sqrt{-q}} \right\} \right], \quad 0 < y < y_0 < y_1, \quad (17)$$

where

$$q = 4\alpha_2' \gamma_2' - (\beta_2')^2. \quad (18)$$

Case (3) Lower Region ( $0 < y < y_1 < y_0$ ).

When the ray is reflected in the upper region, we want the origin of the angular displacement for the lower region to be at the same point as for the upper region. We accomplish this by allowing  $y_0 = y_1$  in (17), and add to this the range of the ray in the upper region, obtained from (15) by writing  $y = y_1$ . Then

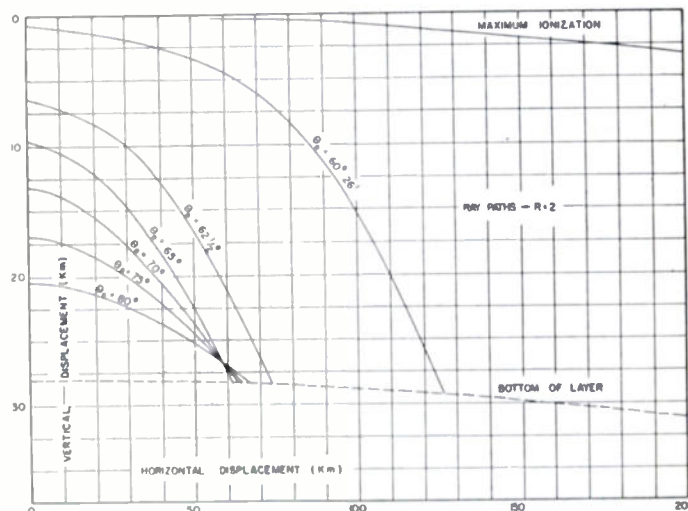

Fig. 3—Ray paths in a curved ionosphere with the angle of incidence  $\theta_0$  as a parameter. The ratio of wave frequency to vertical incidence critical frequency,  $R=2.0$ .

<sup>5</sup> J. M. Kelso, "A note on the maximum height of reflection of a radio wave in a curved ionosphere layer," *Jour. Appl. Phys.*, vol. 20, pp. 632-633; June, 1949.

<sup>6</sup> K. Forsterling and H. Lassen, "Die Ionisation der Atmosphäre und die Ausbreitung der kurzen elektrischen Wellen (10-100m) über der Erde. III," *Zeit. Tech. Phys.*, vol. 12, pp. 502-527; November, 1931.

A set of ray paths in a curved ionosphere is shown in Fig. 3, along with two curves to indicate the bottom of the layer and the level of maximum ionization, respectively. It was necessary to distort this figure by using a very different scale horizontally than that used vertically. The horizontal displacements are measured from the point of reflection.

The set of paths shown is for the value  $R=2.0$ , and for the values of the angle of incidence,  $\theta_0=80^\circ, 75^\circ, 70^\circ, 65^\circ, 62^\circ 30', 60^\circ 26'$ . This last, rather peculiar, choice was made because it is the highest reflected ray for which it was convenient to calculate. It is interesting to note that, for reflection in the lower region, the range in the ionosphere increases with increasing angle of incidence.

#### REFLECTION COEFFICIENT

The principal feature of the present study is the calculation of the reflection coefficient in a curved ionosphere, which has not previously been studied in closed form, although Jaeger<sup>7</sup> has given some results obtained by numerical integration of the exact Chapman relation.

$$\begin{aligned} \ln \rho_1 = & \frac{2HK_m}{R^2} \left[ \left\{ b_0 RT - \frac{b_1 R^3 T^3 \beta_1'}{2} + b_2 \left( \frac{3\beta_1'^2 - 4\alpha_1' \gamma_1'}{8} \right) R^5 T^5 \right\} \right. \\ & \times \ln \left\{ \frac{\sqrt{\alpha_1' + \beta_1' y_0 + \gamma_1' y_0^2} + y_0' RT + (1/2) RT \beta_1'}{\sqrt{\alpha_1' + \beta_1' y_1 + \gamma_1' y_1^2} + y_1' RT + (1/2) RT \beta_1'} \right\} \\ & + \left\{ b_1 R^2 T^2 + b_2 R^2 T^2 \left( \frac{y_0}{2} - \frac{3R^2 T^2 \beta_1'}{4} \right) \right\} \sqrt{\alpha_1' + \beta_1' y_0 + \gamma_1' y_0^2} \\ & \left. - \left\{ b_1 R^2 T^2 + b_2 R^2 T^2 \left( \frac{y_1}{2} - \frac{3R^2 T^2 \beta_1'}{4} \right) \right\} \sqrt{\alpha_1' + \beta_1' y_1 + \gamma_1' y_1^2} \right]. \end{aligned} \quad (22)$$

We wish to determine the fraction of the incident field that is ultimately sent back from the ionosphere. This fraction is given by the reflection coefficient  $\rho$ .

$$\rho = \exp \left( -2 \int k ds \right),$$

$$\begin{aligned} \ln \rho_2 = & \frac{2HK_m}{R^2} \left[ \left\{ \frac{b_0 R}{.1} + \frac{b_1 \beta_2' R^3}{2.1^3} + b_2 \left( \frac{3\beta_2'^2 - 4\alpha_2' \gamma_2'}{8} \right) R^5 \right\} \right. \\ & \times \left\{ \sin^{-1} \left( \frac{2\gamma_2' y_3 + \beta_2'}{\sqrt{-q}} \right) - \sin^{-1} \left( \frac{2\gamma_2' y_0 + \beta_2'}{\sqrt{-q}} \right) \right\} \\ & - \left\{ \frac{b_1 R^2}{.1^2} + \frac{b_2 R^2}{.1^2} \left( \frac{y_0}{2} + \frac{3\beta_2' R^2}{4.1^2} \right) \right\} \sqrt{\alpha_2' + \beta_2' y_0 + \gamma_2' y_0^2} \\ & \left. + \left\{ \frac{b_1 R^2}{.1^2} + \frac{b_2 R^2}{.1^2} \left( \frac{y_3}{2} + \frac{3\beta_2' R^2}{4.1^2} \right) \right\} \sqrt{\alpha_2' + \beta_2' y_3 + \gamma_2' y_3^2} \right]. \end{aligned} \quad (23)$$

where  $ds$  is the element of path length along the trajectory, and  $k$  is the absorption coefficient given by (7). It is easy to show that

$$ds = \frac{H\mu r dr}{\sqrt{\mu^2 r^2 - r_0^2 \sin^2 \theta_0}}. \quad (20)$$

We now approximate  $Ch(x)e^{-x}$  by  $P_3(y)$ , and write  $\mu^2$  from (13). Since  $r=r_0+y$ , we make the same approximation as was made in the ray path case and obtain for  $\ln \rho$ ,

$$\ln \rho = - \frac{2HK_m}{R^2} \int \frac{P_3(y) dy}{\sqrt{\alpha' + \beta' y + \gamma' y^2}}, \quad (21)$$

where  $\alpha'$ ,  $\beta'$ , and  $\gamma'$  are to be obtained from (14) or (16) depending upon the region in which the integration is to be taken.

*Case (1) Upper region ( $y_1 < y < y_m$ ).*

Integrating from  $y_1$  to  $y_0$ , and making the choice of the negative sign before the square root, we obtain

*Case (2) Lower Region ( $0 < y < y_0 < y_1$ ).*

Integrating from  $y_3$  to  $y_0$  (since  $P_3(y)$  is undefined from  $0 \leq y < y_3$ ), we obtain

*Case (3) Lower Region ( $0 < y < y_1 < y_0$ ).*

Integrating from  $y_3$  to  $y_1$  results in

<sup>7</sup> J. C. Jaeger, "Equivalent path and absorption for oblique incidence on a curved ionospheric region," *Proc. Phys. Soc.*, vol. 61, pp. 78-86; July, 1948.

$$\begin{aligned} \ln \rho_3 = & -\frac{2HK_m}{R^2} \left[ \left\{ \frac{b_0 R}{A} + \frac{b_1 \beta_2' R^3}{2A^3} + b_2 \left( \frac{3\beta_2'^2 - 4\alpha_2' \gamma_2'}{8} \right) \frac{R^5}{A^5} \right\} \right. \\ & \times \left\{ \sin^{-1} \left( \frac{2\gamma_2' y_3 + \beta_2'}{\sqrt{-q}} \right) - \sin^{-1} \left( \frac{2\gamma_2' y_1 + \beta_2'}{\sqrt{-q}} \right) \right\} \\ & - \left\{ \frac{b_1 R^2}{A^2} + \frac{b_2 R^2}{A^2} \left( \frac{y_1}{2} + \frac{3\beta_2 R^2}{4A^2} \right) \right\} \sqrt{\alpha_2' + \beta_2' y_1 + \gamma_2' y_1^2} \\ & \left. + \left\{ \frac{b_1 R^2}{A^2} + \frac{b_2 R^2}{A^2} \left( \frac{y_3}{2} + \frac{3\beta_2' R^2}{4A^2} \right) \right\} \sqrt{\alpha_2' + \beta_2' y_3 + \gamma_2' y_3^2} \right]. \end{aligned} \tag{24}$$

Using (22), (23), and (24) we plot  $(-R \ln \rho)/(HTK_m)$  as a function of the angle of incidence for  $R=1.5, 2, 3, 4, 5$  in Fig. 4. Using the curve of range versus angle of incidence, Fig. 7 (to be given later), we may plot  $(-\ln \rho)/(K_m)$  as a function of the ground range. This is given for each of the cases: (i) plane ionosphere, plane

earth (PI-PE); (ii) plane ionosphere, curved earth (PI-CE); and (iii) curved ionosphere, curved earth (CI-CE); in Figs. 5 and 6 for  $R$  equal to 3 and 4, respectively. The scale height has been chosen as 10 km, and the height of the bottom of the layer as 90 km. The plane ionosphere results are readily obtained from the material given by Hacke and Kelso,<sup>4</sup> by applying simple geometrical relations to the expressions for the range in the ionosphere.

These curves show the rather surprising result that, even for quite large values of  $R$ , the plane-ionosphere, curved-earth geometry gives very good results for the reflection coefficient. However, it is important to have the curved ionosphere results, because in a complete calculation of the field intensities it is necessary to use the correct geometry in order to be able to include divergence or convergence effects of the beam in the ionosphere.

GROUND RANGE

The angular range in the ionosphere itself may be found directly from (17) and (19) by writing  $y=0$ . The ground range corresponding to this angle is found by multiplying the angle in radians by the radius of the earth  $R_0$ . The ground range corresponding to the por-

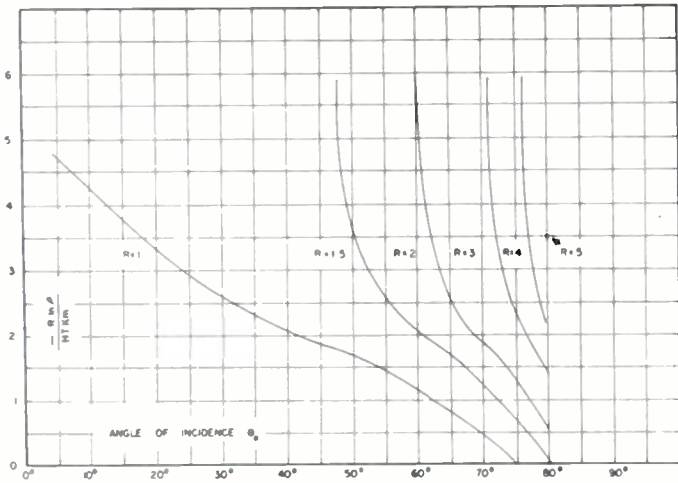

Fig. 4— $(-R \ln \rho)/(HTK_m)$  as a function of the angle of incidence  $\theta_0$  with  $R$  as a parameter. Curved ionosphere;  $H=10$  km,  $h_0=90$  km.

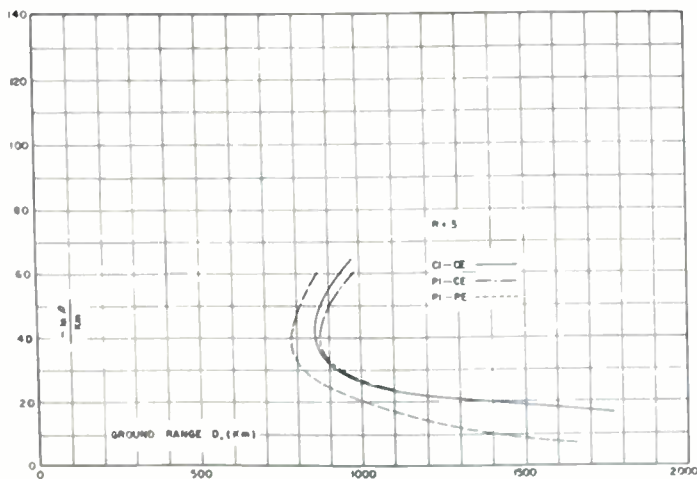

Fig. 5— $(-\ln \rho)/(K_m)$  as a function of ground range  $D$ , for the three ionosphere-earth geometries.  $R=3.0, H=10$  km,  $h_0=90$  km.

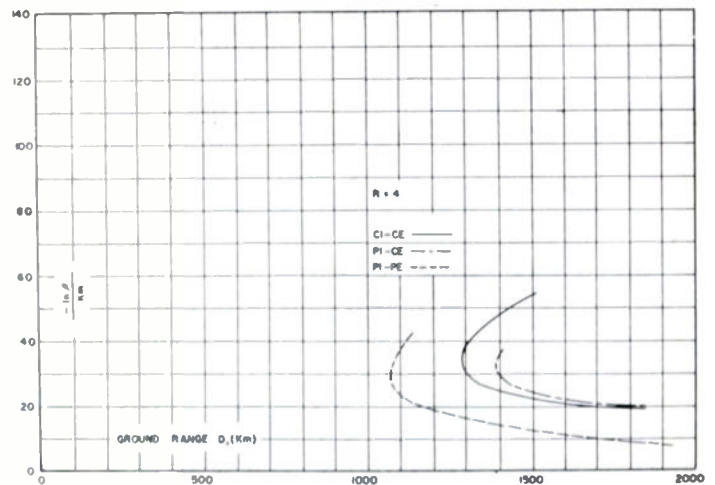

Fig. 6— $(-\ln \rho)/(K_m)$  as a function of ground range  $D$ , for the three ionosphere-earth geometries.  $R=4.0, H=10$  km,  $h_0=90$  km.

tion of the trajectory between the earth and the ionosphere was given approximately by Smith<sup>8</sup> as

$$2R_0 \cot \theta_0 - 2R_0 \sqrt{\cot^2 \theta_0 - 2h_0/R_0}$$

Fig. 7 shows the ground range as a function of the angle of incidence with  $R$  as a parameter for a scale height of 10 km and a height of the bottom of the layer of 90 km.

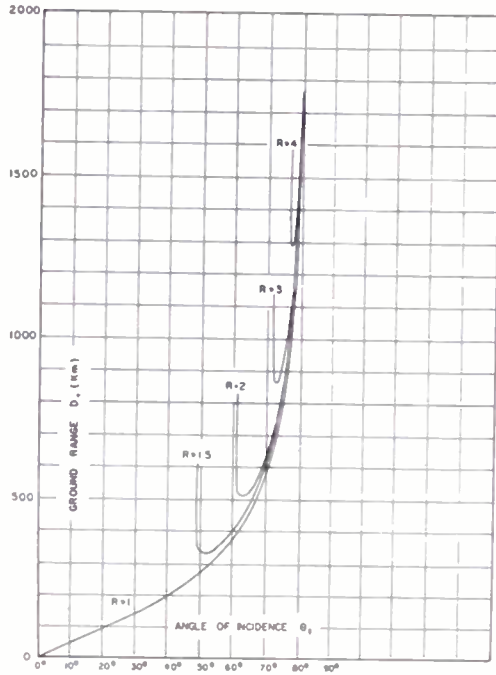

Fig. 7—Ground range  $D$  as a function of angle of incidence  $\theta_0$ , with  $R$  as a parameter. Curved ionosphere;  $H=10$  km,  $h_0=90$  km.

GROUP PATH

The group path in the curved ionosphere may be determined by the use of the well-known relation

$$P' = 2 \int_{\mu=1}^{\mu(y_0)} ds/\mu,$$

where the expression for  $ds$  is given above. Introducing  $\mu$  as before,

$$P' = 2H \int_0^{y_0} \frac{dy}{\sqrt{\alpha' + \beta'y + \gamma'y^2}}$$

Case (1) Upper Region ( $y_1 < y_0 < y_m$ ).

Substituting  $\alpha'$ ,  $\beta'$ , and  $\gamma'$  from (14) and integrating from  $y_1$  to  $y_0$ .

$$P_1' = -2HRT \ln \left\{ \frac{\sqrt{\alpha_1' + \beta_1'y_0 + \gamma_1'y_0^2} + y_0/RT + (1/2)RT\beta_1'}{\sqrt{\alpha_1' + \beta_1'y_1 + \gamma_1'y_1^2} + y_1/RT + (1/2)RT\beta_1'} \right\} \quad (25)$$

where we have prefixed a negative sign because of the choice of square root as before.

Case (2) Lower Region ( $0 < y_0 < y_1$ ).

Using (16) and integrating from 0 to  $y_0$ ,

$$P_2' = \frac{2HR}{A} \left[ \sin^{-1} \left( \frac{\beta_2'}{\sqrt{-q}} \right) - \sin^{-1} \left( \frac{2\gamma_2'y_0 + \beta_2'}{\sqrt{-q}} \right) \right] \quad (26)$$

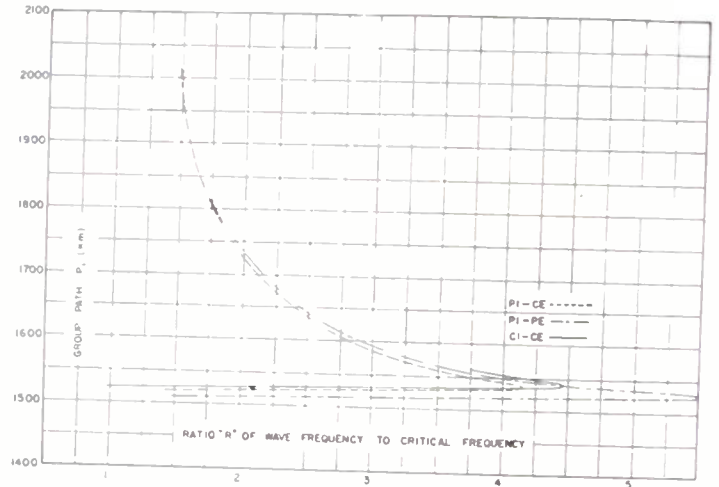

Fig. 8—Group path  $P'$  as a function of the ratio  $R$  of wave frequency to vertical incidence critical frequency, for a ground range,  $D=1,500$  km,  $H=10$  km,  $h_0=90$  km.

Case (3) Lower Region ( $0 < y < y_1 < y_0$ ).

Using (16) and integrating from 0 to  $y_1$ ,

$$P_3' = \frac{2HR}{A} \left[ \sin^{-1} \left( \frac{\beta_2'}{\sqrt{-q}} \right) - \sin^{-1} \left( \frac{2\gamma_2'y_1 + \beta_2'}{\sqrt{-q}} \right) \right] \quad (27)$$

In the same manner as in the range calculations it can be shown that the group path from the ground to the ionosphere is given approximately by

$$P' = \frac{2R_0 \cot \theta_0 - 2R_0 \sqrt{\cot^2 \theta_0 - 2h_0/R_0}}{\sin \theta_0}$$

To obtain the complete group path from the transmitter to the receiver, we add this last quantity to the results obtained in (25), (26), and (27).

<sup>8</sup> N. Smith, "The relation of radio sky-wave transmission to ionosphere measurements," PROC. I.R.E., vol. 27, pp. 332-347; May, 1939.

In the plane ionosphere cases the group path is determined by using the theorem of Breit and Tuve.<sup>9</sup>

Fig. 8 shows the group path plotted as a function of  $R$  for a ground range of 1,500 km for the three geometries, and for a scale height of 10 km, and a height of the bottom of the layer of 90 km.

#### MAXIMUM USABLE FREQUENCY

The maximum usable frequency for a given ground range is the greatest frequency for which a signal is transmitted over that range. It corresponds to the minimum points of the range versus angle of incidence curves given above, or to the "nose" of the  $P'$ - $R$  curves. Appleton and Beynon<sup>10</sup> have determined this quantity analytically and graphically for the single parabola approximation and a number of different geometrical configurations.

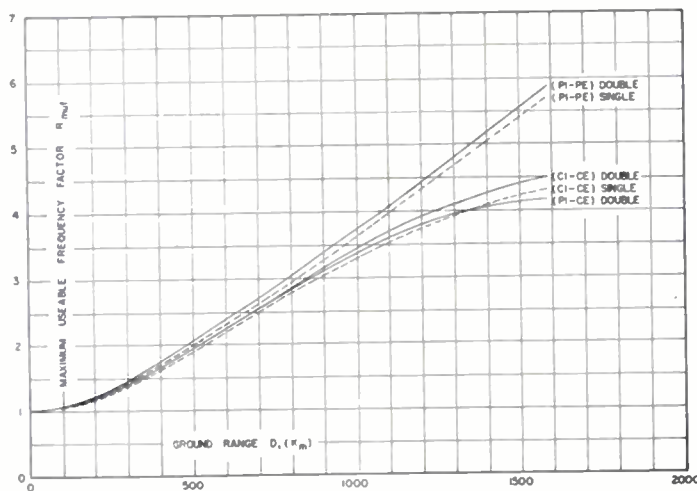

Fig. 9—Maximum usable frequency factor  $R_{muf}$ , as a function of ground range  $D$ . Shown for the single and double parabola approximations for the various geometries.  $H=10$  km,  $h_0=90$  km.

<sup>9</sup> G. Breit and M. A. Tuve, "A test of the existence of the conducting layers," *Phys. Rev.*, vol. 28, pp. 554-573; September, 1926.

<sup>10</sup> E. V. Appleton and W. J. Beynon, "The application of ionospheric data to radio-communication problems: Part I," *Proc. Phys. Soc.*, vol. 52, pp. 518-533; July, 1940.

Similar results have been obtained here for the ( $PI-PE$ ) geometry (analytic), and for the ( $PI-CE$ ) and ( $CI-CE$ ) geometries (graphic) using the double parabola approximation. The maximum usable frequency factor,  $R_{muf} = f_{muf}/f_c$ , is given as a function of ground range for each of the cases above, plus the ( $PI-PE$ ) and ( $CI-CE$ ) cases using the single parabola approximation, in Fig. 9.

#### CONCLUSIONS

Most of the conclusions have been taken up under the individual headings. Aside from the determination of the reflection coefficient, which Hacke<sup>2</sup> has shown to be completely useless at vertical incidence, it might be noted that one of the principal results of the present work is to show that the use of the single parabola is usually justified. This is observed in the group path, where the single parabola curves were not shown because the difference between the single and double parabola approximation only appeared in a displacement of the "nose" of the curve. This displacement is better illustrated in the maximum usable frequency factor curves, where it is seen that the geometry used is more critical than the choice of the two parabolic approximations.

#### ACKNOWLEDGMENTS

The author wishes to express his indebtedness to A. H. Waynick, who supervised this work, and whose advice and assistance were of great value. The large quantities of numerical calculations were performed by Mrs. G. B. Younkin.

This work is taken (in a slightly altered form) from a dissertation submitted in partial fulfillment of the requirements for the degree of Doctor of Philosophy in physics at The Pennsylvania State College.

This work has been supported in part by Contract No. AF19(122)-44 with the U. S. Air Force, through sponsorship of the Geophysical Research Directorate, Air Matériel Command.



## CORRECTION

Matthew T. Lebenbaum, author of the paper, "Design Factors in Low-Noise Figure Input Circuits," which appeared on pages 75-80, of the January, 1950, issue of the PROCEEDINGS OF THE I.R.E., has brought to the attention of the editors the following correction.

In Table I, on page 79, under the subheading "Calculate," the expression  $\alpha_1 = \sqrt{2}f - \alpha_2$  should read  $\alpha_1 = \sqrt{2}b - \alpha_2$ .

# Frequency and Amplitude Stability of the Cathode-Coupled Oscillator\*

PETER G. SULZER†, ASSOCIATE, IRE

**Summary**—An expression is obtained for the frequency and amplitude of the output of the cathode-coupled oscillator. The effects of supply voltage variations are calculated, and the results are confirmed by experiment. It is concluded that the cathode-coupled oscillator is capable of providing excellent frequency stability.

## INTRODUCTION

IT IS THE purpose of this paper to consider the frequency and amplitude stability (with supply-voltage variation) of the cathode-coupled oscillator.<sup>1</sup> An analysis seems desirable because of the wide application of the circuit. Such an analysis also facilitates design for the best stability.

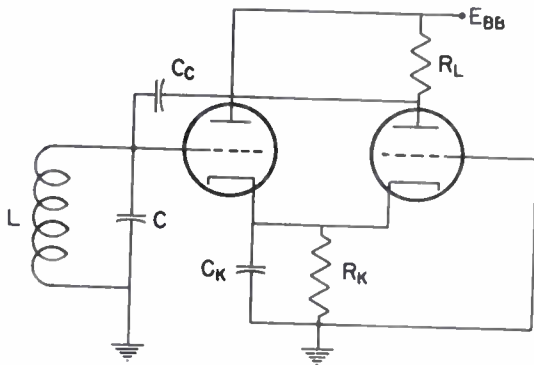

Fig. 1—The cathode-coupled oscillator.

Fig. 1 is a schematic diagram of the circuit under consideration. It consists of a tuned circuit,  $L$ - $C$ , connected to a cathode-coupled negative-resistance circuit.<sup>2-4</sup> Since the oscillator must provide some form of amplitude limiting if stable output is to be maintained, linearity cannot be assumed. For purposes of analysis it is therefore necessary to employ the differential equation for the entire oscillating circuit, which includes the tubes as nonlinear elements.

\* Decimal classification: R355.911.4. Original manuscript received by the Institute, July 29, 1949; revised manuscript received, November 9, 1949. The paper is a portion of a thesis submitted to the Department of Electrical Engineering, The Pennsylvania State College, State College, Pa., in partial fulfillment of the requirements for the degree of Master of Science. The first part of the thesis "Cathode-coupled negative resistance circuit," was published in Proc. I.R.E., vol. 36, pp. 1034-1039; August, 1948.

† Radio Propagation Laboratory, The Pennsylvania State College, State College, Pa.

<sup>1</sup> Murray G. Crosby, "Two-terminal oscillator," *Electronics*, vol. 19, pp. 136-137; May, 1946.

<sup>2</sup> G. C. Sziklai and A. C. Schroeder, "Cathode-coupled wide-band amplifiers," Proc. I.R.E., vol. 33, pp. 701-709; October, 1945.

<sup>3</sup> Keats A. Pullen, Jr., "The cathode-coupled amplifier," Proc. I.R.E., vol. 34, pp. 402-406; June, 1946.

<sup>4</sup> Peter G. Sulzer, "Cathode-coupled negative-resistance circuit," Proc. I.R.E., vol. 36, pp. 1034-1039; August, 1948.

## THEORETICAL RESULTS

It is convenient to treat the circuit as a nonlinear source of negative resistance connected in parallel with an  $R$ - $L$ - $C$  resonator, as shown in Fig. 2. The dif-

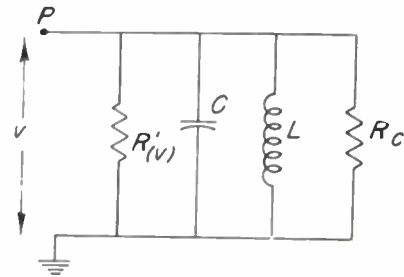

Fig. 2—Equivalent circuit.

ferential equation in terms of the currents at the node  $P$  is

$$\frac{V}{R'(v)} + C \frac{dV}{dt} + \frac{1}{L} \int V dt + \frac{V}{R_C} = 0, \quad (1)$$

where  $R_C$ ,  $L$ , and  $C$  are associated with the resonant circuit, and  $R'(v)$  represents the negative-resistance circuit. Differentiating, we obtain

$$\frac{d^2V}{dt^2} + \frac{1}{C} \frac{d}{dt} \left( \frac{V}{R_C} + \frac{1}{R'(v)} \right) + \frac{1}{LC} V = 0. \quad (2)$$

To obtain a solution it is first necessary to evaluate  $R'(v)$ . It was found by experiment that the current-voltage characteristic of the negative-resistance circuit is of the form shown by the solid line of Fig. 3, which

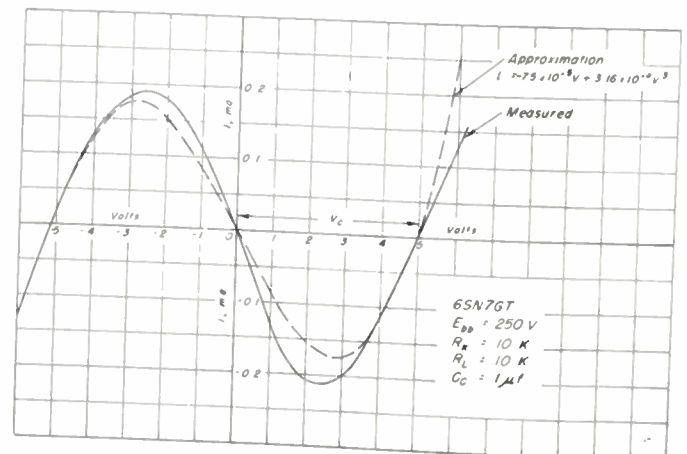

Fig. 3—Voltage versus current for the cathode-coupled negative-resistance circuit.

is symmetrical about the origin. This curve is a tracing of an oscillogram which was obtained by making horizontal deflection proportional to voltage and vertical deflection proportional to current. In view of the symmetry, it is possible to approximate the characteristic by two terms of the series

$$i = -\alpha V + \beta V^3 - \gamma V^5, \text{ etc.},$$

where  $i$  is the current. A typical approximation is shown by the dotted line of Fig. 3. Then,

$$R'(v) = \frac{V}{i} = -\frac{1}{\alpha - \beta V^2}.$$

where  $\alpha$  and  $\beta$  are coefficients to be determined by experiment. Substituting this value in (2),

$$\frac{d^2 V}{dt^2} - \frac{1}{C} \left( -\frac{1}{R_c} + \alpha - 3\beta V^2 \right) \frac{dV}{dt} + \frac{1}{LC} V = 0. \quad (3)$$

To obtain the equation in a recognizable form, let

$$\alpha' = \frac{1}{C} \left( \alpha - \frac{1}{R_c} \right)$$

$$\beta' = \frac{3}{C} \beta$$

$$\omega_0^2 = \frac{1}{LC}.$$

Then

$$\frac{d^2 V}{dt^2} - (\alpha' - \beta' V^2) \frac{dV}{dt} + \omega_0^2 V = 0. \quad (4)$$

It is convenient to incorporate a change in variable such that

$$V^2 = \frac{\alpha'}{\beta'} y^2.$$

Substituting in (4), and letting  $x = \omega_0 t$ ,

$$\frac{d^2 y}{dx^2} - \frac{\alpha'}{\omega_0} (1 - y^2) \frac{dy}{dx} + y = 0, \quad (5)$$

or

$$\frac{d^2 y}{dx^2} - \epsilon (1 - y^2) \frac{dy}{dx} + y = 0, \quad (6)$$

where

$$\epsilon = \frac{\alpha'}{\omega_0} = \sqrt{\frac{L}{C}} \left( \alpha - \frac{1}{R_c} \right).$$

Equation (6) has been investigated by van der Pol<sup>6</sup>, Kryloff and Bogoliuboff,<sup>7</sup> Minorsky,<sup>8</sup> and Brainerd.<sup>9</sup> It is apparent that if  $\epsilon$  is very small, the equation becomes

$$\frac{d^2 y}{dx^2} + y = 0,$$

which has a sine-wave solution. An approximation<sup>7,8</sup> has shown that for moderately small positive values of  $\epsilon$ , the amplitude of this sine wave is 2. A second approximation<sup>7,8</sup> indicates a frequency change such that the solution of (6) becomes

$$y = 2 \sin \left( 1 - \frac{\epsilon^2}{16} \right) x, \quad (7)$$

which is valid for  $0 < \epsilon \ll 1$ . Changing to the original variables  $V$  and  $t$ ,

$$V = 2 \sqrt{\frac{1}{\alpha - \frac{1}{R_c}}} \sin \left[ 1 - \frac{L}{16C} \left( \alpha - \frac{1}{R_c} \right)^2 \right] \frac{1}{\sqrt{LC}} t. \quad (8)$$

The amplitude and frequency can both be obtained directly from (8). Frequency stability can be studied with the aid of the correction factor

$$F = 1 - \frac{L}{16C} \left( \alpha - \frac{1}{R_c} \right)^2, \quad (9)$$

which multiplies  $(1/\sqrt{LC})t$  in (8), and indicates the decrease in frequency caused by nonlinearity of the negative-resistance circuit.

It is of interest to see which choice of values will result in the best stability. Referring to (9), the quantity  $\alpha$  is responsible for frequency variations, since it is a function of tube constants which, in turn, depend on supply voltage. Thus it is desired to minimize the change in  $F$  with respect to  $\alpha$ . Taking the derivative,

$$\frac{dF}{d\alpha} = \frac{L}{8C} \left( \alpha - \frac{1}{R_c} \right). \quad (10)$$

This will vanish if  $\alpha = 1/R_c$ . Unfortunately, oscillation will cease at the same time, since  $\epsilon$  in (6) must be kept positive. This confirms the well-known fact that the best frequency stability is obtained with the smallest amount of feedback consistent with stable amplitude. If, then,  $\alpha$  is maintained slightly larger than  $1/R_c$ , the

<sup>6</sup> B. van der Pol, "The non-linear theory of oscillation," *Proc. I.R.E.*, vol. 22, pp. 1051-1086; September, 1934.

<sup>7</sup> B. van der Pol, "Beyond radio," *Proc. World Radio Convention*, Sydney, 1938.

<sup>8</sup> N. Kryloff and N. Bogoliuboff, "Introduction to Non-Linear Mechanics," Princeton University Press; 1943.

<sup>9</sup> N. Minorsky, "Introduction to Non-Linear Mechanics," pp. 197-199, 217-219, J. W. Edwards (pub.), Ann Arbor, Mich.; 1947.

<sup>10</sup> McIlwain and Brainerd, "High-Frequency Alternating Currents," pp. 507-509, John Wiley and Sons, Inc., New York, N. Y.; 1939.

only other variable in (10) is  $L/C$ , which must be minimized. This justifies the common practice of using a "high- $C$ " tuned circuit for stability. However, the  $Q$  of the circuit is also important. By definition

$$R_c = Q\omega L = Q\sqrt{\frac{L}{C}}$$

and

$$\frac{1}{R_c} = \frac{1}{Q}\sqrt{\frac{C}{L}}$$

In designing an oscillator of this type, one would start with a value of  $\alpha$ , choosing  $(1/Q)\sqrt{C/L}$  slightly smaller than  $\alpha$  for stable oscillation. Keeping this quantity constant,  $\sqrt{C/L}$  would be made as large as possible, which also requires an increase in  $Q$ . It would appear, therefore, that a reasonable figure of merit for the tuned circuit in this type oscillator is  $Q\sqrt{C/L}$ .

### EXPERIMENTAL RESULTS

In general,  $\alpha$  and  $\beta$  must be known for each value of supply voltage at which it is desired to calculate amplitude and frequency. These constants were obtained as follows: The coupling condenser,  $C_c$  in Fig. 1, was replaced with a battery which was adjusted to produce zero current through the circuit terminals, thus establishing an origin. Small increments of voltage  $V$  were applied at the input terminals of the negative-resistance circuit, first positive and then negative, and the resulting currents were measured. Since the voltages were small, the cubed term in the approximation dropped out, and

$$\alpha = -\frac{1}{V}$$

It will be noted in Fig. 3 that  $i=0$  when  $V=V_c$ . Then

$$\beta = \frac{\alpha}{V_c^2}$$

In order to check the theory, an oscillator was designed for poor frequency stability to facilitate measurement. Figs. 4 and 5 show the performance of this oscillator. Fig. 4 is a plot of amplitude versus plate-supply voltage for the circuit values shown. The solid line was calculated with the aid of (8), while the dashed line was obtained by measurement. It will be noted that a reasonably close agreement was obtained between theory and experiment.

Fig. 5 shows the fractional change in frequency with supply voltage for this particular oscillator. The solid curve was calculated with the aid of (8) and (9), while the dashed curve marked  $C_k=0$  was obtained by meas-

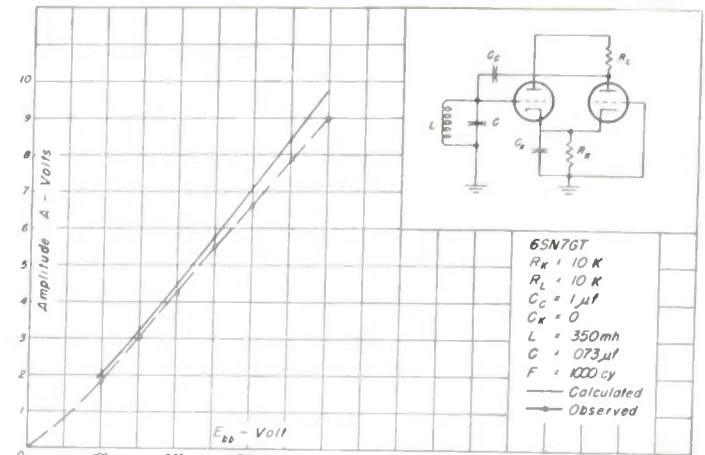

Fig. 4—Amplitude versus plate-supply voltage.

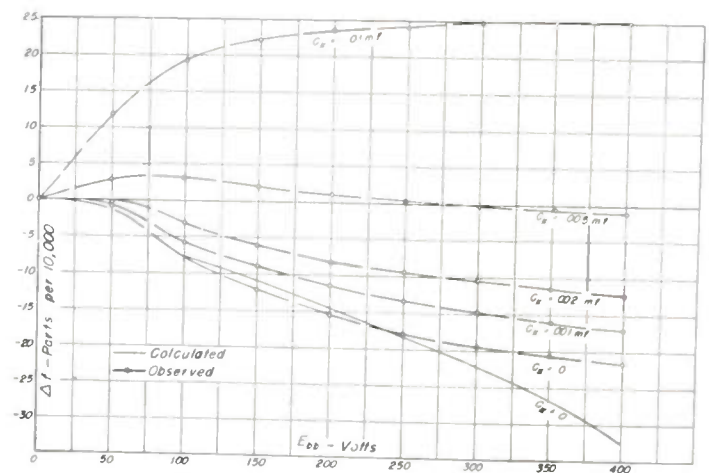

Fig. 5—Frequency change versus plate-supply voltage.

urement. A fair check with theory was obtained over a major portion of the supply-voltage range.<sup>10</sup>

The other dashed curves were obtained with various values of capacity shunting the cathode resistor. Although it is not covered by the theory, it will be noted that excellent frequency compensation for the effects of supply-voltage variation can be obtained in this manner.

In conclusion, it should be stated that well-designed cathode-coupled oscillators have shown a frequency stability of better than 5 parts per million for a two-to-one supply-voltage change.

### ACKNOWLEDGMENT

The writer wishes to acknowledge the encouragement of A. H. Waynick during the preparation of this paper.

<sup>10</sup> It has been pointed out that the measured and calculated frequency-variation curves for the case  $C_k=0$  do not have the same shape. This discrepancy is probably caused by the fact that there was some residual capacity in the cathode circuit during measurement.



# A Method of Simulating Propagation Problems\*

HARLEY IAMS†, SENIOR MEMBER, IRE

**Summary**—Problems relating to reflection, refraction (including continuously variable index of refraction), or scattering can be simulated by propagating centimeter-wave energy in a large sheet of low-loss dielectric material. The conditions of the problem are set up by imbedding objects in the sheet, varying its thickness, or coating its surfaces. One surface of the sheet is then scanned with the probe of a phase-front plotter, and lines of equal phase are recorded on a separate sheet of paper. The behavior of the energy can be judged from the recording so obtained.

**THE PHASE-FRONT PLOTTER**<sup>1</sup> is a device which records on a sheet of paper lines representing those parts of a radio-frequency field which have the same phase. It consists essentially of a probe which scans the area of interest, a radio-frequency reference signal which adds to or subtracts from the probe signal according to their phase relation, and a detector and amplifier, connected to a stylus which scans current-sensitive paper in synchronism with the scanning of the probe.

Although the plotter was originally intended for use in developing microwave antennas, the pictorial representation which it produces has been found useful for other purposes. The purpose of the present discussion is to call attention to a technique which permits the simulation of problems relating to the reflection or scattering of radiation by obstacles, or refraction (including the case of a continuously variable refractive index).

The method is simply that of propagating the radiation in a large sheet of low-loss dielectric, such as polystyrene, having a thickness of the order of a quarter of a free-space wavelength. When the electric vector of the field is at right angles with the surface of the sheet, it is found that the energy is kept from spreading in one dimension by the action of the dielectric, and that the probe of the phase-front plotter picks up a strong enough signal (when it scans within a tenth wavelength of the surface) to observe how the energy propagates. Problems in reflection or scattering can then be set up by imbedding various discontinuities in the dielectric sheet.

Fig. 1 is an illustration of such a test. A low-power oscillator having a free-space wavelength of 1¼ cm (0.492 inch) delivered power through a waveguide which ended between two parallel metal sheets spaced ½ inch apart. The end of the waveguide served as a point source from which the energy spread, while the metal sheets insured that all of the power was coupled into the ½-inch thick dielectric sheet. In this particular test, it was desired that the phase fronts incident upon the model should be

straight, as though the source had been distant. Therefore, the input edge of the polystyrene sheet was curved with a radius  $R$ , according to the familiar optical formula for a plano-convex lens

$$(n - 1) \left( \frac{1}{R} \right) = \frac{1}{f}$$

where  $n$  is the refractive index (1.6 for bulk polystyrene),  $R$  is the radius of curvature of the lens, and  $f$  is the focal length. Also, in order to minimize the reflection which occurs when the refractive index changes abruptly, the edges of the sheet were tapered from full thickness to zero over a distance of ¼ inch. (A taper longer than a half-wavelength would have reduced the reflection still more, but it was not needed.)

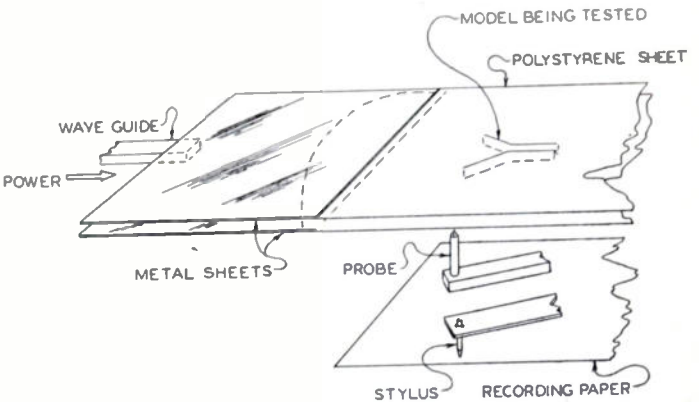

Fig. 1—Test arrangement.

The model representing the cross section of a horn consisted of metal strips imbedded in slots cut in the polystyrene. The picture of Fig. 2 was recorded by scanning the surface of the dielectric with the probe of the plotter and recording its output on Teledeltos paper. In this, and all the subsequent pictures, the direction of propagation is left to right. The outline of the horn was subsequently drawn on the paper. From this plot, one

can see that the radiation incident on the horn is focused into the narrow section of the horn.

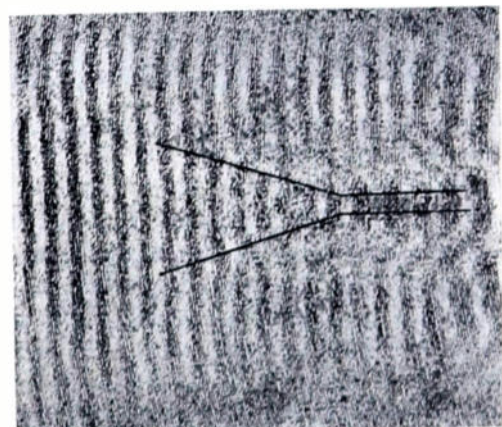

Fig. 2—Radiation incident on horn.

\* Decimal classification: R113.7. Original manuscript received by the Institute, July 11, 1949; revised manuscript received, December 1, 1949. Presented, 1949 West Coast IRE Convention, San Francisco, Calif., August 31, 1949.

† Formerly, RCA Laboratories, Princeton, N. J., now, Hughes Aircraft Co., Culver City, Calif.

<sup>1</sup> For description, see Harley Iams, "Phase-front plotter for centimeter waves," *RCA Rev.*, vol. 8, pp. 270-275; June, 1947.

sees how the received energy was directed into the throat of the horn, and observes the change in wavelength which occurred in the narrower waveguide.

Another type of problem which can be simulated is that of propagation in the presence of a variable index of refraction, such as is met in nature in the ionosphere.

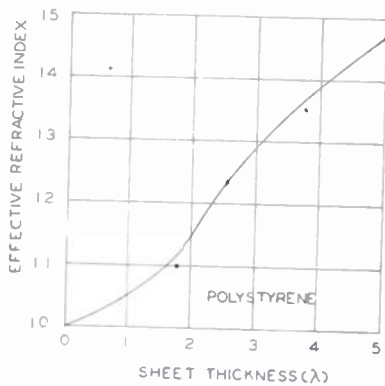

Fig. 3—Effective refractive index versus sheet thickness.

The effective index of refraction (which may be defined as the wavelength in free space divided by the wavelength in the sheet) of a polystyrene sheet guiding radiation in the manner described is a function of its thickness. Fig. 3 shows the experimentally determined effective index of refraction as a function of the thickness measured in free-space wavelengths. The desired distribution of propagation conditions is set up by cutting

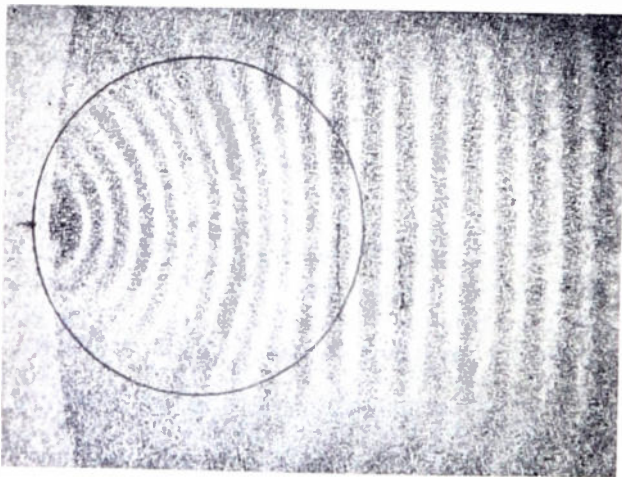

Fig. 4—Propagation through region having variable refractive index.

a thick sheet of the dielectric to the required thickness, or by piling up thin sheets in the form of contour maps of the desired pattern. When an effective index of refraction less than unity is desired, one uses a thin section in conjunction with a thicker one, calling the index of the latter unity. It is the ratio of the indices which is important to the problem, not the magnitudes measured in comparison with some arbitrary standard.

An illustration of the behavior of a variable-thickness

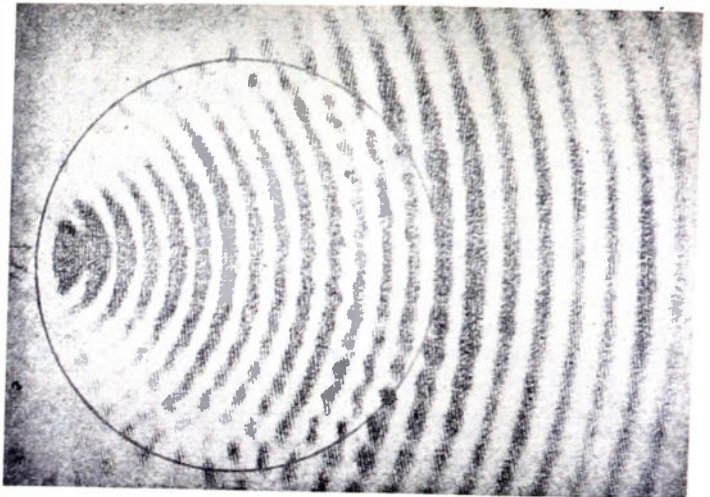

Fig. 5—Propagation through abrupt change in refractive index.

model is given in Fig. 4. A disk of polystyrene was so cut that the effective refractive index varied according to the following relation:

$$n_{\text{eff}} = \sqrt{2 - r^2}$$

where  $r$  is the radius to the point under consideration.

Power fed in at one edge of the disk was propagated with a velocity depending upon the thickness, so that the phase fronts are not arcs of circles. The transfer to free space occurs without appreciable reflection and the power continues in a parallel beam.

In comparison, the constant-thickness model of Fig. 5 shows lack of bending of the phase fronts until the edge of the disk is reached, and interference patterns due to reflections at the boundaries. The final beam is somewhat divergent.

Another way of controlling the effective index of refraction of a dielectric sheet is to coat one or both sides with metal foil. Of course, when both sides are covered, the speed of propagation is the same as for a great thickness. When one side only is covered with metal, the be-



Fig. 6—Control of refractive index by metal foil on dielectric sheet.

havior is similar to that of a dielectric sheet twice as thick as the one actually used.

Fig. 6 shows how a strip of tinfoil  $\frac{1}{2}$ -inch (one free-space wavelength) wide applied to one surface of a polystyrene sheet  $\frac{3}{32}$ -inch thick controlled the propagation well enough to keep the energy in a narrow path. In this and other tests, it was found that the power

could be deflected around moderate bends, but that it was radiated at sharp ones.

#### ACKNOWLEDGMENT

The author wishes to express his appreciation to RCA Laboratories, where the work was done, for the support of the investigation and permission to report the results.

## Design Analysis of a $TM$ -Mode Piston Attenuator\*

ANTHONY B. GIORDANO†, SENIOR MEMBER, IRE

**Summary**—The design analysis of a transverse magnetic mode piston attenuator which may be utilized as a microwave absolute standard in the comparison method of measuring attenuation is described. The system employs a coaxial section input and a coaxial section output separated by a cylindrical waveguide section operating below cutoff. The electromagnetic coupling between the two coaxial sections is comprised of exponentially decaying field components of the  $TM_{om}$  modes associated with the waveguide section. A method of satisfying input and output boundary conditions based upon circular symmetry is detailed and applied in approximate form to obtain numerically the attenuation, input impedance, and VSWR characteristics of a model designed for a wavelength of 10 centimeters. The predicted data apply to coupling separations of 0.5 cm and higher.

### I. INTRODUCTION

WITH THE ADVENT of metallized-glass precision-type attenuators for coaxial transmission systems<sup>1</sup> designed for use at microwave frequencies, it became necessary to devise an accurate method of attenuation calibration. One of the most accurate schemes for measuring attenuation is the comparison method utilizing an absolute standard. Such a standard may be realized by employing a below cutoff cylindrical waveguide as part of a standard coaxial transmission line.

The electromagnetic behavior of a waveguide is similar to the behavior of a high-pass filter as frequency is varied. Below the cutoff frequency of the waveguide, the excited electromagnetic field does not propagate. It develops as an induction field, the magnitude of which decays exponentially as the field distributes itself between the input and output planes of the guide. It is substantially an electro- or magneto-static field distribution varying harmonically in time. The magnitude of the field at the output end of the guide is dependent on the physical length of the guide. As this length increases, the output field decreases, and, consequently, the output power diminishes. The difference in input power and

output power of the guide appears as reflected power from the entrance into the guide. Thus, the over-all effect is a reduction of output power and the waveguide behaves as an attenuator.

Numerous types of cutoff attenuators or reactive attenuators or piston attenuators have been described in the literature.<sup>2-6</sup> However, the piston attenuator to be analyzed is rather unique, since the structure becomes a matched coaxial section when the physical length of the guide is zero.

The classical Maxwell field theory as applied to bounded structures reveals that the electromagnetic fields within such structures may be represented as a superposition of mode functions. In general, there are three types of mode functions or modes, namely: the Transverse Electromagnetic or  $TEM$  mode, the field components of which are oriented entirely in the transverse plane; the Transverse Electric or  $TE$  mode which has electric field components only in the transverse plane; the Transverse Magnetic or  $TM$  mode having magnetic field components oriented solely in the transverse plane.

For a given geometry, perhaps, all three mode functions are required to describe rigorously the electromagnetic field which satisfies the boundary restrictions of the structure. For example, the electromagnetic field within a coaxial line of proper dimensions away from the generator consists of the  $TEM$  mode which propagates since its cutoff frequency is zero. The field in the vicinity of the generator is usually highly distorted and equivalent to the superposition of  $TEM$ ,  $TE$ , and  $TM$  modes. These latter modes are high-pass modes and will propagate only if a proper relationship exists between the excitation frequency and the cross-sectional dimensions. In coaxial system, these high-pass modes are usually below cutoff.

\* See chapter 11 of footnote reference 1, "Cutoff Attenuators," by R. N. Griesheimer.

<sup>2</sup> R. E. Grantham and J. J. Freeman, "A standard of attenuation for microwave measurements," AIEE Technical Paper 48-50, presented, AIEE Winter Meeting, Pittsburgh, Pa., January 26-30, 1948.

<sup>3</sup> C. W. Oatley, "Ultra-high-frequency measurements," *Jour. IEE*, vol. 93, Part IIIA, no. 1, pp. 199; 1946.

<sup>4</sup> G. F. Gainsborough, "A method of calibrating standard-signal generators and radio-frequency attenuators," *Jour. IEE*, vol. 94, Part III, no. 29, pp. 203; May, 1947.

<sup>5</sup> D. E. Harnett and N. P. Case, "The design and testing of multi-range receivers," *PROC. I.R.E.*, vol. 23, pp. 578-592; June, 1935.

\* Decimal classification: R396.9. Original manuscript received by the Institute, August 9, 1948; revised manuscript received, November 18, 1949. Presented, 1948 IRE National Convention, March 25, 1948, New York, N. Y., under the title, "Analysis of a Microwave Absolute Attenuation Standard."

† Microwave Research Institute, Polytechnic Institute of Brooklyn, Brooklyn, N. Y.

<sup>1</sup> C. G. Montgomery, "Technique of Microwave Measurements," vol. 11—Radiation Laboratory Series; McGraw-Hill Book Co., New York, N. Y., 1947; also, chapter 12, "General Laboratory Attenuators," by E. Weber.

If a discontinuity is introduced in a coaxial line which is far removed from the generator, then both  $TE$  and  $TM$  modes may be generated at the discontinuity and the original field becomes distorted. If the discontinuity is caused by a cylindrical waveguide terminating a coaxial line, only  $TM$  modes will be generated in both the coaxial and waveguide sections if the discontinuity is circularly symmetrical. Throughout the following analysis, circular symmetry will be assumed.

Each type of high-pass mode is characterized by field components which possess spatial harmonic variations. To indicate these variations, subscripts are added. The first subscript yields the harmonic variations around the periphery and the second subscript refers to the harmonic variations along the diameter. If circular symmetry is assumed, the first subscript becomes zero. The field components of the mode functions will be set up in cylindrical co-ordinates  $Z, \rho, \theta$ .

The derivation of the field components of electromagnetic mode functions will not be detailed since such equations are available in most books on the subject.<sup>7-10</sup> The rationalized mks system of units will be employed throughout, together with complex notation.

## II. PRELIMINARY ANALYSIS

The basic structure of a  $TM$ -mode piston attenuator is illustrated by Fig. 1. The diameter of the waveguide section is selected to yield a desired mode decay rate corresponding to the asymptotic value of curve  $B$  of Fig. 4.

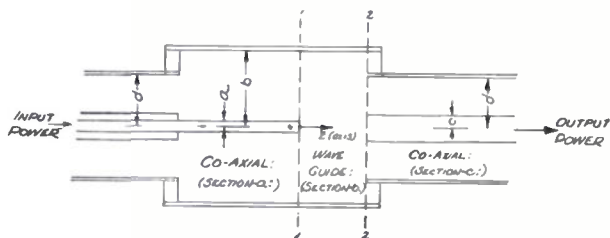

Fig. 1—Preliminary design of a  $TM$ -mode piston attenuator.

Referring to Fig. 1, the  $TEM$  mode of section  $a$  propagates from the generator toward plane 1-1 where it is reflected. At plane 1-1,  $TM$  modes are generated in section  $a$  and section  $b$ . The coaxial  $TM$  modes of section  $a$  decay to zero in the direction of the generator. The waveguide  $TM$  modes decay toward plane 2-2 where they are reflected. At plane 2-2, these modes excite the  $TEM$  mode of section  $c$ , as well as  $TM$  modes which decay to zero. The  $TEM$  mode propagates to the load where it is completely absorbed, since the load represents a matched termination. The magnitude of the  $TEM$  mode of section  $c$  depends on the magnitude of the

$TM$  modes of section  $b$  at plane 2-2. Thus, the waveguide length controls the coupling between the  $TEM$  modes of section  $a$  and section  $c$ . What is the interpretation of this coupling in terms of transmitted power to the load?

To illustrate, it will be assumed that the  $TM_{b1}$  mode is the only high-pass mode excited in the structure. (For identification purposes, the zero subscript will be substituted by subscript  $b$ . Thus, the  $TM_{b1}$  mode identifies the  $TM_{01}$  mode of section  $b$ .) This condition is depicted in Fig. 2.  $\bar{A}$  and  $\bar{C}$  represent the amplitudes of the elec-

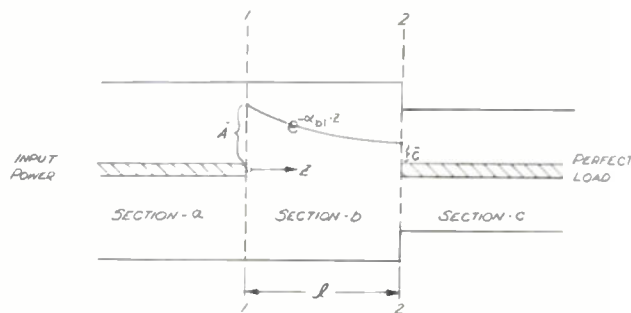

Fig. 2— $TM_{01}$  or  $TM_{b1}$  waveguide mode coupling between  $TEM$  modes of the coaxial sections.

tric field of the  $TEM$  mode at planes 1-1 and 2-2, respectively, and they are related by equation (1), where  $\alpha_{b1}$  is the attenuation constant or decay

$$\bar{C} = A(\log b/a) \left( \frac{1}{\log d/c} \right) e^{-\alpha_{b1}l} \quad (1)$$

rate of the  $TM_{b1}$  mode. An expression relating power transmitted to the coefficients  $\bar{C}$  and  $\bar{A}$  will be derived.

The field components of the  $TEM$  mode of section  $a$ <sup>9,10</sup> are

$$\bar{E}_{\rho a} = \frac{1}{\rho} [\bar{A}_0 e^{-j(2\pi/\lambda) \cdot z} + \bar{a}_0 e^{+j(2\pi/\lambda) \cdot z}] \quad (2)$$

$$\bar{H}_{\theta a} = \frac{1}{\rho\eta} [\bar{A}_0 e^{-j(2\pi/\lambda) \cdot z} - \bar{a}_0 e^{+j(2\pi/\lambda) \cdot z}], \quad (3)$$

where  $\eta$  is the intrinsic impedance of the medium and equal to  $\sqrt{\mu/\epsilon}$ , where  $\mu$  and  $\epsilon$  are the permeability and permittivity factors, respectively;  $\bar{A}_0$  and  $\bar{a}_0$  are the coefficients of the incident and reflected components, respectively; the center of plane 1-1 is the zero reference of the co-ordinate system and the positive  $z$  direction is toward the load end.

At  $z=0$ , the  $TEM$  mode components reduce to

$$\bar{E}_{\rho a} = \frac{\bar{A}_0 + \bar{a}_0}{\rho} = \frac{\bar{A}}{\rho} \quad (4)$$

$$\bar{H}_{\theta a} = \frac{\bar{A}_0 - \bar{a}_0}{\rho\eta} = \bar{Y}_a \cdot \bar{E}_{\rho a} \quad (5)$$

where  $\bar{A}$  is constant at plane 1-1 and  $\bar{Y}_a$  is the input wave admittance at plane 1-1, a variable depending on the waveguide length and reduces to  $1/\eta$  when  $l=0$ .

<sup>7</sup> S. Ramo and J. R. Whinnery, "Field and Waves in Modern Radio," John Wiley and Sons, Inc., New York, N. Y.; 1944.

<sup>8</sup> S. A. Schelkunoff, "Electromagnetic Waves," D. Van Nostrand Co., New York, N. Y.; 1943.

<sup>9</sup> J. A. Stratton, "Electromagnetic Theory," McGraw-Hill Book Co., New York, N. Y.; 1941.

<sup>10</sup> Ernst Weber, "Lectures on Ultra-Short Electromagnetic Waves," Polytechnic Institute of Brooklyn, Brooklyn, N. Y.; 1943.

Similarly, the field components of the *TEM* mode of section *c* are

$$\bar{E}_{\rho c} = \frac{1}{\rho} \bar{C} \cdot e^{-j(2\pi/\lambda)(z-l)} \quad (6)$$

$$\bar{H}_{\theta c} = \frac{1}{\rho\eta} \bar{C} \cdot e^{-j(2\pi/\lambda)(z-l)}, \quad (7)$$

assuming that section *c* is ideally terminated. At plane 2-2, these components reduce to

$$\bar{E}_{\rho c} = \frac{\bar{C}}{\rho} \quad \text{and} \quad \bar{H}_{\theta c} = \frac{\bar{C}}{\rho\eta} \quad (8)$$

Power flow may be ascertained by utilizing the Poynting theorem.<sup>9</sup> When the waveguide length is zero, the input power is evaluated from the integral

$$P_1 = \frac{1}{2} \int_a^b \int_0^{2\pi} \bar{E}_{\rho a} \cdot \bar{H}_{\theta a}^* \cdot \rho \cdot d\rho \cdot d\theta \quad (9)$$

where  $\bar{H}_{\theta a}^*$  is the conjugate of  $\bar{H}_{\theta a}$ .

Substituting (4) and (5) in (9) when the waveguide length is zero, the integral becomes

$$P_1 = \pi \frac{|A|^2}{\eta} \log\left(\frac{b}{a}\right) \quad (10)$$

where the vertical lines signify absolute value.

For a given waveguide length, the output power at plane 2-2 is evaluated from

$$P_2 = \frac{1}{2} \int_c^d \int_0^{2\pi} \bar{E}_{\rho c} \cdot \bar{H}_{\theta c}^* \cdot \rho \cdot d\rho \cdot d\theta \quad (11)$$

which reduces to

$$P_2 = \pi \frac{|\bar{C}|^2}{\eta} \cdot \log\left(\frac{d}{c}\right) \quad (12)$$

by utilizing (8).

The attenuation introduced by the waveguide length is defined to be

$$L = 10 \log_{10} \left( \frac{P_1}{P_2} \right) db. \quad (13)$$

Substituting (12) and (10) in (13), the attenuation becomes

$$L = 10 \log_{10} \left| \frac{A}{\bar{C}} \right| \cdot \log\left(\frac{b}{a}\right) \cdot \frac{1}{\log(d/c)}. \quad (14)$$

Upon substituting (1), (14) evaluates to be

$$L = 8.68(\alpha_{01})ldb. \quad (15)$$

Thus, the ratio of two powers reduces to a measurement of waveguide length.

It is important to note that the evaluation of (14) is dependent upon the relationship between  $\bar{A}$  and  $\bar{C}$ .

The difference between  $P_1$  and  $P_2$  is reflected from plane 1-1 toward the generator and is completely ab-

sorbed by a bilaterally matched lossy attenuator, so that the output power of the generator remains constant at all times. The over-all effect is an attenuation of power as shown by Fig. 3.

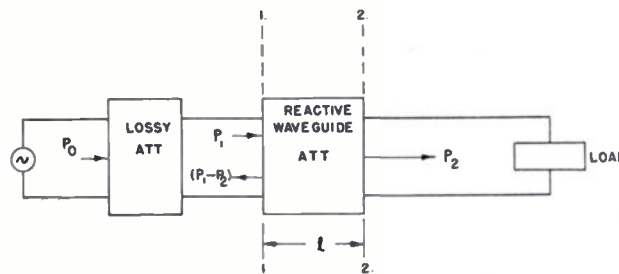

Fig. 3—Utilization of a piston attenuator as a power attenuator.

$$\text{Attenuation} = \log_{10} \left( \frac{P_1}{P_2} \right) \text{ decibels.}$$

Curve *A* of Fig. 4 is a plot of (15) referred to as the ideal attenuation equation. However, the experimental curve is shown by curve *B*. The curvature at the lower end of curve *B* is influenced by the presence of modes higher than the  $TM_{01}$  mode and by the interaction between planes 1-1 and 2-2. As the waveguide length increases, the influence of these higher modes diminishes and the slope approaches the ideal slope represented by  $\alpha_{01}$ . A rigorous analysis will follow.

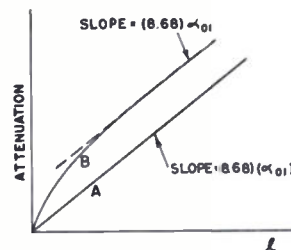

Fig. 4—Qualitative attenuation curves of the piston attenuator indicating the effect of modes higher than the  $TM_{01}$  or  $TM_{10}$  mode; *l* represents the waveguide length and attenuation is expressed in db.

*A* = Theoretical curve for  $TM_{01}$  mode.

*B* = Experimental curve.

Ideal attenuation =  $(8.68) (\alpha_{01})l$ .

### III. RIGOROUS ANALYSIS

Throughout the present discussion, the center of plane 1-1 of Fig. 1 is the selected zero reference of the co-ordinate system. To the right of plane 1-1 along the waveguide section, *z* is positive; to the left of plane 1-1, *z* is negative. At plane 2-2, *z* is equal to *l*. To the right of plane 2-2 along the coaxial section with reference to the center of plane 2-2, *z* is equivalent to  $(z-l)$ .

For circular geometry based upon ideal bounding conductors, the *TM* mode functions may be derived<sup>9,10</sup> in terms of boundary constants which are dependent on conditions at the discontinuity planes 1-1 and 2-2. These conditions are that the total transverse electric and magnetic field components be continuous across planes 1-1 and 2-2.

At plane 1-1 of Fig. 1 for  $z=0$ , the conditions to be satisfied are

$$\bar{E}_{\rho 0T} = 0, \quad \text{when } 0 < \rho < a \quad (16)$$

$$\bar{E}_{\rho a T} = \bar{E}_{\rho b T}, \quad \text{when } a < \rho < b \quad (17)$$

$$\bar{H}_{\theta a T} = \bar{H}_{\theta b T}, \quad \text{when } a < \rho < b. \quad (18)$$

The corresponding mode components<sup>10</sup> are

$$\bar{E}_{\rho a T} = \frac{\bar{A}}{\rho} + \sum_{m=1}^{\infty} \bar{A}_m \cdot z_1(k_{am} \cdot \rho) \quad (19)$$

$$\bar{H}_{\theta a T} = \bar{Y}_a \frac{\bar{A}}{\rho} + \sum_{m=1}^{\infty} \bar{Y}_{am} \cdot \bar{A}_m \cdot z_1(k_{am} \cdot \rho) \quad (20)$$

$$\bar{E}_{\rho b T} = \sum_{n=1}^{\infty} (\bar{B}_n + \bar{b}_n) \cdot J_1(k_{bn} \cdot \rho) \quad (21)$$

$$\bar{H}_{\theta b T} = \sum_{n=1}^{\infty} \bar{Y}_{bn} (\bar{B}_n - \bar{b}_n) \cdot J_1(k_{bn} \cdot \rho). \quad (22)$$

The subscript  $T$  signifies total field component.  $\bar{Y}$  is related to the  $TM$  mode admittances as follows:

$$\bar{Y}_{am} = \bar{H}_{\theta a T} / \bar{E}_{\rho a T} \quad (23)$$

$$\bar{Y}_{bn} = j \frac{\omega \epsilon}{\alpha_{bn}}. \quad (24)$$

where  $\alpha_{bn}$  is the attenuation constant and dependent on  $k_{am}$ <sup>10</sup>; the  $k$ 's are the distinct roots corresponding to the boundary condition at the enclosing cylindrical surfaces. Thus,

$$\alpha_{bn} = \sqrt{k_{bn}^2 - \left(\frac{2\pi}{\lambda}\right)^2} \text{ nepers/meter} \quad (25)$$

$$k_{bn} = n\text{th root of } [J_0(k_{bn} \cdot b) = 0] \quad (26)$$

where  $J_r$  = Bessel function of the first kind,  $r$ th order. Also,

$$\alpha_{am} = \sqrt{k_{am}^2 - \left(\frac{2\pi}{\lambda}\right)^2} \text{ nepers/meter} \quad (27)$$

$k_{am} = m$ th root of

$$J_0(k_{am} \cdot a) \cdot N_0(k_{am} \cdot b) - J_0(k_{am} \cdot b) \cdot N_0(k_{am} \cdot a) = 0. \quad (28)$$

$z_r$  represents the linear combination of the  $r$ th order Bessel function of the first kind and the Neumann function, namely,

$$z_1(k_{am} \cdot \rho) = J_1(k_{am} \cdot \rho) + R_{am} N_1(k_{am} \cdot \rho) \quad (29)$$

where

$$R_{am} = - \frac{J_0(k_{am} \cdot b)}{N_0(k_{am} \cdot b)}$$

$\bar{A}_m$  and  $\bar{B}_n$  are associated with the incident components of the  $TM$  modes of section  $a$  and section  $b$ , respectively.  $\bar{b}_n$  is related to the reflected component of the  $TM$  mode of section  $b$ .

Likewise, the boundary conditions at plane 2-2 for  $z=l$  become

$$\bar{E}_{\rho b T} = 0, \quad \text{when } 0 < \rho < c \text{ and } d < \rho < b \quad (30)$$

$$\bar{E}_{\rho c T} = \bar{E}_{\rho b T}, \quad \text{when } c < \rho < d \quad (31)$$

$$\bar{H}_{\theta b T} = \bar{H}_{\theta c T}, \quad \text{when } c < \rho < d. \quad (32)$$

The corresponding mode components are specified as

$$\bar{E}_{\rho a T} = \sum_{n=1}^{\infty} (\bar{B}_n e^{-\alpha_{bn} \cdot l} + \bar{b}_n \cdot e^{+\alpha_{bn} \cdot l}) \cdot J_1(k_{bn} \cdot \rho) \quad (33)$$

$$\bar{H}_{\theta b T} = \sum_{n=1}^{\infty} \bar{Y}_{bn} (\bar{B}_n e^{-\alpha_{bn} \cdot l} - \bar{b}_n e^{+\alpha_{bn} \cdot l}) \cdot J_1(k_{bn} \cdot \rho) \quad (34)$$

$$\bar{E}_{\rho c T} = \frac{\bar{C}}{\rho} + \sum_{s=1}^{\infty} \bar{C}_s \cdot z_1(k_{cs} \cdot \rho) \quad (35)$$

$$\bar{H}_{\theta c T} = \frac{\bar{Y} \cdot \bar{C}}{\rho} + \sum_{s=1}^{\infty} \bar{Y}_{cs} \cdot \bar{C}_s \cdot z_1(k_{cs} \cdot \rho) \quad (36)$$

where  $\bar{C}_s$  is related to the incident component of the  $TM$  mode of section  $c$  and

$$\bar{Y}_{cs} = j \frac{\omega \epsilon}{\alpha_{cs}}. \quad (37)$$

As discussed in part II, to ascertain the attenuation introduced by the length of the waveguide section, it is necessary to relate  $\bar{C}$  to  $\bar{A}$ . This can be accomplished by satisfying the boundary conditions at planes 1-1 and 2-2 of Fig. 1 which results in mode coefficient equations leading to the relationship that  $\bar{C} = K\bar{A}$ . These conditions indicate that  $\bar{E}_{\rho b T}$  is completely defined at planes 1-1 and 2-2. Thus, corresponding to plane 1-1, the following integration may be performed:

$$\int_0^b \bar{E}_{\rho b T} d\rho = \int_a^b \left[ \frac{\bar{A}}{\rho} + \sum_{m=1}^{\infty} \bar{A}_m \cdot z_1(k_{am} \cdot \rho) \right] d\rho. \quad (38)$$

the solution of which yields

$$\sum_{n=1}^{\infty} \frac{\bar{B}_n + \bar{b}_n}{k_{bn}} = \bar{A} \log(b/a). \quad (39)$$

The mode coefficients  $\bar{A}$ ,  $\bar{A}_m$ ,  $\bar{B}_n$ , and  $\bar{b}_n$  may be interrelated by multiplying (38) by  $\rho \cdot J_1(k_{bn} \cdot \rho)$  and evaluating the resulting integrals which are Lommel integrals<sup>11-13</sup> relating to the orthogonality property of Bessel functions. The resulting equation is

$$\frac{\bar{B}_n + \bar{b}_n}{\bar{A}} = T_n \left( 1 - \sum_{m=1}^{\infty} \frac{\bar{A}_m}{\bar{A}} I'_{mn} \right). \quad (40)$$

A relationship between the input wave admittance at plane 1-1 and the mode coefficients at plane 1-1 may be determined by considering (18). If this equation is integrated between the limits of  $a$  and  $b$ , the following expression is obtained:

$$Y_a = \sum_{n=1}^{\infty} \left( \frac{\bar{B}_n - \bar{b}_n}{\bar{A}} \right) \frac{1}{\log(b/a)} S_n. \quad (41)$$

If both sides of (18) are multiplied by  $\rho \cdot z_1(k_{am} \rho)$  and integrated between the limits of  $a$  and  $b$ , the result is

$$\frac{\bar{A}_m}{\bar{A}} = V_m \sum_{n=1}^{\infty} \left( \frac{\bar{B}_n - \bar{b}_n}{\bar{A}} \right) W_{nm}. \quad (42)$$

<sup>11</sup> E. Jahnke and F. Emde, "Tables of Functions," Dover Publications, New York, N. Y.; 1943.

<sup>12</sup> R. V. Churchill, "Fourier Series and Boundary Value Problems," McGraw-Hill Book Co., New York, N. Y.; 1941.

<sup>13</sup> N. W. McLachlan, "Bessel Functions for Engineers," Oxford University Press, London, England; 1941.

Similar expressions exist at plane 2-2. They follow by applying the described procedure to (30), (31), and (32). The resulting mode coefficient equations are

$$\frac{\bar{B}_n e^{-\alpha_{bn} \cdot l} + \bar{b}_n e^{+\alpha_{bn} \cdot l}}{\bar{C}} = P_n + \sum_{s=1}^{\infty} \frac{\bar{C}_s}{\bar{C}} Q_{sn} \quad (43)$$

$$\frac{\bar{C}_s}{\bar{C}} = R_s \sum_{n=1}^{\infty} \left( \frac{\bar{B}_n e^{-\alpha_{bn} \cdot l} - \bar{b}_n e^{+\alpha_{bn} \cdot l}}{\bar{C}} \right) S_{ns} \quad (44)$$

$$\bar{C} = \sum_{n=1}^{\infty} (\bar{B}_n e^{-\alpha_{bn} \cdot l} - \bar{b}_n e^{+\alpha_{bn} \cdot l}) \cdot M_n \quad (45)$$

The constants  $T_n$ ,  $U_{mn}$ ,  $S_n$ ,  $V_m$ ,  $W_{nm}$ ,  $Q_{sn}$ ,  $P_n$ ,  $R_s$ ,  $S_{ns}$  and  $M_n$  are geometric parameters which are evaluated for a given structure. They are given by

$$T_n = \frac{2J_0(k_{bn}a)k_{bn}}{[(k_{bn}b)J_1(k_{bn}b)]^2} \quad (46)$$

$$U_{mn} = \frac{2}{\pi} \frac{1}{k_{am}} \frac{1}{\left[ \frac{k_{am}}{k_{bn}} \right]^2 - 1} \frac{1}{N_0(k_{am} \cdot a)} \quad (47)$$

$$S_n = \frac{\bar{Y}_{bn}}{k_{bn}} J_0(k_{bn} \cdot a) \quad (48)$$

$$V_m = \frac{\pi \cdot N_0(k_{am} \cdot a)}{\left[ 1 - \frac{N_0^2(k_{am} \cdot a)}{N_0^2(k_{am} \cdot b)} \right]} \quad (49)$$

$$W_{nm} = \frac{\bar{Y}_{bn} k_{bn}}{\bar{Y}_{am} k_{am}} \frac{1}{\left[ 1 - \left( \frac{k_{bn}}{k_{am}} \right)^2 \right]} J_0(k_{bn} \cdot a) \quad (50)$$

$$Q_{sn} = \frac{2}{b^2 [J_1(k_{bn} \cdot b)]} \frac{k_{bn}}{k_{cs}} \frac{2}{\pi} \frac{1}{(k_{cs}^2 - k_{bn}^2)} \left[ \frac{J_0(k_{bn} \cdot d)}{N_0(k_{cs} \cdot d)} - \frac{J_0(k_{bn} \cdot c)}{N_0(k_{cs} \cdot c)} \right] \quad (51)$$

$$P_n = \frac{2}{b^2 [J_1(k_{bn} \cdot b)]^2} \left[ \frac{J_0(k_{bn}c) - J_0(k_{bn}d)}{k_{bn}} \right] \quad (52)$$

$$R_s = \frac{\pi}{\frac{1}{N_0^2(k_{cs} \cdot c)} - \frac{1}{N_0^2(k_{cs} \cdot d)}} \quad (53)$$

$$S_{ns} = \frac{\bar{Y}_{bn} k_{bn}}{Y_{cs} k_{cs}} \frac{1}{\left[ 1 - \left( \frac{k_{bn}}{k_{cs}} \right)^2 \right]} \left[ \frac{J_0(k_{bn} \cdot c)}{N_0(k_{cs}c)} - \frac{J_0(k_{bn}d)}{N_0(k_{cs}d)} \right] \quad (54)$$

$$M_n = \frac{\bar{Y}_{bn}}{\bar{Y}_{cs} \log(d/c)} \left[ \frac{J_0(k_{bn}c) - J_0(k_{bn}d)}{k_{bn}} \right] \quad (55)$$

Thus the mode coefficient equations, (40), (41), (42), (44), and (45), represent the most general mathematical formulation of the structure of Fig. 1 and their manipulation yields  $\bar{C} = \bar{K}\bar{A}$ . However, the mathematical re-

duction cannot be performed in closed form, since the mode coefficient equations are infinite series.

#### IV. APPLICATION

The structure of Fig. 1 is incorporated in the model shown by Fig. 5. The model is designed for a  $\frac{7}{8}$ -inch standard coaxial line, the wavelength corresponding to the excitation frequency being 10 centimeters. Various matching principles are utilized in this model resulting in a measured input VSWR of 1.04 when the length of the waveguide section is zero. The dimensions of the structure of Fig. 1 at planes 1-1 and 2-2 are  $a=0.0938$  inch,  $b=0.786$  inch,  $c=0.118$  inch, and  $d=0.406$  inch.

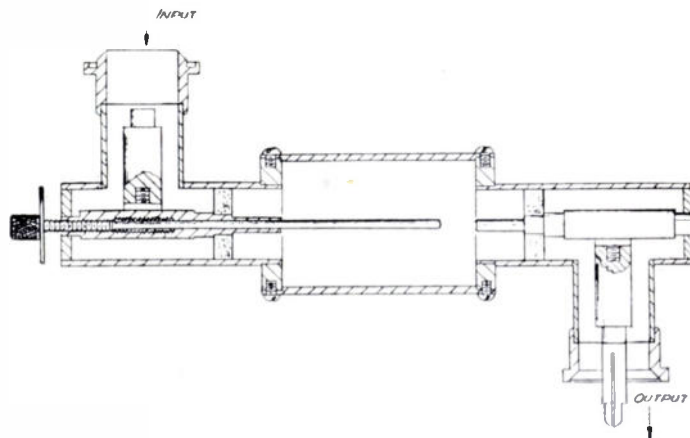

Fig. 5—Model of the TM-mode piston attenuator.

In order to evaluate the theoretical attenuation curve of the model shown by Fig. 5, only the first six terms of the mode coefficient equations are utilized in the present analysis, since these equations converge fairly rapidly. Moreover, the influence of reflections from plane 2-2 at plane 1-1 is neglected, which leads to a further simplification. Consequently, the present solution is inaccurate for small waveguide lengths. The method is as follows.

From the dimensions of the structure, the geometric parameters are evaluated. Equations (40) and (42) are expanded to six terms and combined yielding a sixth-order determinant involving  $\bar{B}_n$  and  $\bar{A}_n$ ,  $\bar{b}_n$  being suppressed. The sixth-order determinant is solved by a method described by Crout.<sup>14</sup> The solution yields each  $\bar{B}_n$  coefficient in terms of  $\bar{A}_n$ . These coefficients are substituted in (42) and each  $\bar{A}_m$  coefficient is solved in terms of  $\bar{A}_n$ .

To ascertain whether these values of  $\bar{B}_n$  and  $\bar{A}_n$  satisfy the boundary conditions across plane 1-1, (19) and (21) are plotted disregarding  $\bar{b}_n$ . If these plots indicate that the boundary conditions are not closely satisfied over the surface of the inner conductor at plane 1-1, a Bessel function series is introduced and equated so that it represents the negative variation of (21) over the region  $\rho=0$  to  $\rho=a$ . This series is added to (21), and the resulting curve will satisfy the boundary restrictions very well.

<sup>14</sup> P. D. Crout, "A short method for evaluating determinants and solving systems of linear equations with real or complex coefficients," *Trans. AIEE*, p. 1235; December, 1941.

At plane 2-2, all summations being restricted to six terms, (43) and (44) are expanded and combined. For

$$V = \int_a^b \bar{E}_{\rho a} d\rho = \bar{A} \log(b/a). \quad (57)$$

The ratio of  $\bar{I}$  to  $\bar{V}$  represents the input circuit admittance, namely,

$$\bar{Y}_a' = \frac{2\pi\rho \cdot \bar{H}_{\theta a}}{\bar{A} \cdot \log b/a} = \frac{2\pi}{\log b/a} \bar{Y}_a, \quad (58)$$

where  $\bar{Y}_a$  is given by (41).

The input resistance and capacitive reactance components of the designed model are shown by Fig. 7. When  $l$  is greater than 3 cm, the input impedance is practically capacitance reactance and the capacitance is equal to  $0.1213 \times 10^{-12}$  farad. The VSWR corresponding to the input impedance of Fig. 7 and expressed in db units is illustrated by Fig. 8.

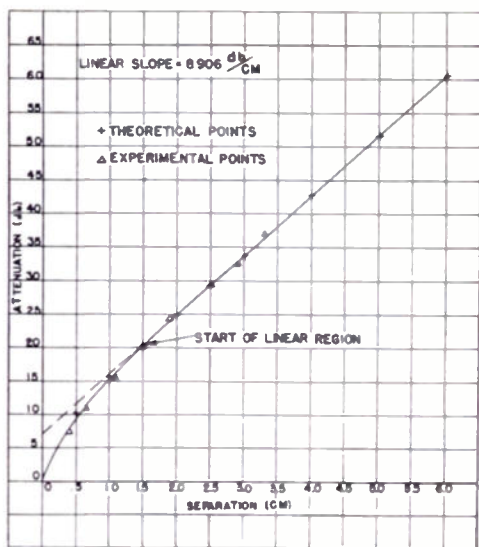

Fig. 6—Theoretical attenuation curve of the piston attenuator with experimental verification.

specific values of  $l$ , these equations are reduced yielding  $b_n$  as a linear function of  $\bar{C}$  and coefficients  $\bar{B}_n$ . Upon substituting  $b_n$  and  $\bar{B}_n$  in (48),  $\bar{C} = \bar{K}\bar{A}$  is obtained for each specific value of  $l$ .

The theoretical attenuation curve is evaluated from (14). This curve is shown by Fig. 6. It agrees rather well with the measured curve for values of  $l$  greater than 0.5 cm. When  $l$  is less than 0.5 cm a marked discrepancy is noted, since the present solution does not account for the effect of  $b_n$  at plane 1-1.

The input circuit admittance may be deduced by converting the input wave admittance given by (41), as follows:

The current and voltage at plane 1-1 of Fig. 1 are respectively equivalent to

$$\bar{I} = \int_c^{2\pi\rho} \bar{H}_{\theta a} \cdot d\theta = 2\pi\rho \cdot \bar{H}_{\theta a} \quad (56)$$

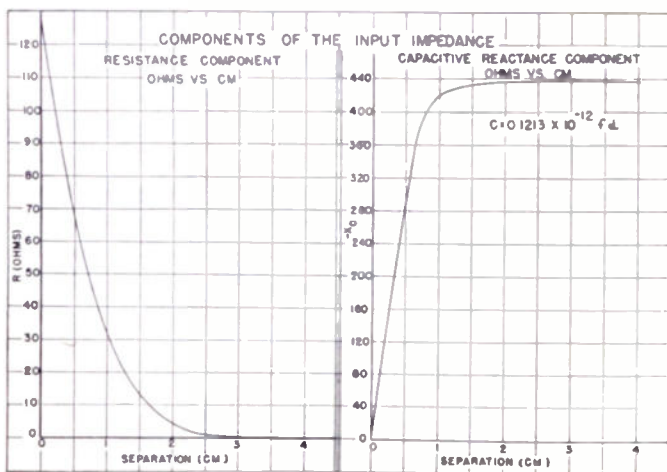

Fig. 7—Computed components of the input impedance at plane 1-1 of the piston attenuator.

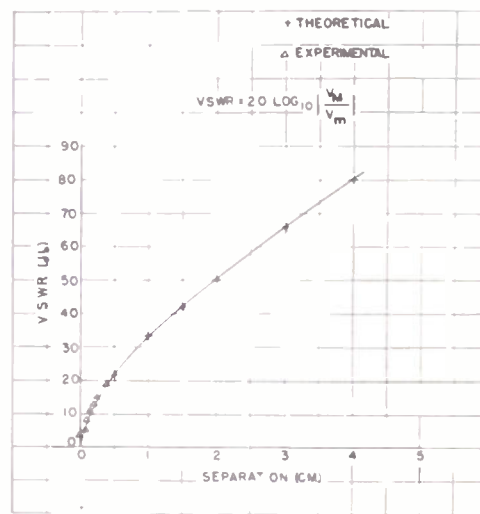

Fig. 8—Voltage standing-wave ratio at the input end of the piston attenuator.

### V. CONCLUSION

The *TM*-mode attenuator has been rigorously formulated in terms of an infinite number of mode coefficients. These equations have been applied in finite form to yield a numerical solution which explains somewhat the nonlinear region of the attenuation characteristic and predicts the displacement of the linear region of such a characteristic to yield a measure of absolute attenuation. The rigorous mathematical formulation may be applied to predict the total nonlinear attenuation region. However, the reduction process is rather prohibitive.

### VI. ACKNOWLEDGMENT

In part, this paper is based on a thesis entitled "On the Transverse Magnetic Mode Cylindrical Waveguide Cutoff Attenuator," submitted in partial fulfillment of the degree of Doctor of electrical engineering at the Polytechnic Institute of Brooklyn. This work was commenced in 1943 under OSRD Contract OEMsr-335. The author is deeply indebted to Ernst Weber, Head of the Department of Electrical Engineering and Director of the Microwave Research Institute of Polytechnic Institute of Brooklyn, for his inspiring guidance.



# Standards on TELEVISION: METHODS OF MEASURE- MENT OF TELEVISION SIGNAL LEVELS, RESOLUTION, AND TIMING OF VIDEO SWITCHING SYSTEMS, 1950\*

## COMMITTEE PERSONNEL

### Standards Committee, 1949-1950

J. G. BRAINERD, *Chairman*  
A. G. JENSEN, *Vice-Chairman*  
L. G. CUMMING, *Vice-Chairman*

|                    |                   |                  |                  |
|--------------------|-------------------|------------------|------------------|
| M. W. Baldwin, Jr. | P. S. Carter      | J. E. Keister    | R. F. Shea       |
| R. R. Batcher      | A. B. Chamberlain | E. A. Laport     | J. R. Steen      |
| S. J. Begun        | Dudley Chambers   | Wayne Mason      | W. N. Tuttle     |
| H. S. Black        | E. J. Content     | J. F. McDonald   | L. C. Van Atta   |
| G. M. Brown        | J. W. Forrester   | L. S. Nergaard   | K. S. Van Dyke   |
| C. R. Burrows      | R. A. Hackbusch   | A. F. Pomeroy    | D. E. Watts      |
| Henri Busignies    | L. R. Hafstad     | George Rappaport | Ernst Weber      |
| W. G. Cady         | J. V. L. Hogan    | E. S. Seeley     | L. E. Whittemore |

### Video Techniques Committee

J. E. KEISTER, *Chairman*  
W. J. POCH, *Vice-Chairman*  
H. A. CHINN, *Chairman*, Audio and Video Techniques Committee, 1948-1949

|                    |                      |                |               |
|--------------------|----------------------|----------------|---------------|
| M. W. Baldwin, Jr. | R. H. Daugherty, Jr. | R. L. Garman   | R. S. O'Brien |
| A. J. Baracket     | V. J. Duke           | L. W. Morrison | J. F. Wiggin  |
| P. F. Brown        | G. L. Fredendall     | C. G. Pierce   |               |

### Subcommittee on Video Signal Transmission

L. W. MORRISON, *Chairman*

|               |               |                  |                 |
|---------------|---------------|------------------|-----------------|
| S. Brand      | E. D. Goodale | L. R. Moffett    | E. H. Schreiber |
| Rodney Chipp  | A. M. Gray    | R. S. O'Brien    | B. F. Tyson     |
| D. K. Gannett | J. L. Jones   | C. A. Rosencrans |                 |

### Subcommittee on Video Systems and Components

W. J. POCH, *Chairman*

|                |              |                  |                     |
|----------------|--------------|------------------|---------------------|
| I. C. Abrahams | R. Cotelesso | G. L. Fredendall | J. H. Mulligan, Jr. |
| A. J. Baracket | R. DeBaun    | J. R. Hefe       | J. F. Wiggin        |
| R. W. Clark    |              |                  |                     |

\* Reprints of this Standard, 50 IRE 23.S1, may be purchased from The Institute of Radio Engineers, 1 East 79 Street, New York 21, N. Y., at \$0.70 per copy. A 20 per cent discount will be allowed for 100 or more copies mailed to one address.

## PART I. MEASUREMENT OF TELEVISION SIGNAL LEVELS

### 1. INTRODUCTION

#### 1.1 Description

This Standard describes methods of measuring the significant amplitude "levels" of a television signal, either composite or noncomposite. For the purpose of this Standard, the level of a voltage or current is defined as the difference between that voltage or current value and an arbitrary reference value. It is concerned primarily with measurements at points on transmission systems where the signals are at video frequency, and does not necessarily apply to measurements of carrier-modulated signals. The methods described in this Standard are limited to those involving the use of oscilloscopes.

Transmission measurements in general divide functionally into three classes; namely, engineering or laboratory measurements made in the course of the design and development of equipment; test and maintenance measurements; and measurements required to operate a working facility. The principal need for standardizing television level measurements is in connection with the last class. This Standard therefore is primarily directed to specifying a method of measuring television levels for operating purposes.

Adherence to a common standard method of measuring levels at different parts of a television system will greatly facilitate its operation. It will aid in insuring the proper levels on the parts of a system, in maintaining standard signal wave forms, and in obtaining uniform levels when signals from many sources are switched to and from program circuits. It is urged that the Standard set forth herein be universally adopted.

For the purposes of this Standard, six significant amplitude levels of a composite television signal may be defined as follows. These are shown in the right-hand portion of Fig. 1.

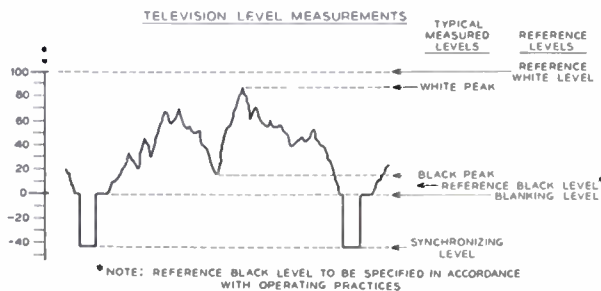

Fig. 1—Significant levels and details of standard scale.

**Reference White Level.** The level at the point of observation corresponding to the specified maximum excursion of the picture signal in the white direction.

**White Peak.** The maximum excursion of the picture signal in the white direction at the time of observation.

**Black Peak.** The maximum excursion of the picture signal in the black direction at the time of observation.

**Reference Black Level.** The level at the point of observation corresponding to the specified maximum excursion of the picture signal in the black direction.

**Blanking Level.** The level of the signal during the blanking interval. It coincides with the level of the base of the synchronizing pulse.

**Synchronizing Level.** The level of the peaks of the synchronizing signal.

This Standard specifies a method of measuring the differences between these levels in a manner permitting ready correlation between the measurements at different parts of a system, regardless of the nominal absolute levels in volts at the points of measurement.

#### 1.2 Theory of Measurements

##### 1.2.1 General

The method of level measurement prescribed in this Standard is based on the provision of an oscilloscope of standardized characteristics, with a linear scale having arbitrary numbers for reading the various levels. The scale is the same on all oscilloscopes, but each oscilloscope is calibrated with a voltage related to the nominal signal level at the point where the measurements are to be made. If the gains or losses between two measuring points on a system are normal, therefore, similar scale readings should be obtained for all the significant levels on oscilloscopes at both points regardless of differences in the absolute voltage levels at the two points. These readings may if desired be readily converted to volts.

##### 1.2.2 Scale

The standard scale is shown on the left-hand portion of Fig. 1, together with an illustrative signal to show the relation between the scale and the oscilloscope presentation. It will be observed that the zero or reference point of this scale is placed at the blanking level. The upper part of this scale is marked from 0 to 100 with 100 corresponding to the reference white level. The scale is linear and two additional points are marked beyond 100 to permit reading abnormally high white peaks. The scale above zero covers the range of the picture signal proper, and on it are read the actual white-and-black peaks.

The lower part of the scale covers the part of the composite signal normally composed of the synchronizing signal, and is marked downward in linear steps from 0 to 50. The synchronizing level is read on this scale.

The blanking level was chosen as the reference point of the scale because it is the natural dividing line between the two principal parts of a composite signal,

the picture signal and the synchronizing signal. With the blanking level as reference, therefore, the same scales are well adapted to reading levels of a composite signal, of a picture signal, or of a signal consisting only of synchronizing pulses.

The scale provided for reading the synchronizing level indicates this level relative to the difference between the reference white and blanking levels. This may be converted to an expression of the synchronizing level in terms of percentage of any other level if desired.

Where other scales are used for specific purposes, such as at television broadcast transmitter modulation monitoring positions, it is recommended that the standard scale be added to any existing scales to permit ready correlation with measurement at other points in the system. The standard level scale should be placed with the 0 and 100 markings corresponding to the normal blanking and reference white levels, respectively, of the other scale.

## 2. APPARATUS REQUIRED

### 2.1 List of Equipment

One piece of equipment is required for these measurements; namely, a suitable oscilloscope. The specifications of the oscilloscope given below are a part of this Standard. A separate external calibrator is needed if the oscilloscope itself does not contain suitable calibration means as discussed below.

### 2.2 Specifications of Standard Oscilloscope for Level Measurements

#### 2.2.1 Measurement Accuracy

An oscilloscope which is suitable for this application shall be capable of television level measurements with errors not exceeding 5 units on the scale. The factors which may contribute to error include:

- Spot size and brightness.
- Deflection amplitude.
- Amplifier linearity.
- Readability of scales or markers, including a reasonable allowance for parallax.
- Calibration accuracy, and stability of calibration.

#### 2.2.2 Bandwidth

The oscilloscope bandwidth and shape of response characteristic should be such as to introduce negligible measurement errors due to low-frequency distortion or overshoot. The bandwidth should be standardized so that uniform measurements are obtained with different oscilloscopes. Furthermore the bandwidth should be as low as consistent with satisfactory readings of the levels. To meet these requirements, this Standard prescribes that the response shall be within the limits indicated in Fig. 2. This provides 6-db attenuation (+2 db or -3 db) at 3 megacycles with respect to the low frequencies, and a rise time of approximately 0.175 microseconds without overshoot.

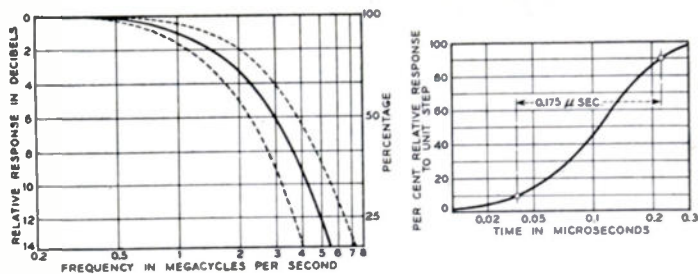

Fig. 2—Frequency and time response for standard oscilloscope.

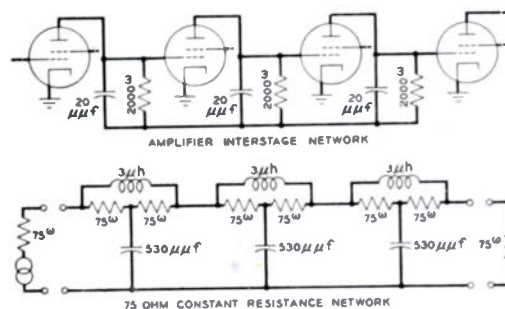

Fig. 3—Idealized networks for standard oscilloscope.

The specified characteristic may be obtained if desired by adding a suitable network to an oscilloscope of wider bandwidth. By arranging a key to cut out the network, the oscilloscope can be made available for other uses where its full bandwidth is needed. Fig. 3 shows a three-section network that may be used for this purpose with an oscilloscope whose bandwidth is much wider than the specified characteristic. It shows the circuit constants of an idealized amplifier having the specified nominal characteristic, and an equivalent constant resistance network. For oscilloscopes having intermediate bandwidths, the prescribed response may be obtained with a fewer number of sections of the network of Fig. 3, or with some other network.

There should be no sudden variations in the response characteristic below 4 Mc per second. The oscilloscope should indicate less than 2 per cent tilt on a 60-cps symmetrical square wave.

#### 2.2.3 Scale

The oscilloscope shall be provided with the standard scale shown in Fig. 1 and described in section 1.2.1 of this Standard.

#### 2.2.4 Calibration

A suitable calibration means shall be provided. This device may be of the substitution type and may be either external or built-in.

#### 2.2.5 Direct-Current Restoration

It is highly desirable that dc restoration at the deflection plates of the oscilloscope be employed for operational measurements on ordinary television signals having changing picture content in order to prevent shifts of

the trace with variations in average value of the signal. It is desirable that the time constants of such dc restoration circuits be shorter than the equivalent time constants of the ac portions of the oscilloscope amplifier to avoid shift and bounce of the base line with picture changes. At the same time, it is desirable that the time constants of the restoration circuits be as long as the above limitation allows in order that the true low-frequency content of the signal may be exhibited.

### 2.2.6 Vertical and Horizontal Centering

Means shall be provided for adjusting the relative position of the scale and the oscilloscope image. This may consist either of electrical centering controls on the oscilloscope or of a movable scale.

## 3. METHOD OF MEASUREMENT

### 3.1 Application

Whether the oscilloscope is permanently connected to the circuit to be measured, as is the case in many operational systems, or is connected only periodically, care must be taken that the oscilloscope input circuit and the manner of connection have no adverse effect upon the signal circuit. It is essential that the circuit being measured operate with its normal source and load impedances during the measurements.

In a transmission system, the terminations may often be a complex impedance, which causes the wave form to appear severely distorted when observed on an oscilloscope bridged across such a circuit. In measuring signal levels at such points, care must be exercised to properly interpret the indications or, preferably, to connect the measuring equipment at a suitably isolated circuit branch. For example, where a constant current source is used to drive a transmission system through a coupling transformer, the wave form measured directly across the transformer terminals may be so distorted as to be unusable for level measurements.

Low-frequency interference or distortion may seriously impair the accuracy of observation unless effective clamping means are employed. It is therefore recommended that such devices be employed wherever possible.

### 3.2 Adjustment

In using the oscilloscope the usual precautions must be taken to insure adequate brightness, sharp nonastigmatic beam focus, and gain-control settings which allow the necessary deflection without over amplifier overload.

The oscilloscope time base should normally be synchronized at either the line rate or at one half of the line rate when making level measurements, providing a convenient display of the longer duration blanking and synchronizing levels which occur during the vertical blanking interval. The oscilloscope brightness and focus

should be adjusted to make these portions of the signal wave form visible and well defined.

### 3.3 Calibration

Since, in general, the measurements will be made on a video bus or line in which the signal is to be maintained at a predetermined voltage level chosen for that point in the system, it shall be standard practice to maintain an oscilloscope deflection within the appropriate calibrated boundaries of the standard scale.

In using the oscilloscope method of level measurement, accurate calibration of the oscilloscope amplifier gain is a very important aspect of the technique. Calibration is concerned with adjustment of the oscilloscope amplifier gain so that a normal signal level will produce a standard oscilloscope deflection. This may conveniently be done by introducing a known calibrating voltage to the input of the oscilloscope in place of the normal input signal. The calibrating signal should be one whose principal frequency components lie within the band of uniform response of the oscilloscope. If such a calibrating signal has a peak-to-peak deflection equivalent to, for example, the blanking to reference white level of the standard signal, the oscilloscope gain would be adjusted so its calibrating voltage produces a deflection from 0 to 100 on the standard scale. Experience will indicate how often calibration checks should be made to maintain the desired accuracy of level measurement.

### 3.4 Interpretation

Standardizing the response characteristic of the oscilloscope serves to minimize possible differences in interpretation of signal levels. To further insure uniformity in interpreting the oscilloscope indication, the measurement of synchronizing and blanking levels should be observed at a point in the waveform where the voltages representing these levels are substantially at their

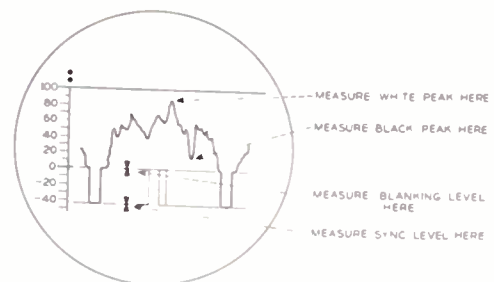

Fig. 4—Use and interpretation of standard scale.

steady state value. The longer duration signals of both synchronizing and blanking levels which occur during the vertical synchronizing interval, are suitable. A representation of the appearance of these portions is shown in Fig. 4, the measurements being made as indicated to minimize errors due to transmission distortion. In the measurement of noncomposite signals, blanking level may similarly be measured during the vertical blanking interval. In measuring picture signal portions, impor-

tant information-bearing signal peaks will be normally held within the 0 to 100 scale range. Certain spurious highlight signals may occasionally be allowed to exceed this range. Where comparison measurements are being made at different points in a transmission system, it is important to insure that identical peaks are being considered.

Measurements made within the IRE standard scale in the above manner will be expressed as in the following illustrative example:

White Peak: 86 (86% of Blanking to Reference White Level)  
Black Peak: 13 (13% of Blanking to Reference White Level)  
Synchronizing Level: 43 (43% of Blanking to Reference White Level).

In measuring oscilloscope deflection levels by means of an external scale, due care must be taken to avoid errors from parallax, centering shift, etc.

## PART II. MEASUREMENT OF RESOLUTION

### 1. INTRODUCTION

One of the major characteristics of a television system affecting over-all picture quality is the ability of the system to reproduce fine detail found in the original image. This ability to resolve detail is determined by a number of factors such as the number of scanning lines employed, the frame repetition rate, and the over-all response which is usually specified in terms of frequency and phase characteristics. Performance of the pickup and reproducing tubes also have considerable influence on the ability of the system to resolve detail. A satisfactory method for measuring this characteristic is therefore of utmost importance.

#### 1.1 General Description

The fundamental basis for making a measurement of resolution or resolving power of a television system is to televise a suitable test chart with the equipment under test. This test chart must include a pattern which will have a sufficient amount of fine detail so that a quantitative observation can be made of the amount of this detail in the reproduced picture. This is usually done by incorporating in the chart a series of lines having graduated widths. The point in the reproduced picture where these lines no longer are visible as separately defined images gives a measure of the system performance with respect to resolution.

#### 1.2 Definition

*Resolution (Resolving Power)*. In television, a measure of ability to delineate picture detail. It is usually expressed in terms of a number of lines discriminated on a test chart. For a number of lines  $N$  (normally alternate black-and-white lines) the width of each line is  $1/N$  times the picture height.

## 2. APPARATUS AND CIRCUITS

### 2.1 Basic Methods

When an over-all television system is being measured including both the pickup and reproducing devices, then

the measurement can be made by the use of a suitable test chart focused on the sensitive surface of the pickup tube. An observation of the resulting image on the reproducing device under suitable test conditions permits the evaluation of the over-all resolution. If the measurement of resolution is restricted to the pickup device only as it may be when the performance of studio equipment by itself must be determined apart from the transmitter or receiver, then the observation of resolution must be made by the use of a picture-reproducing device or monitor which does not in itself limit over-all performance. Similarly, if a measurement is required of the resolution of the reproducing device then a test pattern signal must be supplied from a source which does not limit over-all performance. The resolution of an intermediate link between the pickup and reproducing devices can also be specified by an over-all measurement, provided neither the pickup or reproducing units limit performance.

### 2.2 Practical Measuring Devices

The essential tool for this measurement is a suitable test chart. The chart developed by the RMA is considered to be the best presently available for this purpose. The original of the accompanying chart has a height of 18 inches and a width of 24 inches, the size supplied by the RMA Data Bureau. Besides having the resolution wedges both in the center and in the corners for checking resolution it has other features which permit adjustments of scanning amplitude, aspect ratio, scanning linearity, and shading, besides brightness and contrast of the reproduced picture. All these factors must be taken into account when the resolution measurement is being made.

### 2.3 Requirements and Characteristics of Measuring Equipment

A photograph of the standard RMA test chart is reproduced on page 557. Essential data concerning this chart are given in the Appendix.

### 3. PROCEDURE

#### 3.1 Conditions

Before a measurement of resolution is made it is essential that both the pickup and reproducing equipment be in proper adjustment. After the test pattern has been properly oriented with respect to the pickup device the following items must be given attention.

##### 3.1.1 Scanning

The scanning adjustment involves: size, linearity, and aspect ratio.

The chart must be focused on the camera tube so that its area (boundaries determined by arrows) exactly covers the usable area scanned by the camera. The resulting picture should be observed on a suitable picture monitor. This assures a substantially accurate setting of the aspect ratio of the pickup camera.

Vertical sweep linearity may be adjusted by comparing the spacing of the short horizontal bars at both top and bottom of picture with that of the bars midway between. The horizontal sweep linearity may be adjusted in a similar manner by comparing the spacing of the vertical bars in the square at each side of picture with that of the bars in the center square.

A measurement of the large pattern formed by the gray scales provides a means for checking the aspect ratio. The aspect ratio of the reproducing device is substantially correct if the horizontal and vertical scanning is linear and the above pattern is square.

##### 3.1.2 Shading or Landing

If the camera equipment employs signals for correcting shading or landing, two methods for proper adjustment are suggested: (a) visual inspection of the picture monitor to determine if the background is an even gray, and (b) use of the wave-form monitor to determine whether the average picture signal axis is parallel to the black level line both at line and field frequencies. As an additional aid in correcting the shading or landing, appropriate controls should be adjusted until the gray scale readings are the same (and a maximum) for all four scales.

##### 3.1.3 Low-Frequency Phase Shift

Streaking following any one of the four horizontal black bars at the top of the large circle is an indication of low-frequency phase shift.

##### 3.1.4 Focus

Camera lens focus as well as cathode-ray beam focus for both the camera tube and the reproducing tube must be in optimum adjustment. Cathode-ray beam focus adjustments are made for a maximum resolution reading, first of the horizontal scanning and then of the vertical. (Due to beam characteristics a maximum adjust-

ment for one may not be the maximum adjustment for the other.)

##### 3.1.5 Light Level

If a test chart is used for making this measurement it is necessary that the illumination level on the chart be made essentially uniform. With a test projector and slide arrangement the same requirement applies to the optical system so that the illumination on the sensitive surface of the pickup tube will be substantially uniform when a clear glass slide is used.

It is usually quite important that the light level used in conjunction with the test chart be recorded as a part of the measurement. This can be done by using a calibrated photoelectric light meter or an illuminometer.

#### 3.2 Measurement Technique

After all these adjustments have been made the distinguishable number of gray scale elements should be noted. An ideal system would produce the same readings on all four scales. Maximum resolution readings on the large wedges in the central portion of the picture may then be recorded. Corner resolution may be observed on the wedges in the corner circles.

The resolution should be read at the point along the converging wedge beyond which each individual line cannot be recognized with certainty. Since readings of resolution are subjective, it is preferred to use the average of the readings of several observers where the measurement is very important or its accuracy is subject to challenge.

The reading on the vertical wedge is the horizontal resolution and the reading on the horizontal wedge is the vertical resolution.

Pictures may have different values of resolution in different areas. Unless otherwise specified, the resolution cited is presumed to apply to the central portion of the picture.

It is recognized that inspection of the test pattern as described does not provide an extremely accurate testing method. It is, however, widely used because of its directness, ease of application, and because no generally satisfactory alternative is available. It is recommended for use only when its limitations are appreciated and can be accepted. The greatest use of the test pattern is for rough over-all operational checking of an entire system.

A special method has occasionally been employed whereby a single line from the 525 composing a television picture may be selected for observation on an oscilloscope by blanking out the remaining lines in the picture. This allows an amplitude measurement to be made at several points along the vertical wedge so that amplitude may be plotted as a function of the frequency as indicated by the position of the selected line along the wedge. Insufficient data are available concerning this method so that a definite recommendation concerning its use cannot be made at this time.

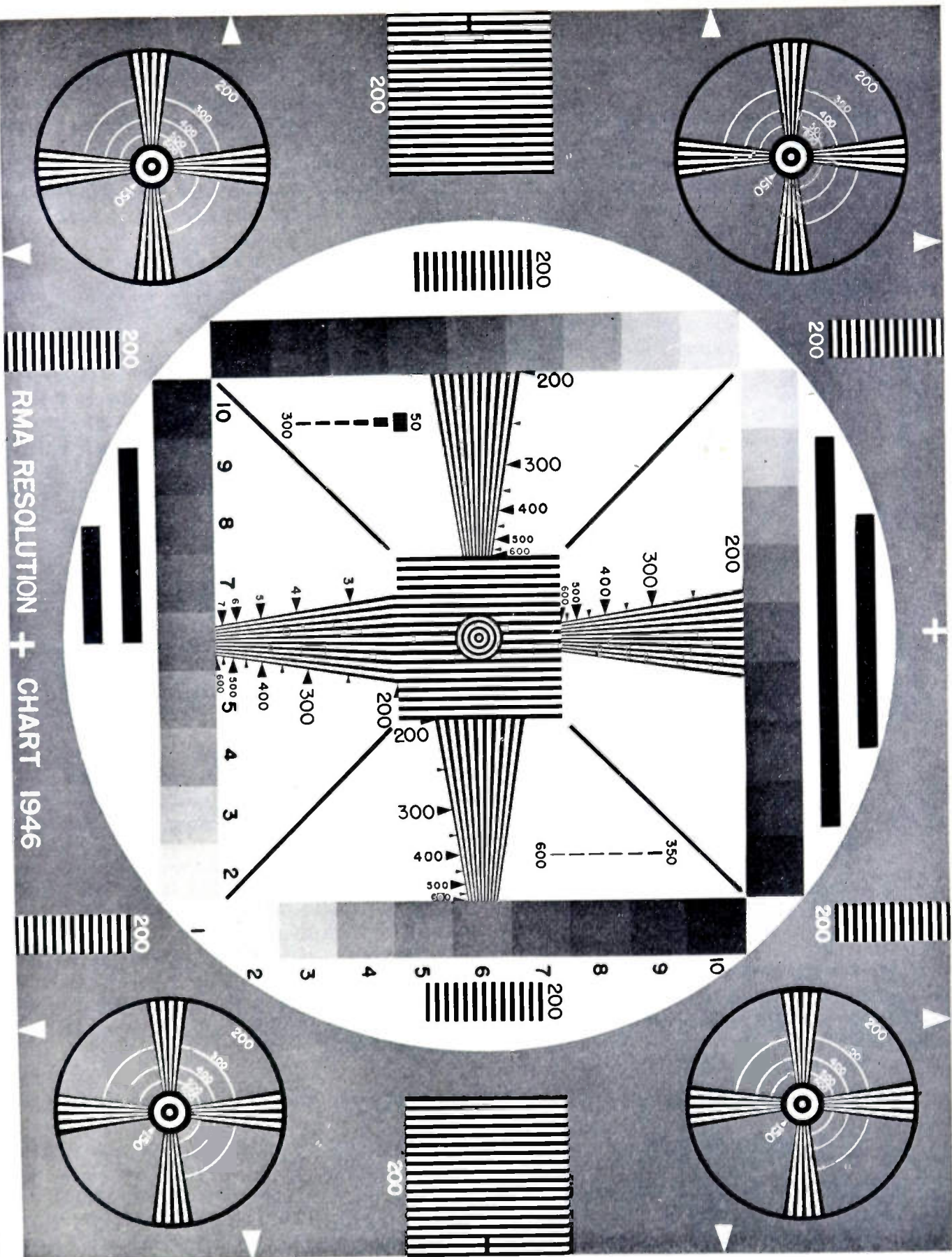

RMA RESOLUTION CHART 1946

Chart I

3.3 Presentation of Data

For each measurement of resolution the following data should be recorded:

- Light level and lens setting (if used)
- Gray scale readings (4 scales)
- Vertical resolution measurement
- Horizontal resolution measurement.

3.4 Reference Material

1. RMA Standards Proposal 217.
2. IRE Standards on Television; Methods of Testing Television Transmitters, 1947.
3. IRE Standards on Television; Methods of Testing Television Receivers, 1948.
4. A. V. Bedford, "Figure of merit for television performance," *RCA Rev.*, vol. 3, pp. 36-44; July, 1938.

APPENDIX

TABLE A—LINE CALIBRATION OF RESOLUTION WEDGE, BASED ON 18" CHART HEIGHT

| Number of Lines | Width per Line (inches) | Width (in inches) of |          |
|-----------------|-------------------------|----------------------|----------|
|                 |                         | 9 Lines              | 19 Lines |
| 200             | 0.090                   | 0.810                | 1.71     |
| 250             | 0.072                   |                      | 1.37     |
| 300             | 0.060                   | 0.540                | 1.14     |
| 350             | 0.051                   |                      | 0.97     |
| 400             | 0.045                   | 0.405                | 0.85     |
| 450             | 0.040                   |                      | 0.76     |
| 500             | 0.036                   | 0.324                | 0.68     |
| 550             | 0.033                   |                      | 0.62     |
| 600             | 0.030                   | 0.270                | 0.57     |

TABLE B

$$f_n = A_r n \frac{10^6}{H_a \times 2}$$

where

- $f_n$  = fundamental frequency for a number of lines
- $A_r$  = aspect ratio = 4/3
- $n$  = number of lines
- $H_a$  = active time of horizontal trace. (Horizontal time less blanking time. Blanking time is 0.16  $H$ —the average between maximum and minimum allowable time.) Horizontal time = 63.5 microseconds and  $H_a = 63.5 \times 0.84 = 53.3$  microseconds.

Substituting given values in the above formula:

$$f_n = \frac{4}{3} \frac{10^6 n}{53.3 \times 2} = 0.0125 n \text{ megacycles, or } n = f_n / 0.0125 \text{ lines.}$$

When

|           |     |     |     |                |
|-----------|-----|-----|-----|----------------|
| $f_n = 3$ | 4.0 | 5.0 | 6.0 | 7.0 megacycles |
| $n = 340$ | 320 | 400 | 480 | 560 lines.     |

| $f_n$ | Number of Lines | Width per Line (inches) | Width of 19 Lines (inches) |
|-------|-----------------|-------------------------|----------------------------|
| 3     | 240             | 0.0750                  | 1.42                       |
| 4     | 320             | 0.0562                  | 1.07                       |
| 5     | 400             | 0.0450                  | 0.85                       |
| 6     | 480             | 0.0375                  | 0.71                       |
| 7     | 560             | 0.0325                  | 0.62                       |

Locate frequency calibration along wedge by same method employed to locate line calibration (see example in Table A).

An alternate method suggested for locating the line calibration along the wedge uses the following formula:

$$L_n = L \left\{ \frac{300}{n} - 1/2 \right\}$$

where

- $L_n$  = distance from end of wedge indicating maximum lines resolution (in this case, 600)
- $L$  = length of entire wedge (shortest distance between ends)
- $n$  = number of lines per picture height.

Additional information regarding the RMA test chart follows:

- a. All bars for checking sweep linearity are spaced for 200 lines resolution.
- b. One horizontal resolution wedge is calibrated in both lines and megacycles to facilitate equipment checking.
- c. The gray scale is composed of 9 steps varying from maximum white brightness to approximately 1/30 of this value. This scale may be used in connection with a waveform monitor to check the transfer characteristic of the system.
- d. The 4 diagonal lines in the square may be used to check quality of interlacing. A jagged line indicates pairing of the interlaced lines. (Not effective when interlace failure is 100 per cent.)
- e. The circumference of each small circle is tangent to an imaginary circumference at the point nearest the corner of the chart. The radius of this imaginary circle is 4 1/2 inches and located along a line bisecting the corner angle of the chart.

PART III. MEASUREMENT OF TIMING OF VIDEO SWITCHING SYSTEMS

1. INTRODUCTION

Switching between video signals from cameras, studios, or remote pickup sources is usually accomplished by interlocked magnetic relays, mechanically interlocked push buttons, or electronic switching. A quantity of prime interest in such a system is the continuity of signal from the output.

The adjustment of the switching system to provide a "gap" or a "lap" in the video output signal when switching, i.e., a switching interval when neither video signal is present at the switching system output, or a switching interval when both video signals are present at the switching system output, is dependent upon the judgment and desires of the individual manufacturer or broadcaster. In general, video signals originating within



one installation are usually switched with systems employing a "lap" adjustment and composite video signals originated by independent installations are usually switched with systems employing a "gap" adjustment. Ordinarily this "lap" or "gap" is held to an interval of not more than 0.01 second.

Where "lap" switching is employed, whether by means of relays, push buttons, or electronic mixers, the design of the system must include provisions to maintain the output, when composed of two or more video signals, to not more than the permissible peak-to-peak value of one signal. When "gap" switching is employed and two or more signals are not present simultaneously on the output, this problem is not experienced.

Switching accomplished by means of electronic mixers or "lap dissolve" units makes use of two inputs, switchable between video signal sources by means of magnetic relays or push buttons. These two signals are electronically mixed to produce one output. Continuity of signal is secured in the mixer and the necessity of providing a "lap" adjusted input switching system is obviated. Synchronized electronic switching, i.e., switching during field or line blanking time, is not in common use at present.

The problem of measuring the "gap" or "lap" adjustment of the relays is that of measuring the time between the opening of one contact and the closing of another for "gap" switching, and of measuring the time in the reverse order, i.e., the time between the closing of one contact and the opening of another for "lap" switching.

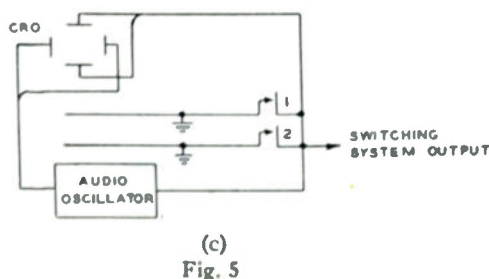
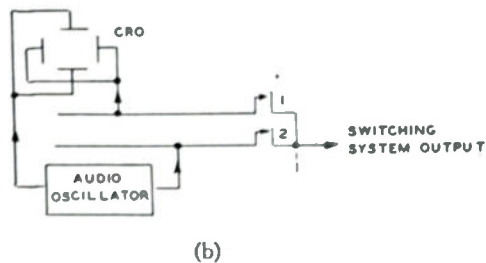
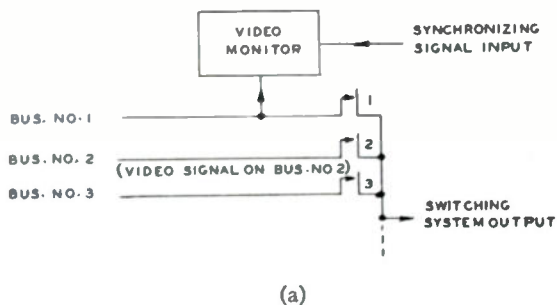

Fig. 5

## 2. APPARATUS AND CIRCUITS

### 2.1 Basic Method of Measurement

The interval to be measured, i.e., the "lap" or "gap," is aperiodic unless some method of cycling the switching system is devised. This does not present a problem for qualitative measurements nor for coarser quantitative measurements. For greater accuracy, the test equipment must be designed for the measurement of aperiodic phenomena. The measurement is therefore basically the same as the measurement of any aperiodic function.

### 2.2 Practical Measuring Circuits

For a practical qualitative check, the measurement is perhaps most readily made by utilizing a video monitor as illustrated in Fig. 5(a). For a rough quantitative check to determine whether the 0.01-second limit is met, the arrangements of Fig. 5(b), Fig. 5(c) or of Fig. 6 are satisfactory. For measurements of greater ac-

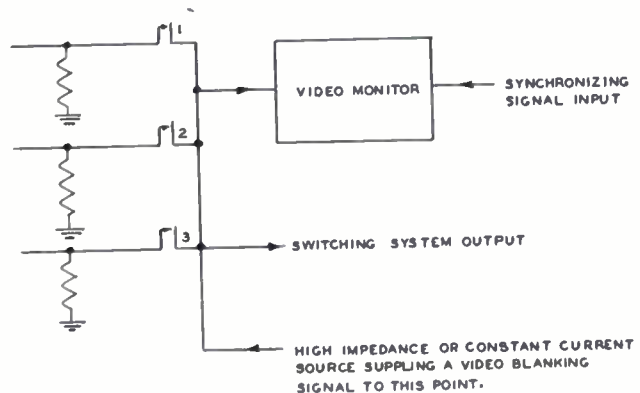

curacy, circuits indicated in Figs. 7 and 8 may be employed. The use of these circuits is covered in paragraph 3.2.

### 2.3 Requirements and Characteristics of Measuring Equipment

#### 2.3.1 General

In measurements indicated in Fig. 5 and Fig. 6, use is made of a video signal or the output of an audio oscillator in conjunction with a cathode-ray oscillograph and video monitor. In general, the methods indicated in Figs. 5 and 6 will suffice for operational and maintenance work.

#### 2.3.2. Cycling Relay System

As mentioned in paragraph 2.1, a means of cycling a relay system would reduce the measurement to that of measuring a periodic quantity. A synchronous motor driving a contact in the 60-to-120-per-minute range, which will provide an integral number of field traces on the cathode-ray oscillograph between closings of the contact, can be used to actuate the relay system and thus provide a more readable result from the circuit of

Fig. 6. The contact must close and open in a positive manner—without chattering.

### 2.3.3 Special Sweep Circuits

The equipment of Fig. 7 requires an aperiodic sweep on the vertical deflection of the cathode-ray oscillograph and is triggered from the magnetic circuit of the switching system. The use of vertical scanning on the cathode-ray oscillograph improves the accuracy with which the "lap" or "gap" can be measured. The presentation of information will now be associated aperiodically with the interval to be measured and also utilizes what amounts to a very long trace on the cathode-ray oscillograph. Fig. 8 indicates a means of measuring which affords perhaps greater accuracy than the method of Fig. 7. However, this requires some modification to the switching system for the purpose of making the measurement and a cathode-ray oscillograph with an aperiodic horizontal sweep and marker system. A marker frequency one thousand cycles (in Fig. 8) will approach the maximum usable graduation consistent with the possible adjustments to current switching systems.

### 2.3.4 Triggering Information

With the exception of the aperiodic sweep of Fig. 7, the cathode-ray oscillograph with the aperiodic sweep in Fig. 4, and the triggering information, none of the test equipment is special equipment not normally present in a television installation. The triggering informa-

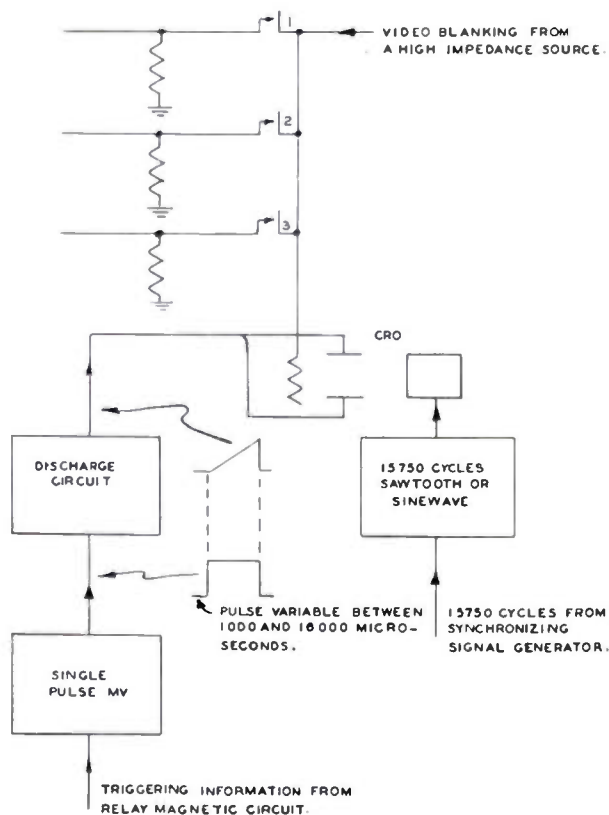

Fig. 7

tion, as indicated in Figs. 7 and 8, must of necessity be derived from some act associated with but preceding the closing or opening of the contacts under inspection. This information can perhaps be best obtained from some point in the magnetic circuit, such as the push button which supplies set-up battery. However, to lend significance to the measurement on the cathode-ray oscillograph, the triggering information must precede the closing or opening of the contacts under observation by a few milliseconds at the most. Otherwise, the quantity to be measured will be crowded to the end of the trace and accuracy of measurement will suffer. In general, this implies that some intermediate link, controllable in terms of elapsed time, must be inserted between the points of insertion of triggering information in Figs 7 and 8 and the source of anticipatory triggering information. This can be an aperiodic multivibrator with a variable width output. By using the trailing edge of this multivibrator output for the cathode-ray oscillograph triggering information, the above requirements can be met.

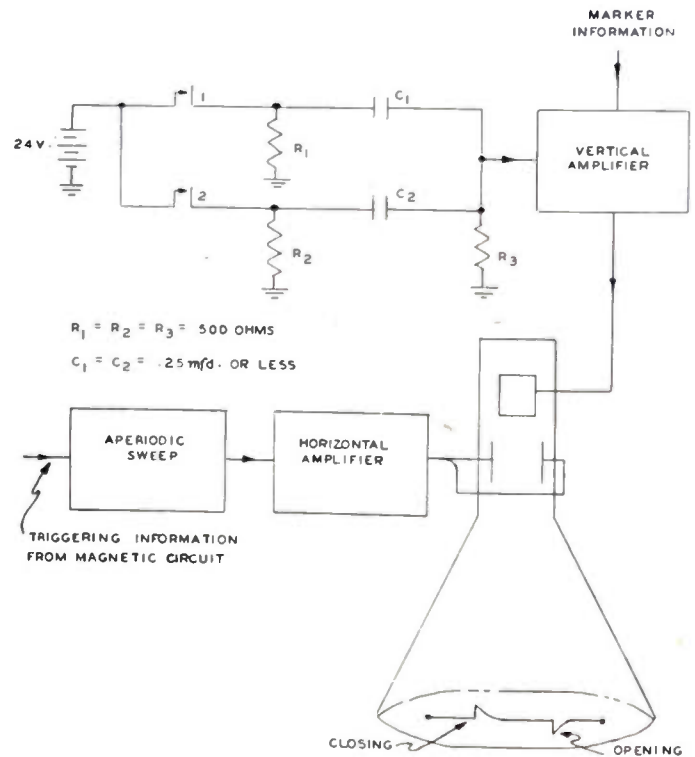

Fig. 8

## 3. PROCEDURE

### 3.1 Conditions

Since the quantity to be measured is of relatively long duration, no special conditions, such as extremely short leads, etc., are imposed on these measurements.

### 3.2 Technique of Measurement

#### 3.2.1 Operational Qualitative Checks

In Fig. 5, the quantitative check for the existence of a "lap" or a "gap" adjustment is made by:

3.2.1.1 Connecting the video monitor to bus no. 1 which is without a signal.

3.2.1.2 Closing contact no. 2 which places the video signal from bus no. 2 on the switching system output bus.

3.2.1.3 Closing contact no. 1 while observing the results on the monitor. Any momentary flash of video on the monitor indicates a "lap." If no signal is observed, a "gap" exists.

3.2.1.4 Repeating steps 3.2.1.2 and 3.2.1.3 and transposing the monitor input and the video signal until all possible combinations of contacts in the switching system have been checked for the existence of a "lap" or a "gap."

3.2.1.5 A better estimate of the amount of "lap" can be secured by substituting the output of an audio oscillator for the video signal on bus no. 2 and by using a cathode-ray oscillograph on bus no. 1 instead of the monitor as indicated in Fig. 5(b). If the horizontal deflection of the cathode-ray oscillograph is synchronized with the audio oscillator output to provide a one-cycle trace of sine wave when the audio oscillator output is placed on the vertical plates of the cathode-ray oscillograph, the connections described above will provide a trace of the one cycle each time both contacts are closed, i.e., for the duration of the "lap." If the frequency of the oscillator and the cathode-ray oscillograph horizontal scan is selected so the time of the "lap" is less than the one cycle presented, the estimate obtainable is fairly accurate in terms of the one cycle. It also indicates the uniformity of adjustment as the contacts are switched from one to two and from two to one.

3.2.1.6 For a "gap" measurement, the same process as in the preceding paragraph is employed except the connections of Fig. 5(c) are substituted.

#### 3.2.2 Operational Quantitative Checks

In Fig. 2, the procedure is as follows:

3.2.2.1 Close contact no. 2. This should reduce the brightness of the raster on the monitor by virtue of the load imposed by the termination on bus no. 2. Monitor brightness should now be adjusted so that either a decrease or an increase in brightness is discernible.

3.2.2.2 Close contact no. 1. If a "lap" exists, additional loading (due to the termination on bus no. 1 paralleling the termination on bus no. 2) of the constant current source will cause a decrease in brightness on the monitor for the duration of the "lap." If a "gap" exists, there will be an increase in brightness on the monitor for the duration of the "gap."

3.2.2.3 The results obtainable are of the nature of an estimate. The 0.01-second limit is somewhat less than  $\frac{2}{3}$  of the visible scanning lines in a *field*. Since there is no synchronization between the closing of the second relay contact and the field scan, it may be necessary to repeat the operation between each two contacts in both directions several times before the "lap" or "gap" indication falls in a position on the raster that permits a satisfactory estimate of its duration. The synchronously driven contact mentioned in 2.3 remedies this limitation.

#### 3.2.3 Quantitative Checks

In Fig. 3, the results are observed in the same manner as in Fig. 5, i.e., by increase or decrease in brightness. However, the addition of the aperiodic vertical scan will enhance the accuracy and the rapidity with which the measurement can be made. As in Fig. 6, the results are presented in terms of number of scanning lines.

#### 3.2.4

Fig. 8 indicates a possible means of measuring the "lap" or "gap" between two contacts with greater accuracy than that obtainable from the previously described methods. The procedure is as follows:

3.2.4.1 Close contact no. 1.

3.2.4.2 Initiate the closing of contact no. 2. If contact no. 1 opens before contact no. 2 closes,  $C_1$  will discharge through  $R_1$  and  $R_3$  and produce an indication on the cathode-ray oscillograph due to the drop across  $R_3$ . If, however, contact no. 2 closes first, the indication will be of the opposite polarity due to the charging of  $C_2$  through  $R_3$ .

3.2.4.3 The marker will preferably not be above 1,000 cycles.

3.2.4.4 The triggering information indicated in Figs. 7 and 8 as coming from the relay magnetic circuit can be taken from any point in the circuit, either mechanical or magnetic, that will supply anticipatory information for the cathode-ray oscillograph scan.

### 3.3 Presentation of Data

#### 3.3.1

All methods, except that of Figs. 5(b) and (c) and Fig. 8, indicated will present the information in terms of line scanning frequency. In the methods outlined in Figs. 7 and 8, a long persistence screen on the cathode-ray tube will enhance the ease and accuracy of measurement.

## 4. REFERENCES

- (1) M. E. Kron, "Electronic timing test sets," *Bell Lab. Rec.*, vol. 27, pp. 176-180; May, 1949.

# Correspondence

## Note on Total Emission Damping and Total Emission Noise\*

It is well known<sup>1-3</sup> that a diode in the exponential part of its characteristic shows an appreciable input damping  $G$  at uhf, which is caused by the electrons turning in front of the anode. From a thermodynamical point of view, one would expect a noise temperature of  $G$  equal to the temperature  $T_c$  of the cathode. This also follows from pure shot-effect considerations for those cases in which the influence of the space-charge upon the potential distribution between cathode and anode is relatively small; that is, for low values of the saturation current  $I_s$ , small values of the cathode-anode distance  $d$  or large negative values of the anode voltage  $V_a$ .

Let the electrons emitted with a velocity between  $V_0$  and  $(V_0+dV_0)$  volts give a contribution  $dI_s$  to the emission current;  $dI_s$  follows from the Maxwellian velocity distribution. The flow of this current  $dI_s$  in the alternating electric field between cathode and anode gives rise to a certain input conductivity; the total conductivity is found by integrating over all possible initial velocities  $V_0$  of the electrons turning in front of the anode ( $0 < V_0 < V_a$ ). The spontaneous fluctuations of the current  $dI_s$  give rise to a noise current flowing from cathode to anode; taking the mean-square values of it and integrating it over all possible initial velocities  $V_0$  gives the mean-square value  $\bar{i}^2$  of the total noise current.

After the laws of uhf vacuum-tube electronics<sup>4</sup>

$$G = \int_0^{V_a} \frac{4V_0}{V_a^2} \operatorname{Re} \left[ \frac{1}{2} (j\omega\tau_{cc}) \phi_1(j\omega\tau_{cc}) \right] I_s e^{-V_0/V_T} dV_0 / V_T \quad (1)$$

$$\bar{i}^2 = \int_0^{V_a} \frac{4V_0^2}{V_a^2} \left| \frac{1}{2} (j\omega\tau_{cc}) \phi_1(j\omega\tau_{cc}) \right|^2 2e\Delta\nu I_s e^{-V_0/V_T} dV_0 / V_T \quad (2)$$

where  $\operatorname{Re}$  means real part,

$$\frac{1}{2} \alpha \phi_1(\alpha) = \frac{2}{\alpha^2} [(\alpha - 2) + (\alpha + 2)e^{-\alpha}] \quad (3)$$

by definition;  $\tau_{cc}$  the transit time of the electrons in their journey from the cathode and back to it;  $V_T = kT_c/e = T_c/11,600$  volts.  $\tau_{cc}$  can be expressed in terms of the transit time  $\tau_0$  of those electrons which arrive at the anode with zero velocity:

\* Received by the Institute, June 3, 1949.

<sup>1</sup> C. N. Smyth, "Total emission damping with space-charge limited cathodes," *Nature*, vol. 157, p. 841; June 22, 1946.

<sup>2</sup> A. van der Ziel and A. Versnel, "Total emission noise in diodes," *Nature*, vol. 159, pp. 640-641; May 10, 1947. Also by these authors, "Induced grid noise and total emission noise," *Phil. Res. Rep.*, vol. 3, pp. 13-23; February, 1948.

<sup>3</sup> N. A. Begovich, "High frequency loading," *Phys. Rev.*, vol. 74, p. 1563; November 15, 1948.

<sup>4</sup> C. J. Bakker and G. de Vries, "On vacuum tube electronics," *Physica*, vol. 2, pp. 683-697; July, 1935.

$$\begin{aligned} \tau_{cc} &= 2\tau_0(V_0/V_a)^{1/2}; \\ \tau_0 &= 2d \left( \frac{2e}{m} \right)^{-1/2} V_a^{-1/2} \\ &= 0.33 \times 10^{-8} d V_a^{1/2} \end{aligned} \quad (4)$$

Fig. 1

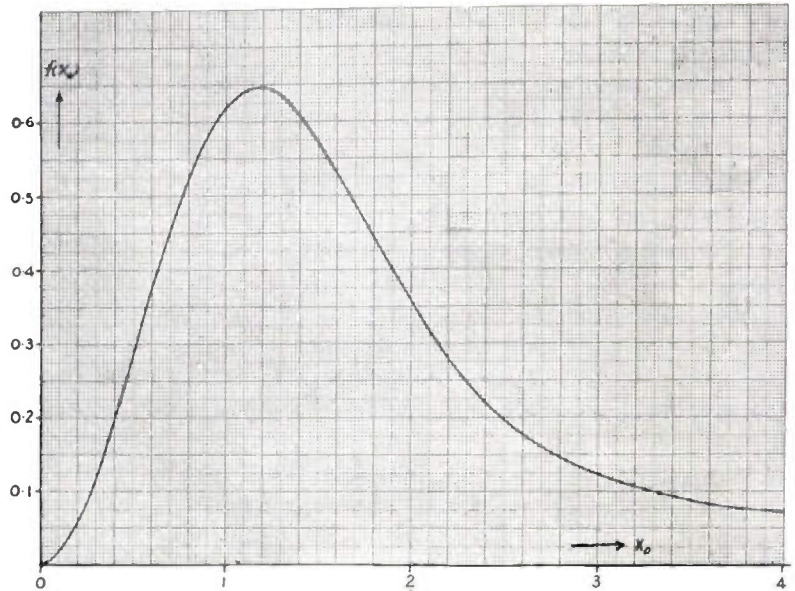

$I_a/V_a$ . Introduction  $\omega\tau_{cc}$  as a new variable in the integral and

$$x_0 = \omega\tau_0(V_T/V_a)^{1/2}$$

as a constant, one obtains after some integrations by parts

$$G = \frac{4I_s V_T}{V_a^2} [-1 + (1 + 2x_0^2)e^{-x_0^2} M(\frac{1}{2}, 3/2, x_0^2)] = \frac{4I_s V_T}{V_a^2} f(x_0), \quad (7)$$

$M(\frac{1}{2}, 3/2, x_0^2)$  being a confluent hypergeometric function, which can be derived with the help of Jahnke-Emde's<sup>5</sup> tables. This is the result obtained by Begovich only in slightly different notation.

$f(x_0)$  is plotted against  $x_0$  in Fig. 1; it increases as  $x_0^2$  for low values of  $x_0$ , attains a maximum value at  $x_0 = 1.2$  and is nowhere negative.

Note: Freeman<sup>6</sup> expressed  $\bar{i}^2$  directly in terms of the confluent hypergeometric function used above, whereas Begovich<sup>7</sup> published a fuller account of his work.

( $d$  in  $m$ ,  $V_a$  in volts).

Integrating (2) by parts, we obtain

$$\begin{aligned} \bar{i}^2 &= 4kT_c\Delta\nu G \\ &\quad - 2eI_a\Delta\nu \cdot 4 \left| \frac{1}{2} (2j\omega\tau_0) \phi_1(2j\omega\tau_0) \right|^2 \end{aligned} \quad (5)$$

where  $I_a$  is the anode current

$$I_a = I_s e^{-V_a/V_T}. \quad (6)$$

If  $I_a$  is very small, the second term in (5) is negligible.

Begovich<sup>3</sup> recently gave an expression for  $G$ . It can be derived from (1) by observing that it is usually allowed to replace the upper limit of integration in (1) by  $\infty$ , as this only introduces errors of the order

<sup>5</sup> E. Jahnke and F. Emde, "Tables of Functions," Dover Publications, New York, N. Y., p. 275; 1943.

<sup>6</sup> J. J. Freeman, "Noise spectrum of a diode with a retarding field," *Jour. Res. Nat. Bur. Stand.*, vol. 42, pp. 75-88; January, 1949.

<sup>7</sup> N. A. Begovich, "High frequency total emission loading in diodes," *Jour. Appl. Phys.*, vol. 20, pp. 457-461; May, 1949.

A. VAN DER ZIEL  
University of British Columbia  
Vancouver, Canada

# Correspondence

## Density Distribution of Transient Currents in Conductors\*

The study of the current density distribution in the cross section of conductors is usually limited to the case in which periodic currents are involved. However, with the increasing importance of the pulse technique, it appears of interest to extend the study to transient currents.<sup>1,2</sup> In the following, the density distributions of an exponential decay current

$$i = I_0 e^{-\alpha t} \tag{1}$$

and of a pulse current

$$i = I_0 [U(t) - U(t - T_0)] \tag{2}$$

are analyzed, by solving the differential equation

$$\Delta^2 \mathfrak{J} = \sigma \mu \frac{\partial \mathfrak{J}}{\partial t} \tag{3}$$

In (3)  $\mathfrak{J}$  is the current density,  $\sigma$ ,  $\mu$  are respectively the conductivity and the permeability of the material.

### A. Exponential Decay

For a plane surface (semi-infinite) conductor, measuring  $z$  normally from the surface and letting  $\mathfrak{J} = \mathfrak{J}(z)e^{-\alpha t}$ , it is found

$$\mathfrak{J} = \mathfrak{J}_0 \cos(\bar{k}z)e^{-\alpha t} \tag{4}$$

where  $\bar{k} = \sqrt{\sigma \mu \alpha}$  ( $\bar{k} \approx 8.5 \sqrt{\alpha} \text{ m}^{-1}$  for copper) and  $\mathfrak{J}_0$  is the density at the surface at time zero. The density varies sinusoidally as a function of the depth  $z$  (Fig. 1) and presents zeros and inversions of sign at various depths, although the total current (1) is unidirectional.

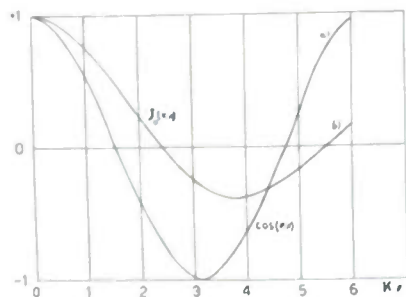

Fig. 1—Density distribution of a transient current  $i = I_0 e^{-\alpha t}$  in the cross section (a) of a plane surface conductor, (b) of a cylindrical conductor.

For a cylindrical conductor, indicating with  $r$  the distance from the axis and letting  $\mathfrak{J} = \mathfrak{J}(r)e^{-\alpha t}$ , it is found

$$\mathfrak{J} = \mathfrak{J}_0 J_0(kr)e^{-\alpha t}, \tag{5}$$

where  $k = \sqrt{\sigma \mu \alpha}$  and  $\mathfrak{J}_0$  is the current density at the axis at time zero. The density varies with the radius as a Bessel function of first kind zero order (Fig. 1) is a maximum at the axis of the conductor and presents zeros and inversions of sign at various values of  $r$ . The total current is

$$I_0 e^{-\alpha t} = \int_A \mathfrak{J} dA = \mathfrak{J}_0 \frac{2\pi a}{k} J_1(ka) e^{-\alpha t}, \tag{6}$$

where  $J_1$  is the Bessel function of first kind, first order,  $A$  is the cross-section area, and  $a$  the external radius of the conductor. The average power loss per unit length from time zero to  $t$  is

$$W_{avo} = \frac{1}{t} \int_0^t \int_A \frac{1}{\sigma} \mathfrak{J}^2 dA$$

and correspondingly the transient resistance per unit length is  $R_t = W_{avo}/(I^2)_{avo}$ . From (5) and (6) it follows that the ratio  $R_t/R_0$ , where  $R_0$  is the dc resistance per unit length, i.e.,  $R_0 = 1/\pi a^2 \sigma$ , is

$$\frac{R_t}{R_0} = \left(\frac{ka}{2}\right)^2 \left\{ 1 + \left[ \frac{J_0(ka)}{J_1(ka)} \right]^2 \right\}. \tag{7}$$

Equation (7) has been plotted in Fig. 2. It is seen that  $R_t$  is practically equal to  $R_0$  up to values of  $ka = 2$ ; for  $ka > 2$ ,  $R_t \gg R_0$ . The transient resistance becomes infinite (and correspondingly  $I_0 = 0$  from (5)) at the zeros of  $J_1(ka)$ ; this is a consequence of the inversions of sign of the current density in the cross section.

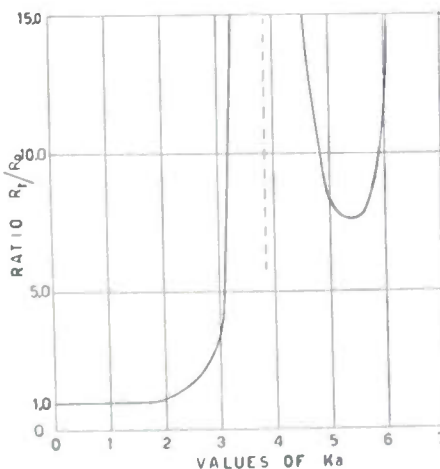

Fig. 2—Transient resistance ratio per unit length of a cylindrical conductor for a current of type  $i = I_0 e^{-\alpha t}$ .

### B. Pulse Current

For a plane surface conductor, the density distribution of transient currents of form (2) is

$$\mathfrak{J} = \frac{I_0}{h\sqrt{\pi}} \left\{ \frac{1}{\sqrt{t}} e^{-z^2/4\sigma\mu t} u(t) - \frac{1}{\sqrt{t-T_0}} e^{-z^2/4\sigma\mu(t-T_0)} u(t-T_0) \right\},$$

where  $h = 1/\sqrt{\sigma \mu}$ , and  $I_0$  is the amplitude of the total current per unit width of the conductor.

At constant depth  $z$  and  $t \leq T_0$ , peak values of  $\mathfrak{J}$  are reached when  $t = z^2/2\sigma\mu$ . At  $t = T_0$  a peak value of  $\mathfrak{J}$  equal to  $I_0 \sqrt{\sigma \mu / \pi \epsilon T_0}$  is reached when

$$z' = \sqrt{\frac{2T_0}{\sigma \mu}}. \tag{8}$$

The value of  $z'$ , which can be taken as equivalent depth of penetration, is proportional to  $\sqrt{T_0}$ . For instance for copper conductor  $z' = 0.166 \sqrt{T_0}$  meters, i.e.,  $z' = 0.166 \text{ mm}$  for  $T_0 = 10^{-6} \text{ sec}$ ,  $z' = 0.524 \text{ mm}$  for  $T_0 = 10^{-5} \text{ sec}$ . The average loss per unit length and per unit width of the conductor up to time  $T_0$  is

$$W_{avo} = I_0^2 \sqrt{\frac{2\mu}{\pi \sigma T_0}}$$

The corresponding transient resistance (per unit square surface) is

$$R_t = \sqrt{\frac{2\mu}{\pi \sigma T_0}}. \tag{9}$$

From (9), letting  $R_t = 1/\sigma \delta$ , it is possible to compute the depth of equivalent dc resistance

$$\sigma = \sqrt{\frac{\pi T_0}{2\sigma \mu}} \approx 0.89z'.$$

LUCIO M. VALLESE  
Duquesne University  
Pittsburgh 19, Pa.

## Principles of Radar\*

A trial-and-error method has been described in the book, "Principles of Radar"<sup>1</sup> for finding the currents and voltages in a square-wave off-on amplifier equipped with decoupling condensers.

However the following direct method may be used: Multiply the value of the decoupling resistor by the mark/period ratio and add this value to the load-resistor. A load-line for this resistor sum should be drawn, starting at the direct supply voltage. Where it crosses the grid-voltage line, the plate voltage and plate current (during the conduction-period) are found. A load-line, for the load-resistor only, drawn down from this point, shows the decoupling condenser voltage on the voltage axis.

RUDOLPH GOLDMANN  
539 W. 112 St.  
New York 25, N. Y.

\* Received by the Institute, January 21, 1950.  
<sup>1</sup> "Principles of Radar," Staff of the Radar School, Massachusetts Institute of Technology, second edition, McGraw-Hill Book Co., New York, N. Y., Chapter II, 6, pp. 2-25, Fig. 15A; 1946.

\* Received by the Institute, December 29, 1949.  
<sup>1</sup> J. A. Stratton, "Electromagnetic Theory," McGraw-Hill Book Co., New York, N. Y., Chapter 5; 1941.  
<sup>2</sup> K. W. Miller, "Diffusion of electric current into rods, tubes, and flat surfaces," *Trans. AIEE*, vol. 66, pp. 1446-1502; 1947.

# Contributors to the Proceedings of the I.R.E.

Leo L. Beranek (S'36-A'41-SM'45) was born in Solon, Iowa, on September 15, 1914. He received the B.A. degree from Cornell College in 1936, the M.S. degree from Harvard University in 1937, and the Sc.D. degree in 1940 from the same institution. He served as faculty instructor at Harvard from 1940 to 1943.



LEO L. BERANEK

In 1943 Dr. Beranek was appointed Director of Harvard's Electro-acoustic Laboratory, and in 1945 he was named, in addition, director of the Systems Research Laboratory. He received the Biennial Award of the Acoustical Society of America for outstanding contributions to acoustics in 1944, and was awarded an honorary Doctor of Science degree from Cornell College in June, 1946.

Dr. Beranek is a member of the Executive Council and a Fellow of the Acoustical Society of America, a Fellow of the American Physical Society, a Fellow of the American Association for the Advancement of Science, and a member of Sigma Xi. In 1946 he studied under a John Simon Guggenheim Fellowship jointly at MIT and Harvard. He has served on the following IRE Committees: National Convention, Professional Groups, and Audio Techniques. He is vice-president of the Acoustical Society of America and chairman of the American Standards Association Committee on Fundamental Sound Measurements. He is also an associate editor of the *Journal of the Acoustical Society of America*.

Dr. Beranek is currently associate professor of communications engineering and technical director of the acoustics laboratory at MIT.

❖

Tung Chang Chen (S'44-A'45) was born on May 15, 1917, in Peiping, China. He received the degree of B.S. in electrical engineering from the National Tsing Hua University in 1941. After graduation he was employed by the Central Radio Manufacturing Works. In 1942 he joined the staff of the department of electrical engineering of National Tsing Hua University.



TUNG CHANG CHEN

In 1944 Mr. Chen came to the United States and began graduate work at the Massachusetts Institute of Technology, receiving the S.M. degree in electrical engineering in 1945. He was then employed by the RCA Victor Division, Radio Corporation of America, Camden, N. J., engaged in development work on

microwave relay systems. In the summer of 1946 he was a research associate at the Moore School of the University of Pennsylvania, concerned with research and development work on the EDVAC electronic computer until it was ready for installation at the Ballistic Research Laboratories, Aberdeen Proving Ground, Md. He is now associated with the research division of the Burroughs Adding Machine Company, where he is continuing his work on electronic digital computers. He is also engaged in further graduate work at the University of Pennsylvania.

Mr. Chen is a member of the Association for Computing Machinery.

❖

John W. Clark (A'41-M'45) was born in Williamsburg, Va., in 1915. He received the B.A. degree in physics and mathematics from the State University of Montana in 1935, followed by the M.S. and Ph.D. degrees from the University of Illinois, in 1937 and 1939, respectively. Dr. Clark was a member of the technical staff at Bell Telephone Laboratories from 1939 through 1946, where he participated in the development of several types of microwave vacuum tubes, including TR tubes, wide-tuning-range local oscillator tubes, and amplifier tubes. In August, 1946, he joined the research division at Collins Radio Company, in Cedar Rapids, Iowa, where he was responsible for the design and application of the resonator. He recently joined the engineering staff of Varian Associates, in San Carlos, Calif., where he is in charge of theoretical tube design.



JOHN W. CLARK

Dr. Clark is a member of Sigma Xi, the American Physical Society, and the American Association for the Advancement of Science. He has served on the IRE Committee on Electron Tubes and Solid-State Devices since 1948.

❖

J. H. Dellinger (F'23) was born on July 3, 1886, in Cleveland, Ohio. He attended Western Reserve University before receiving the A.B. degree from George Washington University in 1908, and the Ph.D. degree from Princeton University in 1913. In 1932 Dr. Dellinger was awarded the Sc.D. degree from George Washington University. During the period from 1907 to 1948 Dr. Dellinger held the following successive posts at the National Bureau of Standards, in Washington, D. C.: physicist; chief, radio section; and chief, Central Radio Propagation Laboratory. During 1928-1929 he was chief engineer of the Federal Radio Commission. He served as a representative of the United

States Department of Commerce on the Interdepartment Radio Advisory Committee from 1922 to 1948; and as a representative of the United States at numerous international radio conferences, from 1921 to the present.



J. H. DELLINGER

Since 1934 Dr. Dellinger has been vice-president of the International Scientific Radio Union. At present he is chairman of Study Group 6 on Radio Propagation, of the International Radio Consultative Committee. He has been chairman of the Radio Technical Commission for Aeronautics since 1941, and has held the same position on the Radio Technical Commission for Marine Services since 1947.

Dr. Dellinger was President of the IRE in 1925, and a Director from 1924-1927. He received the Medal of Honor in 1936, and was Chairman of the Washington Section during 1932-1933. He has served on the following Institute committees, among others: Annual Review, Awards, Nominations, Radio Wave Propagation, Revision of the Constitution, Standardization, and Wave Propagation. He represented the Institute at meetings of the American Documentation Institute during 1944-1948, 1949, and on the American Standards Committee Sectional Committee on Electric and Magnetic Magnitudes and Units for 1936, 1939-1948.

❖

Oskar Döhler was born on January 27, 1913, in Schwarzenbeck, Germany. In 1938, he received the Doctor's degree at the University of Hamburg, and was then made research assistant and instructor at the Institute of Applied Physics of the University of Hamburg. He worked especially on the production and reception of microwaves and gaseous discharges.



O. DÖHLER

After a short time spent in England, Mr. Döhler was engaged in 1946 as an engineer in the electronics laboratory of the Compagnie Générale de T.S.F., Paris, France, where he is occupied with the theoretical problems of magnetron and traveling-wave tubes.

❖

For a photograph and biography of J. P. ECKERT, JR., see page 901 of the August, 1949, issue of the PROCEEDINGS OF THE I.R.E.

Anthony B. Giordano (SM'46) was born on February 1, 1915, in New York, N. Y. He attended the Polytechnic Institute of



A. B. GIORDANO

Brooklyn and was the recipient of the following degrees: B.E.E. in 1937, M.E.E. in 1939, and D.E.E. in 1946. In 1939, Dr. Giordano joined the academic staff of the electrical engineering department as instructor.

At present, he is assistant chairman of the graduate electrical division, in charge of the Master's degree program. His teaching interests are basic electronics, network theory, and electromagnetic fields and waves.

In 1942, Dr. Giordano became associated with the research staff of the Microwave Research Institute and has contributed in the fields of microwave measurements and microwave attenuators. He holds the position of research supervisor in charge of personnel.

During the period of 1937 through 1940, Dr. Giordano was affiliated part-time with the Root Research Laboratory, the International Air-Conditioning Company, and General Electric. With the latter company, he assisted in the lightning research conducted at the Empire State Building.

Dr. Giordano is a member of the American Physical Society, the American Institute of Electrical Engineers, Eta Kappa Nu, Tau Beta Pi, and Sigma Xi. He is now Faculty Representative of the IRE Student Branch at the Polytechnic, and was a member of the Technical Program Committee of the 1947 IRE National Convention.

❖

Harley Iams (A'31-M'38-SM'43) was born in Lorentz, W. Va., on March 13, 1905. In 1927 he received the B.A. degree from



HARLEY IAMS

Stanford University. From then until 1930 he was with the Westinghouse Electric Company, enrolled with their student course and working on facsimile picture transmission and television in the research laboratory. With Radio Corporation of America from 1931 to 1947

at Camden, Harrison, and Princeton, N. J., he performed research on television tubes and circuits, infrared and microwave devices, and rapid-scanning radar antennas. He was then a consultant and group leader on a guided missile project with North American Aviation, Inc., Downey, Calif. He is now a member of the technical staff, department of electronics and guided missiles, Hughes Aircraft Co., Culver City, Calif.

Mr. Iams is a member of Phi Beta Kappa and Sigma Xi.

Harry Huber was born in Berlin, Germany, on July 4, 1912. From 1933, as a student of the University of Berlin, he



HARRY HUBER

worked at the Technological Laboratory in the lamp factory of the Osram K. G., later the radio-tube factory of the Telefunken Company. He was occupied with technological problems and especially engaged in research work on electron emission projects. At the same time he continued his studies at the University of Berlin and received the Doctor's degree in 1941. After his graduation, he was engaged on development of radio and microwave tubes. In 1946, Mr. Huber joined the electronics department of the Compagnie Générale de T.S.F. at Paris, France, where he is working on traveling-wave tubes.

❖

John M. Kelso was born in Punxsutawney, Pa., on March 12, 1922. He received the A.B. degree in physics from



JOHN M. KELSO

Gettysburg College in 1943, and the M.S. degree from the Pennsylvania State State College in 1945. In 1949 he received the Ph.D. degree from the latter institution, having done a thesis on ionospheric radio propagation.

From 1943 to 1948 Dr. Kelso was associated with the physics department at the Pennsylvania State College. Two years of this time were spent in teaching physics, and the remainder were spent with the Wind Tunnel Laboratory and the Electromagnetic Propagation Laboratory.

Since 1948 Dr. Kelso has been employed by the Radio Propagation Laboratory of the Pennsylvania State College, where he now holds the rank of assistant professor of engineering research. He is a member of the American Physical Society, Sigma Xi, Sigma Pi Sigma, and Pi Mu Epsilon.

❖

Alfred Lerbs was born in Hamburg, Germany, on April 16, 1909. In 1928, he entered the Polytechnical High School in



ALFRED LERBS

Stuttgart and, in 1930, the University in Jena, where he worked at the Institute of Technical Physics. After his graduation he joined the staff of the Blaupunkt-Laboratories (Robert Bosch A. G.). From 1938 until 1945, he was engaged in research work on ultra-high-frequency

tubes for the electronics laboratories of the Telefunken Society.

Since 1946, Dr. Lerbs has been occupied with the development of traveling-wave tubes in the electronics department of the Compagnie Générale de T.S.F. in Paris, France.

❖

Herman Lukoff was born in Philadelphia, Pa., on May 2, 1923. He graduated from the Moore School, University of Pennsylvania,



H. LUKOFF

in October, 1943, with the B.S. degree in electrical engineering. He did part-time work on test equipment development during his senior year.

After graduation, he went to work on the ENIAC, and was concerned mainly with the cycling unit and circuit development. He was in the

United States Navy from July, 1944, to June, 1946, at a ship repair base overseas, where he worked on radio-radar repair and installation. Upon release, he joined the EDVAC project at the University of Pennsylvania and worked on logical design, the mercury memory, and electronic circuitry. Mr. Lukoff joined Eckert and Mauchly in September, 1947, to work on various projects, such as magnetic tape information and synchronizing equipment, and electrostatic memory development. He is at present working on the UNIVAC circuits.

❖

Ralph E. Neuber (A'47) was born on February 19, 1916, in Toledo, Ohio. He received the B.E. degree in electrical engineering from the



RALPH E. NEUBER

University of Toledo in January, 1941. In February, 1950, he was given the M.S. degree in electrical engineering from the State University of Iowa. After two years in the research laboratories of the Owens-Illinois Glass Company, working on the project of melting glass electrically, he entered active duty with the Signal Corps in January, 1943. Following ESMWT courses at Harvard University and the Massachusetts Institute of Technology, he was assigned to the 1st Signal Radio Maintenance Unit (Avn.), installing new radar equipment overseas. He was separated from the Air Forces as a captain in January, 1946, at which time he received the Owens-Illinois Glass Company.

Since 1947, Mr. Neuber has been employed in the research division of the Collins Radio Company, engaged in theoretical analyses pertinent to the resonator.

Donald H. Preist (M'44) was born in Tunbridge Wells, England, on January 18, 1916. He received the B.Sc. degree from



DONALD H. PREIST

King's College, London University, in 1936, and subsequently entered the British Government Service as a member of the first radar team in England under Sir Robert Watson-Watt. From then until 1946, he was associated with various aspects of radar development; in particular, the early experiments on detection of ships, development of high-power ground radar transmitters, and development of the MKV IFF and beacon system, including a period with the combined research group at the Naval Research Laboratory, Washington, D. C., from 1943 to 1945. During 1946, he served in the British Ministry of Supply, London, on the application of radio and radar to civil aviation, and represented the ministry of PICAIO international conferences as a scientific advisor.

During the early part of the war he served as a flight lieutenant in the Royal Air Force in connection with the establishment of radar in France, and later with Combined Operations Headquarters.

In December, 1946, Mr. Preist joined the research laboratory staff of Eitel-McCullough, Inc., San Bruno, Calif., where he is engaged as project engineer on problems of high-power vacuum tube and circuit development.

Mr. Preist is an associate member of the Institution of Electrical Engineers, London.

❖

Meier Sadowsky was born in San Antonio, Texas, on May 16, 1915. He received the B.S. degree in 1936 and the M.S. degree



MEIER SADOWSKY

in 1939, both from the College of the City of New York. He has done graduate work at Columbia University and the Newark College of Engineering. After teaching chemistry and physics at the Essex Junior College in Newark, N. J., Mr. Sadowsky joined the Radio Corporation of America in 1940, as chemical engineer for the Tube Development Laboratory.

In 1944 Mr. Sadowsky became advance development engineer on luminescent screen application, and in 1947 was made research engineer at the RCA Laboratories. He joined the Philco Corporation in 1949, as head of the Phosphor and Chemical Development Laboratories at Lansdale, Pa.

Mr. Sadowsky is a member of the Electrochemical Society, the American Chemical Society, and the Franklin Institute.

M. A. Schultz (A'31-SM'48) was born on March 21, 1918, in Portland, Maine. After receiving the B.S. degree in electrical



M. A. SCHULTZ

engineering from the Massachusetts Institute of Technology in 1939, he joined the staff of the industrial electronics division of the Westinghouse Company, engaged in military radio and radar design, and in charge of large naval shipborne radar equipments. In 1945, Mr. Schultz became project engineer at Photoswitch Incorporated, where he again was concerned with military radar. In 1946, he became section manager at the Westinghouse Research Laboratories in charge of radar, sonar, industrial electronic equipment, and nuclear radiation detection devices.

Since February, 1949, Mr. Schultz has been engaged as manager of the Instrumentation and Control Department of the Westinghouse Atomic Power Division. He is a member of Sigma Xi, and is a past Chairman of the IRE Pittsburgh Section.

❖

Gerald Smoliar was born in Brooklyn, N. Y., on December 5, 1917. He received the B.S. degree in electrical engineering from



G. SMOLIAR

the College of the City of New York in 1939. He was employed by the Signal Corps from 1940 to 1947. In 1947, he joined the staff of the Eckert-Mauchly Computer Corporation (formerly Electronic Control Co.) as a design engineer.

Mr. Smoliar is a member of the Association for Computing Machinery.

❖

Peter G. Sulzer (A'46) was born in Media, Pa., on August 3, 1922. He attended Drexel Institute of Technology in Philadelphia from 1940 to 1943; during that time he also spent one year with the Westinghouse Radio Division in Baltimore, Md.



PETER G. SULZER

Mr. Sulzer was in the United States Army Signal Corps from 1943 to 1946, engaged for the most part in ionospheric work. He received the B.S. degree in 1947, and the M.S. degree in 1949, both in electrical engineering, from the Pennsylvania State College, where he had been engaged in designing ionosphere equipment. Since September, 1949, Mr. Sulzer has been employed at the Central Radio Propagation Laboratory of the National Bureau of Standards in Washington, where he is concerned with ionospheric instrumentation.

Robert R. Warnecke (SM'48-F'50) was born on November 16, 1906, at Tours, France. He received the degree of Docteur de l'Université in Paris in 1933. His thesis dealt with the emission of secondary electrons from tantalum. Following this he became chief of the vacuum tube laboratory of the Société Française Radioélectrique; in 1940 he was head of the electronic tube research laboratory of the Compagnie Générale de Télégraphie Sans Fil and, in 1946, chief engineer at the research center of this company. He is now technical director of the electronics department in the same organization.



R. R. WARNECKE

Dr. Warnecke is a member of the Société Française de Physique, the Société Française des Electriciens, the Société des Radioélectriciens, and the Société des Ingénieurs et Techniciens du Vide. He received the IRE Fellow award in 1950 for "his engineering and research contributions to vacuum-tube theory and design in France." Dr. Warnecke also received the Prix Anceel of the Société Française des Electriciens in 1943 and the Prix H. Becquerel de l'Académie des Sciences de Paris in 1945.

❖

A. H. Waynick (A'43-SM'46) was born in Spokane, Wash., on November 6, 1906. He received the B.Sc. degree in 1935, and the M.Sc. degree in physics in 1937, both from Wayne University. He was a research student at Cambridge University during 1938 and 1939, and was awarded the D.Sc. degree in communications engineering in 1943 from Harvard University.



A. H. WAYNICK

Dr. Waynick is currently in charge of the Radio Propagation Laboratory and professor of electrical engineering at the Pennsylvania State College. He is a member of the IRE Wave Propagation Committee and of the U.S.A. National Committee of the U.R.S.I.

❖

John A. Wenzel (S'49) was born on July 22, 1926, in Erie, Pa. He received the B.S. degree in electrical engineering from the Pennsylvania State College in 1947, and the M.S. degree from the same institution in 1949. Since 1947 he has been employed by the Ordnance Research Laboratory at the Pennsylvania State College and has been engaged principally in research on servomechanisms. Mr. Wenzel is a member of Eta Kappa Nu and Tau Beta Pi.



JOHN A. WENZEL

member of Eta Kappa Nu and Tau Beta Pi.



# Institute News and Radio Notes

## TECHNICAL COMMITTEE NOTES

**New Technical Committee Chairmen and Vice-Chairmen** for the ensuing year, May, 1950-May, 1951, were introduced at a meeting of the Standards Committee held during the 1950 IRE National Convention, March 9, at the Hotel Commodore, New York, N. Y., under the Chairmanship of J. G. Brainerd. W. R. G. Baker, Standards Co-ordinator of IRE, addressed the group. . . . On February 16, the **Electron Tubes and Solid-State Devices Committee** held a meeting under the Chairmanship of L. S. Nergaard. . . . A **meeting of the Circuits Committee** was held on February 24, under the Chairmanship of Dr. Tuttle. . . . The **Industrial Electronics Committee** held a meeting on March 8, during the National Convention, with D. E. Watts as Chairman. . . . E. S. Seeley was **Chairman of a meeting of the Electroacoustics Committee** on March 6 at IRE headquarters. . . . With S. J. Begun as Chairman, the **Sound Recording and Reproducing Committee** met on March 8 at IRE headquarters, and A. W. Friend, Chairman of the Subcommittee on Magnetic Recording, reported on the activities of his committee. This Subcommittee is working on the proposed standards on "Noise Definitions and Measurement and Procedures." Upon completion of this work it will be presented to the Standard Committee for approval. Dr. Begun introduced Arnold Peterson, who has been appointed a member of the Committee to effect liaison with the Committee on Measurements and Instrumentation. . . . The **Receivers Committee** under the Chairmanship of R. F. Shea held a meeting on March 10. . . . The **Planning Committee of the Joint IRE/AIEE Nuclear Science Symposium** held a meeting on March 3 with G. W. Dunlap, Chairman. The Symposium will be held on October 23, 24, and 25 in New York City. . . . Donald G. Fink was **Chairman of a meeting of the Joint Technical Advisory Committee** on February 8. A report of the Committee on Consultants on Adjacent Channel Television Interference was submitted to JTAC by the Chairman of the Committee on Consultants, W. T. Wintringham. This report will be presented to the Federal Communications Commission.

## NEW ENGLAND RADIO ENGINEERS' CONFERENCE FEATURES RESEARCH

"Progress Through Research" was the theme of the 1950 Meeting of the New England Radio Engineers who met on April 15 at the Somerset Hotel, Boston, Mass. In addition to a morning and afternoon technical program, those attending the meeting had the opportunity to visit the television facilities of WBZ and to inspect the toll dialing equipment of the New England Telephone and Telegraph Company.

An unusual educational and entertaining lecture-demonstration entitled "Some New Ideas on Radiation" was a feature of the luncheon. Members of Boston and Connecti-

cut Valley Sections, comprising the North Atlantic Region of the IRE, also discussed their mutual problems under the guidance of Herbert J. Reich, Regional Director of the IRE North Atlantic Region.

Lawrence B. Grew, engineer for the Southern New England Telephone Company, and Chairman of the Connecticut Valley Section, conducted the morning technical session, and Hermon H. Scott, president of H. H. Scott, Inc., and Chairman of the Boston Section, presided at the afternoon technical session.

Presentation of technical papers included the following: "A New Pulse Generator for Television," by Calvin Ellis, Electronics Laboratory, General Electric Co., Syracuse, N. Y.; "Transient Phenomena in Loud Speakers," by Osman K. Mawardi and Arthur A. Janszen, Acoustics Research Laboratory, Harvard University, Cambridge, Mass.; "Design and Construction of Variable Four-Phase Radio-Frequency Oscillators," by C. Robert Paulson, Thayer School of Engineering, Dartmouth College, Hanover, N. H.; "Industrial Television," with demonstration by V. K. Zworykin, RCA Laboratories, Princeton, N. J.; "A Multichannel PAM-FM Radio Telemetering System," by E. F. Buckley and T. W. Farnell, Massachusetts Institute of Technology, Cambridge, Mass.; "Magnetrons and Systems," by Jack Donal and Donald S. Bond, Radio Corporation of America, Camden, N. J.; and "A Novel Coaxial Noise Diode Termination," by M. W. P. Strandberg, Massachusetts Institute of Technology, Cambridge, Mass., and Dale Pollack, consulting radio engineer, New London, Conn.

## ANNUAL MEETING OF ASEE WILL BE HELD IN JUNE AT SEATTLE

The 1950 Annual Meeting of the ASEE will be held from June 19 to 23, at the University of Washington at Seattle. The meeting will take place at the University's new Electrical Engineering Building, completed at a cost of nearly one million dollars.

Design, construction, and installation of all electrical equipment was made by the electrical engineering department and features a radio and communications laboratory, which has ten special working stations with removable panel units to provide all types of voltage supplies and testing equipment. This laboratory has its own meter room and switchboard, in addition to the meter room and switchboards serving the machinery laboratories, the industrial control laboratory, the oscillograph laboratory, the measurement laboratory, and the impulse generator laboratory.

The third annual exhibit of teaching aids will be a highlight of the session, showing materials contributed by both universities and industry. Another feature will be the agenda of the Division of English and Humanistic-Social Studies, including: sym-

posium on teaching of art to engineering students; a discussion of human relations in industry; and a four-day summer school session which will focus its attention on the integration of the teaching of English and Humanistic-Social Studies with the teaching of engineering and science.

## Calendar of COMING EVENTS

1950 IRE Technical Conference, Dayton, Ohio, May 3-5

Conference on Improved Quality Electronic Components, sponsored by IRE, AIEE, RMA, Washington, D. C., May 9-11

Armed Forces Communications Association 1950 Annual Meeting, Photographic Center, Astoria, L. I., N. Y. and New York City, May 12; Signal Corps Center, Fort Monmouth, N. J., May 13

IRE Conference on Electron Devices, University of Michigan, Ann Arbor, Mich., June 22-23

Conference on Ionospheric Physics, Pennsylvania State College, Pa., July 24-26

IRE West Coast Convention of 1950, Municipal Auditorium, Long Beach, Calif., September 13-15

National Electronics Conference, Chicago, Ill., September 25-27

IRE/AIEE Conference on Electronics Instrumentation in Nucleonics and Medicine, New York, N. Y., October 23-25

Radio Fall Meeting, Syracuse, N. Y., October 30, 31, November 1

## DAYTON IRE SECTION SCHEDULES MAY CONFERENCE ON ELECTRONICS

"Modern Trends in Airborne Electronics" is the theme of the 1950 Technical Conference to be sponsored by the Dayton Section of the IRE on May 3, 4, 5, at the Dayton Biltmore Hotel, Dayton, Ohio. The conference will feature the presentation of 57 technical papers and over 20 exhibits.

Lewis M. Clement (A'14-M'17-F'26) will be presented with an award in honor of his selection as the "Pioneer Man of the Year" in airborne electronics.

Mr. Clement, who was chosen over 30 candidates this year, was elected for his early interest in airborne electronics dating back to 1914, and his continued contributions to the science up to the present time.

## QUALITY ELECTRONIC COMPONENTS SYMPOSIUM SCHEDULED FOR MAY 9

Announcement has been made of a Symposium on Improved Quality Electronic Components; Unitization, Quality Elements, Miniaturization, to be held on May 9, 10, and 11 under the joint sponsorship of the IRE, AIEE, and RMA, at Washington, D. C.

F. J. Given is Chairman of the Conference Committee. The opening session, which starts at 10:00 A.M., is in charge of A. V. Astin, National Bureau of Standards. F. R. Lack of Western Electric Company will deliver the keynote address.

The following addresses will be made: "Military Equipment," L. V. Berkner, Carnegie Institute of Washington; "Commercial Electronic Equipment," D. E. Noble, Motorola, Inc.; "Home Use Electronic Equipment," F. R. Rollman, A. B. DuMont Laboratories; "Airborne Electronic Equipment," C. R. Banks, Aeronautical Radio, Inc.; "Industrial Electronic Devices," E. D. Cook, General Electric Co.; and "Laboratory Instruments," P. K. Elroy, General Radio Co.

"Unitized Design and Electronic Fabrication Techniques" is the title of the afternoon session under the Chairmanship of C. Brunetti of Stanford Research Institute, with Mr. Brunetti giving the keynote address. Addresses will include: "Printed Electronic Circuits, Applications and Aspects," W. S. Parsons of Centralab; "Miniature Printed Circuit Electronic Assemblies," A. Gross, Stewart-Warner; "Stamped Wiring, Sprayed Copper Wiring," W. H. Kleiver, Minneapolis-Honeywell; "Report on an Electronic Equipment Design," R. M. C. Greenridge, Bell Telephone Laboratories; "Heat Transfer in Miniaturized Unit Assemblies," W. Wheeler, Sylvania Electric Products Inc.; "Hermetically-Sealed Amplifier Design and Application," W. G. Wing, Sperry Gyroscope Co.; "Recent Developments in Potted Circuits," W. G. Tuller, Melpar, Inc.; and "A Program Toward 100 Per Cent Reliability in Telemetering Components," W. J. Mayo-Wells, Johns Hopkins University.

E. I. Green of Bell Telephone Laboratories will give the opening address at the morning session on May 10. Other talks will include: "Capacitors, Users' Viewpoint," C. E. Applegate, Leeds and Northrup; "Paper and Plastic Capacitors, Producers' Viewpoint," Louis Kahn, Aerovox Corp.; "Mica and Ceramic Capacitors, Producers' Viewpoint," Byron B. Minnium, Erie Resistor Corp.; "Electrolytic Capacitors, Producers' Viewpoint," Gordon Peck, P. R. Mallory Co.; "RF Inductors and Transformers, Users' Viewpoint," D. B. Sinclair, General Radio Co.; "RF Inductors and Transformers, Producers' Viewpoint," J. R. Mazzola, Automatic Manufacturing Corp.; "Iron Core Transformers, Users' Viewpoint," L. Batchelder, Submarine Signal Division; and "Iron Core Transformers, Producers' Viewpoint," Reuben Lee, Westinghouse Electric Corp.

The program for the afternoon session will be under the Chairmanship of S. H. Watson, Radio Corporation of America, and will include the following: "Resistors and Potentiometers—Users' Viewpoint," P. S. Darnell, Bell Telephone Labs.; "Composi-

tion Resistors and Potentiometers—Producers' Viewpoint," Jesse Marston, International Resistance Co.; "Wire Wound Resistors and Potentiometers—Producers' Viewpoint," G. M. Stapleton, Ward Leonard Electric Co.; "Connectors," E. C. Quackenbush, American Phenolic Corp.; "Indicating Instruments for Dependable Electronic Equipments," John H. Miller, Weston Electric Instrument Corp.; and miscellaneous contributed short papers on Components.

Professor W. G. Dow of the University of Michigan is Chairman of the morning session of May 11. Speakers and subjects for this session will be: "Tube-Application—Users' Viewpoint," T. H. Schubert, Sperry Gyroscope Co.; "Tubes—Application—Producers' Viewpoint," T. B. Perkins, RCA Victor Division; "Improved Tubes—Octal Series," G. D. Hanchett, RCA Victor Division; "Improved Tubes—Miniature Series," R. E. Moe, Kenrad Division, General Electric; "Improved Tubes—Miniature and Subminiature Series," P. T. Weeks, Raytheon Mfg. Co.; "Improved Tubes—Subminiature Series," A. L. Dolnick, Sylvania Electric Products Inc.; and "Improved Vacuum Tubes for Severe Operating Conditions," J. Wyman, Eclipse Pioneer Division, Bendix.

An open forum and panel discussion will be held at 11:20 A.M. Ernst Weber of Polytechnic Institute of Brooklyn will be the Moderator. Panel members include J. A. Becker of Bell Telephone Laboratories; H. E. Bernstein, Armed Service Electro-standards Agencies; Captain W. W. Rogers, Signal Corps Electronic Laboratory, Fort Monmouth, N. J.; G. F. Metcalf, General Electric Co.; Julian Sprague, Sprague Electric Co.; W. R. Clark, Leeds and Northrup Co.; J. G. Brainerd, University of Pennsylvania; D. B. Smith, Philco Radio and Television Corp.; and D. D. Israel, Emerson Radio and Phonograph Corp.

## UNIVERSITY OF MICHIGAN OFFERS SUMMER ELECTRONICS SYMPOSIUM

An eight-week specialized Summer Electronics Symposium will be offered as part of the 1950 Summer Session of the University of Michigan. Visiting lecturers from other universities and from various industrial and governmental laboratories, including representation from England, will participate in the Symposium to be held from June 26 to August 18.

An outline of lecture subject matter and other pertinent information is given in a bulletin which may be obtained by writing to the Office of the Summer Session, Administration Building, or to Professor W. G. Dow, Director of the 1950 Summer Electronics Symposium, Department of Electrical Engineering, both at the University of Michigan, Ann Arbor, Mich.

Visiting lecture personnel will be as follows: J. C. Slater, Chairman of the Department of Physics, Massachusetts Institute of Technology; E. L. Ginzton, Department of Physics, Stanford University; J. A. Becker and J. R. Pierce, Bell Telephone Laboratories, Murray Hill, N. J.; E. D. MacArthur and LeRoy Apker, Research

Laboratory, General Electric Company, Schenectady, N. Y.; A. V. Haeff, Naval Research Laboratory, Washington, D. C.; E. S. Rittner, Philips Laboratories, Inc., Irvington-on-Hudson, N. Y.; J. S. Donald and H. W. Leverenz, RCA Research Laboratories, Princeton, N. J.; A. H. W. Beck, Standard Telephones and Cables, Ltd., Ilminster, England; J. H. Findlay and J. W. McNall, Research Laboratory, Westinghouse Electric Corp., Bloomfield, N. J.

## NTSC PANELS ANNOUNCED AT MEETING HELD AT IRE

Eight panels were named by W. R. G. Baker, Chairman of the National Television System Committee, at a meeting held Friday, March 3, at IRE headquarters, New York City. The panels, which will assist the Committee in its task of collecting technical data on various aspects of the problems with which it is concerned, are as follows: Panel 1—Color System Analysis, D. G. Fink, Chairman; Panel 2—Subjective Analysis of Color Systems, A. N. Goldsmith, Chairman; Panel 3—Allocations, J. V. L. Hogan, Chairman; Panel 4—Transmitters, P. J. Herbst, Chairman; Panel 5—Receivers, D. B. Smith, Chairman; Panel 6—Transmitter-Receiver Co-ordination, I. J. Kaar, Chairman; Panel 7—Color Rendition, A. V. Loughren, Chairman; and Panel 8—Terminal Apparatus, T. T. Goldsmith, Jr., Chairman.

## IONOSPHERIC PHYSICS WILL BE TOPIC OF CONFERENCE IN JULY

A three-day Conference and Symposium on the topic, "Ionospheric Physics," will be held at Pennsylvania State College on July 24, 25, and 26 for the purpose of acquainting scientists in the field of physics, relative to the upper atmosphere, with the latest theoretical and experimental developments.

Sponsored jointly by the college and the Geophysical Research Directorate of the U. S. Air Force, the meeting will feature the presentation of twelve papers given by foremost scientists in the field. Several symposia will be scheduled.

Several speakers from foreign countries will take part in the conference for which additional details may be obtained from A. H. Waynick, Radio Propagation Laboratory, The Pennsylvania State College, State College, Pa.

## ARMY SIGNAL CORPS WILL GIVE ELECTRONICS PROGRAM IN MAY

An elaborate communications and electronics program will be presented at Fort Monmouth, N. J., on Saturday, May 13, under the joint sponsorship of Fort Monmouth Chapter, Armed Forces Communications Association, and the Signal Corps.

The program is scheduled for the day following the annual National AFCA convention at the Commodore Hotel, New York, under the auspices of the New York Chapter. The annual dinner meeting will be held at the Commodore the same night, with a nationally known speaker.



Left to right: H. B. Richmond, Raymond F. Guy, Major General F. L. Ankenbrandt, Stuart L. Bailey, Raymond F. Guy, and Stuart L. Bailey.

## 1950 IRE Convention and Show Unqualified Success

**T**HE LARGEST ENGINEERING convention ever held became history on March 9 when the 1950 IRE National Convention drew to a close. Over 18,000 persons from some thirty countries registered at the Hotel Commodore and Grand Central Palace in New York City in order to be "Behind the Scenes in Radio-Electronics," the theme of the four-day gathering. The record-breaking attendance, 2,000 more than in 1949, reflected not only the increasing size and stature of the Institute, but also the outstanding importance of the program of 170 technical papers and 253 exhibits to the engineering and scientific world.

### MEETINGS

During the Convention three open meetings were held which were of particular interest to the membership in general: the annual meeting of the Institute, the annual Sections Committee meeting, and a meeting of chairmen and members of Professional Groups. These meetings are an important function of the convention, as they afford members an opportunity to meet with those who direct various phases of Institute activities.

The Convention opened on Monday morning with the annual meeting of the Institute at which officers of the Institute reported to the members on the status of the IRE. The meeting featured an address by Ralph Bown, director of research of Bell Telephone Laboratories, in which he emphasized that television "has a wider destiny and deeper obligation to man than merely to furnish mass entertainment." He pointed out that the radio and communications engineers must lead in developing broader uses for television in the future. President R. F. Guy presided at the meeting.

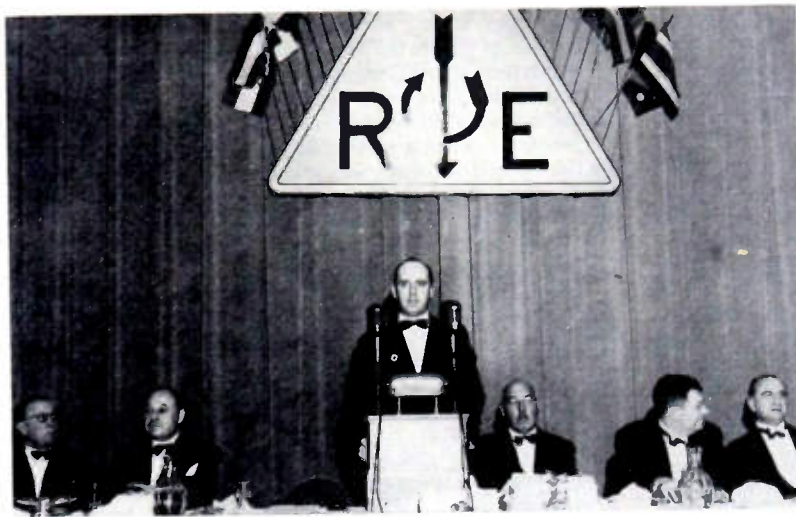

Left to right: Sir Robert Watson-Watt, H. B. Richmond, Donald G. Fink, Raymond F. Guy, Frederick E. Terman, and A. N. Goldsmith.

On Tuesday afternoon the annual meeting of the Sections Committee convened under the chairmanship of J. F. Jordan. The meeting was attended by representatives from each Section, and officers and directors of the Institute. The activities of each Section and Region were reviewed, and problems affecting all Sections were discussed at length.

On Wednesday morning W. R. G. Baker held a meeting of chairmen and members of all Professional Groups. Reports were heard on the membership and activities of the nine active Groups, and on plans to form several additional Professional Groups.

### TECHNICAL SESSIONS

The technical program consisted of 170 papers reporting on advances in every field of the radio-electronics art (substantially as was reported in the February issue of the PROCEEDINGS). The papers were presented at 29 technical sessions and 7 symposia. An innovation in the preparation of the technical program was the opportunity afforded

Professional Groups to sponsor sessions. As a result, five symposia were presented through the efforts of Groups. This valuable addition to the program is expected to become a permanent feature of future convention programs.

The technical program opened on Monday afternoon with two symposia and three technical sessions. The Professional Groups on Broadcast and Television Receivers and on Nuclear Science sponsored symposia on Industrial Design and on Nuclear Science and the Radio Engineer, respectively. Sessions were also held on Applications of Semiconductors, Communication Systems Theory, and Quality Control.

Among the many interesting topics discussed were the effects of good design on cost reduction, a review of the characteristics of nuclear radiation detecting devices, the application of transistors to trigger circuits, the analysis of speech sounds, the transmission of intelligence over narrow-band channels, and the life testing of vacuum tubes.

On Tuesday morning the program continued with a symposium on Engineering for Quality in Television sponsored by the Professional Group on Quality Control, a symposium on Network Synthesis in the Time Domain sponsored by the Circuit Theory Group, and sessions on Antennas, Transmission Systems, and Measurements. A variety of subjects were reported on, including aspects of quality control as applied to television picture tube screens, design data for radio relays operating in the 60- to 600-Mc band, a 5,000-Mc 24-channel radio telephone relay system, the design of electronic and photographic equipment for the study of rocket performance, and new test equipment for the uhf television band.

Left to right: Raymond F. Guy, Sir Robert Watson-Watt, Simon Ramo, Frederick E. Terman, and Raymond F. Guy.



There followed on Tuesday afternoon sessions on Television Transmission Systems, Filter Circuits and Variable Networks, Antennas, Modulation Systems, and Industrial Instruments. Among the advances described were a new photoconductive television pickup tube with high target sensitivity which is only one inch in diameter and six inches long, a compact closed-loop industrial television system, filters for television interference caused by radio amateur transmitters, techniques that permit a more economical use of the vhf and uhf spectrums through frequency-division multiplexing, the use of an image converter tube in obtaining one-microsecond-exposure photographs of objects illuminated by a continuous light source, the use of ultrasonic pulses in measuring the elastic properties of solids and the viscosity of liquids, and an electronic flowmeter which measures the velocity of liquids.

On Tuesday evening a special symposium was held on Television at which current developments in uhf allocations and color television were discussed by nine leading experts. The meeting was attended by 2,000 persons, including several commissioners of the FCC, which had recessed its color television hearings during the week of the Convention at the request of the IRE. The symposium began with a discussion of uhf allocations, followed by black and white versus color, color in general, the CBS color system, the CTI and the RCA color systems. In the final address, the compromises necessary to fit the above color systems to a 6-Mc band were analyzed. The meeting concluded with a discussion period during which questions from the audience were answered.

On Wednesday morning sessions were held on UHF and Color Television, Digital Computers, Electron Tube Theory and Design, and Amplifiers. In addition, the Technical Committee on Measurements and Instrumentation sponsored a symposium on Basic Circuit Elements. The sessions embraced such subjects as the construction and operation of an experimental uhf television station, an electrically controlled television color filter based on the interference phenomenon of polarized light, a new tube capable of such functions as addition, subtraction, multiplication, and selection, a novel method of frequency control which will keep FM and television receivers locked in to the incoming signal regardless of local oscillation or signal drift, and a new circuit design resulting in a large increase in amplification through the "starved" operation of amplifier tubes.

The sessions on Wednesday afternoon were devoted to Television Receivers, Active Circuits, Electron Tubes, Computers, and Transmission and Antennas. Included in the program were discussions on television image reproduction whereby printed material and line drawings take on a third dimensional



Left to right: Haraden Pratt, FCC Commissioner Frieda Hennock, and Raymond F. Guy.

quality, the theory of the AM rejecting properties of the ratio detector, a method of regulating high voltages by means of a corona discharge between coaxial cylinders, the experimental determination of the transfer functions of linear and nonlinear systems by the method of correlation, and a new type of transmission line consisting of an ordinary wire conductor with a specially treated surface along which surface waves in the vhf and uhf bands may be propagated.

The Thursday program began with morning sessions on Audio-Transducer Design, Electronics in Medicine, Propagation at Ionospheric Frequencies, Power Tubes, and Navigation Aids. Among the papers presented were reports on a pocket-size 4-tube radio receiver having a content of 25 cubic inches and utilizing a high-efficiency loudspeaker with a tonal output comparable to those used in larger receivers, a new way of mapping the electrical activity of the heart and brain using a PPI type of display, the effects of intense microwave radiation on living organisms, electronic equipment for making vectorcardiograms of the electromotive forces generated by the cardiac muscle, and a 500-kw super-power beam triode with a gain of 1,000.

The concluding sessions on Thursday afternoon consisted of a symposium on Sound Recording sponsored by the Audio Professional Group, and technical sessions on Propagation, Electron Tube Materials and Techniques, Components, and Oscillators. The sessions included discussions on noise limitations of various types of sound

recording media, diversity reception techniques and systems, a new method of joining metals to insulators for high temperature applications, miniaturization techniques whereby printed circuits, tubes, and components are fabricated as a unit which may be unplugged from the apparatus upon failure of any of its parts, a compact magnetic memory device consisting of a standard aluminum tubing capable of storing 10,000 ten-decimal-digit numbers, and a wide-range variable frequency oscillator capable of being tuned in one sweep of a linear control from 200 cps to 3 Mc and which may eventually provide a frequency range of one billion to one ratio.

#### EXHIBITS

A grand total of 253 exhibitors, including the Armed Services, filled three floors of Grand Central Palace with over \$7,000,000 worth of electronic equipment and products, making the 1950 Radio Engineering Show the largest on record. The theme of the exhibit, "Spotlight the New," was carried out by diversified displays revealing the latest developments in electronic apparatus, techniques, and applications.

In the field of television, a new compact television pickup tube was revealed for the first time. This tube was also the subject of a paper on Tuesday afternoon (see above). Also on display was an industrial color television system operating on an 18-Mc channel with 525 lines and 180 fields per second. Other exhibits included television cameras, studio lighting equipment, 19-inch TV tubes, and a 36- by 27-inch large screen projector.

Complementing a paper delivered on Thursday morning (see above), a high-vacuum tube capable of 500 kw continuous output was on display, representing a power increase of four times over previous types.

The audio field was well represented by exhibits of tape and wire recorders, studio turntable equipment, and a variety of interesting demonstrations in eight sound demonstration rooms. In the components field, the displays ranged from coil winding machines to specially fabricated condensers for use at extremely high temperatures.

The Armed Services exhibits depicted the latest advances in electronic devices designed for military applications. The Signal Corps had on display a new type of transmission line known as the "G-string" or "surface-wave transmission line," which was described during the Wednesday afternoon technical sessions (see above). Also on view were: examples of the latest techniques in the fabrication of printed circuits; a miniature magnetron the size of a small pencil; an Air Force emergency portable transmitter-receiver weighing only 5 pounds, successor to the famous "Gibson Girl" set; and a Navy "S-bomb" whose underwater detonation may

View of Exhibits, first floor, Grand Central Palace.



be detected by listening posts as far as 3,000 miles away in order to determine the position of airmen downed at sea.

Due to the critical coal shortage, novel use was made of standby station generating equipment to provide ac power for the entire Show.

#### SOCIAL EVENTS

On Monday evening, the first evening of the Convention, the "get-together" cocktail party, was attended by more than 1,100 members and guests, providing an excellent opportunity for visitors from all parts of the country to get acquainted.

The highlight of Tuesday's social program was the President's Luncheon, held in honor of President R. F. Guy. S. L. Bailey, the Junior Past President, acted as toastmaster to introduce Major General F. L. Ankenbrandt, Director of Communications

of the Air Force, who spoke on communication systems used in the South Pacific Islands during the war. Sir Robert Watson-Watt, Vice-President, concluded the luncheon with an entertaining talk on the English war effort.

The Annual IRE Banquet was held on Wednesday evening. Donald G. Fink acted as toastmaster to introduce H. B. Richmond, Chairman of the Board of the General Radio Company, who spoke on "For the Radio Engineer—Fission or Fusion?" At this time F. E. Terman was presented with the Medal of Honor, Otto H. Schade with the Morris Liebmann Memorial Prize, Joseph F. Hull and Arthur W. Randalls with the Browder J. Thompson Memorial Award, Andrew V. Haeff with the Harry Diamond Memorial Award, and E. J. Barlow with the Editor's Award. Thirty members were given Fellow awards, with Simon Ramo rendering the speech of acceptance.

#### WOMEN'S ACTIVITIES

The wives of members and guests attending the convention were offered an attractive and entertaining program of activities which included a television program on Monday, a tour of the Museum of Natural History and a tea at IRE Headquarters on Tuesday, a tour of Good Housekeeping Institute and a matinee on Wednesday, and a tour of the liner *Queen Elizabeth* on Thursday. Over 200 ladies participated in these events, which proved highly successful.

#### ACKNOWLEDGMENT

Grateful acknowledgment is due to the more than 150 persons who devoted so much time and effort to every phase of the activities of the Convention, making it the most successful IRE Convention on record.

## Industrial Engineering Notes<sup>1</sup>

### RADIO AND TELEVISION NEWS ABROAD

Radio receivers sold by Canadian manufacturers during the first ten months of 1949 totalled 532,880 units valued at \$39,696,785, compared with 428,391 sets valued at \$36,205,797 sold in the corresponding 1948 period, according to information received by the U. S. Department of Commerce. Of last year's total, 1,551 sets were TV receivers. Production of radio receiving tubes in the first ten months of 1949 was 3,793,353 units valued at \$1,800,621; for the corresponding period of 1948, production was 3,475,597, valued at \$1,637,603. . . . **United Kingdom exports of radio and electronic equipment continued at a high level during the first ten months of 1949**, according to a report of the British Radio Industry Council received by the U. S. Department of Commerce. January-October, 1949, exports totaled 19,518,000, compared with 111,897,000 and 110,272,000 for all of 1948 and 1947, respectively. A steadily increasing production of television receivers, exceeding 36,000 sets in December, is also reported by the Radio Industry Council. Total 1949 production was 205,500 sets, compared with 90,800 in 1948 and 28,200 in 1947. . . . **An estimated 8,000,000 radio receivers were in use in France in January, 1950**, of which about 80 per cent were designed to receive short-wave broadcasts. The number of listeners per set was an estimated 3 to 5 persons, according to the U. S. Department of Commerce. . . . **An estimated 1,200,000 radio receivers were in operation in Spain in November, 1949**, of which 555,000 were licensed. Approximately 90 per cent of the sets in use were designed to receive short-wave broadcasts. . . . Ap-

proximately 343,000 radio receivers were in use in Panama as of December 31, 1949, of which 95 per cent were designed to receive short-wave broadcasts. The number of listeners per set was an estimated 7.5 persons. . . . **The Australian Postmaster General, H. L. Anthony, announced recently that development of black-and-white television would not be delayed pending perfection abroad of color video techniques**, according to information received from the U. S. Embassy at Canberra. The Government official sought to remove a misunderstanding which resulted from a previous statement regarding color and Australian developments. He indicated that television in Australia might not remain a Government monopoly and declared that the whole question of television would be reviewed by the Cabinet. . . . There were 121,862 licensed radio sets in Israel at the end of November, 1949, according to information received by the U. S. Department of Commerce. Denmark had an estimated 1,310,860 radio receivers in operation at the end of 1949, according to information received from the U. S. Embassy there.

### FCC ACTIONS

**The FCC has granted the request of the Celomat Corp. of New York City to testify in the current color television proceedings.** The Celomat Corp. told the FCC it has developed a converter "for viewing color television after a set has been adapted under the CBS system," and is ready to manufacture this unit for sale at a retail price of about \$9.95. . . . The FCC has authorized four new class-B FM broadcasting stations for the New York City-Northeastern New Jersey metropolitan district with an aggregate construction cost in excess of \$330,000. Stations are to be built by the Crosley Broadcasting Corp., the Atlantic Broadcasting Co., Inc., and the Debs Memorial Radio Fund, Inc., in New York, and the Ebbets-McKeever Exhibition Co., Inc., in Brooklyn.

### TELEVISION NEWS

Running counter to the traditional post-holiday pattern, television set production by RMA member companies continued at a record level in January. RMA member companies reported the manufacture of 225,588 television receivers in four working weeks. Radio production also remained at about the fourth-quarter level with 660,195 sets reported. FM and FM-AM receivers reported by RMA member companies totalled 89,136, with an additional 34,087 TV sets reported as equipped for FM reception. . . . **The Allen B. DuMont Laboratories, Inc., last week filed an extended vhf-uhf television allocations plan as an exhibit in the current television hearings.** The DuMont plan extends an original plan from 326 TV markets to more than 1,400. The proposal aims to eliminate too-close spacing of stations and to minimize intermingling of vhf-uhf stations in the same community. The plan would utilize all of the 475- to 890-Mc. band, with 69 channels compared to the 42 proposed by the FCC. . . . **Television picture tube shipments in January continued at a high level exceeding December shipments**, and showed a further trend toward larger screens. TV picture tubes 12 inches or larger constituted over 90 per cent of the January shipments to set manufacturers with tubes 12 to 13.9 inches accounting for more than 61 per cent. Total TV receiver shipments by RMA members during 1949 aggregated 2,227,973 as compared with 808,025 sets in 1948.

### NAVY FLYING LABORATORY TO TEST ITS AIRBORNE RADAR EQUIPMENT

A new Navy flying laboratory, a modified Lockheed Constellation, is being equipped for extensive tests of the Navy's airborne early warning radar equipment and procedures. Designated AEW, the equipment installed on Naval aircraft permits the detection of enemy planes and surface units at much greater distances than is possible with ground-level or shipboard radar.

<sup>1</sup> The data on which these NOTES are based were selected, by permission from *Industry Reports*, issues of February 20, February 24, March 3, and March 10, published by the Radio Manufacturers Association, whose helpful attitude is gladly acknowledged.

# The Chicago Section Silver Anniversary

PAUL S. SMITH\*, SENIOR MEMBER, IRE

## INTRODUCTION

WHETHER 1950 starts a new half-century or winds up the old, it is an important year in the annals of the Chicago Section. On May fifteenth, nineteen hundred and fifty, the Chicago Section of the IRE completes its twenty-fifth year of progress. The Institute of Radio Engineers, as evidenced by the advance of the Chicago Section in the past quarter century, has a noteworthy record of growth and accomplishment. The tremendous progress of commerce and industry, and vast improvement in our standard of living, are directly commensurate with the growth of radio communications and entertainment. Such progress would not have been possible without the kind of "know-how" ability and "I will" spirit exemplified in this record of the Chicago Section.

## THE FOUNDERS OF ENGINEERING

Radio engineering developed from electrical engineering and it, in turn, from civil engineering; for, until a hundred years ago, 1852 to be exact, there were no active engineering societies, and all nonmilitary engineers were called "civil" engineers. The American Society of Civil Engineers was founded in 1839 with only 40 members, though the society didn't begin to function until 1852. The Mining Engineers (AIME) followed in 1871 and the Mechanical Engineers (ASME) in 1880. The Electrical Engineers (AIEE) followed in 1884, five years after Edison gave us the electric light, to complete the "founder" group of engineering societies.

It is interesting to observe that radio engineering, the offspring of the founder group, now outnumbers two of the founder societies in its active membership, the IRE having grown to 27,000 members. Today there are hundreds of technical societies, but only one devoted entirely to radio and electronic engineering. The Institute of Radio Engineers was founded to "advance the theory and practice of radio and allied branches of engineering and related arts and sciences." Radio, now extending into television and the still broader field of electronics, has come a long way in the past half century.

## ENTER RADIO AND THE IRE

Wireless came into being about the turn of the century. Two of the earliest organizations in this field, the Society of Wireless Telegraph Engineers (1906) and the Wireless Institute (1908), pooled their memberships to form The Institute of Radio Engineers in New York City on May 13, 1912, with 45 members. Activity spread from New York City as interest in radio grew. Sections of the IRE were formed in Washington and Boston in 1914; Seattle in 1915; and San Francisco in 1917.

Chicago was the fifth IRE section to be formed. Today Chicago is the second largest and unquestionably one of the most active of the 56 sections now in existence. It was

\* Motorola Inc., Chicago, Ill.

on Friday, May 15, 1925, that five Members and fourteen Associates of The Institute of Radio Engineers met to organize the Chicago Section of the IRE. (See August, 1925, PROCEEDINGS OF THE I.R.E., page 406). A hand-written copy of the original minutes and a few letters with Headquarters are the only records that exist in our files for these years. Headquarters' records show a national membership of 2,245 for 1925. Chicago Section membership for 1925 is listed as 46 founder members. Five meetings were held in 1926, the October meeting being on the Use of Short Waves in the South Pacific, by Lieutenant Fred Schnell. These were peaceful and prosperous times.

## THE ERA OF ECONOMIC ADVERSITY

By June, 1930, after 5 years of existence and right at the beginning of the depression, the Chicago Section had increased to 341 members. One hundred to 180 attended the four meetings held in 1930; the fewest meetings ever held—we all were careful that year. National membership for 1930 was 5,350. There were 17 sections. Under the Chairmanship of Byron B. Minnium, Chicago sponsored the Sixth National IRE Convention in 1930 and the Eighth National Convention in 1933 under the Chairmanship of Robert M. Arnold. Though many radio engineers had holes in their shoes from walking the streets, we had caviar at this convention and listened to Mildred Bailey sing the blues. Chicago was host to the world at the 1933 Century of Progress where the "new" wonders of communications and electronics—including television—were among the featured displays.

At the Tenth Anniversary of the Chicago Section in 1935, with the depression well on its way, the local membership had decreased to 182 paid members. Six meetings were held in 1934 and eight in 1935 with attendance varying from 90 to 400, the latter on television, 15 years ago. Besides television, the crowd-getters were electrolytic condensers, chain broadcasting, police radio, and metal tubes. Chairman Crossley was in Europe to learn that England "was ahead" on high-fidelity, Holland on tubes, and Germany on military communications. We were just in the transition stage from high-priced "mantle" to low-priced "midget" radios.

## PRE-WAR "PROSPERITY"

The year 1937 saw the nation and the IRE well on its road to recovery. The Chicago Section had reversed the trend of membership (321 in 1933, 182 in 1935, and 257 in 1937) by demonstrating real worth and value to its members. War interest in radio and electronics was still four years away and economic recovery was just beginning. Radio sets were getting smaller and sales bigger as purchasing power increased. The campaign for "two radios in every home" started in the Chicago area and its realization largely stemmed from Chicago's exceptionally cost-conscious engineering.

On its fifteenth birthday in 1940, the Chicago Section had regained most of its

depleted membership. There were 284 paid members. The 1940 National membership was 5,540. Nine Chicago Section meetings were held with attendance varying from 85 to 400 (the latter on FM this time). Our early interest in FM, uhf, and miniaturization was to pay dividends, because civilian radio production came to a grinding halt in early 1942 and all facilities were swung almost overnight to war research, development, and production. Where most scientific research had been associated with the East, we know now that the atomic bomb, the handie-talkie, walkie-talkie, many tank, air and landing-craft sets, and much of our radar developments originated in the Chicago area. With the advent of the war, interest in electronics—and IRE membership—climbed at a tremendous rate.

## WAR INSPIRED INTEREST IN ELECTRONICS

The Chicago Section reached its twentieth Anniversary in 1945 with 837 members, a 300 per cent increase in five years. National membership had increased to 15,782, a 280 per cent increase over 1940. March, 1943, brought the First War Production Clinic and affiliation with the Chicago Technical Societies Council as further indication of the war inspired co-operative effort. Closer contact with Headquarters was established, and periodic news letters were sent to the membership from the Section Chairman which ultimately resulted in the establishment of our own publication, *Scan-fax*, in September, 1946. The war brought a greatly increased interest in radio and electronics.

## A NEW DEAL IN IRE AFFAIRS

"New deal" thinking had its effect on the Chicago Section too. With the accession of Al Graf to Chairmanship in 1946, the tempo of Chicago Section activity increased greatly. Where previous Section Executive Committees for this large section had comprised only 6 to 9 members, with three standing committees (besides itself), the Executive Committee was increased to 35, the number of committees to 16—and all of them were put to work.

All IRE members would do well to acquaint themselves with the Bylaw Sections on regional representation, the professional group provisions, the committee and representative provisions, and the paper publication information listed in your 1949 Yearbook. Further details on paper publication are available from the Editor. Now that regional representation has been attained, plus increased outlying representation on IRE committees, much more frequent contribution of midwestern region papers should follow.

## CONSIDERATION OF MEMBER PREFERENCES

A survey was conducted by the Chicago Section in July, 1946, on Member Preference in Technical Papers. Better than 33 per cent response was obtained from the 1,000 questionnaires circulated. The first ten subjects were: 90 per cent general

"Electronics"; 80 per cent Research Developments; 72 per cent Receiver and Transmitter Design Data; 66 per cent Industrial Electronics; 64 per cent (four years ago) wanted Television; 52 per cent Frequency Modulation; 40 per cent Audio and Sound; 36 per cent Vacuum Tubes; 30 per cent Manufacturing Techniques; 25 per cent Management subjects; and only 21 per cent desired papers on Wave Propagation.

Chicago Section membership was given greatly increased opportunity to express itself through the augmented committee structure, the enlarged Executive Committee, the plant-contact Industrial Representatives, and the newly elected Regional Representatives. Utilization of this opportunity is manifest in the Chicago Section record for the past four years.

Perhaps the most monumental accomplishment was that of the new Procedures Committee; it undertook, and in less than a year completed, the task of writing complete operational procedure for all the officers and 16 committees (including itself). This work is already serving as a pattern for sectional operations throughout the country.

Attention was focused in January, 1945, on the IRE Building Fund. A goal of \$425,000 was set for a new National Headquarters. The fund was to be raised by industrial and membership contributions and extended throughout the year. By year's end, the fund had reached 146 per cent of quota. Of this amount 76 per cent was received from industrial and institutional contributors and 24 per cent from the IRE members. Though Chicago had only 5½ per cent of the membership, the Chicago members contributed 9 per cent of the membership fund.

#### MEMBERSHIP STRUCTURE

Chicago Section membership passed the 1,000 mark as of January, 1946, 17½ per cent in the professional grades, and 82½ per cent in the technical grades. Comparable national figures were 12 per cent in the professional grades and 88 per cent in the technical grades. An analysis of the new members showed that 79 per cent of the Senior Members, 64 per cent of the Members, and 32 per cent of the Associates were college graduates. A survey of Chicago Section meeting attendance showed that 40 per cent of the Fellows, 28 per cent of the Senior Members, 25 per cent of the Members, just 10 per cent of the Associates, and less than 1 per cent of the Students regularly attended meetings. The most popular subjects were the Major Armstrong FM paper, October, 1945, with 600 in attendance; Dr. DuMont on Television Prospects, January, 1946, with 480 in attendance; and the "regular" meeting of all time: Dr. Weiner's paper on Cybernetics, of February, 1949, which drew over 800 persons.

The Chicago Section also contributed assistance to the Chicago Technical Societies Conferences of 1943 to date and the National Electronics Conferences of 1944 and 1946 to date; and with the omission of the 1945 NEC because of wartime restrictions, the Chicago Section established its own Technical Conference in 1946. Chicago Section Technical Conferences were continued through 1949, but may not be resumed because of greater concentration on the National Electronics Conferences. In recognition of the broad-

ening application of electronics, and need for occasional release from technical interests, the Chicago Section has featured increased fraternization opportunities, such as our Annual Old Timers Picnic, and has sponsored closer co-operation with other technical and educational institutions engaged in electronics.

#### LOOKING FORWARD

In looking back from our Golden Jubilee in 1975 (provided some of us are still around), very likely the greatest single accomplishment in which the Chicago Section has been instrumental will prove to be the National Electronics Conference. Started in the minds of Beverly Dudley, then Western Editor of *Electronics*; W. O. Swinyard, Secretary of the Section; Professor A. B. Bronwell of Northwestern University; and Professor J. E. Hobson of the Illinois Institute of Technology; the NEC was organized in April, 1944, under the joint sponsorship of the Chicago Section IRE and AIEE, Northwestern University, and Illinois Institute of Technology, in co-operation with the University of Illinois and the Chicago Technical Societies Council, a truly co-operative venture for the advancement of electronic knowledge.

Five Electronic Conferences were held in Chicago in 1944, 1946, 1947, 1948, and 1949 with an average attendance of 2,000 to 2,500 from all sections of the country. *The Sixth and "25 years of Progress" National Electronics Conference will be held in Chicago on September 25, 26, and 27, 1950, to commemorate the Silver Anniversary of the Chicago Section.* Appropriate publicity is scheduled to acquaint all IRE members, the electronic manufacturers, and the public at large with the electronic progress made in Chicago and surrounding area in the past twenty-five years. The theme will include scientific research, engineering development, production operation, public acceptance, and the service maintenance phases of electronic products and services.

An appropriate brochure is being prepared for mailing and circulation on a large scale to proclaim the anniversary and present the record of Chicago's contribution to electronics. It will also include details on the Conference and other anniversary events, such as the special week of exhibits at the Museum of Science and Industry portraying the progress of electronics since 1925. The 1950 IRE Yearbook will contain a section devoted solely to electronic manufacturers in the Chicago area. Reprints of this section will be made available for wide distribution.

The climax of the Silver Anniversary will be the three-day National Electronics Conference, culminating in an Old Timers Night Celebration. Prizes will be given for old equipment exhibits. There will also be a display of the progress made by Chicago area manufacturers, whether they are 2 or 20 years old. Displays and trips featuring the advance of electronic education in the Chicago area are also planned. Though initiated by the Chicago Section of the IRE in commemoration of its twenty-five years of service to the radio industry, collaboration has been extended to include the participation of other technical, educational, industrial, and civic organizations to make this event a milestone in the annals of electronic progress.

#### CONCLUSION

Growth in numbers is but one measure of success. With an increase of almost forty times (45 in 1925 to 1,745 in 1950), and with our *continued* increase in membership, the Chicago Section has unquestionably demonstrated real worth and value to its local membership. The effects of Chicago Section recommendations on national policy, such as the establishment of the Executive Secretary (and improved Headquarters service); the membership upgrading program, improving the 8 to 1 technical/professional ratio of 1945 to a better than 4-to-1 ratio in 1949 (actually 2 to 1, disregarding Students); and the inauguration of regional representation, improving the effectiveness as well as recognition of outlying sections, are certainly to be reckoned with in IRE progress. Most important, the broadening of the IRE's scope in all fields of electronics, exemplified in the co-operative spirit shown at the National Electronics Conferences, is perhaps the greatest accomplishment of the Chicago Section of the IRE. The Silver Anniversary Conference will serve not only to commemorate past achievements, but should also serve to spur the IRE to even greater attainment.

All IRE members are cordially invited to attend the *25 Years of Progress National Electronics Conference* to be held in Chicago on September 25, 26, and 27, 1950.



Paul S. Smith (A'30-SM'45) was born in Brazil in 1904. He received his education in the Chicago Public Schools, majoring in electrical engineering at Armour Institute and business administration at Northwestern University. He holds a Professional Engineering License in the State of Illinois and is a director of the Illinois Engineering Council. He is a past vice-president of the Chicago Technical Societies Council and formerly publisher of the *CTSC Scientist News*. He is also a member of the ASTM, the RMA Engineering Department General Standards Committee, and has been active in RMA and IRE committee work for many years.



PAUL S. SMITH

Mr. Smith's radio experience started with the Sheldon Radio Club in 1919. From 1926 to 1937 he was with Stewart Warner. Starting in production supervision, he served as assistant to the service manager, then field engineer, and became Chicago branch service manager. Since 1937 Mr. Smith has been with Motorola Inc., as production engineer, assistant to the chief engineer, and is now the engineering specifications department head. He has specialized in standardization and simplification, cost estimation and reduction, materials and process engineering, and recently in preferred numbers and color technology.

At present Mr. Smith is Chairman of the Chicago Section Records Committee in which capacity he was delegated to report the Chicago Section's Silver Anniversary.

# IRE People

**William Dubilier** (A'14-M'18-F'29), founder and technical director of Cornell-Dubilier Electric Corporation and also president of Kolweld Corporation, has been awarded the Chevalier Cross of the French Legion of Honor in recognition of "his contribution to the development of the French and International electrical industry and also for his humanitarian activities."

Mr. Dubilier "has rendered a great service to the development of the electrical industry," the citation reads, "notably in the valuable invention of static condensers, which up to this time are best in the world."

This is the third honor that France has bestowed on Mr. Dubilier within a year. In June, 1949, he was presented with two medals simultaneously, the Honorary Medal of the Association des Ingenieurs-Docteurs de France and the Diploma of the Officer of the Academy and the Order of Academic Palms decreed by the French Government. They were in honor of his service to the country during World War I, and a recent peacetime service in assisting in the present rebuilding of France.

One of the early pioneers in radio, Mr. Dubilier is founder of the modern power condenser (capacitor) industry. He has more than 500 patents issued to him in various countries, some 300 of which are in the United States. He is a Fellow of the AIEE.

❖

**Britton Chance** (M'46-SM'46), director of the Eldridge Reeves Johnson Foundation for Medical Physics at the University of Pennsylvania, was awarded the \$1,000 Paul-Lewis Laboratories Award in Enzyme Chemistry on April 10, according to an announcement made by the American Chemical Society.

A gold medal was presented to Professor Chance at a general assembly of the society at the Bellevue Stratford Hotel in Philadelphia. Using photoelectric recording devices, Professor Chance developed a technique for the quantitative study of extremely rapid enzymatic reactions.

**Paul E. Waples** (M'46), senior engineer, Hazeltine Corp., Little Neck, L. I., died recently. Mr. Waples was born August 9, 1916, in Iowa.

He was graduated from Jefferson High School, Jefferson, Iowa and received the B.S. degree in electrical engineering from Iowa State University.

Mr. Waples acquired a radio amateur license in 1929, and did radio service and repair work from 1936 until 1939. Upon his graduation from college he was engaged in the design and development of high-frequency antennas and development engineering on high-frequency oscillators and receiver input circuits.

**Lewis M. Clement** (A'14-M'17-F'26), Director of Research and Engineering, Crosley Division, Avco Manufacturing Corp., Cincinnati, Ohio, has been chosen "Pioneer Man of the Year" by the Dayton Section of the IRE. Presentation of the award, conferred for his contributions to airborne electronics dating back to 1914 and his continued interest and aid to science up to the present, will be made at the Dayton IRE Technical Conference which is scheduled for May 3, 4, 5.

❖

**Robert A. Starek** (A'43), formerly commercial engineer, has been appointed field engineer for the Radio Tube Division of Sylvania Electric Products Inc., at Emporium, Pa. Mr. Starek will make his headquarters in the Cincinnati office.

He became affiliated with Sylvania immediately after receiving the B.S. degree in electrical engineering from Iowa State College in 1943.

❖

**Joshua Sieger** (A'29-SM'49) has been elected vice-president in charge of engineering by the Board of Directors of Freed Radio Corp., New York, N. Y., manufacturer of Freed-Eisemann Television Consoles and Radio-Phonographs. An international authority on television and radar, Mr. Sieger joined Freed Radio as Director of Research and Development in 1948.

Mr. Sieger will direct the activities of Freed Radio's new electronic research laboratories, and will supervise the engineering and development of the company's television receivers and other commercial products.

Prior to his association with Freed Radio, Mr. Sieger was Divisional Leader in charge of Engineering at the British Government's Telecommunications Research Establishment where he served during the war. He has been active in television since 1930, when he was responsible for development of optical-mechanical large-screen television projection for the Scopaphy Corporation. He holds many patents in radio, radar, and television, and has made contributions in techniques of radar display and ultrasonic light control for television and delay systems.

❖

**William W. Eitel** (A'39) and **Jack A. McCullough** (A'39) have been awarded the Distinguished Public Service Award, the highest honor given to civilians by the Navy, for their contributions to Navy Research and Development. Presentation was made at a ceremony on February 13 at Eitel-McCullough, Inc., of which Mr. Eitel is president and Mr. McCullough, vice-president, at San Bruno, Calif.

**Harald Schutz** (M'44-SM'46) has been placed in charge of radio-frequency engineering in the electronics department of the Glenn L. Martin Company, Baltimore, Md. Recently the electronics section was given full departmental status in the company. Dr. Schutz will be responsible for circuitry and antenna development over the entire radio-frequency spectrum.

Other appointments in the new department include that of **John M. Pearce** (SM'49), formerly head of the electronics section of the special weapons department, as chief electronics engineer, and of **Jobe Jenkins** (A'43-M'47), who has been placed in charge of the systems development and analysis group. He will be responsible for system studies and designs of new equipment, and for the solution of analytical problems arising on existing projects.

Dr. Schutz holds degrees of Electrical Engineer and Doctor of Technical Science from the Technische Hochschule, Vienna, Austria. During the war, he was in charge of electrical and radio engineering training at the Thayer School of Engineering, Dartmouth College, and later joined the engineering department of the Raytheon Manufacturing Company to do microwave development work.

Mr. Pearce has extensive experience in the radio and electronic field, having been associated with WGN, Inc., from 1925 to 1942; during the war he joined the staff of the Applied Physics Laboratory, Johns Hopkins University, and was unit supervisor of their proximity-fuze program in 1944 and 1945. He received the Presidential Certificate of Merit for this work. Prior to joining the Martin organization, he was chief engineer of the special products development department of Bendix Aircraft Corporation, Pacific Division, North Hollywood, Calif.

Mr. Jenkins received the B.S. degree in electrical engineering from Carnegie Institute of Technology in 1941, and the M.S. in electrical engineering from the same institution in 1942. From 1942 to 1944, Mr. Jenkins was an instructor in the electrical engineering department of Case Institute of Technology, Cleveland, Ohio.

For the next two years, he served with the U. S. Navy as Lt. (j.g.) and was associated with the "Bat" homing missile program. In 1946 Mr. Jenkins joined the Electronics Laboratory of the Glenn L. Martin Company, where he has been in charge of the development and design of the airborne equipment for a guided missile program.

❖

**Donald R. DeTar** (A'25-SM'47) and **H. T. Lyman** (A'38-SM'45) who are associated with the Johnson Laboratories Division of Aladdin Industries, formerly at 207 East 37 St., New York, N. Y., have moved to new quarters at 15 Crescent St., Glenbrook, Conn.



## Sections\*

| Chairman   |   | Secretary  | Chairman   | Secretary                       |
|--|---|--|--|---------------------------------|
| H. R. Hegbar<br>2145 12th St.<br>Cuyahoga Falls, Ohio                                | AKRON (4)                                   | H. G. Shively<br>736 Garfield St<br>Akron, Ohio  | G. L. Foster<br>Sparton of Canada<br>London, Ont., Canada  | LONDON, ONTARIO (8)             |
| W. J. Miller<br>1074 Springdale Rd.<br>Atlanta, Ga.                                  | ATLANTA (6)<br>May 19-June 16               | D. B. Buchanan<br>5130 Powers Ferry Rd.<br>Atlanta, Ga.                                    | R. L. Sink<br>Consolidated Eng. Co.<br>620 N. Lake Ave.<br>Pasadena 4, Calif.                    | LOS ANGELES (7)                 |
| E. W. Chapin<br>2805 Shirley Ave.<br>Baltimore 14, Md.                               | BALTIMORE (3)                               | J. V. Lebacqz<br>Johns Hopkins Un.<br>Baltimore, Md.                                       | D. C. Summerford<br>Radio Station WKLO<br>Henry Clay Hotel<br>Louisville, Ky.                    | LOUISVILLE (5)                  |
| J. Petkovsek<br>1015 Ave. E<br>Beaumont, Texas                                       | BEAUMONT-<br>PORT ARTHUR (6)                | C. B. Trevey<br>2555 Pierce St.<br>Beaumont, Texas   | E. J. Limpel<br>A. O. Smith Corp.<br>3533 N. 27 St.<br>Milwaukee 1, Wis.                         | MILWAUKEE (5)                   |
| H. H. Scott<br>Hermon Hosmer Scott<br>Inc.<br>385 Putnam Ave.<br>Cambridge 39, Mass. | BOSTON (1)                                  | F. D. Lewis<br>General Radio Co.<br>275 Massachusetts Ave<br>Cambridge 39, Mass.           | A. B. Oxley<br>R.C.A. Victor Co<br>1001 Lenoir St.<br>Montreal, P.Q. Canada                      | MONTREAL, QUEBEC (8)<br>May 10  |
| J. P. Arnaud<br>Guemes 827<br>Vte. Lopez<br>F.C.C.A., Argentina, S.A.                | BUENOS AIRES                                | I. Brandt<br>Uruguay 618<br>Buenos Aires,<br>Argentina, S.A.                               | C. W. Carnahan<br>3169-41 Place<br>Sandia Base Branch<br>Albuquerque, N. M.                      | NEW MEXICO (7)                  |
| L. P. Haner<br>75 Koenig Rd.<br>Tonawanda, N. Y.                                     | BUFFALO-NIAGARA (4)<br>May 17-June 19       | K. R. Wendt<br>Colonial Radio Corp<br>1280 Main St.<br>Buffalo 9, N. Y.                    | H. F. Dart<br>33 Burnett St.<br>Glen Ridge, N. J.  | NEW YORK (2)                    |
| D. B. Harris<br>2003 Glenway Dr.<br>Cedar Rapids, Iowa                               | CEDAR RAPIDS (5)                            | J. L. Hollis<br>2900 E. Ave. N.E.<br>Cedar Rapids, Iowa                                    | C. M. Smith<br>Radio Station WMIT<br>419 N. Spruce St.<br>Winston Salem, N. Car.                 | NORTH CAROLINA-<br>VIRGINIA (3) |
| E. H. Schulz<br>Elec. Engr. Dept.<br>Armour Research Found.<br>Chicago, Ill.         | CHICAGO (5)<br>May 19-June 16               | L. H. Clardy<br>Research Labs.<br>Swift & Co., U. S. Yards<br>Chicago 9, Ill.              | M. W. Bullock<br>Capital Broadcasting Co.<br>501 Federal Securities<br>Bldg.<br>Lincoln 8, Neb.  | OMAHA-LINCOLN (5)               |
| F. W. King<br>6249 Banning Rd.<br>Cincinnati 24, Ohio                                | CINCINNATI (5)<br>May 16-June 13            | J. P. Quitter<br>509 Missouri Ave.<br>Cincinnati 20, Ohio                                  | A. W. Y. Des Brisay<br>240 Clemow Ave.<br>Ottawa, Ont., Canada                                   | OTTAWA, ONTARIO (8)<br>May 18   |
| J. F. Dobosy<br>31748 Lake Rd.<br>Avon Lake, Ohio                                    | CLEVELAND (4)<br>May 25-June 22             | T. B. Friedman<br>2909 Washington Blvd<br>Cleveland Heights 18,<br>Ohio                    | J. T. Brothers<br>Philco Radio and Tele-<br>vision<br>Tiogo and 'C' Sts.<br>Philadelphia 34, Pa. | PHILADELPHIA (3)<br>May 4       |
| R. B. Jacques<br>226 W. Como Ave.<br>Columbus, Ohio                                  | COLUMBUS (4)<br>May 12-June 9               | S. N. Friedman<br>144 N. Edgevale<br>Columbus, Ohio  | M. Glenn Jarrett<br>416 Seventh Ave.<br>Pittsburgh 19, Pa.                                       | PITTSBURGH (4)<br>May 8-June 12 |
| Lawrence Grew<br>S. N. E. Telephone Co<br>New Haven, Conn.                           | CONNECTICUT<br>VALLEY (1)<br>May 18-June 15 | J. E. Merrill<br>16 Granada Terr.<br>New London, Co n.                                     | F. E. Miller<br>3122 S.E. 73 Ave.<br>Portland 6, Ore.  | PORTLAND (7)                    |
| J. H. Homsy<br>6022 Vanderbilt<br>Dallas, Texas                                      | DALLAS-FORT<br>WORTH (6)                    | R. A. Arnett<br>Box 7166<br>Dallas, Texas  | E. W. Herold<br>RCA Laboratories<br>Princeton, N. J.   | PRINCETON (3)                   |
| H. E. Ruble<br>3011 Athens Ave.<br>Dayton 6, Ohio                                    | DAYTON (5)                                  | G. H. Arenstein<br>1224 Windsor Drive<br>Dayton 7, Ohio                                    | K. J. Gardner<br>201 Humbolt St.<br>Rochester 10, N. Y.  | ROCHESTER (4)<br>May 18         |
| T. G. Morrissey<br>Radio Station KFEL<br>Albany Hotel<br>Denver, Colo.               | DENVER (5)                                  | Hubert Sharp<br>Box 960<br>Denver 1, Colo.   | N. D. Webster<br>515 Blackwood<br>N. Sacramento, Calif.  | SACRAMENTO (7)                  |
| G. A. Richardson<br>Dept. of Elec. Eng.<br>Iowa State College<br>Amae, Iowa          | DES MOINES-<br>AMES (5)                     | A. D. Parrott<br>Northwestern Bell Tel. Co.<br>604-Ninth St.<br>Des Moines 9, Iowa         | L. A. Mollman<br>Union Electric Co.<br>12 and Locust Sts.<br>St. Louis 1 Mo.                     | ST. LOUIS (5)                   |
| N. C. Fisk<br>3005 W. Chicago Ave.<br>Detroit 6, Mich.                               | DETROIT (4)<br>May 19-June 16               | P. L. Gundy<br>55 W. Canfield Ave.<br>Detroit, Mich.                                       | C. R. Evans<br>Radio Station KSL<br>Salt Lake City Utah  | SALT LAKE (7)                   |
| W. J. Peterson<br>322 E. Allegheny Ave.<br>Emporium, Pa.                             | EMPORIUM (4)                                | W. R. Rolf<br>364 E. Fifth St.<br>Emporium, Pa.  | F. E. Brooks<br>143 Eng. Bldg.<br>University of Texas<br>Austin, Texas                           | SAN ANTONIO (6)                 |
| R. E. Moe<br>Eng. Dept.<br>General Elec. Co.<br>Owensboro, Ky.                       | EVANSVILLE-<br>OWENSBORO                    | W. W. Furnell<br>Electronics Res. Inc.<br>Evansville, Ind.                                 | E. W. Thatcher<br>2661 Poinsettia Dr.<br>San Diego 6, Calif.                                     | SAN DIEGO (7)                   |
| H. W. G. Salinger<br>2527 Hoagland Ave<br>Ft. Wayne 6, Ind.                          | FORT WAYNE (5)                              | J. F. Conway<br>4610 Plaza Dr.<br>Ft. Wayne, Ind.  | W. R. Hewlett<br>395 Page Mill Rd.<br>Palo Alto, Calif.  | SAN FRANCISCO (7)               |
| C. R. Wischmeyer<br>808 N. Rice Ave.<br>Bellaire, Texas                              | HOUSTON (6)                                 | Wayne Phelps<br>26 N. Wynden St.<br>Houston 6, Texas                                       | J. R. Whinnery<br>Elec. Engr. Dept.<br>University of Calif.<br>Berkeley, Calif.                  |                                 |
| E. H. Pulliam<br>931 N. Parker Ave.<br>Indianapolis 1, Ind                           | INDIANAPOLIS (5)                            | J. H. Schult<br>Indianapolis Elec. School<br>312 E. Washington St.<br>Indianapolis 4, Ind. |  |                                 |
| F. M. Ashbrook<br>111-A Ellis<br>China Lake, Calif.                                  | INYOKERN (7)                                | D. L. Ewing<br>309-B Fowler<br>China Lake, Calif.  |  |                                 |
| C. F. Heister<br>Fed. Com. Comm.<br>838 U. S. Court House<br>Kansas City 6, Mo.      | KANSAS CITY (5)                             | Mrs. G. L. Curtis<br>6005 El Monte<br>Mission, Kan.  |  |                                 |

\* Numerals in parentheses following Section designate Region number.

# Sections

| Chairman  |   | Secretary  |  | Chairman  |   | Secretary  |  |
|---|---|--|--|---|---|--|--|
| S. D. Bennett<br>3437-36 Ave W.<br>Seattle 99, Wash.  | SEATTLE (7)<br>May 11-June 8                                | J. E. Mason<br>2318 Tenth St.<br>Bremerton, Wash.  |  | F. T. Hall<br>Dept. of Elec. Engr.<br>Pennsylvania St. College<br>State College, Pa.          | CENTRE COUNTY<br>(4)<br>(Emporium<br>Subsection)            | J. H. Slaton<br>Dept. of Eng. Research<br>Pennsylvania St. College<br>State College, Pa. |  |
| H. L. Thorson<br>General Elec. Co.<br>Bldg. 269<br>Schenectady, N. Y.                                   | SCHENECTADY   | J. D. Cobine<br>General Elec. Co.<br>The Knolls<br>Schenectady, N. Y.                              |  | A. H. Sievert<br>Canadian Westinghouse<br>Co.<br>Hamilton, Ont., Canada                       | HAMILTON (8)<br>(Toronto Sub-<br>section)                   | J. H. Pickett<br>Aerovox Canada Ltd.<br>1551 Barten St. E.<br>Hamilton, Ont., Canada     |  |
| L. R. Fink<br>416 Cherry Rd.<br>Syracuse 9, N. Y.   | SYRACUSE (4)  | S. E. Clements<br>Dept. of Elec. Engr.<br>Syracuse University<br>Syracuse, N. Y.                   |  | R. B. Ayer<br>RCA Victor Division<br>New Holland Pike<br>Lancaster, Pa.                       | LANCASTER (3)<br>(Philadelphia<br>Subsection)               | J. L. Quinn<br>RCA Victor Division<br>New Holland Pike<br>Lancaster, Pa.                 |  |
| A. M. Okun<br>344 Boston Pl.<br>Toledo 10, Ohio   | TOLEDO (4)  | R. G. Larson<br>2647 Scottwood Ave.<br>Toledo 10, Ohio   |  | O. M. Dunning<br>Hazeltine Elec. Corp.<br>5825 Little Neck Pkwy.<br>Little Neck, L. I., N. Y. | LONG ISLAND (2)<br>(New York<br>Subsection)                 | David Dettinger<br>Wheeler Labs.<br>259-09 Northern Blvd.<br>Great Neck, L. I., N. Y.    |  |
| C. Graydon Lloyd<br>Canadian General Electric<br>Co., Ltd.<br>212 King St., W.<br>Toronto, Ont., Canada | TORONTO, ONTARIO<br>(8)                                     | Walter Ward<br>Canadian General Electric<br>Co., Ltd.<br>212 King St., W.<br>Toronto, Ont., Canada |  | H. Sherman<br>Watson Labs-ENRPS<br>Red Bank, N. J.  | MONMOUTH (2)<br>(New York<br>Subsection)                    | W. L. Rehm<br>Signal Corps Eng. Labs<br>Rm. 247, Squier Lab.<br>Fort Monmouth, N. J.     |  |
| W. G. Pree<br>2500 W. 66 St.<br>Minneapolis, Minn   | TWIN CITIES (5)   | O. A. Schott<br>4224 Elmer Ave.<br>Minneapolis 16, Minn  |  | N. Young, Jr<br>F.C.C.<br>Nutley, N. J.   | NORTHERN N. J.<br>(2)<br>(New York<br>Subsection)           | J. H. Redington<br>Measurements Corp<br>Boonton, N. J.                                   |  |
| H. W. Wells<br>Carnegie Inst. of Wash.<br>5241 Broad Branch Rd.<br>N.W.<br>Washington, D. C.            | WASHINGTON (3)<br>May 8-June 12                             | Mark Swanson<br>8704 Maywood Ave.<br>Silver Spring, Md.  |  | George Weiler<br>1429 E. Monroe<br>South Bend, Ind.   | SOUTH BEND (5)<br>(Chicago<br>Subsection)<br>May 18-June 15 | A. R. O'Neil<br>Radio Sta. WSBT<br>1525 N. Adams<br>South Bend 16, Ind.                  |  |
| G. C. Larson<br>Westinghouse Elec. Corp.<br>Sunbury, Pa.  | WILLIAMSPORT (4)<br>May 3-June 7                            | R. C. Walker<br>Box 414, Bucknell Univ.<br>Lewisburg, Pa.  |  | R. M. Wainwright<br>Elec. Eng. Department<br>University of Illinois<br>Urbana, Ill.           | URBANA (5)<br>(Chicago<br>Subsection)                       | M. H. Crothers<br>Elec. Eng. Department<br>University of Illinois<br>Urbana, Ill.        |  |
| <b>SUBSECTIONS</b>  |   |  |  |   |   |  |  |
| Chairman  |   | Secretary  |  | Chairman  |   | Secretary  |  |
| C. E. Houston<br>Dept. of Elec. Engr.<br>Texas Tech. College<br>Lubbock, Texas                          | AMARILLO-LUBBOCK<br>(6)<br>(Dallas-Ft. Worth<br>Subsection) | R. F. Lee<br>2704-31 St.<br>Lubbock, Texas   |  | R. D. Cahoon<br>C.B.C.<br>Winnipeg, Man., Canada  | WINNIPEG (8)<br>(Toronto<br>Subsection)                     | J. R. B. Brown<br>Suite 2<br>642 St. Marys Rd.<br>Winnipeg, Man., Canada                 |  |

# Books

## Matrix Analysis of Electric Networks by P. Le Corbeiller

Published (1950) by The Harvard University Press and John Wiley and Sons, Inc., 440 Fourth Ave., New York 16, N. Y., 108 pages + 2-page index + xi pages, 49 figures, 5 1/2 x 8 1/2, \$3.00.

This is the first of a series of monographs in applied science to be published by Harvard University in order to make the results of University research available to a wider audience than would be reached by individual professional journals. Judging by this first little book, the series will be of great interest to all engineers concerned with research in the applied physical sciences. Its purpose is to offer a simplified and gradual approach to Kron's method of analysis of stationary electric networks. This the author wishes to accomplish with a minimum of mathematical symbolism, which in fact he limits to the essentials of matrix algebra, very clearly reviewed in the first chapter. Chapter II leads from the classical Kirchhoff and Maxwell (mesh) methods of dealing with electrical networks to the more general mesh method introduced by Gabriel Kron, which includes both symmetric and asymmetric couplings, the latter being obtained by means of vacuum tubes. Chapter III shows that the method is also applicable to a dual set of concepts, in which node pairs, node-pair voltages, admittances, and constant current generators play a similar role to meshes, mesh currents, impedances, and

constant voltage generators. Chapter IV extends the analysis to systems where branches are coupled to each other, and both voltage and current sources applied to the most general way.

The author presents the monograph very modestly as being helpful rather than original. It will be apparent to readers, however, that it is the result of much experience in teaching as well as no little ingenuity in mathematical demonstrations. It can be highly recommended to all radio engineers who want to keep in touch with modern advances in network theory, and study Kron's method of analyzing rotating electrical machinery which the author considers to be the most significant progress in electrical engineering analysis since the introduction of impedances by Kennelly and Steinmetz and of the two reaction method by Andre Blondel.

A. G. CLAVIER  
Federal Telecommunication Laboratories  
500 Washington Avenue  
Nutley, N. J.

## The Characteristics of Electrical Discharges in Magnetic Fields, (Edited by A. Guthrie and R. K. Wakerling)

Published (1949) by McGraw-Hill Book Co., Inc., 330 West 42 St., New York 18, N. Y., 369 pages + 6-page index + xviii pages, 234 figures, 9 x 6, \$3.50.

This book, which is Volume 5 in Division I of the Nuclear Energy Series, reports the principal results of the investigations car-

ried out from about 1943 to 1946 at the University of California Radiation Laboratory on the fundamental processes of gas discharges in magnetic fields. Much of the work was done by a British scientific mission under the leadership of H. S. W. Massey. Thirteen individuals contributed to the book, either as an author or a co-author of one of the chapters.

The aim of the investigations was to develop the basic theory of the type of arc discharge used as the ion source in a mass spectrometer when it is operated in a strong magnetic field. In these experiments a stream of primary electrons of, say, 150 ev energy was admitted into a box-like chamber through a slot. The magnetic field was directed parallel to the electron stream. Under the conditions used, for example, in argon gas at a pressure of 10-3 mm Hg and a field strength of 30,000 gauss, an arc plasma was set up along the electron stream within the box. At first sight it might be thought that the stream would remain constricted to a narrow beam on account of the small radius of curvature of the path of any electron that acquires a component of velocity away from the beam. Experiments proved, however, that the decay of the plasma ion density in a direction perpendicular to the magnetic field was gradual rather than abrupt, so it became desirable to investigate the mechanism by which electrons could move across the magnetic field. A preliminary step

# Books

was to study the characteristics or probes for use in the magnetic fields. A detailed report is given of probe studies in these discharges, mostly in argon but some results are given for chlorine. Other aspects of the problem that receive attention are (1) the conditions for a stable ion sheath, (2) minimum pressure for stable arc operation, (3) cross sections for ionization, and ionization and dissociation of uranium tetrachloride and uranium hexafluoride, (4) discharge cathodes, and (5) experiments on the Philips ionization gauge type of discharge.

An interesting aspect of the results is that the behavior of the plasma seems to be determined, in many cases, by the presence of fluctuations in plasma potentials, ion densities, etc. These were studied by observing the fluctuations, termed "hash," in the currents to the electrodes by means of a cathode-ray oscilloscope. Various types of hash were observed, including relaxation oscillations as well as fluctuations whose principal frequency components seemed to lie in the ranges from 20 to 60 kc or 100 to 300 kc, with lesser components in the range of 1 to 2 Mc.

The book consists primarily of a series of research reports of varying lengths on the topics indicated in the foregoing paragraphs. These reports cover a field that is relatively new and somewhat narrow, but the results have a wider applicability owing to the light that is thrown on some of the complex problems associated with the arc plasma.

R. RALPH BENEDICT  
University of Wisconsin  
Madison, Wis.

## Introduction to the Luminescence of Solids by Humboldt W. Leverenz

Published (1950) by John Wiley and Sons, Inc., 440 Fourth Ave., New York 16, N. Y. 471 pages + 30-page index + 14-page appendix + xv pages. 140 figures. 9 × 6. \$12.00.

It is not often that a book appears containing the distillation of twenty years' experience in a difficult field. The author was already well started on his work with phosphors when this reviewer was struggling with the synthesis of willemite. In the two decades since then, well over 100,000 phosphors have been synthesized and tested in laboratories here and abroad. A detailed discussion of the preparation and properties of each phosphor would be impossible in a single volume. Instead, the author has wisely chosen to describe them generally in terms of preparations, compositions, structures, and physical characteristics, using individual phosphors to illustrate each feature. In this way, a co-ordinated view of the entire subject is obtained, without sacrificing the utility of adequate descriptions of interesting and useful phosphors.

The first chapter reviews the elementary physical concepts leading to energy levels in atoms, molecules, gases, liquids and solids. The second chapter gives the necessary background from crystallography, including a discussion of ideal and real crystals, and introducing the concept of electron trapping in imperfect crystals.

The third chapter discusses some representative chemical procedures used in the synthesis of phosphors, and introduces a symbolism for their identification, a desirable step which has not been taken before in this rapidly growing field. In a section on devising new phosphors, the author points out that present physical theories of their action are too qualitative in nature to allow accurate prediction of the properties of a new phosphor, and that scientific intuition must continue to play a large part in determining the progress of phosphor research.

The fourth chapter treats the constitutions, structures, and energy levels in phosphors. The fifth, and longest, chapter discusses luminescence in terms of excitation processes, energy transformations and storage processes, emissions processes and spectral characteristics, exponential and power-law decays, stimulation and quenching of phosphorescence, and luminescence efficiency of phosphors. Correlations and interpretations are interwoven where they exist and are pertinent. Attempts are also made to direct attention to some major experimental and theoretical problems whose solutions would be particularly useful in advancing the art of phosphors toward the goal of a quantitative science.

Those readers who are interested primarily in the applications of phosphors will find the last two chapters extremely useful. A complete summary is given of the properties and limitations of some of the most useful phosphors and descriptions of procedures for their applications. The uses of phosphors in fluorescent lamps, cathode ray tubes, electron microscopes, nuclear particle counters, and icaroscopes are discussed in considerable detail. Phosphors may now be designed for specific applications, and the author gives on page 404, a general questionnaire for prospective phosphor users.

Much of the author's original work is presented in this volume, together with extensive references to the available literature (the bibliography contains over 1,000 references). The book is written in language easily comprehensible to science graduates. Although it is intended for nonspecialists in luminescence, it will be invaluable as a text in training future specialists and in aiding scientists who wish to refresh and increase their knowledge of solid matter and its interactions with radiations, and changed material particles, or who wish to use phosphors for detecting radiation and material particles. To the radio and radar engineers whose curiosities have been aroused by the various types of luminescent screens before which they spend much of their time, this book will be a refreshing and challenging experience.

C. W. CARNAHAN  
Sandia Corporation  
Albuquerque, N. M.

## Communication Circuit Fundamentals by Carl E. Smith

Published (1949) by McGraw-Hill Book Co. Inc., 330 West 42 St., New York 18, N. Y. 326 pages + 10-page index + x pages + 46-page appendix. 102 figures. 9 × 6. \$5.00.

This is the second of four books which will comprise an advanced radio and communications engineering course for home study. In

the author's words, "The texts are intended to serve as study fundamentals in residence or correspondence courses in which a plan of directed study helps the student learn the subject matter correctly and rapidly."

On the whole, the extent of the topics covered in this book is quite impressive. It includes a discussion of topics which run the gamut from matter and energy, electrical quantities, direct-current circuits and networks, magnetic circuits and fields, generator and motor action, inductance, electrostatic capacity, sinusoidal alternating currents, chapters covering ac circuit elements, impedance, power, series circuits, parallel circuits, network theorems. The last five chapters of the text cover the fundamentals of electron tubes. This is a very readable book, which contains a clear exposition of most topics. It could serve as an aid to students when they first study circuit theory and analysis, but it does not appear suitable as a college level text.

There are a number of faults to be found with the book. Perhaps the most glaring weakness is the lack of discussion of potential and current reference directions, and their relation to network analysis. The introduction of the concept of unit magnetic poles in Chapter 5 on magnetic circuits and fields seems rather unfortunate in present-day writings. The discussion of mutual inductance in Chapter 7 is completely inadequate, both because of its brevity and also as it fails to mention such fundamental considerations as relative winding directions, and the importance of current and potential reference directions before writing Eq. (7-8). Through the book, the author shows impedance triangles with arrow-heads, as for voltage and current diagrams. It might have been better to have shown these impedance diagrams without arrow heads, as such diagrams are fundamentally different from the voltage and current representations. It is stated on page 256 that Norton's theorem is in reality another form of Thevenin's theorem. While these theorems are the equivalents of each other, they are not the same.

In the discussion of vacuum-tube parameters in Chapter 18, the symbolism for partial derivatives is incomplete, as the parameters that are maintained constant during differentiation are not indicated. A relatively minor point is that relating to Section 19-10, Variable- $\mu$  Pentode. There has been considerable discussion, particularly in the editorials in *Wireless Engineer*, as to whether such pentodes should be called variable- $\mu$  or variable- $\mu$ , the latter term being a contraction of variable mutual conductance. Perhaps Fig. 19-8 (b), the usual graphical representation ( $i_{\mu e c}$  plane) to illustrate differences between the sharp-cutoff and remote cutoff tubes might be used as some evidence in favor of variable- $\mu$ .

Finally a word about the Appendix. This is 45 pages long, and contains a wide range of topics, principally mathematics tables and tabulations. Such handbook tabulations undoubtedly prove useful in general radio and communication engineering work. However, in so far as any relation within the text is concerned, much of this is filler only.

SAMUEL SEELY  
Syracuse University,  
Syracuse, N. Y.

# Books (continued)

## Vacuum Equipment and Techniques, Edited by A. Guthrie and R. K. Waklerling

Published (1949) by McGraw-Hill Book Co., Inc., 330 West 42 St., New York 18, N. Y. 242 pages + 6-page index + xviii pages + 16-page appendix. 102 figures. 9 X 6. \$2.50.

This book is concerned primarily with the development and study of high-vacuum equipment made by personnel of the University of California Radiation Laboratory. The routine production of high vacuum in large systems on a scale never previously undertaken was required in the operation of the electromagnetic separation process, and as a consequence the problems involved were of magnitude which required a considerable amount of work on both equipment and testing procedures. While these problems apparently constitute the framework around which the book was written, the problem is fundamental and the discussion comprehensive.

Of the five chapters, the first, written by Robert Loevinger, is concerned with fundamental principles. The treatment is straightforward and rigorous, providing an adequate basis for the design of vacuum systems.

The second chapter, by W. E. Bush, describes the operating principles of high-vacuum and booster pumps. Methods of computing pumping speed and speed requirements are included.

Chapter III, by K. M. Simpson, covers vacuum gauges with thoroughness, this portion of the book occupying 41 pages and providing a list of 62 references. In addition to discussions covering the usual McLeod, Pirain, Knudsen, and ionization gauges, other lesser-known varieties are evaluated and a description given of development work on special gauges at the California Radiation Laboratory.

Chapter IV, also written by W. E. Bush, constitutes a discussion of special topics relating to materials and the design of auxiliary equipment including gaskets, seals, valves, etc. Included are notes concerning the use of a bellows for producing mechanical motion within the evacuated system.

The last chapter is by R. Loevinger and A. Guthrie and is entirely devoted to leak-detection instruments and techniques. The flow of gas in small capillaries is treated quantitatively as an introduction to the more practical aspects of the problem. Conventional methods of leak detection are discussed while the operation of the mass-spectrometer type of leak-detection system is covered in considerable detail.

While, as might be imagined, the volume does not cover fully all problems likely to be encountered in vacuum processes, it is a nice piece of work. Readers engaged in the electron tube and lamp industries and other workers in high-vacuum electronics should find it to be well worth their attention.

GEORGE D. O'NEILL  
Sylvania Electric Products Inc.  
Physics Laboratories  
Bayside, N. Y.

## Fundamentals of Radio-Valve Techniques—Book I by J. Deketh

Published (1949) by Philips' Technical Library, Gloeilampenfabrieken, Eindhoven, Netherlands. 469 pages + 41-page index + 384 figures. 9 X 6. \$5.00.

This is the first member of a series of books having to do with the construction and uses of radio receiving tubes that is to be published by the Philips Technical Library. This first volume covers method of construction and general principles of operation, while subsequent volumes are to include data and circuits for particular tube types as well as full treatment of applications. The emphasis throughout is on the tube types and methods used or produced by the Philips Laboratories. This does affect the value of the book somewhat for an American audience, in that all of the tubes used as concrete examples of the principles under discussion are unfamiliar and obtainable only with more or less difficulty.

The level of treatment is well chosen, neither excessively mathematical nor unduly qualitative. The list of topics covered is practically encyclopedic in its completeness. Such matters as the complicated space-charge interaction in multi-element frequency converters are described for most of the possible arrangements of electrodes and voltages that have found use. The translation is well done, being both clear and readable with only a gentle European flavor typified by the use of valve for tube and a few other obvious differences in colloquial expression on the two sides of the ocean. There are very few errors in evidence, the only one of any consequence noted being the use of an unjustified approximation in the calculation of the effect of incomplete bypassing of a screen resistor.

The book should be of considerable value as a reference work to those concerned with the design of radio receiving equipment and similar apparatus, though it might not be so well suited as a textbook for the usual course in electronics.

S. N. VAN VOORHIS  
Department of Physics  
University of Rochester  
Rochester, N. Y.

## Acoustic Measurements by Leo L. Beranek, S.D., D.Sc. (Hon.)

Published (1949) by John Wiley and Sons, Inc., 440 Fourth Ave., New York 16, N. Y. 896 pages + 12-page index + 5-page author index + vii pages. 523 figures. 8 1/2 X 5 1/2. \$7.00.

This volume covers methods of acoustic measurement, and the apparatus used for such measurements, and includes a very comprehensive background of theory. The contents are very well arranged by chapters, whose titles in conjunction with the subject and author index, make it easy to find the information desired.

The book is designed as a reference volume for workers in the acoustical field and should be eminently satisfactory for those working with sound measurements. The volume includes net work published for the

first time along with excellent references and excerpts from the prior art. It is comprehensive and up-to-date in its coverage.

Chapter 1 contains 24 pages of acoustic terminology which definitions are unusually complete, clear, and concise.

A minor criticism is that in Chapter 5 in the discussion of the human ear "as a background to sound measuring devices," the measurement of the basic characteristics of the ear in the perception of pitch, loudness, timbre, and time are not mentioned. Some references to the Seashore tests would have been informative. Although all 20 chapters of the volume are regarded as excellent, the following chapters seem worth singling out in particular: Chapter 12 on the Analysis of Sound Waves is outstanding in its scope and completeness; Chapter 17 is, as stated in its introduction, an instruction manual for conducting Articulation Tests. It contains many test lists of syllables, words, and sentences with full instructions in their use and analysis. This chapter is based on the work of Dr. James P. Egan. Chapter 15 devotes 45 interesting pages to Loud Speaker Tests. This chapter, accredited to Dr. R. H. Nichols of the Bell Telephone Laboratories, should be of particular interest to radio engineers.

Many of the author's original contributions seem to be contained in Chapter 9 on Sound Sources and Chapter 19 on the Measurement of Materials. Both are long chapters, over fifty pages, and present clear and complete expositions of their subject matter.

Dr. Beranek has made a valuable addition to our technical literature and his reference volume should have a long life in the libraries of all engineers whose work touches on sound measurements.

JOHN D. REID  
Crosley Division  
AVCO Mfg. Corp.  
Cincinnati 25, Ohio

## Terrestrial Radio Waves, Theory of Propagation by H. Bremmer

Published (1949) by Elsevier Publishing Co., Inc., 215 Fourth Avenue, New York 3, N. Y. 336 pages + 6-page index + x pages. 91 figures. 6 1/2 X 9 1/2. \$6.75.

As the title implies, this book is essentially a treatise on various aspects of the theory of wave propagation. The first part deals with the "ground wave" problem simplified by omitting the influences of the ionosphere and atmospheric refraction, but taking into account the curvature of the earth's surface. In the following chapters the effects of the ionosphere and refraction are dealt with.

Relationships between rigorous solutions and working approximations are given. The application of the mathematical solutions to the calculation of field strength is well illustrated by numerous examples and calculated curves, covering a frequency range from about 15 kc to about 10,000 Mc.

H. O. PETERSON  
RCA Laboratories  
140 Moriches Road  
Riverhead, N. Y.

# Abstracts and References

Prepared by the National Physical Laboratory, Teddington, England, Published by Arrangement with the Department of Scientific and Industrial Research, England, and *Wireless Engineer*, London, England

NOTE: The Institute of Radio Engineers does not have available copies of the publications mentioned in these pages, nor does it have reprints of the articles abstracted. Correspondence regarding these articles and requests for their procurement should be addressed to the individual publications, and not to the IRE.

|   |     |
|---|-----|
| Acoustics and Audio Frequencies . . . . .             | 579 |
| Antennas and Transmission Lines . . . . .             | 579 |
| Circuits and Circuit Elements . . . . .               | 580 |
| General Physics . . . . .                             | 582 |
| Geophysical and Extraterrestrial Phenomena . . . . .  | 583 |
| Location and Aids to Navigation . . . . .             | 584 |
| Materials and Subsidiary Techniques . . . . .         | 584 |
| Mathematics . . . . .                                 | 585 |
| Measurements and Test Gear . . . . .                  | 585 |
| Other Applications of Radio and Electronics . . . . . | 587 |
| Propagation of Waves . . . . .                        | 588 |
| Reception . . . . .                                   | 589 |
| Stations and Communication Systems . . . . .          | 589 |
| Subsidiary Apparatus . . . . .                        | 590 |
| Television and Phototelegraphy . . . . .              | 591 |
| Transmission . . . . .                                | 591 |
| Vacuum Tubes and Thermionics . . . . .                | 591 |
| Miscellaneous . . . . .                               | 592 |

The Annual Index to these Abstracts and References, covering those published in the PROC. I.R.E. from February, 1949, through January, 1950, may be obtained for 2s.8d. postage included from the *Wireless Engineer*, Dorset House, Stamford St., London S. E., England. This index includes a list of the journals abstracted together with the addresses of their publishers.

The number in heavy type at the upper left of each Abstract is its Universal Decimal Classification number and is not to be confused with the Decimal Classification used by the United States National Bureau of Standards. The number in heavy type at the top right is the serial number of the Abstract. DC numbers marked with a dagger (†) must be regarded as provisional.

## ACOUSTICS AND AUDIO FREQUENCIES

534.22:[546.212+546.212.02] 796  
 Velocity of Sound in Water and in Heavy Water as dependent upon Temperature—P. P. Heusinger. (*Naturwissenschaften*, vol. 36, pp. 279–280; September, 1949.) Measurements were made at a frequency of 6.45 Mc in the temperature range 0°–100°C. The results are tabulated. For H<sub>2</sub>O the velocity has a maximum value of 1,555.5 meters per second at 3.4°C. For D<sub>2</sub>O the maximum velocity (1461.1 meters per second) is at 75.1°C.

534.231 797  
 Elementary Treatment of the Fundamental Equations for the Radiation and Propagation of Sound—F. A. Fischer. (*Frequenz*, vol. 3, pp. 320–328; November, 1949.) Discussion of a) the two fundamental propagation equations, (b) spherical waves and their propagation through a sphere whose radius is small compared with the wavelength, (c) radiation from a piston membrane in an infinite rigid wall, (d) directed radiation, and (e) radiation resistance.

534.231 798  
 Experimental Demonstration of a Theorem of Lord Rayleigh relative to the Production of Plane Waves—J. Grunenwaldt. (*Ann. Télécommun.*, vol. 4, pp. 203–209; June, 1949.)

534.6:621.395.623:534.771 799  
 Harmonic Distortion of Sound-Receivers and Its Practical Consequences in Audiometry—P. Chavasse, R. Caussé, and R. Lehmann. (*Ann. Télécommun.*, vol. 4, pp. 156–168; May, 1949.) The results of measurements of frequency response and harmonic distortion for high-quality receivers are presented in tables and curves as functions of frequency. The receivers included electrodynamic, piezo-

electric, and magnetic types. The response curves of the first two of these are regarded as satisfactory for audiometry purposes, though the piezoelectric receiver showed an antiresonance near 1,000 cps. A telephone earpiece, however, showed a very pronounced resonance peak near 1,000 cps above which frequency the response decreased practically to zero at 5,000 cps, making it quite unsuitable for any audiometry tests.

534.771 800  
 The Measurement of Hearing Loss—J. T. Story. (*Marconi Instrumentation*, vol. 2, pp. 67–70; November and December, 1949.) General description of an audiometer, Type TF895, designed to the specification embodied in the Medical Research Council report on hearing aids (1245 of 1948). Ten tones in the range 125 to 8,000 cps are provided, with simple intensity control which is calibrated relative to the normal threshold of hearing.

534.851+534.861/.862+621.395.625.3 801  
 New Audio Trends—J. M. (*Electronics*, vol. 23, pp. 68–71; January, 1950.) Three methods of synchronizing magnetic-tape records with cinema film are described. A new directional ribbon microphone, designed to eliminate the microphone-boom problem in television studios, has a pick-up distance of up to 12 feet and a frequency range of 50 to 15,000 cps. A 78 rpm disc-recording technique capable of reproduction up to 20,000 cps is mentioned.

534.86:534.322.1 802  
 Influence of Reproducing System on Tonal-Range Preference—H. A. Chinn and P. Eisenberg. (*Proc. I.R.E. (Australia)*, vol. 10, pp. 297–306; November, 1949.) Reprint. See 2695 of 1948.

534.862.4:621.383.4 803  
 Lead-Sulfide Photoconductive Cells in Sound Reproducers—Lee. (*See* 1027.)

534.862.4:621.395.625.3 804  
 The Reciprocal Relations between Magnetic Tape and Ring Head as affecting the Reproduction—W. Guckenburger. (*Funk. und Ton.*, vol. 4, pp. 24–33; January, 1950.) Discussion of the effect of the magnetic properties of the tape, and of the gap width used in the reproducing head, on the quality of the reproduction.

621.395.61 805  
 The Bantam Velocity Microphone—L. J. Anderson and L. M. Wigington. (*Audio Eng.*, vol. 34, pp. 12–14, 31; January, 1950.) Design of the KB-2C microphone is discussed; operational characteristics approximate to those

of a conventional velocity microphone. Wind-screening, which is lower than normal due to proximity of screens or ribbon, is improved by addition of cotton or fiber-glass between the inner and outer screens, but with some resulting reduction in low-frequency response.

621.395.623.7 806  
 A Loudspeaker for the Range from 5 to 20 kcs—B. H. Smith and W. T. Selsted. (*Audio Eng.*, vol. 34, pp. 16–18; January, 1950.) Theoretical design considerations and constructional details of a loudspeaker with a frequency response level to within ±2.5 db and an average efficiency of about 28 per cent; it will handle a peak power of 5 w.

621.395.92 807  
 American Hearing Aids—A. Dinsdale. (*Wireless World*, vol. 56, pp. 2–5; January, 1950.) Discussion of requirements and current practice in design and fitting. For comparable British information, see 1245 and 1246 of 1948.

## ANTENNAS AND TRANSMISSION LINES

621.315.012.3 808  
 R.F. Transmission Line Nomographs—P. H. Smith. (*Télev. Franç.*, no. 55, pp. 15–19; January and February, 1950.) French version of 1274 of 1949.

621.315.212 809  
 Reflection-Free Supporting Disks in Coaxial Cables—H. Kaden and G. Ellenberger. (*Arch. elek. Übertragung*, vol. 3, pp. 313–322; December, 1949.) For nonreflection the diameter ratio for the disks must be made larger than that of the conductors. The outer and inner conductors must therefore be recessed where the supports fit. The necessary groove depth, which depends on the dielectric constant of the disk material, is calculated. To avoid field distortion the disks must be specially shaped. Exact mathematical determination of the optimum shape appears impracticable, but an approximate solution is obtained by a conformal transformation method. Experimental results confirm the theory.

621.317.336+621.396.67 810  
 Antennas and Open-Wire Lines. Part 3—Image-Line Measurements—P. Conley. (*Jour. Appl. Phys.*, vol. 20, pp. 1022–1026; November, 1949.) An open-wire line is formed by a single wire and its image in a reflecting sheet. This line is inherently balanced and well-shielded. By loading at the center and feeding at the ends, discontinuity at the load and the need for dielectric supports are avoided. Measurements on a symmetrical line give a simple method of determining the load impedance. A

description is given of apparatus for laboratory investigation and of its application to the study of the coupling between a dipole and an open-wire line. Characteristics of the line compared favorably with those of a good coaxial measuring-line. Parts 1 and 2: 281 and 399 of March.

621.317.336 811  
**Antenna Impedance Measurement by Reflection Method**—E. Istvanffy. (*Elec. Commun.*, vol. 26, pp. 285-291; December, 1949.) Reprint. See 2559 of 1949.

621.392.26† 812  
**Principal Waves in Electromagnetic Waveguides**—J. Ortusi and J. C. Simon. (*Ann. Radioélec.*, vol. 5, pp. 12-20; January, 1950.) The application of Maxwell's equations to guided waves is considered and the general solution is applied to the transverse em wave as defined by a velocity of propagation equal to that of light in free space. The characteristic functions of such waves (power, voltage, current, characteristic impedance) are invariant in any conformal transformation of coordinates. This theorem is proved and then used to evaluate the iterative impedance of coaxial and multi-wire lines from the characteristic impedance of two strips of unbounded plane, which corresponds to the simplest TEM wave.

621.392.26† 813  
**Waveguides [operating] beyond the Cut-Off Frequency: Application to Piston Attenuators**—A. Briot. (*Onde Élec.*, vol. 29, pp. 57-63; January, 1950.) A detailed treatment is given of the characteristics of cylindrical piston attenuators for  $E_0$  and for  $H_1$  waves and of rectangular attenuators for  $H_{01}$  waves. Matching of attenuators to waveguides or coaxial lines for a given frequency band is also discussed. See also 551 of April.

621.392.26†:621.396.67 814  
**Slotted Waveguides and their Application as Aerials**—M. Bouix. (*Ann. Télécommun.*, vol. 4, pp. 75-86; March, 1949.) A transmission line with "small loads" distributed along it is first discussed. These loads are in the form of quadrupoles whose shunt admittance and series impedance are small compared with the characteristic impedance of the line. Representation of such loaded lines by means of circle diagrams leads to the concept of an equilibrium cycle. A study is made of resonant slots in the wall of a waveguide, these slots constituting the "small loads." The disposition of slots for a desired radiation distribution is considered, in particular that giving (a) uniform distribution and (b) a 1:4:1 "gable" distribution. The relation between squint angle and the spacing of the slots is determined for different waveguides of American standard dimensions. A method of designing slot systems is outlined and the case is considered of a system of slots with  $\lambda_0/2$  spacing, the waveguide being terminated by a short-circuiting plunger at a distance of  $\lambda_0/4$  from the end slot. Applications of slotted antennas are briefly reviewed.

621.392.43.012.2 815  
**A Graphic Procedure for Calculations Involving Transmitting Line Systems**—de Onis. (See 837.)

621.396.67 816  
**Application of a Variational Principle to Biconical Antennas**—C. T. Tai. (*Jour. Appl. Phys.*, vol. 20, pp. 1076-1084; November, 1949.) A theoretical examination is made of the impedance of a biconical antenna, using a method devised by Schwinger. An integral equation for the aperture field is obtained by fulfilling boundary conditions on a sphere. Hence an expression is derived for the effective

terminating admittance. The solution of zero order is shown to be identical with that obtained by Smith by neglecting higher modes than the principal mode in the interior of the boundary sphere. For cones of small angle, the result agrees with exact solutions obtained by other methods. For cones of any angle, a first-order solution is obtained, and realized numerically for certain angles. See also 1588 of 1949.

621.396.67 817  
**Omnidirectional Wide-Band Aerials for Decimetre and Metre Waves**—O. Zinke. (*Radio Franç.*, no. 12, pp. 7-12; December, 1949.) The construction and impedance characteristics of different types of such antennas are considered. For a frequency coverage  $f_{min}:f_{max}$  of 1:2 or 1:3, the diameter/length ratio should be large (about 0.5). The use of plates, tubes, wire mesh, and multi-wire antennas to obtain such a ratio is illustrated.

621.396.67:621.316.761.2 818  
**Wide-Band Aerials and Resonant Circuits with Simple and Double Compensation**—O. Zinke. (*Radio Franç.*, no. 12, pp. 13-17; December, 1949.) The compensating reactance ratios for series and parallel circuits are determined. A SWR of 2.6 can be reduced to 1.4 by the use of one equalizing circuit, and to 1.25 by using two circuits. Their application to a fan-type antenna of length  $<\lambda/4$  is considered, and shows that the SWR may be kept constant for variations of frequency from -16 per cent to +14 per cent of the resonance frequency. Near antiresonance a much wider frequency band is obtained, with a similar SWR. The equivalence of these compensating circuits to T and  $\pi$  filters is noted.

621.396.67:621.397.62 819  
**Built-in Antennas for Television Receivers**—K. Schlesinger. (*Electronics*, vol. 23, pp. 72-77; January, 1950.) Electrical designs for three types of built-in antennas are given: a short dipole, a bi-resonant loop and a double loop. The characteristics of the antennas are described and their performance is compared with that of a  $\lambda/2$  dipole. Measured values of signal attenuation at various locations in a 3-story brick/steel building are given for three frequencies.

621.396.671 820  
**Gain of Aerial Systems**—D. A. Bell. (*Wireless Eng.*, vol. 27, p. 32; January, 1950.) Comment on 287 of March (Brown).

621.396.677 821  
**Aluminum Aids Television**—(*Metal Ind.*, (London), vol. 76, pp. 71-73; January 22, 1950.) Details are given of the construction of the 14-ft paraboloid grid-type reflectors for the London/Birmingham link. These are constructed from Al-alloy tubes and castings, the tubes forming the actual reflectors being 3/4 in. in diameter and spaced 3 in. between centers. Insulated heater cables are fitted inside the reflector tubes to prevent icing, the heater system being divided into four sections; maximum power dissipated in either the two inner or the two outer sections is 6 kw.

621.396.67 822  
**Aerials for Metre and Decimetre Wavelengths [Book Review]**—R. A. Smith. Publishers: Cambridge University Press, London, 218 pp., 18s. (*Wireless Eng.*, vol. 27, pp. 30-31; January, 1950.) "The antenna systems described are mainly those which have been developed for the wavelength range of 12 m to 1 m, and only one short chapter is devoted specifically to decimeter-wave antennas. . . a most lucid and valuable account of the subject.

The book . . . may be unreservedly recommended."

#### CIRCUITS AND CIRCUIT ELEMENTS

621.3.015.3:517.63+517.432.1 823  
**The Laplace Transformation and the Study of Transient Phenomena**—Colombo. (See 914.)

621.3.016.35 824  
**On the Stability Criterion of H. Nyquist**—F. Kirschstein. (*Arch. elek. Übertragung*, vol. 3, pp. 195-198; September, 1949.) A discussion of Nyquist's rule that an automatic regulating device is stable against self-excitation if its "C-curve" does not embrace the critical point (1.0) in the complex plane. It is proved by an example that this rule does not always hold, and a practical criterion of stability is given.

621.3.016.35:621.3.012.2 825  
**Practical Stability Testing by Means of Circle Diagrams**—F. Strecker. (*Elektrotechnik* (Berlin), vol. 3, pp. 379-388; December, 1949.)

621.314.2.012.3 826  
**Abacs for Output-Transformer Design**—P. L. Courier. (*TSF Pour Tous.*, vol. 26, pp. 13-17; January, 1950.) The first abac gives the transformation and load distribution for optimum impedance matching; the second presents sets of curves from which the lf and hf attenuation and the circuit constants can be determined. Practical numerical examples are given.

621.314.26 827  
**On the Frequency Conversion of Technical Alternating Currents to High Frequency by Means of Valves**—E. Prokott. (*Fernmeldetechn. Z.*, vol. 2, pp. 301-308; October, 1949.) A push-pull transmitter-amplifier is described which is fed with ac and gives a hf output modulated by a frequency which is twice the supply frequency. With two or more amplifier stages, good efficiency can be obtained. If high-emission tubes are used, considerable power can be handled. The transmitter can be keyed and phase modulation or FM can be applied. If tone-frequency energy is used for supplying a push-pull stage, sidebands can be produced.

621.316.761.2:621.396.67 828  
**Wide-Band Aerials and Resonant Circuits with Simple and Double Compensation**—Zinke. (See 818.)

621.318.4 829  
**The Frequency Dependence of the Distortion for Coils with Laminated-Iron Cores**—H. Kämmerer. (*Arch. elek. Übertragung*, vol. 3, pp. 249-256; October, 1949.) Starting from the Rayleigh hysteresis formula and eddy current theory, the frequency characteristic of the distortion factor is determined graphically. For very small field strengths, the calculated values agree well with measurements of the distortion for permanent under no-load conditions. For larger field strengths, the measured distortion is less than the calculated value.

621.318.572 830  
**A Stepping Scale-of-Ten Counting Unit**—I. A. D. Lewis and J. F. Raffle. (*Jour. Sci. Instr.*, vol. 27, pp. 7-10; January, 1950.) The principle, operation, and performance of the circuit are discussed in some detail with the aid of a circuit diagram and waveforms. Developed along the lines of the Miller integrator, the circuit comprises two pentodes and five diodes. It is primarily designed for connection to the output of a commercial scale-of-100 unit. Counting is achieved by the collection of discrete quantities of charge on a capacitor. The mechanical counter sets an upper limit of 9 counts per sec at the output.

- 21.318.572 831  
Electronic Amplitude Selector with a Scaling-Down Circuit—T. Kahan and A. Kwartoff. (*Jour. Phys. Radium*, vol. 7, pp. 357-59; December, 1946.) Description with complete circuit diagram of apparatus which will select and record pulses irrespective of pulse shape, phase, or duration. The associated  $n$ -scale circuit controls the number recorded according to the scale set.
- 21.318.572:621.384.5 832  
Neon Diode Ring Counter—J. C. Manley and E. F. Buckley. (*Electronics*, vol. 23, pp. 4-8; January, 1950.) An inexpensive 3-decade instrument with a counting speed up to 500 impulses per sec. Neon glow-discharge tubes and Ge diodes are used. Circuit details and the mode of operation are described. The counter can be reset instantaneously and the action can be reversed for subtraction. An arrangement is included which produces a special signal when any selected number up to 999 is reached.
- 21.392 833  
Network Theorem—V. Belevitch. (*Wireless Eng.*, vol. 27, p. 33; January, 1950.) The theorem discussed by Wigan (305 of March) has been proved by Cauer (392 of 1942) and applied to various problems in filter design.
- 21.392 834  
Electrical Analogs of Linear Systems—P. Corbett. (*Elec. Eng.*, vol. 68, p. 1075; December, 1949.) Summary only. Discussion of transformations which can be used to change a linear system into one capable of being more easily represented electrically.
- 21.392:621.396.813 835  
Some Aspects of the Theory of Eode—A. Familier. (*Ann. Radiotelec.*, vol. 5, pp. 36-53; January, 1950.) The general principles of the theory (3381 of 1948) are summarized and three basic relations between the real and imaginary components of the principal circuit function  $\theta = A + jB$  are derived. These expressions are developed further to determine the attenuation curve corresponding to a given phase curve in the study of distortion in a selective circuit. The theoretical relations are then applied to negative-feedback amplifiers to determine their characteristics (gain, impedances, etc.) and stability. As an example, a wide-band video amplifier is studied and the optimum total feedback is calculated from given specifications. Two appendices deal respectively with (a) theorems relating to the physical realizability of circuits, and (b) integration in the complex plane, with application of Cauchy's theorem.
- 21.392.43 836  
The Exponential Line as a Transformer—O. Zinke. (*Radio Franç.*, no. 1, pp. 9-13; January, 1950.) See 672 of 1948.
- 21.392.43.012.2 837  
A Graphic Procedure for Calculations Involving Transmitting Line Systems—A. de Onis. (*Commun. News*, vol. 10, pp. 87-97; October, 1949.) A detailed account of the practical use of circle diagrams in calculations involving such devices as matching stubs or transmission-line transformers. Symmetrical branching of the line is also considered. The line is assumed to be lossless and to have a purely resistive characteristic impedance. These conditions are usually satisfied approximately by rf feeders, for which the methods described are particularly intended.
- 21.392.5 838  
On Quadrupoles having their Iterative Impedances Proportional to Those of a Given
- Quadrupole—M. Parodi. (*Jour. Phys. Radium*, vol. 8, pp. 140-142; May, 1947.)
- 621.392.5 839  
Analytical Conditions for Damping in an Electrical Network of  $n$  Independent Meshes. (Note on Hurwitz Polynomials in the Form of Determinants)—M. Parodi and F. Raymond. (*Ann. Télécommun.*, vol. 4, pp. 231-232; June, 1949.) The necessary and sufficient conditions are determined for a symmetrical determinant, with real elements, of order  $n$ ,  $|a_{jk}z^2 + b_{jk}z + c_{jk}|$ , to be a Hurwitz polynomial in  $z$ . A classical result in the theory of electrical networks is thus established. This result is generalized.
- 621.392.5.018.1:621.396.615 840  
The Design of RC Oscillator Phase-Shifting Networks—W. R. Hinton. (*Electronic Eng.*, vol. 22, pp. 13-17; January, 1950.) A method of applying matrix algebra to determine the coefficients used in the equations giving the operating frequency and the gain required to maintain oscillation in RC oscillators. Coefficients for the design equations for a number of different networks are given.
- 621.392.52 841  
Design of Absorption Traps—J. Avins. (*Electronics*, vol. 23, pp. 105-108; January, 1950.) Universal response curves show the ratio of the response of a tuned circuit, to which a trap circuit is inductively coupled, to the response without the trap, for typical values of attenuation and frequency separation. An abac for determination of the coupling factor is given. The response curves indicate that optimum performance is obtained when an absorption trap is coupled to a circuit which is relatively close in frequency.
- 621.392.52 842  
Calculation of Band-Pass Filters using Piezoelectric Crystals in Lattice Structures—A. Fromagot and M. A. Lalande. (*Elec. Commun.*, vol. 26, pp. 305-318; December, 1949.) Theory is developed and applied to the practical design of wide- and narrow-band filters. The attenuation curves are given of a filter for separating the channels in a ssb R/T system, and also for the pilot-selecting filter for the receiver used in that system.
- 621.392.52 843  
A Three-Stage High-Frequency Filter with Variable Bandwidth, and its Practical Realization—W. Pfost. (*Arch. elek. Übertragung*, vol. 3, pp. 199-202 and 257-264; September and October, 1949.) The construction of the filter is described and performance figures are discussed. These indicate that the selective gain of such a filter is nearly independent of the effective bandwidth. With given maximum  $Q$  values for coils and circuit, maximum gain is obtained for  $N=5$ , where  $N$  is the ratio of the sum of the loss angles of all circuits to that of the best circuit. It is advantageous to deviate slightly from the shape of the exact Tchebycheff attenuation curve within the pass band. Filters with  $N$  from 4 to 4.5 can then be designed with the same bandwidth and a sharper cutoff, without appreciable reduction in gain. Experiments confirm these conclusions.
- 621.392.52:621.3.094.1.2:621.396.813 844  
Modulation Distortion by Band-Pass Filters—U. Finkbein. (*Funk. und Ton.*, vol. 4, pp. 11-15; January, 1950.) Attenuation- and phase-distortion of the modulation frequency in a hf filter are calculated, for the steady state, from the amplitude and phase characteristics of the filter. With a symmetrical filter curve and accurate tuning, distortion is at a minimum. The use of a low modulation depth and quadratic rectification is also advantageous.
- 621.392.42:621.396.823 845  
The Design of L-Type Inductance-Capacitance High-Frequency Filters for Suppressing Industrial Interference—S. A. Lyutov. (*Radiotekhnika* (Moscow), vol. 4, pp. 28-40; September and October, 1949. In Russian.)
- 621.392.53 846  
The Design of Reactive Equalizers—A. P. Brogle, Jr. (*Bell Sys. Tech. Jour.*, vol. 28, pp. 716-750; October, 1949.) "This paper describes a systematic method of approximating with a finite number of network elements a transfer characteristic which is a prescribed function of frequency, rather than a constant, over the useful frequency band. Although applied here only to input and output coupling networks as reactive equalizers and where loss equalization to an extremely high degree of precision over a wide frequency band is desired, the mathematical expressions which form the basis for the design are applicable to any 4-terminal network whose transfer characteristic is specified in a similar manner over the real frequency range.
- "The selection of the appropriate form of the transfer function for equalization purposes is the fundamental consideration. A squared Tchebycheff polynomial is found to be particularly suitable to produce a desired cut-off characteristic without impairing the precision of equalization in the useful band.
- "A method of polynomial approximation based on the transformation  $\omega = \tan \phi/2$  is used to obtain the coefficients of the in-band approximating function. Predistorting the transfer specification and minimizing the mean-square error, the coefficients become the Fourier cosine coefficients for an infinite frequency range; and are the solutions of a linear set for a finite range,  $0 \leq \phi \leq \pi/2$ ."
- 621.396.611.1:517.93 847  
Harmonic and Subharmonic Response for the Duffing Equation—M. E. Levenson. (*Jour. Appl. Phys.*, vol. 20, pp. 1045-1051; November, 1949.) The Duffing equation  $\ddot{x} + \alpha x + \beta x^3 = F \cos \omega t$ , in which  $\alpha=0$ , possesses periodic solutions with frequency  $\omega/n$  for all integral values of  $n$ , provided  $\beta$  is sufficiently small. Two types of harmonic solutions and two types of subharmonic solutions exist if  $\beta$  is small enough. The perturbation method is used to find the approximate response curves for each of the four types of solution. The response curves obtained in the nonlinear case ( $\beta \neq 0$ ) and in the linear case ( $\beta=0$ ) are compared and some properties of the solutions in the nonlinear case are discussed. For one particular type of subharmonic solution a comparison is made between the perturbation method and the iteration method used by Rauscher, in which  $F$  is assumed small instead of  $\beta$ . The main result obtained is that the two methods yield similar results for larger values of  $\beta$  than might be expected. See also 582 of April (Elias and Duinker).
- 621.396.615:621.392.52 848  
Oscillators of High Frequency-Constancy—W. Herzog. (*Arch. elek. Übertragung*, vol. 3, pp. 203-207; September, 1949.) The  $Q$  value of an oscillator is defined in terms of the product of the feedback and amplification vectors. Oscillators developed from filter circuits can be much improved by increasing the amplification and also by increasing the steepness of the sides of the filter attenuation curve. Improved forms of oscillators of the bridge and Heegner types are discussed.
- 621.396.615.029.63 849  
On a Particular Characteristic of Disk-Seal Valves 2C40 and 2C43—L. Lot. (See 1033.)

# Books (continued)

## Vacuum Equipment and Techniques, Edited by A. Guthrie and R. K. Waklerling

Published (1949) by McGraw-Hill Book Co., Inc., 330 West 42 St., New York 18, N. Y. 242 pages + 6-page index + xviii pages + 16-page appendix. 102 figures. 9 X 6. \$2.50.

This book is concerned primarily with the development and study of high-vacuum equipment made by personnel of the University of California Radiation Laboratory. The routine production of high vacuum in large systems on a scale never previously undertaken was required in the operation of the electromagnetic separation process, and as a consequence the problems involved were of magnitude which required a considerable amount of work on both equipment and testing procedures. While these problems apparently constitute the framework around which the book was written, the problem is fundamental and the discussion comprehensive.

Of the five chapters, the first, written by Robert Loevinger, is concerned with fundamental principles. The treatment is straightforward and rigorous, providing an adequate basis for the design of vacuum systems.

The second chapter, by W. E. Bush, describes the operating principles of high-vacuum and booster pumps. Methods of computing pumping speed and speed requirements are included.

Chapter III, by K. M. Simpson, covers vacuum gauges with thoroughness, this portion of the book occupying 41 pages and providing a list of 62 references. In addition to discussions covering the usual McLeod, Pirain, Knudsen, and ionization gauges, other lesser-known varieties are evaluated and a description given of development work on special gauges at the California Radiation Laboratory.

Chapter IV, also written by W. E. Bush, constitutes a discussion of special topics relating to materials and the design of auxiliary equipment including gaskets, seals, valves, etc. Included are notes concerning the use of a bellows for producing mechanical motion within the evacuated system.

The last chapter is by R. Loevinger and A. Guthrie and is entirely devoted to leak-detection instruments and techniques. The flow of gas in small capillaries is treated quantitatively as an introduction to the more practical aspects of the problem. Conventional methods of leak detection are discussed while the operation of the mass-spectrometer type of leak-detection system is covered in considerable detail.

While, as might be imagined, the volume does not cover fully all problems likely to be encountered in vacuum processes, it is a nice piece of work. Readers engaged in the electron tube and lamp industries and other workers in high-vacuum electronics should find it to be well worth their attention.

GEORGE D. O'NEILL  
Sylvania Electric Products Inc.  
Physics Laboratories  
Bayside, N. Y.

## Fundamentals of Radio-Valve Techniques—Book I by J. Deketh

Published (1949) by Philips' Technical Library, Gloeilampenfabrieken, Eindhoven, Netherlands. 469 pages + 41-page index + 384 figures. 9 X 6. \$5.00.

This is the first member of a series of books having to do with the construction and uses of radio receiving tubes that is to be published by the Philips Technical Library. This first volume covers method of construction and general principles of operation, while subsequent volumes are to include data and circuits for particular tube types as well as full treatment of applications. The emphasis throughout is on the tube types and methods used or produced by the Philips Laboratories. This does affect the value of the book somewhat for an American audience, in that all of the tubes used as concrete examples of the principles under discussion are unfamiliar and obtainable only with more or less difficulty.

The level of treatment is well chosen, neither excessively mathematical nor unduly qualitative. The list of topics covered is practically encyclopedic in its completeness. Such matters as the complicated space-charge interaction in multi-element frequency converters are described for most of the possible arrangements of electrodes and voltages that have found use. The translation is well done, being both clear and readable with only a gentle European flavor typified by the use of valve for tube and a few other obvious differences in colloquial expression on the two sides of the ocean. There are very few errors in evidence, the only one of any consequence noted being the use of an unjustified approximation in the calculation of the effect of incomplete bypassing of a screen resistor.

The book should be of considerable value as a reference work to those concerned with the design of radio receiving equipment and similar apparatus, though it might not be so well suited as a textbook for the usual course in electronics.

S. N. VAN VOORHIS  
Department of Physics  
University of Rochester  
Rochester, N. Y.

## Acoustic Measurements by Leo L. Beranek, S.D., D.Sc. (Hon.)

Published (1949) by John Wiley and Sons, Inc., 440 Fourth Ave., New York 16, N. Y. 896 pages + 12-page index + 5-page author index + vii pages. 523 figures 8½ X 5½. \$7.00.

This volume covers methods of acoustic measurement, and the apparatus used for such measurements, and includes a very comprehensive background of theory. The contents are very well arranged by chapters, whose titles in conjunction with the subject and author index, make it easy to find the information desired.

The book is designed as a reference volume for workers in the acoustical field and should be eminently satisfactory for those working with sound measurements. The volume includes net work published for the

first time along with excellent references and excerpts from the prior art. It is comprehensive and up-to-date in its coverage.

Chapter 1 contains 24 pages of acoustic terminology which definitions are unusually complete, clear, and concise.

A minor criticism is that in Chapter 5 in the discussion of the human ear "as a background to sound measuring devices," the measurement of the basic characteristics of the ear in the perception of pitch, loudness, timbre, and time are not mentioned. Some references to the Seashore tests would have been informative. Although all 20 chapters of the volume are regarded as excellent, the following chapters seem worth singling out in particular: Chapter 12 on the Analysis of Sound Waves is outstanding in its scope and completeness; Chapter 17 is, as stated in its introduction, an instruction manual for conducting Articulation Tests. It contains many test lists of syllables, words, and sentences with full instructions in their use and analysis. This chapter is based on the work of Dr. James P. Egan. Chapter 15 devotes 45 interesting pages to Loud Speaker Tests. This chapter, accredited to Dr. R. H. Nichols of the Bell Telephone Laboratories, should be of particular interest to radio engineers.

Many of the author's original contributions seem to be contained in Chapter 9 on Sound Sources and Chapter 19 on the Measurement of Materials. Both are long chapters, over fifty pages, and present clear and complete expositions of their subject matter.

Dr. Beranek has made a valuable addition to our technical literature and his reference volume should have a long life in the libraries of all engineers whose work touches on sound measurements.

JOHN D. REID  
Crosley Division  
AVCO Mfg. Corp.  
Cincinnati 25, Ohio

## Terrestrial Radio Waves, Theory of Propagation by H. Bremmer

Published (1949) by Elsevier Publishing Co., Inc., 215 Fourth Avenue, New York 3, N. Y. 336 pages + 6-page index + x pages. 91 figures. 6½ X 9½. \$6.75.

As the title implies, this book is essentially a treatise on various aspects of the theory of wave propagation. The first part deals with the "ground wave" problem simplified by omitting the influences of the ionosphere and atmospheric refraction, but taking into account the curvature of the earth's surface. In the following chapters the effects of the ionosphere and refraction are dealt with.

Relationships between rigorous solutions and working approximations are given. The application of the mathematical solutions to the calculation of field strength is well illustrated by numerous examples and calculated curves, covering a frequency range from about 15 kc to about 10,000 Mc.

H. O. PETERSON  
RCA Laboratories  
140 Moriches Road  
Riverhead, N. Y.



# Abstracts and References

Prepared by the National Physical Laboratory, Teddington, England, Published by Arrangement with the Department of Scientific and Industrial Research, England, and *Wireless Engineer*, London, England

NOTE: The Institute of Radio Engineers does not have available copies of the publications mentioned in these pages, nor does it have reprints of the articles abstracted. Correspondence regarding these articles and requests for their procurement should be addressed to the individual publications, and not to the IRE.

|   |     |
|---|-----|
| Acoustics and Audio Frequencies             | 579 |
| Antennas and Transmission Lines             | 579 |
| Circuits and Circuit Elements               | 580 |
| General Physics                             | 582 |
| Geophysical and Extraterrestrial Phenomena  | 583 |
| Location and Aids to Navigation             | 584 |
| Materials and Subsidiary Techniques         | 584 |
| Mathematics                                 | 585 |
| Measurements and Test Gear                  | 585 |
| Other Applications of Radio and Electronics | 587 |
| Propagation of Waves                        | 588 |
| Reception                                   | 589 |
| Stations and Communication Systems          | 589 |
| Subsidiary Apparatus                        | 590 |
| Television and Phototelegraphy              | 591 |
| Transmission                                | 591 |
| Vacuum Tubes and Thermionics                | 591 |
| Miscellaneous                               | 592 |

The number in heavy type at the upper left of each Abstract is its Universal Decimal Classification number and is not to be confused with the Decimal Classification used by the United States National Bureau of Standards. The number in heavy type at the top right is the serial number of the Abstract. DC numbers marked with a dagger (†) must be regarded as provisional.

## ACOUSTICS AND AUDIO FREQUENCIES

- 534.22:[546.212+546.212.02] 796  
Velocity of Sound in Water and in Heavy Water as dependent upon Temperature—P. P. Heusinger. (*Naturwissenschaften*, vol. 36, pp. 279–280; September, 1949.) Measurements were made at a frequency of 6.45 Mc in the temperature range 0°–100°C. The results are tabulated. For H<sub>2</sub>O the velocity has a maximum value of 1,555.5 meters per second at 73.4°C. For D<sub>2</sub>O the maximum velocity (1461.1 meters per second) is at 75.1°C.
- 534.231 797  
Elementary Treatment of the Fundamental Equations for the Radiation and Propagation of Sound—F. A. Fischer. (*Frequenz*, vol. 3, pp. 320–328; November, 1949.) Discussion of (a) the two fundamental propagation equations, (b) spherical waves and their propagation through a sphere whose radius is small compared with the wavelength, (c) radiation from a piston membrane in an infinite rigid wall, (d) directed radiation, and (e) radiation resistance.
- 534.231 798  
Experimental Demonstration of a Theorem of Lord Rayleigh relative to the Production of Plane Waves—J. Grunenwaldt. (*Ann. Télécommun.*, vol. 4, pp. 203–209; June, 1949.)
- 534.6:621.395.623:534.771 799  
Harmonic Distortion of Sound-Receivers and Its Practical Consequences in Audiometry—P. Chavasse, R. Caussé, and R. Lehmann. (*Ann. Télécommun.*, vol. 4, pp. 156–168; May, 1949.) The results of measurements of frequency response and harmonic distortion for high-quality receivers are presented in tables and curves as functions of frequency. The receivers included electrodynamic, piezo-

The Annual Index to these Abstracts and References, covering those published in the PROC. I.R.E. from February, 1949, through January, 1950, may be obtained for 2s.8d. postage included from the *Wireless Engineer*, Dorset House, Stamford St., London S. E., England. This index includes a list of the journals abstracted together with the addresses of their publishers.

electric, and magnetic types. The response curves of the first two of these are regarded as satisfactory for audiometry purposes, though the piezoelectric receiver showed an anti-resonance near 1,000 cps. A telephone earpiece, however, showed a very pronounced resonance peak near 1,000 cps above which frequency the response decreased practically to zero at 5,000 cps, making it quite unsuitable for any audiometry tests.

534.771 800

The Measurement of Hearing Loss—J. T. Story. (*Marconi Instrumentation*, vol. 2, pp. 67–70; November and December, 1949.) General description of an audiometer, Type TF895, designed to the specification embodied in the Medical Research Council report on hearing aids (1245 of 1948). Ten tones in the range 125 to 8,000 cps are provided, with simple intensity control which is calibrated relative to the normal threshold of hearing.

534.851+534.861/.862+621.395.625.3 801

New Audio Trends—J. M. (*Electronics*, vol. 23, pp. 68–71; January, 1950.) Three methods of synchronizing magnetic-tape records with cinema film are described. A new directional ribbon microphone, designed to eliminate the microphone-boom problem in television studios, has a pick-up distance of up to 12 feet and a frequency range of 50 to 15,000 cps. A 78 rpm disc-recording technique capable of reproduction up to 20,000 cps is mentioned.

534.86:534.322.1 802

Influence of Reproducing System on Tonal Range Preference—H. A. Chinn and P. Eisenberg. (*Proc. I.R.E. (Australia)*, vol. 10, pp. 297–306; November, 1949.) Reprint. See 2695 of 1948.

534.862.4:621.383.4 803

Lead-Sulfide Photoconductive Cells in Sound Reproducers—Lee. (See 1027.)

534.862.4:621.395.625.3 804

The Reciprocal Relations between Magnetic Tape and Ring Head as affecting the Reproduction—W. Guckenburgh. (*Funk. und Ton.*, vol. 4, pp. 24–33; January, 1950.) Discussion of the effect of the magnetic properties of the tape, and of the gap width used in the reproducing head, on the quality of the reproduction.

621.395.61 805

The Bantam Velocity Microphone—L. J. Anderson and L. M. Wigington. (*Audio Eng.*, vol. 34, pp. 12–14, 31; January, 1950.) Design of the KB-2C microphone is discussed; operational characteristics approximate to those

of a conventional velocity microphone. Wind-screening, which is lower than normal due to proximity of screens to ribbon, is improved by addition of cotton or fiber-glass between the inner and outer screens, but with some resulting reduction in low-frequency response.

621.395.623.7 806

A Loudspeaker for the Range from 5 to 20 kcs—B. H. Smith and W. T. Selsted. (*Audio Eng.*, vol. 34, pp. 16–18; January, 1950.) Theoretical design considerations and constructional details of a loudspeaker with a frequency response level to within  $\pm 2.5$  db and an average efficiency of about 28 per cent; it will handle a peak power of 5 w.

621.395.92 807

American Hearing Aids—A. Dinsdale. (*Wireless World*, vol. 56, pp. 2–5; January, 1950.) Discussion of requirements and current practice in design and fitting. For comparable British information, see 1245 and 1246 of 1948.

## ANTENNAS AND TRANSMISSION LINES

621.315.012.3 808

R.F. Transmission Line Nomographs—P. H. Smith. (*Télev. Franç.*, no. 55, pp. 15–19; January and February, 1950.) French version of 1274 of 1949.

621.315.212 809

Reflection-Free Supporting Disks in Coaxial Cables—H. Kaden and G. Ellenberger. (*Arch. elek. Übertragung*, vol. 3, pp. 313–322; December, 1949.) For nonreflection the diameter ratio for the disks must be made larger than that of the conductors. The outer and inner conductors must therefore be recessed where the supports fit. The necessary groove depth, which depends on the dielectric constant of the disk material, is calculated. To avoid field distortion the disks must be specially shaped. Exact mathematical determination of the optimum shape appears impracticable, but an approximate solution is obtained by a conformal transformation method. Experimental results confirm the theory.

621.317.336+621.396.67 810

Antennas and Open-Wire Lines. Part 3—Image-Line Measurements—P. Conley. (*Jour. Appl. Phys.*, vol. 20, pp. 1022–1026; November, 1949.) An open-wire line is formed by a single wire and its image in a reflecting sheet. This line is inherently balanced and well-shielded. By loading at the center and feeding at the ends, discontinuity at the load and the need for dielectric supports are avoided. Measurements on a symmetrical line give a simple method of determining the load impedance. A

description is given of apparatus for laboratory investigation and of its application to the study of the coupling between a dipole and an open-wire line. Characteristics of the line compared favorably with those of a good coaxial measuring-line. Parts 1 and 2: 281 and 399 of March.

**621.317.336** 811  
**Antenna Impedance Measurement by Reflection Method**—E. Istvanffy. (*Elec. Commun.*, vol. 26, pp. 285-291; December, 1949.) Reprint. See 2559 of 1949.

**621.392.26†** 812  
**Principal Waves in Electromagnetic Waveguides**—J. Ortusi and J. C. Simon. (*Ann. Radioelec.*, vol. 5, pp. 12-20; January, 1950.) The application of Maxwell's equations to guided waves is considered and the general solution is applied to the transverse em wave as defined by a velocity of propagation equal to that of light in free space. The characteristic functions of such waves (power, voltage, current, characteristic impedance) are invariant in any conformal transformation of coordinates. This theorem is proved and then used to evaluate the iterative impedance of coaxial and multi-wire lines from the characteristic impedance of two strips of unbounded plane, which corresponds to the simplest TEM wave.

**621.392.26†** 813  
**Waveguides [operating] beyond the Cut-Off Frequency: Application to Piston Attenuators**—A. Briot. (*Onde Elec.*, vol. 29, pp. 57-63; January, 1950.) A detailed treatment is given of the characteristics of cylindrical piston attenuators for  $E_{01}$  and for  $H_{11}$  waves and of rectangular attenuators for  $H_{01}$  waves. Matching of attenuators to waveguides or coaxial lines for a given frequency band is also discussed. See also 551 of April.

**621.392.26†:621.396.67** 814  
**Slotted Waveguides and their Application as Aerials**—M. Bouix. (*Ann. Télécommun.*, vol. 4, pp. 75-86; March, 1949.) A transmission line with "small loads" distributed along it is first discussed. These loads are in the form of quadrupoles whose shunt admittance and series impedance are small compared with the characteristic impedance of the line. Representation of such loaded lines by means of circle diagrams leads to the concept of an equilibrium cycle. A study is made of resonant slots in the wall of a waveguide, these slots constituting the "small loads." The disposition of slots for a desired radiation distribution is considered, in particular that giving (a) uniform distribution and (b) a 1:4:1 "gable" distribution. The relation between squint angle and the spacing of the slots is determined for different waveguides of American standard dimensions. A method of designing slot systems is outlined and the case is considered of a system of slots with  $\lambda_0/2$  spacing, the waveguide being terminated by a short-circuiting plunger at a distance of  $\lambda_0/4$  from the end slot. Applications of slotted antennas are briefly reviewed.

**621.392.43.012.2:** 815  
**A Graphic Procedure for Calculations Involving Transmitting Line Systems**—de Onis. (See 837.)

**621.396.67** 816  
**Application of a Variational Principle to Biconical Antennas**—C. T. Tai. (*Jour. Appl. Phys.*, vol. 20, pp. 1076-1084; November, 1949.) A theoretical examination is made of the impedance of a biconical antenna, using a method devised by Schwinger. An integral equation for the aperture field is obtained by fulfilling boundary conditions on a sphere. Hence an expression is derived for the effective

terminating admittance. The solution of zero order is shown to be identical with that obtained by Smith by neglecting higher modes than the principal mode in the interior of the boundary sphere. For cones of small angle, the result agrees with exact solutions obtained by other methods. For cones of any angle, a first-order solution is obtained, and realized numerically for certain angles. See also 1588 of 1949.

**621.396.67** 817  
**Omnidirectional Wide-Band Aerials for Decimetre and Metre Waves**—O. Zinke. (*Radio Franç.*, no. 12, pp. 7-12; December, 1949.) The construction and impedance characteristics of different types of such antennas are considered. For a frequency coverage  $f_{\min}:f_{\max}$  of 1:2 or 1:3, the diameter/length ratio should be large (about 0.5). The use of plates, tubes, wire mesh, and multi-wire antennas to obtain such a ratio is illustrated.

**621.396.67:621.316.761.2** 818  
**Wide-Band Aerials and Resonant Circuits with Simple and Double Compensation**—O. Zinke. (*Radio Franç.*, no. 12, pp. 13-17; December, 1949.) The compensating reactance ratios for series and parallel circuits are determined. A SWR of 2.6 can be reduced to 1.4 by the use of one equalizing circuit, and to 1.25 by using two circuits. Their application to a fan-type antenna of length  $<\lambda/4$  is considered, and shows that the SWR may be kept constant for variations of frequency from -16 per cent to +14 per cent of the resonance frequency. Near antiresonance a much wider frequency band is obtained, with a similar SWR. The equivalence of these compensating circuits to T and  $\pi$  filters is noted.

**621.396.67:621.397.62** 819  
**Built-in Antennas for Television Receivers**—K. Schlesinger. (*Electronics*, vol. 23, pp. 72-77; January, 1950.) Electrical designs for three types of built-in antennas are given: a short dipole, a bi-resonant loop and a double loop. The characteristics of the antennas are described and their performance is compared with that of a  $\lambda/2$  dipole. Measured values of signal attenuation at various locations in a 3-story brick/steel building are given for three frequencies.

**621.396.671** 820  
**Gain of Aerial Systems**—D. A. Bell (*Wireless Eng.*, vol. 27, p. 32; January, 1950.) Comment on 287 of March (Brown).

**621.396.671** 821  
**Aluminum Aids Television**—(*Metal Ind.*, (London), vol. 76, pp. 71-73; January 22, 1950.) Details are given of the construction of the 14-ft paraboloid grid-type reflectors for the London/Birmingham link. These are constructed from Al-alloy tubes and castings, the tubes forming the actual reflectors being 3/4 in. in diameter and spaced 3 in. between centers. Insulated heater cables are fitted inside the reflector tubes to prevent icing, the heater system being divided into four sections; maximum power dissipated in either the two inner or the two outer sections is 6 kw.

**621.396.67** 822  
**Aerials for Metre and Decimetre Wavelengths [Book Review]**—R. A. Smith. Publishers: Cambridge University Press, London, 218 pp., 18s. (*Wireless Eng.*, vol. 27, pp. 30-31; January, 1950.) "The antenna systems described are mainly those which have been developed for the wavelength range of 12 m to 1 m, and only one short chapter is devoted specifically to decimeter-wave antennas. . . a most lucid and valuable account of the subject.

The book . . . may be unreservedly recommended."

## CIRCUITS AND CIRCUIT ELEMENTS

**621.3.015.3:517.63+517.432.1** 823  
**The Laplace Transformation and the Study of Transient Phenomena**—Colombo. (See 914.)

**621.3.016.35** 824  
**On the Stability Criterion of H. Nyquist**—F. Kirschstein. (*Arch. elek. Übertragung*, vol. 3, pp. 195-198; September, 1949.) A discussion of Nyquist's rule that an automatic regulating device is stable against self-excitation if its "C-curve" does not embrace the critical point (1.0) in the complex plane. It is proved by an example that this rule does not always hold, and a practical criterion of stability is given.

**621.3.016.35:621.3.012.2** 825  
**Practical Stability Testing by Means of Circle Diagrams**—F. Strecker. (*Elektrotechnik* (Berlin), vol. 3, pp. 379-388; December, 1949.)

**621.314.2.012.3** 826  
**Abacs for Output-Transformer Design**—P. L. Courier. (*TSF Pour Tous.*, vol. 26, pp. 13-17; January, 1950.) The first abac gives the transformation and load distribution for optimum impedance matching; the second presents sets of curves from which the lf and hf attenuation and the circuit constants can be determined. Practical numerical examples are given.

**621.314.26** 827  
**On the Frequency Conversion of Technical Alternating Currents to High Frequency by Means of Valves**—E. Prokott. (*Fernmeldetechn. Z.*, vol. 2, pp. 301-308; October, 1949.) A push-pull transmitter-amplifier is described which is fed with ac and gives a hf output modulated by a frequency which is twice the supply frequency. With two or more amplifier stages, good efficiency can be obtained. If high-emission tubes are used, considerable power can be handled. The transmitter can be keyed and phase modulation or FM can be applied. If tone-frequency energy is used for supplying a push-pull stage, sidebands can be produced.

**621.316.761.2:621.396.67** 828  
**Wide-Band Aerials and Resonant Circuits with Simple and Double Compensation**—Zinke. (See 818.)

**621.318.4** 829  
**The Frequency Dependence of the Distortion for Coils with Laminated-Iron Cores**—H. Kämmerer. (*Arch. elek. Übertragung*, vol. 3, pp. 249-256; October, 1949.) Starting from the Rayleigh hysteresis formula and eddy current theory, the frequency characteristic of the distortion factor is determined graphically. For very small field strengths, the calculated values agree well with measurements of the distortion for permanent under no-load conditions. For larger field strengths, the measured distortion is less than the calculated value.

**621.318.572** 830  
**A Stepping Scale-of-Ten Counting Unit**—I. A. D. Lewis and J. F. Raffle. (*Jour. Sci. Instr.*, vol. 27, pp. 7-10; January, 1950.) The principle, operation, and performance of the circuit are discussed in some detail with the aid of a circuit diagram and waveforms. Developed along the lines of the Miller integrator, the circuit comprises two pentodes and five diodes. It is primarily designed for connection to the output of a commercial scale-of-100 unit. Counting is achieved by the collection of discrete quantities of charge on a capacitor. The mechanical counter sets an upper limit of 9 counts per sec at the output.

- 621.318.572 831  
**Electrical Amplitude Selector with a Scaling-Down Circuit**—T. Kahan and A. Kwartiroff. (*Jour. Phys. Radium*, vol. 7, pp. 357-359; December, 1946.) Description with complete circuit diagram of apparatus which will select and record pulses irrespective of pulse shape, phase, or duration. The associated  $n$ -scale circuit controls the number recorded according to the scale set.
- 621.318.572:621.384.5 832  
**Neon Diode Ring Counter**—J. C. Manley and E. F. Buckley. (*Electronics*, vol. 23, pp. 84-87; January, 1950.) An inexpensive 3-decade instrument with a counting speed up to 500 impulses per sec. Neon glow-discharge tubes and Ge diodes are used. Circuit details and the mode of operation are described. The counter can be reset instantaneously and the action can be reversed for subtraction. An arrangement is included which produces a special signal when any selected number up to 999 is reached.
- 621.392 833  
**Network Theorem**—V. Belevitch. (*Wireless Eng.*, vol. 27, p. 33; January, 1950.) The theorem discussed by Wigan (305 of March) has been proved by Cauer (392 of 1942) and applied to various problems in filter design.
- 621.392 834  
**Electrical Analogs of Linear Systems**—J. P. Corbett. (*Elec. Eng.*, vol. 68, p. 1075; December, 1949.) Summary only. Discussion of transformations which can be used to change a linear system into one capable of being more easily represented electrically.
- 621.392:621.396.813 835  
**Some Aspects of the Theory of Podes**—H. Familier. (*Ann. Radioelec.*, vol. 5, pp. 36-53; January, 1950.) The general principles of the theory (3381 of 1948) are summarized and three basic relations between the real and imaginary components of the principal circuit function  $\theta = A + jB$  are derived. These expressions are developed further to determine the attenuation curve corresponding to a given phase curve in the study of distortion in a selective circuit. The theoretical relations are then applied to negative-feedback amplifiers to determine their characteristics (gain, impedances, etc.) and stability. As an example, a wide-band video amplifier is studied and the optimum total feedback is calculated from given specifications. Two appendices deal respectively with (a) theorems relating to the physical realizability of circuits, and (b) integration in the complex plane, with application of Cauchy's theorem.
- 621.392.43 836  
**The Exponential Line as a Transformer**—O. Zinke. (*Radio Franç.*, no. 1, pp. 9-13; January, 1950.) See 672 of 1948.
- 621.392.43.012.2 837  
**A Graphic Procedure for Calculations Involving Transmitting Line Systems**—A. de Onis. (*Commun. News*, vol. 10, pp. 87-97; October, 1949.) A detailed account of the practical use of circle diagrams in calculations involving such devices as matching stubs or transmission-line transformers. Symmetrical branching of the line is also considered. The line is assumed to be lossless and to have a purely resistive characteristic impedance. These conditions are usually satisfied approximately by rf feeders, for which the methods described are particularly intended.
- 621.392.5 838  
**On Quadripoles having their Iterative Impedances Proportional to Those of a Given**
- Quadripole—M. Parodi. (*Jour. Phys. Radium*, vol. 8, pp. 140-142; May, 1947.)
- 621.392.5 839  
**Analytical Conditions for Damping in an Electrical Network of  $n$  Independent Meshes. (Note on Hurwitz Polynomials in the Form of Determinants)**—M. Parodi and F. Raymond. (*Ann. Télécommun.*, vol. 4, pp. 231-232; June, 1949.) The necessary and sufficient conditions are determined for a symmetrical determinant, with real elements, of order  $n$ ,  $|a_{jk}z^2 + b_{jk}z + c_{jk}|$ , to be a Hurwitz polynomial in  $z$ . A classical result in the theory of electrical networks is thus established. This result is generalized.
- 621.392.5.018.1:621.396.615 840  
**The Design of RC Oscillator Phase-Shifting Networks**—W. R. Hinton. (*Electronic Eng.*, vol. 22, pp. 13-17; January, 1950.) A method of applying matrix algebra to determine the coefficients used in the equations giving the operating frequency and the gain required to maintain oscillation in RC oscillators. Coefficients for the design equations for a number of different networks are given.
- 621.392.52 841  
**Design of Absorption Traps**—J. Avins. (*Electronics*, vol. 23, pp. 105-108; January, 1950.) Universal response curves show the ratio of the response of a tuned circuit, to which a trap circuit is inductively coupled, to the response without the trap, for typical values of attenuation and frequency separation. An abac for determination of the coupling factor is given. The response curves indicate that optimum performance is obtained when an absorption trap is coupled to a circuit which is relatively close in frequency.
- 621.392.52 842  
**Calculation of Band-Pass Filters using Piezoelectric Crystals in Lattice Structures**—A. Fromageot and M. A. Lalande. (*Elec. Commun.*, vol. 26, pp. 305-318; December, 1949.) Theory is developed and applied to the practical design of wide- and narrow-band filters. The attenuation curves are given of a filter for separating the channels in a sub-R/T system, and also for the pilot-selecting filter for the receiver used in that system.
- 621.392.52 843  
**A Three-Stage High-Frequency Filter with Variable Bandwidth, and its Practical Realization**—W. Pfost. (*Arch. elek. Übertragung*, vol. 3, pp. 199-202 and 257-264; September and October, 1949.) The construction of the filter is described and performance figures are discussed. These indicate that the selective gain of such a filter is nearly independent of the effective bandwidth. With given maximum  $Q$  values for coils and circuit, maximum gain is obtained for  $N=5$ , where  $N$  is the ratio of the sum of the loss angles of all circuits to that of the best circuit. It is advantageous to deviate slightly from the shape of the exact Chebyscheff attenuation curve within the pass band. Filters with  $N$  from 4 to 4.5 can then be designed with the same bandwidth and a sharper cutoff, without appreciable reduction in gain. Experiments confirm these conclusions.
- 621.392.52:621.3.094.1.2:621.396.813 844  
**Modulation Distortion by Band-Pass Filters**—U. Finkbein. (*Funk. und Ton.*, vol. 4, pp. 11-15; January, 1950.) Attenuation- and phase-distortion of the modulation frequency in a hf filter are calculated, for the steady state, from the amplitude and phase characteristics of the filter. With a symmetrical filter curve and accurate tuning, distortion is at a minimum. The use of a low modulation depth and quadratic rectification is also advantageous.
- 621.392.42:621.396.823 845  
**The Design of L-Type Inductance-Capacitance High-Frequency Filters for Suppressing Industrial Interference**—S. A. Lyutov. (*Radiotekhnika* (Moscow), vol. 4, pp. 28-40; September and October, 1949. In Russian.)
- 621.392.53 846  
**The Design of Reactive Equalizers**—A. P. Brogle, Jr. (*Bell Sys. Tech. Jour.*, vol. 28, pp. 716-750; October, 1949.) "This paper describes a systematic method of approximating with a finite number of network elements a transfer characteristic which is a prescribed function of frequency, rather than a constant, over the useful frequency band. Although applied here only to input and output coupling networks as reactive equalizers and where loss equalization to an extremely high degree of precision over a wide frequency band is desired, the mathematical expressions which form the basis for the design are applicable to any 4-terminal network whose transfer characteristic is specified in a similar manner over the real frequency range.
- "The selection of the appropriate form of the transfer function for equalization purposes is the fundamental consideration. A squared Chebyscheff polynomial is found to be particularly suitable to produce a desired cut-off characteristic without impairing the precision of equalization in the useful band.
- "A method of polynomial approximation based on the transformation  $\omega = \tan \phi/2$  is used to obtain the coefficients of the in-band approximating function. Predistorting the transfer specification and minimizing the mean-square error, the coefficients become the Fourier cosine coefficients for an infinite frequency range; and are the solutions of a linear set for a finite range,  $0 \leq \phi \leq \pi/2$ ."
- 621.396.611.1:517.93 847  
**Harmonic and Subharmonic Response for the Duffing Equation**—M. E. Levenson. (*Jour. Appl. Phys.*, vol. 20, pp. 1045-1051; November, 1949.) The Duffing equation  $\ddot{x} + \alpha x + \beta x^3 = F \cos \omega t$ , in which  $\alpha=0$ , possesses periodic solutions with frequency  $\omega/n$  for all integral values of  $n$ , provided  $\beta$  is sufficiently small. Two types of harmonic solutions and two types of subharmonic solutions exist if  $\beta$  is small enough. The perturbation method is used to find the approximate response curves for each of the four types of solution. The response curves obtained in the nonlinear case ( $\beta \neq 0$ ) and in the linear case ( $\beta=0$ ) are compared and some properties of the solutions in the nonlinear case are discussed. For one particular type of subharmonic solution a comparison is made between the perturbation method and the iteration method used by Rauscher, in which  $F$  is assumed small instead of  $\beta$ . The main result obtained is that the two methods yield similar results for larger values of  $\beta$  than might be expected. See also 582 of April (Elias and Duinker).
- 621.396.615:621.392.52 848  
**Oscillators of High Frequency—Constancy**—W. Herzog. (*Arch. elek. Übertragung*, vol. 3, pp. 203-207; September, 1949.) The  $Q$  value of an oscillator is defined in terms of the product of the feedback and amplification vectors. Oscillators developed from filter circuits can be much improved by increasing the amplification and also by increasing the steepness of the sides of the filter attenuation curve. Improved forms of oscillators of the bridge and Heegner types are discussed.
- 621.396.615.029.63 849  
**On a Particular Characteristic of Disk-Seal Valves 2C40 and 2C43**—Lot. (See 1033.)

- 621.396.615.14 850  
**Coaxial Oscillator Circuit for Decimetre Waves**—L. Liot. (*Radio Franç.*, no. 1, pp. 14-17; January, 1950.) A scale diagram and description of a 600-Mc oscillator giving a useful output of 18 w. The oscillator comprises a grounded-grid triode Type T30H (783 of April) with a  $\lambda/2$  coaxial-line anode circuit and a  $3\lambda/4$  coaxial-line cathode circuit. Maximum operating frequency is 714 Mc. Practical rules for simplifying design calculations for this type of oscillator will be given later.
- 621.396.615.17 851  
**A Flexible High-Voltage Square-Wave Generator**—L. C. Hedrick. (*Rev. Sci. Instr.*, vol. 20, pp. 781-783; November, 1949.) Description of a generator suitable for modulating the absorption cell of a microwave spectrograph. Peak-to-peak voltages up to 1,800 v have been produced at 100 kc, feeding into a capacitive load of 800 pF. Voltage adjustment is effected by variation of a single component. The instrument is kept effectively at ground potential automatically.
- 621.396.615.17 852  
**Transitron Relaxation Oscillators and the Transitron Integrator**—J. Moline. (*Radio Franç.*, no. 12, pp. 20-23; December, 1949.) The principles of operation of the transitron relaxation circuit and of the Miller integrator are described. The combination of the two systems in one circuit is illustrated. This circuit generates a pure sawtooth waveform with good stability. Component values for such a circuit using an EF50 tube are noted.
- 621.396.615.17 853  
**Variable-Pulse-Length Generator**—J. C. May. (*Electronics*, vol. 23, pp. 109-111; January, 1950.) A cathode-coupled clipper circuit with regeneration provides pulses of width linearly variable from 0.5  $\mu$ s to 24  $\mu$ s and with peak voltages of 4.5-6.5 v.
- 621.396.619.16 854  
**Development in Pulse-Modulation Circuits**—F. Butler. (*Wireless Eng.*, vol. 27, pp. 12-16; January, 1950.) The pulses are generated across the common anode load of two tubes fed in push-pull from a low-power primary oscillator whose frequency equals the desired recurrence frequency. Reactance modulator tubes are used to vary the phase of the grid-cathode voltage of one tube with respect to that of the other, giving width-modulation of the pulses. The system is suitable for speech transmission and can be adapted to give several channels on a time-allocation multiplex basis.
- 621.396.621.5 855  
**Methods of Calculating the Sensitivity of Mixer Stages for Decimetre and Centimetre Waves**—H. F. Mataré. (*Arch. elek. Übertragung*, vol. 3, pp. 241-248; October, 1949.) A knowledge of diode theory is assumed; previous work on the subject is reviewed and methods of calculating sensitivity are discussed. The application of these methods in the case of diode mixing is considered. A mathematical analysis shows that by introducing mean values into the expression for the noise function of the network, calculation of sensitivity and receiver circuit design are simplified. A numerical treatment of the mixer-stage equation, together with a comparison of calculated and experimental results, will be given in a later paper.
- 621.396.645 856  
**Design of an Amplifier with Circuits Tuned to Different Frequencies and such that the Phase/Frequency Function is Linear in a Given Range of Frequencies**—A. Fromageot and P. Belgodère. (*Ann. Télécommun.*, vol. 4, pp. 169-176; May, 1949.) Expressions for the modulus and phase of the transfer constant of an  $n$ -stage stagger-tuned amplifier are derived which involve the Newtonian potential function and its conjugate. Certain properties of these functions are reviewed, in particular their behavior with regard to conformal transformation. The continuous distribution of charge which corresponds to a linear variation of the phase function with frequency in a limited frequency band is considered, and an estimate is made of the order of approximation resulting from the adoption of a discontinuous distribution of point charges. The method of calculation enables the tuning frequencies and the  $Q$  values of the different circuits to be determined for an amplifier of given gain in a given frequency band.
- 621.396.645 857  
**High-Quality Amplifier**—D. T. N. Williamson. (*Wireless World*, vol. 56, p. 24; January, 1950.) Replies to readers' queries on 3101 of 1949 and 335 of March.
- 621.396.645 858  
**Reducing the Effect of Capacitance in Screened Cable**—G. H. Rayner. (*Electronic Eng.*, vol. 22, p. 333; January, 1950.) The input capacitance at af of a cathode follower with customary connections is about 10 pF. To reduce this the tube should be mounted within a screen that can be connected to the cathode and the screen-grid should be coupled to the cathode and not by-passed to earth. The input capacitance can thus be reduced by a factor of about 10.
- 621.396.645:621.392.52 859  
**RC-Amplifier Filters**—C. H. Miller. (*Wireless Eng.*, vol. 27, pp. 26-29; January, 1950.) "Simple expressions are derived for the approximate cutoff frequencies of amplifiers which use resistance-capacitance feedback networks to produce high-pass, low-pass, or band-pass frequency characteristics similar to those of conventional filters. The design of such amplifiers is discussed, and illustrations are given of the results obtained with simple amplifiers of this type."
- 621.396.645:621.392.52 860  
**On the Problem of Bandwidth Control**—J. Harmans. (*Funk. und Ton.*, vol. 3, pp. 570-574; 1949.) The conditions necessary for an optimum frequency/amplification response curve (see 1889 of 1948) are realized by the use of two 2-stage filters with variable coupling. Sensitivity, selectivity, and bandwidth are considered for two cases: (a) with one filter variable, the other fixed; and (b) with both variable. With an over-all bandwidth of 21.7 kc, a deviation of less than  $\pm 5$  per cent from the ideal response curve is obtainable.
- 621.396.645:621.396.611.3 861  
**On the Connection between Amplification and Bandwidth in a Multi-Stage Amplifier with Circuits of the Same Resonance Frequency**—W. Kleen. (*Funk. und Ton.*, vol. 3, pp. 584-591; 1949.) The circuit considered uses a single type of tube with given characteristics. The tubes are connected in cascade and are coupled by simple rejection circuits. A formula is derived which gives the maximum attainable amplification for a given bandwidth, and the corresponding values are determined for number of stages, amplification per stage, load resistance, and bandwidth for a single stage. A numerical example is calculated. Similarly, the maximum bandwidth for a given over-all amplification is determined.
- 621.396.645.37:621.3.016.35 862  
**Investigation of the Conditional Stability of Feedback Amplifiers**—K. H. R. Weber. (*Frequenz*, vol. 3, pp. 253-259; September, 1949.) A theoretical and experimental investigation of the dependence of the stability on the parameter  $vK$ , where  $v$  is the voltage gain of the amplifier without feedback and  $K$  is the gain in the feedback path. For the amplifier used, conditional stability existed for values of  $vK$  between 4,000 and 100,000. The conditions for instability to exist and hence for self-oscillation to occur when switching on or off are summarized. The smaller the distance of the  $vK$  characteristic from the point (1, 0), the lower is the maximum permissible input voltage for self-oscillation not to occur. With the experimental amplifier, self-excitation commenced at an input voltage of 700 mv for  $v=100,000$ ,  $K=1$ , but at 180 mv for  $v=100,000$ ,  $K=0.5$ .
- 621.396.645.371 863  
**Negative-Feedback Amplifiers**—É. Chalmagne and G. Guyot. (*Ann. Télécommun.*, vol. 4, pp. 119-122; April, 1949.) Formulas are derived for the amplification factor and output impedance of a feedback amplifier and also for the transient response. Results are given for an amplifier designed to transmit a band of width 3 Mc.
- 621.396.662 864  
**A High-Power Attenuator for Microwaves**—D. Alpert. (*Rev. Sci. Instr.*, vol. 20, pp. 779-781; November, 1949.) The attenuator is for use with waveguides working at  $\lambda$  10 cm. The attenuating material is a mixture of ethylene glycol and water which serves also to remove the absorbed energy. The variation in attenuation and power SWR, with mixture concentration are shown. Power up to 100 w can be absorbed. Attenuation is variable from 1.5 db to 40 db and power SWR is less than 1.1 at all settings.
- 621.392 865  
**Networks, Lines and Fields [Book Review]**—J. D. Ryder. Publishers: Prentice-Hall, New York, 1949, 462 pp., \$7.35. (*Electronics*, vol. 23, pp. 208, 210; January, 1950.) "A rather complete treatment of the undergraduate level of elementary network theory, filters, transmission lines at low and high frequencies, Maxwell equations, reflection of waves, and waveguides." "... will be useful not only to undergraduates but also to an average engineer for direct consultation."
- 621.396.662.3+621.396.645+621.396.62  
**Applications of the Electronic Valve in Receiving Sets and Amplifiers [Book Review]**—Dammers, Haantjes, Otte and van Suchtelen. (See 991.)

## GENERAL PHYSICS

- 53.081+537.713 867  
**The Rationalized Giorgi System and its Consequences**—P. Cornelius and H. C. Hamaker. (*Philips Res. Rep.*, vol. 4, pp. 123-142; April, 1949.)
- 530.12 868  
**Equations of Motion and Tensor of Matter for the System of Finite Mass in the General Theory of Relativity**—N. M. Petrova. (*Zh. Eksp. Teor. Fiz.*, vol. 19, pp. 989-999; November, 1949. In Russian.)
- 534 869  
**On Certain Cases of the General Problem of the Theory of Steady-State Oscillations**—D. I. Sherman. (*Compt. Rend. Acad. Sci. (URSS)*, vol. 56, pp. 567-570; August 21, 1947. In Russian.) An investigation of solutions of the two-dimensional wave equation which satisfy mixed boundary conditions containing derivatives of the wave function up to any finite order. The problem depends on the solution of an integral equation.

- 535.43 870  
**The Scattering Cross Section of Spheres for Electromagnetic Waves**—L. Brillouin. (*Jour. Appl. Phys.*, vol. 20, pp. 1110–1125; November, 1949.) For the case of large spheres, where geometrical optics should apply, the rigorous classical theory yields a scattering cross-section equal to twice the actual cross-section of the sphere. The same holds good for large cylinders. An explanation of this anomalous result is given which shows the role played by the shadow and by the diffraction fringes surrounding the shadow. A reasonable system of approximations yields the well-known Babinet's principle. The physical interpretation is so general that it must apply to similar problems in acoustics or wave mechanics. Experiments designed by Sinclair and LaMer gave an accurate check of the theory.
- 537.291:537.525.92 871  
**Electron Flow in Curved Paths under Space-Charge Conditions**—B. Meltzer. (*Proc. Phys. Soc.*, vol. 62, pp. 813–817; December 1, 1949.) A theoretical treatment of a particular example of 3-dimensional flow for which the electron trajectories all lie on hyperboloids and the equipotential surfaces are ellipsoidal. Some general theorems are deduced from the results of an earlier paper (3120 of 1949). Distinction is made between "normal" flow, in which all electrons on a given equipotential have the same speed, and "abnormal" flow in which the speeds are not the same. It is shown that in normal flow the velocity vector obeys the law  $\mathbf{v} \times \text{curl } \mathbf{v} = 0$ .
- 537.311.62 872  
**Anomalous Skin Impedance as a Function of the Field Strength**—K. F. Niessen. (*Philips Res. Rep.*, vol. 4, pp. 143–153; April, 1949.) A study of the skin effect in a metal of high conductivity subjected to a strong hf field. See also 3404 of 1949.
- 537.525 873  
**Breakdown in Cold-Cathode Tubes at Low Pressure**—F. G. Heymann. (*Proc. Phys. Soc.*, vol. 63, pp. 25–41; January 1, 1950.)
- 537.525.92:621.385.029.631.64 874  
**Increasing Space-Charge Waves**—J. R. Pierce. (*Jour. Appl. Phys.*, vol. 20, pp. 1060–1066; November, 1949.) The equation for the gain per unit length of increasing waves in the presence of two streams of charged particles has been solved numerically for a wide range of values of plasma frequencies and stream velocities. The solutions are presented as curves of a gain parameter versus the ratio of the frequency to the plasma frequency of the faster stream, for various ratios of the stream velocities. Each graph corresponds to a different ratio of plasma frequencies. These curves apply to such effects as ion noise and double-stream rf amplification and it is shown that in certain circumstances the latter may occur in tubes intended to have only a single electron stream. The case of streams moving in opposite directions is also considered. See also 3406 of 1949 (Bailey) and back references, 2486 of 1949 (Pierce and Hebenstreit).
- 537.562 875  
**Measurement of the Complex Conductivity of an Ionized Gas at Microwave Frequencies**—F. P. Adler. (*Jour. Appl. Phys.*, vol. 20, pp. 1125–1129; November, 1949.) "The positive column of a glow discharge is placed along the axis of a cylindrical cavity excited in the  $TM_{010}$  mode. The transmission of 3-cm waves through the cavity and the shift in resonance frequency are observed as a function of discharge current. It is shown that from these measurements values of the complex conductivity,  $\sigma_r + i\sigma_i$ , of the electron gas can be calculated. Curves of the measured conductivity components as functions of pressure and current are given. Using a theoretical formula for the conductivity [Margenau: 3246 of 1946] values of electron density can in turn be calculated from both  $\sigma_r$  and  $\sigma_i$ . Langmuir probe studies are carried out to check the results obtained, and adequate agreement is found."
- 538.56:537.71 876  
**Concerning "The Impedance of Free Space"**—A. Foch. (*Onde Élec.*, vol. 29, pp. 5–7; January, 1950.) Comment on the anomalies of the two systems of units, classical, and rationalized, with an explanation of the apparent discrepancy between the values of free-space impedance for the two systems. See also 607 of April (Budeanu) and 877 below.
- 538.56:537.71 877  
**On the Impedance of Free Waves**—E. Brylinski. (*Bull. Soc. Franç. Élec.*, vol. 10, pp. 37–40; January, 1950.) The ratio  $Z_0$  of the es field  $E$  to the em field  $H$  of a free-space em wave has the dimensions of a resistance but is not a true impedance. It is suggested that it should be called the pseudo-impedance of free space and measured in pseudohms. In the classic (non-rationalized) Giorgi system  $Z_0$  would have the value 30 pseudohms. In the rationalized Giorgi system  $Z_0' = 4\pi Z_0 = 377$  pseudohms and  $Z_0'$  can be distinguished by calling it the pseudo-impedance of free waves. It should be noted that  $Z_0$ , like the velocity  $c$  to which it is closely related, can be either a scalar or a vector quantity.
- 539.11 878  
**Some Electronic Properties of a One-Dimensional Crystal Model**—D. S. Saxon and R. A. Hutner. (*Philips Res. Rep.*, vol. 4, pp. 81–122; April, 1949.) "The Kronig-Penney model of a one-dimensional crystal is studied further with the aid of the formalism of the Dirac  $\delta$ -function. Both a Green's function method and a scattering-matrix method are used to derive the energy levels and wave functions for the monatomic and the diatomic lattices. The scattering-matrix method is used to study the problems of a single impurity, both substitutionally and interstitially located, and the coupling between impurities. In the last section the general problem of a solid solution is discussed."
- 548.0:539.11:537.529 879  
**On the Theory of Electron Multiplication in Crystals**—F. Seitz. (*Phys. Rev.*, vol. 76, pp. 1376–1393; November 1, 1949.) The non-polar coupling between electrons and lattice has an important effect on the retardation of electrons. This retardation is a maximum when the energy of the electron corresponds to the energy level near the boundary of the Brillouin zone. The retardation arising from purely polar interaction in polar crystals is a maximum when the energy is near that of the polar modes. Statistical fluctuations in the velocity of the electrons largely determine electron multiplication, and the value of the field producing breakdown in a standard specimen is no more than a fifth of that obtained from the criteria of von Hippel and Fröhlich.
- 621.3.011.4:513.466 880  
**Potential Problems and Capacitance for a Conductor Bounded by Two Intersecting Spheres**—C. Snow. (*Bur. Stand. Jour. Res.*, vol. 43, pp. 377–407; October, 1949.) Formal expressions, as series and integrals, are derived for the external potential, which takes on assigned values on the two spherical boundary surfaces, either when the body is alone or when it is in any given axially symmetric es field. This is effected by representing a given function  $f(x)$ , for  $1 < x < \infty$ , as a complex integral whose variable is the parameter  $\mu$  of a Legendre function  $P_{\mu-\frac{1}{2}}(x)$  or  $Q_{\mu-\frac{1}{2}}(x)$ . The capacitance of the conductor is found as a series whose terms involve psi-functions. In case the two spheres intersect at an angle  $\omega$  which is a rational function of  $2\pi$ , the capacitance is given in finite terms involving complete elliptic integrals. The field or es potential is given in finite terms when  $\omega = n\pi/m$ , where  $m$  is any positive integer, and  $n=1, 2, 3$ , or 4. The cases  $n=3, n=4$  involve elliptic functions. These would permit the exact computation in finite terms of the penetration of an external applied field into a cavity with any angular aperture.
- 53 881  
**The Physical Society Reports on Progress in Physics. Vol. 12 (1948–49) [Book Review]**—Publishers: The Physical Society, London, 42s. (*Phil. Mag.*, vol. 40, p. 1178; November, 1949.) "The Physical Society has been remarkably successful in obtaining excellent articles on subjects of current interest from authors of eminence." A list of the articles, with authors, is given.
- 534.1+538.56 882  
**Einführung in die Lehre von den Schwingungen und Wellen (Introduction to the Theory of Vibrations and Wave-Motion) [Book Review]**—K. W. Wagner. Publishers: Dieterichsche Verlagsbuchhandlung, Wiesbaden, 1947, 640 pp., 34 DM (*Arch. elek. Übertragung*, vol. 3, pp. 230–231; September, 1949.) A second edition of the full course of lectures given by the author in the Technische Hochschule, Berlin. It is a book for the rising engineer and physicist, with a wealth of material for the teacher and professional man. Aspects dealt with are: forms of oscillation; dynamics of vibration; oscillations and waves in continuous systems; em waves in the ionosphere; vibration systems; and nonlinear systems. Examples of both mechanical and electrical oscillations are considered and the two types related. The book is considered by the reviewer to fill a former gap in the literature on the subject.
- GEOPHYSICAL AND EXTRATERRESTRIAL PHENOMENA**
- 523.72:621.396.822 883  
**Solar Radio-Frequency Radiation of Thermal Origin**—J. L. Pawsey and D. E. Yabsley. (*Aust. Jour. Sci. Res., Ser. A*, vol. 2, pp. 198–213; June, 1949.) Numerous measurements of "noise flux density" in the wavelength range from 1 cm to 4 m are examined. In addition to the occasional bursts, a relatively constant component, which has the characteristics of thermal radiation, is always found; its intensity increases uniformly with frequency from about  $10^4$  °K at 1.25 cm to about  $10^6$  °K at 1.5 m, in substantial agreement with Martyn's theory (2783 of 1948).
- 523.72:621.396.822 884  
**Bursts of Solar Radiation at Metro Wavelengths**—R. Payne-Scott. (*Aust. Jour. Sci. Res., Ser. A*, vol. 2, pp. 214–227; June, 1949.) The variable high-intensity radiation on 85, 65, 60, and 19 Mc was studied during part of 1948. Two types were observed: (a) circularly polarized long-duration radiation, and (b) short unpolarized bursts. The bursts on 85 Mc arrive 0.7 sec before, and on 19 Mc 9 sec after the corresponding bursts on 60 Mc; they decay exponentially with a time constant of about 17 sec; double-humped bursts are common. Their characteristics agree with the hypothesis that they originate in the high corona, that the time constant depends on the collision frequency, and that the second hump is due to a

reflection from the inner corona. The larger bursts are usually associated with solar flares.

523.72:621.396.822 885

**The Noise-Like Character of Solar Radiation at Metre Wavelengths**—R. Payne-Scott. (*Aust. Jour. Sci. Res., Ser. A*, vol. 2, pp. 228-231; June, 1949.) Observations were made of the enhanced radiation on August 5 and 6, 1948. The output on 60 and 85 Mc of a receiver having a bandwidth of 1.5 Mc was fed into a biased diode detector whose current/bias curve was measured. No difference was observed in the amplitude distribution of solar and thermal noise. Solar radiation does not reach us as a series of discrete frequencies separated at intervals of more than 2 Mc.

523.72:621.396.822]:538.566.2 886

**The Wave Equations for Electromagnetic Radiation in an Ionized Medium in a Magnetic Field**—(See 976).

523.854:621.396.822 887

**The Position and Probable Identification of the Source of Galactic Radio-Frequency Radiation Taurus-A**—J. G. Bolton and G. J. Stanley. (*Aust. Jour. Sci. Res., Ser. A*, vol. 2, pp. 139-148; June, 1949.) The source was discovered by an interference method (412 of 1948), using a frequency of 100 Mc. It has a width of less than 6' and coincides with the Crab nebula—a former supernova.

551.510.535 888

**Measurement of Height Distribution of Ionization in the Ionosphere**—G. Goubau. (*Arch. Tech. (Messn)*, no. 166, pp. T99-T100; November, 1949.) Description of a method and apparatus used at Herzogstand for vertical-incidence measurements. Frequency ranges are 1-3 Mc and 3-9.5 Mc.

551.510.535 889

**The Distribution of Ionization according to Height and the Recombination Coefficient of the Ionosphere F Layer**—A. A. Aynberg. (*Zh. Eksp. Teor. Fiz.*, vol. 19, pp. 515-520; June, 1949. In Russian.) From experimental critical-frequency/height characteristics of the F layer the distribution of ionization  $n$  with height is determined. Two curves showing the daily variation of  $n$  at various heights from 230 to 350 km are plotted for July and November (Figs. 2a and 2b). A table is also given showing the day and night values of the recombination coefficient at various heights for the same two months. These values were calculated on the basis of the law of simple recombination. The results obtained in this paper are only approximate.

551.510.535 890

**The Height of the F<sub>2</sub> Ionospheric Layer and the Relative Sunspot Number**—R. Eyfrig. (*Rev. Sci. (Paris)*, vol. 86, pp. 673-674; November, 1948.) The Huancayo monthly median values of the ratio of muf to critical frequency for the F<sub>2</sub> layer, for a reference distance of 3,000 km, are correlated with the corresponding Zurich mean values of the relative sunspot number for the period January, 1944 to April, 1949. Both noon and midnight data are considered. The results show that the height of the F<sub>2</sub> layer increases during the increasing phase of the solar cycle and diminishes during the decreasing phase.

551.510.535:550.385 891

**World Morphology of Ionospheric Storms**—E. V. Appleton and W. R. Piggott. (*Nature (London)*, vol. 165, pp. 130-131; January 28, 1950.) Superposed epoch analyses were made of noon f<sup>o</sup>F<sub>2</sub> values during ionospheric storms. In temperate latitudes there is a marked rise in f<sup>o</sup>F<sub>2</sub> for two days, followed by a sudden

drop; recovery to normal takes several days. Near the equator, only the rise is found and this coincides with the drop at higher latitudes.

In temperate and high latitudes, sudden commencements are often accompanied by a rapid fall in f<sup>o</sup>F<sub>2</sub> followed by a rise; this is often missed because it seldom lasts more than half an hour. Ionospheric storms are usually confined to a limited longitude range and are not equally developed in the North and South hemispheres.

551.510.535:621.3.087.4 892

**Ionospheric Sounding Experiments in Germany**—W. Dieminger. (*Research (London)*, vol. 2, pp. 571-576; December, 1949.) A survey of recent experiments using high-power pulse transmitters (15-150 kw). The transmitters use master-oscillator and power-amplifier tubes whose anodes are pulsed by a charged-line triggered-thyratron modulator. A variable-frequency sounder uses a servo motor to keep the transmitter in step with the receiver. For oblique-incidence work, transmitter pulse frequency and receiver timebase are controlled by crystal clocks to keep them in synchronism.

Experiments on the echoes scattered back to the transmitter via the E or the F regions and ground irregularities, and observations of the screening effect of the E region in oblique incidence transmission, preventing single-hop transmission via the F layer while permitting double-hop transmission, are described.

551.594.6 893

**Study of the Wave-Forms of Atmospherics**—S. R. Khastgir and R. Roy. (*Phil. Mag.*, vol. 40, pp. 1129-1143; November, 1949.) Variations in the field strength from atmospherics were amplified in a wide-band amplifier (100-10,000 cps) and applied to a cro with a linear timebase of duration normally between 1 and 10 ms. Drawings of the traces were made by hand. The waveforms were divided into eight types and their frequencies of occurrence determined. The main characteristics of these types are tabulated and discussed in relation to the physical properties of the lightning discharge.

#### LOCATION AND AIDS TO NAVIGATION

621.396.9 894

**Surveillance Radar System at the Port of Le Havre**—R. Pelicant. (*Electronique (Paris)*, no. 38, pp. 8-12; December, 1949.) A description of the shore-based installation which scans an area of 50-km radius around the port. The horizontal spreading of the beam precludes its use for precise navigation but it is in continual use at times of bad visibility for locating vessels and obstacles. Peak power is 180 kw; wavelength 10 cm; pulse duration 2 μs with 1,000 pulses per sec; antenna height 45 m; angle of spread 3°; 4 different rotation speeds, the fastest being 10 rpm.

621.396.93 895

**A Voltage Discriminator; Its Application to Direction Discrimination**—J. Loeb, M. Jeze, and C. Lombard. (*Ann. Télécommun.*, vol. 4, pp. 57-63; February, 1949.) A description of the principles, construction and performance of a vhf df device which has an angular sensitivity of 10<sup>-4</sup> radian. The apparatus is basically a goniometer which compares two low-level hf voltages and gives a signal which actuates a motor in a direction determined by the sense of the input voltage. Signal-voltage difference sensitivity is of the order of 1 μv.

621.396.933 896

**Crystal Control at 1000 Megacycles for Aerial Navigation**—S. H. Dodington. (*Elec. Commun.*, vol. 26, pp. 272-278; December,

1949.) 1949 IRE National Convention paper. A description of distance-measuring equipment using the ground-beacon interrogation system, which is suitable for multiplex operation. Fifty-one 2-way channels are provided with a spacing of 2.4 Mc. Adjacent channel rejection is better than 70 db, while image rejection and all spurious responses within the distance-measuring band are at least 60 db down in both air and ground equipments. The ranging circuits provide an indication of distance up to 115 nautical miles; accuracy is within 0.2 mile.

629.13.052:621.396.933 897

**Aircraft Radio Altimeters**—B. A. Sharpe. (*Jour. Inst. Nav.*, vol. 3, pp. 79-89; January, 1950.) A description of altimeters using (a) pulse radar systems, and (b) FM of a cw carrier. Accuracy and sources of error are discussed. It is necessary to use both systems in order to cover the range 0 to 50,000 ft.

#### MATERIALS AND SUBSIDIARY TECHNIQUES

533.5 898

**Symposium on High Vacuum**—(*Indus. Eng. Chem.*, vol. 40, pp. 778-847 and 938-944; May, 1948.) Papers presented at a symposium arranged by the National Research Corporation and the American Chemical Society, Cambridge, Mass., October 30 and 31, 1947. These include:—Development of High-Vacuum Technique—S. Dushman; Design of High-Vacuum Engineered Plants—H. C. Weingartner; Design of High-Vacuum Systems—C. E. Normand; New Techniques in the Measurement of Pressures below 10 mm—G. L. Mellen; Measurement and Control of Leakage in High-Vacuum Systems—R. B. Jacobs; Measurement and Comparison of Pumping Speeds—B. B. Dayton; and Surface Phenomena useful in Vacuum Technique—L. Apker. Eight papers on practical industrial applications of vacuum technique are also included.

535.312:546.212:621.396.11 899

**Measurements of the Reflection Coefficient of Water at a Wavelength of 8.7 mm**—D. G. Kiely. (*Proc. Phys. Soc.*, vol. 63, pp. 46-48; January 1, 1950.) An account is given of measurements (carried out in March, 1947) of the reflection coefficient of water at a wave length of 8.7 mm over a range of angles of incidence. The method employed is to measure the relative field strengths of the direct wave and waves reflected from a trough of water, using free-space propagation and high-gain antennas. The following electrical constants of water have been computed from the measured results (water temperature 11.1°C): refractive index 4.40 ± 0.24, dielectric constant 10.86 ± 2.21, absorption coefficient 2.91 ± 0.06, conductivity frequency 12.82 ± 0.42, Brewster angle 79°.

535.312:546.212-16:621.396.11 600

**Reflection coefficient of Snow and Ice at V.H.F.**—J. A. Saxton. (*Wireless Eng.*, vol. 27, pp. 17-25; January, 1950.) A general formula is given for the reflection coefficient of plane waves incident on a layer of ice or snow on the earth's surface, taking account of the multiple reflections within the layer. The reflection coefficients of ice on sea water and of snow on land are calculated for frequencies of 300 and 3,000 Mc, for three angles of incidence, both for vertically and for horizontally polarized waves. The presence of such layers may materially affect the reflection coefficient and hence the vertical-coverage diagram of a vhf transmitter.

537.228.1:546.431.82 901

**The Piezoelectric Effect in Barium Titanate**—A. V. Rzhanov. (*Zh. Eksp. Teor. Fiz.*,

vol. 19, pp. 502-506; June, 1949. In Russian.) Experiments were conducted with polycrystalline samples of barium titanate and the piezo-effect was investigated under static conditions when pressure was applied to the sample, and also under dynamic conditions when longitudinal vibrations were excited. A number of experimental curves are plotted and the values are determined of the piezo-moduli corresponding to the application of the force in the direction of polarization and at right angles to it. The material is quite suitable for use in piezoelectric transducers.

**538.22** **902**  
On the Variation of Thermo-Remanent and Isothermally Remanent Magnetization of Fired Earths as a Function of the Applied Field—J. Roquet. (*Compt. Rend. Acad. Sci. (Paris)*, vol. 229, pp. 1135-1137; November 28, 1949.)

**538.221** **903**  
Magnetic Properties of Nickel-Cobalt and Related Alloys—E. P. Wohlfarth. (*Phil. Mag.*, vol. 40, pp. 1095-1111; November, 1949.)

**538.221** **904**  
Investigation of the Magnetic After-Effect in Commercial Silicon- and Nickel-Iron Laminations—H. Wilde. (*Frequenz*, vol. 3, pp. 309-319 and 348-353; November and December, 1949.)

**538.221** **905**  
Some Ferromagnetic Properties of Mixed Ferrites of Nickel and Zinc—G. Guillaud and M. Roux. (*Compt. Rend. Acad. Sci. (Paris)*, vol. 229, pp. 1133-1135; November 28, 1949.)

**538.221** **906**  
Macroscopic Magnetic Texture of Permalloy Tape—I. Épelboim and A. Marais. (*Compt. Rend. Acad. Sci. (Paris)*, vol. 229, pp. 1131-1133; November 28, 1949.)

**538.221:061.3** **907**  
Ferro-Magnetic Materials—(*Elec. Times*, vol. 116, pp. 655-660; November 10, 1949.) A complete list of titles and authors of 20 papers read at a recent IEE symposium, with brief summaries of 10 of these papers.

**538.221:621.318.22** **908**  
Structure and Properties of the Permanent-Magnet Alloys—A. H. Geisler. (*Elec. Eng.*, vol. 69, pp. 37-44; January, 1950.) Essentially the full text of a paper presented at the symposium on magnetics at the 1949 AIEE Winter Meeting, New York. The reactions during the formation of such alloys, and their properties during and after formation, are described.

**621.315.59** **909**  
The Mechanism of Electrical Conduction in Semiconductors, and their Technical Application—K. Grosskurth. (*Fernmeldelech. Z.*, vol. 3, pp. 22-27; January, 1950.)

**621.315.59** **910**  
The Electrical Conductivity of Simple Semiconductors—W. Ehrenberg. (*Proc. Phys. Soc.*, vol. 63, pp. 75-76; January 1, 1950.) By combining an approximate expression for  $f_0$  of the Busch-Labhart type (1820 of 1947) with Shifrin's results (2218 of 1946), an analytical expression for the conductivity of semiconductors valid for all temperatures becomes available, as well as a simple procedure for determining the constants. The expression is derived under certain limiting assumptions.

**621.315.612.4** **911**  
Alkaline-Earth Titanates as Dielectrics and a New Group of Piezoelectric Materials—W. M. H. Schulze. (*Elektrotechnik (Berlin)*, vol. 3, pp. 365-372; December, 1949.) A detailed

discussion of the physical and electrical properties of these ceramics, with explanatory theory.

**621.318.33** **912**  
A Simply-Constructed Small Electromagnet of High Performance—R. P. Hudson. (*Jour. Sci. Instr.*, vol. 26, pp. 401-404; December, 1949.) A Weiss-type electromagnet is described which will produce fields of 20 kilogauss in a pole gap of width 3 to 5 cm. The coils, designed to dissipate 100 kw, are layer wound with enamelled copper strip and encased in insulating material. Cooling is provided by circulating distilled water through a heat exchanger which is cooled by mains water. The coil cases are made watertight by means of rubber gaskets and can be dismantled easily for inspection.

**668.3:621.396.611.21** **913**  
Uses of a New Adhesive in Production of Piezoelectric Vibrators—J. E. T. (*P.O. Elec. Eng. Jour.*, vol. 42, pp. 187-188; January, 1950.) An account of various applications of a thermosetting adhesive, Araldite, in the production of crystal vibrators. Araldite makes very strong joints between glass, ceramic, and metal surfaces when cured at 160°-240°C. It has been used (a) for attaching thin wires to crystal plates to act as supports and connections to electrodes, and (b) for cementing abrasive powders to the rim of disks used for cutting crystal slices. See also 3450 of 1949.

#### MATHEMATICS

**517.63+517.432.1:621.3.015.3** **914**  
The Laplace Transformation and the Study of Transient Phenomena—S. Colombo. (*Ann. Télécommun.*, vol. 4, pp. 210-222 and 233-249; Errata, nos. 8/9, p. 306 and p. 328. Appendices, no. 10, pp. 358-362. June and July, 1949.) The first part of this article is concerned with generalities relating to functional analysis and to the mathematical study of transient electrical phenomena. Part 2 discusses the operational methods of Heaviside and the Bromwich-Wagner integral. In Part 3 the theories of the symbolic calculus are outlined and their application to various problems of wave propagation is considered. The methods of the symbolic calculus are applied to the solution of integral equations and to the determination of certain asymptotic developments which occur in the mathematical treatment of transients in electrical circuits.

**517.93:621.396.611.1** **915**  
Harmonic and Subharmonic Response for the Duffing Equation—Levenson. (*See* 847.)

**681.142** **916**  
Mathematical Machines—H. M. Davis. (*Sci. Amer.*, vol. 180, pp. 28-39; April, 1949.) A general discussion of the historical development of calculation machines, with some speculations about future developments.

**681.142** **917**  
The EDSAC—An Electronic Calculating Machine—M. V. Wilkes and W. Renwick. (*Jour. Sci. Instr.*, vol. 26, pp. 385-391; December, 1949.) A large-scale electronic calculator which works in the binary system and uses ultrasonic delay units for the storage of orders and numbers. Punched tape is used for the input and a teleprinter for the output. The functions of the various units are described and the means by which orders are taken one by one from the store and executed are explained. See also 3448 of 1948, 1425, 2823, and 3458 of 1949.

**681.142** **918**  
Nonlinear Functions in an Analog Computer—G. D. McCann, C. H. Wilts, and B. N. Locanthi. (*Elec. Eng.*, vol. 69, p. 26; January, 1950.) Summary of a paper presented at the

1949 AIEE Summer Meeting on "Application of the California Institute of Technology Computer to Nonlinear Mechanics and Servomechanisms." Two basic types of device have been developed for use with the computer. These are (a) resistance-switching Ge-diode circuits; and (b) a cr tube/template/photocell servo system. Both devices can be used to represent general nonlinear impedances or amplification factors. Their application in different analyses is described. See also 3176 of 1949.

**681.142:621-526** **919**  
Electronics and Experimental Mathematics—F. H. Raymond. (*Onde Elec.*, vol. 29, pp. 30-44; January, 1950.) The basic principles of mathematical machines of the algebraic (analogue) and arithmetical types are briefly discussed. A general theory of linear servomechanisms with many variables is presented, their accuracy and stability are assessed, and their application in the analogue type of computer is considered. The construction of computers of the type OME (Opérateur Mathématique et Électronique), made by the Société d'Électronique et d'Automatisme, is based on servomechanism theory. These computers are designed for obtaining integro-differential equation solutions which satisfy either the conditions of Cauchy or given initial conditions. Nonlinear equations can be solved. The functional characteristics of the OME are described and its stability conditions are analyzed.

**517.53:621.392** **920**  
Applications Physiques de la Transformation de Laplace [Book Review]—M. Parodi. Publishers: Centre National de la Recherche Scientifique, Paris, 1948, 174 pp. (*Ann. Télécommun.*, vol. 4, p. 104; March, 1949.) The first of a series of monographs on mathematical processes undertaken by the Centre of Mathematical Studies. It presents in condensed form the principal practical aspects of the Laplace transformation.

#### MEASUREMENTS AND TEST GEAR

**531.76** **921**  
Electrostatic Short-Time Measurement—W. Schaaffs. (*Frequenz*, vol. 3, pp. 295-299; October, 1949.) Description of several simple capacitor methods for the measurement of times down to 0.5 ms.

**531.764.5:621.396.91** **922**  
On the Monitoring of the Rate of Quartz Clocks by means of Time Signals—F. Conrad. (*Frequenz*, vol. 3, pp. 270-273; September, 1949.) Discussion of accuracy attainable. An example is given of records, for the month of September, 1948, of time signals from Rugby (GBR), and Washington (WWV); the two curves are essentially parallel.

**531.765** **923**  
Millisecond Measurements in Research—D. W. Gillings. (*Instr. Practice*, vol. 3, pp. 277-287 and 333-341; May and June, 1949.) A comparative survey of four basic types of millisecond chronograph is given, with details of the construction and performance of particular instruments. The recording units usually consist either of a moving-film camera which photographs the trace given by an ordinary oscillograph, or of a static camera in combination with an oscillograph giving a spiral trace. One nonrecording type measures the potential of a standard capacitor charged at a known constant current during the time interval to be measured. Another uses an electronic counter to count the oscillations of a fixed-frequency oscillator during the required interval, and is particularly suitable for making routine measurements "by the thousand."

534.1:621.317.333.4:621.394/.396].6 924

**Fault Location in Transmission Equipment by Vibration Testing and Continuous Monitoring**—H. G. Myers. (*P.O. Elec. Eng. Jour.*, vol. 42, pp. 189–197; January, 1950.) The various types of fault in both transmitting and receiving equipment that can be readily discovered by means of suitable mechanical-vibration tests are discussed. Vibration test methods and apparatus are described and also continuous-monitoring methods which provide invaluable help to the maintenance engineer in solving recurrent-fault problems.

538.71 925

**Three-Component Magnetometer**—J. W. Seaton. (*Electronics*, vol. 23, pp. 165–171; January, 1950.) A small saturable reactor is used for each component of the field. Each reactor is operated at 800 cps, the magnitude and sense of the component being derived from observations of the amplitude and phase of the resulting 1,600 cps voltage developed in the winding. A null method is used in which the steady magnetic component under observation is balanced out by the field derived from a coil carrying dc. Accuracy of measurement is within  $\pm 0.1$  milligauss.

621.3.011.3(083.74):621.3.016.35 926

**The Stability of Inductance Standards**—G. H. Rayner and L. H. Ford. (*Jour. Sci. Instr.*, vol. 27, pp. 19–21; January, 1950.) Information acquired at the National Physical Laboratory since 1917 is reviewed. A brief description is given of the present working standard of mutual inductance, an oil-immersed type with a range of  $-1 \mu\text{H}$  to  $11,000 \mu\text{H}$ , whose value has remained constant to within  $\pm 2$  parts in 105 during the past twelve years. This instrument, when used in a bridge, makes possible the certain detection of changes of 2 parts in  $10^5$  in the values of inductance or capacitance. The stability with time of sub-standard self-inductance and fixed mutual-inductance coils of various types is also discussed.

621.317.3:550.371 927

**Apparatus for Measuring the Intensity of an Electric Field and its Applications**—I. M. Imyanitov. (*Zh. Tekh. Fiz.*, vol. 19, pp. 1020–1031; September, 1949. In Russian.) Many papers have been published during the last two decades, describing various types of apparatus all utilizing the principle of the es generator but designed to measure different electrical quantities such as current, voltage, charge, field strength, etc. An attempt is made to generalize the theory of such apparatus, and a report is given together with a theoretical discussion of experiments with universal apparatus built by the author, in which an es generator is used. The sensitivity of this apparatus is 0.01 v/cm per scale division, the area of the measuring plate  $225 \text{ cm}^2$  and the minimum input impedance  $15 \text{ M}\Omega$ . Various possible applications are discussed.

621.317.3:621.396.82 928

**Electrical Noise. Experimental Correlation between Aural and Objective Parameters**—Maurice, Newell, and Spencer. (See 989.)

621.317.3:621.396.822 929

**A Broad-Band Microwave Noise Source**—W. W. Mumford. (*Bell Sys. Tech. Jour.*, vol. 28, pp. 608–618; October, 1949.) The theory of measurement of receiver noise figure is discussed; an ordinary resistive noise source is unsuitable for accurate microwave measurements because it cannot be raised to a sufficiently high temperature. An alternative source is an electrical gas discharge, and investigation shows that a commercial fluorescent lamp is satisfactory. At 4,000 Mc its effective tem-

perature is about  $1,000^\circ \text{K}$ , which is convenient for measuring noise figures of 20 db or less. The noise power is practically independent of the fluorescent coating and the current density, and is only slightly affected by the room temperature. The lamp lends itself readily to broadband impedance matching in a waveguide.

621.317.3:621.396.822:621.396.645 930

**Study of Some Experimental Methods used for Measurement of Noise of Centimetre-Wave Amplifiers**—M. Denis. (*Ann. Radioléec.*, vol. 5, pp. 27–35; January, 1950.) Noise factor and signal-to-noise ratio are defined. The measurement system considered comprises a crystal mixer to superimpose uhf on a local oscillator signal of several Mc, an amplifier with a relatively very narrow bandwidth at this latter frequency, and a quadratic detector (crystal or thermocouple). The effect of amplifier and detector on the value found for the noise factor is discussed. The amplifier and mixer circuits are described. The measurement of signal-to-noise ratio where the output signal is large is then considered. The method consists of converting the noise frequency to one at which comparison can be made with a saturated diode. The methods used apply specially to measurements on traveling-wave tubes; a report on experimental results will be published later.

621.317.3.029.64 931

**Dynamical Measurement of Q-Factors and Natural Frequencies of Cavity Resonators with a Single Coupling Element**—M. Denis and S. Couybes. (*Ann. Radioléec.*, vol. 5, pp. 54–61; January, 1950.) A theoretical analysis and a description of the measurement equipment used. A reflex klystron source has a 16 db attenuator in an extension of the output line. Such an arrangement acts as if a source of emf were located at the output end of the attenuator. A detector loosely coupled to the attenuator input follows the power variations as a function of frequency. A transformer section couples the artificial source to the resonator. In this section is a second quadratic detector. Measurements are made by comparison of the two detector outputs on an oscillograph screen. The method is especially useful for measuring high-Q circuits and affords a quick means of obtaining the characteristics of a rhumbatron loaded by an electron beam, under varying circuit conditions. See also 1076 of 1948.

621.317.331 932

**An Absolute Measurement of Resistance by the Wenner Method**—J. L. Thomas, C. Peterson, I. L. Cooter, and F. R. Kotter. (*Bur. Stand. Jour. Res.*, vol. 43, pp. 291–353; October, 1949.) A full report of the apparatus and method developed for the measurement of resistance in terms of length, time, and the permeability of free space. A mutual inductor was constructed and its inductance determined from its dimensions to within a few parts in a million. Using Wenner's commutated dc method, the value found for the unit now maintained at the Bureau was 0.999994 absolute ohm.

621.317.336+621.396.67 933

**Antennas and Open-Wire Lines. Part 3—Image-Line Measurements**—Conley. (See 810.)

621.317.336 934

**Methods for measuring Impedances of Circuits shunted with a Negative Resistance**—Kh. I. Cherne. (*Radiotekhnika* (Moscow), vol. 4, pp. 63–70; September and October, 1949. In Russian.)

621.317.336:621.315.6.029.6 935

**Abac of the Function  $\tanh z/z$  for the Study of Dielectrics at U.H.F.**—J. Benoit. (*Ann.*

*Télécommun.*, vol. 4, pp. 27–32; January, 1949.) This function of the complex number  $z = u + j \cdot 2\pi\nu$  occurs in measurements of the impedance of a section of dielectric inserted at the end of a short-circuited line. The method of construction of the abac, which relates measured impedance with dielectric characteristics  $\epsilon'$  and  $\epsilon''$ , is described and geometric properties are established which greatly simplify the plotting of the curves for  $u=C$  and  $w=C$ .

621.317.35 936

**Frequency Analyser with Rapid Automatic Scanning**—L. Pimonov. (*Ann. Télécommun.*, vol. 4, pp. 257–272; July, 1949.) The principal automatic analysis systems are reviewed. The principle of sound analysis by the heterodyne method is illustrated by a detailed description of an analyzer comprising (a) input amplifier, (b) triode-hexode phase converter, (c) compensated modulator, (d) high-Q oscillator, (e) quartz filter, and (f) measuring device. The relation of speed of analysis to selectivity is considered and the analysis of ultrasonic frequencies is discussed. Different applications of the analyzer are considered and records of different sound spectra are reproduced.

621.317.7:621.396.813 937

**Study and Construction of a Distortion Meter**—F. Haas. (*Toute la Radio*, vol. 17, pp. 87–91; February, 1950.) A band-stop filter is interposed between an amplifier and a tube voltmeter to cut out the fundamental frequency. The filter consists of a resonance bridge between two attenuators. Measurement is made either on the tube voltmeter or on an oscillograph. Full circuit details with component values, are given.

621.317.723:621.317.733 938

**The Electrometer as Bridge [balance] Indicator**—T. Gast. (*Frequens*, vol. 3, pp. 264–270; September, 1949.) Detailed discussion of the use of es instruments as null indicators. Advantages are that they take no power, are practically independent of frequency, and can be readily adapted for remote indication or for use in self-balancing bridges.

621.317.725.024.2 939

**A Single-Pulse Voltmeter**—G. T. Rado, M. H. Johnson, and M. Maloof. (*Rev. Sci. Instr.*, vol. 20, pp. 927–929; December, 1949.) The instrument consists of a gated cathode-follower bridge in conjunction with a ballistic indicator. It measures the average amplitude of a single pulse over an arbitrarily selected interval of 2 ms, with a random error of 0.2 per cent of full-scale deflection.

621.317.73 940

**Impedance Measurements with Directional Couplers and Supplementary Voltage Probe**—B. Parzen. (*Elec. Commun.*, vol. 26, pp. 338–343; December, 1949.) Reprint. See 155 of February.

621.317.733 941

**A New Design of Wheatstone Bridge**—W. L. Surman. (*P.O. Elec. Eng. Jour.*, vol. 42, pp. 209–212; January, 1950.) Some disadvantages of the Post-Office-Box type of bridge have been eliminated in the no. 2 bridge which is self-contained, measures resistances from 1 to 9,990  $\Omega$ , and has an accuracy of  $\pm 0.5$  to  $\pm 1$  per cent. A commercial version, No. 3, has P.O. Box accuracy of  $\pm 0.2$  per cent. Four decade resistor combinations are included in the comparison arm; operation of the range switch gives a visual indication of the position of the decimal point.

621.317.733 942

**New Bridge Technique**—T. Roddam. (*Wireless World*, vol. 56, pp. 8–10; January,



1950.) Comment on 2271 of 1949 (Yates). Square-wave excitation, instead of sine-wave, can be used for measuring complex impedances, the bridge output being applied to a cro. The waveform obtained gives an indication of the type of impedance being measured and so facilitates balancing.

621.317.733 943

The Impedance Bridge (No. 2135) constructed by the S.A.C.M. [Société Alsacienne de Constructions Mécaniques] for the Service de L.S.G.D. [Lignes Souterraines à Grande Distance]—G. Chardon and R. Blondé. (*Câbles and Transmission* (Paris), vol. 4, pp. 58–65; January, 1950.) The construction of this portable bridge is described and performance figures are given. Its chief features are a series arrangement of resistance and capacitance standards for the measurement of impedance, and plug-in resistor and capacitor units for measurement of zero and positive reactance. A similar system converts the instrument for measuring admittance unbalance. Precision measurements can be made up to 10,000  $\Omega$  between 200 cps and 10 kc and up to 400  $\Omega$  at 300 kc.

621.317.733 944

Capacitance Bridge with Mechanical Rectifier and Mirror Galvanometer. Elimination of Errors due to Harmonics—F. Koppelman. (*Frequenz*, vol. 3, pp. 259–264; September, 1949.) An account of improvements of the bridge previously described (3181 of 1948) and investigation of sources of error. Adjustment of the timing of the rectifier contacts enables different harmonics of the supply to be cut out. See also 1429 and 3464 of 1949.

621.317.763:621.392.26† 945

Interferometer for Hertzian Microwaves—T. Kahan. (*Jour. Phys. Radium*, vol. 8, p. 192; June, 1947.) Description of apparatus used to measure wavelengths in the 3-cm band. Two sections of rectangular waveguide (30×10 mm) are soldered together in the form of a cross to make the four arms of the instrument. The ends, A and B, of two opposite arms are fitted with horns to concentrate the linearly polarized beams. The klystron generator output is fed into A. A thin trolitul plate fitted with parallel strands of wire is fixed inside the waveguides diagonally across the junction of the four arms. This performs the same function as the semi-transparent plate in Michelson's interferometer. By means of an adjustable reflector  $R_1$  facing the end B and a fixed, grid-type reflector  $R_2$  at the end of the third arm, the two reflected waves are superimposed in the fourth arm, which is terminated with a piston wave trap. Here a crystal detector, which is coupled to an oscilloscope, can be adjusted in position along a fine longitudinal slot. By modulating the generator input at 1,000 cps and controlling the wave-train by adjustment of  $R_1$ , the wavelength may be measured on the oscilloscope. The reflection coefficient of the disk  $R_2$  and terminal impedance may also be measured.

621.396.615 946

The New General Radio Generator 1001-A—A. G. Bousquet. (*Toute la Radio*, vol. 17, pp. 93–96; February, 1950.) A detailed description of the construction and performance of an instrument which replaces the former standard model No. 605. It covers from 5 kc to 50 Mc in 8 ranges. The output may be modulated in amplitude up to 80 per cent either by an external source with a frequency range from 20 cps to 15 kc, or by a 400-cps internal source. Output jacks provide (a) a voltage continuously variable between 0.05  $\mu$ v and 200 mv or (b) a fixed voltage of 2 v. A com-

plete circuit diagram giving all component values is shown.

#### OTHER APPLICATIONS OF RADIO AND ELECTRONICS

536.5:621.396.822 947

An Absolute Noise Thermometer for High Temperatures and High Pressures—J. B. Garrison and A. W. Lawson. (*Rev. Sci. Instr.*, vol. 20, pp. 785–794; November, 1949.) A null device for determining the ratio of two absolute temperatures by balancing the thermal noise voltages developed across two resistors at the relevant temperatures. Temperatures up to 1,200° K have been measured with an accuracy of 0.1 per cent, with an observation time of 2 minutes. Calibration of the thermometer elements is independent of the chemical composition and past physical history of the resistance material used and of the absolute pressure.

539.16.08 948

Dead Times of Self-Quenching Counters—B. Collinge. (*Proc. Phys. Soc.*, vol. 63, pp. 15–24; January 1, 1950.)

551.508.11:621.396.91 949

The Swiss Radiosonde—J. Lugeon, P. Ackermann, and M. Bohnenblust. (*Annales de la Station centrale suisse de Météorologie*, 1948, 17 pp. In French. Reprint.) Illustrated description of the different components and discussion of their operation. The bimetallic-spiral thermometer, aneroid barometer, and goldbeaters'-skin hygrometer are mechanically coupled to pointers carrying at their ends small capacitor plates whose location is scanned by a similar plate carried on a clockwork-driven arm rotating once every 30 sec. This arrangement is used for FM of small 100-Mc transmitter. The equipment used for receiving and recording the transmitted signals is also described.

551.508.5:621.317.755 950

Acoustic Anemometer-Anemoscope—R. E. Corby. (*Electronics*, vol. 23, pp. 88–90; January, 1950.) An instrument giving an instantaneous display of wind direction and velocity on a cro screen. 60-cps pulses from an acoustic transmitter are received by transducers equidistant from the transmitter in the four cardinal directions. A discriminator analyzes the Doppler effect of the wind on the time of arrival of the signals at the four receivers, and actuates an indicator. Wind speed is given by the length of the radial trace on the cro screen.

621.318.572:531.77 951

Precision Measurement of Rotary Motion—H. J. Finden. (*Electronic Eng.*, vol. 22, pp. 2–8; January, 1950.) The measurement is carried out by obtaining a pulsed signal whose pulse repetition rate is directly proportional to rotation speed, and then electronically counting the number of pulses per second, the time scale being derived from a reference standard. Circuits of frequency dividers, gate relays, amplifiers, and counters are given for equipment designed to give visual indication of rpm for speeds varying from 500 to 20,000 rpm. A counter sufficiently light and compact for flight test work can be constructed to read to the nearest 10 rpm over a range of 4,000–20,000 rpm.

621.365.54†:621.314.57 952

A New Method for Converting D.C. Energy into High-Frequency A.C. Energy with a High Efficiency, Specially Intended for High-Frequency Induction Heating—T. Douma. (*Commun. News*, vol. 10, pp. 52–68 and 69–82; June and October, 1949.) The method consists essentially in charging the capacitor of a resonant circuit from a dc source through

a special type of Hg-vapor tube. During a controllable period following the charging process, an oscillatory discharge can take place through a load coil. The experimental Hg-discharge tubes are semicircular in form, with ends shaped like large flat dishes to accommodate the pools of Hg used for anode and cathode. A capacitive igniter projects through the cathode pool and positive hv pulses are applied to it in order to render the tube conducting. Detailed mathematical theory of the operation of such a device is given. An efficiency of 99 per cent is possible at frequencies up to about 10 kc. Operational difficulties are briefly discussed. An output of 10 kw (4a at 2,500 V) has been reached with a relatively small tube, but after 60 hours operation at this loading, operation became unsatisfactory. With a larger tube and better cooling arrangements, an output of 40 kw has been obtained for 30 hours, an output of 80 kw being reached occasionally. Tubes or combinations of tubes are aimed at which can handle continuously an output of 100 to 300 kw.

621.365.54†:621.785.6 953

Automatic Induction Hardening Speeds Dodge Output—C. H. Wick. (*Machinery*, vol. 56, pp. 194–198; November, 1949.) Applications of induction heating in selective surface hardening of countershaft cams, resulting in faster heating and reduced distortion and scaling.

621.365.55† 954

The Physical Principles of Electrical Dielectric Heating of Nonconducting Materials—F. Walter. (*Frequenz*, vol. 3, pp. 299–306; October, 1949.)

621.38 955

Papers Summarized for Conference on Electronic Instrumentation—(*Elec. Eng.*, vol. 69, pp. 68–71; January, 1950.) Authors' summaries of the following papers presented at the joint AIEE and IRE Conference on Electronic Instrumentation in Nucleonics and Medicine, New York, 1949: Low-Frequency Spectrography: Some Applications in Physiological Research—R. R. Riesz; Electrical Methods of Blood-Pressure Recording—F. Noble; A Stable D.C. Amplifier for Biological Recording—H. Grundfeldt; a 25-channel Recorder for Mapping the Electrical Potential Gradients of the Cerebral Cortex: Electro-icnograms—J. C. Lilly; Medical Application of Ionizing Radiations—E. H. Quimby; An Automatic Isodose Recorder—G. J. Hine; The Measurement of Low-Energy Beta Ray Emitters—Ionization Chamber Techniques—N. A. Bailey; Proportional Counters for the Measurement of Soft Radiation—C. J. Borkowski; Small Geiger Counters for Biological Applications—C. V. Robinson; Phosphors for Scintillation Counters—R. H. Gillette; Solids for Radiation Detection—R. M. Lichtenstein; Some Design Features of Electrical Counting Systems—N. F. Moody; Desirable Improvements in Nucleonics Instrumentation—J. B. H. Kuper; and Criteria in the Selection of Radioisotopes for Industrial Use—E. T. Clarke.

621.38.001.8 956

Electronic Instruments in Research and Industry—(*Nature* (London), vol. 165, pp. 181–182; February 4, 1950.) Report of the second symposium arranged by the Electronics Group of the Scientific Instrument Manufacturers' Association, London, November, 1949, with short summaries of the papers presented. See also below.

621.38.001.8 957

Electronic Equipment—(*Electronic Eng.*, vol. 22, pp. 34–35; January, 1950.) Descriptions of a selection of equipment exhibited at the

- Scientific Instrument Manufacturers' Association Symposium, London, November, 1949.
- 621.38.001.8:621.791.7** 959  
Some Particular Applications of Electronic Circuits to the Control of Resistance-Welding Machines—E. Thirion. (*Bull. Soc. Franç. Élec.*, vol. 10, pp. 47-53; January, 1950.) A review of some recent developments in precision welding technique.
- 621.383:621.365.54†:621.791.052** 959  
Phototube Controls R.F. Welding—H. H. Wittenberg. (*Electronics*, vol. 23, pp. 91-93; January, 1950.) Precise automatic control of the welding of small parts is provided by photocell equipment operated by the radiation from the glowing weld. The generator is switched off half a second after the welding metal flows.
- 621.384.611.2†** 960  
On the Capture of Particles into Synchrotron Orbits—T. R. Kaiser. (*Proc. Phys. Soc.*, vol. 63, pp. 52-66; January 1, 1950.) Theory is given for the case in which the rf accelerating voltage rises from zero to its maximum value in a finite time. If this time is long enough, all particles originally within a band of width  $1/\sqrt{2}$  times the maximum width of the final stable region for synchrotron phase oscillations will be captured, irrespective of the initial phase at which they enter the accelerating gap. This conclusion appears to be in agreement with the observed characteristics of existing electron synchrotrons.
- 621.385.611.2†** 961  
Experiments on Electron Capture and Phase Stability in a 14-MEV Synchrotron—T. R. Kaiser, and J. L. Tuck. (*Proc. Phys. Soc.*, vol. 63, pp. 67-74; January 1, 1950.) Observations were made of the effects on output of interrupting the rf accelerating voltage for definite intervals during the acceleration process. Capture is more efficient than expected and for short interruption periods the particle loss is negligible. The results are in quantitative agreement with Kaiser's theory (960 above).
- 621.384.612.1†** 962  
Operation of the 184-in. Cyclotron—L. R. Henrich, D. C. Sewell, and J. Vale. (*Rev. Sci. Instr.*, vol. 20, pp. 887-898; December, 1949.) The operation is reviewed in terms of the theory developed by Bohm and Foldy (1542 of 1947 and 793 of 1948). Certain relevant data on the properties of the magnet and rotating capacitor are presented.
- 621.385.38.001.8** 963  
Examples of the Industrial Application of Gas-Filled Valves—R. Kretzmann. (*Z. Ver. Dtsch. Ing.*, vol. 91, pp. 457-462; September 15, 1949.) Specific applications of thyatron and relay tubes for control purposes. An extensive bibliography is given.
- 621.385.833** 964  
An Electron Gun for an Electron Microscope—V. N. Vertsner. (*Compt. Rend. Acad. Sci.* (URSS), vol. 57, pp. 459-461; August 11, 1947. In Russian.) Description of a gun developed at the State Optical Institute. The main feature of the gun is that the filament can be accurately displaced, horizontally as well as vertically, with respect to the diaphragm aperture while the microscope is in use.
- 621.385.833** 965  
Electron Optics of the Three-Stage Electron Microscope—C. E. Challice. (*Proc. Phys. Soc.*, vol. 63, pp. 59-61; January 1, 1950.) Calculations by Gaussian optical methods, with ray diagrams deduced from the tabulated numerical results.
- 621.385.833** 966  
An Improved Method of Numerical Ray Tracing through Electron Lenses—G. Liebmann. (*Proc. Phys. Soc.*, vol. 62, pp. 753-772; December 1, 1949.) The general ray equation is integrated with the help of Taylor's series, including terms up to those of the fourth order. The method is first developed for combined es and em lenses and then specialized for lenses of pure es or pure em type. Space-charge effects within the lenses are also considered.
- 621.385.833** 967  
Electron-Optical Observation of Magnetic Fields—L. Marton and S. H. Lachenbruch. (*Bur. Stand. Jour. Res.*, vol. 43, pp. 409-428; October, 1949.) A description of the electron optical analogue of the schlieren method and a related shadow method. See also 199 of February.
- 621.396.615:534-6** 968  
An Ultra-Low-Frequency Oscillator—J. E. Stone. (*Electronics*, vol. 23, pp. 94-95; January 1950.) The thermal lag of a current-carrying thermistor enables it to be used as an inductance in the resonant circuit of a subsonic oscillator. An approximately sinusoidal waveform can be obtained over a frequency range of 0.1-0.02 cps.
- 621-57:621.318** 969  
Magnetic Fluid Clutch—K. E. Wakefield. (*Gen. Elec. Rev.*, vol. 52, pp. 39-43; December, 1949.) An account of the results of investigations with special reference to high-duty devices capable of handling several thousand horsepower. See also 50 of February (Parker) and 237 of February (Nelson).
- 621.791.3:534.321.9** 970  
Ultrasonic Soldering Iron for Light Alloys—(*Engineer* (London), vol. 188, p. 737; December 23, 1949.) A removable copper bit is mounted in front of a magnetostrictor transducer excited from a separate generator. Ultrasonic vibrations at about 20 kc destroy the oxide film on the working surface. No flux is needed.
- 621.791.352:621.365.54†** 971  
Industrial Brazing by Pulse Techniques—J. L. Reinartz. (*Electronics*, vol. 23, pp. 78-80; January, 1950.) Extremely high values of peak rf power are applied in short-duration pulses in order to reduce the heating, by thermal conduction, of parts near to the joint being brazed. The method was developed for tube manufacture but may have many other applications.
- 629.13.055.2** 972  
A Shielded Hot-Wire Anemometer for Low Speeds—L. F. G. Simmons. (*Jour. Sci. Instr.*, vol. 26, pp. 407-411; December, 1949.) "A low-speed anemometer is described which comprises an electrically heated wire and a thermocouple contained in a double-bore silica tube. In an air current the temperature change caused by heat loss is registered by the thermocouple and, when the instrument is suitably calibrated, the emf developed serves as a measure of the speed of flow."
- 621.365.54†:55†** 973  
Radio-Frequency Heating [Book Review]—L. Hartshorn. Publishers: Allen and Unwin, London, 237 pp., 21s. (*Wireless Eng.*, vol. 27, p. 31; January, 1950.) "This book covers both induction and dielectric heating and is concerned mainly with the principles of rf heating. . . . A good point about the book is that it deals mainly with just those points upon which general information is lacking—the heating coil or electrode and the material itself. . . .
- Each chapter contains an extensive bibliography and the book undoubtedly forms a useful contribution to the literature."
- 621.38.001.8** 974  
Basic Electronics [Book Review]—R. G. Kloeffler and M. W. Horrell. Publishers: J. Wiley and Sons, New York, and Chapman and Hall, London, 1949, 435 pp., \$5.00. (*Electronics*, vol. 23, pp. 211-212; January, 1950.) "Coverage of the field of electronics from high-powered industrial circuits to low-level communications circuits is complete and comprehensive without being sketchy. Liberal references to the literature suggest further study for those whose interests or needs go beyond the scope of the general text."

## PROPAGATION OF WAVES

538.566 975

The Normal-Wave Method and Its Application to Multi-Layer Plane Media—P. E. Krasnushkin. (*Compt. Rend. Acad. Sci.* (URSS), vol. 56, pp. 687-690; September 1, 1947. In Russian.) A mathematical investigation of wave processes due to given currents in an unlimited, isotropic, nonmagnetic ideal medium, the dielectric constant of which depends only on one Cartesian coordinate.

538.566.2:523.72:621.396.822 976

The Wave Equations for Electromagnetic Radiation in an Ionized Medium in a Magnetic Field—K. C. Westfold. (*Aust. Jour. Sci. Res.*, Ser. A, vol. 2, pp. 169-183; June, 1949.) In the atmospheres of the sun and earth, the refractive index is, in general, a function of the angle between the direction of propagation and the magnetic field, the intensity of this field, electron density, and frequency. Surfaces of constant refractive index cannot be realized and the classical theory is inadequate.

The new treatment is based on axes parallel to the principal directions of the medium. A new form of the Appleton-Hartree equation for complex refractive index is obtained. Three possible types of plasma oscillation and their application to solar noise bursts are discussed. See also 884 and 885 (Payne-Scott)

538.566.2:621.396.11 977

Propagation of Electromagnetic Waves in a Stratified Medium—G. Eckart. (*Ann. Telecommun.*, vol. 4, pp. 142-154 and 223-230, May and June, 1949.) A mathematical treatment for propagation in a medium whose dielectric constant  $\epsilon$  is a linear function of the  $z$  coordinate. The case of waves which transform into plane waves if the slope ( $\alpha$ ) of the  $\epsilon$  curve tends towards zero is particularly considered, and also that of a medium consisting of two or three layers with different values of  $\alpha$ . In the latter case reflection occurs at the discontinuities. Numerical calculations are made.

A solution for the general case, when the values of  $\alpha$  are small, is developed in powers of  $\alpha$ , and the coefficients of reflection and transmission are determined. Both horizontal and vertical polarization are discussed. Theory is also given of the Zenneck surface wave in a stratified medium.

621.396.11 978

Coupling of the Ordinary and Extraordinary Rays in the Ionosphere—T. L. Eckersley. (*Proc. Phys. Soc.*, vol. 63, pp. 49-58; January 1, 1950.) An approximate solution to the wave equation is given for propagation in an ionosphere in which the gradient of the density  $N$  is in the vertical,  $z$ , direction only, and in which account is taken of the earth's magnetic field. It corresponds exactly to the ray theory and expresses a quantity  $Z$ , which is the  $z$  derivative of the phase function  $S$ , by a

quartic equation.  $Z$  can be represented as a function of  $\xi$  (which is proportional to  $N$ ) on a four-sheeted Riemann surface, and the branch points are studied for the case of vertical incidence for which  $Z$  becomes the refractive index. By considering the branch points in the complex  $\xi$  plane, the amount of the coupling between the ordinary and the isolated extraordinary branches of the ( $Z, \xi$ ) curves can be expressed as a function of the obliquity of the magnetic field. The triple splitting of rays reflected from the ionosphere, observable where the field is nearly vertical, can thus be explained, and the theory is substantiated by the observation that the polarizations of the echoes on the ( $P', f$ ) records are ordinary, ordinary and extraordinary in order of increasing critical frequencies, as given by the branches of the ( $Z, \xi$ ) curves.

621.396.11:535.312:546.212 979  
Measurements of the Reflection Coefficient of Water at a Wavelength of 8.7 mm—Kiely. (See 899.)

621.396.11:535.312:546.212-16 980  
Reflection Coefficient of Snow and Ice at V.H.F.—Saxton. (See 900.)

621.396.11:550.837.7 981  
Propagation of Electromagnetic Waves in Earth—O. C. Haycock, E. C. Madsen, and S. R. Hurst. (*Geophys.*, vol. 14, pp. 162-171; April, 1949.) Consideration of attenuation, present-day transmitter technique, and antenna-length limitations, indicates that frequencies in the range 300-1,000 kc are the most practical for propagation through considerable thicknesses of ground.

621.396.11:621.396.8].029.6 982  
The Propagation of Ultra-Short (Quasi-Optical) Waves—W. Lehfeldt. (*Arch. elek. Übertragung*, vol. 3, pp. 137-142, 183-186, 221-228, 265-269, 305-312, 339-346; July-December, 1949.) A comprehensive review including both theory and experimental results. Part 1 discusses (a) sw propagation characteristics ( $\lambda < 10$  m); (b) refraction in a homogeneous troposphere and calculation of range; (c) discontinuities in refractive index causing reflection, and fading or extreme ranges of sw signals; (d) steep refraction gradients leading to total reflection; (e) an estimation of the limiting wavelength (about 5 m) for sky-wave propagation; effects due to ion concentration; and (f) scattering and absorption by water drops.

Part 2 deals with propagation measurements for wavelengths from about 6 m to 9 cm. The experiments were conducted in both hilly and flat country and also over the Baltic Sea. Equipment and measurement technique are described. A special section discusses the statistical evaluation of the distribution of atmospherics. Abnormal ranges are noted. Theoretical and experimental results are compared.

621.396.812.029.63 983  
Interference Fading in the Decimetre-Wave Band Caused by Humidity and Temperature Changes in the Lower Layers of the Atmosphere—A. Grün and W. Kleinstüber. (*Arch. elek. Übertragung*, vol. 3, pp. 209-219; September, 1949.) Observed interference phenomena are explained in terms of (a) the bending of rays caused by gradients of the refractive index due to weather conditions, and (b) the interaction between the direct ray and the ray reflected from the earth. Consideration of the path difference of the two rays confirms that field strength variations may be calculated from the known behavior of the refractive index. Graphical methods of calculation are described. Mean values and variations of the re-

fractive-index gradients derived from observations of received signals are in good agreement with meteorological observations. A wavelength of about 50 cm appears especially advantageous for communication. The possible application of such observations for meteorological purposes is indicated.

621.396.97:621.396.619.13:621.396.8 984  
Propagation Measurements near Geneva for Experimental F.M. Broadcasting Transmissions on 93 Mc/s—W. Ebert. (*Tech. Mitt. Schweiz. Telegr.-Teleph. Verw.*, vol. 27, pp. 209-223; October 1, 1949. In German.) The Philips' equipment used for these tests is described; circuit diagrams of the Type-FZ115a transmitter and Type-FM46 receiver are given. During the measurements the 750-W transmitter was operated at about half power. Field strength and quality of reception are recorded for 49 locations within a radius of 60 miles from the transmitter, (a) using a  $\lambda/2$  dipole with vertical polarization, and (b) using a horizontally polarized turnstile array. The latter gave appreciably better results, the field strength at any particular point being approximately 2.5 times that obtained with a vertical dipole and the same transmitter power. A further report is to be given later.

621.395.11 985  
Radio Research Special Report No. 19. Lateral Deviation of Radio Waves Reflected at the Ionosphere [Book Notice]—W. Ross. Publishers: H.M. Stationery Office, London, 9d (*Govt. Publ.* (London), p. 19; November, 1949.)

#### RECEPTION

621.396.621:621.385 986  
The Sensitivity of Receiving Valves—H. Rothe. (*Arch. elek. Übertragung*, vol. 3, pp. 233-240; October, 1949.) The noise factor which limits receiver sensitivity is calculated for grounded-cathode, grounded-grid, and grounded-anode amplifier circuits. Neglecting the reactive effect of the output circuit, all three types of circuit have the same noise factor. The characteristics of various tubes are compared and discussed with reference to operation at high frequencies. The grounded-grid triode circuit, on account of its lower equivalent noise resistance, gives at vhf a greater sensitivity than the grounded-cathode pentode circuit.

621.396.621.029.62:621.396.933 987  
Airways V.H.F. Communications Receiver—A. H. Wulfsberg. (*Electronics*, vol. 23, pp. 81-83; January, 1950.) A receiver covering the range 108-136 Mc and using the double superheterodyne principle has a 100-db image-rejection ratio and an 80-db attenuation of other spurious responses. Series and shunt noise limiters are used in a special noise-balancing circuit, full details of which are given. Both the first and second local-oscillator frequencies are crystal controlled. Output is 1w into a 600- $\Omega$  load.

621.396.621.5 988  
Methods of Calculating the Sensitivity of Mixer Stages for Decimetre and Centimetre Waves—Mataré. (See 855.)

621.396.82:621.317.3 989  
Electrical Noise. Experimental Correlation between Aural and Objective Parameters—D. Maurice, G. F. Newell, and J. G. Spencer. (*Wireless Eng.*, vol. 27, pp. 2-12; January, 1950.) The dependence of the amount of annoyance, defined as the disturbance caused by noise interference in the presence of a broadcast program, upon the objective parameters of the noise was studied in order to devise a suitable measuring instrument which will simulate a lis-

tener's ear. The significant parameters are the receiver bandwidth and the pulse repetition frequency, considering the noise as repeated Heaviside unit impulses and the effect of the peak value on the annoyance to be logarithmic. Random fluctuation noise in the band 250 cps to 10 kc was used as a standard; a number of observers compared this with seventeen different types of test noise under various combinations of the parameters. Simultaneously, the noise levels were recorded on six different types of noise meters preceded by aural-weighting networks. The results showed that a meter indicating the mean square value of the input waveform less the mean value was the most suitable of those available for the subjective measurement of the interference; suggestions for its improvement are given.

621.396.82:621.396.619.13 990  
Investigation of Interference Phenomena in the Region between Two F.M. Common-Wave Transmitters—H. Fricke, L. Pungs, and K. H. Schmitter. (*Frequenz*, vol. 3, pp. 277-289; October, 1949.) The output voltage curve of a receiver situated between two FM transmitters operating on the same carrier frequency exhibits pronounced peaks which are due to hf and lf phase shifts. The number of these peaks within a given frequency band serves as a measure of the interference to program reception. Harmonic analysis indicates that with increasing number of such peaks the energy distribution trends more and more towards the higher frequencies, so that by using a suitable low-pass filter the interference can be almost completely eliminated. Measurements on model equipment are described which confirm the theoretical conclusions.

621.396.62+621.396.662.3+621.396.645 991  
Applications of the Electronic Valve in Receiving Sets and Amplifiers [Book Review]—B. G. Dammers, J. Haantjes, J. Otte, and H. van Suchtelen. Publishers: Philips Telecommunication Industries, Hilversum, Holland, 467 pp. (*Commun. News*, vol. 10, pp. 98-100; October, 1949.) The first volume of a series of three books on this subject. Only AM is considered. The various sections deal with (a) rf and if amplification, (b) frequency changing, (c) determination of the tracking curve, (d) parasitic effects and distortion due to curvature of tube characteristics, and (e) detection. "A work which should not be absent from any technical library."

#### STATIONS AND COMMUNICATION SYSTEMS

061.3:621.396.1:621.396.97 992  
Results of the Conferences in Copenhagen and Mexico—E. Metzler. (*Tech. Mitt. Schweiz. Telegr.-Teleph. Verw.*, vol. 27, pp. 233-231; October 1, 1949. In German.) Comment on these two conferences, the first on reorganization of European broadcasting channels, the second on international sw broadcasting.

621.39.001.11 993  
Communication Theory of Secrecy Systems—C. E. Shannon. (*Bell Sys. Tech. Jour.*, vol. 28, pp. 656-715; October, 1949.) Analysis of the basic mathematical structure of secrecy systems and discussion of "theoretical secrecy" and "practical secrecy." See also 1361 of 1949.

621.395 994  
15th Plenary Session of the Comité Consultatif International Téléphonique (C.C.I.F.), Paris, July 1949—R. Scur. (*Câbles and Transmission* (Paris), vol. 4, pp. 3-8; January, 1950.) Summaries of the discussions on various subjects.

- 621.395.44:621.315.052.63 995  
Single-Sideband Methods or Frequency Modulation for Power-Line Telephony—J. Herrmann and J. Erben. (*Frequenz*, vol. 3, pp. 341-348; December, 1949.) Discussion of the relative merits of the two systems, with particular reference to corona interference and to distortion due to sideband clipping in FM systems.
- 621.396.41.029.63:621.396.97 996  
Experimental Ultra-High-Frequency Multiplex Broadcasting System—A. G. Kandoian and A. M. Levine. (*Elec. Commun.*, vol. 26, pp. 292-304; December, 1949.) Reprint. See 2629 of 1949.
- 621.396.5/6 997  
Description and General Characteristics of [12-channel] Pulse Multiplex Equipment Studied and Perfected at the C.N.E.T. [Centre National d'Étude des Télécommunications]—J. Icole and G. Potier. (*Ann. Télécommun.*, vol. 4, pp. 315-318; August and September, 1949.)
- 621.396.5:621.396.619.16 998  
Pulse Multiplex Equipment for 24-Channel Telephony—L. J. Libois. (*Onde Élec.*, vol. 29, pp. 23-29; January, 1950.) 0.5- $\mu$ s pulses with a repetition frequency of 8,000 per sec are used. Time distribution of the pulses is effected by means of delay lines. Amplitude modulation of the channel pulses is transformed into pulse-position modulation, a common modulation transformer being used for (a) the even-numbered, and (b) the odd-numbered channels. The transformation procedure is reversed in the receiver. Synchronization pulses are distinguished by their longer duration. Operation of the equipment is satisfactory with a non-stabilized supply. Component tolerances are quite large and though similarity of transmitter and receiver delay lines is important, the precision required does not rule out the possibility of mass production.
- 621.396.5.029.62:621.396.902 999  
The Thames Radio Service—J. Neale and D. W. Burr. (*P.O. Elec. Eng. Jour.*, vol. 42, pp. 213-220; January, 1950.) A description of the recently developed public R/T service for small craft. Full duplex operation is provided. Low-power crystal-controlled transmitters operating in the 160 Mc band are used both for the shore-station and the mobile equipments. Mainly because of ease of maintenance and relative cost of equipment, AM was adopted for the service in preference to FM. A selective-calling system is being developed. Details of signalling systems, precautionary measures, and maintenance facilities are given. The use of more than one shore transmitter is considered.
- 621.396.6:621.396.932 1000  
The Radio Equipment of the Liner "Ile-de-France"—J. Leclère-Courbe. (*Ann. Radioélec.*, vol. 5, pp. 21-26; January, 1950.) General description of the functions and disposition of new apparatus which, except for the emergency equipment, is all grouped in one room. It includes magnetostriction and piezoelectric depth-sounding recorders, radar equipment, general communication equipment for both telegraphy and telephony, and radiogoniometer.
- 621.396.619.13 1001  
Quality Gain in Carrier-Frequency Systems using Frequency Modulation of Metre and Decimetre Waves—P. Barkow. (*Arch. elek. Übertragung*, vol. 3, pp. 287-292; November, 1949.) Formulas are derived for the improvement factors, which are dependent on relative frequency swing and which are represented graphically for different numbers of channels. A numerical example is calculated and two methods are suggested by which equalized signal-to-noise ratio and additional gain in quality may be obtained, especially for the upper channels.
- 621.396.619.13:621.395.813 1002  
Method of Calculating the Nonlinear Distortion of F.M. Signals as a Function of Amplifier Propagation-Time Variations—J. Fagot. (*Ann. Radioélec.*, vol. 5, pp. 8-11; January, 1950.) Phase variation and propagation time of an FM signal are defined mathematically and the following simple relation is derived for third-harmonic distortion:  $D_3 = \omega \Delta t / 4$ , where  $\omega$  is  $2\pi$  times the modulation frequency and  $\Delta t$  the variation of propagation time. The formula is used to find the maximum permissible variation of  $t$  for a given distortion in a 12-channel and a 240-channel carrier-current telephony system.
- 621.396.619.16 1003  
Pulse-Code Modulation and Its Distortion with Logarithmic Amplitude Sampling—H. Holzwarth. (*Arch. elek. Übertragung*, vol. 3, pp. 277-285; November, 1949.) A characteristic of pcm is the increase in distortion with decreasing modulation. This may be partly compensated by a logarithmic pre-distortion of the signals; this acts as a logarithmic sampling of the undistorted signal. Under certain conditions, distortion may be kept at an almost constant value throughout a wide modulation band. An approximate formula is given for the distortion in terms of the degree of pre-distortion and the sampling rate. The method also gives an increased volume range. For the same number of channels, a 7-unit PCM system requires about the same minimum bandwidth as a PPM system. With a 5-unit code the requirements regarding transmission quality could probably not be fulfilled.
- 621.396.65:621.396.5 1004  
A New V.H.F. Multi-Circuit Radio Telephone System: part 1—J. J. E. Aspin. (*GEC Telecommun.*, vol. 4, pp. 62-78; 1949.) The possibilities of the application of vhf trunk radio systems are summarized, the features of vhf propagation are outlined, and frequency separation is discussed. The effect of sites and antenna heights is explained and figures for attenuation due to the radio path are quoted. An outline of design requirements leads to an illustrated description of equipment of two types: (a) the 6-circuit system, which handles seven channels of width 4 kc; and (b) the 12/24-circuit system, which handles 24 such channels. Power output from terminal and relay transmitters is 20 w or, with an additional amplifier, 100 w. Relay spacing may be up to 60 miles. Two rows of 4 center-fed dipoles, with  $\lambda/2$  dipole spacing and  $\lambda$  row spacing,  $\lambda/4$  in front of a wire-mesh screen, form the directional antenna array. Part 2 will describe the automatic change-over and fault-signalling system associated with the duplicate equipment at repeater stations.
- 621.396.65:621.396.619.16 1005  
Port Elizabeth-Uitenhage Time-Sharing-Modulation Radio Link—(*Elec. Commun.*, vol. 26, pp. 269-271; December, 1949.) Illustrated description of equipment operating on frequencies of 440 Mc and 475 Mc in the two directions, with peak power of the pulsed transmitters of 150 w.
- 621.396.65:621.397.5 1006  
The London/Birmingham Television on Radio-Relay Link—D. C. Espley and R. J. Clayton. (*GEC Jour.*, vol. 17, pp. 3-10; January, 1950.) An illustrated general description of the present single-channel reversible link. A more detailed technical account will be given on completion of the two-way link. See also 471 of March.
- 621.396.65(494) 1007  
Transalpine Communication by Radio Beams—W. Gerber. (*Tech. Mitt. Schweiz. Telegr.-Teleph. Verw.*, vol. 27, pp. 231-235; October 1, 1949. In French.) General discussion, with suggestions for the development of a system linking the regions north and south of the Alps. See also 546 of 1948 (Gerber and Tank) and 2326 of 1949 (Klein).
- 621.396.822:[621.396.65+621.395.44] 1008  
Noise Level in F.M. Radio Relay Links for Multichannel Carrier Telephone Systems—A. van Weel. (*Commun. News*, vol. 10, pp. 83-86; October, 1949.) The effective signal-to-noise ratio of radio links is compared theoretically with that of telephone land lines over the same circuits. It is possible to get comparable performance for the radio link only by using highly directive antennas, involving the use of wavelengths  $< 30$  cm. Economic considerations favor the radio link, since for land lines a repeater is required every 25 km, whereas for the radio link the distance is about 45 km.
- 621.396.933 1009  
Modern Aircraft Radio Equipment as Fitted to Convair Liner—J. H. Gerrand. (*Proc. I.R.E. (Australia)*, vol. 10, pp. 306-310; November, 1949.) 1948 Australian IRE Convention paper. The three main requirements of such equipment are light weight, reliability and ease of servicing, and simplicity of operation. Various units of the Convair communication and navigation equipment are described, with emphasis on the way in which they meet these requirements.
- 621.39 1010  
Die Systemtheorie der elektrischen Nachrichtenübertragung. (Theory of Electrical Communication Systems) [Book Review]—K. Küpfmüller. Publishers: S. Hirzel, Stuttgart, 386 pp. (*Wireless Eng.*, vol. 27, p. 30; January, 1950.) "It is a systematic investigation of the transmission of electrical signals of all kinds under all possible conditions. It deals with telegraphic signals, speech, amplitude, frequency and pulse modulation, and all the various types of distortion. The amount of material in the book is very impressive and the treatment is very thorough and detailed and well illustrated with numerous diagrams. When any lesser known mathematical functions are introduced they are carefully explained and illustrated with numerical examples and diagrams. This is certainly a book that can be unreservedly recommended to anyone with a knowledge of German."
- SUBSIDIARY APPARATUS
- 541.136.2:541.133 1011  
The Internal Resistance and the Electrolytes of Galvanic Cells—C. Drotschmann. (*Funk. und Ton.*, vol. 3, pp. 506-524 and 594-600; 1949.)
- 621-526:681.142 1012  
Electronics and Experimental Mathematics—Raymond. (See 919.)
- 621.316.722 1013  
Photo-Tube Input Impedance for a Voltage Stabilizer—E. N. Strait and W. W. Buechner. (*Rev. Sci. Instr.*, vol. 20, pp. 783-785; November, 1949.) A photocell under constant illumination is used as an input impedance, eliminating the necessity for dc amplification of the error signal, which is applied directly to the control grid of a pentode, Type 5693, that is used to control corona leakage current to the hv terminal of an es generator.

621.384.5 1014

**Variations in the Characteristics of Some Glow-Discharge Voltage-Regulator Tubes**—F. A. Benson, W. E. Cain, and B. D. Clucas. (*Jour. Sci. Instr.*, vol. 26, pp. 399-401; December, 1949.) "The variations in the characteristics of two commercial types of glow-discharge voltage-regulator tube have been studied in detail experimentally. The results of short- and long-term tests to determine voltage drift, together with measurements of temperature coefficient, are presented. The properties of tubes run with the cathode potential positive with respect to the anode are discussed."

621.396.69 1015

**Telescopic Mountings in Electronic Equipment**—C. H. Davis. (*Electronic Eng.*, vol. 22, pp. 27-31; January, 1950.) A description is given of different methods of mounting chassis on roller bearings or pivots, for easy withdrawal from racks or other equipment and for convenience in servicing. The use of flexible cable harness ensures permanent circuit connections in both open and closed positions. Plug and socket connections are used if the equipment is to be "dead" in the open position.

## TELEVISION AND PHOTOTELEGRAPHY

621.397.5 1016

**1029-Line Television**—W. Dillenburger. (*Elektron Wiss. Tech.*, vol. 4, pp. 1-10; January, 1950.) The suitability of different scanning methods for high-definition pictures is discussed and their efficiency considered. Tests made with a 1029-line image dissector tube indicate that this line number is too high and that the physical limit for scanning tubes is too closely approached. The cost of transmitters and receivers is considered. The proposed 625-line system for German television seems a good choice, guaranteeing satisfactory picture quality and being economical.

621.397.5:621.396.65 1017

**The London/Birmingham Television Radio-Relay Link**—Espley and Clayton. (See 1006.)

621.397.62 1018

**Technique and Developments of High-Definition Television Receivers**—P. Mandel. (*Onde Elec.*, vol. 29, pp. 45-56; January, 1950.) Paper presented at the 1949 International Television Congress, Milan. An examination of problems of technique and economy. The technical aspects discussed are: antennas and hf feeders; hf amplification and frequency-changing; if amplifiers and detection; and electron beam deflection and image distortion. The relative cost of high and low-definition receivers is considered and the importance of the standardization of components is stressed.

621.397.7 1019

**Extending Television**—(*Wireless World*, vol. 56, pp. 14-15; January, 1950.) Brief description of Sutton Coldfield television station, which operates at 61.7 Mc, with a power of 35 kw, and is the second of a chain of 10 stations which are planned for extending the service to 80 per cent of the population of Great Britain Kingdom by 1954.

## TRANSMISSION

621.39.001.11 1020

**Analytical Signals with Limited Spectrum: Part 1**—J. Ville. (*Cables and Transmission* (Paris), vol. 4, pp. 9-23; January, 1950.) The properties of signals whose spectra lie within a given frequency band are studied mathematically. Such signals are completely defined by their values at instants in arithmetical progression with a sufficiently small common difference. The extension of this result to analytical signals permits the study of circuits whose

indicial admittance is distributed in time. This enables the relation between the bandwidth and the quantity of information carried by the signal to be determined.

621.396.612.1.029.64 1021

**A New Transmitter for Ultra-Short Damped Waves**—J. Le Bot. (*Jour. Phys. Radium*, vol. 8, pp. 142-145; May, 1947.) Description of a Hertzian doublet type of oscillator of simple construction. Two tungsten or platinum wires, of diameter 1 mm and length 4.5 mm, are arranged as a  $\lambda/2$  doublet with a gap of some hundredths of a millimeter which has a micrometer adjustment. The doublet is immersed in a mineral oil and fed through fine resistance wires connected through a high resistance to an 8-10 kv ac supply. At breakdown the spark discharge carbonizes the oil to form an effective short circuit for the hf oscillation generated. The resistive component of the impedance of the doublet being very small, a damped wave-train is radiated at each succeeding half-cycle. The apparatus functions for several hours without adjustment. Radiated power is of the order of 10-20 mw and wavelength about 4.4 cm. Some experiments with cm waves are described, using this transmitter coupled to a short waveguide and horn radiator.

621.396.615:621.396.619.13 1022

**Reactance-Tube Modulation of Phase-Shift Oscillators**—F. R. Dennis and E. P. Felch. (*Bell Sys. Tech. Jour.*, vol. 28, pp. 601-607; October, 1949.) A basic circuit is described and the design of suitable oscillators for a range of frequencies from af to uhf is discussed. The phase-shift networks are conveniently of the RC, LC and transmission-line types for the lower, medium, and higher frequencies respectively. Typical circuits and performance curves are given.

621.396.619.13 1023

**Calculation of the Bandwidth of a Sinusoidal Transmission with Sinusoidal F.M.**—L. Robin. (*Ann. Télécommun.*, vol. 4, pp. 19-26; January, 1949.) The bandwidth necessary to satisfy the requirements fixed at the Atlantic City Convention is determined for any value of the modulation index. The treatment involves Bessel functions of the first kind and a series formed by the squares of these functions. It is found necessary to introduce an asymptotic development of Bessel functions for neighboring values of their index and argument. The results of the calculations are shown on four graphs. Two of these give the ratio of FM bandwidth to AM bandwidth for any value of the modulation index; the others show the relation between the FM bandwidth and the frequency swing.

621.396.619.13 1024

**Reactance Valves and their Use in Frequency-Modulation Circuits**—A. G. Wray. (*Marconi Instrumentation*, vol. 2, pp. 63-67; November and December, 1949.) Simple theory is given of the operation of a typical reactance-tube circuit. This indicates that a tube giving a linear change of mutual conductance with linear variation of control-grid voltage is suitable for use as a reactor. Experiments with a variable- $\mu$  tube showed a reduction in second-harmonic content but an increase of the third harmonic, so that no improvement of the total distortion resulted. With a "straight" tube the third harmonic is practically non-existent and by careful adjustment of bias voltage the second harmonic can also be made negligible for a particular tube. Bias readjustment will probably be necessary if the tube is changed for one of the same type. Using an EF91, EL91, or EF92 tube in the circuit given, a deviation of 0.5 per cent of the carrier frequency can be obtained. Much better per-

formance is obtained with a push-pull circuit, full details of which are given. A deviation of 2 per cent of the carrier frequency is possible with this circuit, using EF91 tubes for both reactor and oscillator. Over-all envelope distortion is <1 per cent. The system has the advantage that random changes due to supply-voltage fluctuations are cancelled.

621.396.619.23 1025

**Study of Rectifier-Type Ring Modulators with regard to their Application in Terminal Installations for 600- or 960-Channel Coaxial-Cable Links**—P. Moll. (*Cables and Transmission* (Paris), vol. 4, pp. 24-46; January, 1950.) The characteristics of Westinghouse rectifiers 30 S9A and 28 S4F and their associated input and output transformers are studied at different frequencies between 10 kc and 10 Mc. Laboratory tests and methods of measurement of circuit losses and nonlinear distortion are described. Results are tabulated and shown graphically. The 30 S9A rectifier is well suited for ring-modulator use between 300 cps and 4 Mc.

## VACUUM TUBES AND THERMIONICS

537.311.33:621.315.59 1026

**Transistors**—J. A. Becker. (*Elec. Eng.*, vol. 69, pp. 58-64; January, 1950.) Discussion of recent advances in the theory, circuit performance, and potential applications of transistors, based on the following papers presented at the 1949 AIEE Summer Meeting: Theory of Transistor Action—W. Shockley; Equivalent Circuits for Transistor Action and Noise—R. M. Ryder; and The Possible Significance of Transistors in the Power Field—J. A. Hutcheson. See also 240 of February.

621.383.4:534.862.4 1027

**Lead-Sulfide Photoconductive Cells in Sound Reproducers**—R. W. Lee. (*Jour. Soc. Mot. Pic. Eng.*, vol. 53, pp. 691-703; December, 1949. Discussion, pp. 703-706.) Results are given of measurements of sensitivity or signal output for a wide range of conditions in a standard 16-mm sound projector, using silver, silver-sulphide, dye-image, and iron-toned sound tracks. The effect of the color temperature of the exciter lamp on frequency response and signal output is also discussed.

621.384.5 1028

**Variations in the Characteristics of some Glow-Discharge Voltage-Regulator Tubes**—Benson, Cain, and Clucas. (See 1014.)

621.385:621.318.572 1029

**Switching Valves**—W. Kleen. (*Elektron Wiss. Tech.*, vol. 4, pp. 11-16; January, 1950.) The principle of operation, application, and development of the gas-filled transmit-receive switch.

621.385:621.396.621 1030

**Modern Receiving Valves: Miniature Valves**—R. Suart. (*Radio Franç.*, no. 1, pp. 3-8; January, 1950.) An illustrated description of their development and of methods of manufacture. Operating characteristics compare favorably with those of the corresponding normal and acorn types of tube. Some 40 types of miniature tube are classified.

621.385:621.396.621 1031

**The Sensitivity of Receiving Valves**—Rothe. (See 986.)

621.385.029.63/.64:537.525.92 1032

**Increasing Space-Charge Waves**—Pierce. (See 874.)

621.396.615.029.63 1033

**On a Particular Characteristic of Disk-Seal Valves 2C40 and 2C43**—L. Liot. (*Radio Franç.*,

no. 2, pp. 9-13; February, 1950.) The physical construction of these tubes allows them to be used as reentrant-cavity oscillators for the frequency range 1,600-2,400 Mc. Maximum output power using a Type-2C40 tube on 2,000 Mc is 200 mw, falling to 70 mw at the limiting frequencies. A scale diagram is given showing the construction adopted.

621.396.615.142 1034

**On the Theory of Velocity-Modulation Transit-Time Valves: Part 2**—H. Döring. (*Arch. elek. Übertragung*, vol. 3, pp. 293-300; November, 1949.) The general reflex type of tube is investigated. Behind the infinitely short alternating field is located the field-free drift space  $\Theta_L$  and a uniform retarding field  $\Theta_B$  of finite length. This arrangement is comparable with the two-field, two-circuit tube with fixed reaction, so that discrete oscillation regions appear when the static transit-time angle is varied. When  $\Theta_L > \Theta_B$  the oscillation regions correspond to those of the Heil generator with antiphase alternating fields. When  $\Theta_L < \Theta_B$  the motion in the retarding field is predominant and the oscillation regions coincide with the damping regions of the Heil generator. For equal transit-time angle in the drift space and retarding field ( $\Theta_L = \Theta_B$ ), only slight density modulation occurs and the efficiency of the generator tends to zero. Two arrangements giving the greatest conversion efficiency are described. The first uses an electrical double layer for the retarding field ( $\Theta_B = 0$ ). In this case, oscillation regions and efficiency are identical with those of the Heil generator. Maximum efficiency of 26 per cent occurs in the second region with  $\beta = 0.5$  and  $\Theta_L = 2.3\pi$ . In the second arrangement  $\Theta_L = 0$  and the maximum efficiency of 25.5 per cent occurs in the first region with  $\Theta_B = 1.55\pi$  and  $\beta = 0.5$ . Exact calculations are made for the first and sixth regions. Approximate formulas may be derived for the maximum efficiency in the higher oscillation regions. Part 1: 2175 of 1944.

621.396.822 1035

**Spontaneous Fluctuations in Double-Cathode Valves**—R. Fürth. (*Wireless Eng.*, vol. 27, p. 33; January, 1950.) Reply to comment by Knol and Diemer (791 of April) on Fürth's theory (2418 and 2419 of 1948). See also 1247 of 1949 (MacDonald).

621.396.822 1036

**Hum in A.C. Valves**—Z. Imre. (*Electronic Eng.*, vol. 22, p. 33; January, 1950.) See also 916 of 1949, where the author's name should be as above.

621.38 1037

**Fundamental Electronics and Vacuum Tubes** [Book Review]—A. L. Albert. Publishers: Macmillan and Co., 2nd edn. 1947,

499 pp., \$6.00. (PROC. I.R.E., vol. 37, pp. 1304-1305; November, 1949.) Intended "for use in courses in electronics required of all electrical engineering students. The treatment is largely nonmathematical." The first edition was noted in 2783 of 1939.

621.385 1038

**International Radio Tube Encyclopedia** [Book Review]—B. R. Babani (Ed.). Publishers: Bernards Ltd., London, 410 pp., 42s. (*Wireless Eng.*, vol. 26, p. 412; December, 1949.) Gives the characteristics and base connections of 15,000 British, American, and Continental tubes, classified according to type and arranged in alphabetical and numerical order.

621.385 1039

**Les Tubes Électroniques et leurs Applications: Tome 1—Principes généraux** [Book Review]—H. Barkhausen. Publishers: Dunod, Paris, 228 pp. (*Radio Tech. Dig.* (Frang.), vol. 3, pp. 377-378; December, 1949.) 2nd French edition, being a translation by C. Poitrat of the 5th German edition. "This book, like the earlier edition, will be of great value to radio engineers and technicians." Further volumes will deal with amplifiers (vol. 2), self-excitation and feedback (vol. 3), and rectifiers and receivers (vol. 4).

#### MISCELLANEOUS

06.064:621.396 1040

**Amateur Exhibition**—(*Wireless World*, vol. 56, pp. 12-13; January, 1950.) Brief descriptions of some of the exhibits at the 3rd annual show of the Radio Society of Great Britain.

530.12 1041

**Albert Einstein on His Seventieth Birthday**—R. A. Millikan. (*Rev. Mod. Phys.*, vol. 21, pp. 343-345; July, 1949.) A short appreciation of Einstein and his work. The rest of this number (pp. 345-540) contains 37 papers on various aspects of the theory of relativity. Each of the authors would wish to express his debt to Einstein, but editorial arrangements made it necessary for such expressions to be voiced only by R. A. Millikan, L. de Broglie, M. von Laue, and P. Frank.

621.3:371.3 1042

**Philosophy of the Teaching of Electricity**—L. Bouthillon. (*Bull. Soc. Franç. Élec.*, vol. 9, pp. 619-640; November, 1949.)

621.385 1043

**Birth Centenary of Ambrose Fleming**—J. T. MacGregor-Morris. (*Electronic Eng.* (London), vol. 21, pp. 442-447; December, 1949 and vol. 22, pp. 22-26; January, 1950.) A review of Fleming's life and work, with particular refer-

ence to the sequence of events leading to his invention of the thermionic tube and to its use for radio reception.

621.396.029.64 1044

**Some Experimental Demonstrations with Electromagnetic Centimetre Waves**—E. Meyer and H. Severin. (*Z. Phys.*, vol. 126, pp. 711-720; August 30, 1949.) Description of simple experiments in an auditorium of Göttingen University during the course of a lecture on "Physical Fundamentals of High-Frequency Technique." A 10-cm tone-modulated magnetron was used as transmitter.

621.396.97:061.3 1045

**Proceedings of the Broadcast Engineers Conference, May 23-25, 1949**—M. A. Honnell (Ed.). (*Georgia Inst. Tech. State Eng. Exp. Station Circular* (Atlanta), vol. 9, 82 pp. October, 1949.) Essential substance of 14 papers read at the conference.

43-3=2 1046

**Technisches Wörterbuch (Deutsch-Englisch)** [Book Review]—R. Ernst. Publishers: Tauchnitz Edition, Hamburg. Vol. 1, 612 pp., 16.50 DM. (*Elektrotechnik* (Berlin), vol. 3, p. iv; May, 1949.) "The problem of including as many technical words as possible in a handy volume has been solved surprisingly well. Space economies in the case of related words and those common to the two languages might have been extended to include other less familiar equivalents, such as geschwindigkeitsmodulierte Röhre=klystron. More verbs are included than is usual in most technical dictionaries, and also the principal expressions for mathematical operations."

621.3:43-3=2=4 1047























**Technical Dictionary: Vol. 2, German-English-French** [Book Review]—H. Thali. Publishers: H. Thali and Co., Hitzkirch, Switzerland, 1948, 311 pp., 35s. (*Electronic Eng.*, vol. 21, p. 437; November, 1949.) A 24,000-word dictionary concerned mainly with electrical engineering, radio, television, and telecommunications. It includes also the most important terms of acoustics, illumination, mathematics, materials, optics, heating, etc. Vol. 1, English-German-French, was noted in 906 of 1948.

45-3=2:621.396 1048

**Dizionario Tecnico della Radio. Italiano-Inglese. Inglese-Italiano** [Book Review]—L. Bassetti. Publishers: Il Rostro, Milan, 275 pp., 900 lire. (*Radio* (Turin) no. 8, pp. 5-6; November, 1949.) Radio terms and terms in physics and electronics connected with radio are explained. A list of abbreviations and symbols for circuit diagrams is included.

# ADVENTURES IN ELECTRONIC DESIGN

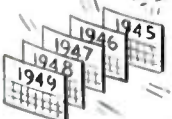
## Centralab's Special Electronic Component Parts Design Service May Solve a Problem for You

How many times  have your design engineers  been called  upon to develop new equipment only to be faced with a new bug  — or special problem of one variety or another? Everything about the new gadget seems  but you need a special part to lick  the special problem. To Centralab Engineers  these queer bugs  and special problems are as welcome as a Rolls Royce  to a burlesque queen . They look on these problems as their own  and from their bag  of 30 years of electronic experience — they always come up with an answer.  Take a look  over the next two pages . See for yourself  some of these "Specials" in ceramics,  switches  and capacitors  that CRL  has developed to meet special needs during the past few years . Maybe you'll see one that can help  — or you'll know where to go with your next special problem.  of course!

**Centralab** — DEVELOPMENTS THAT CAN HELP YOU 

Division of GLOBE-UNION INC. • Milwaukee

# What's your need in

MAY 1950

Centralab  
offers 30 years  
experience in  
special electronic  
part design and  
manufacture

## Define your problem— bring it to Centralab

If you have an unusual electronic or ceramic part design and fabrication problem — bring it to Centralab. It may very well happen that with a combination of standard CRL parts — or a slight modification thereof — we can help you solve it. If special requirements warrant — we can design a completely new unit and produce it for you. All we need is your exact requirements as to purpose, size, capacity, voltage and resistance. Write Dept. "E" outlining your problem. No obligation. Centralab Division, Globe-Union Inc., 900 E. Keefe Ave., Milwaukee 1, Wisconsin.

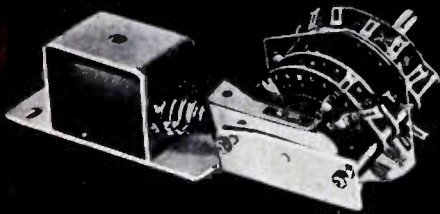

**1** A solenoid operated selector switch.

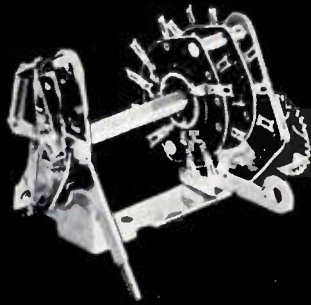

**2** Automatic selector switch for automobile radio.

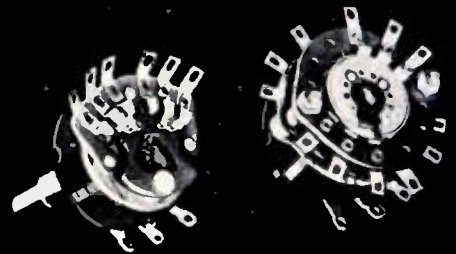

**3** Combination control and selector switches.

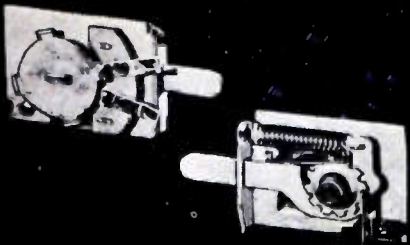

**4** Front and rear view—push button type tone switch.

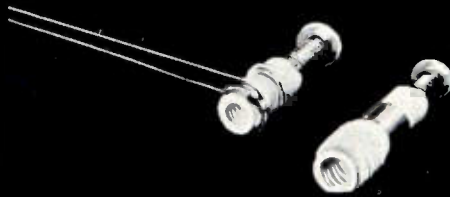

**5** Left — dual TV Trimmer. Right — TV trimmer combined with ceramic coil form.

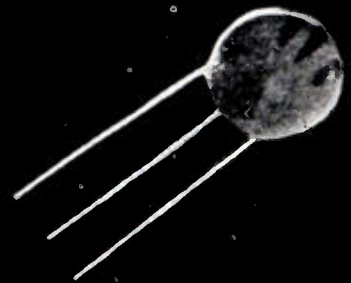

**6** 5000V dual disc ceramic capacitor. Actual size, slightly larger than a nickel.



**7** Special tubular ceramic capacitor — 2200 MMF  $\pm$  1%.



**8** Control with offset shaft and operating gears.

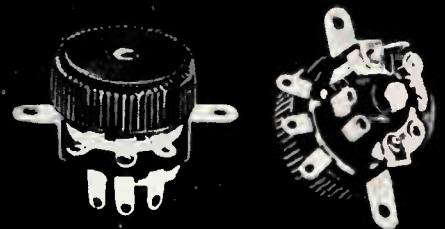

**9** Front and rear view — Centralab's miniature (smaller than a dime!) Dual Model 1 Control.



# Special Electronic Parts?

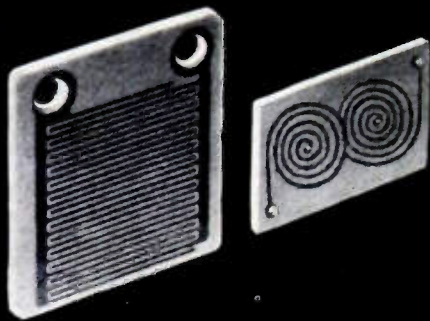

**10** Examples of special "printed circuit" parts. Left — a fixed value capacitor. Right — an inductance coil.

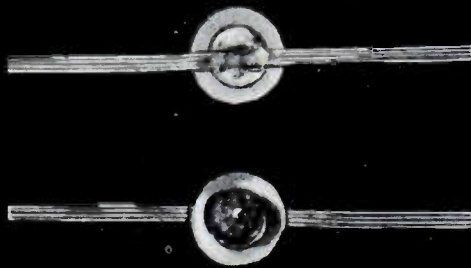

**11** Front and rear view — special type by-pass capacitor.

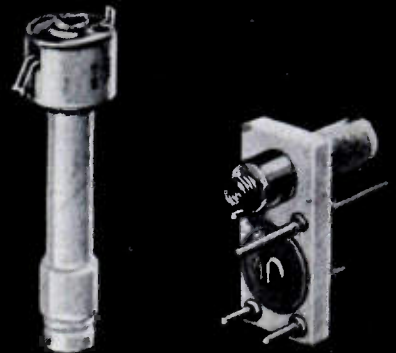

**12** Special ceramic coil form and trimmer assembly.



**13** Steatite ceramic coil form with bonded metal end.



**14** Centralab Steatite ceramic used in special forms — coils etc.

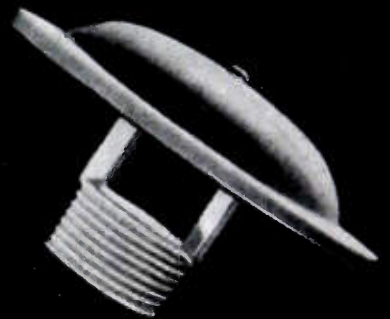

**15** CRL Steatite used as part of diffusion system in hot water heater.



**16** Special feed-thru by-pass capacitor.

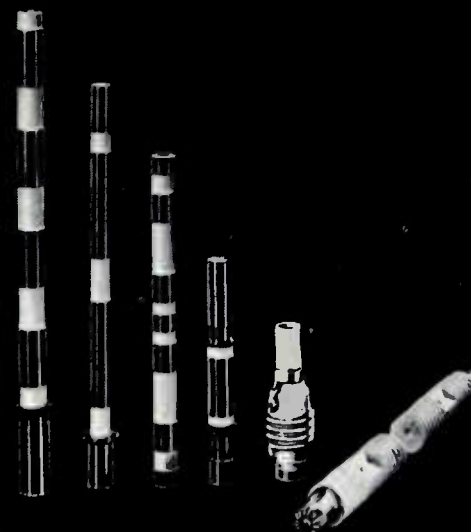

**18** Metallized ceramic rods for rotor sections in hi-voltage variable transmitter capacitors, and resonant lines.

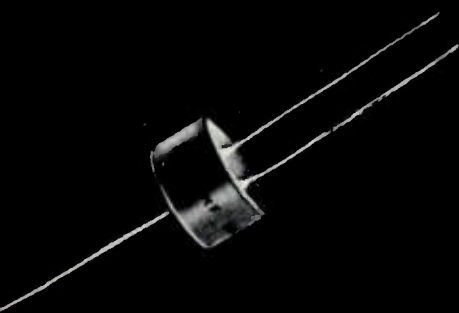

**17** Special 5-10 KV hi-voltage capacitor.

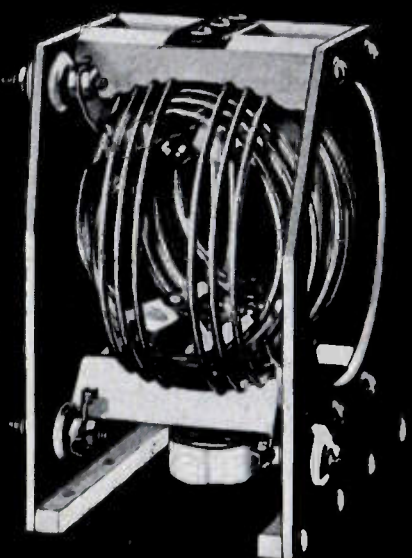

**19** Special antenna loading variometer.

# IMPORTANT BULLETINS FOR YOUR TECHNICAL LIBRARY!

*They're factual!*



**THEY'RE FREE!**

## Choose From This List!

### Centralab Printed Electronic Circuits

- 973 — AMPEC — three-tube P. E. C. amplifier.
- 42-6 — COUPLATE — P. E. C. interstage coupling plate.
- 42-22 — VERTICAL INTEGRATOR — for TV application.
- 42-24 — CERAMIC PLATE COMPONENTS — for use in low-power miniature electronic equipment.
- 42-27 — MODEL 2 COUPLATE — for small or portable set applications.
- 999 — PENTODE COUPLATE — specialized P. E. C. coupling plate.
- 42-9 — FILPEC — Printed Electronic Circuit filter.

### Centralab Capacitors

- 42-3 — BC TUBULAR HI-KAPS — capacitors for use where temperature compensation is unimportant.
- 42-4 — BC DISC HI-KAPS — miniature ceramic BC capacitors.
- 42-10 — HI-VO-KAPS — high voltage capacitors for TV application.
- 695 — CERAMIC TRIMMERS — CRL trimmer catalog.
- 981 — HI-VO-KAPS — capacitors for TV application. For jobbers.

- 42-18 — TC CAPACITORS — temperature compensating capacitors.
- 814 — CAPACITORS — high-voltage capacitors.
- 975 — FT HI-KAPS — feed-thru capacitors.

### Centralab Switches

- 953 — SLIDE SWITCH — applies to AM and FM switching circuits.
- 970 — LEVER SWITCH — shows indexing combinations.
- 995 — ROTARY SWITCH — schematic application diagrams.
- 722 — SWITCH CATALOG — facts on CRL's complete line of switches.

### Centralab Controls

- 42-19 — MODEL "1" RADIOHM — world's smallest commercially produced control.
- 42-85 — MODEL "2" RADIOHM — Radio and TV controls.

### Centralab Ceramics

- 967 — CERAMIC CAPACITOR DIELECTRIC MATERIALS.
- 720 — CERAMIC CATALOG—CRL steatite, ceramic products.

**Look to CENTRALAB in 1950!** First in component research that means lower costs for the electronic industry. If you're planning new equipment, let Centralab's sales and engineering service work with you. For complete information on all CRL products, get in touch with your Centralab Representative. Or write direct.

CENTRALAB  
Division of Globe-Union Inc.  
900 East Keefe Avenue, Milwaukee, Wisconsin

Yes—I would like to have the CRL bulletins, checked below, for my technical library!

- |                                |                                |                               |                                |                                |                              |                                |
|--------------------------------|--------------------------------|-------------------------------|--------------------------------|--------------------------------|------------------------------|--------------------------------|
| <input type="checkbox"/> 973   | <input type="checkbox"/> 42-24 | <input type="checkbox"/> 42-9 | <input type="checkbox"/> 42-10 | <input type="checkbox"/> 42-18 | <input type="checkbox"/> 953 | <input type="checkbox"/> 722   |
| <input type="checkbox"/> 42-6  | <input type="checkbox"/> 42-27 | <input type="checkbox"/> 42-3 | <input type="checkbox"/> 42-85 | <input type="checkbox"/> 814   | <input type="checkbox"/> 970 | <input type="checkbox"/> 42-19 |
| <input type="checkbox"/> 42-22 | <input type="checkbox"/> 999   | <input type="checkbox"/> 42-4 | <input type="checkbox"/> 695   | <input type="checkbox"/> 975   | <input type="checkbox"/> 995 | <input type="checkbox"/> 967   |
|                                |                                | <input type="checkbox"/> 981  |                                |                                |                              | <input type="checkbox"/> 720   |

Name.....

Address.....

City..... State.....

**TEAR OUT COUPON**

for the Bulletins you want

**Centralab**  
CRL

Division of GLOBE-UNION INC. • Milwaukee



#### AKRON

"Submarine Cable," by Earl Wilson, Captain, United States Army Submarine Service; "Motor Control," by Edward Romito, Student; January 10, 1950.

"Electronic Musical Instruments," by A. F. Knoblauch, The Baldwin Company; February 21, 1950.

#### ATLANTA

"High-Speed Distributed Amplifiers," by W. R. Hewlett, Hewlett-Packard Company; February 28, 1950.

#### BALTIMORE

"Characteristics of Airport Traffic Control Radar," by S. F. Clark, Civil Aeronautics Administration; March 15, 1950.

#### BEAUMONT-PORT ARTHUR

"A New Electronic Audio-Sweep-Frequency Generator," by Hershel Toomim, Toomim Laboratories; February 23, 1950.

#### CEDAR RAPIDS

"The Editorial Policy of The Institute of Radio Engineers," an Open Forum; February 15, 1950.

#### CHICAGO

"Some New Developments in the Field of Sound Reproduction," by H. F. Olson, RCA Laboratories; "Development and Application of the Short 16-Inch Metal Kinescope," by L. E. Swedlund, Radio Corporation of America; February 17, 1950.

#### COLUMBUS

"Television Broadcast Antennas," by R. W. Masters, Antenna Laboratory, Ohio State University; January 11, 1950.

"Radio in Astronomy," by C. E. Hesthal, Faculty, Ohio State University; February 22, 1950.

#### DALLAS-FORT WORTH

"Focusing Sound Waves with Microwave Lenses," by W. E. Kock, Bell Telephone Laboratory; February 23, 1950.

#### DAYTON

"The Atomic Clock," by Harold Lyons, National Bureau of Standards; "Recent Developments in Mass Spectrography," by J. A. Hipple, National Bureau of Standards; March 2, 1950.

#### DETROIT

"Multiple Voice Superhighways by Carrier Waves," by J. O. Perrine, American Telephone and Telegraph Company; February 15, 1950.

#### LONDON

"Noise and Noise Measurement at VHF," by O. Marshall, Student, University of Western Ontario; "Odd Resonance Effects," by J. Lekken, Student, University of Western Ontario; "The Pentriode Amplifier," D. Grant, Student, University of Western Ontario; February 13, 1950.

#### LOS ANGELES

"Patents," by F. E. Mauritz, Lyon and Lyon Law Firm; "Latest Developments in Radio Interference Elimination," by R. R. Stoddart, Stoddart Aircraft Radio Company; March 7, 1950.

#### NEW MEXICO

"Television Antennas and Transmission Lines," by R. M. Krueger; February 24, 1950.

#### NORTH CAROLINA-VIRGINIA

"Mechanical Filters for Radio-Frequency—Theoretical Considerations," by W. V. B. Roberts, RCA Laboratories; "Mechanical Filters for Radio-Frequency-Experimental Units," by L. L. Burns, RCA Laboratories; January 13, 1950.

(Continued on page 38A)

HOW TO *Solve* YOUR CARTRIDGE PROBLEMS *Easily!*

# Check the features!

TO GET **EVERYTHING** YOU WANT

## Specify **E-V** Torque Drive\*

**FREQUENCY RESPONSE** tailored to the requirements of your system. Clean, wide range . . . roll-off . . . or cut-off characteristics . . . to your specifications.

**OUTPUT VOLTAGE** sufficient for full power output *without* sacrificing desired compliance.

**LATERAL COMPLIANCE** for excellent low frequency tracking at 5-6 grams force.

**VERTICAL COMPLIANCE** to minimize record and tip wear.

**RUMBLE PICK-UP** audibly suppressed without alteration of frequency response characteristics.

**MOISTURE PROTECTION** from high humidity at no extra cost.

**PERFORMANCE DEPENDABILITY** to assure stable response despite temperature change.

**MINIMUM TRACKING FORCE.** Guaranteed tracking throughout the frequency spectrum at only 5-6 grams force.

**STYLUS QUALITY.** Long wearing, precision ground tips for high fidelity reproduction and minimum record wear.

**UNIFORMITY IN PRODUCTION.** Precise conformity to laboratory established specifications in quantity production.

**DUAL STYLUS SET-DOWN.** Precise set-down unaltered by stylus replacement.

**E-V Torque Drive** cartridges, resonated only by crystal stiffness and low mass driving system, offer wide range, peak-free response. The system can be mechanically tuned to obtain any curve desired.

By mechanical step-up, stylus force is multiplied 20 times in the Torque Drive system, producing a high voltage output to compliance ratio.

Lateral compliance exceeds unity in E-V cartridges because bearings, bushings and other types of friction are eliminated.

The absence of bearing rigidity makes Torque Drive a vertically compliant drive system.

Torque Drive cartridges respond only to lateral tip motions and cancel output of vertical motions.

All E-V cartridges are moisture inhibited for longer trouble-free life by a special coating of silicone . . . at the cost of ordinary weather sealing.

The response of E-V cartridges depends only on a mechanical drive system which does not employ temperature sensitive pads or damping materials.

E-V cartridges track well at 5 grams force because of high lateral compliance and clean, wide range response.

Accurate inspection, exacting tests and highest quality materials assure superior performance from each E-V single-tip or dual-tip stylus.

The performance of Torque Drive cartridges depends only on a simple harness system and crystal; not on a multitude of minute parts.

The E-V in-line, dual tipped stylus admits no set-down variation.

\*Pat. Pend.

• Only E-V Torque Drive gives you *all* these features. Available in single-stylus or dual-stylus types . . . for 33 $\frac{1}{3}$ , 45 and 78 rpm single-speed or multi-speed record players. E-V engineers and full facilities are at your service.

# Electro-Voice

PHONO PICKUPS • MICROPHONES

ELECTRO-VOICE, INC. 403 CARROLL ST., BUCHANAN, MICHIGAN

Export: 13 East 40th Street, New York 16, N.Y. U.S.A., Cables: Arlab

# you get MORE PERFORMANCE for LESS MONEY with the NEW Browning OSCILLOSYNCHROSCOPE



For only  
**\$485.00**

this new five-inch Browning 'scope gives you the basic laboratory equipment for pulse work — in a single, compact unit with:

- Triggered sweep rate continuously variable from 1.0 to 25,000 microseconds per inch.
- Sawtooth sweep rate 10 cycles to 100 KC.
- Sweep calibration (triggered and sawtooth) in microseconds per screen division accurate to  $\pm 10\%$ .
- Vertical amplifier flat within 3 db. from 5 cycles to 5 megacycles.
- Sensitivity 0.075 volts RMS per inch.
- Horizontal amplifier d.c. to 500 KC, sensitivity 2 volts per inch.
- Self-calibrating on both X and Y axis.
- Readily portable . . . weighs but 50 pounds.

## plus these ELECTRICAL and MECHANICAL features

- 5UP1 cathode-ray tube operates at accelerating potential of 2600 volts
- Sweep starting time is approximately 0.1 microsecond
- Sweep may be triggered or synchronized by positive or negative sine-wave or pulse signals of 0.5 volts (external) or 0.75 inches deflection (from vertical amplifier)
- Three-step attenuator — 100:1, 10:1, and 1:1, plus continuous adjustability over entire range
- Peak-to-peak vertical calibration voltages of 0.2-20-200 at accuracy of  $\pm 10\%$
- Cathode connection, brought out to front panel, allows external blanking and marker connection
- All deflection plates are available for direct connection
- Steel cabinet finished in black wrinkle
- Steel panel finished in black leatherette
- Copper-plated steel chassis with lacquer finish
- Controls grouped by function for operating convenience
- Free-view screen has graduated X- and Y-axis scales
- Size: 10" wide, 14½" high, 16¾" deep
- Instrument draws 180 volt-amperes at 115 volts 60 cycles.

NET PRICE, F.O.B. Winchester, Mass.....\$485.00

**FREE BULLETIN** gives further data on this new, low-cost, versatile oscillosynchroscope. Ask for data sheet ON-54R.

In Canada, address Measurement Engineering Ltd., Arnprior, Ontario

Export Sales  
9 Rockefeller Plaza  
Room 1422  
New York 20



**BROWNING**  
Laboratories, Inc.  
Winchester, Mass.  
ENGINEERED FOR ENGINEERS



(Continued from page 37A)

"Measurements of Nonlinearity in Audio Systems," by W. R. Hewlett, Hewlett-Packard Company; March 3, 1950.

#### OMAHA-LINCOLN

"Omnidirectional Radio Range, Equipment, and Utilization," by John Biggs, Collins Radio Range; Election of Officers; January 16, 1950.

#### OTTAWA

"Recent Developments in Vacuum Tubes," by P. A. Redhead, National Research Council; February 16, 1950.

#### PHILADELPHIA

"Interlaced Dot Systems of Monochrome and Color Television," by W. P. Boothroyd, Philco Corporation; November 3, 1949.

"What Price Bandwidth," by W. R. Bennett, Bell Telephone Laboratories; December 1, 1949.

"Application of Sound Portrayal Techniques," by R. K. Potter, Bell Telephone Laboratories; January 5, 1950.

"What's Troubling the Television Industry," by D. B. Smith, Philco Corporation; February 1, 1950.

"Railroad Communications," by L. J. Prendergast, Baltimore and Ohio Railroad; March 2, 1950.

#### PITTSBURGH

"Electronic Instruments Designed for Analytical Application," by E. R. Millen, Fisher Scientific Company; March 13, 1950.

#### ROCHESTER

"Streamlining Railroad Radio," by A. V. Daburg, Robert Haner, and J. C. O'Brien, General Railway Signal Company; February 16, 1950.

#### SAN ANTONIO

"The Weaver-Bray Experiment (Auditory Masking)," by J. Tonndorf, Randolph Field; "Electro-Encephalography," by Jonathan Prast, Randolph Field; Business Meeting; March 2, 1950.

#### SAN FRANCISCO

"Techniques in Antenna Impedance and Pattern Measurement at UHF," by J. T. Bolljahn, Stanford Research Institute, and J. H. Friedigkeit, University of California Antenna Laboratory; February 15, 1950.

"New Developments in Microwave Resonators," by D. H. Sloan, Faculty, University of California; March 8, 1950.

#### SEATTLE

"Velocity of Light by the Resonant Cavity Method," by W. J. Barclay, Faculty, Oregon State College; February 17, 1950.

#### ST. LOUIS

"Microphones and Intermodulation," by J. K. Hilliard, Altec Lansing Corporation; February 23, 1950.

#### TOLEDO

"Electronic Generation of Musical Tones and Organ Concert," by J. F. Jordan, Baldwin Piano Company; March 20, 1950.

#### TORONTO

"Studio Television Equipment," by H. B. Fancher, General Electric Company; October 24, 1949.

"Report on Television," by J. A. Ouimet, Canadian Broadcasting Corporation; November 21, 1949.

"High-Quality Audio Amplifier," by F. H. McIntosh, McIntosh Engineering Laboratories, Inc.; December 12, 1949.

(Continued on page 39A)



(Continued from page 38A)

"Printed Circuits," by J. Marsten, International Resistance Company; January 16, 1950.

"The Image Orthicon Television Camera," by N. S. Bean, Radio Corporation of America; January 30, 1950.

Student Night; February 13, 1950.

"Multi-Voice Superhighways by Carrier Waves," by J. O. Perrine, American Telephone and Telegraph Company; February 27, 1950.

#### WILLIAMSPORT

"Transformer Measurements and Performance," by Reuben Lee, Westinghouse Electric Corporation; March 1, 1950.

#### SUBSECTION MEETINGS

##### CENTRE COUNTY

"Microwave Astronomy," by C. R. Burrowes, Faculty, Cornell University; December 19, 1949.

"Precision Computing Potentiometers," by Paul Caseman, Student, Pennsylvania State College; "Transistors," by William Shaw, Student, Pennsylvania State College; "Oblique Incidence Measurements of Ionosphere Height," by William Falrer; January 10, 1950.

"Garfield Thomas Water Tunnel," by R. B. Power and J. M. Robertson, Faculty, Pennsylvania State College; January 17, 1950.

"Precision Watch Rate Meter," by H. F. Wischnia, Faculty, Pennsylvania State College; "Microphonism in High-Vacuum Triodes," by J. A. Wenzel, Faculty, Pennsylvania State College; February 21, 1950.

##### HAMILTON

"Practical Aspects of Television Antennae," by Arthur Ainlay, Canadian Westinghouse Company, Ltd.; September 19, 1949.

"Some Aspects of Radio Component Design," by G. M. Cox, Marsland Engineering Company; October 17, 1949.

"Electronics Applied to Medicine," by S. J. Albin, Avonde and Albin Clinic; November 14, 1949.

"Projection Television," by R. H. Childerhose, Rogers Majestic, Ltd.; December 5, 1949.

"Ramblings on Loud speaker Design," by C. E. Hoekstra, Magnavox Company; January 16, 1950.

"Television Front Ends," by F. Edwards, Standard Coil Products; February 13, 1950.

##### LANCASTER

"The Ripple-Tank an Aid to Phase Front Visualization," by H. A. Schooley, Naval Research Laboratory; November 9, 1949.

"Some New Developments in the Field of Sound Reproduction," by H. F. Olson, RCA Laboratories; January 11, 1950.

"Radio-Frequency Radiation from the Sun," by J. P. Hagen, Naval Research Laboratory; February 8, 1950.

##### LONG ISLAND

"Television—Why the Deep Freeze?" by S. L. Bailey, Jansky and Bailey; March 15, 1950.

##### MONMOUTH

"Dot Systems of Color Television," by W. P. Boothroyd; February 15, 1950.

##### NORTHERN NEW JERSEY

"Storage Tubes," by L. E. Flory, RCA Laboratories; "AGC and AFC as Feedback Problems," by W. L. Mraz, Bell Telephone Laboratories; February 8, 1950.

**NOW THERE'S A *Magnecorder*  
FOR EVERY TAPE RECORDING NEED**

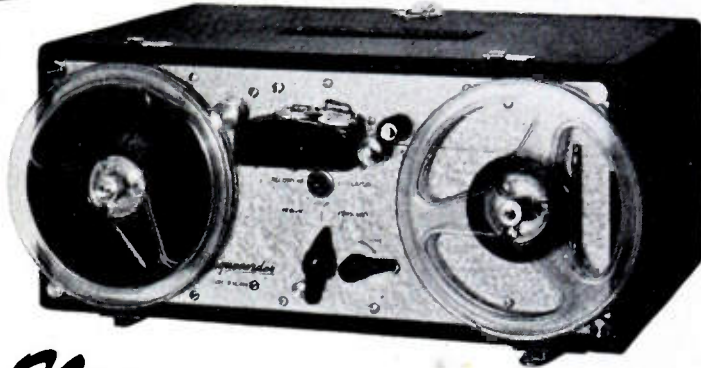

*New*

**PT63-A OFFERS 3 HEADS**

**Monitor from the tape!**

A new professional tape recorder with three separate heads: erase, record, playback for monitoring from the tape. This PT63-A Magnecorder incorporates all other fine features of the PT6-A. The new PT63-J Amplifier for single microphone recording includes separate playback amplifier.

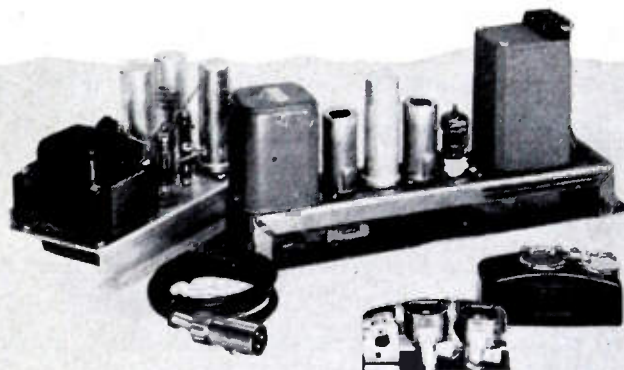

*New* **THREE HEADS AND AMPLIFIER KIT**  
**Converts Your PT6-A To Monitor From Tape**

Complete conversion kit includes new three-head unit, additional monitor amplifier and power supply. Three-head unit simply plugs into receptacle for present two heads on your PT6-A Magnecorder.

#### SPECIFICATIONS JUST RELEASED

Write for detailed information on these latest Magnecorder developments.

SEE THE NEW PT7  
CONSOLE, PORTABLE,  
RACK-MOUNT



**Magnecord, INC., CHICAGO 1, ILLINOIS**  
360 NORTH MICHIGAN AVENUE

World's Largest and Oldest Manufacturers of Professional Magnetic Recorders

# B&W

## Coil Manufact

- Single layer solenoid coils
- Universal wound coils of single, multiple pie, and progressive construction
- RF, IF, and Oscillator Coils
- Traps, Discriminators, Filters, RF and Delay Line Chokes

These are but a few of the many types of coils designed and built by B&W to answer your specific needs.

Whether your problems concern research, design, development, or production . . . in electronics, television, radio broadcasting, or radio communications . . . for long or short production runs—to exacting commercial or military specifications—you'll find the complete facilities of B&W able to answer your coil problems.

For detailed information on coils that are recognized the world over for their consistent dependability, write today to B&W, Dept. PR-50.

*\*Manufacts=manufacturing facts*

# BARKER & WILLIAMSON, Inc.

237 Fairfield Avenue

Upper Darby, Pa.

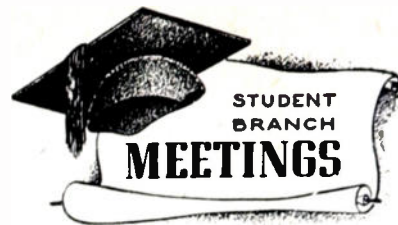

ALABAMA POLYTECHNIC INSTITUTE,  
IRE BRANCH  
Election of Officers; February 13, 1950.

UNIVERSITY OF ALBERTA, IRE BRANCH  
"Recording, Reproduction of Radio Stations,"  
by A. MacDonald, Canadian Broadcasting Corp.;  
February 7, 1950.

CASE INSTITUTE OF TECHNOLOGY,  
IRE BRANCH  
Election of Officers; January 11, 1950.  
"High Current Generator," by Robert Strough,  
Graduate Student, Case Institute of Technology;  
February 21, 1950.

UNIVERSITY OF COLORADO, IRE-AIEE BRANCH  
Films: "Laying Okonite Power Cable Across  
Puget Sound," and "Mining of Copper in Arizona";  
February 22, 1950.

COLUMBIA UNIVERSITY, IRE-AIEE BRANCH  
"What's Ahead in Engineering Employment,"  
by Robert Moore, Director, Columbia University  
Placement Bureau; November 4, 1949.

"General Theory and Future Possibilities of the  
Transistor," by Dr. Hansen, Bell Telephone Labora-  
tories; December 9, 1949.

"Professional Engineer's Examination," by Mr.  
Bisson and C. N. Metcalf, New York State Society  
of Professional Engineers; March 9, 1950.

CORNELL UNIVERSITY, IRE-AIEE BRANCH  
"Registration of Professional Engineers," by  
William Perry, New York Gas and Electric Corpora-  
tion; AIEE Student Paper Contest; March 18, 1950.

UNIVERSITY OF DELAWARE, IRE-AIEE BRANCH  
"Mighty Mites," by Ed Hild, Diamond State  
Telephone Company; January 12, 1950.  
Panel Discussion, by J. Clark, Delaware Power  
and Light Company; E. Palmer, Delaware Rayon  
Company; C. Andersen, General Electric Company;  
and R. Aydelotte, National Vulcanite Fibre, Inc.;  
February 16, 1950.

"Illumination," by Walter Sturrock, General  
Electric Company, and E. F. Lafond, Delaware  
Power and Light Company; March 9, 1950.

UNIVERSITY OF DETROIT, IRE BRANCH  
"Computers' Analog," by A. F. Martz, Holley  
Carburetor Company; October 4, 1949.

"Graduate Studies," by T. Yamauchi, In-  
structor, University of Detroit; October 25, 1949.

"Interference Problems in Auto Radios," by F.  
B. Latham, Ford Motor Company; January 18,  
1950.

Presentation of Technical Papers by Students;  
February 27, 1950.

FENN COLLEGE, IRE BRANCH  
"Taylor Super Modulation Principle," by R.  
W. Gott, Student, Fenn College; February 17, 1950.

UNIVERSITY OF FLORIDA, IRE-AIEE BRANCH  
"Electronics at Bikini," by W. E. Lear,  
Faculty, University of Florida; February 21, 1950.

GEORGE WASHINGTON UNIVERSITY, IRE BRANCH  
"Piezoelectric Crystals," by P. L. Smith, Naval  
Research Laboratory; March 1, 1950.

(Continued on page 41A)

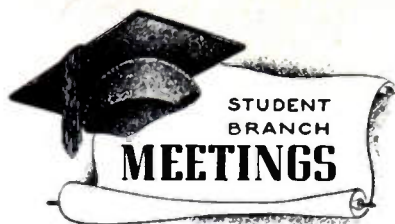

(Continued from page 40A)

GEORGIA INSTITUTE OF TECHNOLOGY,  
IRE BRANCH

"AC Network Calculator and Electronic Wave Synthesizer," by A. W. Bockelheide and George Hawthorne, AIEE Student members, March 2, 1950.

ILLINOIS INSTITUTE OF TECHNOLOGY,  
IRE BRANCH

"Electrical Measurement of Nonelectrical Quantities," by E. H. Schulz, Armour Research Foundation; March 1, 1950.

UNIVERSITY OF ILLINOIS, IRE-AIEE BRANCH

"The Magnetic Amplifier," by E. L. Harder, Westinghouse Electric Corporation; February 21, 1950.

STATE UNIVERSITY OF IOWA, IRE BRANCH

Business Meeting; February 22, 1950.

"You and Your Opportunities," by T. A. Boyd, General Motors Corporation; March 1, 1950.

"A Square Peg in a Square Hole," by E. B. Kurtz, Faculty, State University of Iowa; March 8, 1950.

"The Professional Engineering Examination," by C. M. Stanley, Stanley Engineering Corporation; March 15, 1950.

IOWA STATE COLLEGE, IRE-AIEE BRANCH

Tour through Northwestern Bell Telephone Company's Building; February 22, 1950.

"Television and Radio Relay," by Frank Baird, Northwestern Bell Telephone Company; March 1, 1950.

JOHN CARROLL UNIVERSITY, IRE BRANCH

"Television Networks in Communications," by O. Henderson, Bell Telephone Company; February 21, 1950.

LAFAYETTE COLLEGE, IRE-AIEE BRANCH

"Electronic Digital Computers," by R. A. Kudlich, Student, Lafayette College; February 28, 1950.

UNIVERSITY OF LOUISVILLE, IRE BRANCH

Films: "Frequency Modulation" and "Radar"; February 23, 1950.

MANHATTAN COLLEGE, IRE BRANCH

"The Job Interview," by J. T. Houlihan, Radio Corporation of America; February 20, 1950.

MARQUETTE UNIVERSITY, IRE-AIEE BRANCH

Tour through General Motors Electro-Motive Division; March 16, 1950.

"Audio Tone Controls," by A. F. Petrie; January 23, 1950.

Tour through Cutler-Hammer Plant; January 27, 1950.

Tour through Miller Brewery; Movie; February 16, 1950.

"Printed Circuits and Their Applications," by W. C. Fischer, Centralab, Division of Globe-Union, Inc.; February 17, 1950.

Business Meeting; February 23, 1950.

UNIVERSITY OF MICHIGAN, IRE-AIEE BRANCH

"Magnetic Amplifiers," by W. D. Cockrell, General Electric Company; February 21, 1950.

"Making a Success of Your Job," by R. J. Morrison, Peerless Cement Company; March 8, 1950.

(Continued on page 42A)

## electronic voltage regulators

# by sorensen

MAXIMUM ACCURACY

MINIMUM DISTORTION • FREQUENCY INSENSITIVITY



### Standard AC:

| MODEL IN VA CAPACITY                        | 1505<br>5005   | 2505<br>10005 | 2,0005<br>3,0005 | 5,0005<br>10,0005<br>15,0005 |
|---|--|---------------|------------------|------------------------------|
| Harmonic Distortion                         | 3% max.  | 2% max.       | 3% max.          | 3% max.                      |
| Regulation Accuracy                         | ±0.1% against line or load   |               |                  |                              |
| Input Voltage                               | 95-130 VAC; also available for 190-260 VAC Single Phase 50-60 cycles |               |                  |                              |
| Output Voltage                              | Adjustable between 110-120; 220-240 in 230 VAC models.               |               |                  |                              |
| Load Range                                  | 0 to full load   |               |                  |                              |
| P. F. Range                                 | Down to 0.7 P. F. All models temperature compensated.                |               |                  |                              |
| NOTE: REGULATORS CAN BE HERMETICALLY SEALED |  |               |                  |                              |

### Standard DC:

| *Output Voltage   | 6  | 12      | 28      | 48 | 125  |
|---|--|---------|---------|----|------|
| **Load in Amperes   | 5-15-40-100  | 5-15-50 | 5-10-30 | 15 | 5-10 |
| Input Voltage   | 95-130 VAC single phase 50-60 cycles; adapter available for 230 VAC operation.                                     |         |         |    |      |
| Regulation Accuracy   | 0.2% from 0.1 to full load   |         |         |    |      |
| Ripple Voltage RMS Maximum  | 1%.  |         |         |    |      |
| Recovery Time   | 0.2 seconds-value includes charging time of filter circuit for the most severe change in load or input conditions. |         |         |    |      |
| *Adjustable + 10% -25%.   |  |         |         |    |      |
| **Individual models identified by indicating output voltage first then amperes.<br>Example: E-6-5 = 6 VDC @ 5 amperes |  |         |         |    |      |

**SPECIALS** Your particular requirements can be met by employing the ORIGINAL SORENSEN CIRCUIT in your product or application. SORENSEN REGULATORS can be designed to meet JAN specifications. SORENSEN engineers are always available for consultation about unusual regulators to meet special needs not handled by THE STANDARD SORENSEN LINE.

Write for complete literature

**Sorensen** and company, inc.

375 Fairfield Ave., Stamford, Connecticut

# CP SWITCHES

**- in Fine  
Instruments  
too!**

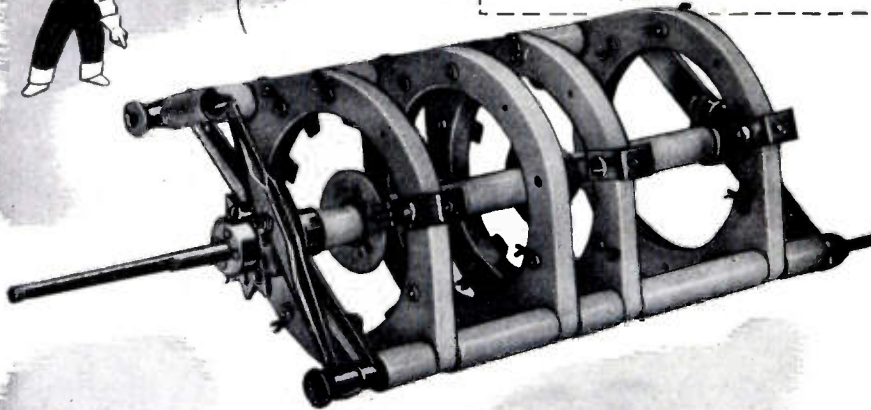

CP switches are found in fine instruments such as the new Model 184C Insulation Tester produced by Radio Frequency Laboratories, Inc. of Boonton, New Jersey. In apparatus of this type, switching equipment must be mechanically sound and long-lasting. It must meet top standards of electrical performance. It must match the high order of technical excellence reflected in the apparatus of which it is an integral part.

All these requirements are fully met by CP switches. CP switches are solidly built of best materials around designs which have been tried and tested over the years. Constructed of inorganic dielectrics having moisture "sealed out", CP switches are electrically stable.

They are reasonably priced and available in a wide range of types and sizes. For full particulars, write for catalog.

COAXIAL DIPOLE ANTENNAS  
TOWER HARDWARE  
Q-MAX LACQUER  
TEFLON TRANSMISSION LINE  
AUTO-DRY AIRE DEHYDRATORS  
LO-LOSS SWITCHES

*Communication Products Company, Inc.*

KEYPORT  NEW JERSEY

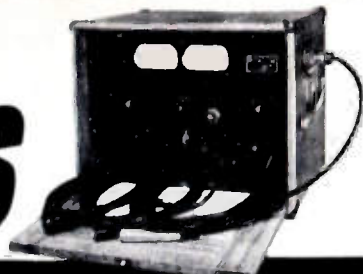

INSULATION TESTER produced by Radio Frequency Laboratories, Inc. of Boonton, New Jersey uses CP switch for flexibility of control and precision measurement.

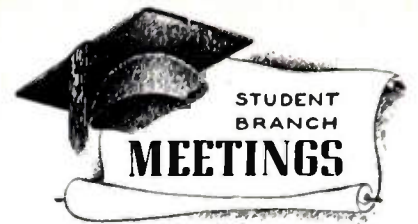
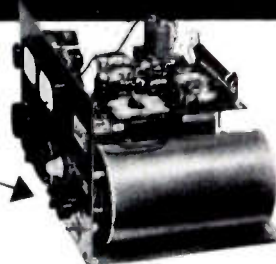

(Continued from page 41A)

"Electronic Equipment and Circuits in Cosmic Ray Research," by W. A. Nierenberg, Faculty, University of Michigan; March 17, 1950.

MISSOURI SCHOOL OF MINES AND METALLURGY.  
IRE-AIEE BRANCH

"Engineering Opportunities in Acoustics," by C. E. Harrison, Technionic Recording Laboratories; February 9, 1950.

Films: "The Banshee" and "Radio-Frequency Heating"; Business Meeting; February 23, 1950.

"Selection of Conductors for Rural Distribution," by D. J. Freeman, "Critical Cable Lengths for Synchronous Machines," by R. D. Ball, "Possibilities of DC Power Transmission," by G. J. Boje, "Ground Resistance," by C. L. Maesa, Undergraduate Students, Missouri School of Mines and Metallurgy; March 7, 1950.

UNIVERSITY OF NEBRASKA, IRE-AIEE BRANCH

"Organization of the AIEE," by W. C. DuVall, Faculty, University of Colorado; Business Meeting; March 15, 1950.

COLLEGE OF THE CITY OF NEW YORK  
IRE BRANCH

Election of Officers; February 16, 1950.

NEW YORK UNIVERSITY, IRE BRANCH

Films: "X-Ray" and "Quartz Springs"; March 3, 1950.

NORTH CAROLINA STATE COLLEGE,  
IRE BRANCH

Election of Officers; February 22, 1950.

UNIVERSITY OF NOTRE DAME, IRE-AIEE BRANCH

Films: "Quicker Than a Wink" and "Seeing the Unseen" and "The Stroboscope," by Kipling Adams, General Radio Company; February 24, 1950.

Tour through United States Rubber Company's Plant; March 8, 1950.

Tour through Studebaker Corporation's Plant; March 14, 1950.

OHIO STATE UNIVERSITY, IRE-AIEE BRANCH

Tour of Battelle Memorial Institute, conducted by Roger Merrill, Battelle Memorial Institute; February 22, 1950.

OREGON STATE COLLEGE, IRE BRANCH

"Background and Future of TV in the Portland Area," by H. C. Singleton, Radio Station KGW; February 22, 1950.

UNIVERSITY OF PENNSYLVANIA,  
IRE-AIEE BRANCH

Tour through Radio Corporation of America; February 17, 1950.

PENNSYLVANIA STATE COLLEGE,  
IRE-AIEE BRANCH

"Honing Pigeons," by H. L. Yeagley, Faculty, Pennsylvania State College; February 16, 1950.

PRATT INSTITUTE, IRE BRANCH

"Color Television," by G. E. Anner, Faculty, New York University; March 2, 1950.

PRINCETON UNIVERSITY, IRE-AIEE BRANCH

"Activities of an Electrical Engineering Graduate in an Electrical Manufacturing Company," by C. T. Pearce, Westinghouse Electric Company; February 8, 1950.

PURDUE UNIVERSITY, IRE BRANCH

"Scientific Calculators and Their Applications," by J. C. McPherson, International Business Machines; February 22, 1950.

Films: "Television" and "Electronics"; Business Meeting; March 1, 1950.

(Continued on page 43A)



## Student Branch Meetings

(Continued from page 42A)

### SAN JOSE STATE COLLEGE, IRE BRANCH

Film: "Naturally, It's FM"; February 17, 1950.  
"Magnetron Vacuum-Tube Manufacturing Processes," by C. V. Litten, Litten Industries; February 27, 1950.

### TUFTS COLLEGE, IRE-AIEE BRANCH

"Boston Dials Long Distance," by W. F. Potter, New England Telephone and Telegraph Company; March 1, 1950.

### WAYNE UNIVERSITY, IRE-AIEE BRANCH

"Professional Registration," by D. E. Trefry, State Board of Registration of Architects; Tour of Pfeiffer Brewing Company; February 9, 1950.



The following transfers and admissions were approved and will be effective as of May 1, 1950:

#### Transfer to Senior Member

Athey, S. W., 6 W. 95 St., New York 25, N. Y.  
Cervenka, F. J., 1809 G St., N. W., Washington, D. C.  
Cheng, D. K., Electrical Engineering Department, Syracuse University, E. Syracuse, N. Y.  
DeWeese, H. W., 109 Dartmouth St., Rockville Center, N. Y.  
Frias, D. E., Mendoza 223, Tucuman, Argentina  
Katz, L., 19 Ward St., Woburn, Mass.  
Loginow, S., 7113 Glenloch, Philadelphia 35, Pa.  
Muller, R. A., 112 Eastbourne Ave., Toronto, Ont., Canada  
Patten, S. F., Allen B. DuMont Laboratories, Inc., 750 Bloomfield Ave., Clifton, N. J.  
Ragsdale, H. W., 654 Cooleedge Ave., N. E., Atlanta, Ga.  
Senter, C. H., 214 N. Pine St., Albuquerque, N. Mex.  
Summerford, D. C., 3037 Wirth Ave., Louisville 13, Ky.  
Sundt, E. V., 4757 N. Ravenswood Ave., Chicago, Ill.  
Ulrich, V. K., 144 Colon St., Beverly, Mass.  
Webber, H. E., Sperry Gyroscope Company, Inc., Great Neck, L. I., N. Y.

#### Admission to Senior Member

Arndt, W. F., 2433 Poli St., Ventura, Calif.  
McAuliffe, E. B., Assistant Superintendent, Telegraphs, Oudh Tirhut Railway, Gorakhpur, India  
Obert, M. J., 2249 Lexington Ave., N. Merchantville, N. J.  
Roeschke, C. W., 3032—33 Pl., Sandia Base Branch, Albuquerque, N. Mex.  
Stinson, R. C., Sr., 3020 Greene, Fort Worth 4, Tex.

#### Transfer to Member

Alexander, D. C., 3 Berkshire St., Worcester 2, Mass.  
Anderson, G. R., 6324 Allott Ave., Van Nuys, Calif.  
Ayer, W. E., 95 Hilltop Dr., San Carlos, Calif.  
Brittain, V. M., 4537 N. E. 12 Ave., Portland 11, Ore.  
Brooks, G. W., 18 Country Way, Greenbush, Mass.

(Continued on page 44A)

# There's a TIC Potentiometer for every application



for top electrical and mechanical precision

#### Type RV2 High Precision Potentiometer

One of a series of semi-standardized types of metal-base potentiometers with exceptionally high electrical accuracy and mechanical precision. For both linear and non-linear functions. Designed for precision instrument, computer and military applications. Accurate phasing of individual units possible with exclusive clamping method of ganging.

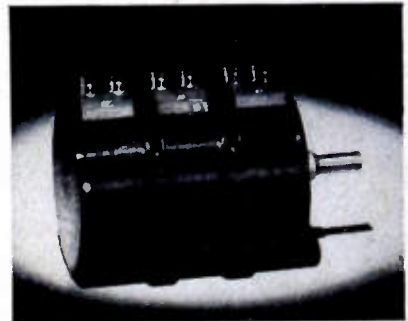

for precision and economy

Tapped mounting inserts  
Bronze bushing  
Totally enclosed with cover  
"Constrict-O-Grip" clamping to shaft  
(no set screws)  
Precious metal contacts  
Silver overlay on rotor take-off slip ring

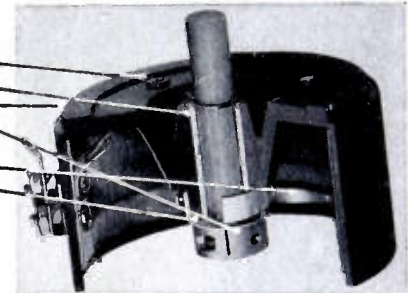

#### Type RV3 Precision Potentiometers

... available in models for either linear or non-linear functions with stock resistance values ranging from 100Ω to 200,000Ω and power ratings of 8 and 12 watts. 360° mechanical rotation or limited by stops as desired. Models with 5% total resistance accuracy — \$6.00 ... 1% accuracy — \$8.00. Special models available for high humidity applications.

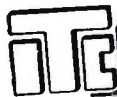

for special use ...

#### Type RVT Translatory Potentiometer

Actuated by longitudinal instead of rotating motion providing linear electrical output proportional to shaft displacement. Used as a position indicator, high amplitude displacement type pickup and for studying low frequency motion or vibration. Features exceptionally high linearity and resolution. Available in various lengths depending on amplitude being studied.

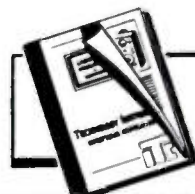
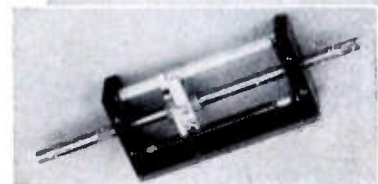
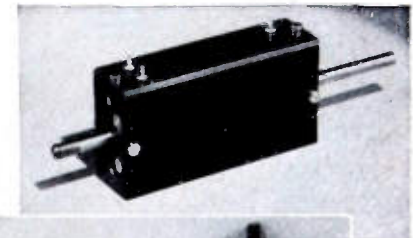

**Valuable catalog** — yours for the asking. Contains detailed information on all TIC Instruments, Potentiometers and other equipment. Get your copy without obligation — write today.



## TECHNOLOGY INSTRUMENT CORP.

1058 Main Street, Waltham 54, Massachusetts

Engineering Representatives  
Chicago, Ill.—Uptown 8-1141  
Dallas, Tex.—Logan 6-5097  
Cambridge, Mass.—Eliot 4-1751  
Cleveland, Ohio — Prospect 6171  
Rochester, N.Y.—Charlotte 3193-J  
Hollywood, Cal.—Hollywood 9-6305  
Canaan, Conn.—Canaan 649

# KENYON

## Fits Your

### Production To A "T"



**KENYON "T's"**—high quality, uniform transformers, are your best bet for development, production and experimental work. For over 20 years, the KENYON "K" has been a sign of skillful engineering, progressive design and sound construction.

Now—reduce inventory problems, improve deliveries, maintain your quality—specify KENYON "T's," the finest transformer line for all high quality equipment applications.

**New Catalog Edition! Write Today!**

**KENYON** new modified edition tells the complete story about specific ratings on all transformers. Our standard line saves you time and expense.

Send for your copy of our latest catalog edition now!

# KENYON

**TRANSFORMER CO., Inc.**  
840 BARRY STREET · NEW YORK 59, N. Y.



(Continued from page 43A)

- Brown, L. R., Patent Department, Bldg. 5-2, RCA, Camden, N. J.
- Earl, R. J., 26 Satellite Lane, Levittown, N. Y.
- Fessler, A. L., 326 W. Fairview Ave., Dayton 5, Ohio
- Hammond, J. G., 12 S. Bellegrove Rd., Baltimore 28, Md.
- Hines, M. E., Bell Telephone Laboratories, Inc., Murray Hill, N. J.
- Manning, D. C., 15732 Sorrento, Detroit 27, Mich.
- McClanahan, R. T., 8305 Toblas, Van Nuys, Calif.
- Michaels, E. L., 23 Thatcher Ave., River Forest, Ill.
- Quick, A. E., Jr., 80 Kingfisher Rd., Levittown, N. Y.
- Reich, P. J., 93 Featherbed Lane, New York 52, N. Y.
- Reid, J. G., Jr., 2929 Connecticut Ave., N. W., Washington, D. C.
- Schroder, R. D., 2201 Rose St., Berkeley 9, Calif.
- Stout, J. V., 4640 York Rd., Baltimore 12, Md.
- Ule, L. A., 4143 N. St. Louis Ave., Chicago 18, Ill.
- Wilton, V. A., 1644 Kenton Rd., Ferndale 20, Mich.
- Zadeh, L. A., 423 W. 120 St., New York 27, N. Y.

#### Admission to Member

- Albright, A. L., Box 433, 1524 Dean, Sulphur, La.
- Cull, R. R., 7580 Garfield Blvd., Cleveland 25, Ohio
- Dobkin, L., Box 1059, Haifa, Israel
- Hull, J. F., R.F.D. 2, Box 248A, Shark River Hills, Neptune, N. J.
- Kaufman, A. B., 1760 N. Wilcox Ave., Hollywood 28, Calif.
- Kerr, A., 17 Middle Green, W. Monkseaton, Whitley Bay, Northumberland, England
- Klink, E. J., 814 Laurel Cir., Albuquerque, N. Mex.
- LaPlant, O., 2117 Hughes Dr., Oxnard, Calif.
- Lowe, M. E., 52 Newman Rd., Malden 48, Mass.
- Lyon, R. S., Box 237, Denville, N. J.
- Masterson, H. T., 301 E. Cowan Dr., Houston 7, Tex.
- Nicholson, W. Q., 1217 S. Stanley Ave., Los Angeles 35, Calif.
- O'Halloran, J. F., 11858 Victory Blvd., N. Hollywood, Calif.
- Pearson, R. W., 927 Parry Ave., Palmyra, N. J.
- Pridmore, T. C., 103 Carmella Dr., McKeesport, Pa.
- Van Renaselaer, C., R.D. 1, Box 667, Los Altos, Calif.
- Wheeler, G. D., 3125 W. Monroe St., Chicago 12, Ill.
- Yeagley, F. W., 3203 Beverly Dr., Austin, Tex.
- Zobel, E. V., Manacor 1, Torre, Barcelona, Spain

The following elections to Associate grade were approved, and were effective as of April 1, 1950:

- Addison, W. G., 7639 Eastlake Terr., Chicago 26, Ill.
- Ahlgren, S. I., 1 Skillingrand, Stockholm, Sweden
- Allen, E. B., 3 Myrtle St., Belmont, Mass.
- Allen, J. A., 218 Mechanics St., Red Bank, N. J.
- Allison, J. B., 742 15 St., Honolulu, T. H.
- Anderson, J. W., 4035 Black Point Rd., Honolulu, T. H.
- Andrews, F. D., Box 133, Kaneohe, Oahu, T. H.
- Applewhite, V. C., Box 3372, Caracas, Venezuela
- Atlas, Z., 1071 Elder Ave., New York 59, N. Y.
- Balfour, A. J., 66B Karsten Dr., Wahiawa, Oahu, T. H.
- Ballard, A. H., 5102 41 Ave., Hyattsville, Md.
- Balletta, A. G., 347 S. Ninth Ave., Mt. Vernon, N. Y.
- Baker, J. H., 900 17 St., Honolulu, T. H.
- Barrick, W. E., R. D. 6, New Green River Rd., Evansville, Ind.

(Continued on page 45A)

## Completely new in every detail!

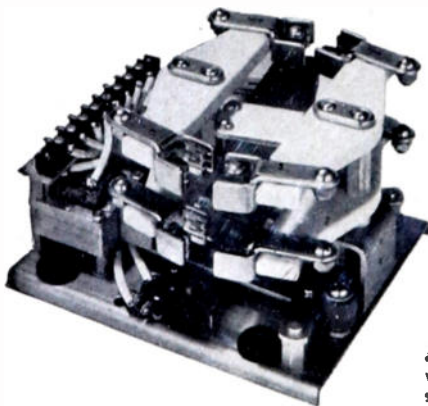

# JOHNSON RF CONTACTORS

Series 145-100  
145-200

Rugged and compact with fast, snappy action, these new JOHNSON contactors were designed primarily for high voltage RF switching and are suitable for many other applications. The toggle actuated balanced rotary armature permits mounting in any position.

Positive contact is maintained even under conditions of extremely heavy vibration. Entirely new wiping contacts, mounted on low-loss insulation, stay aligned.

These JOHNSON contactors are available in two sizes with voltage ratings of 17KV and 22KV peak. Current rating of both is 25 amperes per contact. Either contactor model is available with SPDT or DPDT contact arrangement with or without two auxiliary single pole switches. Solenoids are wired in series for 230 volt operation but may be connected in parallel for 115 volt operation. No holding current is required.

For complete description and prices write for the new "RF CONTACTOR" data sheet.



# JOHNSON ... a famous name in Radio

E. F. JOHNSON CO. WASECA, MINNESOTA

# EMSCO FREE-STANDING SQUARE RADIO TOWERS

Engineered for  
Maximum Safety  
Maintenance

Emsco square self-supporting towers are conservatively engineered according to RMA standards to provide for wind pressures up to 50 lbs.-per-sq.-ft. Several planes of torque bracing prevent twisting of towers. Square cross section with lacing of all four sides provides an extremely strong, rigid structure. Hot dip galvanizing insures long life, low maintenance and maximum electrical conductivity. Standard square self-supporting towers available in heights to 500 feet with 30, 40 or 50 lb. RMA design. Whether your tower requirements be 40' or 1000', there is an Emsco tower engineered for your needs. Write for new bulletin.

Shown here is on Emsco Type 2RT 120-foot 40" RMA design tower installed for South-western Bell Telephone Co. in Dallas, Texas. →

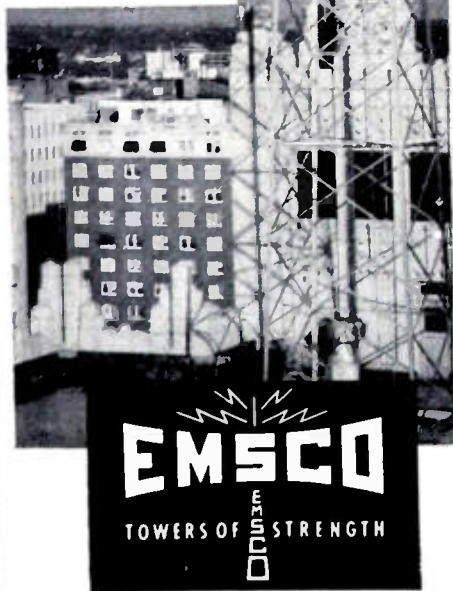

**EMSCO DERRICK & EQUIPMENT COMPANY**  
LOS ANGELES, CALIFORNIA  
Houston, Texas • Garland, Texas



(Continued from page 44A)

- Barron, L., 27 Charlton St., New York 14, N. Y.  
 Bashe, C. J., 398 Mansion St., Poughkeepsie N. Y.  
 Baum, R. V., 80 W. Center St., Rm. 611, Akron, Ohio  
 Baxter, L., 15 Trowbridge St., Cambridge 38, Mass.  
 Becker, S., 8605 Old Bladensburg Rd., Silver Spring, Md.  
 Belle, J. M., 541 E. 20 St., New York, N. Y.  
 Benanti, M. A., 1412 35 St., Brooklyn 18, N. Y.  
 Bennett, R. E., 1871 Sedgwick Ave., New York 53, N. Y.  
 Bernstein, H., 4010 Saxon Ave., New York 63, N. Y.  
 Best, L. E., Jr., 1940 Yosemite Rd., Berkeley, Calif.  
 Billick, P., Great Meadows, N. J.  
 Biondo, E. J., Jr., Beverly Rd. & Hawthorne Ave., Babylon, L. I., N. Y.  
 Blake, R. P., 15 Norwyn Rd., Hatboro, Pa.  
 Blonder, I. S., 101 Elwood Ave., Mt. Vernon, N. Y.  
 Bolinder, E. F., 126 Valhallavagen, Stockholm, Sweden  
 Bostwick, C. B., 4825-D Kahala Ave., Honolulu, T. H.  
 Braverman, R., 8343 Forreast Ave., Philadelphia 19, Pa.  
 Bristol, T. R., 227 Jackson Ave., Schenectady 4, N. Y.  
 Brogan, F. A., 131 Claremont, San Antonio, Tex.  
 Brown, F. L., 527 W. 124 St., New York 27, N. Y.  
 Brown, M. J., c/o Mutual Telephone Company, 1130 Alaskea St., Honolulu, T. H.  
 Brown, R. V., 7731, Calumet Ave., Chicago, Ill.  
 Browne, W. M., 502 Midway Dr., Lexington Park, Md.  
 Caltabiano, J. E., 1-09 34 St., Warren Point, N. J.  
 Castle, R. L., 5 W. 63 St., New York 23, N. Y.  
 Chang, R. H. M., 1420 College Walk, Honolulu, T. H.  
 Chin-Fook, S., 1718 Keeaumoku St., Honolulu, T. H.  
 Chingon, A. C., 3217 Francis St., Honolulu, T. H.  
 Choate, F. M., R. D. 1, Marsing, Idaho  
 Chow, W. H. P., Box 4011, Honolulu, T. H.  
 Chum, C. C. K., Honolulu Fire Department, Honolulu, T. H.  
 Chynoweth, W. R., 35 W. 33 St., Chicago 16, Ill.  
 Clark, F. E., 2 Farm Rd., Marlboro, Mass.  
 Clendenning, W. P., Radio Station WCUM, Cumberland, Md.  
 Cook, H. D., National Bureau of Standards, Washington, D. C.  
 Crowell, D. D., 716 17 St. Cha-3, Honolulu, T. H.  
 Crone, J. L., Box 3062, U.S.A.F.I.T., W-P, A.F.B., Dayton, Ohio  
 Cunningham, B. B., 663 Corona St., Denver, Colo.  
 Dahms, L. B., 215 W. 23 St., New York, N. Y.  
 Davis, C. H., 816 17 St., Honolulu 18, T. H.  
 Davis, R. L., 3921 Waialae Ave., Honolulu, T. H.  
 deBettencourt, J. T., Raytheon Manufacturing Company, 100 River St., Waltham, Mass.  
 DeRemer, K. R., Princeton Junction, N. J.  
 Dickson, A. R. K., C.S.E.A., 216 Balcarce, Buenos Aires, Argentina  
 Diehl, J. A., 221 Crescent Ave., Wyoming, Ohio  
 Diem, J. M., 7631 Fayette St., Philadelphia 38, Pa.  
 Dillon, R. E., Box 542, Wahiawa, Oahu, T. H.  
 Dorband, A. E., 1309 J St., Renton, Wash.  
 Douglas, W., 21-26 Steinway St., Astoria, L. I., N. Y.  
 Downie, R. S., 970 Makaiwa Dr., Honolulu, T. H.  
 Drake, L. J., 244 Liliuokalani Ave., Honolulu, T. H.  
 Duncan, V. D., Apt. F-1, Country Club Homes, Raleigh, N. C.  
 Dwin, D., Garfield-Grant Hotel, Broadway & Fifth St., Long Branch, N. J.  
 Eagan, J. F., Jr., 9949 Shore Rd., Brooklyn, N. Y.  
 Eddleston, J. H., 2584 Richmond Rd., Cleveland 24, Ohio  
 Edwards, A. C., 501 16 St., Cha-3, Honolulu, T. H.  
 Edwards, L. M., 1905 Nottingham, Trenton 9, N. J.  
 Edwards, N. P., 398 Mansion, Poughkeepsie, N. Y.  
 Eaternaux, F. L., 151 W. 57 St., New York 19, N. Y.

(Continued on page 46A)

Dependable  
PERFORMANCE  
at  
LOWER COST



## TOWER LIGHTING EQUIPMENT

H & P lighting equipment, consistently specified by outstanding radio engineers, is furnished as standard equipment by most leading tower manufacturers.

### 300 MM CODE BEACON

Patented ventilator dome circulates the air, assures cooler operation, longer lamp life. Concave base with drainage port at lowest point. Glass-to-glass color screen supports virtually eliminate color screen breakage. Neoprene gaskets throughout. CAA approved



### MERCURY CODE FLASHER

Lifetime-lubricated ball bearings. No contact points to wear out. Highest quality bronze gears. Adjustable, 14 to 52 flashes per minute



### SINGLE and DOUBLE OBSTRUCTION LIGHTS

Designed for standard A-21 traffic signal lamps. Prismatic globes meet CAA specifications.



### "PECA" SERIES PHOTO-ELECTRIC CONTROL

Turns lights on at 35 f.c.; off at 58 f.c., as recommended by CAA. High-wattage industrial type resistors. Low-loss circuit insulation.



ALSO COMPLETE LIGHT KITS  
FOR A-2, A-3, A-4 and A-5 TOWERS

### PROMPT SERVICE and DELIVERY

First-day shipments out of stock. Immediate attention to specifications and unusual requirements.

WRITE OR WIRE FOR CATALOG  
AND DETAILED INFORMATION

### HUGHEY & PHILLIPS

TOWER LIGHTING DIVISION

326 N. LA CIENEGA BLVD.  
LOS ANGELES 48, CALIF.

60 E. 42ND ST. NEW YORK 17, N. Y.

# JOHNSON VARIABLE CONDENSERS

.. Always a Perfect Choice

Available in a wide range of types, in capacities and voltage ratings to meet every need. All incorporate latest design, finest materials and workmanship — your assurance of perfect satisfaction always. Here are just a few in the JOHNSON line.



## TYPE M MINIATURE

Tiniest, with dime sized plates, but proving ever so important for VHF applications such as TV, FM and others. Precision engineered and manufactured for exacting uses. Made in Single (180 degree rotation) and Differential types up to 19.3 mmfd. maximum and Butterfly type up to 11 mmfd. maximum. Air gap .017", end plate 5/8" x 3/4".



## TYPE L

Newest development, employing metal to ceramic soldered joints — not a rivet or eyelet used. Utmost stability and strength, ideal for peak performance under severe conditions such as portable — mobile operation. 15 standard sizes with .030 plate spacing; single section up to 200 mmfd., Dual Section up to 100 mmfd., Differential up to 51 mmfd. and Butterfly up to 51 mmfd., .080 spacing also available. End plate only 1-3/8" square.

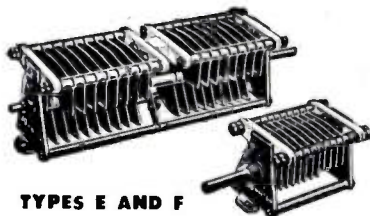

## TYPES E AND F

For medium and low power transmitters. Proved over many years use. Unusually compact. 45 standard sizes in air gaps of .045" (up to 500 mmfd. maximum capacity), .075" (up to 350 mmfd.), and .125" (up to 250 mmfd.). Single and Dual Section Types. Panel space, "E" about 2-5/8" square, "F" about 2" square.



## TYPES C AND D

Rugged condensers with heavy, well rounded plates and exceptionally long steatite insulators for higher voltages. 52 standard sizes in air gaps of .080" (up to 500 mmfd.), .125" (up to 300 mmfd.), .175" (up to 500 mmfd.), .250" (up to 350 mmfd.), .350" (up to 250 mmfd.) and .500" (up to 100 mmfd.). Special spacings and capacities easily provided. Single and Dual Section types. Panel space, "C" about 5-1/2" square, "D" about 4-1/4" square.

Variable Condenser Catalog No. 701, free on request.

**E. F. JOHNSON COMPANY**  
WASECA, MINNESOTA



(Continued from page 45A)

- Feeney, E. J., 2315 Federal St., Philadelphia 46, Pa.  
Fels, L., 275 Ft. Washington Ave., New York 32, N. Y.  
Fenichel, L., 1750 Grand Concourse, New York 57, N. Y.  
Fisher, N. C., R. D. 8, Browning Rd., Evansville, Ind.  
Fitzgerald, R. T., 930 N. Cedar Ave., Inglewood, Calif.  
Foxen, W. B., Tradewinds Apts. 1720, Ala Moana Rd., Honolulu, T. H.  
Foy, T. J., 37 Concord St., Clifton, N. J.  
Foyer, D. R., 320 E. 42 St., New York, N. Y.  
Franklin, R. M., University of Houston, 3801 St. Bernard, Houston, Tex.  
Frost, F. K., 6415 S. E. Tibbetts, Portland, Ore.  
Fuchikami, A. H., Box 3768, Honolulu, T. H.  
Galbraith, H. J., 2409 Revere Ave., Dayton, Ohio  
Gault, G. W., 3629 Rutherford St., Harrisburg, Pa.  
Gebhardt, J. W., 199 Lake Shore Dr., Lake Hiawatha, N. J.  
Gellman, E. S., 312 W. 48 St., New York 19, N. Y.  
Girdwood, J., 330 W. 42 St., New York 18, N. Y.  
Gladden, C. J., 108 Ridgewood Ave., Newark, N. J.  
Goodman, H., 731 Stokes Ave., Collingswood, N. J.  
Gottlieb, E. D., 1501 43, Brooklyn 19, N. Y.  
Gravlee, G. P., 308 E. Delray Ave., Alexandria, Va.  
Greenspan, S., 1037 Lenox Rd., Brooklyn 12, N. Y.  
Greenwald, S., 3220 Chillum Rd., Mt. Rainier, Md.  
Greis, W. F., 34 Silver St., Malverne, L. I., N. Y.  
Grzesik, J., 60 Parker St., Central Falls, R. I.  
Gumaer, H., 68 Elizabeth St., North Hackensack, N. J.  
Haagens, D., 56 Arbor St., Hartford 6, Conn.  
Haase, H. W., 1365 S. W. Watson, Beaverton, Ore.  
Hagin, E. J., 1360 Steele St., Denver, Colo.  
Hahn, G. K. P., 234 California Ave., Wahiawa, Oahu, T. H.  
Halsted, G. P., Bell Aircraft Corp., Box 1, Buffalo, N. Y.  
Hamilton, R. C., 1967 Shaftesbury Rd., Dayton 6, Ohio  
Hannan, M. R., Box 59, Tumwater, Wash.  
Hannon, R. J., 90-40 76 St., Wookhaven 21, N. Y.  
Harris, H. M., 602 15 St., Cha-3, Honolulu, T. H.  
Hart, B. H., Waimanalo, Oahu, T. H.  
Haueter, R. C., 620 Mellon St., Washington 20, D. C.  
Heichlinger, C. L., 60-54 60 Rd., Maspeth, L. I., N. Y.  
Heinis, F. W., 530 Upper Mt. Ave., Upper Montclair, N. J.  
Helmreich, L. W., 4 Wildwood Lane, Kirkwood 22, Mo.  
Hendricks, J. C., 86 Nakeke St., Wahiawa, Oahu, T. H.  
Henry, J. L., 2422—38 Ave., San Francisco, Calif.  
Henry, R. L., 415 Windsor St., Silver Spring, Md.  
Hering, K. W., 263 Dow Ave., Carle Place, N. Y.  
Herud, E. C., 7 Western Ave., Chatham, N. J.  
Higa, J. J., 2423 D. Rose St., Honolulu, T. H.  
Higa, K., 1414-B Kapiolani St., Honolulu, T. H.  
Hirst, J. L., 6001 Dickens Ave., Chicago, Ill.  
Honda, J. M., Honolulu Fire Department, Honolulu, T. H.  
Hopper, R. H., 111 W. 68 St., New York 23, N. Y.  
Hunter, G. H., Box 265, Lanikai, Oahu, T. H.  
Hurst, F. C., 86 Nakeke St., Wahiawa, Oahu, T. H.  
Jans, J. T., R. D. 1, Seneca Falls, N. Y.  
Jensen, P. A., 646 17 St., Cla-3, Honolulu, T. H.  
Johnson, W. G., c/o Mutual Telephone Company, Box 2200, Honolulu, T. H.  
Kadi, F. S., 1123A 11 Ave., Honolulu, T. H.  
Kaluger, M. M., 300 Clifton Ave., Wheeling, W. Va.  
Kamrath, R. W., 1418 N. Humboldt, Milwaukee, Wis.  
Kang, Y. O., 343 Iolani Ave., Honolulu, T. H.  
Kanter, J. I., 8023 Eastern Ave., Silver Spring, Md.  
Kaplan, H., 1517 Jesup Ave., New York 52, N. Y.

(Continued on page 47A)

# CRYSTAL CALIBRATOR

MEASUREMENTS CORPORATION  
Model 111

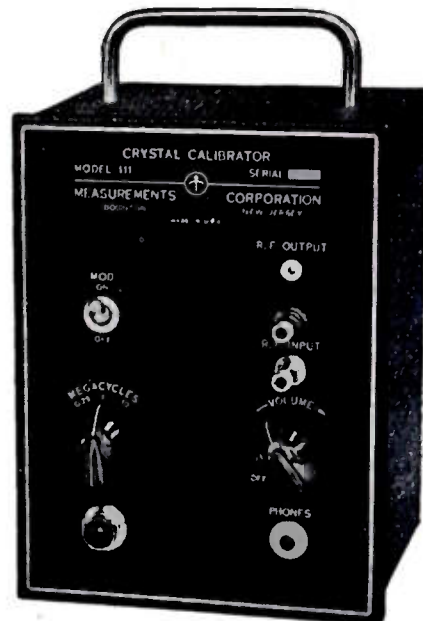

FREQUENCY RANGE: .25Mc.—1000 Mc.

FREQUENCY ACCURACY:

±0.001%

## A Dual-Purpose Calibrator

- CRYSTAL-CONTROLLED OSCILLATOR
- CRYSTAL RECEIVER  
2 Microwatt Sensitivity

Designed for the Calibration and Frequency Checking of Signal Generators, Transmitters, Receivers, Grid-Dip Meters and other equipment where a high degree of frequency accuracy is required.

Harmonic Range:

.25 Mc. Oscillator: .25-450 Mc.  
1 Mc. Oscillator: 1-600 Mc.  
10 Mc. Oscillator: 10-1000 Mc.

117 volts, 50/60 cycles; 18 watts, 6" wide, 8" high, 5" deep; 4 lbs.

**MEASUREMENTS  
CORPORATION**



Boonton

New Jersey

# Airtroon

DESIGNS AND PRODUCES



## Microwave Components

Flexaguide (Flexible Guide)  
Bends—Flexaguide & Rigid  
Twists—Flexaguide & Rigid  
Crystal Mixers • Duplexers  
Coax to Waveguide Adapter  
Directional Couplers  
Tapers—Flexaguide & Rigid  
Flanges

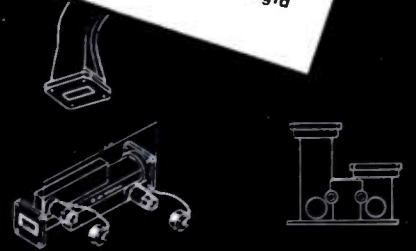

## Aircraft Accessories

Ignition Monifolds  
Conduit  
Fittings  
Spark Plug Elbows  
Connectors  
Power Cable Disconnects  
Junction Boxes  
Thermocouple Connectors  
Wired Assemblies

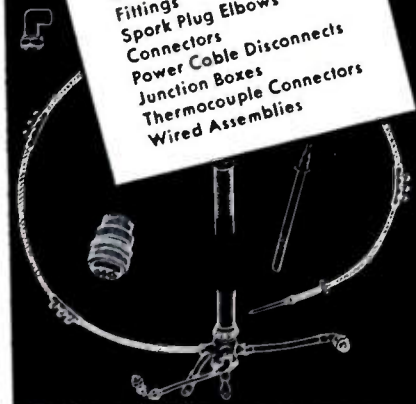

# Airtroon

INC.

105 East Elizabeth Ave., Linden, New Jersey

### BRANCH OFFICES

Baltimore Los Angeles New York  
Boston St. Louis Dallas Dayton



(Continued from page 46A)

- Kappler, M. O., 626 Lorna Lane, Los Angeles 49, Calif.
- Kato, R. S., 1417 Gulick Ave., Honolulu, T. H.
- Kaylor, R. L., Bell Telephone Laboratories, Inc., 463 West St., New York 14, N. Y.
- Keefe, J. W., 2120 Sturdevant, Davenport, Iowa
- Kelley, J. J., Oak Pl., Ayr lawn, Bethesda 12, Md.
- Kelly, V., 827 Coral Ave., Pearl City, Oahu, T. H.
- Khambata, A. J., 1020 N. Broadway, Milwaukee 2, Wis.
- Kilbride, E. E., Box 4009, Honolulu, T. H.
- Kilpatrick, D. G., 3527 Indian Queen Lane, Philadelphia, Pa.
- Kimball, L. L., 3051 Kiele Ave., Honolulu, T. H.
- King, A. M., 2960 Newark St., N. W., Washington 8, D. C.
- King, W. P., 828 S. Highland St., Arlington, Va.
- Kinney, K. W., Box 45, Davisburg, Mich.
- Klemer, B. H., 100 Glenham St., Providence 7, R. I.
- Koehler, A. O., 130 Wadsworth Ave., New York 33, N. Y.
- Kohman, W. G., 133 Ashland Rd., Summit, N. J.
- Koontz, W. A., Box 267, Wahiawa, Oahu, T. H.
- Krasicki, J., 151 E. 67 St., New York 21, N. Y.
- Kullback, I., 468 E. 92 St., Brooklyn 12, N. Y.
- Landfried, H. H., 261 W. Harvey St., Germantown, Philadelphia, Pa.
- Landis, R. I., 1458 W. 20 St., Los Angeles 7, Calif.
- Lane, C. A., 1149-D—23 St., Los Alamos, N. Mex.
- Langford, A. L., 4825 Indiana, Chicago, Ill.
- Learnard, H. P., Box 3737, Honolulu, T. H.
- Lee, R. T. S., 126 Circle Dr., Wahiawa, T. H.
- Legg, W. E., Bell Telephone Laboratories, Box 107, Red Bank, N. J.
- Letendre, L. J., 189-31 44 Ave., Flushing, L. I., N. Y.
- Leverington, R. D., 3138 17 St., N. W., Washington, D. C.
- Lindon, J., 40 Steuben St., East Orange, N. J.
- Lindsey, O. T. C., 87 Main St., Sidney, N. Y.
- Lisle, J., 729 Delaware Ave., Bethlehem, Pa.
- Little, S., 143 Kaluamoo St., Lanikai, Oahu, T. H.
- Littleboy, H. S., 3153 Perry Ave., New York 67, N. Y.
- Lobel, H. A., Box 832, Waipahu, Oahu, T. H.
- Long, R. G., 248 Warren St., Boston, Mass.
- Love, F. B., 49 Hillcrest Ave., Manhasset, N. Y.
- Lowell, T. B., 7250 Burrwood, Normandy 21, Mo.
- Lundgren, E. H., 16 Erstaviksbaden, Saltsjobaden 2, Sweden
- MacInnes, N. A., 19 Locust Rd., Wayne, Pa.
- Maguire, W. M., 54 King, Peabody, Mass.
- Masching, R. G., 1547 Ala Wal Blvd., Honolulu, T. H.
- McClung, D. C., Box 2200, Honolulu, T. H.
- McHenry, G. A., 1727 33 Ave., Seattle 22, Wash.
- McNichols, H. B., 99 N. Front St., Columbus, Ohio
- Merrill, R. B., 2935A Benson St., Camden 5, N. J.
- Meyer, A. W., Box 73, Angola, Ind.
- Meyerhoff, A. J., 1241 Grandview Ave., Union, N. J.
- Mickelson, T. H., N. R. L. Annex, Chesapeake Beach, Md.
- Mills, N. B., 841 Carroll St., Brooklyn 15, N. Y.
- Moore, W. H., 78-15 19 Dr., Jackson Heights, L. I., N. Y.
- Mountain, J. D., 9 Coolidge Ave., White Plains, N. Y.
- Muckenhoupt, F. W., 332 Winchester St., Newton Highlands, Mass.
- Nelfert, K. G., c/o Kauai Telephone System, Lihue, Kauai, T. H.
- Nelson, R. P., 212 Dunkirk Rd., Baltimore 12, Md.
- Newberry, A. W., 4525 Grand Ave., Lacanada, Calif.
- Newell, A. E., 1822 Hunnewell St., Honolulu 14, T. H.
- Nishball, J. L., 53 Newtonville Ave., Newton, Mass.
- O'Brien, T. H., 63 Aster Dr., New Hyde Park, N. Y.

(Continued on page 48A)

Which pin saves the money?

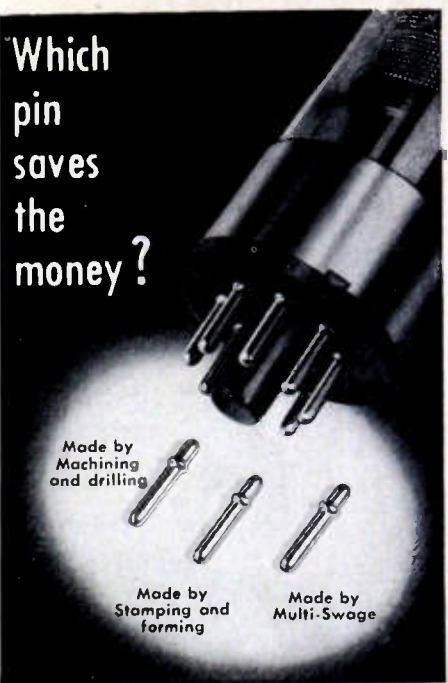

Made by Machining and drilling

Made by Stamping and forming

Made by Multi-Swage

## Choose right and make Big Savings on SMALL METAL PARTS

**COSTS HALVED!** Instead of turning and drilling parts like these from solid rod, or stamping and forming them, the BEAD CHAIN MULTI-SWAGE Process automatically swages them from flat stock. By doubling the production rate and eliminating scrap, this advanced process can save you as much as fifty percent of the cost of other methods.

The BEAD CHAIN MULTI-SWAGE Process produces a wide variety of hollow or solid metal parts—beaded, grooved, shouldered—from flat stock, tubing, rod, or wire—of any metal. Sizes to 1/4" dia. and 1 1/2" length.

**GET COST COMPARISON ON YOUR PARTS**—If you use small metal parts in quantities of about 100,000, don't overlook the almost certain savings of this high-speed, precision process. Send sketch, blueprint or sample part and our engineers will furnish facts about Multi-Swage economy. Or, write for Catalog. The Bead Chain Manufacturing Co., 60 Mountain Grove St., Bridgeport, Conn.

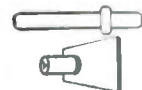

Bearings, Shafts

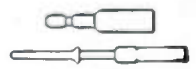

Electrical and Electronic Parts



Friction Fasteners



Guides



Stops



Posts, Pins

# BEAD CHAIN MULTI-SWAGE PROCESS

TRADE MARK



# AMPERITE

THERMOSTATIC METAL TYPE

*Delay Relays*



**PROVIDE DELAYS RANGING FROM 1 TO 120 SECONDS**

**FEATURES:** — Compensated for ambient temperature changes from  $-40^{\circ}$  to  $110^{\circ}$  F... Hermetically sealed; not affected by altitude, moisture or other climate changes... Explosion-proof... Octal radio base... Compact, light, rugged, inexpensive... Circuits available: SPST Normally Open; SPST Normally Closed.

**PROBLEM?** Send for "Special Problem Sheet"

*Regulators*

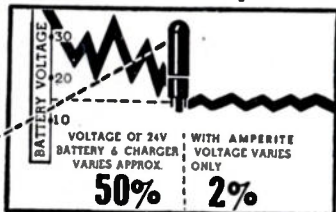

**Amperite REGULATORS are the simplest, lightest,**

**cheapest, and most compact method of obtaining current or voltage regulation... For currents of .060 to 6 Amps... Hermetically sealed; not affected by altitude, ambient temperature, humidity.**

**Write for 4-page Illustrated Bulletin RE**

**AMPERITE CO., Inc., 561 Broadway, New York 12, N. Y.**

*In Canada: Atlas Radio Corp., Ltd., 560 King St., W. Toronto*



(Continued from page 47A)

- O'Meara, T. J., 2718 Bainbridge Ave., New York 58, N. Y.  
 Orłowski, S. J., 227 Furman St., Trenton, N. J.  
 Ornstein, E., 323 Second St., S. E., Washington, D. C.  
 Osborn, M. E., 326 W. Brady St., Butler, Pa.  
 Paradise, R. Y., 1172 Park Ave., Bridgeport, Conn.  
 Parenti, V. M., Calle Mandri 60, Barcelona 6, Spain  
 Parke, H. G., 138 71 St., Brooklyn 9, N. Y.  
 Parris, D. S., 802 E. Broad St., Falls Church, Va.  
 Paterson, H. R. M., 2R & CS, RCAF, Clinton, Ont., Canada  
 Pensiero, L. R., 50 Nelson Terr., Bridgeport, Conn.  
 Petriken, T. E., 1 Moller Pl., Dover, N. J.  
 Phillips, G. D., 2811 First Ave., S. E., Cedar Rapids, Iowa  
 Piety, E. A., Box 1094, Cha-3, Honolulu 18, T. H.  
 Polcyn, S. J., Jr., 1866 Cedar Ave., New York 53, N. Y.  
 Praszynski, P. C., 1013 Brunswick Ave., Trenton, N. J.  
 Reid, W., Mail Sta. F-40, Sperry Gyroscope Company, Great Neck, L. I., N. Y.  
 Rhodes, R. N., 1 Paulus Blvd., New Brunswick, N. J.  
 Richards, J. R., Box 87, Park Ridge, Ill.  
 Robbins, D., 612 W. 116 St., New York, N. Y.  
 Rodewald, M. V., 3108 S. Adams St., Milwaukee 7, Wis.  
 Roth, S. S., 1 Sherwood Terr., Yonkers 4, N. Y.  
 Sagendorf, B. A., 30 S. Ashby Ave., Livingston, N. J.  
 Sahn, E. J., 193 Richard Ave., Merrick, L. I., N. Y.  
 Salem, J., 605 Eighth Ave., Belmar, N. J.  
 Sanderson, A. E., 323 Liberty St., Boonton, N. J.  
 Santaguida, C., 200 Ardmore Ave., Upper Darby, Pa.  
 Saturenky, G., 550 S. Barrington Ave., Los Angeles 49, Calif.  
 Schoch, J. W., 312 Oakley St., Evansville, Ind.  
 Schoen, E. C., Box 1615, Honolulu, T. H.  
 Schwartz, B. S., 4934 N. Lawndale Ave., Chicago 25, Ill.  
 Seibert, G. J., Chaz. 901 16 St., Honolulu, T. H.  
 Seltzer, A. M., 2613 S. Seventh St., Philadelphia, Pa.  
 Slatic, G. A., 1819 Summerfield Ave., Brooklyn 27, N. Y.  
 Sokol, G. M., 3313 Chillum Rd., Mt. Rainier, Md.  
 Simon, E., 1819 Lipepea St., Honolulu, T. H.  
 Skaggs, E. R., Armour Research Foundation, 35 W. 33 St., Chicago, Ill.  
 Smith, R. J., 1234 Wilder Ave., Honolulu, T. H.  
 Soreny, E. V., 874 E. 14 St., Brooklyn 30, N. Y.  
 Spacie, R. W., 131 Gilpin Rd., Willow Grove, Pa.  
 Spenser, C. W., 124 Liberty Ave., Norristown, Pa.  
 Spikula, R. W., 521 E. Polo Rd., Winston-Salem, N. C.  
 Stavrou, A., 5347 N. 13 St., Philadelphia, Pa.  
 Stevens, G. E., 1076 Park Ave., Schenectady 8, N. Y.  
 Stewart, B. L., 1106 Duncan Ave., Yeadon, Pa.  
 Stewart, J. M., 1616 N. Edgewood St., Arlington, Va.  
 Stickney, J. B., 582 Columbia Rd., Bay Village, Ohio  
 Stoltz, G. F., 808 S. E. Riverside Dr., Evansville, Ind.  
 Stone, F. C., 271 Ave. C, New York 9, N. Y.  
 Story, R., 830 Lansdowne Ave., Toronto, Ont., Canada  
 Sward, W. O., 1129 N. Jefferson St., Milwaukee, Wis.  
 Talkin, A. I., Navy Department, Bureau of Ships, Washington, D. C.  
 Tanigawa, N. F., 726 Hausten St., Honolulu 36, T. H.  
 Thomas, D. L., 45 River Dr., Passaic, N. J.  
 Thomasson, J. G., 11, Worcester Pl., Duxbury, Chorley, Lancs., England

(Continued on page 49A)

## ON THE JOB AT THE FAMOUS BELL "LABS"

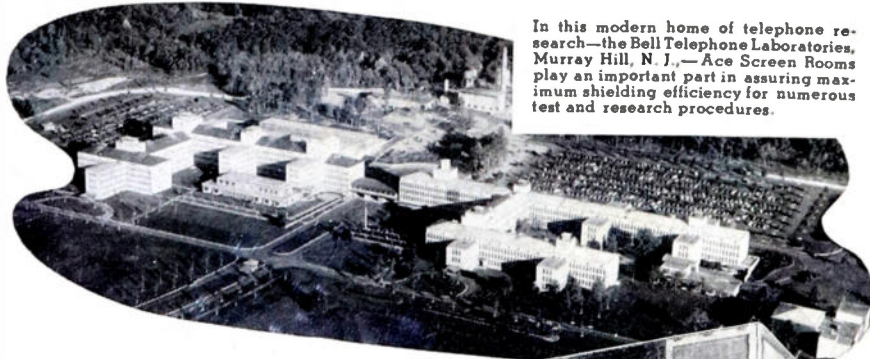

In this modern home of telephone research—the Bell Telephone Laboratories, Murray Hill, N. J.—Ace Screen Rooms play an important part in assuring maximum shielding efficiency for numerous test and research procedures.

## Better Attenuation

**... AT NO GREATER COST!**

Designed to exacting wartime laboratory standards, supplied in ready-built "knock-down" form for installation in a few hours, Ace Screen Rooms provide a minimum of 100 db. attenuation from 0.15 to 1000 mc. Total cost is no greater than that of "homemade" screen rooms of far lower efficiency. Numerous sizes are available and rooms can readily be moved or enlarged as required. Write, wire, or 'phone for details.

**ACE ENGINEERING & MACHINE CO.**

3642 N. Lawrence St.

Philadelphia 40, Pa.

REgent 9-1019

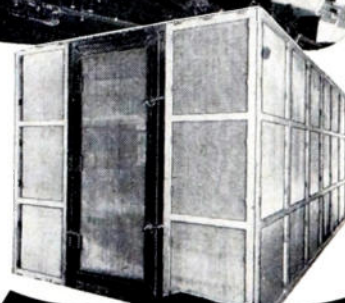

**ACE**  
**READY-BUILT "UNIT CELL"**  
**SCREEN ROOMS**

★  
**2x10<sup>-7</sup>**



**Bliley**  
**TYPE**  
**BCS-1A FREQUENCY STANDARD**

★  
**Stability better than 2x10<sup>-7</sup>**  
**over any 24 hour period**

**FOR THE FIRST TIME . . . A CO-ORDINATION OF ALL DESIGN FEATURES THAT CONTRIBUTE TO HIGH FREQUENCY STABILITY.**

**THE RIGHT COMBINATION AND BALANCE OF CIRCUITRY UTILIZING A SPECIAL BLILEY CRYSTAL AND TEMPERATURE CONTROL OVEN. A PRECISION REFERENCE INSTRUMENT WITH EXCEPTIONAL QUALIFICATIONS.**

WRITE FOR BULLETIN 40

**A COMPLETE FREQUENCY STANDARD BY THE MAKERS OF**

**Bliley**  
**CRYSTALS**

**BLILEY ELECTRIC COMPANY  
UNION STATION BUILDING  
ERIE, PA.**



(Continued from page 48A)

- Thompson, G. S., 144 Chatham St., New Haven 13, Conn.  
Thompson, H. K., 1075 Pacheco St., San Francisco 16, Calif.  
Tippery, M. W., 9316 S. E. Grant St., Portland, Ore.  
Tittle, J. F., 2764H Booth Rd., Honolulu, T. H.  
Tomey, T. B., 1613 Holbrook St., Baltimore 2, Md.  
Tribou, P. W., 720 Central Ave., Dunkirk, N. Y.  
Troll, J. H., 6 Sunset Ave., Farmingdale, N. Y.  
Tucker, W. K., Jr., c/o Kula, 1585 Kapiolani Blvd., Honolulu, T. H.  
Turner, E. M., 207 Ryburn Ave., Dayton 5, Ohio  
Udelson, B. J., 3500—13 St., N. W., Washington, D. C.  
Van Cott, J. M., Naval Base Box 98, Navy 128, c/o F.P.O., San Francisco, Calif.  
Vaughan, V., 3836 Pukalani Ave., Honolulu, T. H.  
Vergon, T. F., 481 Mountainview Dr., North Plainfield, N. J.  
Vittum, M. S., Box 881, Honolulu, T. H.  
Walker, P. M., 623 16 St., Cha-3, Honolulu, T. H.  
Walley, J. E., c/o Kula, Honolulu, T. H.  
Warren, M. V., R. D. 3, Trenton, N. J.  
Weber, D. R., 940 Lawrence Ave., Chicago, Ill.  
Weida, R. L., 93-16 Lamont Ave., Elmhurst, L. I., N. Y.  
Welhe, W. K., Qrts. J-14-B, 23 St., Fort Belvoir, Va.  
Weinberg, A. D., 508 Pennypack Cir., Fulmor Hts., Hatboro, Pa.  
Weinberg, T. L., 1160 E. 13 St., Brooklyn 30, N. Y.  
Weissman, E., Y.M.C.A., Rm. 605, 80 Center St., Akron 8, Ohio  
Wernz, G. L., 355 Kilani Ave., Wahiawa, Oahu, T. H.  
Wier, J. M., Electrical Engineering Dept., Iowa State College, Ames, Iowa  
Wile, E. A., 3435 N. 47 St., Milwaukee 16, Wis.  
Willson, R. E., Lamington Rd., North Branch, N. J.  
Willston, S. S., 806 17 St., N. W., Washington 6, D. C.  
Wilson, R. A., 2301 Maplewood Cir., Evansville, Ind.  
Wise, B., 5225 Euclid Ave., Philadelphia 31, Pa.  
Wise, G. H., 3528 W. Lexington Ave., Chicago, Ill.  
Wolfson, W., 29 Franklin Ave., Chelsea 50, Mass.  
Wright, D. S., 47 Chevy Pl., Hillsdale, N. J.  
Wright, P. H., 1102 S. York St., Denver 10, Colo.  
Yamron, J., 5405 Atlantic Ave., Ventnor, N. J.  
Young, K. J., 23264 Yale Ave., N., Seattle 2, Wash.  
Young, M. F., 3724 Anuhea St., Honolulu, T. H.  
Yusem, S., 517 Miller Ave., Brooklyn, N. Y.  
Zwissler, H. R., Forest Traller Park, Box 87, Park Ridge, Ill.

**When writing to these advertisers we would appreciate your mentioning Proceedings of the IRE.**

## TYPE "DP" SERIES for Rack & Panel

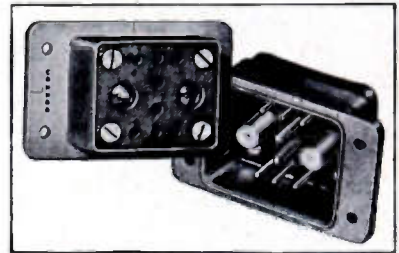

Type DPB—Pin and Socket

## CONNECTORS

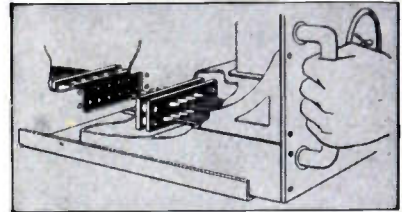

Type  
DPD with  
Socket  
Insert

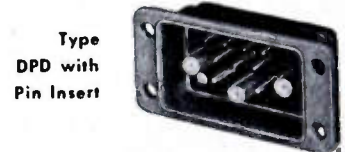

Type  
DPD with  
Pin Insert



DPB with twinax  
contact on program  
monitor for radio.

LANGVIN CO. PHOTO

This type series of Cannon Electric Connectors contains a wide range and many variations of rack and panel connectors for radio equipment, quick-disconnect and instrument applications. For engineering data, write for DP Bulletin; brief data are included in the C48 Catalog.

Cannon Electric also manufactures signal equipment for hospitals, industrial plants, schools, institutions and many other electrical specialties such as conduit fittings, D.C. Solenoids, fire alarm relays, cable terminals, indicator, pathway and pilot lights, etc., etc.

Address Cannon Electric Development Co., Division of Cannon Manufacturing Corporation, 3209 Humboldt Street, Los Angeles 31, Calif. Canadian office and plant: Toronto, Ontario. World export: Frazer & Hansen, San Francisco.

SINCE 1912  
**CANNON ELECTRIC**

## Electronic Engineers

BENDIX RADIO DIVISION  
Baltimore, Maryland  
manufacturer of

**RADIO AND RADAR EQUIPMENT**  
requires:

### PROJECT ENGINEERS

Five or more years experience in the design and development, for production, of major components in radio and radar equipment.

### ASSISTANT PROJECT ENGINEERS

Two or more years experience in the development, for production, of components in radio and radar equipment. Capable of designing components under supervision of project engineer.

Well equipped laboratories in modern radio plant . . . Excellent opportunity . . . advancement on individual merit.

#### Baltimore Has Adequate Housing

Arrangements will be made to contact personally all applicants who submit satisfactory resumes. Send resume to Mr. John Siena:

**BENDIX RADIO DIVISION**  
**BENDIX AVIATION CORPORATION**  
Baltimore 4, Maryland

## ELECTRICAL AND MECHANICAL PRODUCTION ENGINEERS

### Guided Missile Manufacture—Los Angeles Area

Experienced in development of processes and design of equipment and tooling for ULTRA-PRECISION MINIATURE MECHANISMS.

Also supervisory openings for top-caliber men with wide knowledge of latest developments applicable to production of one or more guided missile components.

Send resume of your experience to Dept. 29A, Hughes Aircraft Company, Culver City, Calif. Interviews will be arranged near your home if possible.



The following positions of interest to I.R.E. members have been reported as open. Apply in writing, addressing reply to company mentioned or to Box No. . . .

The Institute reserves the right to refuse any announcement without giving a reason for the refusal.

### PROCEEDINGS of the I.R.E.

1 East 79th St., New York 21, N.Y.

### ENGINEERING PHYSICIST OR SPECIALIST

For research and development work on cracked carbon resistors. Men with some experience preferred. Progressive mid-western manufacturing concern. Give full data as to experience and schooling. Box 597.

### ENGINEERS AND PHYSICISTS

Engineers and physicists, age 25 to 40, with experience in navigational and fire control instrumentation or related equipment involving a combination of electronics and electro-mechanical devices. Client is progressive well-established precision instrument manufacturer with design, development and product engineering opportunities. Electrical engineers or physicists with strong electrical and mathematical ability desired. Starting salaries \$6000-\$8000. Metropolitan New York area. Box 600.

### ELECTRONICS ENGINEER

Well known, 40 year old manufacturer of electrical and electronic instruments wants research engineer experienced in design of radio electronic apparatus at high frequencies, for the development of military and civilian test equipment. Box 601.

### MANUFACTURER-ENGINEER

Wanted for ceramic capacitor manufacturer-engineer familiar with manufacturing techniques, design and development of equipment for use in high speed production of ceramic capacitors. Should be capable of assuming complete charge of manufacturing program. Send resume of education, experience, salary desired to F-58, P.O. Box 3414, Phila. 22, Pa.

### ELECTRICAL ENGINEER

Electrical engineer to design sound equipment, audio amplifiers and electric carillons. Requirements: B.S. degree, 3 years experience in audio, electronic and acoustical systems. Location: Upstate New York. Box 602.

### SALES MANAGER

Sales manager to head up sales force selling public address and intercommunicating systems for old line company. Technical knowledge as well as sales ability required. Location: Upstate New York. Box 603.

(Continued on page 51A)

## Notice to Contractors

GENERAL SERVICES  
ADMINISTRATION  
Community Facilities Service  
Washington 25, D. C.

Sealed proposals will be received by Rufe B. Newman, Jr., Director, Public Works Construction Division, Community Facilities Service, General Services Administration, Room 5143, General Services Building, Washington, D. C., until 11:00 o'clock A.M., Eastern Standard Time, on May 24, 1950, for the construction of telephone and radio link facilities and buildings on the islands of St. Thomas and St. Croix (U. S. Virgin Islands) as follows:

**PROJECT No. 53-113, ST. THOMAS TELEPHONE SYSTEM** (Project No. 13, Public Law 510, 78th Congress)

Subproject 13A—Outside Telephone Plant, St. Thomas

Subproject 13B—Inside Telephone Plant, Charlotte Amalie

Subproject 13C—Subscriber Telephone Plant, St. Thomas

Subproject 13R—Radio Link Stations, Virgin Islands

Subproject 13X—Telephone Exchange, Charlotte Amalie

**PROJECT No. 53-509, ST. CROIX TELEPHONE SYSTEM** (Project No. 26, Public Law 510, 78th Congress)

Subproject 26A—Outside Telephone Plant, St. Croix

Subproject 26B—Inside Telephone Plant, Christiansted and Frederiksted

Subproject 26C—Subscriber Telephone Plant, St. Croix

Subproject 26X—Telephone Exchanges, Christiansted and Frederiksted.

at which time and place the proposals will be publicly opened and read aloud. Bids received after closing time of bid opening will be returned unopened.

Plans and specifications and other proposed contract documents are open for public inspection at the District Engineer's Office, Charlotte Amalie, St. Thomas, U. S. Virgin Islands; the District Engineer's Office, 501 Banco Popular Building, San Juan, Puerto Rico and Room 5130, General Services Building, Washington, D. C. A set of such documents may be procured from any of the above-listed offices upon deposit of \$50.00, all of which will be returned to bona-fide bidders upon the return of plans and specifications, in good condition, within seven days of date of bid opening.

Each proposal must be accompanied by a bid security in an amount not less than 5 per cent of the total bid.

Bids will be accepted on any single subproject or project.

The successful bidder(s) will be required to furnish performance bond(s) in an amount equal to 100 per cent of his (their) bid(s) and payment bond(s) in an amount equal to 100 per cent of his (their) bid(s); such bonds to cover full performance of the contract(s) and payment(s) for labor and materials.

No proposal may be withdrawn after the scheduled closing time for receipt of bids for at least 30 days.

The Government reserves the right to reject any and all proposals and to waive informalities with respect thereto.

**PERE F. SEWARD, Commissioner**







(Continued from page 50A)

#### ELECTRONICS ENGINEER

Opportunities for several experienced electronics engineers in communications, television receivers, television transmitters, classified military equipment, computers, microwave equipment and advanced development of all kinds. Desires graduate engineers with 5 years or more experience. Salary commensurate with ability and experience. We are looking for engineers seeking permanent connections with unusual opportunities for advancement. New and modern facilities and working conditions unequalled anywhere in the world. Reply, Personnel Div. Electronics Dept., General Electric Co., Syracuse N.Y.

#### PHYSICISTS-SENIOR ELECTRONIC ENGINEERS

Familiar with ultra high frequency and microwave technique. Experience with electronic digital and/or analog, computer research and development program. Salaries commensurate with experience and ability. Excellent opportunities for qualified personnel. Contact: C. G. Jones, Personnel Dept. Goodyear Aircraft Corp., Akron 15, Ohio.

#### ELECTRONICS TEACHER

Vacancy in September for instructor in electronics and radio engineering subjects for 1950-51 session. Regular staff member going on leave. Salary depends on qualifications and is up to \$6000, for nine months. Location upper south. Box 605.

#### ASSISTANT TO CHIEF ENGINEER

Large speciality transformer manufacturer wants man experienced in small transformer work. Excellent opportunity for qualified man. Please state education and experience, also salary on last or present position. Southern Ohio location. All replies held strictly confidential. Suitable arrangements will be made to interview qualified applicants. Box 606.

#### ANTENNA ENGINEER

Graduate engineer one or more years experience in design and testing of airborne VHF antennas. Desirable California location, unusual opportunity for advancement. For application form write Route #1, Box 394, Camarillo, California.

#### TELEVISION ENGINEERS

Several engineers experienced in either technical or commercial phases of television are required in the formation of a new department. Send résumé of qualifications to Personnel Department, General Precision Laboratory, Inc., 63 Bedford Road, Pleasantville, New York.

## SALES MANAGER

Large manufacturer of Radio and Television Tubes located in the New York Metropolitan area is seeking the services of an energetic Sales Manager for the Distributor Sales Division. Applicant must be fully capable of supervising field and manufacturer representatives. There is ample opportunity for security and advancement for a well qualified man. Describe your background fully in letter to Box 607. All replies will be held in strictest confidence.

The Institute of Radio Engineers  
1 East 79th St. New York 21, N.Y.

Positions available for

### SENIOR ELECTRONIC ENGINEERS

with

Development & Design  
Experience

in

### MICROWAVE RECEIVERS PULSED CIRCUITS SONAR EQUIPMENTS MICRO-COMMUNICATIONS SYSTEMS

Opportunity For Advancement  
Limited only by Individual  
Ability

Send complete Resume to:  
Personnel Department

**MELPAR, INC.**  
452 Swann Ave.  
Alexandria, Virginia

## CHIEF ENGINEER

Position Open \$12,000 To \$15,000

**WE ARE** nationally known manufacturers of highest precision electronic recording devices. Our expanding activities in the new fields of magnetic recording and reproducing make it imperative that we find a top calibre executive engineer who can relieve our General Manager by assuming complete responsibility for our engineering and production.

**WE NEED** a seasoned electronics engineer with heavy theoretical and practical background in the design and production of complicated electro-mechanical devices and the development of advanced electronic circuits. Must have unusual ingenuity and an exceptionally high degree of mechanical aptitude.

**WE OFFER** the right man unlimited possibilities in an interesting and professionally challenging job, the position of Vice President, a starting salary to \$15,000 and participation in a long range bonus plan. All replies will be handled in complete confidence by the President of our company.

**Box 610** The Institute of Radio Engineers, Inc.  
1 East 79th St. New York 21, N.Y.

## RADAR ENGINEER- PHYSICIST Wanted!

Must have heavy experience in basic study and research on new radar systems and similar electronic equipment.

Excellent opportunity for Senior man. Juniors please do not apply.

State full particulars. Replies confidential.

Write: A. Hoffsommer

**THE W. L. MAXSON CORPORATION**  
460 W. 34th Street  
New York 1, N.Y.

## Senior Electronic Circuit Physicists

for advanced Research and  
Development

### Minimum Requirements:

1. M.S. or Ph.D. in Physics or E.E.
2. Not less than five years experience in advanced electronic circuit development with a record of accomplishment giving evidence of an unusual degree of ingenuity and ability in the field.
3. Minimum age 28 years.

### HUGHES AIRCRAFT COMPANY

Attention: Mr. Jack Harwood  
Culver City, California

## PHYSICISTS AND ENGINEERS

This established but expanding scientist-operated organization offers excellent opportunities for a future in completely new fields to alert experienced engineers and physicists who are weary of making minor improvements in conventional devices and techniques. Men with sound backgrounds and experience in the design of advanced electronic circuits, computers, or precision mechanical instruments, or with experience in gaseous discharges or applied physics are offered the opportunity to qualify for key positions in expanding and completely new fields. This company specializes in research and development work; its well-equipped laboratories are located in the suburbs of Washington, D.C.

### JACOBS INSTRUMENT CO.

4718 Bethesda Ave.  
Bethesda 14, Maryland

★ ★  ★ ★

## Positions Wanted By Armed Forces Veterans

In order to give a reasonably equal opportunity to all applicants, and to avoid overcrowding of the corresponding column, the following rules have been adopted:

The Institute publishes free of charge notices of positions wanted by I.R.E. members who are now in the Service or have received an honorable discharge. Such notices should not have more than five lines. They may be inserted only after a lapse of one month or more following a previous insertion and the maximum number of insertions is three per year. The Institute necessarily reserves the right to decline any announcement without assignment of reason.

### ENGINEER

M.S.E.E. Purdue, Tau Beta Pi, Sigma Xi. One year experience in circuitry involving pulse techniques. Desires position in development or design. Box 391 W.

### ENGINEERING LAW

B.S.E.E. June 1944, Purdue University. Now in second year of Law at University of Notre Dame. 14 months at Oak Ridge, Tenn., doing electronic and high vacuum work while in Army. Other experience. Single. Age 26. Desires position for summer of 1950. Box 392 W.

### ELECTRONIC ENGINEER

M.F.E. Jan. 1950, Polytechnic Institute of Brooklyn. B.F.E. Cooper Union. Age 25. Graduate school fellowship. N.Y. State Regents scholarship. 2 years as Electronic Technician U.S.N. 1½ years design and development of radar receivers and microwave components. Prefer position in vicinity of New York City. Box 393 W.

### ELECTRICAL ENGINEER

Electrical engineer, graduated ninth in class. Former Navy Electronic Technician. Desires development work in New York City or New Jersey. Salary secondary. Box 394 W.

### COMMUNICATIONS ENGINEER

B.S.E.E. West Virginia University. August 1949, Eta Kappa Nu, Sigma Pi Sigma. Age 24. Married. 2 years AAF Radio Maintenance. Desires communications or electronic work anywhere in U. S. Box 395 W.

### PHYSICIST

M.A. Columbia 1949, physics; B.S. Yale 1943, chemistry, highest honors; Phi Beta Kappa, Sigma Xi. 2½ years Atomic Bomb Project; 1½ years Graduate Assistant. Desires work not exclusively in laboratory using my fundamental background. Box 396 W.

### ELECTRICAL ENGINEER

Graduate of University of Illinois, February 1950. Majored in electronics and communications. Prefer position in New York or New Jersey area. 5 years Army experience with Anti-Aircraft equipment including radar. Engineered a wired-wireless radio station in Champaign, Ill. Box 397 W.

(Continued on page 53A)

Desirable positions at a New England Manufacturing plant specializing in Micro-wave Electron Tube Development and Manufacture.

### SENIOR ELECTRONIC ENGINEER

EE or MS degree. 4 years experience in electronics, preferably high voltage pulse equipment as used for radar. A knowledge of pulse transformers, pulse lines, hard tube modulators, line type modulators, spectrum analyzers and micro-wave transmission lines. Will be responsible for the design and maintenance of pulse equipment for frequency, and DC test equipment and RF plumbing for the testing of micro-wave magnetrons.

### JUNIOR OR SENIOR VACUUM TUBE ENGINEER

The openings are in the field of micro-wave vacuum tube development with special emphasis on magnetrons. Academic experience in micro-wave circuits, vacuum tube construction and design highly desirable. Additional training in theory and construction will be given new employees. The applicants for these positions should have been in the upper half of their class scholastically.

Box 608

The Institute of Radio Engineers, Inc.  
1 East 79th Street, New York 21, N.Y.

## PROJECT ENGINEERS

Real opportunities exist for Graduate Engineers with design and development experience in any of the following: Servo-mechanisms, radar, microwave techniques, microwave antenna design, communications equipment, electron optics, pulse transformers, fractional h.p. motors.

SEND COMPLETE RESUME TO  
EMPLOYMENT OFFICE.

### SPERRY GYROSCOPE CO.

DIVISION OF  
THE SPERRY CORP.  
GREAT NECK, LONG ISLAND

## HELP WANTED MALE

### PRODUCTION ENGINEER

Receiving tube manufacturer needs senior engineer with a minimum of 5 years experience. Some supervisory and administrative background desirable. Location Weatherly, Pa.

### DESIGN ENGINEER

Senior engineer with 3 to 5 years experience in design of all types of receiving tubes. Location, Bloomfield, N.J.

### APPLICATIONS ENGINEER

With background and experience of radio circuit engineering work. Location, Bloomfield, N.J.

Forward resumes to E. J. Danneberg, Tung-Sol Lamp Works Inc., 200 Bloomfield Avenue, Bloomfield, N.J.

## PHOSPHOR RESEARCH

**WESTINGHOUSE RESEARCH** Laboratories in East Pittsburgh, Pa., has immediate need for a Scientist with experience or training in preparation of cathode-luminescent materials for basic research in connection with color Television. For applications write

Manager, Technical Employment, Westinghouse Electric Corporation, 306 Fourth Avenue, Pittsburgh 30, Pa.

## Positions Wanted

(Continued from page 52A)

### JUNIOR ENGINEER

B.E.E. Cooper Union, June 1949, electronics option. Age 26. 6 months of radio test experience. 1 year drafting experience. Studying for M.S.E.E. evenings. Looking hard for a real job. New York City preferred. Box 398 W.

### JUNIOR ENGINEER

B.E.E., Top third New York University, communications major. Graduate work in Administrative Engineering. Some experience in design. Excellent references. FCC 1st. class phone. Lt. Army Signal Corps. Will take graduate work in your field. Relocate anywhere in U.S. Single. Salary secondary to future. Box 399 W.

### ENGINEER

B.S.E.E., M.S.E.E. completion of academic work for Ph.D. in June 1950; Sigma Xi, Sigma Pi Sigma. Age 25. Class A Amateur license 10 years, 1st class Radiotelephone license 5 years, intermittent AM and FM experience; 1 year teaching; 1 year microwave research. Interested in microwave circuitry or antenna research which will lead to thesis credit. Available June 1950. Box 401 W.

### ENGINEER

B.M.E. June 1948. 4½ years Air Force electronics and R.C.M. officer, 2 years telemetering weapons, 1½ years electro-mechanical instrumentation in medical field at leading eastern university. Desires suitable position in/or near Baltimore, Md. Married. Age 29. Box 402 W.

### ELECTRONICS-ENGINEER TEACHER

B.S.E.E. Illinois; M.S.E. Michigan. Desires position teaching or in development work with opportunity to work on Ph.D. 1 year experience in radar development, 3 years Assistant Professor of Electrical Engineering. Served as Electronics Maintenance officer in U.S. Navy. Married. Family. Box 403 W.

### ENGINEER

B.S.E.E. New York University, M.S.E.E. Northwestern 1948, Eta Kappa Nu. Age 25. Married. Experience: Army 1½ years Pulse Code Modulation; 2 years teaching communications at Polytechnic Institute of Brooklyn. Interested in microwaves, UHF, antennas. Box 404 W.

### COMMUNICATIONS ENGINEER

AB cum laude, M.S.E.E., Dartmouth College. Married, Age 27. Experience: 1½ years equipment design, ionosphere research project, 4 years as trainee in Signal Corps, instructor, technical writer, project officer—communications equipment, 8 years organizer and director of choral and orchestral groups. Desires position in which engineering and musical training are valuable—radio work, high fidelity equipment design and development. Box 415 W.

### ELECTRONIC ENGINEER

B.B.A. Sept. 1946, City College of N.Y. B.S.E.E. Cum laude Jan. 1950, M.S. physics, June 1950, University of New Hampshire. Pi Mu Epsilon. Phi Kappa Phi. Married. Age 27. 3 years training and experience as radar officer in Anti-Aircraft Artillery. Desires work in production and quality control of electronic equipment. Box 416 W.

(Continued on page 54A)

## THE TWIN TUBE POCKETSCOPE

BY WATERMAN

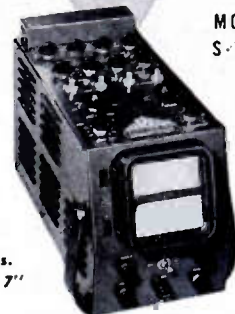

MODEL S-15-A

Wt. 16¼ lbs.  
12" x 6" x 7"

A new concept in multiple trace oscilloscopy made possible by Waterman developed RAYONIC rectangular cathode ray tube, providing for the first time, optional screen characteristics in each channel. S-15-A is a portable twin tube, high sensitivity oscilloscope, with two independent vertical as well as horizontal channels. A "must" for investigation of electronic circuits in industry, school, or laboratory.

Vertical channels: 10mv rms/inch, with response within -2DB from DC to 200kc, with pulse rise of 1.8µs. Horizontal channels: 1v rms/inch within -2DB from DC to 150kc, with pulse rise of 3µs. Non-frequency discriminating attenuators and gain controls, with internal calibration of traces. Repetitive or trigger time base, with linearization, from ½cps to 50kc, with ± sync. or trigger. Mu metal shield. Filter graph screen. And a host of other features.

## WATERMAN PRODUCTS CO., INC.

PHILADELPHIA 25, PA.  
CABLE ADDRESS: POKETSCOPE

### WATERMAN PRODUCTS INCLUDE:

|                         |             |
|-------------------------|-------------|
| S-10-B GENERAL          | POCKETSCOPE |
| S-11-A INDUSTRIAL       | POCKETSCOPE |
| S-14-A HI-GAIN          | POCKETSCOPE |
| S-14-B WIDE BAND        | POCKETSCOPE |
| S-21-A LINEAR TIME BASE |             |

Also RAKSCOPES, LINEAR AMPLIFIERS, RAYONIC® TUBES and other equipment



# Got a Problem?

## IN SHEET METAL

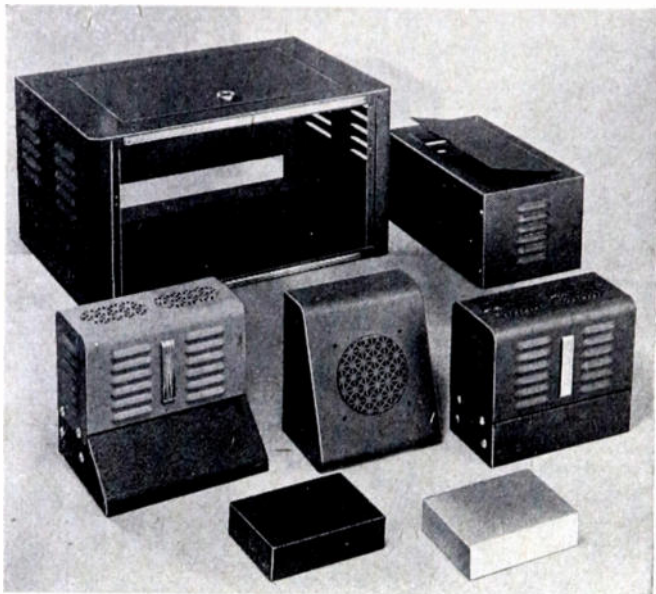

Regardless of your need for sheet metal housings, we probably have a stock item that will fulfill your requirements. OFTEN A SLIGHT CHANGE IN ONE OF OUR STANDARD MODELS WILL ELIMINATE THE NECESSITY OF A SPECIAL DESIGN. Of course we are always glad to quote on any steel or aluminum chassis, box, or cabinet directly from your blue print.

Our facilities, years of experience and "know-how" assure you that you always get the highest quality at the lowest price.

Whether your requirements are ONE OR A MILLION, you will save time and money by consulting us first. The Bud catalog gives complete, concise description of all our products including sizes, applications and prices. Write for a copy today.

RELAY RACKS  
CHASSIS  
CABINETS  
CONDENSERS  
COILS  
CHOKES  
TEST LEADS

THESE ARE SOME OF THE 1274 ITEMS AVAILABLE FROM BUD RADIO, INC.

### BUD RADIO, INC.

2110 E. 55th ST. • CLEVELAND 3, OHIO

Pioneer in Radio Engineering Instruction Since 1927

# CAPITOL RADIO

## ENGINEERING INSTITUTE

An Accredited Technical Institute

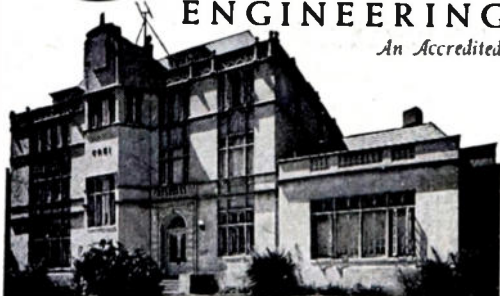

ADVANCED HOME STUDY AND RESIDENCE COURSES IN PRACTICAL RADIO-ELECTRONICS AND TELEVISION ENGINEERING

Request your free home study or resident school catalog by writing to:

DEPT. 265B  
16th and PARK ROAD, N.W.,  
WASHINGTON 10, D.C.  
Approved for Veteran Training

## Positions Wanted

(Continued from page 53A)

### PHYSICIST

Ph.D. in physics, University of Texas, June 1950. Age 30. Married. Several years experience in microwave work. Also Army radar officer. Desires position in southwest, teaching and/or research. Box 417 W.

### SERVO ENGINEER

M.S.E.E. servomechanisms major, Ohio State University, June 1950; B.S.E.E. University of Wisconsin 1944. Age 27, married. 3 years experience in research and development of small electromechanical systems plus 2 years Navy electronics. Box 418 W.

### PHYSICIST

B.S. physics, Feb. 1950, Columbia University. Age 23. 23 months Naval electronics. 3 months Student Aide physicist, radionic design. Desires work in applied physics with opportunity for graduate work. Single. New York area preferred. Box 419 W.

### ELECTRONIC ENGINEER

B.E.E. October 1948. 8 months experience trouble-shooting IBM machines; 6 months radio repair school in Signal Corps. Desires position in south or mid-west in development work of transformers, electronics or power. Available March 1950. Box 420 W.

(Continued on page 55A)

## RCA VICTOR Camden, N. J.

### Requires Experienced Electronics Engineers

RCA's steady growth in the field of electronics results in attractive opportunities for electrical and mechanical engineers and physicists. Experienced engineers are finding the "right position" in the wide scope of RCA's activities. Equipment is being developed for the following applications: communications and navigational equipment for the aviation industry, mobile transmitters, microwave relay links, radar systems and components, and ultra high frequency test equipment.

These requirements represent permanent expansion in RCA Victor's Engineering Division at Camden, which will provide excellent opportunities for men of high caliber with appropriate training and experience.

If you meet these specifications, and if you are looking for a career which will open wide the door to the complete expression of your talents in the fields of electronics, write, giving full details to:

National Recruiting Division  
Box 550, RCA Victor Division  
Radio Corporation of America  
Camden, New Jersey

## Positions Wanted

(Continued from page 54A)

### ELECTRO-MECHANICAL ENGINEER

B. Aero. E. 1948. B.E.E. 1950. 2 years Navy and industrial electronic technician. 1 year M.E. development, servo-controlled aircraft radar. Some E.E. work on instruments and dielectric heating. Desires servo, instrument, TV or technical writing position. New York City area. Box 421 W.

### ENGINEER

B.S.E.E. University of Washington 1947. Age 27. Married. AAF radio mechanic and instructor, GCA radar mechanic course with honors; 2½ years engineering specification department, telephone switching manufacturer. Desires position with communications or electronics manufacturing firm. Location secondary. Box 422 W.

### JUNIOR ELECTRONIC ENGINEER

B.S.E.E. June 1950. University of Connecticut. Age 26. Married, child. 27 months as Navy electronic technician, plus other experience. Prefer design, development, research in communication field. Will relocate anywhere. Resume on request. Box 423 W.

### JUNIOR ELECTRICAL ENGINEER

B.E. (E.E. major) February 1950, University of Toledo. Married. Age 29. Graduate of Navy radar, gyro and interior communications schools. Desires electronic work any where in U. S. Box 424 W.

### BUSINESS ADMINISTRATION-ENGINEER

B.S. Business Administration, major accounting, Wayne University, June 1949, age 27, married. Broad background in radio communications. Desires employment in accounting department of electronics or communications anywhere in U. S. where knowledge of electronics and accounting can be combined. Commercial and amateur licenses. Experience with airborne radio and high-power radio teletype equipment. Box 426 W.

### ENGINEER

B.S.E.E. Columbia June 1950. Age 27, single. 3 years experience as radio technician, building, operating and repairing electronic equipment and assisting in application engineering projects. Work preference: application engineering. Desired location: metropolitan N.Y. Box 427 W.

### ELECTRONIC-CHEMICAL ENGINEER

Electronic-chemical engineer, age 27. B.S. in Chemical Engineering and in E.E. 1949, M.S. in E.E. January 1950. University of Wisconsin. Some Signal Corps radio school experience. Single. Will locate anywhere. Box 428 W.

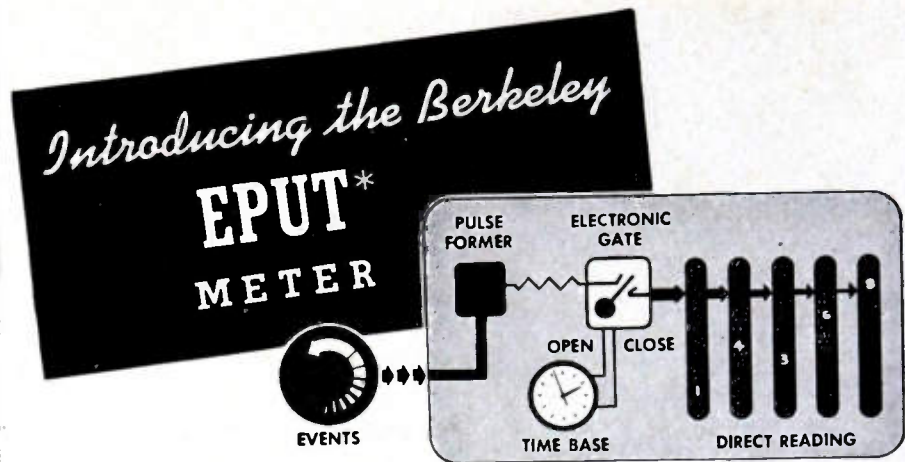

**NOW . . . determine Events-Per-Unit-Time\* automatically with a single, compact direct-reading instrument!**

Any physical, electrical or optical events of unknown occurrence rate that can be translated into changing voltages can be accurately counted during a precisely-measured time interval of one second. (Time base other than one second can be provided.)

In frequency measurements, for

example, each cycle occurring during the accurately timed one-second interval is individually counted and the total displayed in direct-reading numerals on the illuminated front panel. Maximum counting rate is 100,000 per second; accuracy is  $\pm 1$  event regardless of rate.

Send for bulletin for full, detailed description.

# Berkeley Scientific Company

SIXTH AND NEVIN AVENUE • RICHMOND, CALIF.

## Test Equipment FOR RADAR and PULSE APPLICATIONS



### MODEL 712 SWEEP CALIBRATOR

Pip markers at 2.5, 10, 50, and 100 microseconds; spacings either positive or negative. Internal or external trigger from 200 cps to 3000 cps. Continuously variable gate on markers to 2500 microseconds. Accuracy within 0.2% with ambient of 10°C to 65°C. Calibrate directly from CW frequency standard. Power—115 volts 60 to 400 cycles, 85 volt-amperes.

### MODEL 708 SPECTRUM ANALYZER

Frequency range—8500 mc to 9600 mc. IF bandwidth—approximately 100 kc. Sweep frequency—10 cps to 25 cps. Minimum frequency dispersion—1 mc/inch. Maximum frequency dispersion—10 mc/inch. Signal input attenuator—100 db linear. Power—115V or 230V, 50 cps to 800 cps.

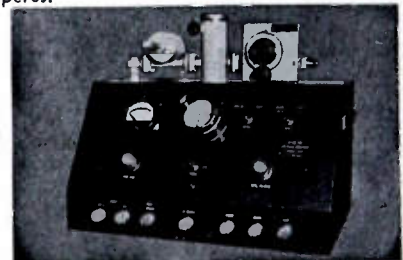

Write for complete technical data

# Canoga Corporation

14315 Bessemer St., Van Nuys, Calif. • Box 361

*Gold Plated*  
**TUNGSTEN**  
 and  
**MOLYBDENUM**  
**GRID WIRE**

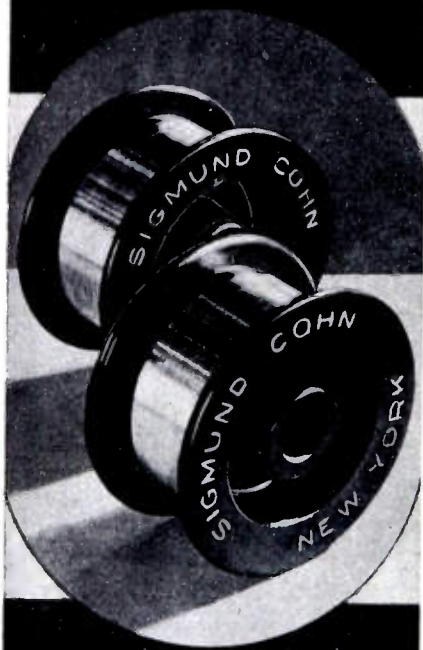

Made to meet your specifications for gold content and diameter . . .

Write for details and list of products

**SIGMUND COHN CORP.**

44 GOLD ST., NEW YORK



**News—New Products**

These manufacturers have invited PROCEEDINGS readers to write for literature and further technical information. Please mention your I.R.E. affiliation.

(Continued from page 49A)

**Recording Counting Rate Computer**

In collaboration with the Radiation Laboratory at the University of California and of the U. C. Medical School, a new instrument has been developed by Berkeley Scientific Co., Sixth & Nevin Ave., Richmond, Calif.

This recording counting rate computer, Model 1600 is capable of recording rapidly changing counting rates with speed of response limited only by statistical accuracy required. The Model 1600 employs a simple electronic computing device in conjunction with the output of any standard Geiger Mueller Scaler. Counting rate versus time is recorded on a calibrated moving strip chart. The instrument is fully portable and convenient for use in laboratory, the field, or medical therapy.

**Feedback Problems Calculator**

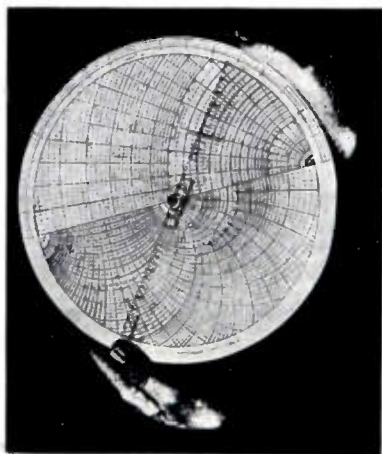

A commercial version of the Mu-Beta Effect Calculator for feedback problems is being produced by Graphimatics, 201 N. Taylor, Kirkwood 22, Mo.

The 10-inch calculator is cut from a solid disk of vinelite, protected by a chemically deposited transparent surface.

Complete instructions and five examples of the use of the calculator are printed on the reverse side. Reprints of the article, "Calculator and Chart for Feedback Problems," are available on request.

**New Recorder Plots X vs. Y Automatically**

A new Speedomax recorder that automatically plots the relationship between two variables, showing one as a function of the other, has been developed by Leeds & Northrup Co., 4934 Stenton Ave., Philadelphia 44, Pa.

(Continued on page 57A)

**COSSOR**  
*for* **QUALITY**

**TWIN BEAM OSCILLOSCOPES**

compare . . .

**INPUT VS. OUTPUT  
 VOLTAGE VS. CURRENT  
 CAUSE VS. EFFECT**

with twin beams in exact time synchronism plus accurate voltage and time measurement controls at your fingertips.

**IS YOUR WORK TV?**

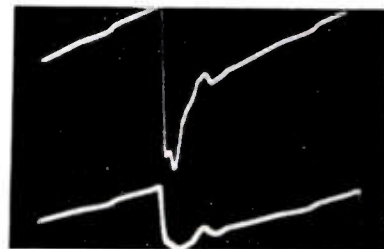

TV horizontal output tube waveform  
 upper trace—grid volts  
 lower trace—cathode current

**STUDY THIS PHOTO**—note exact phase comparison given by unique Cossor twin beam tube. . .no need for electronic switching with attendant troubles.

Photographed on Cossor Model 1035 with Model 1428 Camera.

Cossor simplifies scope photography.

Model 1035 Scope for wide band amplifiers and fast traces.

Model 1049 Scope for DC amplifiers and slow traces.

both with the **COSSOR TWIN BEAM TUBE**

Write today for details and demonstration.

**ALL MODELS AND COMPLETE SPARES IN STOCK NEW YORK AND HALIFAX**

**COSSOR (CANADA) LIMITED**

Windsor St., Halifax, Nova Scotia



**BEAM INSTRUMENTS CORP.**

Room 208, 55 W. 42nd Street,  
 New York 18, N. Y.

## News—New Products

These manufacturers have invited PROCEEDINGS readers to write for literature and further technical information. Please mention your I.R.E. affiliation.

(Continued from page 56A)

The variables to be plotted are converted dc signals and connected to the instrument, one to the horizontal axis and the other to the vertical axis. The result is a permanent record, accurately plotting in minutes data that would require hours using the usual point by point method.

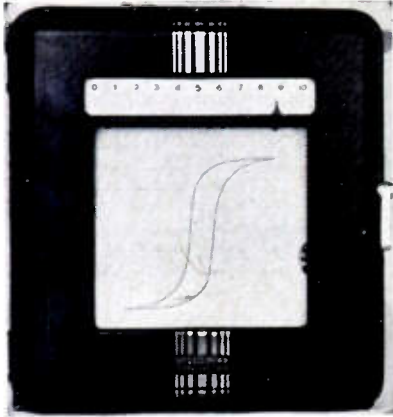

As compared to the usual recorder, which has one measuring circuit and a constant speed nonreversing chart paper drive and which plots a variable as a function of time, this new recorder has two measuring circuits. Pen travel (*X* axis) is controlled by Speedomax *G* electronic circuit. A similar circuit controls the chart paper drive, (*Y* axis) and makes it reversible. Thus, the new recorder makes it possible automatically to draw curves such as a hysteresis loop, temperature vs. temperature difference, stress vs. strain or other two variable curves.

### DC Power Supply

An electronic cell to supply any specified dc output voltage from 0 to 100 volts and for any load up to 30 ma is available from the manufacturer, Hastings Instrument Co., Inc., Box 1275, Hampton, Va.



Output voltage is constant to better than 0.1 per cent and with ripple less than 0.1 per cent, throughout an input range of 75 to 135 volts ac at frequencies from 50 to 400 cps.

Described as the Electronic Standard Cell, the instrument may be used over a wide temperature range and is not damaged by momentary short circuits.

(Continued on page 58A)

## Simple • Reliable • Economical Potter decimal counter

Highest quality pretested components, conservative ratings

Four large, easy reading, bulls-eye glow lamps — replaceable socket type

All components turret-lug mounted and accessible . . . all wiring color coded

Special silver plated, self-aligning contact and rigid connectors for positive mechanical mounting

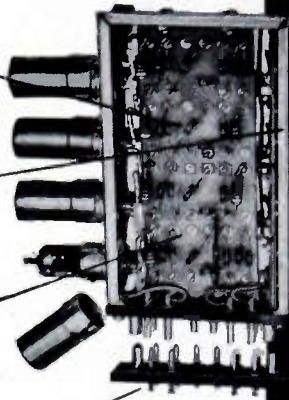

DIRECT DECIMAL READ-OUT — FOUR NEON GLOW LAMPS DESIGNATED 1-2-4-8 PROVIDE DIRECT INDICATION (0-9) AND INSTANTANEOUS LOCATION OF ANY DEFECTIVE TUBE.

STABLE OPERATION — WIDE VOLTAGE RANGE.

HIGH COUNTING RATES — UP TO 130,000 PER SECOND ABSOLUTE ACCURACY GUARANTEED.

COVERED BY BOTH I.B.M. AND POTTER PATENTS ISSUED AND PENDING

WRITE DEPT 3-A FOR COMPLETE INFORMATION AND QUANTITY DISCOUNTS

A NEW LOW UNIT PRICE OF \$45.00 IS ANNOUNCED AS A RESULT OF WIDE ACCEPTANCE AND QUANTITY PRODUCTION

**POTTER INSTRUMENT CO.**

INCORPORATED

136-56 ROOSEVELT AVE., FLUSHING



## CONTINUOUSLY VARIABLE FILTERS

MODEL 302

VARIABLE ELECTRONIC FILTER



### "Another SKL first"

The — SKL — Model 302 includes two independent filter sections, each having a continuously variable cut-off range of 20 cps to 200 KC. Providing a choice of filter types each section has 18 db per octave attenuation. When cascaded 36 db is obtained in the high and low pass setting and 18 db in the band pass position. With low noise level and 0 insertion loss this versatile filter can be used as an analyzer in the communications laboratory, radio broadcasting, recording and moving picture industries.

### SPECIFICATIONS

- CUT-OFF RANGE  
20 cps to 200 KC
- SECTIONS  
2—can be high, low and band pass
- ATTENUATIONS  
36 db/octave maximum
- INSERTION LOSS . 0 db
- NOISE LEVEL  
70 db below 1 volt
- FREQUENCY RESPONSE  
2 cps to 2 MC

**SKL SPENCER-KENNEDY LABORATORIES, INC.**  
181 MASSACHUSETTS AVE., CAMBRIDGE 39, MASS.

# IT'S KINGS FOR CONNECTORS

# News—New Products

These manufacturers have invited PROCEEDINGS readers to write for literature and further technical information. Please mention your I.R.E. affiliation.

(Continued from page 57A)

## Regulated DC Supply

A regulated supply of dc with a continually variable output from 0 to 500 volts has been developed by **Chatham Electronics Corp.**, 475 Washington St., Newark 2, N. J.

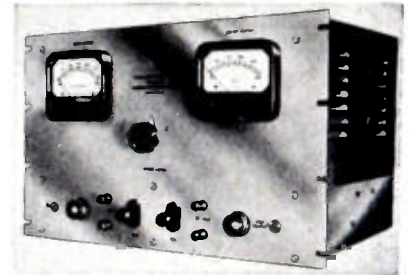

Regulation between 10 and 30 volts is 2 per cent; between 30 and 500 volts it is 1 per cent. Output is from 0 to 500 volts dc; 6.3 volts at 10 amperes (nonregulated) ac.

Described as EA-50A, this unit is suitable for relay rack or cabinet mounting.

## Packaged Resistor Assortment

A large industrial assortment of resistors, factory packed in plastic cabinets, is now being produced by **Ohmite Mfg. Co.**, 4835 Flournoy St., Chicago 44, Ill.

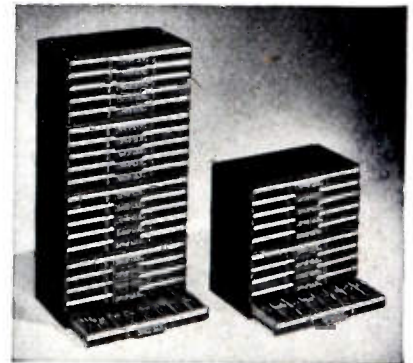

Resistance values in each assortment cover the complete RMA range in either  $\pm 5$  or  $\pm 10$  per cent tolerance.

There is a choice of  $\frac{1}{2}$ , 1, 2, or assorted wattage sizes, each of these in either  $\pm 5$  or  $\pm 10$  per cent tolerance. Assortment quantities vary from 510 to 2,025 resistors.

## Radiation Survey Meter

A 5-range ionization chamber-type gamma survey meter covering a range from 0-5 mr/hr to 0-50,000 mr/hr has been developed by the **Instrument Div., Kelley-Koett Mfg. Co.**, 12 E. 6th St., Covington, Ky.

(Continued on page 59A)

Pictured here are some of the more widely used R. F. co-axial, U. H. F. and Pulse connectors. They are all Precision-made and Pressurized when required. Over 300 types available, most of them in stock.



Backed by the name **KINGS**—the leader in the manufacture of co-axial connectors. Write for illustrated catalogs. Department "T"



Manufacturers of Radar, Whip, and Aircraft antennas  
Microphone Plugs and Jacks.  
Radar Assemblies, Cable Assemblies, Microwave and  
Special Electronic Equipment

**Kay-Lab**  
LOGATEN

## LOGARITHMIC ATTENUATOR

THERMOSTATICALLY CONTROLLED  
50 DB RANGE



**ACCURATE**

**STABLE**

Output voltage is the logarithm of input voltage

Write for Bulletin 511b

**KALBFELL LABORATORIES, INC.**  
1076 Morena Boulevard  
San Diego 10, California



## News—New Products

These manufacturers have invited PROCEEDINGS readers to write for literature and further technical information. Please mention your I.R.E. affiliation.

(Continued from page 58A)

This model, K-350, has a scale changing meter with only one range visible at a time. There are separate scales for the five ranges: 0-5, 0-50, 0-500, 0-5,000, and 0-50,000 mr/hr.

This meter has a  $\pm 10$  per cent accuracy over a range from  $-10^{\circ}$  to  $125^{\circ}\text{F}$ .

### Four-Section Spiral-Type Inputuner

A four-section spiral-type inputuner which has twice the gain of previous models has been designed by Electronics Parts Div., Allen B. DuMont Labs., Inc., 35 Market St., East Paterson, N. J.

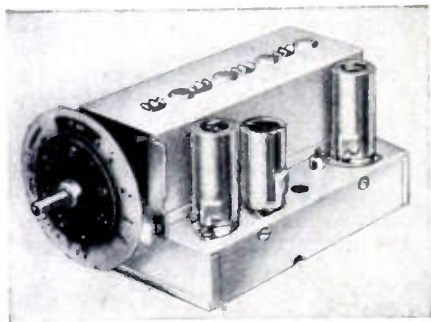

Range is continuous from 54 to 216 Mc, television channels 2 to 13, and the FM band. By means of an incorporated input transformer, efficient operation on either 300- or 72-ohm antenna systems is obtained.

### Shock Resistant Meters

A new group of shock and vibration resistant panel meters is at present available from Marion Electrical Instrument Co., 400 Canal St., Manchester, N. H.



Described as the "Ruggedized" line, these instruments have a redesigned basic D'Arsonval type dc movement which is internally shock-mounted.

Detailed information regarding these meters and the other improvements which have been incorporated may be obtained directly from the manufacturer.

(Continued on page 60A)



MODEL 36B

## BROAD BAND DC-AMPLIFIER

0-1,000,000 CYCLES

Stable, High Gain, No Overshoot on Square Waves. Equipped with Illuminated Dial Meter and Internal DC Calibrating Voltage that Permits Use as Sensitive DC Voltmeter. Shielded Low-Capacitance Two-Conductor Input Cable.

Voltage Gain 10,000 to Balanced Output, 5,000 to Unbalanced Output. Either Balanced or Unbalanced Input. Peak Undistorted Output of One Watt into 6,000 Ohms, or 220 Volts into High Impedance.

*Electro-Mechanical Research, Inc.*

RIDGEFIELD, CONNECTICUT

## NEW WIDE BAND D.C. AMPLIFIER MODEL 120

A precision instrument designed for use as a preamplifier in conjunction with an oscilloscope, vacuum tube voltmeter or other instruments.

### SPECIFICATIONS

FREQUENCY RESPONSE: Within  $\pm 1$  db between D.C. and 100,000 cycles per second.

GAIN: Approximately 100.

INPUT CONNECTION: Double channel, can be used for single ended and push-pull signals or as a differential amplifier.

INPUT IMPEDANCE: One Megohm shunted by approximately 15mmf in each channel.

DUAL INPUT ATTENUATOR: One to one, 10 to one, 100 to one and "off" positions in each channel independently adjustable.

OUTPUT CONNECTION: Push-pull or single ended.

OUTPUT IMPEDANCE: Less than 50 Ohms single ended or 100 Ohms push-pull.

HUM AND NOISE LEVEL: Below 40 Microvolts referred to input.

LOW DRIFT due to regulated heater voltage in input stage ( $\pm 1$  millivolt referred to input)

MOUNTING: Metal cabinet approximately 7" wide by 7" high by 11" deep.



**FURST ELECTRONICS**

14 S. Jefferson St., Chicago 6, Illinois

# New Type 2A TAP SWITCHES

HAVE A CONSTANT CONTACT RESISTANCE OF  
**ONLY 1 or 2 MILLIOHMS!**

These high quality switches with up to 24 contacts were specifically developed to meet the need for rugged precision instrument switches that have longer operating life and are economical components in competitively priced electronic instruments and military equipment.

Write for Technical Bulletin No. 28.

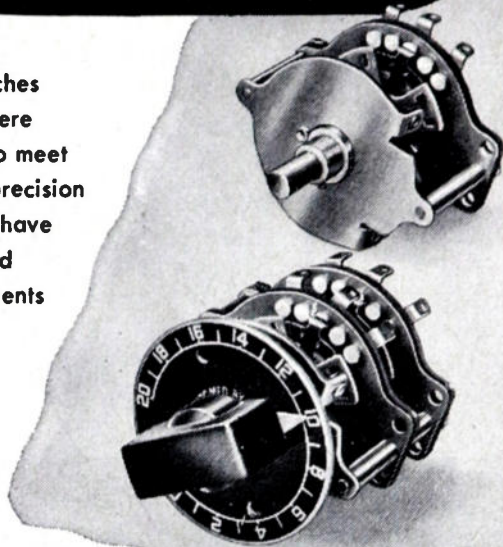

**TECH LABORATORIES** PALISADES PARK  
NEW JERSEY

## VERSATILITY + ACCURACY



Price \$950 f.o.b. Portland, Oregon

**ACCURATE . . .** In addition to waveform observation, the **Type 512** provides direct reading quantitative measurements. Precision components and stabilized circuits permit the use of approximately 50 inches of scale on both time and amplitude dials, giving accuracies of 5% or better at all points.

**DIFFERENTIAL INPUT • DELAYED TRIGGER • SWEEP MAGNIFICATION**

Please write or wire for complete specifications.



**TEKTRONIX, INC.**

Cables, Tektronix  
712 S.E. Hawthorne Blvd. Portland 14, Ore.

**VERSATILE . . .** The **Tektronix Type 512** Oscilloscope is capable of meeting most requirements in the varied fields of SONAR, RADAR, GEOPHYSICS and BIOPHYSICS. With a vertical amplifier band width of DC to 2 mc and sweep speed range from .3 sec/cm to 3 microsec/cm the observation of either low or high speed phenomena is readily accomplished.

## News—New Products

These manufacturers have invited PROCEEDINGS readers to write for literature and further technical information. Please mention your I.R.E. affiliation.

(Continued from page 59A)

### Variable Electronic Filters

Model 300 single-section, and Model 302 dual-section variable electronic filters with a continuously variable cutoff from 20 cps to 200 kc are announced by **Spencer-Kennedy Labs., Inc.**, 186 Massachusetts Ave., Cambridge 39, Mass.

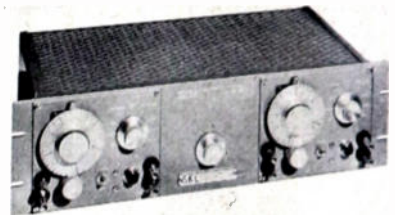

Each section has an attenuation rate of 18 db per octave, and sections can be cascaded to provide 36-, 54-, etc. db attenuation. A range switch selects the type of section desired—high-pass or low-pass—as well as four-decade frequency ranges. The Model 302 can be switched to a band-pass position so that any bandwidth between 20 cps and 200 kc can be selected.

### Ohm's Law Calculator

A new pocket-size Ohm's Law calculator, featuring separate slide-rule and parallel resistance scales, has just been announced by **Ohmite Manufacturing Co.**, 4937 Flournoy St., Chicago 44, Ill.

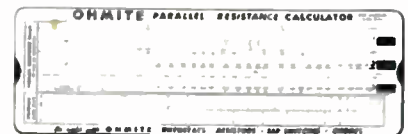
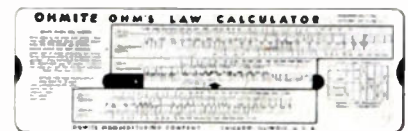

Like previous Ohmite calculators, the redesigned calculator provides a simple means of solving resistance problems. With one setting of the slide it gives the answer to any Ohm's Law problem—reading directly in ohms, volts, amperes and watts.

The redesigned calculator, however, has new features which make it even more useful. Two new scales on the back provide a standard slide rule as well as a quick, one-setting means of solving parallel resistance problems. The slide rule will multiply, divide, and find squares and square roots.

The electrical scales on the new calculator cover all values of resistance, current, voltage, and wattage commonly encountered.

(Continued on page 61A)

# NEWS—NEW PRODUCTS

These manufacturers have invited PROCEEDINGS readers to write for literature and further technical information. Please mention your I.R.E. affiliation.

(Continued from page 60A)

## Servomechanisms Testing Equipment

A new instrument, the Servoscope, for analyzing, testing, and synthesizing servomechanisms has been designed by Servo Corp. of America, 20-20 Jericho, Turnpike, New Hyde Park, N. Y.



The Servoscope accepts any carrier from 50 to 800 cps without adjustment, modulates the selected carrier with any envelope from 0.1 to 20 cps (0.15 to 30 cps) r; other ranges are also available.

## Plastic-Sealed Paper Capacitors

Smaller paper tubular capacitors, designated as Type P85, featuring the same materials and processes as the Aerocon Type P 87, are announced by Aerovox Corp., New Bedford, Mass.

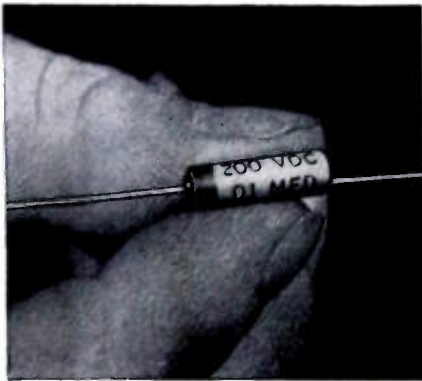

The paper section of the Type P 85 is Aerolene-impregnated, and the capacitor is sealed with Duranite. They can be used at temperatures up to 212° F without drips.

## Plant Expansion

The representative organization of Burlingame Associates and its affiliate Brujac Electronic Corp. announce that they have increased facilities and moved to larger quarters at 103 Lafayette St., New York 13, N. Y.

The organization has been distributing electronic instruments, devices, and components for over 22 years, and now covers the area from Washington, D. C., to Buffalo, N. Y., and the New England States.

## Direct-Coupled Thyatron Power Supplies

A new series of electronically regulated and stabilized power supplies, utilizing a new type of direct-coupled amplifier to control a pair of Thyatron rectifier tubes, is in production at the Industrial Div., Amplifier Corp. of America, 398-1 Broadway, New York 13, N. Y.

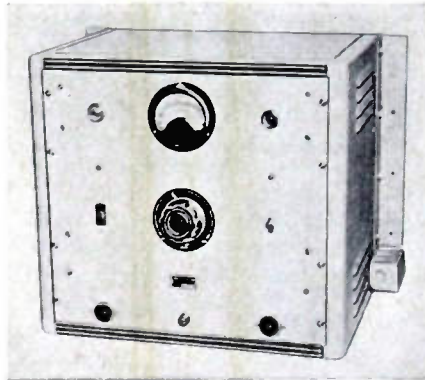

Two separate series of 250 watt (output power) supplies are available. The Standard Series is stabilized against line changes of 90 to 130 volts within  $\pm 0.5$  per cent, and load regulated within  $\pm 0.5$  per cent from no load to full load. The Super Series, with a more sensitive error control circuit, is line stabilized and load regulated to well within  $\pm 0.1$  per cent.

The stabilization control circuit provides full load stabilization in less than one second, under conditions of minimum to maximum full load changes. Line voltage stabilization takes place within  $\frac{1}{2}$  second. Ripple is less than 1 per cent at full rated output, and proportionately lower under partial load conditions.

## New Voltmeter

A new model of the Mini-Volt voltmeter featuring an expanded scale centered on the common 110 and 220 line voltages is now available from Industrial Devices, Inc., Edgewater, N. J.



This Mode 410A is accurate to within 2 volts at 100 volts ac. It is equipped with a neon indicator guaranteed for 25,000 hours.

(Continued on page 62A)



FOR  
BETTER  
PERFORMANCE  
BETTER BUY  
Acme  Electric  
TRANSFORMERS

Acme Electric has been identified with the electronic industry since the crystal set days. The vast store of experience that Acme engineers have accumulated over these many years can be of considerable value in helping you solve your electronic transformer problems. We offer transformer engineering cooperation and facilities to build quality transformers in quantity production.

**ACME ELECTRIC CORP.**

454 Water Street

Cuba, N. Y., U. S. A.

**Acme  Electric**  
TRANSFORMERS

# ELECTRONICALLY REGULATED LABORATORY POWER SUPPLIES



**BENCH  
MODEL 25**

• STABLE  
• DEPENDABLE  
• MODERATELY  
PRICED  
•

- **INPUT:** 105 to 125 VAC. 50-60 cy
- **OUTPUT #1:** 200 to 325 Volts DC at 100 ma regulated
- **OUTPUT #2:** 6.3 Volts AC CT at 3A unregulated
- **RIPPLE OUTPUT:** Less than 10 millivolts rms

WIDTH 14"  
DEPTH 6"  
HEIGHT 8"  
WT: 17 LBS.

For complete information write for Bulletin G



**LAMBDA ELECTRONICS  
CORPORATION**  
CORONA NEW YORK

## PROCEEDINGS OF THE — 1949 — NATIONAL ELECTRONICS CONFERENCE — CHICAGO —

Now Available

60 Papers on Electronics research and development in this 575-page cloth-bound volume just off the press.

Mail Your Coupon Now To Obtain Your Copy of This Limited Edition.

NATIONAL ELECTRONICS  
CONFERENCE, INC.  
852 East 83rd St. Dept. IRS  
Chicago 19, Illinois

I enclose \$4.00 (check or money order) for which please send me one (1) copy of the Proceedings of the 1949 National Electronics Conference.

Name .....  
Street Address .....  
City ..... Zone ..... State .....

(Proceedings of previous conferences available upon request)

## NEWS—NEW PRODUCTS

The manufacturers have invited PROCEEDINGS readers to write for literature and further technical information. Please mention your I.R.E. affiliation.

(Continued from page 61A)

### Subminiature Terminals

Production of a new line of small terminal lugs is announced by U. S. Engineering Co., Dept. O., 521 Commercial St., Glendale 3, Calif.

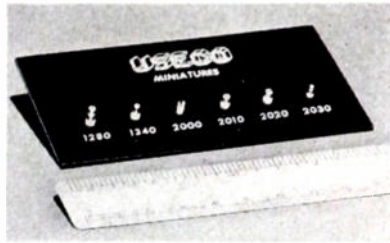

These terminals are silver-plated and treated to prevent corrosion. They should be of interest to all manufacturers of small devices and equipment.

### RF Waveform Monitor

An rf waveform monitor, Type 5034-A, is announced by the Television Transmitter Div., Allen B. DuMont Labs., Inc., Clifton, N. J.



This equipment is designed for use in TV broadcast installations to monitor the unrectified rf signal at the rf transmission line. The cathode-ray tube displays the rf carrier voltage on a linear time base at either field or line frequency. Further provision is made for measuring the relative amplitude of the various portions of the rf envelope. By adjusting the meter reading to full scale when a sync peak is positioned to reference line, the meter is calibrated to read any modulation level directly as "percentage of peak signal."

Among the features of this monitor are: self-contained power supply; less than 10 watts of peak rf power required to produce a peak-to-peak deflection; and a simple gas-triode linear sweep circuit. The accuracy of any amplitude measurement with respect to the peak signal value is within  $\pm 2$  per cent for peak-to-peak signal deflections of over 3 inches in the cathode-ray tube.

### Recent Catalogs

••• A new technical Bulletin No. 342, entitled "The Oscillograph In Modern AM, FM, and TV Service," by Walter Weiss is available from Hickok Electrical Instrument Co., 10514 DuPont Ave., Cleveland 8, Ohio.

••• A 44-page Catalog "C" presenting the line of standard signal, TV signal, pulse and square-wave generators, megacycle meters, vacuum-tube voltmeters, and other "Laboratory Standards" by Measurements Corp., Boonton, N. J.

Also available is the first issue of "Measurements Notes," a 4-page catalog describing the use of the Model 59 Megacycle Meter in the design and construction of traps and filters for the elimination of TV interference.

••• Engineering Bulletin No. 58, for stacking high-band antennas, is available from Technical Appliance Corp., Sherburne, N. Y.

••• A new booklet "Reverse Aluminum Products," explaining production economies, and a number of illustrations of aluminum fabrications may be obtained from Revere Copper & Brass, Inc., 230 Park Ave., New York 17, N. Y.

## Look It Up In Your IRE Directory

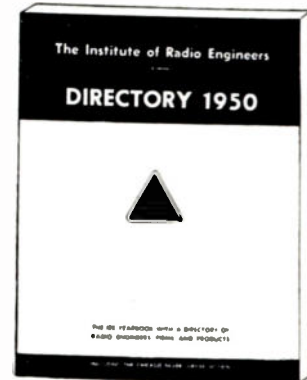

Use its Engineering  
Product Listings

## News—New Products

These manufacturers have invited PROCEEDINGS readers to write for literature and further technical information. Please mention your I.R.E. affiliation.

(Continued from page 62A)

### Self-Healing Paper Capacitor

A new midget self-healing metallized paper capacitor in both hermetically sealed and cardboard tubular designs is now being marketed by the manufacturer, **Astron Corp.**, 900 Passaic Ave., East Newark, N. J.

These capacitors, trade-named Metalite, are available in voltage ratings up to 600 volts, and are supplied in a hermetically sealed construction with glass-to-metal terminal seals.

### New Portable Recorder

A new combination recorder and reproducer, portable and battery operated, is available from the manufacturer **Miles Reproducer Co., Inc.**, 812-814 Broadway, New York 3, N. Y.

Known as "Walkie-Recordall," this instrument weighs 8 pounds, and measures 4x8x10 inches.

Models are available for continuous recording up to 3½ hours at a cost of 2½ cents an hour. Recordings are made on an endless plastic belt.

### TV Sweep Signal Generator

A new sweep signal generator, designed for servicing FM and television receivers, has been announced by the **Radio Tube Div., Sylvania Electric Products Inc.**, 500 Fifth Ave., New York 18, N. Y.



The instrument incorporates electronically controlled sweep circuits and provides sweep linearity and consequent distortion-free scope patterns. FM sweep range is from 0 to 600 kc; television sweep 0 to 15 Mc. Fundamental output frequencies are provided that range from 2 to 230 Mc, in four bands.

Output is at least 100 millivolts on all bands controlled by the attenuator. Double shielding prevents signal leakage and frequency stability is assured by voltage regulated power supply. Wide-range phasing control permits adjustment for single oscilloscope response curve. Voltage for driving or synchronizing horizontal oscilloscope deflection is provided.

## CO-AX AIR-SPACED ARTICULATED R.F. CABLES

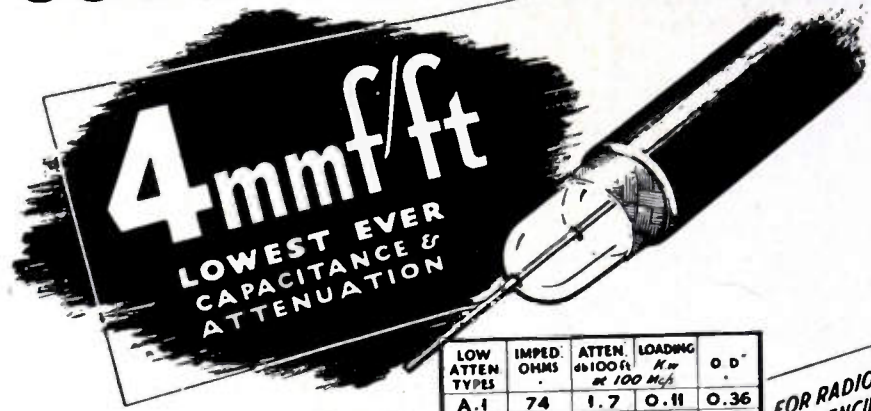

**4mm/ft**  
LOWEST EVER  
CAPACITANCE &  
ATTENUATION

| LOW ATTEN TYPES | IMPED. OHMS | ATTEN db/100ft at 100 Mc | LOADING K <sub>W</sub> | Ø D" |
|-----------------|-------------|--------------------------|------------------------|------|
| A.1             | 74          | 1.7                      | 0.11                   | 0.36 |
| A.2             | 74          | 1.3                      | 0.24                   | 0.44 |
| A.34            | 73          | 0.6                      | 1.5                    | 0.85 |

FOR RADIO FREQUENCIES

We are specially organized to handle direct enquiries from overseas and can give **IMMEDIATE DELIVERIES TO U.S.A.**

HIGH POWER FLEXIBLE

| LOW CAPAC TYPES | CAPAC. mm <sup>2</sup> /ft | IMPED. OHMS | ATTEN db/100ft at 100 Mc | Ø D" |
|-----------------|----------------------------|-------------|--------------------------|------|
| C.1             | 7.3                        | 150         | 2.5                      | 0.36 |
| PC.1            | 10.2                       | 132         | 3.1                      | 0.36 |
| C.11            | 6.3                        | 173         | 3.2                      | 0.36 |
| C.2             | 6.3                        | 171         | 2.15                     | 0.44 |
| C.22            | 5.5                        | 184         | 2.8                      | 0.44 |
| C.3             | 5.4                        | 197         | 1.9                      | 0.64 |
| C.33            | 4.8                        | 220         | 2.4                      | 0.64 |
| C.44            | 4.1                        | 252         | 2.1                      | 1.03 |

FOR VIDEO and SPECIAL APPLICATIONS

PHOTOCELL CABLE

VERY LOW CAPACITANCE CABLES

Cable your rush order for delivery by air. Settlement in dollars by check on your own bank. Transaction as simple as any local purchase-and delivery just as quick.

## TRANSRADIO LTD

CONTRACTORS TO H.M. GOVERNMENT.

138A CROMWELL ROAD  
LONDON, S.W.7-ENGLAND

CABLES: TRANSRAD · LONDON

## Lacquer-Stik

the perfect WIPE-ON  
for Stampings, Engravings, etc.

**SO EASY TO USE**



**Just RUB IN—WIPE OFF . . .  
HANDLE AT ONCE**

Lacquer-Stik is a highly specialized paint, compounded and prepared solely for use as a wipe-on. It is semi-solidified in stick form for quick, convenient use, but soon hardens and becomes permanent. Fill-in will expand and contract with the part and can be subjected to temperatures as high as 500° F. Will not rub off or smear when handled after application.

You'll be delighted with the attractive colors of this time-saving, labor-saving, practical and permanent wipe-on.

At your Supply House—or send 50¢ coin for sample, specifying color.

Submit your problem and sample of material for laboratory recommendations.

**LAKE CHEMICAL CO.**

3034 Carroll Avenue · Chicago 12, Illinois

## Unequaled

- instantaneous start and stop
- ease of operation and editing
- WOW-proof performance
- true-to-life fidelity
- installation assistance
- for scientific research
- mechanical ruggedness
- critical user satisfaction

## AMPEX

magnetic tape recorder

Models to \$3800

Shown model 300-C \$1575

(control panel \$105 extra)

AMPEX ELECTRIC CORP., San Carlos, California

Without obligation please send 16-page illustrated booklet containing technical specifications of AmpeX Magnetic Tape Recorders.

NAME \_\_\_\_\_

ADDRESS \_\_\_\_\_

CITY \_\_\_\_\_

STATE \_\_\_\_\_

Our need is for:

Laboratory Research

Telemetering

Multi-Channel Recording

Industrial Recording

Recording-Broadcasting

Aerophysical Research

Distributed by . . .

BING CROSBY ENTERPRISES (Hollywood)

AUDIO & VIDEO PRODUCTS CORP. (New York City)

GRAYBAR ELECTRIC COMPANY (Everywhere)

EXPORT: WESTREX (New York City)

# COMMUNICATIONS EQUIPMENT COMPANY

## X BAND

|  |                |
|--|----------------|
| Directional coupler, UG-40/U take off, 20 DB   | \$17.50        |
| Directional coupler, APS-6, Type "N" take off, 20 DB, calibrated   | \$17.50        |
| Broad Band Directional coupler, type "N" take off, choke to cover, 23 DB, calibrated   | \$18.50        |
| Directional coupler, APS-31, type "N" take off, 25 DB  | \$17.50        |
| Bi-directional coupler, type "N" take off  | \$22.50        |
| Flexible Section 18" long  | \$12.00        |
| Straight Sections 2 1/2 ft. long choke to cover, silver plated   | \$6.50         |
| Pressure Test Section with 15 lb. gauge and pressurizing nipple  | \$10.00        |
| Bulk Head Feed Through, choke to cover   | \$12.00        |
| Mitered Elbow, choke to cover or choke to choke  | \$12.00        |
| Right Angle Bend 2 1/2" Radius, choke to cover   | \$12.00        |
| 90° Twist, 6" long   | \$7.50         |
| 45° Twist, 6" long   | \$7.50         |
| 90° Twist, 5" long with pressurizing nipple  | \$7.50         |
| 15° Bend, 10", choke to cover  | \$4.50         |
| 5 ft. Sections UG-39 to UG-40, silver plated   | \$9.50         |
| 180° Bend, 26" choke to cover 2 1/2" radius  | \$5.00         |
| SWR Measuring Section 4" long, 2 type "N" probes mounted full wave apart 1 1/4" x 3/8" guide                                     | \$8.50         |
| WE attenuator 0 to 20 DB, less cards, bell size guide  | \$12.50        |
| 90° Bend, E Plane 18"  | \$4.00         |
| Rotary Joint, choke to choke   | \$10.00        |
| Rotary Joint, choke to choke with deck mounting  | \$10.00        |
| TR-ATR Duplexer Section for 1B24 and 724B  | \$24.50        |
| Wavemeter-Therimstar MTG Sect.   | \$6.00         |
| 2K25/723 AB Receiver, Local Oscillator Klystron Mount, complete, with Crystal Mount, Iris Coupling and Choke Coupling to TR      | \$22.50        |
| TR-ATR Duplexer Section for above  | \$8.50         |
| 723AB Mixer—Beacon Dual Oscillator Mount with Crystal Holder, Used   | \$12.00        |
| 723AB Mixer—Beacon Dual Oscillator Mount with Matching Slugs and tunable termination, new  | \$24.50        |
| Bi-Directional Coupler, type "N" termination, 26 DB, calibrated, 1 1/4" x 3/8" guide   | \$24.50        |
| 12" Flexible Section, 1 1/4" x 3/8" guide  | \$10.00        |
| Crystal Mount in Waveguide   | \$17.50        |
| SO-3 Echo Box, Transmission type cavity with bellows   | \$28.50        |
| 180° Bend with pressurizing nipple   | \$5.00         |
| "S" Curve 18" long   | \$5.00         |
| "S" Curve 6" long  | \$3.25         |
| APS-31 Mixer Section for mounting two K25's, Beacon Reference Cavity, 1B24 TR Tube   | \$42.50        |
| Transition 1 x 1/2" to 1 1/4" x 3/8" 14" long  | \$8.00         |
| Receiver Front End, complete, C/O Dual 723AB Klystron mount, TR-ATR Duplexer Section, 2 Stage 30 MC, Preamp, new, with all tubes | \$59.50        |
| Random Lengths of Waveguide 6" to 18" long   | \$1.00 per ft. |

## RADAR SETS

|   |        |
|---|--------|
| APS-2, Airborne, 10 CM, Major Units, New                    | \$500  |
| APS-4, Airborne, 3 CM, Compl., Used                         | \$1800 |
| APS-15, Airborne, 3 CM, Major Units, New                    | \$500  |
| SD-4, Submarine, 200 MC, Compl., New                        | \$1100 |
| SE, Shipboard, 10 CM, compl., New                           | \$1200 |
| SF-1, Shipboard, 10 CM, Compl., New                         | \$2800 |
| SJ-1, Submarine, 10 CM, Compl., Used                        | \$1500 |
| SL-1, Shipboard, 10 CM, Compl., Used                        | \$1700 |
| SN, Portable, 10 CM, Compl., Used                           | \$600  |
| SQ, Portable, 10 CM, Comp., Used                            | \$650  |
| SO-1, Shipboard, 10 CM, Compl., Used                        | \$1500 |
| SO-8, Shipboard, 10 CM, Compl., Used                        | \$1500 |
| Mark 4, Gunlaying, 800 MC, Less Ant., Used                  | \$850  |
| Mark 10, Gunlaying, 10 CM, Compl., New                      | \$2000 |
| Less Rack, New, \$1500; Less Rack, Used, \$1100             |        |
| CPN-3, Beacon, 10 CM, Major Units, Used                     | \$1200 |
| CPN-6, Beacon, 3 CM, Complete, New                          | Write  |
| CPN-8, Beacon, 10 CM, Complete New                          | \$2000 |
| Less Ant., New  | \$1400 |
| SCR-533, IFF/AIR, 500 MC, New                               | \$1200 |
| Search Tracer Airborne Radar Altimeter, 500 MC, Compl., New | \$175  |

## RADAR

## COUPLINGS—UG-CONNECTORS

|        |        |        |        |
|--------|--------|--------|--------|
| UG/15U | \$.75  | UG86U  | \$1.40 |
| UG206U | \$.90  | UG342U | \$3.25 |
| UG87U  | \$.125 | UG85U  | \$1.45 |
| UG27U  | \$.169 | UG58U  | \$.60  |
| UG21U  | \$.89  | UG9U   | \$.89  |
| UG167U | \$.225 | UG102U | \$.45  |
| UG29U  | \$.90  | UG103U | \$.45  |
| UG254U | \$.169 | UG255U | \$.165 |

## S BAND

|   |                 |
|---|-----------------|
| 90° Twist, circular cover to circular cover   | \$25.00         |
| Magnetron to Waveguide Coupler with 721A Duplexer Cavity, gold-plated   | \$45.00         |
| Waveguide Switch—Transposes one input to any of three outputs. Standard 1 1/2" x 3" square flanges. Complete with 115V drive motor. Raytheon CRT24AAS new | \$150.00        |
| 721A TR Box complete with tube and tuning Plungers  | \$12.50         |
| McNally Klystron Cavities for 707B or 2K28. Three types available   | \$4.00          |
| Right Angle Bend 5 1/2 ft. over-all with 8" slotted section   | \$21.00         |
| Pick-up Dipole in Lucite Ball with Sperry Fitting   | \$4.50          |
| F-29/SPR-2 Filters. Type "N" input and output   | \$12.50         |
| 726 Klystron Mount, Tunable output to type "N" complete, with socket and mounting bracket   | \$12.50         |
| WAVEGUIDE to 7/8" Rigid Coax. "Doorknob" Adapter, Choke Flange, Silver Plated, Broad Band   | each, \$37.50   |
| WAVEGUIDE Directional Coupler, 27 db. Navy type CABV-47AAN, with 4 in. slotted section  | \$32.50         |
| SQ. FLANGE to rd choke adapter, 18 in. long OA 1 1/2 in. x 3 in. guide, type "N" output and sampling probe  | \$27.50         |
| Crystal Mixer with tunable output TR pick up loop, Type "N" connectors, Type 62ABH  | \$14.50         |
| Slotted line probe, Probe depth adjustable. Sperry connector, type CPR-14AAO  | \$9.50          |
| Coaxial slotted section, 5/8" rigid coax with carriage and probe  | \$25.00         |
| Right Angle Bend 6" radius E or H plain   | \$15.00         |
| Right Angle Bend 3" radius E or H plain—Circular flanges  | \$15.00         |
| AN/APR5A 10 cm antenna equipment consisting of two 10 CM waveguide sections, each polarized, 45 degrees   | \$75.00 per set |
| PICKUP LOOP, Type "N" Output  | \$2.75          |
| TR BOX Pick-up Loop   | \$1.25          |
| POWER SPLITTER: 726 Klystron input dual "N" output  | \$5.00          |
| "S" BAND Mixer Assembly, with crystal mount pick-up loop, tunable output  | \$3.00          |
| 721-A TR CAVITY WITH TUBE. Complete with tuning plungers  | \$12.50         |
| 10CM OSC. PICKUP LOOP, with male Home-dell output   | \$2.00          |
| MAGNETRON To W.G. Coupl'g for 1 1/4" Mag. Outp't Fitt'g   | \$65.00         |
| 10 CM FEEDBACK DIPOLE ANTENNA, in lucite ball, for use with parabola 7/8" Rigid Coax. Input   | \$8.00          |
| PHASE SHIFTER, 10 CM Waveguide, WE type ES-683816, E Plane to H Plane Matching Slugs, Mark 4  | \$95.00         |
| 721A TR cavities, Heavy silver plated   | \$2.00 ea.      |
| 16 cm. horn and rotating joint assembly, gold plated  | \$65.00 ea.     |
| AS14A/AP 10 CM dipole pickup ant. w/10 ft. cable type N fittings  | \$3.25          |

## 7/8" RIGID COAX

|  |         |
|--|---------|
| Directional coupler, Type "N" take off       | \$22.50 |
| Magnetron Coupling with TR Loop, gold plated | \$7.50  |

## THERMISTORS

|                                    |        |            |        |
|------------------------------------|--------|------------|--------|
| D-167332 (tube)                    | \$.95  | D-168087   | \$.95  |
| D-170396 (bead)                    | \$.95  | D-171812   | \$.95  |
| D-67613 (button)                   | \$.95  | D-171528   | \$.95  |
| D-104690 for MTG in "X" band Guide | \$2.50 | D-168549   | \$.95  |
| D-167618 (tube)                    | \$.95  | D-168442   | \$.95  |
|                                    |        | D-168442   | \$3.00 |
|                                    |        | D-163293   | \$1.25 |
|                                    |        | D-98428    | \$2.00 |
|                                    |        | D-16187A   | \$2.85 |
|                                    |        | D-171121   | \$.95  |
|                                    |        | SA (12-43) | \$1.50 |
|                                    |        | D-167620   | \$3.00 |
|                                    |        | D-105598   | \$2.25 |

## VARIATORS

|          |        |
|----------|--------|
| D-170225 | \$.125 |
| D-167176 | \$.95  |

## MICROWAVE COMPONENTS

### TEST EQUIPMENT

|   |             |
|---|-------------|
| CG-176/AP Directional coupler X Band, 20 DB nominal, type "N" take off, choke to choke, silver-plated   | \$17.50     |
| X Band 1 1/4" x 3/8" absorption type wavemeter, micrometer head, 6000 to 8500 mc, Demornay-Budd #358  | \$185.00    |
| C Band "T" gold-plated at   | \$97.00     |
| C Band Flap attenuator Demornay-Budd type #339, gold-plated   | \$100.00    |
| X Band 1 3/8" x 3/8" Klystron mount with tunable termination, gold-plated   | \$75.00     |
| X Band 1 3/8" x 3/8" low power load, gold-plated  | \$45.00     |
| X Band 1 1/8" x 1/2" waveguide to type "N" adaptor, gold-plated   | \$22.50     |
| X Band 1 1/8" x 1/2" "T" Section, gold-plated   | \$55.00     |
| DEHYDRATOR UNIT, CPD 10137 Automatic Cycling, Compressor to 50 lbs., Compl. for Radar XSMN, Linc. New   | \$425.00    |
| H.V. PWR. SUPPLY 15000 v 30 ma. DC Bridge Rect. Pwr. Sply. Oper. CM. 115 v 60 cy.   | \$115.00    |
| SO-3 RECEIVER 30 mc. IF, 6 stages 6AC7, 10 mc. Band width inpt. 5.1 mc B.W. per stg., 9.6 volt gain per stage as desc. in ch. 13 vol. 23 M.I.T. Rad. Lab. Series  | \$99.50     |
| APS-2 10CM RF HEAD COMPLETE WITH HARD TUBE (715B) Pulsar, 714 Magnetron 417A Mixer all 7/8" rigid coax, incl. revr. front end   | \$210.00    |
| MODEL TS-268/U Test set designed to provide a means of rapid checking of crystal diodes IN21 IN21A, IN21B, IN23, IN23A, IN23B. Operates on 1 1/2 volt dry cell battery, 3 x 6 x 7. New  | \$35.00     |
| 3CM WAVEMETER Coverage 9000-9500 Mcs w/Calib. Chart Absorb. Type w/Circ. Flange or XMSN, Type w/Sq. Flanges, New  | \$75.00     |
| SL WAVEMETER Type Cw60ABM   | \$125.00    |
| 10CM ECHO BOX CABV 14ABA-1 of OBU-3, 2890 MC to 3170 MCS, direct reading micrometer head, Ring prediction scale plus 9% to minus 9%. Type "N" input. Resonance indicator meter. New and Comp. w/access. Box and 10 CM Directional Coupler | \$350.00    |
| 10 cm. horn assembly consisting of two 5 dishes with dipoles feeding single type "N" output. Includes UG28/U type "N" "T" junction and type "N" pickup probe. Mfg. cable. New   | \$15.50     |
| 10 cm. cavity type wavemeters 6" deep 6 1/2 in diameter. Coax output. Silver plated   | \$64.50 ea. |
| 10 Cm. echo box part of SF radar w/115 volt DC tuning Motor sub sig 1148A   | \$47.50     |
| THERMISTOR BRIDGE: Power meter I-203 A 10cm-mg. W.E. Complete with meter, interpolation chart, portable carrying case   | \$72.50     |
| W.E. I 138. Signal generator, 2700 to 2900 Mc. range. Lighthouse tube oscillator with attenuator & output meter, 115 VAC input reg. Pwr. supply. With circuit diagram   | \$75.00     |
| 3 CM. stabilizer cavity, transmission type  | \$20.00     |
| 3 CM. HORN AT-4B/UP model 710. Type "N" input. Hvy. silver plated   | \$6.50      |
| AT-68/UP 3 CM Horn with type "N" fitting  | \$5.00      |
| TS-89/AP Voltage Divider: Ranges 100; 1/2 for 200 to 20000V; I for 200 to 2000V. Input Z 2000 ohm, output Z 4 meg. flat response 150-5 mc. cys.   | \$42.50     |
| 10 CM WAVEMETER W.E. type B-43590 Transmission type, "N" fittings. Veeder root mic. dial gold plated w/calib chart, P/O W.E. Freq. mtr. X66404A, New  | \$99.50     |

## K BAND

|  |                |
|--|----------------|
| APS-34 Rotating Joint  | \$49.50        |
| Right Angle Bend E or H Plane; specify combination of coupling desired | \$12.00        |
| 45° Bend E or H Plane, Choke to cover                                  | \$12.00        |
| Directional coupler CU-103/APS 32                                      | \$49.50        |
| Mitered Elbow, cover to cover  | \$4.00         |
| TR-ATR Section, choke to cover   | \$4.00         |
| Flexible Section 1" choke to choke                                     | \$5.00         |
| "S" Curve choke to cover   | \$4.50         |
| Adaptor, round to square cover   | \$5.00         |
| Feedback to Parabola Horn with pressurized window                      | \$27.50        |
| Low Power Load, less cards   | \$18.50        |
| K Band Mixer Block   | \$45.00        |
| Waveguide 1/2" x 1/4"  | \$1.00 per ft. |
| Circular Flanges   | \$.50          |
| Flange Coupling Nuts   | \$.50          |
| Slotted line, Demornay-Budd #397, new                                  | \$450.00       |
| 90° Twist  | \$10.00        |
| "K" BAND DIRECTIONAL COUPLER CU104/APS-34 20 DB                        | \$49.50 ea.    |
| 3J31 K BAND MAGNETRON  | \$55.00        |

All merch. guar. Mail orders promptly filled. All prices, F.O.B., N.Y.C. Send Money Order or Check. Only shipping charges sent C.O.D. Rated Concerns send P.O.

131 LIBERTY STREET, NEW YORK, N.Y. DEPT. P-5 PHONE DIGBY-9-4124

# COMMUNICATIONS EQUIPMENT COMPANY

## PULSE EQUIPMENT

**PULSE TRANSFORMERS**

G.E.K.-23745 ..... \$39.50  
 G.E.K.-23744-A, 11.5 KV High Voltage, 3.23 KV Low Voltage @ 200 KW oper. (270 KW max.) 1 microsec. or 1/4 microsec. @ 600 PPS ..... \$39.50  
 W.E. 2D166173 Hi-Volt input transformer, W.E. Impedance ratio 50 ohms to 900 ohms. Freq. range: 10 kc. to 2 mc. 2 sections parallel connected, potted in oil ..... \$36.00  
 W.E. KS 9800 Input transformer. Winding ratio between terminals 3-5 and 1-2 is 1:1, and between terminals 6-7 and 1-2 is 2:1 Frequency range: 380-520 c.p.s. Permalloy core ..... \$6.00  
 G.E. 2K2731 Repetition Rate: 635 PPS. Pri. Imp: 50 Ohms. Sec. Imp: 450 Ohms Pulse Width: 1 Microsec. Pri. Input: 9.5 KV PK Sec. Output: 28 KV PK. Peak Output: 800 KW Riflar 2.75 Amp. \$44.50  
 W.E. 2D169271 Hi Volt input pulse transformer ..... \$27.50  
 G.E. K2450A. Will receive 13KV. 4 micro-second pulse on pri. secondary delivers 14KV Peak power out 100 KW G. E. ..... \$34.50  
 G.E. 2K2748A. Pulse input line to magnetron ..... \$36.00  
 29262 Utah Pulse or Blocking Oscillator XFMR Freq. Limits 790-810 cy-3 windings turns ratio 1:1 Dimensions 1 13/16 x 1 1/8" 19/32 ..... \$1.50  
 Pulse 131-AWP L-421435 ..... \$6.00  
 Pulse 134-BW-2F L-440895 ..... \$2.25

**PULSE NETWORKS**

Ray-WX4298F ..... \$39.50  
 GE-K6824730 ..... \$50.00  
 GE-K9216945 ..... \$50.00  
 15A-1-400-50: 15 KV, "A" CKT, 1 microsec 400 PPS, 50 ohms imp. .... \$42.50  
 G.E. 26E3-5-2000-50P2T, 6KV "E" circuit, 3 sections, 5 microsecond, 2000 PPS, 50 ohms impedance ..... \$6.50  
 G.E. 23E (3-84-810; 8-224-405) 50P4T; 3KV, "E" CKT Dual Unit: Unit 1, 3 Sections, .84 Microsec. 810 PPS, 50 ohms imp.; Unit 2, 8 Sections, 2.24 microsec. 405 PPS, 50 ohms imp. .... \$6.50  
 7.5E3-1-200-67P, 7.5 KV, "E" Circuit, 1 microsec 200 PPS, 67 ohms impedance, 3 sections \$7.50  
 7.5E4-16-40-67P, 7.5 KV, "E" circuit 4 sections, 16 microsec, 60 PPS, 67 ohms impedance \$15.00  
 7.5E3-3-200-6PT, 7.5 KV, "E" Circuit, 3 microsec, 200 PPS 67 ohms imp. 3 sections ..... \$12.50

**DELAY LINES**

D-163169 Delay Line Small quantity available ..... \$50.00  
 D-168184: .5 microsec. up to 2000 PPS 1800 ohm term ..... \$4.03  
 D-170499: .25/.50/.75 microsec 8 KV 50 ohms imp. .... \$16.50  
 D-165997: 1/4 microsec. .... \$7.50

**DIRECTION FINDERS**

DAB 3 & 4, 2 1/8 Mc mfg. like new ..... \$850.00  
 DAK Direction Finder Automatic bearing indicators complete receiver ..... \$185.00  
 complete receiver ..... \$225.00  
 loops ..... \$125.00  
 RG 23U Twin conductor rf cable 250 ft. reel ..... \$50.00  
 DFI2 Direct. Finder 100-1500 kc. .... \$250.00  
 DF Rec. only Bludworth Standard Arrow \$150.00

**I.F.F.** 1 KW Pulsed Output Pkg. Tunable 154-186 mc. adj. modulating pulses 4-10 micro sec. comp. 115v 60 cy ac pwr. supply. Vidio output receiver. New w/tubes \$350.00  
 Wavemeter for above ..... \$75.00  
 Dipole Array for above ..... \$85.00

**INDICATORS—SCOPES**

BC 931B 4-20-50-100 mile range 5" scope w/mtg. rack, indicator amplifier, BC 932B, visor, n/w/tubes ..... \$24.50  
 BC 704A 9-36-90 mile range 5" scope. Write  
 BC 937A & BC 938A 12" PPI & "A" scope. Complete desk Rack assy w/osc. control unit, rec., pwr. supls. in unused cond. but shelf worn ..... \$300.00  
 Radar Indicator RW 281 mfg. by Research Enterprise Ltd. 5" scope ..... \$30.00  
 12" PPI Radar indic. console P/O SK-1M Radar ASD Indicator } Write or phone for information and price.  
 ID30 APS2 Indicator }  
 929 Indicator }  
 Many others in stock.

**PULSE EQUIPMENT**

MIT. MOD. 3 HARD TUBE PULSER: Output Pulse Power 144 KW (12 KV at 12 Amp). Duty Ratio: 001 max. Pulse duration: 5, 1.0, 2.0 microsec. Input voltage: 115 v. 400 to 2400 ops. Uses: 1-7158, 4-829-B, 3-72's, 1-73. New ..... \$110.00  
 APO-13 PULSE MODULATOR. Pulse Width .5 to 1.1 Micro Sec. Rep. rate 624 to 1348 Pps. Pk pwr. out 35 KW Emergy 0.018 Joules ..... \$49.00  
 TPS-3 PULSE MODULATOR. Pk. power 50 amp. 24 KW (1200 KW pk); pulse rate 200 PPS. 1.5 microsec. pulse line impedance 50 ohms. Circuit—series charging version of DC Resonance type. Uses two 705-A's as rectifiers. 115 v. 400 cycle input. New with all tubes ..... \$49.50  
 APS-10 MODULATOR DECK. Complete, less tubes ..... \$75.00  
 BC 1203B Loran pulse modulator ..... \$125.00  
 BC 758A Pulse modulator ..... \$395.00  
 APS-10 Low voltage power supply less tubes \$18.50  
 725A magnetron pulse transformers ..... \$18.50 ea.

**MAGNETRONS**

| Tube      | Freq. Range                | Pk. Pwr. | Output | Price   |
|-----------|----------------------------|----------|--------|---------|
| 2J31      | 2820-2860 mc.              | 265 KW   |        | \$25.00 |
| 2J21-A    | 9345-9405 mc.              | 50 KW    |        | \$25.00 |
| 2J22      | 3267-3333 mc.              | 265 KW   |        | \$25.00 |
| 2J26      | 2992-3019 mc.              | 275 KW   |        | \$25.00 |
| 2J27      | 2965-2992 mc.              | 275 KW   |        | \$25.00 |
| 2J32      | 2780-2820 mc.              | 285 KW   |        | \$25.00 |
| 2J37      |                            |          |        | \$45.00 |
| 2J38 Pkg. | 3249-3263 mc.              | 5 KW     |        | \$35.00 |
| 2J39 Pkg. | 3267-3333 mc.              | 87 KW    |        | \$35.00 |
| 2J40      | 9305-9325 mc.              | 10 KW    |        | \$65.00 |
| 2J49      | 9000-9160 mc.              | 58 KW    |        | \$85.00 |
| 2J34      |                            |          |        | \$55.00 |
| 2J61      | 3000-3100 mc.              | 35 KW    |        | \$65.00 |
| 2J62      | 2914-3010 mc.              | 35 KW    |        | \$65.00 |
| 3J31      | 24,000 mc.                 | 50 KW    |        | \$55.00 |
| 5J30      |                            |          |        | \$39.50 |
| 714AY     |                            |          |        | \$25.00 |
| 718DY     | 2720-2890 mc.              | 250 KW   |        | \$25.00 |
| 720BY     | 2800 mc.                   | 1000 KW  |        | \$50.00 |
| 720CY     | 2860 mc.                   | 1000 KW  |        | \$50.00 |
| 725-A     | 9345-9405 mc.              | 50 KW    |        | \$25.00 |
| 730-A     | 9345-9405 mc.              | 50 KW    |        | \$25.00 |
| 728       | AY, BY, CY, DY, EY, FY, GY |          |        | \$50.00 |
| 700       | A, B, C, D                 |          |        | \$50.00 |
| 706       | AY, BY, DY, EY, FY, GY     |          |        | \$50.00 |
| Klystrons | 723A/B \$12.50; 707B       |          |        | \$20.00 |
|           | W/Cavity                   |          |        |         |
|           | 417A \$25.00               | 2K41     |        | \$65.00 |

**MAGNETRON MAGNETS**

| Gauss | Pole Diam. | Spacing    | Price   |
|-------|------------|------------|---------|
| 4850  | 3/4 in.    | 3/4 in.    | \$ 8.90 |
| 5200  | 2 1/32 in. | 3/4 in.    | \$17.50 |
| 1300  | 1 1/2 in.  | 1 5/16 in. | \$12.50 |
| 1860  | 1 1/2 in.  | 1 1/2 in.  | \$14.50 |

Electromagnets for magnetrons ..... \$24.50 ea.  
 GE Magnets type M7765115, GI Distance Between pole faces variable, 2 1/16" (1900 Gauss) to 1 1/2" (2200 Gauss) Pole Dia. 1 1/2". New Part of SCR 584 ..... \$34.50

**CW MAGNETRONS**

QK 62 3150-3375 mc.  
 QK 59 2675-2900 mc.  
 QK 61 2975-3200 mc.  
 QK 60 2800-3025 mc.  
 New, Guaranteed Each \$65.00  
 QK 915 ..... \$150.00

**FILAMENT TRANSFORMER**

for above 115V/60 cy Pri: four 6.3V/4A Sec. 5000VT ..... \$27.50  
 Magnetron Kit of four QK's 2675-3375 inc. w/trans special ..... \$250.00

**PRECISION CAPACITORS**

D-163707: 0.4 mfd @ 1500 vdc. —50 to plus 85 deg C ..... \$4.50  
 D-163035: 0.1 mfd @ 600 vdc, 0 to plus 65 deg C ..... \$2.00  
 D-170908: 0.152 mfd, 300 v. 400 cy. —50 to plus 85 deg C ..... \$2.50  
 D-164960: 2.04 mfd @ 200 vdc. 0 to plus 55 deg C ..... \$2.50  
 D-168344: 2.16 mfd @ 200 vdc. 0 to plus 55 deg C ..... \$3.00  
 D-161555: 5 mfd @ 400 vdc. —50 to plus 85 deg C ..... \$3.00  
 D-161270: 1 mfd @ 200 vdc. temp comp —40 to plus 65 deg C ..... \$12.50

**30' U. S. ARMY SIGNAL CORPS RADIO MASTS**

Complete set for the erection of a full flat top antenna. Of rugged plywood construction telescoping into 3 ten-foot sections for easy storage and transportation. Supplied complete: 2 complete masts, hardware, shipping crate. Shipping wt. approx. 300 lbs. Sig Corps 22A289-223-A. New ..... \$35.00 per set of 2

**MICROWAVE ANTENNAS**

AN-122 Dipole Assy. .... \$22.50  
 LP-21-A ADF Loop W/Selsyn and Housings. New ..... \$8.00  
 DAK Bellino Tossi DF Loops ..... \$125.00  
 Adcock DF Arrays, Complete ..... \$65.00  
 SA Radar, 200 MC Bed Springs, Complete with Pedestal, Less Drive ..... \$600.00  
 AN MGP-1 Antenna. Rotary feed type high speed scanner antenna assembly, including horn parabolic reflector. Less internal mechanisms. 10 deg. sector scan. Approx. 12' L x 4' W x 3' H. Unused. (Gov't Cost—\$4500.00) ..... \$250.00  
 APS-4 3 cm. antenna. Complete. 14 1/2" dish. Cutler feed dipole directional coupler, all standard 1" x 1/2" waveguide. Drive motor and gear mechanisms for horizontal and vertical scan. New, complete ..... \$45.00  
 AN/TPS3. Parabolic dish type reflector approx. 10' diam. Extremely lightweight construction. New in 3 carrying cases ..... \$89.50  
**RELAY SYSTEM PARABOLIC REFLECTORS:** approx. range: 2000 to 6000 mc. Dimensions: 4' x 3' rectangle, now ..... \$35.00  
 TDY "JAM" RADAR ROTATING ANTENNA, 10 cm, 30 deg. beam. 115 v.a.c. drive. New ..... \$100.00  
 DBM ANTENNA. Dual, back-to-back parabolas with dipoles. Freq. coverage 1,000-4,500 mc. No drive mechanism ..... \$65.00  
 AS125/APR Cone type receiving antenna, 1080 to 3208 megacycles. New ..... \$4.50  
 140-400 MC. CONE type antenna, complete with 25' sectional steel mast, guys, cables, carrying case, etc. New ..... \$49.50  
 ASD 3 cm. antenna, used, ex. cond. .... \$49.50  
 YAGI ANTENNA AS-46A, APG-4, 5 elements ..... \$14.50 ea.  
**DISH FOR PARABOLA 30"** ..... \$4.85  
 AS17/APS 10 CM Antenna, APS-2 30 Inch Dish with 7/8 Coax Dipole and fittings, New and Compl. with 24 V DC Drive motor, selsyn, 360 Deg. Rotation and Vertical Tilt ..... \$94.50  
 RC-224 Antenna, 10 CM, 30" Dish P/O. SCR-717 Radar, New and Complete ..... \$94.50

**R. F. EQUIPMENT**

LHTR. LIGHTHOUSE ASSEMBLY, Part of RT-30/APG-5 & APG 15. Receiver and Transmitter Lighthouse Cavities with assoc. Tr. Cavity and Type N CPLG. To Revr. Uses 2C40, 2C43, 1827, Tunable APX 2400-2700 MCS. Silver plated. .... \$49.50  
 APS-2 10CM RF HEAD COMPLETE WITH HARD TUBE (715B) Pulser. 714 Magnetron 417A Mixer all 7/8" rigid coax. incl. revr. front end ..... \$210.00  
 Beacon Lighthouse cavity 10 cm with miniature 28 volt DC FM motor, Mig. Bernard Rice ..... \$47.50 ea.  
 T-120-APN-19 10 cm. radar Beacon transmitter package, used, less tubes ..... \$59.50 ea.  
 SO-3 "X" band 3 cm RF package, new complete, including receiver unit as illustrated on Page 337, Volume 23 RAD LAB Series ..... \$375.00 ea.  
 Pre-Amplifier cavities type "M" 7410590GL, to use 446A lighthouse tube. Completely tuneable, Heavy silver plated construction ..... \$37.50 ea.  
 RT32/APS 6A RF HEAD. Compl. with 725A Magnetron magnet pulse xfmr. TR-ATR 723A/B local osc. and beacon mount, pre amplifier. Used but exc. cond. .... \$97.50  
 AN/APS-15A "X" Band compl. RF head and modulator, incl. 725-A magnetron and magnet, two 723A/B klystrons (local osc. & beacon) 1824, TR, RCVR. ampl. duplexer, HV supply blower, pulse xfmr. Peak Pwr Out: 45 KW apx. Input: 115, 400 cy. Modulator pulse duration 5-2 microsec., apx. 13KV, PK, Pulse, with all tubes incl. 7158, 8298, RKR 73, two 72's. Complete pkg. .... \$210.00  
 S BAND AN/APS2. Complete RF head and modulator, including magnetron and magnet, 417A mixer, TR receiver duplexer, blower, etc., and complete pulser. With tubes, used, fair condition ..... \$75.00  
 10 CM RF Package. Consists of: SO Xmr. receiver using 2J27 magnetron oscillator, 250 KW peak input. 707-B receiver-mixer ..... \$150.00  
 ASB-500 Megacycles Radar Receiver with two GI 446 lighthouse cavities, new less tubes ..... \$37.50

## MICROWAVE ANT. RF EQUIPMENT

All merch. guar. Mail orders promptly filled. All prices, F.O.B., N.Y.C. Send Money Order or Check. Only shipping charges sent C.O.D. Rated Countries send P.O.

131 LIBERTY STREET, NEW YORK, N.Y. DEPT. P5 PHONE DUGBY—9-4124

# Latest WELLS Tube Price List

Many Types Are Now Scarce At These Low Prices. Check your requirements at once for your own protection. All tubes are standard

brand, new in original cartons, and guaranteed by Wells. Order directly from this ad or through your local Parts Jobber.

| TYPE.        | PRICE EA. | TYPE.     | PRICE EA. | TYPE.              | PRICE EA. | TYPE.           | PRICE EA. | TYPE.       | PRICE EA. | TYPE.              | PRICE EA. |
|--------------|-----------|-----------|-----------|--------------------|-----------|-----------------|-----------|-------------|-----------|--------------------|-----------|
| 0A4G         | .95       | 5J29      | 13.45     | 714                | .90       | 66B4            | .90       | 705A        | 1.00      | 955                | .55       |
| 01A          | .45       | 5V40      | 1.07      | 9-3                | .45       | VT67/30         | .90       | 706A1       | 17.00     | 956                | .55       |
| E1-C1A       | 3.95      | 5W4       | .76       | 10                 | .55       | 7017            | 1.08      | 707A        | 14.00     | 957                | .45       |
| IA3          | .80       | 5Z3       | .80       | 10 ACORN           | .65       | 71A             | .75       | 707B        | 15.00     | 958                | .55       |
| IA5GT        | .85       | 5Z30      | .75       | 10 (VT-25A)        | .55       | CEQ72           | .80       | 708A        | 3.75      | 959A               | .55       |
| C1B/3C31     | 4.85      | 6-4       | .35       | 10E/146            | 1.00      | CRP72           | .95       | 708A        | 4.75      | 959                | .55       |
| IB4P         | 1.75      | 6-7       | .35       | 10T1               | .60       | CYN72           | 1.75      | 710A        | 2.45      | 961, FG17          | 3.25      |
| IB21A/G1471A | 2.65      | E1-C6A    | 2.00      | 10Y (VT-25)        | .45       | RKR72           | .90       | 713A        | 1.50      | 991/WF-16          | .24       |
| IB22         | 3.40      | 6A3       | .80       | 12A6               | .25       | RKR73           | 1.25      | 714A        | 3.75      | 1005               | .35       |
| IB23         | 7.50      | 6A6       | .65       | 12A9GT             | .25       | 75              | .89       | 715B        | 9.75      | 1007               | 4.60      |
| IB32/532A    | 1.85      | 6AB7      | .85       | 12A7               | .80       | 76              | .55       | 717A        | .85       | 1148               | .35       |
| IB42         | 9.90      | 6AC7      | .90       | 12AH7GT            | 1.12      | 77              | .55       | 718BY       | 15.00     | 1201               | .45       |
| E1 IC        | 4.85      | 6AE6G     | .85       | 12AU7              | .95       | 78              | .60       | 718EY       | 15.00     | 1203               | .55       |
| IC50T        | .65       | 6AG5      | 1.20      | 12AX7              | 1.20      | VR78            | .65       | 721A        | 3.75      | 1203A              | .60       |
| MC6          | .75       | 6AK5      | 1.10      | 12BD6              | 1.20      | 80              | .45       | 721B        | 3.95      | 1294               | .55       |
| MC70         | .85       | 6AK8      | .80       | 12C6               | .60       | FG-R1-A         | .90       | 722A/287A   | 9.50      | D51295             | 9.95      |
| ID6GT        | .95       | 6AL5      | .95       | 12FS6T             | .80       | 83V             | .90       | 723AB       | 14.95     | 1295/3D8           | .45       |
| IE7GT        | 1.85      | 6AU6      | .95       | 12H6               | .40       | 89              | .73       | 724A        | 4.25      | 1813-SELECT. 6P6   | .55       |
| IF4          | .90       | 6AV8      | .81       | 12J5GT             | .40       | 89Y             | .40       | 725A        | 9.95      | 1816               | 1.25      |
| IG8          | .65       | 6B4C      | .95       | 12J7GT             | .70       | VR90            | .65       | 726A        | 12.50     | 1510               | .35       |
| IH4G         | .80       | 6B7       | .75       | 12K8               | .65       | VT90 (BRITISH)  | 2.55      | 726B        | 13.50     | 1624               | 1.25      |
| IH6G         | .80       | 6B8       | .95       | 12Q7GT             | .75       | VR92            | .65       | 730A        | 9.85      | 1625               | .35       |
| IL4          | .50       | 6B8       | .75       | 12S47              | .75       | FG95, DG1295    | 9.85      | 801         | .50       | 1626               | .35       |
| ILC6         | .75       | 6B8G      | .95       | 12SC7              | .75       | VT94, RE15      | 14.95     | 801A        | .70       | 1629               | .35       |
| ILN5         | .85       | 6BA6      | .85       | 12SF7              | .60       | 100H            | 11.50     | 803         | 5.25      | 1630               | 3.95      |
| IN6GT        | .75       | 6B26      | .65       | 12SG7              | .65       | 101/837         | 1.85      | 804         | 8.95      | 1638               | .90       |
| IP24         | 2.50      | 6C4       | .40       | 12SH7              | .40       | 102F            | 3.55      | 805         | 5.95      | 1641/RK60          | .65       |
| IQ5GT        | .85       | 6C8G      | 1.05      | 12S17              | .73       | FG105           | 9.75      | 807         | 1.25      | 1642               | .60       |
| IR4          | .70       | 6C21      | 19.25     | 12SK7              | .60       | FG105           | 9.75      | 808         | 1.65      | 1652/6AC7          | .90       |
| IS6          | .70       | 6D6       | .50       | 12SK7GT            | .60       | VR105           | .85       | 809         | 2.50      | 1653/6AB7          | .95       |
| IT4          | .75       | 6F5       | .85       | 12S17GT            | .60       | VU-111-S        | .65       | 812         | 2.95      | 1900               | 1.35      |
| 2A3          | 1.05      | 6F6       | .60       | 12SN7GT            | 1.10      | 114R            | 1.20      | 813         | 7.85      | 1961/532A          | 1.85      |
| 2A7          | .75       | 6F6G      | .60       | 12SQ7GT            | .60       | 121A            | 2.68      | 814         | 3.75      | 2050               | .78       |
| 2AP1         | 4.75      | 6F8G      | .95       | 12SR7              | .60       | 122A            | 2.65      | 815         | 2.85      | 2051               | .75       |
| 2B7          | .75       | 6G9G      | .80       | 12X425-2AMP. TUNG. | 1.85      | VT127 (BRITISH) | .35       | 826         | .75       | TX6653             | 1.20      |
| 2B22/G1559   | 3.25      | 6H6       | .45       | 12Z3               | .90       | VT127A          | 2.95      | 830B        | 3.95      | 7193               | .35       |
| 2C22/7193    | .35       | 6J8       | .90       | 13-4               | .35       | VR150           | .60       | 832A        | 7.95      | 8011/VT90. BRITISH | 2.95      |
| 2C26         | .30       | 6J8GT     | .95       | 14A7               | .90       | VT154 (HK)      | 14.95     | 834         | 5.75      | 8012               | 3.25      |
| 2C26A        | .40       | 6J8G      | .95       | 14B5               | .75       | FG172           | 19.75     | 835/39111A  | 1.10      | 8013               | 1.25      |
| 2C34         | .40       | 6K6GT     | .55       | 14F7               | .90       | 205B            | 1.45      | 836         | 1.35      | 8013A              | 1.50      |
| 2C44         | 1.25      | 6K7       | .60       | 14H7               | .90       | 211 (VT-4-C)    | .60       | 837         | 1.65      | 8019               | 1.75      |
| 2J21         | 10.45     | 6K7G      | .80       | 14Q7               | .90       | 215A (VT5)      | 1.20      | 839         | 3.25      | 8020               | 3.25      |
| 2J21A        | 11.45     | 6L9G      | 1.35      | 14R7               | .90       | CEP220          | 2.00      | 841         | .50       | 8025               | 6.75      |
| 2J22         | 9.85      | 6L7       | .75       | 15E                | 1.50      | 221A            | 1.75      | 842         | 2.75      | 9001               | .65       |
| 2J26         | 8.45      | 6N7/GT    | .75       | 15R                | 1.20      | 227A            | 4.75      | 843         | .50       | 9002               | .45       |
| 2J27         | 12.95     | 6Q7       | .65       | 16X679-2AMP. TUNG. | 3.95      | 231D            | 1.20      | 851         | 39.00     | 9003               | .60       |
| 2J31         | 9.95      | 6R7G      | .75       | FG17/967           | 1.25      | RK233A          | 1.95      | 852         | 6.25      | 9004               | .40       |
| 2J32         | 12.85     | 6S47      | .65       | 19                 | 1.20      | 257A            | 9.00      | 861         | 29.45     | 9006               | .40       |
| 2J33         | 18.95     | 6SC7      | .75       | 20-4 BALLAST.      | .45       | 268A            | 2.95      | 864         | .45       | 9811A/85           | 1.10      |
| 2J34         | 17.50     | 6SC7GT    | .70       | 21-2 BALLAST.      | .45       | 282R            | 4.25      | 866-JUNIOR. | 2.55      |                    |           |
| 2J37         | 13.85     | 6SF7      | .80       | RE121              | 2.75      | 287A/722A       | 9.50      | 868A        | .95       |                    |           |
| 2J39         | 6.85      | 6SF5      | .65       | 23D4               | .45       | 304TI           | 1.75      | 869         | 1.30      |                    |           |
| 2J46         | 12.85     | 6SG7      | .65       | RK24               | 1.75      | 304TH           | 5.75      | 869B        | 10.75     |                    |           |
| 2J61         | 24.50     | 6SH7      | .40       | HK25/H02           | 2.85      | 307A            | 4.25      | 872A        | 27.25     | IN21               | .85       |
| 2J62         | 14.95     | 6SH7GT    | .40       | VT-25-A, 10        | .55       | 316A            | .55       | 874         | 1.95      | IN21A              | .95       |
| 2X2          | .55       | 6SJ7      | .60       | 2525               | .73       | 327A            | 2.60      | 876         | .50       | IN21B              | 1.20      |
| 2Y3G         | 1.20      | 6SK7      | .60       | 2576GT             | .55       | 350B            | 2.65      | 878         | 1.95      | IN22               | .80       |
| 3A4          | .35       | 6SK7GT    | .60       | 2579G              | .55       | 354C            | 4.95      | 879/2X2     | .55       | IN23               | .80       |
| 3A4/47       | .45       | 6SK7GT    | .60       | 26                 | .65       | 356B            | 14.95     | 902         | 3.50      | IN23A              | .85       |
| 3B7          | .45       | 6S17GT    | .60       | 27                 | .60       | 368AS, 703A     | 3.95      | 923 (PHOTO) | 1.35      | IN27               | .85       |
| 3B22         | 2.35      | 6SN7GT    | .85       | 28D7               | .40       | 371A VT62       | .95       | 930         | 1.90      | IN29               | .85       |
| 3B24         | 1.75      | 6SQ7      | .60       | 30/AT-67           | .75       | 371B            | .85       | 931A        | 1.00      | IN51 (GE)          | .75       |
| 3BP1         | 3.75      | 6SQ7GT    | .60       | 30 (NOT VT-87)     | .75       | 388A            | 3.95      | 954         | 3.95      | IN48 (GE)          | .90       |
| E1-3C        | 3.95      | 6SR7      | .60       | 33                 | .75       | 393A            | 4.65      |             | .35       | IN52 (GE)          | 1.00      |
| 3C21         | 5.00      | 6SR7GT    | .60       | 34                 | .35       | 396A            | 4.95      |             |           |                    |           |
| 3C24/240     | .50       | 6SS7      | .60       | GI24               | 1.50      | VR4081-BALLAST. | .30       |             |           |                    |           |
| 3C31-C1B     | 4.85      | 6U7G      | .85       | RK34/2C34          | .45       | 434A            | 14.60     |             |           |                    |           |
| 3CP1-81      | 1.05      | 6V6GT     | .75       | 35/51              | .60       | 446A            | 3.40      |             |           |                    |           |
| 3DP1         | 3.75      | 6W5G      | .80       | 3516GT             | .73       | 446B            | 1.55      |             |           |                    |           |
| 3D5/1299     | .45       | 6X5GT     | .73       | 3594               | .73       | 450TH           | 17.95     |             |           |                    |           |
| 3FP7         | 4.85      | 6Y6G      | .65       | 3525GT             | .62       | GI45 I          | 1.90      |             |           |                    |           |
| 3GP1         | 4.50      | 7-7-11    | .35       | 38                 | .40       | GI471A          | 2.55      |             |           |                    |           |
| 3H17         | 1.00      | 7A4, XX1  | .90       | 37                 | .40       | SS501           | 3.00      |             |           |                    |           |
| 3HP7         | 2.95      | 7A5       | .80       | 38                 | .40       | 527             | 9.95      |             |           |                    |           |
| 3Q5          | .90       | 7A6       | .75       | 39/44              | .35       | W1530           | 5.00      |             |           |                    |           |
| 3Q5GT        | .90       | 7A7       | .60       | 41                 | .50       | W1531           | 12.95     |             |           |                    |           |
| 3S4          | .75       | 7B4       | .60       | 42                 | .50       | W1532           | 1.85      |             |           |                    |           |
| 6A4          | 2.00      | 7B6       | .60       | 43                 | .50       | 532A, 1R32      | 3.55      |             |           |                    |           |
| RE15         | 14.95     | 7B8       | .60       | 45 SPEC.           | .50       | GI569           | 3.75      |             |           |                    |           |
| VT5/216A     | 1.20      | 7BP7      | 4.95      | 46                 | .75       | KU810           | 7.45      |             |           |                    |           |
| 5AP1         | 3.95      | 7C4/1203A | .35       | EF50               | .45       | H1815           | 1.05      |             |           |                    |           |
| E1-C5B       | 4.25      | 7C5       | .65       | UH50               | 1.00      | W1632A          | 4.75      |             |           |                    |           |
| 5BP1         | 2.75      | 7C7       | .65       | 50R5               | 1.00      | 700             | 7.95      |             |           |                    |           |
| 5BP4         | 3.95      | 7E5/1201  | .60       | 5016GT             | .95       | 700C            | 7.85      |             |           |                    |           |
| 5CP1         | 3.75      | 7E6       | .60       | 56                 | .65       | 700D            | 7.85      |             |           |                    |           |
| 5D21         | 24.75     | 7F7       | .70       | 57                 | .45       | 701A            | 3.00      |             |           |                    |           |
| 5FP7         | 2.75      | 7H7       | .70       | 58                 | .60       | 702A            | 2.95      |             |           |                    |           |
| 5GP1         | 4.75      | 7I7       | .70       | RK60/1641          | .65       | 703A 368AS      | 3.95      |             |           |                    |           |
| 5HP4         | 4.75      | 7N7       | .70       | VT92 (BRITISH)     | 1.10      | 704A            | 1.75      |             |           |                    |           |
| 5J23         | 14.25     | 7T7       | .90       | 65                 | 1.25      |                 |           |             |           |                    |           |

**JUST OUT - CATALOG H500**

Manufacturers, Distributors and Amateurs: Write for the brand new Wells Electronic Catalog H500. It's full of Tremendous values in highest quality components.



**PARTS SHOW VISITORS: Be Sure to See Our Huge Display at Our LaSalle Street Show Rooms**

**320 N. LA SALLE ST. DEPT. P, CHICAGO 10, ILL.**



TO SELL THE  
RADIO  
INDUSTRY



## Proceedings of the I.R.E.



Monthly Publication of the



**INSTITUTE OF RADIO ENGINEERS**

WILLIAM C. COPP — *National Advertising Manager*  
303 WEST 42nd STREET, NEW YORK 18, N. Y.  
Circle 6-6357

TELL THE  
RADIO  
ENGINEERS

May, 1950

Dear Reader:

A valuable service is rendered by the industrial listings in the IRE DIRECTORY (Yearbook). Sections 2 and 3 of this 500 page book, which will again be distributed to over 18,000 IRE members in September 1950, list more than 3400 firms serving the radio-electronic field, and the products or services they offer.

We have received excellent cooperation from the industry. Thousands of the companies have already answered our questionnaires, checking off the data shown on the next two pages.

But, we can miss a new firm, or one with a changed address. Or, perhaps someone has been too busy to answer!

You are invited to mail in this information to us, using the following classification pages. If you have not filled out such information for IRE recently, this action may insure that the information we list for your firm is up-to-date.

When checking off your products, please note that we classify functionally, rather than by terminology -- so look carefully THROUGH ALL CLASSIFICATIONS. Engineers prefer the speed and ease the simpler listings provide.

Our service is free, and we only publish information we have procured ourselves by questionnaires, or derived from product stories or interviews. Your cooperation alone will insure that your firm is listed.

The fourth page of this section tells the story of advertising in the IRE DIRECTORY (formerly Yearbook) and shows how economically and effectively you can back up our listings for your firm, with your own story and display data -- reaching the engineer who is seeking exactly that information in his IRE DIRECTORY.

Cordially,  
Industry Research Division  
THE INSTITUTE OF RADIO ENGINEERS  
303 West 42nd. St., N.Y. 18, N.Y.

# INFORMATION SERVICE

## I.R.E. Yearbook and I.R.E. Industry Research Division

A two-fold service is available without cost to firms supplying products for or rendering technical services to the radio-and-electronic industry. (1) The I.R.E. Yearbook, which is noted for its reference value, lists more than 2,000 firms and furnishes product or industry classification. (2) A classified index of products and services is maintained by the I.R.E. Industry Research Division. Radio engineers continuously draw upon this bank of statistical data.

These two sources of information are not only invaluable to I.R.E. members and other engineers, but the proper listing of your company may bring you new business.

To help keep up to date, please check-off your products and services,

and send to: Industry Research Div., Proceedings of the I.R.E. Room 707, 303 West 42nd St., New York 18, N.Y.

### Products to Be Checked By Radio-Electronic Manufacturers

- |  |  |  |   |
|--|--|--|---|
| <p><b>1. AMPLIFIERS, Audio Frequency.</b></p> <ul style="list-style-type: none"> <li><input type="checkbox"/> a. Broadcast Speech Input Equipment.</li> <li><input type="checkbox"/> b. Dynamic Noise Suppressors.</li> <li><input type="checkbox"/> c. High Fidelity.</li> <li><input type="checkbox"/> d. Inter-communication Systems.</li> <li><input type="checkbox"/> e. Medical Equipment.</li> <li><input type="checkbox"/> f. Peak Limiting.</li> <li><input type="checkbox"/> g. Phonograph Preamplifiers-equalized.</li> <li><input type="checkbox"/> h. Power Amplifiers.</li> <li><input type="checkbox"/> i. Pre-amplifiers.</li> <li><input type="checkbox"/> j. Public Address Systems.</li> <li><input type="checkbox"/> k. Recording Amplifiers.</li> </ul> | <p><b>9. CAPACITORS: Variable.</b></p> <ul style="list-style-type: none"> <li><input type="checkbox"/> a. Neutralizing.</li> <li><input type="checkbox"/> b. Precision.</li> <li><input type="checkbox"/> c. Temperature Frequency Compensating.</li> <li><input type="checkbox"/> d. Trimmers.</li> <li><input type="checkbox"/> e. Tuning.</li> <li><input type="checkbox"/> f. Vacuum.</li> </ul>   | <ul style="list-style-type: none"> <li><input type="checkbox"/> d. Fire Prevention &amp; Detection.</li> <li><input type="checkbox"/> e. Production Controls, Counting &amp; Sorting.</li> <li><input type="checkbox"/> f. Variable Speed Regulators.</li> <li><input type="checkbox"/> g. Voltage Control &amp; Stabilization.</li> </ul>   | <ul style="list-style-type: none"> <li><input type="checkbox"/> e. Low Frequency Types.</li> </ul> <p><b>32. MACHINERY, FIXTURES &amp; TOOLS FOR RADIO-ELECTRONIC MANUFACTURING.</b></p> <p><b>33. MAGNETS.</b></p> <ul style="list-style-type: none"> <li><input type="checkbox"/> a. Electro.</li> <li><input type="checkbox"/> b. Permanent.</li> </ul> <p><i>Measuring Equipment, see 35, 59, 60, 61.</i></p>   |
| <p><b>2. ANTENNAS.</b></p> <ul style="list-style-type: none"> <li><input type="checkbox"/> a. AM Broadcast.</li> <li><input type="checkbox"/> b. Dummy.</li> <li><input type="checkbox"/> c. FM Broadcast.</li> <li><input type="checkbox"/> d. Miscellaneous.</li> <li><input type="checkbox"/> e. Receiving Types, all services.</li> <li><input type="checkbox"/> f. Television Broadcast.</li> </ul>   | <p><b>10. CERAMICS.</b></p> <ul style="list-style-type: none"> <li><input type="checkbox"/> a. Coil Forms.</li> <li><input type="checkbox"/> b. Custom Fabrication.</li> <li><input type="checkbox"/> c. Rods.</li> <li><input type="checkbox"/> d. Sheets.</li> </ul> <p><b>11. CHASSIS &amp; RELAY RACK CABINETS: Metal.</b></p> <ul style="list-style-type: none"> <li><input type="checkbox"/> a. Open Stock.</li> <li><input type="checkbox"/> b. Special Order &amp; Custom Fabrication.</li> </ul> <p><i>Coil Forms, see 10a.</i></p> | <p><b>20. EQUALIZERS.</b></p> <ul style="list-style-type: none"> <li><input type="checkbox"/> a. Dialogue.</li> <li><input type="checkbox"/> b. Line.</li> <li><input type="checkbox"/> c. Magnetic Reproducer Types.</li> <li><input type="checkbox"/> d. Sound Effects.</li> </ul> <p><b>21. FACSIMILE EQUIPMENT.</b></p> <p><b>22. FILTERS.</b></p> <ul style="list-style-type: none"> <li><input type="checkbox"/> a. Band Pass &amp; Band Rejection.</li> <li><input type="checkbox"/> b. Dividing Networks.</li> <li><input type="checkbox"/> c. Noise Elimination.</li> </ul> <p><i>Sound effects, see 20d.</i></p> | <p><b>34. METALS: Base.</b></p> <ul style="list-style-type: none"> <li><input type="checkbox"/> a. Copper.</li> <li><input type="checkbox"/> b. Ferrous.</li> <li><input type="checkbox"/> c. Non-ferrous, excluding Copper.</li> <li><input type="checkbox"/> d. Powdered.</li> <li><input type="checkbox"/> e. Precious &amp; Rare.</li> </ul>  |
| <p><b>3. ANTENNA ACCESSORIES.</b></p> <ul style="list-style-type: none"> <li><input type="checkbox"/> a. Feeder Systems.</li> <li><input type="checkbox"/> b. Insulators.</li> <li><input type="checkbox"/> c. Phasing &amp; Tuning Equipment.</li> <li><input type="checkbox"/> d. Support Towers.</li> <li><input type="checkbox"/> e. Tower Lighting Equipment.</li> </ul>  | <p><b>12. COILS.</b></p> <ul style="list-style-type: none"> <li><input type="checkbox"/> a. A. F. Chokes.</li> <li><input type="checkbox"/> b. Miscellaneous.</li> <li><input type="checkbox"/> c. R. F. Chokes.</li> <li><input type="checkbox"/> d. Toroids.</li> <li><input type="checkbox"/> e. Transformer Coils.</li> <li><input type="checkbox"/> f. Tuning.</li> </ul> <p><i>Condensers, see 8 &amp; 9.</i></p>  | <p><i>Frequency Measuring Equipment, see 37a, 59a, 61b, c, d, and e.</i></p> <p><b>23. FUSES &amp; FUSE HOLDERS. Generators, see 38c.</b></p>  | <p><b>35. METERS.</b></p> <ul style="list-style-type: none"> <li><input type="checkbox"/> a. Ammeters.</li> <li><input type="checkbox"/> b. Elapsed Time.</li> <li><input type="checkbox"/> c. Frequency Indicating.</li> <li><input type="checkbox"/> d. Voltmeters.</li> <li><input type="checkbox"/> e. Volume Level Meters (db &amp; vu).</li> <li><input type="checkbox"/> f. Wattmeters &amp; Watt Hour Meters.</li> </ul> <p><i>Vacuum Tube Voltmeters, see 60i.</i></p>   |
| <p><b>4. ATTENUATORS.</b></p> <ul style="list-style-type: none"> <li><input type="checkbox"/> a. Audio Frequency.</li> <li><input type="checkbox"/> b. Radio Frequency.</li> </ul>   | <p><b>12X. COMPUTERS</b></p> <ul style="list-style-type: none"> <li><input type="checkbox"/> a. Electronic</li> </ul> <p><b>13. CONNECTORS.</b></p> <ul style="list-style-type: none"> <li><input type="checkbox"/> a. AN Standard Types.</li> <li><input type="checkbox"/> b. Microphone.</li> <li><input type="checkbox"/> c. Power.</li> </ul> <p><i>Consoles, see 1a.</i></p>  | <p><b>24. GRAPHIC RECORDERS</b></p> <p><b>25. HARDWARE &amp; MANUFACTURING AIDS.</b></p>   | <p><b>36. MICROPHONES.</b></p> <ul style="list-style-type: none"> <li><input type="checkbox"/> a. Carbon.</li> <li><input type="checkbox"/> b. Condenser.</li> <li><input type="checkbox"/> c. Crystal.</li> <li><input type="checkbox"/> d. Magnetic.</li> </ul>   |
| <p><b>5. BATTERIES.</b></p> <ul style="list-style-type: none"> <li><input type="checkbox"/> a. Flashlight &amp; Miscellaneous Dry.</li> <li><input type="checkbox"/> b. Hearing Aid.</li> <li><input type="checkbox"/> c. Portable Radio Types.</li> <li><input type="checkbox"/> d. Storage.</li> </ul>   | <p><b>14. CONVERTERS.</b></p> <ul style="list-style-type: none"> <li><input type="checkbox"/> a. Frequency.</li> <li><input type="checkbox"/> b. Vibrator.</li> </ul> <p><i>Rotary, see 38.</i></p> <p><b>15. CORES &amp; CORE MATERIALS.</b></p> <ul style="list-style-type: none"> <li><input type="checkbox"/> a. Complete Cores.</li> <li><input type="checkbox"/> b. Laminations.</li> <li><input type="checkbox"/> c. Powdered Metal.</li> </ul>   | <p><b>26. INDUCTION HEATING EQUIPMENT.</b></p> <ul style="list-style-type: none"> <li><input type="checkbox"/> a. Manufacturing Processes.</li> <li><input type="checkbox"/> b. Medical Applications.</li> </ul> <p><i>Inductors, see 12.</i></p>  | <p><b>37. MONITORING EQUIPMENT.</b></p> <ul style="list-style-type: none"> <li><input type="checkbox"/> a. Frequency.</li> <li><input type="checkbox"/> b. Modulation.</li> <li><input type="checkbox"/> c. Television</li> </ul> <p><b>38. MOTOR GENERATORS.</b></p> <ul style="list-style-type: none"> <li><input type="checkbox"/> a. Dynamotors.</li> <li><input type="checkbox"/> b. Frequency Changers.</li> <li><input type="checkbox"/> c. Motor-Generators.</li> <li><input type="checkbox"/> d. Rotary Converters.</li> </ul> |
| <p><b>6. BLOWERS &amp; COOLING FANS</b></p> <p><i>Bridges, see 60a.</i></p>  | <p><b>16. CRYSTALS.</b></p> <ul style="list-style-type: none"> <li><input type="checkbox"/> a. Germanium &amp; Silicon, etc.</li> <li><input type="checkbox"/> b. Oscillating Quartz.</li> <li><input type="checkbox"/> c. Piezo-Electric.</li> </ul>  | <p><b>27. INSULATION.</b></p> <ul style="list-style-type: none"> <li><input type="checkbox"/> a. Cloth.</li> <li><input type="checkbox"/> b. Glass.</li> <li><input type="checkbox"/> c. Mica.</li> <li><input type="checkbox"/> d. Paper.</li> <li><input type="checkbox"/> e. Varnished Cambric.</li> </ul> <p><i>See also 10 &amp; 45.</i></p>  | <p><b>39. MOTORS: Very Small.</b></p> <ul style="list-style-type: none"> <li><input type="checkbox"/> a. Blower Motors.</li> <li><input type="checkbox"/> b. Selsyn Controls.</li> <li><input type="checkbox"/> c. Timing Devices.</li> </ul>   |
| <p><b>7. CABLE &amp; WIRE.</b></p> <ul style="list-style-type: none"> <li><input type="checkbox"/> a. Co-axial Cable.</li> <li><input type="checkbox"/> b. Pre-formed Harnesses</li> <li><input type="checkbox"/> c. Rubber Insulated Wires.</li> <li><input type="checkbox"/> d. Shielded Types.</li> <li><input type="checkbox"/> e. Synthetic Insulated Wires.</li> <li><input type="checkbox"/> f. U.H.F. Types.</li> </ul>  | <p><b>17. CRYSTAL HOLDERS.</b></p> <p><i>Discs, Recording, see 51a.</i></p> <p><b>18. DRAFTING EQUIPMENT &amp; SUPPLIES.</b></p> <p><i>Dynamotors, see 38a.</i></p>  | <p><b>28. JACKS, JACK FIELDS, PLUGS, &amp; PATCH CORDS.</b></p> <p><b>29. KEYS.</b></p> <ul style="list-style-type: none"> <li><input type="checkbox"/> a. Switching.</li> <li><input type="checkbox"/> b. Telegraph.</li> </ul> <p><i>Knobs, see 40c.</i></p>   | <p><b>40. MOULDED PRODUCTS &amp; SERVICES.</b></p> <ul style="list-style-type: none"> <li><input type="checkbox"/> a. Cabinets.</li> <li><input type="checkbox"/> b. Insulators.</li> <li><input type="checkbox"/> c. Knobs &amp; Parts.</li> <li><input type="checkbox"/> d. Proprietary Mouldings.</li> <li><input type="checkbox"/> e. Special Fabrication.</li> </ul>   |
| <p><b>8. CAPACITORS: Fixed.</b></p> <ul style="list-style-type: none"> <li><input type="checkbox"/> a. Ceramic.</li> <li><input type="checkbox"/> b. Electrolytic.</li> <li><input type="checkbox"/> c. Mica.</li> <li><input type="checkbox"/> d. Oil Filled.</li> <li><input type="checkbox"/> e. Paper.</li> <li><input type="checkbox"/> f. Pressurized Gas.</li> <li><input type="checkbox"/> g. Vacuum.</li> </ul>   | <p><b>19. ELECTRONIC CONTROL EQUIPMENT.</b></p> <ul style="list-style-type: none"> <li><input type="checkbox"/> a. Air conditioning Controls.</li> <li><input type="checkbox"/> b. Burglar Alarm &amp; Protection Devices.</li> <li><input type="checkbox"/> c. Combustion &amp; Smoke Elimination.</li> </ul>   | <p><b>30. LACQUERS.</b></p> <ul style="list-style-type: none"> <li><input type="checkbox"/> a. Finishing.</li> <li><input type="checkbox"/> b. Fungus Proofing.</li> <li><input type="checkbox"/> c. Moisture Proofing.</li> </ul> <p><b>31. LOUSPEAKERS &amp; HEADPHONES.</b></p> <ul style="list-style-type: none"> <li><input type="checkbox"/> a. Commercial Grade Loudspeakers.</li> <li><input type="checkbox"/> b. Headphones.</li> <li><input type="checkbox"/> c. High Fidelity Loudspeaking Systems.</li> <li><input type="checkbox"/> d. High Frequency Types.</li> </ul>                                       | <p><b>41. OPTICAL SYSTEMS, MIRRORS, SCREENS, &amp; ACCESSORIES.</b></p> <p><i>Oscillators, see 59a, d &amp; 61b, c, d, e.</i></p>   |

Please check clearly each item you manufacture or service you render.

**12. OSCILLOGRAPHS & ACCESSORIES.**

- a. General Purpose, Cathode Ray.
- b. Recording.
- c. Synchronoscopes, Cathode Ray.
- d. U.H.F. Cathode Ray Equipment.

*Panels, see 11.***13. PHONOGRAPH & TRANSCRIPTION REPRODUCING EQUIPMENT.**

- a. Crystal Pick-ups.
- b. Magnetic Pick-ups.
- c. Phonograph Motors.
- d. Playback arms.
- e. Record Changers.
- f. Turntables, complete.

*Pre-amplifiers, see 11.***14. PILOT LIGHTS & ASSEMBLIES.**

- a. Incandescent.
- b. Neon.

**15. PLASTICS.**

- a. Raw Powders for Moulding.
- b. Rods.
- c. Sheets.

*Plugs, see 13 & 28.***16. POINT TO POINT COMMUNICATION EQUIPMENT.**

- a. Aircraft & Airport Equipment.
- b. Citizen Radio.
- c. Emergency Communications.
- d. Fleet Dispatching.
- e. Police & Fire Department Equipment.
- f. Ship to Shore Equipment.

**17. POWER SUPPLIES.**

- a. Electrically Powered.
- b. Gasoline Driven.
- c. Voltage Regulated Output types.

*Printed circuits, see 25.***18. PUMPS: Vacuum.***Racks, see 11. Radar Equipment, see 64b.***19. RADIO RECEIVERS.**

- a. Broadcast.
- b. Communications.
- c. Fixed Frequency.
- d. Frequency Modulation.
- e. Special Purpose.
- f. Television.

**20. RECORDING EQUIPMENT.**

- a. Disc Recording Machines.
- b. Magnetic Tape Recorders.
- c. Magnetic Wire Recorders.

**21. RECORDING ACCESSORIES & SUPPLIES.**

- a. Blanks.
- b. Cutting Needles.

- c. Disc Recording Heads.

- d. Magnetic Recording Playback, & Biasing Heads.

- e. Magnetic Recording Tape.

- f. Magnetic Recording Wire.

**22. RECTIFIERS.**

- a. Metallic.
- b. Vacuum Tube.

*Regulators, Voltage, see 67.***23. RELAYS.**

- a. Hermetically sealed.
- b. Instrument.
- c. Keying.
- d. Mercury.
- e. Power Control & Overload.
- f. Stepping.
- g. Telephone Types.
- h. Time Delay.

**24. REMOTE CONTROLLING EQUIPMENT.**

- a. Automatic Tuning Mechanisms.
- b. Remote Controls.
- c. Switching Functions.
- d. Servo-Mechanisms.

**25. RESISTORS.**

- a. Carbon fixed.
- b. Carbon Variable.
- c. Precision.
- d. Vacuum Sealed.
- e. Wire Wound, Fixed.
- f. Wire Wound, Variable.

**26. SOCKETS, VACUUM TUBE.**

- a. Receiving Tube Types.
- b. Transmitting Tube Types.
- c. Underwriters Laboratories Approved Types.

**27. SOLDER.**

- a. Acid Cored.
- b. Plain.
- c. Precious Metal.
- d. Pre-forms.
- e. Rosin Cored.

*Speakers, see 31.***28. SWITCHES.**

- a. Band Switches.
- b. Circuit Breaking.
- c. Key.
- d. Mercury Switches.
- e. Momentary Contact.
- f. Power.
- g. Precision Snap-Acting.
- h. Rotary.
- i. Time Delay.
- j. Toggle & Push Button.

**28X. TELEVISION EQUIPMENT.**

- a. Cameras.
- b. Projectors.
- c. Studio Lighting Equipment.

*Also see 37c, 49f, 61d, 63e, & 65k.***29. TESTING & MEASURING EQUIPMENT: Audio Frequency.**

- a. Beat Frequency Oscillators.
- b. Distortion & Noise Analyzers.
- c. Intermodulation Distortion Analyzers.
- d. Resistance Capacity Oscillators.
- e. Square Wave Generators.
- f. Wave Form Analysis Equipment.

**30. TESTING & MEASURING EQUIPMENT: General.**

- a. Bridges, all types.
- b. Capacitance Decades.
- c. Capacitor Testers.
- d. Multi-meters.
- e. Resistance Decades.
- f. Resistor Testers-Ohmmeters.
- g. Stroboscopes.
- h. Tube Testers.
- i. Vacuum Tube Voltmeters.
- j. Vibration Testing Equipment.

**30X. TESTING & MEASURING EQUIPMENT: Nuclear**

- a. Dosimeters.
- b. Ionization Chambers.
- c. Scalers.
- d. Scintillation Counters.
- e. Survey Meters.

*Geiger-Mueller Tubes, see: Vacuum Tubes.***31. TESTING & MEASURING EQUIPMENT: Radio Frequency.**

- a. "Q" Meters.
- b. Signal Generators AM.
- c. Signal Generators, FM.
- d. Signal Generators, TV.
- e. Standard Frequency Generators & Multi-Vibrators.
- f. Sweep Generators & Calibrators.
- g. Wavemeters.

**32. TRANSFORMERS.**

- a. Audio Frequency.
- b. Hermetically Sealed.
- c. High Fidelity Audio Types.
- d. Power Components.
- e. Pulse Generating Types.
- f. Radio Frequency.
- g. Voltage Regulating.

**33. TRANSMITTERS.**

- a. AM Broadcast.
- b. Communications.
- c. FM Broadcast.
- d. Special Types.
- e. TV Broadcast.

**34. ULTRA HIGH FREQUENCY EQUIPMENT & ACCESSORIES.**

- a. Antennas & Reflectors.
- b. Radar Apparatus.
- c. Receivers.
- d. Transmitters.
- e. Waveguides.

**35. VACUUM TUBES.**

- a. Cathode Ray.
- b. Geiger-Mueller.
- c. Industrial types.
- d. Klystrons & Magnetrons.
- e. Phototubes.
- f. Pirani Tubes.
- g. Receiving Types.
- h. Rectifiers.
- i. Special Purpose.
- j. Thyratrons.
- k. Television Types.
- l. Transmitting Types.
- m. Voltage Regulators.

**36. VACUUM TUBE COMPONENT PARTS.***Varnishes, see 30.***37. VOLTAGE REGULATORS.**

- a. Automatic.
- b. Manually Controlled.

**38. WAXES, POTTING & SEALING COMPOUNDS.****39. WOODEN CABINETS.**

- a. Radio Sets.
- b. Record Storage.

**NON-MANUFACTURING CLASSIFICATIONS.****40. BOOKS AND BOOK PUBLISHERS.****41. BROADCASTING STATIONS & COMMUNICATION COMPANIES.****42. CONSULTING ENGINEERS.**

- a. Acoustical.
- b. Electrical.
- c. Mechanical.
- d. Radio.

**43. DISTRIBUTION.**

- a. Jobbers and Wholesalers
- b. Manufacturers Representatives
- c. Sales and Service

**44. FREQUENCY MEASURING & MONITORING SERVICES.****45. LABORATORIES & CUSTOM BUILDERS OF EQUIPMENT.****46. RECORDING STUDIOS & SERVICES.****47. TECHNICAL SCHOOLS & INSTITUTIONS.****48. TRANSCRIPTION LIBRARIES.****COUPON**

May, 1950

Send to: Industry Research Div., Proceedings of the I.R.E.  
Rm. 707, 303 West 42nd St., New York 18, N.Y.

Date .....

Firm Name: ..... Phone No. ....

Address: ..... Place ..... Zone ..... State .....

To whom in your organization should we direct correspondence concerning:

Product Data .....

IRE Yearly Convention ..... Advertising .....

# Do Radio-Electronic Engineers KNOW what you make?

Distributors Edition, over 200 pages of supply firms index, plus comprehensive engineering products list. Advertising repeated here.

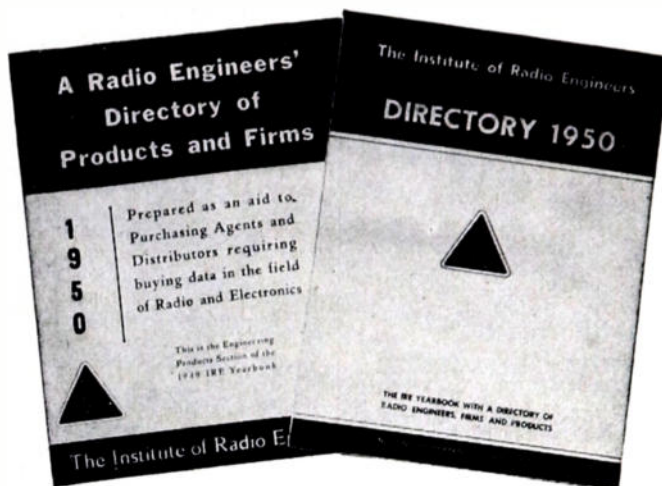

Full IRE DIRECTORY supplied to members, nearly 500 pages of three directories in one, engineers, firms and products. Advertising originates here.

● If they ought to know, tell them in the IRE DIRECTORY. This is the Directory in which they have a personal interest. It lists more than 17,500 members of The Institute of Radio Engineers and gives their membership grade, length of membership, business connection and address. It contains the annual report of the Institute, its Constitution, an index to supply firms in the radio-electronic field, and an engineers' guide to products.

● 3327 different firms have cooperated in helping set up the company and product indexes, supplying detailed listings of the radio-and-electronic products they make or services offered. 17,500 members have helped by furnishing their personal reports. The whole project is a co-operative, non-profit service to members and the industry they serve by supplying an annually corrected directory of engineers, firms and products in one, easy-to-use volume.

● The information provided is unique. Engineers work with engineers and the membership lists provide both a fellowship service and a record of experience and standing, vital in a technical and scientific industry.

The product data is arranged in fundamental classifications, established by engineers, for engineers. They are director, and faster to use than terminology classifications. In the alphabetical list of firms, number coding reveals all the engineering products each firm makes for our industry. This gives a more comprehensive picture of manufacturing and service firms than appears in any other directory in the field.

● One advertisement works a whole year for your

firm in the IRE DIRECTORY. Issued annually in September, this book is kept as a prized possession by each member until the next comes out. It is used again and again because of its three important services—engineers, firms and products, so completely and clearly indexed. Moreover, the advertiser gets all the “breaks” in this Directory because all his listings are in bold type, with cross-reference to the page of his display message.

● Space costs are economical, and requirements very flexible, ranging from a one inch engineers card, or a sixth of a page display unit to complete catalog inserts. All ad unit sizes are standard to the 7x10 inch, 3 column page. Rates are:

|                                  |        |   |
|----------------------------------|--------|---|
| 1/6th page                       | \$ 60. | Identical to one Time “Proceedings of the I.R.E.” rates. Contract advertisers get same discounts. |
| 1/3 page                         | \$100. |   |
| 2/3rd page                       | \$180. |   |
| Full page                        | \$250. |   |
| 2 pages or spread                | \$450. |   |
| Catalog insert rates on request. |        |   |

● The economical catalog insert plan started in 1948 has proved a boon to firms wishing radio engineers to have their full data in a permanent and always available file. Catalog advertisers doubled in 1949. Prices will be quoted simply for inserting preprinted 8½” x 11” technical catalogs, or including production and printing.

● The IRE DIRECTORY is the “product reference” part of the IRE Balanced Promotion Program. Advertising in “Proceedings of the I.R.E.” provides “product promotion.” and a Radio Engineering Show exhibit is “product presentation.” Ask us for the Program Plan.



## THE INSTITUTE OF RADIO ENGINEERS

Established  1913

A Balanced Promotion Package  
“Proceedings of the I.R.E.” The IRE Yearbook  
The Radio Engineering Show

303 WEST 42nd STREET, NEW YORK 18, N. Y.  
Circle 6-6357

TO SELL THE  
RADIO  
INDUSTRY

TELL THE  
RADIO  
ENGINEERS

# Spectrum Analysis

from AF to UHF

**Faster and Simpler with these Panoramic Instruments**

Whether your problem is investigation of noises, vibrations, harmonics, characteristics of AM, FM or pulsed signals, oscillations, cross modulation, transmission characteristics of lines and filters, tele-metering or any phenomena requiring spectrum analysis, these panoramic instruments will help collect information faster, easier and accurately. Panoramic instruments automatically visualize spectral content. Indications in the form of vertical pins whose height and horizontal location respectively show signal level and frequency, enable rapid examination of one or more signals at one time.



AP-1

## PANORAMIC SONIC ANALYZER AP-1 Complete Audio Waveform Analysis in One Second

Recognized as THE practical answer for analyzing waves of random or static character, the AP-1 automatically separates and measures complex wave components in only one second.

Frequency Range: 40-20,000 c.p.s., log scale.

Input Voltage Range: 500  $\mu$ V-500V.

Voltage Scale: linear and two decade log, harmonic products suppressed by at least 60 db. Direct Reading. Simple Operation. Optimum Resolution.



SB-7

## PANORAMIC ULTRASONIC ANALYZER Entirely New for Ultrasonic Studies

An invaluable new direct reading instrument, the SB-7 enables overall observation of the ultrasonic spectrum or very highly detailed examination of any selected narrow segment of the spectrum.

Frequency Range: 2KC-300KC, linear scale.

Scanning Width: Continuously variable, 200 KC to zero.

Input Voltage Range: 1 mV-50V.

Amplitude Scale: linear and two decade log.



SB-8

## PANALYZER-PANADAPTOR For RF Spectrum Analysis

Long accepted as the simplest and fastest means of observing segments of the RF Spectrum, Panadaptor units operate with superheterodyne receivers, which tune in the segment to be examined. Panalyzers use an external signal generator for this purpose and have a flat amplitude response for determining relative levels of signals.

Both are available in over a dozen standard models and types differing in Maximum Scanning Widths ranging from 50KC to 20MC, continuously variable to zero. Signal Resolution Capabilities from 250KC down to 100 CFS.

Write for Complete Technical Data



# INDEX AND DISPLAY ADVERTISERS

|                         |     |
|-------------------------|-----|
| Section Meetings        | 37A |
| Student Branch Meetings | 40A |
| Membership              | 43A |
| Positions Open          | 50A |
| Positions Wanted        | 52A |
| News—New Products       | 30A |

## DISPLAY ADVERTISERS

|   |          |
|---|----------|
| Ace Engineering & Machine Co., Inc.     | 48A      |
| Acme Electric Corp.                     | 61A      |
| Aerovox Corp.                           | 26A      |
| Airtron Inc.                            | 47A      |
| Amperex Electronic Corp.                | Cover II |
| Amperite Co., Inc.                      | 48A      |
| Ampex Electric Corp.                    | 63A      |
| Antara Products, General Aniline & Film | 14 & 15A |
| Arnold Engineering Co.                  | 8A       |

|                              |     |
|------------------------------|-----|
| Barker & Williamson, Inc.    | 40A |
| Bead Chain Mfg. Co.          | 47A |
| Bell Telephone Labs.         | 2A  |
| Bendix Aviation (Radio Div.) | 50A |
| Berkeley Scientific Co.      | 55A |
| Bliley Electric Co.          | 49A |
| W. J. Brown                  | 72A |
| Browning Labs.               | 38A |
| Bud Radio, Inc.              | 54A |

|                                 |                    |
|---------------------------------|--------------------|
| Cambridge Thermionic Corp.      | 71A                |
| Cannon Electric Development Co. | 49A                |
| Canoga Corp.                    | 55A                |
| Capitol Radio Engineering Inst. | 54A                |
| Centralab                       | 33A, 34A, 35A, 36A |
| Cleveland Container Co.         | 7A                 |
| Sigmund Cohn Corp.              | 56A                |
| Collins Radio Co.               | 27A                |
| Communication Products Co.      | 42A                |
| Communications Equipment Co.    | 64A & 65A          |
| E. J. Content                   | 72A                |
| Cornell-Dubilier Electric Corp. | Cover III          |
| Cossor Ltd.                     | 56A                |
| Crosby Labs                     | 72A                |

|                                    |     |
|------------------------------------|-----|
| Allen B. DuMont Laboratories, Inc. | 28A |
| Eitel-McCullough, Inc.             | 18A |
| Electrical Reactance Corp.         | 5A  |
| Electro-Mechanical Research, Inc.  | 59A |
| Electro-Motive Mfg. Co., Inc.      | 9A  |
| Electro Search                     | 72A |
| Electro-Voice, Inc.                | 37A |

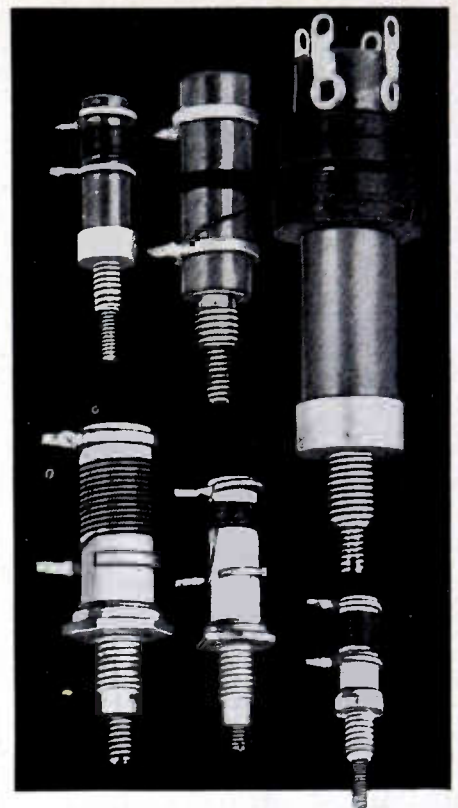

## Which Of These Coil Forms Best Fits YOUR Needs?

Coil Forms Only, Or Coils Wound To Your Specifications . . . Cambridge Thermionic will furnish slug tuned coil forms alone or wound with either single layer or pie type windings to fit your needs, in high, medium or low frequencies . . . and in small or large production quantities.

See table below for physical specifications of coil forms.

### SEND COMPLETE SPECIFICATIONS FOR SPECIALLY WOUND COILS

| Coil Form | Material       | Mounting Stud Thread Size | Form O.D. | Mounted O.A. Height |
|-----------|----------------|---------------------------|-----------|---------------------|
| LST       | L-5 Ceramic    | 8-32                      | 3/16"     | 1 1/2"              |
| LS6       | L-5 Ceramic    | 10-32*                    | 1/4"      | 2 1/4"              |
| LS5       | L-5 Ceramic    | 1/4-28*                   | 3/8"      | 1 1/8"              |
| LSM       | Paper Phenolic | 8-32                      | 1/4"      | 2 1/4"              |
| LS3       | Paper Phenolic | 1/4-28                    | 3/8"      | 1 3/8"              |
| LS4†      | Paper Phenolic | 1/4-28                    | 1/2"      | 2"                  |

\*These types only provided with spring locks for slugs.  
†Fixed lugs. All others have adjustable ring terminals.  
All ceramic forms are silicone impregnated. Mounting studs of all forms are cadmium plated.

*custom or standard the guaranteed components*

**CAMBRIDGE THERMIONIC CORP.**  
456 Concord Ave., Cambridge 38, Mass.  
West Coast Stock Maintained By: E. V. Roberts,  
3014 Venice Blvd., Los Angeles, California

# PROFESSIONAL CARDS

## W. J. BROWN

Registered Professional Engineer Specializing in  
**INDUSTRIAL ELECTRONICS**  
New Systems developed from Basic Principles  
512 Marshall Bldg., Cleveland 13, Ohio  
TOwer 1-6498 FAirmount 1-0030

## EDWARD J. CONTENT

*Acoustical Consultant*  
**Functional Studio-Theater Design**  
FM — Television — AM  
Audio Systems Engineering  
Roxbury Road Stamford 3-7459  
Stamford, Conn.

## CROSBY LABORATORIES

*Murray G. Crosby & Staff*  
FM, Communications, TV  
Industrial Electronics  
High-Frequency Heating  
Offices, Laboratory & Model Shop at:  
126 Herricks Rd. Mineola, N.Y.  
Garden City 7-0204

Richard B. Schulz

## *Electro-Search*

Radio-Interference Reduction;  
Development of  
Interference-Free Equipment,  
Filters, Shielded Rooms  
615 W. Wyoming Ave., Philadelphia 40, Pa.  
Gladstone 5-5353

## ELK ELECTRONIC LABORATORIES

Jack Rosenbaum  
Specializing in the design and  
development of  
Test Equipment for the communications,  
radar and allied fields.  
12 Elk Street Telephone:  
New York 7, N.Y. WOrth 2-4963

## WILLIAM L. FOSS, INC.

927 15th St., N.W. REpublic 3883  
WASHINGTON, D.C.

## PAUL GODLEY CO.

*Consulting Radio Engineers*  
P.O. Box J, Upper Montclair, N.J.  
Offs & Lab.: Great Notch, N.J.  
Phone: Montclair 3-3000  
Established 1926

## HERMAN LEWIS GORDON

Registered Patent Attorney  
Patent Investigations and Opinions  
Warner Building 100 Normandy Drive  
Washington 4, D.C. Silver Spring, Md.  
National 2497 Shepherd 2433

# DISPLAY ADVERTISERS

Elk Electronic Associates ..... 72A  
Emsco Derrick & Equipment Co. .... 45A  
W. L. Foss ..... 72A  
Freed Transformer Co., Inc. .... 25A  
Furst Electronics ..... 59A  
General Electric Co. .... 10A & 11A  
General Radio Co. .... Cover IV  
General Services Administration ..... 50A  
Paul Godley ..... 72A  
H. L. Gordon ..... 72A  
Samuel Gubin ..... 72A  
Hewlett-Packard Co. .... 3A  
Hughes Aircraft Co. .... 50A, 52A  
Hughes & Phillips ..... 45A

Samuel Gubin, Electronics  
G. F. Knowles, Mech. Eng.  
**SPECTRUM ENGINEERS, Inc.**  
*Electronic & Mechanical Designers*  
540 North 63rd Street  
Philadelphia 31, Pa.  
GRanite 2-2333; 2-3135

## MEASUREMENTS CORP.

RESEARCH & MANUFACTURING  
ENGINEERS  
Harry W. Houck Jerry B. Minter  
John M. van Beuren  
Specialists in the Design and  
Development of Electronic Test Instruments  
BOONTON, N.J.

## PICKARD AND BURNS, INC.

*Consulting Electronic Engineers*  
Analysis and Evaluation  
of Radio Systems  
Research, Development & Design  
of Special Electronic Equipment  
240 Highland Ave., Needham 94, Mass.

## PAUL ROSENBERG ASSOCIATES

*Consulting Physicists*  
Main office: Woolworth Building,  
New York 7, N.Y.  
Cable Address Telephone  
PHYSICIST WOrth 2-1939  
Laboratory: 21 Park Place, New York 7, N.Y.

## TECHNICAL MATERIEL CORPORATION

COMMUNICATIONS CONSULTANTS  
RADIOTELETYPE - FREQUENCY SHIFT  
INK SLIP RECORDING - TELETYPE NETWORKS  
453 West 47th Street, New York 19, N.Y.

## WHEELER LABORATORIES, INC.

Radio and Electronics  
Consulting — Research — Development  
R-F Circuits — Lines — Antennas  
Microwave Components — Test Equipment  
Harold A. Wheeler and Engineering Staff  
Great Neck, N.Y. Great Neck 2-7806

Jacobs Instrument Co. .... 52A  
E. F. Johnson Co. .... 44A, 46A  
Kalbfell Laboratories, Inc. .... 58A  
Kenyon Transformer Co., Inc. .... 44A  
Kings Electronics ..... 58A  
Lake Chemical Co. .... 63A  
Lambda Electronics Corp. .... 62A  
Magnecord, Inc. .... 39A  
P. R. Mallory & Co., Inc. .... 6A  
Marion Electrical Instruments Co. .... 21A  
W. L. Maxson Corp. .... 51A  
Measurements Corp. .... 46A, 72A  
Melpar, Inc. .... 51A  
Mycalex Corp. of America ..... 24A  
National Carbon Co. .... 13A  
National Electronics Conference ..... 62A  
Ohmite Mfg. Co. .... 29A  
Panoramic Radio Products, Inc. .... 71A  
Pickard & Burns ..... 72A  
Potter Instrument Co. .... 57A  
Radio Corp. of America .... 22A, 32A, 54A  
Raytheon Mfg. Co. .... 23A  
Paul Rosenberg Assoc. .... 72A  
Sheldon Electric Co. .... 20A  
Sorensen & Co., Inc. .... 41A  
Spencer Kennedy Labs. .... 57A  
Sperry Gyroscope Co. .... 52A  
Sprague Electric Co. .... 1A  
Stackpole Carbon Co. .... 19A  
Stoddart Aircraft Radio Co. .... 4A, 31A  
Sylvania Electric Prod. Co. .... 16A  
Tech Labs. .... 60A  
Technical Materiel Corp. .... 72A  
Technology Instrument Corp. .... 43A  
Tektronix, Inc. .... 60A  
Transradio Ltd. .... 63A  
Truscon Steel Co. .... 12A  
Tung-Sol Lamp Works, Inc. .... 53A  
United Transformer Corp. .... 17A  
Waterman Products Co., Inc. .... 53A  
Wells Sales, Inc. .... 66A  
Westinghouse Electric Corp. .... 53A  
H. A. Wheeler ..... 72A  
S. S. White Dental Mfg. Co. .... 30A

Still another C-D first!

**C-D**

NOW BRINGS YOU THE NEW

# ROYAL TIGER POLYKANE\* CAPACITORS

★ **STURDY**

★ **HUMIDITY PROOF**

★ **-35° to 100°C.**



## \*Polykane

— a solid synthetic thermosetting compound, developed by C-D engineers for use in Royal Tigers — provides new sturdy construction for operation at temperatures from -35°C to +100°C.

Royal Tiger Capacitors are Polykane impregnated and filled, resulting in exceptionally uniform electrical properties and performance over extra long service life. No oil or wax used within capacitor. End seal or impregnant will not flow at any temperature.

Royal Tiger Capacitors now make possible a standardized line of tubulars for operation at temperatures up to 100°C., thus eliminating need for stocking low and high temperature oil or wax tubular capacitors.

For full details, write for Bulletin RT349. CORNELL-DUBILIER ELECTRIC CORPORATION, Dept. M50, South Plainfield, New Jersey. Other plants in New Bedford, Brookline and Worcester, Mass.; Providence, R. I.; Indianapolis, Ind., and subsidiary, The Radiart Corp., Cleveland, Ohio.



# CORNELL-DUBILIER CAPACITORS



# G-R Announces a Complete, Integrated Line of U-H-F MEASURING EQUIPMENT

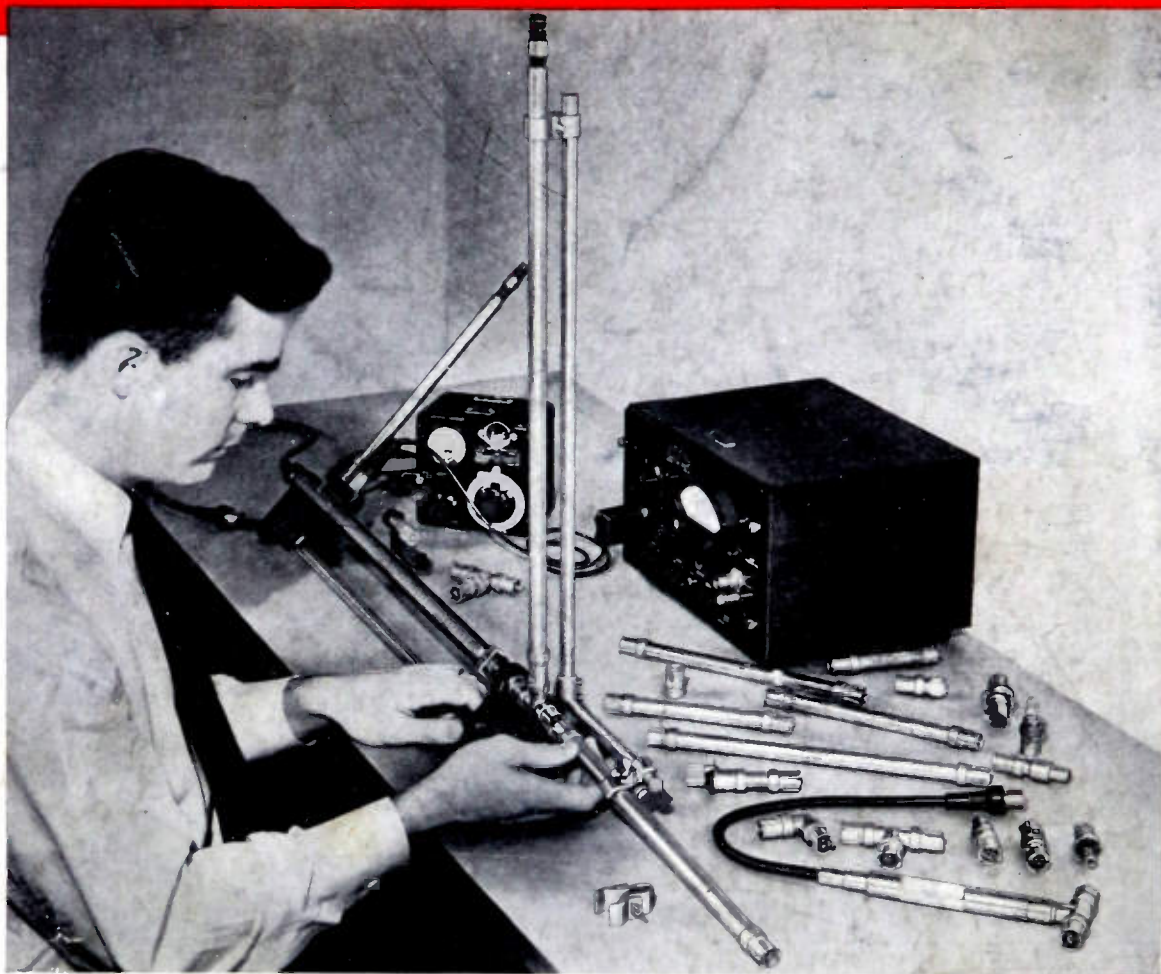

for Measurements of **POWER · VOLTAGE · IMPEDANCE**  
**ATTENUATION · STANDING-WAVE RATIO up to 3,000 Mc**

This new line of U-H-F Measuring Equipment is the most complete General Radio has ever offered. Available are a large number of coaxial parts for simple and rapid assembly into a number of different measurement set-ups.

For the college laboratory, research and development laboratories and consulting engineers, and for measurements in the proposed U.H.F. T-V Band these Type 874 components offer an inexpensive and versatile means for making accurate determinations of:

**OSCILLATORS**— Power output · Output Impedance · Wavelength

**AMPLIFIERS**— Gain · Input and Output Voltage & Impedance

**COMPONENTS**— Standing-wave Ratio and Impedance

The complete line of parts is shown in the illustration. It includes foundation elements such as basic universal connectors, cable connectors, panel connectors, adapters for other types of connector and patch cords; fixed and adjustable line elements as air lines, 90-degree ells, tees, adjustable tuning stubs, adjustable lines and rotary joints; 500- and 1000-Mc low-pass filters and coupling capacitors, and a number of terminations, coupling elements and attenuators.

Throughout the entire line the characteristic impedance is 50 ohms wherever possible. The wide frequency range of 300 to 3,000 Mc is covered by all of the parts; many operate on lower frequencies and up to 5,000 Mc.

If you plan any work in frequencies up to 3,000-5,000 Mc you will find this new line of G-R measuring equipment of great help.

WRITE FOR FORM 722-A FOR COMPLETE INFORMATION

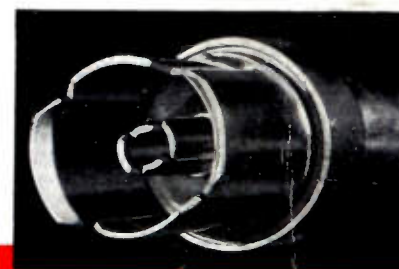

## Radically New Basic COAXIAL CONNECTOR

The key element of the entire group of coaxial parts is the Type 874 Coaxial Connector. Any two of these connectors, though identical, plug smoothly into each other without any intermediate elements, eliminating the complication of male and female ends. This new connector is ideally suited for use on coaxial measuring equipment. Its low reflections at ultra-high frequencies are negligible except in very accurate work.



# GENERAL RADIO COMPANY

Cambridge 39,  
Massachusetts

90 West St., New York 6 920 S. Michigan Ave., Chicago 5 1000 N. Seward St., Los Angeles 38