

# Proceedings



of the I·R·E

**A Journal of Communications and Electronic Engineering**  
(Including the WAVES AND ELECTRONS Section)

**July, 1949**

Volume 37

Number 7

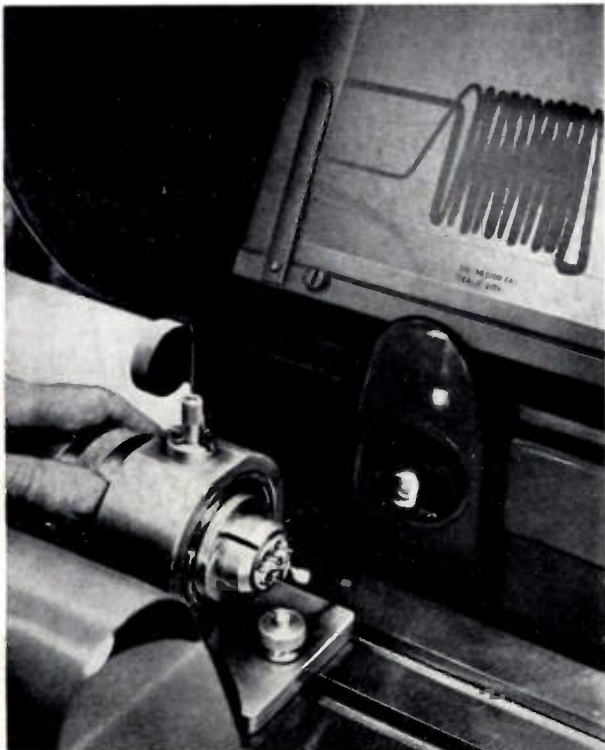

*Western Electric Co.*

**"OPTICAL MICROMETER" FOR  
MICROWAVE TUBES**

Radio-relay systems utilize transmitting tubes of high precision controlled by observation of optical enlargements of tube parts.

## PROCEEDINGS OF THE I.R.E.

- Part I—Electrical Network Analyzers for Electromagnetic Field Problems
- Operation of AM Broadcast Transmitters into Sharply Tuned Antenna Systems
- A Power-Equalizing Network for Antennas
- Transmission-Line Characteristics of the Sectoral Horn
- Theory of Electromagnetic Horn Radiation Patterns
- Piezoelectric Transducers
- Broad-Band Power-Measuring Methods at Microwave Frequencies
- A Forward-Transmission Echo-Ranging System
- Measurement and Interpretation of Antenna Scattering

## Waves and Electrons Section

- Geiger Counter Tubes
- Microwave Phase Front Measurements for 12- and 32-Mile Overwater Paths
- Predetermined Electronic Counter
- Carrier Current Pulsing over Toll Telephone Circuits
- Nomograms for Ionosphere Control Points
- Experimental Determination of Cylindrical Antenna Current and Charge Distribution
- Course-Line Computer for Aircraft Radio Navigation
- Abstracts and References

TABLE OF CONTENTS FOLLOWS PAGE 32A

# The Institute of Radio Engineers

If your reserve tube is ready for active service in your THERMONIC equipment ... it will pay you to put another tube on your shelf ... the tube designed to our specifications, for your THERMONIC UNIT ...

**because**

we have been keeping an accurate check on tube performance life ... and find that even though the manufacturer guarantees a minimum of 1,000 hours of operating life ...

**we** can safely extend that guarantee to **1500 HOURS!**  
**at** a new LOWER PRICE!

... by purchasing your THERMONIC tube replacement through us, you now can be assured of

**50% more**  
for your "efficient operation" dollar.

**THER-MONIC**

INDUCTION HEATING CORP.

**INDUCTION HEATING CORPORATION**  
181 WYTHE AVENUE • BROOKLYN 11, N. Y.

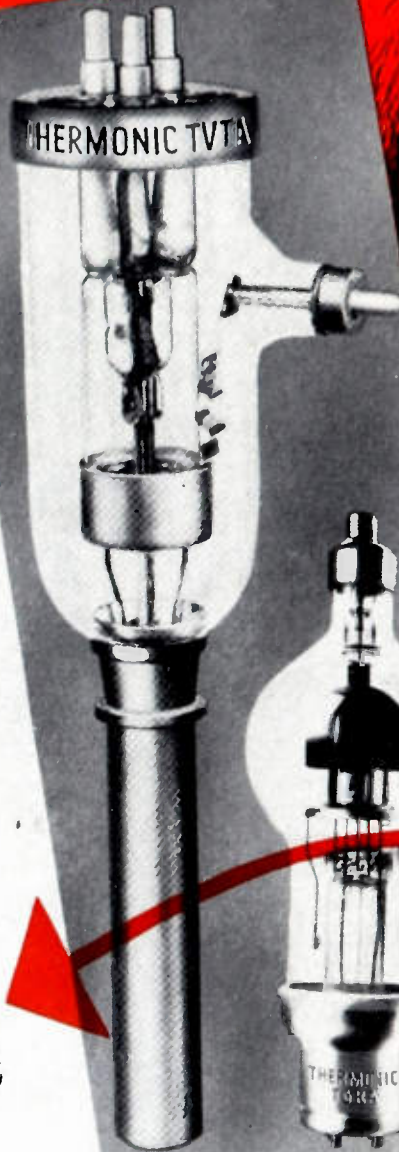

... More People Find That They Get MORE out of AMPEREX Electronic Tubes... Whatever the Application—it Will Pay You to ...

**Re-tube with AMPEREX**

**AMPEREX ELECTRONIC CORP.**

25 WASHINGTON STREET, BROOKLYN 1, N. Y.

In Canada and Newfoundland: Rogers Majestic Limited  
11-19 Brentcliffe Road, Leaside, Toronto, Ontario, Canada





# West Coast IRE

## Invites Engineers

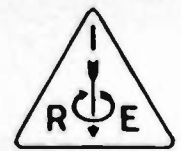

# to a Convention



August 30th to September 2nd are the dates for the Western Region Convention of the Institute of Radio Engineers. This year the San Francisco Section is the host, and plans technical sessions and social events which will attract IRE members throughout the West together with engineers in related fields. Excellent facilities, including a 1200 seat theatre and the large exhibition hall in the Civic Auditorium of San Francisco. This will be a record breaking Regional Convention, satisfying the information needs of radio engineers and accelerating electronic progress by sharing research knowledge.

## 5th Annual Pacific Electronic Exhibit

An estimated 200 manufacturers will bring their most recent advances in instrumentation, components, production tools, materials, audio equipment and transmitters directly to Western engineers in the exhibits sponsored by the West Coast Electronic Manufacturers Association at this convention. From station engineer to production engineer, the exhibition offers a meeting place for producer and user to get together and match each others needs.

### Schedule of Events

	Tuesday—August 30	Wednesday—August 31	Thursday—September 1	Friday—September 2
Morning	Registration—Civic Auditorium. Make reservations for field trips	Technical Session on Industrial Electronics	Technical Session	Inspection Trips E. Hewlett-Packard Co. F. Eitel-McCullough, Inc.
Luncheon		President's Luncheon Hotel Whitcomb Banquet Room	Informal Luncheons for committees and special interest groups	Dinah's Shack or Rickey's
Afternoon	Technical Session on Instrumentation Symposia* WCEMA Electronic Exhibit 2:00-6:00	Inspection Trips A. U. C. Radiation Laboratory B. Hunter's Point Naval Shipyard WCEMA Electronic Exhibit	Technical Session Student Session WCEMA Electronic Exhibit	E. Stanford Microwave and Electronic Labs. F. San Francisco Airport and Maintenance Base
Dinner	Cocktail Party	WCEMA Electronic Exhibit	International Dining in San Francisco WCEMA Electronic Exhibit	
Evening	Technical Session on Microwave Techniques	Technical Session WCEMA Electronic Exhibit	Inspection Trips** C. KGO Television Studio D. KRON Television Studio WCEMA Electronic Exhibit	

\* Three symposia will be held at different times during the convention on  
1. Propagation, 2. Television, and 3. Airborne Antennas.  
\*\* These trips will be scheduled several times each day throughout the convention.

For further information write:

**On Convention Program:**

Joseph M. Pettit  
General Chairman  
Stanford University, Stanford, Calif.

**On San Francisco IRE:**

F. R. Brace  
IRE Section Chairman  
158 18th Ave., San Francisco 21

**On Exhibition Space:**

Heckert Parker  
WCEMA Exhibits Manager  
530 Gough St., San Francisco 2

## IRE Regional Meetings Accelerate Electronic Progress!

PROCEEDINGS OF THE I.R.E. July, 1949, Vol. 37, No. 7. Published monthly in two sections by The Institute of Radio Engineers, Inc., at 1 East 79 Street, New York 21, N.Y. Price \$2.25 per copy. Subscriptions: United States and Canada, \$18.00 a year; foreign countries \$19.00 a year. Entered as second class matter, October 26, 1927, at the post office at Menasha, Wisconsin, under the act of March 3, 1879. Acceptance for mailing at a special rate of postage is provided for in the act of February 28, 1925, embodied in Paragraph 4, Section 412, P. L. and R., authorized October 26, 1927.

Table of contents will be found following page 32A

Follow the Leaders to

**Eimac**  
TUBES  
The Power for R-F

# Skill

## HELPS BUILD BETTER VACUUM TUBES

Skill in the form of old fashioned individual dexterity, teamed with modern manufacturing techniques, plays a very important part in the manufacture of better vacuum tubes . . . Eimac tubes.

Craftsmanship of Eimac employees is the result of years of training at one specific art . . . vacuum tube assembly . . . and the degree of proficiency they have attained is manifest in the quality of the product they produce.

Illustrated is the screen-grid assembly operation of the Eimac 4X150A tetrode. Precise geometric alignment of these parts provides the excellent electron beam action in the 4X150A. This operation is but one of over a hundred similar operations in the construction of this tube requiring the painstaking abilities of the Eimac craftsman.

**ABOUT THE 4X150A . . . . .**  
This extremely compact external anode type tetrode is capable of relatively high-output power at low plate voltage. It is intended for use as an r-f amplifier or oscillator. The 4X150A is used extensively as a wide-band amplifier for video and in single or multi-tube high-power ultra-high-frequency equipment. Good operational characteristics are maintained up to 950-Mc.

**ELECTRICAL CHARACTERISTICS**

Cathode Coated Unipotential	60	volts
Heater Voltage	2.6	amperes
Heater Current	50	
Screen-Grid Amplification Factor (Average)		
Direct Interelectrode Capacitances (Average)		
Grid-Plate (without shielding)	0.02	uuf.
Input	16.1	uuf.
Output	4.7	uuf.
Transconductance ( $i_b = 250$ ma., $e_c = 500$ v., $E_{r1} = 250$ v.)	12,000	umhos.

**CLASS-C TELEGRAPHY OR FM TELEPHONY**  
Maximum Ratings: (Frequencies up to 500 Mc.)

D-C Plate Voltage	1250	Max. Volts
D-C Screen Voltage	300	Max. Volts
D-C Grid Voltage	-250	Max. Volts
D-C Plate Current	250	Max. Ma.
Plate Dissipation	150	Max. Watts
Screen Dissipation	15	Max. Watts
Grid Dissipation	2	Max. Watts

Complete data available on request.

# EITEL-McCULLOUGH, INC.

728 San Mateo Ave., San Bruno, California  
Export Agents: Frazer & Hansen, 301 Clay St., San Francisco, California



# ACCURATE TEST VOLTAGES

## 1/2 cps to 50 kc

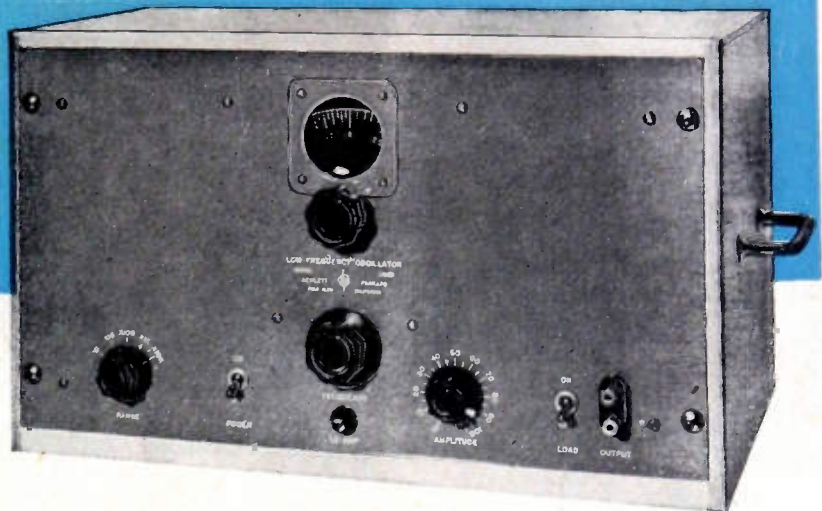

### Person-to-Person Help With Your Measuring Problems

Almost anywhere in America, *-hp-* field representatives can give you personal help with your measuring problems. They have complete data on *-hp-* instruments, their performance, servicing and adaptability. Call the nearest *-hp-* field representative whenever, wherever you need help with a measuring problem.

#### BOSTON, MASSACHUSETTS

Burlingame Associates  
270 Commonwealth Ave.  
KENmore 6-8100

#### CHICAGO 6, ILLINOIS

Alfred Crossley & Associates  
549 W. Randolph St.  
State 7444

#### CLEVELAND 12, OHIO

M. P. Odell  
1748 Northfield Avenue  
Potomac 6960

#### DALLAS 5, TEXAS

Earl W. Lipscomb  
4433 Stanford Street  
Logan 6-5097

#### DENVER 10, COLORADO

Ronald G. Bowen  
1896 So. Humboldt Street  
Spruce 9368

#### DETROIT 6, MICHIGAN

S. Sterling Company  
13331 Linwood Avenue  
TOWnsend 8-3130

#### FORT MYERS, FLORIDA

Arthur Lynch and Associates  
P. O. Box 466  
Fort Myers 1269M

#### HIGH POINT, NORTH CAROLINA

Bivins & Caldwell  
Room 807, Security Bank Building  
Phone 3672

#### LOS ANGELES 46, CALIFORNIA

Norman B. Neely Enterprises  
7422 Melrose Avenue  
Whitney 1147

#### NEW YORK 7, NEW YORK

Burlingame Associates  
11 Park Place  
Digby 9-1240

#### SAN FRANCISCO 3, CALIFORNIA

Norman B. Neely Enterprises  
954 Howard Street  
Douglas 2-2609

#### TORONTO 1, CANADA

Atlas Radio Corporation, Ltd.  
560 King Street West  
Waverley 4761

#### WASHINGTON 9, D. C.

Burlingame Associates  
2017 S. Street N. W.  
Decatur 8000

## *-hp-* 202B LOW-FREQUENCY OSCILLATOR

New, wider frequency range, improved circuits, higher stability—those are but a few of the time-saving new features of this improved *-hp-* Model 202B Low-Frequency Oscillator.

This *-hp-* instrument now covers the low-frequency, audio and supersonic spectra from 1/2 cps to 50 kc. Throughout this range it provides excellent wave form, high stability and an unusual degree of accuracy.

Like other *-hp-* instruments, this resistance-tuned oscillator features amazing simplicity and speed of operation. Frequency is set and read directly. Frequency range is selected from 5 ranges by a front-panel control. No zero-set is required during operation. Construction is simple yet rugged; the instrument is designed for long years of

trouble-free operation in field or laboratory.

The *-hp-* 202B Oscillator is particularly designed for the following tests: Vibration or stability characteristics, electrical simulation of mechanical phenomena, performance checks on electro-cardiograph or encephalograph equipment, testing geophysical prospecting equipment, checking seismograph response. Its versatility makes it adaptable for almost any operation where an accurate low or audio frequency source is required.

### HEWLETT-PACKARD CO.

1875-D Page Mill Road, Palo Alto, California

Export: FRAZAR & HANSEN

301 Clay Street, San Francisco, California, U. S. A.  
Offices: New York, N. Y.; Los Angeles, Calif.

### SPECIFICATIONS

**Frequency Range:** 1/2 cps to 50 kc, 5 ranges.

RANGE	FREQUENCY
X1	1/2 to 5 cps
X10	5 to 50 cps
X100	50 to 500 cps
X1K	500 to 5,000 cps
X10K	5,000 to 50,000 cps

**Calibration Accuracy:** ± 2%.

**Frequency Stability:** Better than ± 5% under normal conditions including warm-up drift. Less than ± 1% for power voltage changes of ± 10%.

**Output Voltage:** 10 v into 1,000 ohm resistive load over entire range.

**Internal Impedance:** Approx. 25 ohms at 10 cps.

**Frequency Response:** ± 1 db, 10 to 50,000 cps; ± 2 db, 1 to 50,000 cps.

**Distortion:** Less than 1% total distortion, 1 cps to 50 kc.

**Hum Voltage:** Less than 0.1% of rated output voltage.

Data subject to change without notice

**hp laboratory instruments**  
FOR SPEED AND ACCURACY

Listen for the words "Transcribed by AMPEX" after the great shows in radio

Here's why.....  
the new series 300

**AMPEX**

**MAGNETIC TAPE RECORDER  
answers industry need!**



Designed by engineers  
who had your engineering  
needs in mind!

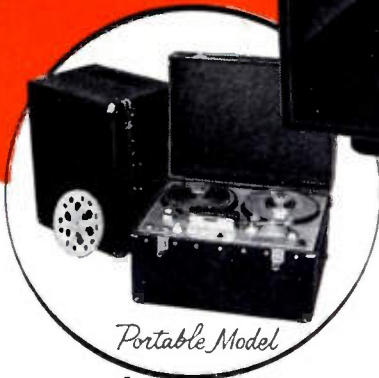

Portable Model

**Console Model 300 - \$1,573.75\***  
**Portable Model 300 - \$1,594.41**  
**Rack mounted - \$1,491.75**

\*Meter panel extra

F. O. B. Factory, San Carlos, Calif.

★ **Original program quality preserved**

Use of independent reproduction facilities allows instantaneous monitoring and makes possible the most stringent comparisons between recordings and originals.

★ **Tape and playback noise non-existent**

Use of special record and bias circuits has eliminated tape noise.\* Extreme care has been exercised to eliminate hum pick-up.

★ **Editing made easy**

With Ampex editing is almost instantaneous. Single letters have been actually cut off the end of words. Scissors and scotch tape are all the tools needed.

★ **You can depend on Ampex**

Read what Frank Marx, Vice President in charge of Engineering, American Broadcasting Company, says: "For the past two years A.B.C. has successfully used magnetic tape for rebroadcast purposes... A.B.C. recorded on AMPEX in Chicago... 17 hours per day. For 2618 hours of playback time, the air time lost was less than 3 minutes: a truly remarkable record."

**SPECIFICATIONS**

**FREQUENCY RESPONSE:**

At 15" ± 2 db. 50-15,000 cycles  
At 7.5" ± 2 db. 50- 7,500 cycles

\***SIGNAL-TO-NOISE RATIO:** The overall unweighted system noise is 70 db. below tape saturation, and over 60 db. below 3% total harmonic distortion at 400 cycles.

**STARTING TIME:** Instantaneous. (When starting in the Normal Play mode of operation, the tape is up to full speed in less than .1 second.)

**FLUTTER AND WOW:** At 15 inches per second, well under 0.1% r.m.s., measuring all flutter components from 0 to 300 cycles, using a tone of 3000 cycles. At 7.5 inches, under .2%.

**Manufactured by Ampex Electric Corporation, San Carlos, Calif.**

**AUDIO & VIDEO PRODUCTS CORP. ★**

1650 Broadway, New York 19, N.Y.

DISTRIBUTED BY

**GRAYBAR ELECTRIC CORP. ★**

Graybar Building, New York 17, N.Y.

**CROSBY ENTERPRISES**

9028 Sunset Boulevard  
Hollywood 16, Calif.



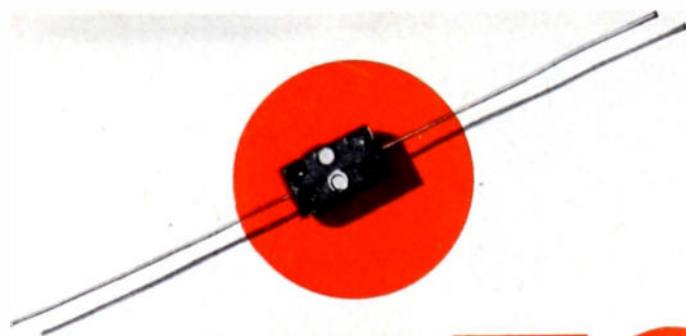

**EL-MENCO'S PLACE**

**in**

**YOUR PRODUCT**

*Wherever fixed mica dielectric capacitors are used, the first choice with men of experience is always El-Menco*

Precision-made under rigid conditions, tested seven ways to meet strict Army-Navy standards, thoroughly impregnated and provided in water-sealed low-loss bakelite; these tiny capacitors protect and maintain your reputation for quality equipment. To insure performance-excellence, place *El-Menco* capacitors in *your* product. Results will prove El-Menco to be a wise choice.

**THE ELECTRO MOTIVE MFG. CO., Inc.**  
WILLIMANTIC CONNECTICUT

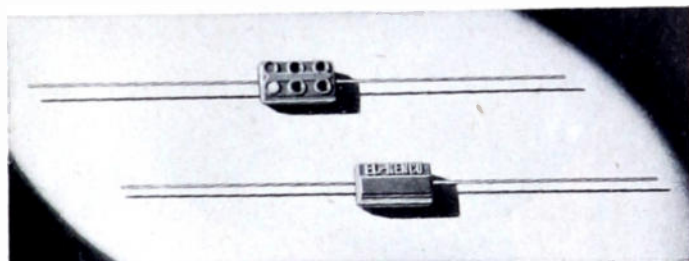

**CM 15 MINIATURE CAPACITOR**

Actual Size  $\frac{3}{16}$ " x  $\frac{1}{2}$ " x  $\frac{3}{16}$ "  
For Radio, Television and Other Electronic Applications  
2 to 420 mmf. capacity at 500v DCW  
2 to 525 mmf. capacity at 300v DCW  
Temp. Co-efficient  $\pm 50$  parts per million per degree C for most capacity values  
6-dot standard color coded

Write on your firm letterhead for Catalog and Samples

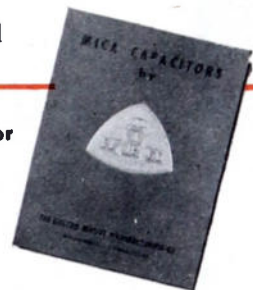

**MOLDED MICA** **El-Menco** **MICA TRIMMER**  
**CAPACITORS**

FOREIGN RADIO AND ELECTRONIC MANUFACTURERS COMMUNICATE DIRECT WITH OUR EXPORT DEPT. AT WILLIMANTIC, CONN.  
**ARCO ELECTRONICS, INC.** 135 Liberty St., New York, N. Y.—Sole Agent for Jobbers and Distributors in U.S. and Canada



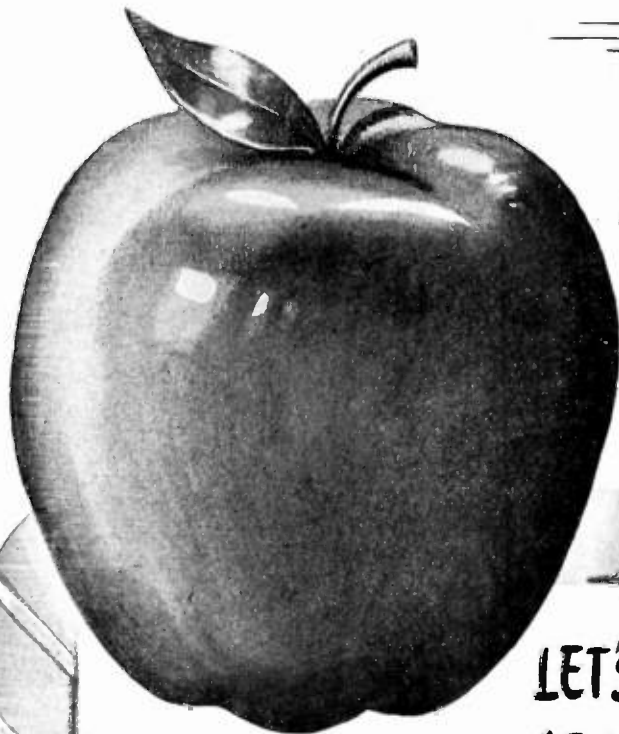
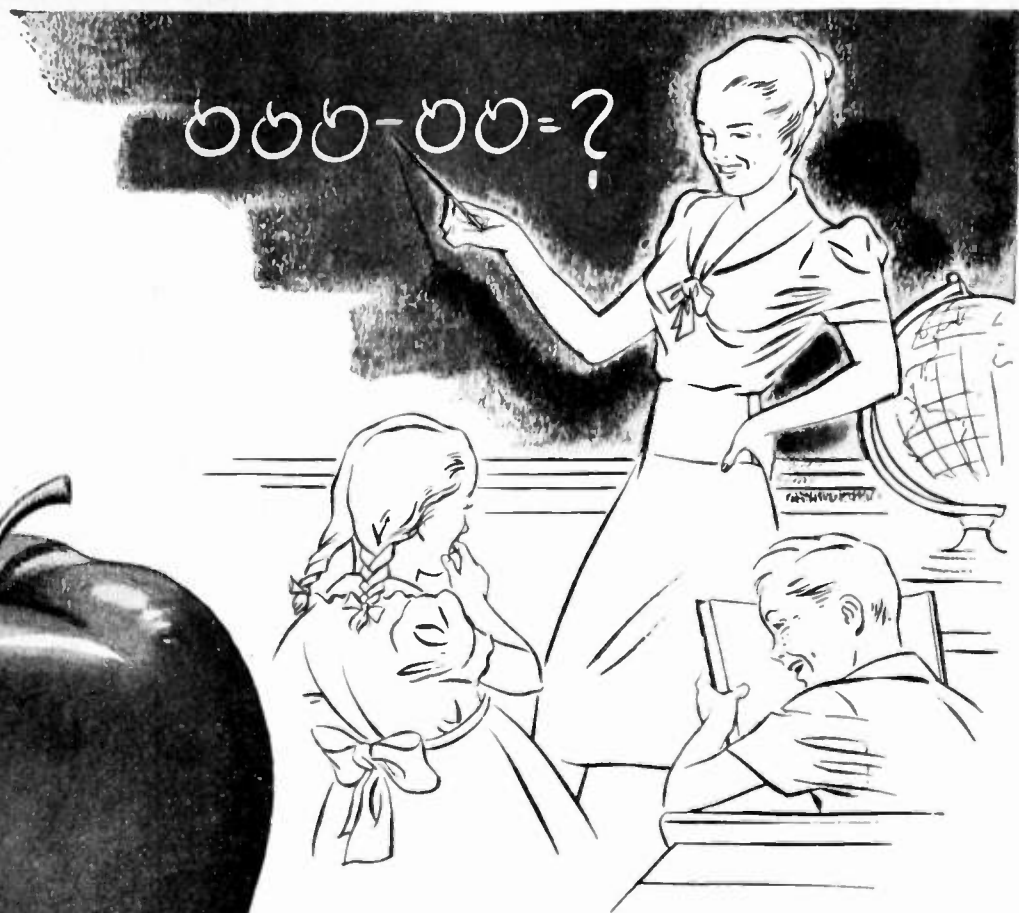

## LET'S NOT DO CAPACITOR ARITHMETIC IN APPLES!

Remember the old story?

"Look, Ruthie," said the substitute teacher, "if you had 3 peaches and gave 2 to Johnny, how many peaches would you have left?"

Ruthie pondered.

"I don't know, teacher," she finally whispered. "When our regular teacher is here, we always do arithmetic in apples."

In capacitor arithmetic, calculations *a la Ruthie* may not add up in your best interest.

Because Sprague, and only Sprague, makes all four—ceramic, mica, paper and electrolytic—Sprague can recommend and supply the particular kind of fixed capacitor best suited for your specific application with due regard for the performance, space and economic considerations involved.

When you want peaches, Sprague doesn't try to sell you apples, for we have plenty of *both* on the shelf.

SPRAGUE ELECTRIC COMPANY • NORTH ADAMS, MASS.

# SPRAGUE

PIONEERS IN ELECTRIC AND ELECTRONIC DEVELOPMENT

# ERIE TRIMMERS

- easy assembly
- dependable performance
- reasonable cost

These Erie Resistor Trimmers are compactly designed for easy installation on the assembly line and give the design engineer wide latitude in chassis layout. They have a rugged stability that spells long life and dependable performance.

Erie Trimmers have the quality that indicates their use on the highest priced sets, with a price tag that permits their adoption for the most competitive FM and TV numbers. Specifications are given below. Samples will be sent to interested manufacturers on request.



STYLE 531 and 532

## STYLES 531 and 532

Capacity Ranges: 0.5-5 MMF & 1-8 MMF  
 Working Voltage: 500 V.D.C.  
 Max. Temperature: 75°C  
 Q Factor @ 1 MC.: 1,000 min.  
 Initial Leakage Resistance: 10,000 megohms min.  
 Styles: 531 for panels .015" to .039"; 532 for .040" to .065"



STYLE TD2A

STYLE TS2A

## STYLES TS2A and TD2A

Capacity Ranges:  
 Zero Temp. Coeff. 1.5-7 MMF & 3-12 MMF  
 N300 Temp. Coeff. 3-13 MMF & 5-20 MMF  
 N500 Temp. Coeff. 4-30 MMF & 7-45 MMF  
 Working Voltage: 500 V.D.C.  
 Q Factor @ 1 MC.: 500 min.  
 Initial Leakage Resistance: 10,000 megohms min.  
 Styles: TS2A, Single Condenser;  
 TD2A, Dual Condenser



STYLE 554

STYLE 557

## STYLES 554 and 557

Capacity Ranges:  
 Zero Temp. Coeff. 1.5-7 MMF, 3-12 MMF & 5-25 MMF  
 N750 Temp. Coeff. 5-30 MMF & 8-50 MMF  
 Working Voltage: 350 V.D.C.  
 Q Factor @ 1 MC.: 500 min.  
 Initial Leakage Resistance: 10,000 megohms min.  
 Styles: 554 Mounted with Spring-Clip; 557 for Sub-panel or Bracket Mounting



*Electronics Division*

**ERIE RESISTOR CORP., ERIE, PA.**

LONDON, ENGLAND • • TORONTO, CANADA



# Crowded chassis are



## on resistors too!

The smaller you make your electrical or electronic instruments and equipment, the bigger your problems grow. But when you specify miniature IRC resistors you conserve space without sacrificing efficiency, and miniaturization creates no bottlenecks.

Because of our years of experience in the manufacture of resistors, IRC long ago foresaw the trend to miniaturization—and prepared for it. With the widest line of resistor types in the industry, we are able now to supply miniature components for most resistor applications.



**TINY** Type BTR were the first miniature insulated resistors. Designed originally for the wartime VT Fuze, they have since been used with success in hearing aids and similar circuits requiring minimum size in a JAN approved resistor.  $\frac{1}{3}$  watt rating in RMA ranges up to 22 megohms. The convenient coupon brings you full details.



# tough



**THIN AS A WAFER** and no bigger than a nickel, IRC Type HB Fingertip Control features a quiet element, simplified construction and a unique rotating cover and contactor which permit ready resistance adjustment. It entirely eliminates the shaft, bushing and bulky knob of conventional-type controls. Four point switch of similar design is also available. Fully described in IRC Catalog Bulletin A-1.

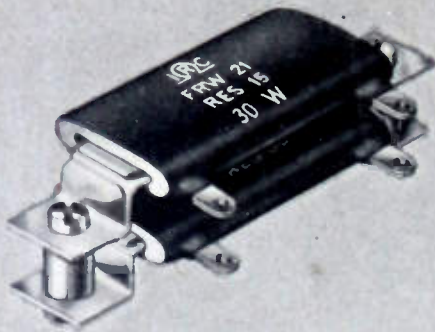

**FLAT POWER WIRE WOUND RESISTORS** provide a higher space-power ratio than tubular types. Designed to satisfy requirements of high wattage dissipation in limited space applications, they can be mounted vertically or horizontally, singly or in stacks. The lightweight construction of these flat units includes non-magnetic mounting brackets which permit easy installation and transfer of heat to chassis. Flat FRW's are manufactured in fixed and adjustable types. Bulletin C-1 gives characteristics and specifications.

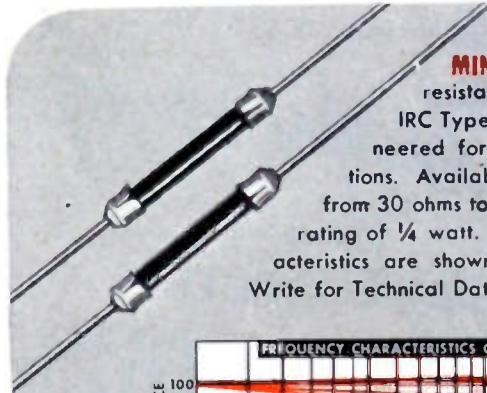

**MINIATURE UNITS** with active resistance section only  $\frac{3}{8}$ " long, IRC Type MPM Resistors are engineered for VHF and UHF applications. Available in resistance values from 30 ohms to 1.0 megohm, at a power rating of  $\frac{1}{4}$  watt. Excellent frequency characteristics are shown in the adjacent chart. Write for Technical Data Bulletin F-1.

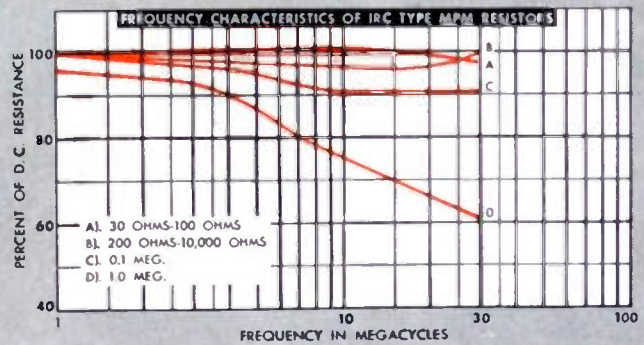

When you are cramped for standard resistors in a hurry, IRC's Industrial Service Plan gives you the speedy service you need. For small orders of standard resistors for experimental work, pilot runs, maintenance, simply call your local IRC Distributor. We'll gladly send you his name and address.



*Wherever the Circuit Says*

Power Resistors • Precisions  
Insulated Composition Resistors  
Low Wattage Wire Wounds  
Rheostats • Voltage Dividers  
Controls • Voltmeter Multipliers  
Deposited Carbon Precistors  
HF and High Voltage Resistors  
Insulated Chokes

**INTERNATIONAL RESISTANCE COMPANY**

401 N. Broad Street, Philadelphia 8, Pa.

In Canada: International Resistance Co., Ltd., Toronto, Licensee

**INTERNATIONAL RESISTANCE COMPANY**  
405 N. BROAD ST., PHILA. 8, PA.

Send me additional data on the items checked below:

- BTR Resistors       Fingertip Controls  
 Flat FRW Resistors       MPM Resistors  
 Name and address of local IRC Distributor

NAME.....

TITLE.....

COMPANY.....

ADDRESS.....



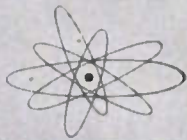

# Designers

*Now..higher voltage*  
 from  
**GENERAL ELECTRIC**  
**SELENIUM STACKS**

using new 18-volt (D-C) cells



New process for depositing selenium gives rectifier stacks greater uniformity, higher efficiency and longer useful life.

Here's real news for rectifier users. G.E.'s new 18-volt selenium cells, made by a special evaporation process which deposits selenium on the aluminum base with greater uniformity than otherwise possible, give you these advantages:

**GREATER OUTPUT**—With 50% more output than the standard 12-volt cells, the new design can be used for any application except those few which demand 24-hour, year-around service.

**HIGHER EFFICIENCY**—Not only is the initial efficiency higher, but more uniform coating keeps it high during the life of the stack.

**SAVING IN SPACE**—About one-quarter less space is required for the same output.

**LOWER COST**—Depending on the voltage across the stack, the 18-volt cells can save 25% in cost compared to standard 12-volt cells.

*Selenium stacks are available in several standard sizes. Output in d-c voltage ranges from 18 to 126; applied a-c voltage, from 26 to 161. Bulletin GEA-5258 will give you detailed information. Send for it today!*

**STYLED FOR READABILITY  
 BUILT FOR RELIABILITY**

This brand-new line of 2 1/4-inch thin panel instruments has streamlined features which will give your panels a "new look." Arc lines have been eliminated,

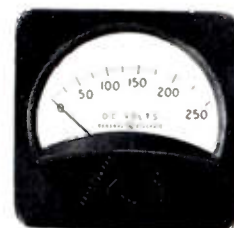

**GENERAL  ELECTRIC**

# Digest

## TIMELY HIGHLIGHTS ON G-E COMPONENTS

leaving only the upright scale divisions. New tapered pointer helps eye focus only on the reading. All but essential markings are masked by attractive case.

Internal mechanism is designed for extra reliability. High coercive Alnico magnet assures proper alignment, even under severe operating conditions. Large air gap reduces danger of stickiness caused by foreign particles. A variety of types and ratings in round or square cases are available for use in radio, television or testing equipment. Get complete details from Bulletin GEC-368.

### DESIGNED FOR YOUR REQUIREMENTS

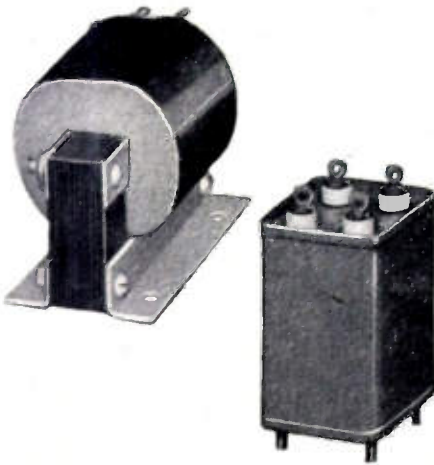

General Electric pulse transformers for radar and associated applications are designed to perform dependably in extremes of operating conditions. Many ratings in current production are of a special nature—designed to keep pace with rapidly changing requirements of the industry. However, for certain applications, they can be built to the specifications of electronic equipment manufacturers. Types available include interstage transformers, blocking oscillator transformers, charging chokes, current transformers, and pulse thyatron grid transformers. For a listing of available designs and ratings, send for bulletin GEC-481.

### THEY'RE SMALL BUT THEY CAN TAKE IT

Cast-glass bushings with sealed-in nickel-steel hardware can be readily welded, soldered, or brazed directly to the apparatus, thus eliminating gaskets and providing a better seal. Small, compact structure often makes possible reduction of over-all size and weight of equipment. Practically unaffected by weathering, micro-organisms, and thermal shock, they're particularly well suited for use in electronic equipment and in installations where operating conditions are severe. Available in ratings up to 8.6 kv and for currents to 1200 amperes. Check Bul. GEA-5093.



### RELY ON THESE FOR STABILITY

Fixed paper-dielectric capacitors are manufactured in accordance with joint Army-Navy specification JAN-C-25. They're constructed with thin Kraft paper, oil or Pyranol\* impregnated, for stable characteristics and high dielectric strength. Plates are aluminum foil; special bushing construction provides for short internal leads, prevents possible grounds and short circuits. Cases have permanent hermetic seal.



Case style-CP 63 (shown above) is rated 0.1-0.1 muf and 1000 volts. Other ratings range from .01 muf to 15 muf and from 100 to 12,500 volts. Write for detailed description and operating data in bulletin GEA-4357A. \*Reg. U.S. Pat. Off.

### DOES A BIG JOB IN CLOSE QUARTERS

G.E.'s midget soldering iron can do a big job with only one-fourth the wattage usually used. This handy 6-volt, 25-watt iron is only 8 inches long with 1/8" or 1/4" tips and weighs but 1 3/4 ounces. Designed for close-quarter, pinpoint precision soldering, the "midget" offers you all these advantages: low cost soldering; "finger-tip" operation; quick, continuous heat; easy renewal; long life; low maintenance. A real aid in designing radios, instruments, meters, electric appliances, and many other products requiring precision soldering. Available from stock. Check bulletin GEA-4519.



General Electric Company, Section B667-2  
Apparatus Department, Schenectady, N. Y.

Please send me the following bulletins:

- GEA-4357A D-C Capacitors  GEC-481 Pulse Transformers  
 GEA-4519 Midget Soldering Iron  
 GEA-5093 Glass Bushings  
 GEA-5258 Selenium Stacks  
 GEC-368 Panel Instruments

NAME .....

COMPANY .....

ADDRESS .....

CITY ..... STATE .....



operate  
in safety

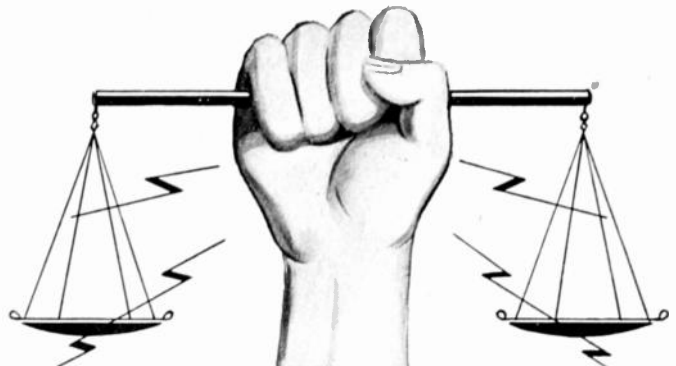

WITH FULLY

# PROTECTED

## LINE AND LOAD STABILIZATION

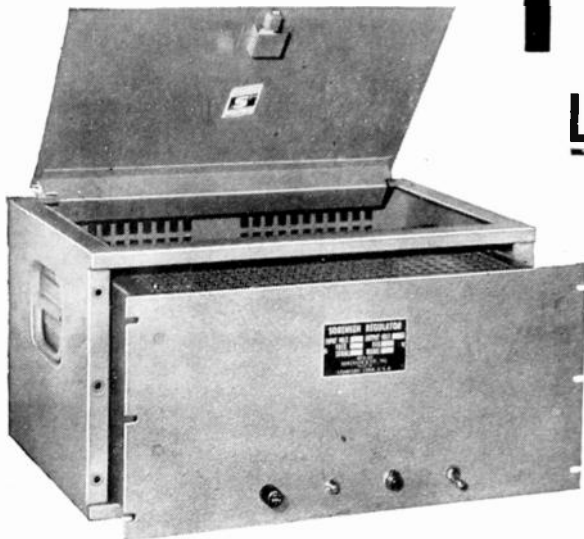

### Sorensen Electronic Voltage Regulators

alone give you all these extra safety features:—

- Full protection against both line and load changes from one instrument.
- Overvoltage protection using the special Safety Diode, developed by Sorensen for hair line precision.
- Additional protection against overvoltage by use of a Heinemann Circuit Breaker.
- Protection against overload through a Klixon Overload Protector.

The Sorensen Voltage Regulator is simple and compact, easy to install. It has only four tubes — all standard except the special Sorensen Diode\*. It is designed to fit in a small space — ideal for either relay rack mounting or cabinet mounting. Don't take chances! There is one sure, safe protection for delicate instruments and complex equipment — Sorensen Voltage Regulators.

### SPECIFICATIONS for the 10005 Model

Input Voltage Range	95—125 V.
Output Voltage Range	adjustable between 110—120 V.
Output Load Range	0—1 KVA
Regulation Accuracy	± 0.1% against line ± 0.2% against load
Harmonic Distortion	less than 2%
Power Factor Range	down to 0.7 P. F.
Recovery Time	3 to 6 cycles
Line Frequency Range	50 to 60 cycles

Other Models from 150 VA to 15 KVA single phase and 45 KVA three phase.

### NOBATRON and B-NOBATRON

Send for information on these highly stabilized D. C. Regulators.

Literature Available! Send for your Saturable Core Reactor Data Booklet — It's FREE.

### NEW 400 CYCLE REGULATORS



Two 400 cycle regulators of higher capacity than previously advertised are now available in the Sorensen 400 cycle line.

These units, primarily designed for aircraft, are compact and lightweight. Working from a 115 VAC, 400 cycle source, the regulators will hold the output at 115 VAC at an accuracy of 0.5% over a wide input frequency and voltage range. The capacities of the regulators are 1200 and 2000 VA.

### TECHNICAL SPECIFICATIONS

Input Voltage Range	95 to 125 volts
Output Voltage Range	110 to 120 volts
Regulation Accuracy	0.5%
Inductive Power Factor Range	Down to 0.7 P. F.
Ambient Temperature Range	—55°C to +70°C
Input Frequency Range	400 to 2400 cycles

**Sorensen** and Company, Inc.

375 Fairfield Ave., Stamford, Connecticut

# FREED "PRODUCTS of EXTENSIVE RESEARCH"

## OUTSTANDING ADDITIONS TO OUR LINES OF *Instruments & Components*

### NEW HI Q MINIATURE TOROIDAL COILS

### HIGH FIDELITY OUTPUT TRANSFORMERS

FAMOUS  
FREED  
QUALITY



Size  $\frac{7}{8}$ " D. x  $\frac{3}{8}$ " — Wt.  $\frac{3}{4}$  ounce.  
Type TI-5 Frequency range 1000 cycles-15,000 cycles  
Type TI-7 Frequency range 10,000 cycles-100,000 cycles  
High quality toroidal coils wound on molybdenum permalloy dust cores. Can be supplied in hermetically sealed cans, commercial type construction or open units.



Type No.	Primary Impedance	Secondary Impedance	Power Rating	Frequency Range	Notes
FT100	250 Ω	100 Ω, 250 Ω, 500 Ω, 1000 Ω, 2000 Ω, 5000 Ω, 10000 Ω, 20000 Ω, 50000 Ω, 100000 Ω	100 W	1000-15000	Hermetic
FT101	250 Ω	100 Ω, 250 Ω, 500 Ω, 1000 Ω, 2000 Ω, 5000 Ω, 10000 Ω, 20000 Ω, 50000 Ω, 100000 Ω	100 W	1000-15000	Commercial
FT102	250 Ω	100 Ω, 250 Ω, 500 Ω, 1000 Ω, 2000 Ω, 5000 Ω, 10000 Ω, 20000 Ω, 50000 Ω, 100000 Ω	100 W	1000-15000	Open
FT103	250 Ω	100 Ω, 250 Ω, 500 Ω, 1000 Ω, 2000 Ω, 5000 Ω, 10000 Ω, 20000 Ω, 50000 Ω, 100000 Ω	100 W	1000-15000	Hermetic
FT104	250 Ω	100 Ω, 250 Ω, 500 Ω, 1000 Ω, 2000 Ω, 5000 Ω, 10000 Ω, 20000 Ω, 50000 Ω, 100000 Ω	100 W	1000-15000	Commercial
FT105	250 Ω	100 Ω, 250 Ω, 500 Ω, 1000 Ω, 2000 Ω, 5000 Ω, 10000 Ω, 20000 Ω, 50000 Ω, 100000 Ω	100 W	1000-15000	Open
FT106	250 Ω	100 Ω, 250 Ω, 500 Ω, 1000 Ω, 2000 Ω, 5000 Ω, 10000 Ω, 20000 Ω, 50000 Ω, 100000 Ω	100 W	1000-15000	Hermetic
FT107	250 Ω	100 Ω, 250 Ω, 500 Ω, 1000 Ω, 2000 Ω, 5000 Ω, 10000 Ω, 20000 Ω, 50000 Ω, 100000 Ω	100 W	1000-15000	Commercial
FT108	250 Ω	100 Ω, 250 Ω, 500 Ω, 1000 Ω, 2000 Ω, 5000 Ω, 10000 Ω, 20000 Ω, 50000 Ω, 100000 Ω	100 W	1000-15000	Open
FT109	250 Ω	100 Ω, 250 Ω, 500 Ω, 1000 Ω, 2000 Ω, 5000 Ω, 10000 Ω, 20000 Ω, 50000 Ω, 100000 Ω	100 W	1000-15000	Hermetic
FT110	250 Ω	100 Ω, 250 Ω, 500 Ω, 1000 Ω, 2000 Ω, 5000 Ω, 10000 Ω, 20000 Ω, 50000 Ω, 100000 Ω	100 W	1000-15000	Commercial
FT111	250 Ω	100 Ω, 250 Ω, 500 Ω, 1000 Ω, 2000 Ω, 5000 Ω, 10000 Ω, 20000 Ω, 50000 Ω, 100000 Ω	100 W	1000-15000	Open
FT112	250 Ω	100 Ω, 250 Ω, 500 Ω, 1000 Ω, 2000 Ω, 5000 Ω, 10000 Ω, 20000 Ω, 50000 Ω, 100000 Ω	100 W	1000-15000	Hermetic
FT113	250 Ω	100 Ω, 250 Ω, 500 Ω, 1000 Ω, 2000 Ω, 5000 Ω, 10000 Ω, 20000 Ω, 50000 Ω, 100000 Ω	100 W	1000-15000	Commercial
FT114	250 Ω	100 Ω, 250 Ω, 500 Ω, 1000 Ω, 2000 Ω, 5000 Ω, 10000 Ω, 20000 Ω, 50000 Ω, 100000 Ω	100 W	1000-15000	Open
FT115	250 Ω	100 Ω, 250 Ω, 500 Ω, 1000 Ω, 2000 Ω, 5000 Ω, 10000 Ω, 20000 Ω, 50000 Ω, 100000 Ω	100 W	1000-15000	Hermetic
FT116	250 Ω	100 Ω, 250 Ω, 500 Ω, 1000 Ω, 2000 Ω, 5000 Ω, 10000 Ω, 20000 Ω, 50000 Ω, 100000 Ω	100 W	1000-15000	Commercial
FT117	250 Ω	100 Ω, 250 Ω, 500 Ω, 1000 Ω, 2000 Ω, 5000 Ω, 10000 Ω, 20000 Ω, 50000 Ω, 100000 Ω	100 W	1000-15000	Open
FT118	250 Ω	100 Ω, 250 Ω, 500 Ω, 1000 Ω, 2000 Ω, 5000 Ω, 10000 Ω, 20000 Ω, 50000 Ω, 100000 Ω	100 W	1000-15000	Hermetic
FT119	250 Ω	100 Ω, 250 Ω, 500 Ω, 1000 Ω, 2000 Ω, 5000 Ω, 10000 Ω, 20000 Ω, 50000 Ω, 100000 Ω	100 W	1000-15000	Commercial
FT120	250 Ω	100 Ω, 250 Ω, 500 Ω, 1000 Ω, 2000 Ω, 5000 Ω, 10000 Ω, 20000 Ω, 50000 Ω, 100000 Ω	100 W	1000-15000	Open

## PRECISION LABORATORY EQUIPMENT

### #1150 UNIVERSAL BRIDGE



FAMOUS  
FREED  
ACCURACY

Frequency Range — 20 cycles-20,000 cycles.  
An Indispensable Laboratory Instrument for measurements of Inductors, Capacitors, and determination of Resistive and reactive components of impedances. Used as Maxwell Bridge, Hay Bridge, Resonance Bridge, Series Resistance Condenser Bridge, Parallel Resistance Condenser Bridge. 1% accuracy.

### #1210 NULL DETECTOR AND VACUUM TUBE VOLTMETER



Designed for A.C. Bridge Measurements. Provides simultaneous measurement of the voltage across the unknown and the balance of the bridge. Vacuum tube voltmeter. Sensitivity .1, 1, 10, 100 volts. Input Impedance 50 megohms shunted by 20 mmfd. Frequency range 20 cycles-20,000 cycles. Null Detector—gain 94 Db. Selective Circuits for 60 cycles — 400 cycles — 1000 cycles. Frequency range 20 cycles-30,000 cycles.

## FREED HERMETICALLY SEALED COMPONENTS CLASS A GRADE 1 COMPONENTS TO MEET JAN—T—27 SPECIFICATIONS.

FAMOUS  
FREED  
DEPENDABILITY



MANUFACTURERS OF  
POWER TRANSFORMERS  
FILTER REACTORS  
AUDIO TRANSFORMERS  
SUPERSONIC TRANSFORMERS  
WAVE FILTERS  
HI-Q COILS  
DISCRIMINATORS  
SATURABLE REACTORS  
PULSE TRANSFORMERS  
CHARGING CHOKES

SEND FOR THE *new* FREED CATALOG

**FREED TRANSFORMER CO., Inc.**  
DEPT. PY 1718-36 WEIRFIELD ST., (RIDGEWOOD) BROOKLYN 27, NEW YORK



These manufacturers have invited PROCEEDINGS readers to write for literature and further technical information. Please mention your I.R.E. affiliation.

## New Space-Saving Thin Resistor

A new, wire-wound, vitreous-enameled, thin-type resistor, which provides higher wattage per unit of space and is particularly useful when space is limited, has been developed by Ohmite Mfg. Co., 4835 Flournoy St., Chicago 44, Ill.

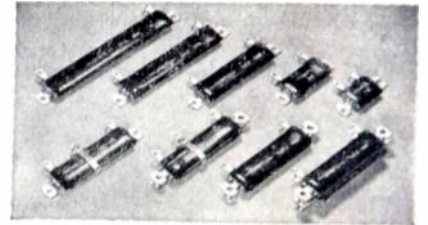

This component is manufactured with either a single unit mounting-bracket, which allows mounting close to the surface, or with a stud bracket, which provides for stacking of two or more units. The brackets extend the entire length of the core, dispersing developed heat evenly throughout the resistor.

Irrespective of the type of bracket, the resistor may be obtained as a fixed component, or as an adjustable lug type, with which odd resistances may be obtained.

Lengths vary from 1 1/4" for 30-watt size, to 6" for 75-watt size. Five wattages are available, all in a wide range of resistance values.

The thin-type resistor is made to order only, and is fully described in bulletin 138.

## Remote Control TV Unit

A remote control unit designed to operate and control a TV receiver up to a distance of fifty feet has been put on the market by Transvision, Inc., North Ave., New Rochelle, N. Y.

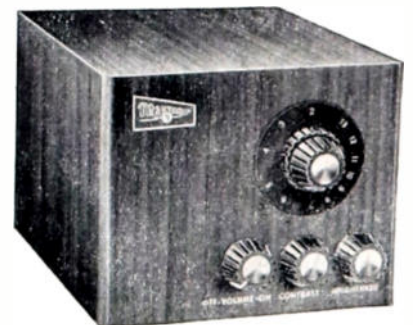

The manufacturer claims that this unit may be used with any receiver, and that it permits continuous tuning and coverage of all channels. This increases the function of early sets which have only 3- or 5-channel tuners. The unit has high-gain with about 50-microvolt sensitivity, factory wired and tuned.

(Continued on page 22A)

## JUST LOOK AT THESE FEATURES!

### CONTACTS

High current capacity  
... Practically no voltage drop. No additional solder required.

### SHELL

High strength aluminum alloy ... High resistance to corrosion ... with surface finish.

### SCINFLEX ONE-PIECE INSERT

High dielectric strength  
... High insulation resistance.

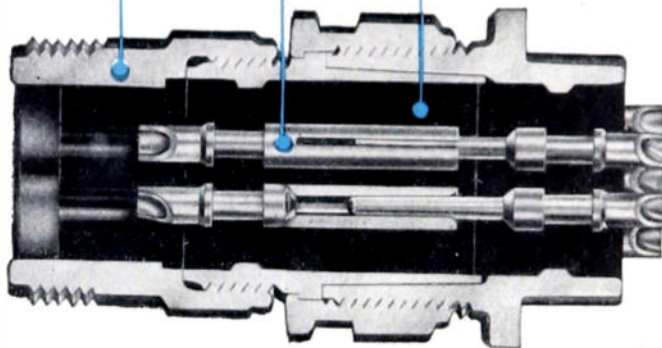

# BENDIX-SCINTILLA

## ELECTRICAL CONNECTORS

the Finest money can buy!

Contacts that carry maximum currents with a minimum voltage drop are only part of the many new advantages you get with Bendix-Scintilla\* Electrical Connectors. The use of "Scinflex" dielectric material, an exclusive new Bendix-Scintilla development of outstanding stability, increases resistance to flashover and creepage. In temperature extremes, from  $-67^{\circ}$  F. to  $+300^{\circ}$  F., performance is remarkable. Dielectric strength is never less than 300 volts per mil. Bendix-Scintilla Connectors have fewer parts than any other connector—and that means lower maintenance costs and better performance.

\*TRADEMARK

## THEN CHECK THESE OTHER ADVANTAGES

- Moisture-proof, Pressure-tight
- Radio Quiet
- Single-piece Inserts
- Vibration-proof
- Light Weight
- High Insulation Resistance
- Easy Assembly and Disassembly
- Fewer Parts than any other Connector
- No additional solder required

Write direct to the Sales Department



SCINTILLA MAGNETO DIVISION of



SIDNEY, NEW YORK



Export Sales: Bendix International Division, 72 Fifth Avenue, New York 11, New York

# ONCE AGAIN, MYCALEX 410 GETS THE CALL . . .

Leading Automobile firm specifies MYCALEX 410 molded insulation for new dashboard lightswitch . . .

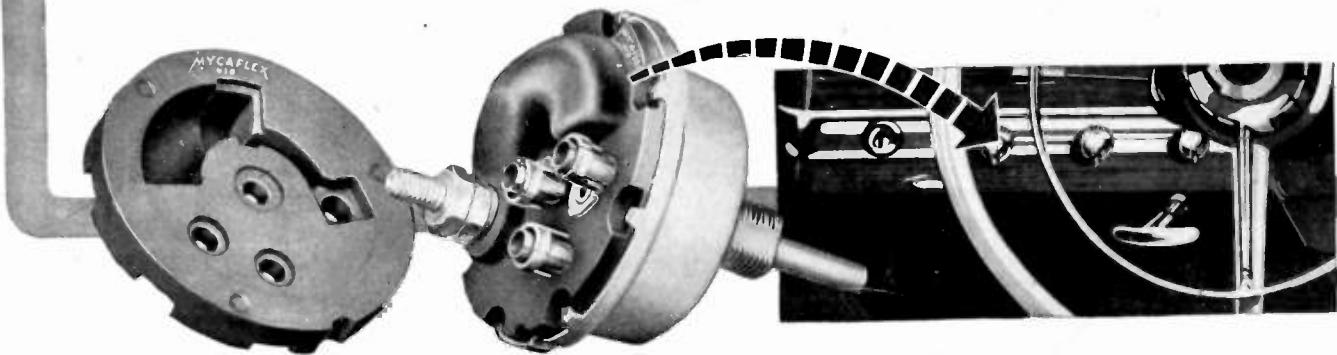

**Sorry**, we can't mention names, but this is the insulator body for a new type of dash-board light-switch being manufactured of MYCALEX 410 molded insulation for one of the leading lines of cars\* . . . \*names on request.

It's no great secret that automotive firms buy wisely and well . . . and it's justly proud we are that after making exhaustive tests and comparisons, this large maker of cars specified MYCALEX 410 molded insulation as ideal for the new type dash-board light-switch being introduced in their 1949 line.

**Again**, it was proved that on long run, round the clock production, MYCALEX 410 insulation parts, molded with or without metal inserts, are low-cost and competitive with less-effective molded insulation materials.

**Again**, MYCALEX 410 molded insulation demonstrated its absolute dimensional and electrical stability; low dielectric loss; high dielectric strength; high arc resistance; stability over wide

humidity and temperature changes; resistance to high temperatures, moisture and oils; and great mechanical precision and strength. Inserts of common or precious metals may be injected in the MYCALEX 410 molding process.

**Yes**, MYCALEX 410 molded insulation meets the most exacting requirements of high frequency applications.

## REMEMBER . . .

MYCALEX 410 MOLDED INSULATION IS THE EXCLUSIVE FORMULATION OF MYCALEX CORPORATION OF AMERICA.

We stock these  
**MYCALEX 410**  
Tiny Tie-In Terminals  
for . . .  
Sub-miniature  
Transmitting Equipment

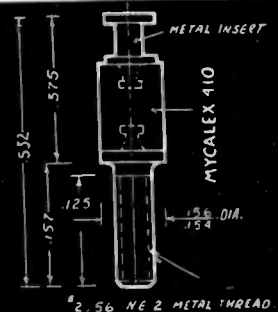

## MYCALEX CORP. OF AMERICA

"Owners of 'MYCALEX' Patents"

Plant and General Offices, CLIFTON, N. J.

Executive Offices, 30 ROCKEFELLER PLAZA, NEW YORK 20, N. Y.



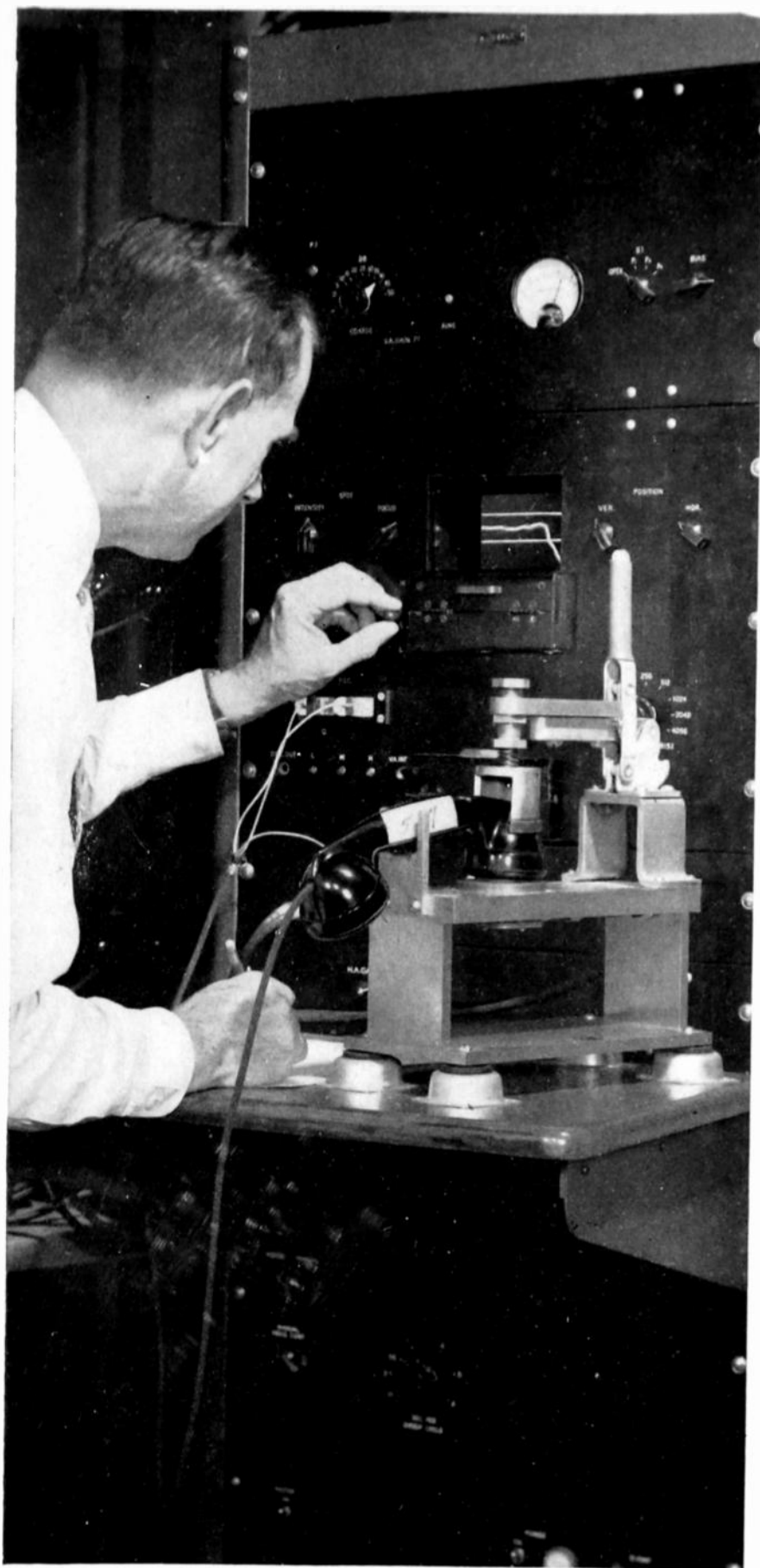

**Y**OUR telephone receiver should treat each tone in the voice alike; that is important to you, because proper balance makes pleasant listening and easy understanding. Naturalness in receiver performance is pictured in a matter of seconds by the apparatus shown at left.

The receiver is clamped in place and an oscillator feeds into it frequencies representing all talking tones. Then a bright spot darts across an oscilloscope screen leav-

---

**It listens so  
YOU  
can hear better**

---

ing behind it a luminous line which shows instantly the receiver's response at each frequency. It is precise; and it is many times faster than the old method of measuring receiver performance point-by-point and then plotting a curve.

At Bell Laboratories, development of techniques to save *time* parallels the search for better *methods*. For each time an operation is made faster, men are freed to turn to other phases of the Laboratories' continuing job—making your telephone system better and easier for you to use each year.



**BELL TELEPHONE LABORATORIES**  
EXPLORING AND INVENTING, DEVISING AND PERFECTING, FOR CONTINUED IMPROVEMENTS AND ECONOMIES IN TELEPHONE SERVICE.



# Linear Standard Units...

## THE ULTIMATE IN QUALITY...

UTC Linear Standard Audio Transformers represent the closest approach to the ideal component from the standpoint of uniform frequency response, low wave form distortion, high efficiency, thorough shielding and utmost dependability.

### UTC Linear Standard Transformers feature...

- **True Hum Balancing Coil Structure**... maximum neutralization of stray fields.
- **Balanced Variable Impedance Line**... permits highest fidelity on every tap of a universal unit... no line reflections or transverse coupling.
- **Reversible Mounting**... permits above chassis or sub-chassis wiring.
- **Alloy Shields**... maximum shielding from inductive pickup.
- **Hiperm-Alloy**... a stable, high permeability nickel-iron core material.
- **Semi-Toroidal Multiple Coil Structure**... minimum distributed capacity and leakage reactance.
- **Precision Winding**... accuracy of winding .1%, perfect balance of inductance and capacity; exact impedance reflection.
- **High Fidelity**... UTC Linear Standard Transformers are the only audio units with a guaranteed uniform response of  $\pm 1$  DB from 20-20,000 cycles.

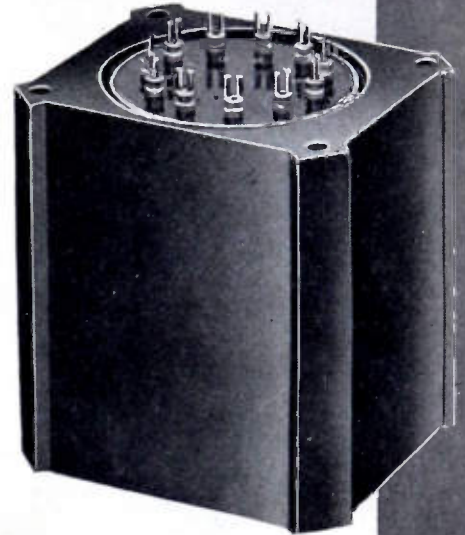

## TYPICAL LS LOW LEVEL TRANSFORMERS

Type No.	Application	Primary Impedance	Secondary Impedance	$\pm 1$ db	Max. Level	Relative hum-pickup reduction	Max. Unbalanced DC in prim'y	List Price
LS-10	Low impedance mike. pickup, or multiple line to grid	50, 125, 200, 250, 333, 500/600 ohms	60,000 ohms in two sections	20-20,000	+15 DB	-74 DB	5 MA	\$25.00
LS-10X	As Above	As above	50,000 ohms	20-20,000	+14 DB	-92 DB	5 MA	32.00
LS-12	Low impedance mike. pickup, or multiple line to push pull grids	50, 125, 200, 250, 333, 500/600 ohms	120,000 ohms overall, in two sections	20-20,000	+15 DB	-74 DB	5 MA	28.00
LS-12X	As above	As above	80,000 ohms overall, in two sections	20-20,000	+14 DB	-92 DB	5 MA	35.00
LS-26	Bridging line to single or push pull grids	5,000 ohms	60,000 ohms in two sections	15-20,000	+20 DB	-74 DB	0 MA	25.00
LS-19	Single plate to push pull grids like 2A3, 6L6, 300A. Split secondary	15,000 ohms	95,000 ohms; 1.25:1 each side	20-20,000	+17 DB	-50 DB	0 MA	24.00
LS-21	Single plate to push pull grids. Split primary and secondary	15,000 ohms	135,000 ohms; turn ratio 3:1 overall	20-20,000	+14 DB	-74 DB	0 MA	24.00
LS-22	Push pull plates to push pull grids. Split primary and secondary	30,000 ohms plate to plate	80,000 ohms; turn ratio 1.6:1 overall	20-20,000	+26 DB	-50 DB	.25 MA	31.00
LS-30	Mixing, low impedance mike, pickup, or multiple line to multiple line	50, 125, 200, 250, 333, 500/600 ohms	50, 125, 200, 250, 333, 500/600 ohms	20-20,000	+17 DB	-74 DB	5 MA	25.00
LS-30X	As above	As above	As above	20-20,000	+15 DB	-92 DB	3 MA	32.00
LS-27	Single plate to multiple line	15,000 ohms	50, 125, 200, 250, 333, 500/600 ohms	30-12,000 cycles	+20 DB	-74 DB	8 MA	24.00
LS-50	Single plate to multiple line	15,000 ohms	50, 125, 200, 250, 333, 500/600 ohms	20-20,000	+17 DB	-74 DB	0 MA	24.00
LS-51	Push pull low level plates to multiple line	30,000 ohms plate to plate	50, 125, 200, 250, 333, 500/600 ohms	20-20,000	+20 DB	-74 DB	1 MA	24.00
LS-141	Three sets of balanced windings for hybrid service, centertapped	500/600 ohms	500/600 ohms	30-12,000	+10 DB	-74 DB	0 MA	28.00

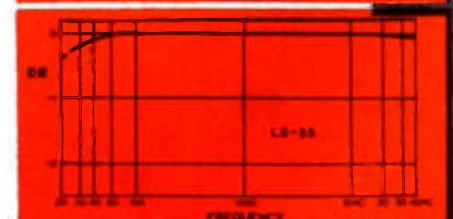
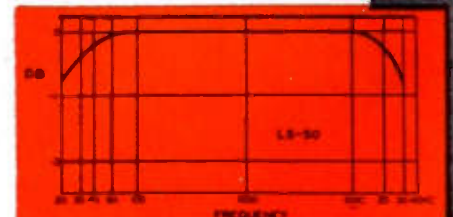
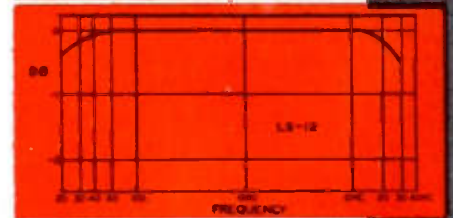

## TYPICAL LS OUTPUT TRANSFORMERS

Type No.	Primary will match following typical tubes	Primary Impedance	Secondary Impedance	$\pm 1$ db from	Max. Level	List Price
LS-52	Push pull 2A5, 250, 6Y6, 42 or 2A5 A prime	8,000 ohms	500, 333, 250, 200, 125, 50, 30, 20, 15, 10, 7.5, 5, 2.5, 1.2	25-20,000	15 watts	\$28.00
LS-55	Push pull 2A3's, 6A5G's, 300A's, 275A's, 6A3's, 6L6's	5,000 ohms plate to plate and 3,000 ohms plate to plate	500, 333, 250, 200, 125, 50, 30, 20, 15, 10, 7.5, 5, 2.5, 1.2	25-20,000	20 watts	28.00
LS-57	Same as above	5,000 ohms plate to plate and 3,000 ohms plate to plate	30, 20, 15, 10, 7.5, 5, 2.5, 1.2	25-20,000	20 watts	20.00
LS-58	Push, pull parallel 2A3's, 6A5G's, 300A's, 6A3's	2,500 ohms plate to plate and 1,500 ohms plate to plate	500, 333, 250, 200, 125, 50, 30, 20, 15, 10, 7.5, 5, 2.5, 1.2	25-20,000	40 watts	50.00
LS-6L1	Push pull 6L6's self bias	9,000 ohms plate to plate	500, 333, 250, 200, 125, 50, 30, 20, 15, 10, 7.5, 5, 2.5, 1.2	25-20,000	30 watts	42.00

Write for our Catalog PS-409

*United Transformer Co.*

150 VARICK STREET NEW YORK 13, N. Y.  
EXPORT DIVISION: 13 EAST 40th STREET, NEW YORK 16, N. Y., CABLES: "ARLAB"



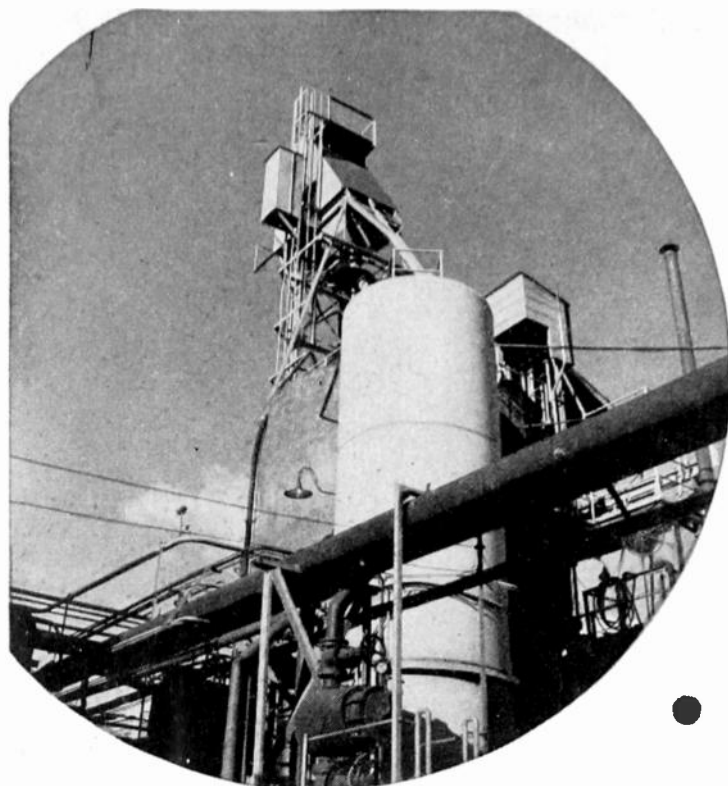

*Chemically Processed*—Highly specialized chemical equipment, such as illustrated here, reacts carbon monoxide with iron-containing ores to form liquid iron pentacarbonyl. Further processing decomposes the liquid into the spheres which are Carbonyl Iron Powder. The closest attention to detail assures products of constantly uniform properties.

## carbonyl iron

*Plant Facilities*—The Grasselli N. J. plant, right, was the sole producer of Carbonyl Iron Powders until this month. Now, increased production will be forthcoming from the new plant at Huntsville, Ala. The demand for all grades of Carbonyl Iron Powder has made this production increase necessary.

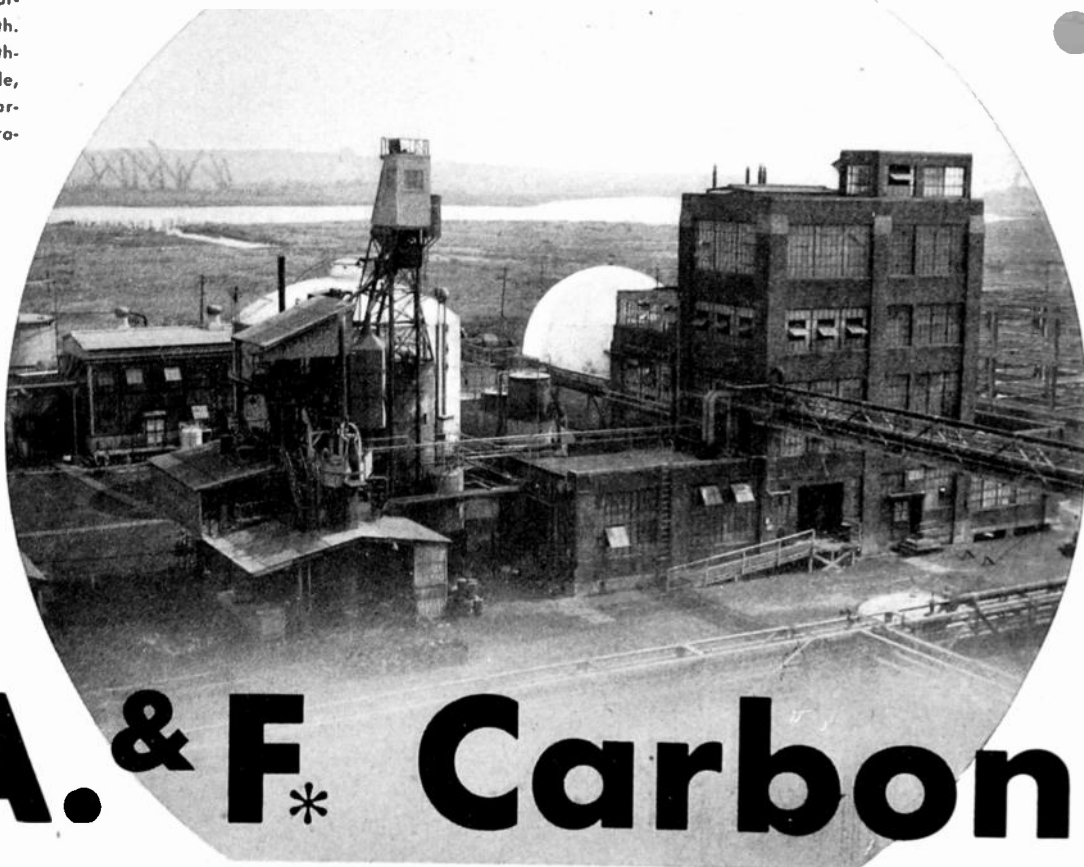

# G. A. & F. Carbon



*Laboratory Controlled*—Every batch of CIP must be put through very extensive laboratory tests to keep quality high. Test cores are made from every batch at the lab. Above, a small section of the test equipment.

## powders are superior

Carbonyl Iron Powders are high quality products with low loss characteristics—superior in every way because this quality is achieved by strict control in processing. These high "Q" materials work best because they are manufactured and tested for quality under the most careful conditions.

Chemically, Carbonyl Iron Powders are high in iron with an absence of non-ferrous materials. Structurally, the particles are spherical, built up of concentric cells. Particle distributions range from 0.5 to 15 microns diameter. Some grades are mechanically hard and quite incompressible. Hysteresis loss is low, insulation is easy thus keeping eddy currents low. Particle size distribution is controlled.

The illustrations on these pages show to some extent the manufacture, the tests for quality, and the checks on control made by GA&F. For more detailed information on any problem involving Carbonyl Iron Powders write . . .

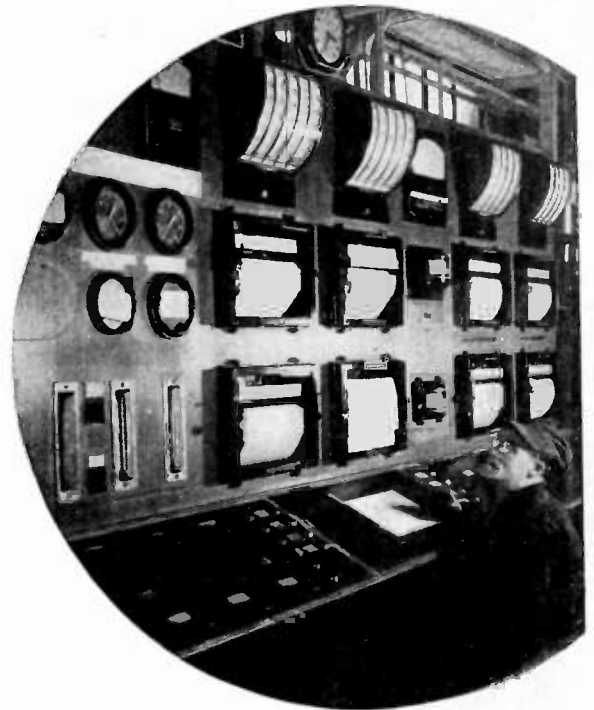

*Production Controlled*—Instruments, such as these, control the processes which make Carbonyl Iron Powders. Such control makes possible the constant uniformity of CIP. The panel above is one of many instrument boards used for controlling the processing of GA&F Carbonyl Iron Powders.



↓

**ANTARA\* PRODUCTS**  
GENERAL ANILINE & FILM CORPORATION

444 Madison Ave.  
New York 22, N. Y.

\*®

# yl Iron Powders



P.R. MALLORY & CO. Inc.  
**MALLORY**

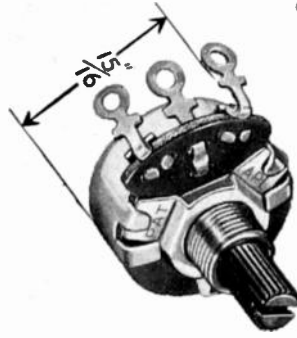

**Midgetrol**

**Has Designing Ways**

## MALLORY

sets the pace in carbon controls with the revolutionary Mallory Midgetrol.

### NEW TELEVISION TYPES

Resistance stability specially provides for critical applications in television circuits. Insulated shafts are knurled for ease in adjustment. Shaft and current-carrying parts provide 2000-volt insulation.

### NEW SMALL SIZE

The small size of  $1\frac{5}{8}$ " diameter saves precious space, can be specified where a  $1\frac{1}{2}$ " diameter control ordinarily would be required.

### NEW FLAT SHAFT

It makes possible a standardization of products which means faster production schedules and faster deliveries.

### NEW TWO-POINT SHAFT SUSPENSION

Double bearing suspension of the new flat shaft eliminates shaft wobble. Assures smooth, even contact pressure on the resistance element. Improves the quality of the control mechanically and electrically.

### NEW RESISTANCE ELEMENT

Resistance element is automatically machine-coated and electronically selected to eliminate any chance of human error.

### NEW CONSTRUCTION

Use of phenolic material eliminates metal-to-metal contact, thus there's no chance for mechanical noise.

### NEW CONTACT ASSEMBLY

The contact assembly is made of a special Mallory contact alloy. New contact design makes the Mallory Midgetrol the quietest, smoothest control by laboratory tests.

### NEW TYPE END TERMINALS

End terminals are hot tinned—can be formed, bent, or twisted many times without breaking. Terminal holes are large enough to easily and quickly secure all leads.

### NEW SWITCH

Designed and manufactured by Mallory under the highest quality standards. This new switch is built for a long, trouble-free life and eliminates many switch problems.

*...It's the little Volume Control with BIG Advantages*

Are you planning for smallness, and yet want to deliver big results? Well, here's an all-new revolutionary volume control that lives up to Mallory's name.

It's rugged. It can take it. It gives longer life and it is the quietest by actual tests. Yes, the Mallory Midgetrol has designing ways... and more and more designers have fallen in love with its nine big features.

Mallory Midgetrol is the crowning result of years of work to pack all the dependability, all the toughness and all the precision work that has made Mallory famous into SMALLER space.

We earnestly suggest you study the many extra features offered by the Mallory Midgetrol which are listed in the box here. They, in total, prove again that the Midgetrol is worthy of joining the big Mallory line of volume controls of every type for every use.

*You Expect More And Get More From Mallory*

Precision Electronic Parts—Switches, Controls, Resistors

P.R. MALLORY & CO. Inc.  
**MALLORY**

P. R. MALLORY & CO., Inc., INDIANAPOLIS 6, INDIANA

### SERVING INDUSTRY WITH

Capacitors      Rectifiers

Contacts        Switches

Controls        Vibrators

Power Supplies

Resistance Welding Materials



# THESE NEW LONG-LIVED THYRATRONS LEAD FOR MOTOR-CONTROL APPLICATIONS

With oversize gas charge to offset absorption from inductive loads

- high anode voltage
- high peak-to-average current ratio
- stable control characteristics
- short heating time
- “climate-proof” ambient temperature range

**GL-5544**



**GL-5545**



**S**PECIFY General Electric's 3.2-amp GL-5544 or 6.4-amp GL-5545 for the motor-control unit now on your drawing-boards. Your equipment will benefit (no snubber circuit is needed with these tubes), while users will have the advantage and economy of full-measure tube life.

Both thyratrons have a charge of inert gas twice that of former types—sufficient to offset anode gas absorption caused by the inductive load in field and armature-control circuits.

Though of paramount value, this is but one of many improvements that put the GL-5544 and GL-5545 far ahead of other gas-filled thyratrons. Study the list of features above. Then add *strength of construction*. Key tube parts are internally braced; the grid-anode structure is solidly supported both at top and bottom. Add *electrical stability* . . . a special shielded-grid design cushions any grid effect from voltage surges. Here are dependable tubes you can count on to do a job where men are pushing machines hard for high production!

Help in applying the GL-5544 or GL-5545 to new motor-control circuits gladly will be given you by experienced G-E tube engineers. Phone your nearby G-E electronics office. Or wire or write *General Electric Company, Electronics Department, Schenectady 5, New York.*



**“THEY OUTLAST AND  
OUT-PERFORM GAS-FILLED  
TUBES OF EARLIER DESIGN”**

	<b>GL-5544</b>	<b>GL-5545</b>
Filament voltage	2.5 v	2.5 v
Filament current	12 amp	21 amp
Peak anode voltage, forward and inverse	1,500 v	1,500 v
Peak cathode current	40 amp	80 amp
Avg cathode current	3.2 amp	6.4 amp
Current averaging time	15 sec	15 sec
Ambient temp range	-55 to +70 c	-55 to +70 c

# GENERAL ELECTRIC

180-M20

FIRST AND GREATEST NAME IN ELECTRONICS



Reeves leads the field in

# Servo Component Design

Designed originally for our own precision control systems, these high performance units are now available to all.

## Reeves Servo Control Motors

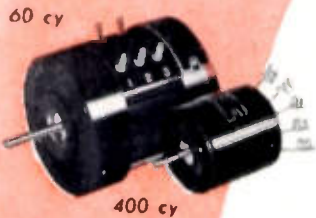

Operating Directly off the output tubes of a servo amplifier, these specially designed 60 and 400 cycle control motors completely eliminate use of bulky output transformers . . . eliminate transformer losses . . . permit use of smaller amplifier tubes . . . save weight, space, cost . . . have high corner frequency . . . high torque to inertia ratio. A.C. tachometers available in combination with motors or separately.

## Reeves 60 Cycle Electrical Resolvers

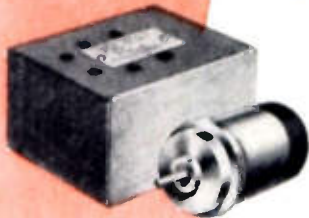

These newly developed units provide the most accurate and convenient means for solving trigonometric functions. The size 1 resolver, here illustrated, has over twice the accuracy of other available units — and is only 1/3 the size and weight of present types! Each resolver is matched with its own small compensating booster amplifier for peak performance.

## Reeves Functional Potentiometers

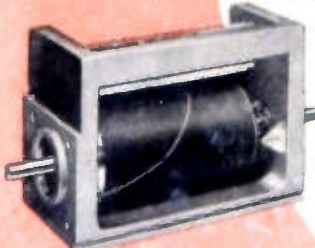

Potentiometer shaft rotation is transformed into a voltage corresponding to a rectangular or polar function. Any reasonable function may be easily installed with special function generating equipment in our plant. Function may be changed at any time by returning the potentiometer to Reeves with information on the new curve desired. Accuracy is within 0.05% at a 60° slope, and even finer at lesser slopes.

REEVES specializes in the development and manufacture of complete Electronic and Mechanical Control Systems, including Computing devices and Radar systems.

# Reeves

INSTRUMENT CORPORATION

215 EAST 91st STREET • NEW YORK 28 • NEW YORK

For complete information write for catalog RICO-1F, "STANDARD INSTRUMENTATION PARTS AND SERVO-MECHANISM COMPONENTS".



## News—New Products

These manufacturers have invited PROCEEDINGS readers to write for literature and further technical information. Please mention your I.R.E. affiliation.

(Continued from page 14A)

### Miniature Hermetically Sealed Transformers

The two new types of hermetically sealed audio transformers (shown on either side of 3S4 miniature tube for comparative size) can be designed to manufacturer's specifications by Triad Transformer Mfg. Co., 423 N. Western Ave., Los Angeles 4, Calif.

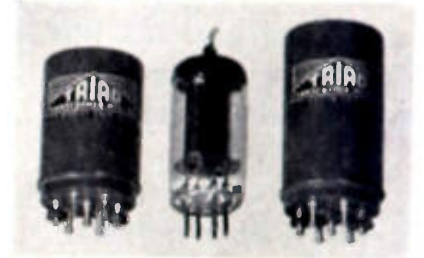

Described as "Trijets," the type JO is 1 1/4" in diameter, 1 3/4" in height, and 1 1/2 oz. in weight. Type JOA is 1 1/4" by 1 1/4" and weighs 1 1/2 oz.

Transformers and reactors using this construction are custom-made in a wide variety of low-level and power applications. If necessary, 40-db alloy shielding will be supplied.

### New TV and X-Ray Volt Meter

The Model 4000, a kilovoltmeter designed to measure TV and X-ray voltages up to 50,000 volts dc is being manufactured by Bradshaw Instrument Co., 348 Livingston St., Brooklyn 17, N. Y.



The Model 4000 is a 20-microampere meter with an input impedance of 1,250 megohms. All voltage is dissipated in the probe. The test leads are shielded, and the shields are joined to insure safety. A "Normal-Reverse" key is provided so that the probe may be used, regardless of the polarity of the voltage under test.

(Continued on page 61A)

You can use a sledge hammer to make it fit...



... **BUT** it's simpler to design the radio around the battery!

THE LOGICAL starting point in designing a new portable receiver is its batteries. You have to get them in sooner or later, and it's simpler to design them into the set at the start.

There's an "Eveready" battery to fit

virtually *any conceivable* radio design. Build maximum efficiency and utility into your radios by designing them around standard "Eveready" brand batteries. Our Battery Engineering Department will gladly provide you with complete technical data.



← "Eveready" No. 950 "A" batteries and the No. 467 "B" battery make an ideal combination for small portable receivers.



The registered trade-marks "Eveready" and "Mini-Max" distinguish products of **NATIONAL CARBON COMPANY, INC.**  
Unit of Union Carbide and Carbon Corporation



30 East 42nd Street, New York 17, N. Y.

Division Sales Offices: Atlanta, Chicago, Dallas, Kansas City, New York, Pittsburgh, San Francisco



# Magnetic Materials

The Arnold Engineering Company  
offers to the trade a complete line of  
Magnetic Materials



## PERMANENT MAGNET MATERIALS

- Cast Magnets, Alnico I, II, III, IV, V, VI, XII, X-900
  - Sintered Magnets, Alnico II, IV, V, VI, X-900, Remalloy\*
    - Vicalloy\* • Remalloy\* (Comol)
    - Cunico • Cunife • Cast Cobalt Magnet Steel

## HIGH PERMEABILITY MATERIALS

- Deltamax Toroidal Cores • Supermalloy\* Toroidal Cores
  - Powdered Molybdenum Permalloy\* Toroidal Cores • Permendur\*

\*Manufactured under licensing arrangements with WESTERN ELECTRIC COMPANY

*Write for information relating to any of these Magnetic Materials*



## THE ARNOLD ENGINEERING COMPANY

SUBSIDIARY OF ALLEGHENY LUDLUM STEEL CORPORATION

147 EAST ONTARIO STREET, CHICAGO 11, ILLINOIS

PROCEEDINGS OF THE I.R.E.

July, 1949

# One **CLARE RELAY** will do the work...

of a Relay and Filter-Condenser in Many Plate Circuit Installations

This...

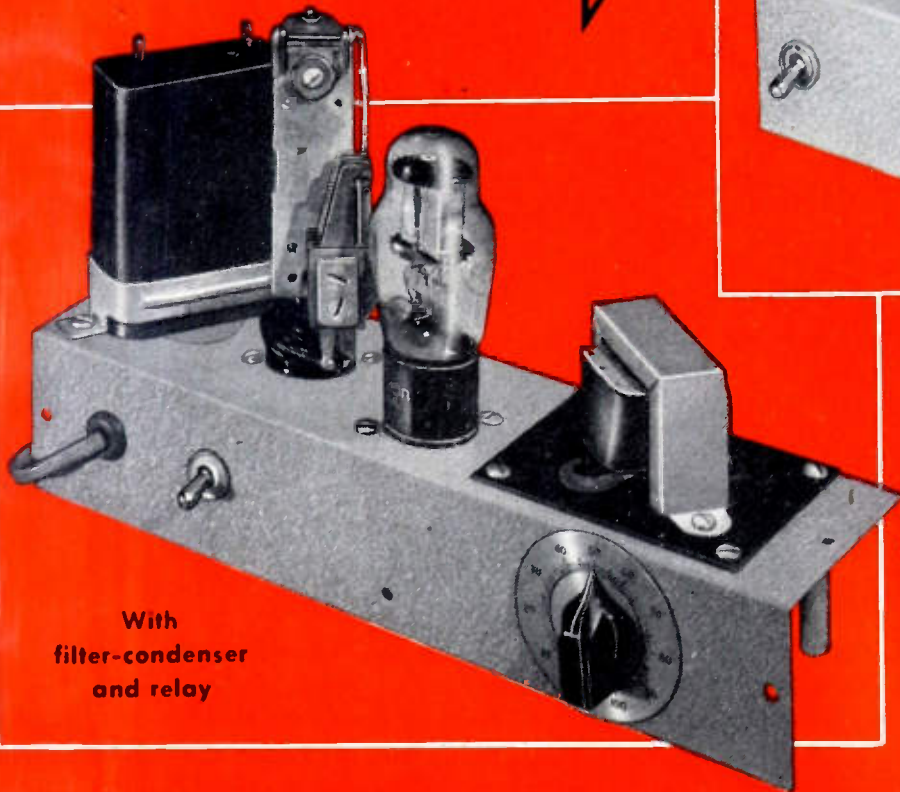
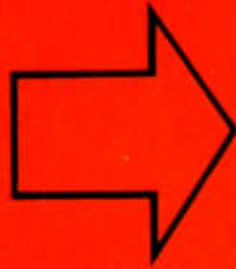

With  
filter-condenser  
and relay



With CLARE Plate  
Circuit Relay alone



**Not  
this!**

## THREE SIZES AND TYPES OF CLARE PLATE CIRCUIT RELAYS

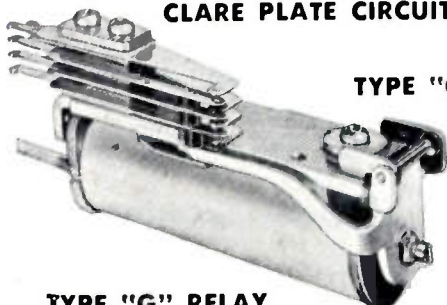

TYPE "C" RELAY

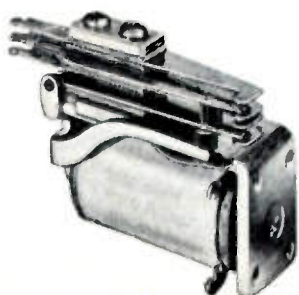

TYPE "G" RELAY

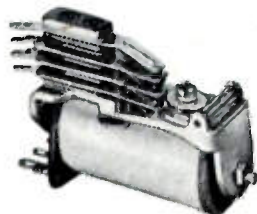

TYPE "J" RELAY

Utmost simplification of many plate circuit installations is possible with CLARE Plate Circuit Relays which make unnecessary the use of filter-condensers with or without induction networks.

By thus reducing the number of circuit elements, these CLARE Relays often make possible real savings of weight, wiring and cost.

If your design involves plate circuits, it will pay you to get full information at once. CLARE sales engineers are located in principal cities. You are invited to make use of their wide experience in every problem which involves the use of relays. Call them today, or write: C. P. Clare & Company, 4719 West Sunnyside Avenue, Chicago 30, Illinois. In Canada: Canadian Line Materials Ltd., Toronto 13. Cable Address: CLARELAY.

Write for Clare Bulletin No. 104

# CLARE RELAYS

**First in the Industrial Field**



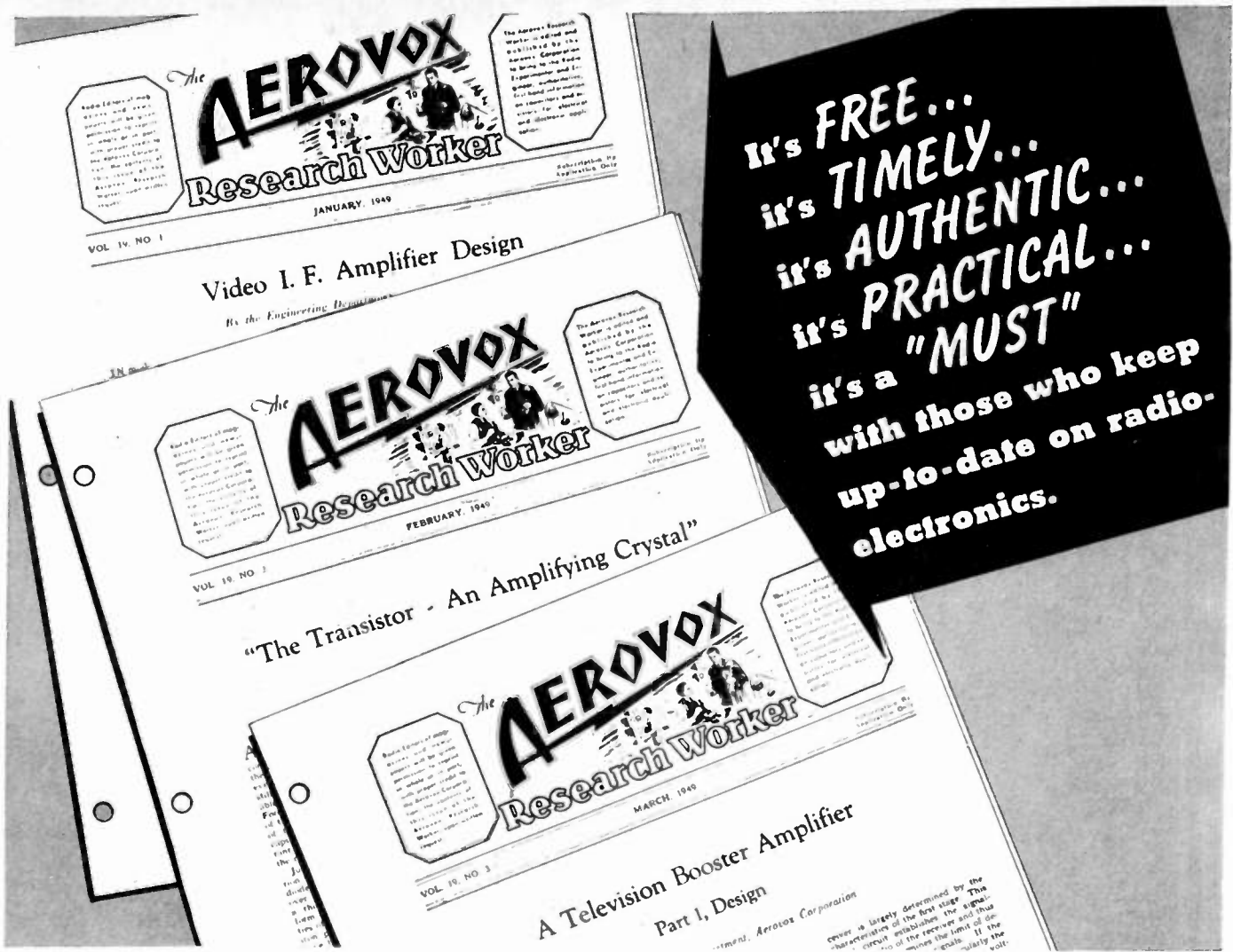

**It's FREE...  
it's TIMELY...  
it's AUTHENTIC...  
it's PRACTICAL...  
it's a "MUST"  
with those who keep  
up-to-date on radio-  
electronics.**

● The Aerovox Research Worker is edited for a specific reader audience—the engineers and designers of radio-electronic equipment. Every page, every word, is directed to the prime interest of this audience. The editorial program is patterned to serve the reader in all phases of the radio-electronic field.

Each monthly issue unfolds a new and useful phase of this round-the-calendar publication which aims to keep you informed on all that is new and significant. The editorial content anticipates the needs and interests of its readers. And it is always authentic.

Timely and practical articles on these subjects are written by men of the Aerovox engi-

neering departments who are authorities in their specialized field. Featured, too, are many helpful suggestions on processes and construction. Every article speaks the language of the reader—is written up to the level of his technical knowledge and training but down to earth in the bedrock fundamentals of the subject discussed.

The Aerovox Research Worker is distributed gratis to all interested parties. To get your FREE subscription, simply write us on your business letterhead.



**FOR RADIO-ELECTRONIC AND INDUSTRIAL APPLICATIONS**

**AEROVOX CORPORATION, NEW BEDFORD, MASS., U.S.A.**  
SALES OFFICES IN ALL PRINCIPAL CITIES • Export: 13 E. 40th St., NEW YORK 16, N. Y.  
Cable: 'ARLAB' • In Canada: AEROVOX CANADA LTD., HAMILTON, ONT.

# MARION

## helps TECHNOLOGY INSTRUMENT

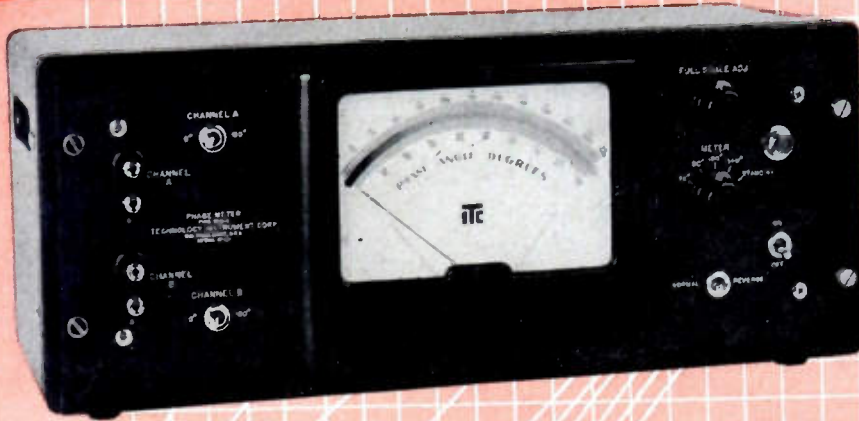

## measure Phase Difference

Type 320-A (electronic) Phase Meter by Technology Instrument Corporation is the first commercially available instrument for the direct measurement of Phase Angle as an independent quantity at audio and supersonic frequencies. Important fields of application are: Audio Facilities, Supersonics, Servomechanisms, Geophysics, Acoustics, Aerial Navigation, Electric Power Transformation and Signaling.

To make this instrument practical, T. I. C. had to have a special meter with special characteristics which would integrate extreme low frequency pulses and eliminate needle flutter. Other requirements included critical accuracy, an exceptionally long scale, readability, reliability, freedom from bearing failure, protection from heavy overloads and long life. By working in closest cooperation with Marion engineers and using all of Marion's extensive meter making experience and facilities a satisfactory type was finally developed.

When you need special- or general-purpose instruments for electrical or electronic measuring get in touch with us. Here at Marion we have solved many a complicated meter problem. We would appreciate the chance to help solve yours.

the  
name  
**MARION**  
means the  
most in  
meters



**MARION ELECTRICAL INSTRUMENT COMPANY**

**MANCHESTER, NEW HAMPSHIRE**

Export Division, 458 Broadway, New York 13, U. S. A., Cables MORHANEX

IN CANADA: THE ASTRAL ELECTRIC COMPANY, SCARBORO BLUFFS, ONTARIO



First with the Finest in

# TELEVISION TUBES!

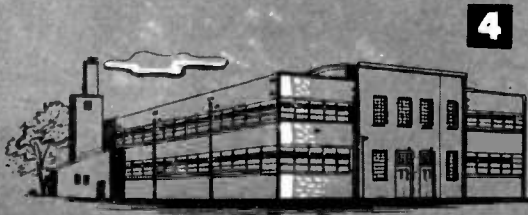
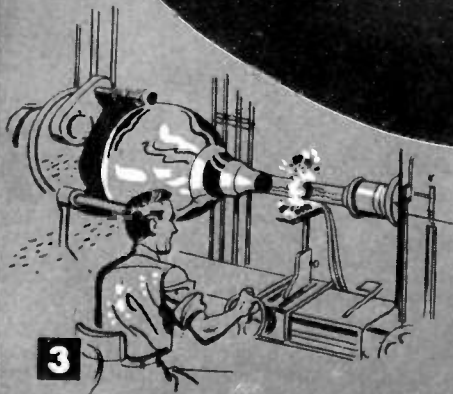
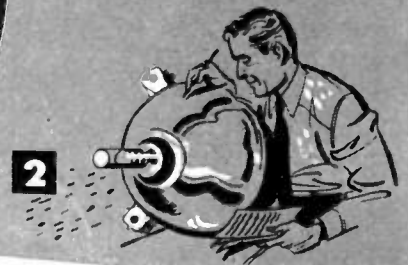
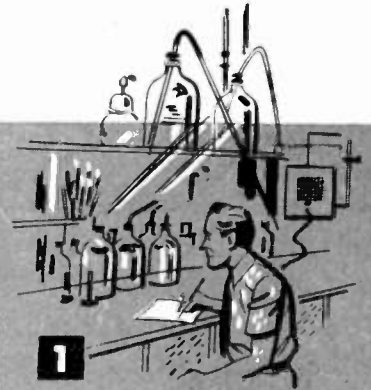

Allen B. Du Mont gave us the commercialized cathode-ray tube. Starting with a scientific curiosity in 1931, he pioneered the practical television picture tube of today. And Du Mont pioneering has never ceased. Examples? **1** Du Mont chemical research has led to tube screens of various persistencies and intensities precisely matched to any television requirements. **2** Du Mont research and development engineers have always led in large television tubes—those 12½", 15" and 20" Teletrons\*—because Dr. Du Mont has insisted on "comfortable" televiewing. **3** Du Mont craftsmen, provided with the finest glass-working equipment known, can translate advanced tube designs into greater tube values at lesser prices. **4** And to keep pace with the huge and still growing demands, Du Mont quantity-quality production has steadily stepped up, climaxed by the new Allwood plant. Yes, it's Du Mont Teletrons for the "First with the Finest in Television Tubes."

ALLEN B. DU MONT LABORATORIES, INC.

\*Trade-mark

FIRST WITH THE FINEST  
IN TELEVISION TUBES

# DU MONT Teletrons

ALLEN B. DU MONT LABORATORIES, INC., TUBE DIVISION, PASSAIC, N. J.



# OHMITE

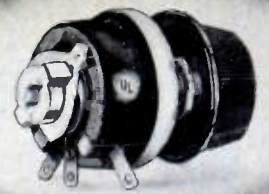

**RHEOSTATS**—Six stock sizes. Others to order. 25 to 1000 watts.



**FIXED RESISTORS**—Five sizes, 25 to 200 watts, 1 to 250,000 ohms.

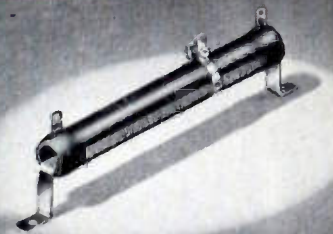

**DIVIDOHM RESISTORS**—Adjustable resistances. 10 to 200 watts.



**TWIN TYPE RESISTORS**—Made to order only—five wattage sizes.



**BROWN DEVILS**—Vitreous-enamelled resistors, 5, 10, and 20 watts.



**R.F. CHOKES**—Seven sizes, for frequencies from 1 to 520 megacycles.

**AVAILABLE** for Immediate Delivery

*From a Stock of Several Million*

**RHEOSTATS • RESISTORS • TAP SWITCHES • CHOKES**

WHEN your purchasing orders for resistance units are stamped "Rush" . . . wire Ohmite. Chances are the exact unit you need can be shipped immediately from Ohmite stock—believed to be the largest supply of power rheostats, wire-wound resistors, rotary tap switches, and chokes in the world. Actually several million units—in 1859 types, sizes, and values—are ready for delivery. All, of course, of typically high Ohmite quality—*Industry's First Choice.*

Ohmite rheostats are characterized by their all-ceramic construction . . . their smoothly gliding metal-graphite brush . . . their uniform windings locked in place by vitreous enamel . . . and their ability to provide close control and trouble-free service under the toughest operating conditions.

Ohmite resistors are built on a strong ceramic core . . . wound with even windings that prevent "hot spots" . . . protected by special vitreous enamel. Terminal lugs are tin-dipped for easy soldering.

Ohmite tap switches are unsurpassed in combining high current capacity, large number of taps, and compactness.

Ohmite r-f chokes are "frequency rated" for easy selection and top performance.

Why not let Ohmite serve you when you need resistance units *fast?*



*Write* on company letterhead for your copy of the Ohmite Catalog and Engineering Manual No. 40

OHMITE MANUFACTURING CO., 4860 Flournoy St., Chicago 44

**Be Right with-OHMITE**



# IT'S **STACKPOLE** FOR **IRON CORES!**

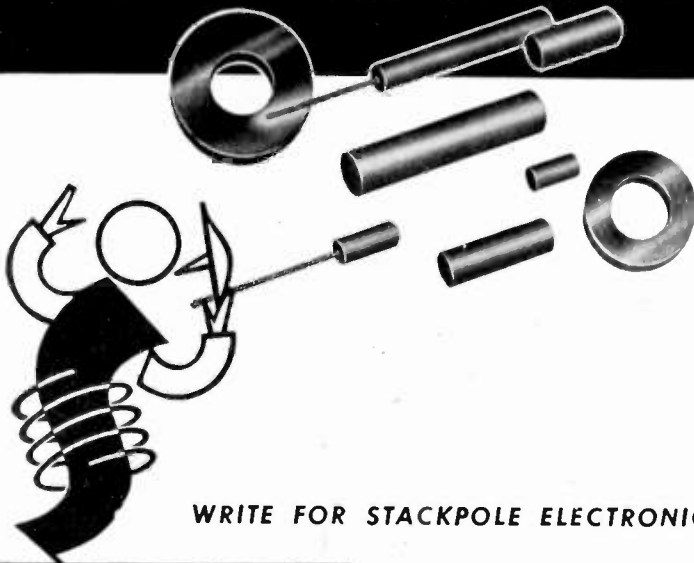

The rapid increase in the use of molded iron cores throughout electronic engineering has resulted in large part from Stackpole engineering that has made new and improved types available at attractive prices. In addition to dozens of standard broadcast, permeability tuning and high frequency types, Stackpole offers numerous others, a few of which are illustrated below.

WRITE FOR STACKPOLE ELECTRONIC COMPONENTS CATALOG RC-7

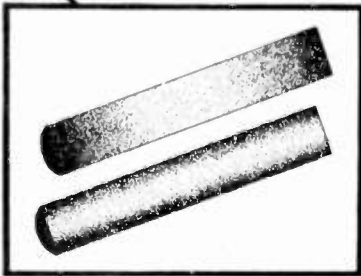

## ◀ SIDE MOLDED

Extra density of pressure extends evenly the entire length of the core. Resulting uniform permeability makes Stackpole Side-Molded Cores outstandingly superior for tuning applications. Broadcast band and short-wave types available.

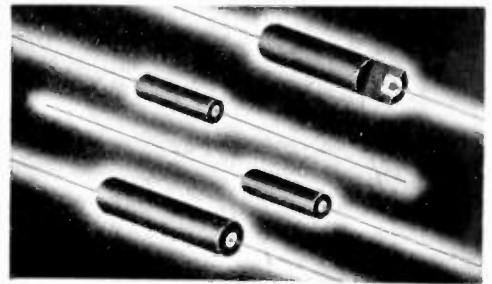

## CHOKE COIL CORES ▲

Ideal for audio, "hash," r-f chokes and others. Reduce coil dimensions and increase "Q." Insulated leads connect to coil and permit point-to-point wiring. Frequency ranges from 100 cycles to 175 megacycles.

## TRANSFORMER CORES ▶

for filter coils in carrier frequency equipment. Assure constant inductance over a given frequency range. Widely used where constant inductance, limited only by predetermined saturation point of core, is needed for various currents.

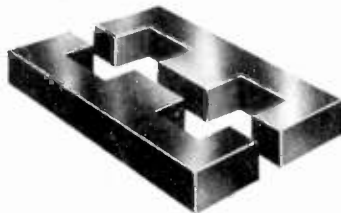

## HIGH-RESISTIVITY CORES

Made of a special material showing resistance of practically infinity. Reduce leakage currents and noise troubles, minimize voltage breakdown possibilities between coils and core; and, where cup cores are used, eliminate heavily insulated lead-in wires.

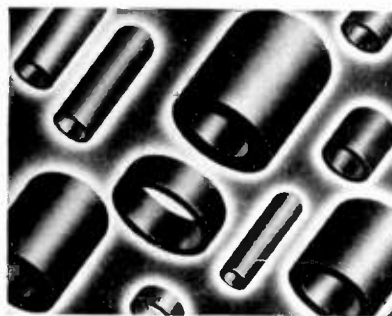

## ◀ SLEEVE CORES

By permitting use of smaller cans of less critical and less costly materials, these cores assure a high order of tuning efficiency in greatly reduced size. In some instances, it may not even be necessary to use cans.

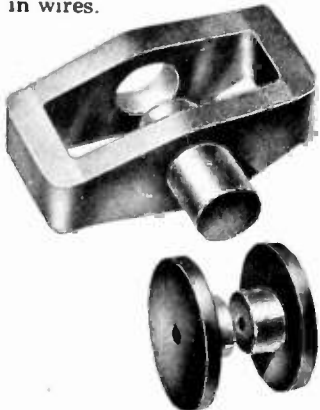

## ◀ TELEVISION CORES

From horizontal deflection and flyback transformer cores to I.F. and other types, Stackpole offers a complete line. The types illustrated here assure remarkably uniform results, save on assembly costs.

## CUP CORES ▶

These unique, self-shielding units are available in a wide range of shapes and sizes and are finding steadily increasing use throughout modern electronics. Can be mounted close to chassis or other metal parts.

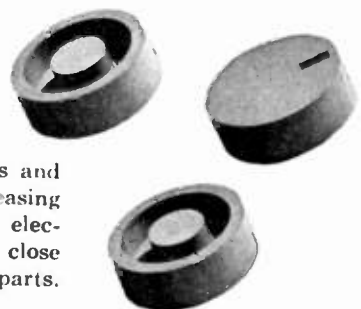

ELECTRONIC COMPONENTS DIVISION

**STACKPOLE CARBON COMPANY, St. Marys, Pa.**

# Capital Performance

## in the Tennessee capitol— WMAK at Nashville

Latest addition to the distinguished group of stations serving the important 51-county Nashville trading area, 1000-watt WMAK supplies central Tennessee with Mutual Broadcasting System fare. Six miles northwest of the city and WMAK's five new Truscon Self-Supporting Steel Radio Towers, each 210 feet high.

While extreme height is not necessary to achieve the required signal strength, this group demonstrates one outstanding characteristic of all Truscon Radio Towers



*Five More*  
**TRUSCON**  
**TOWERS OF STRENGTH**  
**210 FT.**  
**HIGH**

—each is designed and erected to fit the purely local conditions under which it must operate. Truscon engineers have a world-wide background of field experience to aid you in determining all operating factors, and in fitting the right tower to them.

Whether you're planning in terms of AM, FM, or TV, call or write your nearest Truscon district office. Capable technicians will work with you in selecting location and type of tower—guyed or self-supporting, uniform or tapered cross-section, tall or small—which best will serve you and your audience.

**TRUSCON STEEL COMPANY**  
YOUNGSTOWN 1, OHIO  
Subsidiary of Republic Steel Corporation

**TRUSCON**   
SELF-SUPPORTING  
AND UNIFORM **TOWERS**  
CROSS SECTION GUYED





*Another RCA First...*



THE FOUNTAINHEAD OF MODERN TUBE DEVELOPMENT IS RCA

*A new milestone in television progress*

**... the RCA 16-inch metal-cone television kinescope**

● The RCA-16AP4—a 16-inch, directly viewed metal-cone kinescope—is RCA's newest contribution to the television industry. It is the outgrowth of a perfected process of sealing glass to large areas of metal.

Use of the metal cone reduces weight substantially below that of a similar all-glass tube and provides greatly increased strength.

Other features of the 16AP4 include high picture brightness, good contrast even under high ambient light conditions, a high-quality face plate, and large useful screen area in relation to face area.

The RCA-16AP4 meets the growing demand for a picture size midway between that of the popular directly viewed RCA-10BP4 and the larger, projected picture provided by the RCA-5TP4.

The 16AP4 is currently being produced in quantity at the RCA Lancaster plant. Ground has been broken for a new large plant in Marion, Indiana, the entire production of which will be centered on the 16-inch metal tube.

**RCA Application Engineers** are ready to cooperate with you in applying the 16AP4 and associated components to your specific designs. For further information write RCA, Commercial Engineering, Section 47GR, Harrison, New Jersey.



The world's most modern tube plant . . .

**RCA, LANCASTER, PA.**



**RADIO CORPORATION of AMERICA**

**ELECTRON TUBES**

**HARRISON, N. J.**

BOARD OF DIRECTORS, 1949

- Stuart L. Bailey  
*President*
- A. S. McDonald  
*Vice-President*
- D. B. Sinclair  
*Treasurer*
- Haraden Pratt  
*Secretary*
- Alfred N. Goldsmith  
*Editor*
- W. R. G. Baker  
*Senior Past President*
- B. E. Shackelford  
*Junior Past President*

1949-1950

- Ben Akerman  
J. V. L. Hogan  
F. H. R. Pounsett  
J. E. Shepherd  
J. A. Stratton  
G. R. Town

1949-1951

- W. L. Everitt  
D. G. Fink

1949

- J. B. Coleman  
M. G. Crosby  
E. W. Engstrom  
R. A. Heising  
T. A. Hunter  
J. W. McRae  
H. J. Reich  
F. E. Terman  
H. A. Zahl

- Harold R. Zeamans  
*General Counsel*

- George W. Bailey  
*Executive Secretary*

- Laurence G. Cumming  
*Technical Secretary*

BOARD OF EDITORS

- Alfred N. Goldsmith  
*Chairman*

PAPERS REVIEW COMMITTEE

- George F. Metcalf  
*Chairman*

PAPERS PROCUREMENT COMMITTEE

- John D. Reid  
*General Chairman*

# PROCEEDINGS OF THE I.R.E.

(Including the WAVES AND ELECTRONS Section)

Published Monthly by

The Institute of Radio Engineers, Inc.

VOLUME 37

July, 1949

NUMBER 7

PROCEEDINGS OF THE I.R.E.

Murray G. Crosby, Director, 1947-1949	722
Buried Treasure	W. C. White 723
3366. Part I—Electrical Network Analyzers for the Solution of Electromagnetic Field Problems. K. Spangenberg, G. Walters, and F. Schott	724
3367. Operation of AM Broadcast Transmitters into Sharply Tuned Antenna Systems	W. H. Doherty 729
3368. A Power-Equalizing Network for Antennas	R. W. Masters 735
3369. Transmission-Line Characteristics of the Sectoral Horn	Herbert S. Bennett 738
3370. On the Theory of the Radiation Patterns of Electromagnetic Horns of Moderate Flare Angles	C. W. Horton 744
3371. Piezoelectric Transducers	Wilfred Roth 750
3372. Broad-Band Power-Measuring Methods at Microwave Frequencies	L. E. Norton 759
3373. A Forward-Transmission Echo-Ranging System	Donald B. Harris 767
3374. The Measurement and Interpretation of Antenna Scattering	D. D. King 770
3236. Discussion on "The Electron Wave Tube" by Andrew V. Haeff	W. B. Hebenstreit and Andrew V. Haeff 777
Contributors to the PROCEEDINGS OF THE I.R.E.	779

INSTITUTE NEWS AND RADIO NOTES SECTION

IRE News and Notes	781
Industrial Engineering Notes	783
Books:	
3375. "Microwave Antenna Theory and Design," edited by Samuel Silver	784
3376. "Spherical Harmonics" by T. M. MacRobert	Reviewed by Richard C. Raymond 785
3377. "Wave Mechanics and Its Applications" by N. F. Mott and I. N. Sneddon	Reviewed by Milton Dishal 785
3378. "Microwaves and Radar Electronics" by Ernest C. Pollard and Julian N. Sturtevant	Reviewed by G. Gamow 785
3379. "Exploring Electricity" by Hugh Hildreth Skilling	Reviewed by R. J. Philipps 785
3380. "Industrial Electronics Reference Book" by Electronics Engineers of the Westinghouse Corp.	Reviewed by Donald McNicol 786
3381. "Basic Electrical Engineering" by George F. Corcoran	Reviewed by Walther Richter 786
Sections	787
IRE People	788

WAVES AND ELECTRONS SECTION

IRE Section Chairman	Herbert Friedman 790
3382. Geiger Counter Tubes	791
3383. Microwave Phase Front Measurements for Overwater Paths of 12 and 32 Miles	A. W. Straiton 808
3384. Predetermined Electronic Counter (Abstract)	B. R. Gossick 813
3385. Carrier Current Pulsing over Toll Telephone Circuits	Imre Molnar 814
3386. Nomograms for Ionosphere Control Points	James C. W. Scott 821
3387. Experimental Determination of the Distribution of Current and Charge along Cylindrical Antennas	Giorgio Barzilai 825
3388. The Course-Line Computer for Radio Navigation of Aircraft	F. J. Gross 830
Contributors to Waves and Electrons Section	835
3389. Abstracts and References	836
News—New Products	14A 48A
Section Meetings	37A 50A
Student Branch Meetings	44A 52A
Advertising Index	63A

EDITORIAL DEPARTMENT

- Alfred N. Goldsmith  
*Editor*
- Clinton B. DeSoto†  
*Technical Editor,*  
1946-1949
- E. K. Gannett  
*Technical Editor*
- Mary L. Potter  
*Assistant Editor*
- William C. Copp  
*Advertising Manager*
- Lillian Petranek  
*Assistant Advertising Manager*

Responsibility for the contents of papers published in the PROCEEDINGS OF THE I.R.E. rests upon the authors. Statements made in papers are not binding on the Institute or its members.

Changes of address (with advance notice of fifteen days) and communications regarding subscriptions and payments should be mailed to the Secretary of the Institute, at 450 Ahnaip St., Menasha, Wisconsin, or 1 East 79 Street, New York 21, N. Y. All rights of republication, including translation into foreign languages, are reserved by the Institute. Abstracts of papers, with mention of their source, may be printed. Requests for republication privileges should be addressed to The Institute of Radio Engineers.

† Deceased







## Murray G. Crosby

BOARD OF DIRECTORS, 1947-1949

Murray G. Crosby was born at Elroy, Wisconsin, in 1903. He received the B.S. degree from the University of Wisconsin in 1927, having joined the IRE as an Associate in 1925. In the latter year he became research engineer for the communications division of the RCA Laboratories, and there he specialized in frequency and phase modulation and point-to-point reception. He has written a number of technical articles in those fields, and has been issued 150 patents.

Mr. Crosby was transferred to IRE Member Grade in 1938, and two years later was awarded the Modern Pioneer Award from the National Association of Manufacturers for contributions which improved the American standard of living. Receiving the professional electrical engineering degree from the University of Wisconsin in 1943, he became a Senior Member of the Institute and subsequently was made a Fellow that same year for his "contributions to the development of high-

frequency radio communications." In 1943 and 1944, while still associated with RCA, he served as expert technical consultant to the Secretary of War, and he also served on Panel Number One of the Radio Technical Planning Board.

Mr. Crosby left RCA in 1944, and joined the Paul Godley Co., consulting radio engineers, in 1945. Three years later he opened his own firm, Crosby Laboratories, in Mineola, Long Island, N. Y.

Mr. Crosby has been a member of a number of Institute Committees. Currently he is a member of the Executive, Policy Development, Editorial Administrative, Modulation Systems, and Standards Committees, as well as the Board of Editors; and Chairman of the IRE-RMA Problem Number Two Committee. He is on the Executive Committee of the Long Island Subsection. A fellow of the Radio Club of America, he is also a member of the AIEE.

An apparent fairy tale might be written, beginning: "Once upon a time, a group of farseeing engineers, scientists, teachers, and authors decided to form their own society having as its aim the advancement of the new wonder-art: radio. They planned to present in their meetings and journal not only thoughts of the moment, but guiding inspirations for the future."

And now a great pioneer and leader in radio and electronics has written the following guest editorial which adds to this tale almost these concluding words: "Fate smiled on their efforts. Their labors were crowned with unparalleled success, and they and their industry lived happily ever after."

But even if their happiness be clouded occasionally by doubt or confusion, they can still gain comfort, and mayhap some pride, from the thought that, in all essentials, they and their Institute have labored mightily and contributed essentially to the welfare of humanity.—*The Editor.*

## Buried Treasure

W. C. WHITE

Recently I had occasion to refer to volume 2, 1914, of the PROCEEDINGS OF THE I.R.E. The reference completed, I found it fascinating to thumb through the papers in that volume. Without spending too many minutes, I found a number of statements therein which were quite prophetic, and would at that time have made a good starting point for a research or development that later turned out to have considerable interest and value. In deForest's paper on the audion, for instance, mention was made of the whistling sound on the telephone receiver connected in the plate circuit under certain conditions and, in the lively discussion that followed the meeting, there were some surmises as to the cause. In the same paper, mention was made of the luminous streaks in the audion bulb that varied with the signal, allowing one to read by eye the message received. There is also in that paper the suggestion that a vacuum tube as an amplifier could be operated right next to a microphone for certain possible applications. Some of our modern electronic devices now utilize certain of the ideas expressed, and they might have been arrived at earlier and by a different engineer, if work had been started on them soon after this paper was published.

In the same volume, a paper by John Stone Stone described the use of a cathode-ray tube for measurement work at radio frequencies. Apparently, however, its usefulness as a tool in the radio field was not appreciated until many years later.

Some material in the same volume intrigued me as possibly showing the beckoning finger of opportunity even today. There was, for instance, the paper on "The Influence of Alternating Currents on Certain Melted Metallic Salts." It described some experiments and results that appeared to its author to be mysterious. It is possible that even today the ideas expressed might represent the starting point for a profitable piece of research.

In volume 3, Dr. Alfred N. Goldsmith contributed a paper on various types of frequency changers having possible usefulness in the radio field and, to my surprise, found, even at that early date, that one of them was an electronic method.

Early descriptions of unexpected experimental results or chance observations may sometimes be explained by modern concepts. Also, new methods and new materials may enable a skilled engineer to produce a useful result therefrom.

Of course, our PROCEEDINGS over the years represent a tremendous accumulation of information in the radio and electronics field, and radio engineers are constantly digging into this mine of information for specific aids for some of their problems. Just to browse through some of the early volumes, however, is a most interesting experience, and, if followed up, may well reveal a "treasure" of considerable interest and value.



# Electrical Network Analyzers for the Solution of Electromagnetic Field Problems\*

K. SPANGENBERG†, FELLOW, IRE, G. WALTERS‡, STUDENT MEMBER, IRE, AND  
F. SCHOTT§, ASSOCIATE, IRE

## Part I THEORY, DESIGN AND CONSTRUCTION

**Summary**—This is the first part of a paper on the design, construction, and operation of electrical network analyzers capable of obtaining solutions of the wave equation. There is discussed herein the design and construction of two network analyzers for solving the wave equation in both two-dimensional, axially symmetric, cylindrical co-ordinates and rectangular co-ordinates. The various design parameters are discussed and suitable solutions presented.

### I. INTRODUCTION

THIS PAPER will describe the design, construction, and testing of two network analyzers especially constructed to solve the wave equation and thus obtain the solution of various electromagnetic field problems.

It is well known that certain analogues may be used for the solution of differential equations. One of the best known analogues is the electrolytic tank, which provides solutions of the Laplace equation. It is also possible to construct electrical networks which will give solutions of the wave equation. An intimation of this was given in an early paper by Alford<sup>1</sup> but the complete details of this analogue were first enunciated by Kron and colleagues.<sup>2-6</sup>

The general principle involved is that solutions of ordinary and partial linear differential equations are closely approximated by solutions of corresponding difference equations which, in turn, have the same solution as the voltages and currents in properly constructed networks. In this paper there will be considered

only the case of the wave equation in two-dimensional, axially symmetric, cylindrical co-ordinates and rectangular co-ordinates. The networks to be described bear the same relation to the wave equation that the electrolytic tank bears to the Laplace equation.

### II. GENERAL THEORY

#### A. General Two-Dimensional Network Relations

In Fig. 1 is shown a two-dimensional electrical network. This network is two-dimensional in the sense that

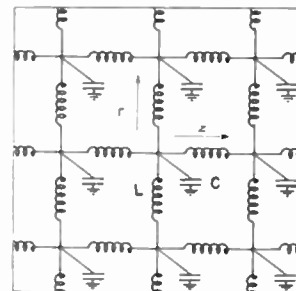

Fig. 1—General network configuration and notation.

it will support the propagation of waves in two distinct co-ordinate directions. Essentially this network consists of two sets of interconnected artificial transmission lines made up of pi sections comprising series inductances and shunt capacitances. Waves may propagate in two component directions on such a network and thus be propagated at any angle. The particular network shown is represented as being in two-dimensional cylindrical co-ordinates, but the resulting network relations will be equally valid for two-dimensional rectangular co-ordinates if  $r$  is replaced by  $x$  and  $z$  is replaced by  $y$ .

The Kirchhoff's law relations for the network of Fig. 1 are approximately as follows:

$$\frac{\partial I_r}{\partial r} + \frac{\partial I_z}{\partial z} = -Y_\phi V_\phi \quad (1)$$

$$\frac{\partial V_\phi}{\partial r} = -I_r Z_r \quad (2)$$

$$\frac{\partial V_\phi}{\partial z} = -I_z Z_z \quad (3)$$

\* Decimal classification: R143. Original manuscript received by the Institute, October 19, 1948; revised manuscript received, February 2, 1949. Presented, 1948 IRE National Convention, New York, N. Y., March 25, 1948. This paper reports work on a program sponsored by the Office of Naval Research under Contract N6onr-251, Task Order 7.

† Office of Naval Research, Washington, D. C.

‡ Dalmo Victor Co., San Carlos, Calif.

§ University of California, Los Angeles, Calif.

<sup>1</sup> A. Alford, "A method for calculating transmission properties of electrical networks consisting of a number of sections," *Proc. I.R.E.*, vol. 21, pp. 1210-1220; August, 1933.

<sup>2</sup> G. Kron, "Numerical solution of ordinary and partial differential equations by means of equivalent circuits," *Jour. Appl. Phys.*, vol. 16, pp. 172-186; March, 1945.

<sup>3</sup> J. R. Whinnery and S. Ramo, "A new approach to the solution of high-frequency field problems," *Proc. I.R.E.*, vol. 32, pp. 284-288; May, 1944.

<sup>4</sup> G. Kron, "Equivalent circuit of the field equations of Maxwell," *Proc. I.R.E.*, vol. 32, pp. 289-299; May, 1944.

<sup>5</sup> J. R. Whinnery, C. Concordia, W. Ridgway, and G. Kron, "Network analyzers studies of electromagnetic cavity resonators," *Proc. I.R.E.*, vol. 32, pp. 360-367; June, 1944.

<sup>6</sup> G. Kron, "Electric circuit models of partial differential equations," *Elec. Eng.*, vol. 67, pp. 672-684; July, 1948.

In the above equations, the symbols used have the following significance:

- $I_r$  = current in a radial element
- $I_z$  = current in a longitudinal element
- $V_\phi$  = voltage across a shunt element, i.e., between a lattice junction and the ground plane
- $Z_r$  = impedance per unit length of a radial element in the  $r-z$  lattice
- $Z_z$  = impedance per unit length of a longitudinal element in the  $r-z$  lattice
- $Y_\phi$  = shunt admittance per unit area.

**B. Cylindrical Network-Field Relations**

The general curl equations of Maxwell have the form

$$\text{curl } \vec{H} = \epsilon \frac{\partial \vec{E}}{\partial t} = j\omega \epsilon \vec{E} \tag{4}$$

and

$$\text{curl } \vec{E} = -\mu \frac{\partial \vec{H}}{\partial t} = -j\omega \mu \vec{H} \tag{5}$$

where all of the vector field components are assumed to have a time factor of the form  $\epsilon^{j\omega t}$ .

The corresponding components of the curl equations of Maxwell for a  $TM$  wave having only a  $\phi$  component of magnetic field and no variation of any field component in the  $\phi$  direction, i.e.,  $H_r = 0, H_z = 0, E_\phi = 0$ , are

$$\frac{\partial E_r}{\partial z} - \frac{\partial E_z}{\partial r} = \frac{-j\omega\mu}{r} (rH_\phi) \tag{6}$$

$$\frac{\partial(rH_\phi)}{\partial z} = -j\omega\epsilon r E_r \tag{7}$$

$$\frac{\partial(rH_\phi)}{\partial r} = j\omega\epsilon r E_z \tag{8}$$

in which the symbols have the usual significance for rationalized mks units.

From a comparison of the two sets of equations above, Table I shows the correspondence which is seen to exist between network and field quantities. The relations in Table I are valid for  $TEM$  and  $TM_0$  waves only for problems in cylindrical co-ordinates having radial and axial variations of field only.

TABLE I  
FIELD-NETWORK RELATIONS FOR CYLINDRICAL  $TM_0$  AND  $TEM$  MODES

Field	Network
$E_r$	$I_z$
$-E_z$	$I_r$
$rH_\phi$	$V_\phi$
$j\omega\epsilon r$	$Z_r = j\omega L$
$j\omega\epsilon r$	$Z_z = j\omega L$
$\frac{j\omega\mu}{r}$	$Y_\phi = j\omega C$

Examination of the network-field relations for  $TM$  modes show that the radial and longitudinal series

impedances are positive reactances whose magnitudes increase directly with frequency and radius. This indicates that the radial and longitudinal series-circuit elements are appropriately inductances which must increase linearly with the radius. Similarly, the shunt-circuit elements are capacitances whose magnitude varies inversely with the radial distance. This particular case, the one most commonly used with cylindrical co-ordinates, exhibits an inversion in the network-field analogy in that a magnetic field is represented by a voltage whereas an electric field is represented by a current.

For  $TE_0$  modes in two-dimensional, axially symmetric, cylindrical co-ordinates, the correspondence between network and field quantities shown in Table II

TABLE II  
FIELD-NETWORK RELATIONS FOR CYLINDRICAL  $TE_0$  MODES

Field	Network
$-H_r$	$I_z$
$H_z$	$I_r$
$rH_\phi$	$V_\phi$
$j\omega\mu r$	$Z_r = j\omega L$
$j\omega\mu r$	$Z_z = j\omega L$
$\frac{j\omega\epsilon}{r}$	$Y_\phi = j\omega C$

holds. Here the analogy is direct; a magnetic-field component is represented by a current, an electric-field component by a voltage. It will be noted that, again, the required network elements are reactances, the series values having values directly proportional to frequency and to radial distance, whereas the shunt values are inversely proportional to frequency and directly proportional to radius. These conditions are easily met by using, for the series elements, inductances which increase with radius and, for the shunt elements, capacitances which vary inversely with the radius.

**C. Rectangular Network-Field Relations**

If one now writes the field curl equations for a two-dimensional rectangular  $TE$  mode, i.e., for  $E_z = 0, H_x = 0, H_y = 0$ , the equations have the form:

$$\frac{\partial E_y}{\partial x} - \frac{\partial E_x}{\partial y} = -j\omega\mu H_z \tag{9}$$

$$\frac{\partial H_z}{\partial x} = -j\omega\epsilon E_y \tag{10}$$

$$\frac{\partial H_z}{\partial y} = j\omega\epsilon E_x \tag{11}$$

When these equations are compared with the network equations (1), (2), and (3), with  $r$  replaced by  $x$ , and  $z$  replaced by  $y$ , it is seen that the network-field relations exist as shown in Table III. Here it is seen that the electric-field components are represented by current, and that the magnetic-field components are represented by voltages. It is also seen that the series elements may be



TABLE III  
FIELD-NETWORK RELATIONS FOR RECTANGULAR *TE* MODES

Field	Network
$E_y$	$I_x$
$-E_x$	$I_y$
$H_x$	$V_z$
$j\omega\epsilon$	$Z_x = j\omega L$
$j\omega\epsilon$	$Z_y = j\omega L$
$j\omega\mu$	$Y_z = j\omega C$

inductances of constant value throughout the network, whereas the shunt elements may be capacitances, likewise of constant value throughout the network. This is the analogy which is used to represent the cutoff field in the cross section of an odd-shaped waveguide. The designations *TE* and *TM* for rectangular field problems as applied to resonators is somewhat arbitrary depending upon how the resonator is observed.

For *TM* modes in two-dimensional rectangular coordinates, the field-network relations are as shown in Table IV. The analogy in this case is seen to be direct,

TABLE IV  
FIELD-NETWORK RELATIONS FOR RECTANGULAR *TM* MODES

Field	Network
$H_x$	$I_y$
$-H_y$	$I_x$
$E_z$	$V_z$
$j\omega\mu$	$Z_x = j\omega L$
$j\omega\mu$	$Z_y = j\omega L$
$j\omega\epsilon$	$Y_z = j\omega C$

in that electric-field components are represented by voltages, and magnetic-field components are represented by currents. Again, in this case, the proper network elements are inductances everywhere equal for the series elements, and capacitances everywhere equal for the shunt elements. This is the analogy used to study waveguide resonators with parallel upper and lower planes.

### III. DESIGN CONSIDERATIONS

#### A. Two-Dimensional, Cylindrical-Co-ordinate Network

1. *LC Product.* A basic relation that is involved in all of the equivalent networks is

$$f_n = \frac{1}{N_\lambda \sqrt{LC}} \quad (12)$$

where

$L$  = inductance per section at any point in the network

$C$  = capacitance per section at a corresponding point in the network

$f_n$  = network operating frequency

$N_\lambda$  = number of elements per wavelength.

Actually, this is the low-frequency velocity relation for the equivalent filter made up of the tandem connection of the pi sections. If the cutoff frequency of the pi section is made sufficiently high relative to the operating frequency, the velocity will be substantially constant in the operating range.

2. *Frequency of Operation.* The selection of the operating frequency is an important one. For purposes of measurement, it would be desirable to have the operating frequency as low as possible. This would make possible the use of ordinary measuring instruments. However, a low operating frequency requires a large *LC* product, which, in turn, requires large values of inductance and capacitance. Large values of inductance are undesirable because in general, they have a low *Q* and a large bulk. Likewise, large capacitances are undesirable because of their bulk and difficulty of adjustment. From the standpoint of having network elements of convenient size, it would be desirable to operate at radio frequencies, where the inductances and capacitances could be quite small. However, operation at high radio frequencies is undesirable from the standpoint that an open network would radiate, and the coupling between elements would be quite high. Accordingly, a compromise between these requirements was made, and, in the network built at Stanford, operating frequencies in the range of 20 to 300 kc were selected. This range of operating frequencies has turned out to be a very desirable one. Stray field effects are just beginning to appear at the upper end of this frequency band, and yet the frequencies are high enough so that the circuit elements are reasonably small. At the same time, the operating frequency is low enough so that ordinary electronic instruments can be used in observing the circuit behavior. In the cylindrical network, an *LC* product of  $16 \times 10^{-14}$  (sections per second)<sup>-2</sup> was selected.

3. *Range of Inductance Values.* In the cylindrical network, the inductances are required to vary linearly with radius. This means that very small inductances are required close to the axis, while large inductances are required for large radial values. The smallest size inductor that can be used is determined by the smallest coil *Q* that can be tolerated. The largest inductor is determined by the physical size that can be used without inconvenience. The inductors were chosen to have a value of inductance equal to 200 microhenrys per radial section.

4. *Range of Capacitance Values.* As previously stated, the values of capacitance are required to vary inversely with radius for the cylindrical network. This means that very large capacitances are required near the axis, while small capacitances are needed for large radial values. In order to have capacitances which could be set with reasonable accuracy, it was decided to use ordinary mica trimmer capacitors. The largest size capacitor of this type commonly available is of the order of 1,000  $\mu\text{mf}$ . Accordingly, the capacitance values were made equal to 800  $\mu\text{mf}$  divided by the number of radial sections corresponding to the location. This choice was, in part, determined by the fact that the smallest capacitance used at the point most remote from the axis must still be fairly large compared to the input capacitance of any measuring device, such as a voltmeter, which may subsequently be used with the network. Since the net-

work had twelve radial sections, this meant that the outermost capacitors had a value of 67  $\mu\text{mf}$ . It would be possible to use somewhat larger values of capacitance.

5. *Allowable Coil Losses.* Since the network-field relations which have been developed assumed perfect inductances, it is desirable to have  $Q$ 's as large as possible. An idea of the allowable minimum coil  $Q$  can be obtained by examining the characteristics of an artificial transmission line having series inductances with finite coil  $Q$ 's and perfect shunt capacitances. In such an artificial transmission line, the series impedance is given by

$$Z = R + j\omega L = j\omega L \left( 1 - \frac{j}{Q} \right) \quad (13)$$

where  $Q = \omega L / R$  and the admittance of the shunt element is given by

$$Y = j\omega C. \quad (14)$$

Using these values, the characteristic impedance of the line has a low-frequency value of

$$Z_0 = R_0 + jX_0 = \sqrt{\frac{Z}{Y}} = \sqrt{\frac{L}{C} \left( 1 - \frac{j}{Q} \right)}. \quad (15)$$

Expanding this expression by the binomial theorem,

$$R_0 = \sqrt{\frac{L}{C} \left( 1 + \frac{1}{8Q^2} - \dots \right)} \quad (16)$$

$$X_0 = \frac{-1}{2Q} \sqrt{\frac{L}{C} \left( 1 - \frac{1}{8Q^2} + \dots \right)}. \quad (17)$$

Likewise, the propagation constant is

$$\Gamma = \alpha + j\beta = \sqrt{ZY} = j\omega \sqrt{LC} \left( 1 - \frac{j}{Q} \right). \quad (18)$$

Expanding this by the binomial theorem,

$$\alpha = \frac{\omega \sqrt{LC}}{2Q} \left( 1 - \frac{1}{8Q^2} + \dots \right) \quad (19)$$

$$\beta = \omega \sqrt{LC} \left( 1 + \frac{1}{8Q^2} - \dots \right). \quad (20)$$

Examination of the above relations shows that the value of  $Q$  can be fairly low without destroying the basic relations demanded by the network for proper representation of the electromagnetic field. The minimum  $Q$  of the coarse section of the cylindrical network is 25, which corresponds to an attenuation of 1.09 db per wavelength or a voltage reduction of 10 per cent. For most of the coarse section, the  $Q$ 's are of the order of 50, for which the voltage reduction is only 0.6 per cent per wavelength. Accordingly, the finite  $Q$ 's of the coils are not a matter of serious concern.

6. *Coil Data.* Coils were wound with No. 7-41 Litz wire on a 5/16-inch bakelite rod. The coils were universally wound in the form of a small pi 1/4 inch in width. The coils were so made that they could be plugged in and out of the circuit. This was accom-

plished by placing small contact rings on either end of the mounting rod of such size as to fit into a standard 3/8-inch fuze clip. The maximum radius of a given winding was determined by the height of the mounting (approximately 1/2 inch). For the large values of inductance, it was found necessary to use two and sometimes three such pi windings. The Litz wire was considered necessary to get a high  $Q$  at the operating frequency. Curves of inductance and corresponding coil  $Q$  as a function of the number of turns and the inductance, respectively, are shown in Figs. 2 and 3. As indicated in

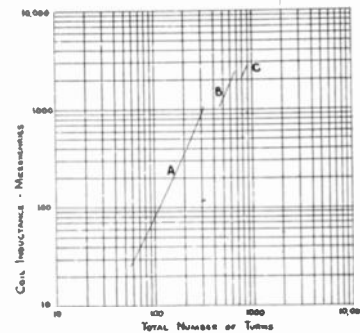

Fig. 2—Inductance versus turns of network-analyzer coils; coils pi-wound on 5/16-inch diameter fiber rod, all pi windings are wound on 11/16-inch centers, length of windings 1/4 inch, wire No. 7-41 Litz, measurements made at 100 kc; (A) single-pi coils, (B) 2-pi coils, and (C) 3-pi coils.

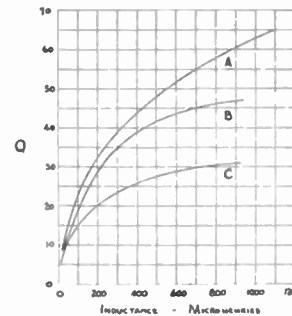

Fig. 3— $Q$  versus inductance at 100 kc for network-analyzer coils pi-wound with No. 7-41 Litz wire on 5/16-inch diameter fiber rod, winding length 1/4 inch; (A) free space (long-form coils); (B) rings only (short-form coils); and (C) rings and clips (short-form coils).

Fig. 3, the  $Q$  of the longer coils used in the coarse section were unaffected by either the contact rings or clips; whereas, the  $Q$  of the short coils used in the fine section was considerably reduced. The need of the fine section is explained in a later section. Coils were wound and inductance adjusted to the proper value within an accuracy of 0.5 per cent. The coils were wound on a Meissner coil winder, and the value of inductance was adjusted under conditions corresponding to mounting in the network, so that the effect of the rings and clips was properly accounted for.

7. *Physical Form of the Network.* The cylindrical network was constructed to have a radial dimension of one-half wavelength and an axial dimension of 1.5 wavelengths at the mean operating frequency of 100 kc. The major portion of the network was constructed with twenty-five elements per wavelength at the mean



operating frequency. There was, in addition, a fine section constructed in one corner of the network having fifty elements per wavelength at the mean operating frequency. The physical dimensions of the network are  $4 \times 12$  feet. It is mounted on a  $\frac{1}{4}$ -inch Micarta panel, supported by a wooden framework. A picture of the network is shown in Fig. 4. An open-type structure was



Fig. 4—Cylindrical-co-ordinate network in operation.

used, with posts at the inductance junctions. The trimmer capacitors comprising the shunt-reactance elements were located physically in the center of the squares made up of the inductors. A ground network was used on the back of the board to connect to the capacitors. The distance between junction posts was  $3\frac{3}{4}$  inches. This gave a spacing of the inductors large enough to result in no observable mutual coupling between inductances at the operating frequencies.

8. *Fine-Section Junction.* In building the cylindrical co-ordinate network, it was considered desirable to have a portion of the network give more detail than the rest of the board. Accordingly, one-sixth of the network, the total dimensions of which were  $0.5\lambda$  by  $1.5\lambda$ , was constructed with fifty elements per wavelength at a mid-operating frequency of 100 kc, while the remaining five-sixths of the network was constructed with twenty-five elements per wavelength. Of the various arrangements possible to give greater detail than a network with a uniform construction of twenty-five elements per wavelength, this arrangement gives greatest detail for the smallest number of coils.

Although the use of a small fine section in conjunction with a larger coarse section results in economy of construction for a given detail, the problem of matching the

fine to the coarse section does arise. The requirements of a junction are:

a. Time delays of an electrical wave must be proportional to the length of each section for propagation both normal and parallel to the junction.

b. The  $Z_0$  of each section comprising the junction must be such that power will divide properly over the areas involved without reflection for waves both normal and parallel to the boundary. If the above conditions are realized, waves normal and parallel to the boundary will not be disturbed, nor will any wave crossing the boundary at an angle be disturbed. It is very difficult to meet all of the above conditions exactly. Of the various junction arrangements possible, one suggested by V. A. Westberg has been found to match the fine and coarse section so well the disturbance is hardly measurable. This junction configuration is shown in Fig. 5. In Fig. 5(a) are shown the impedance and delay values. In Fig. 5(b) these have

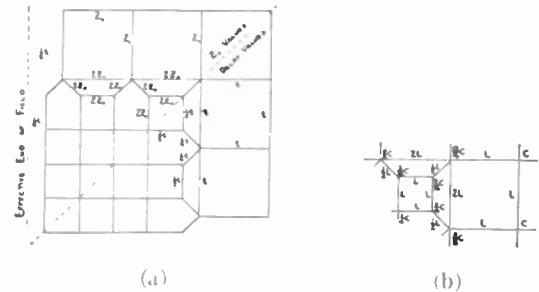

Fig. 5—Junction configuration, (a) impedance and delay values, and (b) relative values of circuit parameters.

been translated into the proper relative inductance and capacitance values. For the cylindrical-co-ordinate network, the inductance values shown in Fig. 5(b) must be multiplied by radial distance, while the capacitance values must be divided by radial distance.

9. *Cost of Construction.* As analyzers go, networks of the type described here are relatively inexpensive devices. The first network built was the one for cylindrical co-ordinates. Coils for this network were wound in the Stanford laboratories by student assistants, and the entire construction was made, without recourse to external facilities, in a period of about one month. The cost of construction of this network, including materials, labor, and overhead is conservatively estimated at \$6,500. The cost of the materials alone was approximately \$2,000.

The second network was constructed for rectangular co-ordinates. Since the coils were all of the same size on this network, their fabrication was subcontracted. The rectangular co-ordinate network is estimated as having cost only \$2,000. The reduction in cost resulted from a design without a fine section, which involved only half as many coils as in the first network at half the unit cost plus the reduction in time resulting from experience with the first network. The cost of the materials alone was under \$1,000.

### B. Rectangular-Co-ordinate Network

1. *LC Product.* The design problem encountered in constructing a network for two-dimensional rectangular co-ordinates is much simpler than that for cylindrical co-ordinates. A much greater tolerance in choice of values is permitted in this case because radial variation of circuit elements need not be considered. The *LC* product for the rectangular network was taken as about 2.8 times that used for the cylindrical-co-ordinate network. This gave a velocity of twenty-five elements per wavelength at 60 kc.

2. *Values of Circuit Parameters.* The coils for the rectangular-co-ordinate network were specified as hav-

ing an inductance of 1,200 microhenries and a *Q* of 50 at 100 kc. The coils were of similar construction to those used in the coarse section of the cylindrical-co-ordinate network; however, it was found that sufficiently high *Q* was obtainable with No. 30 enameled solid-copper wire. The distributed capacitance of these coils was higher than that of the Litz-wire-wound coils, but still resulted in a natural resonant frequency of 2 Mc, well above the operating frequency. The capacitors for the rectangular network were 350  $\mu\mu\text{f}$  trimmer capacitors. These could be set anywhere in the range of 50 to 500  $\mu\mu\text{f}$ ; the lower the value, the higher the operating frequency for a given number of electrical degrees per section. A compromise value of 370  $\mu\mu\text{f}$  was chosen.

## Operation of AM Broadcast Transmitters into Sharply Tuned Antenna Systems\*

W. H. DOHERTY†, FELLOW, IRE

*Summary*—The impedance of some broadcast antenna arrays varies so much over the transmitted band as to impair the performance of the radio transmitter. The impairment consists in clipping of sidebands and distortion of the envelope at high modulation frequencies. This paper reports on an experimental determination of the nature and magnitude of this impairment and on its substantial reduction by suitable coupling methods.

### INTRODUCTION

THE IMPEDANCE of a broadcast antenna, and particularly the common-point impedance of an array, often varies widely over the transmission band. When this is the case, the frequency response, amplitude linearity, and modulation capability of the broadcast transmitter can be adversely affected. Recognition of this difficulty by transmitter manufacturers has led to the formulation of an RMA specification for the "normal load" into which a transmitter should operate and meet its performance requirements. This is a load whose resistance does not depart more than 5 per cent from its midband or carrier-frequency value at  $\pm 5$  kc or 10 per cent at  $\pm 10$  kc, and whose reactance, which is zero at midband, does not exceed 18 per cent of the midband resistance at  $\pm 5$  kc or 35 per cent at  $\pm 10$  kc.

A study of the effect of frequency-sensitive loads from the viewpoint of the transmitter designer has been carried out by engineers of the broadcast transmitter development group of Bell Telephone Laboratories under the supervision of J. B. Bishop. Extensive data

and oscillograms have been taken which indicate the extent of the impairment of transmitter performance under a variety of conditions, and the effectiveness of corrective methods which are to be described.

### I. MONITORING METHODS

The first phase of the study necessarily involved determination of proper monitoring conditions whereby actual sideband power, effective percentage modulation, and true distortion in the signal delivered to the antenna system can be measured. A preliminary discussion of the monitoring problem appeared in a previous publication,<sup>1</sup> in which it was shown that the appearance of the modulation envelope is greatly different at different points in a coupling circuit or at different points along a transmission line when the impedance of the termination at the side frequencies differs substantially from the impedance at the carrier frequency. This is illustrated by the oscillograms of Fig. 1, which show the voltage envelope for a modulation frequency of 7500 cps as observed at three points along a transmission line or coupling network whose termination, for example, is equivalent to a series-tuned circuit resonant at the carrier frequency. At the termination, or at points removed therefrom by an even number of quarter wavelengths, a fully modulated voltage wave may appear (Fig. 1(a)), and the amplitude of each of the two side-frequency voltages accordingly will be one-half the amplitude of the carrier voltage. But, because the impedance rises on either side of the carrier frequency (Fig. 1(d)), the side-

\* Decimal classification: R355.131×R326.4. Original manuscript received by the Institute, September 28, 1948; revised manuscript received, January 3, 1949. Presented, 1948 IRE West Coast Convention, September 30, 1948, Los Angeles, Calif.

† Bell Telephone Laboratories, Inc., Murray Hill, N. J.

<sup>1</sup> W. H. Doherty, "Notes on modulation of AM transmitters," *The Oscillator*, p. 22, no. 5; October, 1946.



frequency currents will each be less than one-half the carrier current, and an inspection of the current envelope would show substantially less than 100 per cent modulation. On the other hand, at points removed from the termination by odd quarter wavelengths, the impedance will correspond to that of a parallel-tuned circuit (Fig. 1(f)), decreasing on either side of the carrier frequency; and, although the current envelope if observed would show a fully modulated wave, the voltage

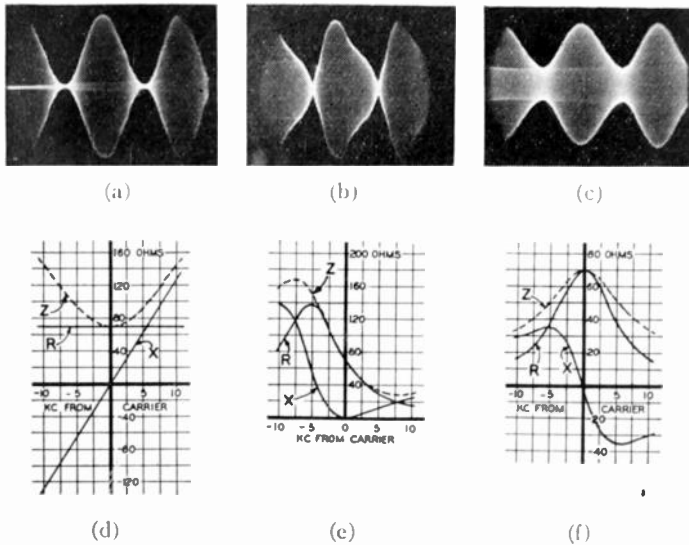

Fig. 1—Voltage envelopes and impedance versus frequency relations at three points in an output circuit or transmission line with narrow-band termination.

envelope (Fig. 1(c)) shows considerably less than 100 per cent modulation—in the case illustrated, only 60 per cent, since the impedance at the side frequencies is only 60 per cent of the impedance at the carrier frequency (the inverse of the situation of Fig. 1(d)). Finally, at odd eighth-wavelength points, where the impedance versus frequency curve is dissymmetrical (Fig. 1(e)), the voltage envelope has the distorted appearance indicated in Fig. 1(b). The current envelope at this point would also be badly distorted. A monitoring rectifier and conventional distortion-measuring instrument would register a high percentage of distortion for this wave, yet there are no extraneous side frequencies being radiated, the envelope distortion being entirely due to the inequality and phase dissymmetry of the two desired side-frequency voltages at this particular point in the line or coupling circuit. It is obvious that if, in addition, the operator were to raise the audio input level, endeavoring to bring about apparent full modulation at this point, much more severe distortion would be registered, because the wave at other points would then be over-modulated.

The impedance versus frequency relations indicated are those corresponding to a simple resonant circuit in which the ratio of reactive volt-amperes to watts at 550 kc, for example, is approximately fifty to one. The impedance curve of a simple resonant circuit appears

on a Smith chart<sup>2</sup> as a circle. Fig. 2 shows impedance circles *D*, *E*, and *F* for points along a transmission line

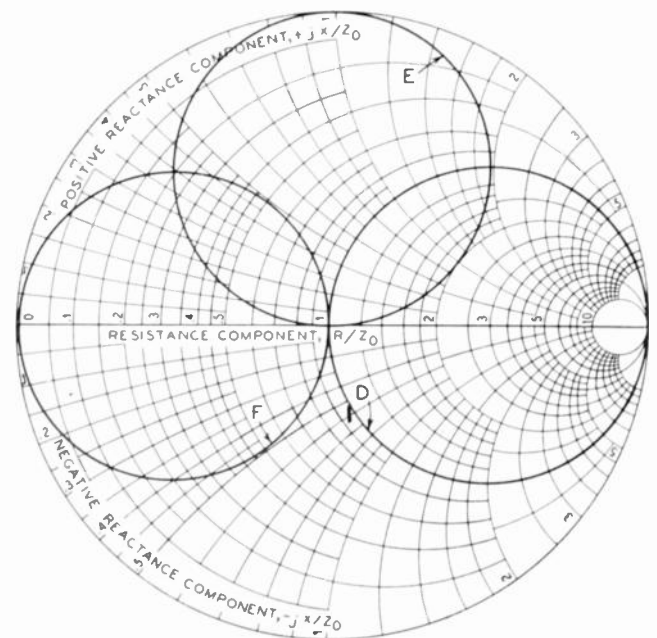

Fig. 2—Smith-chart impedance diagrams for a simple resonant circuit at points along a transmission line corresponding to *D*, *E*, and *F*, of Fig. 1.

or coupling circuit where the impedance versus frequency relations would correspond to *D*, *E*, and *F* of Fig. 1. The frequency dependence in the case shown is several times more severe than the RMA standard for artificial antennas for transmitter testing, but is comparable with that frequently found in actual broadcast installations.

#### Measurement of Effective Modulation and Distortion

If one wishes to determine actual delivered sideband power by measurement of a sample of the current envelope, it is necessary to make the inspection and measurement at a point in the circuit corresponding to Fig. 1(d), where the series resistance is independent of frequency over the band transmitted, since it is the current squared times the series resistance that determines power. We may refer to such points as *D* points for convenience. In order that the measurement may include true radiated distortion power, i.e., power in extraneous sidebands, the constancy should hold over a correspondingly wider band. Now, when measuring at such points, one should not try to adjust the audio input for 100 per cent modulation of the current envelope observed on the oscilloscope, but for a certain lower percentage—60 per cent, in the case considered in Fig. 1—since the voltage envelope (not being observed by the operator, but shown in Fig. 1(a)) will then have reached full modulation, and any further increase

<sup>2</sup> P. H. Smith, "An improved transmission line calculator," *Electronics*, vol. 17, pp. 130-134; January, 1944.

would necessarily entail severe distortion in both the voltage wave and the current wave.

If, on the other hand, it is the voltage envelope rather than the current envelope that is to be monitored, the point of measurement should be one where the *parallel* rather than the series resistance is constant over the transmitted band, since the power is the voltage squared divided by the parallel resistance. It can be shown<sup>3</sup> that this constancy will be found only at points corresponding to Fig. 1(f), one-quarter wavelength removed from *D* points. We may label these as *F* points. At these *F* points one must not look for a fully modulated wave, since the *current* wave (not being observed) will have reached full modulation, in the case considered, when the voltage wave, seen in Fig. 1(c), is only 60 per cent modulated.

Thus we have the curious situation that, with narrow-band antennas, and when modulating at high audio frequencies, only certain points *D* in the output circuit of the transmitter are suitable for determination of effective sideband power and distortion power when a sample of the current wave is being analyzed, and only certain other points *F* when a voltage sample is being analyzed; while the maximum permissible modulation of the wave being analyzed has to be set in the reverse manner, i.e., by inspection of the voltage envelope at points *D* or the current envelope at points *F*, or by calculation from the impedance versus frequency curve.

It should be noted that at *D* points, where the series resistance is independent of frequency, the parallel resistance is greater for the sidebands than for the carrier frequency, and a distortion measurement on the voltage envelope would be pessimistic since a given distortion power will be represented by a disproportionately high sideband voltage. Similarly, at *F* points, where the parallel resistance is independent of frequency but the series resistance is lower for the sidebands than for the carrier, a distortion measurement on the current envelope will be pessimistic. Thus the point where minimum distortion is registered is the correct monitoring point for the ideal case described, and will also, in general, afford the most reliable measure of distortion power in cases where the impedance diagram is irregular.

In order to permit the plotting of conventional curves of distortion versus modulation frequency for particular percentages of modulation, it is necessary to express the percentage modulation in terms of the quantity—current or voltage—which can be allowed to attain full modulation at the monitoring point, even though the true sideband power, with sharply tuned loads, does not correspond to full modulation. There is, moreover,

justification for this in the fact that, when the maximum permissible modulation (without overmodulation) is reached, the power amplifier tubes are being required to deliver either full peak current or full peak voltage to the load, even if not both.

While it is only in certain types of programs that a broadcast transmitter is subjected to heavy modulation at high audio frequencies, the application of a test tone and measurement of harmonic distortion at such frequencies is a part of regular testing routine carried out with standard station equipment, and, when correctly done, provides valuable information both in the initial tune-up of a transmitter and in maintenance. However, an equally important application of the monitoring technique just described is in connection with the over-all frequency characteristic of the transmitter from audio input to sideband power output. This will be discussed in Section II. With the recent establishment by the Federal Communications Commission of a requirement for submission of performance data prior to renewal of licenses, it is important to be able to verify delivery of appropriate energy to the array from the transmitter for all modulation frequencies.

## II. OPERATION OF THE POWER AMPLIFIER

With the impedance-versus-frequency characteristic varying widely from point to point in a coupling circuit, it is scarcely necessary to state that the characteristic as found at the particular point where the power-amplifier tubes are connected is of profound importance in the performance of the amplifier, regardless of the type of circuit or modulation method used. In particular, reverting to Fig. 1, if the impedance seen by the tubes were to vary with frequency in the manner given by Fig. 1(e), the tubes would *have* to impress on the circuit a voltage envelope resembling Fig. 1(b) in order that the voltage envelope at a proper voltage monitoring point (an *F* point) might be free of distortion. Indeed, since the impedance dissymmetry of Fig. 1(e) necessarily entails considerable phase modulation in the radio-frequency wave which does not show up in the oscillogram, it would be necessary for the tubes to introduce a corresponding phase modulation as well as to deliver a voltage envelope distorted in amplitude. Since one can ask only that a transmitter deliver to its load a voltage wave or a current wave free of phase modulation and having its envelope identical in shape to the audio input wave, it is apparent that, when the load is frequency-sensitive, only a point of impedance symmetry such as a *D* point or an *F* point is appropriate for making connection to the tubes. In the former case, when a high-frequency test tone is applied, the tubes will be asked to deliver full rated voltage and less than full rated current at the peak of the envelope; in the latter case, full rated current at less than full rated voltage. In either case, undistorted voltage and current envelopes are desired.

<sup>3</sup> The well-known impedance-inverting property of quarter-wave lines and their equivalent networks can be expressed in a form which shows, interestingly, that if one speaks of parallel components at one end and series components at the other end, the inversion holds for the resistances and also, *independently*, for the reactances; hence, the constant series resistance at *D* points necessarily means constant parallel resistance at points one-quarter wavelength therefrom, irrespective of reactance values.



Tests on several transmitters at powers from 1 to 10 kw, with very sharply tuned artificial antennas, have confirmed that when arrangements are made to connect the tubes to a *D* or *F* point the distortion at high modulation frequencies, when properly measured, differs very little from the distortion measured with a flat antenna, the slight increase observed being attributable to the effect of the sharp antenna on the width of the band over which negative feedback is effective. Fig. 3 shows the harmonic distortion in an experimental 10-kw broadcast transmitter at 95 per cent modulation with (1) a flat dummy antenna, and (2) a dummy

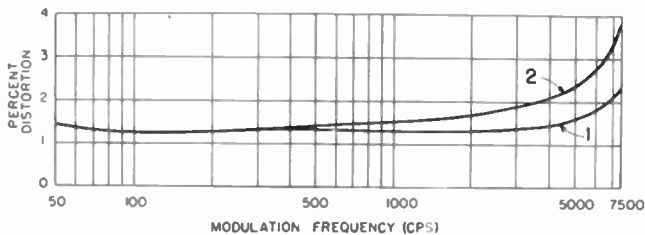

Fig. 3—Distortion curves for an experimental 10-kw transmitter at 95 per cent modulation with flat antenna (curve 1) and frequency-sensitive antenna (curve 2).

antenna having a ratio of kva to kw of 25 to 1 at 550 kc, giving an impedance-versus-frequency characteristic about half as severe as that of Fig. 1. The tubes were connected at an *F* point and the distortion and per cent modulation were determined in the manner described. In contrast, with the tubes connected at a point of impedance dissymmetry and the distortion and per cent modulation improperly monitored, apparent distortions as high as 20 and 30 per cent were recorded. Fig. 4 gives an example of the kind of envelope shape that was observed under such conditions. A distortion-measuring instrument registered 21 per cent for this wave.

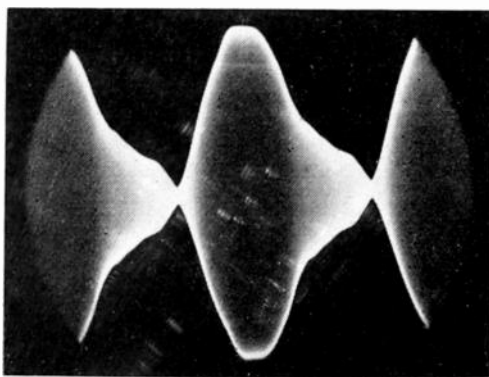

Fig. 4—Modulation envelope of a 10-kw transmitter for frequency-sensitive load as seen under improper operating and monitoring conditions.

The transmitter used for this test employed the high-efficiency circuit<sup>4</sup> devised by the author, with grid-bias modulation<sup>5</sup> of the final stage and employing "envelope" feedback, in which a sample of the radio-frequency out-

put is detected and fed back to the audio input circuits.

From a distortion standpoint, the *D* and *F* connections are found to be about equally satisfactory. For transmitters employing envelope feedback, the *F* connection offers an important advantage in that it provides automatic compensation for the sideband-clipping tendency of the antenna. This comes about from the fact that with envelope feedback it is desirable for reasons of bandwidth to "pick off" a radio-frequency voltage sample directly at the plate of the final power tube; and if this point is an *F* point, the sample will then represent the voltage across a parallel resistance that is the same for the sidebands as for the carrier, and consequently the feedback will act to maintain a flat frequency characteristic in the radiated sideband power. When the impedance-versus-frequency characteristic of an antenna differs from that of a simple tuned circuit (i.e., exhibits in the transmitted band a curvature differing from that of the circles in Fig. 2), the corrective action of the feedback is less complete but still substantial. To achieve equivalent compensation for a narrow-band antenna characteristic by the use of high-kva coupling meshes in the output circuits would be unduly expensive in apparatus and would involve critical tuning and considerable radio-frequency power loss.

The potency of feedback derived from the radio-frequency envelope in bringing about delivery of the desired sideband energy to the antenna system is shown in Fig. 5, which pertains to the same 10-kw transmitter and the same types of loads to which the distortion curves of Fig. 3 apply. Curve 1 of Fig. 5 gives the overall frequency characteristic of the transmitter at 50 per cent modulation with no feedback when operating into a broad-band resistance load. The departures from flatness at the low and high ends arise mainly in the audio circuits in the transmitter. Curve 2, still without feed-

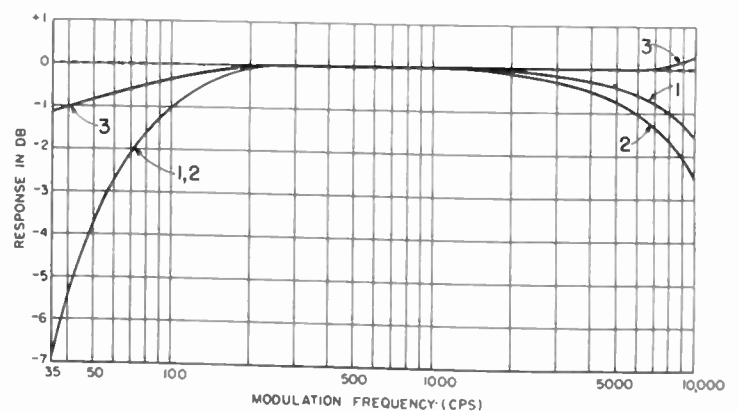

Fig. 5—Frequency characteristic curves for a 10-kw transmitter.

back, includes the additional loss at high modulation frequencies due to the frequency-sensitive load when the tubes are connected at an *F* point, the monitor being also connected at this point. But with envelope feedback applied, as derived from the voltage at this *F* point where the parallel resistance is constant over the band, the improved performance indicated by curve 3 is ob-

<sup>4</sup> U. S. Patent No. 2,210,028, W. H. Doherty.

<sup>5</sup> U. S. Patent No. 2,226,258, H. A. Reise and A. A. Skene.

tained. Fig. 6 shows, in contrast, corresponding curves for connection of the power amplifier tubes at a *D* point, where the parallel resistance is higher for the sidebands than for the carrier (but with the monitor still connected at an *F* point, since it is only here that a voltage-operated monitor will give a true indication of sideband power). The feedback in this case, being derived from

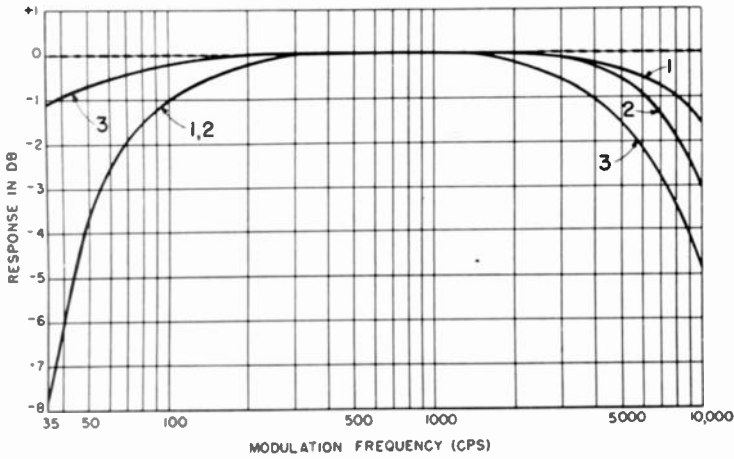

Fig. 6—Effect of unfavorable feedback connection on the frequency characteristic.

the voltage at the *D* point where the tubes are connected, actually aggravates the sideband-clipping action of the sharp antenna, as seen in curve 3 of Fig. 6. This is because, while the power tubes tend to impress higher than normal sideband voltages on the circuit on account of higher impedance to sideband frequencies, and thus partially compensate for the clipping action of the circuit, the feedback acts to prevent this compensation.

### III. TRANSMITTER OUTPUT-CIRCUIT DESIGN

To incorporate in broadcast transmitters the facilities for reorientation of the impedance-versus-frequency characteristic of any sharply tuned load that may be encountered, a variable phase shifter is required, equivalent to a "line stretcher," with a total range approaching 180 degrees to cover all cases. Such a phase shifter, as built for the experimental 10-kw transmitter on which these tests were conducted, is shown in Fig. 7(a). With the recent commercial availability of variable vacuum capacitors of wide capacitance range, linear calibration, and high voltage rating, it was most practical to incorporate this phasing device in the high-impedance output circuit of the transmitter prior to transforming down to the transmission line. The transformation ratio of the phase shifter shown is unity, and the coils  $L_1$  and  $L_2$  have reactances equal to the terminating resistance  $R$  regardless of the phase shift desired. For the minimum phase shift of 90 degrees, capacitor  $C_2$  likewise has a reactance of  $R$  ohms, and  $C_1$  and  $C_3$  have zero capacitance. For greater phase shifts, capacitor  $C_2$  is increased, and capacitors  $C_1$  and  $C_3$  come into play. By proper choice of these three capacitances, the phase shift can be increased to any value up to 270 degrees (or more) with

no change required in the inductances, the input impedance remaining a pure resistance of  $R$  ohms through-

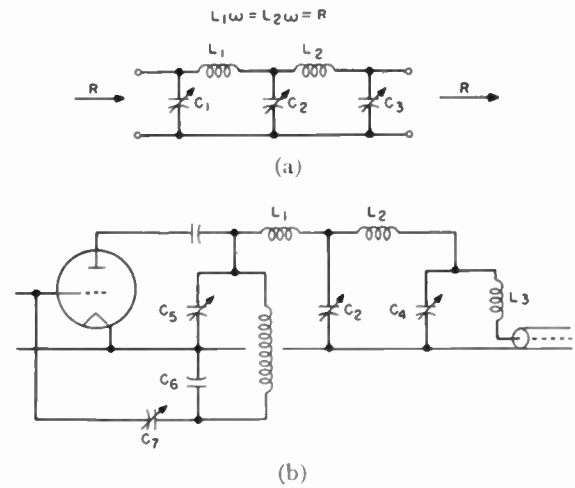

Fig. 7—Incorporation of a phase shifter in the transmitter output circuit.

out the range. The required admittances for these capacitances are:

$$C_1\omega = C_3\omega = \frac{1}{R} (1 - \cot \frac{1}{2} \Phi) \tag{1}$$

$$C_2\omega = \frac{2}{R} (1 - \frac{1}{2} \sin \Phi) \tag{2}$$

where  $\Phi$  is the phase shift desired. These relations are shown in Fig. 8.

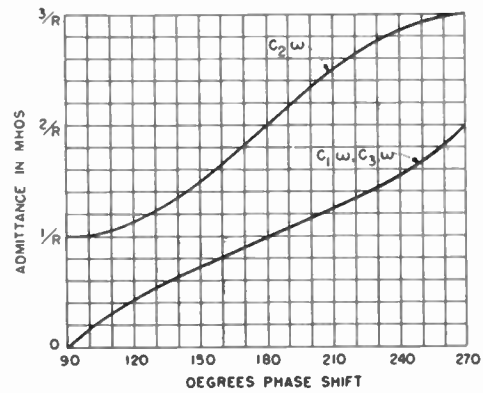

Fig. 8—Capacitive admittance required for the phase shifter of Fig. 7.

This phasing device is inserted, as shown in Fig. 7(b), between the radio-frequency plate terminal of the power amplifier and a load circuit consisting of  $C_4$  and  $L_3$ , normally tuned to resonance and matching the amplifier to the transmission line. The built-out neutralizing circuit shown contains a "tank" capacitor  $C_6$  with which the power tube is tuned in the conventional manner. With this arrangement, when a phase shift other than 90 degrees is required for improving performance with a frequency-sensitive antenna, the capacitances  $C_1$  and  $C_3$  of Fig. 7(a) are obtained by simply increasing the

values of  $C_4$  and  $C_5$ , which, like  $C_2$ , are variable vacuum capacitors.

In stations whose radiation patterns are different for day and night operation, the daytime pattern usually involves a simpler excitation of the antenna array, giving a flatter impedance characteristic. The phase-shifter adjustment chosen would, accordingly, be that best fitted to the nighttime impedance curve.

In the 10-kw transmitter built for testing these principles, the tube shown in Fig. 7(b) was the No. 2 or "peak" tube of a high-efficiency amplifier operating at a plate potential of 10,000 volts. The desired load impedance for the amplifier was 720 ohms. Coils  $L_1$  and  $L_2$  were accordingly made 720 ohms each and coil  $L_3$  was adjusted for 186 ohms to obtain, in combination with  $C_4$  a transformation from the 51.5-ohm coaxial-line impedance to 720 ohms. Capacitor  $C_2$  is made 720 ohms in all cases where the antenna presents no bandwidth problem. When a narrow-band antenna is encountered, the required phase shift for best operation is determined by plotting the impedance characteristic at the input terminals of the transmission line on a Smith chart with an added peripheral scale, as shown in Fig. 9. Recalling

obtain the total of 212 degrees required orientation. Fig. 8 then gives the values of  $C_2$  and for the increments to be made in  $C_4$  and  $C_5$  to constitute effectively the capacitances  $C_1$  and  $C_3$  of Fig. 7(a). The actual final adjustment of  $C_5$  is, of course, that which gives a unity power-factor load at the amplifier tube.

The radio-frequency plate terminal, being an  $F$  point, is used as the source of energy for the feedback rectifier and monitoring rectifier, due consideration being given to the fact that with a narrow-band antenna the voltage envelope observed when modulation is applied at high audio frequencies will not indicate 100 per cent modulation when the current delivered by the tubes is fully modulated.

With some antenna arrays the impedance may vary so irregularly with frequency as to call for a compromise adjustment which is difficult of prediction from the impedance diagram. In such cases, experimental determination of optimum phase shift is desirable by direct observation of the envelope shape at the plates of the tubes. The type of phase shifter described is especially well adapted to this procedure because of the wide range of adjustment possible without removal of power and the constancy of carrier-frequency impedance as the phase shift is varied.

Because of the extra harmonic suppression provided by the phase-shifting network, the usual harmonic filter connected at the input to the transmission line and employing mica capacitors (due to the low impedance) is no longer required. In cases where an unusually high degree of suppression is needed for one harmonic, a small fixed vacuum capacitor paralleling  $L_3$  will provide a substantial increase in suppression. The circuit described thus combines with its property of handling frequency-sensitive loads the features of high harmonic suppression and long-life components.

In most cases, a station with a new antenna and transmitter would operate initially with the phase shifter set for its minimum shift of 90 degrees. After the completion of all antenna adjustments and the establishment of the final radiation pattern, the transmission-line input impedance would be measured over a wide band, and the desirability of phase correction determined. By merely increasing the capacitances of three variable capacitors, any additional phase shift desired can then be introduced to permit optimum performance of the transmitter and provide a monitoring point where the most reliable measurements of this performance can be made.

#### ACKNOWLEDGMENT

The experimental transmitters used in the investigations reported were built by H. A. Reise and C. W. Norwood of Bell Telephone Laboratories, who were also responsible for all of the performance data obtained. The contributions of these engineers and their colleagues are gratefully acknowledged.

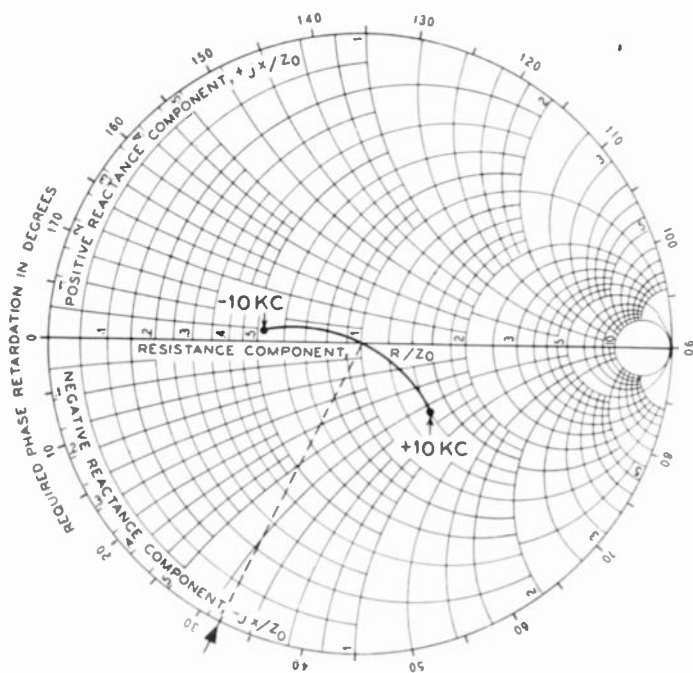

Fig. 9—Determination of the required phase shift in a typical case from the Smith chart.

that the desired orientation of the characteristic at the plate of the power-amplifier tube is that of circle  $F$  of Fig. 2, it is seen from Fig. 9 that the total phase retardation desired between the transmission line and the power tube for the case illustrated is either 32 degrees, or 180 plus 32 degrees. Since the phase retardation introduced by coil  $L_3$  is  $\tan^{-1} 186/51.5$  or 75 degrees, it is necessary to adjust the phase shifter to 137 degrees to



# A Power-Equalizing Network for Antennas\*

R. W. MASTERS†, ASSOCIATE, IRE

**Summary**—A bridge type of network, which causes equal power to be delivered to two load impedances whose product is a predetermined real constant, is discussed. The input impedance of the bridge is found to be practically independent of suitably paired load-impedance values over a considerable band of frequencies.

Immediate application to the design of television broadcast antennas is indicated, examples are given, and power loss is discussed.

## I. INTRODUCTION

IT IS AN accepted fact that almost all of the various pattern-shape and power-gain requirements for a television broadcast antenna can be met by antennas falling into one general classification. These antennas are comprised of two separate parts which are equal in their impedance-versus-frequency characteristics in a common band of frequencies. The parts are energized with equal power at a relative phase of  $90^\circ$  at midband, and are located so that no mutual coupling exists.

The phasing of the parts is accomplished by using transmission lines which differ in length from a common driving point by one-quarter wavelength. Unless the lines are perfectly matched by their loads, their input impedances differ, and unequal power is delivered to the loads. Objectionable field-pattern distortion may result, and, if the lines are long, the pattern shape may fluctuate with frequency variations because of the cyclic change of the line input impedances. Reverberations sufficient to cause secondary images at a television receiver occur if the values of the voltage reflection coefficients of the antenna halves exceed 0.05 inside the channel. Moreover, transmitters operate least favorably into varying loads. The difficulty of matching antennas to their lines within the 0.05 reflection tolerance over the television channel probably explains why so few satisfactory designs exist.

This paper discusses a bridge network which greatly simplifies the design problem in regard to power division and impedance match for this large class of important antennas, as well as for a more general impedance group.

## II. THE POWER EQUALIZER

A dissipationless coaxial-transmission-line version of the power-equalizing bridge is shown schematically in Fig. 1(a).  $K_1$  and  $K_2$  designate characteristic impedances of transmission lines,  $Z_L$  are equal loads of arbitrary complex value including zero and infinity,  $R$  is a pure resistor, and  $x$  indicates a line length. A generator

of voltage  $V_3$  is connected between points 0 and 3. All voltages are understood to be rms.

Let  $\lambda_0$  represent the wavelength at the midfrequency of the band throughout which it is desired to equalize the power dissipation in the loads and eliminate reverberations. Let the lines  $K_2$  feeding the loads differ in length by  $\lambda_0/4$ , and, temporarily, set

$$K_1 = K_2 = K = 2R. \tag{1}$$

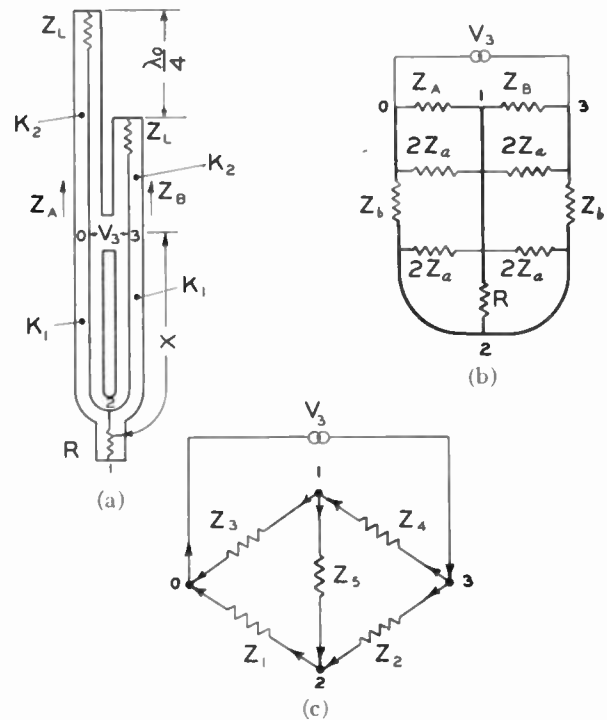

Fig. 1—Transformation from distributed- to lumped-constant bridge.

Except when  $Z_L = K$ , the loads will cause unequal impedances  $Z_A$  and  $Z_B$  to be presented in series across the generator. At  $\lambda_0$ , due to the odd quarter-wavelength line difference, these impedances obey the relationship,

$$Z_A Z_B = K^2, \tag{2}$$

which is fundamental in what is to follow. This relationship changes but slowly with frequency, so that (2) is approximately true for a considerable band of frequencies.  $Z_A$  and  $Z_B$  are the network loading, while the rest of the network, with the exception of  $R$ , is the bridge. A consideration of traveling waves in Fig. 1(a) leads intuitively to the following conclusions:

- (a) All power dissipated in the loads at  $\lambda_0$  is equally divided between them.
- (b) The impedance presented to the generator at  $\lambda_0$  is invariant with respect to variations in  $Z_L$ , and resistive if  $x = \lambda_0/4$ .

\* Decimal classification: R221X R117.121. Original manuscript received by the Institute, August 26, 1948; revised manuscript received, February 23, 1949.

† RCA Victor Division, Radio Corporation of America, Camden, N. J.

- (c) The generator and resistor may be interchanged if  $R = 2K$  and  $x = \lambda_0/4$ , without altering the salient network properties.
- (d) Reflections at the loads are removed from the system by absorption in  $R$ .
- (e) Small cumulative reflections due to imperfect junctions, elbows, and impedance matches throughout the lines  $K_2$  are largely removed if the imperfections are equal and are located the same distance from the load in both lines.
- (f) At  $\lambda_0$ , the ratio of power lost in  $R$  to the total input power is precisely the square of the absolute value of the voltage reflection coefficient  $q$  of the loads on  $K_2$ .
- (g) The system is relatively wide-band with respect to frequency.
- (h) If the loads are equal antenna halves, then the field pattern is remarkably stabilized with respect to frequency.
- (i) The system permits considerable deviation from design perfection.

Waves initiated by  $V_1$  at 0-3 of length  $\lambda_0$  traveling toward  $Z_L$  are partially reflected at  $Z_L$  by a complex factor  $q_0$  times the incident voltage. Due to the quarter-wave difference in the two line lengths, the reflected waves return to the generator out of phase. They therefore ignore its presence, and instead continue along the lines  $K_1$  to be absorbed in  $R$ , which matches the impedance of the parallel combination of lines  $K_1$ . These reflected waves are absorbed before they can react on the generator or reverberate. The impedance load presented to the generator is, therefore,  $2K$  (the series sum of the characteristic impedances of lines  $K_2$ ) in parallel with the reactances of the lines  $K_1$ , and the real power delivered to the two lines is equally divided. The power wasted is evidently  $|q|^2$  times the input power, where  $q$  is the complex voltage reflection coefficient of  $Z_L$  on the lines  $K_2$ . It is important to note that  $R$  cannot absorb energy from initial waves traveling toward it from 0-3, since these waves arrive in the wrong phase at its terminals.

When the positions of the generator and resistor are interchanged, the reasoning proceeds along the same lines with about the same result. The only difference is that the generator load becomes  $K/2$ ,  $x$  must be one quarter-wavelength long for perfect absorption of the reflected wave, and  $R$  must have a value equal to  $2K$ .

The network can likewise remove the small over-all reflections caused by imperfect transmission-line elements, such as elbows and transforming sections, as long as like elements are located at the same distance from the load in each line and the long line contains one perfect quarter-wavelength of line at the network terminals. This is obvious, since the imperfections combine with the loads to form new, equal loads.

Many antennas and loads are required to operate over a specified frequency range. In this case, the lines

$K_2$  differ in electrical length by  $\pi/2 + \Delta$  radians, where

$$\Delta = \frac{\pi}{2} (\lambda_0/\lambda - 1) \quad (3)$$

Reflected waves returning to 0-3 from  $Z_L$  have a relative phase of  $\pi + 2\Delta$ , and present a net voltage, between terminals 0-3, of

$$q'V_1 = (q \sin \Delta)V_1 \quad (4)$$

which assumes the role of a different sized reflection as far as the generator is concerned. Only this component of the reflection can reverberate, since the rest of the wave is absorbed in  $R$ . It is the pseudo reflection coefficient  $q_0'$  which must be held to the 0.05 value required in television broadcast antennas. Since  $\sin \Delta$  is less than 0.08 for any television channel, reverberation effects are almost completely eliminated, and the network loading seems practically constant to the generator, even for the absurd load values of zero or infinity.

The shunting effect of the lines  $K_1$  will, of course, change with frequency, but their effect can be minimized. Assume that a two-wire balanced transmission line of impedance  $2K$  supplies the terminals 0-3. A short-circuited length  $x$  of this line is then connected in parallel with the line  $2K$  at a distance  $y$  from 0-3. By properly adjusting lengths  $x$  and  $y$ , both nearly equal to  $\lambda_0/4$ , the reflections on line  $2K$  due to the shunt elements  $2K$  and  $2K_1$  (these elements are equal) may be made zero at any two frequencies in the band, especially picture and sound carriers in a television channel. If the input to the two-wire line be considered as the new driving point, it will be seen that the bridge is broad-banded. It is also broad banded when the positions of the generator and the resistor  $R$  are interchanged, with  $R$  equal to  $2K$ .

Because of some imperfection in manufacture, it may be that  $R$  is not a perfect match to the system, but has a reflection coefficient  $q'' \neq 0$  on the lines  $K_1$ . The pseudo reflection coefficient presented to the transmitter at  $\lambda_0$  becomes

$$q_0' = q + q_0'' \quad (5)$$

which is harmlessly small if  $q$  and  $q_0''$  are both less than 0.50, for example. The power being radiated at  $\lambda_0$  in the first reverberation by an antenna, namely,

$$P_1' = |q + q_0''|^2 (1 - |q_0''|^2) P_i \quad (6)$$

is likewise negligible under the same circumstances.  $R$  does not need to match the system very well in order to effect a great improvement in reverberation damping and power equalization.

Sometimes the loads  $Z_L$  are not equal, as is usually the case when one tries to make two antennas exactly alike. Small mechanical differences cause the impedances to differ. The pseudo reflection at the driving points can be minimized by using a small capacitor or inductor to alter the phase of the reflection coefficient

of one load to match that of the other. At  $\lambda_0$ , the pseudo reflection is then equal to the difference between the absolute magnitudes of the reflections from the two unequal loads, and the rest of the reflected energy is absorbed in  $R$ .

Equation (2) is sufficient to insure that the loads receive equal power, but not necessarily all the power, when they are connected to the bridge network. Accidental external coupling between  $Z_A$  and  $Z_B$  will upset this impedance relationship, so that the conclusions regarding the behavior of the network will no longer be strictly true. Nevertheless, considerable improvement may be obtained if such coupling is small, as may happen between poorly isolated antenna halves.

The configuration of Fig. 1(a) is representative of a group of several transmission networks able to perform the same general functions. All of them can be reduced to lumped-constant equivalent bridges through transformations similar to those of Fig. 1. Fig. 1(b) shows 1(a) after replacing the transmission lines  $K_1$  by their equivalent  $\pi$  sections according to the well-known relations:

$$2Z_a = K_1 \coth \frac{\Gamma x}{2} = -jK_1 \frac{(1 + \cos \beta x)}{\sin \beta x} \quad (7)$$

$$Z_b = K_1 \sinh \Gamma x = jK_1 \sin \beta x \quad (8)$$

where  $\Gamma = \alpha + j\beta$  is the complex propagation constant of the lines. The attenuation constant  $\alpha$  has been assumed zero, leaving only the phase constant,  $\beta$  radians per meter. Fig. 1(c) shows the lumped bridge analogue after combining the elements of Fig. 1(b) in an obvious manner.

A more satisfactory proof of the performance of the bridge involves Fig. 1(c), in which the arrows indicate assumed directions of the currents. The network is solved for the voltages at the junctions relative to 0 in terms of  $V_3$  by applying Kirchhoff's law concerning the sum of the currents at a junction. Knowing these voltages and letting an asterisk signify the complex conjugate of a quantity, the expressions are written for the complex power  $\psi_n$  delivered to each branch of the network; e.g.,

$$\psi_5 = \frac{(V_1 - V_2)(V_1 - V_2)^*}{Z_5^*} \quad (9)$$

Assume that equations (1) and (2) are satisfied at all frequencies. The total complex power supplied to the network by  $V_3$  is then found to be

$$\psi_t = \sum_{n=1}^5 \psi_n = (1 + j \cot \beta x) |V_3|^2 / 2K = \frac{V_3 V_3^*}{Z_{in}^*} \quad (10)$$

the real part of which represents the power  $P_t$  delivered to the network. The input impedance  $Z_{in}$  of the network at the generator terminals is evidently

$$Z_{in} = 2K / (1 - j \cot \beta x). \quad (11)$$

If  $x = \lambda_0/4$ , the input impedance is  $2K$ . If the broad-banding stub is used as outlined above, the network presents an almost constant impedance to the generator over a wide range of frequencies.

The square of the absolute value of the reflection coefficient  $q_v$  is the power-loss factor, as is readily seen by taking the ratio of the real part of  $\psi_5$  to that of  $\psi_t$ ; thus,

$$\frac{Re \psi_5}{Re \psi_t} = \left| \frac{Z_B - K_2}{Z_B + K_2} \right|^2 = |q_v|^2.$$

The real parts of  $\psi_3$  and  $\psi_4$  are equal, showing that the dissipation in  $Z_A$  and  $Z_B$  is equally divided.

The reversible nature of the network is demonstrated by interchanging  $R$  and the generator and letting  $K_1 = K_2 = K = R/2$ . Using the same procedure, it turns out again that, if the broad-banding stub is used, the input impedance is practically constant, dissipation in the loads is equal and the power-loss factor is  $|q_v|^2$ .

$K_1$  need not equal  $K_2$ , but in order to match impedances it then becomes necessary to have  $x = \lambda_0/4$  and  $K_1 = \sqrt{2RK_2}$ . The bridge works just as well at  $\lambda_0$ , but is not quite so broad-band as when  $K_1 = K_2$ , owing to the transforming action of the lines  $K_1$ . The bandwidth can be improved as before by using a broad-banding stub of impedance  $2K_1$  on the line  $2K_2$  supplying 0-3. The system is about equally broad-band in either of its reversible directions.

### III. EXAMPLES OF USE OF THE POWER EQUALIZER

In connection with a certain antenna design, it was necessary to investigate the nature of the field patterns obtained from an array of equally energized radiators mounted on the four sides of a square tower. The opposite radiators were connected together in such a way that the currents in them were in time phase, but opposing each other in a peripheral sense around the tower. Two equal, uncoupled sets were thus formed, and, since it was desired to phase them in quadrature, the power equalizer was applicable.

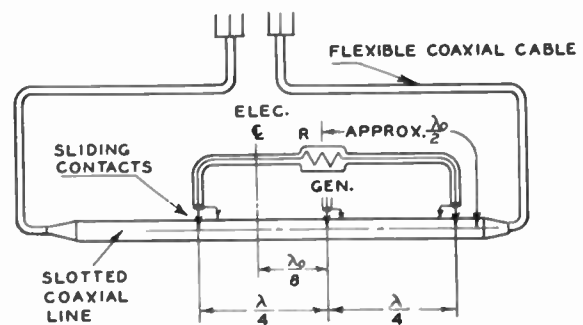

Fig. 2—A laboratory version of the power equalizer.

Ordinarily, in order to obtain good patterns from such an antenna over a wide range of frequencies and variations of tower size and spacing parameters, etc., a prohibitive amount of work would have had to be done



for each different variation to match impedances all the way to the generator on each line. With an adjustable laboratory version of the power equalizer, similar to that shown in Fig. 2, the work was made easy, and almost perfectly equalized patterns were always obtained. Fig. 3 compares two patterns taken on the same

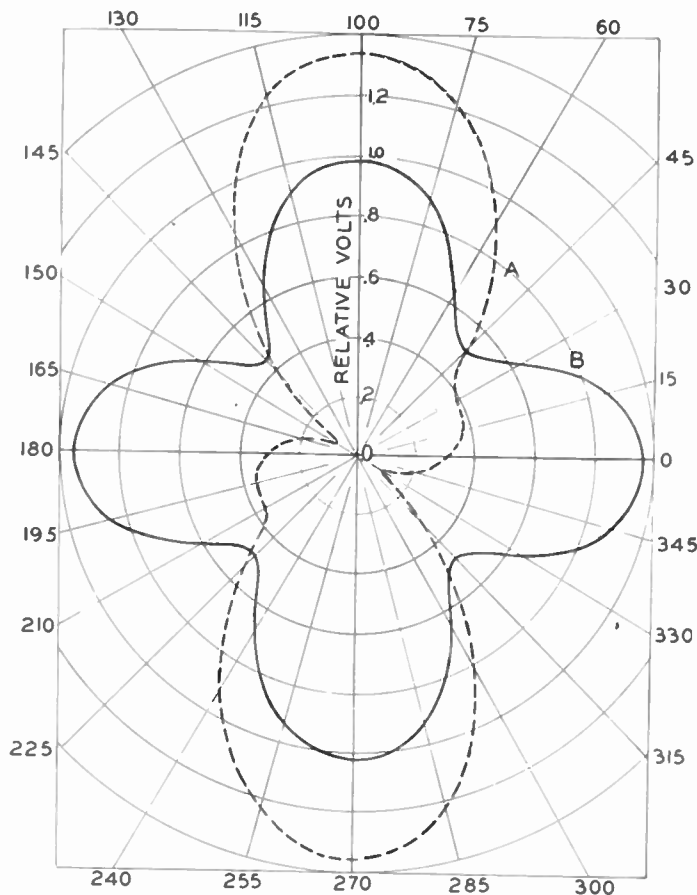

Fig. 3—Comparison of measured field patterns. Curve B with, and curve A without, the power equalizer connected.

antenna at the same frequency with and without the branch loop containing  $R$  in Fig. 2. Curve B illustrates

how well the power equalizer equalized the radiation from the four tower faces. Much of the remaining asymmetry can be attributed to small differences between the opposite radiators and to variations in the cables.

The application of the power-equalizer principle to television antennas is not difficult. A bridge circuit<sup>1</sup> almost identical with Fig. 1(a) is already commonly used to diplex the picture and sound transmitters into an antenna which satisfies all requirements for the power equalizer. The picture transmitter drives terminals 0-3, while the sound transmitter drives terminals 1-2.

The necessary addition is a separation filter in the sound side which will divert the reflected energy of the picture transmitter, at and near its carrier into the resistor  $R$  without serious reflection. The filter must also prevent sound-power dissipation in the resistor. Such filters are well known.<sup>2,3</sup> The secret of satisfactory operation in this case is to match the antenna halves at the narrow sound-channel frequency, and then use the power equalizer to achieve broadband match for the picture frequencies. Another method is to use a separation filter to insert the sound energy into the picture side of the bridge. Both signals are then equalized, and only one line up the tower need be used if the bridge is located at the top. The cost of good transmission line is high.

#### IV. CONCLUSIONS

Since certain poorly matched antennas may be made to give excellent service at a negligible cost in lost power, it is felt that the power-equalizing bridge will definitely influence antenna designs. It is a powerful tool, applicable in any circumstance where the loading satisfies (2).

<sup>1</sup> L. J. Wolf, "Triplex antenna for television and F-M," *Electronics*, vol. 20, p. 88; July, 1947.

<sup>2</sup> See p. 91 of footnote reference 1.

<sup>3</sup> N. E. Lindenblad, "Antennas and transmission lines at the Empire State television station," *Communications*, vol. 20, pp. 13-18; May, 1949. Also vol. 21, pp. 10-26, April, 1941, and vol. 21, pp. 9-33, May, 1941; esp. May, 1941, p. 9.

## Transmission-Line Characteristics of the Sectoral Horn\*

HERBERT S. BENNETT†, SENIOR MEMBER, IRE

**Summary**—The sectoral horn is analyzed from the engineering viewpoint in such a manner as to make it feasible to consider it as one component of an over-all microwave transmission system. Equivalent network functions are derived and graphed which are based on the consideration of the sectoral horn as a nonuniform transmission line. The resulting curves should be useful to those

designing systems containing sectoral-horn components. The physical significance of the derived normalized functions is discussed, and the applicability of network philosophy is pointed out.

#### I. INTRODUCTION

THE COMPLETE solution of Maxwell's equations for a given electromagnetic field problem is intimately connected with the geometry of the system. After setting up the differential equations of the

\* Decimal classification: R117.1. Original manuscript received by the Institute, September 16, 1948; revised manuscript received, January 20, 1949.

† Watson Laboratories, Red Bank, N. J.

field in the appropriate co-ordinate system, the classical approach has been to treat each problem as a peculiar and individual entity. The solution of the equations, with appropriate boundary conditions, for the region under consideration has been the end objective. Under this approach, no co-ordinated attempt is made to apply the results to the solution of problems with similar geometries.

On the other hand, by borrowing a leaf from the procedures developed by the circuit designers who deal with the analysis of such iterative structures as filter networks and transmission lines, it can be seen that their techniques may be used with profit in the microwave regions where only the classical boundary-value "cavity" method of solving the Maxwell field equations had originally been used.

In this paper we will analyze the sectoral geometry, with the field vector orientation shown in Fig. 1, as one component of a microwave transmission system. This geometry is characterized by a uniformly increasing cross section in the plane perpendicular to the axis of symmetry. Thus we may expect the nonuniform trans-

mission-line theory developed by Marcuvitz.<sup>1</sup>

II. GLOSSARY

$a$  = height of horn as defined in Fig. 1

$ctr(x, y)$  = sectoral-horn transmission functions (see (6))

$Ctr(x, y) = \frac{1}{Tnr(x, y)}$  sectoral-horn transmission functions (see (7))

$E$  = electric field vector

$H$  = magnetic field vector

$II_n^{(2)}(x)$  = Hankel function =  $J_n(x) - jN_n(x)$

$II_n^{(2)'}(x) = \frac{d}{dx} (II_n^{(2)}(x))$

$J_n(x)$  = Bessel function of first kind of order  $n$  and argument  $x$

$J_n'(x) = \frac{d}{dx} (J_n(x))$

$Kr(x, y)$  = sectoral-horn transmission functions (see (8))

$k = \frac{2\pi}{\lambda}$

$m = 1, 2, 3, 4, \dots$  = the order of the mode for the field in the  $\phi$  direction

$N_n(x)$  = Neumann function (or Bessel function of the second kind) of order  $n$  and argument  $x$

$N_n'(x) = \frac{d}{dx} (N_n(x))$

$n = \frac{m\pi}{\theta}$

$n' = \sqrt{\frac{\epsilon}{\mu}}$

$r$  = cylindrical co-ordinate as defined in Figs. 1 and 3

$x = kR_1$  = input radius in wavelengths (see Fig. 3)

$y = kR_2$  = output radius in wavelengths (see Fig. 3)

$Y_{(x)}$  = admittance at a given cross section,  $x$ , i.e., the ratio of equivalent current to equivalent voltage at that cross section

$Y_{(x)}'$  = normalized input admittance

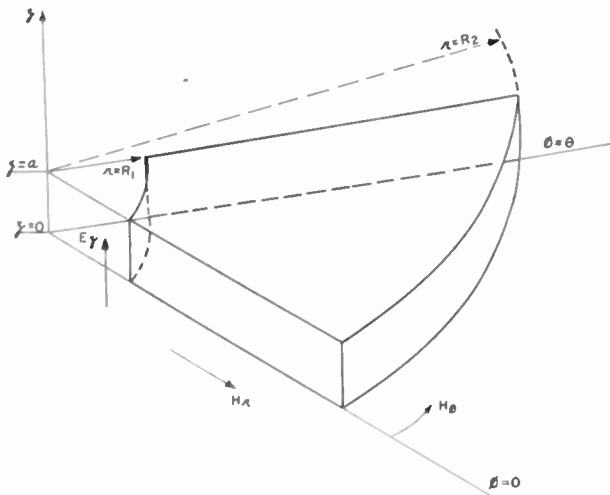

Fig. 1—Sectoral horn geometry in cylindrical co-ordinates ( $E$  type field shown).

mission-line formulation (or the "sectoral radial" transmission line, as we shall call it) to be applicable. In securing the solution, we shall attempt to mimic the uniform transmission-line representation. This will aid in the understanding of the physical significance of the various functions, and will require merely an extension of the concepts of the uniform transmission line which are more commonly used and understood.

The sectoral geometry being considered has wide application in the microwave field. Some of its applications are: (1) coupling section between two rectangular guides, (2) resonator, and (3) radiating horn antenna.

It should be noted that this paper applies the impedance and network concepts of Schelkunoff, Marcuvitz, and others. The sectoral-horn analysis contained herein

<sup>1</sup> C. G. Montgomery, "Principles of Microwave Circuits," vol. 8, Chapter 8, McGraw-Hill Book Company, Inc., New York, N. Y., 1948.

$$= \frac{Y_{(x)}}{Y_0'} \text{ (see (4))} = -\frac{H_\phi(x)}{n'E_z(x)}$$

$Y_{(y)'} =$  normalized output admittance

$$= \frac{Y_{(y)}}{Y_0'}$$

$Y_0' = \frac{n'r\theta}{a} =$  normalizing admittance factor (In the uniform case this reduces to the characteristic admittance)

$z =$  cylindrical co-ordinate as defined in Figs. 1 and 3

$\lambda =$  free-space wavelength

$\phi =$  cylindrical co-ordinate as defined in Figs. 1 and 3

$\theta =$  flare angle as defined in Figs. 1 and 3.

### III. RELATIVE INPUT ADMITTANCE FUNCTIONS AND THEIR PHYSICAL SIGNIFICANCE

By solving the electromagnetic boundary value problem of Fig. 1 in cylindrical co-ordinates, assuming perfectly conducting walls with a perfect dielectric in between and  $E$  type field, (1), (2), and (3) may be secured:

$$E_z = [AJ_n(kr) + BN_n(kr)] \sin n\phi \quad (1)$$

$$H_r = \left[ \frac{-n}{j\omega\mu r} AJ_n(kr) + BN_n(kr) \right] \cos n\phi \quad (2)$$

$$H_\phi = jn' [AJ_n'(kr) + BN_n'(kr)] \sin n\phi. \quad (3)$$

$A$  and  $B$  are constants which are evaluated<sup>2</sup> from the boundary conditions. By proper manipulation of the equations one can achieve a relative or normalized in-

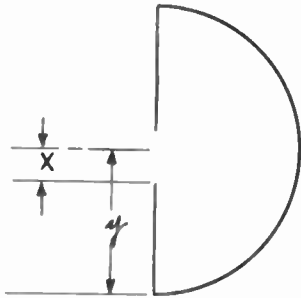

Fig. 2—Resonant cavity representation.

put admittance  $Y_{(x)'}$  similar to the one developed by Marcuvitz for the radial-line case, except that the component functions (6)–(8) are more complicated.

$$Y_{(x)'} = \frac{\text{input admittance at } x}{Y_0'} = \frac{j + Y_{(y)'} \text{ctr}(x, y) K_r(x, y)}{\text{Ctr}(x, y) + jY_{(y)'} K_r(x, y)} \quad (4)$$

<sup>2</sup> H. S. Bennett, "The electromagnetic transmission line characteristics of the sectoral horn geometry," thesis, Polytechnic Institute of Brooklyn, Brooklyn, N. Y., pp. 6–19; June, 1947.

This is analogous to the relative input admittance for the uniform transmission line.

$$Y_{(x)'}^{\text{uniform}} = \frac{j + Y_{(y)'} \cot(y - x)}{\cot(y - x) + jY_{(y)'}} \quad (5)$$

The various symbols used throughout are explained in Figs. 1 and 3 and in the glossary of symbols in Section

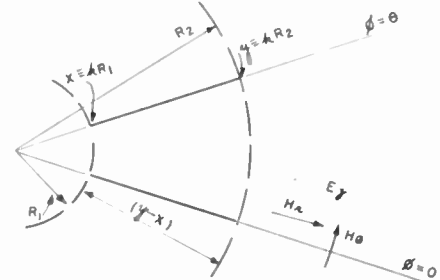

Fig. 3—Plan view of sectoral horn geometry (for reference with succeeding figures).

II. The component functions in (4) are new and defined as follows:

$$\text{ctr}(x, y) \equiv \frac{N_n'(x)J_n(y) - J_n'(x)N_n(y)}{J_n(x)N_n(y) - N_n(x)J_n(y)} \quad (6)$$

$$\text{Ctr}(x, y) \equiv \frac{1}{\text{Tnr}(x, y)} = \frac{J_n(x)N_n'(y) - N_n(x)J_n'(y)}{J_n'(x)N_n'(y) - N_n'(x)J_n'(y)} \quad (7)$$

$$K_r(x, y) \equiv \frac{J_n(x)N_n(y) - N_n(x)J_n(y)}{J_n'(x)N_n'(y) - N_n'(x)J_n'(y)} \quad (8)$$

If  $y/x$  approaches 1 and  $(y-x)$  remains finite it means, in effect, that we are considering a portion of the horn so far out that the flaring sides represented by  $(y-x)$  appear to be parallel and in the limit when  $y/x = 1$  they are parallel. Thus, in this limit, the relative input admittance functions for the sectoral case reduce to those applicable to uniform transmission lines. By employing the asymptotic expressions for Bessel and Neumann functions of large argument it can be shown that for  $x, y \gg n$ , (4) passes into (5). If we tabulate and plot these component functions of (4) as extensively as the ordinary trigonometric functions have been tabulated, we should find (4) just as useful for sectoral radial-line calculations as (5) is in the uniform-line case; and, furthermore, if  $x$  and  $y$  are sufficiently large, the uniform line formulas offer an excellent approximation. Component functions other than (6)–(8) could be evolved<sup>3</sup> for the horn; but, as indicated below, our functions have very definite physical significance.

Consider the output end shorted, i.e.,  $Y_{(y)'} = \infty$ . From (4) we get

$$Y_{(x)'} = -j \text{ctr}(x, y). \quad (9)$$

<sup>3</sup> See pp. 21–22 of footnote reference 2.



In the limit of the uniform line where  $y/x = 1$ , this becomes

$$\Gamma_{(x)}' = -j \cot(y - x). \quad (10)$$

For the output properly terminated to give  $\Gamma_{(y)}' = 0$ ,

$$\Gamma_{(x)}' = j \operatorname{Tnr}(x, y), \quad (11)$$

and for the uniform line this becomes

$$\Gamma_{(x)}' = j \tan(y - x). \quad (12)$$

The familiar formulas showing the fact that quarter-wave shorted uniform lines and half-wave open uniform lines both have zero admittance, etc., can be deduced from the preceding statements; and we see that for values of  $y/x$  not too far removed from unity the sectoral radial line approaches this uniform line behavior. Graphs of the type shown in this paper will indicate for which values of  $y/x$  (in any given range of  $(y-x)$ ) such engineering approximations are valid.

It can be shown<sup>4</sup> that when the sectoral geometry is used to connect two rectangular waveguides  $1 < y/x < 2$ . It can also be shown<sup>4</sup> that our graphs can be used for higher order modes by suitably adjusting the flare angle.

$$n = m \frac{\pi}{\theta} = 1 \times \frac{180^\circ}{30^\circ} = 2 \times \frac{180^\circ}{60^\circ}. \quad (13)$$

The data on the ctr function can be used in connection with the design of the sectoral geometry as a non-dissipative resonant cavity. In order to have a true cavity we must, in addition, have the "x" end shorted and  $y'_{(y)} = x$ . If we can neglect the lumped circuit introduced by the discontinuity at the input, the resonant frequencies would be determined by the poles of the ctr curves. (Remember that  $(y-x)$  is a function of frequency.) The quasicyclic nature (approximating the interval  $\pi$ ) of the ctr function indicates that there will be a series of resonant frequencies. It should be emphasized that the cycles are only similar, not identical, and therefore the resonant frequencies for a given mode order (e.g.,  $m=1$ ) are not just simple multiples of each other.

The case where  $n=1$ ,  $\theta=180^\circ$  is of interest only as a resonant cavity (see Fig. 2) since the only type of termination that is practical is  $\Gamma_{(y)}' = x$ .

The data in Section IV may be used for calculating impedance characteristic of a radiating horn. If the horn is considered as feeding into the impedance of free space  $= \sqrt{\mu_0/\epsilon_0}$ , we can determine the input admittance from (4) and the definition of the normalizing factor, provided the horn is long enough, in which case it can be shown<sup>5</sup> that (4) reduces to:

$$\Gamma_{(x)}' = \frac{H_n^{(2)'}(x)}{H_n^{(2)}(x)}. \quad (14)$$

If the horn is not long enough to justify the use of (14) instead of (4), but the susceptance of the lumped circuit equivalent of the discontinuity at  $y$  is small compared with  $\sqrt{\epsilon_0/\mu_0}$ , then we get  $\Gamma_{(y)}' = a/r\theta$ ; otherwise  $\Gamma_{(y)}'$  must include the effect of the discontinuity.

It may happen that in any given design problem  $y/x$  and/or  $(y-x)$  will fall outside the range of the curves in Section IV. This can be handled by breaking up the given sectoral geometry into two or more (usually two will be sufficient) sectoral radial lines in tandem. The output impedance of the first one is merely the input impedance of the second, and so forth. In this case there are no discontinuities at our assumed junction points. However, in most other practical cases a knowledge of the circuit elements equivalent to the discontinuities is necessary for the design of an over-all microwave transmission system.

#### IV. DISCUSSION OF FUNCTION GRAPHS

In this section are shown graphs of the functions (Figs. 4 through 12) for three values of flare angle;  $180^\circ$  (which is the limiting case of interest in the direction of large flare angle),  $27.7^\circ$ , and  $51.4^\circ$  are shown. These odd flare angles were made necessary because only multiples of half-order Bessel and Neumann function tables<sup>6,7</sup> were available. However, in the usual region of interest, which is between  $\theta=20^\circ$  and  $\theta=65^\circ$ , the plotting of curves for multiples of half-order Bessel and Neumann functions should allow interpolations with engineering accuracy for  $\theta$  values. For example, if  $n=13/2$ , and  $m=1$ , then  $\theta=27.7^\circ$ ; while for  $n=11/2$ ,  $m=1$ ;  $\theta=32.7^\circ$ . At the higher end however, the interval is large.  $n=7/2$  gives  $\theta=51.4^\circ$ , while  $n=5/2$  gives  $\theta=71.9^\circ$ . The  $n=3$  values ( $\theta=60^\circ$ ) would be very useful in this area.

The curves shown in this section were not intended as working curves. They were intended to illustrate the limiting ranges of usefulness. Thus, in some areas of the function graphs, the curves have relatively large slopes. These areas are not very useful for design purposes, since small changes in frequency or physical dimensions will cause very large changes in characteristics. Of course there are some design problems where such critical (resonant effect) response is desired. However, it is not advised that the very steep portions of the curves be used because the accuracy is not very good in these ranges. To aid somewhat in the use of these steep portions, the asymptotes to the curves are drawn as dash-dot vertical lines. (See Figs. 4 and 6.)

Two cycles were plotted for each curve to illustrate the repetitive nature of the functions. In general as we proceed out along the  $(y-x)$  axis, the succeeding cycles become more "well behaved" over larger ranges of  $y/x$  and also, the curves, for adjacent values of  $y/x$ , form

<sup>6</sup> E. Jahnke and F. Emde, "Tables of functions," Dover Publications, New York, N. Y., 1945.

<sup>7</sup> Math. Tables Project, National Bureau of Standards, "Tables of Spherical Bessel Functions, Vol. I," Columbia University Press, New York, N. Y., 1947.

<sup>4</sup> See pp. 23-24 of footnote reference 2.

<sup>5</sup> See pp. 15-16 of footnote reference 2.

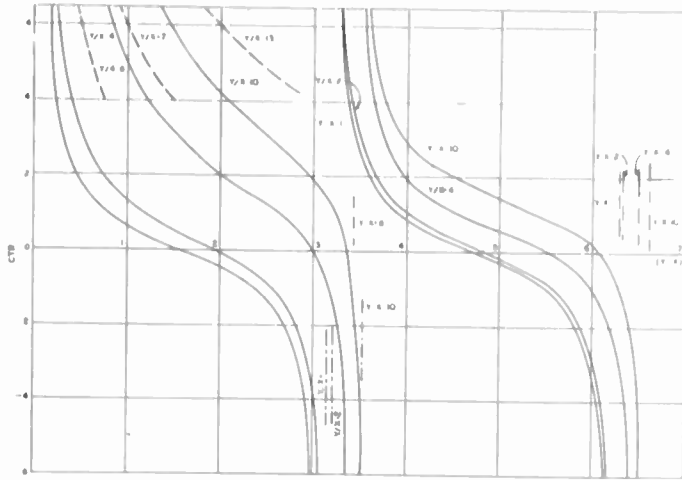

Fig. 4— $-cr$  function  
 $n = 1$  (dominant mode  $\theta = 180^\circ$ )  
 $E$  type impressed field.

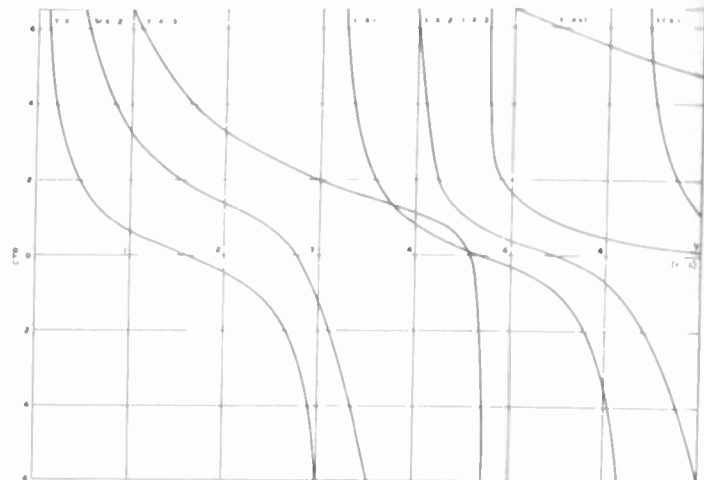

Fig. 7— $cr$  function  
 $n = 7/2$  (dominant mode  $\theta = 51.4^\circ$ )  
 $E$  type impressed field.

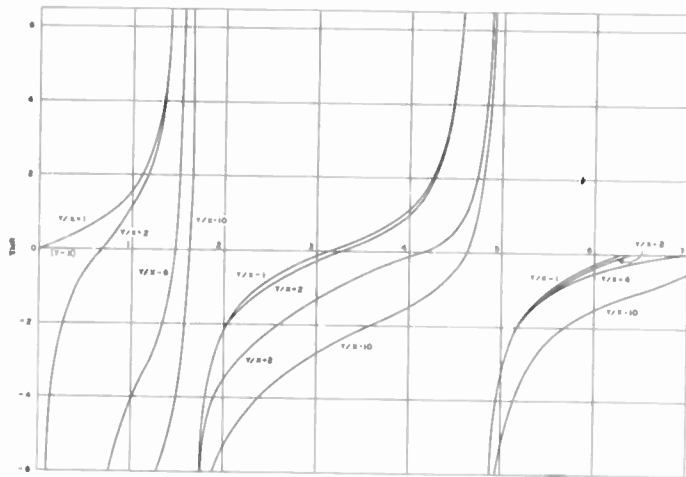

Fig. 5— $-Tnr$  function  
 $n = 1$  (dominant mode  $\theta = 180^\circ$ )  
 $E$  type impressed field.

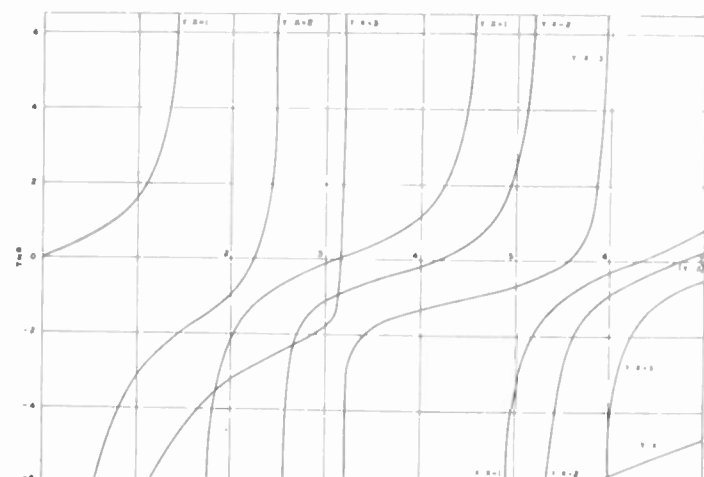

Fig. 8— $-Inr$  function  
 $n = 7/2$  (dominant mode  $\theta = 51.4^\circ$ )  
 $E$  type impressed field.

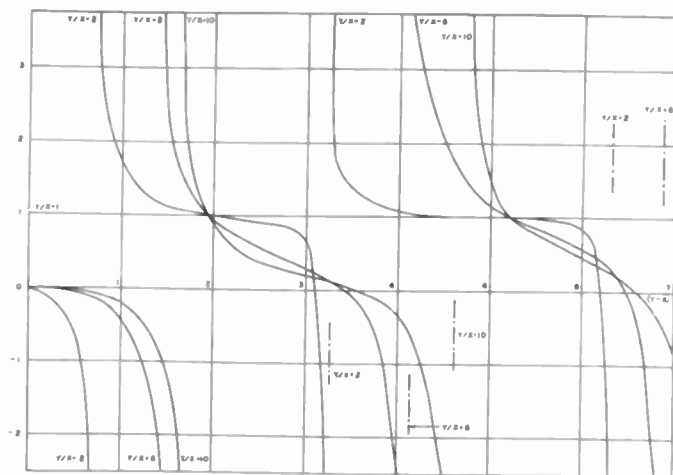

Fig. 6— $-Kr$  function  
 $n = 1$  (dominant mode  $\theta = 180^\circ$ )  
 $E$  type impressed field.

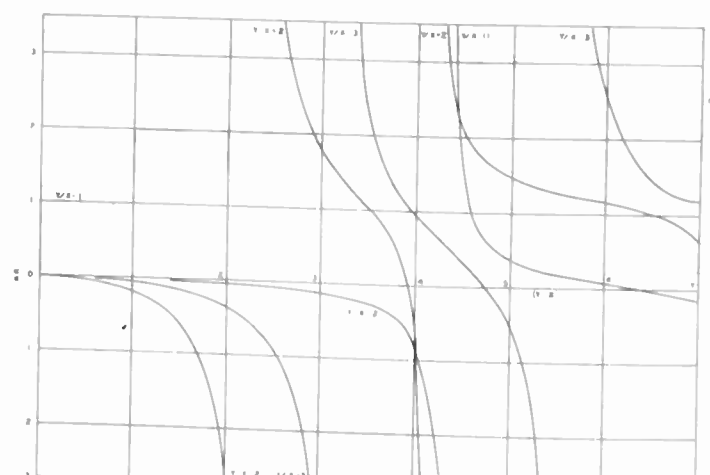

Fig. 9— $Kr$  function  
 $n = 7/2$  (dominant mode  $\theta = 51.4^\circ$ )  
 $E$  type impressed field.

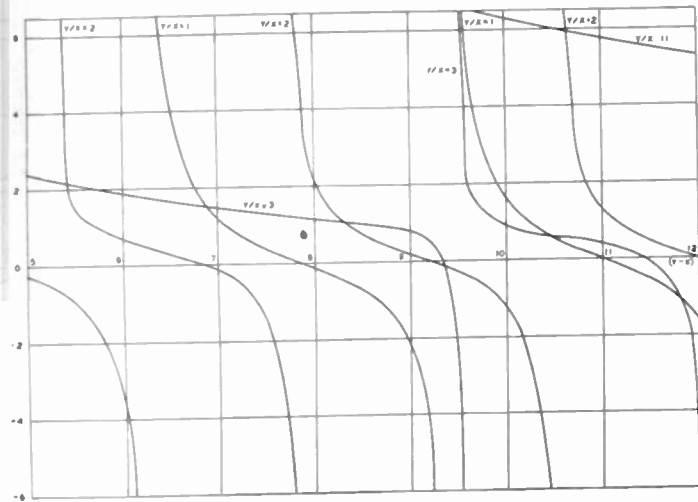

Fig. 10—*ctr* function  
 $n = 13/2$  (dominant mode  $\theta = 27.7^\circ$ )  
*E* type impressed field.

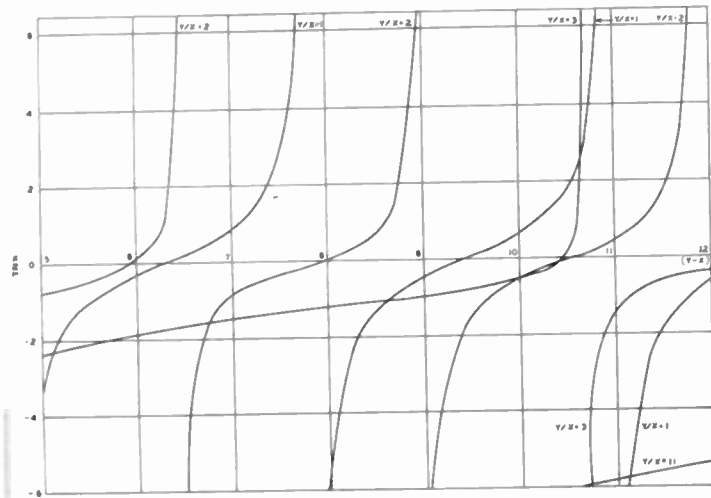

Fig. 11—*Tnr* function  
 $n = 13/2$  (dominant mode  $\theta = 27.2^\circ$ )  
*E* type impressed field.

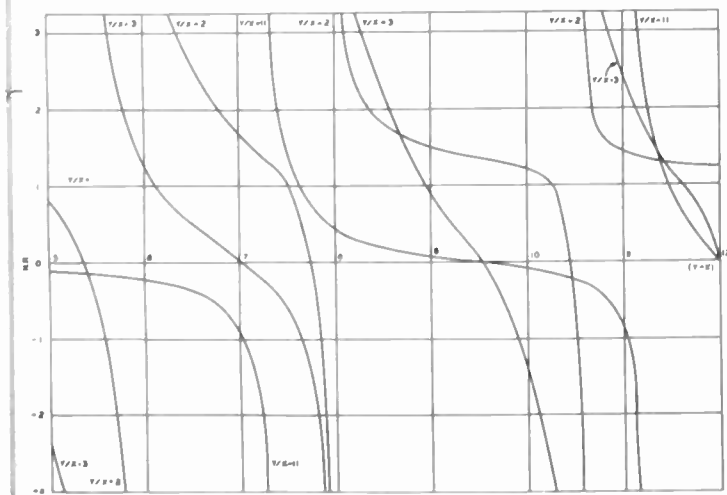

Fig. 12 *Kr* function  
 $n = 13/2$  (dominant mode  $\theta = 27.7^\circ$ )  
*E* type impressed field.

tighter envelopes. Whenever a family of curves in any given cycle of the *ctr* or *Tnr* functions start to cross each other, we have reached the upper limit of usefulness for the  $y/x$  parameter of that group insofar as engineering calculations are concerned, since it is not useful to interpolate between two curves which cross each other. The crossing is caused by the fact that the range in question requires  $x$  to be less than  $n$ , and it can be shown that  $x < n$  defines the attenuation region.

It can be shown that when  $x < n/(y/x)$

$$ctr = n/x \tag{15}$$

$$Tnr = -n/x \tag{16}$$

$$Kr = \left(\frac{-x}{n}\right) \left(\frac{J_n(y)}{J_n'(y)}\right) \tag{17}$$

In the appropriate ranges where  $x < n/(y/x)$  we can use the relationships of (15) through (17) to secure very quickly additional graphs for intermediate values of  $y/x$ . This is illustrated in the *ctr* function graph for  $n = 1$  (Fig. 4) by the dotted line curves for  $y/x = 4$ ,  $y/x = 7$ , and  $y/x = 13$ . These curves aid greatly when a method of interpolation has to be decided upon, since they show the relative spacing as  $y/x$  varies.

It should be noted that, on the curves for  $n = 1$ , the asymptotic values are indicated as dash-dotted lines. The values of zeros of the denominators for  $n$  half order were not available, so the asymptotic values are only shown on the curves for  $n = 1$ . However, by studying the upper and lower lobes of the function as it goes to infinity one can estimate fairly well the  $(y-x)$  values of the asymptote.

### V. CONCLUSIONS

This paper has attempted to merely outline the steps leading to the resulting sectoral transmission functions drawn in Figs. 4 through 12. Since none of the modern calculating machines were available to the author, the calculation of the graphs was a very laborious chore. Therefore, only as many curves as were absolutely necessary to illustrate the point were actually plotted. Should these functions prove useful enough, it is believed that additional curves could be readily calculated by using one of the many large calculators now in existence. In the meantime, however, it is believed that the foregoing material should assist in the design of microwave transmission circuits employing the sectoral horn geometry.

### VI. ACKNOWLEDGMENTS

The author wishes to acknowledge gratefully the valuable assistance furnished by E. Weber and N. Marcuvitz of the Polytechnic Institute of Brooklyn in the preparation of the thesis upon which this material is based. Appreciation is also expressed to the USAF, Air Materiel Command, Watson Laboratories, and to the Polytechnic Institute of Brooklyn for granting permission to the author to submit this paper.



# On the Theory of the Radiation Patterns of Electromagnetic Horns of Moderate Flare Angles\*

C. W. HORTON†

**Summary**—A method attributed to Schelkunoff for the computation of radiation patterns is considered. For the case of transverse electric waves in a waveguide or horn of moderate flare angle, the problem of calculating the radiation pattern is reduced to that of evaluating two definite integrals. These integrals are evaluated for rectangular, circular, and semicircular horns for some common modes of vibration. A small amount of experimental data are presented to illustrate the agreement between theory and experiment.

## I. INTRODUCTION

A METHOD of computing radiation patterns from electromagnetic horns that is easy to apply and which leads to patterns that agree well with experimental patterns has been developed by Schelkunoff.<sup>1,2</sup> Schelkunoff's theorems may be formulated in several different ways of which the following is selected for the present purpose. When an electromagnetic wave is radiated from the open end of a semi-infinite waveguide, the radiation pattern is the same as the pattern of a suitable distribution of surface electric currents  $J$ , and of surface magnetic currents  $M$ , over the aperture  $\Sigma$  of the waveguide. These current distributions are determined by

$$\vec{J} = \vec{n} \times \vec{H}^o \quad (1)$$

$$\vec{M} = -\vec{n} \times \vec{E}^o \quad (2)$$

$\vec{n}$  is the normal to the aperture pointing out into the space away from the waveguide.  $\vec{E}^o$  and  $\vec{H}^o$  are the values of the electric and magnetic fields that would exist across  $\Sigma$  if the waveguide had not been terminated. When computing the radiation pattern of the current distributions, it is necessary to allow for the presence of the metallic waveguide which acts as a baffle. If the waveguide is large, its effect is secondary and may be neglected. This approximation is made in the following analysis.

It can be shown that the modes of vibration in sectoral and conical horns approach the corresponding modes of vibration in rectangular and circular wave-

guides as the limiting case when the flare angle approaches zero. This means that the radiation patterns which are derived for an open waveguide may be applied directly to an electromagnetic horn, as long as the flare angle is not too large.

The values of  $\vec{E}$  and  $\vec{H}$  in the radiation field may be computed from

$$\vec{E} = i\omega\mu\vec{A} - (1/i\omega\epsilon) \text{grad div } \vec{A} - \text{curl } \vec{F} \quad (3)$$

$$\vec{H} = i\omega\epsilon\vec{F} - (1/i\omega\mu) \text{grad div } \vec{F} + \text{curl } \vec{A} \quad (4)$$

where  $\vec{A}$  and  $\vec{F}$  are a magnetic and an electric vector potential, respectively, which are given by

$$\vec{A} = (1/4\pi) \int_{\Sigma} (\vec{J}/r') \exp(ikr') d\Sigma \quad (5)$$

$$\vec{F} = (1/4\pi) \int_{\Sigma} (\vec{M}/r') \exp(ikr') d\Sigma \quad (6)$$

Here  $r'$  is the distance from the surface element  $d\Sigma$  to the field point. These equations are in mks units and are true for periodic fields with the time factor  $\exp(-i\omega t)$ .

In the next section the case of a transverse electric wave is considered, and (1) to (6) are reduced to a simple form suitable for the computation of the distant, or Fraunhofer, diffraction pattern.

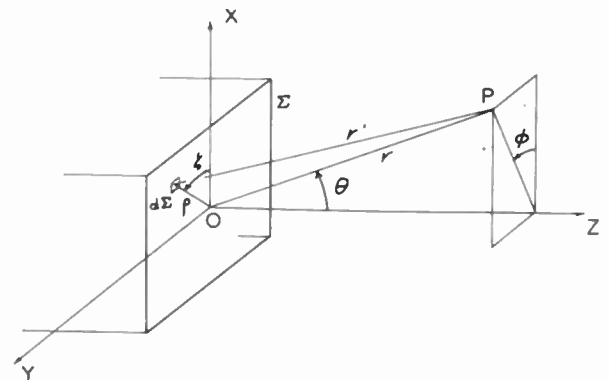

Fig. 1—The relations between the co-ordinate systems and the waveguide.

## II. APPLICATION TO THE TRANSVERSE ELECTRIC FIELD

Consider the co-ordinate systems shown in Fig. 1. The location of the field point  $P$  is given in spherical coordinates  $(r, \theta, \phi)$ , while the location of the apertural element  $d\Sigma$  is given in polar co-ordinates  $(\rho, \zeta)$ . One has

$$r'^2 = \rho^2 + r^2 - 2\rho r \cos(\phi - \zeta) \sin \theta \quad (7)$$

For large values of  $r$ , the  $\rho^2$  may be neglected and the binomial expansion may be applied to give

\* Decimal classification: R118XR120. Original manuscript received by the Institute, September 10, 1948; revised manuscript received, January 24, 1949.

This work has been done under sponsorship of the Bureau of Ordnance, Navy Department, Contract NOrd-9195, at The University of Texas, and has been extracted from "On the Theory of the Radiation Patterns of Electromagnetic Horns," Bumblebee Report No. 86, Defense Research Laboratory, The University of Texas.

† Defense Research Laboratory, The University of Texas, Austin, Tex.

<sup>1</sup> S. A. Schelkunoff, "Some equivalence theorems of electromagnetics and their application to radiation problems," *Bell Sys. Tech. Jour.*, vol. 15, pp. 92-112; January, 1936.

<sup>2</sup> S. A. Schelkunoff, "On diffraction and radiation of electromagnetic waves," *Phys. Rev.*, vol. 56, pp. 308-316; August 15, 1939.

$$r' \cong r - \rho \cos(\phi - \zeta) \sin \theta. \quad (7)$$

The  $r'$  in the denominator of (5) and (6) may be replaced directly by  $r$ , while the  $r'$  in the exponent must be replaced by the more accurate form of (7). Thus (5) and (6) become

$$\vec{A} = \int_{\Sigma} \vec{J} \exp \{ ikr \} / 4\pi r \quad (8)$$

$$\vec{F} = \int_{\Sigma} \vec{M} \exp \{ -ik\rho \cos(\phi - \zeta) \sin \theta \} d\Sigma. \quad (9)$$

Although  $\vec{A}$  and  $\vec{F}$  are functions of  $\theta$  and  $\phi$  as well as  $r$ , if we confine our attention to distant field points so that powers of  $(1/r)$  greater than the first are negligible, then  $\vec{A}$  and  $\vec{F}$  may be treated as a constant vector times a function of  $r$  in performing the vector operations indicated in (3) and (4).

A transverse electric wave in the waveguide may be represented by

$$\vec{E} = \{ i f(x, y) + j g(x, y) \} \exp(ik'z - i\omega t) \quad (10)$$

where  $k' (= 2\pi/\lambda_{\text{guide}})$  need not equal the free-space value  $k$ . The magnetic field  $\vec{H}$  associated with  $\vec{E}$  has components given by

$$\left. \begin{aligned} H_x &= -(k'/\omega\mu)g(x, y) \exp(ik'z - i\omega t) \\ H_y &= (k'/\omega\mu)f(x, y) \exp(ik'z - i\omega t) \\ H_z &= (1/i\omega\mu) \{ g_x(x, y) - f_y(x, y) \} \exp(ik'z - i\omega t) \end{aligned} \right\} \quad (11)$$

When  $\vec{E}$  is evaluated from (3), (8), (9), (10), and (11) and powers of  $(1/r)$  higher than the first are neglected, one finds

$$\left. \begin{aligned} E_r &= 0 \\ E_\theta &= -i(k + k' \cos \theta) \{ R_1(\theta, \phi) \cos \phi \\ &\quad + R_2(\theta, \phi) \sin \phi \} (1/r) \exp(ikr - i\omega t) \\ E_\phi &= +i(k' + k \cos \theta) \{ R_1(\theta, \phi) \sin \phi \\ &\quad - R_2(\theta, \phi) \cos \phi \} (1/r) \exp(ikr - i\omega t) \end{aligned} \right\} \quad (12)$$

where

$$R_1(\theta, \phi) = (1/4\pi) \int_{\Sigma} f(x, y) \exp \{ -ik\rho \cos(\phi - \zeta) \sin \theta \} d\Sigma. \quad (13)$$

This derivation is given in the Appendix. Since  $\vec{E}$  is a transverse wave, the components of the magnetic field may be found from the relationships

$$\left. \begin{aligned} H_r &= 0 \\ H_\theta &= -(k/\omega\mu)E_\phi \\ H_\phi &= +(k/\omega\mu)E_\theta \end{aligned} \right\} \quad (14)$$

It might be pointed out that, normally, in spherical co-ordinates,  $\theta$  is required to be positive, so that two values of  $\phi$  (say,  $\phi_0$  and  $\phi_0 + \pi$ ) are required to specify a full plane. However, it is equally permissible to specify a fixed value of  $\phi$  and allow  $\theta$  to take on both positive and negative values. This interpretation will be used in the discussion of patterns.

The problem of computing the radiation pattern of a semi-infinite waveguide for a transverse electric wave has been reduced to the problem of performing the integration of (13). This integration will be performed for various common waveguide sections.

### III. SYMMETRY CONSIDERATIONS

It is possible to state certain general properties of the radiation pattern, provided the functions  $f(x, y)$  and  $g(x, y)$  are real. For example, the real parts of  $R_1(\theta, \phi)$  and  $R_2(\theta, \phi)$  are even functions of  $\theta$  while the imaginary parts are odd functions of  $\theta$ .

Consider the pattern in the plane  $\phi = 0$ . If the waveguide is symmetric about the  $x$  axis, and if  $g(x, y)$  is an odd function of  $y$ , the component  $E_\phi = 0$ . Similarly, if  $f(x, y)$  is an odd function of  $y$ ,  $E_\theta = 0$ . On the other hand, if the waveguide is symmetric about the  $y$  axis, then  $R_1(\theta, \phi)$  is pure real or imaginary according as  $f(x, y)$  is an even or odd function of  $x$ . Likewise,  $R_2(\theta, \phi)$  is even or odd according as  $g(x, y)$  is an even or odd function of  $x$ .

Consider next the plane  $\phi = 90^\circ$ . If the waveguide is symmetric about the  $y$  axis, and if  $f(x, y)$  is an odd function of  $x$ , the component  $E_\phi = 0$ . Similarly, if  $g(x, y)$  is an odd function of  $x$ ,  $E_\theta = 0$ . On the other hand, if the waveguide is symmetric about the  $x$  axis, then  $R_1(\theta, \phi)$  is pure real or imaginary according as  $f(x, y)$  is an even or odd function of  $y$ . Likewise,  $R_2(\theta, \phi)$  is even or odd according as  $g(x, y)$  is an even or odd function of  $y$ .

### IV. THE EFFECT OF A PERFECTLY CONDUCTING BAFFLE

If the mouth of the waveguide or horn is mounted in a large, flat, perfectly conducting sheet, the pattern will be altered. The effect of these changes has been discussed by Schelkunoff.<sup>3</sup> When these changes are carried out, one has in place of (12)

$$\left. \begin{aligned} E_r &= 0 \\ E_\theta &= -2ik \{ R_1(\theta, \phi) \cos \phi \\ &\quad + R_2(\theta, \phi) \sin \phi \} (1/r) \exp(ikr - i\omega t) \\ E_\phi &= +2ik \cos \theta \{ R_1(\theta, \phi) \sin \phi \\ &\quad - R_2(\theta, \phi) \cos \phi \} (1/r) \exp(ikr - i\omega t) \end{aligned} \right\} \quad (15)$$

### V. TRANSVERSE ELECTRIC WAVES IN A RECTANGULAR WAVEGUIDE

The radiation patterns of rectangular horns are well known,<sup>4</sup> and consequently they will be treated briefly

<sup>3</sup> See page 312 of footnote reference 2.

<sup>4</sup> S. A. Schelkunoff, "Electromagnetic Waves," p. 359, D. van Nostrand Co., New York, N. Y., 1945.

only in order to show the practicality of the present approach.

The transverse electric wave  $TE_{m,n}$  has an electric field characterized by

$$f(x, y) = - (n\pi/b) \cos (m\pi/2 + m\pi x/a) \sin (n\pi/2 + n\pi y/b) \quad (16)$$

$$g(x, y) = + (m\pi/a) \sin (m\pi/2 + m\pi x/a) \cos (n\pi/2 + n\pi y/b) \quad (17)$$

where  $a$  is the dimension of the waveguide in the  $x$  direction and  $b$  is the dimension in the  $y$  direction.

In order to evaluate  $R_1(\theta, \phi)$  and  $R_2(\theta, \phi)$  simply, it is desirable to introduce two dimensionless parameters,  $\alpha$  and  $\beta$ , defined as

$$\alpha = (ka/2) \cos \phi \sin \theta \quad (18)$$

$$\beta = (kb/2) \sin \phi \sin \theta. \quad (19)$$

Integration of (13) gives

$$R_1(\theta, \phi) = (\pi n^2 ab / 8b) A \alpha / \left\{ (\pi/2)^2 - \alpha^2 \right\}^{1/2} + (n\pi/2) - \beta^2 \quad (20)$$

and

$$R_2(\theta, \phi) = - (m^2 b / n^2 a) R_1(\theta, \phi). \quad (21)$$

The constant  $A$  takes on the following four possible values:

$m$ even, $n$ even	$A = i \sin \alpha \sin \beta$
$m$ even, $n$ odd	$A = \sin \alpha \cos \beta$
$m$ odd, $n$ even	$A = \cos \alpha \sin \beta$
$m$ odd, $n$ odd	$A = -i \cos \alpha \cos \beta.$

In the particular case of the  $TE_{0,1}$  mode the radiation patterns can be evaluated to give

$$\left. \begin{aligned} E_r &= 0 \\ E_\theta &= i(\pi a/8)(k + k' \cos \theta) \\ &\quad \cdot \cos \phi (\sin \alpha / \alpha) \cos \beta / \left\{ (\pi/2)^2 - \beta^2 \right\} \\ E_\phi &= -i(\pi a/8)(k' + k \cos \phi) \\ &\quad \cdot \sin \phi (\sin \alpha / \alpha) \cos \beta / \left\{ (\pi/2)^2 - \beta^2 \right\} \end{aligned} \right\} \quad (22)$$

The spherical wave factor  $(1/r) \exp(ikr - i\omega t)$  has been omitted in these and in the remainder of the equations. The various factors have simple physical explanations. In the  $TE_{0,1}$  mode there is no variation in the electric field strength with the variable  $x$ . Thus there is no shading in the  $x$  direction, and the part of the pattern that results from integrating with respect to  $x$  is  $(\sin \alpha / \alpha)$ , which is the radiation pattern commonly associated with an unshaded rectangular opening. In the  $y$  direction the intensity of the electric vector varies cosinusoidally. This shading gives rise to the terms which are a function of  $\beta$ . The terms in  $\phi$  represent the effects of the polarized source. The factors of the form  $(1 + \cos \theta)$  occur because of the flow of energy through the opening.

Figs. 2 and 3 show the experimental and theoretical patterns in the  $E$  and  $H$  planes, respectively, for a bisectoral horn. By the "E plane" is meant the plane containing the electric vector in the  $TE_{0,1}$  mode. The dimensions of the horn are  $1.82\lambda_0$  in the  $H$  plane and  $1.47\lambda_0$  in the  $E$  plane. It may be seen that the agreement between theory and experiment is good.

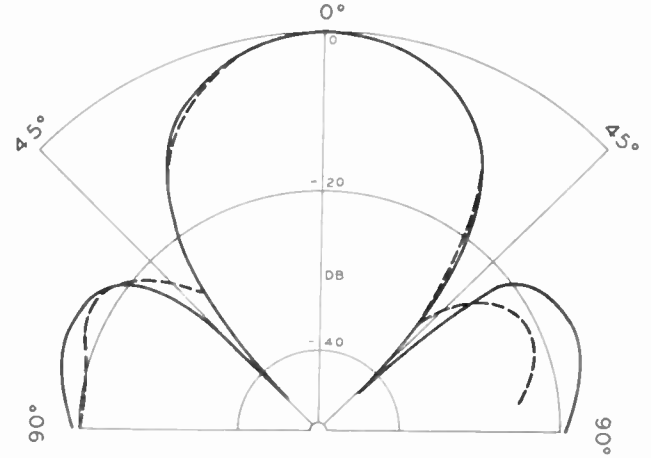

Fig. 2—The pattern in the  $E$  plane produced by a  $TE_{0,1}$  wave in a bisectoral horn of dimensions  $1.47\lambda_0$  and  $1.82\lambda_0$  in the  $E$  and  $H$  planes, respectively. The solid line is theoretical and the dashed line is experimental.

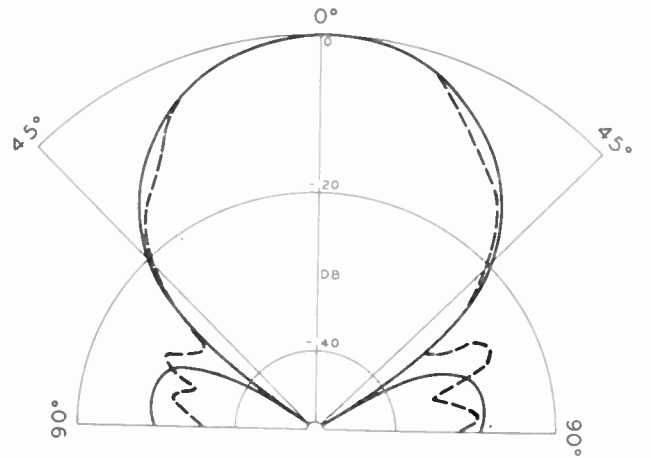

Fig. 3—The pattern in the  $H$  plane produced by a  $TE_{0,1}$  wave in a bisectoral horn of dimensions  $1.47\lambda_0$  and  $1.82\lambda_0$  in the  $E$  and  $H$  planes, respectively. The solid line is theoretical and the dashed line is experimental.

## VI. TRANSVERSE WAVES IN A CIRCULAR WAVEGUIDE

### A. The $TE_{0,1}$ Mode of Vibration

The simplest mode of vibration in a circular waveguide is known as the  $TE_{0,1}$  mode. For this mode, omitting an amplitude constant,

$$E_r = 0 \quad (23)$$

$$E_\phi = J_1(q\rho/a) \exp(ik'z - i\omega t) \quad (24)$$

where

$a$  = radius of the guide

$q = 3.832$  = first positive root of  $J_1(x) = 0$ .

For this mode of vibration, the functions  $f(x, y)$  and  $g(x, y)$  defined in (10) become



$$f(x, y) = -J_1(q\rho/a) \sin \zeta \tag{25}$$

$$g(x, y) = +J_1(q\rho/a) \cos \zeta. \tag{26}$$

Hence, one has

$$R_1(\theta, \phi) = \mp (1/4\pi) \int_0^a \int_0^{2\pi} J_1(q\rho/a) \frac{\sin \xi}{\cos \xi} \exp \{ -ik\rho \cos(\phi - \zeta) \sin \theta \} \rho d\rho d\zeta. \tag{27}$$

This can be integrated in a straightforward manner to give

$$R_1(\theta, \phi) = \mp (ia^2 J_0(q)/2) \frac{\sin \phi J_1(\gamma)}{\cos \phi} / (q^2 - \gamma^2) \tag{28}$$

where

$$\gamma = ka \sin \theta. \tag{29}$$

Thus (12) gives

$$\left. \begin{aligned} E_r &= 0 \\ E_\theta &= 0 \\ E_\phi &= (a^2 J_0(q)/2q) (k' + k \cos \theta) q^2 J_1(\gamma) / (q^2 - \gamma^2) \end{aligned} \right\} \tag{30}$$

is the pattern of a circular waveguide excited in the  $TE_{0,1}$  mode.

The function  $q^2 J_1(\gamma) / (q^2 - \gamma^2)$  is plotted in Fig. 4 as a function of the dimensionless angle  $\gamma$ . This is the pattern that one would observe in any plane through the  $0z$  axis.

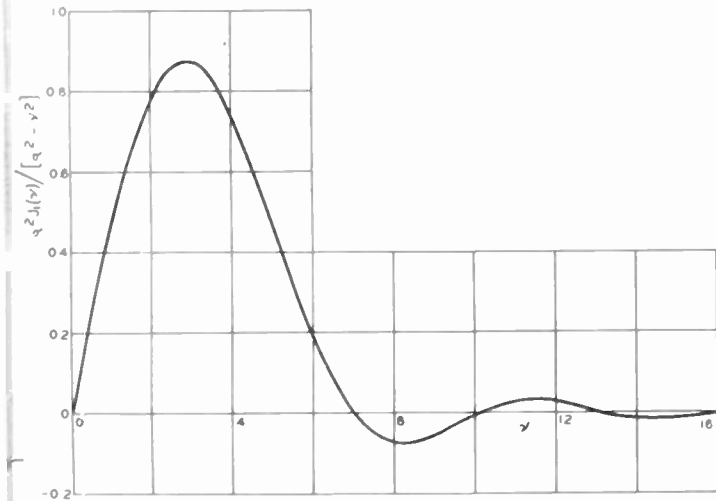

Fig. 4—The pattern in any plane of a  $TE_{0,1}$  wave in a circular waveguide versus the dimensionless angle  $\gamma$ .

### B. The $TE_{1,1}$ Mode of Vibration

The next most simple mode of vibration in a circular waveguide is known as the  $TE_{1,1}$  mode in which the electric field components are

$$E_\rho = (a/p\rho) J_1(p\rho/a) \cos \zeta \exp(ik'z - i\omega t) \tag{31}$$

$$E_\zeta = -J_1'(p\rho/a) \sin \zeta \exp(ik'z - i\omega t) \tag{32}$$

where

$a$  = radius of the waveguide

$p = 1.841$  = first positive root of  $J_1'(x) = 0$ .

Corresponding to these components, one has

$$f(x, y) = (a/p\rho) J_1(p\rho/a) \cos^2 \zeta + J_1'(p\rho/a) \sin^2 \zeta \tag{33}$$

$$g(x, y) = \{ (a/p\rho) J_1(p\rho/a) - J_1'(p\rho/a) \} \sin \zeta \cos \zeta. \tag{34}$$

After some manipulation of Bessel functions, one arrives at the following expressions for the components of the electric field.

$$\left. \begin{aligned} E_r &= 0 \\ E_\theta &= -i \{ a^2 J_1(p) / 4p \} (k + k' \cos \theta) \cos \phi P_1(\gamma) \\ E_\phi &= +i \{ a^2 J_1(p) / 4p \} (k' + k \cos \theta) \sin \phi P_2(\gamma) \end{aligned} \right\} \tag{35}$$

where

$$\gamma = ka \sin \theta \tag{29}$$

$$P_1(\gamma) = 2J_1(\gamma) / \gamma \tag{36}$$

$$P_2(\gamma) = 2p^2 J_1'(\gamma) / (p^2 - \gamma^2). \tag{37}$$

For the orientation under consideration, the planes  $\phi=0$  and  $\phi=\pi/2$  will be denoted as the  $E$  and the  $H$  planes, respectively. Aside from the factor  $(k+k' \cos \theta)$ ,  $P_1(\gamma)$  is the pattern in the  $E$  plane of a circular waveguide or horn with  $TE_{1,1}$  waves. Fig. 5 shows a plot of  $P_1(\gamma)$  versus the dimensionless angle  $\gamma$ .

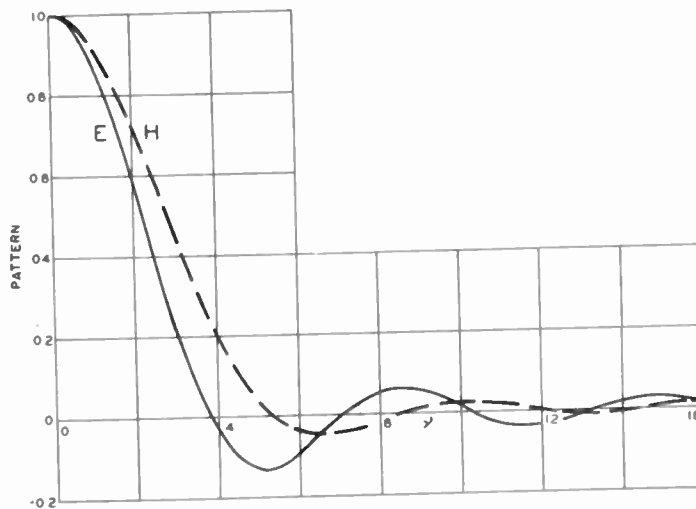

Fig. 5—The patterns in the  $E$  and  $H$  planes of a  $TE_{1,1}$  wave in a circular horn versus the dimensionless angle  $\gamma$ . The solid curve  $E$  is a plot of  $P_1(\gamma)$  of (36) and is the pattern in the  $E$  plane. The dashed curve  $H$  is a plot of  $P_2(\gamma)$  of (37) and is the pattern in the  $H$  plane.

Aside from the factor  $(k'+k \cos \theta)$ ,  $P_2(\gamma)$  is the pattern in the  $H$  plane of a circular waveguide with  $TE_{1,1}$  waves. Fig. 5 shows a plot of  $P_2(\gamma)$  versus the dimensionless angle  $\gamma$ .

Figs. 6 and 7 show experimental and theoretical patterns in the  $E$  and  $H$  planes, respectively, for a circular horn whose diameter is  $1.85\lambda_0$ .

### VII. THE $TE_{1,1}$ MODE IN A SEMICIRCULAR WAVEGUIDE

The circular waveguide is frequently criticized because there is no physical restraint to prevent the rotation of the plane of the  $E$  vector. A possible solution of this difficulty would be to use a semicircular waveguide,

although the writer has not seen this discussed. The field components given by (31) and (32) will satisfy the boundary conditions in a semicircular waveguide bounded by the plane  $\phi = \pm \pi/2$ . The writer has not been able to effect the integration for  $R(\theta, \phi)$  except for the two principal planes,  $\phi = 0$  and  $90^\circ$ .

$$\left. \begin{aligned} E_r &= 0 \\ E_\theta &= -i \left\{ a^2 J_1(\rho) / 4\rho \right\} (k + k' \cos \theta) \left\{ A(\gamma) - iB(\gamma) \right\} \\ E_\phi &= 0 \end{aligned} \right\} \quad (38)$$

where

$$\left. \begin{aligned} A(\gamma) &= P_1(\gamma) / 2 = J_1(\gamma) / \gamma \\ B(\gamma) &= H_1(\gamma) / \gamma \end{aligned} \right\} \quad (39)$$

It will be noted that the real part of  $E_\theta$  is equal to one-half the value of  $E_\theta$  for a circular waveguide given in (35). That this must be true can be seen as follows. If two semicircular waveguides are matched together to form one circular waveguide, then the combined pattern is

$$A(\gamma) - iB(\gamma) + A(\gamma) + iB(\gamma) = 2A(\gamma).$$

A plot of  $2A(\gamma)$  is shown in Fig. 5. The graph of  $B(\gamma)$  is shown in Fig. 8.

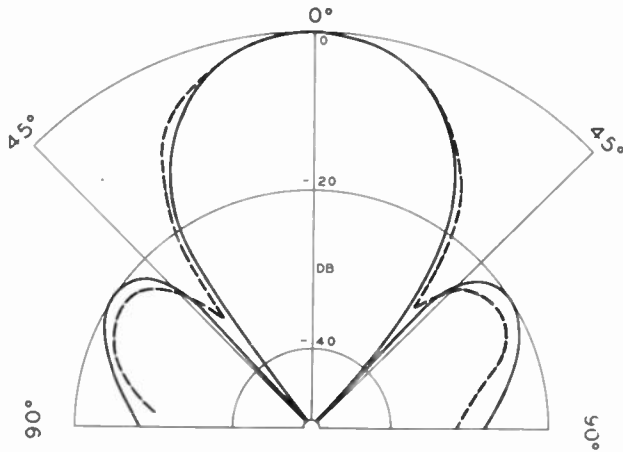

Fig. 6—The pattern in the  $E$  plane produced by a  $TE_{1,1}$  wave in a conical horn whose largest diameter is  $1.85\lambda_0$ . The solid line is theoretical and the dashed line is experimental.

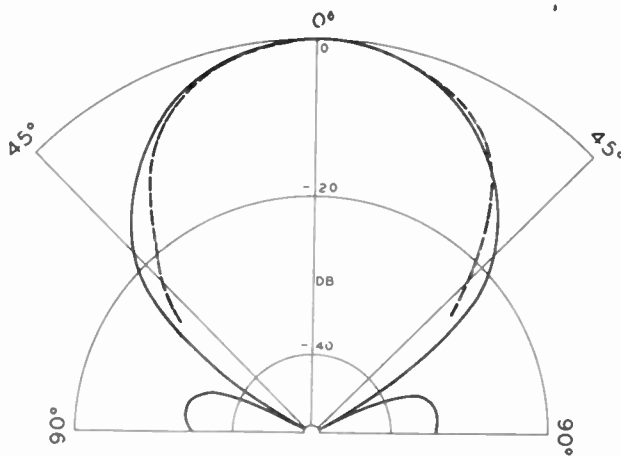

Fig. 7—The pattern in the  $H$  plane produced by a  $TE_{1,1}$  wave in a conical horn whose largest diameter is  $1.85\lambda_0$ . The solid line is theoretical and the dashed line is experimental.

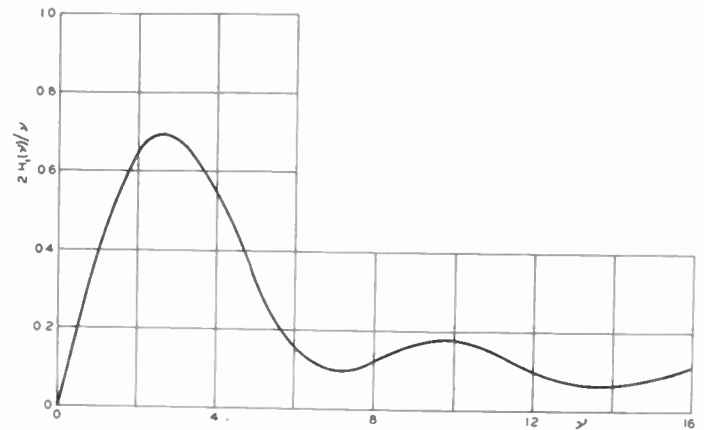

Fig. 8—A plot of the imaginary part of the pattern in the  $E$  plane of a  $TE_{1,1}$  wave in a semicircular waveguide versus the dimensionless angle  $\gamma$ . A plot of twice the real part is given by the solid curve in Fig. 5.

A. The Plane  $\phi = 0$

It is possible to apply the arguments used in section III to show that  $E_\phi = 0$ ; i.e.,  $R_2(\theta, 0) = 0$ . After the integration with respect to  $\zeta$  has been performed, one has

$$\begin{aligned} R_1(\theta, 0) &= (a^2/8) \int_0^1 [J_0(\rho s)J_0(\gamma s) - J_2(\rho s)J_2(\gamma s)] s ds \\ &\quad - i(a^2/4) \int_0^1 [J_1(\rho s)H_0(\gamma s)/\rho s - J_2(\rho s)H_1(\gamma s)/\gamma s] s ds. \end{aligned}$$

Obviously, the final pattern will be of the form  $A(\gamma) - iB(\gamma)$ , where  $A(\gamma)$  is an even and  $B(\gamma)$  is an odd function of  $\gamma$ . The integration can be performed to give the following pattern in the plane  $\phi = 0$ :

B. The Plane  $\phi = \pi/2$

It is obvious from considerations of symmetry that  $E_\phi$  will have the same pattern in the case of the semicircular waveguide as it does in the circular waveguide. The exact expressions will differ by a factor 2 which arises from the fact that the area is doubled in the case of the full waveguide. Therefore, the pattern of  $E_\phi$  in the present case is one-half of the value given in (35) and plotted in Fig. 5.

$E_\theta$  is zero in the plane  $\phi = \pi/2$  for the full circular waveguide, but it is not zero in the case of the semicircular waveguide. When the integration with respect to  $\theta$  is performed over the semicircle, one finds

$$R_2(\theta, \pi/2) = i(a^2/2\pi\gamma) \int_0^1 \left\{ \cos(\gamma s) - \sin(\gamma s)/\gamma s \right\} \left\{ J_1(\rho s)/\rho s - J_1'(\rho s) \right\} ds.$$

This can be integrated to give

$$R_2(\theta, \pi/2) = i(a^2/2\pi\rho^2) \left\{ J_0(\rho, \gamma) + \cos \gamma J_0(\rho) - 1 \right\}. \quad (40)$$

The function  $J_s(p, x)$ , which is defined as

$$J_s(p, x) = \int_0^x J_0(pu) \sin u du, \quad (41)$$

has been extensively studied by Schwartz,<sup>5</sup> who tabulates the function  $J_s(p, x)$  to 8D for  $p=0.1$  (0.1) 1 and  $x=0$  (0.1) 5. Unfortunately, this range of values is not suitable for the application to the diffraction patterns.

Thus the pattern in the plane  $\phi = \pi/2$  becomes

$$\begin{aligned} E_r &= 0 \\ E_\theta &= -i(a^2/2\pi p^2)(k+k' \cos \theta) \frac{1}{2} J_s(p, \gamma) + \cos \gamma J_0(p) - 1 \frac{1}{2} \\ E_\phi &= +i \frac{1}{2} a^2 J_1(p)/8p \frac{1}{2} (k+k' \cos \theta) P_2(\gamma). \end{aligned}$$

Figs. 9 and 10 show the patterns in the  $E$  and the  $H$  planes, respectively, of a semicircular horn whose diameter is  $1.85\lambda_0$ . The measurement in the  $H$  plane is for  $E_\phi$  only.

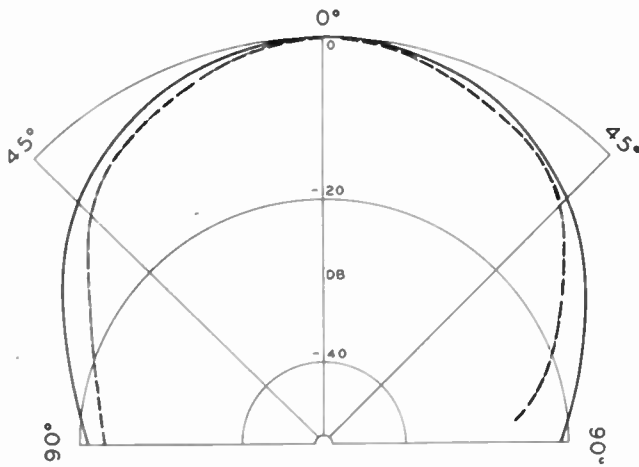

Fig. 9—The pattern in the  $E$  plane produced by a  $TE_{1,1}$  wave in a semicircular horn whose largest diameter is  $1.85 \lambda_0$ . The solid line is theoretical and the dashed line is experimental.

ACKNOWLEDGMENT

The writer wishes to thank R. B. Watson for the use of the experimental patterns that are shown in this paper.

APPENDIX

The derivation of (12) can best be done in two parts. First, let  $g(x, y) \equiv 0$ . Then

<sup>5</sup> L. Schwartz, "Investigations of some functions related to the cylindrical functions of zero order," *Luftfahrtforschung*, vol. 20, pp. 341-372; 1944. This paper has been translated by J. Lotsif for the Cornell Aeronautical Laboratory, May, 1946.

$$\vec{J} = \vec{n} \times \vec{H}^0 = -\vec{i} (k'/\omega\mu) f(x, y) \exp(ik'z - i\omega t)$$

$$\vec{M} = -\vec{n} \times \vec{E}^0 = -\vec{j} f(x, y) \exp(ik'z - i\omega t).$$

Neglecting powers of  $(1/r)$  larger than the first, one has

$$\vec{A} = -\vec{i} (k'/\omega\mu r) R_1(\theta, \phi) \exp(ikr - i\omega t)$$

$$\vec{J} = -\vec{j} (1/r) R_1(\theta, \phi) \exp(ikr - i\omega t),$$

where  $R_1(\theta, \phi)$  is defined in (13), and, consequently,

$$\begin{aligned} \text{curl } \vec{F} &= \vec{i} R_1(\theta, \phi) (ik/r) (\partial r / \partial z) \exp(ikr - i\omega t) \\ &\quad - \vec{k} R_1(\theta, \phi) (ik/r) (\partial r / \partial x) \exp(ikr - i\omega t) \end{aligned}$$

and

$$\text{grad div } \vec{A} = \vec{r}_0 R_1(\theta, \phi) (k'k^2/\omega\mu r) (x/r) \exp(ikr - i\omega t).$$

Upon converting  $\vec{i}, \vec{k}$ , and the cartesian components to polar form, one obtains

$$\begin{aligned} E_r &= 0 \\ E_\theta &= -i(k+k' \cos \theta) \cos \phi \cdot R_1(\theta, \phi) (1/r) \exp(ikr - i\omega t) \\ E_\phi &= +i(k+k' \cos \theta) \sin \phi \cdot R_1(\theta, \phi) (1/r) \exp(ikr - i\omega t). \end{aligned}$$

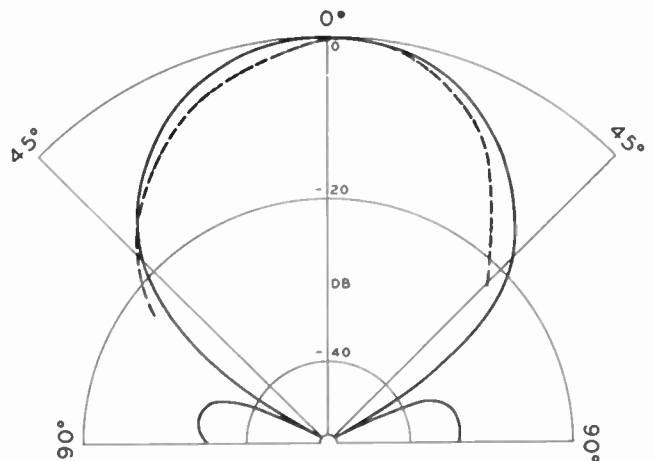

Fig. 10—The pattern in the  $H$  plane produced by a  $TE_{1,1}$  wave in a semicircular horn whose largest diameter is  $1.85 \lambda_0$ . The solid line is theoretical and the dashed line is experimental.

The second case of  $f(x, y) \equiv 0$  can be derived as a special case of the preceding equations. If the electric vector in the waveguide is rotated  $90^\circ$  from  $+\vec{i}$  to  $+\vec{j}$ , the electric and magnetic vectors in the radiation field must be rotated  $90^\circ$ . Hence the angle  $\phi$  in the coefficients of the preceding equations must be replaced by  $\phi - 90^\circ$ , and  $f(x, y)$  must be replaced by  $g(x, y)$ .





# Piezoelectric Transducers\*

WILFRED ROTH†, STUDENT, IRE

**Summary**—A piezoelectric transducer operating in the thickness-vibration mode is represented as a six-terminal network. The mesh equations, electromechanical impedance matrix, and equivalent circuit valid for any general conditions of loading and frequency are obtained. Thus properties of the transducer can be determined once the crystal, the impedance of the loads, and the energy sources are specified. Equations for the electrical driving-point impedance and admittance are derived for all conditions of loading and frequency consistent with the original assumptions.

## I. ELECTROMECHANICAL IMPEDANCE MATRIX

### 1. Introduction

THE USE OF piezoelectric transducers to produce ultrasonic energy for research and commercial purposes has increased rapidly in recent years. As a result, a theoretical analysis of the operation of such elements, which is capable of simplifying the work of the equipment designer, is extremely desirable. The analysis presented here was undertaken with this end in view.

Piezoelectric materials have the property of reacting mechanically to an applied electrical stimulus, and, reciprocally, of reacting electrically to an applied mechanical stimulus.<sup>1,2</sup> Such bilateral conversion of electrical to mechanical energy, and vice versa, is the function performed by the piezoelectric element in its various applications. Hence, any theoretical conclusions must be in a form equally convenient for use with either electrical or mechanical systems.

Although piezoelectric crystals are useful when operating in many varied modes, the mode principally in use for generation of the higher ultrasonic frequencies is that corresponding to X-cut quartz—the so-called thickness vibration. This mode is characterized by the collinearity of the mechanical strain and electric field-intensity vectors, and is the mode to be considered here.

### 2. Statement of Problem and Assumptions

Fig. 1 illustrates the problem to be considered. The crystal, its physical constants and geometry, and the loading acoustic media are specified, while the relations holding among the four mechanical and two electrical parameters are to be determined. The rationalized mks

system of units is employed throughout to facilitate the joint use of mechanical and electrical parameters.<sup>3</sup>

To simplify the problem, the following assumptions are made:

(i) The crystal is an infinite slab with two plane, parallel surfaces perpendicular to the direction of propagation of the resulting acoustic disturbance.

(ii) The two plane surfaces are electric equipotentials.

(iii) The mechanical energy dissipated in the piezoelectric material is negligible.

(iv) The electrical or mechanical stresses either applied or produced are not sufficient to cause departure from a linear operating region.

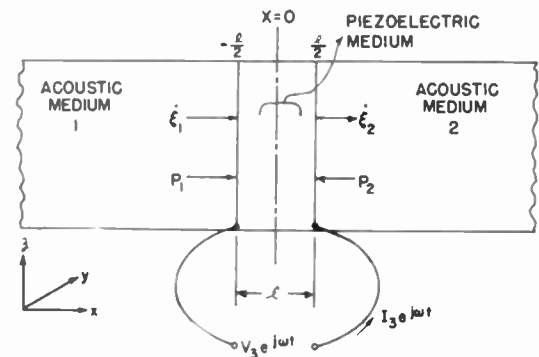

Fig. 1—The piezoelectrical medium terminated by two acoustic media and one electrical terminal pair.

These assumptions are not restrictive when applied to the type of transducer generally used for ultrasonic applications. In accordance with (i), the width of the crystal must be very much larger than its thickness. In practice, this ratio is frequently as large as 25 or 50 to 1; hence, this assumption is certainly valid. At very low frequencies, edge effects assume importance since the thickness may be in the order of the width, and a more elaborate theory is required.

Assumption (ii) restricts the analysis to widths small compared to the electrical wavelengths employed. This is always the case except for operation in the microwave region, where the wavelengths become comparable to the crystal dimensions.

Assumption (iii) is not at all restrictive unless the transducer is operating in a vacuum, in which case, all the mechanical energy is dissipated within the crystal. In most cases of practical importance, the dissipation in the acoustic material and supporting structure greatly exceeds that in the transducer, and no noticeable error is introduced by treating the dissipationless case.

<sup>3</sup> O. W. Eshbach, "Handbook of Engineering Fundamentals," John Wiley and Sons, New York, N. Y., 1936. Contains a useful table of conversion factors for various unit systems, pp. 1-130 to 1-149, and a discussion of existing systems, pp. 3-02 to 3-36.

\* Decimal classification: R214.21×R265. Original manuscript received by the Institute, February 10, 1948; revised manuscript received, October 27, 1948. This work has been supported in part by the United States Signal Corps, the Air Materiel Command, and the Office of Naval Research.

† Formerly, Harvey Radio Laboratories, Inc., Cambridge, Mass.; now, Raytheon Manufacturing Corporation, Waltham, Mass.

<sup>1</sup> W. G. Cady, "Piezoelectricity," McGraw-Hill Book Co., Inc., New York, N. Y., 1946. An extremely complete, well-documented book on electromechanical phenomena in crystals. An excellent bibliography is included.

<sup>2</sup> W. P. Mason, "Electromechanical Transducers and Wave Filters," D. Van Nostrand Co., Inc., New York, N. Y., 1942; pp. 195-215. An equivalent circuit for a piezoelectric transducer is derived and used in several examples. Derivation of the piezoelectric equations is given in Appendix C.

In most applications, (iv) is not limiting. However, if phenomena such as cavitation are encountered, the mechanical loading becomes a function of the intensity and cannot be treated as a constant. In these cases, the present treatment must be considered only as a first-order theory which indicates trends and approximate magnitudes rather than quantitative behavior.

### 3. Procedure

We shall regard the piezoelectric transducer as a circuit element—either electrical or mechanical, depending upon which terminals of the transducer are under examination. By adopting this viewpoint, it becomes possible to characterize the transducer completely by an electromechanical impedance matrix relating electrical and mechanical "currents" to the associated "voltages." More will be said about the definition of these terms in a later section.<sup>4</sup>

Since the mode we are considering has two opposing crystal surfaces from which ultrasonic energy is radiated, to represent this situation we can evidently introduce four mechanical terminals. To affect the crystal electrically, it is necessary to attach electrodes to these faces. This also makes it possible to introduce two electrical terminals. In this manner, the transducer is considered as a six-terminal network and we seek the "mesh" equations and the electromechanical impedance matrix which describes the interaction occurring among the variables specified for the respective terminal pairs.

As is the case with pure electrical networks, we must first obtain the equations relating "voltages" and "currents" at the six terminals. From this set of three "mesh" equations, the impedance matrix can be defined and thenceforth used for design purposes. We shall see that all properties of the transducer can be determined from a knowledge of this matrix and the boundary conditions at the terminals.

The impedance matrix is developed in accordance with the following procedure:

(i) Maxwell's equations and the constitutive relations satisfied by the piezoelectric crystal are introduced to obtain the equations satisfied by the electrical parameters.

(ii) The piezoelectric equations which describe the interrelation among the electrical and mechanical variables for piezoelectric materials are used to develop preliminary mesh equations in conjunction with the results of (i).

(iii) Newton's first law is used to derive the wave equation satisfied by the mechanical displacement. After integration, the result is employed to obtain the final mesh equations in the desired form.

(iv) The impedance matrix follows directly from the

mesh equations by proper definition of the operational process involved.

**3.1. Introduction of Maxwell's Equations.** In the rationalized mks system of units, Maxwell's equations are<sup>5</sup>

$$\nabla \times E + \frac{\partial B}{\partial t} = 0 \quad (1a)$$

$$\nabla \times H - \frac{\partial D}{\partial t} = J \quad (1b)$$

$$\nabla \cdot D = \rho \quad (1c)$$

$$\nabla \cdot B = 0. \quad (1d)$$

The constitutive relations for piezoelectric materials operating in the mode considered here are

$$B = \mu H \quad (1e)$$

$$D_x = \epsilon_x \left( E_x - h \frac{\partial \xi}{\partial x} \right) \quad (1f)$$

$$D_y = \epsilon_y E_y \quad (1g)$$

$$D_z = \epsilon_z E_z \quad (1h)$$

where

$E$  = electric field intensity in volts per meter

$B$  = flux density in webers per square meter

$H$  = magnetic field intensity in ampere-turns per meter

$D$  = dielectric displacement in coulombs per square meter

$J$  = current density in amperes per square meter

$\rho$  = charge density in coulombs per cubic meter

$\mu$  = permeability in henrys per meter

$\epsilon$  = inductive capacitance in farads per meter

$h$  = piezoelectric constant in volts per meter

$\xi$  = mechanical displacement in meters.

It is to be understood that all variables are functions of both space and time until proved otherwise.

In view of our original assumption of equipotential, parallel, plane surfaces, infinite in extent, it is evident that  $E_y = E_z = 0$ , and  $\partial E_x / \partial y = \partial E_x / \partial z = 0$ . From (1g) and (1h), we find that  $D_y = D_z = 0$  and by expanding  $\nabla \times E$  into its rectangular components, it is clear also that  $\nabla \times E = 0$ . From the former condition and (1c) we obtain

$$\frac{\partial D_x}{\partial x} = \rho, \quad (2a)$$

while the latter and (1a) result in

$$\frac{\partial B}{\partial t} = 0. \quad (2b)$$

From this result and (1e), it follows that  $B$  and  $H$  are independent of time. We know from physical considerations that, if a time-varying voltage is applied to the

<sup>4</sup> M. F. Gardner and J. L. Barnes, "Transients in Linear Systems," John Wiley and Sons, New York, N. Y., 1942. Chap. II contains a discussion of the equations of electrical and mechanical systems both alone and in combination.

<sup>5</sup> J. A. Stratton, "Electromagnetic Theory," McGraw-Hill Book Co., Inc., New York, N. Y., 1941; chap. I.

electrical terminals,  $E$ ,  $D$ , and  $J$  must also vary with  $t$  in the same way. We found above that  $H$ , and, therefore  $\nabla \times H$ , is independent of  $t$ ; hence, from (1b) we see that  $\nabla \times H = 0$ . Since both  $\nabla \times H$  and  $\nabla \cdot H$  are zero,  $H$  itself must be a constant vector; and if no external sources of  $B$  are present, we are free to impose the conditions that

$$B = 0$$

and

$$H = 0, \quad (3)$$

The charge density  $\rho$  appearing in (1c) is real charge density, as opposed to polarization charge density, usually denoted by  $\rho'$ . As the crystal is a dielectric,  $\rho$  is zero except on the surfaces, whereas  $\rho'$  is certainly not necessarily zero. Thus, within the crystal we find that

$$\frac{\partial D_x}{\partial x} = 0; \quad (2c)$$

hence,  $D$  is independent of position—varying only with time. This is an important result and will be used in a later section.

We found above that  $\nabla \times E = 0$  and  $E_y = E_z = 0$ . This permits us to set

$$E_x = -\frac{\partial \phi}{\partial x}$$

in the usual manner, where  $\phi$  is a scalar potential function. By using the definition of voltage difference,

$$V_3 = \int_{\phi_1}^{\phi_2} d\phi,$$

it is immediately evident that

$$V_3 = -\int_{-l/2}^{l/2} E_x dx. \quad (4)$$

This result will be needed in the later development of the mesh equations.

As a result of the above, (1b) becomes

$$J_x = -\frac{\partial D_x}{\partial t}.$$

By remembering that  $I = J \cdot A$ , where  $A$  is the active area of the crystal, and by choosing the time variation of the impressed voltage to be  $e^{j\omega t}$ , we arrive at the expression for current

$$I_3 = -j\omega l D, \quad (5)$$

which is also required for the derivation of the mesh equations. It is no longer necessary to continue the use of subscripts, since we found a variation only with  $t$ , and  $x$ ,  $y$  and  $z$  are no longer of concern.

It should be noted that an important result of the above discussion is that no electromagnetic radiation is produced by the transducer, since Poynting's vector,

$E \times H$ , is zero. This is a direct consequence of the assumptions concerning the shape of the crystal and the electrode arrangement, and only applies when these assumed conditions are valid.

**3.2. Formulation of the Mesh Equations.** The behavior of the piezoelectric medium for the mode considered here is described by the piezoelectric equations<sup>6</sup>

$$-P = C^D \frac{\partial \xi}{\partial x} + hD \quad (6a)$$

$$E = h \frac{\partial \xi}{\partial x} + SD. \quad (6b)$$

These correspond to the equivalent equations for normal elastic dielectric materials<sup>7, 8</sup>

$$-P = \frac{Y(1-\sigma)}{(1+\sigma)(1-2\sigma)} \frac{\partial \xi}{\partial x} = C' \frac{\partial \xi}{\partial x} \quad (6c)$$

$$E = \frac{1}{\epsilon} D = S'D \quad (6d)$$

where

$P$  = pressure in newtons per square meter

$C^D$  = stress-to-strain ratio for infinite slab with  $D=0$  in newtons per square meter

$\xi$  = mechanical displacement of the meter

$h$  = piezoelectric constant in newtons per coulomb or volts per meter

$D$  = dielectric displacement in coulombs per square meter

$E$  = electric field intensity in volts per meter

$S$  = electric intensity to dielectric displacement ratio with  $\partial \xi / \partial x = 0$  in meters per farad (reciprocal of inductive capacitance)

$Y$  = Young's modulus in newtons per square meter

$\sigma$  = Poisson's ratio (dimensionless).

**3.2.1. Mechanical Mesh Equations.** From the first piezoelectric equation, (6a), and (5), we have

$$-P_1 = C^D \frac{\partial \xi_1}{\partial x} - \frac{h}{j\omega l} I_3 \quad (7a)$$

$$-P_2 = C^D \frac{\partial \xi_2}{\partial x} - \frac{h}{j\omega l} I_3, \quad (7b)$$

where the subscript 1 refers to  $x = -l/2$ , and 2 to  $x = l/2$ . In order to combine both mechanical and electrical variables in one equation, it is frequently convenient to consider velocity as the analogue of current, and force the analogue of voltage. It should be noted that this choice is not unique; other analogues are perfectly permissible.<sup>9</sup>

<sup>6</sup> See footnote reference 2; p. 202, formulas 6.32. This set is converted to apply to the thickness vibration by changing the  $y$  subscripts to  $x$ . Displacement is introduced rather than charge from the relation  $Q = 1/4\pi$  (Disp.), and the two sets become similar in form but not in units. This conversion is made if  $C^D = y_0/10$ ,  $h = 3 \cdot 10^4 D$  and  $S = 36\pi \cdot 10^9 k$ . Mason's values for the coefficients for different crystals can be used above if these changes are made.

<sup>7</sup> G. Joos, "Theoretical Physics," Stechert-Hafner, Inc., New York, N. Y., 1934, p. 165 (with  $e_{22} = e_{33} = 0$ ,  $P_{11} = -P$  and  $Y = E$ ).

<sup>8</sup> See footnote 5, p. 10.

<sup>9</sup> See footnote 4, pp. 60-64.



We shall follow this procedure here; but since pressure and not force is the parameter of interest, it is convenient to consider velocity analogous to current density, or surface area times velocity analogous to current.

In order to put (7a, b) in proper form, it is necessary to find the relation between  $\partial\xi/\partial x$  and  $\xi$  since the latter is the desired variable. This can be done by integration of the wave equation which expresses  $\xi$  as a function of  $x$  and  $t$ . By application of Newton's first law to a small volume element of density  $\rho$  (in  $kg/m^3$ ) as shown in Fig. 2, we can write

$$\rho dx dy dz \frac{\partial^2 \xi}{\partial t^2} = [P(x) - P(x + dx)] dy dz.$$

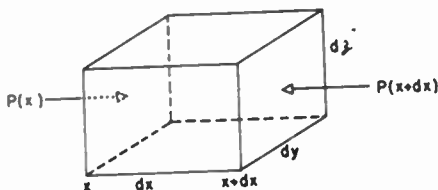

Fig. 2—Forces acting on a small volume element.

Since

$$P(x + dx) = P(x) + \frac{\partial P(x)}{\partial x} dx + \dots,$$

we find, after neglecting higher-order terms,

$$\rho \frac{\partial^2 \xi}{\partial t^2} = - \frac{\partial P}{\partial x}.$$

Upon differentiation of (6a) and introduction in the above, we obtain

$$\rho \frac{\partial^2 \xi}{\partial t^2} = C^D \frac{\partial^2 \xi}{\partial x^2} + h \frac{\partial D}{\partial x}.$$

Recalling from (2c) that  $D$  is independent of  $x$ , we finally obtain the simple wave equation

$$\frac{\partial^2 \xi}{\partial x^2} = \frac{1}{c^2} \frac{\partial^2 \xi}{\partial t^2}, \tag{8a}$$

where

$$c = \sqrt{\frac{C^D}{\rho}} \tag{8b}$$

is the velocity of propagation of the elastic wave in the piezoelectric medium.

Assuming a time variation of the form  $e^{i\omega t}$  as before, this integrates simply, and we have

$$\xi = [\xi_+ e^{-ikx} + \xi_- e^{ikx}] e^{i\omega t} \tag{9}$$

where

$$k = \frac{\omega}{c} = \frac{2\pi}{\lambda}.$$

This form of solution represents the mechanical displacement as the superposition of two traveling waves; one propagating in the positive  $x$  direction, and the other propagating in the negative  $x$  direction.

Upon differentiation, we find

$$\frac{\partial \xi_1}{\partial x} = jk\xi_+ [-e^{i\theta} + \gamma e^{-i\theta}] e^{i\omega t} \tag{10a}$$

$$\frac{\partial \xi_2}{\partial x} = jk\xi_+ [-e^{-i\theta} + \gamma e^{i\theta}] e^{i\omega t}, \tag{10b}$$

where

$$\theta = \frac{kl}{2}$$

$$\gamma = \frac{\xi_-}{\xi_+},$$

and

$$\xi_1 = j\omega\xi_+ [e^{i\theta} + \gamma e^{-i\theta}] e^{i\omega t} \tag{11a}$$

$$\xi_2 = j\omega\xi_+ [e^{-i\theta} + \gamma e^{i\theta}] e^{i\omega t}. \tag{11b}$$

Solving for  $\xi_+$  in (11a), and substituting this in (10a), we obtain

$$\frac{\partial \xi_1}{\partial x} = \frac{k\xi_1}{\omega} \left[ \frac{\gamma e^{-i\theta} - e^{i\theta}}{\gamma e^{-i\theta} + e^{i\theta}} \right]. \tag{12a}$$

In a similar manner, by using (11b) and (10b), we have

$$\frac{\partial \xi_2}{\partial x} = \frac{k\xi_2}{\omega} \left[ \frac{\gamma e^{i\theta} - e^{-i\theta}}{\gamma e^{i\theta} + e^{-i\theta}} \right]. \tag{12b}$$

Recalling the fact that

$$\tanh x = \frac{e^x - e^{-x}}{e^x + e^{-x}},$$

if we define

$$\gamma = e^{2\psi}, \tag{13}$$

the above equations take the simple form

$$\frac{\partial \xi_1}{\partial x} = \frac{k\xi_1}{\omega} \tanh(\psi - j\theta) \tag{14a}$$

$$\frac{\partial \xi_2}{\partial x} = \frac{k\xi_2}{\omega} \tanh(\psi + j\theta). \tag{14b}$$

These two latter equations can now be substituted in (7a, b) to give the proper forms of mesh equations which describe the transducer from the mechanical terminals. By so doing, we obtain finally

$$P_1 = - \frac{\rho c}{A} \tanh(\psi - j\theta) A \xi_1 + \frac{h}{j\omega A} I_3 \tag{15a}$$

$$P_2 = - \frac{\rho c}{A} \tanh(\psi + j\theta) A \xi_2 + \frac{h}{j\omega A} I_3 \tag{15b}$$

where we have included the relation  $C^D k/\omega = c^2 \rho \cdot \omega/c \cdot 1/\omega = \rho c$ . These equations have the desired form, but an ex-

pression for  $\psi$  in terms of the mechanical boundary conditions is required in order to make them more readily usable.

If the ratio of pressure to particle velocity is defined as acoustic impedance,<sup>10</sup> the boundary conditions at  $x = -l/2$  and  $x = l/2$  are specified by stating the acoustic impedances of the loading media. These are determining characteristics of materials, and in general, are both complex and functions of frequency. It should be remembered that the acoustic impedance for a wave traveling in the negative direction in a given medium equals the negative of the impedance for a wave traveling in the positive direction. This is simply seen physically from the fact that at a particular point of reference, the pressure is the same for both waves, but the velocities have opposite signs.

With this understood, the mechanical boundary conditions are imposed by stating

$$-z_1 = \frac{P_1}{\xi_1} \quad (16a)$$

$$z_2 = \frac{P_2}{\xi_2} \quad (16b)$$

Employing (15a) and (16a), we find

$$-z_1 \xi_1 = -\rho c \tanh(\psi - j\theta) \xi_1 + \frac{h}{j\omega A} I_3,$$

and similarly, from (15b) and (16b),

$$z_2 \xi_2 = -\rho c \tanh(\psi + j\theta) \xi_2 + \frac{h}{j\omega A} I_3.$$

Reverting to the original exponential form for  $\tanh x$  and (13), the defining relation for  $\psi$ , these become

$$z_1 \xi_1 = \rho c \frac{\gamma e^{-i\theta} - e^{i\theta}}{\gamma e^{-i\theta} + e^{i\theta}} \xi_1 - \frac{h}{j\omega A} I_3 \quad (17a)$$

$$z_2 \xi_2 = -\rho c \frac{\gamma e^{i\theta} - e^{-i\theta}}{\gamma e^{i\theta} + e^{-i\theta}} \xi_2 + \frac{h}{j\omega A} I_3. \quad (17b)$$

By introducing the expressions for  $\xi_1$  and  $\xi_2$  from (11a) and (11b), respectively, the two equations can be manipulated to solve for  $\gamma$  in terms of the boundary impedances and the constants of the crystal. The resulting expression is

$$\gamma = - \left[ \frac{(\zeta_1 + 1)e^{i\theta} + (\zeta_2 - 1)e^{-i\theta}}{(\zeta_2 + 1)e^{i\theta} + (\zeta_1 - 1)e^{-i\theta}} \right] \quad (18)$$

where

$$\zeta_1 = \frac{z_1}{\rho c}$$

$$\zeta_2 = \frac{z_2}{\rho c}.$$

Finally, from (13), the expression for  $\psi$ , we obtain

$$\psi = \frac{1}{2} \ln \left[ \frac{(\zeta_1 + 1)e^{i\theta} + (\zeta_2 - 1)e^{-i\theta}}{(\zeta_2 + 1)e^{i\theta} + (\zeta_1 - 1)e^{-i\theta}} \right] e^{i\pi}. \quad (19)$$

Having determined the value of  $\psi$  for any general conditions of loading, equations (15a, b) are complete. All the quantities are known with the exception of the three variables  $P$ ,  $A\xi$ , and  $I$ . These, however, are just the quantities of interest, so that the remaining mesh equation describing the transducer from the electrical terminals must be derived. This will then give three equations and three unknowns from which the quantities of interest may be obtained.

**3.2.2. Electrical Mesh Equations.** By integrating the second piezoelectric equation (6b) with respect to  $x$  between the limits  $-l/2$  and  $l/2$  and then introducing (4) we find

$$-V_3 = h(\xi_2 - \xi_1) + SDI \quad (20)$$

where the subscripts have the same meaning as before.

Since  $\xi = j\omega\xi$ , (20) assumes the desired form

$$V_3 = \frac{1}{j\omega C_P} A\xi_1 - \frac{1}{j\omega C_P} A\xi_2 + \frac{1}{j\omega C_E} I_3 \quad (21)$$

where

$$C_P = \frac{A}{n}$$

$$C_E = \frac{A}{Sl}.$$

$C_E$  is recognized as simply the electrostatic capacitance of the parallel-plate capacitor formed by the equipotential surfaces of the transducer separated by the dielectric material.  $C_P$  is defined here as the piezoelectric capacitance of the transducer as a matter of convenience, since it is so similar to  $C_E$ . This completes the derivation of the three mesh equations. We now proceed with the definition of the impedance matrix and a brief discussion of its use.

**3.3. Electromechanical Impedance Matrix.** The mesh equations obtained above are repeated here for convenience.

$$P_1 = -\frac{\rho c}{A} \tanh(\psi - j\theta) \cdot l \xi_1 + \frac{1}{j\omega C_P} I_3 \quad (15a')$$

$$P_2 = -\frac{\rho c}{A} \tanh(\psi + j\theta) \cdot l \xi_2 + \frac{1}{j\omega C_P} I_3 \quad (15b')$$

$$V_3 = \frac{1}{j\omega C_P} \cdot l \xi_1 - \frac{1}{j\omega C_P} \cdot l \xi_2 + \frac{1}{i\omega C_E} I_3. \quad (21')$$

These were obtained for the polarity conditions shown in Fig. 3. Here all arrows point in the positive direction. The lack of symmetry made evident by the signs in (21)' can be rectified by reversing the positive direction of  $\xi_2$ . This is shown in Fig. 4, where the symbol  $v$  has re-

<sup>10</sup> P. M. Morse, "Vibration and Sound," McGraw-Hill Book Co., Inc., New York, N. Y., 1936; p. 191.

placed  $\xi$  to eliminate confusion. That is,  $v_1 = \xi_1$ , but  $v_2 = -\xi_2$ .

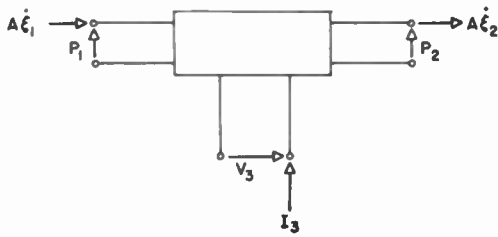

Fig. 3.—Six-terminal network with the original positive polarities.

We see by inspection of Fig. 4 that the six-terminal network is now completely symmetric; all currents are taken positive when feeding into the network at the particular terminals shown. The revised mesh equations become

$$P_1 = \frac{\rho c}{A} \tanh\left(-\psi + j \frac{\omega}{c} \frac{l}{2}\right) A v_1 + \frac{1}{j\omega C_P} I_3 \quad (22a)$$

$$P_2 = \frac{\rho c}{A} \tanh\left(\psi + j \frac{\omega}{c} \frac{l}{2}\right) A v_2 + \frac{1}{j\omega C_P} I_3 \quad (22b)$$

$$V_3 = \frac{1}{j\omega C_P} A v_1 + \frac{1}{j\omega C_P} A v_2 + \frac{1}{j\omega C_E} I_3. \quad (22c)$$

These can be written in matrix form if the usual rules of matrix multiplication are followed.<sup>11</sup>

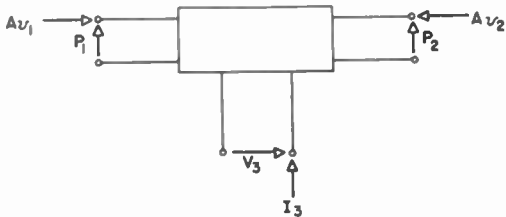

Fig. 4.—Six-terminal network with the revised positive polarities.

Thus,

$$\begin{bmatrix} P_1 \\ P_2 \\ V_3 \end{bmatrix} = [Z] \times \begin{bmatrix} A v_1 \\ A v_2 \\ I_3 \end{bmatrix} \quad (23)$$

where the electromechanical impedance matrix  $[Z]$  is

$$[Z] = \begin{bmatrix} \frac{\rho c}{A} \tanh\left(-\psi + j \frac{\omega}{c} \frac{l}{2}\right) & 0 & \frac{1}{j\omega C_P} \\ 0 & \frac{\rho c}{A} \tanh\left(\psi + j \frac{\omega}{c} \frac{l}{2}\right) & \frac{1}{j\omega C_P} \\ \frac{1}{j\omega C_P} & \frac{1}{j\omega C_P} & \frac{1}{j\omega C_E} \end{bmatrix} \quad (24)$$

<sup>11</sup> E. A. Guillemin, "Communication Networks," vol. II, John Wiley and Sons, New York, N. Y., 1935; chap. IV. The application of matrix algebra to network analysis and the concept of an impedance matrix is discussed in considerable detail.

This matrix is seen to possess some very special properties. Since  $Z_{13} = Z_{31}$ , and  $Z_{23} = Z_{32}$ , the transducer obeys the reciprocity theorem if the proper precautions are taken as to the equality of the internal impedances of any power generating and indicating apparatus introduced.<sup>12</sup> This, of course, must always be the case when applying reciprocity tests. We see also that  $Z_{13} = Z_{23}$  and  $Z_{31} = Z_{32}$ . This implies that the mechanical terminal pairs are equivalent so far as the electrical terminals are concerned. The third point of interest is that  $Z_{12} = Z_{21} = 0$ . This states that the velocity of one crystal face has no effect on the pressure at the other face. Only the current flowing into the electrical terminals and the velocity of the surface in question affects this pressure.

Finally, we recognize that the impedance elements comprising the matrix which are not only functions of frequency but also of acoustic loading once the crystal type and geometry are specified, are the two mechanical self-impedances,  $Z_{11}$  and  $Z_{22}$ . These are functions of loading since  $\psi$  is determined by the acoustic media at the two surfaces. If it were not for this complicating factor, the piezoelectric transducer would be a simpler element with which to work both theoretically and experimentally, since the remaining self- and mutual-impedances assume simple forms.

In the particular case of symmetric loading, we see from (19) that  $\psi = j(\pi/2)$ . Since

$$\tanh j\left(\frac{\omega}{c} \frac{l}{2} \pm \frac{\pi}{2}\right) = -j \cot \frac{\omega l}{c2},$$

we obtain the impedance matrix

$$[Z_s] = \begin{bmatrix} \frac{\rho c}{jA} \cot\left(\frac{\omega}{c} \frac{l}{2}\right) & 0 & \frac{1}{j\omega C_P} \\ 0 & \frac{\rho c}{jA} \cot\left(\frac{\omega}{c} \frac{l}{2}\right) & \frac{1}{j\omega C_P} \\ \frac{1}{j\omega C_P} & \frac{1}{j\omega C_P} & \frac{1}{j\omega C_E} \end{bmatrix} \quad (25)$$

which is only a function of frequency once the crystal is specified. Thus, the treatment of systems employing symmetrical acoustic loading is much simpler than that for the corresponding asymmetrical system.

By inspection of the general  $Z$  matrix, an equivalent circuit for the transducer which is valid for any operating conditions can immediately be determined. This is shown in Fig. 5.

#### 4. Conclusions

The electromechanical impedance matrix, mesh equations, or equivalent circuit obtained above can be used to determine the operating characteristics of the transducer for any general conditions of driving or loading,

<sup>12</sup> See vol. 1, p. 152 of footnote reference 11.

regardless of the terminals in question. The procedure is identical to that used in connection with pure electrical networks whose impedance matrix is specified.

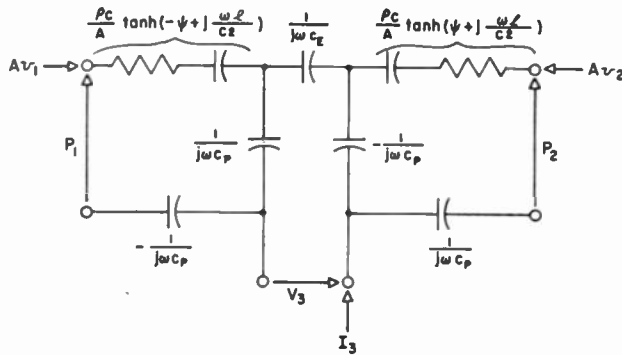

Fig. 5—Six-terminal equivalent circuit valid for any general terminating condition.

Once the boundary conditions satisfied by the respective terminal pairs are stated in terms of the actual values of loading impedances or energy sources, sufficient information is introduced to permit the solution of the set of linear equations for the unknown parameters. Because of the simple form of our final equations, these solutions can be obtained by any of the techniques for solving a set of three linear equations. The methods for solution of such a set of linear equations are numerous and varied, and hence, are beyond the scope of this paper.

As an example of the use of the above theory for the solution of a design problem, the properties of a piezoelectric transducer driven electrically and loaded acoustically in any arbitrary manner are investigated in Section II. General formulas of driving-point impedance and admittance are developed, and a summary of the principal operating characteristics is included. This information is of fundamental importance to the designer who is faced with the task of developing electrical apparatus capable of properly exciting a piezoelectric crystal when loaded by specified media.

## II. ELECTRICAL DRIVING-POINT IMPEDANCE AND ADMITTANCE

### 1. Network Analysis of General Acoustic Loading

By use of (16) and the further relations introduced above,  $\xi_1 = v_1$  and  $\xi_2 = -v_2$ , we specify the boundary conditions existing at the mechanical terminals in the general case by letting

$$\xi_1 = -\frac{P_1}{v_1} \quad (26a)$$

and

$$\xi_2 = -\frac{P_2}{v_2} \quad (26b)$$

Incorporation of these conditions in the circuit of Fig. 5

leads to the circuit of Fig. 6. For problems dealing with reception of acoustic waves, the mechanical boundary conditions would be represented by pressure sources with suitable internal impedances and the electrical boundary condition would be represented by an electrical impedance. It is evident that many combinations of energy sources and sinks are possible, in accordance with the problem to be treated.

The method by which the minus signs in (26) are introduced in this circuit deserves particular comment. The pressure  $P$  has been considered a positive quantity in all the preceding work when the stress applied to a crystal face produces compression with the electrical terminals open-circuited; i.e.,  $I_3 = 0$ . Hence,  $P$  denotes a pressure "rise" completely analogous to a voltage "rise" introduced when discussing a source of electromotive force.

In this sense, the arrows at the terminals of the circuit of Fig. 5 indicate directions of pressure and voltage rises. If we choose to keep both the same positive directions for current flow in the respective meshes as above and positive values for the terminating impedances, (26) shows that  $P$  is negative. Thus, the directions of pressure rises at the two mechanical terminal pairs must be opposite to those indicated in Fig. 5; or the pressure "drops" must be in the arrow directions. By following the velocity mesh currents in Fig. 6, it will be seen that this is indeed the case.

With this clearly in mind, it is evident that the complete solution of the asymmetrical transducer problem can be obtained from an analysis of the relatively simple three-mesh circuit of Fig. 6.

By solving this circuit for the driving-point impedance  $Z = V_3/I_3$ , we obtain the result

$$Z = \frac{1}{j\omega C_E} \left[ 1 - \frac{K^2}{j2\theta} S^* \right], \quad (27a)$$

where

$$S^* = \left[ \frac{1}{\tanh(\psi + j\theta) + \zeta_2} + \frac{1}{\tanh(-\psi + j\theta) + \zeta_1} \right] \quad (27b)$$

in which  $\zeta = Z/\rho c$ , the normalized load impedance, and  $K^2$  is as defined below.

By comparison of the piezoelectric equations (6) with those for a two-mesh electrical network, the simplification included above is achieved. For a two-mesh electrical network, the mesh equations can be written in the form<sup>13</sup>

$$V_1 = Z_{11}I_1 + Z_{12}I_2$$

$$V_2 = Z_{21}I_1 + Z_{22}I_2.$$

In the analysis of such systems, it is usually convenient

<sup>13</sup> See vol. II, p. 135 of footnote reference 11.



to define the dimensionless quantity  $K$  known as the "coupling coefficient," by the relation<sup>14</sup>

$$K^2 = \frac{Z_{12}Z_{21}}{Z_{11}Z_{22}}$$

Equations (6) have the same form as those above, and here, too, it is convenient to define a dimensionless coupling coefficient. In this instance, we obtain

$$K^2 = \frac{h^2}{C^D S} \tag{28}$$

If we recall from (21) that  $C_P = A/h$  and  $C_B = A/Sl$ , and from (8b), that  $c = \sqrt{C^D/\rho}$ , we find

$$K^2 = \frac{A}{C_P^2 \rho c} \times \frac{C_B 2\theta}{\omega} \tag{29}$$

For applications in which the crystal and acoustic loads are specified, the solution is now complete, since all the parameters entering in the above expression for  $Z$  are known. However, we wish here to investigate the behavior of this impedance as we vary the parameters; so, unfortunately, a considerable amount of algebra is necessary in order to convert (27) to a more useful form. Our goal is to obtain expressions for the real and imaginary parts of  $Z$  in terms of the system parameters: crystal constants, normalized load impedances, and frequency.

Substitution of the expression for  $\gamma$  (18) into those for  $\tanh(\psi + j\theta)$  and  $\tanh(-\psi + j\theta)$  [cf. (12) and (14)], respectively leads to

$$\tanh(\psi + j\theta) = \frac{\zeta_2 + \zeta_1 \cos 2\theta + j \sin 2\theta}{\cos 2\theta - 1 + j\zeta_1 \sin 2\theta} \tag{30a}$$

$$\tanh(-\psi + j\theta) = \frac{\zeta_1 + \zeta_2 \cos 2\theta + j \sin 2\theta}{\cos 2\theta - 1 + j\zeta_2 \sin 2\theta} \tag{30b}$$

Using these results for substitution in (27b), we have

$$S^* = \frac{2(\cos 2\theta - 1) + j(\zeta_1 + \zeta_2) \sin 2\theta}{(\zeta_1 + \zeta_2) \cos 2\theta + j(1 + \zeta_1 \zeta_2) \sin 2\theta} \tag{31}$$

Rationalization of this expression to obtain real and imaginary parts results in

$$S^* = S_1 + jS_2 \tag{32a}$$

where

$$S_1 = \frac{[\zeta_1 + \zeta_2][2(1 - \sec 2\theta) + (1 + \zeta_1 \zeta_2) \tan^2 2\theta]}{[\zeta_1 + \zeta_2]^2 + [1 + \zeta_1 \zeta_2]^2 \tan^2 2\theta} \tag{32b}$$

$$R = \frac{K^2}{\delta^2 \frac{\pi}{2} \omega_0 C_B} \left\{ \frac{[\zeta_1 + \zeta_2][1 - \sec \delta\pi + \frac{1}{2}(1 + \zeta_1 \zeta_2) \tan^2 \delta\pi]}{[\zeta_1 + \zeta_2]^2 + [1 + \zeta_1 \zeta_2]^2 \tan^2 \delta\pi} \right\} \tag{35b}$$

<sup>14</sup> A lower-case letter is usually used, but to avoid confusion with  $k$  appearing in (9), the upper case will be used throughout.

and

$$S_2 = \frac{[\tan 2\theta][(\zeta_1 + \zeta_2)^2 + 2(1 + \zeta_1 \zeta_2)(\sec 2\theta - 1)]}{[\zeta_1 + \zeta_2]^2 + [1 + \zeta_1 \zeta_2]^2 \tan^2 2\theta} \tag{32c}$$

If we now consider the driving-point impedance as comprising a resistance  $R$  and reactance  $X$  in series, from (27a) and (32), we find

$$Z = R + jX \tag{33a}$$

where

$$R = \frac{K^2 S_1}{\omega C_B 2\theta} \tag{33b}$$

and

$$X = \frac{K^2}{\omega C_B 2\theta} \left[ S_2 - \frac{2\theta}{K^2} \right] \tag{33c}$$

Although these are expressions for which we have been looking, they can be improved insofar as their applicability to a large range of design problems is concerned. It will be seen from the final equations that a crystal which is symmetrically vacuum-loaded,  $\zeta_1 = \zeta_2 = 0$ , has its first "resonance" for  $\theta = \pi/2$ . Since

$$\theta = \frac{\omega}{c} \frac{l}{2} = \frac{2\pi}{\lambda} \frac{l}{2},$$

if we define the quantity  $\lambda_0$  from the condition that

$$\frac{2\pi}{\lambda_0} \frac{l}{2} = \frac{\pi}{2},$$

we have

$$\lambda_0 = 2l. \tag{34a}$$

Since the velocity of propagation within the crystal  $c$  is a constant of the piezoelectric material, we are able to define the quantity  $\omega_0$  by the equation

$$\omega_0 = \frac{2\pi c}{\lambda_0} \tag{34b}$$

Finally, by defining the dimensionless parameter  $\delta$  by

$$\delta = \frac{\omega}{\omega_0} = \frac{\lambda_0}{\lambda} \tag{34c}$$

we find

$$\theta = \delta \frac{\pi}{2} \tag{34d}$$

Upon introducing these relations in the expressions for the impedance, we obtain the final results:

$$Z = R + jX \tag{35a}$$

where

and

$$X = \frac{K^2}{\delta^2 \frac{\pi}{2} \omega_0 C_E} \left\{ \frac{\tan \delta\pi \left[ \frac{1}{2}(\zeta_1 + \zeta_2)^2 + (1 + \zeta_1\zeta_2)(\sec \delta\pi - 1) \right]}{[\zeta_1 + \zeta_2]^2 + [1 + \zeta_1\zeta_2]^2 \tan^2 \delta\pi} - \frac{\delta \frac{\pi}{2}}{K^2} \right\} \quad (35c)$$

The driving-point admittance is obtained very easily from these equations. Since the admittance  $Y$  is the sum of a conductance  $G$  and susceptance  $B$  in parallel, we have

$$Y = G + jB. \quad (36a)$$

By definition,  $Y=1/Z$ ; thus, from (35a) and (36a) it follows immediately that

$$G = \frac{R}{R^2 + X^2} \quad (36b)$$

and

$$B = -\frac{X}{R^2 + X^2}. \quad (36c)$$

Equations (35) and (36) are the general relations valid for all conditions of loading and frequency consistent with our original assumptions. The crystal constants,  $K$ ,  $\omega_0$ , and  $C_E$ , are only dependent upon the type of piezoelectric material used and its dimensions; whereas, the normalized load impedances,  $\zeta_1$  and  $\zeta_2$ , are determined by the choice of crystal and the loading media. It must be remembered that, in general,  $\zeta$  is complex, although in the majority of ultrasonic applications,  $\zeta$  can be considered real.

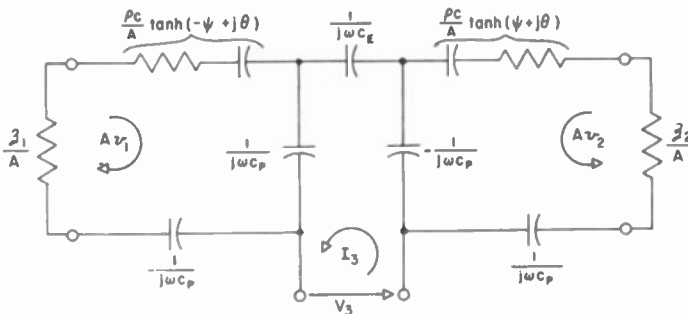

Fig. 6—Two-terminal equivalent circuit including two asymmetric mechanical terminations.

The two representations of the transducer driving its acoustic loads as electrical circuit elements are shown in Fig. 7. The series form is useful when the source of electrical energy has a high internal impedance, while the shunt form is useful for a source having a low internal impedance. These two limiting cases are usually approximated by constant current and constant voltage sources, respectively.

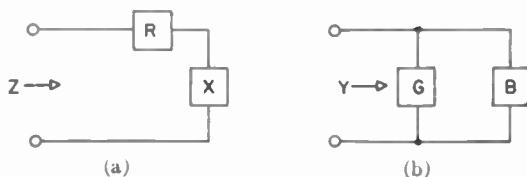

Fig. 7—(a) Two-terminal series equivalent circuit. (b) Two-terminal shunt equivalent circuit.

### 2. Summary of Important Characteristics

Detailed impedance and admittance curves, plotted as functions of frequency for several important loading conditions, are presented in an earlier report,<sup>15</sup> but for the sake of brevity are not repeated here. They give much information concerning the operating characteristics of piezoelectric transducers under varied conditions of loading and frequency. Although most of the details have been left to the actual curves, a listing of the important trends should be of considerable value in assisting the designer to comprehend the behavior of such elements. For verification of the items listed, reference to the curves and equations is required.

- (i.) No power output is obtained at even harmonics of the fundamental frequency other than  $f=0$ .
- (ii.) Bandwidth increases when the load impedance increases. In most cases, this increase continues for load impedances greater than that of the crystal.
- (iii.) Loading of both crystal surfaces leads to greater bandwidths than are obtained by keeping one surface unloaded.
- (iv.) Maximum power output at resonance for a given driving source varies inversely with transducer bandwidth.

- (v.) Operation at very low frequencies requires heavy loading of both surfaces and a source with a high internal impedance.
- (vi.) Loading by materials having impedances greater than that of the transducer leads to doubly peaked resonance curves analogous to those obtained with over-coupled electrical circuits.
- (vii.) With a high internal-impedance source, the resonance frequencies decrease with an increase in loading; but with a low internal-impedance source, the resonance frequencies remain very nearly constant.
- (viii.) With a high internal-impedance source, the power output varies inversely with the square of the order of the harmonic of the fundamental frequency. With a low internal-impedance source and light loading this is also roughly the case; but with heavy loading the power output is very nearly independent of the order of the harmonic.

### ACKNOWLEDGMENTS

The author wishes to express his appreciation to Hans Mueller and J. A. Stratton for their interest in this problem, and for their helpful criticism and suggestions throughout the course of this work.

<sup>15</sup> W. Roth, "Piezoelectric Transducers," Research Laboratory of Electronics, Massachusetts Institute of Technology, Technical Report No. 43, July, 1947.

# Broad-Band Power-Measuring Methods at Microwave Frequencies\*

L. E. NORTON†

*Summary*—Two broad-band methods of measuring power at microwave frequencies have been investigated. In both methods, the normal load termination may remain connected to the microwave generator while the power is being measured.

The first method makes use of the forces due to the electromagnetic fields in a transmission system to cause displacements of a diaphragm or membrane. This displacement is proportional to the square of the actuating fields and is made to operate an indicating system which gives output proportional to the microwave power.

In the second method, thin films on a skin-depth scale are inserted in a microwave transmission system so as to cause only small discontinuities. A small fraction of the total power, usually 1/1800 to 1/200, is dissipated in the film. The indicator system measures the temperature rise of the film, ordinarily as a function of its resistance change, and output is again proportional to the microwave power.

Continuous characteristics have been measured from 1,000 to 10,000 Mc, with additional isolated data at about 300 kc, 5 Mc, and 300 Mc. Both methods give a calibration flat to better than  $\pm 1$  db between 1,000 and 10,000 Mc with gradually reduced sensitivity at lower frequencies for the tellurium-zinc unit.

## INTRODUCTION

WITH RAPID ADVANCES in the entire microwave field, and with ever-increasing use of this region of the frequency spectrum, improved measuring techniques of all kinds have become more and more important. One of the quantities which must frequently be measured is power. While single-frequency methods, and methods applicable to frequency bands only a few per cent in width, have been used for many years, little work has been reported on truly wide-band methods—methods by which power could be measured over frequency intervals of ten, and even approaching (theoretically, at least) bands extending from very low frequencies to the highest now obtainable in the microwave spectrum.

Two broad-band methods of measuring power have been investigated. In each of these methods, the normal termination may be connected to the system at all times.

The two methods are basically different and will be described separately.

## METHOD I

In the first method, use is made of the forces due to electromagnetic fields in a microwave transmission system to produce deflections of a diaphragm. This diaphragm is inserted in a transmission system so as to produce only a small discontinuity. Consequently, the fields

are only slightly disturbed by the insertion of the diaphragm. The displacements of the diaphragm are then made to produce output from an indicator system, and the indicator output is proportional to the square of the fields at the diaphragm. For the case where the termination matches the transmission system and the standing-wave ratio is unity, the output is proportional to the power in the system. For any other termination which produces a standing-wave ratio other than unity, power may again be measured. In this case, an ordinary probe is incorporated in the transmission system near the diaphragm. By measuring both the standing-wave ratio and the value of the field at the diaphragm relative to either the maximum or minimum value, the power may again be calculated from the output indication. The field at the diaphragm is best determined  $n\lambda/2$  distant from the diaphragm, where  $\lambda$  is the wavelength. However, for many applications, the normal termination produces a standing-wave ratio close to unity and the power may, therefore, be read directly.

The first experimental work was done with hollow transmission systems (waveguides) simply because the absence of an inner conductor made constructional work easier. However, in this case, the output indication is independent of frequency only so far as the fields are independent of frequency and, as is well known, in waveguides the fields have a frequency dependence. Therefore, a transmission system in which the fields are independent of frequency was later substituted for the waveguide. A coaxial line with a diameter small enough at the highest frequency so that only the principal mode is propagated is satisfactory to fulfill this condition.

One of the first factors to be considered was the magnitude of the force and diaphragm displacement for moderate powers in the transmission system.

For either waveguide or coaxial line, it should be pointed out that the force due to charges on the inner surface and the electric field terminated by the charge is opposite in sign to the force on the same surface due to the magnetic field and the field terminating current flowing on the surface. Fortunately, for any geometry of transmission which was investigated, these forces could always be made unequal and the resultant force was always approximately that of the larger force.

Orders of magnitude for component and resultant forces for waveguides and coaxial lines for specific powers are shown in Table I and Fig. 1. As indicated, for the best geometry for either waveguide or coaxial line, the maximum force for  $10^{-3}$  watts in the transmission path is far from enormous. It is, in fact, about  $10^{-6}$  dynes/cm<sup>2</sup> for 1 milliwatt.

\* Decimal classification: R245. Original manuscript received by the Institute, March 14, 1948; revised manuscript received, January 21, 1949.

† Radio Corporation of America, RCA Laboratories Division, Princeton, N. J.

TABLE I

Rectangular cross-section waveguide. Only $E_{1,0}$ mode propagated Power $10^{-3}$ watts. $\lambda = 3.22 \times 10^{-2} m$ . $a = 1.016 \times 10^{-2} m$ . $b = 2.286 \times 10^{-2} m$ . $F_e$ , $F_m$ , and $ F_r $ are times $10^6$ dynes/cm $^2$ .							
Waveguide height $a$				Waveguide height $a/10$			
Waveguide Width $b$	$F_e$	$F_m$	$ F_r $	Waveguide Width $b$	$F_e$	$F_m$	$ F_r $
0.204	0.101	0.103		2.04	1.01	1.03	
				$8b/10$	3.80	0.86	2.94
				$3b/4$	5.52	0.68	4.84

These calculations are given in Appendix I and Appendix II. In a waveguide, both  $F_e$ , the force due to the electric component of field, and  $F_m$ , the force due to the magnetic component of field, vary inversely with the

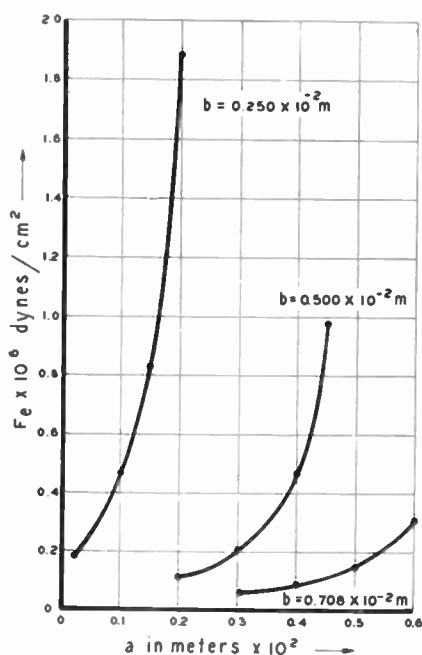
Fig. 1—Force  $F_e$  for several sizes of coaxial line.

small waveguide dimension  $a$  so the ratio  $F_e/F_m$  is independent of  $a$ . The important resultant quantity  $|F_r|$ , which is the difference between  $F_e$  and  $F_m$ , varies inversely with  $a$ . However, by reducing the large, or  $b$ , waveguide dimension, the  $F_e/F_m$  ratio is made large so that the resultant  $|F_r|$  is reasonable and the indication is more sensitive.

In a coaxial line,  $F_e = F_m$  so the resultant  $|F_r|$  is zero. If there are gaps between the ends of the ribbon-type membrane and the main outer wall, the longitudinal current and associated  $F_m$  reduce nearly to zero and the resultant force  $|F_r|$  is nearly equal to  $F_e$ .

If this method is to be used to measure power as small as several milliwatts, it is necessary to determine the signal-to-noise ratio for small actuating powers. The small magnitude of the force for small powers seemed to indicate that there was little point in attempting to use the deflected diaphragm in the equivalent of a dc system

where the deflection would have to be measured from a zero reference which itself would be far from fixed in position due to the effects of other extraneous mechanical or acoustic forces which might be present.

Therefore, microwave energy impinging on the diaphragm was modulated completely and the over-all diaphragm and indicator system, with the diaphragm itself operating at its lowest resonant frequency, was made a narrow-band system. Modulation may be effected by direct modulation of the generator, a shutter placed anywhere in the path between generator and diaphragm, or by use of a switched parallel path with the diaphragm in one of the two parallel channels. It is most essential to choose the modulation rate of the microwave fields not so low that an additional and enormous "flicker effect" noise appears in the first tube, since it is then convenient to divide the total noise into only four contributing groups—the thermal noise of the grid-cathode circuit of the first tube following the diaphragm, the plate noise of the first tube, the thermal noise of the diaphragm, and the thermal noise of the air coupled to the diaphragm.

For a bandwidth of 10 cps at the modulation frequency of several kilocycles, the largest noise contribution is the thermal noise of the diaphragm. It seems unlikely that microwave powers smaller than about 1 milliwatt can be measured by this method since the computed signal-to-noise ratio at 1 milliwatt is only about 3. Experimental evidence appears to bear this out.

Any of several methods may be used to make use of the diaphragm displacement. A back plate may be placed immediately adjacent to the diaphragm so as to produce a capacitor. For use in an amplitude system, this capacitor is maintained at constant charge over the modulation cycle by a long-time-constant charging circuit. The resulting changing voltage across the capacitor is used as in a condenser microphone except that, in this case, the following system is made narrow band. It was found necessary to use special cathode-follower coupling circuits between the diaphragm capacitor and the first amplifier tube when operating with only several milliwatts of microwave power. The small capacitor was also used to frequency-modulate a small line-controlled oscillator operating at a convenient frequency near 500 Mc. The ultimate limiting signal-to-noise ratio at low microwave power is about the same with the FM and AM systems. A metal-surfaced piezoelectric material with the inner metal surface replacing a section of metallic wall of the transmission system may also be used. The result is still another form of AM system. If desired, it is also possible to use optical methods for measuring the small diaphragm displacements.

The diaphragm arrangement applied to waveguides appears in Fig. 2. In adapting either piezoelectric crystals or metallic diaphragms to a coaxial-line system operating at wavelengths as short as 3 cm, to insure propagation of only the principal mode, the diameter must, of necessity, be small. To avoid serious geometric disconti-



nities, it becomes impossible to incorporate a square or circular cross-section unit of 1 cm<sup>2</sup> dimension in the wall. Therefore, it is expedient to use long and narrow

A plot of the output of the force unit at constant power input is shown in Fig. 6 for a wavelength range 3 to 30 cm.

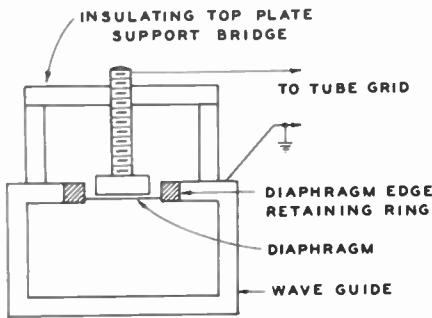

Fig. 2—Force-actuated diaphragm in a waveguide.

units with about the same over-all area to insure about the same acting force. A coaxial unit is shown in the photograph of Fig. 3.

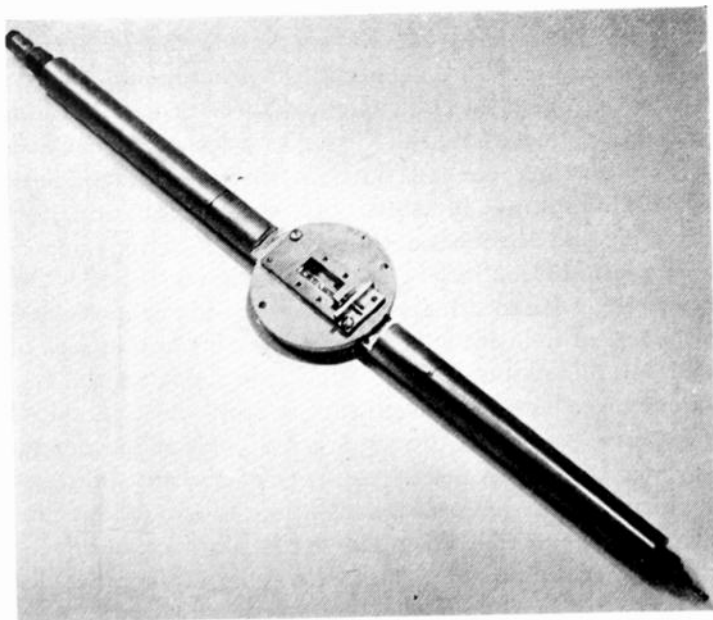

Fig. 3—Force-actuated diaphragm in a coaxial line.

As has been indicated, the output potential of any of the force-operated units is proportional to the square of the electromagnetic fields. A calibration of the force unit against a standard thermistor wattmeter is shown in Fig. 4. It is also possible to calibrate the unit by another simple method. Since the microwave fields in the coaxial system are independent of frequency, the forces are likewise independent of frequency, and it is only necessary to substitute low-frequency fields (from the modulator, for example) as determined by voltmeters or ammeters and then to observe the relation between the known low-frequency fields and the output indicator.

If a standing wave of the form  $\alpha = \alpha_0 \cos 2\pi L/\lambda$  exists along the diaphragm of length  $L$ , then Fig. 5 is a plot of the total force on the diaphragm as the length is increased, at constant frequency.

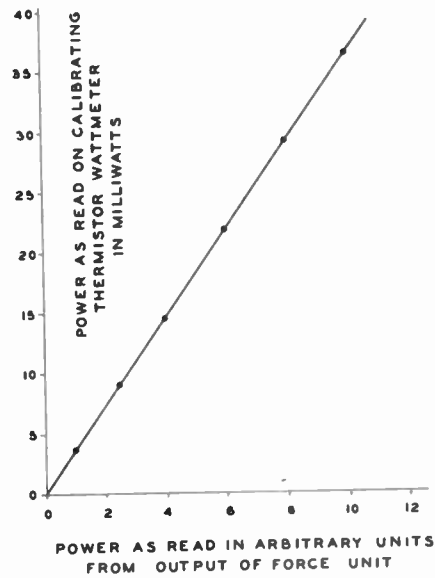

Fig. 4—Calibration of force-operated diaphragm unit versus a standard thermistor unit.

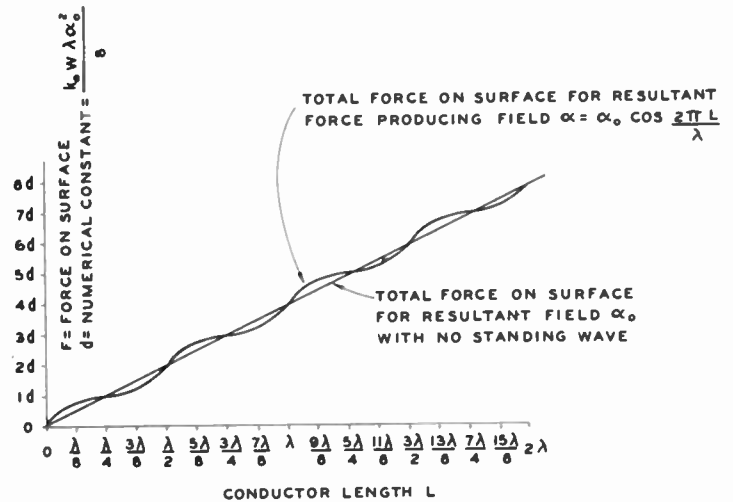

Fig. 5—Plot of total force on diaphragm versus length at constant frequency

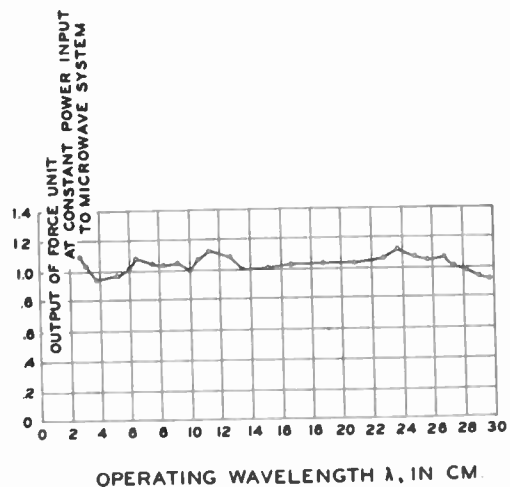

Fig. 6—Output of force-operated unit at constant power input for a wavelength range from 3 to 30 cm.

At power levels of the order of  $10^{-3}$  watts, some care must be taken to isolate the diaphragm from extraneous noise excitation or acoustic excitation. If the minimum power is raised to  $10 \times 10^{-3}$  watts, the severity of the over-all problem is materially reduced.

As indicated in Fig. 4, the force-operated unit measures powers in the transmission system of the order of milliwatts. It is impossible to specify, in absolute fashion, the minimum power-measuring capabilities, since the result depends upon finally chosen minimum filter bandwidths and values of mechanical  $Q$  of the diaphragm. The result is modified further if, for example, instead of an integrating meter, a cathode-ray output device is used so as to utilize the selection and integrating properties of the eye in the presence of noise. However, for a diaphragm mechanical  $Q$  of about 3 in the presence of the closely spaced back plate near the diaphragm, and using a filter with an ultimate bandwidth of 1 cps at a resonance frequency of about 300 cps, the over-all signal-to-noise ratio is favorable for a driving force due to 1 milliwatt in the transmission system. Equally important, the output is independent of frequency.

## METHOD II

This method uses a low-conductivity film, thin on a skin-depth scale, which is inserted in a transmission system so as to introduce small discontinuity into the system. A small fraction of the power is dissipated in the film. The fractions used have ranged from 1/1,800 to 1/200. The output indicating system provides a potential which is a function of the temperature rise of the film, and which is proportional to the square of the actuating electromagnetic field.

The thin film may be inserted in waveguide or coaxial line in either of several methods. Two general classifications may be made.

(a) Insertion of the thin film, with proper backing in a slot made by cutting away a section of waveguide wall, or of inner or outer conductor of coaxial line. Because of the difficulty of bringing out leads which would not disturb the microwave field configuration, no attempt was made to attach the thin film to a slot in the inner conductor.

(b) Insertion of the thin film in a plane normal to the direction of propagation in a waveguide or coaxial line. In the latter case, the plane of the thin film is, of course, also normal to the axes of the concentric conductors.

The first method is shown in Fig. 7. When a section of

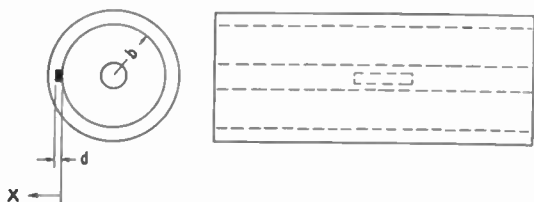

Fig. 7—Method of insertion of film and backing in a slot in the outer conductor of a coaxial line (shown schematically).

the wall of the transmission system is slotted and replaced by a strip of thin film, it is essential to place a high-conductivity surface in back of, and close to, the film to prevent fields from appearing in the region behind the film with resulting frequency-dependent radiation. For this case of a thin film strip backed by a high-conductivity surface replacing a section of wall, to a good approximation the total fields remain unchanged from the original values.

However, the currents thus indicated are the total currents flowing in the thin film and high-conductivity backing. Since only the fraction of the current flowing in the film contributes materially to its temperature rise, it is necessary to determine the current division ratio. This may be done as follows. The film and backing are approximately in parallel for longitudinal current flow and the division ratio will depend on the equivalent impedances of the two surfaces, each having a finite conductivity.

The exponential decrease of fields through the thickness of the thin film is small. Therefore, the entire physical volume of the thin film is exposed to the fields independent of frequency so long as the film remains thin on a skin-depth scale. The current density in the thin film does not change materially from its value at the surface. The important result is that the equivalent impedance of the thin film remains nearly constant as the frequency is varied and is almost entirely real.

The situation is different in the thick, high-conductivity backing for the film. Here, because of the exponential decrease of field intensity in the metal, more or less of the actual volume is exposed to the fields as the frequency is changed. The result is that the equivalent resistance varies as the square root of the frequency. Because the equivalent resistance of the thin film remains constant with frequency while the equivalent resistance of the thick backing varies as the square root of the frequency, the power absorbed in the thin film varies with the frequency.

This result is based on the assumption that a thin film has only the properties of a scaled-down thin section of conductor. There is some experimental evidence, although it is sketchy and incomplete, that evaporated thin films of certain metals exhibit either an equivalent series-inductance or shunt-capacitance effect which, over a certain frequency interval, eliminated this power

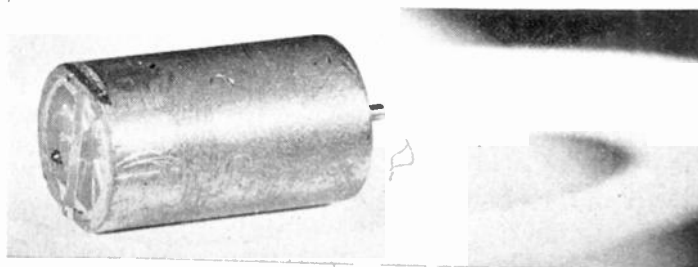

Fig. 8—Thin-film unit for insertion in a slot in a waveguide or coaxial line.

frequency dependence. However, in general, the above result holds and the configuration of Fig. 7 can never be made very broad band.

A thin film unit suitable for insertion in a slot in a waveguide or coaxial-line wall appears in Fig. 8.

Referring to the structure of Fig. 9 where the thin film is placed in a plane normal to the axes of the concentric conductors, a different situation exists. The thin film, with some approximation, may be considered as a very short section of line of complex characteristic impedance which is inserted between the other two sections of normal line.

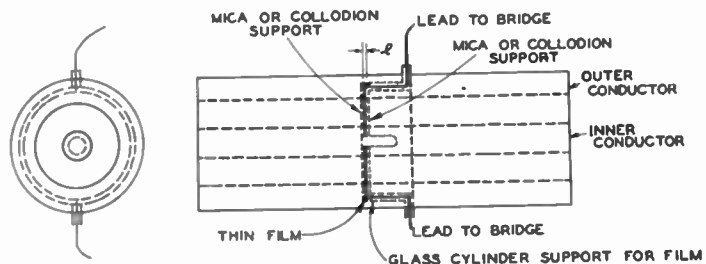

Fig. 9—Method of inserting thin film in a plane normal to the axes of the concentric conductors of a coaxial line.

The conductivity of the tellurium-zinc thin-film material is 500 mhos per meter. For a maximum operating frequency of  $10^{10}$  cps and assuming (so as to obtain a definite number) that the maximum standing-wave ratio introduced by the thin film should not exceed about 1.02 for all phases, the maximum permissible thickness of the film,  $l$  in Fig. 9, was calculated to be  $3.2 \times 10^4$  Angstrom units. For a film thickness equal to or less than this value, the discontinuity and reflection at the film is slight provided the film is supported on a very thin base material like collodion or mica.

The leads from the thin film are brought out and connected as one arm of a four-element bridge. For a small unbalance, the unbalance current and potential are proportional to the incremental resistance change. The incremental resistance change for a small incremental temperature rise is proportional to the power in the transmission system. Because of the nonlinear resistance-voltage characteristic of the tellurium-zinc films, filters with bandwidths narrow enough to eliminate harmonics of the low-frequency potential applied to the bridge must be used with the amplifier and indicator system following the bridge.

Initial calibration is effected by comparison with a calibrated wattmeter which is substituted for the normal termination. Calibration was also made in another way. A known amount of power was supplied to the transmission system and the corresponding output reading noted. The incremental resistance change which was required to give this output was determined by substituting known values of incremental resistance to give the same output reading. From the known resistance-temperature characteristic of the film material, the cor-

responding temperature rise was computed. The power required to provide this temperature rise for a long, thin film was then calculated. This power, when compared with the power in the system, produced the ratio of power dissipated in the film to the power transmitted in the system.

Once this fraction is known, calibration is effected by switching in a known amount of power to the bridge at zero frequency as determined by a dc milliammeter, and noting the output of the indicator. The system gain is then always set to give the same output for the known value of calibrating dc power input.

For the case where a standing wave exists in the transmission system, the same procedure using a standing-wave detector, as described for the force-operated wattmeter, again permits power to be measured.

A calibration obtained by plotting output of the thin film against known powers in the transmission system is shown in Fig. 10. Although the sensitivity can be ex-

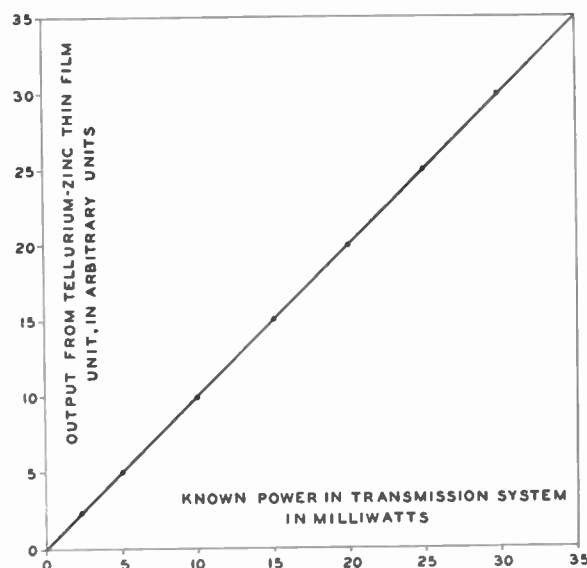

Fig. 10—Calibration of thin-film unit showing output versus known powers in the transmission system.

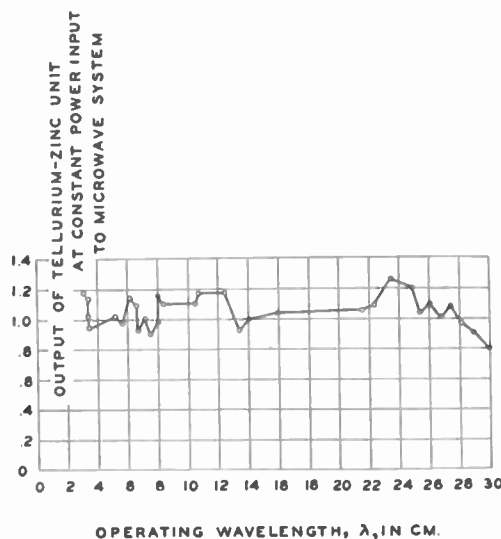

Fig. 11—Thin-film output versus frequency at constant microwave power

tended somewhat, because of the fact that only a small fraction of the power is dissipated in the film, many difficulties can be avoided if the minimum system power to be measured is made about 1 mw.

A plot of the indicator output against frequency at constant microwave power appears in Fig. 11. Most of the fluctuations are due to reflections at the various line couplings.

One of the thin film units for transverse insertion in a waveguide or coaxial line is shown in Fig. 12.

As in the case of the force-operated wattmeter, readings may be taken continuously with the normal termination always connected to the transmission system.

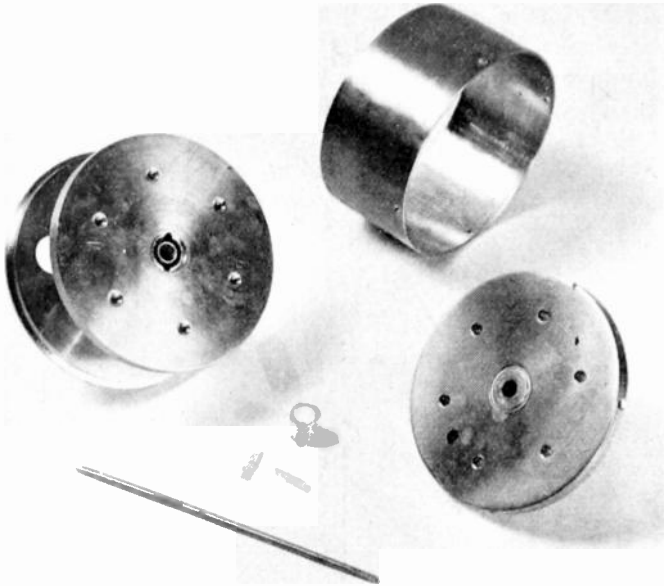

Fig. 12—Thin-film unit for insertion in a coaxial line or waveguide, plane normal to direction of propagation.

## APPENDIX I

### Force-Operated Unit and Waveguide Transmission Path

For the infinite conductivity, rectangular cross-section waveguide of Fig. 13, and with only the  $E_{1,0}$  mode propagated, the following fields exist

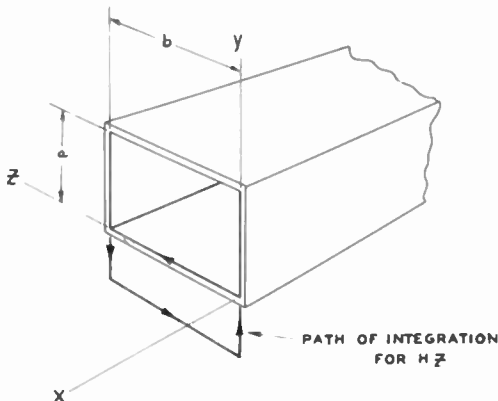

Fig. 13—Waveguide for discussion in Appendix I.

$$E_y = iA\omega\mu_0 \frac{b}{\pi} \sin\left(\frac{\pi z}{b}\right) e^{i(\omega t - \beta x)} \quad (1)$$

$$E_x = 0 \quad (2)$$

$$E_z = 0 \quad (3)$$

$$H_x = A \cos\left(\frac{\pi z}{b}\right) e^{i(\omega t - \beta x)} \quad (4)$$

$$H_y = 0 \quad (5)$$

$$H_z = iA \frac{b}{\pi} \sin\left(\frac{\pi z}{b}\right) e^{i(\omega t - \beta x)} \quad (6)$$

where

$$\beta = \left[ \left( \frac{\omega}{c} \right)^2 - \left( \frac{\pi}{b} \right)^2 \right]^{1/2} \quad (7)$$

The following notation will be used:

- $a$  = small waveguide dimension
- $b$  = large waveguide dimension
- $\mu_0 = 4\pi \times 10^{-7}$  henrys per meter
- $\epsilon_0 = 10^{-9}/36\pi$  farads per meter
- $c = 3 \times 10^8$  meters per second
- $\lambda_0 = 2b$  = waveguide cutoff wavelength in meters
- $f_0 = c/2b$  = waveguide cutoff frequency in cps
- $f$  = frequency in cps
- $S$  = power in watts.

The potential between top and bottom surfaces of the waveguide midway between the side walls ( $z = b/2$ ) is

$$V = \int_0^a E_y dy = \frac{iA\omega\mu_0 ab}{\pi} \text{ volts} \quad (8)$$

and the total longitudinal current flowing along the top or bottom surfaces is expressed by the integral

$$I = \int_s H_x \cdot ds = \int_0^b H_x \cdot dz = i2.1\beta \left( \frac{b}{\pi} \right)^2 \text{ amperes.} \quad (9)$$

Since it will be convenient to compute various quantities on a unit power basis it is well to note that, from the complex Poynting vector, the average power is

$$S = \int 1/2 [E_y \times H_x^*] dA = \frac{A^2}{4} \omega\mu_0 \beta \left( \frac{b}{\pi} \right)^2 ab \quad (10)$$

where the asterisk indicates the conjugate of  $H_x$ .

Defining a characteristic impedance on a power-current basis,

$$Z_{SI} = \frac{S}{I_{rms}^2} = \frac{\omega\mu_0\pi^2 a}{8\beta b} \quad (11)$$

and defining another characteristic impedance on a potential-current basis

$$Z_{VI} = \frac{V}{I} = \frac{\omega\mu_0\pi a}{2\beta b}, \quad (12)$$

then from (8), (9), (10), (11), and (12) the rms potential between top and bottom surfaces is



$$V_{rms} = \left[ \frac{2\omega\mu_0 a S}{\beta b} \right]^{1/2} = \left[ \frac{S\pi\omega a S \times 10^{-7}}{\beta b} \right]^{1/2} \text{ volts.} \quad (13)$$

The field  $E_y$  has no  $y$  dependence and so the field is simply

$$E_y = \frac{V}{a} = \left[ \frac{S\pi\omega S \times 10^{-7}}{\beta b a} \right]^{1/2} \text{ volts/meter.} \quad (14)$$

The longitudinal rms current along either top or bottom of the waveguide for a power  $S$  is

$$I_{rms} = \left[ \frac{8\beta b S}{\omega\mu_0 \pi 2a} \right]^{1/2} \text{ amperes,} \quad (15)$$

and, since the longitudinal current in the  $z$  direction has a  $\sin \pi z/b$  distribution, the current per unit strip at the center where  $z=b/2$  is

$$\begin{aligned} (I_x)_{z=b/2} &= \frac{\pi}{2b} \left[ \frac{8\beta b S}{\omega\mu_0 \pi 2a} \right]^{1/2} \\ &= \left[ \frac{\beta S \times 10^7}{2\omega\pi b a} \right]^{1/2} \text{ amperes.} \end{aligned} \quad (16)$$

The force per unit area due to the electric component is directed along  $E_y$  and is

$$F_e = \frac{\epsilon_0 E^2}{2} = \frac{E^2}{72\pi} \times 10^{-4} \text{ dynes/meter}^2 \quad (17)$$

or

$$\begin{aligned} F_e &= \frac{\omega S \times 10^{-11}}{9\beta b a} \text{ dynes/meter}^2 \\ &= \frac{S \times 10^{-3}}{3ab \left[ 1 - \left( \frac{\lambda}{2b} \right)^2 \right]^{1/2}} \text{ dynes/meter}^2. \end{aligned} \quad (18)$$

The force at the center of the bottom ( $z=b/2$ ) conductor per strip of unit width and of unit length due to the magnetic field  $B$  and the field terminating longitudinal current is

$$F_m = (I_x)_{z=b/2} \times \frac{B_z}{2} \quad (19)$$

or

$$\begin{aligned} F_m &= \mu_0 (I_x)_{z=b/2} \times \left( \frac{H_z}{2} \right)_{z=b/2} = \frac{\mu_0}{2} (I_x)_{z=b/2}^2 \\ &= 2\pi (I_x)_{z=b/2}^2 \times 10^{-7} \text{ newtons} \\ &= 2\pi (I_x)_{z=b/2}^2 \times 10^{-2} \text{ dynes,} \end{aligned} \quad (20)$$

all per unit width strip per unit length.

From (20) and (16), the force is

$$\begin{aligned} F_m &= \frac{\beta S \times 10^6}{ba} \text{ dynes/meter}^2 \\ &= \frac{\left[ 1 - \left( \frac{\lambda}{2b} \right)^2 \right]^{1/2} S \times 10^{-3}}{3ab} \text{ dynes/meter}^2. \end{aligned} \quad (21)$$

The ratio  $F_e/F_m$  becomes

$$\begin{aligned} \frac{F_e}{F_m} &= \frac{\omega S \times 10^{-11}}{9\beta b a} = \frac{\omega^2 \times 10^{-16}}{9\beta^2} \\ &= \frac{1}{\left[ 1 - \left( \frac{\lambda}{2b} \right)^2 \right]} \end{aligned} \quad (22)$$

The resultant force acting on a unit surface of top or bottom wall is

$$F_r = F_e + F_m \quad (23)$$

and, since  $F_e$  is directed in the positive  $y$  direction and  $F_m$  in the negative  $y$  direction,

$$|F_r| = F_e \left\{ 1 - \left[ 1 - \left( \frac{\lambda}{2b} \right)^2 \right] \right\}$$

or

$$|F_r| = \left( \frac{\lambda}{2b} \right)^2 F_e. \quad (24)$$

Near cutoff,  $F_e$  becomes large, but of course, other considerations preclude the possibility of operating too near this critical wavelength. The resultant force  $F_r$  becomes very much larger as the cutoff wavelength is approached. In fact,

$$|F_r| \lim_{\lambda \rightarrow 2b} = \left( \frac{\lambda}{2b} \right)^2 \lim_{\lambda \rightarrow 2b} F_e = F_e. \quad (25)$$

## APPENDIX II

### Force-Operated Unit and Coaxial-Line Transmission Path

Referring to Fig. 14, the field conditions which exist are as follows:

$$E_r = \left[ \frac{\mu_0}{\epsilon_0} \right]^{1/2} \frac{H_0}{r} e^{i(\omega t - \gamma z)} \quad (26)$$

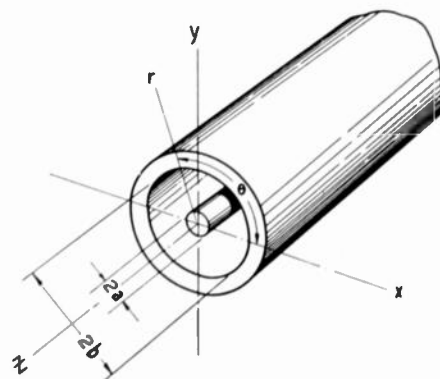

Fig. 14—Coaxial line for discussion in Appendix II.

$$E_\theta = 0 \quad (27)$$

$$E_r = 0 \quad (28)$$

$$H_r = 0 \quad (29)$$

$$H_\theta = \frac{H_0}{r} e^{i(\omega t - \gamma z)} \quad (30)$$

$$H_z = 0 \quad (31)$$

where

$$\gamma = \omega [\epsilon_0 \mu_0]^{1/2} = \frac{\omega}{c} \quad (32)$$

and  $H_0$  is a number.

The total voltage across the inner and outer conductors is

$$\begin{aligned} V &= \int_a^b E_r \cdot dr = \left[ \frac{\mu_0}{\epsilon_0} \right]^{1/2} H_0 e^{i(\omega t - \gamma z)} \int_a^b \frac{dr}{r} \\ &= \left[ \frac{\mu_0}{\epsilon_0} \right]^{1/2} H_0 e^{i(\omega t - \gamma z)} \log b/a. \end{aligned} \quad (33)$$

Combining (26) and (33),

$$V = r E_r \log b/a \quad (34)$$

or

$$E_r = \frac{V}{r \log b/a} \quad (35)$$

The field at  $r = b$  is

$$(E_r)_{r=b} = \frac{V}{b \log b/a} \quad (36)$$

The total longitudinal current flowing on the inside surface of the outer conductor is

$$I = \int_0^{2\pi b} H_\theta \cdot da = 2\pi b H_\theta = 2\pi H_0 e^{i(\omega t - \gamma z)}. \quad (37)$$

The characteristic impedance of the line may be defined as

$$\begin{aligned} Z_0 &= \frac{V}{I} = \frac{\left[ \frac{\mu_0}{\epsilon_0} \right]^{1/2} H_0 e^{i(\omega t - \gamma z)} \log b/a}{2\pi H_0 e^{i(\omega t - \gamma z)}} \\ &= \frac{\left[ \frac{\mu_0}{\epsilon_0} \right]^{1/2}}{2\pi} \log b/a. \end{aligned} \quad (38)$$

Since  $\mu_0 = 4\pi \times 10^{-7}$  henrys/meter

$$\epsilon_0 = \frac{10^{-9}}{36\pi} \text{ farads/meter}$$

$$Z_0 = 60 \log b/a. \quad (39)$$

Computing the various quantities on a constant-power basis,

$$S = \frac{V^2}{Z_0} = \frac{V^2}{60 \log b/a}, \quad (40)$$

so that (36) becomes

$$(E_r)_{r=b} = \left[ \frac{60S}{b^2 \log b/a} \right]^{1/2} \quad (41)$$

The force due to the field is, from (17),

$$F_e = \frac{(E_r)_{r=b}^2 \times 10^{-4}}{72\pi} = \frac{5S \times 10^{-4}}{6\pi b^2 \log b/a}. \quad (42)$$

The longitudinal current per unit width strip on the inside surface of the outer conductor is

$$I_z = \int_0^1 H_\theta \cdot ds = H_\theta = \frac{H_0}{b} e^{i(\omega t - \gamma z)}. \quad (43)$$

$$\begin{aligned} I_z &= \frac{V}{b \left[ \frac{\mu_0}{\epsilon_0} \right]^{1/2} \log b/a} \\ &= \left[ \frac{60S}{b^2 \frac{\mu_0}{\epsilon_0} \log b/a} \right]^{1/2} \text{ amperes/meter.} \end{aligned} \quad (44)$$

The force per unit area due to the magnetic field  $H_\theta$  and the field terminating current  $I_z$  is

$$F_m = I_z \times \frac{H_\theta}{2} = \mu_0 I_z \times \frac{H_\theta}{2}.$$

From (43) and (44)

$$F_m = \frac{5S \times 10^{-4}}{6\pi b^2 \log b/a} \text{ dynes/meter}^2. \quad (45)$$

The ratio of the two forces  $F_e$  and  $F_m$  is

$$\frac{F_e}{F_m} = 1. \quad (46)$$

The force  $F_m = \mu_0 I_z \times H_\theta / 2$  is, of course opposite in sign to the force  $F_e = \epsilon_0 E^2 / 2$ , so that the resultant force is zero, since

$$|F_r| = F_e - F_m = F_e - F_e = 0. \quad (47)$$

It is possible to make a ribbon membrane in a coaxial line almost entirely  $F_e$  operated by providing small gaps between the ends of the ribbon membrane and the main outer wall. The longitudinal current and corresponding  $F_m$  then reduce nearly to zero.

# A Forward-Transmission Echo-Ranging System\*

DONALD B. HARRIS†, SENIOR MEMBER, IRE

**Summary**—A new type of echo-ranging system is described in which the receiver is located at a distance from the transmitter. It is shown that, with a configuration of this type, the range of the target with respect to the receiving station is equal to the difference in path between the direct and reflected waves divided by the versine of the angle of elevation of the receiving antenna ( $\rho = \delta / 1 - \cos \theta$ ). By making the radial writing speed proportional to this function, a PPI presentation system can be realized which shows a profile of the propagation path viewed from the side. This system has particular application in detecting targets such as, for example, atmospheric irregularities, which have a low reflection coefficient at normal incident angles. The system, therefore, promises to be useful in the study of propagation problems.

## INTRODUCTION

UHF PROPAGATION studies have revealed the undeniable existence of irregularities of some type in the propagation path, which result in multipath transmission and variation in signal strength received at distances considerably beyond the horizon. This phenomenon does not appear to be due to "ducts," which produce a strong and fairly steady signal over a considerable period of time: the irregularities referred to exist at times when ducts appear to be absent, and cause extremely rapid fading. The appearance on the recording instruments is similar to that which would be caused by reflections from a multiplicity of reflecting objects moving at random in the propagation path.

Vertical radar soundings have been made<sup>1</sup> and have successfully located, directly overhead, air-mass boundaries of the type which may be responsible for the observed results. It appears possible that similar soundings taken horizontally, with grazing incidence and, consequently, enhanced reflection response at the target surface, might reveal numerous irregularities distributed throughout a considerable length of the propagation path.

This paper considers the possibility of developing an instrumentation system, using radar techniques, capable of operating with small beam-to-target-surface angles, and of displaying, on a PPI indicator, a profile of at least a portion of the propagation path, in order to show the instantaneous shape, size, and location of irregularities located in the path at any time, and their motion over a period of time. The approach suggested and analyzed involves a pulsed transmitter at the transmitting site, and a receiver at a distant receiving site adapted to measure the difference in path between a wave received directly from the transmitter and waves reflected from or refracted by irregularities at the same

small angles encountered in propagation work; to indicate the angle of arrival of the reflected or refracted waves; and to apply the resultant information to a sweep circuit and PPI indicator in such a manner as to display the coordinates of the irregularities, with reference to a rectangular frame of reference in which the horizontal axis represents distance along the propagation path and the vertical axis represents elevation.

## FORM OF THE DISPLAY CONTROL FUNCTIONS

Fig. 1 shows a profile of the propagation path, viewed from the side. It is evident from the figure that the

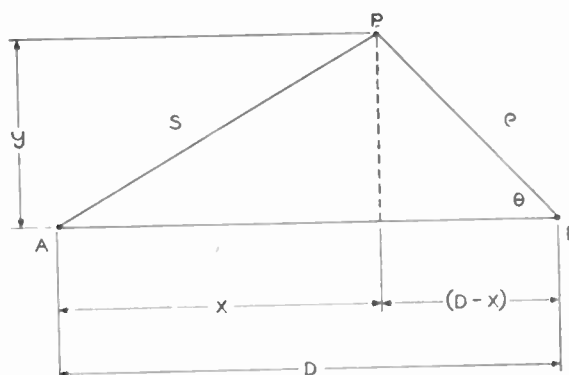

Fig. 1—Profile of propagation path between transmitter at A, and receiver at B, with target or irregularity at P.

range  $\rho$  may be determined from the following relationship:

$$S + \rho = D + \delta \quad (1)$$

where  $\delta$  is the difference in path length between the direct and the reflected or refracted wave. We can eliminate  $S$  from this equation by employing the trigonometric relation

$$S = \sqrt{\rho^2 + D^2 + 2\rho D \cos \theta}, \quad (2)$$

which, when substituted in (1) gives, after expansion and collection of terms,

$$\rho = \frac{\delta(2D + \delta)}{2[D(1 - \cos \theta) + \delta]} \quad (3)$$

If this equation were used directly to control the sweep voltage of a PPI-display system, some complication would result from the nonlinear dependence of  $\rho$  on  $\delta$ . This disadvantage may be obviated by making the simplifying assumption that  $\delta$  is small in comparison with  $2D$  and with  $D(1 - \cos \theta)$ . Under these conditions, (3) reduces to

$$\rho_a = \frac{\delta}{1 - \cos \theta}, \quad (4)$$

\* Decimal classification: R537.1XR365.33. Original manuscript received by the Institute, October 18, 1948; revised manuscript received, March 9, 1949. Presented, 1949 IRE National Convention, New York, N. Y., March 9, 1949.

† Collins Radio Co., Cedar Rapids, Iowa.

<sup>1</sup> A. W. Friend, "Theory and practice of tropospheric sounding by radar," *PROC. I.R.E.*, vol. 37, pp. 116-138; February, 1949.

where  $\rho_a$  is the approximate range. This is an expression which can easily be used to control the sweep voltage along the scanning line.

#### INSTRUMENTATION

In practice, (4) would be applied to the control of the scanning voltage in the following manner: We first convert the independent variable of (4) from a distance to a time base, by substituting the relation

$$\delta = ct, \quad (5)$$

where  $c$  is the velocity of propagation, and  $t$  is the elapsed time between the reception of the direct wave and the reception of the reflected or refracted wave, to obtain

$$\rho_a = \frac{c}{1 - \cos \theta} t. \quad (6)$$

It is to be noted that this relationship is linear for any given value of the antenna elevation  $\theta$ , but that it depends on this elevation. It is now evident that the displacement  $\rho_s$  of the spot across the face of the scope should be proportional to the range, or

$$\rho_s = k_1 \rho_a = \frac{k_1 c}{1 - \cos \theta} t. \quad (7)$$

We attain this exact displacement by superimposing a sweep voltage

$$e_s = k_2 \rho_s = \frac{k_1 k_2 c}{1 - \cos \theta} t \quad (8)$$

on the deflecting elements of the scope. Here  $k_2$  is a constant depending on the characteristics of the tube. ( $k_2$  is about 70 volts per inch in typical tubes.)

From (7), it is evident that the radial writing speed is

$$\frac{d\rho_s}{dt} = \frac{k_1 c}{1 - \cos \theta}. \quad (9)$$

As the elevation of the antenna changes, this radial writing speed is also varied by changing the time constants of the sweep circuits in accordance with information transmitted by synchros attached to the antenna elevation axis. The intensity of the spot is modulated by the echo signal received from the target, and, therefore, if such a signal is received at time  $t$  it will be displayed as a bright spot displaced along the scanning line by a distance  $k_1 \rho_a$  linearly proportional to the range of the target, as required.

The value of  $k_1$  is, of course, determined by the range required and the size of the scope. If, for example, we wish to have the total length of the scanning line represent a distance of  $0.5 \times 10^6$  feet (about 95 miles), and the scanning line is 4 inches, or 0.333 feet long,  $k_1$  is  $0.666 \times 10^{-6}$ . Substituting this value, together with the velocity of light, in (9), we obtain for the writing speed in meters per second

$$\frac{d\rho_s}{dt} = \frac{0.666 \times 10^{-6} \times 300 \times 10^6}{1 - \cos \theta} = \frac{200}{1 - \cos \theta}. \quad (10)$$

This quantity will actually vary between wide limits, depending upon the antenna elevation, as will be demonstrated later.

The synchronizing pulse for starting the sweep can probably best be transmitted over a separate channel.

#### APPRAISAL OF ACCURACY AND FEASIBILITY

The manner in which the approximate-range equation (4) deviates from the exact-range equation (3) at range values beyond  $0.01D$  is shown by Fig. 2. It appears that, for our purposes, the discrepancy becomes unacceptable as the range exceeds  $0.5D$ , is probably tolerable between  $0.5D$  and  $0.1D$ , and is negligible at a range of  $0.1D$  or below.

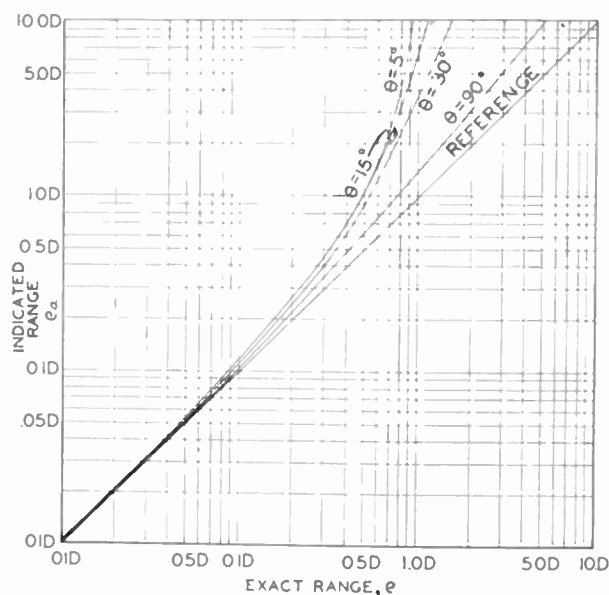

Fig. 2—Correct range  $\rho$  versus approximate range  $\rho_a$  for various elevation angles  $\theta$ .

The pulse length required can be most easily determined by examining the actual path differences encountered at various altitudes and horizontal distances from the receiver. Since we are presumably interested in a horizontal layer of irregularities this procedure will be facilitated by the development of an equation relating the rectangular co-ordinates of the irregularity to the path difference. It can easily be shown that such an equation can be obtained from (1) by substituting the co-ordinate values of  $S$  and  $\rho$ . The result is

$$y = \frac{D}{2(p+1)} \sqrt{p(p+2)[p(p+2) - 4q^2 + 4q]} \quad (11)$$

where

$$p = \frac{\delta}{D} \quad (12)$$



and

$$q = \frac{x}{D} \tag{13}$$

This is the equation of an ellipse in  $x$  and  $y$ . Thus, for any given value of  $\delta$  (or  $p$ ), the irregularity may lie anywhere on an ellipse defined by (11), the foci of which are points  $A$  and  $B$ . Equation (11) is plotted in Fig. 3. It is seen from this figure that if a base line of  $D = 500,000$  feet, or about 95 miles, be assumed, the delay ratio of an object at  $q = 0.90$ , or at a distance of 50,000 feet from the receiver, and at an elevation of 2,500 feet, is somewhat greater than 0.0001; a precise calculation employing (11) shows that the exact value is 0.000138, corresponding to a path difference of 69 feet or a time delay of 0.0702 microsecond.

Since the irregularities involved may actually lie at an elevation of 2,500 feet, it is concluded that extremely short pulses of the order of 0.01 microsecond in length will be required.

The range resolution realizable at a given elevation angle can be determined from the approximate range equation (6), which immediately gives, for the change in range  $\Delta\rho_a$  with change in time  $\Delta t$ ,

$$\Delta\rho_a = \frac{c}{1 - \cos \theta} \Delta t \tag{14}$$

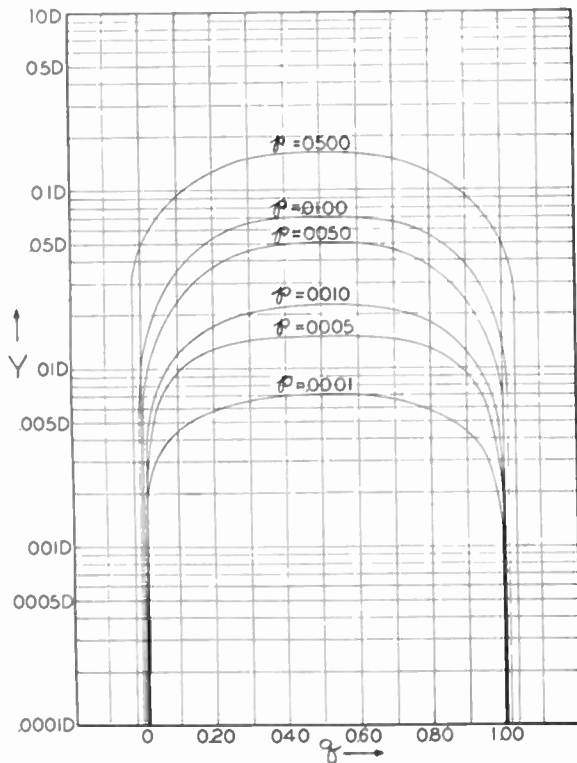

Fig. 3—Lines of constant delay ratio  $p = \delta/D$ , where  $\delta$  is difference in path length between direct and reflected or refracted waves, and  $D$  is total length of path.

Now it is evident that, in order to obtain resolution, the time interval  $\Delta t$  between echoes from consecutive

objects along the scanning line, must be at least equal to the pulse length  $T$ . Or,

$$\Delta\rho_{ar} = \frac{c}{1 - \cos \theta} T, \tag{15}$$

where  $\Delta\rho_{ar}$  is the approximate range resolution.

The application of (10) and (15) to a surface at a constant elevation of 2,500 feet gives the following results at various horizontal distances from the receiver, assuming a base line of 500,000 feet, and a pulse length of 0.01 microsecond:

At a horizontal distance of 50,000 feet, corresponding to an antenna-elevation angle of  $2.87^\circ$ , the range resolution along the scanning line is 7,868 feet. The writing speed is 16.0 centimeters per microsecond.

At lower antenna-elevation angles, representing objects at a greater distance along the 2,500-foot constant-elevation surface, the range resolution will, of course, deteriorate, and the writing speed will also increase to a value attainable only with the greatest difficulty.

On the other hand, as the range decreases, the definition improves greatly, and the writing speed decreases to normal values. For example, for a target 2,500 feet high at a horizontal distance of 9,310 feet (0.018D) from the receiving site, corresponding to an elevation angle of  $15^\circ$ , the writing speed is 0.587 centimeter per microsecond, and the range resolution is about 290 feet.

With regard to the minimum range at which irregularities are observable, no data are available as to the maximum angle between the beam and the surface of the irregularity, beyond which the irregularity ceases to reflect or refract the beam. It seems safe to assume, however, that reflections will continue to be obtained up to an angle of arrival of  $15^\circ$ . It should, therefore, be possible to see irregularities lying at an elevation of 2,500 feet at horizontal distances from the receiving site not less than 9,310 feet.

This discussion of irregularities at minimum altitudes represents, of course, the worst condition. Irregularities lying at higher elevations will be readily detectable with improved definition.

Fig. 4 provides, for purposes of example, an over-all graphical summary of the specific propagation application proposed, involving a base line of 500,000 feet. In this figure the elevation  $y$ , in feet, is plotted against the horizontal co-ordinate  $x$  of the target, in feet, measured from the transmitter, for various constant values of the writing speed  $d\rho_a/dt$ , here designated as  $V_s$ , expressed in centimeters per microsecond, and of the resolution  $\Delta\rho_{ar}$ , in feet, employing the approximate equations (10) and (15).

CONCLUSION

Summarizing the analysis, it is indicated that it should be possible, using the proposed system, with a base line of 500,000 feet, to obtain valuable data regarding the nature of irregularities causing anomalous propagation phenomena, provided that the irregularities lie

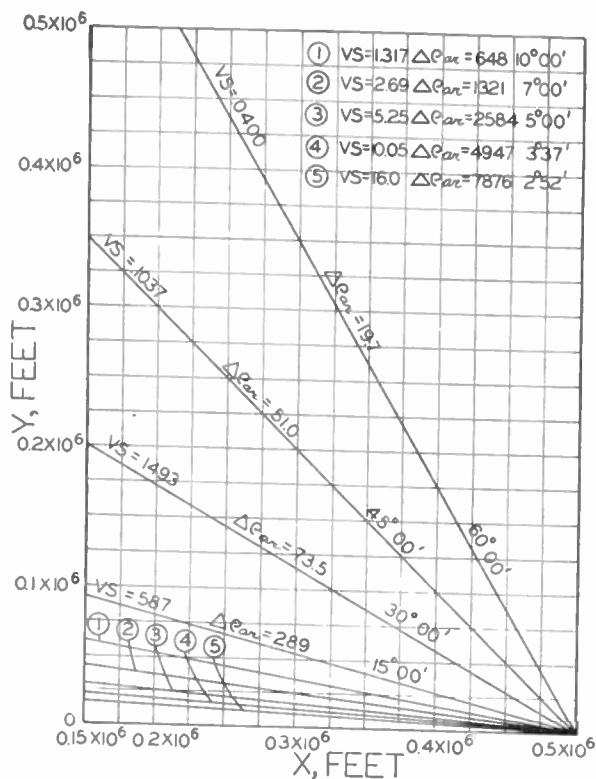

Fig. 4—Lines of constant sweep velocity  $V_s$  and constant range resolution  $\Delta\rho_{par}$  for various elevation angles  $\theta$ , assuming base line of 500,000 feet, and oscilloscope scanning line length of 4 inches.

at elevations in excess of 2,500 feet. That portion of a hypothetical layer of irregularities at an elevation of 2,500 feet which extends along the propagation path between distances of  $0.1D$ , 50,000 feet, 9.48 miles, and  $0.018D$ , 9,310 feet, 1.76 miles, from the receiving site, should be presented with sufficiently good definition to permit detailed study. In order to achieve this result, it will be necessary to use equipment capable of detecting and displaying path differences as small as 69 feet, and time intervals as small as 0.07 microsecond, leading to the conclusion that a pulse length not greater than  $0.01 \times 10^{-6}$  seconds is required. A receiving antenna pattern  $0.5^\circ$  wide is required. Irregularities lying at higher elevations can be displayed with less difficulty and with improved definition.

In view of these requirements, it appears evident that the study should be made at microwave frequencies, probably in the  $X$  or  $K$  band.

#### ACKNOWLEDGMENT

The author gratefully acknowledges the assistance of his colleagues in the Collins Radio Co., J. W. Clark, W. W. Farley III, I. H. Gerks, J. P. Giacometto, J. J. Livingood, D. O. McCoy, and W. W. Salisbury, and of F. W. Pierce of Rock Island, Ill., all of whom have read the original manuscript and made valuable suggestions.

## The Measurement and Interpretation of Antenna Scattering\*

D. D. KING†, MEMBER, IRE

**Summary**—The significance of scattering cross section and back-scattering cross section in terms of antenna current distribution is considered. In particular, the influence of antenna load impedance on the magnitude and directional pattern of the scattered radiation is pointed out. A measuring scheme is described which utilizes the standing waves set up by energy reflected toward the transmitter from any receiving antenna or parasite. This method permits direct study of the back-scattering from loaded and unloaded antennas. Approximate scattering data for several types of antennas are included.

### I. INTRODUCTION

ALTHOUGH the concept of scattering and absorption cross sections is common to many branches of physics, its applications to antennas have been limited. This is reasonable, since the field pattern and input impedance suffice to specify antenna

performance in a convenient fashion for practical use. An exception to this statement is the obvious application to radar of the back-scattering or radar cross section. The assigning of a radar cross section to a given target, whether it is an aircraft or a piece of "window," implies that this object functions as an antenna. The back-scattering cross section may therefore be interpreted as a measure of the antenna currents excited on such an object. The use of scattering data as a clue to the mechanism of antennas with complex shapes appears logical and the work described in the present paper was undertaken with this in mind.

The standing-wave method of measurement which was developed for the study of back-scattering furnishes information on the amplitude and phase of the scattered radiation relative to the incident beam. The image system used for the data to be presented also allows convenient variation of the antenna load. Of course, only antennas with a plane of symmetry are treated by image methods. The results obtained so far are of a preliminary nature and are presented to illustrate the possibilities and limitations of the method.

\* Decimal classification: R221. Original manuscript received by the Institute, August 16, 1948; revised manuscript received, January 17, 1949. The research reported in this paper was made possible through support extended Cruft Laboratory, Harvard University, jointly by the Navy Department (Office of Naval Research) and the Signal Corps, U. S. Army, under Contract N5ori-76, T. O. I.

† Formerly, Cruft Laboratory, Harvard University, Cambridge, Mass.; now, Radiation Laboratory, Johns Hopkins University Baltimore, Md.

Nevertheless, certain conclusions may be drawn from the results presented which are not explicit in impedance and pattern data.

In the following sections some aspects of the scattering concept are reviewed briefly. The experimental procedure and results are discussed subsequently. Details of algebra are deferred to the Appendix for the convenience of the reader.

## II. BASIS OF SCATTERING AND ABSORPTION MEASUREMENTS ON ANTENNAS

Ordinarily, three cross sections or effective areas are defined for an antenna. In these definitions the antenna is assumed to be illuminated by a substantially plane wave front.

Absorption:

$$A_0 = \frac{\text{power in load}}{\text{incident power density}}$$

Scattering:

$$A_r = \frac{\text{power reradiated}}{\text{incident power density}}$$

Back scattering:

$$\sigma = 4\pi \frac{\text{power reflected toward the source/unit angle}}{\text{incident power density}}$$

The absorption cross section may be derived from the field pattern by integrating the power received over the entire solid angle. This summation of the power received divided by the incident power density defines an average absorption cross section equal to  $\lambda^2/4\pi$  for any antenna with matched load.<sup>1</sup> The product  $(\lambda^2/4\pi) \cdot (\text{directivity})$  then gives the absorption cross section in any particular direction. Actually, the power received in the load is reduced by the amount of the losses in the antenna.<sup>2</sup>

An alternative definition of the absorption cross section is available in terms of the effective height  $h_e$  and the input resistance  $R_a$  of an antenna.

$$A_0 = \frac{h_e^2}{R_a} \sqrt{\frac{\mu_0}{\epsilon_0}} \quad (1)$$

The calculated value of  $A_0$  given by (1) depends on the current distribution, and hence measurement of  $A_0$  provides a test of calculated current distributions.<sup>3</sup>

The scattering cross section  $A_r$  is best considered in

<sup>1</sup> J. C. Slater, "Microwave Transmission," McGraw-Hill Book Co., 1942, p. 264.

<sup>2</sup> C. G. Montgomery, "Techniques of Microwave Measurements," McGraw-Hill Book Co., New York, N. Y., 1947, pp. 898-915.

<sup>3</sup> R. W. King, H. R. Mimno, and A. H. Wing, "Transmission Lines, Antennas, and Wave Guides," McGraw-Hill Book Co., New York, N. Y., 1945, pp. 164-173.

terms of the equivalent circuit for the receiving antenna drawn in Fig. 1.

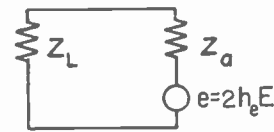

Fig. 1—Circuit of receiving antenna.

Here

$Z_L$  = load impedance

$Z_a$  = antenna input impedance

$E$  = incident electric field

$h_e$  = effective height of antenna for the particular angle of incidence.

Three values of the load impedance  $Z_L$  are now chosen in turn for the equivalent circuit:

1.  $Z_L = Z_a^*$  where the asterisk means that the term is a complex conjugate. Then

$$P_L = P_a = e^2/4R_a \quad (2)$$

Here  $P_L$  is the power dissipated in the load and  $P_a$  the power dissipated in the antenna; i.e., the power reradiated or scattered. Hence, for a matched load, absorption and scattering cross sections are equal.

2.  $Z_L = 0$  Then.

$$P_a = e^2 R_a / (R_a^2 + X_a^2) \quad (3)$$

The power scattered, and hence the scattering cross section, depends on the reactance  $X_a$ . In general, the scattering is small both far from resonance ( $X_a$  large) and at antiresonance ( $R_a$  large). At resonance, however, the scattering is four times as great with  $Z_L = 0$  as with  $Z_L = Z_a^*$ . According to the equivalent circuit the phase of the scattered radiation relative to the incident wave varies from  $-\pi/2$  for very short dipoles to  $+\pi/2$  before antiresonance. However, the expression for the radiated field in terms of antenna current contains a factor  $-j$  or  $\exp. (-j(\pi/2))$  which corresponds to a phase shift of  $+\pi/2$ . Therefore, the observed phase angle of the scattered radiation in the far zone should approach zero for short, unloaded dipoles; the observed phase angle should approach  $\pi/2$  for  $h = \lambda/4$  when  $Z_L = 0$ , and for all  $h$  when  $Z_L = Z_a^*$ .

3.  $Z_L \rightarrow \infty$ . With open-circuited terminals the equivalent circuit predicts zero scattering. This is correct in so far as the current distribution of the loaded or short-circuited antenna is concerned. However, an open circuit at the terminals of a complex antenna may permit other currents elsewhere in the antenna with appropriate scattering. An example of this is a dipole with a flat plate or a corner reflector.

The back-scattering cross section  $\sigma$  is the product of the total scattering cross section  $A_r$  and the directivity. Actually,  $\sigma$  is proportional to the square of the directivity, since  $A_r$  involves the directivity and the energy is received and reradiated at the same angle. If the scatterer is operated with a matched load, the current distribution, and hence the directivity, is the same as for the antenna when used as a driven element. However, an unloaded scatterer,  $Z_L=0$ , may have a current distribution different from the loaded distribution.<sup>4</sup> Similarly, a more complicated structure involving parasitic elements may exhibit a scattering pattern different from its pattern as a driven or a receiving element. This is not contrary to reciprocal theorems since the scatterer then contains no load.

The dependence of the scattering pattern on the antenna load is generally small. However, the amplitude of the scattered radiation continues to be a function of the load impedance. This fact has been used in a scheme for antenna pattern measurements on aircraft models,<sup>5</sup> in which the load impedance of the receiving antenna in the model is varied at an audio rate and the resultant modulation of the back-scattering is detected in the transmitting horn.

Aside from furnishing a means of obtaining field patterns, scattering data provide information on the current distributions in complex antennas. Thus, the metal surfaces of aircraft, ships, or vehicles mounting antennas support parasitic currents. Considerable attention has lately been devoted to the study of such surface currents.<sup>6</sup>

In principle, the efficient utilization of the metallic surfaces of, say, an aircraft, as elements of a receiving antenna might be achieved as follows: First, locate regions of large surface current, and second, devise a scheme for efficient coupling of a transmission line and load to the surface currents. The success of such a scheme is measured in terms of input impedance and field pattern data. However, the choice of coupling depends on knowledge of the initial currents on the surfaces. These unloaded currents or "natural modes" are evidenced by corresponding maxima in the scattering cross section  $A_r$ . The back-scattering cross section  $\sigma$  is a more sensitive indicator of these "natural-mode" currents by virtue of the squared directivity factor involved. The effectiveness of coupling to the unloaded surface currents may be observed in terms of the ratio of unloaded to loaded scattering.

### III. STANDING-WAVE MEASUREMENT OF BACK-SCATTERING

The determination of back-scattering by direct intensity measurements usually is hampered by the large attenuation from the inverse fourth-power term in the

radar equation. Moreover, pulse techniques fail at short ranges. An alternative approach to back-scattering measurements is suggested by the analogy between wave transmission in free space and on a line. The application of transmission-line methods to the scattering problem yields formulas of practical value subject to certain mild restrictions.

The radiation field of an antenna is a traveling wave with propagation constant  $\beta = 2\pi/\lambda$ , which is the same as on a lossless line; the decline in amplitude is proportional to  $1/r$ . An obstacle placed in the path of these traveling waves generates a reflected wave having a certain fraction of the incident amplitude. The reflection coefficient may be defined as usual in terms of the ratio of the sum and difference of incident and reflected waves. The resultant expression is more complicated than for a line since the standing-wave ratio is a function of position. However, the formula as derived in Appendix II involves no assumptions except that the field everywhere is of the form, constant  $\cdot (e^{-i\beta r})/r$ .

The formulas necessary to calculate the back-scattering cross section  $\sigma$  in terms of measured standing-wave ratios are derived in Appendix II. An application to sample data is discussed in the following section. It remains to analyze the actual distribution of the fields as a function of the distance  $r$  from an antenna.

In case the antennas involved have dimensions much greater than the wavelength, the situation may be discussed in optical terms. The so-called Fresnel-Fraunhofer boundary, defined as  $R = D^2/\lambda$ , (where  $D$  is the aperture diameter of the antennas and  $R$  their separation) is the basic unit in this approach. At the distance  $r = R$ , the phase error is less than  $\pi/4$  and the power received is less than 5 per cent below the ideal value. This assumes a very small probe to test the field. Larger probes increase the distance  $R$  for the above limits of error. In general, when the two antennas involved have apertures  $D_1$  and  $D_2$ , the minimum separation is  $R = (D_1 + D_2)^2/\lambda$ . From this, the minimum separation  $R$  may be expressed in terms of the distances  $R_s$  and  $R_p$  calculated for the scatterer and probe separately.

$$R = R_s + R_p + 2\sqrt{R_s R_p} \quad (4)$$

Details of the optical arguments are available in the literature.<sup>2</sup>

The situation when the antenna dimensions are of the same magnitude as the wavelength is of greater interest in the present discussion. Under such conditions well-defined antenna resonances are to be expected. An exact analysis, of course, presumes a knowledge of the current distribution of the particular antenna under test. However, an estimate of the distances involved is obtainable by assuming a dipole of appropriate length with sinusoidal current distribution. A

<sup>4</sup> See p. 165 of footnote reference 3.

<sup>5</sup> G. Sinclair, E. C. Jordan, and E. W. Vaughan, "The measurement of aircraft antenna patterns using models," Proc. I.R.E., vol. 35, pp. 1451-1467; December, 1947.

<sup>6</sup> J. V. N. Granger, "Low-Frequency Aircraft Antennas," Cruft Laboratory Technical Report No. 25, December 30, 1947.



brief derivation of the necessary expression is given in Appendix I. Graphs of the results are shown in Fig. 2.

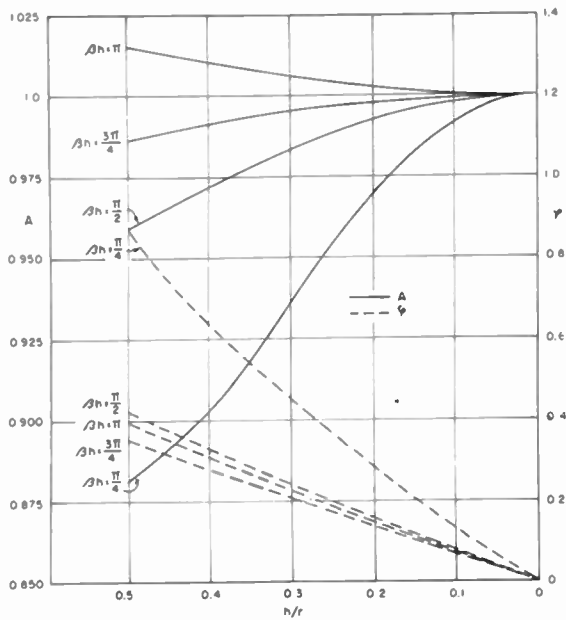

Fig. 2—Variation of amplitude  $A$  and phase  $\phi$  of the field near a dipole. The abscissa is the ratio of dipole half-length to distance from the dipole.

Here,  $A$  represents the factor by which the ideal amplitude of  $E$  field must be multiplied to obtain the actual amplitude;  $\phi$  is the phase shift from the ideal value.

The graph shows that errors in both amplitude and phase become small at relatively short distances from a dipole. These results are in agreement with those of Dunn and King<sup>7</sup> for the case of a dipole parallel to a conducting sheet. It appears that the radiation or far-zone field is a good approximation at points quite close to a dipole for all lengths  $h \leq \lambda/2$ , i.e., as long as the gain, and hence the aperture remains small. Apparatus making use of this fact for the measurement of back-scattering at relatively short distances from antennas is described in the next section. Since a finite probe length is used, a somewhat larger separation,  $R$ , is required than Fig. 2 would indicate. By inserting in (4) separate readings from the graph for probe and scatterer, a good estimate of the new minimum separation may be obtained.

#### IV. AN APPARATUS FOR BACK-SCATTERING MEASUREMENTS

The standing-wave measurements proposed are to be made near the scatterer along the radius vector  $\vec{r}$ , between scatterer and source. The use of an image-plane system simplifies the design problem. This restricts the antennas under test to types with planes of symmetry, but there are many symmetrical structures which may

<sup>7</sup> B. C. Dunn, Jr., and Ronold King, "Currents excited on a conducting plane by a parallel dipole," *Proc. I.R.E.*, vol. 36, pp. 221-229; February, 1948.

be examined profitably. An image system eliminates the need of supports for the model under test and permits the use of a transmission-line probe protruding through a slot along  $\vec{r}$  in the image plane. Furthermore, matching stubs and control equipment may be located directly behind the test position. These considerations favor the use of an image screen provided one of sufficient size and uniformity is available.

A large size is desirable for two reasons. First, reflections from the edges are thereby reduced to negligible proportions, and second, the transmitting antenna may be located very far from the region of measurement so that the incident beam approaches a plane wave. This effectively eliminates attenuation in the incident wave over the region in which measurements are made, and hence an inverse square relation replaces the inverse fourth power in the radar equation.

The standing-wave method is characterized by simplicity in the electronic apparatus required. The electronic equipment used for the present measurements is shown in Fig. 3. Monitors are provided for frequency

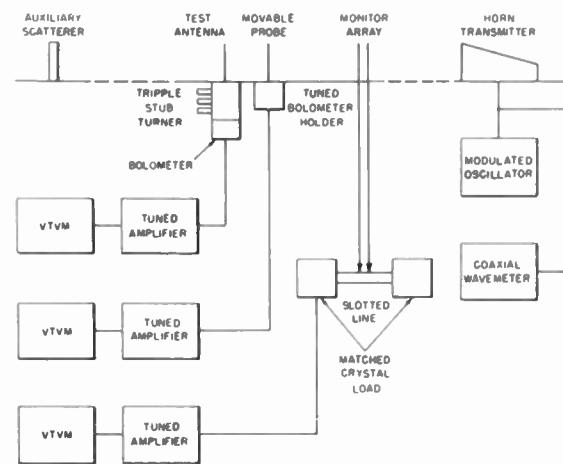

Fig. 3—Block diagram of the measuring system.

and power. The latter consists of a directional coupler formed by two quarter-wave elements spaced a quarter-wavelength apart. The two cables from this array terminate in adjustable probes mounted on a slotted line matched at both ends. Crystals in the terminations at each end of this line give indications proportional to the incident and reflected power on the image screen. The incident-power output operates the monitor meter. Because of the critical adjustment required for a high front-to-back ratio, the reflected-power output of this type of directional coupler is not a satisfactory substitute for the standing-wave probe. In principle, the use of a directional coupler in the equivalent transmission line formed by the image screen appears feasible.

The antenna under test is mounted a short distance beyond the end of a slot cut in the image plane to accommodate a movable probe. The monitor is mounted at the opposite end of the slot, permitting the standing-

wave detector to travel over an interval of several wavelengths between monitor array and scatterer. To provide a matched load for certain measurements, a triple-stub tuner with bolometer load is used. The output of the bolometer amplifier furnishes the data for the determination of relative absorption cross sections, as mentioned earlier. Fig. 3 shows a block diagram of the system.

Intrinsic standing waves attributable to irregularities in the surface of the image screen proved to be an undesirable feature of the image-plane method. Here again the transmission-line analogy turned out to be useful: An auxiliary scatterer placed many wavelengths beyond the measuring position along the line can be adjusted to reduce substantially the intrinsic standing waves over the measuring interval. The remaining slight variations are compensated by the simple expedient of plotting the residual standing-wave pattern. Deviations from the mean value of the residual pattern are added to the observed maxima and minima or subtracted from them, according to the sign of the deviation.

### V. DATA AND RESULTS

A curve of the residual standing waves and the standing waves produced by a dipole slightly longer than  $\lambda/4$ , with  $Z_L = 0$ , is shown in Fig. 4. The standing-wave ratios

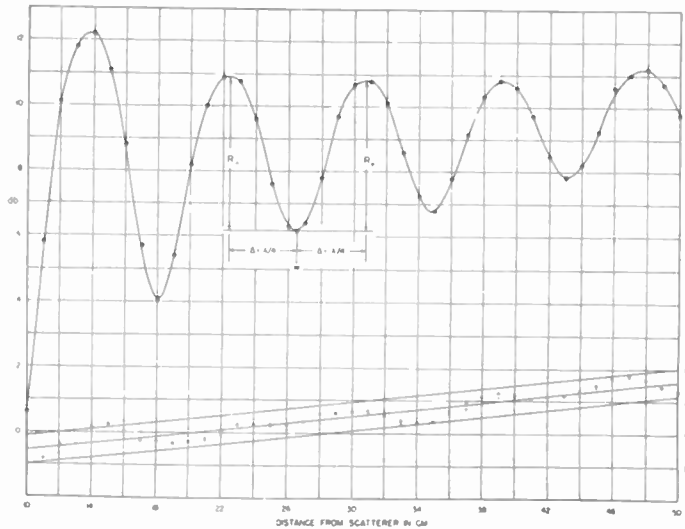

Fig. 4—Standing-wave data. The top curve was taken with a dipole scatterer; the lower curve shows residual standing waves.

relative to one of the minima are indicated. It is interesting to note that the mean slope of the intrinsic standing-wave pattern corresponds to an attenuation roughly double that calculated from the  $1/r^2$  power attenuation from the distant source. Since here the distance  $r$  from the source is over  $40\lambda$ , the discrepancy is presumably due to ohmic loss on the corroded surface of the screen, which is mounted on the outside wall of the laboratory.

Values of the reflection coefficient  $b(\sigma = 4\pi b^2)$ , obtained for all values of the standing-wave ratio  $R_{\pm}$

contained in the data of Fig. 4, are listed in Table I. (The  $\pm$  sign refers to ratios taken to the left and right, as defined in Appendix II.)

TABLE I

$\omega$	$b_-$	$b_+$	
43	3.79	3.94	
34.8	3.99	3.81	
26.5	3.57	3.69	$(\bar{b} = 3.78)$
18.0	3.74	3.69	

Values of  $\sigma$  plotted in Fig. 5 are calculated from the average of four values of  $b$ . Values of  $\sigma$  in Fig. 6 are taken from one value of  $b$  only. Assignment of a probable error of  $\pm 5$  per cent for the averaged values appears reasonable, except for small scattering when the standing-wave ratio is very low. A larger error is present in Fig. 6.

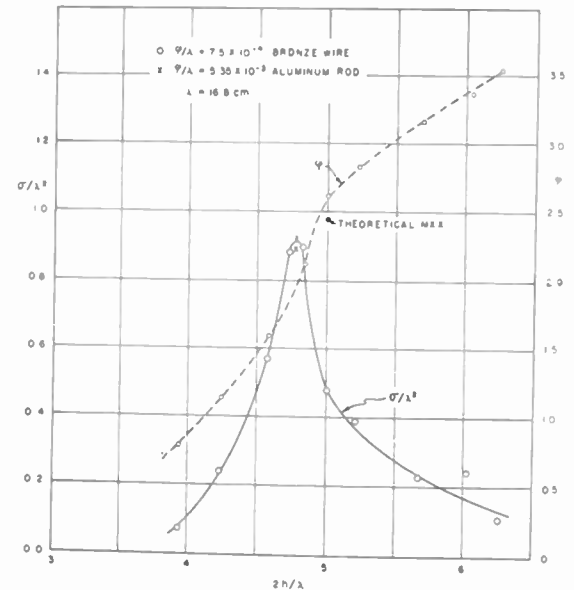

Fig. 5—Back-scattering from an unloaded dipole.

A systematic error arises from the position of the residual standing-wave pattern at the scattering antenna. The values of  $\sigma$  are roughly 10 per cent lower than they would be without residual standing waves on the image screen.

The correction for the deviation from the ideal radiation field with  $(ke^{-i\beta r})/r$  dependence is generally less than 10 per cent. Thus, assuming a probe length  $h = \lambda/8$  and a scatterer of length  $h = \lambda/4$ , the use of (4) and Fig. 2 leads to a minimum distance  $R \approx 2\lambda$  for an error of 4 per cent in amplitude and  $\pi/8$  in phase. The actual probe length used is less than  $\lambda/10$ , but the minimum distance  $R$  is not reduced thereby. In standing-wave measurements, only the change in the deviation within the interval  $\Delta = \lambda/4$  between maximum and minimum contributes. Furthermore, the averaging of  $R_+$  and  $R_-$  values should remove the error almost entirely, since

the deviations are in the opposite sense for the plus and minus directions. No correction for the systematic errors mentioned above is included in the results.

The dimensionless ratio  $\sigma/\lambda^2$  and the phase angle  $\phi$  of the scattered radiation are plotted in Fig. 6 for a thin dipole. The maximum value of  $\sigma/\lambda^2$  agrees well with the theoretical and experimental data given by Van Vleck.<sup>8</sup> The theoretical resonant point is misplaced in Fig. 5, and occurs at 0.475 in agreement with the data plotted.

The dependence of  $\sigma/\lambda^2$  on the load  $Z_L$  is illustrated in Fig. 6. The sharp resonance peak when  $Z_L=0$  is absent for a matched load. The steady increase of  $\sigma/\lambda^2$  with matched load is approximately twice as rapid as the increase in the absorption cross section  $A_0$ . This is to be expected, since the directivity appears as a square in the back-scattering. The phase of the scattered radiation is independent of antenna length for matched loads, but exhibits resonance behavior for the unloaded case.

A few results for a folded dipole and for the shunt-fed plate or "flag-stub" described by Granger<sup>9</sup> are shown in Fig. 7. The presence of a load at the base of one edge of the metal plate results in a decrease in scattering; the large scattering from the unloaded edge of the metal plate is evidence of the antenna currents excited along the longitudinal edges.

No rapid changes in scattering and absorption appear as the width of the shunt-fed plate increased, nor does the length  $l$  of the coupling wire materially alter the

results. However, any great reduction in the over-all length  $h$  causes a decline in both scattering and absorption. On the basis of these facts it seems reasonable to describe the operation of the shunt-fed plate in terms of resonant currents along both edges. Insertion of a coupling wire  $l$  produces a structure with similar currents to those in a folded dipole. An investigation of the impedance characteristics of the shunt-fed plate supports these conclusions.<sup>10</sup>

For the purpose of comparison, data for a quarter-wave dipole are included in Fig. 7: the length of the vertical lines represents the maximum spread of the four values used to obtain an average. The remaining curves in this figure represent similar averages, and hence only qualitative conclusions can be drawn from them.

Tests were also made on small aluminum hemispheres. The results obtained agree with the Rayleigh law within the probably error mentioned previously. In another trial, scattering from the flame of a small air-acetylene torch could not be detected for any flame length, even when the probe was within a half-wavelength of the flame.

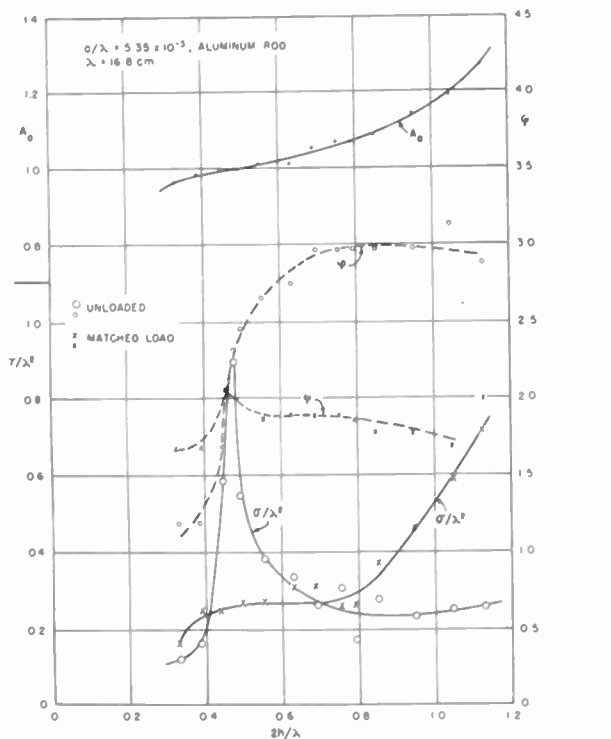

Fig. 6—Back-scattering and relative absorption from matched and from unloaded dipoles.

<sup>8</sup> J. H. Van Vleck, F. Vloch, and M. Hamermesh, "Theory of radar reflection from wires and thin metal strips," *Jour. Appl. Phys.*, vol. 18, p. 280; March, 1947.

<sup>9</sup> See chapter 5 of footnote reference 6.

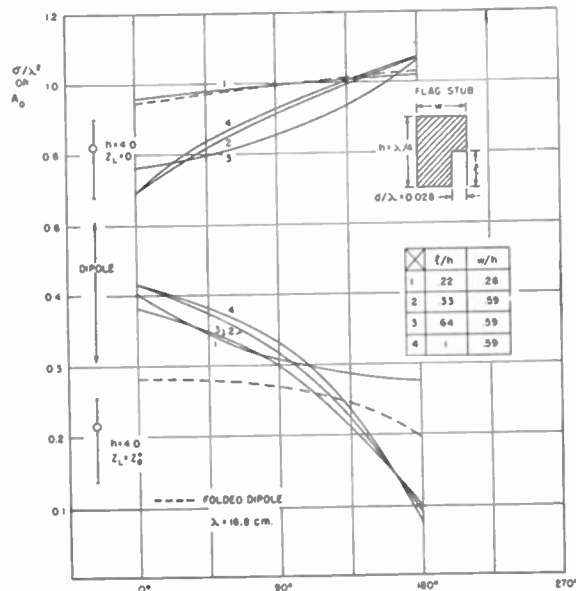

Fig. 7—Back-scattering (lower curves) and absorption from folded dipoles and stubs. The points at far left are for a dipole,  $h=4$  cm.

### VI. CONCLUSION

In spite of large experimental errors, the results presented are in good agreement with the expected scattering properties of the antennas tested. The inaccuracy of the present data is, in the opinion of the writer, largely a result of shortcomings in the image-screen used. Insufficient supports for the fine-mesh screening produced unstable ripples in the surface of the image plane. With some refinement, the standing-wave method of measurement may become a convenient tool in the determination of back-scattering. The results so ob-

tained should, in turn, facilitate the design of aircraft antennas and the like where natural resonances are important in the operation of the antenna system as a whole.

#### ACKNOWLEDGMENTS

Thanks are due to J. V. N. Granger and to Ronold King for reading the manuscript, and to Miss M. L. Richardson for numerical computations.

#### APPENDIX I

##### DEVIATION FROM THE RADIATION FIELD PATTERN NEAR A LINEAR RADIATOR

The component of the electric field parallel to the axis of a dipole with sinusoidal current distribution is given at all points in space by equation (5):<sup>10</sup>

$$E_z = -j30I_m \left\{ \frac{e^{-i\beta R_1}}{R_1} + \frac{e^{-i\beta R_2}}{R_2} - \frac{2}{r} e^{-i\beta r} \cos \beta h \right\}. \quad (5)$$

Here  $R_1$  and  $R_2$  are radius vectors drawn from the ends of the antenna to the field points;  $r$  is drawn from the center of the antenna to the field point. The dipole half-length is  $h$  and  $\beta = 2\pi/\lambda$ ;  $I_m$  is the maximum value of the current amplitude.

For the present discussion, the field in the plane perpendicular to the antenna at its center is desired. Therefore,

$$R_1 = R_2 = R \quad (6)$$

$$R = \sqrt{r^2 + h^2}. \quad (7)$$

In the expansion of (7), terms in  $(h/r)^2$  are retained but fourth power terms are neglected.

$$R = r \left( 1 + \frac{1}{2} \left( \frac{h}{r} \right)^2 \right). \quad (8)$$

Substitution in (5) and expansion of the exponential yields the following result:

$$E_z = -j60I_m \frac{e^{-i\beta r}}{r} \left\{ \frac{1 - j\beta \frac{r}{2} \left( \frac{h}{r} \right)^2}{1 + \frac{1}{2} \left( \frac{h}{r} \right)^2} - \cos \beta h \right\}. \quad (9)$$

This formula may be simplified by expanding the term  $(1 + 1/2(h/r)^2)$  in the denominator and by using a trigonometric identity for the quantity  $(1 - \cos \beta h)$ .

$$E_z = -j60I_m \frac{e^{-i\beta r}}{r} \left\{ 2 \sin^2 \frac{\beta h}{2} - \frac{1}{2} \left( \frac{h}{r} \right)^2 (j\beta r + 1) \right\}. \quad (10)$$

Evidently the actual field differs in both amplitude and phase from the value predicted by the simple  $1/r$

law. The correction factor is obtained by rearranging the formula.

$$E_z = \left[ -j60I_m \frac{e^{-i\beta r}}{r} \cdot 2 \sin^2 \frac{\beta h}{2} \right] \cdot A e^{-i\phi} \quad (11)$$

where

$$A = \sqrt{ \left[ 1 - \frac{\left( \frac{h}{r} \right)^2}{4 \sin^2 \frac{\beta h}{2}} \right]^2 + \left[ \frac{\beta h \left( \frac{h}{r} \right)}{4 \sin^2 \frac{\beta h}{2}} \right]^2 } \quad (12)$$

$$\phi = \tan^{-1} \left\{ \frac{\beta h \left( \frac{h}{r} \right)}{4 \sin^2 \frac{\beta h}{2} - \left( \frac{h}{r} \right)^2} \right\}. \quad (13)$$

The functions  $A$  and  $\phi$  are plotted in Fig. 2.

#### APPENDIX II

##### BACK SCATTERING OR RADAR CROSS SECTION IN TERMS OF STANDING WAVES

Let the source be located at  $x=0$ , and the scatterer at  $x=l$ . A movable probe occupies an intermediate position  $x$  ( $x < l$ ), along the radius vector between source and scatterer. The signal received by the probe is proportional to the electric field strength. The periodic maxima and minima which are received as the probe is moved along the line  $xl$  serve to define a standing-wave ratio in voltage. The usual definition in terms of incident and reflected waves is

$$VSWR = \frac{E_i + E_r}{E_i - E_r}. \quad (14)$$

For convenience, let  $w = l - x$ . Application of the inverse first-power dependence for the electric field yields the following values for  $E_i$  and  $E_r$  in terms of the reference potential  $E_0$  near the source:

$$E_i = \frac{E_0}{x}; \quad E_r = \frac{E_0 b}{lw}. \quad (15)$$

The coefficient  $b$  is a measure of the reflected amplitude. A relation between  $b$  and the VSWR is obtained next.

In order to define precisely the standing-wave ratio to be measured, let  $w_1$  be the co-ordinate of the maximum, and  $w_2$  that of the minimum of the standing-wave pattern. The expression for the VSWR may now be written

$$VSWR = \frac{\frac{lw_1}{l - w_1} + b}{\frac{lw_2}{l - w_2} - b} \cdot \frac{w_2}{w_1}. \quad (16)$$

In order to eliminate  $w_1$ , let  $w_1 = w_2 \pm \Delta$ . Here it is understood that  $+\Delta$  corresponds to a maximum at  $w_1$  in the direction of the source, and  $-\Delta$  corresponds to a

<sup>10</sup> Taken from unpublished notes of Prof. Ronold King; a similar result is found in J. A. Stratton, "Electromagnetic Theory," McGraw-Hill Book Co., New York, N. Y., p. 456; 1941.



maximum at  $w_1$  in the direction of the scatterer. Accordingly,  $R_+$  is taken to mean the ratio of maximum to minimum with  $+\Delta$ , i.e., the minimum nearest the scatterer, and  $R_-$  the ratio of maximum to minimum with  $-\Delta$  i.e., the maximum nearest the scatterer. With these definitions a formula for the coefficient  $b$  may be obtained from (16).

$$b = \frac{lw_2}{l-w_2} \left\{ \frac{R_{\pm} - \frac{1}{1 \pm \frac{\Delta}{l-w_2}}}{R_{\pm} + \frac{1}{1 \pm \frac{\Delta}{w_2}}} \right\}. \quad (17)$$

Since the source is usually far away,  $l-w_2 \gg 1$ , a slightly more convenient form is sufficiently accurate:

$$b = \frac{lw_2}{l-w_2} \left\{ \frac{R_{\pm} \mp \frac{\Delta}{l-w_2} - 1}{R_{\pm} + \frac{1}{1 \pm \frac{\Delta}{w_2}}} \right\}. \quad (18)$$

The cross section  $\sigma$  is given by

$$\sigma = 4\pi b^2. \quad (19)$$

The phase shift  $\phi$  at the scatterer is obtained from the relation

$$2\beta w + \phi = (2n + 1)\pi. \quad (20)$$



## Discussion on

# “The Electron Wave Tube”\*

ANDREW V. HAEFF

William B. Hebenstreit:<sup>1</sup> In one place in his theoretical treatment, Dr. Haeff has omitted a rather interesting point. In another place he has written two equations which are likely to give a misleading impression.

His equation (21) can be recast as follows:

$$\frac{1}{\left(\delta \frac{\omega}{v} + \gamma v\right)^2} + \frac{1}{\left(\delta \frac{\omega}{v} - \gamma v\right)^2} = \frac{1}{\omega_1^2}. \quad (1)$$

The question is, what happens when the current or the space-charge density gets very large? More precisely, what is the limiting gain as  $\omega_1 \rightarrow \infty$ ? Setting the right-hand side of (1) equal to zero, we find the limiting value of the incremental propagation constant for the increasing wave to be

$$\gamma_{\infty} = j \left( \frac{\delta}{v} \right) \left( \frac{\omega}{v} \right). \quad (2)$$

Defining a beam wavelength  $\lambda_s$ , analogous to a guide

wavelength in a waveguide,

$$\frac{2\pi}{\lambda_s} = \frac{\omega}{v}. \quad (3)$$

The number of wavelengths  $N$  in length  $l$  of a beam is

$$N = l/\lambda_s. \quad (4)$$

Further, if we call  $b$  the fractional velocity separation, then

$$\frac{\delta}{v} = \frac{b}{2}. \quad (5)$$

The limiting gain of a section  $N$  wavelengths long is, then,

$$G_{\infty} = 27.3Nb \text{ decibels}. \quad (6)$$

Equations (23) and (24) in Haeff's paper might give a misleading impression. Both equations are derived on the assumption that all four waves are started out at  $t=0$  and  $z=0$  with equal phases and amplitudes.

Since the four waves are independent, this is not, in general, true, but it may be true fortuitously. The relative phases and amplitudes with which the four waves start out depend upon the input boundary conditions.

\* A. V. Haeff, "The electron wave tube—a novel method of generation and amplification of microwave energy," *Proc. I.R.E.*, vol. 37, pp. 4-10; January, 1949.

<sup>1</sup> Hughes Aircraft Co., Culver City, Calif.

**Andrew V. Haef<sup>2</sup>** The expression for the limiting gain, as the space-charge density becomes very large, can be obtained quite directly from the equation (22) of my paper under the assumption that  $\delta/v \cdot \omega/\omega_1 \ll 1$ . Indeed,

$$\begin{aligned} \left| \gamma \frac{v}{\omega_1} \right|_{\omega_1 \rightarrow \infty} &= \pm \sqrt{\left(\frac{\delta\omega}{v\omega_1}\right)^2 + 1} \pm \sqrt{4\left(\frac{\delta\omega}{v\omega_1}\right)^2 + 1} \\ &\approx \pm \sqrt{1 + \left(\frac{\delta\omega}{v\omega_1}\right)^2} \pm \left[1 + 2\left(\frac{\delta\omega}{v\omega_1}\right)^2\right] \\ &\approx \pm j \frac{\delta\omega}{v\omega_1}. \end{aligned} \quad (7)$$

Thus,

$$\gamma_{\omega_1 \rightarrow \infty} = j \frac{\delta\omega}{v \cdot v} = j \left(\frac{2\delta}{v}\right) \frac{\pi}{\lambda_s}, \quad (8)$$

and the gain

$$G = 20 \log_{10} e^{\gamma z} = 27.3 \left(\frac{2\delta}{v}\right) \frac{z}{\lambda_s} \text{ decibels.} \quad (9)$$

This result is the same as was obtained by Mr. Hebenstreit (his equation (6)).

I may also point out that my formula (14) yields solutions quite readily in several other cases not specifically mentioned in my paper. Of particular interest is the case of two streams of electrons of equal charge densities moving in opposite directions. If the velocities of the two components of the stream are assumed to be  $+v$  and  $-v$ , respectively, the expression for the propagation constant obtained from equation (14) is

$$\frac{\Gamma v}{\omega_1} = \pm \sqrt{-\left(1 + \frac{\omega^2}{\omega_1^2}\right)} \pm \sqrt{1 + 4 \frac{\omega^2}{\omega_1^2}}. \quad (10)$$

The above expression is of the same form as equation (22) of my paper. Therefore, the curve of Fig. 1 applies to this case, assuming that  $x = \omega/\omega_1$ . It is to be noted that space-charge waves propagate in either direction through electron plasma consisting of streams moving in opposite directions. Furthermore, since within a certain range of signal frequencies the propagation constant is real, such plasma is intrinsically unstable, and the amplitude of oscillations, once initiated in the plasma, will build up to saturation level, as was mentioned in my letter to the Editor of *The Physical Review*, November 15, 1948.

A somewhat similar situation holds for the case of uniform distribution of space charge over a range of velocities from  $-v$  to  $+v$ . Such a condition can be taken as a rough approximation to quasistationary plasma in

which electrons have Maxwellian distribution with the velocity  $v = \sqrt{kT/2\pi m}$ , where  $k$  is Boltzman's constant;  $T$  is absolute temperature; and  $m$  is the mass of the particle. In this case, the integration of equation (14) of my paper gives

$$1 = \int_{-v}^{+v} \frac{d\omega_1^2}{(\omega + j\Gamma v)^2} = \int_{-v}^{+v} \frac{cdv}{(\omega + j\Gamma v)^2} = \frac{2cv}{\omega^2 + \Gamma^2 v^2} \quad (11)$$

where

$$c = \frac{d\omega_1^2}{dv} = \left(\frac{e}{m\epsilon}\right) \cdot \frac{di}{vdv} = \left(\frac{e}{m\epsilon}\right) \cdot \frac{2i}{v^2} = \frac{\omega_1^2}{v},$$

$i$  is the density of current in either direction, and  $\omega_1^2 = 2(i/v) \cdot (e/m\epsilon)$ .

The propagation constant in this case can be determined from the following expression:

$$\frac{\Gamma v}{\omega_1} = \pm \sqrt{2 - \frac{\omega^2}{\omega_1^2}}. \quad (12)$$

Similarly to the previous case of two streams of discrete velocities  $+v$  and  $-v$ , the plasma consisting of a uniform distribution of velocities  $-v$  to  $+v$  also exhibits negative attenuation for oscillations of all frequencies below  $\omega = \sqrt{2}\omega_1$ .

When the plasma density is very high, so that it can be assumed that  $\omega/\omega_1 \ll 1$ , the propagation constant approaches the values given below:

$$\Gamma_{\omega_1 \rightarrow \infty} \approx \frac{\omega}{v} \quad (13)$$

(discrete velocities),

$$\Gamma_{\omega_1 \rightarrow \infty} \approx \frac{\sqrt{2}\omega_1}{v} \quad (14)$$

(uniform charge versus density distribution), for the two cases, respectively. It may be mentioned that the injection of electron streams moving in the direction opposite to the main stream makes it possible to transmit space-charge waves in the backward direction (with respect to the motion of the main stream), and thus provides regenerative effects. The degree of regeneration can be controlled by regulating the amount of the injected current.

I appreciate Mr. Hebenstreit's comments (and comments received informally from R. G. E. Hutter, H. Krutter, and others) on the fact that the four solutions given by equation (22) are independent, so that, in general, the relative phases and amplitudes of the four possible waves are determined by the initial conditions of excitation.

<sup>2</sup> Naval Research Laboratory, Washington 20, D. C.

# Contributors to the Proceedings of the I.R.E.

Herbert S. Bennett (A'42-M'43-SM'44) was born on June 13, 1917, in New York, N. Y. He received the degree of bachelor of electrical engineering from the College of the City of New York in 1938, and the M.E.E. degree in 1939, from the same institution. From 1939 until 1942 he was employed by the U. S. Army Signal Corps as a radio engineer. In 1942 he was commissioned and served as a Technical Officer, first with the Signal Corps, and then with the United States Air Forces until 1946. In 1946 he resumed his civilian employment as a research and development engineer with the U. S. Air Forces, at Watson Laboratories. He is now Chief, Program Planning and Analysis Branch, at these Laboratories.



HERBERT S. BENNETT

In June, 1947, Mr. Bennett received the degree of master of science in physics from the Polytechnic Institute of Brooklyn, and is at present engaged in research in the field of electromagnetic diffraction in connection with his doctoral studies at that Institute.

Mr. Bennett is a member of Sigma Xi, the Scientific Research Association of America, the National Society of Professional Engineers, the American Institute of Electrical Engineers, Tau Beta Pi, and Eta Kappa Nu. He is now serving on the Admissions Committee of the IRE, and was an active member of the Technical Program Committee for the 1947 IRE National Convention.



W. H. Doherty (A'29-M'36-SM'43-F'44) was born in Cambridge, Mass., on August 21, 1907. He received the S.B. degree in electric communication engineering in 1927, and the S.M. degree in 1928, both from Harvard University. In 1928 and 1929 he was associated with the radio section of the National Bureau of Standards. In 1929 he joined the Technical Staff of Bell Telephone Laboratories, Inc., at Whippany, N. J. Until 1940 his work was mainly on high-power broadcast transmitter design. In 1937 he received the Institute's Morris Liebmann Memorial Prize for his development of a new high-efficiency power-amplifier circuit.



W. H. DOHERTY

During and since World War II, Mr. Doherty has supervised Navy radar and

fire-control projects, as well as the development of radio broadcasting equipment. He was recently transferred from Whippany to the Murray Hill laboratories as director of electronic and television research.

Mr. Doherty is a member of Tau Beta Pi and Sigma Xi.



Donald B. Harris (SM'45) was born at Minneapolis, Minn., on February 10, 1901. He received the B.A. degree from Yale University in 1922, after completing a physics major. During the school year of 1922 to 1923, he occupied the position of master in physics and mathematics at the Adirondack-Florida School, Onchiota, N. Y. and Miami, Fla. In 1923 he became associated with the Cutting and Washington Radio Corp., Minneapolis, Minn. He joined the Northwestern Bell Telephone Co., in 1924, subsequently occupying various technical and administrative positions. During this period he independently developed a number of devices on which patents were granted, or are now pending.



DONALD B. HARRIS

In 1943 Mr. Harris became technical aide of Division 15 of the National Defense Research Committee stationed at Radio Research Laboratory, Harvard University, where he was responsible for the administration of contracts of Division 15 in the Cambridge, Mass., area. In 1947 he was a transmission and protection engineer of the Northwestern Bell Telephone Co., stationed at Des Moines, Iowa. At present, he is executive assistant to the director of research at the Collins Radio Co., Cedar Rapids, Iowa.



C. W. Horton was born on September 23, 1915, at Cherryvale, Kan. He received the B.A. degree with honors in physics in 1935, and the M.A. degree in 1936, both from The Rice Institute, Houston, Tex. In 1945 he was awarded the Ph.D. degree from the University of Texas.



C. W. HORTON

Dr. Horton was a research associate at the Underwater Sound Laboratory, Harvard University, from 1943 to 1945.

For this work he received a Development Award from the U. S. Navy Bureau of Ordnance, and a Certificate of Appreciation from the Office of Scientific Research and Development. Since 1945 he has been a research physicist at the Defence Research Laboratory and an assistant professor of physics at the University of Texas. He is a member of the American Physical Society, the American Geophysical Union, and the Society of Exploration Geophysicists.



D. D. King (M'46) was born on August 7, 1919, at Rochester, N. Y. He received the A.B. degree in engineering sciences from Harvard College in 1942, and the Ph.D. degree in physics from Harvard University in 1946. He was a teaching fellow in physics and communication engineering in 1943, serving as a staff member of the pre-radar Officer's Training School at Cruft Laboratory, Harvard University.



D. D. KING

During 1945 he was a research associate at Cruft Laboratory. In 1946 he was appointed research fellow in electronics, and in 1947 assistant professor of applied physics at Harvard University.

Since 1948 Dr. King has been an associate professor of physics in the Institute for Co-operative Research of The Johns Hopkins University. He is a member of Sigma Xi and the American Physical Society.



R. Wayne Masters (S'40-A'43) was born on May 25, 1914, in Fort Wayne, Ind. He received the B.S. degree in electrical engineering from the University of Alabama in 1938, and the M.S. degree from the Ohio State University in 1941. In 1941 Mr. Masters became associated with the Victor Division of RCA, where he developed several antennas for radar equipments produced for the armed services. He is presently engaged there in research on television antennas and associated transmission equipment, and is credited with the invention and development of the RCA Super-Turnstile television antenna.



R. WAYNE MASTERS

# Contributors to the Proceedings of the I.R.E.

Mr. Masters recently completed a pre-doctoral course of study at the University of Pennsylvania. He is a member of Tau Beta Pi and Eta Kappa Nu.



Lowell E. Norton was born on August 12, 1909, in Arlington, Minn. He received the B.S. degree in electrical engineering in 1932 and the M.S. degree in communications in 1935, both from the University of Minnesota.



LOWELL E. NORTON

Mr. Norton is a member of Sigma Xi.



Wilfred Roth (S'43-A'45-S'46) was born on June 24, 1922, in New York, N. Y. He received the B.S. degree in electrical engineering from Columbia University in 1943, and the Ph.D. degree in physics from the Massachusetts Institute of Technology in 1948.



WILFRED ROTH

Dr. Roth was employed as a staff member of the MIT Radiation Laboratory from 1943 to 1946. His work consisted principally of development of electronic circuitry for specialized applications, with particular emphasis on the design of servomechanisms and computer systems.

Dr. Roth was a contributing author of the Radiation Laboratory Technical Series. In the years 1946 and 1947, he held an appointment as research associate in physics at MIT, where he conducted research on the propagation of ultrasonics in metals.

From January to August of 1948, Dr. Roth was associated with the Rieber Research Laboratory in New York, N. Y., as chief physicist, where he was concerned with the development of instruments for the geophysical and meteorological fields. In September, 1948, he became development group leader for the Harvey Radio Laboratories in Cambridge, Mass. He is engaged in the research and development of electronic aids to navigation.

Dr. Roth is a member of Tau Beta Pi, Sigma Xi, the American Physical Society, and the American Association for the Advancement of Science.



Frederick William Schott (S'41-A'45) was born in Phoenix, Ariz., on October 2, 1919. In 1940, he received the degree of Bachelor of Arts (Honors) from San Diego State College. In 1941, he was awarded a university scholarship and began graduate work at Stanford University. The following year he continued under a Westinghouse Fellowship, and received the degree of electrical engineer in 1943. He resumed graduate study at Stanford University in 1947 and received the Ph.D. degree in 1948.



F. W. SCHOTT

He has held the following positions: junior engineer, San Diego Gas and Electric Co., San Diego, Calif., 1943 to 1944; ensign, United States Navy, 1944 to 1946; instructor in engineering and physics, San Diego State College, 1946 to 1947; acting instructor, Stanford University, summer, 1947; research associate, Stanford University, 1947 to 1948; and assistant professor, University of California at Los Angeles, 1948 to date.

Dr. Schott is a member of Tau Beta Pi, Sigma Xi, Sigma Pi Sigma, the American Association for the Advancement of Science, and the American Institute of Electrical Engineers, and is a registered electrical engineer in the State of California.

Karl R. Spangenberg (A'34-SM'45-F'49) was born at Cleveland, Ohio, on April 9, 1910. He received the B.S. degree in electrical engineering in 1932, and the M.S. degree in electrical engineering in 1933, both from the Case School of Applied Science; and the Ph.D. degree from Ohio State University in 1937.



K. R. SPANGENBERG

Since 1937, Dr. Spangenberg has been a member of the faculty of the electrical engineering department of Stanford University, as associate professor of electrical engineering.

During the war, Dr. Spangenberg was granted a leave of absence from Stanford University to serve as consultant to the Signal Corps and to work at the Naval Research Laboratory. He is presently head of the Electronics Branch of the Office of Naval Research.



Glenn A. Walters (S'42) was born in Fresno, Calif. on March 31, 1920. He received the B.S. degree in engineering at the University of California at Berkeley, Calif., in 1943. He then joined the Navy in its Flight Training Program. In 1945 he was assigned as Naval Liaison Officer at the Radiation Laboratory at the Massachusetts Institute of Technology, and later at Harvard University, where he worked on the development of microwave communication systems.



G. A. WALTERS

Upon his discharge in 1946, Mr. Walters accepted a position as research associate at Stanford University. He is at present engaged in research and development of radar antenna systems at Dalmo Victor Co., San Carlos, Calif.





# Institute News and Radio Notes

## NOMINATIONS—1950

At its May 4, 1949, meeting, the Board of Directors received the recommendations of the Nominations Committee and the reports of the Regional Committees for officers and directors for 1950. They are:

*President:* Raymond F. Guy

*Vice-President:* Sir Robert Watson-Watt

*Directors-at-Large, 1949-1951 (two to be elected):* Lloyd V. Berkner, Alois W. Graf, William R. Hewlett, James W. McRae

*Regional Directors, 1950-1951:*

*Region 1:* Herbert J. Reich

*Region 3:* Ferdinand Hamburger, Jr., Walter C. Johnson

*Region 5:* Kenneth W. Jarvis, George Rappaport, John Reid

*Region 7:* Austin Eastman

According to Article VI, Section 1, of the Constitution, nominations by petition for any of the above offices may be made by letter to the Board of Directors, setting forth the name of the proposed candidate and the office for which it is desired he be nominated. For acceptance, a letter of petition must reach the executive office before August 12, 1949, and shall be signed by at least 100 voting members qualified to vote for the office of the candidate nominated.

## TECHNICAL COMMITTEE NOTES

The **Standards Committee** met on April 14. The Master Index of Terms prepared by the Definitions Co-ordinating Subcommittee, under the Chairmanship of A. G. Jensen, has been completed, and a list of the terms will be distributed to the Chairmen of all IRE Technical Committees, subcommittees, and task groups. It can be made available on request to members of the IRE Committees, or to such persons as the Definitions Co-ordinating Subcommittee shall deem proper. The Standards Committee also plans to review the scope of all Technical Committees and to revise its Manual at an early date. The proposed standard on Radio Aids to Navigation, prepared by the Committee of that name and presented by its Chairman, Henri Busignies, was approved . . . . The initial meeting of the new **Joint IRE/AIEE Committee on Noise Definitions**, which reports to the Standards Committees of the IRE and AIEE, was held on April 22. Since this Committee does not stem from a Technical Committee, it was organized as a full committee with the power to form subcommittees, task groups, or any other groups that might facilitate its work. T. A. Taylor is Chairman . . . . A meeting of the **Industrial Electronics Committee** was held on April 20. This Committee is a joint activity of the IRE, AIEE, and NEMA, and is currently working in the field of induction and dielectric heating. There are three Subcommittees: Good Engineering Practice, which is concerned at the moment

with the prevention of harmful radiation from industrial equipment; Definitions, which is drafting definitions of a number of terms used in this field; and the newly formed Measurements Group, which is studying the methods and instrumentation necessary to obtain the electrical characteristic of dielectric material at both room and elevated temperatures . . . . The **Video Techniques Committee** held a meeting during the IRE/RMA Spring Meeting in Philadelphia on April 27, at which the activities of the following Subcommittees were reported by their chairmen: V-1—Video Systems; V-3—Components and Signal Transmission, Definitions, and Symbols; V-2—Video Systems Components and Methods of Measurement and Test; and V-4—Video-Signal Transmission-Methods of Measurement and Test . . . . The **Committee on Electron Tubes and Solid State Devices** met at IRE headquarters on April 21 and plans to submit its work on definitions of terms for publication at an early date. The 1949 IRE Conference held June 20-21 at Princeton University, under the Chairmanship of Jack Morton, proved successful. Sessions on Microwave Tubes, Cathode-Ray and Storage Tubes, and Solid-State Devices were held. On the afternoon of the second day, several parallel "Rump Sessions" were held, at which informal discussion on various topics took place. C. M. Wheeler was appointed Chairman of the POHVT Subcommittee, and consideration was given to the forming of a Professional Group . . . . K. S. Van Dyke, Chairman of the **Piezoelectric Crystals Committee**, called the first meeting of this committee on May 9. The new Standards on Piezoelectric Crystals are expected to be available by the end of the summer . . . . The Joint Technical Advisory Committee convened at Headquarters on April 19 for its eighth meeting.

It was decided that the JTAC will release in bound form at the end of the Committee's fiscal year, June 30, all official correspondence between the Committee and the FCC . . . . The first meeting of the **ASA Section Committee C-16 (Radio)** was held on April 29 at the American Standards Association Headquarters. Action was taken on thirteen IRE Standards and nine RMA Standards, in order to bring them up to date . . . . The Standards Co-ordinator, W. R. G. Baker, was host to a meeting of chairmen of the six organized **Professional Groups—Audio, Antenna and Wave Propagation, Broadcast Transmission Systems, Circuit Theory, Nuclear Science, and Vehicular and Railroad Radio Communications**—and promoters of potential IRE Groups at Syracuse on May 9, 1949. A Professional Group on Television had been considered, but at this meeting it was decided that the original Broadcast Engineers Group would change its scope to include television, AM, FM, Facsimile, etc. The Group was renamed the IRE Professional Group for Broadcast Transmission Systems . . . . The first meeting of the **Professional Group on Nuclear Science** was held at Washington on April 29 to discuss organization and future plans. Harner Selvidge was appointed Chairman, to succeed L. R. Hafstad. Immediate plans for the Group include the acquisition of papers on nuclear theory, heat transference, liquid metals, radiological instruments, new-type instrument controls, radio-isotopes, and radioactive materials in general. The Group decided to hold its annual meeting in the form of a Symposium sometime during the beginning of November. R. E. Lapp was named Chairman of the Planning Group of the 1949 IRE Nucleonics Symposium, which will emphasize biological tolerances. . . . The next **general meeting of Group Chairmen and Promoters** will be held in New York City in September.

## Calendar of COMING EVENTS

AIEE Pacific General Meeting, San Francisco, Calif., August 23-26

1949 IRE West Coast Convention, San Francisco, Calif., August 30-September 2

1949 National Electronics Conference, Chicago, Ill., September 26-28

National Radio Exhibition, Olympia, London, England, September 28 to October 28

AIEE Midwest General Meeting, Cincinnati, Ohio, October 17-21

Radio Fall Meeting, Syracuse, N. Y., October 31, November 1-2

1950 IRE National Convention, New York, N. Y., March 6-9

## PROCEEDINGS EDITOR ELECTED LIFE MEMBER OF AUSTRALIAN IRE

At the Annual General Meeting of the Institution of Radio Engineers, Australia, Alfred N. Goldsmith, Editor of the *PROCEEDINGS OF THE I.R.E.*, was elected unanimously to honorary life membership of the Institution as of January 1, 1949.

The award was made in view of Dr. Goldsmith's "many years of successful contribution . . . to the development of radio science and in particular to the advancement of the technical well-being of those engaged in the art." It was also stated that the benefits of Dr. Goldsmith's efforts were regarded as world-wide, and that the Institution accordingly showed its appreciation by the grant of honorary life membership.

In his acceptance of the award, Dr. Goldsmith emphasized the present co-operative and friendly relationships that exist between the Institution of Radio Engineers,

Australia, and The Institute of Radio Engineers. He stressed the fact that these two organizations have demonstrated the essential unity of scientists and engineers working toward a common aim—namely, the advancement of their art.

### IRE-URSI MET IN MAY

The Institute of Radio Engineers and the International Scientific Radio Union (URSI) met jointly at the National Bureau of Standards in Washington, D. C., on May 2, 3, and 4. On the morning of May 2, J. H. Dellinger headed a session sponsored by URSI Commission 1—Radio Standards and Methods of Measurement. In the afternoon, Commission 7—Electronics, Including Properties of Matter—convened under the chairmanship of C. F. Metcalf.

The following day, J. C. Schelling (H. Norinder, Sweden, is the regular chairman) headed Commission 4's—Terrestrial Radio Noise—session in the morning, and L. C. Van Atta (B. van der Pol, Netherlands, is official chairman) took charge of the session on Radio Waves and Circuits, including General Theory and Antennas (Commission 6), which convened again in the afternoon. On May 4 there were organization meetings of Commissions 1 and 6 in the morning, and of Commissions 4 and 7 in the afternoon.

### DISTINGUISHED SCIENTISTS TO SPEAK AT ELECTRONICS CONFERENCE

At the noon luncheon on the opening day, September 26, of the 1949 National Electronics Conference at the Edgewater Beach Hotel in Chicago, E. U. Condon, director of the National Bureau of Standards, will speak. F. Wheeler Loomis, President of the American Physical Society and head of the physics department of the University of Illinois, will be the speaker at the second noon luncheon of the three-day conference.

### CINCINNATI SECTION HELD SPRING CONFERENCE

The Cincinnati Section of the IRE held a Spring Technical Conference on Television on April 23, which drew an attendance of 345. J. F. Jordan headed a morning session at which E. W. Allen spoke on "The Propagation Characteristics of UHF Radiation," C. E. Nobles on "The Use of Stratovision in the UHF Band," O. M. Woodward, Jr., on "UHF Television Antennas and Matching Networks," and R. F. Romero on "UHF Tuners for Receiver and Converter Use." A buffet luncheon followed, during which time various exhibits relating to television were on view. The afternoon session, at which L. M. Clement was Chairman, featured papers by R. F. Wakeman, "UHF Converters for Use with Present Receivers"; J. D. Reid, "The Influence of UHF Allocations on Receiver, Design and Performance"; E. W. Commery, "The Psychophysiological Effects of Viewing Television"; and

D. G. Fink, "Trends in Television Receiver Design."

In the evening a cocktail party preceded the official banquet, at which C. K. Gieringer, Section Chairman, presided. T. A. Hunter, Director of Region Five of the IRE, spoke on "Your Regional Director Looks at the IRE," and V. F. Cottrell delivered a speech on "Energy and Society." Inspection trips were held on the following day to the two television stations operating in Cincinnati (WKRC-TV and WLW-T).

### RADIATION LABORATORY REPORTS PROVE COMMERCIAL SUCCESS

The first instance of commercial publication of government reports has proved a success: early this year the McGraw-Hill Book Co. sent the U. S. Treasury a check for \$24,250, a sum representing the royalties earned on 1948 sales of the partially published MIT Radiation Laboratory Series. Although the check is small, as payments into the U. S. Treasury go, it is one of the results of a transaction which saved the government close to \$330,000.

In 1945 the wartime U. S. Office of Research and Development was confronted with the problem of publishing in report form the vast results of five years of intensive work on radar done at the Radiation Laboratory of MIT during the war. The laboratory was obligated by contract to supply the OSRD with 400 copies of the result of its work.

Under strict interpretation of Federal law, these reports would have to be produced by the Government Printing Office, but Vannevar Bush, director of the OSRD, believed that, if they were thus produced, they would be buried in government files. Accordingly, after prolonged debate it was decided that MIT would act as prime contractor and let a subcontract for commercial publication of the report. McGraw-Hill won the contract and, by the end of 1948, twenty-one volumes, averaging 600 pages each, had been produced. The remaining six are scheduled for publication in 1949. This not only saved the government the cost of printing, but, since 4,000 copies of each were printed, rather than 400, copies of the reports will be in the hands of thousands of scientists and engineers, where they will be useful for peacetime research in physics, biology, and other natural science, and will provide the engineering foundation for future industrial developments in television, communications, and electronics.

### BRITISH INDUSTRIES FAIR FEATURED RADIO EQUIPMENT

The most up-to-date equipment used in television transmitting and receiving, radio communications, aids to navigation, sound reproducing, and other branches of the radio and electronic engineering industries was shown at the British Industries Fair, held in both London and Birmingham from May 2 to May 13.

The world's first public demonstration of television on the 625-line system took place at Birmingham. Complete antenna systems

were shown in three individual kits, comprising dipole, reflector, and cross-arm for different frequencies, eight- or twelve-foot masts, and different lashing kits and chimney brackets for the masts. A new high-tensile light alloy was used in the manufacture of the elements and masts, reducing the weight of the antenna system by roughly one-third.

The increasing industrial applications of electronics were displayed, including methods of drying grass to ensure full nutritive value for livestock, a moisture meter for measuring the moisture content of grain, and a portable PH meter which, by pushing an electrode into the soil, gives a direct reading of its acidity or alkalinity. A directly heated tetrode for use in mobile equipment, an electron microscope capable of magnifying an object one to one-hundred-thousand times, and the only controlled neon discharge lamp manufactured in England were also shown at Birmingham.

Shown at Olympia, London, was the first radio to incorporate the special double super-heterodyne circuit, and which has bandspread tuning on the eight important short-wave bands. Also displayed was cloud and collision warning radar equipment designed to enable aircraft pilots to detect certain types of clouds associated with storm areas at a distance of forty miles. Other uses for this equipment include map pointing facilities, detecting other aircraft in the vicinity, and selecting a route through dangerous cloud formations at night or in poor visibility.

An automatic record changer displayed plays eight records of either size or mixed, which can be repeated or rejected by a pre-selecting button. Also exhibited was an electronic ionization voltage tester developed on a new principle to avoid damage to insulation under test.

### NAB STUDIES TELEVISION STAFFS

Television currently employs approximately ten per cent as many full-time persons as does the total AM-FM broadcasting industry, the National Association of Broadcasters announced, although television has only fifty-seven stations on the air. Approximately fifty per cent of television station staffs (aggregating 3,456 full-time persons) consist of technical personnel, eight per cent of film department personnel, twenty-two per cent of program personnel, sixteen per cent of administrative personnel, and four per cent of sales personnel.

### ASA HELD COMPANY MEMBER CONFERENCE

The American Standards Association held a Company Member Conference on May 19 and 20; the first day at the Benjamin Franklin Hotel in Philadelphia, Pa., the second at the Princeton Labs. of RCA. The Conference is the group in the ASA which gives companies an opportunity to exchange ideas, discuss standardization problems, and make recommendations for standard practices that will help to give better service to both producer and user groups.

## SMPE OFFERS TEST FILMS

The Society of Motion Picture Engineers and the Motion Picture Research Council have developed a series of test films for use in the standardization of practices and equipment in most pictures. These films are also applicable to television.

The 35-mm test films are: Visual, Theater Sound, Multifrequency, Transmission, Buzz-Trade, Scanning-Beam Illumination, Sound Focusing, 3000-Cycle Flutter Test, 1000-Cycle Balancing Test, and Multifrequency Warble.

The 16-mm test films are: Sound Projector, Sound Service, Multifrequency, Buzz-Track, Scanning-Beam Illumination, Sound-Focusing, 3000-Cycle Flutter, 400-Cycle Signal-Level, and Projector Lens Resolution Target.

Further information may be obtained from the SMPE, 342 Madison Ave., New York 17, N. Y.

## PANEL INSPECTS OCEANOGRAPHIC INSTALLATIONS

The Panel on Oceanography of the National Military Establishment's Research and Development Board held a meeting at La Jolla, Calif., at the end of April. At that time they also inspected the military research and development work carried on by the Scripps Institute of Oceanography at La Jolla, and the work in oceanographic research of the U. S. Navy Electronics Laboratory at San Diego. Created by the Committee on Geophysics and Geography of the Board, the Panel concerns itself with oceanographic studies and the mutual relations existing between water, air, and the land adjacent to it as they affect the problems of military research and development.

## BRITISH RADIO COUNCIL ISSUES NEW SPECIFICATION

A specification describing the general conditions and procedure for climactic durability testing of components for radio and other electronic equipment has been published by the British Radio Industry Council. The specification, No. RIC/II, is the work of the RIC Technical Specifications Committee in consultation with the British Radio Equipment Manufacturers' Association, the Radio Communication and Electronic Engineering Association, and the Radio Component Manufacturers' Federation, and is the first produced by the Committee.

The object of the Technical Specifications Committee's work is to produce a series of radio component specifications designed to ensure a high standard of reliability and performance for British components during use, transit, and storage. The first basic need is to devise a standard series of tests for components, and RIC/II is intended to fulfill that need.

# Industrial Engineering Notes<sup>1</sup>

## REPORT ESTIMATES RADIO DISTRIBUTION ABROAD

An eight-page mimeographed report detailing the distribution of radio receiving sets by countries and geographical regions throughout the world was issued this week by the International Broadcasting Division, U. S. Department of State. A total of 53,191,000 sets was estimated to be in use in Europe, with 35,292,000 capable of short-wave reception. It was stated that radio receivers behind the "Iron Curtain," which includes Russia and her satellites, number 9,534,000, of which 8,263,000 are equipped with short-wave facilities.

There are 1,785,240 receivers in the Middle East and Africa, and 1,626,015 of them are short-wave sets. Latin American republics have an estimated 6,495,500 radio sets with 3,677,200 capable of short-wave reception. Although a total of 11,808,000 radio receivers are estimated to be in use in the Far East, only 1,478,650 of them are short-wave sets.

## OTS PUTS OUT TWO NEW INDEXES

A subject index to technological documents issued in Volume X (July-December, 1948) of the "Bibliography of Scientific and Industrial Reports," and a subject index and abstract collection of more than 1,000 unclassified scientific and technical reports dealing with European technology were published by the Office of Technical Services.

Copies of the first may be obtained from the OTS, Department of Commerce, Washington 25, D. C., at \$1.00 per copy; and the second (PB 96941), which includes material on radar, communication devices, and tubes, may be secured from the same source.

## FCC CHAIRMAN HEADS U.S. GROUP AT PARIS CONFERENCE

FCC Chairman Wayne Coy was appointed by President Truman to head the U. S. Delegation to the International Administrative Telephone and Telegraph Conference of the International Telecommunication Union, which was held in Paris in May. Frances Colt De Wolf, chief of the Department of State's Telecommunications Division, and Paul A. Walker, FCC Commissioner, were named vice-chairman and delegate, respectively.

## FCC ACTIONS

The FCC adopted final rules (Mimeo. No. 32308) for the Citizens Radio Service. Designed primarily to afford a two-way

short-range private communication service, the CRS is defined in its rules as "a fixed and mobile service intended for use for private or personal radio-communication, radio signalling, control of objects or devices by radio, and other purposes not specifically prohibited." In general, any U. S. citizen eighteen years of age or older will be eligible for a station license. Licenses will be valid for a period of five years, and the station license is normally the only authorization that will be required in order to operate a citizen's station. Two types of citizens stations may be authorized, with the distinctions based on technical and operating specifications, including input power of 10 watts for one type and 50 watts for the other type. All citizens operation will be in the 460- to 470-Mc band previously allocated to this service.

The FCC adopted a report and order (Mimeo. No. 33669) in Docket 9154, amending the Standards of Good Engineering Practice for AM broadcasting stations. The new rules concern ground-wave signals and were announced as proposed rules on October 1. . . . Restricted amateur radio operation in the band 1800 to 2000 kc on a shared basis with the Loran Service will be permitted, according to the FCC's amendment of its rules, subject to certain conditions and limitations.

The FCC has proposed a new over-all plan to "provide scope and direction for the immediate and long range development" of the Amateur Radio Service. The objectives of the scheme are to provide for the continued and directed improvement of the Amateur Service in its value to the public as a voluntary, noncommercial communications service; to extend the amateur's proven ability to contribute to the advancement of radio; to continue the improvement of the Amateur Service through a program which will encourage advancing skills in both the communication and technical phases of radio; and to provide a reservoir of trained operators, technicians, and electronics experts, both for the growing radio industry in peace-time and the greatly increased industrial and military demands in times of national emergency. The proposal (Mimeo. No. 33917) would reclassify amateur frequencies by usage within the service and create a new license classification comparatively easy to attain. Higher performance standards would also be adopted. . . . The FCC amended its rules governing the Aeronautical Services to provide for the assignment of very high frequencies in accordance with a chain system of allocation. The amendments (Mimeo. No. 33914) do not involve any change in the medium and high frequencies. . . . Mimeo. No. 32808, 33669, 33917, and 33914 may be obtained from the Secretary of the FCC, Washington 25, D. C. . . . The effective date of the Commission's amended rules and regulations regarding electric welding devices using radio frequencies was postponed to July 30, but the FCC denied a petition submitted by the Joint Industry Committee on High Frequency Stabilized Arc Welders and others, seeking further hearings on the new rules. . . . Extended use of mobile radio communications and the ever-increasing problem of finding spectrum space for these specialized services

<sup>1</sup> The data on which these NOTES are based were selected, by permission, from "Industry Reports," issues of April 22 and 29 and May 6 and 13, published by the Radio Manufacturers' Association, whose helpful attitude is gladly acknowledged.

were highlighted this week in a comprehensive FCC action making over-all revisions in the rules governing, and the frequencies utilized by, a multitude of mobile radio services. Rules and frequencies covering the operation of about 50,000 authorized stations and nearly 200,000 mobile units became effective July 1. Of importance to television is the notice taken by the FCC of possible effects the various services may have on nearby television channels in the 66-72 and 76-82 Mc bands. Fixed operations in the 72-76 Mc band will be permitted under the changed rules only if there is no interference to television. Text of the FCC Reprint and Order, which deals with assignments to services in the frequency bands 25-39, 30-44, 44-50, 72-76, 152-162, 450-460 Mc and certain portions of the government band, 162-174 Mc, were published in the May 6 issue of the "Federal Register," copies of which may be obtained from the Superintendent of Documents, Government Printing Office, Washington 25, D. C., for twenty cents.

#### TELEVISION NEWS

FCC Chairman Wayne Coy has announced that the "freeze" on television station grants will probably be lifted within the year. After stating that the next significant phase of television development will be the addition of channels in the proposed uhf band, Mr. Coy added that modern television sets will probably not become obsolescent for a long time because the FCC plans to retain twelve channels in the uhf band; adaptors can readily be built for the present sets if the current 6-Mc black and white standards are employed in the uhf; and that most of the sets now in use are in cities having at least four authorized television stations—the few set-owners living in cities having fewer than four stations, and where uhf stations may some day be built, will be able to purchase converters to tune them in at a reasonable cost. . . . In the first ruling of its kind, the FCC granted a construction permit to NBC for the operation of an experimental uhf television station at Bridgeport, Conn., which will be operated as a satellite to station WNBTV, New York, N. Y. WNBTV'S programs will be picked up and rebroadcast by the experimental station, and will be received by a limited number of sets capable of receiving uhf broadcasts. . . . The American Tele-

phone and Telegraph Co. plans to extend its facilities in order to carry television network programs. The new channels will enable stations in the Midwest to present a wider choice of programs coming from New York's television stages. Under present plans, the fourteen cities already on the Bell System's television network will be joined by Erie and Lancaster, Pa., and Wilmington, Del., during the summer. By fall it is expected that Providence, R. I., Rochester, N. Y., and Dayton, Columbus, and Cincinnati, Ohio will be linked. . . . Rapidly increasing sales of television sets have been accompanied by a rise in the job prospects in the television field, according to an "Occupational Outlook Handbook" prepared for the Veterans Administration by the Bureau of Labor Statistics, U. S. Department of Labor. The 454-page handbook, containing complete reports on 288 occupations, is available at \$1.75 from the Superintendent of Documents, U. S. Government Printing Office, Washington 25, D. C. . . .

A special RMA Committee on television equipment for export met on March 23 in New York to develop a series of recommendations as to export standards. The committee believes that, ideally, a television system should be independent of power line frequencies, and that "in view of the current experience with 525-line, 60-field, 30-frame television systems, as set forth in the U. S. standards, and, in view of the flicker considerations, this committee feels that it should reaffirm these standards as representative of a practically achievable ideal at this time." The committee's "suitable secondary recommendation" is a 625-line, 50-field, 25-frame system for use in areas where the power supply frequency is 50 cycles. An additional secondary recommendation was the adoption of a 525-line, 60-field, 30-frame system in areas where the power frequency is 60 cycles. In all other respects the committee recommends adherence to U. S. television standards.

There are sixty-one television stations on the air as well as sixty-one construction permits outstanding, and 323 applications to construct pending but "frozen." New stations on the air are: WKRC-TV, Cincinnati, WLWC, Columbus, WLWD, Dayton, Ohio, and WTVJ, Miami, Fla.

About two dozen applications to construct television broadcasting stations have been received by the Mexican Government,

and, although no permits to operate television stations have been granted as yet, the first television station in that country is expected to be on the air before the end of the year. Arrangements have been completed for one station, and some sets are being assembled in Mexico City from parts imported from the United States. One experimental station (XEZA) has been certified by the Mexican Government to operate with 1-kw power in the 66 to 72-Mc band. Representatives of the Mexican Government are consulting the FCC with respect to their television standards.

#### FM NOTES

According to the FM Association, a growing number of television sets are being equipped with FM sound reception facilities.

The number of FM stations on the air has reached 755, including 31 noncommercial educational outlets. New stations went on the air at Gainesville, Fla. (WDUN-FM); Berkeley, Calif. (KPFA); and Orlando, Fla. (WDBO-FM).

#### TELEVISION SET PRODUCTION RISES AS RADIO PRODUCTION FALLS

Television set production by RMA member-manufacturers reached new records, both in March and during the first quarter of 1949. Radio receiver output continued at the reduced level to which it declined early this year.

In the first quarter, 422,537 television sets were manufactured and 182,361 sets were made in March. The quarterly output of television receivers was three and one-half times that of the first quarter of 1948.

FM-AM radio set production continued to decline, along with general radio receiver manufacturing, in the trend from radio to television. The total quarterly production was 317,918 FM and AM sets, just over half of the number manufactured during the first quarter of 1948.

Indicative of the sharp rise in television receiver production in 1948, sales of cathode-ray tubes during the year increased more than 361 per cent in number of units and over 142 per cent in value compared with 1947 sales. Cathode-ray receiving tube sales in 1948 numbered 1,265,472, valued at \$31,985,461, compared with 274,008 tubes valued at \$7,756,204 in 1947.

## Books

### Microwave Antenna Theory and Design, edited by Samuel Silver

Published (1949) by the McGraw-Hill Book Co., Inc., 330 W. 42 St., New York 18, N. Y. 613 pages +9-page index +xviii pages. 337 figures. 6 1/2 x 9 1/2. \$8.00.

Microwave antennas bridge a transition region between the geometrical optics of light waves interacting with large objects, and the physical optics of light waves interacting with small objects. In the microwave region the apparatus used is neither very

large nor very small with respect to the wavelength employed, and it is thus necessary in using either the geometrical or the physical method of treating an antenna problem to remember the limitations imposed by the other effects.

This volume covers the theoretical, practical, installation, and testing phases of microwave antenna design as developed by the MIT Radiation Laboratory and other similar agencies during the war. Because microwave antennas involve consideration of the

effects listed above, many of the methods and much of the information will be found of value in the uhf and vhf regions. Although some of the basic theory of radio antennas is in a rather complicated and unsatisfactory state at present, the theory which has been given includes the most valuable approximations and the most general methods of use in the actual design and construction of antennas. Basic logic is used in the development of most of the material presented, and, where possible, the performance of various types of



ntennas or antenna components is compared in a way which is very helpful in deciding questions of design.

The book is complete and up to date, with the exception of material which remains unpublished for reasons of national security. Although the text was prepared by a number of authors, the editor has done a very good job of unifying the presentation and preventing duplication among the various sections. The book connects the theory with the practice in a very able manner.

RICHARD C. RAYMOND  
Pennsylvania State College  
State College, Pa.

### Spherical Harmonics, by T. M. MacRobert

Published (1948) by Dover Publications, 1780 Broadway, New York 19, N. Y. 367 pages + 4-page index + xv pages. 20 figures. 5½ × 8½. \$4.50.

This is the revised edition of the book by the present professor of mathematics in the University of Glasgow which was written to provide a textbook on the theory of Fourier Series, spherical harmonics, and Bessel Functions. In this second edition, the restriction to integral values of the orders of the associated Legendre functions has been removed, although it still retains the original goal of not employing the method of contour integration. Two new chapters have been added; Chapter Eight deals with some properties of the hypergeometric function and Chapter Nine deals with the associated Legendre Functions of general real degree and order. A set of examples has been added to the text.

The first three chapters deal with the theory of Fourier Series and their application to conduction of heat and vibrations of strings. Chapters Four to Seven are devoted to spherical harmonics, Legendre Coefficients, Legendre Functions, and the associated Legendre Functions. In Chapters Eight to Twelve, expressions are obtained for the gravitational and electrostatic potentials of bodies bounded by circles, spheres, spheroids, ellipsoids of revolutions, and eccentric spheres. Chapters Fourteen to Sixteen deal with the Bessel Functions and their application to vibrations of membranes and conduction of heat.

For the engineer endeavoring to acquaint himself with the mathematical tools supplied by the above functions, the book is difficult reading because of the small amount of explanatory material on an engineering level. For the student aided by accompanying lectures, however, and for the applied mathematician, the book provides a useful, up-to-date, and thorough treatment of the subject.

MILTON DISHAL  
Federal Telecommunications Laboratories  
Nutley 10, N. J.

### Wave Mechanics and Its Applications, by N. F. Mott and I. N. Sneddon

Published (1948) by the Oxford University Press, 114 Fifth Ave., New York 11, N. Y. 338 pages + 2-page name index and 3-page subject index + xii pages. 67 figures. 6½ × 9½. \$10.00.

This book by Mott and Sneddon fills an important gap in the existing literature on wave mechanics, the lack of a text which would cover more or less uniformly the entire field of the present quantum theory

and its application to various problems concerning the structure and properties of matter. There are excellent books presenting in complete form the mathematical foundations of wave mechanical theory, but treating its applications to various concrete problems only as examples of general theorems. Other books discuss in detail the theory of atomic and molecular structure (the field in which wave mechanics grew originally), but leave applications in other important fields, such as the theory of solids or nuclear physics, to special monographs on the subject.

In this book the authors make a successful attempt to describe the entire subject, showing the role of wave mechanical theory in the present development of the physics of matter. Extremely useful as a textbook for students beginning the study of theoretical physics, it will also appeal to experimentalists who would like to get acquainted with the wave mechanical interpretation of various classes of physical phenomena without getting into the deep waters of abstract considerations. For many years the reviewer was at a loss when asked to recommend a single good text for his classes in wave mechanics. With the appearance of this volume, the difficulty has been removed.

G. GAMOW  
George Washington University  
Washington, D. C.

### Microwaves and Radar Electronics, by Ernest C. Pollard and Julian N. Sturtevant

Published (1948) by John Wiley and Sons, Inc., 440 Fourth Ave., New York 16, N. Y. 414 pages + 11-page index + vii pages. 193 figures. 5½ × 8½. \$5.00.

The authors' intention in this book is to present to the engineer, who has had little or no experience with microwaves, the basic fundamental and practical aspects of microwave and radar engineering. A sufficiently broad survey of the microwave field is given in order to enable the reader to continue intelligently with more detailed study of any particular phase which may be of interest to him. As a prerequisite, the reader requires only a working knowledge of physics, calculus, and electron tube theory and practice. The material of the book is primarily descriptive in nature, and the authors have avoided complex mathematical treatment, except as required for the proper presentation of specific subjects. To the engineer who has been in close contact with radar and microwaves, the book will appear far too brief and lacking in detail, but these factors will make the publication more attractive to those less experienced in the field.

The text is divided into three major sections of approximately equal length. In the first part the authors open their subject with a brief analysis of electromagnetic fields, the knowledge of which is essential for an intelligent understanding of the microwave circuit. The work then proceeds to a description and explanation of coaxial and waveguide lines and cavity resonators. Following this is a description of various microwave devices: low-level cw generators, magnetrons, crystal detectors, and measuring devices—including wavemeters, bolometers, and spectrum analyzers. Brief treatment is given to impedance matching in microwave

lines, the basic fundamentals of antennas, and descriptive information on the more important waveguide and cavity elements, such as directional couplers, TR boxes, and "magic T."

The second section of the book covers the other electronic elements associated with radar systems. Included here are descriptions of various pulsing circuits for high and low levels, video amplifiers, cathode-ray tube indicators and their associated sweep and deflection circuits, amplifiers for low-level signals, and other radar receiver accessories. A brief chapter is devoted to servomechanisms and computer elements, and a final chapter of this section to miscellaneous circuits, such as regulated power supplies, multivibrators, and clamp circuits.

The concluding sections of the text give an explanation of the physical basis of radar, brief descriptions of typical radar systems, and the application of microwaves to physical research.

Obviously so broad a field can be covered only lightly in a single volume, but the coverage is singularly complete and sufficient references are included to facilitate further study if desired. The book is easy to read and the material is well presented. This is not a microwave reference book or handbook, nor is it intended as such. The engineer specializing in communications, power, or allied fields will find this volume a good introduction to the microwave art, since it presents a clear over-all picture without confusing detail.

R. J. PHILIPPS  
Bell Telephone Laboratories  
Whippany, N. J.

### Exploring Electricity, by Hugh Hildreth Skilling

Published (1948) by the Ronald Press, 15 E. 26 St., New York 10, N. Y. 272 pages + 5-page index + vii pages. 18 figures. 6 × 8½. \$3.50.

Forty years ago a science writer in New York turned out a book entitled "What Is Electricity." With commendable candor the author began the book by stating, "We do not know what electricity is."

Professor Skilling in his new book, backed by what has come to light in the intervening decades of time, can with assurance say in the first sentence of his book, "There is a cliché that 'no one knows' [what electricity is]. This is absurd: pay no attention to it. Electricity is very well known. To know a thing is to know how it behaves, and few things are as well-known as electricity."

In full measure, "Exploring Electricity" fits in as an acceptable volume of the Humanizing Science Series, for Professor Skilling has done an excellent job in narrating a personalized history of electricity from the time of Thales forward to our own times. The "how to do it" type of technical book, popular thus far in the industrial age, may retain its usefulness indefinitely, but there is evidence that educators in science and engineering are increasingly attaching new importance to study which identifies scientific discoveries and inventions not only with the names of their respective discoverers and inventors, but with the conditions under which they worked and with their processes of thought. This has ever been the procedure in the study of political history: knowledge of

events has been closely linked with informative biographical material dealing with the life experiences of the outstanding participants. Emerson went the whole distance when he wrote, "Properly there is no history, only biography."

There are other histories of electricity, but, because of its clear treatment, readable style, and engaging sidelights, Professor Skilling's book could be made available in all engineering and science schools, elementary and advanced, as recommended reading. Purposeful students should derive inspiration from a reading acquaintance with the great men of science.

The reviewer regards the book as sufficiently complete to serve the author's purpose, and it is not, therefore, intended as adverse criticism, to note that there is no mention of the work of H. Abraham, A. C. Becquerel, and P. Langevin in France; O. J. Lodge in England; and C. F. Brackett, Robert Spice, Nikola Tesla, M. I. Pupin, John Trowbridge, and W. A. Rowland among the Americans.

DONALD MCNICOL  
25 Beaver St.  
New York, N. Y.

#### Industrial Electronics Reference Book, by Electronics Engineers of the Westinghouse Corp.

Published (1948) by John Wiley and Sons, Inc., 440 Fourth Ave., New York 16, N. Y. 669 pages + 10-page index + x pages. 1135 figures. 8½ × 11½. \$7.50.

The combined efforts of a group of electronics engineers of the Westinghouse Electric Corp. have produced a book which should find its way into the library of every industrial electronic engineer. The book proves, as did the distinguished MIT series, that, by proper co-ordination and editing, the work of several authors can present a unified and coherent story of a wide field, yet give in each chapter the authoritative treatment that comes only with the intensive knowledge of one aspect of the field.

Into the 669 large-sized pages, the thirty-seven authors have crammed an amount of information not found in any other book. While, as the title implies, the book is hardly meant to serve as a text in schools, yet the instructor will find much useful material, especially in the first four or five chapters which present an excellent explanation of the fundamental physical principles on which electron tubes operate.

To single out any one of the thirty-six chapters for particular praise would be an injustice to the rest; depending on his own interests, each reader will find some chapters of more interest than others. It should be noted here, however, that the sixty-seven pages of Chapter 24 on the timely subject of radio-frequency heating furnish formulas, graphs, and other data most useful to anybody engaged either in the design or operation of this type of apparatus.

Chapter 8, on industrial X-ray tubes, contains the description of as relatively recent developments as the betatron. The chapters on tuned circuits and filters, on transformers, and on rectifiers should also be mentioned for the completeness with which the material is treated.

Each chapter carries a list of references

at the end which will be welcomed when further information on the subject is wanted. Happily the authors have completely avoided turning out a glorified catalogue of Westinghouse equipment and achievements; they have used freely charts and data from the work of others, giving credit in all instances.

Even with a book as complete as this, any reader could probably think of a few things that should have been included, in his opinion. Thus, the word "servomechanism" is not found among the chapter headings, or even in the index, although Chapter 30, entitled "Regulation," could almost as well have been called "Servomechanism Theory," since it deals with many features of the latter. Among oscillators, the *RC* tuned oscillator of the Wien-bridge type is not discussed. The multivibrator is mentioned a few times, but not much data pertaining to its design is given. Flip-flop, counting, and trigger circuits could also have been described in a little more detail. These things might have been included without increasing the size of the book by cutting down on the twenty-five page chapter on antennas, which seem to receive more attention than is justified in an industrial electronics book.

These are minor criticisms, however; the important fact is that the subjects included in the book are treated with authority, completeness, and skill, and for this reason the book can be wholeheartedly recommended.

WALTHER RICHTER  
Allis-Chalmers Manufacturing Co.  
Milwaukee 1, Wis.

#### Basic Electrical Engineering, by George F. Corcoran

Published (1949) by John Wiley and Sons, Inc., 440 Fourth Ave., New York 16, N. Y. 444 pages + 5-page index + vii pages. 284 figures. 6 × 9½. \$4.50.

As the title implies, this book is a text designed primarily for introducing the field of electrical engineering to college undergraduates. Before courses in circuits, electrical machinery, electronics, and electronic circuits are taken, a certain background in basic material is required and this book is designed to fulfill that need.

The system of rationalized mks units is used throughout, after having been explained in the first chapter of the book. Concepts such as current, voltage, and power are skillfully introduced, and are followed by branch-current, mesh-current, and nodal methods of dc circuit analysis. The subjects of electric and magnetic fields, as well as magnetic circuits, are lucidly handled. This is followed by an introduction to the generation of electrical or mechanical power by means of rotating electrical machinery. Classical field theorems, like Gauss's Theorem, Ampere's Law, and the circuital law of magnetism, are discussed fully. Included also are such subjects as elementary transients, batteries, electrolysis, contact potential, and nonlinear circuit elements.

The book is very well written and the material excellently chosen. As a basic text, it covers material which is essential to both power and electronic engineering. Examples in both fields are given with a balance that

is noteworthy. Especially good are the numerical examples which serve to illustrate the text. This book deserves the highest recommendation.

JOHN R. RAGAZZINI  
Columbia University  
New York 27, N. Y.

#### New Publications

The National Bureau of Standards has recently published three new pamphlets: "Tables of the Confluent Hypergeometric Function ( $n/2, \frac{1}{2}; x$ ) and Related Functions," (NBS Applied Mathematics Series 3), "Tables of Scattering Functions for Spherical Particles" (NBS Applied Mathematics Series 4), and "Medical X-Ray Protection up to Two Million Volts" (NBS Handbook 41). The confluent hypergeometric function appears in the probability distribution of the statistics used in the analysis-of-variance tests when the hypothesis to be tested is not true, and a table of this function is also needed for the construction of the so-called *t*-test; moreover, statisticians will find this large-sized (eight-by-ten-inch), 73-page book of tables useful in connection with other tests . . . . The tables of intensities of light scattered by small spherical particles are based on Mie's theory on the scattering of light by particles with a radius comparable in magnitude with the wavelength of light, and will prove of interest to workers in many branches of physics, chemistry, and biology. In 119 eight-by-ten pages, the tables give the angular distribution of intensity and the total light scattered by a small spherical particle in terms of size of particle and wavelength of the incident light, thus permitting both the concentration and diameter of spherical particles in suspension to be determined from measurements of the alternation of an incident beam due to scattering, providing the particles are of uniform size . . . . "Medical X-Ray Protection" supersedes Handbook 20 ("X-Ray Projects") and consists of 43 five-by-eight pages. The recommendations are intended primarily for the protection of the radiation worker and not for the patient . . . . All three of the publications mentioned may be obtained from the Superintendent of Documents, U. S. Government Printing Office, Washington 25, D. C., at 35, 45, and 25 cents per copy, respectively . . . . "Radio Communication Transmitters," by J. J. Hubert, has been published by ATA Scientific Progress, Ltd., 76 Warwick Square, London, S. W. 1, England. Containing 286 pages and 167 illustrations, the book deals with the basic principles of radio transmitting equipment. Copies may be obtained for 30 shillings each, plus postage, from the publishers . . . . "The Photofact Auto Radio Manual" has been put out by Howard W. Sams and Co., Inc., 2924 E. Washington St., Indianapolis, Ind., from whom it may be obtained for \$4.95. Large (eight and one-half by eleven inches) and profusely illustrated, the book contains 392 pages giving service information on more than 100 post-war automobile radio receivers, representing the products of 24 manufacturers. Standard notation schematics are used throughout.

## Sections

Chairman		Secretary	Chairman	Secretary
H. I. Metz C.A.A. 84 Marietta St. N.W. Atlanta, Ga.	<b>ATLANTA</b> May 20-June 17	M. S. Alexander 2289 Memorial Dr., S.E. Atlanta, Ga.	R. W. Wilton 71 Carling St. London, Ont., Canada	<b>LONDON, ONTARIO</b> G. H. Hadden 35 Becher St. London, Ont., Canada
G. P. Houston 3000 Manhattan Ave. Baltimore, Md.	<b>BALTIMORE</b>	J. W. Hammond 4 Alabama Ct. Baltimore 28, Md.	Berhard Walley Radio Corp. of America 420 So. San Pedro St. Los Angeles 13, Calif.	<b>LOS ANGELES</b> May 17-June 20 J. J. Fiske Westinghouse Electric Corp. 600 St. Paul Ave. Los Angeles 14, Calif.
T. B. Lawrence 1833 Grand Beaumont, Texas	<b>BEAUMONT— PORT ARTHUR</b>	C. B. Trevey 2555 Pierce St. Beaumont, Tex.	D. C. Summerford Radio Station WKLO Henry Clay Hotel Louisville, Ky.	<b>LOUISVILLE</b> R. B. McGregor 2100 Confederate Pl. Louisville, Ky.
R. W. Hickman Cruft Laboratory Harvard University Cambridge, Mass.	<b>BOSTON</b>	A. F. Coleman Mass. Inst. of Technology 77 Massachusetts Ave. Cambridge, Mass.	F. J. Van Zeeland Milwaukee School of Eng. 1020 N. Broadway Milwaukee, Wis.	<b>MILWAUKEE</b> H. F. Loeffler Wisconsin Telephone Co. 722 N. Broadway Milwaukee 1, Wis.
G. E. Van Spankeren San Martin 379 Buenos Aires, Arg.	<b>BUENOS AIRES</b>	A. C. Cambre San Martin 379 Buenos Aires, Arg.	K. R. Patrick RCA Victor Div. 1001 Lenoir St. Montreal, Canada	<b>MONTREAL, QUEBEC</b> May 11-June 8 S. F. Knights Canadian Marconi Co. P.O. Box 1690 Montreal, P. Q., Canada
J. F. Myers 249 Linwood Ave. Buffalo 9, N. Y.	<b>BUFFALO-NIAGARA</b> May 18-June 15	R. F. Blinzler 76 Woodward Ave. Buffalo 14, N. Y.	L. A. Hopkins, Jr. 1711 17th Loop Sandia Base Branch Albuquerque, N. M.	<b>NEW MEXICO</b> T. S. Church 3079-Q-34th Street Sandia Base Branch Albuquerque, N. M.
M. S. Smith 1701 10th St. Marion, Iowa	<b>CEDAR RAPIDS</b>	V. R. Hudek Collins Radio Co. Cedar Rapids, Iowa	J. W. McRae Bell Telephone Labs. Murray Hill, N. J.	<b>NEW YORK</b> May 4-June 1 R. D. Chipp DuMont Telev. Lab. 515 Madison Ave. New York, N. Y.
K. W. Jarvis 6058 W. Fullerton Ave. Chicago 39, Ill.	<b>CHICAGO</b> May 20-June 17	Kipling Adams General Radlo Co. 920 S. Michigan Ave. Chicago 5, Ill.	J. T. Orth 4101 Fort Ave. Lynchburg, Va.	<b>NORTH CAROLINA- VIRGINIA</b> C. E. Hastings 117 Hampton Rds. Hampton, Va.
C. K. Gieringer 3016 Lischer Ave. Cincinnati, Ohio	<b>CINCINNATI</b> May 17-June 14	F. W. King RR 9 Box 263 College Hill Cincinnati 24, Ohio	W. L. Haney 117 Bourque St. Hull, P. Q.	<b>OTTAWA, ONTARIO</b> May 19-June 16 G. A. Davis 78 Holland Ave. Ottawa, Canada
F. B. Schramm 2403 Channing Way Cleveland 18, Ohio	<b>CLEVELAND</b> May 26-June 23	J. B. Epperson Box 228 Berea, Ohio	M. W. Bullock Capital Broadcasting Co. 501 Federal Securities Bldg. Lincoln 8, Nebr.	<b>OMAHA-LINCOLN</b> B. L. Dunbar Radio Station WOW Omaha, Nebr.
Warren Bauer 376 Crestview Rd. Columbus 2, Ohio	<b>COLUMBUS</b> May 13-June 10	George Mueller Electrical Eng. Dept. Ohio State University Columbus, Ohio	A. N. Curtiss Radio Corp. of America Camden, N. J.	<b>PHILADELPHIA</b> May 5-June 2 C. A. Gunther Radio Corp. of America Front & Cooper Sts. Camden, N. J.
S. E. Warner Aircraft Electronics As- soc. 1031 New Britain Ave. Hartford 10, Conn.	<b>CONNECTICUT VALLEY</b> May 17-June 16	H. L. Krauss Dunham Laboratory Yale University New Haven, Conn.	M. A. Schultz 635 Cascade Rd. Forest Hills Borough Pittsburgh, Pa.	<b>PITTSBURGH</b> May 9-June 13 E. W. Marlowe Union Switch & Sig. Co. Swissvale P.O. Pittsburgh 18, Pa.
A. S. Leville 801 Telephone Bldg. Dallas 2, Texas	<b>DALLAS-Ft. WORTH</b>	E. A. Hegar 802 Telephone Bldg. Dallas 2, Texas	A. E. Richmond Box 441 Portland 7, Ore.	<b>PORTLAND</b> Henry Sturtevant Rt. 6, Box 1160 Portland 1, Ore.
George Rappaport 132 East Court Harshman Homes Dayton 3, Ohio	<b>DAYTON</b> May 12	C. J. Marshall 1 Twain Place Dayton 10, Ohio	A. V. Bedford RCA Laboratories Princeton, N. J.	<b>PRINCETON</b> L. J. Giacometto 9 Villa Pl. Eatontown, N. J.
T. G. Morrissey Radio Station KFEL Albany Hotel Denver, Colo.	<b>DENVER</b>	Hubert Sharp Box 960 Denver 1, Colo.	K. J. Gardner 111 East Ave. Rochester 4, N. Y.	<b>ROCHESTER</b> May 19 Gerrard Mountjoy Stromberg-Carlson Co. 100 Carlton Rd. Rochester, N. Y.
F. E. Bartlett Radio Station KSO Old Colony Bldg. Des Moines, Iowa	<b>DES MOINES- AMES</b>	O. A. Tennant 3515 Sixth Ave. Des Moines, Iowa	E. S. Naschke 1073-57 St. Sacramento 16, Calif.	<b>SACRAMENTO</b> W. F. Koch 1340 33rd St. Sacramento 14, Calif.
C. F. Kocher 17186 Sioux Rd. Detroit 24, Mich.	<b>DETROIT</b> May 20-June 17	P. L. Gundy 519 N. Wilson Royal Oak, Mich.	G. M. Cummings 7200 Delta Ave. Richmond Height 17, Mo.	<b>ST. LOUIS</b> C. E. Harrison 818 S. Kings Highway Blvd. St. Louis 10, Mo.
R. W. Slinkman Sylvania Electric Products Inc. Emporium, Pa.	<b>EMPORIUM</b>	T. M. Woodward 203 E. Fifth St. Emporium, Pa.	O. C. Haycock Dept. of Elec. Eng. University of Utah Salt Lake City, Utah	<b>SALT LAKE</b> M. E. Van Valkenburg Dept. of Elec. Eng. University of Utah Salt Lake City, Utah
J. C. Ferguson Farnsworth Tel. & Radio Co. 3700 E. Pontiac St. Fort Wayne, Ind.	<b>FORT WAYNE</b>	S. I. Harris Farnsworth Tel. & Radio Co. 3702 E. Pontiac Fort Wayne, Ind.	C. L. Jeffers Radio Station WOAI 1031 Navarro St. San Antonio, Texas	<b>SAN ANTONIO</b> L. K. Jonas 267 E. Mayfield Blvd. San Antonio, Texas
W. H. Carter 1309 Marshall Ave. Houston 6, Texas	<b>HOUSTON</b>	J. C. Robinson 1422 San Jacinto St. Houston 2, Texas	L. G. Trolese U. S. Navy Elect. Lab. San Diego 52, Calif.	<b>SAN DIEGO</b> May 3-June 7 Jack Jacoby U. S. Navy Elect. Lab. Point Loma, Calif.
R. E. McCormick 3466 Carrollton Ave. Indianapolis, Ind.	<b>INDIANAPOLIS</b>	Eugene Pulliam 931 N. Parker Ave. Indianapolis, Ind.	F. R. Brace 955 Jones St. San Francisco 9, Calif.	<b>SAN FRANCISCO</b> R. A. Isberg Radio Station KRON 901 Mission St. San Francisco 19, Calif.
E. R. Toporeck Naval Ordnance Test Sta. Inyokern, Calif.	<b>INYOKERN</b>	R. W. Johnson 303 B. Langley China Lake, Calif.	J. M. Paterson 2009 Nipsic Bremerton Wash.	<b>SEATTLE</b> May 12-June 9 J. E. Hogg General Electric Co. 710 Second Ave. Seattle 1, Wash.
C. F. Heister 838 U. S. Court House Kansas City 6, Mo.	<b>KANSAS CITY</b>	Mrs. G. L. Curtis 6005 El Monte Mission, Kan.		

# Sections

Chairman		Secretary		Chairman		Secretary			
<b>F. M. Deerbake</b> 600 Oakwood St. Fayetteville, N. Y.		<b>SYRACUSE</b> <b>S. E. Clements</b> Dept. of Electrical Eng. Syracuse University Syracuse 10, N. Y.		<b>F. T. Hall</b> Dept. of Elec. Engr. Pennsylvania St. College State College, Pa.		<b>CENTRE COUNTY</b> (Emporium Subsection)		<b>J. H. Staten</b> Dept. of Eng. Research Pennsylvania St. College State College, Pa.	
<b>A. R. Bitter</b> 4292 Monroe St. Toledo 6, Ohio		<b>TOLEDO</b> <b>J. K. Beins</b> 435 Kenilworth Ave. Toledo 10, Ohio		<b>E. Olson</b> 162 Haddon Ave., N Hamilton, Ont., Canada		<b>HAMILTON</b> (Toronto Sub- section)		<b>E. Ruse</b> 195 Ferguson Ave., Hamilton, Ont., Canada	
<b>C. Graydon Lloyd</b> Canadian General Electric Co., Ltd. 212 King St., W. Toronto, Ont., Canada		<b>TORONTO, ONTARIO</b> <b>Walter Ward</b> Canadian General Electric Co., Ltd. 212 King St., W. Toronto, Ont., Canada		<b>R. B. Ayer</b> RCA Victor Division New Holland Pike Lancaster, Pa.		<b>(LANCASTER</b> Philadelphia Subsection)		<b>J. L. Quinn</b> RCA Victor Division New Holland Pike Lancaster, Pa.	
<b>D. A. Murray</b> Fed. Comm. Comm. 208 Uptown P.O. & Fed- eral Cts. Bldg. Saint Paul, Minn.		<b>TWIN CITIES</b> <b>C. I. Rice</b> Northwest Airlines, Inc. Holman Field Saint Paul 1, Minn.		<b>H. A. Wheeler</b> Wheeler Laboratories 259-09 Northern Blvd. Great Neck, L. I., N. Y.		<b>LONG ISLAND</b> (New York Subsection)		<b>M. Lebenbaum</b> Airborne Inst. Lab. 160 Old Country Rd. Box 111 Mineola, L. I., N. Y.	
<b>T. J. Carroll</b> National Bureau of Stand. Washington, D. C.		<b>WASHINGTON</b> May 9-June 13 <b>P. DeF. McKeel</b> 9203 Sligo Creek Parkway Silver Spring, Md.		<b>L. E. Hunt</b> Bell Telephone Labs. Deal, N. J.		<b>MONMOUTH</b> (New York Subsection)		<b>G. E. Reynolds, Jr.</b> Electronics Associates, Inc. Long Branch, N. J.	
<b>J. C. Starke</b> Box 307 Sunbury, Pa.		<b>WILLIAMSPORT</b> May 4-June 1 <b>R. G. Petts</b> Sylvania Electric Prod- ucts Inc. 1004 Cherry St. Montoursville, Pa.		<b>J. B. Minter</b> Box 1 Boonton, N. J.		<b>NORTHERN N. J.</b> (New York Subsection)		<b>A. W. Parkes, Jr.</b> 47 Cobb Rd. Mountain Lakes, N. J.	
<b>SUBSECTIONS</b>				<b>A. R. Kahn</b> Electro-Voice, Inc. Buchanan, Mich.		<b>SOUTH BEND</b> (Chicago Subsection) January 20		<b>A. M. Wiggins</b> Electro-Voice, Inc. Buchanan, Mich.	
<b>Chairman</b>		<b>Secretary</b>		<b>R. M. Wainwright</b> Elec. Eng. Department University of Illinois Urbana, Ill.		<b>URBANA</b> (Chicago Subsection)		<b>M. H. Crothers</b> Elec. Eng. Department University of Illinois Urbana, Ill.	
<b>H. R. Hegbar</b> 2145 12th St. Cuyahoga Falls, Ohio		<b>AKRON</b> (Cleveland Sub- section)		<b>S. S. Stevens</b> Trans Canada Airlines Box 2973 Winnipeg, Manit., Can- ada		<b>WINNIPEG</b> (Toronto Subsection)		<b>S. G. L. Horner</b> Hudson's Bay Co. Brandon Ave. Winnipeg, Manit., Can- ada	
<b>H. W. Harris</b> 711 Kentucky St. Amarillo, Tex.		<b>AMARILLO-LUBBOCK</b> (Dallas-Ft. Worth Subsection)		<b>E. N. Luddy</b> Station KFDD Amarillo, Tex.					

## IRE People

Hans W. Kohler (A'34-VA'39), formerly a staff member of the U. S. Army Signal Corps, research laboratories, was appointed to the staff of the National Bureau of Standards, where he will engage in theoretical work in the electronics division. Dr. Kohler has conducted extensive investigations in the vhf range, including antennas, wave propagation, transmitter, and measurement problems.

Born in Thun, Switzerland, Dr. Kohler received the electrical engineering degree in 1925 from the Federal Polytechnic Institute in Zurich. From 1926 to 1932 he was employed by the American Telephone and Telegraph Co.'s department of development and research.

He taught at the Cruft Laboratory, Harvard University, from 1925 to 1936, and was awarded the Sc.D. degree in the latter year. In 1937 he joined the staff of the Radiomarine Corporation of America's transmitter laboratory, leaving the same year to work for the Naval Research Laboratory, where from 1937 to 1942 he did theoretical and laboratory work on superfrequencies.

In 1942 he joined the radio development section of the Civil Aeronautics Administration, where he engaged in theoretical studies and field work on very-high-frequency radio ranges and localizers and on interference problems. He is the author of several papers published in the PROCEEDINGS.



ELWOOD K. GANNETT

Elwood K. Gannett (A'46) who has been appointed Technical Editor of the PROCEEDINGS OF THE I.R.E., was born on August 26, 1923, in New York, N. Y. He attended the University of Michigan, in Ann Arbor, receiving the B.S. degree in electrical engineering in October, 1944.

During World War II, Mr. Gannett served in the United States Navy as an ensign. He attended Pre-Radar School at Bowdoin College and Radar School at the Massachusetts Institute of Technology. Subsequently he was assigned to duty as the

electronics officer on a seaplane tender operating in the ports of Hongkong and Shanghai.

Mr. Gannett joined the administrative staff of the Institute in August, 1946, as assistant to the Executive Secretary. In December, 1947, he became the Assistant Secretary of the IRE. He has served as Chairman of the Institute Activities Committee for the 1947 National IRE Convention, and Chairman of the Facilities Committee for the 1948 and 1949 Conventions.

As Assistant Secretary, Mr. Gannett's duties were chiefly concerned with Student Branch activities, Sections, and PROCEEDINGS circulation.



Thomas A. Elder (SM'45), formerly section engineer in the tube division of the General Electric Co.'s electronics department, has been named designing engineer for transmitting tubes in the industrial and transmitting tube division.

Born in Kenton, Ohio, he attended Ohio University and was graduated in 1930 with the B.S. degree in electrical engineering. He then joined the General Electric Co. as a student engineer, and, after leaving the test course, was employed in the vacuum-tube engineering department until 1931, when he was promoted to assistant section engineer in the tube division.



**Robert Delavergne Avery (J'29-A'33-SM'44)**, chief engineer of J. H. Bunnell and Co., Brooklyn, N. Y., died recently.

Mr. Avery was born in Canon City, Colo., on June 4, 1911. He was educated at the Jefferson High School in Roanoke, Va., from which he was graduated in 1928. In that year he joined radio station WDRJ as chief operator; in that capacity he designed the first broadcasting studio equipment for the Virginia Polytechnic Institute, and designed and supervised the construction of the 250-watt radio station WLNA at Lynchburg, Va.

From 1931 to 1938 he was chief engineer of radio station WDBJ, where he was in complete charge of the technical operation of the station and where he designed a new broadcasting plant. In 1938 he was appointed chief engineer of the Commonwealth of Virginia. There he designed, supervised, constructed, and took charge of the operation of the state police communications system.

In 1943 he started work on a confidential research project under Columbia University's contract with the OSRD at the Airborne Instrument Laboratory, leaving in 1944 to join the Bunnell Co.

From 1946 to 1948 Mr. Avery was a member of the Institute's Admissions Committee.

**Wilbur S. Hinman, Jr. (SM'46)**, deputy chief of the National Bureau of Standards' ordnance development laboratory, has been appointed assistant chief of the Bureau's electronics division. In his new capacity he will, besides continuing to act as chief of the ordnance electronics section, aid in the direction of research and development of electronic apparatus, instruments, controls, circuits, tubes, and ordnance devices.

Born in Washington, D. C., Mr. Hinman attended the Virginia Military Institute, from which he received the bachelor of science degree in electrical engineering in 1926. In that year he joined the Westinghouse Electric and Manufacturing Co. as a student engineer, later becoming a radio engineer.

In 1928 Mr. Hinman joined the staff of the National Bureau of Standards as a member of the radio section. From 1941 to 1948 he was chief of the Bureau's fuze development section, chief of the special projects group for the production of a new electronic bomb director, and consultant to division four of the National Defense Research Committee. As deputy chief of the ordnance development laboratory, Mr. Hinman is responsible for research and development in the field of proximity fuzes for bombs, rockets, mortars, and guided missiles.

Mr. Hinman has achieved recognition as an authority on the radio proximity fuze and radio meteorography. A co-inventor with the late Harry Diamond (see page 1011 of the August, 1948, issue of the PROCEEDINGS) of a basic design utilized in the radio proximity

fuze, radiosonde, and the automatic weather station, Mr. Hinman has also conducted extensive research in upper-air wind measuring equipment, direction finders, automatic-volume control for aircraft radio receivers, radio compasses, and blind landing aids.

In recognition of his original contributions to the nation during the war, Mr. Hinman has received the Presidential Certificate of Merit, the Ordnance Development Award, the Army's citation for exceptional service, and the Department of Commerce Medal for meritorious service. The author of numerous technical papers, some of which have appeared in the PROCEEDINGS, he is a member of the American Ordnance Association.

**Arnold E. Bowen (SM'46)** microwave research worker on the Bell Telephone Laboratories' technical staff, died this year.

Mr. Bowen was born in Massachusetts on October 31, 1900. He received the Ph.D. degree in 1921 from the Sheffield Scientific School of Yale University, after which he served as an instructor in the Yale Graduate School until 1924. During the summer sessions he worked as an engineer for the American Telephone and Telegraph Co., and in 1924 he became a full-time member of their development and research department, where he specialized in inductive co-ordination of power and telephone systems.

In 1934 Mr. Bowen transferred to the technical staff of the Bell Telephone Laboratories, where he did research in field and waveguides and microwave electronics. In 1942 he became technical consultant on airborne radar to the U. S. AAF, but returned to Bell the following year to act as consultant on microwave communication systems for the Signal Corps and to investigate microwave propagation.

From 1943 to 1945 he was chief of the U. S. AAF's airborne radar section, where he was concerned with the characteristics, requirements, operational use, etc., of all airborne radar equipment. In 1945 he returned to Bell Laboratories to do research in the microwave field.

**William R. Patton (A'36-VA'39)** has joined the Lenkurt Electric Co. at San Carlos, Calif., as a field engineer in the carrier-equipment division.

A graduate of Oregon State College with the communications engineering degree, Mr. Patton is an active radio amateur (W6CCR). After finishing school, he was employed by the U. S. Naval Research Laboratory at Anacostia, Washington, D. C., and then took charge of radio communication systems for the Oregon State Highway Commission.

During World War II, Mr. Patton was on the staff of the OWI, working on the operation and construction of high-power broadcast and short-wave radio transmitters. Subsequently, he was assistant super-

intendent of communications for Africa and the Middle East with Trans-World Airlines at Cairo Egypt, after which he joined the staff of United Airlines.



**Frank E. Norton (A'31-M'40-SM'43)** was appointed chief engineer of the Bendix Aviation Corp.'s Television and Broadcast Division.

Mr. Norton received the B.S. degree from the University of California, and later earned the A.M. degree in physics from Columbia University. In 1937 the University of California awarded him a degree in electrical engineering.

After engaging in development work for the Bell Telephone Laboratories, where he specialized in television transmission and synchronization circuits, broad-band amplifiers, and cathode-ray tube equipment, Mr. Norton joined the development division of the Curtiss-Wright Corp. as senior development engineer in charge of the electronic laboratory development of radar devices and flight trainers.

Mr. Norton holds original patents on television sweep circuits, and he did some of the pioneer development work in color television for the Bendix Radio Division. He is a senior member of the Society of Motion Picture Engineers.

**Joseph Willard Milnor (A'16-M'26-SM'43)**, retired consulting engineer, died recently. Born October 25, 1889, in Williamsport, Pa., Mr. Milnor was graduated from Lehigh University in 1912, with first honors in mathematics. After serving for a year with the General Electric Co. of Pittsfield, he entered the engineering department of the Western Union Telegraph Co. in 1913. Nine years later he was promoted to research engineer, and in 1936 became transmission engineer. Appointed consulting engineer in 1943, Mr. Milnor retired from active work the following year.

During his thirty-one years with Western Union, Mr. Milnor engaged in a variety of problems in the field of telegraph transmission and the design of communications equipment. He made many important contributions to methods for reducing interference from power and other sources into telegraph circuits, and to telegraph signal transmission, submarine cables, and carrier current telegraphy.

The author of many papers, Mr. Milnor held a large number of patents in the fields of interference suppression, submarine cable, and carrier current telegraphy. He was a member of the American Association for the Advancement of Science, the American Museum of Natural History, Tau Beta Pi, and the Wire Club of New York.

## IRE SECTION CHAIRMAN

### Kenneth W. Jarvis

#### CHICAGO SECTION

Kenneth W. Jarvis (A'24-M'27-F'34) was born in Mansfield, Ohio, in October, 1901, and received the B.E.E. degree from Ohio State University in 1923. In that year he entered the employment of the Westinghouse Electric and Manufacturing Co., leaving in 1925. For the next nine years he worked as a radio engineer with various manufacturers, and entered private development and consulting engineering in 1934. At present he is manager of the electronics division of the Automatic Electric Co., president of the Jarvis Electronics Corp., and a lecturer in the graduate school of Northwestern University.



### George Rappaport

#### DAYTON SECTION

Born on December 7, 1917, in New York, N. Y., George Rappaport (A'41-M'49-SM'46) received the B.E.E. degree from the College of the City of New York in 1940. After graduation he joined the General Electric Co., leaving in 1941 to work on microwave instrument landing systems for the Aircraft Radio Laboratory at Wright Field. In 1942 he was transferred to Washington, D. C. Later he was sent back to Wright Field to become assistant chief engineer of the Air Matériel Command's special projects laboratory. In 1946 he was promoted to chief engineer in charge of advanced development at the Aircraft Radiation Laboratory. In 1947 he received the M.S. degree from Ohio State University.



### Thomas G. Morrissey

#### DENVER SECTION

Thomas G. Morrissey (M'47) was born in Denver, Col., on January 25, 1915. After receiving the B.S. degree in electrical engineering from the University of Colorado in 1936, he became a member of the Bell Telephone Laboratories' radio research staff. In 1942 he transferred to the long lines department of A.T. & T., and was assigned to Denver as a transmission engineer on the transcontinental buried cable project. Returning to private industry in 1946, Mr. Morrissey became chief engineer of station KFEL in Denver, where he established KFEL-FM, and now directs the experimental television station WXEL.



### F. E. Bartlett

#### DES MOINES-AMES

Born in Marshalltown, Iowa, on October 16, 1906, F. E. Bartlett (A'45) worked as a railroad telegraph operator after finishing school; then became interested in amateur radio work, which contributed to his becoming associated with radio broadcast operation. He worked for various radio stations in the Midwest, beginning as an announcer and later turning to the engineering aspect of the field. In 1944 he joined the staff of the Murphy Broadcasting Co. as chief engineer for radio station KSO in Des Moines, his present position.



Mr. Bartlett was active in the organization of the Des Moines-AMES section of the IRE in 1947.

### Charles F. Kocher

#### DETROIT SECTION

Charles F. Kocher (M'44) was born in Detroit, Mich., on February 1, 1914. From 1933 to 1939 he served as transmitter and studio operator at radio stations WEXL, WJBK, and WWJ, Detroit, while attending the Lawrence Institute of Technology, from which he graduated in 1939 with the B.E.E. degree. Upon graduation he became transmitter engineer at NBC's Chicago radio station WMAQ. In 1940 he joined the FCC's field staff and, after various assignments throughout the country, he was placed in charge of the Cleveland Field Office in 1942. Two years later he became chief engineer of radio station WXYZ in Detroit.



### Raymond E. McCormick

#### INDIANAPOLIS SECTION

Raymond E. McCormick (A'44-M'46) was born in Lincoln, Neb., on February 22, 1905. He received the B.Sc. degree in 1928, and the M.S. degree in 1932, both from the University of Nebraska. After teaching at Northeastern State College in Oklahoma, Mr. McCormick became an instructor at an electronics training school for military service men in Omaha, Neb., in 1942. A year later he joined the Military Intelligence Division Laboratories of the War Department at Arlington, Va. In 1945 he became associated with the Radio Development Division of the CAA Experimental Station at Indianapolis, Ind.



### Mark W. Bullock

#### OMAHA-LINCOLN SECTION

Born August 20, 1911, in West Winfield, N. Y., Mark W. Bullock (S'33-A'37-M'45) was graduated from the University of Nebraska in 1934 with the B.S.E.E. degree, and became transmitter supervisor for radio station KOHL, Omaha. In 1938 he was appointed chief engineer for radio stations KFAB and KFOR in Lincoln, as well as for KOHL. In 1943 he took charge of the construction of the OWI's international broadcast station at Mason, Ohio. This completed, he became principal radio engineer in the OWI's Washington bureau of communications facilities. After returning to KFAB, he left in 1948 to become technical director of the Capital Broadcasting Co.



### Obed C. Haycock

#### SALT LAKE SECTION

Obed C. Haycock (A'40-SM'47) was born in Panguitch, Utah, on October 5, 1901. After receiving the B.S.E.E. degree from the University of Utah in 1925, he joined the graduate student program at the Westinghouse Electric and Manufacturing Co. In 1926 he returned to the University of Utah and he has remained there, except for several leaves, including one to receive the M.S.E.E. from Purdue University in 1931, and one during the war to work on jungle acoustics in Panama. Professor Haycock is currently associate director of an Army research project at the University of Utah.



### Donald A. Murray

#### TWIN CITIES SECTION

Donald A. Murray (A'35-VA'39-M'48) was born in Redlands, Calif., on October 12, 1905. After receiving the A.B. degree in electrical engineering from Stanford University in 1928, he went to Germany on an exchange scholarship, returning to Stanford and receiving the E.E. degree in 1932. From then until 1937 he worked for the Mackay Radio and Telegraph Co., and for Heintz and Kaufman, Ltd., leaving in the latter year to join the FCC's engineering department. From 1941 to 1945 he was inspector in charge of the FCC's Fifteenth Radio District at Denver; then he was transferred to the FCC's Sixteenth Radio District, in St. Paul, where he is engineer in charge.



# Geiger Counter Tubes\*

HERBERT FRIEDMAN†, ASSOCIATE, IRE

**Summary**—The following are some of the many processes that contribute to the mechanism of the discharge in Geiger counters: formation of the primary ion pairs; ion multiplication within the gas by Townsend avalanche formation; spreading of the avalanches through photoelectric absorption of ultraviolet quanta in the gas; transfer of ionization energy from positive ions of the rare gases to the polyatomic molecules of the "quenching" admixture; release of secondary electrons at the cathode by positive ions and metastable atoms; de-excitation of metastable atoms of the rare gases by collisions with atoms of admixed foreign gases; and decomposition of polyatomic molecules by electron impacts and photon absorption. Present theories provide a qualitative understanding of the fundamental roles played by all of these processes, but their combined effects are too complex to predict the wide variation in characteristics of tubes obtained with slightly altered practices of construction or choices of gases. This paper is a review of existing theories and methods of constructing tubes to obtain maximum counting efficiencies and other desirable characteristics, such as low threshold voltage, thermal insensitivity, long life, high resolution, and low background.

SINCE THE FIRST demonstration of the tube counter by Geiger and Muller in July 1928,<sup>1</sup> the unusual sensitivity of such counters has found widespread applications in the detection of high-speed particles and energetic photons. The extensive literature on Geiger counters is not only indicative of their manifold uses, but is also a measure of the divergence of theories devised to explain their mechanism and the numerous recipes prescribed for the preparation of good counters. In the last ten years, however, a consistent and relatively complete theory of counter-tube operation has been developing,<sup>2-8</sup> together with a know-how for their construction, which now permits production of large numbers of reliable tubes with identical characteristics. This paper is a review of current theories of the mechanism of the Geiger-counter discharge and a survey of the many different types of counters designed for specialized applications.

A Geiger counter is a gas-filled diode operated in the region of the unstable corona

discharge. There are two types of counters, characterized by their filling gases. One uses simple monatomic or diatomic gases, such as hydrogen, air, the rare gases, or mixtures of these, and is known as the nonself-quenching type. The second category includes mixtures of simple gases and small percentages of "quenching" admixtures, which are usually polyatomic organic molecules. In general, the firing characteristics of both types of fillings are very much alike, but the subsequent stages of the discharge and the deionization processes are distinctly different. The emphasis in this paper will be devoted almost entirely to a description of the self-quenching type of tube, which is now used almost universally in preference to the simple gas type. The condition for starting a discharge is that at least one low-energy electron be produced within the counter gas. This electron kindles an avalanche discharge which spreads rapidly throughout the length of the tube and lasts for a few microseconds. Within a fraction of a millisecond after the triggering event, all ions and electrons are cleared out of the interelectrode space, and the tube is ready to respond again to the passage of another ionizing particle. A single electron is capable of triggering a discharge which can be easily detected with little or no amplification. In this respect, the Geiger counter comes close to fulfilling the requirements of a perfect detector.

The electrode system of a Geiger counter usually consists of a fine wire and coaxial cylinder. Most tubes are filled with a rare gas combined with a trace of a polyatomic vapor such as alcohol, ether, amyl acetate, and many others. At low voltages, the tube behaves as an ionization chamber with an internal amplification factor of unity. A relatively small potential difference prevents recombination losses, and is sufficient to draw a saturation current from the tube, supplied entirely by the primary ionization. Raising the voltage brings on gas multiplication by impact ionization of the gas molecules in the manner of the familiar Townsend avalanche. The multiplication factor increases with increase in voltage, and the current delivered by the tube is proportional to the primary ionization up to multiplications of  $10^6$  or  $10^8$ . Throughout this range, the discharges are single Townsend avalanches, each avalanche originating from a primary ion pair and localized within a fraction of a millimeter along the length of the wire. At still higher voltages, every avalanche breeds new avalanches, spreading the discharge along the full length of the tube, through the medium of the very-short-wavelength ultraviolet rays generated in each Townsend avalanche. The discharge continues to burn until a critical space-charge density of positive ions is reached. The amplification factor then becomes independent of the amount of primary ionization, and all discharge pulses attain equal amplitudes. This condition characterizes the operation of the Geiger counter. The Geiger-counting threshold is usually determined experimentally by observing, with an oscilloscope cou-

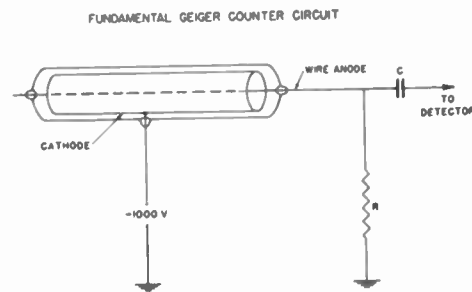

Fig. 1—Fundamental Geiger-tube circuit.

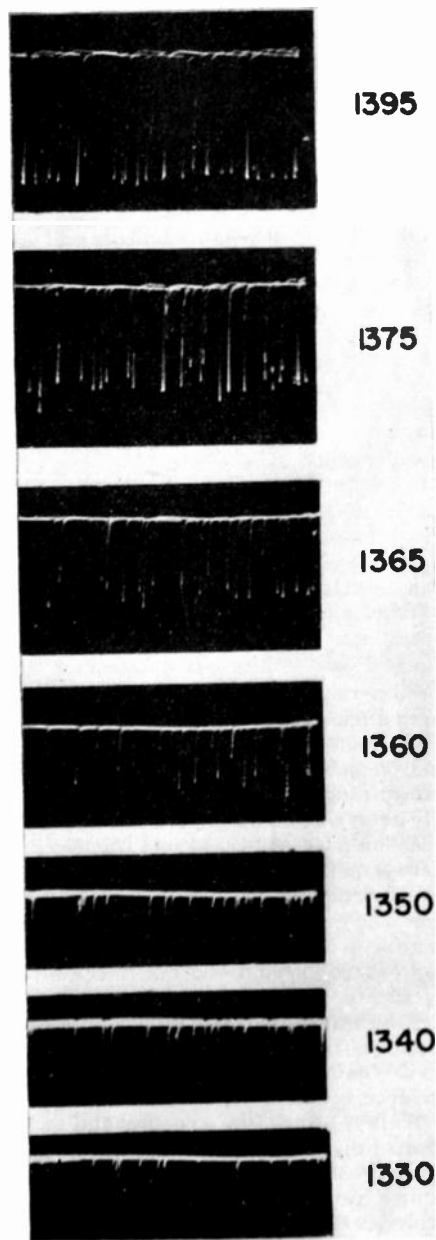

Fig. 2—Approach to uniform pulse amplitudes near Geiger-counting threshold. Counter-tube dimensions are 10, 1.0, and 0.0125 cm. Argon-ammonia filling.

\* Decimal classification: 621.375.2. Original manuscript received by the Institute, March 7, 1949.

† Naval Research Laboratory, Washington 20, D. C.

<sup>1</sup> H. Geiger and W. Muller, "Technical considerations concerning the electron counting tube," *Phys. Zeit.*, vol. 29, pp. 839-841; November, 1928. Also, vol. 30, pp. 489-493; August, 1929.

<sup>2</sup> A. Trost, "The addition of saturated vapors to G-M tubes," *Zeit. für Phys.*, vol. 105, pp. 399-444; May, 1937.

<sup>3</sup> C. G. Montgomery and D. D. Montgomery, "Discharge mechanism of the G-M counter," *Phys. Rev.*, vol. 57, pp. 1030-1040; June, 1940.

<sup>4</sup> W. E. Ramsey, "Measurements of discharge characteristics of G-M counters," *Phys. Rev.*, vol. 57, pp. 1022-1029; June, 1940.

<sup>5</sup> H. G. Stever, "The discharge mechanism of fast G-M counters from the dead time experiment," *Phys. Rev.*, vol. 61, pp. 38-52; January, 1942.

<sup>6</sup> S. A. Koff and R. D. Present, "The role of polyatomic gases in fast counters," *Phys. Rev.*, vol. 65, pp. 274-282; May, 1944.

<sup>7</sup> A. Nawijn, "The mechanism of the G-M counter," *Physica*, vol. 9, pp. 481-493; May, 1942.

<sup>8</sup> A. G. M. Van Gemert, H. Den Hartog, and F. A. Muller, "Measurements on self-quenching G-M counters," Parts I and II, *Physica*, vol. 9, pp. 556-564 and 658-664; June and July, 1942.

pled to the simple circuit of Fig. 1, the lowest voltage at which all pulses become equal in size. As threshold is approached, statistical fluctuations in the breeding of new avalanches from preceding avalanches may interrupt the chain before the discharge has filled the entire length of the tube. The transition to Geiger counting is ordinarily very sharply defined, as is illustrated in Fig. 2, which shows the rapid transition from incomplete growth of the discharge characterized by nonuniform pulse heights, to the threshold where each discharge has spread throughout the tube. The number of discharges is directly related to the number of primary particles striking the tube, and does not depend appreciably on the applied potential over a range of a few hundred volts known as the "plateau." At higher voltages, the condition of a self-sustained corona is reached, and the discharge maintains itself until the potential is removed. Sufficiently high potentials bring on the transition to a glow discharge in which the current rises very rapidly and the voltage across the electrodes falls to a low stable value. The complete voltage characteristic of the cylindrical ionization tube is illustrated in Fig. 3.

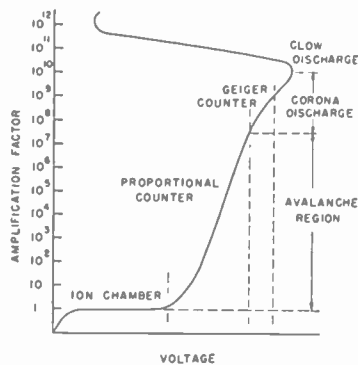

Fig. 3—Gas amplification versus voltage in a coaxial-cylinder type of ionization tube.

Since the gradient of the electric field between a fine wire and a cylinder is very high in the immediate neighborhood of the wire, electron multiplication in the Geiger-counter plateau range is confined to a narrow zone only a few wire diameters in width. Electron collection is accomplished in a fraction of a microsecond, during which the positive ions form a virtually stationary sheath about the wire. The eventual severing of the chain of electron avalanches is attributable to the electrostatic shielding effect of this positive-ion sheath. Subsequently, the ion sheath must be neutralized without reigniting the discharge. This constitutes the major problem in obtaining successful counter-tube performance.

At first glance, the structure and mechanism of the Geiger counter appear to be deceptively simple. The complete Geiger-counter mechanism is rather complex and involves (1) the Townsend avalanche, (2) the spreading of the discharge, (3) the motion of the ion sheath and growth of the pulse, (4) the deionization process, and (5) all the effects involved in suppression of spurious pulses. This last category includes

ionization transfer from positive ions of the rare gas to polyatomic vapor molecules, suppression of secondary emission at the cathode, quenching of metastable states, and photodecomposition of the polyatomic gas.

The performance of any particular Geiger counter is described by its threshold voltage, the length and slope of its plateau, its efficiency, pulse characteristics, maximum counting rate, temperature dependence, and useful life. No single type of counter exhibits all of the ideal characteristics, but some tubes meet the requirements of specialized applications almost to perfection.

#### THE TOWNSEND AVALANCHE

The electric field strength between coaxial cylinders is given by

$$E(r) = \frac{V}{r \log \frac{b}{a}} \quad (1)$$

where  $E(r)$  is the field at distance  $r$  from the axis,  $V$  is the applied potential difference, and  $b$  and  $a$  are the cathode and anode radii, respectively. Consider a typical counter, operating with an applied potential difference of 1,000 volts. The field strength at the surface of the wire is about 40,000 volts per cm. It falls inversely as the distance from the wire and is less than a few hundred volts per centimeter at distances greater than  $b/2$  from the anode. Immediately after the passage of an ionizing particle, the secondary electrons which it produced are accelerated radially toward the wire. Each electron gains energy, which it loses through inelastic collisions leading to excitation or ionization of the gas. Every inelastic collision brings the electron to rest, after which it starts to travel its next free path in the direction of the field. The excited molecules may radiate their energy or be de-excited by subsequent collisions. If, for example, the counter is filled with hydrogen to a pressure of 100 mm Hg, the electron mean free path is about  $10^{-3}$  cm, and sufficient energy for impact ionization cannot be gained in one mean free path until the electron reaches the high-field region very close to the wire. The potential fall per mean free path at the cathode is as little as 0.2 volts, but rises to about 20 volts at the surface of the wire. This energy gained per mean free path first reaches the ionization potential of the hydrogen molecule, 16 ev, at a distance of four free paths, which is slightly less than one wire radius from the surface of the wire. Beyond the immediate neighborhood of the wire, the energy for ionization can be acquired only over several mean free paths.

Increasing the voltage across the counter toward the threshold for Geiger counting expands the multiplication zone in the gas over an increasing number of mean free paths. More and more electrons are added to the avalanche, together with photons radiated from excited states of higher energy which are capable of photoionizing the gas or photoelectrically releasing electrons from the cathode. These photoelectrons are in turn accelerated toward the wire, where they contribute new avalanches. Geiger-counting threshold is marked by the release of a sufficient number of photons per avalanche to guarantee the generation of a succeeding

avalanche by photoelectric effect in the gas or at the cathode.

The properties of the single Townsend avalanche can generally be summarized as follows: At threshold the multiplication factor in the avalanche is about  $10^5$ ; each avalanche is quite discrete, and the lateral extension along the length of the wire arising from diffusion of the electrons in the avalanche is about 0.1 mm; the duration of the single avalanche is less than  $10^{-9}$  second measured from the beginning of the multiplication process.

The threshold voltage for the corona discharge depends for the most part on the nature of the gas as characterized by the first Townsend coefficient  $\eta$ , which is defined as the ionization produced by an electron per volt of potential difference. The coefficient  $\eta$  depends on the energy gained by an electron per mean free path, which is a function of the ratio of field strength  $E$  to pressure  $p$ . The threshold requirement that each avalanche release a sufficient number of quanta to photoelectrically trigger another avalanche is expressed in terms of a second coefficient,  $\gamma$ , as

$$\gamma n = 1 \quad (2)$$

where  $\gamma$  is the number of photoelectrons ejected per ion pair formed in the gas and  $n$  is the number of ion pairs per Townsend avalanche. Experimentally, it is observed that  $\gamma$  for the simple gases does not vary markedly with different cathode materials, but that the nature of the gas, its pressure, and the electrode geometry, as reflected in  $\eta$ , are the quantities which are mainly responsible for establishing the threshold voltage.

Among the diatomic and inert gases, equal values of  $\eta$  are achieved at widely different values of  $E/p$ . The rare gases—helium, neon, argon, krypton, and xenon—produce higher threshold voltages in the order of increasing atomic number. Hydrogen requires a higher starting voltage than argon, and that of air or nitrogen is still higher. Traces of impurities have a pronounced effect on the starting voltage of the corona, as will be shown in a later section. Most present-day counter tubes include a small percentage of a polyatomic "quenching" gas in addition to the rare gas which is usually the major constituent. Although the ionization potential of this polyatomic constituent is always lower than that of the rare gas, its presence almost invariably raises the threshold voltage. This is so, because a large portion of the electron energy is dissipated in exciting molecular vibrations at each impact, rather than ionizing. Polyatomic molecules with absorption bands in the near-infrared portion of the spectrum can absorb energies amounting to a fraction of an electron-volt, or less than the energy acquired by an electron per mean free path even in the neighborhood of the cathode. Inelastic collisions can, therefore, bring the electron to rest every time it encounters a polyatomic molecule. In contrast to the simple gas fillings, an electron is much less likely then to acquire ionization energy over several free paths. As a result, the zone of ionization contracts with addition of the polyatomic gas, and the minimum field strength for a corona discharge increases. Argon with alcohol admixture is one of the most commonly used



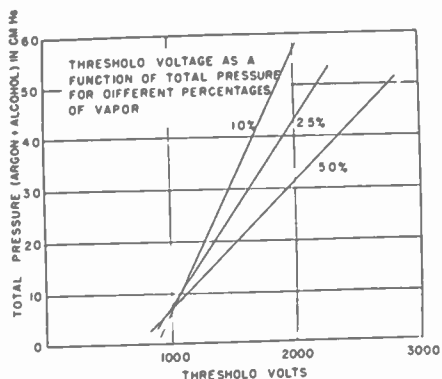

Fig. 4—Variation of threshold voltage with composition and pressure of a self-quenching gas mixture. (After Trost in footnote reference 2.)

Geiger-counter fillings. Fig. 4 illustrates the effect of argon pressure, percentage of alcohol admixture, and the size of the electrodes on the threshold voltage.

#### SPREAD OF THE DISCHARGE AND FORMATION OF THE ION SHEATH

Above the threshold of Geiger counting, thousands of Townsend avalanches per centimeter of length of the tube are ignited through the emission and absorption of ultraviolet light. Neutral gas molecules are excited by electron impacts in the avalanche process and, in returning to the ground state, emit ultraviolet quanta with energies below the ionization potential of the gas. If the counter tube is filled with simple gases, the ultraviolet photons generate new avalanches by releasing photoelectrons at the cathode. The rate of spread of the discharge is then dependent only on the lifetime of excited atoms or molecules and on the photon transit time.

If a polyatomic vapor admixture such as alcohol is included with the simple gas, the photon mechanism is very much altered. In a mixture of argon and alcohol, the highest excited states of argon at about 11.6 eV exceed the energy required to ionize an alcohol molecule, 11.3 eV. Energetically, therefore, it is possible for the ultraviolet photon radiated by an argon atom to ionize a molecule of alcohol, and thereby release an electron which may trigger a new avalanche. The efficiency of such absorption processes is so great that the number of quanta arriving at the cathode is insufficient to provide any significant number of photoelectrons. In addition to the absorption of ultraviolet quanta by the polyatomic gas, there is evidence for absorption processes in the rare gas itself, although their mechanism at present is not well understood.

Many investigations have been attempted with the object of identifying the nature of the ultraviolet radiation and its modes of production and absorption within the gas mixtures used in counters. Among the earliest of these experiments was that of Greiner,<sup>9</sup> who studied counters filled with oxygen, hydrogen, or air. The experiment consisted of mounting two counters inside

the same envelope, with their cylinders open to each other and their anodes separated by about 1 centimeter. From measurements of the number of counts which spread from one counter to the other at different pressures, Greiner computed absorption coefficients for the different gases. To prove that the spreading was accomplished by the passage of ultraviolet radiation across the gap between the counters, he inserted light filters between the tubes. Only the thinnest nitrocellulose films, about twenty-thousandths of a micron in thickness, which were transparent to ultraviolet radiation below 1,000 Å, permitted the discharge to spread from one tube to the other.

Greiner's experiment was performed with simple gases, in which the ultraviolet radiation regenerated Townsend avalanches by a cathode photoelectric effect. In another version of this type of experiment, Ramsey<sup>10</sup> showed that two counters would trigger each other in coincidence when filled with monatomic or diatomic gases, but that the introduction of a small amount of polyatomic admixture caused the counters to fire at random with respect to each other. Furthermore, by plotting coincidence rate versus resolving time of the coincidence circuit, it was found that the photoemission was confined to a period of approximately 1 microsecond, even though the pulse on the counter wire required from 1 to 20 microseconds to attain one-half its peak amplitude.

The mean free path of the ultraviolet radiation responsible for spreading the discharge in counters with polyatomic constituents has been evaluated by a number of experimenters. Stever<sup>4</sup> obtained an interesting picture of the process by using divided cathodes and beaded anodes. In the latter type of counter, glass beads were sealed on to the wire at equal intervals along its length. From observations of pulse size, it was established that the discharge jumped the obstacle of the glass bead only if the beads had less than a minimum diameter, or what is equivalent, if the ratio of field strength to pressure  $E/p$  exceeded a critical value. Further<sup>11</sup> studies showed that, besides the obstructing effect of the glass bead for ultraviolet light, the field intensity was reduced about the glass bead. The photons were all absorbed in the immediate neighborhood of the bead where the field was too low to develop a complete avalanche.

Attempts to clarify the details of the emission and absorption processes have not been entirely successful. Alder<sup>12</sup> and his co-workers recently performed a variation of the Greiner type of split-counter experiment to determine the absorption coefficient of an alcohol vapor admixture for the ultraviolet photons emitted in the discharge. The two counters were mounted in a common envelope at a fixed separation of 11 centimeters. At first, the counters were filled with a mixture of simple gases, argon plus air, which gave satisfactory counting character-

istics. With this filling, every count in one tube triggered the companion tube coincidentally. Contaminating the simple gas mixture with only a few tenths of a millimeter Hg of alcohol sufficed to reduce the number of spreading discharges to a vanishingly small figure. The absorption coefficient computed from this experiment was  $640 \text{ cm}^{-1}$  (at atmospheric pressure). With an admixture of 15 mm Hg of alcohol, the number of photons fell to  $1/e$  of its initial value in 0.8 mm. In obtaining this result it was assumed that introducing alcohol in these low concentrations did not affect the number of photons per discharge nearly so much as it did the absorption of photons.

Still another experiment of this type, reported by Liebson,<sup>13</sup> attempted to avoid the possibility of confusing a decrease in photon emission with an increase in absorption coefficient. All conditions of the discharge were held constant and only the gas path which the photons were required to traverse was altered, by an expanding bellows connection between the counters. The magnitudes of the total absorption coefficients for the rare gases, with the alcohol or methylene bromide admixtures which he used, were comparable to those computed by Alder and his coworkers, but Liebson found that constant coefficients per unit pressure were obtained only if the absorption were attributed entirely to the rare gas.

The qualitative conclusion to be drawn from these experiments is that, in gases containing polyatomic admixtures, the absorption of ultraviolet quanta by photoionization of the gas is very effective in confining the spreading mechanism to the immediate neighborhood of the wire. The ultraviolet radiation may be composed of a number of wavelengths, some of which may reach the cathode and contribute a photoelectric effect. Experiments with split-cathode counters,<sup>14,15</sup> filled with the typical operating mixtures, showed a small but measurable spreading of the discharge by ultraviolet radiation absorbed in the gas at distances of many centimeters, which could not be attributed to the same photons which propagate the discharge along the wire. These less-abundant photons were also capable of ejecting an appreciable number of cathode photoelectrons as part of the mechanism of spreading the discharge. In any combination of gas mixtures and cathode surfaces, it may be expected that all of these processes of photon emission and absorption in the gas and photoelectric emission at the cathode play a role, but their relative importance may differ considerably. There is a need for still more refined measurements of the production of photons and the cross sections of photon absorption between 600 Å and 1,200 Å before the Geiger-counter mechanism can be quantitatively described.

If Alder's value of about 1 millimeter for the mean free path of the quanta is accepted, it is immediately apparent that the dis-

<sup>9</sup> W. E. Greiner, "Period of photon emission in a counter discharge," *Phys. Rev.*, vol. 58, pp. 476-477; September 1, 1940.

<sup>11</sup> M. H. Wilkening and W. R. Kanne, "Localization of the discharge in G-M counters," *Phys. Rev.*, vol. 62, pp. 534-537; December, 1942.

<sup>12</sup> F. Alder, E. Baldinger, P. Huber, and F. Metzger, "On the growth of the discharge in counter tubes with alcohol vapor admixtures," *Helv. Phys. Acta.*, vol. 20, pp. 73-95; Issue 1, 1947.

<sup>13</sup> S. H. Liebson, "The discharge mechanism of self-quenching G-M counters," *Phys. Rev.*, vol. 72, pp. 602-608; October, 1947.

<sup>14</sup> J. D. Craggs and A. A. Jaffe, "Discharge spread in Geiger counters," *Phys. Rev.*, vol. 72, pp. 784-792; November, 1947.

<sup>15</sup> C. Balakrishnan, J. D. Craggs, and A. A. Jaffe, "Discharge spread in Geiger counters with methane and methane-argon fillings," *Phys. Rev.*, vol. 74, pp. 410-414; August, 1948.

<sup>8</sup> E. Greiner, "On the spreading of the discharge in counter tubes," *Zeit. Phys.*, vol. 81, pp. 543-555; March, 1933.

charge in a counter with a polyatomic admixture will spread with a smaller velocity than in a simple gas counter. The original avalanche will radiate quanta in all directions and breed new avalanches, whose number will fall exponentially with distance from the parent avalanche. The first generation of avalanches will initiate succeeding generations and the discharge will spread step-wise along the length of the wire, producing thousands of avalanches per centimeter. Since the duration of a single step can not be much less than  $10^{-8}$  second, the velocity of spread may be as slow as  $10^6$  to  $10^7$  centimeters per second.

The relation between the velocity of spread and the overvoltage is almost linear.<sup>16</sup> By lowering the noble-gas pressure without altering the quenching-gas pressure, the spread velocity is increased. This behavior could be explained by a decrease in the duration of a single avalanche because of increased electron mobility in the avalanche. The velocity of propagation furthermore depends on the nature of the noble gas, all other factors being constant. For example, the discharge spreads about three times as fast in helium as in argon. Here, again, the explanation may be in the higher electron mobility in helium compared to argon, which would be expected to decrease the duration of the individual avalanche.

#### GROWTH OF THE PULSE

Because of the enormously greater mobility of the electrons compared to the positive ions (about 1,000/1), the positive ions at the wire move only a few thousandths of a centimeter before the completion of the electron avalanche. As the discharge continues, the positive-ion space-charge sheath builds up, until the field strength near the wire is lowered beyond that required to maintain gas multiplication.

For small overvoltages, the charge generated per unit length of counter depends almost linearly on the overvoltage  $V-V_0$ , which is the difference between operating

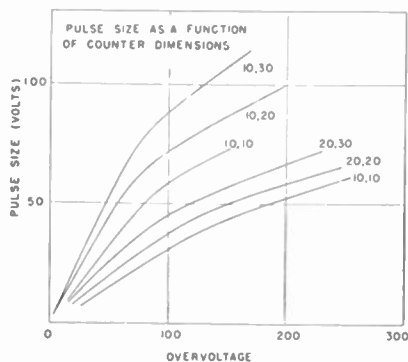

Fig. 5—Dependence of pulse amplitude on counter-tube dimensions and overvoltage. Tube dimensions are indicated as cathode radius (mm), and wire radius (thousandths of a cm). (After Trost in footnote reference 2.)

voltage and threshold. At higher overvoltages the slope of the curve of charge per pulse versus overvoltage falls to about half its initial value. At a given overvoltage the charge per pulse is almost independent of the pressure and depends only on the geometry. These characteristics are illustrated by the curves of Fig. 5 for alcohol-argon mixtures. The capacitance of a typical counter ( $=1$  cm,  $a=0.01$  cm) supports a charge of about  $1.2 \times 10^{-12}$  coulombs per cm of length per volt of potential difference. In most counters of average size, the charge per pulse lies between  $10^{-11}$  and  $10^{-12}$  coulomb per cm of length at threshold, and may be 100 times as great at the end of the plateau.

The voltage pulse on the wire can be attributed entirely to the motion of the positive ions. The electrons are held on the wire by the image force field of the positive ions. Initially, with the sheath almost in contact with the wire, nearly all the electrons are bound to the wire. As the sheath expands radially, the image charge decreases and the electrons flow away from the anode, giving rise to a voltage pulse on the grid of the amplifier coupled to the wire of the counter. The rate of release of electrons at the wire depends on the rate of drift of the ion sheath, which, in turn, varies with the radius of the sheath. The radial velocity of the sheath is approximately proportional to the field or inversely proportional to the radial distance from the wire. At the start, the shape of the pulse is affected by the time required to propagate the discharge through-

out the length of the tube. Since the discharge may spread at the rate of about 10 cm per microsecond in a self-quenched counter, it may require of the order of a microsecond for the entire ion sheath to mature in a long counter, during which time the voltage pulse can rise to a few tenths of its peak value (without differentiation). The rate of rise increases until the time at which the ion sheath is completed. After the sheath is completed, the rate of rise of the pulse decreases. It may attain one-half its peak value in 1 or 2 microseconds, and thereafter increase very slowly. With infinite series resistance in the fundamental circuit (no RC differentiation), the pulse would reach its final and maximum value in the time required for the positive-ion sheath to traverse the tube, about  $10^{-4}$  to  $10^{-3}$  second. Decreasing the series resistance allows the applied potential to be restored on the wire in accordance with the time constant given by the product of the wire system capacitance and the series resistance. The appearance of the differentiated pulse for different values of the series resistance is shown in Fig. 6.

#### THE DEAD TIME AND RECOVERY TIME

As the positive-ion sheath moves outward towards the cathode, the field near the wire returns to normal. The time required for the positive ions to reach the critical distance from the wire corresponding to threshold field defines the dead time of the counter. During this period the counter is insensitive to the passage of further ionizing particles. The additional time required for the ions to reach the cathode is called the "recovery time," and the size of any pulse occurring within this time is determined by the time elapsed since the initial discharge, a pulse at the end of the recovery time being of the same size as the initial pulse.

Figs. 7(a) and 7(b) show a triggered sweep pattern of the type first used by Stever<sup>6</sup> to illustrate the dead-time and recovery-time characteristics for a self-quenching tube. Following the trigger pulse, the sweep shows no pulses until the dead-time interval is passed, at which time small pulses begin to appear. These grow in amplitude with elapsed time from the triggering of the sweep. The envelope of these pulses traces the shape of the recovery curve of the electric field near the anode wire, as shown in Fig. 7(c). From studies of the recovery curve, it is possible to obtain considerable information about ion mobilities in different gases and at various field strengths. Many interesting observations have already been made. For example, it is possible to identify the ions making up the sheath in mixtures of polyatomic gases, such as, for example, alcohol and methane, where the recovery time was found to be characteristic of the drift time of alcohol ions.<sup>17</sup> In many gases the observed mobilities are identified with fragment ions, rather than the parent molecules.<sup>18</sup> The drift time of the ions in a hydro-

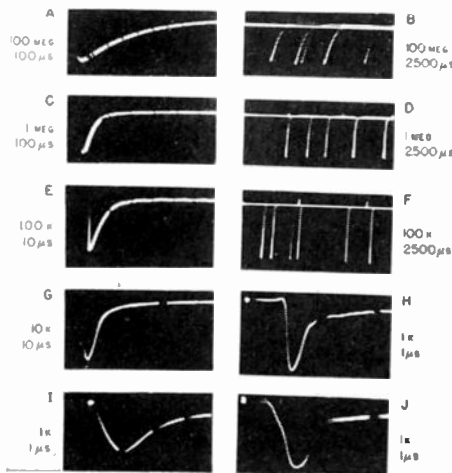
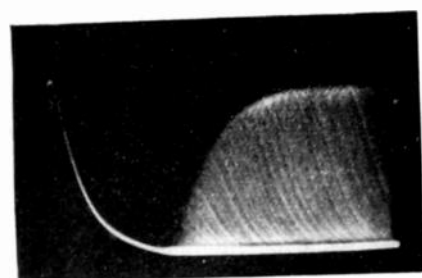

Fig. 6—Effect of series resistance on pulse shape. The counter tube had the dimensions 10, 1.0, 0.0125 cm, and a capacitance of a few micromicrofarads. The series resistance  $R$  was varied to alter the RC constant of the fundamental circuit, Fig. 1. Strips A to H were taken with an argon- $\text{CH}_2\text{Br}_2$  mixture in the counter. The time markers on each trace are identified alongside each strip. Traces B, D, and F were photographed with a recurrent sweep. All of the others are triggered sweep patterns. Strips I and J illustrate the effect of overvoltage on the rise time of the pulse in a neon-argon-chlorine mixture with a threshold of 550 volts. Trace I was taken at an overvoltage of 50 volts, trace J at 300 volts. All photographs were made with a DuMont Type 248 oscilloscope.

<sup>16</sup> J. M. Hill and J. V. Dunworth, "Rate of spread of discharge along the wire of a Geiger counter," *Nature*, vol. 158, pp. 833-834; December 7, 1946.

<sup>17</sup> S. C. Curran and E. R. Rae, "Analysis of the impulses from Geiger-Mueller tubes," *Rev. Sci. Instr.*, vol. 18, pp. 871-877; December, 1947.

<sup>18</sup> P. B. Weisz, "Radiation chemistry of the Geiger-Mueller counter discharge," *Jour. Phys. and Colloid Chem.*, vol. 52, pp. 578-585; March, 1948.



(a)

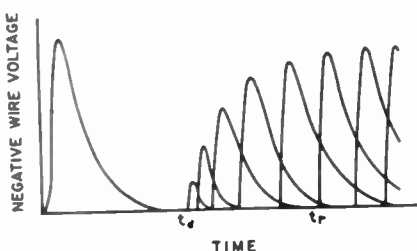

(b)

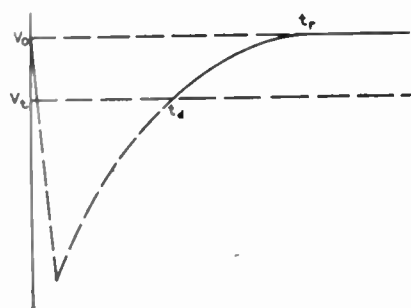

(c)

Fig. 7—(a) Dead-time pattern photographed on triggered sweep.

(b) Schematic representation of a dead-time pattern, indicating dead time  $t_d$  at the foot of the envelope of pulses triggered during the recovery interval from  $t_d$  to  $t_r$ .

(c) Variation of electric field at the anode surface during the period of ion-sheath transport from anode to cathode.

gen-alcohol mixture, surprisingly enough, was found to be longer than in oxygen-alcohol, indicating that the mobilities of these ions in the high fields of counters may be considerably different from those measured at small field strengths.<sup>17</sup>

The dead time and recovery time in a tube of ordinary dimensions are roughly equal to each other, and of the order of a few hundred microseconds. The critical distance to which the ions must move before the field at the wire recovers to threshold is about half the counter radius. This critical radius  $r_c$  is related to the overvoltage  $V - V_s$ , the cylinder radius  $b$ , and the charge  $q$ , per unit length of the ion sheath by

$$r_c = be^{-V-V_s/2q}. \quad (3)$$

The dead time therefore decreases with increasing overvoltage, and is shorter in a tube of smaller dimensions and larger ratio of anode to cathode diameter. Dead times as short as 5 microseconds have been obtained in tubes having cathode and anode diameters of 0.25 inch and 0.15 inch, respectively.

### THE ROLE OF THE QUENCHING ADMIXTURE

The treatment of the Geiger-counter mechanism up to this point provides a picture of the growth of the discharge and the shape of the pulse. Upon the subsequent arrival of the positive-ion sheath at the cathode, the electric field within the counter tube is fully restored. This introduces the possibility of rekindling the discharge by secondary electron emission. Suppose, for example, that the sheath consists of argon ions whose ionization potential is in excess of twice the work function of the cathode surface. An argon ion can first draw an electron out of the cathode and become neutralized. The energy difference between the ionized argon and the work function appears as recombination radiation with an energy in excess of the photoelectric threshold energy. The recombination photon can then eject an electron from the cathode and initiate a new avalanche. In a nonself-quenching counter it is, therefore, necessary to quench the discharge by the use of either a large series resistance or an electronic quenching circuit, which prevents recovery of the threshold counting field until deionization of the gas is complete.

Self-quenching counters are usually produced by admixing a small amount of polyatomic organic vapor to the nonself-quenching gas. Almost any molecule, inorganic as well as organic, containing three or more atoms, will contribute the quenching mechanism. Self-quenched counters have been made with triatomic gases, such as sulphur dioxide and nitrous oxide. Among the diatomic molecules, only the halogens have been found to quench properly. The primary requirement for quenching is that no excited or ionized molecules capable of inducing secondary emission shall reach the cathode surface. In a typical mixture of ten parts of argon to one of alcohol at a total pressure of 10 cm Hg, an argon ion formed in the discharge must make about  $10^6$  collisions with gas molecules in traversing the anode-to-cathode distance. Because of this large number of collisions, the chances are very favorable for the transfer of ionization from argon ions to molecules of alcohol.<sup>19</sup> Energetically, all that is required is that the ionization potential of the quenching gas be lower than that of argon. This condition is fulfilled by alcohol in argon, and is satisfied by almost all polyatomic molecules in combination with helium, neon, or argon. The ionization potential usually decreases with increasing complexity of the molecule. In the experience of this laboratory alone, over thirty different admixtures were investigated which produced usable self-quenching counters. When krypton or xenon are the vehicular gases, their ionization potentials are lower than those of many of the commonly used quenching gases, and it becomes much more difficult to select admixtures which satisfy the requirements of the transfer process.

In transferring ionization energy to the polyatomic molecule, the neutralized argon ion emits recombination radiation. This ra-

diation may be absorbed by another polyatomic molecule, which then photodissociates into two or more neutral molecules or radicals, with emission of still-longer-wavelength photons. The degradation of the original photon through many processes of this type amounts to a "red shift" of the photon spectrum beyond the photoelectric threshold of the cathode. The positive ions of the polyatomic molecules and dissociation fragment ions migrate to the cathode, where they are neutralized by drawing electrons out of the metal surface. After neutralization, the molecule is left in an excited state from which it may radiate a photon or predissociate without radiating. Radiation is very unlikely to occur because the lifetime against radiation is about  $10^{-8}$  second, which is much greater than the time required for the neutralized atom to travel the remaining distance to the cathode. The quenching process can be completed successfully, then, if (1) the excitation energy left with the neutralized molecule is less than the photoelectric threshold of the cathode, in which case no secondary electrons can be ejected, or (2) the excitation energy is dissipated in predissociation before the molecule collides with the metal wall.

It is possible that the first process, which requires the ionization energy  $E_i$  of the quenching admixture to be less than twice the work function  $\phi$  of the metal/cathode, may be largely responsible for the excellent quenching properties of the halogens, and perhaps the halogenated hydrocarbons, such as methylene bromide. In experiments conducted here, tubes filled with these admixtures were equipped with quartz windows but produced no photocathode response to the shortest U.V. transmitted by quartz, about 1,850 Å or 6.5 ev. The cathodes used in these tubes were iron or copper, which in vacuum photocells are known to have work functions of 4 to 5 ev. However, it is also well known that in the presence of even the less active gases, the photoelectric threshold of these metals may be considerably shifted, so that it would not be surprising if the halogens were capable of increasing the threshold energies well beyond the limit of 6.5 ev observed in the quartz window tubes. Since  $E_i$  of  $\text{Cl}_2$  is 13.2 ev and of  $\text{Br}_2$  is 12.8 ev, it is apparent that the condition for secondary emission,  $E_i > 2\phi$ , is not fulfilled.

The second process, in which the molecule predissociates before radiating, becomes more and more probable, the greater the complexity of the polyatomic molecule. Neutralization of a polyatomic ion molecule occurs by field emission<sup>20</sup> which is effective at a distance of about  $10^{-7}$  cm from a metal surface whose work function is about 4 or 5 ev. After neutralization, the excited molecule ( $E_{\text{exc}} = E_i - \phi$ ) must approach within about  $10^{-8}$  cm, of the surface before secondary electron emission is possible.<sup>21</sup> At the thermal velocities with which the positive ions approach the cathode,  $10^{-7}$  cm is traversed in about  $10^{-12}$  second. To avoid secondary emission, the molecule must predissociate in less than

<sup>20</sup> M. L. E. Oliphant and P. B. Moon, "The liberation of electrons from metal surfaces by positive ions," *Proc. Roy. Soc. A.*, vol. 127, pp. 386 et seq; 1930.

<sup>19</sup> H. Kallmann and B. Rosen, "Elementary processes in collisions of ions and electrons," *Zeit. für Phys.*, vol. 61, pp. 61-86; March, 1930.

<sup>21</sup> H. S. W. Massey, "The theory of the extraction of electrons from metals by positive ions and metastable atoms," *Proc. Camb. Phil. Soc.*, vol. 26, pp. 386-401, part III; 1930.

$10^{-13}$  second. The lifetime against predissociation in polyatomic molecules is closer to  $10^{-13}$  second, about the time of one interatomic vibration. Spectroscopically, this property of predissociation in polyatomic molecules can be detected by the appearance of continuous absorption at wavelengths equal to  $(E_i - \phi)$ . Using alcohol ( $E_i = 11.3$  ev) and copper ( $\phi = 4.0$  ev) for illustration, the difference  $(E_i - \phi)$  is 7.3 ev, which remains with the molecule as excitation energy, equivalent to absorption of a quantum of 1,700 Å wavelength. The alcohol spectrum shows continuous absorption below 2,000 Å accompanied by photodecomposition, indicating that the neutralized but excited molecules should predissociate in about  $10^{-13}$  second and satisfy the quenching requirement.

#### THE INFLUENCE OF METASTABLE ATOMS

A metastable atom produced in the discharge remains in that state until its energy is radiated or dissipated in a collision of the second kind. If the metastable atom, which is electrically neutral, drifts to the cathode wall, the probability of ejecting an electron there may be as high as 50 per cent. Although the average lifetime of metastable states in neon before radiation is about  $10^{-4}$  second, Paetow<sup>22</sup> found a measurable current caused by metastable atoms in neon persisting for as long as a second after terminating a discharge between parallel plates.

The highly purified rare gases, taken by themselves, are unsuited for use in counters because their metastable states are so readily excited by electron impacts. Ejection of electrons by these metastables, after the positive-ion sheath has spread beyond the critical dead-time radius, reignites the discharge and leads to trains of multiple counts, or continuous discharge. A counter tube filled with rare gas is, therefore, unusable unless a foreign gas is admixed which de-excites the metastable atoms on colliding with them. Hydrogen is effective in quenching the metastable states of argon and neon, and has been used with those rare gases to make permanent gas mixtures for nonself-quenching tubes. The effect of mixing hydrogen with argon or neon on the performance of a counter operated with an external quenching circuit is illustrated by the plateau curves of Fig. 8. Less than 10 per cent of hydrogen in neon does not provide enough collisions between hydrogen atoms and metastable neon atoms to de-excite completely the metastables before they radiate or reach the cathode. Adding more than 10 per cent of  $H_2$  produces a plateau almost as long as is obtained in pure hydrogen. Argon requires a much greater admixture of hydrogen to produce a satisfactory plateau. The ionization energies  $E_i$ , and metastable energies  $E_m$ , listed in Table I, show that it is energetically possible that metastable neon can be quenched by ionizing hydrogen, but that argon can be quenched only by exciting hydrogen ( $E_{\text{exc}} = 11.5$  ev).

Much more striking effects attributable to the quenching of metastable states were

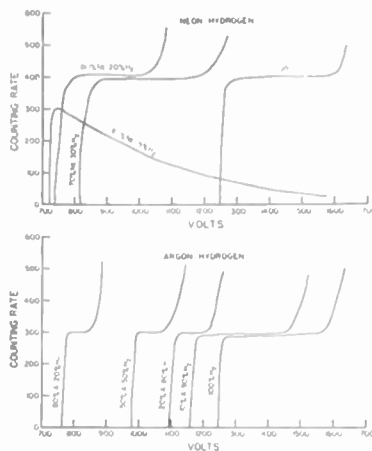

Fig. 8—Plateau curves for mixtures of neon-hydrogen and argon-hydrogen obtained with a Neher-Harper electronic quenching circuit.

discovered by Penning<sup>23</sup> and his coworkers in their studies of breakdown voltages  $V_B$  in rare gas discharges. Great differences appeared in the measured  $V_B$  which could only be attributed to minute traces of impurities. For example, baking a tube filled with pure neon dropped its  $V_B$  by 100 volts, but a subsequent glow-discharge treatment raised it again. A high-frequency electrodeless discharge sometimes raised and sometimes lowered  $V_B$ . Only after prolonged glow discharging, which is known to clean up many impurity gases, would  $V_B$  reach a stable upper value. By deliberately contaminating neon with traces of argon, mercury, and krypton in concentrations as low as 0.0001 per cent, Penning obtained remarkable reductions in  $V_B$ .

TABLE I

Vehicular gas	Admix. Per cent	$E_i$	$pd$	$V_B$	$V_B'$
None $E_m = 16.6$ ev	0.02 $K_r$	13.3	20	350	170
	0.01 $H_2$	16.1	18	350	260
	0.05 $H_2$	16.1	18	340	210
	0.01 $N_2$	16-17	18	350	200
	0.05 $N_2$	16-17	18	340	160
Argon $E_m = 11.6$ ev	0.03 $K_r$	13.3	15	500	500
	0.03 $Xe$	11.5	14	520	530
	0.05 $CO_2$	15	14	460	470
	0.05 $CO_2$	14	14	480	500
	0.05 $NO$	9	14	470	480

$NO$  was the only exception to the rule that  $V_B$  is reduced if  $E_i < E_m$ . Penning suggested that the neutral  $NO$  molecule had many states above the ionization limit of 9 volts which were closer to the 11.6 ev of metastable argon, making excitation to those levels more probable than ionization.

It was impossible to explain these results by hypothesizing that, since the admixed gas had a lower ionization potential than the main gas, it was therefore more readily ionized, resulting in a lowering of  $V_B$ . The relative contribution of the mercury admixture to ionization, for the case of  $Hg$  contamination in neon, was computed to be about 0.0005, entirely too small to be significant. An explanation of the reduced  $V_B$ , based on the transfer of excitation energy of neon to ionization energy of the admixture, was more plausible. In pure neon there is no

mechanism for converting excitation energy to ionization, but neon atoms excited to metastable states in the discharge could have a relatively great efficiency for ionization of a trace admixture if the energy condition  $E_m > E_i$  is fulfilled. Many collisions are made during the life of the metastable atom, and, consequently, the chance of an eventual collision with an admixture atom is great. To materially influence the breakdown voltage, these collisions should occur within a few microseconds of the first avalanche. At the pressures ordinarily used in counter tubes, a metastable atom may make between  $10^4$  and  $10^6$  molecular collisions per microsecond. A concentration of quenching admixture as low as  $10^{-4}$  to  $10^{-6}$  would, therefore, effectively remove almost all the metastable atoms within a few microseconds, if every collision between a metastable and an admixture molecule had a high probability of de-exciting the metastable.

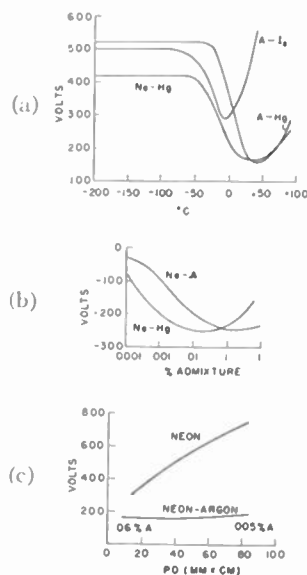

Fig. 9—Effects of impurity gases on the breakdown characteristics of the rare gases. (After Penning in footnote reference 23.) Fig. 9(a) shows the effect of different concentrations of iodine and mercury in argon and neon on the breakdown voltage of the discharge between parallel plates about 1 cm apart. The argon pressure was 15 mm, neon pressure was 21 mm, and the admixture concentration was controlled by its vapor pressure at different temperatures. Fig. 9(b) is a senologarithmic plot of the Ne-Hg data in percentage of admixture versus decrease in  $V_B$ . A similar curve is shown for neon with small percentages of argon admixture. The data of Fig. 9(c) were obtained by starting with 0.06 per cent argon in 10.1 mm of neon, which gave a  $V_B$  of 159 volts, and then diluting the mixture with neon up to a maximum pressure of 112 mm, which raised  $V_B$  to only 185 volts.

Fig. 9 and Table I summarize the results of Penning and his coworkers. The columns of Table I list:  $E_i$ , the ionization potential of the admixture;  $pd$ , the product of pressure and distance between electrodes;  $V_B$ , the breakdown voltage of the pure rare gas;  $V_B'$ ,

<sup>22</sup> H. Paetow, "Spontaneous electron emission and field emission following gas discharge bombardment of thin insulating layers," *Zeit. für Phys.*, vol. 111, pp. 770-790; March, 1939.

<sup>23</sup> F. M. Penning, "The influence of very minute admixtures on the striking voltage of the rare gases," *Zeit. für Phys.*, vol. 46, pp. 335-348; January, 1927.



the breakdown voltage with the admixed impurity gases. The most pronounced effects were obtained with an admixture of argon in neon, where as little as 0.005 per cent argon in 112 mm Hg of neon reduced the striking voltage from 770 volts to 185 volts between parallel plates, 7.5 millimeters apart (Fig. 1(c)).

#### LOW-VOLTAGE COUNTERS

The condition that  $E_m$  of the rare-gas atoms be higher than  $E_i$  of the admixture is satisfied by a great many of the polyatomic quenching gases commonly used in counters. The tendency to reduce the striking voltage by converting metastable energy to ionization energy, however, is opposed by the tendency toward inelastic electron impacts with the polyatomic molecules. These impacts keep the electron energies below  $E_m$  and  $E_i$  of the rare gas and suppress the growth of Townsend avalanches, thereby raising the threshold-voltage requirement. In normal counter mixtures, the concentration of polyatomic constituent needed to quench adequately the discharge and produce a satisfactory life is so high that the process of holding down the distribution of electron energies in the avalanche through inelastic impacts with polyatomic molecules is more important than the ionization of metastables. The most notable exception observed here thus far was methylene bromide in argon, where the amount of admixture could be reduced to a few tenths of a per cent without destroying the quenching properties of the mixture. Such tubes, operating at 250 volts, exhibited plateaus about 100 volts long and had useful lives of  $10^7$  counts. Weisz<sup>24</sup> observed the effect of diluting hydrocarbon admixtures in argon to very low concentrations. The threshold voltage was markedly reduced in every case satisfying  $E_m > E_i$ , although no examples were observed which promised practical usefulness in the sense of satisfactory plateaus and long counting life.

Recent attempts to produce low-voltage thresholds in counters, with the neon-argon mixture and others described in Table I above, have been very successful. Previously the lowest operating voltages had been obtained by reducing the gas pressure, decreasing the anode and cathode radii, or introducing a grid. None of these techniques produced low voltage thresholds without sacrificing other desirable features, such as high efficiency and fast recovery times. The theory of operation of counters filled with permanent gases having high threshold voltages and utilizing electronic quenching, applies equally well to mixtures of the Ne-A type with their characteristically low values of  $V_B$ . Simpson<sup>25</sup> prepared counters filled with 5 cm Hg of neon and 0.01 per cent argon, which operated in a Neher-Harper quenching circuit with thresholds at 120 to 135 volts. Self-quenching counters having low threshold voltages were prepared by adding fractions of a mm Hg pressure of

polyatomic vapors to the neon-argon mixture. At the lowest threshold voltages, obtained by using the minimum amounts of vapor, such counters were temperature-sensitive, short-lived, and required some electronic circuitry to assist the quenching. Using somewhat higher pressures, i.e., 1 mm Hg of ethylacetate and 50 cm Hg of Ne-A fast counters were made in this Laboratory with thresholds of 350 volts and plateaus of 100 to 150 volts. These counters had useful lives of about  $10^7$  counts.

Counters employing traces of the halogen gases with neon or argon<sup>26</sup> have low threshold voltages combined with many other desirable properties. They cannot be damaged by excessive counting rates or running over the upper voltage limit of the plateau. When chlorine or bromine is used, the tubes are insensitive to temperature variations over a wide range. As was indicated in Penning's experiments, a halogen admixture is also capable of reducing the corona breakdown voltage, when the energetic requirement  $E_i > E_m$  is satisfied. Fig. 9 shows that a trace of iodine ( $E_i = 9.7$  ev), in argon ( $E_m = 11.6$  ev) was as effective in reducing  $V_B$  as was Hg. In a similar manner, chlorine ( $E_i = 13.8$  ev) and bromine ( $E_i = 12.8$  ev) should ionize metastables in neon ( $E_m = 15.6$  ev). At higher concentrations of halogen admixture, the halogen acts predominantly as an electron trap and raises the breakdown voltage. As the halogen concentration is reduced, however, ionization of the halogen molecules upon impact with metastable rare gas atoms becomes more probable than electron attachment, and the starting voltage is lowered. Fortunately, relatively small concentrations of halogen are required to satisfy all the Geiger-counter quenching requirements. It has been pointed<sup>27</sup> out that, in theory, the halogens possess the properties required in quenching that are otherwise found only in polyatomic molecules.

A major difficulty in the use of halogen admixtures is the clean-up of the small amount of halogen, originally present, by chemical reactions within the tube. Tubes constructed with electrodes of brass, copper, silver, aquadag, and various plated surfaces failed very quickly when filled with a rare gas plus a halogen admixture. Satisfactory results have thus far been obtained with the use of tantalum and of chrome-iron, and bromine appears to be much less reactive than chlorine. If the efficiency of the counter for ionizing events need not be greater than 90 per cent, higher concentrations of the halogens may be used, and a slow clean-up then produces a correspondingly slower deterioration. Both the inefficiency and operating voltage rise rapidly with increasing halogen admixture, however, and it is much more desirable to seek to eliminate the chemical clean-up process from the beginning, rather than to resort to higher concentrations of the halogen.

The pulse characteristics in low-voltage counters differ only to a minor degree from those of the more common higher-voltage counters. The lower the operating voltage,

the longer is the rise time of the pulse. At the lowest voltages, the time to reach peak amplitude may be ten times as long as in similar "high"-voltage counters. The charge per pulse is also considerably greater. Dead times are not appreciably different, and generally center about 200 microseconds for tubes of ordinary dimensions.

#### THE PLATEAU CHARACTERISTIC AND SPURIOUS COUNTS

The plateau of a Geiger counter may be defined as the voltage range over which the counting rate at a constant intensity of irradiation is substantially independent of voltage. If the term "counting range" is taken to mean the difference in voltage between threshold and the inception of a self-sustained corona discharge, then the plateau is always much shorter than the counting range. No Geiger counter exhibits an ideally flat plateau characteristic for any considerable range above the threshold voltage. An increase in counting rate with overvoltage is always observed which may be as high as 0.1 per cent per volt in counters that are still considered satisfactory for many applications.

A portion of the slope can be attributed to a real increase in sensitivity, but the remainder arises from increasing numbers of spurious counts at high overvoltages. The former effect is largely explained as an increase in volume of the counter through the growth of the electrostatic field at its ends. Of course, any misalignment of the electrodes, such as the wire being cocked at an angle to the axis of the cylinder, will increase the sensitivity with increasing overvoltage by causing different portions of the counter to exhibit different threshold voltages. Finally, any inefficiency from failure to mature a complete discharge would be lessened by an increase in overvoltage, since the number of photons per discharge increases with overvoltage and improves the probability of spreading the discharge completely. The electrostatic effects can be minimized, in general, by carefully aligning the electrodes, making the length-to-diameter ratio as large as convenient, polishing the anode to remove sharp points, and shielding the ends of the wire with insulating sleeves so as to limit the expansion of the sensitive volume beyond the ends of the cylinder. In the preparation of most counters these precautions are more or less routine, so that spurious pulses generated by the discharge itself are usually the major contributors to plateau slope.

The most serious source of plateau slope in Geiger counters is a type of spurious counts that appear in the form of "after-discharges" or trains of counts following a valid count. In some counters these multiples appear almost immediately above threshold; in all counters they appear at sufficiently high overvoltages. The voltage region in which these trains of multiple counts begin to appear in appreciable numbers marks the limit of the useful plateau range. Certain fillings, such as argon and alcohol, which show no spurious pulses at overvoltages of 100 to 200 volts, produce very flat plateaus. If the argon is of spectroscopic purity (99.9 per cent) and the alcohol is free of air and water, a plateau slope less

<sup>24</sup> P. B. Weisz, "Startling potential of the Geiger-Mueller counter discharge," *Phys. Rev.*, vol. 74, pp. 1807-1812; December, 1948.

<sup>25</sup> J. A. Simpson, "The theory and properties of low-voltage radiation counters," MDDC report 870, Declassified, 1947.

<sup>26</sup> S. H. Liebson and H. Friedman, "Self-quenching halogen-filled counters," *Rev. Sci. Instr.*, vol. 19, pp. 303-307; May, 1948.

<sup>27</sup> R. D. Present, "On self-quenching halogen counters," *Phys. Rev.*, vol. 72, pp. 243-244; August, 1947.

than 0.01 per cent per volt may be obtained. A commercial grade of argon (98 per cent), on the other hand, produced slopes from 0.05 to 0.15 per cent per volt, and contamination with air increased the slopes proportionately.<sup>28</sup> An optimum concentration of quenching admixture was also observed which was about 5 per cent for alcohol. Larger concentrations increased the slope. This behavior could be explained by failure of an increased number of discharges to develop fully because of the suppression of photon emission in the avalanches. A mixture of 20 per cent of alcohol in argon increased the slope to 0.05 per cent per volt. The behavior of alcohol-argon is also typical of helium and neon and many of the more commonly used hydrocarbon quenching admixtures, such as ether, ethyl acetate, amyl acetate, and ethylene. In contrast, many spurious counts were observed<sup>17</sup> when alcohol was used with O<sub>2</sub>, N<sub>2</sub>, or H<sub>2</sub>. For a mixture of hydrogen and alcohol, 27 per cent of the counts observed in the middle of the plateau were spurious; in oxygen and alcohol the fraction of spurious counts was 10 per cent.

Although a counter may initially exhibit a very flat plateau, the slope invariably increases with use. The rate at which this proceeds initially and over longer periods of use varies with the particular gas mixture. In argon, with alcohol admixture, the slope may increase considerably at first, then remain relatively unchanged for a major portion of the useful life, and finally deteriorate very rapidly. Some mixtures show a tendency to recover when not in use. All of these effects reflect the contamination of the gas mixture by decomposition products of the discharge and the correlated loss of the optimum concentration of quenching constituent.

The process responsible for the major portion of the spurious pulses observed in counter tubes is positive-ion bombardment of the cathode. As the overvoltage is raised, the number of positive ions per discharge increases. Since the emission of secondary electrons is directly proportional to the number of ions arriving at the cathode, the number of spurious counts should increase with overvoltage. Because of the well-defined time require for the positive-ion sheath to traverse the interelectrode space, spurious pulses arising from secondary emission are readily recognized. On an oscilloscope screen, trains of spurious pulses at high overvoltage have the appearance of relaxation oscillations. The successive pulses in a train are uniformly spaced in accordance with the nature and pressure of the vehicular gas and the overvoltage, as predicted by the dependence of ion mobility on pressure and field strength. Figs. 10, 11, and 12 illustrate the increasing length of the trains of multiple pulses with increasing overvoltage or decreasing concentration of quenching admixture; the increase in spacing of multiples as the mobility of the positive ions is reduced by increased pressure; and the dependence of the mobility, as reflected by the spacing of pulses, on the collision cross sec-

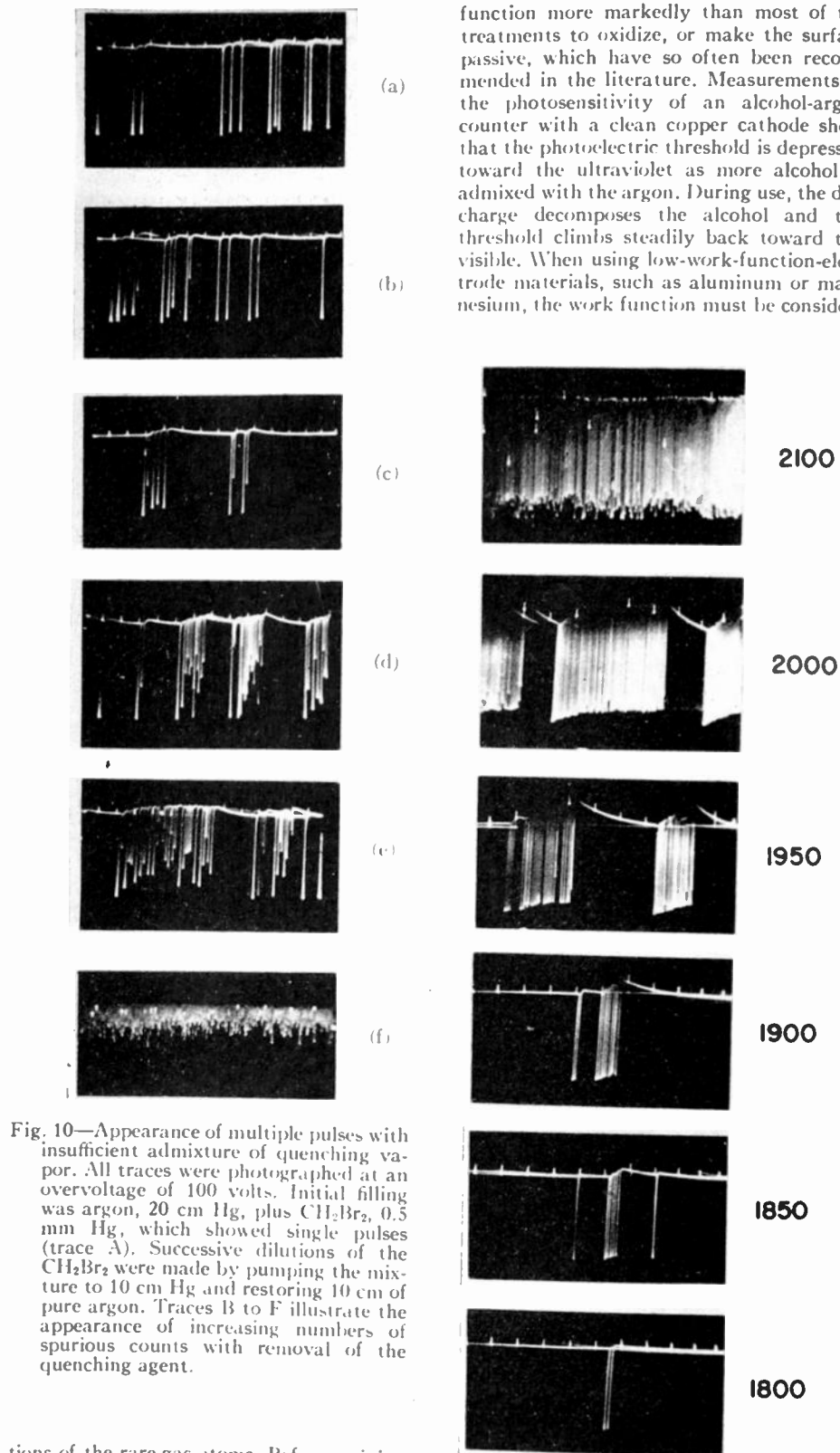

Fig. 10—Appearance of multiple pulses with insufficient admixture of quenching vapor. All traces were photographed at an overvoltage of 100 volts. Initial filling was argon, 20 cm Hg, plus CH<sub>2</sub>Br<sub>2</sub>, 0.5 mm Hg, which showed single pulses (trace A). Successive dilutions of the CH<sub>2</sub>Br<sub>2</sub> were made by pumping the mixture to 10 cm Hg and restoring 10 cm of pure argon. Traces B to F illustrate the appearance of increasing numbers of spurious counts with removal of the quenching agent.

tions of the rare-gas atoms. Before arriving at the condition of continuous corona discharge, the number of pulses in individual trains may reach thousands without destroying the perfect spacing between pulses.

The idea behind most procedures for treating counter tubes prior to filling is to produce a high work function at the cathode surface, and thereby reduce spurious pulses due to secondary emission. In many instances the effect of adsorbed polyatomic molecules on the metal surface is to increase its work

function more markedly than most of the treatments to oxidize, or make the surface passive, which have so often been recommended in the literature. Measurements of the photosensitivity of an alcohol-argon counter with a clean copper cathode show that the photoelectric threshold is depressed toward the ultraviolet as more alcohol is admixed with the argon. During use, the discharge decomposes the alcohol and the threshold climbs steadily back toward the visible. When using low-work-function-electrode materials, such as aluminum or magnesium, the work function must be consider-

Fig. 11—Development of spurious pulses at high overvoltages. The filling was 20 cm Hg of argon plus 10 mm Hg of CH<sub>2</sub>Br<sub>2</sub>. Threshold was 1,500 volts. At overvoltages in excess of 300 volts, multiple pulses, appear with uniform spacings characteristic of secondary emission due to positive ion bombardment of cathode. Higher overvoltages increase the average length of the trains of pulses and their frequency of occurrence. Marker pulses are 2,500 microseconds apart.

<sup>28</sup> S. A. Korff, W. B. Spartz, and J. A. Simpson, "Summary report on neutron counter work," MDDC Report 1704.

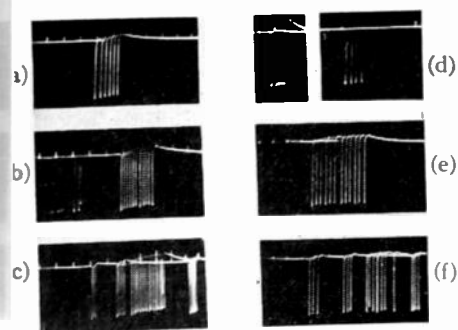

Fig. 12—Effect of gas mixture on spacings between multiple pulses. Traces (a), (b), and (c) were made with 75, 35, and 15 cm Hg of argon respectively and a constant admixture of 10 mm Hg of  $\text{CH}_2\text{Br}_2$ . As the pressure of the argon was reduced, the mobility of the positive ions increased, and the intervals between pulses became shorter. Trace (d) illustrates the greater mobility in helium as compared to argon. All markers are spaced 2,500 microseconds apart, but the right-hand portion of trace (d) is expanded. Traces (e) and (f) show the opposite trend toward decreasing mobility in a heavier gas such as Xe.

ably increased by chemical treatment or by deposition of a very thin layer of a more suitable surface, such as copper, before satisfactory counting can be obtained. Glow discharging in an active gas, before filling is often effective in subsequently preventing spurious counts. Several more extreme treatments have been described, such as mechanically coating the cathode with a very thin layer of a high-work-function surface; for example, a coating of lacquer. The influence of such a coating can be judged from its effect on the photoelectric threshold. Because the lower-energy photoelectrons released at threshold cannot penetrate the thin coating, the photoelectric limit appears to be shifted toward the ultraviolet.

A less-important class of spurious counts are those attributable to the charging of particles or thin layers of insulating material on the cathode. During the discharge, positive ions may remain bound to these insulating surfaces, or the particles may acquire charge as a result of photoelectric emission. Subsequently, spurious counts may be triggered by electrons released in the neighborhood of these charged spots. Experiments with plane-parallel electrodes<sup>29</sup> demonstrated the presence of an electron current decreasing roughly exponentially with time, following the termination of a glow discharge. A measurable current was observed for fully 15 minutes with nickel electrodes coated with colloidal graphite and magnesium oxide. After prolonged baking to remove the oxide, this after-discharge current almost entirely disappeared. The effect of irradiation was demonstrated by an experiment<sup>30</sup> in which parts of a counter tube were exposed to intense X rays and the

counter subsequently reassembled. A much higher background was then observed, which decayed slowly with time. Many counters go over into an unbroken chain of counts when the overvoltage exceeds the limit of the plateau and do not recover when returned to what was previously normal operating voltage. The applied voltage must then be dropped below threshold for at least a few seconds before such tubes recover. This general behavior closely resembles the phenomena observed in the aforementioned experiments with MgO coatings and irradiated electrodes.

#### LIFE OF SELF-QUENCHING COUNTERS

Most self-quenching counters exhibit similar symptoms of aging. The threshold voltage rises, the plateau slope increases, and multiple pulses appear at progressively lower voltages. Many tubes become increasingly photosensitive. Some counters may be brought into self-sustained discharge above the plateau, yet recover immediately when returned to operating voltage; whereas others are permanently destroyed if brought into continuous discharge, even momentarily. Most of these observations are understandable in terms of the decomposition of the quenching admixture in the course of the discharge. A typical counter initially contains approximately  $10^{20}$  polyatomic molecules. About  $10^{10}$  of these molecules are ionized in each discharge, and dissociate when they reach the cathode wall. It seems necessary, therefore, to accept an upper limit of about  $10^{10}$  counts for the maximum life of a self-quenching Geiger counter containing polyatomic molecules. A simple demonstration of the breakdown of the polyatomic constituent is obtained by attaching a sensitive manometer to a counter tube under life test. The increase in total pressure contributed by the partial pressures of the end products of the discharge is readily observed. It is now believed that the aging may generally be attributed to a combination of two processes: (1) an alteration in the optimum gas composition resulting from decomposition of the quenching vapor, and (2) the deposition on the electrodes of polymerization products manufactured as a result of the discharge. The former process is sufficient to account for most of the deterioration of ethyl alcohol and ethyl acetate fillings. The latter process has been identified with the short-lived performance of methane fillings.

The primary decomposition products<sup>31</sup> are neutral radicals and fragment ions. Mass-spectrometer research in recent years has revealed an abundance of fragment ions formed in electron bombardment of complex molecules, compared to the number of ions of the parent molecules. In some molecules, such as tetramethyllead,<sup>32</sup> the parent ion is not observed at all. Some of the dissociated fragments may combine to form other organic molecules, which may or may not be quenching molecules. It may be reasoned that, starting with a large molecule, a relatively greater portion of the products of the discharge may again have quenching prop-

erties. This seems to be generally true. The lifetime of a counter using amyl acetate, for example, is about ten times as long as that obtained with ethyl-alcohol admixture. Eventually, all the larger molecules must be broken down into the lighter fractions, including nonself-quenching gases such as hydrogen and oxygen.

In the case of methane, tubes are found to fail at between  $10^7$  and  $10^8$  counts, which is insufficient to account for decomposition of enough of the original admixture to spoil the tube. It has been shown<sup>33</sup> that the decomposition of methane yields hydrogen along with saturated and unsaturated hydrocarbons, and a deposit on the cathode cylinder which can be identified as a polymerization product formed from the unsaturated hydrocarbons. This polymerization process is known to occur quite readily in an electrical discharge at the surface of a metal electrode. The failure of counters using propane and butane also appears to be traceable largely to the deposition of dielectric polymers on the cathode surface. Such tubes cannot be restored to operation by refilling with a fresh gas mixture, unless the electrodes are washed with a solvent capable of removing the deposits.

#### SHORT TIME DELAYS IN THE FIRING OF GEIGER COUNTERS

Coincidence counting is one of the most powerful tools available for the analysis of nuclear-disintegration schemes and cosmic-ray phenomena. In all cases, it is advantageous to reduce the coincidence resolving time to as short an interval as possible, if merely to reduce the number of accidental coincidences which statistically occur in direct proportion to the resolving time. In determining the decay scheme of a nucleus which undergoes a series of radioactive transitions in rapid succession, observations of delayed coincidences can reveal the time relationships in the chain of nuclear radiations. If two transitions follow each other in less than  $10^{-8}$  second, it is experimentally impossible to distinguish the spacing between them with Geiger counters. If, however, the second transition in a sequence follows the first after an average time interval greater than  $10^{-8}$  second, it becomes possible to detect the deviation from simultaneity by delaying the count produced by the first transition long enough to bring it into coincidence with the second. To apply this type of measurement to timing events separated by as little as tenths of a microsecond requires experimental resolution times of a few hundredths of a microsecond. In attempting to decrease the resolving time much below a microsecond, however, many experimenters found inherent uncertainties in the firing times of counters of the order of a tenth of a microsecond,<sup>33</sup> which were entirely distinct from the occasional longer delays of 10 to 100 microseconds resulting from electron attachment to form negative ions.

<sup>29</sup> E. C. Farmer and S. C. Brown, "A study of the deterioration of methane-filled Geiger-Mueller counters," *Phys. Rev.*, vol. 74, pp. 902-905; October 15, 1948.

<sup>30</sup> C. W. Sherwin, "Short time delays in Geiger counters," *Rev. Sci. Instr.*, vol. 19, pp. 111-116; February, 1948.

<sup>31</sup> S. S. Friedland, "On the life of self-quenching counters," *Phys. Rev.*, vol. 74, pp. 898-901; October 15, 1948.

<sup>29</sup> A. Guntherschulze, "Electron velocity in insulators at high field strengths and its relation to the theory of electric penetration," *Zeit. Phys.*, vol. 86, pp. 778-786; December 7, 1942.

<sup>30</sup> Mr. Roggen and Mr. Scherrer, "An After-effect of X-ray irradiation on counter tube performance," *Hevl. Phys. Acta*, vol. 15, pp. 497-499; 1942.

The maximum resolution achieved with any coincidence arrangement using a pair of Geiger counters depends on the rate of growth of the pulse in each counter following the passage of the ionizing photon or particle. Experimentally, it is observed that, even when a pair of counters of average dimensions are fired by the same high-speed particle, there occurs a relative randomness in firing times with an average difference of as much as 0.2 microsecond. Short time delays in firing of a counter may be attributed to two sources: (1) the electron-transit time in the avalanche; (2) the time required to develop the initial part of the ion sheath after the first electron avalanche reaches the wire. The former delay arising from electron-transit time is essentially independent of overvoltage, whereas the latter delay, involving growth of the ion sheath, decreases with increasing overvoltage. As was mentioned earlier, the elementary process of avalanche production, beginning at a distance of a few wire diameters from the anode, requires about  $10^{-9}$  second. The collection time for the triggering electron and single Townsend avalanche which it creates, will obviously depend on the radial distance at which the primary electron is produced. To compute this time it is necessary to know the velocity of the electron at all distances from the wire. However, since an electron starting at the cathode must traverse the first half of the radial distance to the wire at nearly thermal velocities, its motion in the outer  $r/2$  portion of its path counts for almost all of the collection time. The average energy acquired per mean free path over the first half radius from the cathode is about 1/4 ev., which corresponds to an average velocity of about  $3 \times 10^7$  cm/sec. The maximum possible transit time in a tube of one centimeter radius will therefore be somewhat greater than  $3 \times 10^{-8}$  second.<sup>34</sup> For an electron starting at intermediate radial distances, the transit time is roughly proportional to the square of the distance. In counters of larger diameters, transit times can, therefore, reach values in excess of a microsecond. Measurements<sup>35</sup> on a tube 7 cm in diameter revealed transit time delays of 0.3 to 2 microseconds.

The portion of the delay attributable to the rate of growth of the ion sheath depends on the sensitivity of the detector amplifier, the position along the length of the tube at which the sheath starts to develop, and the overvoltage. During the first tenth of a microsecond required for the sheath to spread a distance of a few millimeters, the rate of rise of the pulse on the wire may be less than one volt per tenth of a microsecond. Obviously, a wide-band, high-sensitivity amplifier would be required to detect the pulse within this time interval. The rate of rise increases rapidly after the first  $10^{-7}$  second, depending somewhat on whether the counter is triggered at the center or near one end. At the center, the discharge may spread in both directions; whereas, at

either end of the tube, the discharge can propagate only in the direction of the opposite end. The slope of the pulse during the spread of the discharge is roughly twice as steep in the former case. The behavior with change in overvoltage is also readily understandable, since the discharge is matured by photon emission and absorption, and the abundance of photons per avalanche increases with higher overvoltage.

It is clearly indicated, then, what steps may be taken to achieve the fastest possible coincidence resolving times. The smallest diameters and lowest filling pressures consistent with other experimental requirements should be selected to minimize transit time fluctuations. A sensitive wide-band amplifier and operation at high overvoltage will make it possible to detect the pulse in the earliest stage of its growth. Resolving times as low as 0.035 microsecond without coincidence losses due to random time delays were obtained in experiments by Mandeville and Scherb,<sup>36</sup> with argon-ethyl ether fillings and a fast coincidence circuit.

#### COSMIC-RAY EFFICIENCY

In the majority of Geiger-counter-tube types, it may be safely assumed that a single ion pair formed anywhere within the volume of the Geiger counter will trigger a discharge. In detecting the passage of an ionizing particle, such as a cosmic-ray meson, the efficiency can ordinarily be made greater than 99.5 per cent by selecting a heavy gas and filling to a relatively high pressure. The rare gases, except for helium, yield many ions per centimeter of path when traversed by a high-speed cosmic-ray particle. The values of the specific ionization (ions per cm per atmosphere) in neon, argon, and xenon are 12, 29, and 44, respectively, but the values for helium and hydrogen are no greater than about 6. Since the number of ions produced per centimeter of path fluctuates statistically, there is always a chance that the particle may traverse the counter without producing an ion pair. The average number of electrons  $N$  left behind by a meson if it traverses a path length  $d$  in the counter is  $npd$ , where  $n$  is the specific ionization, and  $p$  is the fraction of atmospheric pressure. The probability of not producing an electron is, therefore,  $e^{-N}$  and the efficiency  $\epsilon$  is given by

$$\epsilon = 1 - e^{-N}. \quad (4)$$

For example, when the gas in the counter is argon at 1/10 atmospheric pressure, and the track length through the tube is 2 cm, 6 ions per meson are produced, on the average, and the efficiency is 99.8 per cent. If, now, the particle penetrates the counter close to the wall, traversing about 1/6 centimeter,  $N$  becomes equal to 1, and the efficiency is only 63 per cent. In the same way, one finds that the efficiency for small counters and for counters filled with hydrogen or helium is considerably lower. For 90 per cent efficiency in a 2-cm path, it is necessary to use about 15 cm Hg pressure of hydrogen or helium, as compared to 3 of argon.

In certain cosmic-ray experiments, low efficiencies are deliberately sought so as to distinguish, for example, between heavily ionizing mesons and electrons. Counters are prepared for such experiments by filling with a lower pressure of hydrogen or with three or four centimeters of helium, to which is added the minimum amount of a light polyatomic vapor sufficient to produce a self-quenching counter with a usable plateau.

There is another type of inefficiency associated with electron attachment which was first demonstrated<sup>37</sup> in studies of coincidence counting, with cosmic-ray telescope arrangements. In the region near the cathode, the combined effects of low field strength and production of relatively few ion pairs makes electron capture to form negative ions sufficiently probable to have a marked effect on efficiency. The heavy negative ions drift slowly into the high-field region, where the negative charge may detach and initiate a delayed discharge, or the ion may retain its charge and not produce an avalanche at all. By varying the resolving time<sup>38</sup> of the coincidence circuit used with an oxygen-filled counter from 0.2 to 70 microseconds, the efficiency of coincidence counting was altered from 50 to 80 per cent. When the oxygen was diluted to 6 per cent of an oxygen-argon mixture, the efficiency remained about 96 per cent from 0.2 to 600 microseconds. The portion of the inefficiency which disappeared with increasing resolving time represented delayed counts originating from negative ions which gave up their electrons near the wire from 10 to 100 microseconds after their attachment. The inefficiency which is unaffected by resolving time represents the fraction of primary ionizing events which do not mature into counts. Although this inefficiency is only barely detectable in argon plus 6 per cent oxygen, it is very pronounced in tubes containing admixtures of the halogens, halogenated hydro-

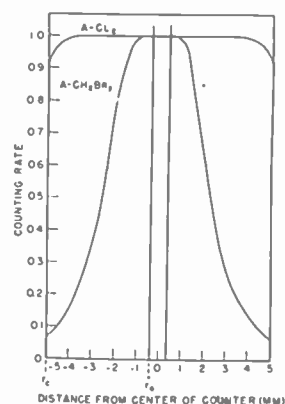

Fig. 13—Variation of counting rate with radial distance from the anode. The counter tube was scanned with a fine pencil of X-rays traveling parallel to the anode. (After Friedman and Birks, in footnote reference 39.)

<sup>34</sup> S. A. Korff, "On the rise of the wire potential in counters," *Phys. Rev.*, vol. 72, pp. 477-481; September, 1947.

<sup>35</sup> H. Den Hartog, F. A. Muller, and N. F. Verster, "Time lags in Geiger-Muller counters," *Physica*, vol. 13, pp. 251-264; May, 1947.

<sup>36</sup> C. E. Mandeville and M. V. Scherb, "Disintegration schemes and the coincidence method," *Nucl. Electronics*, vol. 3, pp. 2-12; October, 1948.

<sup>37</sup> J. C. Street and R. H. Woodward, "Counter calibration and cosmic ray intensity," *Phys. Rev.*, vol. 46, pp. 1029-1034; December, 1934.

<sup>38</sup> M. E. Rose and W. E. Ramsey, "On time lags in coincident discharges of Geiger-Muller counters," *Phys. Rev.*, vol. 59, pp. 616-617; April, 1941.



carbons, ammonia, or sulphur dioxide. Fig. 13 shows the response to a collimated beam of X-rays passing axially down an end-window counter tube at various radial distances from the cathode.<sup>39</sup> With a filling of argon plus methylene-bromide admixture, the efficiency decreased from close to 100 per cent near the wire, to only a few per cent at the cathode. Exposed to cosmic rays this tube showed an over-all efficiency of about 15 per cent. Corresponding measurements are shown for chlorine and argon.

### SOFT X-RAY COUNTERS

A counter tube for detection of soft X-rays can be designed so as to produce a count for virtually every quantum which enters the tube. In early work with X-ray counters, relatively low pressures of filling gases were used, and ionization of the gas played a minor role in triggering the counters. The X-ray beam was usually directed at the cathode cylinder, and released photoelectrons which initiated the counts. The X-ray photoelectric yield of any element reaches a maximum on the short-wavelength side of its X-ray critical-absorption limit. For wavelengths longer than those associated with the critical absorption, the absorber is relatively transparent, yielding few photoelectrons. By selecting for the cathode a material whose *K* absorption limit fell at a slightly longer wavelength than the radiation being measured, it was possible to detect about 15 per cent of the quanta which struck the cathode,<sup>40</sup> as in the case of a zirconium cathode used to measure X rays generated at 30 keV ( $\lambda_{\max} = 0.6 \text{ \AA}$ ).

The form of counter tube best suited to the measurement of soft X-ray beams is the end-window type, filled with a gas capable of absorbing a large fraction of the radiation admitted in the direction of the axis of the tube. The absorption of X rays of wavelengths softer than  $0.5 \text{ \AA}$  is almost entirely a photoelectric process in heavy gases such as argon, krypton, and xenon. It is, therefore, permissible to assume that the percentage of an X-ray beam absorbed in the counter-tube gas represents the quantum counting efficiency, provided that each ejected photoelectron triggers a discharge. If argon is the vehicular gas, it strongly absorbs the *K*-series radiations of elements up to about Zn (30). Krypton (36) whose critical X-ray absorption falls at  $0.9 \text{ \AA}$ , is an efficient absorber of wavelengths shorter than this limit, and also matches the absorption in argon at the longer wavelengths. Xenon (54) absorbs strongly throughout this entire region of the spectrum. Fig. 14 illustrates the absorption characteristics of these three gases in the wavelength range from  $0.4$  to  $2.4 \text{ \AA}$ .<sup>39</sup> It is apparent that efficiencies approaching 100 per cent are attainable over a large portion of this spectral range, if the proper gas is used at sufficiently high pressure or if a long-enough gas path is provided to absorb the X-ray beam.

The most transparent, yet vacuum-tight, windows for X-ray counters are in-

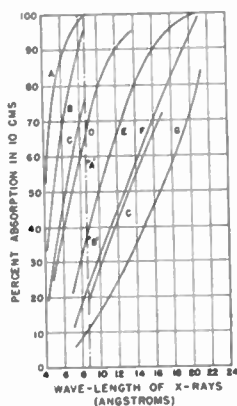

Fig. 14—Absorption of soft X rays in 10 centimeters of the rare gases at various pressures. A—krypton, 76 cm Hg; B—krypton, 40 cm Hg; C—krypton, 20 cm Hg; D—xenon 20 cm Hg; E—argon, 76 cm Hg; F—argon, 40 cm Hg; G—argon, 20 cm Hg; A'—continuation of A; B'—continuation of B. (See footnote reference 39.)

blown glass bubbles, mica, beryllium, and Lindemann glass (consisting mainly of lithium tetraborate). Glass-bubble windows of thicknesses between  $0.5 \text{ mg/cm}^2$  and  $1.0 \text{ mg/cm}^2$ , with apertures 2 centimeters in diameter, are strong enough to support atmospheric pressure on the concave side and still transmit, 1,000 eV X rays. Table II indicates the X-ray transparencies of mica, beryllium, and Lindemann glass at a few wavelengths in the soft X-ray region.

TABLE II

Window	Transmission (per cent)		
	CrK $\alpha$ (2.27 \AA)	FeK $\alpha$ (1.94 \AA)	CuK $\alpha$ (1.54 \AA)
0.020 inch Lindemann	4.5	14	38
0.010 inch Lindemann	22	37	61
0.001 inch Aluminum	37	53	71
0.001 inch Mica	40	56	74
0.0005 inch Mica	64	75	86
0.020 inch Beryllium	65	76	86

At MoK $\alpha$  (0.74 \AA), all the windows listed above transmit in excess of 90 per cent of the X rays.

Typical tube constructions are illustrated in Fig. 15. With glass or mica windows, the active counting region can be brought up close to the window. Beryllium, and aluminum windows are highly transparent, but introduce the difficulty of insulating the window from the cathode, or

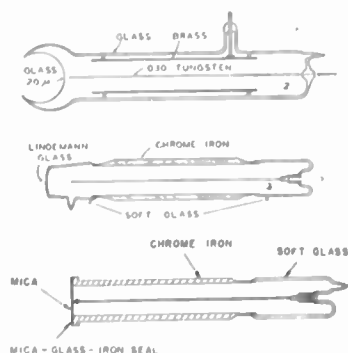

Fig. 15—End-window constructions for soft X-ray counters.

retracting the anode to eliminate discharging to the window. The resultant dead space immediately behind the window somewhat reduces the efficiency of the counter.

A beryllium window is particularly useful when it is necessary to measure soft X rays in the presence of beta rays. For example, 5-year Fe<sup>55</sup> decays by *K*-electron capture into Mn<sup>55</sup>, which then emits 5.9 keV X rays. Fe<sup>59</sup> has a 47-day half life, and emits beta rays with a maximum energy of 0.46 MeV and hard gamma rays. An argon counter with a beryllium window, 0.4 mm thick, detects about 50 per cent of the soft X rays of Fe<sup>55</sup> but less than 2 per cent of the Fe<sup>59</sup> betas. The ratio of sensitivities can then be inverted by using a thin mica window and helium, which will respond to every beta particle entering the tube, but cannot absorb the X rays.

### GAMMA-RAY COUNTERS

As the frequency of the electromagnetic radiation increases beyond the soft X-ray region, the photoelectric absorption in the gas assumes an insignificant role. Most gases used in counter tubes do not appreciably absorb photons whose energies exceed 60,000 or 70,000 electron volts, and direct ionization of the gas is negligibly small. Hard X rays or gamma rays are detected by virtue of the ionization of the counter gas by secondary photoelectrons, Compton recoil electrons, and electron-positron pairs produced within the cathode material. For the lighter elements and higher frequencies of gamma rays, the absorption is almost entirely the result of Compton scattering. At the other extreme of higher atomic numbers and softer radiation, photoelectric absorption becomes most important. Electron-positron pairs do not appear below 1.02 MeV, the sum of the mass energies of the two particles. The cross section for pair production increases slowly with the excess of energy above this threshold, and is proportional to atomic number. The photoelectric absorption coefficient is approximately proportional to the cube of the atomic number, and decreases rapidly with increasing frequency. At 1 MeV, the photoelectric absorption coefficient in copper is already reduced to roughly 2 per cent of the Compton scattering coefficient. In the very heavy elements, however, the photoelectric effect remains relatively important up to much higher energies. At 2.6 MeV, the photoeffect in lead is still about 15 per cent of the Compton scattering. Pair production becomes comparable to Compton effect at much higher energies. In lead, gamma rays of 5 MeV produce about one positron for every three Compton recoil electrons. The same ratio is reached in copper at closer to 10 MeV, and in aluminum at about 15 MeV. The combined effect of all three processes contributing secondary electrons is to make the counting efficiency roughly proportional to gamma-ray energy, if the counter is constructed of a light element such as copper. Cathodes of heavier elements—lead, bismuth, or gold—raise the efficiencies to a pronounced degree at both the low and high energy extremes.

In many nuclear experiments, such as the determination of reaction yields, it is necessary to know the absolute counting

<sup>39</sup> H. Friedman and L. S. Birks, "Geiger counter spectrometer for X-ray fluorescence analysis," *Rev. Sci. Instr.*, vol. 19, pp. 323-331; May, 1948.

<sup>40</sup> H. M. Sullivan, "Quantum efficiency of Geiger-Müller counters for X-ray intensity measurements," *Rev. Sci. Instr.*, vol. 11, pp. 356-362; November, 1940.

efficiency at particular wavelengths. In order to compute what percentage of gamma-ray quanta of a given energy incident on a Geiger counter will trigger counts, it is essential to understand how the number of secondaries injected into the gas of the counter depends upon the thickness and material of the cathode. If, for example, the thickness of the cathode wall is much less than the range of the secondaries, almost all the secondaries will enter the gas and produce counts; but, by the same token, the fraction of the primary beam converted to secondaries will be small. On the other hand, when the thickness is much greater than the range of the secondaries, the absorption of primary radiation may be relatively great, but the secondaries produced at depths from the inner wall surface greater than the maximum recoil-electron range cannot emerge to contribute counts. This behavior is illustrated in Fig. 16, computed for 2-Mev gamma rays entering aluminum. An optimum thickness exists which produces the maximum number of secondaries per primary quantum. This thickness is of the order of the maximum range of the secondaries in the cathode material.

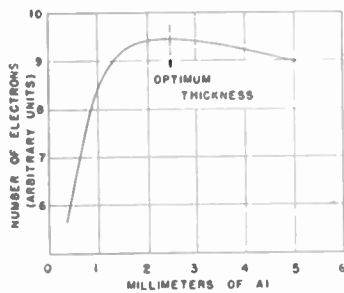

Fig. 16—Ratio of secondary electrons to primary gamma rays (2 Mev) emerging from aluminum absorbers of different thicknesses.

The Compton electrons exhibit a roughly exponential absorption as a consequence of multiple scattering and the dependence of recoil energy on angle. Let an absorption coefficient  $\mu_2$  be assigned to the recoil electrons, and let  $\mu_1$  represent the linear absorption coefficient for gamma rays. It then can be shown that, for cathode thicknesses equal to or greater than the optimum, the ratio  $R$  of the number of secondaries emerging from the cathode to the number of primary quanta transmitted is, approximately,

$$R = \frac{\mu_1}{\mu_2 + \mu_1} \quad (5)$$

This ratio is very nearly the efficiency of the counter. For example, a 2-Mev gamma ray, whose absorption coefficient in Al is about 0.12, produces Compton recoil electrons having an absorption coefficient of about 20. The efficiency according to (5), should be about 0.6 per cent. At 1.0 Mev,  $\mu_1$  is 0.17, and  $\mu_2$  about 55, which should reduce the efficiency to about 0.3 per cent. It is approximately true for lighter elements, such as Al and Cu, that the efficiency in the gamma-ray region from 0.2 to 3 Mev is pro-

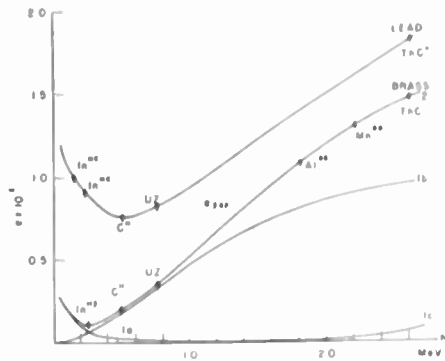

Fig. 17—Efficiencies of gamma-ray counters with brass or lead cathodes in the spectral range from 0.1 to 2.6 Mev. Curves 1(a), 1(b), and 1(c) are the theoretical contributions from photoelectric effect, Compton scattering and pair production in brass. Curve 2 for brass and that for lead are experimental. (See H. Bradt *et al.*, footnote reference 44.)

portional to the energy, and increases at the rate of about 1 per cent per Mev.

The wavelength dependence of the contributions to counting efficiency<sup>41</sup> for each of the three absorption processes is shown in Fig. 17 for a copper cathode. The major contribution to the efficiency comes from Compton scattering. When the cathode is made of a heavier element, the efficiency is higher because of the more important contributions from photoelectric absorption and pair production. Fig. 17 also shows the total efficiency curve for lead. Since the Compton effect is independent of atomic number, the difference between the Pb and Cu curves represents the enhanced photoelectric contribution at lower frequencies and pair production at higher frequencies.

Considerable numbers of Geiger-counter survey instruments are being used to monitor radioactive contaminations in atomic-energy activities and X-ray laboratories, and in many cases the meter readings are calibrated in roentgens. It is interesting to apply some of the above data on efficiency to the problem of the ratio of counting rate to roentgen dose at various wavelengths. If, for example, the counting rate per milliroentgen per hour is assumed to be 100 cps at 1 Mev, then a copper-cathode counter will deliver about 135 cps and a lead counter 106 cps at 2 Mev, for the same dose rate. This ratio of counts to roentgens has a minimum somewhere between 0.1 and 0.5 Mev. On the low-frequency side of the minimum, the counting rate and roentgen dosage rate diverge widely.

Several years ago, Trost<sup>42</sup> attempted to apply counters to roentgen dose measurements under 0.5 Mev in connection with stray radiation from X-ray apparatus. Using a typical metal-in-glass counter tube, he found it possible to keep the ratio of counts to roentgens constant within  $\pm 12$  per cent between 60 and 120 kv. When a filter com-

<sup>41</sup> H. Bradt, P. C. Gugelot, O. Huber, H. Medicus, P. Preiswerk, and P. Scherrer, "Sensitivity of counter tubes with lead, brass, and aluminum cathodes for gamma rays in the energy interval 0.1 Mev-3 Mev," *Helv. Phys. Acta*, vol. 19, pp. 77-90; Sec. II, 1946.

<sup>42</sup> A. Trost, "Application of counter tubes to non-destructive testing," *VDI-Zeitschrift*, vol. 85, pp. 829-833; October, 1941.

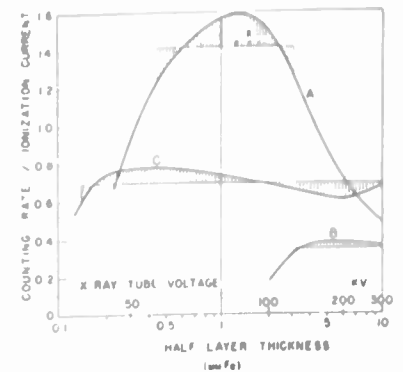

Fig. 18—Ratio of ionization-chamber current to output of a Geiger counter: (A) Unfiltered; (B) filtered; and a proportional counter (C) made of plexiglass. (See Trost, footnote reference 42.)

bination consisting of 1 mm of tin plus 1 mm of brass was interposed between the source and the tube, the curve of counts versus roentgens was flat to  $\pm 10$  per cent from 120 to 300 kv. To include the very soft radiation under 60 kv, he constructed a tube with a plexiglass wall, 1 mm thick, and operated it slightly below Geiger threshold in the region of limited proportionality. For energies in excess of 35 keV, the current delivered by this tube paralleled an "air wall" ionization-chamber response within  $\pm 10$  per cent. These results are illustrated in Fig. 18 reproduced from the literature.<sup>43</sup>

#### METHODS OF IMPROVING THE GAMMA-RAY EFFICIENCY

Any construction which increases the area of cathode surface per unit volume of the counter will increase the number of secondary electrons injected into the gas, and thereby increase the efficiency. The exposed inner surface of a cylindrical cathode may be increased by a factor of  $\sqrt{2}$  over that of a smooth surface by cutting 45-degree threads on the inside or by a factor of  $\pi/2$  by employing a closely wound helix of 16- or 20-gauge wire as the cathode. The greatest advantage was gained by the substitution of a wire-mesh screen for the solid-wall cathode.<sup>43</sup> The optimum mesh was found to be about 100 wires per inch, and gave about a 50 per cent improvement in efficiency over a smooth-walled cathode of similar material. Part of this gain was attributed to the ability of the electric field to penetrate the apertures in the mesh and draw in electrons formed on the outside.

Bundling large numbers of smaller-diameter tubes within the volume of a single large tube is another simple method of increasing efficiency, particularly when dealing with a collimated beam of radiation. Since perhaps 99 per cent of the gamma-ray beam is transmitted through the walls of the first cylinder, the second cylinder in the path of the rays has almost as much chance of producing a count as the first. Ten

<sup>43</sup> R. D. Evans, and R. A. Mugele, "Increased gamma ray sensitivity of tube counters and the measurement of the thorium content of ordinary materials," *Rev. Sci. Instr.*, vol. 7, pp. 441-449; December 1936.

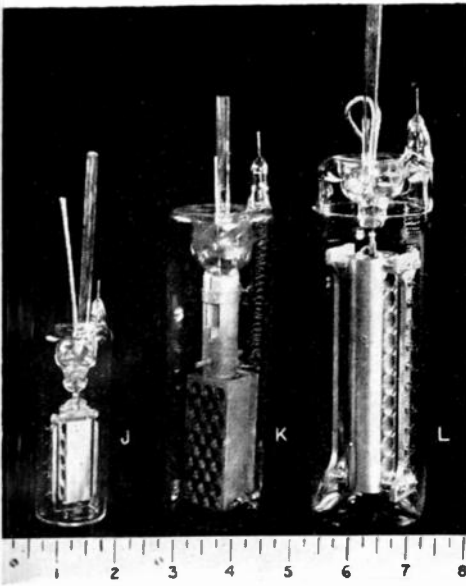

Fig. 19—Multiple counter tubes in parallel combinations.

counter cylinders in line may, therefore, yield about nine times as many counts as a single counter placed in the path of a parallel bundle of rays. The counters shown in Fig. 19 were intended for use in this way. If, however, a number of smaller-diameter cylinders are bundled in place of a single large tube of comparable over-all dimensions, the gain in efficiency for detection of an isotropic flux of radiation is not very great unless a very large number of tubes is used. The relative efficiencies of the bundle of tubes and the equivalent simple tube are given by the ratio of the sum of the diameters of the individual tubes to the diameter of the simple large tube. For a bundle of seven tubes, the ratio is 7/3; for nineteen tubes, the improvement in efficiency is only 19/7.

Perhaps the most successful multi-element tubes designed to increase efficiency were described by Hare in a series of patents<sup>44</sup> filed in 1941-1943. It is not necessary to retain the coaxial-cylinder arrangement in order to obtain a Geiger-counting plateau. Because of the concentration of the field near the wire, the plateau is relatively insensitive to the shape of the cathode. For example, a plane electrode may be substituted for the cathode cylinder (Fig. 20(a)). This configuration may be expanded in one dimension, as shown in Fig. 20(b), and finally in two dimensions to form a multiplicity of both plates and wires, as in Fig. 20(c). The efficiency of such an assembly is approximately equal to the number of plates, even when as many as ten plates are used, and does not depend very much on orientation. Theoretically, the limit to the efficiency obtainable with such structures may approach 30 to 40 per cent. Practical restrictions on the number of plates employed would be governed by the mechanical limitations on the closest spacings. Hare stated that spacings between plates of 2 millimeters were successfully employed.

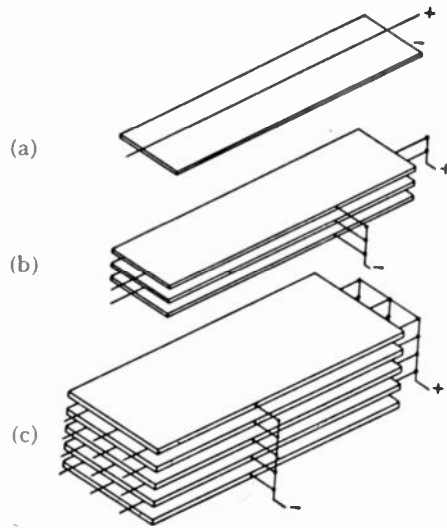

Fig. 20—Multiple plate and wire construction of a gamma-ray counter.

The extent to which the geometry of the counter may deviate from the simple coaxial cylinders, and still retain full volume sensitivity, depends on the nature of the gas in the counter. With the more commonly used "100 per cent efficient" mixtures, such as argon-alcohol, a considerable asymmetry is tolerable. However, with halogen admixtures, halogenated hydrocarbons, and other electronegative gases, the loss of sensitivity in the weak-field regions near the corners of a box counter of rectangular cross section, for example, would leave most of that part of the counter volume insensitive to radiation. Recently, Curran and Reid<sup>45</sup> investigated the behavior of box-shaped cathodes with various numbers of parallel-wire anodes, and determined the effects of asymmetries in anode positions relative to cathode walls and of anode spacings relative to each other.

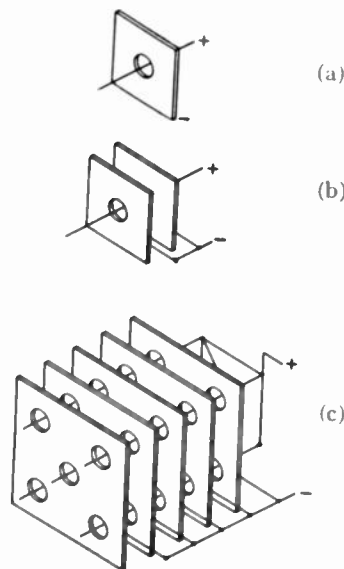

Fig. 21—Perforated disk-type of construction for a high-sensitivity gamma-ray counter.

<sup>44</sup> U. S. Patent Numbers 2,397,073 and 2,397,071 to D. G. C. Hare, 1946.

<sup>45</sup> S. C. Curran and J. M. Reid, "Properties of some new types of counters," *Rev. Sci. Instr.*, vol. 19, pp. 67-76; February, 1948.

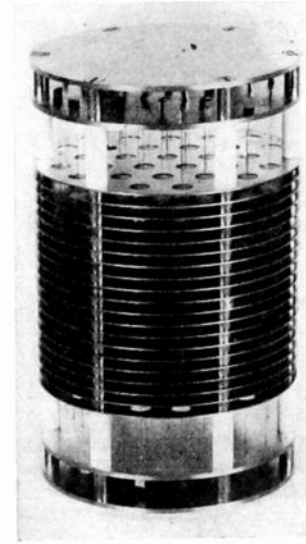

Fig. 22—Photograph of a multiple-disk counter.

Many other arrangements to increase the cathode surface have been suggested. The construction shown in Fig. 21(a) consisting of a wire anode passed perpendicularly through a hole in a plate, will function as a Geiger counter. The sensitive volume of such a configuration extends out considerably farther than the radius of the hole in the neighborhood of the plate. Extending this arrangement, as shown in Figs. 21(b) and (c) and Fig. (22), leads to a structure of stacked disks perforated with holes that are aligned on common cylinder axes. The anode wires are strung axially through the holes. The entire assembly may be compared to a bundle of counters, the effective diameter of each counter being appreciably greater than the hole diameter because of the penetration of the fringing field between the plates. Again, Hare cited the following figures: If the cathode plate was 1 inch in diameter, the hole 5/16 inch, and the plate spacing 0.1 inch, the same number of counts was obtained as with a conventional counter of 1 3/8 inches diameter.

DuMond<sup>46</sup> described a form of multicellular counter in which the cathode structure was a stack of die-cast lead-alloy disks, each disk having a round hole at the center. As shown in Fig. 23, four anode wires are spread out in the form of a spider between each pair of plates, from a common supporting rod extending through the holes in the centers of the disks. This type of tube was used to receive the converging beam of gamma rays from a bent crystal spectrometer designed to measure wavelengths up to 1 Mev. At 0.5 Mev, the counter detected about 8 per cent of the incident quanta.

Another multisection counter, recently described by Beyster and Wiedenbeck,<sup>47</sup> was based upon a simple unit cell, any number of which could be stacked up to produce the

<sup>46</sup> J. W. M. DuMond, "High resolving power, curved-crystal focusing spectrometer for short wavelength X-rays and gamma rays," *Rev. Sci. Instr.*, vol. 18, pp. 626-639; September, 1947.

<sup>47</sup> J. B. Beyster and M. L. Wiedenbeck, "Cell-type gamma counter," *Rev. Sci. Instr.*, vol. 19, p. 819; November, 1948.

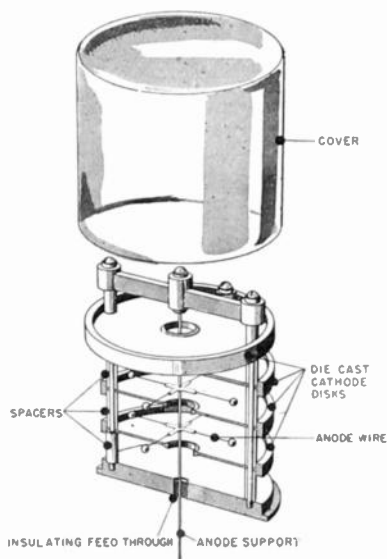

Fig. 23—Multicell gamma-ray counter. (See Du Mond, footnote reference 46.)

desired increase in efficiency. Each cell resembled a flat cylindrical cheesebox, made of brass, 4 inches in diameter and  $\frac{1}{2}$  inch deep. The anode was a circular loop of 10-mil wire 2 inches in diameter, supported midway between the two faces of the box by glass-insulated "feed-throughs," waxed into the cylindrical wall of the box.

#### BETA-RAY COUNTERS

The specific ionization of beta rays is high enough so that any particle traversing the interelectrode space of a Geiger counter is almost certain to trigger a discharge. The major problem in designing a beta-ray counter is, therefore, one of providing a suitable window for the particles to penetrate from outside. Alternatively, a demountable counter tube may be used, which can be assembled with the sample inside the envelope of the tube, and then filled with the counting gas mixture.

The simplest type of beta-ray counter closely resembles the ordinary gamma-ray counter except that the cathode wall and envelope are thinned down to the extreme permitted by requirements of mechanical strength. Most familiar of this type is the thin glass-wall tube, about 30 mg/cm<sup>2</sup>, coated with a thin conductive layer of silver, copper, or colloidal graphite (Fig. 24(c)). Because of the fragility of the thin blown-glass portion, attempts have been made to achieve equivalent transparency in metal-wall tubes. Two such tubes have been offered commercially, one fabricated of aluminum with a 0.005-inch wall, and the other of chrome iron with a 0.002-inch wall. The wall thickness of 30 mg/cm<sup>2</sup> is generally considered to be the minimum compatible with requirements of mechanical strength and vacuum tightness, so that tubes of the thin-wall type are unsuited for use with the softer beta-ray emitters.

The thin-walled counter has been used extensively to measure the artificially induced activities in foils which could be wrapped around the counter and measured

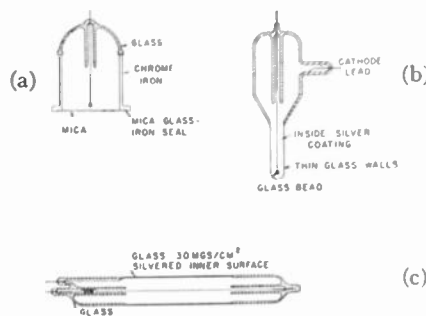

Fig. 24—(a) End-window beta-ray counter. (b) Thin-walled dipping counter. (c) Thin-walled beta counter.

after activation. Larger tubes of the same form are well suited to filter-paper measurements, where again the paper is wrapped around the counter, exposing a relatively large surface to the cylindrical beta-ray window. Fig. 24(b) illustrates an adaptation<sup>48</sup> of the thin-walled tube for the measurement of beta activity in liquids. The thin-walled, thimble-shaped end may be dipped directly into the liquid. In still another arrangement, the thin-walled portion of the tube is surrounded by a jacket with provision for admitting the active liquid into one end of the jacket, circulating it about the thin-walled portion, and finally passing it out the opposite end.

The most popular type of beta-ray counter is the end-window tube intended for use with small, flat disks of radioactive deposits. Mechanically, such a tube is identical with the X-ray counters of Fig. 15, but the length of the cylinder is reduced to the minimum consistent with maintaining a flat plateau (Fig. 24(a)). The dimensions are chosen with the intention of providing the maximum solid angle of collection and the minimum response to gamma rays and cosmic-ray background. Reducing the length of the tube relative to its diameter creates end effects which increase the slope of the plateau and decrease its length. Most tubes compromise at a ratio of length to diameter between  $3/2$  and 2.

A more effective approach to the problem of increasing window area relative to cathode area is to construct a shallow counter bounded by two plane-parallel cathode surfaces. One of these faces is the mica window, conductively coated on the inner surface. The anode wire is mounted parallel to the plane of the window. An approach to such a construction was implicit in the early type of beta counter shown in Fig. 25. The usual cathode cylinder was replaced by a half cylinder with its concave side open toward a thin window. In the tube illustrated, the window was an aluminum foil mounted on a supporting grid. The half cylinder was later succeeded by a multiplicity of half cylinders (Fig. 26(a)), and finally by a flat plate,<sup>49</sup> producing the shallow box form of counter (Fig. 26(b), (c)), one

<sup>48</sup> W. F. Bale, F. L. Haven, and M. L. LeFevre, "Apparatus for the rapid determination of  $\beta$ -ray activity in solutions," *Rev. Sci. Instr.*, vol. 10, p. 193; June, 1939.

<sup>49</sup> R. Thompson and B. Diven, "The multiple wire proportional counter," MDDC Report 99, declassified, July 30, 1946.

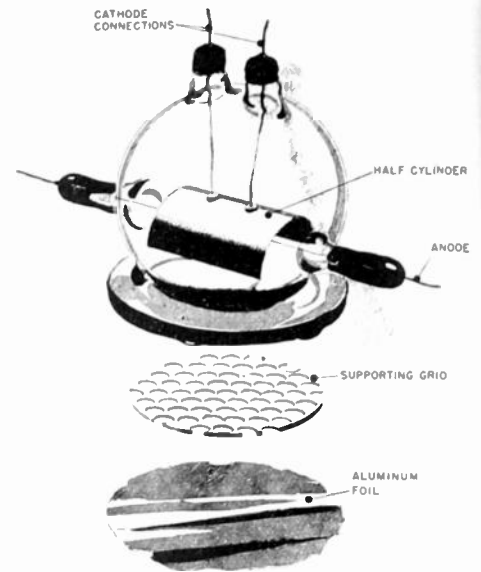

Fig. 25—Beta-ray counter with hemicylindrical cathode.

large face of which was the thin window. One or more anode wires were strung parallel to the cathode planes depending on the width of the box. Large counters of this type are widely used as air-proportional counters by laboratories of the Atomic Energy Commission, with a thin nylon film coated with colloidal graphite serving both as the window and one of the cathode plates.<sup>50</sup> In principle, such an arrangement is well suited to beta-ray counting when a vacuum-tight window is provided and the counter is filled with a Geiger counting gas.

Another way of accomplishing the same result was suggested by Beyster and Wieden-

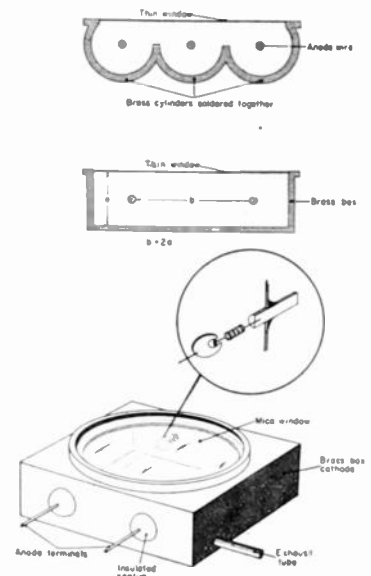

Fig. 26—Development of the flat-box form of beta counter from hemicylindrical cathode structure.

<sup>50</sup> J. A. Simpson, Jr., "Air proportional counters," *Rev. Sci. Instr.*, vol. 19, pp. 733-744; November, 1948.

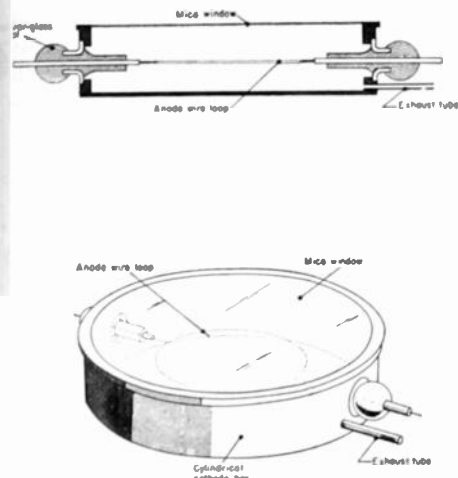

Fig. 27—Low-background beta-ray counter with loop form of anode.

neck<sup>47</sup> in connection with the high-efficiency gamma-ray construction described above. Replacing one face of the shallow cylindrical box with a thin window (Fig. 27) produces a flat-box counter with the same counting geometry as the ordinary end-window counter, but with a minimum of volume and anode surface.

Mica is the most suitable window for beta-ray counters. It can be split in very thin layers which are strong enough to withstand atmospheric pressure over relatively large areas. The best grade of material for thin windows is imported from Africa. Perhaps the most notable recent advance in the technique of constructing beta-ray counters is the use of powdered glass as the sealing medium for joining mica to soft glass or to chrome iron. In the past, mica windows were attached by methods involving compression seals and lead gaskets, wax joints, or the use of special cements such as selenium. None of these produce satisfactory permanent seals, the tightness of the joints being affected by aging, temperature changes, and reactions between the sealing compounds and the gas of the counter. The powdered-glass technique employs a fine powder of lead-borosilicate glass which has a temperature coefficient of expansion very close to those of soft glass, chrome iron, and mica. The glass is used as a thick water paste, applied with a brush around the rim of the mica and the seating flange of the glass or chrome-iron-tube body. With the mica window in place, the seal is heated to the fusing point of the glass powder, producing a vacuum-tight, inert, and permanent seal.

A common difficulty with mica windows is a tendency to acquire a charge, thereby introducing spurious counts and a hysteresis in the response of the tube to changes in intensity. This effect is minimized in tubes filled with gas mixtures containing electro-negative components such as the halogens. Ordinarily, it can be eliminated by making the inner surface of the mica slightly conductive.

One-inch mica windows of 1.5 mg/cm<sup>2</sup> thickness are supplied in commercial tubes. Such windows are adequate for measure-

ments of S<sup>36</sup> (167 kev) and C<sup>14</sup> (145 kev), but are not thin enough for tritium, H<sup>3</sup>, whose beta rays have a maximum energy under 15 kev. Extremely thin films of materials such as nitrocellulose, formvar, and evaporated silica can transmit electrons with energies as low as 1,000 or 2,000 electron volts. These films are sufficiently vacuum tight and strong enough, when mounted on a fine supporting grid, that semipermanent fillings can be made, which retain satisfactory counting characteristics for a day or longer.

In working with tritium, it is generally desirable to admit the radioactivity directly into the counter as part of the counting gas.<sup>51</sup> The tritium can be converted to HTO water, which may be introduced into the counting mixture as water vapor at a pressure of 1 or 2 mm Hg without seriously damaging the counting characteristics. Alternatively, tritium gas may be electrolyzed from tritium water and used in the same manner as inactive hydrogen as a counter gas. If C<sup>14</sup> is carried in CO<sub>2</sub>, it may be used as the counting gas<sup>52,53</sup> in combination with CS<sub>2</sub> vapor and the aid of an electronic quenching circuit. About 2 cm Hg of CS<sub>2</sub> is used with anywhere from 10 to 50 cm Hg of CO<sub>2</sub>, providing thresholds from about 2,000 to 5,000 volts, depending on the tube dimensions.

The screen-wall counter<sup>54</sup> shown in Fig. 28(b) is illustrative of a demountable type in which the source is placed inside the envelope, so as to eliminate the need for a window. Radioactive material to be measured is coated on the inside of the metal sample cylinder. This cylinder can be made of nickel, so that it may be moved within the tube by means of an external magnet. The active volume of the counter is defined by the wire-mesh cathode in the center of the tube. When the sample holder is in alignment with the screen cylinder, as shown in the figure, the counter presents a large solid angle to the source and accommodates a relatively large area of sample. Background count is determined with the sample cylinder drawn to one end of the tube, out of the sensitive region. Any suitable gas mixture may be used. It is recommended that the tube be operated with "drag-in" voltage between the screen and the sample cylinder or outer wall, so as to sweep out positive ions which drift outside the gauze. The disadvantage of this type of counting is, of course, the need for disassembling the tube every time a sample must be changed, a procedure which may consume about 20 minutes between sample measurements.

An apparatus, known as a "gas-flow" counter<sup>55</sup> which provides for quick sample changes and eliminates the inconvenience

<sup>51</sup> R. Cornog and W. F. Libby, "Production of radioactive hydrogen by neutron bombardment of boron and nitrogen," *Phys. Rev.*, vol. 59, pp. 1046; June 15, 1941.

<sup>52</sup> W. F. Libby, "Measurement of radioactive tracers," *Anal. Chem.*, vol. 19, pp. 2-6; January, 1947.

<sup>53</sup> W. W. Miller, "High efficiency counting of long-lived radioactive carbon as CO<sub>2</sub>," *Science*, vol. 105, pp. 123-125; January 31, 1947.

<sup>54</sup> W. F. Libby and D. D. Lee, "Energies of the soft beta radiations of rubidium and other bodies. Method for their determination," *Phys. Rev.*, vol. 55, pp. 245-251; February 1, 1939.

<sup>55</sup> S. C. Brown, "Beta ray energy of H<sup>3</sup>," *Phys. Rev.*, vol. 59, pp. 954-956; June 15, 1941.

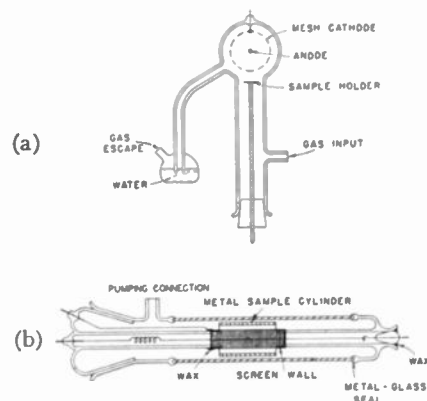

Fig. 28—(a) Demountable windowless beta counter for internal samples. "Gas flow" beta-ray counter for internal samples.

(b) Demountable beta-ray counter for internal samples.

of disassembling and reassembling the counter tube, and evacuating before refilling, is shown in Fig. 28(a). The sample is brought up close to the mesh cathode through a side tube. Methane, helium, or a mixture of helium and a quenching gas stored in a high pressure tank, is admitted through the input sidearm. The incoming gas flushes the air out of the tube through a bubbling bottle. By maintaining a continuous flow of gas at atmospheric pressure, it is unnecessary to have a perfectly vacuum-tight system. The operating voltages need not exceed 2,500 volts with methane, and are much lower with helium mixtures. The arrangement illustrated in Fig. 28(a) is relatively crude compared to some more recent versions of gas-flow counters which permit the use of larger samples and more efficient geometries.

#### SIZE LIMITATIONS

There are many problems, particularly in medical physics and in nuclear physics, which call for the use of small-sized probes for gamma- and beta-ray detection. For example, in medical tracer work it may be desirable to determine the location of a radioisotope within the tissue of an animal or human "in vivo." The limitations on the extent to which the dimensions of a Geiger counter may be scaled down have thus far been entirely mechanical. Curtis described<sup>56</sup> what is perhaps the smallest counter yet built. The glass envelope was coated with aquadag on the inner wall to form a cathode cylinder only 0.8 mm inside diameter and a length of 3 mm. The anode was a tungsten wire 0.005 m in diameter. Curtis compared the size of the tube to a number 2 sewing needle, as shown in Fig. 29. The tube was filled with the usual amyl-acetate and argon mixture at 4 cm Hg total pressure, and gave a background count of 20 per hour. Pulse size in such small tubes is comparable to, or greater than, that obtained in larger tubes. Because of the small volume of the tube, it is natural to expect the life to be shorter than in larger tubes, where the number of

<sup>56</sup> L. F. Curtis, "Miniature Geiger-Müller counter," *Jour. Res. Nat. Bur. Stand.*, vol. 30, pp. 157-158; February, 1943.



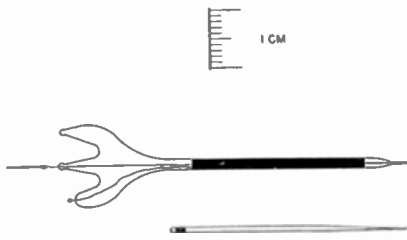

Fig. 29—Miniature Geiger counter. (See Curtiss, footnote reference 55).

molecules dissociated per pulse constitute a smaller percentage of the total number originally present.

At the other extreme, unusually large counters offer no constructional difficulties, but they are inherently slow, have relatively high background rates, and a greater percentage of delayed and spurious counts. To avoid excessively high operating voltages, the anode diameter is ordinarily kept small, while the cathode diameter is increased. The field throughout most of the counter volume is, therefore, relatively weak. As a result, the electron collection time is longer and the positive-ion sheath must cover most of the enlarged distance from wire to cylinder in a weak field, with a consequent increase in the dead time. In the enlarged weak-field part of the counter volume there is also a greater probability for negative ion formation, and delayed counts. Finally, the increased capacitance slows up the recovery of the wire potential and broadens the pulse.

#### REDUCTION OF DEAD TIME

Stever's experiments<sup>57</sup> demonstrated the existence of a natural dead time of  $10^{-3}$  to  $10^{-4}$  second. The dead time explained the choking of Geiger counters at rates of a few thousand counts per second, when used with low-sensitivity amplifiers. Trost<sup>57</sup> found that the integrated current flowing through a counter tube increased well beyond the "choking rate," as shown in Fig. 30. The conclusion to be drawn from Trost's experiment was that pulses appeared within the dead time which were reduced in amplitude below the detection level of the amplifier. They were then not counted, but contributed a reduced charge per pulse to the flow of current through the tube. Muehlhouse and Friedman,<sup>58</sup> using a sensitive wide-band amplifier, measured counting rates as high as 100,000 per second in a Geiger tube whose resolving time at low rates appeared to be 10,000 per second. The dead time decreased with counting rate above 10,000 per second in such a manner that a constant 40 per cent of the counts were lost at any rate up to 100,000 counts per second.

Baldinger and Huber<sup>59</sup> recently studied the behavior of counters at rates higher

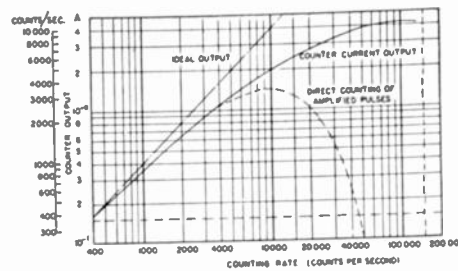

Fig. 30—Counting losses due to dead time. The amplifier responded to pulses as small as half normal amplitude. (See Trost, footnote reference 56.)

than the "Stever dead time." At very high rates almost all pulses fell into the "recovery period," and the average pulse height became a small fraction of normal. These smaller pulses were followed by shorter dead times. The dependence of dead time on pulse height was linear down to pulses of about one-fifth normal amplitude, which was the range covered by the experiment. Increasing the amplifier sensitivity is, therefore, effective in raising the maximum counting rate, but does not materially improve the resolution at low rates.

Attempts have been made to reduce the dead time by reversing the collecting field immediately after formation of the positive ion sheath so as to return the positive ions to the wire. The recovery time, instead of being governed by the time required for the positive ions to cross the diameter of the counter, would then be reduced to the time required to cover the very small distance from the initial radius of the sheath to the wire. Simpson's<sup>60</sup> original circuit for this purpose applied a high and adjustable negative pulse of a few microseconds duration to the wire. The pulse was derived from a fast one-shot multivibrator, triggered by the amplified initial pulse of the Geiger discharge. Simpson estimated that the improvement in speed of ion collection obtained this way could reduce the dead time by almost a factor of ten.

Other reversing circuits have since been described by Hodson<sup>61</sup> and by Smith<sup>62</sup> but they attributed most of the dead-time reduction which they obtained to limitation of the discharge spread, rather than to positive-ion collection. Before the discharge could propagate the full length of the tube, the wire potential dropped below threshold, bringing the discharge to a stop and leaving the remaining length of the counter still sensitive. Since the rate of spread of the discharge is about 10 centimeters per microsecond, this effect is most readily observed in a long counter. Extremely fast circuitry would be required to limit the discharge spread appreciably in a short counter. Smith estimated that ion collection alone reduced the dead time by only a factor of two, and

cautioned against the possibility of interpreting spurious pulses which arise from secondary emission at the wire during the positive ion collection period, as evidence of dead-time reduction.

An effective way to reduce the dead time is to limit the discharge spread along the wire by the use of glass beads. If, for example, the counter wire were divided into two equal lengths by a bead at the center, it would behave as two separate counters connected in parallel. The effective dead time of the combination would then be half the dead time of either section alone. Because the positive-ion sheath is only half as long, normal pulse amplitude must, of course, be only half that of the same counter minus the bead on the wire.

Substituting a bundle of small counters for the equivalent volume of a single large counter will increase the resolution by more than simply the number of counters in the bundle, since each counter of the bundle will itself have a shorter dead time than the single large counter. Multi-element structures of the types illustrated in Figs. 19–23 show similar gains in resolving power. The parallel-plate and wire structure is particularly effective, because the small spacing of individual plates in itself produces a short dead time per element. In open structures, such as the tube of Fig. 21, only a few per cent of the discharges can spread from one wire to another because of the strong absorption of ultraviolet light in fillings of rare gases in combination with polyatomic quenching admixtures. The effect on resolution is almost equivalent, therefore, to operation of independent counters in parallel. If such a tube is filled with simple gases, or the rare gases with halogen admixtures, the discharges spread throughout the entire structure, and the effect of limiting each discharge to a single wire is lost.

#### BACKGROUND REDUCTION

When measuring weak activities, the ultimate sensitivity of the counting method is controlled by the background count against which the sample activity must be distinguished. This background consists of cosmic radiation, gamma rays from natural radioactivity in the surroundings, and, in many laboratories, stray radiation from near-by accelerators. A rough figure for the cosmic radiation is about 1.5 cosmic rays per minute per square centimeter of horizontal surface at sea level. The larger the background, the more difficult it becomes to detect a small increase in counting rate. For example, if the background is equal to the counting rate being measured, then six times as many counts are needed to achieve a given statistical accuracy compared to the number required in the absence of background. If the ratio of sample count to background is as low as one tenth, then 121 times as many counts are required as in the absence of background. The advantage to be gained by any technique which reduces background is obvious.

In discussing the construction of Geiger counters for beta-ray measurements, consideration was given to designs in which the ratio of sensitive volume to window area was minimized, thereby improving the ratio of beta count to background. It is customary to surround a counter and the sample to be

<sup>57</sup> A. Trost, "A method for measuring high radiation intensities using a counter tube," *Zeit. für Phys.*, vol. 117, pp. 257–264; 1941.

<sup>58</sup> C. O. Muehlhouse and H. Friedman, "Measurement of high intensities with the Geiger-Mueller counter," *Rev. Sci. Instr.*, vol. 17, pp. 506–511; November, 1946.

<sup>59</sup> E. Baldinger and P. Huber, "On the resolving power of self-quenching counter tubes at high rates," *Helv. Phys. Acta*, vol. 20, pp. 470–475; November 6, 1947.

<sup>60</sup> J. A. Simpson, "Reduction of the natural insensitive time in Geiger-Mueller counters," *Phys. Rev.*, vol. 66, pp. 39–47; August, 1944.

<sup>61</sup> A. L. Hodson, "Reduction of insensitive time in Geiger-Mueller counters," *Jour. Sci. Instr.*, vol. 25, pp. 11–13; January, 1948.

<sup>62</sup> P. B. Smith, "Dead-time reduction in self-quenching counters," *Rev. Sci. Instr.*, vol. 19, pp. 453–458; July, 1948.

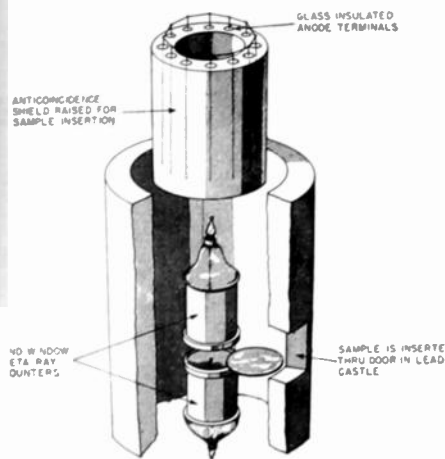

Fig. 31—Schematic arrangement for background reduction.

measured by a lead shield which effectively eliminates the gamma-ray background, but does not stop the penetrating cosmic-ray particles. However, because the efficiency of cosmic-ray particle detection with Geiger counters is close to 100 per cent, it is a simple matter to screen out the counts due to penetrating cosmic-ray particles by anticoincidence circuitry.

Fig. 31 illustrates an arrangement of high geometry for beta-ray detection combined with an anticoincidence shield. Two end-window beta-ray counters are mounted face to face with a sufficient gap between them to accommodate a flat sample. The sample material may be supported on a thin aluminum foil or plastic film which is capable of transmitting almost all the beta rays emitted by the radioactive atoms in the sample. With a small source, this arrangement collects nearly every particle emitted over the entire solid angle or presents what is ordinarily referred to as a  $4\pi$  geometry. The circuitry is so arranged that single random firings of the two counters are transmitted to the scaling circuit, but coincident pulses, excited by the passage of the same cosmic-ray particle through both tubes, are rejected. The cosmic ray shield is completed by slipping the anticoincidence guard counter down around the two beta counters. The guard counter as illustrated is equivalent to a cylindrical ring of counters connected in parallel. Any coincidence between this shield counter and either of the two beta counters is rejected by the electronic circuit. The net result achieved by this arrangement for rejecting coincidence counts is to reduce the background, after shielding in lead, by still another factor of five, without loss of beta-ray counts. Fig. 31 illustrates a system employing two conventional end-window counters. It is immediately apparent that shallow counters of the type shown in Figs. 26 and 27 are still better suited to anticoincidence counting. If the depth of each Geiger counter is much less than its window diameter, then it is possible to dispense with the outer cylindrical shield and rely entirely on rejection of coincidences between the two beta-ray counters.

Gamma-ray counters of the multiple-element types illustrated in Figs. 19–23 are well suited to the application of anticoincidence

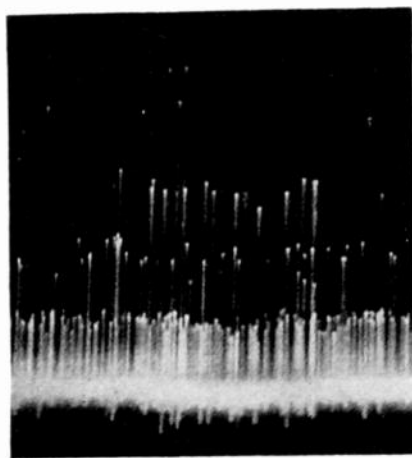

Fig. 32—Variety of pulse amplitudes obtained from tube of Fig. 22.

counting. Fig. 32 is a photograph showing the variety of pulse amplitudes observed on an oscilloscope with the counter of Fig. 22 exposed to gamma rays. Since the anodes and cathodes are connected in parallel, coincidence pulses on more than one wire appear with double, triple, quadruple, etc., amplitudes, depending on whether two, three, four, etc., wires are fired by the passage of a single particle. The great majority of the pulses are single counts typical of gamma rays. Occasionally, the Compton electron ejected by a gamma ray traverses the fields of two wires, and a few per cent of the discharges spread from one wire to another, leading to double-amplitude counts. Triple-amplitude pulses from gamma rays are very infrequent. On the other hand, all wires whose sensitive regions are cut by the trajectory of a cosmic-ray particle fire in coincidence. The largest pulses are, therefore, produced by a cosmic-ray particle penetrating the tube along a plane through its axis. If the cosmic ray penetrates fewer elements of the tube, pulses of lesser amplitude result. By selecting the proper pulse-amplitude discrimination level, it is possible to reject pulses above a given level so as to eliminate almost all background from penetrating cosmic rays.

#### DIRECTIONAL COUNTERS

The production of a preferred directional sensitivity in a gamma-ray counter, without the benefit of external shielding by means of lead or other high density absorbers, is rather difficult to achieve in any high degree. Since the efficiency of counting depends on the material of the cathode wall, its thickness, and distribution in the path of the beam, it is possible to construct a tube so as to present a higher counting efficiency to a source in one direction than in others. Also, since gamma rays are detected mainly by virtue of the ejected Compton electrons, which have a predominantly forward distribution, a tube that is responsive to electrons moving in a particular direction should, therefore, be directional in response to the primary gamma rays.

Rajewski<sup>62</sup> described a bimetallic cathode

<sup>62</sup> B. Rajewsky, "The use of the Geiger-Mueller counter in mining," *Zeit. für Phys.*, vol. 120, pp. 627–638; March, 1943.

for a gamma-ray counter consisting of two hemicylinders of lead and aluminum. Because of the different efficiencies of the two metals, the counting rate for rays entering lead and leaving aluminum was greater than for rays traveling in the reverse direction. Craggs and his coworkers<sup>64</sup> recently determined the contrast in sensitivity obtainable by such tubes with the aid of a parallel-plate and wire form of counter. Diametrically opposed windows were cut in the glass envelope of the tube at positions orthogonal to the planes of the plates. These windows were covered with aluminum foil 0.002 inch thick. The response of this counter to a collimated beam of gamma rays was 32 per cent lower when the beam passed through the windows than when it was directed perpendicularly to the surfaces of the plates. This experiment indicates the extreme of contrast obtainable in a bimetallic form of directional counter.

The experiments of Stever showed that it was possible to localize the discharge in a Geiger counter by placing glass beads on the anode wire. If the beads were opaque to ultraviolet light, the spreading of the discharge by photoelectric effect in the gas was blocked at the bead. Stever suggested the use of the beaded-wire counter as a directional detector of energetic particles. For example, if the wire were partitioned into three sections by glass beads, a particle traversing the tube in a direction normal to the axis would fire only one section, whereas a particle traversing the counter parallel to the axis would fire all three sections. Since the pulse amplitude developed by the counter is proportional to the length of the discharge along the wire, a circuit which discriminates against smaller pulses arising from the firing of one or two sections rather than all three will register only those counts arising from the triggering of all three sections by a primary particle traveling essentially parallel to the axis of the counter.

Since high-energy gamma rays produce a distribution of recoil electrons with a maximum in the forward direction, a Stever type of beaded-wire counter should have directional properties for gamma-ray detection. However, because of the angular distribution of recoil electrons, the directionality of response is not very pronounced, and the counting rate is correspondingly low.

The most satisfactory arrangements for obtaining directional sensitivity with gamma counters are those which simply employ shielding with lead or other high-density absorbers. When the gamma rays are emitted from a point source, it is advantageous to use two counters separated by a lead barrier and coupled to a differential-counting-rate meter.

#### PHOTON COUNTERS

The photon counter combines the principle of the photocell with the amplification mechanism of the G-M counter. Rajewski<sup>65</sup> and Locher<sup>66</sup> described the behavior of such

<sup>64</sup> J. D. Craggs, P. W. Bosley, and A. A. Jaffe, "Some experiments with Geiger-Mueller counters," *Jour. Sci. Instr.*, vol. 25, pp. 67–71; March, 1948.

<sup>65</sup> B. Rajewsky, "On the sensitivity of photon counters," *Phys. Zeit.*, vol. 32, pp. 121–124; February, 1931.

<sup>66</sup> G. L. Locher, "Photoelectric quantum counters for visible and ultraviolet light," part I, *Phys. Rev.*, vol. 43, pp. 525–546; November 15, 1932.

tubes in 1931. Much of the work since then has been confined to ultraviolet counters operating in the region below 3,000 Å, although Locher achieved considerable success in the preparation of blue-sensitive (threshold, 4,000 Å) tubes. So little effort appears to have been expended on the production of photon counters with long-wavelength sensitivities that it is difficult to evaluate their possibilities. Of all detectors, the photon counter has inherently the maximum sensitivity for measuring the photocurrent; i.e., it counts every photoelectron. To date, however, it has not been possible to duplicate in gas-filled tubes the quantum yields obtained with photo surfaces in vacuum in the spectral range from 3,000 to 5,000 Å. Surfaces that are highly photosensitive in vacuo when exposed to visible light are invariably poisoned and desensitized by contact with the gas in a counter. At shorter wavelengths in the ultraviolet, however, quantum efficiencies between  $10^{-4}$  and  $10^{-3}$  counts per quantum are commonly obtained<sup>67</sup> in photon counters. These yields are comparable to those observed for most photosurfaces in vacuum in that region of the spectrum.

<sup>67</sup> O. S. Duffendack and W. E. Morriss, "An investigation of the properties and applications of the Geiger-Mueller photoelectron counter," *Jour. Opt. Soc. Amer.*, vol. 32, pp. 8-24; January, 1942.

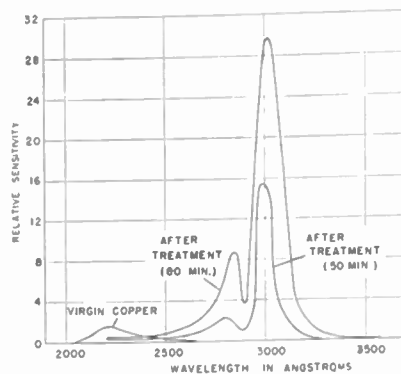

Fig. 33—Ultraviolet sensitivity of activated photon counter tube. (See Scherb, footnote reference 58.)

Locher described many surface coatings and treatments which produced enhanced quantum yields in photon counters operating in the blue and ultraviolet portions of the spectrum. Since Locher's experiments, very little has been published on photon counters. More recently, Scherb<sup>68</sup> described un-

<sup>68</sup> M. V. Scherb, "Photoelectric effect in self-quenching Geiger-Mueller counters," *Phys. Rev.*, vol. 73, pp. 86-87; January 1, 1948.

usual spectral sensitivities obtained by glow-discharging an argon-butane-filled copper-cathode counter at liquid-air temperature. Fig. 33 illustrates the results of this treatment which produced a peak at about 3,000 Å with a quantum yield about 15 times as great as that of the untreated copper surface between 2,000 and 2,500 Å. It seems reasonable to expect that many similar improvements would develop out of research on photon counters if an effort were made to continue such investigations. There are interesting possibilities for the application of such tubes to spectroscopic instruments and in connection with scintillation counting.

#### CONCLUSION

The writer has limited the contents of this paper to a discussion of Geiger-counter tubes for the detection of cosmic rays, X rays, gamma rays, beta particles, and ultraviolet light. Neutrons, protons, and alpha particles are ordinarily detected by means of proportional counters and pulse ionization chambers, which do not fall within the scope of this paper.<sup>69</sup>

<sup>69</sup> The references cited here represent only a small portion of the published literature on Geiger counter tubes.

## Microwave Phase Front Measurements for Overwater Paths of 12 and 32 Miles\*

A. W. STRAITON†, MEMBER, IRE

**Summary**—This paper presents the results of microwave measurements at a wavelength of 3.2 cm for overwater paths of 12 and 32 miles near Galveston, Texas. Continuous curves of phase and signal strength for a range of transmitter and receiver heights between 10 and 55 feet mean sea level are shown. Comparison of the two radio paths is made, and deviations of the results from those commonly expected for overwater propagation are pointed out.

### I. INTRODUCTION

THE UNUSUAL characteristics of microwave propagation over water at low elevations have been discussed in numerous papers.<sup>1,2</sup> When the air along the radio path used in this study has traveled a considerable distance over water, radio ducts are produced in which microwave signals may be trapped.

\* Decimal classification: R248. Original manuscript received by the Institute, June 10, 1948; revised manuscript received, September 13, 1948. Presented, joint meeting, American Section, URSI and Washington Section, IRE, Washington, D. C., May 3, 1948. This work was sponsored by the Office of Naval Research, under contract N5 ori-136.

† Electrical Engineering Research Laboratory, The University of Texas, Austin 12, Texas.

<sup>1</sup> P. A. Anderson, K. E. Fitzsimmons, G. M. Grover, and S. T. Stephenson, "Results of low level atmospheric sounding in the southwest and central Pacific oceanic areas," Department of Physics, Washington State College, Report No. 9, February 27, 1945.

<sup>2</sup> Katzin, Martin, Robert W. Buchman, and William Binnian, "Three and nine centimeter propagation in low ocean ducts," *Proc. I.R.E.*, vol. 35, pp. 891-906; September 1, 1947.

This trapping produces signal strengths beyond the optical horizon much greater than would occur under standard conditions.

This paper describes the measurement of phase and signal strength as functions of transmitter and receiver heights at a wavelength of 3.2 cm for overwater paths of 12 and 32 miles. It is believed that these are the first microwave vertical phase measurements which have been made for overwater paths.

### II. RADIO PATH

The radio path was adjacent to the shoreline along Bolivar Peninsula near Galveston, Texas. A curve in the shoreline permitted completely overwater paths as shown in Fig. 1. The receiving tower was located on a projection of land near the west end of the peninsula.

The transmitting tower was set up at two points on the shoreline at distances of 12.3 and 31.6 miles from the receiver. A few measurements were made for other distances with the transmitter mounted on top of a truck.

### III. RECEIVING EQUIPMENT

The receiving equipment measured the phase difference between two antennas spaced 10 feet apart

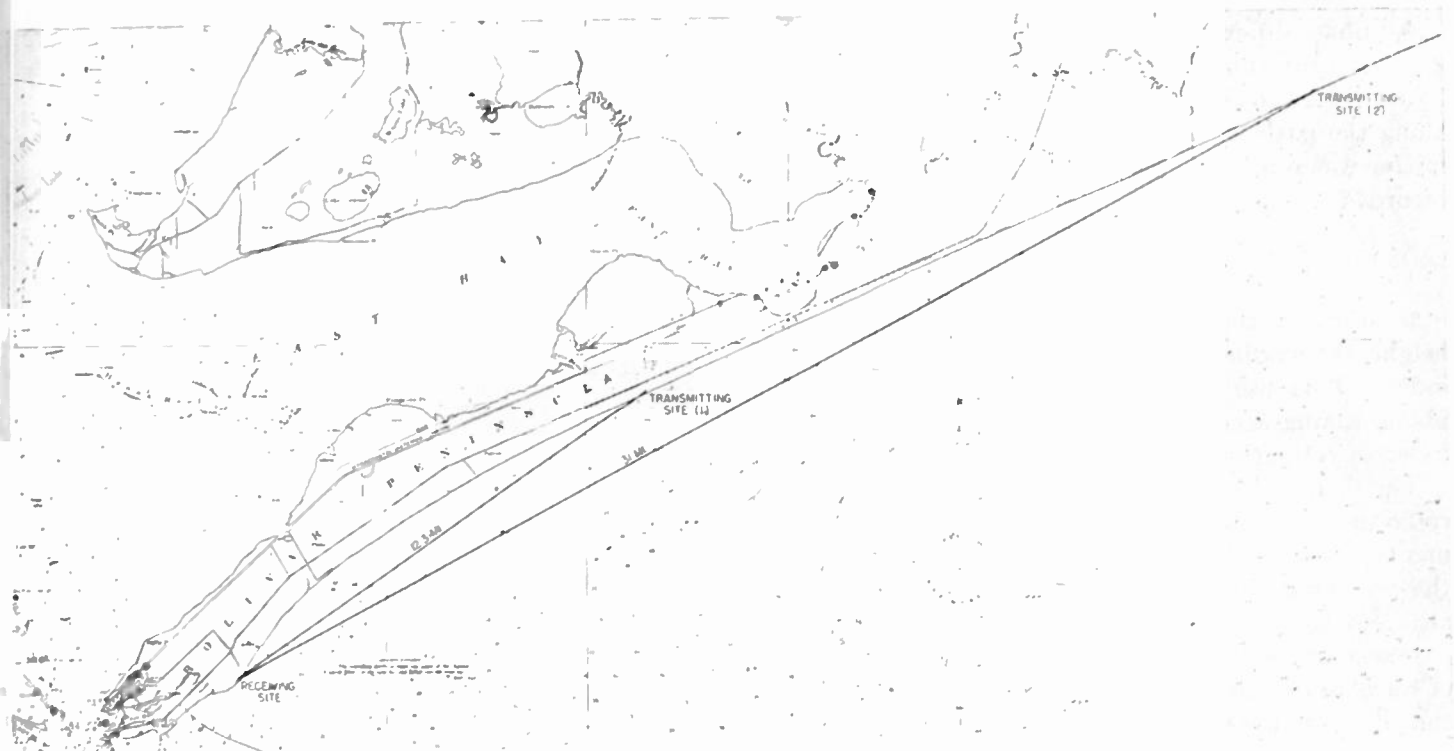

Fig. 1—Radio path.

vertically and the signal strength at the two antennas. This equipment was developed by the Electrical Engineering Research Laboratory of The University of Texas, and is described elsewhere.<sup>3</sup> The receiving antennas were mounted on an elevator on the face of the 50-foot receiving tower as shown in Fig. 2. Deviations in the alignment of the antennas from a vertical plane were recorded, and appropriate corrections were applied to the phase measurements. The center point between the antennas was raised continuously from 10 to 55 feet mean sea level in an interval of approximately three minutes.

#### IV. TRANSMITTING EQUIPMENT

The transmitting equipment was mounted on the elevator of a fifty-foot tower. The elevator was raised from 10 to 55 feet mean sea level in approximately two minutes.

The transmitter employed a 2K39 reflex klystron with a cw output of 200 milliwatts.

#### V. PROCEDURE FOR TAKING DATA

The general procedure for taking data was to take six sets of phase-difference and signal-strength variations with height in an interval of approximately 20 minutes. The receiver was moved through its complete height range with the transmitter fixed successively at elevations of 10, 30, and 54 feet mean sea level. The transmitter was then moved through its complete height range with the receiver fixed successively at 11, 31, and 55 feet mean sea level. Fifteen complete sets or ninety

height runs were made for the 12.3-mile path and 18 complete sets or 108 runs were made for the 31.6-mile path. With the transmitter height fixed, two receiver runs were made for a 40-mile path and eight receiver runs for a 47-mile path.

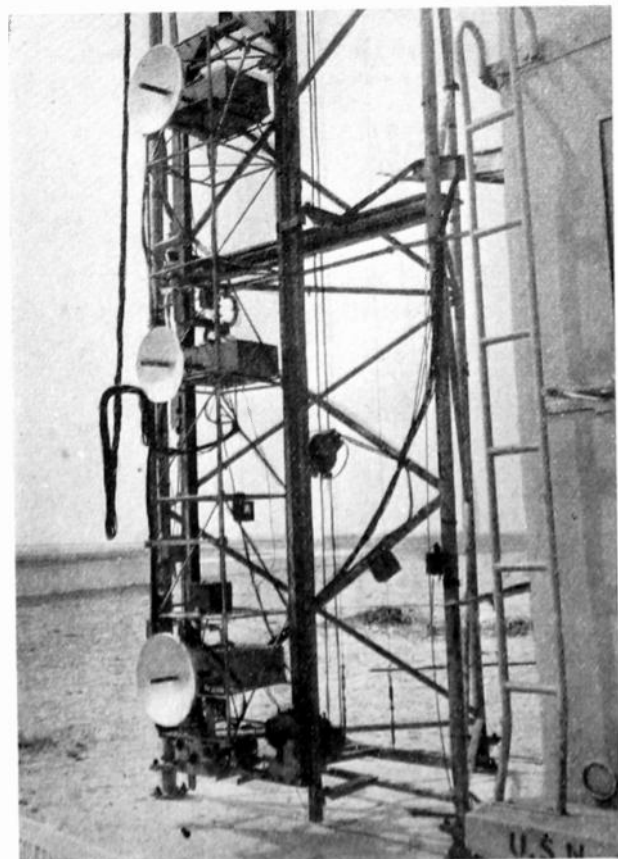

Fig. 2—Receiving equipment.

<sup>3</sup> F. E. Brooks, Jr., et al., "Operating manual for phase difference equipment," The University of Texas, Electrical Engineering Research Laboratory, Report No. 8, May 1, 1948.

All phase differences were measured with reference to that for a ray coming in horizontally. This was obtained by use of a reference transmitter several hundred feet along the path from the receiver. This reference transmitter was removed when the distant signals were being recorded.

## VI. MODIFIED INDEX OF REFRACTION

In studying the variation of index of refraction with height, the modified index was used instead of the actual index.<sup>4</sup> This use permits treating the sea surface as plane, taking account of the curvature in the modified index of refraction.

The meteorological data taken in connection with the radio measurements are described elsewhere.<sup>5</sup> Measurements of the modified index of refraction were made at the receiving site and on board a ship which cruised adjacent to the radio path.

It was found that the variation of the modified index of refraction with height could be made to approximate the linear-exponential curve suggested by Pekeris<sup>6</sup> above the first few feet by the proper choice of equation constants. The general form of the height variation was always the same, and since only minor variations existed in the necessary values of the constants, it was possible to represent the prevailing meteorological condition by a single curve of modified index of refraction  $M$  as a function of height  $h$ , above the sea surface. This curve is shown in Fig. 3 and is expressed by

$$M - M_0 = 0.04h + 10.5e^{-0.14h} - 10.5.$$

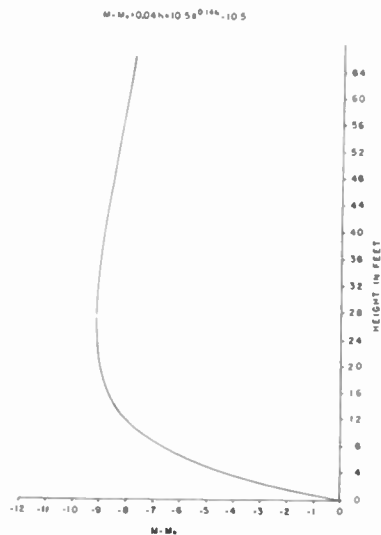

Fig. 3—Modified index of refraction.

<sup>4</sup> J. C. Schelleng, C. R. Burrows, and E. B. Ferrell, "Ultra-short-wave propagation," *Proc. I.R.E.*, vol. 21, pp. 427-463; March, 1933.

<sup>5</sup> John R. Gerhardt, "Summary of meteorological measurements in the vicinity of Galveston, Texas, during July and August, 1947," The University of Texas, Electrical Engineering Research Laboratory, Report No. 18, March 1, 1948.

<sup>6</sup> C. L. Pekeris, "Wave theoretical interpretation of propagation of 10-centimeter and 3-centimeter waves in low level ocean duct," *Proc. I.R.E.*, vol. 35, pp. 453-462; May, 1947.

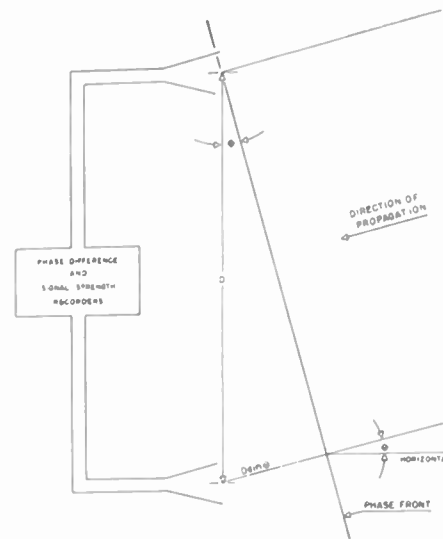

Fig. 4—Principle of angle-of-arrival measurements.

## VII. PRINCIPLE OF ANGLE-OF-ARRIVAL AND PHASE FRONT DETERMINATIONS

The angle-of-arrival equipment measured the phase difference between two points 10 feet apart vertically. For a phase front which is approximately plane in this interval, the phase difference may be used to obtain the angle of arrival of the phase front. If the phase front has an angle of arrival of  $\theta$  above the horizontal, as shown in Fig. 4, the phase front will travel an extra distance in reaching the lower antenna after reaching the upper antenna given by

$$D \sin \theta.$$

The phase delay  $\phi$  at the lower antenna will then be given approximately by

$$\phi = 2\pi D \sin \theta / \lambda.$$

For a separation  $D$  of 10 feet and a wavelength  $\lambda$  of 0.105 feet (3.2 cm), this becomes

$$\phi = 600\theta.$$

The angle of arrival of the phase front is then obtained by dividing the phase difference by 600.

The shape of the phase front may be obtained from the phase difference measurements.<sup>7</sup> Since the phase difference is known between any two points 10 feet apart in the height range of the receiver, the phase with reference to a particular point may be obtained at 10-foot intervals above that point by adding the successive differences. This phase front determination can only be applied to the data for which the receiver was moving, and cannot be applied to the data for which the transmitter was moving.

## VIII. CONSISTENCY OF DATA

For each of the radio paths used, the general characteristics of all of the signal strength and phase dif-

<sup>7</sup> A. H. LaGrone, E. W. Hamlin, and A. W. Straiton, "The indicated angle-of-arrival by phase front analysis," The University of Texas, Electrical Engineering Research Laboratory, Report No. 12, June 15, 1948.



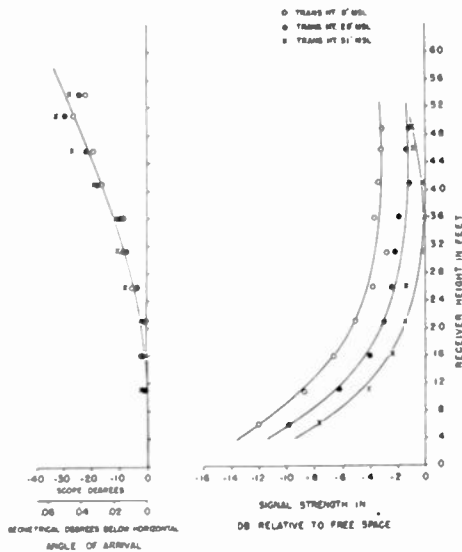

Fig. 5—Angle-of-arrival and signal-strength curves for 12.3-mile path with the receiver moving.

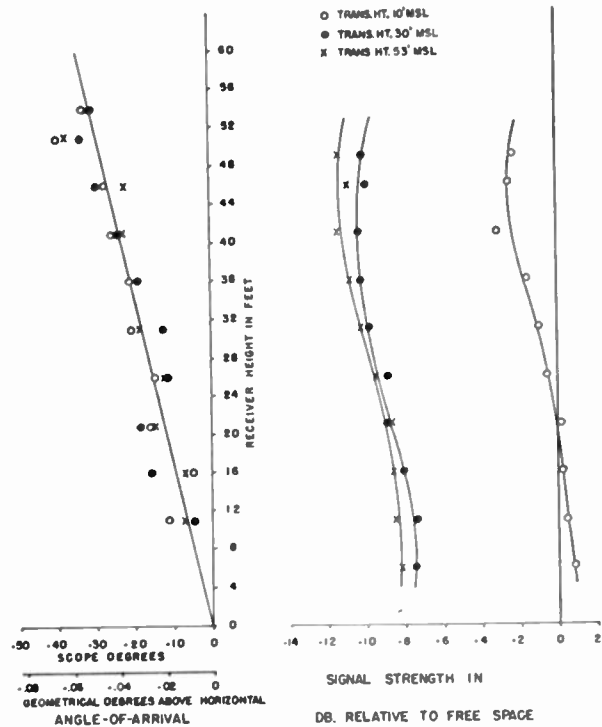

Fig. 7—Angle-of-arrival and signal-strength curves for 31.6-mile path with the receiver moving.

ference curves were the same, and only minor variations occurred in the details of the curves. Therefore, it seemed desirable to use average data instead of individual curves in presenting the results of the measurements. Accordingly, all of the data for corresponding height runs were averaged to obtain the curves shown later.

IX. GENERAL CHARACTERISTICS OF DATA

The signal strength and angle-of-arrival curves for the average data of the 12.3-mile path are shown in Fig. 5 for the receiver moving and in Fig. 6 for the transmitter moving. The corresponding curves for the 31.6-mile path are shown in Figs. 7 and 8, respectively. The general characteristics of these curves are as follows:

1. The phase difference at the receiver is independent of transmitter height.
2. The phase front angle of arrival was negative (below horizontal).

3. The signal strength increased with height for the 12-mile path and decreased with height for the 32-mile path.

4. The same signal strength does not result when the transmitter and receiver heights are interchanged.

A few receiver runs were made for 40- and 47-mile paths with the transmitter placed on a truck. The data for these paths show characteristics similar to those of the 12- and 32-mile path.

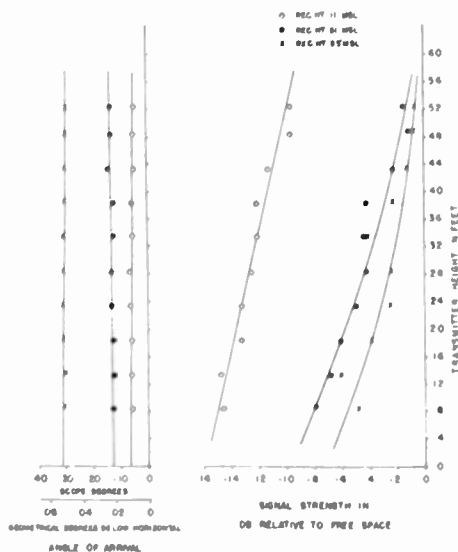

Fig. 6—Angle-of-arrival and signal-strength curves for 12.3-mile path with transmitter moving.

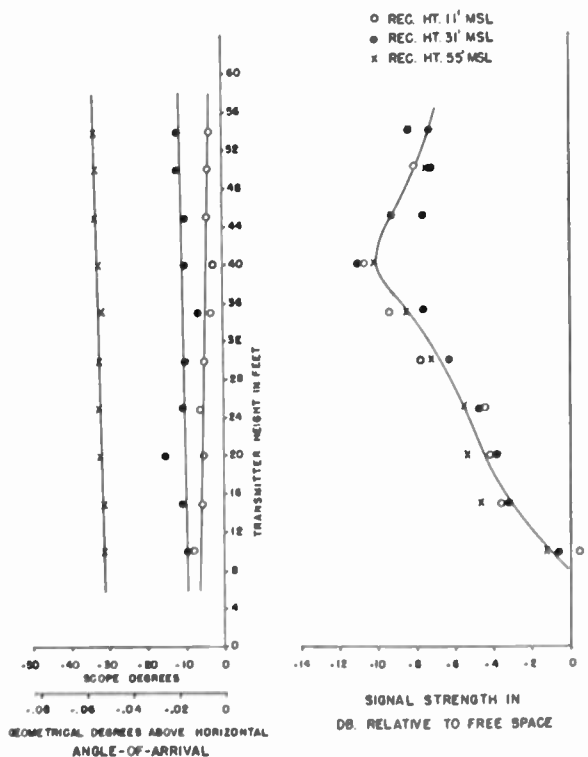

Fig. 8—Angle-of-arrival and signal-strength curves for 31.6-mile path with the transmitter moving.

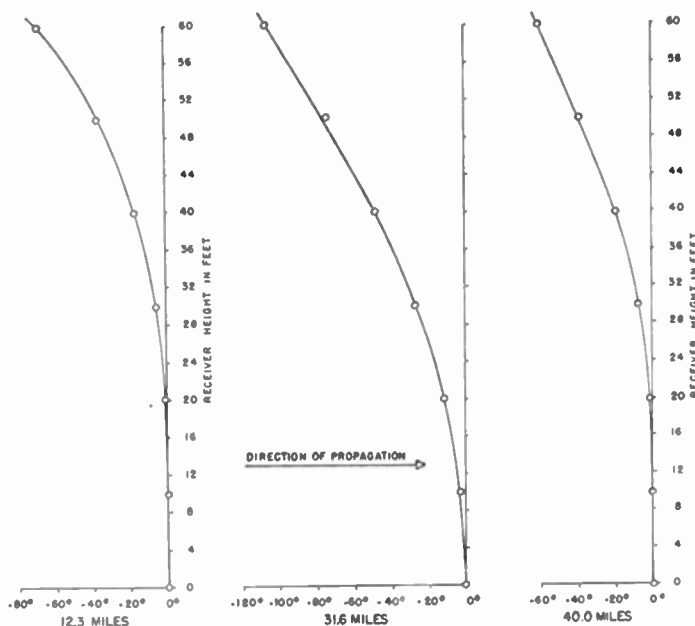

Fig. 9—Phase fronts.

The shape of the phase fronts for the various path lengths is shown in Fig. 9. It is seen to be divergent.

## X. NORMAL MODE SOLUTION OF WAVE EQUATION

### 1. General Solution

The problem of calculating the phase front and the field strength from the modified index of refraction distribution may be handled by ray tracing methods for relatively short distances.<sup>8</sup> However, for greater distance, the solution is given in terms of a sum of a number of normal modes.<sup>9</sup> Thus,

$$\psi = e^{i\omega t - i\pi/4} \left[ \frac{2\pi}{KR} \sum_m e^{-\delta_m R} U_m(h_t) U_m(h_r) \right] \quad (1)$$

where

$R$  is the distance along the earth surface,  $K$  is  $2\pi$  divided by the wavelength,  $\delta_m$  is the propagation function of the  $m$  mode, and  $U_m(h_t)$  and  $U_m(h_r)$  are the height-gain relationships as functions of transmitter and receiver heights, respectively. It is convenient to express  $\delta_m$  in terms of a characteristic function such that

$$\delta_m^2 = -k^2(1 - \Lambda_m).$$

### 2. First Mode

For the modified index of refraction curve shown in Fig. 3, the first mode is found to fall in the transition region between complete trapping in the duct and considerable leakage from the duct. By use of the charts

<sup>8</sup> W. E. Gordon, and A. T. Waterman, Jr., "Angle-of-arrival aspects of radio meteorology," The University of Texas, Electrical Engineering Research Laboratory, Report No. 1, Appendix, March 23, 1946.

<sup>9</sup> W. H. Furry, "Theory of characteristic functions in problems of anomalous propagation," Radiation Laboratory Report No. 680.

prepared by Pekeris and Ament<sup>10</sup> for asymptotic solution for transition modes, the value of  $\Lambda$  is given as

$\Lambda = 15 + 0.18i$  where distances are in natural units (1 natural unit of height = 15.1 feet and 1 natural unit of horizontal distance = 5.22 miles).

From the value of  $\Lambda$ , the attenuation of the first mode with reference to the inverse square root decrease is found to be 0.3 db per mile.

The characteristic height-gain function for the trapped mode is one which increases to a maximum at a height slightly less than the modified index of refraction minimum, and decreases for somewhat greater heights. The phase front to be expected is one which is constant for height changes in the duct, and decreases for values above the duct.

### 3. Second Mode

By the phase-integral method of footnote reference 9 the attenuation of the second mode is found to be 4.2 dbs per mile below the inverse square root value. It then appears that the second mode will not be significant, except possibly for the 12.3-mile path.

## XI. DISCUSSION

### 1. Phase Difference as a Function of Transmitter Height

For the 12.3-mile and 31.6-mile paths, the phase difference was found to be independent of the position of the transmitter. This condition indicates that only one mode is present for each of these paths. This follows from (1) since a change in transmitter height for one mode will produce the same change in phase at all receiver heights. The phase difference and the shape of the phase front are then independent of transmitter height for a single mode. For more than one mode, the changes in the signal strengths of the various modes with transmitter height would normally cause the resulting phase angle to change.

### 2. Phase Difference as a Function of Receiver Height

The direction of the angle of arrival of the phase front was found to be negative and the phase front was found to be divergent.

For a completely trapped mode, the phase would remain constant below the track width, and become negative above the track width. For the slightly leaky first mode, the phase would decrease consistently with height, giving a divergent phase front. It would normally be expected that the agreement would be better for the longer paths.

### 3. Signal Strength as a Function of Receiver and Transmitter Heights

The field equation solution for a single mode indicates that the shape of the height-gain curve is independent

<sup>10</sup> C. L. Pekeris, and W. S. Ament, "Characteristic value of the first normal mode in the propagation of microwaves through an atmosphere with a linear-exponential modified index of refraction, Naval Research Laboratory MPG-5.

of distance, except for changes in magnitude. With either the transmitter or receiver increasing in height, the single mode solution would give a signal strength increasing in magnitude up to a maximum at slightly less than 25 feet.

4. Deviation Between Receiver and Transmitter Signal-Strength Height Curves

As pointed out previously, the signal-strength curves as a function of receiver heights were distinctly different from the curves as a function of transmitter height. The field equation (1) indicates, however, that the transmitter and receiver height may be interchanged without changing the signal strength. No satisfactory explanation has been made for the deviation in the shape of the signal-strength curves, although several suggestions have been advanced. These will be discussed in the following sections.

a. One explanation is the possibility that the index of refraction varies with horizontal distance. However, the meteorological measurements indicated no measurable variation of index with distance.

b. A second suggestion is that the differences in the transmitter and receiver antenna sizes may have caused the deviation. A 30-inch paraboloidal dish was used at the transmitter and 18-inch dishes were used at the receiver. However, the effective transmission angles were so small compared to the antenna beam angles that it is felt that the effect of the difference in antenna size is negligible.

c. A third possibility is that the horizontal distances and heights used were too great for the use of ray treatment and too short for the use of the wave theory. Even though the mode theory indicates that the higher mode would be negligible, the ranges used may not have been sufficiently long to establish the phase front predicted by the mode theory.

Phase and signal strength measurements for a large number of distances appear to be desirable. In addition, it seems desirable to obtain data with the receiver and transmitter interchanged. It is hoped that it will be possible for the Electrical Engineering Research Laboratory to take these additional data in the not too distant future.

# Predetermined Electronic Counter\*

B. R. GOSSICK†

**Summary**—Proof is given that any integral scaling base can be obtained using binary counters with appropriate feedback connections. As examples, two different sets of feedback connections are given for each integer between  $2^{n-1}$  and  $2^n$ .

CONSIDER  $n$  multivibrators connected in cascade. The two positions of stable equilibrium will be designated as 0 and 1. Connections are made so that the initial position for each multivibrator is zero. This arrangement is shown in Fig. 1.

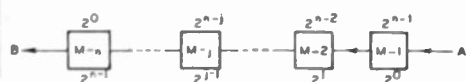

Fig. 1

The 2's underneath the multivibrators give the number of input pulses required at A to make the associated multivibrator shift position. Thus, if a pulse is fed into the  $j^{th}$  multivibrator it has the same effect as  $2^{j-1}$  pulses fed into the first multivibrator at A. The 2's above each multivibrator represent the number of times their associated multivibrator makes the shift 0-1 per cycle of the chain, i.e., per output pulse produced at B. Grosdoff<sup>1</sup> has shown how to make a connection between the  $k^{th}$  and  $j^{th}$  multivibrators,

so that each time the  $k^{th}$  makes the shift 0-1, it transmits a pulse to the input of the  $j^{th}$  multivibrator. In general,  $k > j$ . Then, each time the  $k^{th}$  multivibrator shifts 0-1, it has the effect of  $2^{j-1}$  pulses applied at A. Furthermore, as the  $k^{th}$  multivibrator makes  $2^{n-k}$  shifts 0-1 for each complete cycle of the chain, it is evident that the feedback connection  $k-j$  has the same effect as  $2^{n-k+j-1}$  pulses applied at A. Thus, the natural count  $2^n$  has been reduced by this number, so that there are now only  $2^n - 2^{n-k+j-1}$  input pulses per cycle of the chain.

It follows that, by making other feedback connections in the chain, the count C (i.e., the number of input pulses per cycle) is given by

$$C = 2^n - \sum_{k=2}^n 2^{n-k-1} \sum_{j=1}^{k-1} 2^j \delta_j^k \quad (1)$$

$$\delta_j^k = \begin{cases} 1, & \text{if } k \text{ and } j \text{ are connected.} \\ 0, & \text{if } k \text{ and } j \text{ are not connected.} \end{cases} \quad (2)$$

Consequently, it is clear that the natural count can be changed to any integral number of input pulses per cycle; because any integer can be expressed in the binary system, and in that system the symbol for the number  $k$  is the sequence of coefficients  $a_i$ , where  $a_i$  equals either unity or zero, and

$$k = \sum_i a_i 2^i, \quad i = 0, 1, 2, 3, \dots \quad (3)$$

Two examples follow. As the natural counts  $2^n$  and  $2^{n-1}$  are produced by chains of  $n$  and  $n-1$  multivibrators, respectively, it only remains to show how to fill the gap between  $2^n$  and  $2^{n-1}$ . The first example is a circuit where feedback connections are from

the  $k^{th}$  to the first multivibrator. Thus, by (1),

$$C = 2^n - \sum_{k=2}^n 2^{n-k} \delta_1^k \quad (4)$$

$$= 2^{n-1} + 1, \quad (k = 2, 3, 4, \dots, n) \quad (5)$$

$$= 2^{n-1} + 2, \quad (k = 2, 3, 4, \dots, n-1) \quad (6)$$

$$= 2^{n-1} + 3, \quad (k = 2, 3, 4, \dots, n-2, n) \quad (7)$$

$$= 2^{n-1} + 4, \quad (k = 2, 3, 4, \dots, n-2) \quad (8)$$

$$\vdots \quad \vdots$$

$$= 2^n - 4, \quad (k = n-2) \quad (9)$$

$$= 2^n - 3, \quad (k = n-1, n) \quad (10)$$

$$= 2^n - 2, \quad (k = n-1) \quad (11)$$

$$= 2^n - 1, \quad (k = n). \quad (12)$$

The second example is a circuit where feedback connections are from the  $n^{th}$  to the  $j^{th}$  multivibrators. Thus, again by (1),

$$C = 2^n - \sum_{j=1}^{n-1} 2^{j-1} \delta_j^n \quad (13)$$

$$= 2^{n-1} + 1, \quad (j = 1, 2, 3, \dots, n-1) \quad (14)$$

$$= 2^{n-1} + 2, \quad (j = 2, 3, 4, \dots, n-1) \quad (15)$$

$$= 2^{n-1} + 3, \quad (j = 1, 3, 4, \dots, n-1) \quad (16)$$

$$= 2^{n-1} + 4, \quad (j = 3, 4, 5, \dots, n-1) \quad (17)$$

$$\vdots \quad \vdots$$

$$= 2^n - 4, \quad (j = 3) \quad (18)$$

$$= 2^n - 3, \quad (j = 1, 2) \quad (19)$$

$$= 2^n - 2, \quad (j = 2) \quad (20)$$

$$= 2^n - 1, \quad (j = 1). \quad (21)$$

To prevent interaction it is, of course, necessary to provide isolation in the case of multiple feedback connections.

\* Decimal classification: 621.375.2. Original manuscript received by the Institute, July 22, 1948; abstract received, February 16, 1949. The solutions disclosed by the author in this paper were developed and completed by him in the course of his employment by the Radio Corporation of America, RCA Victor Division, Camden, N. J.  
† Nepa Division, Fairchild Engine and Airplane Corporation, Oak Ridge, Tenn.  
<sup>1</sup> I. E. Grosdoff, "Electronic counters," RCA Rev., vol. 7, pp. 438-448; September, 1946.

# Carrier Current Pulsing over Toll Telephone Circuits\*

IMRE MOLNAR†, SENIOR MEMBER, IRE

**Summary**—Recently developed multichannel carrier telephone systems, where calls are extended through automatic switching equipment, are described, together with performance data and application in commercial telephone service. Connections are established and dial pulses extended, utilizing the carriers associated with the various voice transmission channels.

## INTRODUCTION

**N**O MATTER what medium is used to transmit intelligence between two points—whether it consists of writing a letter, sending a telegram, or making a telephone call—two fundamental objectives are common to all such methods. One is that the “addressee” of the message must be sought out and reached; the other is that the message itself must be intelligibly transmitted.

In line with this dual aim, communication engineering concerns itself with two distinct kinds of techniques. There are, first, the techniques by which the path to the “addressee” is selected and made ready to receive the message; second, there are the techniques by which the message is transmitted over that path. In the following discussion we are concerned only with the former techniques, and specifically with their application to carrier telephone channels.

Generally speaking, a telephone connection can be established by the intermediary of one or more operators, by the substitution of remotely controlled switching equipment for the operators, or by a combination of the two methods. Since telephone connections now extend over unlimited distances and increasingly complex routes, the individual path chosen can no longer be identified. Accordingly, universal operating procedures are necessary; the same standard procedure must apply in all cases, irrespective of the transmission medium—open wire, cable, carrier, or radio—which is employed.

Because of their advantages in line plant economy and in quality of transmission, carrier systems today form the backbone of the nation’s long-distance telephone network, as well as of a large number of systems used by service organizations such as railroads, power utilities, and pipelines. Consequently, the problem of signaling through, and switching of, carrier circuits is of the greatest importance.

## PULSING METHODS IN TOLL OPERATION

Whenever connections are established by automatic switching equipment, there exists the problem of trans-

mitting certain signals over whatever type of circuit is employed. Although it is often believed that all conditions for automatic operation are fulfilled simply by assuring that pulses can be satisfactorily transmitted, it is in addition necessary at times to transmit a large number of signals in one direction or the other. There are a number of satisfactory toll dialing systems in operation, although this paper will mention only two of them.

The first method is called “voice-frequency signaling,” because the signals used consist of short applications of voice-frequency current to the voice-frequency terminals of the talking channel. In a telephone circuit, because a speech path exists from one end to the other, a signal path is provided automatically as long as voice frequencies are used for signaling. And, since speech transmission is maintained at a satisfactory level and quality over unlimited circuit lengths, a satisfactory signal level and quality is automatically maintained without additional provisions. The various signals are distinguished from one another by their sequence, direction of transmission, frequency, timing, and modulation.

Although its theory is sound and attractive, voice-frequency pulsing possesses inherent difficulties which make it about the most intricate problem in the whole art of automatic control. While most of these difficulties may be eliminated by proper circuit design, every such step results in a considerable increase in cost.

Voice-frequency pulsing is useful on long and complex circuits, which include one or more carrier links (not necessarily of the same system), and which are operated from end to end on a voice-frequency signaling basis. In many instances, however, inexpensive carrier systems are installed because of their economy on relatively short-haul toll lines. Since a properly designed terminal for voice-frequency signaling is quite costly, its use may defeat the economy of carrier installation on such circuits. Although voice-frequency dialing is widely and effectively used over all types of circuits, a much simpler, less costly, and even more efficient system for carrier operation has been developed jointly by Automatic Electric Company and Lenkurt Electric Company.

The second system of long-distance pulsing employs direct current exclusively. There are several types in operation, probably the most useful of which is known as “composite” pulsing. With suitable networks of chokes and capacitors it is possible to send dc signals independently over each wire of a pair, without mutual interference with speech simultaneously present on the same pair. It is possible, furthermore, to arrange these composite circuits for duplex operation, that is, for signaling simultaneously in both directions over the

\* Decimal classification: 621.385. Original manuscript received by the Institute, April 7, 1947; revised manuscript received, October 27, 1948. Presented, 1947 IRE National Convention, New York, N. Y., March 3, 1947.

† Automatic Electric Co., Chicago, Ill.

same conductor. In spite of its excellent performance, however, composite pulsing also has its limitations. One is that dc signals must have a dc path, which is seldom available in carrier operation, and never on radio circuits. Furthermore, a three-channel carrier system provides four speech circuits (including the physical one) over one pair of wires, while the maximum in dc operation is two duplex composite signaling channels on the pair, leaving two speech channels without means for signaling.

From the standpoint of circuit technique, nothing could be simpler and more straightforward than dc signaling. Practically all signals for toll or straight automatic operation can be provided by the application and removal of a dc potential. This becomes particularly simple if a reliable duplex system or separate signaling channels are available for either direction. With a few exceptions the signals are independent of any timing or sequence, and the marginal conditions are even less stringent than in ordinary local operation. This makes it apparent that the most suitable pulsing method in carrier operation is one which duplicates dc signaling by means which permits the passage of signals through carrier circuits. For instance, two independent frequencies, one for each direction within the transmission band of the system, can be applied, exactly as the dc operation. If the signal frequencies are located within the transmission band of the carrier system, but outside of the intelligence sidebands, they will travel the whole distance together with speech transmission without being subjected to mutual interference in the final demodulation process. The boundary conditions are particularly simple; there is a 1:1 correspondence of direct to alternating current at the sending terminal, and back again at the receiver.

There are several ways to provide such a circuit. If there is a surplus frequency band beyond what is needed for the speech channels, it can be divided into a number of narrow bands, with two of these assigned to each channel for signaling in either direction. While this is a practical method and is used to some extent, it is also wasteful, because the signaling channels extend the total bandwidth upwards, and the surplus frequency spectrum could be more usefully employed for additional speech channels.

A far more efficient method is to exploit the channel carrier frequency for signaling purposes, since it is suppressed in single-sideband operation, as far as voice transmission is concerned. In the system frequency spectrum there is a separation between sidebands comprising adjacent channels varying between 600 and 1300 cps, and also a 250-cps separation between each sideband and its associated carrier. This space can now be utilized for signal transmission. The signal channels thus take advantage of the frequency bands which would otherwise be wasted, and make use of the existing carrier frequency supply instead of separate signal frequency oscillators.

### ESTABLISHING A TOLL CONNECTION OVER CARRIER CIRCUITS

As a typical example, let us consider a connection between a manually operated toll center and a distant automatic network.

Fig. 1 shows a schematic layout of a carrier toll connection. The carrier terminal (left) is connected to the toll board jacks through a special manual-to-automatic trunk circuit. The interconnection between the trunk circuit and the carrier terminal apparatus consists of a

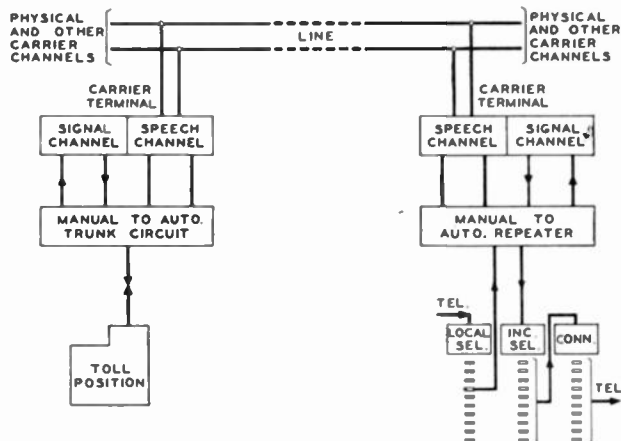

Fig. 1—Signaling system schematic diagram

pair of talking conductors and two signaling leads—one for each direction. A Strowger Automatic telephone exchange (right) is tied to the carrier system by a manual-to-automatic two-way repeater through a like number of conductors. A block diagram of the carrier signaling channel, and curves showing its transmission performance, appear in Fig. 2.

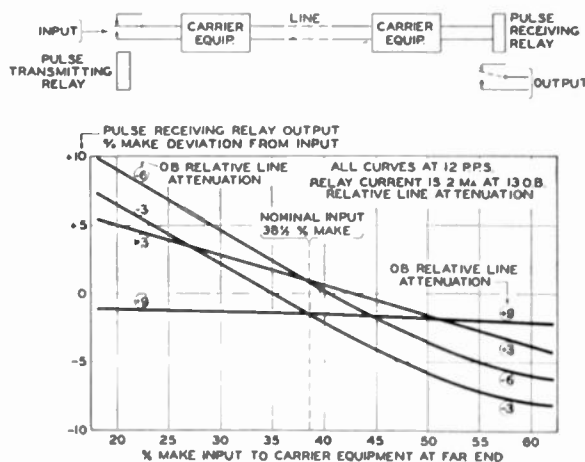

Fig. 2—Pulsing characteristics.

To reach a subscriber at the automatic exchange, the toll operator first inserts a plug into the jack of an idle carrier channel, placing a dc potential on the signaling lead in the direction of the automatic exchange. This



causes the carrier frequency signal to be transmitted. At the receiving end the carrier frequency signal is selected, amplified and detected, which establishes a dc circuit to the manual-to-automatic repeater, ready for seizure of the automatic equipment.

The operator now sends several series of dial pulses corresponding to the requested number. These pulses, consisting of interruptions of the steady potential, are set at an approximately rate of 10 per second, one interruption occupying  $61\frac{1}{2}$  per cent of each pulse cycle. In the automatic exchange these pulses, after being reconverted into direct current, alternately energize and de-energize ratchet-driven devices (switches) which extend the circuit step by step to a set of contacts to which the called subscriber's telephone line is connected.

The line is now tested. If it is free, it is automatically signaled by ringing current; if it is engaged, the operator receives a busy signal. When the called subscriber answers, a dc potential is placed on the signaling lead in the direction of the toll board. Upon receipt and detection it causes the carrier-frequency signal to be transmitted, which extinguishes the called-end supervisory lamp in the cord circuit. When the called subscriber hangs up, this dc potential is removed and the supervisory lamp again glows. If the operator's local subscriber has disconnected in the meantime, the operator removes the plug, thereby removing the potential from the signaling lead. The corresponding potential at the automatic terminal also disappears, and all switches there return to their normal position.

When a call originates at the automatic exchange, the calling subscriber dials the number of the distant toll board. The switches in the local office operate under the subscriber's control and automatically seize an idle carrier circuit through its manual-to-automatic repeater. The same dc potential as before is placed on the signal lead, and carrier-frequency current is transmitted. After being selected, amplified, and detected, the carrier signals appear as dc signals, and the line lamp associated with the carrier trunk glows at the toll switchboard. An operator plugs in, extinguishing the line lamp, and places a dc potential on the signal lead towards the automatic exchange. After receiving the number request, the operator completes the connection locally.

When the calling subscriber hangs up, the signaling potential is removed, and the calling-end supervisory lamp in the cord circuit glows. When the operator removes the plug from the carrier-circuit jack, the potential towards the automatic exchange is removed, and the toll circuit is again available for a new call in either direction. Whether the local equipment in the automatic exchange is held operated during the period between the calling subscriber's disconnect and the operator's taking down of the connection, or is released as soon as the calling subscriber hangs up, is optional; each practice has points in its favor. These are typical procedures for the simplest connections.

### THREE-CHANNEL CARRIER SYSTEM

Fig. 3 is a schematic diagram of the Lenkurt type 32 three-channel carrier telephone system, which is widely used in automatic toll operation. The meeting point between the carrier equipment and the individual local voice-frequency physical circuits is the hybrid network. The transmitting branch of the four-wire circuit consists of the transmitting low-pass filter for attenuating the voice frequencies above the desired pass band, the modulator, the output filter for passing the selected sideband only, and the transmitting amplifier. The receiving branch includes the demodulator, the receiving low-pass filter and the receiving amplifier.

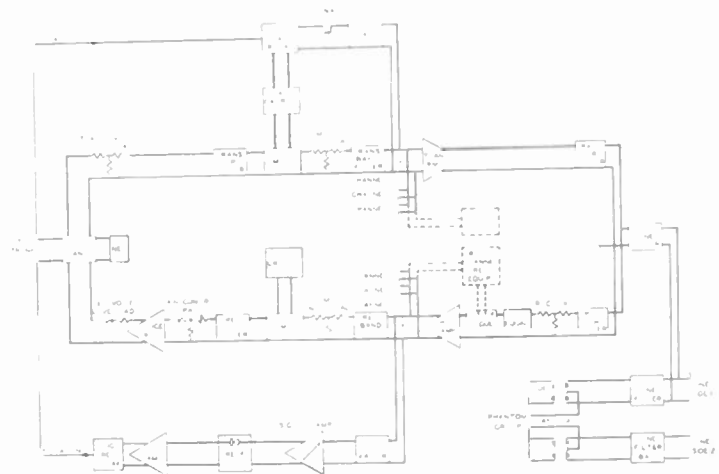
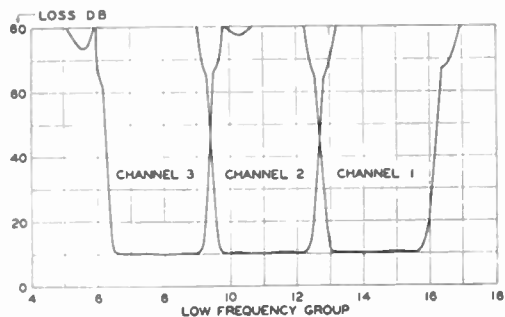

Fig. 3—Carrier terminal schematic diagram.

Disregarding for the time being the associated signaling equipment, the three transmitting branches are grouped together through their receiving band filters. Each group is amplified by the transmitting and receiving amplifiers, respectively, and further combined by the directional filters. The high-low-pass filter at the toll line entrance segregates the carrier band from the physical circuit.

The line current is a complex mixture of frequencies. It includes the voice-frequency of the physical circuit, the side-bands of the three carrier channels, and the carrier frequencies proper when employed for signaling. About 30 kc is the highest transmitted frequency on a three-channel system. Each repeater section may have up to 43 db line attenuation at 27 kc, and can furnish a 0-db loss circuit between the voice frequency terminals with the usual transmitting input level of 18 db above the transmitting switchboard. This attenuation would limit a repeater section of 114-mil copper wire to a distance of between 125 and 300 miles under adverse weather conditions. However, the distance can be somewhat increased if automatic gain regulating equipment is employed. The transmission range, of course, can be further extended to almost any distance by intermediate carrier repeaters.



(a)

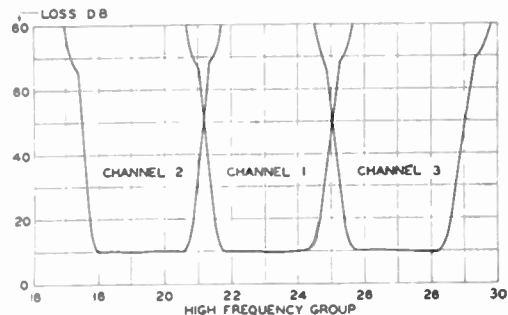

(b)

Fig. 4—Band filter attenuation characteristics.

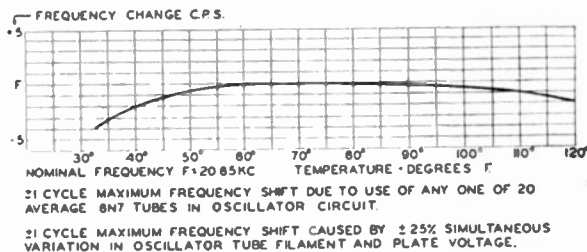

Fig. 6—Oscillator stability characteristics.

terminal. The amount is actually doubled, since there are identical transmitting and receiving pass-band filters at both ends of the circuit. Although there may be a difference of 43 db in the levels of the transmitting and receiving paths, cross talk between them at the same terminal is negligible. Their wide frequency separation and the directional filters between the transmitting and receiving amplifiers also help prevent cross talk. The net result is equivalent to what is known as "near-end cross talk" in physical circuits.

Fig. 5 shows the characteristics of typical signal receiving and transmitting filters. Sharp signal receiving filters are essential for satisfactory pulsing performance, because the selectivity of the signal receivers against the arriving complex frequency mixture depends entirely upon them.

Fig. 6 shows the stability of a typical carrier oscillator over a temperature range of 30 to 120°F. Within this range there may be a variation of  $\pm 1\frac{1}{2}$  cps. If the filament and plate voltages applied to the oscillator tube circuit change simultaneously by 25 per cent, the frequency will not change more than  $\pm 1$  cps. There may be a like amount of random variation upon inserting any one of twenty commercial 6N7 tubes in the oscillator circuit.

CARRIER PULSING CIRCUIT OPERATION

Fig. 7 is a circuit diagram showing one version of a signaling terminal. The dc potential which is placed on the signaling lead at the switching equipment operates the pulse-transmitting relay in the terminal. The contacts of this relay apply the carrier frequency source, through a signal-transmitting pad and the narrow-band signal transmitting filter, to the transmitting circuit common to all speech and signal channels. The carrier frequency signal is interrupted by the pulse-transmitting relay contacts while dial pulses are sent, at the rate and ratio specified below.

At the distant terminal the incoming signaling frequencies enter the signal receiving channel unit through the narrow-band signal receiving filter. This selects the proper signaling frequency for its particular channel out of the complex mixture of several carrier signals and speech sidebands. The signal then passes through a two-stage resistance-coupled amplifier, the output of which is transformer-coupled to a germanium diode. The recti-

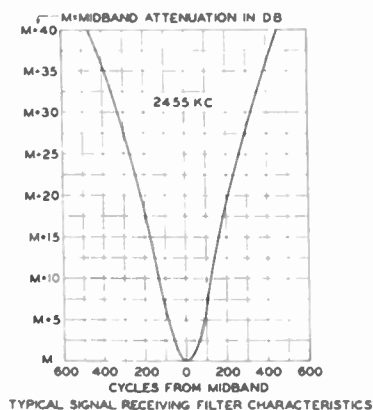

Fig. 5—Signal filter characteristics.

The success of carrier dialing depends entirely on success in reproducing sharp pass-band filters which (1) keep the speech sidebands out of the signal channels; (2) keep the carrier frequency out of the speech channel; and (3) reproduce with little distortion important sidebands of the signal current. In addition, systems having well-defined characteristics also required well-balanced modulators, and stable oscillators for permanent centering of the carrier frequency inside the filter pass band. A 10-cps deviation between modulating and demodulating frequencies is about the limit of tolerance; during system lineup these frequencies can be adjusted to within  $\pm 2$  cps. The components which meet these requirements must be economical to manufacture, since low cost frequently determines the installation of carrier systems.

Fig. 4 shows the characteristics of typical transmitting and receiving band filters. They are substantially flat in the pass band, and in every case the attenuation is better than 60 db between adjacent channels in one

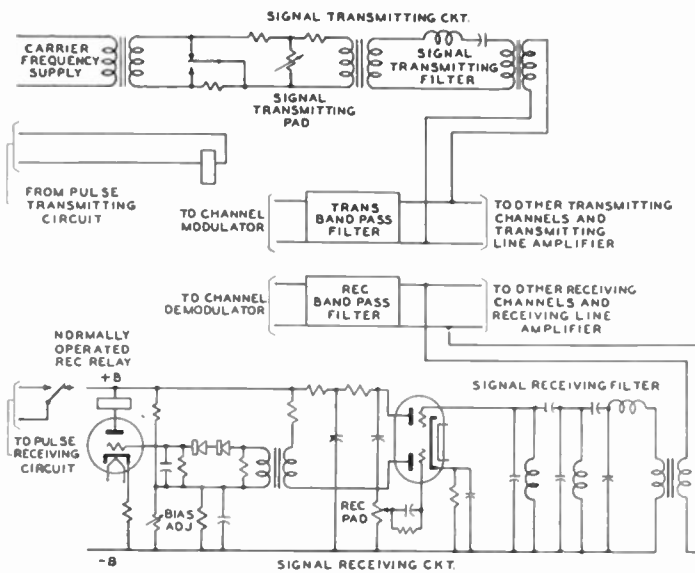

Fig. 7—Signaling circuit diagram.

fied signal voltage is connected to the grid of a relay tube. Since the rectified voltage is negative with respect to the cathode, the plate current of the relay tube is reduced on receipt of carrier signal, causing the normally energized receiving relay to release and to connect a marking potential through its contacts to the signaling lead to the switching equipment. The signal receiving relay follows the interruptions of the carrier signal during dialing, and reproduces these pulses in the form of interrupted direct current over the signal lead and the manual-to-automatic repeater to the switching equipment. The operation of the signal receiver is further discussed in the sections on signaling range and interference.

#### DIALING PERFORMANCE

Specifications for automatic telephone equipment call for a pulsing speed of 8 to 12 pulses per second, and an exchange voltage held within  $\pm 10$  per cent of its nominal value. The limits in the ratio between "on" and "off" periods of the pulse are less explicit; it is customary instead to specify the extreme line conditions which can be tolerated. While the nominal value of the "off" pulse is  $38\frac{1}{2}$  per cent of the cycle, satisfactory performance can generally be obtained between 30 to 50 per cent, and in many cases somewhat beyond this range.

The permissible deviation from the nominal pulse ratio must be apportioned among the several successive stages which are required to build up a complex connection. The local switching plant of a telephone system uses so many units of apparatus that they must be produced in the most economical manner: in other words, the tolerances in their performance should be as wide as feasible. Conversely, since there is only a comparatively small number of toll circuits having access to local equipment, it is sound economy to keep distortion over the toll signaling circuit as low as possible.

A further reason why the pulse tolerances should be apportioned to the local plant as far as feasible is that most of these plants were installed long before toll dialing entered the picture, and thus have already taken up a considerable portion of the permissible pulse distortion.

Carrier toll dialing circuits are subject to distortion from several sources, including (1) pulse-repeating from the outgoing trunk circuit; (2) pulsing conductor between trunk circuit and carrier terminal; (3) pulse-repeating by the pulse-transmitting relay in the carrier equipment; (4) characteristic performance and attenuation of the carrier signaling channel, and interference with it; (5) pulse-repeating by the pulse-receiving relay at the carrier terminal; (6) pulsing conductor between carrier terminal and repeater; and (7) pulse-repeating by the automatic repeater.

The above causes of distortion (except for (3), (4) and (5)) are not confined to carrier systems, they are general problems in the design of relay-type pulse-repeating equipment over certain voltage, lines, and input ranges. With suitable adjustment and circuit design, the distortion can be kept within practically any desired limits. Actually, standard telephone-type relays are used under (1), (3), and (7), with standard adjustments and circuit arrangements. Their performance, therefore, corresponds to that of pulse-repeating circuits over physical lines.

It is obvious that the performance of carrier dialing circuits depends almost entirely on the quality of items (3), (4), and (5). Fig. 2 shows the over-all signal distortion of a carrier circuit as a function of input pulse ratio, for various line attenuations, relative to their nominal value. It is apparent from the diagram that the carrier dialing circuit as a whole has a certain compensating tendency on signals already distorted at the input, pulses which were short are stretched, normal ones are reproduced with negligible distortion, and those which were long at the input are shortened.

#### SIGNALING RANGE

With a given sending power and channel attenuation, the performance of the signaling circuit depends on the sensitivity of the receiver and on the amount of interference. The sending power is specified to be between +2 and +6 dbm, measured at the transmitting amplifier output. The signal is amplified by the receiving amplifier to about the same level. This level is considered throughout the paper as the normal operating level of the signal receiver, and the system is adjusted to this level during its initial lineup. Subsequently, there will be some variation from this normal operating level due to changes of line attenuation. Although these variations can be offset by manual or automatic gain regulators, the usefulness of the signaling system is greatly enhanced if the signal receiver responds reliably over a fairly broad range of signal levels. On a 200-mile circuit without intermediate repeater, for example, the signal

receiver should perform satisfactorily between a 4-db reduction and an 8-db increase from normal line attenuation.

With reference again to the signal receiver, Fig. 8 shows the amount of plate current of the relay tube

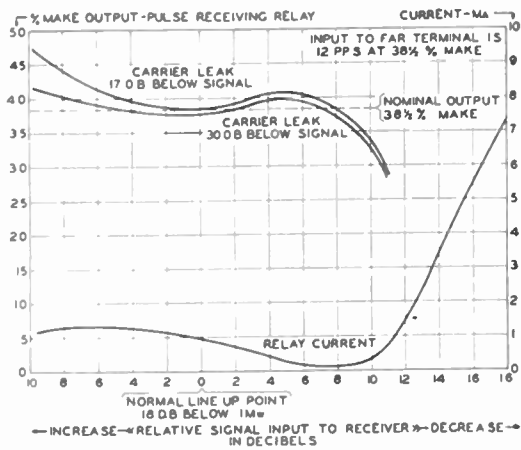

Fig. 8—Signal receiver characteristics.

over the signal input range to the receiver—0 being the normal operating level, as defined above. When a certain channel is not in use, the corresponding carrier is absent, and the relay tube is biased to about  $-4$  volts, passing 13 ma plate current through the pulse receiving relay, which is thus held operated. When the toll circuit is seized, the received carrier signal, upon being amplified and rectified, increases the bias and reduces the plate current to a value insufficient to hold the relay, which therefore restores. Plate current cutoff is at about  $-8$  volts.

During pulsing the carrier is alternately interrupted and reintroduced. Plate current flows and is shut off, while the receiving relay operates and releases accordingly. While carrier signal is received, dc potential is extended through the back contact of the released pulse receiving relay to the automatic equipment. Conversely, during interruptions of the dial and the carrier, the dc potential is removed by the operated pulse receiving relay. Fig. 8 shows the output from the back contacts of the signal receiving relay, covering the period (nominal value  $38\frac{1}{2}$  per cent) corresponding to the closed condition of the dial. The diagram is prepared for 12 pulses per second with the standard input pulse ratio, and is representative of the over-all performance of the channel, including the signal transmitting relay. The total output pulse ratio variation over a 12-db range is about  $2\frac{1}{2}$  per cent—only a fraction of the distortion that the automatic equipment can tolerate. The 12-db range itself is much wider than that occurring on a day-to-day basis in most practical applications.

The consistent pulsing output over such a wide variation of input level is achieved by a special circuit arrangement of the signal receiving amplifier. The latter is normally operated with current flowing in the grid circuit. However, a variable back-bias voltage, proportional to the input signal level to the receiver, is de-

veloped across a capacitance-resistance combination. The output of this amplifier, therefore, remains substantially steady over a considerable variation in signal input level.

#### INTERFERENCE

The next problem involves investigating possible sources of interference with the signaling channel. The principal ones are: (1) noise induced on the line from external sources; (2) interference caused by the associated or electrically adjacent speech channel; and (3) carrier leak.

External interference is even more detrimental to signaling than to voice transmission. Fortunately, there are several methods available for controlling this interference, such as suitable transposing of wires or, in case of severe power disturbances, shortened repeater sections. If the interference has the same frequency as the signal carrier, its effect is similar to that caused by carrier leak; if it has a frequency some distance away from that of the carrier, the effect is comparable to speech-channel interference.

Should interference cause trouble in signal transmission, there is one remedy which always works: improving the signal-to-noise ratio by raising the signal level. There are, unfortunately, certain objections to this practice. As mentioned before, the signal power is specified at 2 to 6 db above 1 milliwatt. This is considerably lower than the level at which speech is transmitted, the latter being 18 db above the audio input level at the switchboard. Such a comparison may prove misleading. While a 1-milliwatt reference level for speech is generally accepted as a convenience and reflects at least the order of magnitude of the power content of speech, the major portion of a conversation has considerably less power, because the frequencies under 200 to 250 cps with high energy content are effectively eliminated.

Peak values of several decibels above 1 milliwatt are rare, and of comparatively short duration. On the other hand, the signal frequency is present at a constant level during conversation, and it may leak through the band-pass filter of the adjacent channel and demodulate there to a high-frequency tone—between 3,200 and 3,900 cycles, depending on the channel in question.

The signal frequency must therefore be limited to a safe compromise value, lest it cause interference with speech during periods of low energy level. Inspection of the band pass and demodulator low-pass filter characteristics reveals that the residual tone will be from 65 to 90 db below 1 milliwatt, with the specified signal transmitting level and on a 0-net-loss circuit. The value is perfectly satisfactory and barely detectable on a listening test, but it also indicates the limitation in signal power.

The second source of interference comes from the speech channels. Two must be considered: the lower frequencies of the associated voice band and the higher frequencies of the next channel. It will be recalled that

the signal receiving relay is normally energized, and releases upon receipt of carrier frequency. This relay is adjusted to release when the plate current falls below 1.8 ma. The plate current versus signal level curve of Fig. 7 shows that this value is reached when the carrier is 12 db below the nominal setting of the signal receiver, or stronger. This means that the interference must be kept below this value to maintain proper operation.

Fig. 4 shows the attenuation characteristics of a signal-receiving filter. Since frequencies under 300 cycles are substantially attenuated in the audio channel, and those under 200 cps effectively cut off, the signal filter attenuation—18 db at 200 cps, and 28 db at 300 cps off the carrier—is sufficient for reliable operation. There is an even greater margin against interference by the upper frequencies of the adjacent channel.

Interference may also be caused by carrier leak which is the residual carrier frequency which passes from the voice channel modulator, through the transmitting channel band filter, onto the line. Since the carrier leak and the signal current have identical frequencies, the "leak" current will pass through the signal-receiving filter with a minimum of attenuation. If it is sufficiently strong it will cause a false signal to the switching equipment by releasing the signal-receiving relay. Although the carrier frequency is adequately suppressed, as a rule, by the balanced circuit arrangement of the modulator, imperfect balance may nevertheless permit a small amount to be present. This will be further attenuated by the transmitting band pass filter.

As mentioned above, a maximum carrier leak of  $-15$  dbm is specified—in other words, 17 db below signal level. It was also mentioned that the release value of the signal-receiving relay is 1.8 ma, and that (see Fig. 8) no signal less than 12 db below the nominal adjustment of the receiver would bring the relay current under this value. Since the carrier leak is at least 17 db below the normal signaling power, the line attenuation could drop 5 db before false operation occurs. Such a drop in attenuation is hardly permissible, because the associated four-wire-to-two-wire terminations of the voice channels would become unstable. A reduction of channel loss of such magnitude is almost impossible, and is not permitted in practice.

In this connection the efficiency of the automatic bias control in the signal-receiving amplifier can be strikingly demonstrated. Fig. 8 shows that the current through the receiving relay is 1.3 ma when the signal level is 5 db above that for which the nominal adjustment of the receiver was made. The same amount of relay current is also obtained for a signal power 12 db below the nominal adjustment point. Since 1.3 ma is below the value at which the relay holds, it releases.

The significance of this is that with the maximum permissible carrier leak of 17 db under the signal power and the line attenuation reduced to 5 db below its normal value, the receiving relay is in its released position, regardless of whether there is a signal current present or

not. On the other hand, also according to Fig. 8, actual tests indicate that under the same conditions the receiving relay is pulsing satisfactorily with only 2 per cent loss from the standard pulse ratio. The explanation of this apparent contradiction can be found in the time constant of the bias adjustment. The bias is always determined by the combined signal current plus carrier leak level. It is maintained at this point by the time constant of the bias circuit during subsequent short-period interruptions of the signal current, even with the carrier leak still present.

#### APPLICATIONS OF TOLL DIALING SYSTEMS

The link between the carrier terminal and the automatic or toll equipment is a trunk circuit or repeater. Its function is to convert the simple on-and-off conditions of dc potential on the signal "in" and "out" leads into the various conditions required by the associated switching equipment. Conversely, it translates the various signals used in telephone switching into these on-and-off potentials to the carrier terminal.

Four conductors are used between terminal and switching equipment. Two of them are for voice transmission and two for signaling, one in each direction. Terminal and switching equipment may be in the same location or some distance apart, since a conductor resistance of up to 300 ohms is permissible without special provisions.

There are many different types of trunk circuits and repeaters, since there are many different methods of operating telephone systems. All consist, however, of relays, retardation coils, capacitors, and resistors. Some of the circuits are simple, employing only three relays. Others are of varying complexity, depending on how they are used and what they have to do. The toll circuit between an automatic exchange and a toll board, discussed above, is an example.

On an incoming call, the following procedure must take place: seizure of the local equipment, busying of the repeater against attempted outgoing calls, transference of dial pulses from the signal leads to the talking loop, return of supervision to the operator when the called subscriber answers, flashes his switchhook or disconnects, and release of the connection from the distant end. On an outgoing call to toll, on the other hand, this sequence must occur; seizure of the carrier circuit and signaling of the distant operator, return of ring-back tone to the calling subscriber, signaling of the automatic equipment when the operator answers, forwarding of identification to the operator if the call originates from a pay station (a repeat identification on challenge), forwarding of a disconnect signal when the calling subscriber hangs up, and release of the connection when both the operator and the calling subscriber disconnect.

The same general method of operation described above can be applied to many other types of telephone traffic—such as intertoll dialing between remote toll centers, or interconnection of several automatic tele-



phone centers by carrier dialing circuits which permit subscribers to complete connections themselves without the assistance of an operator. The problem of subscriber dialing in toll traffic has become increasingly important, and a simple carrier-dialing system contributes a great deal to its solution.

Public toll dialing, employing the normally suppressed speech carrier as a signaling channel, was first used in commercial traffic by the Interstate Telegraph Company between Bishop and Leavening, Calif. The dialing equipment was designed and manufactured by Automatic Electric Company of Chicago, and the carrier system by Lenkurt Electric Company of San Francisco. Several similar systems have since been placed in service.

A typical example is a Director network of several widely separated Strowger Automatic exchanges in

Venezuela. All calls between offices are completed by the subscribers themselves, without the assistance of an operator. Some of the offices are interconnected by carrier dialing circuits.

In all these applications the carrier equipment and signal terminals are identical, with the trunk circuits and repeaters, custom-made for the purpose, accomplishing the special functions.

Carrier dialing also solves the problem of automatic operation over radio links. Carrier telephone channels are superimposed on the radio carrier, and dialing or signaling is performed through the telephone carrier signaling channel exactly as described for wire communications. The first public use of automatic impulsing over radio links was when the Mutual Telephone Company of Hawaii installed Automatic Electric and Lenkurt equipment for dialing inter-island connections.



## Nomograms for Ionosphere Control Points\*

JAMES C. W. SCOTT†, MEMBER, IRE

*Summary*—Knowing the length of a radio circuit and the latitudes of its terminals, nomograms are given which permit rapid derivation of the latitudes of the ionospheric control points. The use of world charts of maximum usable frequency is thus facilitated.

THE PROVISIONAL FREQUENCY BOARD (PFB) of the International Telecommunications Union now meeting in Geneva, Switzerland, has the difficult problem of preparing a new international radio-frequency list that will satisfy the growing requirements of all countries for space in the radio spectrum. In order to accomplish this task, the spectrum must be utilized with maximum efficiency. The PFB is, therefore, attempting to elaborate rules for the assignment of those frequencies to each circuit which will give optimum results over the whole period of a sunspot cycle for all seasons and all times of the day.

In this undertaking, the measurements of over 60 ionosphere recording stations situated all over the world are being fused to predict the maximum usable frequencies that should be used at any time on a circuit of given length with terminals at given latitudes. From these ionospheric measurements, contour charts of maximum usable frequency are prepared by a number of radio-propagation laboratories such as the Central Radio Propagation Laboratory, Washington, D. C. These charts give the muf as a function of latitude and

local time for a given month and a given period of the cycle of solar activity.

In applying these charts to find the optimum frequencies for a particular circuit, it is necessary to know the latitude of the control points in the ionosphere for the great circle path of propagation between transmitter and receiver. It is the conditions in the ionosphere at the latitude of these control points which determine transmission over the circuit and not the conditions directly over the transmitter and the receiver. Consequently, we must be able to trace out the great circle path of propagation and locate the control points upon it.

It is well known that for paths under 4,000 km, propagation is chiefly by refraction at the midpoint of the path so that conditions at the midpoint control transmission. For such circuits, the midpoint of the path is the control point. For paths longer than 4,000 km, single-hop propagation is impossible because the curvature of the earth cuts off the ray path. For such circuits, propagation is by two or more reflections back and forth between the earth's surface and the ionosphere so that, in effect, transmission is guided between the earth's surface and the ionosphere. Under these conditions, in practice, the effective control points are found to be 2,000 km from each end.

The two following nomograms (Figs. 1 and 2) were developed for use by the PFB to permit rapid derivation of the latitude of circuit control points from the positions of the terminals. It is thought that they may be of value

\* Decimal classification: R082XR115.1. Original manuscript received by the Institute, June 24, 1948; revised manuscript received, September 29, 1948.

† Radio Propagation Laboratory, Ottawa, Ontario, Canada.

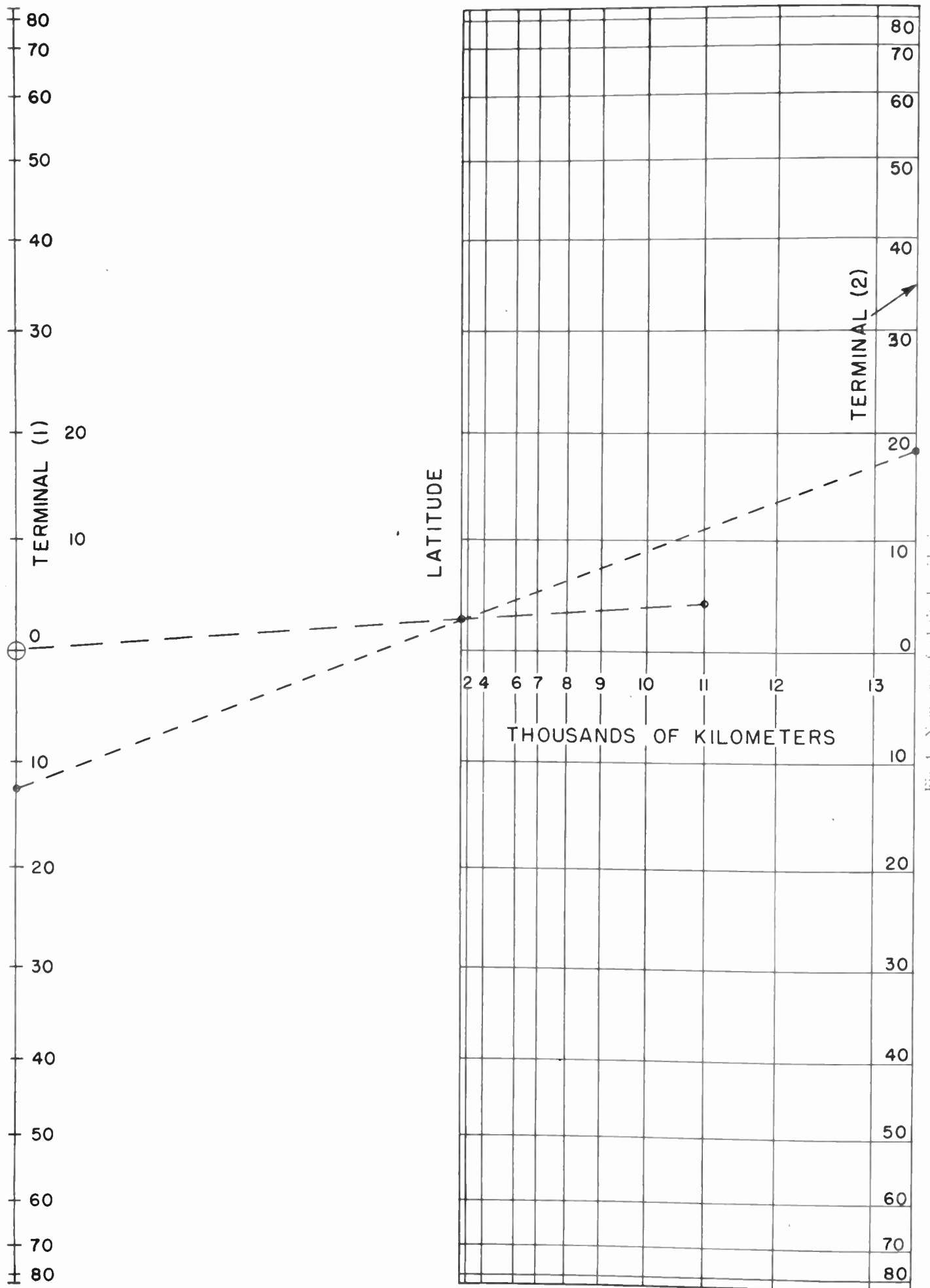

Fig. 1—Nomogram for latitude midpoint.

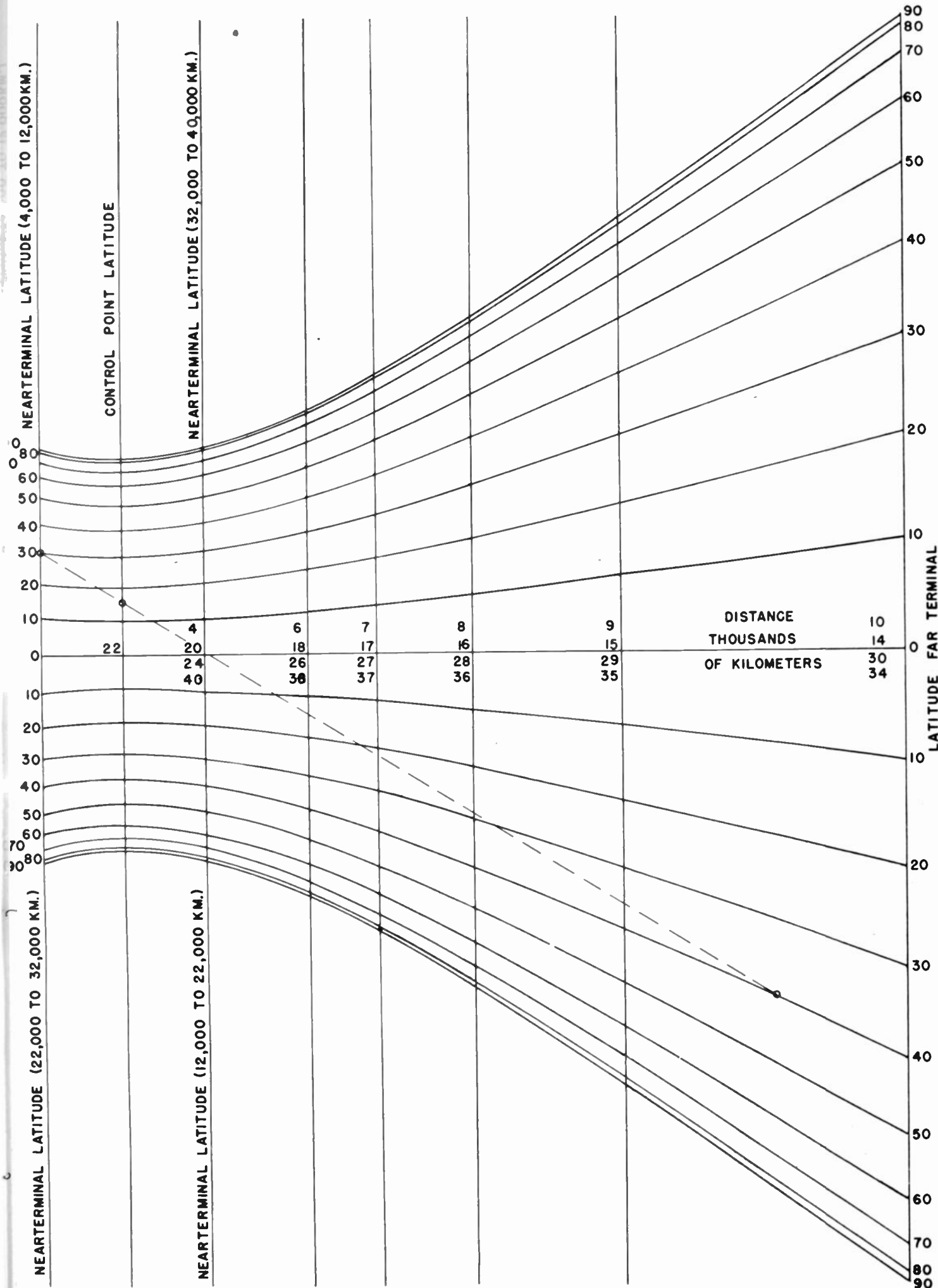

Fig. 2—Nomogram for latitudes of 2,000-km control points.

to other radio engineers concerned with propagation problems.

The construction of nomograms is based on the well-known condition for collinearity:<sup>1</sup>

$$\begin{vmatrix} x_a & y_a & 1 \\ x_b & y_b & 1 \\ x_c & y_c & 1 \end{vmatrix} = 0.$$

In this determinant,  $x_a, y_a; x_b, y_b; x_c, y_c$  are the cartesian co-ordinates of three points  $a, b,$  and  $c$ . Its vanishing is the condition that these three points be on the same straight line. Consequently, if  $a, b,$  and  $c$  are points on three curves determined by three parameters  $u, v,$  and  $w$  so that the determinant may be written

$$\begin{vmatrix} f_1(u) & f_2(u) & 1 \\ f_3(v) & f_4(v) & 1 \\ f_5(w) & f_6(w) & 1 \end{vmatrix} = 0.$$

The vanishing of this determinant insures that corresponding values of  $u, v,$  and  $w$  on the three curves are collinear. Thus, to construct a nomogram for an equation  $f(u, v, w) = 0$ , it is only necessary that this equation can be written in the above determinant form.

The relations of spherical trigonometry give the latitude  $L_K$  of the midpoint of a great circle path in terms of its length  $d$  and the latitudes of its terminals  $L_R$  and  $L_T$ .

$$\sin L_K = \frac{\sin L_R + \sin L_T}{2 \cos d/2}.$$

This equation may be put into the required determinant form to represent a nomogram for  $L_K$  in terms of  $d$  and the sum of  $\sin L_R$  and  $\sin L_T$ .

#### Midpoint Nomogram Equations

$$\begin{vmatrix} 1 & \frac{1}{2}(\sin L_R + \sin L_T) & 1 \\ \sec \frac{d}{2} & \sin L_K & 1 \\ 0 & 0 & 1 \end{vmatrix} = 0.$$

Now, if we also write the identity  $\sin L_R + \sin L_T = (\sin L_R + \sin L_T)$  in the form

$$\begin{vmatrix} 1 & \frac{1}{2}(\sin L_R + \sin L_T) & 1 \\ 2 & \sin L_R & 1 \\ 0 & \sin L_T & 1 \end{vmatrix} = 0$$

we obtain a combined nomogram for  $L_K$  in terms of  $d, L_R,$  and  $L_T$ . This is the nomogram drawn for the midpoint latitude.

Its use is illustrated by the example. If the path is shorter than 2,000 km it is necessary only to draw a

line from the transmitter latitude on the left-hand scale to the receiver latitude on the right-hand scale, and then read the midpoint latitude off the middle, zero-range, scale. If the circuit is longer, a second line must be drawn through the point just found and through zero on the left-hand scale. This line will intersect the required midpoint latitude at the distance ordinate corresponding to the path length.

Further considerations of spherical trigonometry lead to the following equation for the latitude of the control point 2,000 km from one end of the path.

$$\frac{\sin L_T}{\sin 18^\circ} + \frac{\sin L_R}{\sin (d - 18^\circ)} = \sin L_{KT}(\cot 18^\circ + \cot (d - 18^\circ)).$$

Here  $L_{KT}$  is the latitude of the control point 2,000 km from the transmitter and  $18^\circ$  is the angular distance equal to 2,000 km on the earth.

This equation may be transformed into the following equivalent determinant form which defines the nomogram drawn for the 2,000-km control points.

#### 2,000-km Control-Point Nomogram

$$\begin{vmatrix} \frac{\sin L_T}{\cos 18^\circ} & -\tan 18^\circ & 1 \\ \sin L_{KT} & 0 & 1 \\ \frac{\sin L_R}{\cos (d - 18^\circ)} & \tan (d - 18^\circ) & 1 \end{vmatrix} = 0.$$

The use of this nomogram is as follows:

The latitude of the terminal nearest the control point is read off the ordinate to the left or right of the control-point ordinate for the ranges as marked. However, when the range is marked below the equatorial line, it is necessary to change the sign of the far terminal latitude. Thus for ranges between 12,000 and 32,000 km, if the far terminal is in the northern hemisphere, the equivalent southern latitude must be used in the nomogram and vice versa. The example gives a control-point latitude of  $16^\circ$  north when the near terminal is at  $30^\circ$  north. The circuit is either 29,600 km long with the far terminal at  $40^\circ$  north or is 9,600 km long with the far terminal at  $40^\circ$  south.

It is interesting to note that, for the critical ranges of 12,000 or 32,000 km, which on the chart are at an infinite distance to the right, the nomogram can be used quite easily by remembering that parallel lines meet at infinity. In this case, it is merely necessary to line up the latitude of the near terminal, at the proper ordinate, with the straight edge parallel at the extreme right to the curve corresponding to the far terminal latitude.

Since these nomograms together give the latitudes of the midpoint and of the control points 2,000 km from each end, propagation conditions along the path which depend on latitude can be quickly determined.

<sup>1</sup> S. Brodetsky, "First Course in Nomography," G. Bell and Sons, London, England; 1925.

# Experimental Determination of the Distribution of Current and Charge along Cylindrical Antennas\*

GIORGIO BARZILAI†

**Summary**—This paper describes an experimental arrangement to determine the distributions of current and density of charge along cylindrical antennas.

Using a wavelength of 1.90 meters, the distributions are determined for center-fed straight cylindrical antennas of a diameter of 29 mm, and lengths of  $1.25\lambda$ ,  $1.00\lambda$ ,  $0.50\lambda$ . For the first two cases, the measurements are repeated when a center self-tuned parasitic antenna, of the same length and diameter as the driven antenna, is situated at a distance of  $0.30\lambda$  and  $0.15\lambda$ . The distributions are determined also on the parasite.

To test the accuracy of the measurements and to relate the relative values of the current with the relative values of the density of charge, the distributions are determined on a coaxial line, having the inner conductor of the same diameter as the antenna under experiment, and fed at the same frequency as the antenna.

A few comparisons with theoretical results are made.

## INTRODUCTION

THE PROBLEM of determining the distribution of current along an antenna is of the utmost importance, since the knowledge of this distribution allows the input impedance, and the spatial distribution of the radiated field, to be calculated. The hypothesis of the sinusoidal current distribution is acceptable when the antenna is very thin and short (not much longer than  $\lambda/2$  for center-fed antennas), but for thick and long antennas, such as those used in microwave technique, this hypothesis leads to results that very often are not even a rough approximation.

In recent years, the theoretical determination of the distribution of current along an antenna has been studied by many authors,<sup>1-5</sup> and very interesting results have been obtained. However, the numerical calculations are invariably difficult and laborious even in the simplest cases. The majority of the investigations on this subject are theoretical and few are experimental, and the experimental results usually refer to the input impedance.

This paper describes an experimental arrangement to determine the distributions of the moduli of current and density of charge along thick cylindrical antennas. The distributions determined are relative, but it is possible,

\* Decimal classification: R221×R326.611. Original manuscript received by the Institute, August 30, 1948; revised manuscript received, November 29, 1948.

† Compagnia Generale Elettrotecnica, Electronics Park, Syracuse, N. Y.

<sup>1</sup> S. A. Schelkunoff, "Theory of antennas of arbitrary size and shape," Proc. I.R.E., vol. 21, pp. 493-521; September, 1941.

<sup>2</sup> C. J. Boukamp, "Hallen's theory for a straight perfectly conducting wire," Physics, vol. 9, p. 609; July, 1912.

<sup>3</sup> R. King and C. W. Harrison, "The distribution of current along a symmetrical center driven antenna," Proc. I.R.E., vol. 31, pp. 548-567; October, 1943.

<sup>4</sup> Marion C. Gray, "A modification of Hallen's solution of antenna problem," Jour. Appl. Phys., vol. 15, pp. 61-65; January, 1944.

<sup>5</sup> R. King and D. Middleton, "The cylindrical antenna," Quart. Appl. Math., vol. 3, pp. 302-335; January, 1946.

by measurements on a coaxial line, to refer both distributions to only one reference value of current or charge so that, once this reference value is supposed to be known, from the relative distributions, the absolute distributions can be obtained. In this way, using the equation of continuity, it is possible to calculate the phase of the current and the phase of the density of charge at every point of the antenna. It will be noted, however, that, since the equation of continuity is a differential relation and graphical procedure must be used, great accuracy cannot be expected in the estimates of the phases.

Some experimental results, relating to a wavelength of 1.90 meters, were recorded in diagrams. They refer to center-fed straight cylindrical antennas of a diameter of 29 mm, and lengths of  $1.25\lambda$ ,  $1.00\lambda$ , and  $0.50\lambda$ . It was considered of interest to carry out measurements on antennas with a parasitic element. The experiments with the parasitic antenna were carried out with a center self-tuned parasite of the same length and diameter as the driven antenna, situated at distances of  $0.30\lambda$  and  $0.15\lambda$ . The distributions of current and charge were determined also on the parasite.

## THE EXPERIMENTAL EQUIPMENT

Consider Fig. 1, a hollow cylindrical conductor maintained in a state of forced electrical oscillation of a very high frequency. Suppose this conductor to be longitudinally slotted, and a small loop or probe to be situated as indicated in Figs. 1(a) and 1(b). If the projections  $\Delta r$  and  $\Delta' r$  of the loop and probe above the metallic surface are sufficiently small, it can be assumed that the emf induced on the loop is essentially due to the magnetic field  $\mathbf{H}$  associated with the conductive current  $\mathbf{I}$ , while the emf induced on the linear probe is due to the electric field  $\mathbf{E}$  arising out of surface charge  $\rho$ . We can, therefore, write

$$\mathbf{I} = K_{AB} \cdot \mathbf{V}_{AB} \quad (1)$$

$$\rho = K_{A'B'} \cdot \mathbf{V}_{A'B'} \quad (2)$$

where

$\mathbf{I}$  = the conductive current, in amperes,

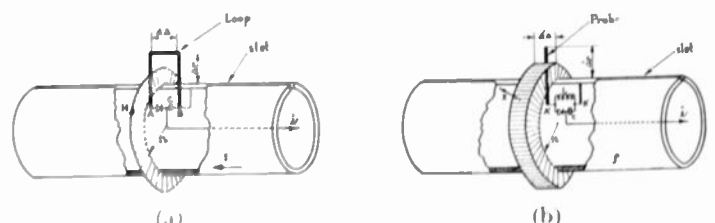

Fig. 1—Sketch to explain the method used to determine the distributions of current and density of charge along the antenna.



flowing through that section of the conductor on which the center of the loop is situated ( $\Delta a \ll \lambda$ )

$\rho$  = the linear density of charge, in coulombs per meter, at that section of the conductor on which the probe is situated ( $\rho \Delta' a$  = total charge existing on that portion of conductor of length  $\Delta' a \ll \lambda$ )

$V_{AB}$  and  $V_{A'B'}$  = the voltages measured across the terminals  $A-B$  and  $A'-B'$

$K_{AB}$  and  $K_{A'B'}$  = two constants independent of the position of the loop or probe along the conductor.

Measurements of the phases of  $V_{AB}$  and  $V_{A'B'}$  are possible but difficult, and the equipment was designed to measure only the moduli of those voltages. For this purpose a small crystal, of the type used in microwave receivers, was used. The rectifiers circuits for the loop and probe are shown in Fig. 1(a) and Fig. 1(b).

The practical realization of the system sketched in Fig. 1 is shown in Fig. 2, where the slotted conductor, the carrier which slides inside the conductor and contains the rectifier crystal, capacitor  $C$ , and choke  $L$ , the loop that can be inserted in the carrier instead of the probe, and the flat end of the antenna removed, are clearly visible. It was assumed  $\Delta a = \Delta r = \Delta' r = 1$  cm.

The whole experimental arrangement is sketched in Fig. 3. The oscillator 10, employing a push-pull of 4,304 Ca/F (834), feeds the driven antenna 0 through the line 8. The stub 7 is a matching device. The wire, carrying the rectified current  $i$ , runs inside one of the brass tubes of the lines 8 and 9, and it is connected at the reflection galvanometer 4, situated inside the screened box 3. The purpose of line 9 is to remove the operator to a reasonable distance from the antennas. Line 9 is short-circuited at the end and its length is  $7/4\lambda$ .

The parasitic antenna 1 is slotted in the same way as the driven antenna, so that the distributions can also be

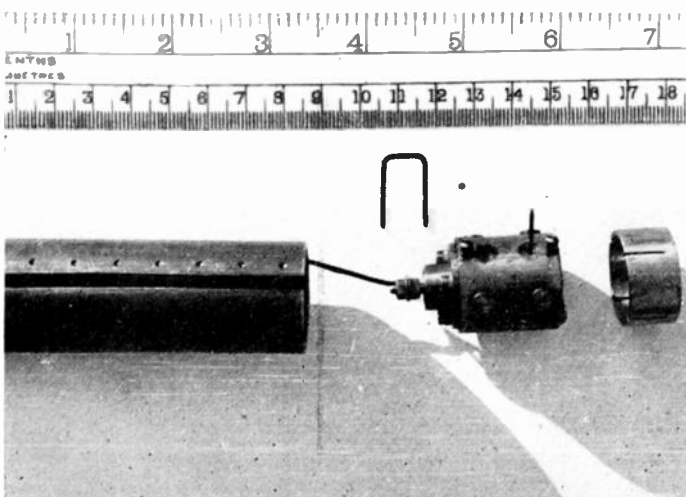

Fig. 2—View of the practical layout of the system used to measure the distributions of current and charge.

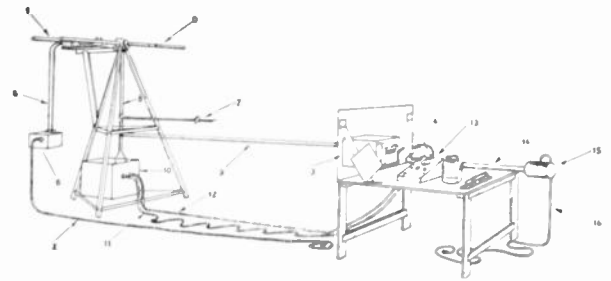

Fig. 3—Perspective sketch of the whole experimental arrangement.

determined on the parasite, using the same carrier used for the driven antenna. The wire, carrying the current  $i$ , runs inside one of the tubes of line 5 and it is connected to an insulated socket on the screened box 6. The screened cable 2 is plugged into the above said socket and the other end can be connected to the galvanometer 4, when the measurement on the parasite is carried out. To tune the parasitic antenna, after it was removed at a distance of about 2 wavelengths from the driven antenna, a short-circuit bridge on line 5, and the indication of the galvanometer 4, were used.

The oscillator 10 also feeds, through the coaxial cables 11 and 12 (polyethylene cables), the coaxial line 14, air insulated and short-circuited at the end. Line 14 has a length of about 1.60 meters, the inner conductor has the same diameter as the antennas and it is slotted in the same way, so that the same carrier used for the antennas can be employed, and the internal diameter of its outer conductor is 68 mm. The vacuum-tube voltmeter 13 (General Radio 726 A) indicates the input voltage of line 14. The screened box 15 and the cable 16 have the same purpose as 6 and 2.

By inspection of Fig. 3, it is clear that all the wires carrying the rectified current  $i$  are screened.

In the operation of the equipment,  $I$  and  $\rho$  are the absolute values of the moduli of current and linear density of charge, and  $I_r$  and  $\rho_r$  are the relative values of current and linear density of charge, referred to the reference values  $I_{ref}$  and  $\rho_{ref}$  ( $I_r = I/I_{ref}$  and  $\rho_r = \rho/\rho_{ref}$ ). When particular reference is made to the values relating to the coaxial line, to the driven antenna, or to the parasite, we shall add the indexes  $l, 0$  and  $1$ , respectively to those symbols. For instance, we shall indicate with  $I_{1r}$ , the relative value of the current on the parasite.

To determine the relative distributions of current and charge, the current  $i$  was always reset to a certain value  $i_0$ , by varying the output of the oscillator. The output of the oscillator was controlled by varying the plate voltage. Tests, which will be reported later, were made to check that the variations of the plate voltage of the oscillator did not affect the measurements appreciably.

By using the above procedure, the quantity under measurement is inversely proportional to the voltage indicated by the vacuum-tube voltmeter 13 and, therefore, we can write

$$I = K_l \frac{1}{V_l} \quad (3)$$

$$\rho = K_\rho \frac{1}{V_\rho} \quad (4)$$

where  $K_I$  and  $K_\rho$  are two constants, independent from the position of the carrier along the conductor and  $V_I$  and  $V_\rho$  are the voltages indicated by the vacuum-tube voltmeter 13, when the current  $i$  is set at the value  $i_c$ . In the following, we shall indicate the voltages appearing in (3) and (4) by a capital  $V$  having the quantity to which that voltage refers for index.

Now, it is possible to show how to refer both distributions of current and charge to only one reference value of current or charge. For the coaxial line 14, the following relation holds

$$\frac{E_{l \max}}{H_{l \max}} = 377\Omega \quad (5)$$

where  $E_{l \max}$  and  $H_{l \max}$  are the moduli of the maximum electric and magnetic field at the surface of the inner conductor of the coaxial line. Now, if we indicate with  $I_{l \max}$  and  $\rho_{l \max}$  the maximum current and density of charge on the coaxial line, we can write:

$$\frac{K_\rho}{K_I} = \epsilon_0 377 \frac{V_{\rho l \max}}{V_{I l \max}} \quad (6)$$

where  $\epsilon_0 = 8.85 \cdot 10^{-12}$  F/m.

We can also write the following relations, which hold irrespectively if they refer to the coaxial line, to the driven antenna, or to the parasite

$$\rho = \frac{K_\rho}{K_I} \frac{V_{I \text{ref}}}{V_{\rho \text{ref}}} I_{\text{ref}} \rho_r \quad (7)$$

$$I = \frac{K_I}{K_\rho} \frac{V_{\rho \text{ref}}}{V_{I \text{ref}}} \rho_{\text{ref}} I_r \quad (8)$$

From (7) and (8) it can be seen that, once the ratio  $K_\rho/K_I$  has been determined from (6), through measurements on the coaxial line, both distributions  $\rho_r$  and  $I_r$  can be referred to a unique reference value  $I_{\text{ref}}$  or  $\rho_{\text{ref}}$ . If, for instance, we suppose  $I_{\text{ref}}$  to be known, from (7) we can obtain the absolute distribution of charge.

#### EXPERIMENTAL RESULTS

The measurements were made indoors. The antennas were situated at a height of about one wavelength (2 metres) from the floor, and all the reflecting obstacles were removed within a radius of about 2 wavelengths. Tests were made to insure that all the wires, carrying the rectified current  $i$ , were completely screened. To do that it was only necessary to remove the loop or the probe and to observe if any indication was recorded by the galvanometer when the system was excited. No appreciable indications were observed in those conditions. People walking around the antennas, even at a considerable distance, produced variations on the indications of the galvanometer. In order to appreciate the order of magnitude, these spurious effects and also the effect of the

floor, a half-wavelength tuned antenna was placed in different positions, at a distance of about 2 wavelengths. Absolute variations of the order of 2 per cent were observed in the absolute values of current and charge, but the relative distributions were not appreciably affected.

A first set of measurements was carried out on the coaxial line, both to test the accuracy of the measurements and to determine the ratio  $K_\rho/K_I$  from (6). From these measurements, it can be concluded that the approximation that can be expected is satisfactory, as the experimental curves were quite near to the theoretical sinusoidal ones, and the errors did not exceed a few per cent of the maxima values. The chief source of errors was probably the harmonics of the oscillator. The minimum current was about 4 per cent of the maximum value instead of zero, while the minimum value of the density of charge was practically zero. This indicates presence of harmonics. The wavelength on the coaxial line was 1.90 meters for any one of the plate voltages used, and difference of 2 or 3 mm could be appreciated. The curves of current and charge were somewhat displaced with respect to one another. Differences of about  $2^\circ$ , with respect to the theoretical value of  $90^\circ$ , were found.

For

$$i_c = 30\mu \text{ amp}$$

$$V_{I \max} = 7.9 \text{ volts}, \quad V_{\rho \max} = 9 \text{ volts}$$

and, therefore, from (6)

$$\frac{K_\rho}{K_I} \approx 3.8 \cdot 10^{-9} \text{ seconds per meter.}$$

The ratio  $K_\rho/K_I$  was measured several times and under different conditions of operation of the oscillator, and no appreciable differences were found.

Both arms of the antenna and parasite were slotted in the same way, so that it was possible to test whether or not the system was balanced. This test was made before starting the measurements and, when necessary, the system was readjusted.

The results obtained with antennas of a half length  $l = 0.625\lambda$  ( $l \approx 1.19$  meters) are recorded in Fig. 4.  $I_{0 \text{ref}}$  is the maximum value of the current on the driven antenna and  $\rho_{0 \text{ref}}$  is the value of the linear density of charge at  $x = 1.15$  meters ( $x = 0$  at the center of the antenna). The values recorded in Fig. 4(a) refer to the antenna without the parasitic element, and two sets of measurements, corresponding to two different values of the current  $i_c$ , were recorded. The black circles refer to  $i_c = 30\mu$  amp, except for those points for which it was impossible to reach that value of  $i_c$ . In these cases, the current  $i_c$  was set at a value lower than  $30\mu$  amp, and the calibration curve of the rectifying system used. The white circles refer to  $i_c = 3\mu$  amp. Small differences, of about 1 to 2 per cent, were found between the two sets of measurements, despite the very different conditions of operation of the oscillator. For instance, for the set cor-

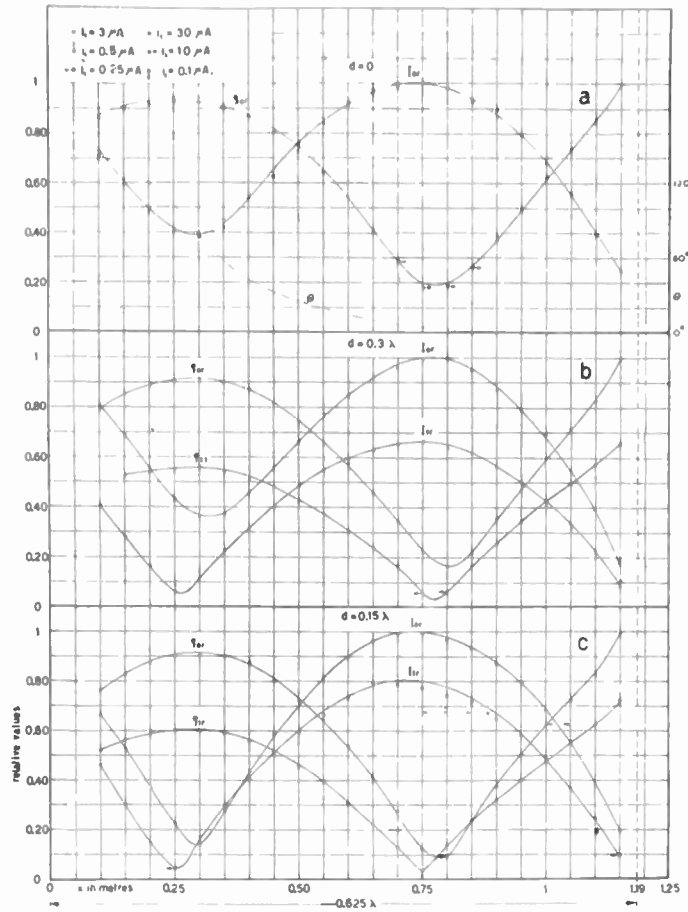

Fig. 4—Experimental relative distributions of the moduli of current and density of charge, along the driven antenna and the center self-tuned parasitic, for  $\lambda=1.90$  m,  $l=0.625\lambda$ , and distances between the two antennas  $d=0$ ,  $0.15\lambda$ , and  $0.30\lambda$ .

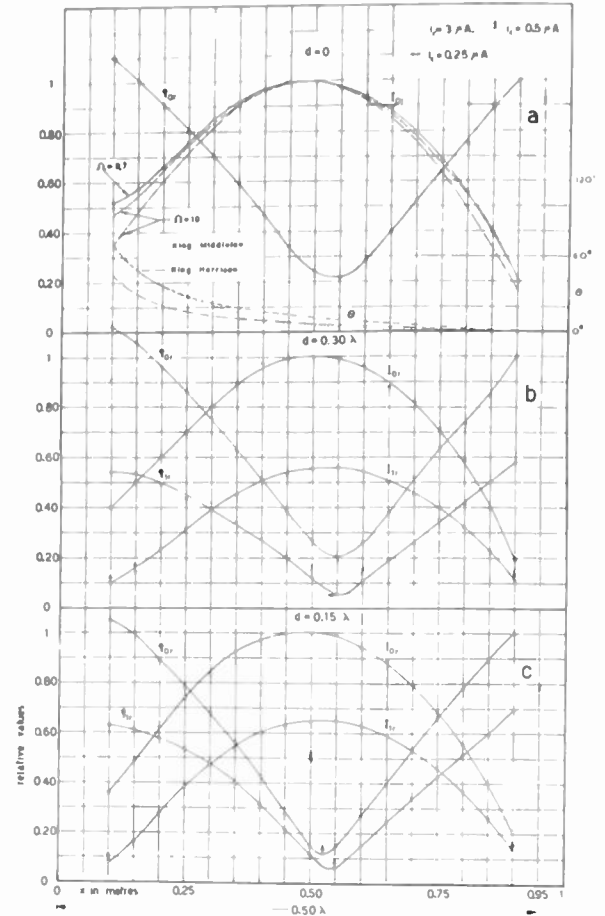

Fig. 5—The same as Fig. 4 but for  $l=0.50\lambda$ .

responding to the black circles, the plate voltage of the oscillator varied from 400 to 1,050 volts in the measurements with the loop, and from 360 to 1,300 volts in those with the probe, while for the white circles, the corresponding values of the plate voltage of the oscillator were 220 to 760 volts and 210 to 850 volts. This test was made to ensure that the procedure of varying the plate voltage of the oscillator did not appreciably affect the measurements.

The curves of Figs. 4(b) and 4(c) refer to antennas with a center self-tuned parasitic element, of the same length and diameter as the driven antenna, situated at a distance  $d=0.3\lambda$  and  $d=0.15\lambda$ . For both values of the distance  $d$ , it was assumed  $I_{1\text{ ref}}=I_{0\text{ ref}}$  and  $\rho_{1\text{ ref}}=\rho_{0\text{ ref}}$ .

The curves of Fig. 5 are similar to those of Fig. 4, except that they refer to a value of  $l=0.5\lambda$  ( $l=0.95$  meter). In these diagrams,  $I_{0\text{ ref}}$  is equal to the value of the maximum current on the driven antenna, and  $\rho_{0\text{ ref}}$  is equal to the value of the linear density of charge on the driven antenna for  $x=0.90$  meter. For both values of the distance  $d$ , it was assumed  $I_{1\text{ ref}}=I_{0\text{ ref}}$  and  $\rho_{1\text{ ref}}=\rho_{0\text{ ref}}$ .

Fig. 6 shows the measurements for an antenna of half length  $l=0.25\lambda$  ( $l=0.475$  meter) without parasitic element.  $I_{0\text{ ref}}$  is the value of  $I_0$  for  $x=0.10$  meter, and  $\rho_{0\text{ ref}}$  is the value of  $\rho_0$  for  $x=0.425$  meter.

In all the measurements recorded in Figs. 4, 5, and 6, the minimum value of  $x$  was  $x=10$  cm, because the holders, clamping the heavy tubes constituting the antennas, did not permit the smaller value of  $x$  to be reached.

TABLE I

$l/\lambda$	$d/\lambda$	$V_{I_{0\text{ ref}}}$	$V_{\rho_{0\text{ ref}}}$	$K_0 V_{I_{0\text{ ref}}} / K_I V_{\rho_{0\text{ ref}}}$
0.625	0 (black circles)	35 volts	37 volts	$3.6 \times 10^{-9}$ seconds per meter
0.625	0 (white circles)	18 volts	19 volts	$3.6 \times 10^{-9}$ seconds per meter
0.625	0.30	17 volts	17.5 volts	$3.7 \times 10^{-9}$ seconds per meter
0.625	0.15	14 volts	14.5 volts	$3.7 \times 10^{-9}$ seconds per meter
0.50	0	17.4 volts	19.1 volts	$3.5 \times 10^{-9}$ seconds per meter
0.50	0.30	18.5 volts	18.5 volts	$3.8 \times 10^{-9}$ seconds per meter
0.50	0.15	15 volts	16 volts	$3.6 \times 10^{-9}$ seconds per meter
0.25	0	10.5 volts	11.5 volts	$3.5 \times 10^{-9}$ seconds per meter

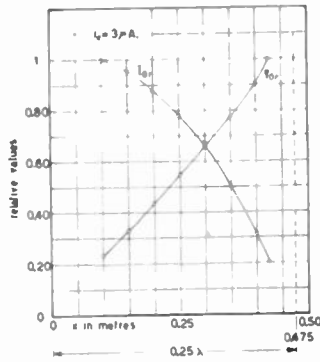

Fig. 6—The same as Fig. 4 except that the measurements were carried out without parasite, and for  $l=0.25\lambda$ .

Table I gives the values of  $V_{I_{0\text{ref}}}$  and  $V_{\rho_{0\text{ref}}}$  found in the different cases, and the corresponding values of the constant appearing in (7).

The distributions of the phases of current and density of charge can be obtained, with a reasonable approximation, using the equation of continuity which, in our case, can be written as follows:

$$\frac{dI}{dx} = -j\omega\rho \quad (9)$$

where  $\omega = 2\pi f$ .

Now, dividing the antenna in  $m$  equal parts of length  $\Delta m$ , we can apply (9), written in an approximate finite form, to each element of length  $\Delta m$ , using (7) and the experimental values recorded in the last column of Table I. The above procedure can be easily understood by inspection of Figs. 7(a) and 7(b), which refer to the cases of Figs. 4(a) and 5(a), respectively. Each triangle drawn in Fig. 7 has one side which represents the vector  $j\rho_{(n)}$ , where  $\rho_{(n)} (n=1, 2, \dots, m)$  is the density of charge at

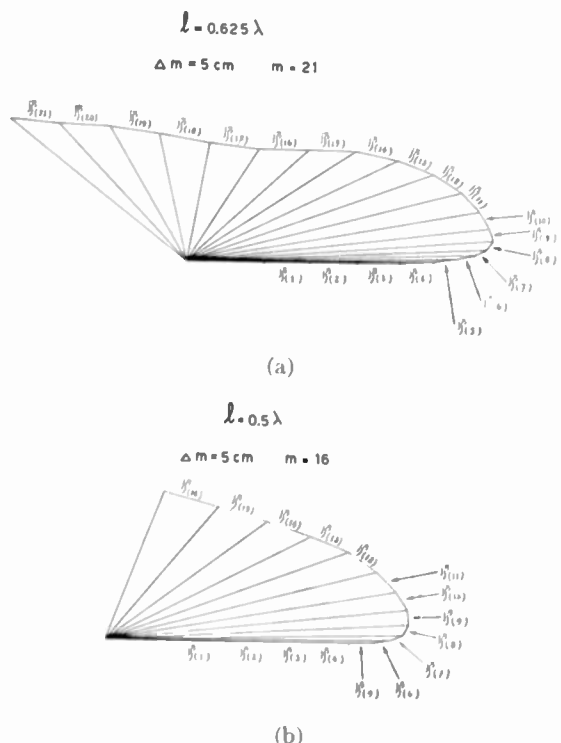

Fig. 7—Geometrical construction, based on (9), to find out the distribution of the phase of the current along the antenna.

the center of the  $n$ th element. The other two sides represent the vectors  $I_{(n)}/\omega\Delta m$  and  $I_{(n+1)}/\omega\Delta m$ , where  $I_{(n)}$  and  $I_{(n+1)}$  are the currents at the two ends of the  $n$ th element.

In Figs. 4(a) and 5(a) are recorded the distributions of the phase  $\theta$  of the current (dotted lines) obtained from Figs. 7(a) and 7(b).  $\theta$  was assumed equal zero at the open end of the antenna.

It was thought interesting to compare some of the experimental results with theoretical calculations. Unfortunately, the distributions calculated refer to a few cases, and they were carried out only for the current, as this quantity allows the input impedance to be calculated. No theoretical calculations seem to be available for the distribution of the charge.

In Fig. 5(a) we have recorded the theoretical results obtained by King and Harrison<sup>3</sup> and by King and Middleton,<sup>5</sup> assuming 1 equal to the modulus of the maximum current. The calculations refer to the case of  $l=0.50\lambda$  and  $\Omega=2 \ln 2l/r_0=10$ , and the experimental results to  $l=0.50\lambda$  and  $\Omega=9.7$ . As it can be seen from Fig. 5(a), the results of King and Middleton seem to agree better with the experiments than those of King and Harrison. It is well known, in fact, that these last calculations are less approximate than the first ones.

For  $l=0.625\lambda$  and  $\Omega=10$ , King and Harrison calculated the distribution of current, but unfortunately the more approximate solution obtained by King and Middleton has not been used. Peroni<sup>6</sup> calculated the distribution of current for  $l=0.625\lambda$  and  $\Omega=11.1$ , using his own graphical method. The experimental results recorded in Fig. 4(a) refer to  $l=0.625\lambda$  and  $\Omega=10.2$ . In this case also, the values of  $\Omega$  do not differ much, and therefore, it is interesting to compare these results. We shall compare the most characteristic quantities; i.e. the ratio of the maximum current  $I_{0\text{max}}$  to the minimum current  $I_{0\text{min}}$ , and the total variation of the phase  $\theta$  along the antenna from  $x=10$  cm to  $x=119$  cm. The theoretical and experimental results are shown in Table II.

TABLE II

	$I_{0\text{max}}/I_{0\text{min}}$	Variation of $\theta$ from $x=10$ cm to $x=119$ cm
King and Harrison	6.2	162°
Peroni	2.9	130°
Experimental	2.6	142°

#### ACKNOWLEDGMENT

The author wishes to thank L. G. H. Huxley of the University of Birmingham, England, who suggested the use of slotted antennas, for his kind help in obtaining from the electrical department of the University of Birmingham the necessary mechanical and electrical facilities for preparing this paper.

<sup>6</sup> B. Peroni, "Antenne e Propagazione delle Onde Elettromagnetiche," Michele Dell'Aira, Roma, 1945.

# The Course-Line Computer for Radio Navigation of Aircraft\*

F. J. GROSS†, ASSOCIATE, IRI

**Summary**—This paper describes an experimental model of a course-line computer which accepts bearing information from a vhf omnirange receiver and distance information from distance-measuring equipment and converts it to simple track-guidance directions for the pilot of an aircraft. Results of flight tests over eight parallel tracks are presented in map form. Theoretical relations between computer errors and errors in the bearing and distance information are also presented.

## INTRODUCTION

THE COURSE-LINE computer is a recent development in a group of aircraft navigation aids which already includes the CAA instrument-landing system,<sup>1</sup> the vhf omnirange,<sup>2</sup> and distance-measuring equipment.<sup>3</sup>

The vhf omnirange system consists of a ground station and an airborne receiver. In the airborne omnirange receiver, the phase angle between two 30-cps voltages is a measure of the magnetic bearing of the line between the aircraft position and the ground station. These voltages are used to position a bearing indicator in the aircraft. The distance-measuring equipment (DME) system consists of an airborne transmitter and receiver and a ground transmitter and receiver. A pulse initiated in the airborne transmitter is received on the ground and retransmitted to the aircraft. A circuit in the airborne equipment measures the round-trip travel time of the pulse and develops a dc voltage which is proportional to the distance. This dc voltage is hereafter referred to as the range voltage.

The course-line computer is an analogue-type computer that uses this bearing and distance information to continuously calculate the deviation of the aircraft from a straight-line course selected by the pilot. The result is presented on a course-line deviation indicator such as that shown in the lower left-hand corner of Fig. 3. If the vertical pointer of this indicator is centered, the pilot knows that the aircraft is on the course line that he has selected. Furthermore, if the aircraft heading is within 90° of the bearing of the intended course, then a pointer deflection to the right indicates the course is to the pilot's right, and a left deflection indicates the

course is to the left. This deviation indicator is the same one that is connected to the localizer receiver when the aircraft is using the CAA instrument landing system. The computer also calculates the distance along the course between the aircraft and a selected destination and presents this information on a dial calibrated in miles.

Because there had been a great deal of theoretical and speculative discussion about computers, the CAA Office of Technical Development contracted with the Minneapolis-Honeywell Regulator Company to construct an experimental computer suitable for making flight tests with the bearing-distance facilities available at the Experimental Station at Indianapolis. To expedite delivery, weight and space limitations were excluded from the specifications. Also, the manufacturer was permitted to mount all but one of the indicator dials and controls in one unit which was to be mounted in the radio compartment of a DC-3 aircraft. The exception was the course-deviation indicator, which was to be mounted on the pilot's instrument panel. The computer is illustrated in Fig. 1. In future models, all essential controls and indicators will be available to the pilot, and it is estimated that the amplifier unit will be compressed to the size of a standard one-half ATR.

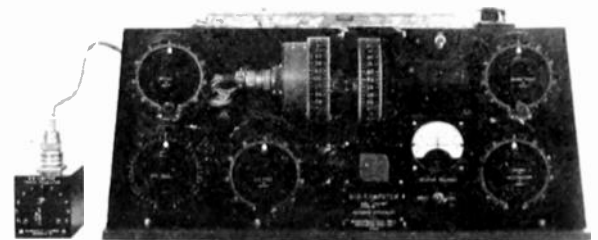

Fig. 1—Experimental model of course line computer.

## OPERATION

The method of operating the computer can be best described with the aid of the trigonometric diagram of Fig. 2. In setting the computer dials for a particular course, the following operations are performed:

(1) Draw the selected course line on the chart such as the heavy line through the destination in Fig. 2.

(2) Measure the bearing of the course with respect to magnetic north. In Fig. 2 this is the angle  $C$ .

(3) Set the course angle into the computer by adjusting dial  $C$  in upper-left center of Fig. 1.

(4) Locate the desired station on the chart and measure the course-line offset distance, which is the shortest distance between the station and the course.

\* Decimal classification: R526. Original manuscript received by the Institute, June 6, 1948; revised manuscript received, December 28, 1948. Presented, 1948 IRE National Convention, New York, N. Y., March 22, 1948.

† Civil Aeronautics Administration, Experimental Station, Indianapolis, Ind.

<sup>1</sup> Peter Caporale, "The CAA instrument landing system," *Electronics*, Part I, vol. 18, pp. 116-124; February, 1945. Also Part II, vol. 18, pp. 128-135; March, 1945.

<sup>2</sup> Peter Caporale, "Status of vhf facilities for aviation," *Electronics*, vol. 20, pp. 90-95; October, 1947.

<sup>3</sup> Publication entitled, "Radio Pulse Distance Measuring Equipment," available from Aviation Information, Civil Aeronautics Administration, U. S. Department of Commerce, Washington 25, D. C.





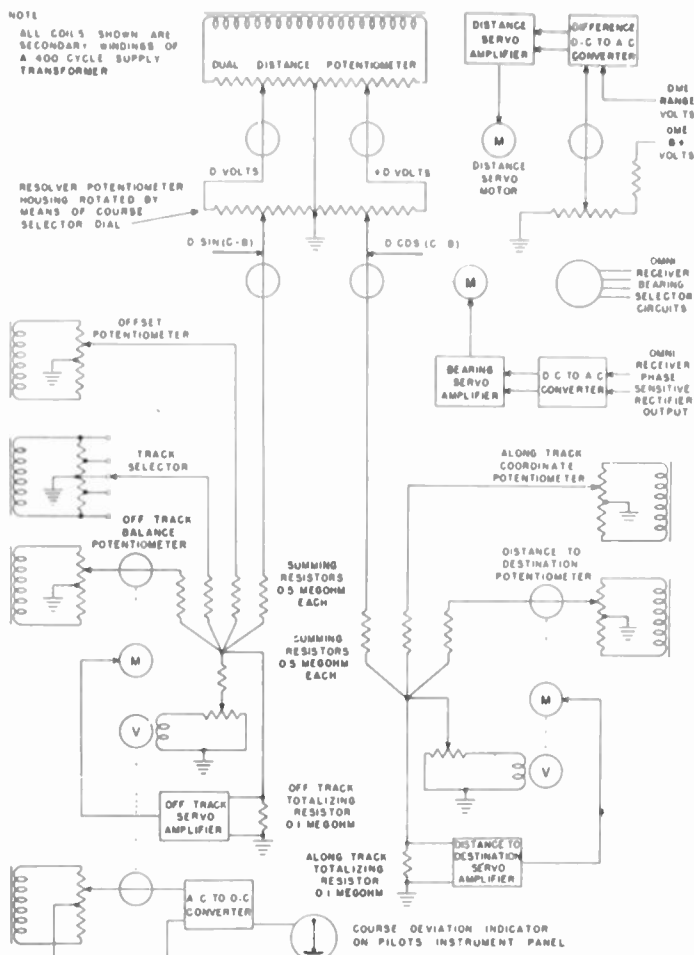

Fig. 5—Simplified schematic of computer.

indicator. In a similar manner, the circuits in the lower-right side of Fig. 5 continuously calculate the distance to destination.

After the computer was delivered, flag-alarm circuits were added. The flag alarm of the course-deviation indicator is actuated by the omni receiver. However, a relay, actuated by the DME, interrupted the flag-alarm current whenever the DME signal failed. Future development of more adequate flag-alarm circuits is contemplated.

THEORY OF OFF-TRACK ERRORS

Given errors in bearing and distance information produce off-track errors of different magnitude at different points on a track. Since the omnirange errors are less than 3° and distance-measuring-equipment errors are less than 3 per cent, the following equation can be used to calculate the off-track error introduced by errors in the omni-bearing and the distance-measuring equipment:

$$\left[ \begin{array}{l} \text{off-track error} \\ \text{caused by bearing} \\ \text{and distance errors} \end{array} \right] = 0.017bD \cos(C - B) - d \sin(C - B)$$

where

$b$  = the omni-bearing error in degrees (assumed less than 4°)

$d$  = the DME distance error in miles (assumed less than 3 miles)

$D$ ,  $B$ , and  $C$  are defined in Fig. 2.

Note that, in this equation, the bearing error makes a negligible contribution to the off-track error when the  $\cos(C - B)$  is zero, namely when  $(C - B)$  is 90°. This condition exists when the aircraft is at the offset point, which is the point nearest the station for any track. Conversely, the bearing error has its greatest effect on the off-track error at the extremes of the track where the angle  $(C - B)$  is small and, therefore,  $\cos(C - B)$  is very nearly unity. As shown in Fig. 6, the off track error component for a given bearing error is proportional to the distance between the aircraft and the offset point.

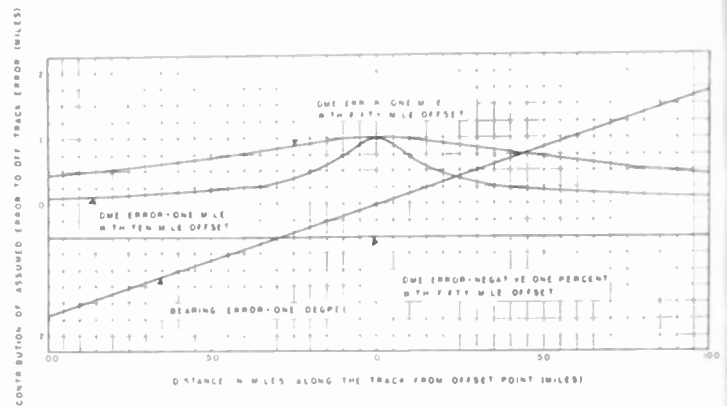

Fig. 6—Contribution of off track error of different assumed bearing and distance errors.

The off-track error caused by a given DME error in miles is proportional to the  $\sin(C - B)$  and is, therefore, greatest at the offset point and negligible at the extreme ends of any track. When the component is plotted against distance along the track, as in Fig. 6, its effect is also a function of the offset distance.

Another condition of interest is that in which the error in the DME distance information is a fixed percentage of the distance. Such a given fixed per cent error produces a constant off-track error, which is proportional to the offset distance for any track as is shown graphically in Fig. 6.

The errors introduced by the computer itself were determined by a bench test in the laboratory. The computer was energized but the DME and bearing servo mechanisms were disconnected. The bearing and distance dials were positioned manually to the nearest even division for several calculated values on various tracks. The calculated off-track error was then subtracted from the observed off-track indication to obtain the computer error. For offsets up to and including 30 miles, the computer circuits introduced off-track errors of less than 1 mile right or left.

One possible source of off-track error was discovered in a bench check for accuracy made after the off-track servo motor was changed. It was found that the induc-

tion-type velocity generator used for feedback in the servo mechanism had a voltage output at standstill which introduced a 1-mile off-track error. This was eliminated by carefully selecting another servo-motor assembly.

**THEORY OF DISTANCE-TO-DESTINATION ERRORS**

Components of the distance-to-destination errors can be separated in a manner similar to that used for the off-track errors.

The following equation can be used to calculate the distance-to-destination error introduced by errors in the bearing and distance information:

$$\left[ \begin{array}{l} \text{Distance-to-destination} \\ \text{error caused by bearing} \\ \text{and distance errors} \end{array} \right] = d \cos (C - B) - 0.017bD \sin (C - B).$$

In this case, the DME errors have the greatest effect at the extremes of the track, while the effect of a given bearing error is the same along any one track but is proportional to the offset distance  $D \sin (C - B)$  which is practically constant for a given track.

Distance-to-destination errors introduced by the computer were determined by bench test and found to be less than plus or minus 3 miles.

**RESULTS OF FLIGHT TESTS OVER PARALLEL COURSES**

In Fig. 7 is reproduced a simplified map of test flights on this computer. The triangular symbol in the center represents the station. The number near the center of each track represents the offset in miles, for example, the track numbered *N 10* is offset 10 miles to the north

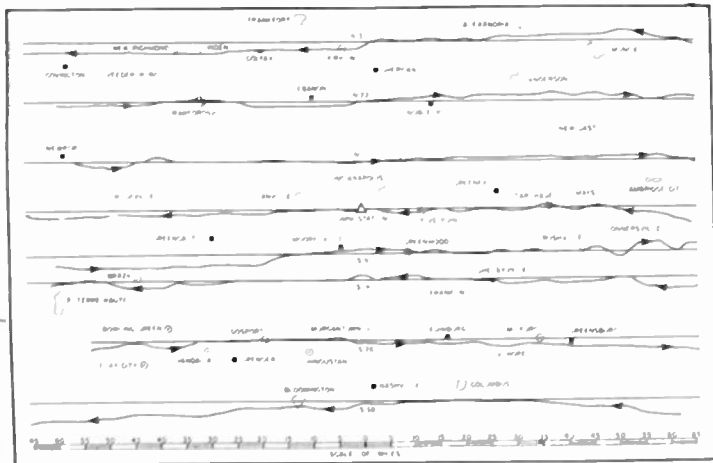

Fig. 7—Simplified map presentation of the data from flight tests over parallel courses.

of the station. The straight lines represent the intended courses and the lines with arrow heads represent the actual tracks of the aircraft, the arrow head indicating the direction of flight. The deviation in miles of the aircraft track from the intended courses can be readily estimated by noting the proportion between deviation and course spacing. Spacing for two courses is, of course, the difference between offset distances.

The average observed off-track error without regard

to algebraic sign was  $\frac{3}{4}$  mile. The service area of the station is expected to be within 45 miles of the offset point. The greatest single observed error within that service area was 2.5 miles. The greatest single error observed in these tests were 3 miles at the extreme ends of track S 38. A portion of this latter error is known to have been caused by a percentage change in the calibration of the distance-measuring equipment during this series of tests.

The method of plotting these computer tracks may be of interest. During the flights, the pilot endeavored to keep the needle centered while either the copilot or an engineer sat in the copilot's seat and plotted the path of the aircraft on detailed county maps having a scale of  $\frac{1}{2}$  inch per mile. At the beginning of these tests, the observer's accuracy was tested by comparing his observation of the aircraft's position with that observed through an Army Type B-3 gyro-stabilized drift sight. The two observations were found to agree to better than 0.2 mile up to an altitude of 5,000 feet. The maps used were also compared with the sectional aeronautical charts and found to be in excellent agreement.

Although distance-to-destination readings were made during the flights illustrated in Fig. 7, it was not practical to precisely correlate these readings with the map. All that was done on these flights was to determine that distance-to-destination indications were reasonably accurate. However, one flight was repeated over track *N 10* of Fig. 7 in an east-to-west direction taking the data in a different manner. Some of the tracks, such as *N 10*, are township lines of the U. S. Land Survey and are visible from the air as straight continuous lines clearly marked by roads and farm boundaries. In making this flight over track *N 10*, the pilot ignored the course-deviation indicator and flew the aircraft on a straight track along this township line. Check points were selected in advance at intervals of approximately 5 miles. All the computer dials were read whenever the aircraft passed over one of these check points. True bearings and true distances for each point were determined from the detailed county maps having a scale of one-half inch per mile. The resulting data is contained in Table I.

**RESULTS OF FLIGHT TESTS OVER CIRCULAR ORBITS AROUND THE STATION**

In the lower-right center of Fig. 1 is a switch labeled "orbit or line." If this switch is thrown to the "orbit" position, and the offset dial is set to a distance such as 20 miles to the left, then the pilot can fly a left-hand circular pattern about the station by flying the deviation indicator with normal sensing. The flight paths shown in Fig. 8 were made in a manner similar to those of Fig. 7 except that the orbiting function of the computer was used. The perfect circles are the intended orbital tracks, and the adjacent tracks are those made by the aircraft. Bench tests of the computer indicated that, of the errors shown in Fig. 8, 1 mile was cou-

TABLE I  
RESULTS OF STRAIGHT-LINE COMPUTER FLIGHT OVER COURSE N10

Check Point	Computer settings: Offset—Left 9.7 miles Course—268.5° Along-track co-ordinate—0 miles							
	Omni Distance Dial	Omni Distance From Map	Omni Bearing Dial	Omni Bearing From Map	Off-track Indication	Distance-to-Destination Dial	Distance-to-Offset Point From Map	Distance-to-Destination Correction
	(miles)	(miles)	(°)	(°)	(miles)*	(miles)	(miles)	(miles)†
80	62.6	62.5	259	259.6	0.8 L	L 62.0	61.8	-0.2
79	57.4	56.7	258	258.7	0.6 L	L 56.5	55.9	-0.6
78	53.3	52.3	258	257.8	0.6 L	L 52.8	51.4	-1.4
65	51.5	49.4	257.5	257.2	0.4 L	L 50.5	48.4	-2.1
64	43.5	42.6	255	254.7	0.1 L	L 42.3	41.5	-0.8
63	37.1	36.4	252	253.1	0.7 L	L 35.5	35.1	-0.4
62	33.0	32.1	253	250.5	1.2 R	L 31.3	30.4	-0.9
61	27.1	26.2	249	247.2	1.1 R	L 25.0	24.4	-0.6
60	23.4	23.0	246	243.8	0.8 R	L 22.0	21.0	-1.0
59	19.6	18.9	240	238.0	0.3 R	L 17.0	16.3	-0.7
58	14.3	13.8	226.5	224.6	0.3 L	L 9.5	10.1	+0.6
57	12.5	11.8	216	215.0	0.3 L	L 8.0	10.0	+2.0
56	10.3	9.6	186	183.0	1.0 L	L 1.5	0.9	-0.6
55	10.2	9.6	172.5	168.3	1.0 L	R 2.0	1.5	-0.5
53	13.5	13.0	138.5	135.3	0.8 L	R 10.0	8.8	-1.2
52	18.5	18.0	121.5	120.6	0.6 L	R 17.0	15.2	-1.8
51	20.5	20.3	118.0	117.0	0.6 L	R 19.0	17.6	-1.4
49	27.8	27.3	110.5	109.4	0.7 L	R 26.0	25.5	-0.5
48	32.7	32.2	106.0	106.1	0.4 L	R 32.0	30.7	-1.3
47	36.4	36.2	104.5	104.1	0.6 L	R 36.0	34.9	-1.1
46	44.1	45.9	103.0	100.5	2.2 L	R 44.0	44.9	+0.9
84	49.4	50.5	99.0	99.7	0.6 R	R 49.0	49.6	+0.6
85	55.0	57.3	99.0	98.3	0.5 R	R 55.0	56.5	+1.5

\* Note—Right and left deflection of course-deviation indicator is indicated by R and L, respectively.

† Note—Correction is to be added algebraically to distance-to-destination dial reading.

tributed by the computer at 20 miles radius, 0.6 mile at a 10-mile radius, and 0.5 mile at a 5-mile radius.

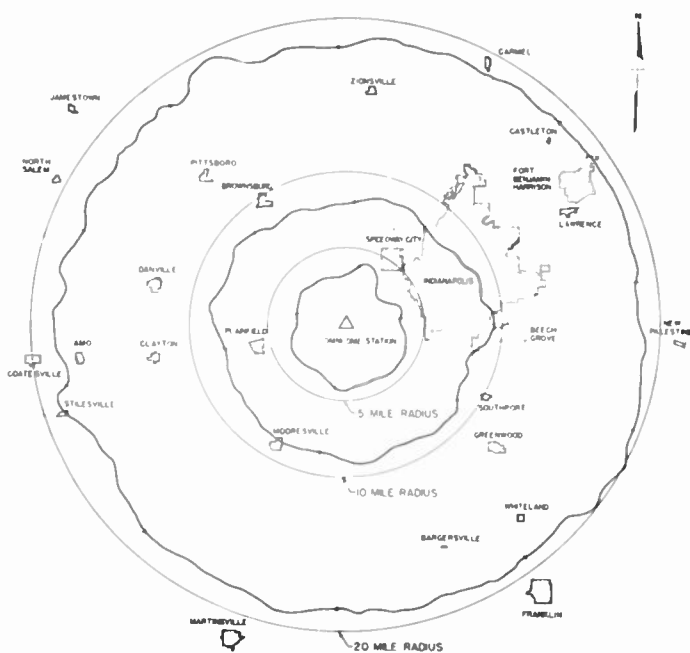

Fig. 8—Simplified map presentation of data from flight tests over circular orbits about the station.

### CONCLUSIONS

Flight tests of the experimental computer show that it has an average off-track error of  $\frac{3}{4}$  mile and a maxi-

imum error of 2.5 miles within the expected service range of the station. Errors in the distance-to-destination or way point are found to be of the same order or magnitude. These errors are well within the limits recommended by the January, 1947, Report of the Special Radio Technical Division of ICAO. There will soon be available navigation receivers and distance-measuring equipments built to more rigid specifications than those used in these tests, and as a consequence, the errors of computer flying will be reduced to less than those shown in this report.

In procuring the experimental computer, size and weight limitations were waived to obtain prompt delivery. With the precision potentiometers and autosyn units of compact design now available, it is believed that the size can be reduced to that of a one-half ATR unit, and the weight to approximately 20 pounds.

Off-track errors of the magnitude found in these tests would permit the use of 10-mile track separation with safety. Occasionally, the use of right- and left-hand prefixes for off-track and along-track settings was found to cause confusion in converting map measurements to computer settings. For this reason the settings to be made in future computers will be course angle, distance from omni station to destination, and bearing of destination from omni station. Additional circuits will convert the last two settings to voltages which are proportional to "offset" and "along-track" distances.

# Contributors to Waves and Electrons Section

G. Barzilai was born in Rome, Italy, on June 23, 1911, and obtained the B.Sc. degree in industrial engineering from the University of Rome in 1935. For two years, he worked at the radio laboratory of the Italian Ministry of Communications on rf measurements. He was appointed vice-director of the Experimental Centre G. Marconi of the Italian National Council of Research and did



GIORGIO BARZILAI

some research work on antennas and propagation of radio waves. In 1941 he was sent to the radio laboratory of the Italian Air Force for research work on radar equipment. He remained on the technical staff of the Italian Air Force until the end of 1946 when, with a British Council scholarship, he went to the University of Birmingham, England, for eleven months and did research work on antennas, obtaining his M.Sc. degree.

In 1948 Mr. Barzilai was granted, from the Italian Ministry of Education, the "Libera Docenza in Radiotecnica" which is an academic degree for teaching radio engineering at an Italian University.

Mr. Barzilai is, at present, in the United States as technical liaison between General Electric Co. and Compagnia Generale Elettronica, licensee for General Electric electronic equipment in Italy.



Herbert Friedman (A'45) was born in New York, N. Y., on June 21, 1916. He received the A.B. degree from Brooklyn College in 1936 and the



HERBERT FRIEDMAN

Ph.D. degree in physics from the Johns Hopkins University in 1940. He joined the Physical Metallurgy Division of the Naval Research Laboratory in 1941. In 1943, he transferred to the Optics Division of the same institution as Head of the Electron Optics Section, where

he has conducted research in electron microscopy, X-ray and electron diffraction, and gaseous discharge tubes.

Dr. Friedman is a member of the American Physical Society, the American Society for X-ray and Electron Diffraction, the Washington Philosophical Society, and Sigma Xi.

Francis J. Gross (A'46) was born at Seattle, Wash., on October 15, 1911. In 1933 he received the B.S. degree in electrical engineering from the University of Washington. He was with the meter testing department of the Puget Sound Power and Light Company from 1934 to 1937, and with the U. S. Patent Office as a patent examiner from 1937 to 1938. From 1938 to 1945 he



FRANCIS J. GROSS

served as an engineer and physicist in the electrical instrument section of the National Bureau of Standards. He joined the staff of the Technical Development, Civil Aeronautics Administration, as electronic engineer in 1945.

From 1941 to 1945 Mr. Gross also served on the faculty of George Washington University in Washington, D.C., as an instructor in electrical engineering. He is a member of Tau Beta Pi and the American Institute of Electrical Engineers.



Imre Molnar (SM'46) was born in 1906, and studied communication engineering at the University and Institute of Technology in Berlin, Germany, completing his studies there at the Master level in 1930. He has subsequently studied chemistry at the Illinois Institute of Technology in Chicago, and at the present is doing graduate work towards a Ph.D. degree at Northwestern University, Evanston, Ill.



IMRE MOLNAR

Mr. Molnar's first experience in telephone work was received between 1921 and 1925, with the International Telephone and Telegraph Corp., as an apprentice and installer. Since 1930 he has been associated with the Automatic Electric Company, engaged in circuit design, transmission engineering, and installation. He has also represented the Company as resident engineer in several foreign countries. In his present position as project engineer, he is concerned with general developments in the Company's

laboratories. Mr. Molnar has been responsible for a number of major developments in practically all phases of the electrical communication field, which include manual, automatic, and long-distance telephony; voice frequency systems; carrier current systems; power supervisory; remote control; radio switching; airport traffic control; and automatic reservation systems.

Mr. Molnar has published numerous major papers and several hundred abstracts in electrical communications, as well as several other publications in various fields. He is a life member of the American Numismatic Association and a member of Sigma Xi.



James C. W. Scott (M'47) was born at le Havre, France, on March 1, 1904. He graduated from the University of Washing-



J. C. W. SCOTT

ton with the degree of B.Sc. in physics. In 1930 he was employed by Bell Telephone Laboratories, where he did research work on copper-oxide rectifiers. In 1933 he returned to the University of Washington with a teaching fellowship to do graduate work in physics.

During the war, he joined the Royal Canadian Air Force and served overseas as a radar officer. He later was in charge of the Canadian east-coast chain of radar sections and started the radio propagation prediction section of the RCAF. At the end of the war, Mr. Scott retired from the Air Force with the rank of Squadron Leader to join the staff of the National Research Council of Canada. He transferred to his present position with the Defense Research Board in 1947 to take part in the organization of the new Radio Propagation Laboratory.

He has been secretary of the Canadian Radio Wave Propagation Committee, and is a member of the American Physical Society.



For a photograph and biography of A. W. STRAITON, see page 931 of the July, 1948, issue of the PROCEEDINGS OF THE I.R.E.



# Abstracts and References

Prepared by the National Physical Laboratory, Teddington, England, Published by Arrangement with the Department of Scientific and Industrial Research, England, and *Wireless Engineer*, London, England

NOTE: The Institute of Radio Engineers does not have available copies of the publications mentioned in these pages, nor does it have reprints of the articles abstracted. Correspondence regarding these articles and requests for their procurement should be addressed to the individual publications and not to the I.R.E.

Acoustics and Audio Frequencies	836
Antennas and Transmission Lines	837
Circuits and Circuit Elements	838
General Physics	839
Geophysical and Extraterrestrial Phenomena	840
Location and Aids to Navigation	841
Materials and Subsidiary Techniques	841
Mathematics	842
Measurements and Test Gear	843
Other Applications of Radio and Electronics	844
Propagation of Waves	845
Reception	845
Stations and Communication Systems	846
Subsidiary Apparatus	847
Television and Phototelegraphy	847
Transmission	848
Vacuum Tubes and Thermionics	848
Miscellaneous	848

The number in heavy type at the upper left of each Abstract is its Universal Decimal Classification number and is not to be confused with the Decimal Classification used by the United States National Bureau of Standards. The number in heavy type at the top right is the serial number of the Abstract. DC numbers marked with a dagger (†) must be regarded as provisional.

## ACOUSTICS AND AUDIO FREQUENCIES

534+621.395.6 1563

1949 IRE National Convention Program—(Proc. I.R.E., vol. 37, pp. 160-178; February, 1949.) Abstracts are given of the following papers read at the convention:—18. The Reproduction of Sound, by H. F. Olson. 19. New Developments in Studio Design in Europe, by L. L. Beranek. 20. The Technique of Television Sound, by R. H. Tanner. Titles of other papers are given in other sections.

534.13 1564

Study, to the Second Approximation, of the Acoustic Transparency of a Rectangular Plate—T. Vogel. (*Ann. Phys.* (Paris), vol. 2, pp. 502-516; September and October, 1947.) The discussion of the case of an elastic plate forming a window in an infinite rigid wall and subjected to plane sound waves incident normally (2728 of 1947) is here extended to oblique incidence and vibrations of finite amplitude. The results are applied to the vibration of aircraft structures.

534.21 1565

Waves in Compressible Media—W. Weibull. (*Kungl. Tekn. Högsk. Handl.* (Stockholm), no. 18, 38 pp.; 1948. In English.) General equations of motion are derived and applied to plane, cylindrical, and spherical waves. Boundary conditions involving fixed and moving surfaces are considered.

534.232:621.313.12:538.652 1566  
Magnetostriiction Generators—Osborn. (See 1802.)

534.321.9 1567

Propagation of Ultrasonic Waves in Solid Rods—T. Hüter. (*Z. Angew. Phys.*, vol. 1, pp. 274-289; January, 1949.) Discussion with special reference to the transmission of ultrasonic energy along rods for medical purposes. Various

The Institute of Radio Engineers has made arrangements to have these Abstracts and References reprinted on suitable paper, on one side of the sheet only. This makes it possible for subscribers to this special service to cut and mount the individual Abstracts for cataloging or otherwise to file and refer to them. Subscriptions to this special edition will be accepted only from members of the IRE and subscribers to the PROC. I.R.E. at \$15.00 per year. The Annual Index to these Abstracts and References, covering those published from February, 1948, through January, 1949, may be obtained for 2s. 8d. postage included from the *Wireless Engineer*, Dorset House, Stamford St., London S. E., England.

theories are reviewed. Dispersion and resonance effects are considered and a graphical method of solution of the frequency equation is described. Determination of the cross-sectional distribution of the amplitude of axial displacement affords a new experimental method for velocity measurement.

Experiments showed that in Al rods of diameter 1.5 cm and 1.0 cm respectively, harmonics up to the order 40 could be detected. The use of an initial solid cone to concentrate the energy transmitted along a rod 20 cm long and 1.5 cm diameter, at a frequency of 780 kc, increased the energy density in the rod from 4 watts/cm<sup>2</sup> to 7.4 watts/cm<sup>2</sup>.

534.7 1568

Determinations of Ear Fatigue with the Automatic Audiometer—G. G. Sacerdote. (*Alta Frequenza*, vol. 17, pp. 257-264; December, 1948. In Italian, with English, French, and German summaries.) An account of results obtained with an instrument of the type described by G. von Békésy (*Arch. Elek. Übertragung*, no. 1, p. 13; 1947.)

534.845 1569

Absorption of Sound by Porous Materials: Part 5—C. Zwikker, J. van den Eijk, and C. W. Kosten. (*Physica, 's Grav.*, vol. 10, pp. 239-247; April, 1943. In English.) An account of further measurements using a system of glass tubes of a porous wall, the structure factors of which could be calculated as well as measured. Results confirmed the theory given in part 2. For parts 1 to 4 see 3322 of 1948.

534.851:621.395.813 1570

A Study of Frequency Fluctuations in Sound Recording and Reproducing Systems—P. E. Axon and H. Davies. (Proc. I.R.E., part III, vol. 96, pp. 65-75; January, 1949.) Discussion of the imperfections arising in the manufacture of phonographs and disks, causing wow. An instrument for measuring total wow is described. By statistical analysis of the results the sources of wow can be identified and appropriate corrections made.

534.86:621.396.61/.62:621.395.623.7 1571  
Fundamental Electroacoustic Principles for the Transmission of a Wide Band of Audio Frequencies—Furrer, Lauber, and Werner. (See 1787.)

534.861:534.76 1572

Duplication of Concerts—R. Vermeulen. (*Philips Tech. Rev.*, vol. 10, pp. 169-177; December, 1948.) Stereophonic reproduction, with or without intermediate recording, enables the audience in an overflow auditorium to hear

what is claimed to be an exact reproduction of the original music.

621.395.623.7 1573

Voigt Permanent-Magnet Loudspeaker—(*Wireless World*, vol. 55, p. 103; March, 1949.) The speaker has a flux density of 18,000 lines per cm<sup>2</sup> in a 1½-mm gap. The magnetomotive force is supplied by a massive center block of Ticonal, with two parallel return paths of large cross section. Difficulties of alignment or due to inaccurate machining of the gap are overcome by making the pole tip assembly a separate unit. The speech coil impedance is 15 Ω and the total weight 30 lb.

681.85:534.43:621.395.813 1574

High-Fidelity Response from Phonograph Pickup—E. J. O'Brien. (*Electronics*, vol. 22, pp. 118-120; March, 1949.) The main causes of poor performance are briefly considered. Formulas for voltage gain and input admittance with results for feedback circuits, are given. Input circuits and response curves for several pickups using feedback, and typical response curves for different feedback networks, are illustrated.

534 1575

Vibration and Sound. [Book Review]—P. M. Morse. McGraw-Hill, London, 2nd edition, 468 pp., 33s. (*Wireless Eng.*, vol. 26, p. 38; January, 1949.) Intended primarily as a textbook on the mathematical theory of vibration, for students of physics and communication engineering. The first edition (noted in 3023 of 1937) has been extensively revised to include discussion of modern techniques used in acoustics and a comprehensive treatment of transient phenomena. A sound knowledge of the calculus is assumed.

534.321.9 1576

Supersonics—The Science of Inaudible Sounds [Book Review]—R. W. Wood. Brown University, Providence, R. I., 1939, 162 pp., \$2.00. (*Jour. Frank. Inst.*, vol. 247, p. 84; January, 1949.) An historical review of supersonic research. Investigations in the last 15 years are not reported, but the 1939 edition is reprinted with a supplementary bibliography which is "probably the most complete one ever published in this field."

621.395.625.2 1577

Practical Disk Recording [Book Review]—R. H. Dorf. Gernsback Library No. 39; Radcraft Publications Inc., New York, N. Y., 96 pp., 75c. (*Electronic Eng.* (London), vol. 21, p. 69; February, 1949.) "... should prove of great interest and usefulness to beginners and

mateur enthusiasts in the sound recording world, to whom it is recommended."

### ANTENNAS AND TRANSMISSION LINES

- 21.315+621.392+621.396.67 1578  
**1949 IRE National Convention Program**—  
 Proc. I.R.E., vol. 37, pp. 160-178; February,  
 1949.) Abstracts are given of the following pa-  
 pers read at the convention:—7. Elliptically  
 Polarized Radiation from Inclined Slots on  
 Cylinders, by G. Sinclair. 8. Some Properties of  
 Radiation from Rectangular Waveguides by  
 T. Bolljahn. 9. Theory of End-Fire Helical  
 Antennas, by A. E. Marston and M. D. Ad-  
 cock. 10. A Broad-Band Transition from Coax-  
 ial Helix, by C. O. Lund. 11. Equivalent Cir-  
 cuits for Coupling of Waveguides by Aper-  
 tures, by N. Marcuvitz. 22. Wide-Angle Metal-  
 Plate Optics, by J. Ruze. 23. Diffraction Pat-  
 tern from an Elliptical Aperture, by R. J. Ad-  
 ams and K. S. Kelleher. 24. The Measurement of  
 Current and Charge Distributions on Trans-  
 mitting and Receiving Antennas, by T. Mo-  
 rita. 25. Antenna Systems for Multichannel  
 Mobile Telephony, by W. C. Babcock and  
 H. W. Nylund. 26. A Low-Drag Aircraft An-  
 tenna for Reception on Omnidirectional Range  
 Signals in the 108- to 122-Mc Band, by J. P.  
 Shanklin. 63. A Unidirectional Reversible-Beam  
 Antenna for Twelve-Channel Reception of Tel-  
 evision Signals, by O. M. Woodward, Jr. 75. A  
 Magnetostrictive Delay Line, by E. Bradburd.  
 Titles of other papers are given in other sec-  
 tions.
- 521.315 1579  
**High-Frequency Polyphase Transmission  
 Line**—C. T. Tai. (Proc. I.R.E., vol. 37, p. 58-  
 January, 1949.) Correction to 637 of April.
- 621.315.2:621.3.09 1580  
**Diagram for Determining the Propagation  
 Constant [for a cable]**—E. B. B. di Sambuy.  
 (Alta Frequenza, vol. 17, pp. 274-279; Decem-  
 ber, 1948. In Italian.)
- 621.315.212:621.397.743 1581  
**Coaxial Cable Joins East and Mid-West  
 TV Networks**—R. Hertzberg. (Tele-Tech, vol.  
 8, pp. 18-20, 55; February, 1949.) The cable  
 links Philadelphia, Pittsburgh, and Cleveland.  
 Each cable has 8 individual lines, four being for  
 telephone services; each television circuit has  
 two lines, one being a spare.
- 621.315.65 1582  
**A Coaxial-Line Support for 0 to 4,000 Mc**—  
 R. W. Cornes. (Proc. I.R.E., vol. 37, pp. 94-  
 97; January, 1949.) The design of a broad-band  
 undercut support is discussed, based on a slowly  
 changing image impedance of the bead, so that  
 this differs only slightly from the line imped-  
 ance up to some maximum frequency. A typical  
 microwave application is described which has  
 voltage SWR less than 1.025 up to 4,000 Mc.
- 621.392.2:621.385 1583  
**Study of the Propagation of an Electromag-  
 netic Wave in the Presence of Two Electron  
 Beams of Neighbouring Velocities**—P. Lapos-  
 tolle. (Compt. Rend. Acad. Sci. (Paris), vol. 228,  
 pp. 753-754; February 28, 1949.) Theory is  
 given for an arrangement consisting of a trans-  
 mission line, in which the propagation velocity  
 may have any value whatever, and two concen-  
 tric electron beams of neighboring velocities.  
 One beam, e.g. the external one, permits the  
 propagation of waves whose velocity is near  
 that of the electrons; the other beam, starting  
 off with the velocity of one of the preceding  
 waves, causes the appearance of another wave  
 which increases exponentially.
- 621.392.26† 1584  
**Wave Guides for Slow Waves**—L. Brill-  
 ouin. (Jour. Appl. Phys., vol. 19, pp. 1023-  
 1041; November, 1948.) "Boundary conditions  
 are obtained for structures with very narrow  
 slots, either closed or open, and a general meth-  
 od of solution of the wave equations is dis-  
 cussed. Fields in the free region and in the slot  
 region are expanded in convenient Fourier se-  
 ries and these series joined along the border of  
 both regions. In doing this, it can be proven  
 that the field contains a dominant term, com-  
 pleted by corrections that represent the field  
 distortion near the open end of the slots. Under  
 favorable conditions, and for very narrow slots,  
 the dominant terms are by far the most impor-  
 tant. This allows for a simplified discussion of  
 variety of examples." See also 1253 of 1948  
 (Chiu and Hansen).
- 621.392.26† 1585  
**Diffraction and Perturbation in a Wave-  
 guide due to an Electromagnetic Wave**—  
 T. Kahan. (Jour. Phys. Radium, vol. 6, pp.  
 300-301; November, 1945.) Formulas are de-  
 rived, in the form of series, for the electric field  
 within a cylindrical waveguide and for the dif-  
 fraction field outside it produced by an external  
 plane wave incident normally to the waveguide  
 axis.
- 621.392.26†:621.396.67 1586  
**Laterally Displaced Slot in Rectangular  
 Waveguide**—A. L. Cullen. (Wireless Eng., vol.  
 26, pp. 3-10; January, 1949.) The admittance  
 presented by a resonant slot cut in the top face  
 of a rectangular waveguide and offset from the  
 center of the face is calculated by a simple ap-  
 plication of transmission-line theory. The  $Q$  of  
 such a slot is calculated and it is shown that slots  
 designed for a broad-band system should be as  
 wide as possible. The phase of the radiation  
 from the slot at resonance is independent of the  
 amount of offset and bears a fixed relation to  
 the phase of the field in the waveguide at the  
 center of the slot. The effect of a small deviation  
 from resonance is considered. Experimental re-  
 sults agree very well with the theory.
- 621.396.67 1587  
**Physical Limitations of Omni-Directional  
 Antennas**—L. J. Chu. (Jour. Appl. Phys., vol.  
 19, pp. 1163-1175; December, 1948.) The di-  
 rectivity gain  $G$  and the  $Q$  of such antennas are  
 calculated in terms of spherical wave functions  
 under idealized conditions. Alternative criteria  
 for optimum performance are (a) maximum  $G$   
 for a given complexity of the antenna structure  
 (b) minimum  $Q$ , and (c) maximum  $G/Q$ . An an-  
 tenna of maximum dimension  $2a$  can have  
 broad bandwidth provided that  $G \leq 4a/\lambda$ . As  $G$   
 increased beyond this value,  $Q$  increases rapidly.  
 The antenna which has potentially the broad-  
 est bandwidth has a radiation pattern corre-  
 sponding to that of an infinitesimally small di-  
 pole.
- 621.396.67 1588  
**On the Theory of Biconical Antennas**—C. T.  
 Tai. (Jour. Appl. Phys., vol. 19, pp. 1155-1160;  
 December, 1948.) Discussion of the work of  
 Schelkunoff (1049 of 1941 and 852 of 1946) and  
 Smith (644 of April). Smith's expressions are  
 extended to derive, for small-angle cones, an  
 expression for the effective load admittance  
 which is the same as that which Schelkunoff de-  
 rived by other methods. Smith's results are not  
 valid for large-angle cones. The advantages of  
 the method over Schelkunoff's are demon-  
 strated by deriving the characteristics of a bi-  
 conical antenna where the space between the  
 cones is filled with a dielectric other than air.
- 621.396.67 1589  
**Properties of a Long Antenna**—E. Hallén.  
 (Jour. Appl. Phys., vol. 19, pp. 1140-1147; De-  
 cember, 1948.) Well-known integral expressions  
 for the outgoing current waves are transformed  
 into series expansions valid for all distances  
 from the feeding point; results thus obtained  
 are shown graphically.
- 621.396.67 1590  
**The Received Power of a Receiving An-**
- tenna and the Criteria for its Design**—Yung-  
 Ching Yeh. (Proc. I.R.E., vol. 37, pp. 155-158;  
 February, 1949.) A general formula for the re-  
 ceived power is derived. Two theorems which  
 can be used as design criteria are deduced.
- 621.396.67:517.54(083.5) 1591  
**Iterated Sine and Cosine Integrals**—Hal-  
 lén. (See 1702.)
- 621.396.67:538.569 1592  
**Surface Currents on a Conducting Sphere  
 Excited by a Dipole**—C. H. Papas and R.  
 King. (Jour. Appl. Phys., vol. 19, pp. 808-816;  
 September, 1948.) Curves of the real and imagi-  
 nary parts of the surface currents are given for  
 the case of a  $\lambda/2$  dipole erected on the surface of  
 the sphere and various radii of the sphere.
- 621.396.67:621.396.9 1593  
**A Solution of the Problem of Rapid Scan-  
 ning for Radar Antennas**—R. F. Rinchart.  
 (Jour. Appl. Phys., vol. 19, pp. 860-862; Sep-  
 tember, 1948.) The theory of parallel plate  
 waveguides was used by Myers (2679 of 1947)  
 to design an antenna for rapid scanning, but the  
 illumination properties of this antenna were  
 unsatisfactory. A plane optical system with  
 variable index of refraction can satisfy the re-  
 quirements. By a suitable transformation, a  
 surface of revolution of constant refractive in-  
 dex can be found whose optical properties are  
 the same as those of the plane system. This sur-  
 face provides an apparently practicable solu-  
 tion of the scanning problem. The diameter of  
 the feed circle can be made arbitrarily small by  
 judicious use of an ellipsoidal reflector.
- 621.396.67:621.396.931 1594  
**Flush-Mounted Antenna for Mobile Appli-  
 cation**—D. R. Rhodes. (Electronics, vol. 22,  
 pp. 115-117; March, 1949.) A small annular-slot  
 antenna with the same radiation pattern as a  
 dipole, and which can be used in the metal roof  
 of a car. Theory and performance are discussed.
- 621.396.67:621.396.97 1595  
**Multi-V Antenna for F.M. Broadcasting**—  
 M. W. Scheldorf. (Electronics, vol. 22, pp. 94-  
 96; March, 1949.) Folded dipoles are bent into  
 V-shape to form a light-weight array that can  
 be mounted on top of existing AM antennas.  
 The array is tuned by extensions on each arm,  
 without seriously changing the impedance match  
 and radiation pattern.
- 621.396.67.029.63:621.392.43 1596  
**The Design of Wide-Band Aerial Elements  
 or 500 600 Mc/s Ground Radar**—C. H. West-  
 cott and F. K. Goward. (Proc. IEE (London),  
 part III, vol. 96, pp. 41-51; January, 1949.)  
 Smith's circle diagrams are used to enable the  
 matching of antennas with parabolic reflectors  
 to feeders to be effected by means of a system of  
 series and parallel stubs. Systems are described  
 in which impedance changes in the stubs com-  
 pensate for the impedance changes in the an-  
 tenna system as the frequency is varied.
- 621.396.671 1597  
**On Antenna Impedances**—E. Hallén.  
 (Kungl. Tekn. Högsk. Handl. (Stockholm),  
 no. 13, 18 pp.; 1947. In English.) Formulas  
 given for the current in and impedance of a  
 straight, symmetrical, center-fed antenna con-  
 tain asymptotic series, and the importance of  
 the smaller terms of these series is discussed.  
 Coefficients of the second-order terms are ex-  
 pressed in a new form and are tabulated as  
 functions of the antenna length.
- 621.396.671 1598  
**Radiation Impedance and Aerial Shortening  
 of the Transmitter Dipole**—J. Müller-Strobel.  
 (Bull. Schweiz. Elektrotech. Ver., vol. 37, pp.  
 710-714; November 30, 1946. In German, with  
 French summary.) The theory of forced oscil-  
 lations is applied to the case of the transmitter  
 dipole (a) neglecting and (b) taking account of

antenna losses. Derivation of the formulas used is given in papers mentioned in the references and is omitted here. Calculated values are in good agreement with the results of measurements on a bronze wire supported by a balloon.

621.396.671

1599

**An Experimental Investigation of Formulas for the Prediction of Horn Radiator Patterns**—G. A. Wootton, D. R. Hay, and E. L. Vogan. (*Jour. Appl. Phys.*, vol. 20, pp. 71-78; January, 1949.) Measured *E*-plane radiation patterns give satisfactory agreement with the well-known Kirchhoff formula for angles up to 20° and distances as short as 1 foot from the horn mouth; *H*-plane measurements agree less well. Distant patterns are compared with the Stratton and Chu corrected formula (3875 of 1939).

621.396.671

1600

**Gains and Effective Areas of Horn Antennas**—R. B. Watson and C. M. McKinney. (*Jour. Appl. Phys.*, vol. 19, pp. 871-876; October, 1948.) A reciprocity method is described for determining absolute gain. An alternative method is used to obtain both gain and effective area by comparison of experimental and theoretical radiation patterns; results thus obtained are in satisfactory agreement with values obtained by the reciprocity method.

621.396.671

1601

**Parasitic-Array Patterns**—J. L. Gillson. (*QST*, vol. 33, pp. 11-15, 104; March, 1949.) Patterns determined experimentally are presented for a 3-element array adjusted both for maximum forward and minimum rear radiation at several heights, and for a 2-element array at a height of  $5\lambda/4$  with various lengths of the parasitic element.

621.396.671

1602

**On the Calculation of Radiation Patterns of Dielectric Rods**—R. B. Watson and C. W. Horton. (*Jour. Appl. Phys.*, vol. 19, pp. 836-837; September, 1948.) Continuation of 1297 of June. The equivalent currents may be expressed, in terms of traveling waves without appreciably changing the computed radiation patterns.

621.396.677

1603

**Design of Yagi Aerials**—R. M. Fishenden and E. R. Wilm. (*Proc. IEE* (London), part III, vol. 96, pp. 5-12; January, 1949.) An account of work done at the Telecommunications Research Establishment between 1938 and 1942. Discussion of: (a) advantages and limitations of multiple arrays, (b) the mode of operation of a Yagi antenna and (c) the effect on the polar diagram of changing parameters. Only antennas of length  $>\lambda$  are considered; these normally consist of 3 or more directors in addition to an exciter and a reflector. Sufficient information is tabulated for approximate design of an antenna of given characteristics. See also 1348 of 1947 (Walkinshaw) and 1349 of 1947 (Reid).

621.396.677

1604

**Dielectric Directive Radiators**—P. Malach. (*Fremmeltech. Z.*, vol. 2, pp. 33-39; February, 1949.) Discussion of the polar diagrams of uniform and tapered dielectric rods and of arrays of such rods. Design theory is presented; experimental results are in excellent agreement.

621.396.677.029.54

1605

**Design Considerations for Directive Antennae-Arrays at Medium-Wave Broadcast Frequencies, taking into account the Final Radio-Frequency Amplifier Circuits**—J. C. Nonnekens. (*HP* (Brussels), no. 1, pp. 26-31; 1949. In English.) The horizontal directivity of broadcasting arrays is briefly reviewed and the power distribution, as determined from the impedance at the base of the antenna, is calculated. The general case of vertical antennas of unequal heights, with mutual inductance, is analyzed and measurement methods are out-

lined. The practical design of 4-terminal networks for matching and power distribution is considered. Difficulties due to parallel capacitance in the case of towers with high base impedance are discussed, and possible antiparasitic devices for inclusion in the final amplifier are mentioned.

### CIRCUITS AND CIRCUIT ELEMENTS

621.310.87

1606

**Pulse-Sinewave Converter**—W. M. Cameron. (*Electronics*, vol. 22, pp. 174, 180; March, 1949.) A pulse input produces a positive and a negative exponential wave which are folded to produce a wave of approximately sinusoidal characteristics. Design and performance are discussed and a typical 2-tube circuit illustrated, in which a 30-volt pulse input provides a 17-volt peak-to-peak sinusoidal output of low harmonic content.

621.314.2.029.3:621.317.784

1607

**Audio Frequency Transformer Design**—C. F. Brockelsby. (*Marconi Rev.*, vol. 12, pp. 1-11; January to March, 1949.) Analysis for the transformer of a wide-range of absorption wattmeter.

621.316.726.078.3:621.396.615.142.2:538.569.4

1608

**Frequency Stabilization of Microwave Oscillators by Spectrum Lines: Part 2**—J. L. G. de Quevedo and W. V. Smith. (*Jour. Appl. Phys.*, vol. 19, pp. 831-836; September, 1948.) "The design of both narrow-band high-stabilization and broad-band lower-stabilization spectrum line discriminators is developed in a generalized form applicable to various spectrum lines and cavity designs. Comparison with experiment is made for two broad-band discriminators utilizing the  $\text{NH}_3$  3,3-absorption line at 24,870 Mc as the frequency determining element. These discriminators, used with an amplifier of 2,000 gain, reduce drifts by factors of 250 and 1,000 respectively, compared to an unstabilized tube." Part 1, 2180 of 1948.

621.318.572:518.5

1609

**Rectifier Networks for Multiposition Switching**—D. R. Brown and N. Rochester. (*Proc. I.R.E.*, vol. 37, pp. 139-147; February, 1949.) 1948 IRE National Convention paper. For computers and other applications where switching times  $< 1$  microsecond are required. Various types of network, including that using the minimum number of rectifiers, are discussed. Generalized equivalent circuits are derived.

621.318.572:621.396.822

1610

**Spurious Signals Caused by Noise in Triggered Circuits**—Middleton. (See 1777.)

621.319.4:551.57:621.317.335

1611

**The Effect of Humidity on the Calibration of Precision Air Capacitors**—L. H. Ford. (*Proc. I.R.E.*, part III, vol. 96, pp. 13-16; January, 1949.) See 978 of May.

621.39

1612

**1949 IRE National Convention Program**—(*Proc. I.R.E.*, vol. 37, pp. 160-178; February, 1949.) Abstracts are given of the following papers read at the convention.—Symposium on Network Theory, comprising (a) Modern Developments in the Topology of Networks, by R. M. Foster, (b) A Survey on the Status of Linear Network Theory, by E. A. Guillemin, (c) Recent Developments in Broad-Band Active Networks, by J. G. Linvill, and (d) General Review of Linear Varying-Parameter and Nonlinear Circuit Analysis, by W. R. Bennett. 27. A Method of Synthesizing the Resistor-Capacitor Lattice Structure, by J. L. Bower, J. T. Fleck, and P. F. Ordnung. 28. Exact Design of Bandpass Networks using  $n$  Coupled Finite- $Q$  Resonant Circuits ( $n=3$  and 4), by M. Dishal. 29. Network Approximation in the Time Domain, by W. H. Huggins. 30. The Design of Frequency-Compensating Matching

Sections, by V. Rumsey. 31. Amplifier Synthesis through Conformal Transformations, by D. L. Trautman, Jr., and J. M. Pettit. 47. Impedance Curves for Two-Terminal Networks, by E. L. Michaels. 48. An Analysis of Triple-Tuned Coupled Circuits, by N. W. Mather. 49. The Bridged Parallel-tee Network for Suppressed-Carrier Servo Systems, by C. F. White. 50. Transients Response of Linear Networks with Amplitude Distortion, by M. J. Di Toro. 52. Subminiaturization of IF Amplifiers, by G. Shapiro and R. L. Henry. 53. New Applications of a Four-Terminal Titanate Capacitor, by A. A. Pascucci. 54. Frequency-Control Units, by A. E. Miller. 55. The Type 5811 and Type 5807 Tubes—The Smallest Commercial Pentode Amplifiers, by L. G. Hector and H. R. Jacobus. 68.  $G$  Curves as an Aid in Circuit Design, by K. A. Pullen. 69. A Direct-Coupled Amplifier Employing a Cross-Coupled Input Circuit, by J. N. Van Scoyoc and G. F. Warnke. 70. Angular Circuits for High-Power Multiple-Tube Generators at VHF and UHF, by D. H. Preist. 71. Considerations on Electronic Multicouplers, by W. R. Aylward and E. G. Fubini. 74. Speed of Electronic Switching Circuits, by E. M. Williams and D. F. Aldrich. 76. An Electromechanical Strain-Gage Multiplier, by C. H. Woods, E. St. George, L. Isenberg, and A. C. Hall. 86. A High-Efficiency Sweep Circuit, by B. M. Oliver. 93. High-Power Sawtooth Current Synthesis from Square Waves, by H. E. Kallmann. 94. Comparison of the LC Toroidal Filter with the Parallel-tee Feedback Amplifier Filter, by A. J. Stecca. 95. A Peak-Selector Circuit, by M. J. Parker. 96. A Low-Frequency Synchronized Sawtooth Generator Providing Constant Amplitude Sweep with Aperiodic Synchronization Input, by P. Yaffee. 97. Regenerative Amplifiers, by Y. P. Yu. 98. A Rectifier Filter Chart, by R. Lee. 121. Aspects of Double-Stream Amplifiers, by J. R. Pierce; W. B. Hebenstreit; A. V. Hollenberg. 135. An Analysis of Oscillator Performance under Varying Load Conditions and an Electronic System for Automatic Load Compensation, by E. Mittelmann. 136. Low-Power Wide-Tuning-Range VHF Oscillators, by F. J. Kamphoefner and J. M. Pettit. 137. Reactance-Tube Modulation of Phase-Shift Oscillators, by F. R. Dennis and E. P. Felch. 138. A Low-Distortion Audio-Frequency Oscillator, by C. W. Clapp and C. L. Hackley. 139. An Automatic-Frequency-Control System for Mechanically Tuned Oscillators, by J. G. Stephenson. Titles of other papers are given in other sections.

621.392

1613

**The Duality between Interlinked Electric and Magnetic Circuits and the Formation of Transformer Equivalent Circuits**—E. C. Cherry. (*Proc. Phys. Soc.*, vol. 62, pp. 101-111; February 1, 1949.) Discussion of the conditions under which equivalent circuits exist for circuits containing impedances and transformers, and of rules for the formation of equivalent circuits. A physically realizable equivalent circuit does not exist if the given magnetic circuit is nonplanar. Under certain conditions, the process may be reversed and the impedances in a circuit may be coupled by a suitable transformer so that the various current and voltage constraints are unaltered.

621.392

1614

**Properties of some Wide-Band Phase-Splitting Networks**—D. G. C. Luck. (*Proc. I.R.E.*, vol. 37, pp. 147-151; February, 1949.) Discussion of passive networks producing polyphase output from single-phase input. The properties of simple branch circuits are considered, and an expression is derived for the phase difference produced between branches, as a function of frequency. This expression facilitates direct circuit design from required performance. General performance and design curves are included.

- 621.392 1615  
Thévenin's Theorem—"Cathode Ray." (*Wireless World*, vol. 55, pp. 109-112; March, 1949.) A simple explanation, with applications to various network calculations.
- 621.392.43:621.396.67.029.63 1616  
The Design of Wide-Band Aerial Elements for 500-600 Mc/s Ground Radar—Westcott and Goward. (See 1596.)
- 621.392.52 1617  
Transmission-Line Filters—E. K. Sandeman. (*Wireless Eng.*, vol. 26, pp. 11-25; January, 1949.) The discussion is limited to filters using transmission lines whose loss is negligible and whose lateral dimensions are small compared with  $\lambda$ . The treatment is thus not normally applicable to waveguides. Three general types of filter are considered: (a) lengths of line shunt-loaded with short-circuited or open-circuited stabs consisting of lengths of the same type of line, (b) lengths of line series-loaded with short-circuited or open-circuited stabs, and (c) two electrically unequal lengths of the same type of line in parallel. Although the image impedances are different, the pass bands of filter sections constituted by lines shunt-loaded with shorted stabs are the same as those of lines series-loaded with open stabs. Similarly the pass bands of lines shunt-loaded with open stabs are the same as those of lines series-loaded with shorted stabs. The relevant formulas are developed, using matrix theory. Pass and attenuating bands are shown graphically.
- 621.392.52 1618  
Filters and Filter Problems—F. Locher. (*Bull. Schweiz. Elektrotech. Ver.*, vol. 37, pp. 559-568; September 21, 1946. In German, with French summary.) General discussion of the present state of the art.
- 621.392.52:621.392.26† 1619  
Paralleled-Resonator Filters—J. R. Pierce. (*Proc. I.R.E.*, vol. 37, pp. 152-155; February, 1949.) Discussion of microwave filters in which input and output waveguides are connected by a number of resonators, each coupled directly to both waveguides. Signal components of different frequencies can pass from the input to the output largely through different resonators. An experimental filter is described.
- 621.396.611.1 1620  
Resonance Curves of Forced Oscillations excited by Disturbances with Frequency-Dependent Amplitude—M. Päsler. (*Ann. Phys. (Lpz.)*, vol. 4, pp. 1-13; September 20, 1948.) Discussion for a mechanical oscillatory system subjected to a force whose amplitude is proportional to the  $n$ th power of the frequency. Results are given for  $n=0, 1, \dots, 4$ . The analysis can be applied to oscillations in an electrical circuit.
- 621.396.611.4 1621  
On the Excitation and Coupling of Cavity Resonators—J. Bernier. (*Ann. Radioélec.*, vol. 4, pp. 3-11; January, 1949.) Starting from Maxwell's equations, methods of exciting and of coupling cavities by means of conduction currents in loops or probes are discussed, and also the interaction of cavities with periodic convection currents due to electron beams traversing the cavities. The results of Bethe (706 of 1945) for diffraction by small holes are applied to (a) the excitation of a cavity by an electromotive field entering the cavity through a circular hole, and (b) the coupling of two cavities by a circular hole in their common wall. Practical formulas are given which allow numerical calculation for cases in which the relative value of the electromotive field in an ideal cavity, with neither loop, probe, hole, nor electron beam, is known in the neighborhood of the point where the excitation or coupling device is to be located.
- 621.396.611.4:621.317.336 1622  
On the Measurement of Cavity Impedance—Hansen and Post. (See 1719.)
- 621.396.615:621.385.029.63/.64 1623  
Travelling-Wave Valves as Oscillators with Wide-Band Electronic Tuning—Doehler, Klen, and Palluel. (See 1830.)
- 621.396.615.029.3 1624  
Study of a RC Audio-Frequency Oscillation Generator—E. Divoire. (*IEE (Brussels)*, no. 1, pp. 5-15; 1949. In French.) Theory is given for the Wien-bridge oscillator with automatic regulation by means of a small incandescent lamp. If the components of the bridge and its associated amplifier are suitably chosen, such oscillators can have purity and stability characteristics at a comparable or even superior to those of resonant-circuit oscillators. Experimental results confirm the theoretical calculations.
- 621.396.615.17:621.317.755 1625  
The Miller Time Base—B. H. Briggs. (*RSGB Bull.*, vol. 22, pp. 198-202; June, 1947.) Discussion of the basic circuit and various derivatives.
- 621.395.645 1626  
Square-Wave Analysis of Compensated Amplifiers—P. M. Seal. (*Proc. I.R.E.*, vol. 37, pp. 48-58; January, 1949.) The theoretical response of a single-stage compensated video amplifier to square-wave and sinusoidal inputs is found. High-frequency compensation is obtained by a shunt peaking coil, and low-frequency compensation by a RC network, in series with the anode load resistance. Output wave shapes for typical operating conditions are shown. Experimental verification has been obtained for a low-frequency amplifier.
- 621.396.645 1627  
Theory of the Superregenerative Amplifier—L. Riebmán. (*Proc. I.R.E.*, vol. 37, pp. 29-33; January, 1949.) A very general solution is obtained mathematically for the superregenerative circuit, by regarding it as an oscillatory circuit which includes a resistance varying with time from a positive to a negative value. An ideal control-voltage wave form is deduced, approximations to which may be obtained in practice. For this wave form, the minimum realizable static bandwidth is 0.89 times the control frequency.
- 621.396.645 1628  
Design of Resistance-Capacity Coupled Amplifiers—H. Mayr. (*Microtechnic (Lausanne)*, vol. 2, pp. 245-248; December, 1948. In English.) Theoretical analysis using an equivalent circuit, applicable to such amplifiers of any bandwidth and center frequency. The impedance of by-pass capacitors is neglected; a correction for this can be made.
- 621.396.645 1629  
Amplifier Problems for Ultra-Short Waves—W. Sigrist. (*Bull. Schweiz. Elektrotech. Ver.*, vol. 37, pp. 5-22; January 12, 1946. In German, with French summary.) A detailed examination of the relations between electron beam concentration and tube geometry and construction, as affecting amplification factor, limiting wavelength, and efficiency.
- 621.396.645:621.385.032.24 1630  
Practical Notes on Grid Current and Neutralization—Dickson. (See 1838.)
- 621.396.645.029.62/.63:621.396.822 1631  
On the Reduction of the Effect of Spontaneous Fluctuations in Amplifier Valves for Metre and Decimetre Waves—M. J. O. Strutt and A. van der Ziel. (*Physica. 's Grav.*, vol. 10, pp. 823-826; December, 1943. In German.) Further discussion, with special reference to the optimum detuning of the input circuit of an amplifier. For long abstract of main paper, see 749 of 1945.
- 621.396.662.029.64:621.315.61 1632  
Attenuator Materials for Microwaves—Teal, Rigterink and Frosch. (See 1691.)
- 621.396.69+621.317.7 1633  
Standardized Super High-Frequency Components and Instruments—(*Engineer (London)*, vol. 187, pp. 143-144; February 4, 1949.) Special matching features are incorporated to prevent confusion; female types of connection are used for power outputs and male for power inputs. Wavemeters, attenuators, bolometers, matching stubs, crystal units, adjustable loop probes, fixed probes, tuning plungers, and connectors are all briefly discussed.
- 621.396.69 1634  
1949 Components Exhibition, Paris—(*Radio Prof. (Paris)*, vol. 18, pp. 16-23, 25; February, 1949. *Toute la Radio*, vol. 16, pp. 115-122; April, 1949. *TSF Pour Tous*, vol. 25, pp. 99-101 and 143-146; March and April, 1949.) Descriptions of novelties and exhibits of particular interest or merit.
- 621.397.645 1635  
On the Design of Television Intermediate-Frequency Amplifiers—J. Sokolov. (*Bull. Schweiz. Elektrotech. Ver.*, vol. 37, pp. 509-514; August 24, 1946. In German, with French summary.) A very wide pass band is required and the phase variation of the signal with frequency should be as nearly linear as possible. Taking these conditions into account, the necessary formulas for complete design calculations are deduced; a numerical example is given.
- 621.392.029.64 1636  
Principles of Microwave Circuits [Book Review]—C. G. Montgomery, R. H. Dicke, and E. M. Purcell (Eds.). McGraw-Hill, London, 486 pp., 36s. (*Wireless Eng.*, vol. 26, p. 37; January, 1949.) Vol. 8 of the MIT Radiation Laboratory series. The field equations of waveguides are discussed very generally; waveguide elements (irises etc.) and cavities are considered. Much space is given to the matrix algebra of the general network and to equivalent network theory. See also 1016 of May (Ragan).
- 621.396:518.3 1637  
Technische Nomogramme [Book Review]—H. J. Schultze. Ingenieurbüro für Nomographie und Fernmeldetechnik, München, 1948, 71 nomograms, 26 DM. (*Elektron Wiss. Tech.*, vol. 3, p. 88; February, 1949.) Abacs for calculations relating to oscillatory circuits, filters, amplifiers, transformers, coils, tracking, etc.
- 621.396.645 1638  
Vacuum Tube Amplifiers [Book Review]—G. E. Valley, Jr., and H. Wallman (Eds.). McGraw-Hill, London, 743 pp., £3. (*Wireless Eng.*, vol. 26, pp. 37-38; January, 1949.) Vol. 18 of the MIT Radiation Laboratory series. The book necessarily includes much well-known material, but also contains much not previously published, such as pulse-response curves of band-pass amplifiers and some items concerning dc amplifiers. The treatment is essentially practical.

## GENERAL PHYSICS

- 53 1639  
1949 IRE National Convention Program—(*Proc. I.R.E.*, vol. 37, pp. 160-178; February, 1949.) Abstracts are given of the following papers read at the convention:—Symposium on Nuclear Science, comprising (a) The Fundamental Particles, by D. J. Hughes, (b) The Detection and Measurement of Nuclear Radiation, by H. L. Andrews, (c) The Effects of Ionizing Radiation on Tissue, by J. P. Cooney, and (d) The Application of Nuclear Radiation to Industry, by J. R. Menke. 90. Geometrical Representation of the Polarization of a Plane

Electromagnetic Wave, by G. A. Deschamps. 122. On the Theory of Axial Symmetric Electron Beams is an Axial Magnetic Field, by A. L. Samuel. 123. Electron Beams in Axial Symmetric Magnetic and Electric Fields, by C. C. Wang. Titles of other papers are given in other sections.

53.081+621.3.081 1640

Some Units in the Giorgi System and the C.G.S. System—E. Hallén. (*Kungl. Tekn. Högsk. Handl.* (Stockholm), no. 6, 44 pp.; 1947. In English.) In the Giorgi system, corresponding electric and magnetic quantities have dimensions differing by a velocity. All factors of conversion to the Summerfeld cgs system are powers of 10, and are tabulated.

537.521 1641

Electronic Interaction in Electrical Discharges in Gases—J. H. Cahn. (*Phys. Rev.*, vol. 75, pp. 293-300; January 15, 1949.

537.523.3:621.396.823 1642

Radio Influence from High-Voltage Corona—Slemon. (See 1780.)

537.523.4.029.64 1643

Oscillographic Observations on Ultra-High-Frequency Sparks—W. A. Prowse and W. Jasiński. (*Nature* (London), vol. 163, pp. 103-104; January 15, 1949.) Tracings show the collapse of field in a resonator energized at 2,800 Mc, during breakdown of irradiated hydrogen, nitrogen, and oxygen at atmospheric pressure in a 1.4-cm gap. With mid-gap irradiation, abruptness of breakdown is comparable to that with dc. Breakdown stress is independent of rate of voltage rise and location of irradiation. See also 361 of March (Cooper and Prowse).

537.525:538.551.25 1644

Plasma-Electron Oscillations—T. R. Neill. (*Nature* (London), vol. 163, pp. 59-60; January 8, 1949.) Experiments using a specially designed tube with a straight wire filament and movable probes confirm the existence of plasma-electron vibrations and v.m. of primary electron beams passing through a small volume close to the cathode, as suggested by Armstrong (2506 of 1948). The relationship between the bunching parameter  $V^{3/2}\lambda/l$  and the bunching distance  $d$  has approximately the linearity predicted by Webster (968 of 1940) in a particular case,  $V$  being the tube voltage,  $\lambda$  the vacuum wavelength of the oscillations, and  $l$  the amplitude of response of the resonator with the probe at the bunching point.

538.3:517.54 1645

Application of Conformal Representation to Wave Fields—H. H. Meinke. (*Z. Angew. Phys.*, vol. 1, pp. 245-252; January, 1949.) By means of conformal representation, the inhomogeneous plane wave between two surfaces of relatively general form is transformed into a plane wave between two parallel planes with an intervening inhomogeneous dielectric. Maxwell's equations for this wave then give an infinite system of linear differential equations of the second order with an infinite number of unknown functions of a variable. Convergence considerations for these functions show that the problem can be treated with sufficient accuracy with only two functions. This makes it possible to develop a systematic step-by-step approximation method for the wave field of such inhomogeneous systems, starting from the electrostatic field, which, in most cases, is a satisfactory first approximation.

538.3:531.314.2 1646

An Extension of Lagrange's Equations to Electromagnetic Field Problems—P. D. Crout. (*Jour. Appl. Phys.*, vol. 19, pp. 1007-1019; November, 1948.) If, in a given problem, a sufficiently close approximation to the instantaneous electric field can be obtained by a linear combination of chosen "current modes," whose

coefficients are functions of time and of generalized co-ordinates, then Lagrange's equations are satisfied if the kinetic and potential energies are replaced by the magnetic and electric energies respectively. In certain cases, the generalized co-ordinates can be considered as charges which have flowed around the various meshes of a lumped network whose Kirchhoff voltage equations are identical with the Lagrange equations. This lumped network is, therefore, an equivalent network whose accuracy depends on the current modes chosen. The method has been applied to the design of complex echo boxes; other high-frequency applications are indicated.

538.566.029.64:53.087.3 1647

Experiments in Electromagnetic Optics—N. Carrara, P. Checucci, and M. Schaffner. (*Alta Frequenza*, vol. 17, pp. 243-256; December, 1948. In Italian, with English, French, and German summaries.) A description of apparatus and methods for observation of interference, circular polarization, and double refraction with centimeter waves.

549.211:537.533.8:537.525.92 1648

Space Charge Effects in Bombardment Conductivity through Diamond R. R. Newton. (*Phys. Rev.*, vol. 75, pp. 234-246; January 15, 1949.) A tentative theory is given and found to agree reasonably well with experiment. Suggestions for future work are included.

621.39.001.11:621.396.822 1649

Communication in the Presence of Noise—C. E. Shannon. (*Proc. I.R.E.*, vol. 37, pp. 10-21; January, 1949.) Messages and the corresponding signals are represented geometrically as points in two "function spaces." The modulation process is regarded as a mapping of one space into the other. Results concerning expansion and compression of bandwidth and the threshold effect are deduced. Formulas are found for the maximum rate of transmission of binary digits over a system subject to various types of noise. Ideal systems which transmit at this maximum rate are discussed. The number of binary digits necessary for satisfactory transmission of a continuous source is also calculated. See also 1361 of June.

621.396.029.64:43 1650

The Physical Applications of Microwaves—J. B. Birks. (*Jour. Brit. I.R.E.*, vol. 9, pp. 10-28; January, 1949.) Discussion of: (a) the principles and experimental methods used in the study of electromagnetic properties of materials at microwavelengths, (b) the dielectric properties of solids and liquids, including polar solutions, (c) the magnetic properties of solids, and (d) the absorption spectra of gases.

#### GEOPHYSICAL AND EXTRATERRESTRIAL PHENOMENA

523.7 1651

Recent Results of Solar Investigations—W. Menzel. (*Elektron Wiss. Tech.*, vol. 3, pp. 55-61; February, 1949.) Solar problems still unsolved include the origin of sunspots, their magnetic fields and relatively regular period, the general solar magnetic field, and solar rf radiation.

523.72 1652

1949 IRE National Convention Program—(*Proc. I.R.E.*, vol. 37, pp. 160-178; February, 1949.) Abstracts are given of papers read at the convention, including:—89. On the Origin of Solar Radio Noise, by A. V. Haeff. Titles of other papers are given in other sections.

523.746+523.72 1653

Sunspots, Radio-Fading, and Radio-Noise—H. Spencer Jones. (*Not. Proc. Roy. Inst.*, vol. 33, no. 153, pp. 637-648; 1948.) Discussion of the nature and characteristics of sunspots, flares, etc., and their association with magnetic

storms and rf solar radiation. The importance of the solar corona is emphasized.

523.746:550.385 1654

Giant Sunspot and Geomagnetic Storm—(*Nature* (London), vol. 163, pp. 203-204; February 5, 1949.) A bipolar group of sunspots of size 2,300 millionths of the sun's hemisphere had central meridian passage on January 22, 1949. A severe magnetic storm associated with aurora began suddenly on January 24. There is so far little evidence of any large associated solar flare.

538.12:521.15 1655

Magnetic Fields of the Heavenly Bodies—H. von Klüber. (*Elektron Wiss. Tech.*, vol. 3, pp. 45-54; February, 1949.) General discussion, with special reference to the Zeeman effect, sunspot phenomena, magnetic field of the sun and of the fixed stars, and Blackett's theory (3112 of 1947.)

550.38:521.15 1656

Non-Uniformity of the Earth's Rotation and Geomagnetism—W. M. Elsasser. (*Nature* (London), vol. 163, pp. 351-352; March 5, 1949.) Study of the secular variation of the earth's magnetic field suggests that the loss of, and irregularities in, the angular momentum of the earth are due to changes in the liquid core, rather than to the frictional effect of oceanic tides.

550.385:523.746.5 1657

On the Variation, during the Solar Cycle, of the Period and Extent of the Recurrence of Magnetic Storms—É. Thellier and O. Thellier. (*Compt. Rend. Acad. Sci. (Paris)*, vol. 228, pp. 701-703; February 21, 1949.) Magnetic storms with sudden commencements show no evidence of recurrence at 27-day intervals, whereas those starting gradually show a definite tendency to recur. Study of 328 storms of the latter type show that variation of the recurrence period is certainly not great. The extent of the recurrence is most strongly marked in the decreasing phase of the cycle.

551.510.52:621.396.11 1658

A Theory on Radar Reflections from the Lower Atmosphere—Gordon. (See 1761.)

551.510.52:621.396.11 1659

Theory and Practice of Tropospheric Sounding by Radar—Friend. (See 1760.)

551.510.535 1660

Comparison of Ionospheric Data from Antipodal Points—(*Jour. Frank. Inst.*, vol. 247, pp. 64-65; January, 1949.) The two most suitable existing stations for such comparison are Watheroo, Western Australia, and Baton Rouge, Louisiana. A statistical comparison shows that Baton Rouge conditions can be predicted nearly as efficiently from Watheroo data as from Baton Rouge data. Watheroo data can be used to predict Brisbane conditions with similar efficiency; this is probably because the difference in longitude between Watheroo and Brisbane is nearly equal to that between Baton Rouge and the antipodal point of Watheroo.

551.510.535 1661

The Ionosphere over Mid-Germany in January 1949—Dieninger. (*Fernmeldetechn. Z.*, vol. 2, p. 44; February, 1949.) An account of features of special interest, with graphs of the diurnal variation of the monthly mean values of the critical frequencies and heights of the different layers, as determined at the Institute for Ionosphere Research, Lindau über Northeim. See also 1475 of June.

551.510.535 1662

Note on Night-Time Phenomena in the F<sub>2</sub>-Region at Brisbane—G. de V. Gipps, D. I. Gipps, and H. R. Venton. (*Jour. Coun. Sci. Industr. Res.* (Australia), vol. 21, pp. 215-221;



August, 1948.) ( $h'p$ ,  $f_oF_2$ ) records made on the multi-frequency recorder at Indooroopilly reveal departures from normal  $F_2$ -layer formation at night. Possible ionospheric configurations for producing these abnormalities are discussed.

**551.510.535** 1663  
**Evidence of Horizontal Motion in Region  $F_2$  Ionization**—W. J. G. Beynon. (*Nature* (London), vol. 162, p. 887; December 4, 1948.) Irregularities in the  $F_2$  layer near the midpoint of the path, detected by means of signals received at Slough from a transmitter at Zeesem, 990 km east of Slough, were observed 60 to 75 minutes later overhead. A 70-minute delay would require a horizontal motion of 430 km per hour. See also 1664 below.

**551.510.535** 1664  
**Short-Period Changes in the  $F$  Region of the Ionosphere**—G. H. Munro. (*Nature* (London), vol. 162, pp. 886-887; December 4, 1948.) An account of observations during the period November, 1947 to May, 1948, to detect horizontal movements in the ionosphere. Signals from a group of three synchronized and suitably phased transmitters were received at one or more of three points, the locations being chosen to provide eight possible combinations for checking uniformity of motion. Clearly defined changes in echoes from the  $F$  region showed time differences at the three receiving points indicating a horizontal velocity of 3.9 miles per minute in a direction  $60^\circ$ E of N. Time differences also occurred in quasiperiodic variations in the "split" observed at one receiving point in the echo records for the three transmitters. See also 1663 above.

**551.510.535:525.624** 1665  
**Lunar Variations in the Principal Ionospheric Regions**—D. F. Martyn. (*Nature* (London), vol. 163, pp. 34-36; January 1, 1949.) Vertical tidal air movements do not account for the semidiurnal variations in ionosphere characteristics. From consideration of the electrodynamic forces brought into play by horizontal air movements, a semidiurnal tilting motion about an axis corresponding to the parallel of latitude at about  $35^\circ$  is deduced, with oscillations which are out of phase on opposite sides of the axis.  $E$ -layer height measurements confirm this.  $F$ -layer variations show no consistent phase difference between high and low latitudes, but this can be explained by the electrical connection between the layers. In the  $F$  region, tidal air motions may be relatively weak, so that ionospheric variations would be influenced by the stronger low-latitude effects in the  $E$  region, with results such as are found. Further support is also provided for the conclusion that the main seat of the lunar magnetic variations is below the  $E$  region. See also 1053 of May and back references.

**551.510.535:621.396.11** 1666  
**The Radio Amateur and Upper Atmosphere Research**—O. P. Ferrell. (*IC*, vol. 5, pp. 25-27, 77; February, 1949.) Discussion of sporadic- $E$  clouds and the part that radio amateurs, operating at frequencies in the 50-Mc band, can play in locating them. Observations of marked sporadic- $E$  clouds for two days in 1948 are discussed in detail. See also 3117 of 1948 and 3410 of 1948 (Revirieux; Lejay).

**551.551:621.396.11** 1667  
**The Problem of Diffusion in the Lower Atmosphere**—O. G. Sutton. (*Quart. Jour. R. Met. Soc.*, vol. 73, pp. 257-276; July to October, 1947. Discussion, pp. 276-281.) A detailed discussion, including the conjugate power-law theory of eddy diffusion which was applied by Booker to the problem of superrefraction (1159 of May and back references).

**551.553.11:621.396.11** 1668  
**Sea Breeze Structure with Particular Reference to Temperature and Water Vapour Gra-**

**dients and Associated Radio Ducts**—R. W. Hatcher and J. S. Sawyer. (*Quart. Jour. R. Met. Soc.*, vol. 73, pp. 391-406; July to October, 1947.) Marked superrefraction occurs when dry air is heated over land and drifts out over cooler sea. The program of observations here discussed was undertaken because lack of knowledge of sea breeze structure hindered the development of an adequate theory of such superrefraction. Hygrometer readings were taken at vertical intervals of a few hundred feet and horizontal intervals of a few miles near the coast in the Madras district. Results are shown graphically and discussed. The existence of a surface radio duct, as suggested by Booker, is confirmed, but the observations do not indicate any elevated radio duct. See also 1159 of May (Booker) and back references.

**551.578.1:621.396.9** 1669  
**Radar Observation of Heavy Rain**—Whalley and Scoles. (See 1675.)

#### LOCATION AND AIDS TO NAVIGATION

**534.88** 1670  
**Use of Sonar in Harbor Defense and Amphibious Landing Operations**—E. Klein and T. F. Jones. (*Elec. Eng.*, vol. 68, pp. 107-114; February, 1949.) Discussion of the development of ultrasonic ranging and direction-finding equipment. The "Herald" equipment comprised a station on the sea bed and a shore station. Remote control of the training and tilting mechanisms for the acoustic mirror was achieved with a step-by-step transmission. A common oscillator for receiver and transmitter, of frequency 175 kc above that of the sound beam, greatly simplified operation of the equipment. Ultrasonic beacons for guidance of assault craft transmitted for 12 hours in the band 17 to 25 kc and then automatically flooded and sank.

**535.61-15:621.383** 1671  
**Infra-Red Location of Objects with Lead Sulphide Cells**—Ochmann. (See 1732.)

**621.396.9** 1672  
**1949 IRE National Convention Program**—(Proc. I.R.E., vol. 37, pp. 160-178; February, 1949.) Abstracts are given of the following papers read at the convention:—Symposium on Radio Aids to Navigation, comprising (a) The Radio Technical Commission for Aeronautics—its Program and Influence, by J. H. Dellinger, (b) Frequency Allocations to the Aeronautical Services above 400 Mc, by V. J. Weihe, (c) Experimental Multiplexing of Functions in the 960 to 1,660-Mc Frequency Spectrum—its Influence on Weight and Complexity of Equipment, by P. C. Sandretto and R. I. Colin, (d) The Philosophy and Equivalence Aspects of Long-Range Radio Navigation Systems, by M. K. Goldstein, and (e) The Future in Approach and Landing Systems, by H. Davis. 92. A Forward-Transmission Echo-Ranging System, by D. B. Harris. 115. The Determination of Ground Speed of Aircraft using Pulse-Doppler Radar, by I. Wolff, S. W. Seeley, E. Anderson, and W. D. Hershberger. 116. The Dual Aircraft Approach and Landing System, by L. B. Hallman, Jr. 117. Theoretical Aspects of Non-synchronous Multiplex Systems, by W. D. White. 118. Band-Pass Circuit Design for Very-Narrow-Band, Very-Long Range Direction-Finder Receivers to minimize Bearing Error due to Receiver Mistuning, by M. Dishal and H. Morrow. 119. Crystal Control at 1,000 Mc for Aerial Navigation, by S. H. Dodington. 130. VHF Airborne Navigational Receiver and Antenna System, by A. G. Kandoian, R. T. Adams, and R. C. Davis. 131. Certain New Performance Criteria for Localizer and Glide-Slope Ground Installations, by P. R. Adams. 132. Phase and other Characteristics of 330-Mc Glide-Path Systems, by S. Pickles. 133. Principles of Volume Scan (for radar), by D. Levine. 134. The Control of Resonance Effects

on the Radio Bearings of an Aircraft High-Frequency Direction Finder, by M. K. Goldstein. Titles of other papers are given in other sections.

**621.396.9** 1673  
**Principle of Constant Path-Time Difference and its Application in Radiolocation**—W. Stanner. (*Elektron Wiss. Tech.*, vol. 3, pp. 70-78; February, 1949.) Discussion of systems using (a) elliptical, (b) hyperbolic-isodromes.

**621.396.9** 1674  
**Position-Finding by Radio: First Thoughts on the Classification of Systems**—C. E. Strong. (*Jour. IEE* (London), part 1, vol. 95, pp. 31-35; January, 1948. Reprinted in *Elec. Commun.*, vol. 25, pp. 278-285; September, 1948.) Full paper; long summary noted in 1039 of 1948.

**621.396.9:551.578.1** 1675  
**Radar Observation of Heavy Rain**—H. Whalley and G. J. Scoles. (*Nature* (London), vol. 163, p. 372; March 5, 1949.) Photographs of a radar PPI screen showing a belt of heavy rain passing over the Manchester district are reproduced and briefly discussed.

**621.396.9:551.594.6** 1676  
**Location of Thunderstorms by Radio**—(*Nature* (London), vol. 163, p. 75; January 8, 1949.) Brief discussion of the British Meteorological Office storm-location network. The apparatus used was described by Adcock and Clarke (2779 of 1947). See also 1056 of May (Ockenden).

**621.396.932** 1677  
**The Application of Radar to the Science and Art of Marine Navigation**—P. G. Satow. (*Jour. Roy. Soc. A.*, vol. 97, pp. 221-234; February 25, 1949.) General discussion of the way in which marine radar, developed primarily for war purposes, has been adapted to assist navigation in harbors and narrow waters, collision prevention, position fixing, etc.

**621.396.932** 1678  
**The Decca Navigator System with Lane Identification**—(*Engineer* (London), vol. 187, pp. 101-102; January 28, 1949.) The English and Danish chains cover an area of 500,000 square miles; other chains in Scotland and Western England are under construction. Lane identification enables navigators entering the area of coverage to determine a reference point. For this purpose, special transmissions take place at approximately one-minute intervals. The identification meter is then illuminated by the appropriate color (red, green, or purple), and the pointer takes up a position from which the corresponding deometer can be set. A vernier arrangement gives greater accuracy of setting, particularly at night.

**621.396.933** 1679  
**Developing an Indicator for H<sub>2</sub>S Equipment**—R. T. Croft. (*Jour. Brit. I.R.E.*, vol. 9, pp. 75-81; February, 1949.) Description of a rotating radial timebase for a PPI, with a particular attention to the design of deflection circuits for complete and sector display. The basic circuits for the deflection amplifiers, the cathode-ray-tube supplies, and the video amplifiers are also considered.

**629.13.014.57:621-526** 1680  
**Automatic Pilots**—J. C. Owen. (*Elec. Eng.*, vol. 67, pp. 551-561; June, 1948.) Discussion of the application of servomechanisms to airplane control.

#### MATERIALS AND SUBSIDIARY TECHNIQUES

**533.5+621.315.59+621.315.61** 1681  
**1949 IRE National Convention Program**—(Proc. I.R.E., vol. 37, pp. 160-178; February, 1949.) Abstracts are given of the following papers read at the convention:—Symposium on Germanium and Silicon Semiconductors, com-

prising (a) Electrical Properties of Germanium and Silicon, by K. Lark Horowitz, (b) The Metallurgy of Germanium and Silicon Semiconductors, by J. H. Seall, (c) Theory of Rectification, by F. Seitz, and (d) Physics of the Transistor, by W. H. Brattain. 56. Conductive Plastic Materials, by M. A. Cole, F. R. Barnett, A. Lightbody, and H. A. Perry. 79. A Critical Survey of Methods of Making Ceramic-to-Metal Seals and their Use for Electron-Tube Construction, by R. P. Wellinger. 81. An Improved Method of Testing for Residual Gas in Electron Tubes and Vacuum Systems, by F. W. Herold. Titles of other papers are given in other sections.

535.37 1682  
Theory of the Extinction of Luminescence of Organic Phosphors—B. Ya. Sveshnikov. (*Zh. Eksp. Teor. Fiz.*, vol. 18, pp. 878-885; October, 1948. In Russian.)

535.37 1683  
Dependence of the Intensity of the Luminescence of ZnO and ZnS-Zn on the Intensity of Excitation—F. I. Vergunas and F. E. Gavrilov. (*Zh. Eksp. Teor. Fiz.*, vol. 18, pp. 873-877, October, 1948. In Russian.)

535.37 1684  
Contributions to the Study of the Photoluminescence of Zinc Sulphide—J. Saddy. (*Ann. Phys. (Paris)*, vol. 2, pp. 414-455; July and August, 1947.) The suppressing or enhancing effect of traces of metals of the Fe group on the photoluminescence of Cu-activated ZnS is studied. The principal formulas proposed for the natural decay of the phosphorescence of ZnS-Cu are discussed theoretically and compared with experimental results.

537.228.1:549.514.51 1685  
Calculation of the Piezo-Electric Constants of  $\alpha$ -Quartz on Born's Theory—B. D. Saxena and K. G. Srivastava. (*Indian Jour. Phys.*, vol. 22, pp. 475-482; November, 1948.)

538.23:621.318.323.2 1686  
Hysteresis and Eddy Currents in Coil-Core Stampings in Weak A.C. Fields—R. Feldtkeller. (*Fernmelde- u. Z.*, vol. 2, pp. 9-14; January, 1949.) Measurement results are presented graphically for various Si/Fe and Ni/Fe alloys of German manufacture.

546.287:621.315.01 1687  
Silicones. Their Use in Electrical Technique—G. de Senarclens. (*Bull. Schweiz. Elektrotech. Ver.*, vol. 37, pp. 117-126; March 9, 1946. In French.) A general account of the preparation and properties of silicone liquids, greases, resins and varnishes, and their use for insulation or lubrication, particularly at relatively high temperatures.

546.289:621.315.591.1†:537.311.33 1688  
Interpretation of Dependence of Resistivity of Germanium on Electric Field—E. J. Ryder and W. Shockley. (*Phys. Rev.*, vol. 75, p. 310; January 15, 1949.)

546.431.82:621.315.012 1689  
Production and Investigation of BaTiO<sub>3</sub> Single Crystals—H. Blattner, W. Künzig, and W. Merz. (*Helv. Phys. Acta*, vol. 22, pp. 35-65; February 15, 1949. In German.) The investigations were concerned with the behavior of the dielectric constant, the specific heat, and the resonance frequency as functions of temperature. Results are shown graphically and discussed.

621.315.553 1690  
On the Use of New Resistance Materials for Standard Resistors—A. Schulze. (*Elektrotechnik (Berlin)*, vol. 3, pp. 23-28; January, 1949.) A detailed account of measurements, extending over a period of about 10 years, of the values of various resistors of the Cu/Mn group of materials, including manganin, novocon-

stant (82.5 per cent Cu, 12 per cent Mn, 1.5 per cent Fe, 4 per cent Al) and a Heusler alloy 306, and also of Au-Cr and Ag-Mn resistors. The alloy 306 contains some Zn and has a temperature coefficient of resistance of less than 1 part in 10<sup>6</sup> per 1°C. The coefficients of the Au-Cr and Ag-Mn resistors are of the same order. Curves and tables show the variations of the different resistors with time.

621.315.61:621.396.602.029.64 1691  
Attenuator Materials for Microwaves—G. K. Teal, M. D. Rigterink, and C. J. Frosch. (*Elec. Eng.*, vol. 67, pp. 754-757; August, 1948.) Homogeneous dielectrics have serious drawbacks as attenuator materials. The dielectric properties of inhomogeneous solid lossy dielectrics such as silicon carbide dispersed in porcelain, or graphite dispersed in phenol formaldehyde, are considered, methods of reducing unwanted reflections at the air versus solid interface are discussed. Resistor strips such as sprayed films of graphite pigmented acryloid or silicone can also be used.

621.315.612.011.5 1692  
Electrical Properties of Ceramics—E. W. Lindsay and L. J. Berberich. (*Elec. Eng.*, vol. 67, p. 440; May, 1948.) Long summary of AIEE paper. If the logarithm of the resistivity, dielectric strength, or power factor be plotted against the reciprocal of the absolute temperature, the graph consists of two straight lines whose intersection determines a transition temperature. Below this temperature, current flow appears to be dominated by dielectric absorption; above, by electrolytic conduction.

621.315.614 1693  
Thermal Aging Properties of Cellulose Insulation Materials—G. Malmlov. (*Kungl. Tekn. Hogsk. Handl. (Stockholm)*, no. 19, 67 pp.; 1948. In English.) A general discussion with historical introduction and bibliography of 56 references.

621.315.615.011.5 1694  
Dielectric Strength of Liquids for Short Pulses of Voltage—K. A. Mactadyen and W. D. Edwards. (*Nature (London)*, vol. 163, pp. 171-172; January 29, 1949.) Measurements on ethyl alcohol and benzene indicate an increase in their dielectric strength as the pulse duration is reduced. The breakdown, once started, becomes complete in about 10<sup>-9</sup> second.

621.315.616.011.5 1695  
The Electric Strength of some Synthetic Polymers—W. G. Oakes. (*Proc. I.R.E.*, part I, vol. 96, pp. 37-43; January, 1949. Discussion, p. 43.) Results for the temperature range -200° to +110°C are discussed in the light of Fröhlich's electronic theory of breakdown (2405 of 1947 and back references).

621.315.616.015.5 1696  
A Note on Crystallite Size and Intrinsic Electric Strength of Polythene—D. W. Bird and H. Pelzer. (*Proc. I.R.E.*, part I, vol. 96, pp. 44-45; January, 1949.) Continuation of 764 of 1947 (Austen and Pelzer). No significant difference is found between measurements on quenched and unquenched polythene. Crystallite size, therefore, appears to have little effect on electric strength.

621.316.99 1697  
The Behaviour of Earth Connections Subjected to High Current Surges—K. Berger. (*Bull. Schweiz. Elektrotech. Ver.*, vol. 37, pp. 197-211; April 20, 1946. In German, with French summary.) The results of measurements with various types of earth connection, subjected to surges from 200 to 800 kv with currents ranging up to 11,000 amperes are shown graphically and tabulated.

621.318.22 1698  
The Permanent Magnet Steel "Ticonal"

and its Application in Loudspeakers (Philips Tech. Commun. (Australia), pp. 3-14, April, 1948.)

666.11†:621.315.612.011.5 621.385 1699  
Contribution to the Study of the Electrical Properties of Glasses used in the Construction of Radio Valves—P. Munier. (*Ann. Radio Elec.*, vol. 3, pp. 54-67; January, 1949.) Methods are described for investigating the variations of resistivity, loss factor, dielectric constant, and power dissipation with temperature and frequency. The results obtained have an immediate practical application in tube manufacture.

621.315.59 + 621.314.6 + 621.396.622 + 621.383 1700  
German Research on Semi-Conductors, Metal Rectifiers, Detectors and Photocells [Book Notice] B.I.O.S. Final Report No. 1751. H.M. Stationery Office, London, 46 pp., 5s. 6d.

## MATHEMATICS

517.512.2 1701  
A Clear Representation of the Spectral Distribution of Periodic and Nonperiodic Phenomena—F. A. Fischer. (*Fernmelde- u. Z.*, vol. 2, pp. 21-23; January, 1949.) A direct derivation of the Fourier integral for nonperiodic phenomena, for the periodic case, the integral transforms into Fourier series.

517.65(083.5):621.396.67 1702  
Iterated Sine and Cosine Integrals—I. H. Iden. (*Kungl. Tekn. Hogsk. Handl. (Stockholm)*, No. 12, 6 pp.; 1947. In English.) The following functions relevant to antenna theory are tabulated:

$$L_{11}(v) = C_{11}(v) + iS_{11}(v) = \int_0^v \frac{L(\xi)}{\xi} d\xi$$

$$L_{-1}(v) = C_{-1}(v) + iS_{-1}(v)$$

$$= \int_0^v \frac{e^{i\xi}}{\xi} [L(2\xi) - L(\xi)] d\xi$$

where

$$L(v) = \int_0^v \frac{(1 - e^{-\xi})}{\xi} d\xi.$$

518.5 1703  
1949 IRE National Convention Program (Proc. I.R.E., vol. 37, pp. 160-178, February, 1949.) Abstracts are given of the following papers read at the convention—Symposium on Electronic Computing Machines, comprising (a) Results of Tests on the Binaic, by J. W. Mauchly, (b) The Mark III Computer, by H. H. Aiken, (c) The IBM Type 604 Electronic Calculator, by R. Palmer, (d) Electronic Memory for a Binary Computer, by E. C. Williams, (e) Counting Computers, by G. R. Stibitz, and (f) Programming a Computer for Playing Chess, by C. E. Shannon. 37. A Dynamically Regenerated Memory Tube, by J. P. Eckert Jr., H. Lukoff, and G. Smolar. 38. An Electronic Differential Analyzer, by A. B. Macnee. 39. An Analogue Computer for the Solution of Linear Simultaneous Equations, by R. M. Walker. 40. The Electronic Isograph for a Rapid Analogue Solution of Algebraic Equations, by B. O. Marshall, Jr. 41. A Parametric Electronic Computer, by C. J. Hirsch. Titles of other papers are given in other sections.

518.5 1704  
Electronic Analog Computer—H. R. Hegbar. (*Electronics*, vol. 22, pp. 168, 174, March 1949.) Results are accurate within 0.1 per cent. Sets of simultaneous differential equations with constant coefficients can be solved.

518.5:512.39 1705  
An Electronic Method for Solving Simultaneous Equations—A. C. Hardy and F. C. Dench. (*Jour. Opt. Soc. Amer.*, vol. 48, pp. 308

312; April, 1948.) For solving equations in 3 or 4 variables arising in color printing. Each individual variable is involved linearly, but the total degree equals the number of variables. Solutions are obtained at the rate of about 1,000 per second.

518.5:517.944 1706

**Electric Circuit Models of Partial Differential Equations**—G. Kron. (*Elec. Eng.*, vol. 67, pp. 672-684; July, 1948.) Discussion of electrical models developed to represent some of the basic linear partial differential equations of mathematical physics. The models can be used for all orthogonal curvilinear co-ordinate systems and can represent transient, sinusoidal, or static fields. Particular equations thus represented include: (a) Laplace's and Poisson's equations, (b) the general scalar-potential and vector-potential equations, (c) compressible fluid flow equations, (d) Maxwell's equations, (e) the wave equations of Schrödinger, and (f) the basic equations of elasticity. The models can be used to solve initial-value, boundary-value, and characteristic-value problems. Accuracy is within 1 to 5 per cent.

518.5:517.947.4 1707

**An Electrical Potential Analyser**—S. C. Redshaw. (*Proc. Inst. Mech. Eng.* (London), vol. 159, War Emergency Issue No. 38, pp. 55-62; 1948. Discussion, pp. 62-80.) The analyzer provides, in effect, an electrical analogy to the solution of Poisson's and Laplace's equations when expressed in finite difference form. It consists essentially of a square mesh, the nodal points of which are interconnected by low-value wire resistances, and a base. Corresponding points on the mesh and base are connected through high-value resistances. A mesh separation of 1/12 of the side length is satisfactory.

517.564.3(083.5) 1708

**Tables of the Bessel Functions of the First Kind [Book Review]**—Harvard University Press, Cambridge, Mass.; Oxford University Press, London, 1948, 55s. each volume. (*Nature* (London), vol. 163, p. 152; January 29, 1949.) Vols. 7 to 10 of the tables compiled by the staff of the Computation Laboratory, Harvard, covering orders 10 to 39. For orders above 15, a uniform interval of 0.01 is used for the argument. Vols. 3 to 6 were noted in 463 and 1396 of 1948.

518.2 1709

**Five-Figure Tables of Natural Trigonometrical Functions [Book Review]**—H. M. Nautical Almanac Office. H. M. Stationery Office, London, 1947, 124 pp., 15s. (*Nature* (London), vol. 163, p. 347; March 5, 1949.) An auxiliary table gives values of the cotangent for every second of arc up to 7:30'. The main table gives values of the sine, tangent, cotangent, and cosine at 10-second intervals.

## MEASUREMENTS AND TEST GEAR

531.76:681.11 1710

**A Watch Rate Recorder**—H. G. M. Spratt. (*Electronic Eng.*, vol. 21, pp. 39-44; February, 1949.) The amplified ticks of the watch under test actuate a printing bar and are recorded on a paper chart, which is driven at a constant known rate by a power source whose frequency is derived from a quartz oscillator. Circuit diagrams are given, together with detailed examples of the use of the instrument. See also 1669 of 1948 (Mackay and Soule) and 2838 of 1948 (van Suchtelen).

531.761 1711

**Time Service Equipment at the Dominion Observatory**—G. A. Eiby. (*N. Z. Jour. Sci. Tech.*, vol. 29, pp. 296-308; May, 1948.) The electrical wiring and relay system for this service is described, with photographs and circuit diagrams of certain parts of the equipment. The

development, present capabilities, and possible extension of the service are considered.

621.3.018.4(083.74) 1712

**Microwave Frequency Standards**—B. F. Huston and H. Lyons. (*Elec. Eng.*, vol. 67, pp. 436-439; May, 1948.) Long summary of AIEE paper. Discussion of a new National Bureau of Standards service providing frequency measurements and calibrations of frequency meters or voltage sources. The standard frequencies are derived from a primary 100-kc standard, accurate to 1 part in 10<sup>8</sup>, by frequency multiplication, conversion, and harmonic selection.

621.317 1713

**1949 IRE National Convention Program**—(Proc. I.R.E., vol. 37, pp. 160-178; February, 1949.) Abstracts are given of the following papers read at the convention:—12. Measuring the Efficiency of a Superheterodyne Converter by the Input-Impedance Circle Diagram, by H. A. Wheeler and D. Dettinger. 13. Electrolytic-Tank Measurements for Microwave Delay-Lens Media, by S. B. Cohn. 14. A Michelson-Type Interferometer for Microwave Measurements, by B. A. Lengyel. 15. Impedance Instrumentation for Microwave Transmission Lines, by P. A. Portmann. 16. A Broad-Band High-Power Microwave Attenuator, by H. J. Carlin. 17. An Absolute Method for Measuring Microwave Power of Low Intensity, by H. Herman. 21. The Measurement of Nonlinear Distortion, by A. P. G. Peterson. 32. An Impulse Generator-Electronic Switch for Visual Testing of Wide-Band Networks, by T. R. Finch. 33. A 50-Mc Wide-Band Oscilloscope, by A. M. Levine and M. Hoberman. 34. A Timing-Marker Generator of High Precision, by R. C. Palmer. 35. The Evaluation of Specifications for Cathode-Ray Oscillographs, by P. S. Christaldi. 51. Spectrum Analysis of Transient-Response Curves, by H. A. Samulon. 73. An AM Broadcast Station Monitor, by H. R. Summerhayes, Jr. 99. High-Impedance Millivolt Measurements above 5 Mc, by W. J. Volkers. 101. A Wide-Band Audio Phasemeter, by J. R. Ragazzini and L. A. Zadeh. 102. A Device for Admittance Measurements in the 50 to 500-Mc Range, by W. R. Thurston. 103. An Improved RF Capacitometer, by E. F. Travis and T. M. Wilson. Titles of other papers are given in other sections.

621.317.324†:621.396.615.141.2 1714

**Rotating Probe Machine**—G. L. Stambach. (*Electronics*, vol. 22, pp. 182, 189; March, 1949.) For investigating field patterns inside multi-cavity magnetrons. Brief details are given of construction and operation; measured and theoretical results are compared.

621.317.33(083.74) 1715

**Radio Standards**—L. Hartshorn and L. Esen. (Proc. I.R.E., part III, vol. 96, pp. 37-39; January, 1949.) The status and accuracy of the standards of capacitance, inductance, and frequency are briefly reviewed.

621.317.331:621.316.99 1716

**The Measurement of Earth Resistance**—H. Engel. (*Tech. Mitt. Schweiz. Telegr.-Teleph. Verw.*, vol. 27, pp. 14-20; February 1, 1949. In French and German.) An account of simple dc methods and also of a new method with particular advantages which uses the ac mains supply.

621.317.335.3†:621.315.611 1717

**Dielectric Measurement Methods for Solids at Microwave Frequencies**—W. H. Surber, Jr., and G. E. Crouch, Jr. (*Jour. Appl. Phys.*, vol. 19, pp. 1130-1139; December, 1948.) A high-loss dielectric sample is enclosed within a section of waveguide; the loss is then calculated from the SWR obtained with open-circuit and with short-circuit termination of the waveguide. Using the same apparatus, the loss of low-loss dielectrics can be measured by match-

ing-in the sample and using a frequency-variation method.

621.317.336 1718

**Impedance Measurements in Decimetre Wave Band**—B. Josephson. (*Kungl. Tekn. Högsk. Handl.* (Stockholm), no. 23, 70 pp.; 1948. In English.) For relatively low impedances, a standing-wave method is described in which the distance between the probe and the inner conductor is varied so as to keep the line voltage constant. For high impedances, a resonant-circuit method analogous in principle to a  $\Omega$  meter is considered. A comprehensive practical and theoretical study of the two methods includes detailed discussion of apparatus and results.

621.317.336:621.396.611.4 1719

**On the Measurement of Cavity Impedance**—W. W. Hansen and R. F. Post. (*Jour. Appl. Phys.*, vol. 19, pp. 1059-1061; November, 1949.) The ratio  $R/Q$  is defined, where  $R$  is the shunt resistance.  $R/Q$  is measured by observing the change in resonant wavelength caused by introducing small conducting buttons into the cavity.

621.317.44 1720

**An Arrangement for Maintaining a Constant Magnetic Field**—H. Naumann. (*Z. Angew. Phys.*, vol. 1, pp. 260-264; January, 1949.) Apparatus using large Helmholtz coils for producing fields of the order of that of the earth is compensated for external disturbing effects, both as regards intensity and direction, by means of a variometer. This variometer is operated by photo cells whose currents are controlled by the motion of small magnetic needles suitably oriented at points on the axis of the system.

621.317.444† 1721

**A Simple Direct-Reading Fluxmeter**—J. H. Briggs and W. H. Mitchell. (*Jour. Sci. Instr.*, vol. 26, pp. 40-42; February, 1949.) Eccentric cylindrical vanes of aluminium are thinly coated with dust iron having negligible hysteresis. The large torque in a field of the order of 1,000 gauss enables strong control springs and ball-ended pivots to be used for robust instruments that can measure fluxes up to 7,500 gauss, for magnets of various shapes, to an accuracy within 2 per cent.

621.317.7+621.396.69 1722

**Standardised Super-High-Frequency Components and Instruments**—(See 1633.)

621.317.73 1723

**An Automatic Impedance Meter**—H. Werthén and B. Nilsson. (*Kungl. Tekn. Högsk. Handl.* (Stockholm), no. 8, 95 pp.; 1947. In English.) The meter includes a signal generator and alternative recording instruments for rough and accurate measurements respectively. Attenuation and phase can be determined for 2-terminal and 4-terminal networks, at frequencies from 10 to 500 kc.

621.317.73:621.315.2.029.6 1724

**A Pulse Test Set for the Measurement of Small Impedance Irregularities in High-Frequency Cables**—F. F. Roberts. (Proc. I.R.E., part III, vol. 96, pp. 17-23; January, 1949.) The impedance irregularities are measured in terms of the return loss (up to 90 db) of echo pulses reflected from the irregularities when 0.3-microsecond 20-Mc pulses are fed into the coaxial cable.

621.317.761 1725

**Some Problems in the Accurate Measurement of Frequencies in the Region of Microwaves (1,500-40,000 Mc/s)**—M. Denis and B. Epstein. (*Ann. Radioélec.*, vol. 4, pp. 12-25; January, 1949.) Standard-frequency generators of the type developed at the National Bureau of Standards are described and the possibility

is considered of using klystron frequency multipliers, associated if need be with traveling wave tube amplifiers, in lieu of some of the crystal multipliers normally used at uhf. Methods of calibrating cavity-type frequency meters are described and block diagrams are given. A suitable klystron frequency multiplier is the X.M. 10, this has an input cavity whose resonance frequency is adjustable from 250 to 310 Mc, and an output cavity giving any harmonic of the input from the 8th to the 13th. A frequency band from 2,000 to 4,000 Mc can thus be covered with a useful power of about 250 mw, the high-frequency input power being about 5 watts. Crystal multipliers can then extend the range to frequencies of the order of 40,000 Mc.

621.317.772 1726

**An Electronic Phasemeter**—E. F. Florman and A. Tait. (Proc. I.R.E., vol. 37, pp. 207-210; February, 1949.) An instrument designed to read within  $0.5^\circ$  and record directly on calibrated scales the phase angle between two sinusoidal voltages for a voltage range of 1 to 30 volts and frequency range 100 to 5,000 cps. The voltages are converted to square waves through cascade amplifiers and limiters and applied to two separate phase indicators. One of these has a  $180^\circ$  ambiguity and records the average of the algebraic sum of the square waves. The second indicator is unambiguous; the square waves are differentiated and the proper resultant pulses are used to fire an Eccles-Jordan trigger circuit. The average trigger-tube anode current is proportional to the phase angle between the input voltages.

621.317.784 1727

**Absolute Power Measurement at Microwave Frequencies**—A. L. Cullen. (Nature (London), vol. 163, p. 403; March 12, 1949.) The technique is similar to that used for measuring light-radiation pressure with a torsion balance.

621.317.784:621.314.2.029.3 1728

**Audio Frequency Transformer Design**—Brockelsby. (See 1607.)

621.317.79:621.392.26† 1729

**The Reflectometer**—H. R. Allan and C. D. Curling. (Proc. I.R.E., part III, vol. 96, pp. 25-30; January, 1949.) General theory is given and a design suitable for waveguides using 10-cm waves is described. Applications to the monitoring of standing waves and transmitted power in a radar transmitter system and to the testing of radar receiver sensitivities are considered; reflectometer methods are shown to be superior to other methods. See also 3968 of 1947 (Parzen and Valow).

621.396.662(083.74) 1730

**Microwave Attenuation Standard**—R. E. Grantham and J. J. Freeman. (Elec. Eng., vol. 67, pp. 535-537; June, 1948.) Long summary of AIEE paper.) A standard has been established using the heterodyne or if substitution method of calibration. A preliminary model of the standard has been built and its accuracy is within 0.02 db and 0.02 percent of measured attenuation in the 0 to 10 db and 10 to 50-db ranges respectively. Methods of eliminating unwanted modes are discussed.

#### OTHER APPLICATIONS OF RADIO AND ELECTRONICS

534.321.9.001.8:539.32 1731

**Determination of the Elastic Constants of Solids by Ultrasonic Methods**—W. C. Schneider and C. J. Burton. (Jour. Appl. Phys., vol. 20, pp. 48-58; January, 1949.)

535.61-15:621.383 1732

**Infra-Red Location [of objects] with Lead Sulphide Cells**—W. Oehmann. (Elektron Wiss. Tech., vol. 3, pp. 96-101; March, 1949.) A description of German equipment for the location

of aircraft, ships, etc. A parabolic mirror 150 cm in diameter, with a special reflector system, concentrates the received radiation on the sensitive cell. A device using a rotating glow lamp provides a visual indication of direction adjustment, a sector of light of increasing extent being seen as the mirror axis approaches the target, with a complete ring of light when on target. Under good conditions, the range for aircraft is of the order of 20 km and the accuracy of location within  $\frac{1}{16}$  degree.

Optical apparatus, developed at a later date used lenses 8 cm in diameter made from a special material, principally lithium fluoride, with very good infrared transmission properties. With this apparatus, a bomber could be located at a distance of 3 km.

539.16.08+621.3 1733

**1949 IRE National Convention Program** (Proc. I.R.E., vol. 37, pp. 160-178, February, 1949.) Abstracts are given of the following papers read at the convention: 57. The RF System for the University of Rochester 130 inch Synchrocyclotron, by W. W. Salisbury. 59. Design of a G-M Counter Tube for High Counting Rates, by W. W. Managan. 61. Proportional-Counter Equipment for Beta Detection, by W. Bernstein. 62. Industrial Thickness Gauges employing Radioisotopes, by J. R. Carlin. 77. Radar-Circuit-Powered X-Ray Movie Equipment for Operation at 150 Frames per Second, by D. C. Dickson, Jr., C. T. Zavales, and I. F. Ehrke. 104. A Radio Frequency Gas Discharge Phenomenon and its Application to Mechanical Measurements, by K. S. Lyon and J. W. Sheetz. Titles of other papers are given in other sections.

550.838:538.71 1734

**Canadian Aerial Magnetic Surveys (M.A.D.)**—R. Bailey. (Canad. Jour. Res., vol. 26, sec. F, pp. 523-539; December, 1948.) Tests with an airborne magnetic detector measuring the earth's total field indicate that it has a high degree of accuracy and speed for reconnaissance work over large areas and is cheap to operate.

551.508.1:621.396.9 1735

**The Development of the Meteorological Office Radar Reflector, Mk. IIB**—O. M. Ashford and H. J. Ferrer. (Met. Mag., vol. 77, pp. 224-227; October, 1948.) The development and performance of a corner reflector, with planes of nylon mesh impregnated with silver, for use with 10-cm radar in the detection of upper winds. The reflector performs slightly better than a standard 3-foot paper reflector; it has less drag and requires less storage space.

621.317.39 1736

**Electronic Gauges**—J. Schwartz. (Microtechnic (Lausanne), vol. 2, pp. 199-206 and 267-274; October and December, 1948. In English.) Discussion of various devices for transforming mechanical quantities into electrical voltages, including (a) piezoelectric gauging heads for measuring large pressures or forces, (b) strain gauges of the resistance type, (c) gauges using variation of capacitance, magnetic flux or inductance, and (d) arrangements which transform dimension changes into variations of the illumination of photo cells. The relative merits of these various types for precision measurements are considered; methods using variations of capacitance or inductance are particularly suitable for precision measurements of length.

621.317.39:620.178.3 1737

**Vibration Testing of Airplanes**—A. R. Willson. (Electronics, vol. 22, pp. 86-91; March, 1949.) Fatigue and vibration test methods are described and the layout of equipment for a typical aircraft test is illustrated. Below 7 cps, motor-triggered thyratrons operate the electromotive source of vibration, while electronic equipment is used for higher frequencies. Measuring and recording techniques are described and the type of oscillograph record obtained is

shown. See also 3217 of 1947 (Cogan) and 3218 of 1947 (Corke).

621.365.5† 621.365.92 1738

**Radio-Frequency Heating**—I. Hartshorn. (Vol. Proc. Roy. Inst., vol. 33, no. 153, pp. 541-553, 1948.) Discussion of the underlying principles of induction and dielectric heating, with illustrative examples.

621.38.001.8 1739

**Design for a Brain**—W. Gray Walter, W. Summer, H. F. Shepard, A. Greenwood Wilson, P. I. Hobson, W. R. Ashby. (Electronic Eng. (London), vol. 21, pp. 62-63, February, 1949.) Discussion on 1144 of May.

621.38.001.8:061.3 1740

**Applications of Electronics to Research and Industry**—(Nature (London), vol. 163, pp. 291-297, February 19, 1949.) For another account see 1145 of May.

621.38.001.8:578.088.7 1741

**Electronic Mapping of the Activity of the Heart and the Brain**—S. Goldman, W. I. Vivian, Chi Kuang Chen, and H. N. Bowes. (Science, vol. 108, pp. 720-723; December 24, 1948.) Any point  $P$  of the surface of the chest or skull corresponds to a point  $P'$  on the face of a cathode-ray tube. The brightness at  $P'$  is proportional to the potential at  $P$ .

621.38.001.8:615.84 1742

**The Electromedical Significance of Decimetre and Centimetre Waves**—W. Reuss. (Elektronik (Berlin), vol. 3, pp. 3-10, January, 1949.) Review of capacitor, inductor, and radiation methods of applying high frequency energy in medicine, with discussion of the absorption of dm and cm waves by various organic substances, selective effects, and methods of treatment.

621.384.611.1† 1743

**16-MeV Betatron at the Clarendon Laboratory, Oxford**—(Engineering (London), vol. 167, pp. 55-58, January 21, 1949.) For an earlier account see 3482 of 1948 (Wilkinson, Tuck, and Retton).

621.384.62† 1744

**A Proposed New Form of Dielectric-Loaded Wave-Guide for Linear Electron Accelerators**—R. B. R. S. Harvie. (Nature (London), vol. 162, p. 890; December 4, 1948.) A cylindrical metal waveguide has dielectric loading in the form of circular washers, whose thickness and spacing are small compared with the wavelength in the waveguide. The washers have a smaller dielectric constant in the direction of the waveguide axis than in the transverse directions. This anisotropy reduces power losses. The total losses compare favorably with those for a corrugated waveguide. A numerical example is discussed.

621.385.833 1745

**The Theoretical Resolution Limit of the Electron Microscope**—O. Scherzer. (Jour. Appl. Phys., vol. 20, pp. 20-29, January, 1949.) The resolving power of the electron microscope and the contrast in the image are calculated for different conditions of focusing, illumination, and aperture.

621.385.833 1746

**The Optical Properties of Electrostatic Lenses, and the Proton Microscope**—P. Chanson. (Ann. Phys. (Paris), vol. 2, pp. 333-413, July and August, 1947.) A comprehensive treatment, including discussion of aberration and of the resolving power of the electron microscope. With the proton microscope, higher resolution should be possible.

621.385.833 1747

**A New Horizontal Electron Microscope**—N. N. Das Gupta, M. L. De, D. T. Bhattacharya, and A. K. Chaudhury. (Indian Jour.

*Phys.*, vol. 22, pp. 497-513; November, 1948.) Technical details of construction, power supplies, and operation of an instrument constructed at the University College of Science, Calcutta. Capable of operating at a maximum electron energy of 80,000 eV, it is designed to give a magnification of 20,000 diameters. The horizontal arrangement enables any part to be easily dismantled or adjusted. An historical outline of research in this field is also given.

**621.385.833** 1748  
Electron Microscopy—C. J. Burton. (*Anal. Chem.*, vol. 21, pp. 36-40; January, 1949.) A survey of progress in the last 10 years, with bibliography of 159 references.

**621.385.833:061.3** 1749  
Electron Microscopy Conference [Cambridge, England, Sept. 1948]—V. E. Cosslett. (*Nature* (London), vol. 163, pp. 32-34; January 1, 1949.) A general account of the proceedings.

**621.385.833:621.316.722.1** 1750  
Stabilization of the Accelerating Voltage in an Electron Microscope—van Dorsten. (*See* 1805.)

**621.385.833:621.317.729:[537.291+538.691**

**1751**  
Plotting Electron Trajectories—K. F. Sander, C. W. Oatley, and J. G. Yates. (*Nature* (London), vol. 163, p. 403; March 12, 1949.) A new method for electron optical systems. A differential analyzer is used to integrate the equations of motion of an electron, the components of acceleration being determined by automatic measurements in an electrolyte tank. Results obtained agree satisfactorily with theory.

**621.386.1:778.332:548.73** 1752  
An Improved X-Ray Diffraction Camera—W. Parrish and E. Cisney. (*Phillips Tech. Rev.*, vol. 10, pp. 157-167; December, 1948.) Various factors involved in design and interrelated in their influence on the properties of diffraction patterns are considered.

**621.38.001.8** 1753  
Industrial Electronics Reference Book [Book Review]—Westinghouse Electric Corp. J. Wiley, New York, N. Y.: Chapman and Hall, London, 1948, 680 pp., \$7.50. (*Science*, vol. 109, p. 44; January 14, 1949.) A "digest embracing the applications as well as the design data." Many excellent graphs, tables, and illustrations concerning materials and equipment are included; theory is necessarily treated briefly. See also *Electronics*, vol. 22, pp. 247, 248; March, 1949.

## PROPAGATION OF WAVES

**535.421:538.56** 1754  
On the Diffraction of Electromagnetic Waves at a Wire Grid—R. Honerjäger. (*Ann. Phys.* (Lpz.), vol. 4, pp. 25-45; September 20, 1948.) The theory of Wessel (5 of 1940) for plane waves incident normally on an unlimited plane grid of parallel wires applied to wavelengths exceeding half the grid spacing. The theory is here extended to any angle of incidence and any wavelength, and verified by experiments with waves in a rectangular waveguide.

**538.566** 1755  
Study of the Wave obtained by Total Vitreous Reflection in Media with Non-Zero Magnetic Susceptance—H. Arzelès. (*Ann. Phys.* (Paris), vol. 2, pp. 517-535; September and October, 1947.) The classical formulas of Fresnel only apply to nonmagnetic media. The corresponding general formulas here derived are symmetrical for the two principal waves and are consequently, in spite of their generality, easier to handle than the particular formu-

las of Fresnel. Applications to the technique of centimeter and millimeter waves are discussed.

**538.566** 1756  
On the Calculation of the Electromagnetic Energy Dissipated in a Medium with Selective Absorption—H. Arzelès. (*Ann. Phys.* (Paris), vol. 2, pp. 536-544; September and October, 1947.)

**621.396.11** 1757  
1949 IRE National Conventional Program—(PROC. I.R.E., vol. 37, pp. 160-178; February, 1949.) Abstracts are given of the following papers read at the convention:—42. VHF Television—Propagation Aspects, by E. W. Allen Jr. 43. Propagation Variations at VHF and UHF, by K. Bullington. 44. Propagation Tests at UHF, by J. Fisher. 45. A Test of 450-Mc Urban-Area Transmission to a Mobile Receiver, by A. J. Aikens and L. Y. Lacy. 46. Echoes in Transmission at 450 Mc from Land-to-Car Radio Units, by W. R. Young and L. Y. Lacy. 88. An Analysis of Distortion Resulting from Two-Path Propagation, by I. H. Gerks. 91. Propagation Conditions and Transmission Reliability in the Transitional Microwave Range, by T. F. Rogers. Titles of other papers are given in other sections.

**621.396.11** 1758  
Ground-Wave Propagation over an Inhomogeneous Smooth Earth—G. Millington. (PROC. I.R.E., part III, vol. 96, pp. 53-64; January, 1949.) Assuming the inhomogeneity to consist of annulae of homogeneous earth, concentric with the transmitter, the terminal field strength for short waves is shown to be the geometric mean of the values it would have if the earth were homogeneous and of the type near (a) the transmitter and (b) the receiver. Energy considerations enable the result to be extended, approximately, for longer waves. A tentative solution at the boundary shows that there is a recovery of field strength before attenuation sets in, when the wave passes to a more highly conducting region. Stress is laid on the need for more experimental verification.

**621.396.11** 1759  
Radiation Pressure of Centimetre Waves—N. Carrara and P. Lombardini. (*Nature* (London), vol. 163, p. 171; January 29, 1949.) The pressure was measured by the torque produced on a torsion balance in a rarefied atmosphere at a pressure of 10 mm Hg. The balance was placed near the mouth of a rectangular waveguide connected to a magnetron generating 50 watts mean power at  $\lambda=3$  cm. The observed pressure was about  $10^{-2}$  dyne/cm<sup>2</sup>. Theoretical considerations suggest a reduction in radiation pressure inside a waveguide.

**621.396.11:551.510.52** 1760  
Theory and Practice of Tropospheric Sounding by Radar—A. W. Friend. (PROC. I.R.E., vol. 37, pp. 116-138; February 1949.) 1948 IRE National Convention paper. Soundings have been made (a) at medium-frequency between 1935 and 1942, (b) more recently, by means of a modified SCR-584 and AN/CPS-1 (MEW) microwave radar, with continuous photographic recording. The types of echo that can be received in each of these cases are discussed, with illustrative examples; they include, at medium frequencies, discrete echoes from air-mass boundaries or thick regions of relatively high dielectric-constant gradient and, with microwaves, scattering from raindrops, snowflakes, etc., and dot, line, and other unusual weak-echo signals. The origins of many microwave echoes appear from theory and experimental evidence to be in the fine structures of the dielectric transition layers of air-mass boundaries and turbulent regions. Much valuable information could be obtained by the use of 3 vertical beam systems for simultaneous and continuous sounding and recording, operating with high-gain antennas and the maximum

power available at frequencies of say 400, 4,000 and 40,000 Mc.

**621.396.11:551.510.52** 1761  
A Theory on Radar Reflections from the Lower Atmosphere—W. E. Gordon. (PROC. I.R.E., vol. 37, pp. 41-43; January, 1949.) "Angels" may be attributed to sharp changes in the dielectric constant produced by atmospheric turbulence.

**621.396.11:551.510.535** 1762  
Predicting Maximum Usable Frequency from Long-Distance Scatter—A. H. Benner. (PROC. I.R.E., vol. 37, pp. 44-47; January, 1949.) From observations of long-distance scatter, it is concluded that E-layer clouds are responsible for the leading edge of the echo but that the maximum amplitude is returned from the ground. This is used as a basis for calculating the maximum usable frequency from the time delay of the scatter.

**621.396.11:551.510.535** 1763  
Deviation at Vertical Incidence in the Ionosphere—G. Millington. (*Nature* (London), vol. 163, p. 213; February 5, 1949.) Even at vertical incidence, the reflection points of the ordinary and extraordinary rays can be separated by a horizontal distance of some 50 km if the frequency is near the ordinary-ray critical frequency. *P/f* records, therefore, need careful interpretation if a large horizontal gradient in ionization is likely.

**621.396.11:551.510.535** 1764  
The Radio Amateur and Upper Atmosphere Research—Ferrell. (*See* 1666.)

**621.396.11:551.551** 1765  
The Problem of Diffusion in the Lower Atmosphere—Sutton. (*See* 1667.)

**621.396.11:551.553.11** 1766  
Sea Breeze Structure with Particular Reference to Temperature and Water Vapour Gradients and Associated Radio Ducts—Hatcher and Sawyer. (*See* 1668.)

**621.396.812+538.566.3** 1767  
Photographic Record and Diagrams of Luxembourg Effect with Resonance (Gyro-Interaction)—M. Cutolo and R. Ferrero. (*Nature* (London), vol. 163, pp. 59-60; January 8, 1949.) Discussion of the results of observations carried out in May and June, 1948, to measure the depths of parasitic modulation obtained when using a disturbing wave whose frequency was equal to the local gyrofrequency. For earlier work, see 513 of 1947 (Cutolo, Carlevaro, and Ghergi), 2055 of 1948 (Cutolo), and 1477 of May.

## RECEPTION

**621.316.729:621.396.619.16:621.396.41** 1768  
Synchronization for the PCM Receiver—J. M. Manley. (*Bell. Lab. Rec.*, vol. 27, pp. 62-66; February, 1949.) The incoming pulse frame is automatically and continuously examined every 125 microseconds. Any errors of alignment are corrected in under 0.1 second by a switch system.

**621.396.621** 1769  
1949 IRE National Convention Program—(PROC. I.R.E., vol. 37, pp. 160-178; February, 1949.) Abstracts are given of the following papers read at the convention:—100. Some Aspects of the Performance of Mixer Crystals, by P. D. Strum. 125. Design in Nature [for improved signal-to-noise ratio] as Exploited by the Communication Engineer, by L. A. de Rosa. 128. Signal-to-Noise Improvements through Integration in a Storage Tube, by J. V. Harrington and T. F. Rogers. 129. Theory of Receiver Noise Figure, by L. J. Cutrona. Titles of other papers are given in other sections.

**621.396.621** 1770  
Panoramic Reception—S. A. W. Jolliffe and



J. D. Peat. (*Marconi Rev.*, vol. 12, pp. 27-33; January to March, 1949.) General design considerations are discussed and a panoramic adaptor for the Type CR. 100 communications receiver is described in detail.

621.396.621 1771

**The Marconi Single Sideband Receiver Type CRD.150/20B-SSR-2.**—C. P. Beanland. (*Marconi Rev.*, vol. 12, pp. 21-26; January to March, 1949.) Advantages of single-sideband working for short-wave radio links are discussed. The receiver is adapted for single-sideband working from a basic receiver unit Type CRD.150/20B which by itself is a triple-diversity commercial telephony receiver.

621.396.621:621.396.619.13 1772

**The Demodulation of a F.M. Carrier and Random Noise by a Limiter and Discriminator**—N. M. Blachman. (*Jour. Appl. Phys.*, vol. 20, pp. 38-47; January, 1949.) Analysis based on the statistics of random noise. When the degree of limiting is large, as the input signal-to-noise ratio  $s_1$  increases from 0 to 6 db, the output signal-to-noise ratio increases sharply from a value far below  $s_1$  to a value only 0.9 db below. As the limiting action is reduced, so the ratio of output versus input signal-to-noise ratio tends to increase to the values obtained with square-law detection of a carrier with 100 per cent AM.

621.396.621.53 1773

**On the Mixing Properties of Non-Linear Condensers**—A. van der Ziel. (*Jour. Appl. Phys.*, vol. 19, pp. 999-1006; November, 1948.) If the charge and voltage are assumed to be related by the equation

$$Q = \alpha_0 V + \alpha_1 V^2 + \alpha_2 V^3 + \dots,$$

it is shown that the conversion transconductance is imaginary and the input and output impedances are capacitive. If the mixing oscillator frequency  $f_m$  is lower than the signal frequency  $f_s$ , the power gain is less than unity; if  $f_m > f_s$ , oscillations may occur; and if the  $f_m + f_s$ , frequency instability may result. Bandwidth and noise factor are discussed, and a few supporting experiments described. A brief comparison with Pound's work (2609 of 1948) on diodes is given.

621.396.622+621.315.59+621.314.6+621.383 1774

**German Research on Semi-Conductors, Metal Rectifiers, Detectors and Photocells [Book Notice]**—(See 1700.)

621.396.622.71 1775

**A Study of the Operating Characteristics of the Radio Detector and its Place in Radio History**—E. H. Armstrong. (*Proc. Radio Club Amer.*, vol. 25, no. 3, pp. 3-20; 1948.) An experimental investigation of the FM ratio detector, with circuit diagrams and oscillograms. See also 2346 of 1948 (Seeley) and back references.

621.396.822 1776

**Some Notes on Noise Figures**—H. Goldberg. (*Proc. I.R.E.*, vol. 37, p. 40; January, 1949.) Corrections to 505 of March.

621.396.822:621.318.572 1777

**Spurious Signals Caused by Noise in Triggered Circuits**—D. Middleton. (*Jour. Appl. Phys.*, vol. 19, pp. 817-830; September, 1948.) The expected number of spurious peaks per second, caused by noise or by a triggering pulse in the presence of noise, above a given triggering level, is calculated. The effects of bandwidth, pulse shape, filter response-curve shape, and rectification are considered. Significantly improved rejection of spurious peaks by a circuit follows only when the maximum tolerable number of triggering peaks is of the same order of magnitude as the noise bandwidth. Results are summarized in tables and curves.

621.396.822:621.396.619.16 1778

**Noise in a Pulse-Frequency-Modulation System**—F. L. H. M. Stumpers. (*Philips Res. Rep.*, vol. 3, pp. 241-254; August, 1948.) The optimum filter for pulse-frequency modulation is derived for any given pulse form and large signal-to-noise ratio. For some special pulse forms, the signal-to-noise ratio is calculated and normal FM is shown to give a better result. A method of calculating the noise spectrum is given; it is valid for all signal-to-noise ratios but is intricate. The noise threshold is estimated and the suppression of the modulation by noise is considered.

621.396.823 1779

**Radiation from Car Ignition Systems**—B. G. Pressey and G. E. Ashwell. (*Wireless Eng.*, vol. 26, pp. 31-36; January, 1949.) Field strength measurements on a typical car ignition system were made with a set having a bandwidth of 2.5 Mc and a cathode-ray indicator. The general level of the field was maintained throughout the frequency range of 40 to 650 Mc and its value was about 10 millivolts per meter at a distance of 9 meters, for either vertical or horizontal polarization. The effect of two resistive suppressor systems was examined; suppression ratios of the order of 20 db were obtained.

621.396.823:537.523.3 1780

**Radio Influence from High-Voltage Corona**—G. R. Slemmon. (*Elec. Eng.*, vol. 68, pp. 139-143; February, 1949.) Experiments were conducted using a single conductor at high voltage mounted parallel to an earthed plane. Experimental verification of Peek's formula for corona threshold voltage was obtained. Noise threshold was independent of frequency, though increase of frequency produced increased noise. Noise from a smooth conductor was produced only during negative peaks of the applied ac voltage. Weathering and conductor-contamination usually reduced noise considerably, indicating a possible method of controlling corona interference. Water on the conductor caused severe noise with positive dc, but eliminated noise with negative dc. In all cases, the initiation of audible sound and light radiation was coincident with that of radio noise.

621.396.828 1781

**The Measurement and Suppression of Radio Interference**—J. H. Evans. (*Jour. Brit. I.R.E.*, vol. 9, pp. 46-59; February, 1949.) A survey of the nature of interference and the principles of its measurement, with particular reference to mains-borne noise and domestic appliances. A comprehensive measuring set and a simpler version for factory use are briefly described. Methods of suppression and the difficulties of application are discussed. The recommended limits of interference are considered and some of the anomalies arising from the specification of such limits are indicated.

621.396.828 1782

**Heterodyne Eliminator**—J. L. A. McLaughlin. (*Electronics*, vol. 22, pp. 83-85; March, 1949.) For high attenuation of interference at frequencies close to that of a continuous-wave or modulated carrier. There is no loss in transmitted intelligence.

## STATIONS AND COMMUNICATION SYSTEMS

621.39:665.5 1783

**Telecommunications in the Petroleum Industry**—Z. Friedberg. (*Jour. Inst. Petroleum*, vol. 34, pp. 309-330; May, 1948.) A general description of systems used by oil companies. The basic principles essential for securing reliable communications under the conditions encountered are outlined.

621.39.001.11:621.396.822 1784

**Communication in the Presence of Noise**—Shannon. (See 1649.)

621.396 1785

**1949 IRE National Convention Program**—(*Proc. I.R.E.*, vol. 37, pp. 160-178; February, 1949.) Abstracts are given of the following papers read at the convention:—1. Development of a High-Speed Communication System, by D. S. Bond. 2. Distortion in a Pulse-Count-Modulation System with Nonuniform Spacing of Levels, by P. F. Panter and W. Dite. 3. Cross-Talk Considerations in Time-Division Multiplex, by S. Moskowitz, L. Diven, and L. Feit. 4. Experimental Verification of Various Systems of Multiplex Transmission, by D. R. Crosby. 5. Interference Characteristics of Pulse-Time Modulation, by E. R. Kretzmer. 6. Factors Involved in the Design of an Improved Frequency-Shift Receiving System [for Naval facsimile], by C. C. Rae. 67. Television by Pulse-Code Modulation, by W. M. Goodall. 110. A Microwave System for Television Relaying, by J. Z. Millar and W. B. Sullinger. 112. Intercity Television Radio Relays, by W. H. Forster. 113. Video Design Considerations in a Television Link, by M. Silver, H. French, and L. Staschover. 114. Six-Channel Urban Mobile System with 60-ke Spacing, by R. C. Shaw, P. V. Dimock, W. Strack, and W. C. Hunter. 117. Theoretical Aspects of Nonsynchronous Multiplex Systems, by W. D. White. 126. Experimental Determination of Correlation Functions and the Application of these Functions in the Statistical Theory of Communications, by T. P. Cheatham, Jr. 127. The Transmission of Information through Band-Limited Transmission Systems, by W. P. Boothroyd and E. M. Creamer, Jr. Titles of other papers are given in other sections.

621.396.61/.62 1786

**Modifying the T.R.1143 for Amateur Use**—G. L. Benbow. (*RSGB Bull.*, vol. 24, pp. 85-87; October, 1948.) The T.R. 1143 covers frequencies from 100 to 125 Mc and is obtainable under the Ministry of Supply disposals scheme. Full circuit details for the conversion are given, with practical notes.

621.396.61'.62:534.86:621.395.623.7 1787

**Fundamental Electroacoustic Principles for the Transmission of a Wide Band of Audio Frequencies**—W. Furrer, A. Lauber, and P. Werner. (*Tech. Mitt. Schweiz. Telegr.-Teleph.-Verw.*, vol. 27, pp. 3-14; February 1, 1949. In French and German.) Microphones, amplifiers, transmitter and receiver circuits, and the acoustic properties of studios are today all capable of meeting requirements for an af band extending up to about 15 kc. The outstanding problem is that of loudspeakers, which are particularly considered here. Some types of combination coaxial loudspeakers give satisfactory results. For high-fidelity ultra-short-wave reception, special loudspeakers appear indispensable, even if this does increase the cost considerably.

621.396.619.16 1788

**Timing Control for PCM**—A. E. Johanson. (*Bell. Lab. Rec.*, vol. 27, pp. 10-15; January, 1949.) A detailed explanation, with block and wave-form diagrams.

621.396.619.16 1789

**The Spectrum of Modulated Pulses**—E. Fitch. (*Proc. IEE* (London), part III, vol. 96, p. 24; January, 1949.) Discussion on 2619 of 1948. See also 3752 of 1946 (Gladwin).

621.396.619.16:621.396.41 1790

**Multiplex Employing Pulse-Time and Pulsed-Frequency Modulation**—H. Goldberg and C. C. Bath. (*Proc. I.R.E.*, vol. 37, pp. 22-28; January, 1949.) Pulsed time-division transmission channels may be effectively doubled in number by adding FM bursts on the pulsed microwave carrier. Experimental studies indicate that crosstalk on either channel may be kept 60 db below maximum output, in the worst case of a single pulse-time channel. Ex-

perimental transmitter and receiver circuits and wave forms are described and illustrated.

**621.396.619.16:621.396.41:621.316.729** 1791  
Synchronization for the PCM Receiver—Manley. (See 1768.)

**621.396.65:621.396.932** 1792  
The Great Lakes Radiotelephone System—R. H. Herrick. (*Elec. Eng.*, vol. 68, pp. 152-157; February, 1949.) Description of the ship and shore equipment and services provided. See also 2432 of 1947.

**621.396.65.029.64** 1793  
A Broad-Band Microwave Relay System between New York and Boston—G. N. Thayer, A. A. Roetken, R. W. Friis, and A. L. Durkee. (*Proc. I.R.E.*, vol. 37, pp. 183-188; February, 1949.) See 2920 of 1948 (Chaffee) and back references.

**621.396.712** 1794  
The Skeleton Short-Wave Transmitting Station of the British Broadcasting Corporation—(*Engineering* (London), vol. 167, pp. 7-9 and 32-33; January 7 and 14, 1949.) A fuller account than that noted in 3521 of 1948.

**621.396.712.3+621.397.7** 1795  
Planning Radio and Television Studios—G. M. Nixon. (*Broadcast News*, pp. 58-69; December, 1948.) General discussion of requirements of space, shape, noise prevention, control arrangements, etc.

**621.396.72** 1796  
Headquarters' Station GB1RS—(*RSGB Bull.*, vol. 24, pp. 26-27; August, 1948.) A short description of the equipment, which is crystal-controlled on a frequency of 3,500.25 kc. This frequency and its harmonics provide a series of points below which an amateur transmitter in the 3.5-, 7-, 14-, or 28-Mc bands cannot be considered "safely inside." Transmission, lasting a few minutes, are made each hour from 0600 to 2400 G.M.T. (or B.S.T. if in force) in Morse code at 12 words per minute.

**621.396.931** 1797  
V.H.F. Radio Equipment for Mobile Services—D. H. Hughes. (*Jour. Brit. I.R.E.*, vol. 9, pp. 30-44; January, 1949.) The advantages of the frequency band 30 to 180 Mc for local radio-telephone services to vehicles and the planning of such systems are reviewed. The design of suitable transmitters and receivers for the mobile and fixed stations is illustrated by a description of a particular type of equipment. Future trends in development are discussed.

**621.396.932** 1798  
Single Sideband Radio-Telephony—H. D. B. Kirby. (*Wireless World*, vol. 55, pp. 90-91; March, 1949.) An outline of single-sideband working is given, together with the block diagram of a 300-watt transmitter installed on the liner Caronia. Two signals, together with the output of a 100-kc oscillator, are fed to balanced modulators. Crystal filters select the upper sideband from one and the lower sideband from the other. These are mixed with a greatly reduced carrier and applied with the output of a 3-Mc oscillator to another balanced modulator. A 3.1-Mc filter selects the upper modulation product, which is mixed with a variable frequency (7 to 19 Mc) to give the signal frequency (4 to 22 Mc). See also *Engineer* (London), vol. 187, p. 145; February 4, 1949.

**621.396.932** 1799  
Caronia Radio Equipment—(*Wireless World*, vol. 55, pp. 91-92; March, 1949.) A few details of the various telegraphy, telephony, direction finders, and radar sets installed in SS. Caronia.

#### SUBSIDIARY APPARATUS

**621-526+621.316.7+621.396.68** 1800  
1949 IRE National Convention Program—

(*Proc. I.R.E.*, vol. 37, pp. 160-178; February, 1949.) Abstracts are given of the following papers read at the convention:—36. Photographic Techniques in Cathode-Ray Oscillography, by C. Berkley and H. Mansberg. 60. High-Voltage Supplies for Radiation-Measuring Equipment, by R. Weissman and S. Fox. 72. Improved Degenerative Regulators, by Y. P. Yu. Titles of other papers are given in other sections.

**621-526:629.13.014.57** 1801  
Automatic Pilots—Owen. (See 1680.)

**621.313.12:538.652:534.232** 1802  
Magnetostriction Generators—J. A. Osborn. (*Elec. Eng.*, vol. 67, pp. 571-578; June, 1948.) A survey of fundamental magnetostriction phenomena and their application to the conversion of mechanical to electrical energy, and vice versa.

**621.313.3:629.135** 1803  
A Rectified A.C. Electric System for Aircraft—L. M. Cobb, W. L. Kershaw, and Q. E. Erlanson. (*Elec. Eng.*, vol. 68, pp. 95-101; February, 1949.) A system using four 30-volt 3-phase engine-driven alternators, each output being rectified by means of a Se rectifier to 28 volts dc and connected to a common bus-bar. Two 34-ampere hour batteries provide initial field excitation and are permanently connected in parallel with the supply. Each rectifier, with suitable cooling arrangements, can supply 400 amperes. An estimated over-all efficiency of 72 per cent is obtained.

**621.316.722** 1804  
Some Characteristics of Glow-Discharge Voltage Regulator Tubes—E. W. Titterton. (*Jour. Sci. Instr.*, vol. 26, pp. 33-36; February, 1949.) Measurements of samples of different tube types indicate that (a) the static characteristics show negative resistance discontinuities, (b) hysteresis voltage effects occur under dynamic conditions, and (c) characteristics of tubes of the same type differ widely. The input voltage with series resistor is calculated in terms of the load current and the permissible tube current.

**621.316.722.1:621.385.833** 1805  
Stabilization of the Accelerating Voltage in an Electron Microscope—A. C. van Dorsten. (*Philips Tech. Rev.*, vol. 10, pp. 135-140; November, 1948.) Two regulating tubes are used in a feedback circuit to keep the voltage constant within 0.02 per cent for at least 30 seconds at any level between 50 and 150 kv.

**621.362** 1806  
Thermoelectric Generator Designs—G. B. Ellis. (*Elec. Eng.*, vol. 67, pp. 657-660; July, 1948.) Theoretical and practical aspects of the design of thermocouples as sources of power are discussed and the required magnitude of some of the thermal and electrical characteristics is indicated. No efficient thermocouple has yet been developed; the best approach may be in the field of semiconductors. Characteristics of some materials are given.

**621.396.68** 1807  
Some Additions to the Theory of Radio-Frequency High-Voltage Supplies—G. W. C. Mathers. (*Proc. I.R.E.*, vol. 37, pp. 199-206; February, 1949.) The double-tuned over-coupled air transformer is represented by an equivalent primary circuit, which is used to develop the theory of the oscillator, including the two possible operating frequencies, the necessary conditions for oscillation and maximum efficiency, and the variation of operating frequency and load resistance with primary tuning. At the operating frequency, the load impedance is purely resistive. The various resistances in the circuit representing the power losses and the load resistance are included in the equivalent circuit resistance, which appears as the anode load of the class-C oscillator tube.

Methods of designing a circuit to give any required power and voltage output are discussed.

**621.396.68:621.397.62:535.88** 1808  
Projection-Television Receiver: Part 3—The 25-kV Anode Voltage Supply Unit—G. J. Siezen and F. Kerkhof. (*Philips Tech. Rev.*, vol. 10, pp. 125-134; November, 1948) Part 1: 1215 of May. Part 2: 1836 below. For another account see 2387 of 1948.

**621.314.6+621.315.59+621.396.622+621.383** 1809  
German Research on Semi-Conductors, Metal Rectifiers, Detectors and Photocells [Book Notice]—(See 1700.)

#### TELEVISION AND PHOTO-TELEGRAPHY

**621.397** 1810  
1949 IRE National Convention Program—(*Proc. I.R.E.*, vol. 37, pp. 160-178; February, 1949.) Abstracts are given of the following papers read at the convention:—6. Factors involved in the Design of an Improved Frequency-Shift Receiving System [for Naval facsimile] by C. C. Rae. 20. The Technique of Television Sound, by R. H. Tanner. 42. VHF Television—Propagation Aspects, by E. W. Allen, Jr. 64. A Method of Multiple Operation of Transmitter Tubes particularly adapted for Television Transmission in the UHF Band, by G. H. Brown, W. C. Morrison, W. L. Behrend, and J. G. Reddeck. 65. Transient-Response Tests on the WPTZ Television Transmitter, by R. C. Mooie. 66. Television Transmitter Carrier Synchronization, by R. D. Kell. 67. Television by Pulse-Code Modulation, by W. M. Goodall. 83. The Measurement of the Modulation Depth of Television Signals, by R. P. Burr. 84. Development and Performance of Television Camera Tubes, by R. P. Janes, R. E. Johnson, and R. S. Moore. 85. An Anastigmatic Yoke for Television Deflection, by K. Schlesinger. 86. A High-Efficiency Sweep Circuit, by B. M. Oliver. 87. Current Developments in UHF Television, by T. T. Goldsmith, Jr. 112. Intercity Television Radio Relays, by W. H. Forster. 113. Video Design Considerations in a Television Link, by M. Silver, H. French, and L. Staschover. 140. The Graphophon—A Picture-Storage Tube, by L. Pensak. Titles of other papers are given in other sections.

**621.397.62** 1811  
Superheterodyne Television Unit—(*Wireless World*, vol. 55, pp. 97-102; March, 1949.) Continuation of 1527 of June. Mechanical details and alignment are discussed.

**621.397.62:535.88:621.385.832** 1812  
Projection-Television Receiver: Part 2—The Cathode-Ray Tube—de Gier. (See 1836.)

**621.397.62:535.88:621.396.68** 1813  
Projection-Television Receiver: Part 3—The 25-kV Anode Voltage Supply Unit—Siezen and Kerkhof. (See 1808.)

**621.397.62:656.22** 1814  
Train Television—F. R. Norton, C. G. McMullen, and G. L. Haugen. (*Electronics*, vol. 22, pp. 100-101; March, 1949.) Two sizes of folded dipole, with ends bent back, are used. This arrangement is more satisfactory than ring antennas. A normal type of 12-channel receiver has a special double-clamp age circuit which improves synchronization considerably. Power-supply difficulties are mentioned.

**621.397.645** 1815  
On the Design of Television Intermediate-Frequency Amplifiers—Sokolov. (See 1635.)

**621.397.7+621.396.712.3** 1816  
Planning Radio and Television Studios—Nixon. (See 1795.)

621.397.7 1817  
**Practical Equipment Layouts for Television Stations**—(Broadcast News, pp. 12-39; December, 1948.) Illustrated discussion of the requirements for stations of various types.

621.397.743:621.315.212 1818  
**Coaxial Cable Joins East and Mid-West TV Networks**—Hertzberg. (See 1581.)

621.397.5 1819  
**Six Papers on Television (Translation)** [Book Notice]—F.I.A.T. Final Report 865 (Supplement). H.M. Stationery Office, London, 74 pp., 7s. The papers are entitled: 1. New Scanning Method for Television. 2. Phase Modulation for Television. 3. Channeling by Time Division on a Wide-Band Carrier. 4. Apartment-House Television Distribution. 5. Code-Modulated Telephony. 6. Multiplex Code-Modulated Telephony. All these papers are by F. Schroter; they are preceded by a preface briefly describing recent advances in television techniques.

#### TRANSMISSION

621.396.61 1820  
**Broadcasting Transmitters at Villebon, Rennes and Lille**—H. Campet. (*Ann. Radio-élec.*, vol. 4, pp. 85-88; January, 1949.) The amplitude versus phase method of modulation used in these three reconditioned stations is described and performance figures for the Lille transmitter are given.

621.396.61 1821  
**Daily Routine of the Sottens [broadcasting] Transmitter**—R. Pièce. (*Bull. Schweiz. Elektrotech. Ver.*, vol. 37, pp. 31-39; January 26, 1946. In French.) A short description of the quartz-controlled 100-kw 677-kc equipment with an outline of the functions of the staff and discussion of service faults due to external and internal causes.

621.396.619 1822  
**1949 IRE National Convention Program**—(Proc. I.R.E., vol. 37, pp. 160-178; February, 1949.) Abstracts are given of papers read at the convention, including:—111. Synchrodyne Modulation of Klystrons, by V. Learned. Titles of other papers are given in other sections.

621.396.619.13 1823  
**Impedance Valves for Frequency Modulation**—H. Klausner. (*Bull. Schweiz. Elektrotech. Ver.*, vol. 37, pp. 624-627; October 19, 1946. In German, with French summary.) The mode of operation of such devices, particularly for FM of transmitters, is explained and equivalent circuits are discussed, two of which give controllable capacitance and two controllable inductance, one of each pair being loss free. The conditions for distortionless modulation are considered for both capacitive and inductive impedance tubes. For a given frequency, it is possible, under certain conditions, to suppress the AM which is produced together with the FM.

#### VACUUM TUBES AND THERMIONICS

621.385+621.396.615 1824  
**1949 IRE National Convention Program**—(Proc. I.R.E., vol. 37, pp. 160-178; February, 1949.) Abstracts are given of the following papers read at the convention:—10. A Broad-Band Transition from Coax to Helix, by C. O. Lund. 55. The Type 5811 and Type 5807 Tubes—The Smallest Commercial Pentode Amplifiers by L. G. Hector and H. R. Jacobus. 58. Electrometer Tubes and Circuits, by H. F. Starke. 78. Microphonism Investigation, by L. Feinstein. 79. A Critical Survey of Methods of Making Ceramic-to-Metal Seals and Their Use for Electron-Tube Construction, by R. P. Wellinger. 80. Rugged Tubes, by G. W. Baker. 81. An Improved Method of Testing for Residual

Gas in Electron Tubes and Vacuum Systems, by E. W. Herold. 82. Design Factors, Processes, and Materials for the Envelope of a Metal Kinoscope, by R. D. Faulkner and J. C. Turnbull. 105. The Effects of Various Barium Compounds with respect to Cold-Cathode Behavior as a function of Life in a Glow Discharge, by H. Jacobs and A. P. LaRocque. 106. Oxide-Cathode Properties and their Effects on Diode Operation at Small Signals, by G. C. Dalman. 107. Microanalysis of Gas in Cathode-Coating Assemblies, by H. Jacobs and B. Wolk. 108. Exposure of Secondary-Electron-Emitting Surfaces to the Evaporation from Oxide Cathodes, by C. W. Mueller. 109. The Use of Thoriated-Tungsten Filaments in High-Power Transmitting Tubes, by R. B. Ayer. 120. General Solution of the Two-Beam Electron Wave-Tube Equation, by A. V. Haeff, H. D. Arnett, and W. Stein. 124. Space-Charge Effects and Frequency Characteristics of CW Magnetrons relative to the problem of Frequency Modulation by H. W. Welch, Jr. 140. The Graphochon—A Picture-Storage Tube, by L. Pensak. 141. The Pencil-Type UHF Triode, by G. M. Rose and D. W. Power. 142. Practical Applications of the Resonator in the High-Power Transmitter Field, by W. W. Salisbury. 143. The Electron Coupler—A Developmental Tube, Utilizing New Principles, for the Modulation and Control of Power at UHF, by C. L. Cucchi and J. S. Donal, Jr. 144. A Wide-Tuning-Range Low-Power CW Magnetron, by L. R. Bloom and W. W. Cannon. Titles of other papers are given in other sections.

621.385 1825  
**The Electron-Wave Tube—A Novel Method of Generation and Amplification of Microwave Energy**—A. V. Haeff. (Proc. I.R.E., vol. 37, pp. 4-10; January, 1949.) Beams of electrons moving with different mean velocities are allowed to mix. Interchange of energy takes place, resulting in negative attenuation characteristics. Oscillators and amplifiers for microwave frequencies may thus be constructed without resonant structures of small dimensions. The paper gives a mathematical analysis of the two-velocity case, and indicates how to extend the results to multiple and continuous velocity distributions. It is shown that amplification is obtained for a limited range of values of stream inhomogeneity.

Experimental tubes of two-velocity and space-charge types are described. A comparison of experimental and theoretical gain curves shows good agreement. Gains of the order of 80 db at 3,000 Mc and electronic bandwidths of over 30 per cent have been observed. The new method is likely to have important applications to tubes for millimeter waves. See also 1540 of June (Nergaard).

621.385 1826  
**The Development and Design of Cooled-Anode Valves**—F. Smith. (Proc. IEE, (London), part III, vol. 96, pp. 1-4; January, 1949.) Long summary of Radio Section Chairman's address.

621.385 1827  
**Trends in Electron Tube Design**—W. C. White. (*Elec. Eng.*, vol. 67, pp. 517-530; June, 1948.) A comprehensive survey of modern practices and developments in the construction of all types of tube.

621.385:621.392.2 1828  
**Study of the Propagation of an Electromagnetic Wave in the Presence of Two Electron Beams of Neighbouring Velocities**—Lapostolle. (See 1583.)

621.385:666.11:621.3.011 1829  
**Contribution to the Study of the Electrical**

**Properties of Glasses used in the Construction of Radio Valves**—Meunier. (See 1699.)

621.385.029.63/.64:621.396.615 1830  
**Traveling-Wave Valves as Oscillators with Wide-Band Electronic Tuning**—O. Doehler, W. Kleen, and P. Palluel. (*Ann. Radioélec.*, vol. 4, pp. 68-75; January, 1949.) Self-oscillation due to internal feedback is discussed. For tubes in which the delay line gives an attenuation sufficient to suppress all possibility of internal feedback, external feedback may be applied by means of a waveguide coupling the tube output to the input. In this case, the tuning band is about double that obtained with internal feedback and may be of the order of 10 per cent for a frequency of 3,000 Mc and 2.5 per cent for 24,000 Mc. For traveling-wave tubes with a central conductor provided with a system of equidistant circular fins, and in which the electron beam passes through the space between the edges of the fins and the outer wall of the tube, output power is high. At 3,000 Mc this may be of the order of 20 watts, at 9,000 Mc about 1 to 2 watts, and at 24,000 Mc about 0.1 to 0.2 watt.

621.385.032.24:621.396.645 1831  
**Practical Notes on Grid Current and Neutralization**—F. Dickson. (*Philips Tech. Commun.* (Australia), vol. 10, pp. 3-6; September and October, 1948.)

621.385.2:621.396.822 1832  
**The Behaviour of a Diode Noise Generator at Ultra High Frequencies**—A. W. Love. (*Jour. Inst. Eng.* (Australia), vol. 20, p. 201; December, 1948.) Discussion on 567 of March.

621.385.3.012 1833  
**Factors Influencing the Perveance of Power-Output Triodes**—G. R. Partridge. (Proc. I.R.E., vol. 37, pp. 87-94, January, 1949.) Perveance is a factor relating anode voltage and current. Several formulas for perveance and for cathode current are listed and discussed.

621.385.38 1834  
**A New Line of Thyratrons**—A. W. Coolidge, Jr. (*Elec. Eng.*, vol. 67, p. 435; May, 1948.) Long summary of AIEE paper. Description of the GL-5545 gas-filled thyatron, which is claimed to have 10 times the life of other gas-filled thyratrons. The GL-5545 seldom requires a series RC circuit (snubber) for industrial applications.

621.385.4.032.2 1835  
**The Anode to Screen Grid Space in Beam Tetrode**—Chai Yeh. (*Science Rec.* (Nanking), vol. 2, pp. 57-62; October, 1947. In English.)

621.385.832:621.397.62:535.88 1836  
**Projection-Television Receiver: Part 2—The Cathode-Ray Tube**—J. de Gier. (*Philips Tech. Rev.*, vol. 10, pp. 97-104; October, 1948.) Part 1: 1215 of May. Part 3: 1808 above. For another account see 2387 of 1948.

621.383:621.315.59+621.314.6+621.396.622 1837  
**German Research on Semi-Conductors, Metal Rectifiers, Detectors and Photocells** [Book Notice]—(See 1700.)

#### MISCELLANEOUS

621.396 1838  
**Fundamentals of Electric Waves** [Book Review]—H. H. Skilling. J. Wiley and Sons, New York: Chapman and Hall, London, 2nd edition 1948, 245 pp., \$4.00. (*Jour. Frank. Inst.*, vol. 247, p. 80; January, 1949.) An elementary text on electromotive theory, illustrating its application to related items such as antennas and waveguides. Vector notation is explained and used. Considerable revision of the first edition (noted in 319 and 2027 of 1943) has taken place.

# ADVENTURES IN ELECTRONIC DESIGN

## HOW FRAZER CUT COSTS 60%!

This is the success story of the Frazer Company, Auckland, New Zealand. Recently, using Centralab's amazing P. E. C.\* *Ampec* — a tiny audio-amplifier — in the hearing aids it manufactures, Frazer quickly found that with *Ampec's* help, it could produce more and finer hearing aids than ever before. What's more, Frazer found it could cut the costs of its hearing aid production nearly 3/5ths. Now — less than one year since Ampec, seven out of every ten deaf patients applying for hearing aids, under New Zealand's Social Security System, ask for . . . and get Frazer's. Is there any doubt that is proud of being **FIRST** in the British Empire to use *Ampec* in hearing aids?

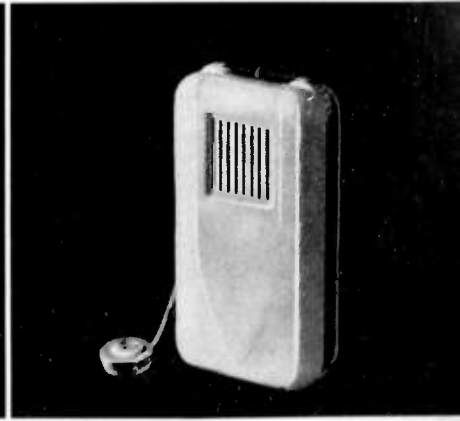
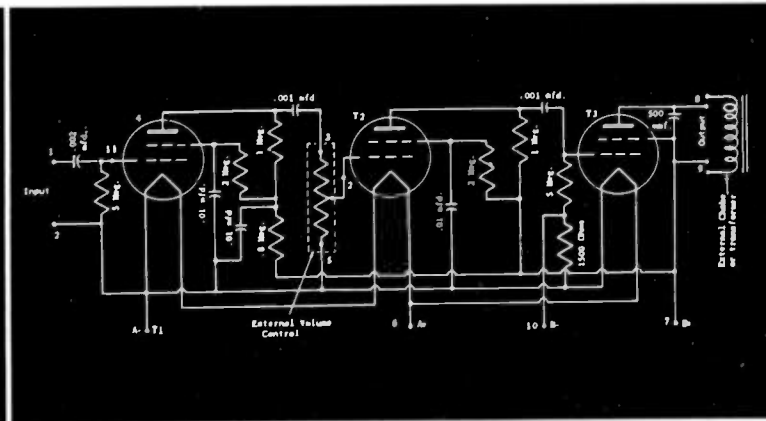
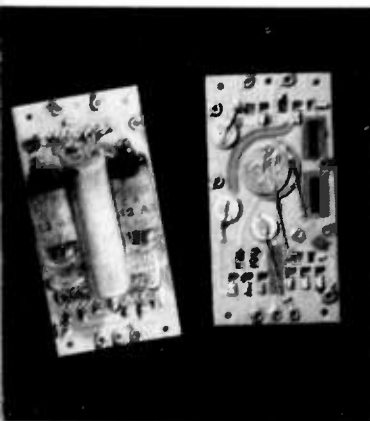
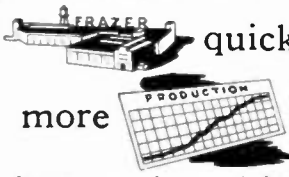

\*Each P. E. C. unit—including *Ampec*, above—is an integral assembly of *Hi-Kap* capacitors and resistors, closely bonded to a ceramic plate and connected by "printed" silver paths.

This is a schematic diagram of *Ampec*, Centralab's amazing P. E. C. unit that combines all components of an audio-amplifier — tube sockets, capacitors, resistors and wiring — on one compact, ceramic chassis.

Here's the Frazer Hearing Aid. Because it uses *Ampec*, the Frazer is smaller, lighter. What's more, *Ampec* helps Frazer produce more dependable hearing aids, faster.

**Centralab** — DEVELOPMENTS THAT CAN HELP YOU

Division of GLOBE-UNION INC. • Milwaukee

# Centralab reports to

**JULY, 1949**

How Admiral Uses  
CRL's Printed  
Electronic Circuit  
to build  
more and finer  
TV sets!

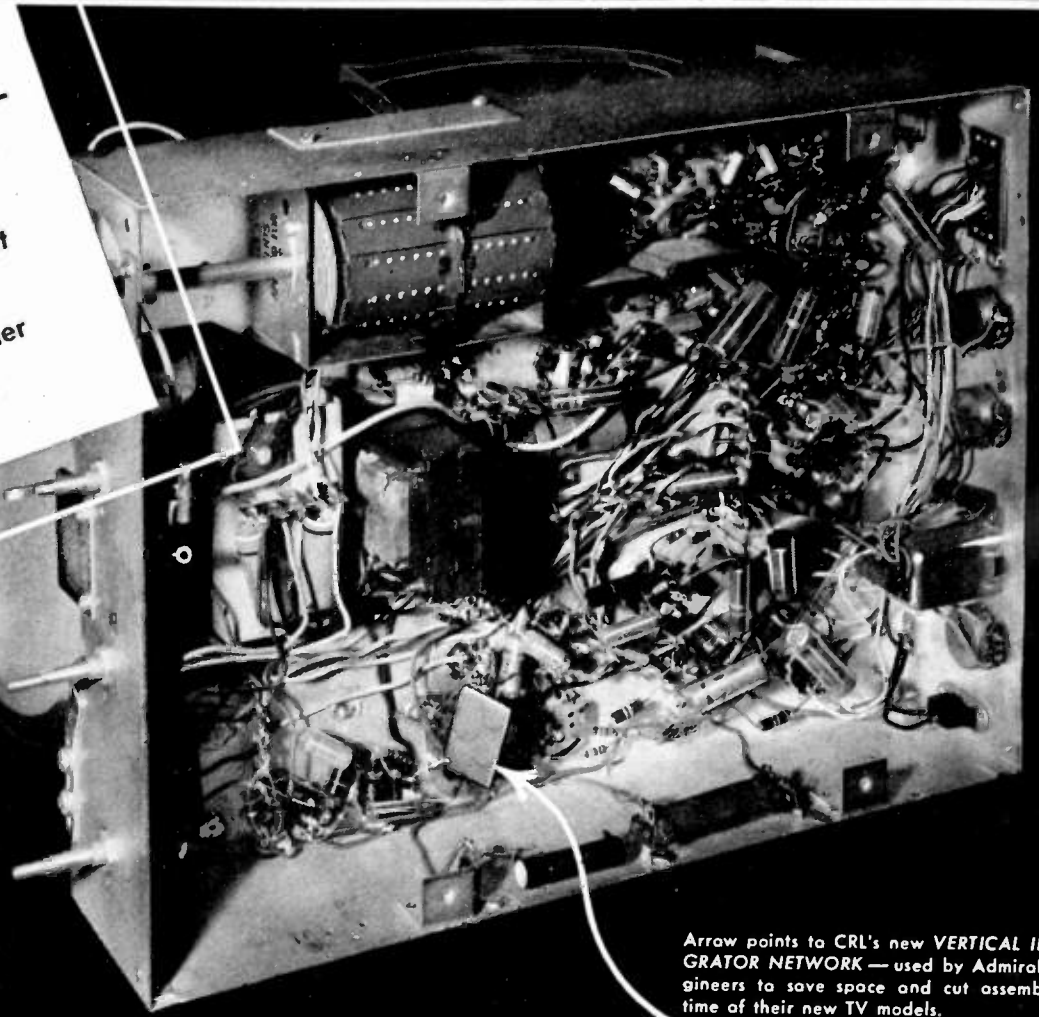

Arrow points to CRL's new VERTICAL INTEGRATOR NETWORK — used by Admiral engineers to save space and cut assembling time of their new TV models.

**I** Wherever Centralab's revolutionary P. E. C. is used, you are sure to find speeded production . . . quality products. Just look at Admiral Corporation's fine new television receivers. A series of Admiral's video sets makes use of CRL's Vertical Integrator Net-

*Chassis courtesy of Admiral Corp.*  
work — a tiny, compact plate containing both capacitors and resistors. It saves production time . . . reduces 16 soldered connections to 3. Simplifies wiring operations for faster assembly. What's more, the Network helps produce better TV receivers.

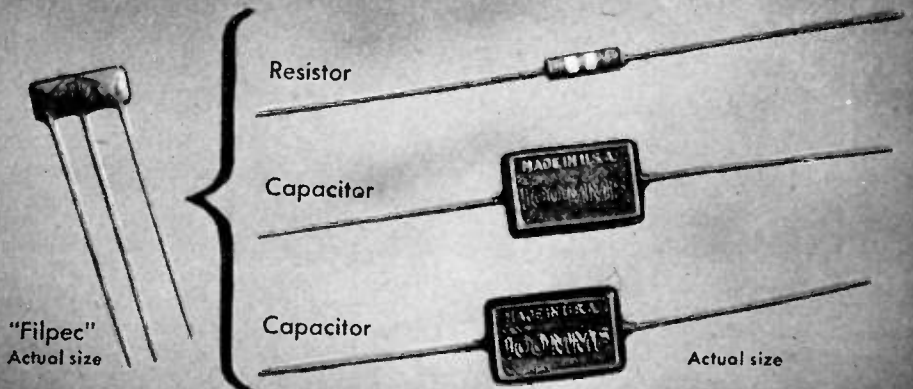
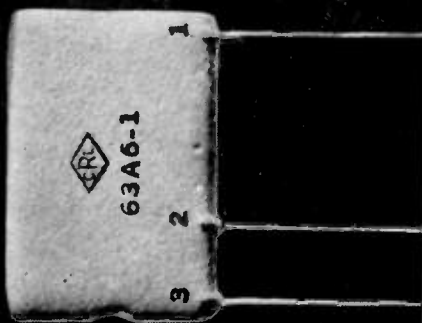

**2** This is the new CRL Vertical Integrator Network used by Admiral. Variations of this Centralab Network are available on special order.

**3** Centralab's Filpec is designed for use as a balanced diode load filter, combines up to three major components into one tiny unit, lighter and smaller than one ordinary capacitor. What's more, Filpec's Ceramic-X construction assures long life. Capacitor values from 50 to 200 mmf. Resistor values from 5 ohms to 5 megohms.



# Electronic Industry



**4** *Hi-Vo-Kaps* are filter and by-pass capacitors combining high voltage, small size and a variety of terminal connections to fit most TV needs.

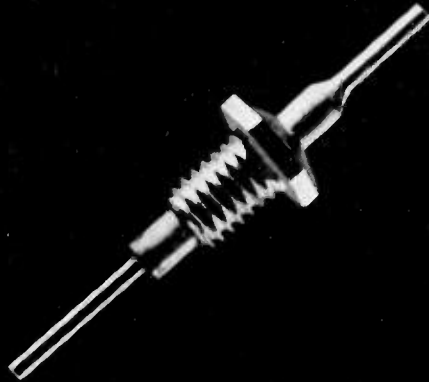

**5** FT *Hi-Kaps* Centralab's new feed-thru or bushing mounted capacitors eliminate structural and electrical damage during installation.

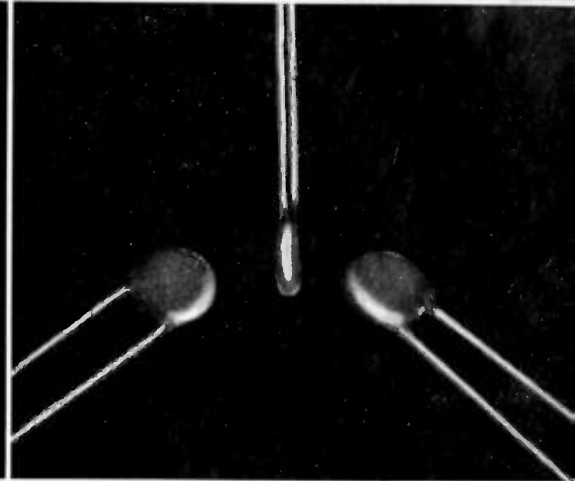

**6** For by-pass or coupling applications, check CRL's original line of ceramic disc and tubular *Hi-Kaps*. *Disc Hi-Kaps* are smaller than a dime!

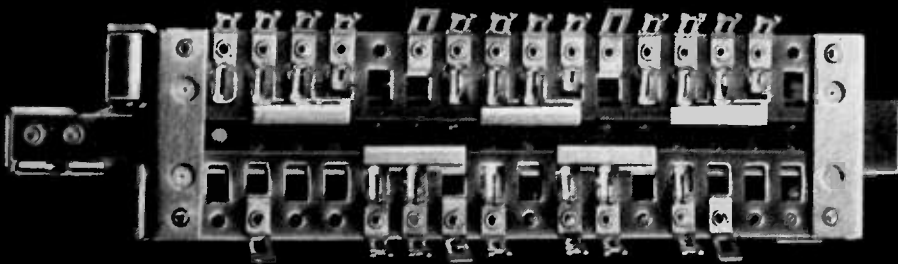

**7** Centralab's development of a revolutionary, new *Slide Switch* promises improved AM and FM performance! Flat, horizontal design saves valuable space, allows short leads, convenient location to coils, reduced lead inductances for increased efficiency in low and high frequencies. CRL *Slide Switches* are rugged and efficient, too.

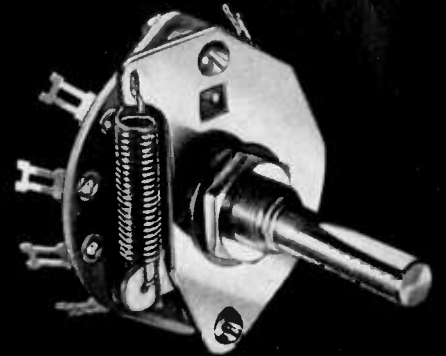

**8** Great step forward in switching is CRL's New *Rotary Coil and Cam Index Switch*. Its coil spring gives you smoother action, longer life.



**9** Model "1" *Radiobm* control is no larger than a dime. Especially designed for hearing aids, pocket radio receivers, miniature amplifiers.

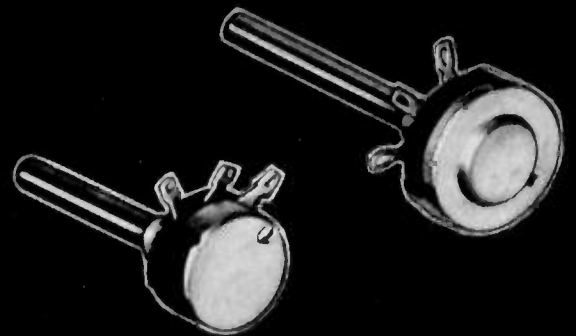
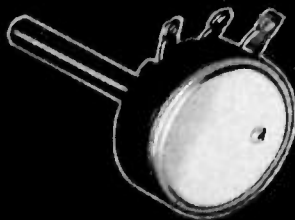

**10** Let Centralab's complete *Radiobm* line take care of your special needs. Wide range of variations: Model "R" — wire wound, 3 watts; or composition type, 1 watt. Model "E" — composition type, 1/4 watt. Direct contact, 6 resistance tapers. Model "M" — composition type, 1/2 watt.

# IMPORTANT BULLETINS FOR YOUR TECHNICAL LIBRARY!

*They're factual!*



**THEY'RE FREE!**

## Choose From This List!

### Centralab Printed Electronic Circuits

- 973 — AMPEC — three-tube P. E. C. amplifier.
- 42-6 — COUPLATE — P. E. C. interstage coupling plate.
- 999 — PENTODE COUPLATE — specialized P. E. C. coupling plate.
- 42-9 — FILPEC — Printed Electronic Circuit filter.

### Centralab Capacitors

- 42-3 — BC TUBULAR HI-KAPS — capacitors for use where temperature compensation is unimportant.
- 42-4 — BC DISC HI-KAPS — miniature ceramic BC capacitors.
- 42-10 — HI-VO-KAPS — high voltage capacitors for TV application.
- 695 — CERAMIC TRIMMERS — CRL trimmer catalog.
- 991 — HI-VO-KAPS — capacitors for TV application. For jobbers.
- 42-18 — TC CAPACITORS — temperature compensating capacitors.
- 814 — CAPACITORS — high-voltage capacitors.
- 975 — FT HI-KAPS — feed-thru capacitors.

### Centralab Switches

- 953 — SLIDE SWITCH — applies to AM and FM switching circuits.
- 970 — LEVER SWITCH — shows indexing combinations.
- 995 — ROTARY SWITCH — schematic application diagrams.
- 722 — SWITCH CATALOG — facts on CRL's complete line of switches.

### Centralab Controls

- 42-7 — MODEL "1" RADIOHM — world's smallest commercially produced control.
- 697 — VARIABLE RESISTORS — full facts on CRL Variable Resistors.

### Centralab Ceramics

- 720 — CERAMIC CATALOG — CRL's steatite and ceramic products.

### General

- 26 — GENERAL CATALOG — Combines Centralab's line of products for jobber, ham, experimenter, serviceman or industrial user.

**Look to CENTRALAB in 1949!** First in component research that means lower costs for the electronic industry. If you're planning new equipment, let Centralab's sales and engineering service work with you. For complete information on all CRL products, get in touch with your Centralab Distributor. Or write direct.

CENTRALAB  
Division of Globe-Union Inc.  
900 East Keefe Avenue, Milwaukee, Wisconsin

Yes—I would like to have the CRL bulletins, checked below, for my technical library!

- |                               |                               |                                |                              |                              |                               |                              |
|-------------------------------|-------------------------------|--------------------------------|------------------------------|------------------------------|-------------------------------|------------------------------|
| <input type="checkbox"/> 973  | <input type="checkbox"/> 42-9 | <input type="checkbox"/> 42-18 | <input type="checkbox"/> 953 | <input type="checkbox"/> 953 | <input type="checkbox"/> 722  | <input type="checkbox"/> 720 |
| <input type="checkbox"/> 42-6 | <input type="checkbox"/> 42-3 | <input type="checkbox"/> 695   | <input type="checkbox"/> 814 | <input type="checkbox"/> 970 | <input type="checkbox"/> 42-7 | <input type="checkbox"/> 26  |
| <input type="checkbox"/> 999  | <input type="checkbox"/> 42-4 | <input type="checkbox"/> 991   | <input type="checkbox"/> 975 | <input type="checkbox"/> 995 | <input type="checkbox"/> 697  |                              |

Name.....

Address.....

City..... State.....

**TEAR OUT COUPON**

for the Bulletins you want

**Centralab**  

Division of GLOBE-UNION INC. • Milwaukee



ATLANTA

"Recent Trends in Oscillography," by M. B. Kilne, Allen B. DuMont Laboratories; April 15, 1949.

BALTIMORE

"GCA (Ground Controlled Approach) Past, Present and Future," by C. W. Hicks, Bendix Radio Division; April 26, 1949.

BEAUMONT-PORT ARTHUR

"Prospecting for Petroleum," by A. Winterhalter and J. Millington, Sun Oil Company; February 21, 1949.

"Super-Sensitive Electrical Mechanism," by L. E. Bohrer, Faculty of Lamar College; March 24, 1949.

"Progress in Engineering Science," by C. H. Scarlett, Westinghouse Electric Corporation; April 29, 1949.

"Instruments in Industry," by O. Haultunen and K. McEntire, General Electric Company; May 4, 1949.

BUFFALO-NIAGARA

"Television Picture Quality," by K. R. Wendt, Colonial Radio Corporation; April 20, 1949.

CEDAR RAPIDS

"Engineering Aspects of the Transistor," and "A New Microwave Tube," by R. M. Ryder, Bell Telephone Laboratories; April 25, 1949.

"Technical Details of the Baldwin Electronic Organ," by A. F. Knoblauch, Baldwin Company; May 12, 1949.

CHICAGO

"The Relation of the Radio Engineer to his Management and to the Radio Industry," by J. E. Brown, Zenith Radio Corporation; Panel Discussions; March 18, 1949.

"Professionalism and Professional Consciousness—They Grow," by A. Von Praag, National Society of Professional Engineers; Panel Discussions; April 15, 1949.

Election of Officers; May 13, 1949.

CLEVELAND

"Particle Accelerators," by W. P. Simpson, General Engineering Laboratory; April 28, 1949.

"RMA Composite Television Signal," by T. B. Friedman, Television Station KXEL; Nomination of Officers; May 12, 1949.

CONNECTICUT VALLEY

"Traveling-Wave Tubes," by R. Hutter, Sylvania Electric Products; April 21, 1949.

"Improved System of Heterodyne Frequency Measurement," by J. L. Galen, University of Connecticut; "On the Measurement of Piezoelectric Resonator Properties," by G. D. Gordon, Wesleyan University; "A Continuously-Adjustable Filter for Audio Frequencies," by G. E. Tisdale, Yale University; "Electronic Arithmetic," by C. N. Hoyer, RCA Laboratories; Nomination of Officers; May 12, 1949.

New England Radio Engineering Meeting; Annual Outing and election of Officers; May 21, 1949.

DALLAS-FORT WORTH

"Four-Terminal Direct-Coupled Amplifier," by L. W. Erath, Southern Industrial Electronics Research and Development Corporation; April 28, 1949.

(Continued on page 38A)

# B & W TEST INSTRUMENTS

**Inexpensive . . . Accurate . . . Reliable**

## Built to Match Broadcast Station Requirements

Although relatively low in cost, these B & W instruments meet the exacting demands of modern research and engineering laboratories, as well as the full indorsement of many well-known broadcast stations. They combine a high degree of accuracy with outstanding durability and ease of use.

### B & W AUDIO OSCILLATOR

Provides an extremely low distortion source of frequencies between 30 and 30,000 cycles. Self-contained power supply. Calibration accuracy of  $\pm 3\%$  scale reading. Stability 1% or better. Frequency characteristics: output flat within  $\pm 1$  DB, 30 to 15,000 C.P.S. Size  $13\frac{3}{4}'' \times 7\frac{1}{4}'' \times 9\frac{1}{2}''$ . Fully portable.



\$115

MODEL 200

### B & W DISTORTION METER

An ideal instrument for either laboratory or field use. Measures total harmonic distortion for the range of 50 to 15,000 cycles, and measures harmonics to 45,000 cycles. Also measures residual hum and noise up to 60 DB below any reference level. Voltmeter and DB meter range is from 30 to 30,000 cycles. Highly sensitive and accurate. Size  $13\frac{3}{4}'' \times 7\frac{1}{4}'' \times 9\frac{1}{2}''$ .



\$140

MODEL 400

### B & W FREQUENCY METER

An accurate and convenient means of making direct measurements of unknown frequencies up to 30,000 cycles. Useful in measuring beat frequency between two R.F. signals. Integral power supply. Handy for routine checking of audio oscillators or tone generators. Highly sensitive, this unit will operate on any wave form with peak ratios under 8 to 1. Size  $13\frac{3}{4}'' \times 7\frac{1}{4}'' \times 9\frac{1}{2}''$ .



\$105

MODEL 300

WRITE FOR B & W CATALOG SUPPLEMENT NO. 1 . . . containing full details on these and other B & W instruments and electronic specialties.

# BARKER & WILLIAMSON, INC.

Dept. PR-79, 237 Fairfield Ave., Upper Darby, Pa.

# The TURN-OVER Type PICKUP...



**THE  
ASTATIC  
CLD**

*That is Engineered*

**TO PLAY 33-1/3, 45 AND 78 RPM  
RECORDS AT THE . . .**

**SAME LOW NEEDLE PRESSURE**

NO concealed mechanism raises or lowers needle pressure as the knob is turned on Astatic's new CLD Turn-over Type Pickup, in switching of play from one type record to another. Thanks to Astatic engineering accomplishments, the CLD plays 33-1/3 or 45 RPM recordings and standard 78 RPM at the same feather-light, eight-gram pressure . . . tracking perfectly, providing first quality reproduction free of needle talk. Elimination of a needle pressure adjusting mechanism abolishes a potential source of trouble and varying reproduction characteristics. The CLD Pickup employs the LQD-1 Crystal Cartridge, with two separate "Q" Needles (sapphire or precious metal) which snap in or out independently by gentle pry or pressure with the tip of a penknife and without removing cartridge from arm. The excellence of frequency response is particularly notable at low frequencies. A die-cast curved arm finished in dark brown Hammerlin, mounts seven inches from turntable center. Available for prompt delivery.

**THE Astatic CORPORATION**  
ASTATIC  
CONNEAUT, OHIO  
IN CANADA CANADIAN ASTATIC LTD. TORONTO ONTARIO

Astatic  
Crystal  
Devices  
manufactured  
under  
Brush  
Development  
Co. patents

MODEL	FINISH	CARTRIDGE USED	OUTPUT 1 kc.	NEEDLE PRESSURE
CLD	Dark Brown Hammerlin	LQD-1J or LQD-1M	LP.—0.9 Volts† Std.—1.2 Volts*	8 Grams
†Columbia #281 Test Record, 33-1/3 RPM			*Audio-tone Test Record, 78 RPM	



(Continued from page 37A)

#### DENVER

"Principles of Servomechanisms," by D. S. Stacey, Faculty of University of Colorado; "Demonstration of a Clapp Frequency Stabilized Oscillator," by W. Luebke and C. Goss, Students of University of Colorado; May 11, 1949.

#### DETROIT

"The Synchrotron—A New Type of Electronic Accelerator," by H. R. Crane, Faculty of University of Michigan; April 15, 1949.

#### HOUSTON

"Factors Affecting Design of Turnstile Antennas," by G. H. Brown, RCA Laboratories; February 21, 1949.

"Applications of Inverse Feedback," by L. W. Erath, S.I.E. Research and Development Company; March 21, 1949.

"Marine Depth Recorder," by D. E. Stotler, Gulf Radiotelephone Company; April 19, 1949.

"Measurements of Nuclear Radiations," by G. Herzog, The Texas Company; May 12, 1949.

#### INVOKERN

"Microtime Techniques," by A. Zarem, Stanford Research Institute; April 27, 1949.

"A Device for Admittance Measurements in the 50- to 500-Mc Range," by F. Ireland, General Radio Company; May 18, 1949.

#### KANSAS CITY

Tour of Midwest Research Institute; April 5, 1949.

"Television Picture Quality," by R. G. Artman, Television Station KMBC; Election of Officers; May 24, 1949.

#### LOS ANGELES

"Facsimile: Applications and Design," by H. Doeleman, Sierra Engineering; "Nuclear Energy," by A. B. Brown, Graduate Student of California Institute of Technology; "San Diego Yellow Cab Communication System," by H. Grove, West Coast Electronics Company; April 19, 1949.

#### LOUISVILLE

"Basic Theory of Magnetic Recorders Using AC and DC Bias," by L. L. Anderson; Election of Officers; May 13, 1949.

#### MILWAUKEE

"Energy Relations in Oscillatory Circuits," by W. E. Richter, Allis Chalmers Company; January 12, 1949.

"Audio Amplifiers and Feedback Considerations," by J. P. Goodell, Minnesota Electronics Corporation; January 18, 1949.

"Waveguides and Magnetrons," by R. O. Kallenberger, Faculty of Marquette University; January 26, 1949.

"Lateral Disk Recording and Reproduction," by N. Pickering, Pickering and Company; February 9, 1949.

"Mechanical and Electrical Analogies," by E. Halbach, Perflex Corporation; February 23, 1949.

"Measurement of Energy of Microwave Frequencies," by W. Hewlett, Hewlett-Packard Company; March 17, 1949.

"The Effect of Stylus Design of Disk Recorded Material," by I. Capps, Frank L. Capps Company; March 29, 1949.

#### NEW MEXICO

"A Microwave Vibration Analyzer," by H. F. Clarke, Sandia Laboratory; April 22, 1949.

#### NORTH CAROLINA-VIRGINIA

"The Magic of Microwaves," by R. N. Marshall, Western Electric Company; April 22, 1949.

(Continued on page 40A)



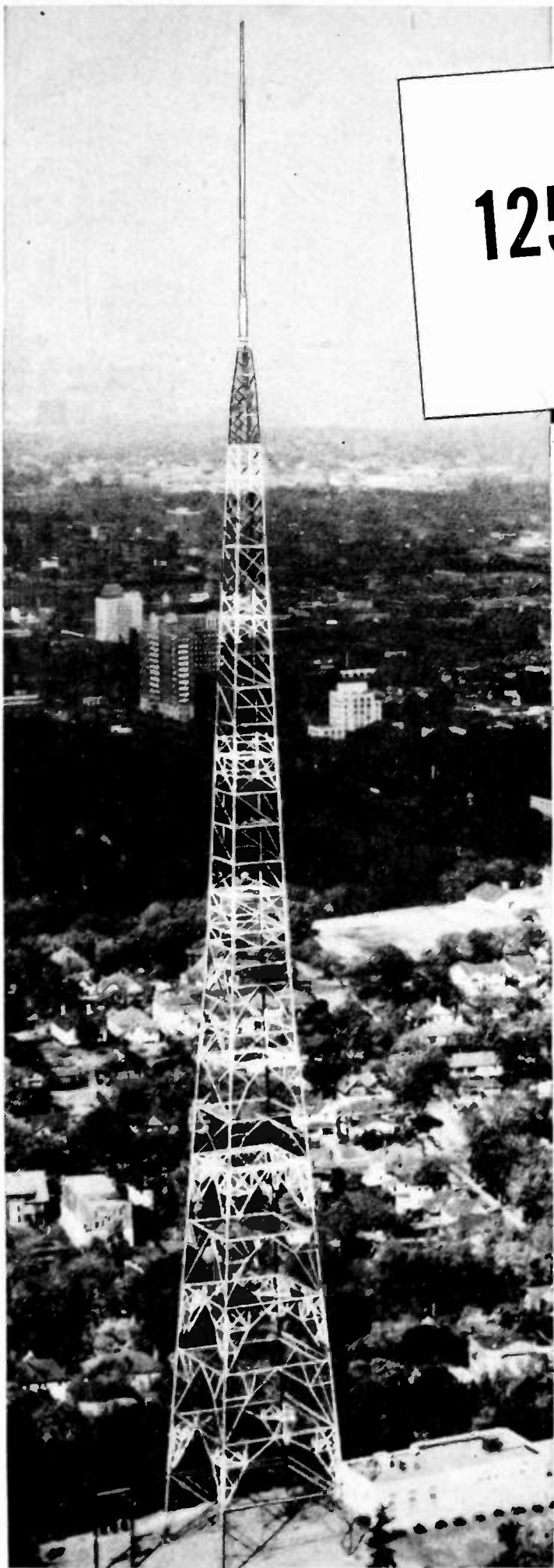

*A*  
**125,000 SQ. MILE  
BLANKET!**

**T**he most powerful FM installation in the world recently completed on Red Mountain near Birmingham, Alabama for Station WBRC-FM brings static-free entertainment to residents in a transmission radius of 200 miles.

Important to this installation is the 450 ft. Blaw-Knox type N-28 heavy-duty tower supporting the 8-section Pylon FM antenna. Sturdy, safe and backed by the many years of Blaw-Knox design and engineering in the radio field, it will enable this great new FM Voice of the South to utilize the full capacity of its modern facilities.

**BLAW-KNOX DIVISION** of Blaw-Knox Company  
2037 Farmers Bank Building, Pittsburgh 22, Pa.

**BLAW KNOX**



**BLAW-KNOX**  
**ANTENNA TOWERS**



**AIRCRAFT  
RADIO  
CORPORATION**

*Announces*

THE TYPE H-12

**SIGNAL GENERATOR**

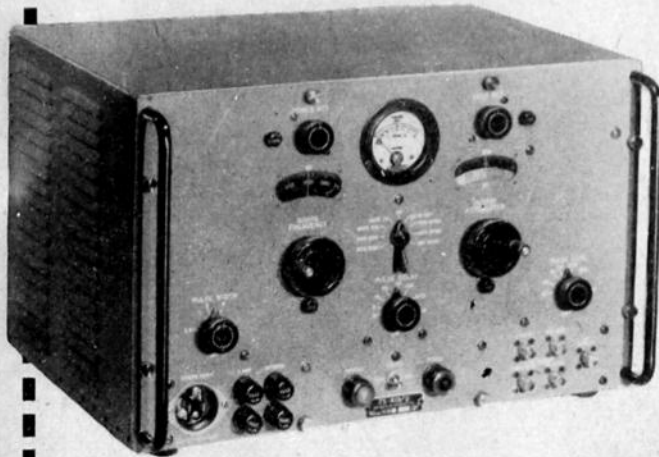

**900-2100 Megacycles**

*... for research and for  
production testing*

- 900-2100 megacycles, single band
- Continuous coverage with single-dial control directly calibrated
- Directly calibrated attenuator, 0 to -120 dbm
- CW or AM pulse modulation
- Extensive pulse circuitry

*Write for details*

**Aircraft Radio Corporation**  
BOONTON, New Jersey



**Dependable Electronic Equipment Since 1928**



*(Continued from page 38A)*

**OMAHA-LINCOLN**

"TV, Its Mechanics and Promise," by W. W. Lawrence, RCA Victor Division; October 14, 1949.

**OTTAWA**

"Transmission of Intelligence by Facsimile," by G. F. Godfrey, Department of National Defense; April 14, 1949.

"Institute Activities," by F. H. R. Pounsett, Stromberg-Carlson Company, Ltd.; May 16, 1949.

**PITTSBURGH**

"The Transistor—A New Semiconductor Amplifier," by J. A. Becker, Bell Telephone Laboratories; December 13, 1948.

"The Bell Telephone Company and Television," by L. R. Huggler, Bell Telephone Company; January 10, 1949.

"Electron Tube Phonograph Pickup," by J. R. Horach, Student of Carnegie Institute of Technology; "High-Fidelity Phonograph Systems," by H. L. Brenton, Student of Carnegie Institute of Technology; February 14, 1949.

"Ceramics That Talk," by R. E. Stark, Stupakoff Ceramic and Manufacturing Company; March 14, 1949.

"Behind the Scenes in the Broadcasting Business," by T. C. Kenney, Radio Station KDKA; J. Greenwood, Radio Station WCAE; W. W. McCoy, Radio Station WJAS; J. J. Schultz, Radio Station KQV; H. R. Kaier, Radio Station WWSW; April 11, 1949.

"Magnetic Amplifiers," by L. A. Finzi, Faculty of Carnegie Institute of Technology; May 9, 1949.

**PORTLAND**

"Coaxial Cable Carrier System for Message, Program, and Television Service," by J. M. Roberts, Pacific Telephone and Telegraph Company; April 15, 1949.

"Engineering Books," by A. L. Albert, Faculty of Oregon State College; May 5, 1949.

**PRINCETON**

Open House; April 28, 1949.

"Old and New Theories of Conduction in Solids," by K. K. Darrow, Bell Telephone Laboratories; Election of Officers; May 12, 1949.

**ROCHESTER**

"Electron Tube Ratings and Characteristics," by R. L. Kelly, RCA Tube Division; April 21, 1949.

"Some Aspects of Atomic Power Development," by E. H. Bancker, General Electric Company; Election of Officers; May 19, 1949.

**SACRAMENTO**

"Graphical Solutions," by I. J. Sandorf, Faculty of University of Nevada; March 8, 1949.

"Printed Circuits and Miniature Electronics," by C. Brunetti, Faculty of Stanford Research Institute; April 18, 1949.

**SALT LAKE**

"Techniques of Television Servicing," by C. E. Kitto, General Electric Supply Corporation; April 25, 1949.

**SAN FRANCISCO**

"Low-Noise Figure Traveling-Wave Tubes at Meter and Centimeter Wavelengths," by L. M. Field, Faculty of Stanford University; April 13, 1949.

*(Continued on page 42A)*

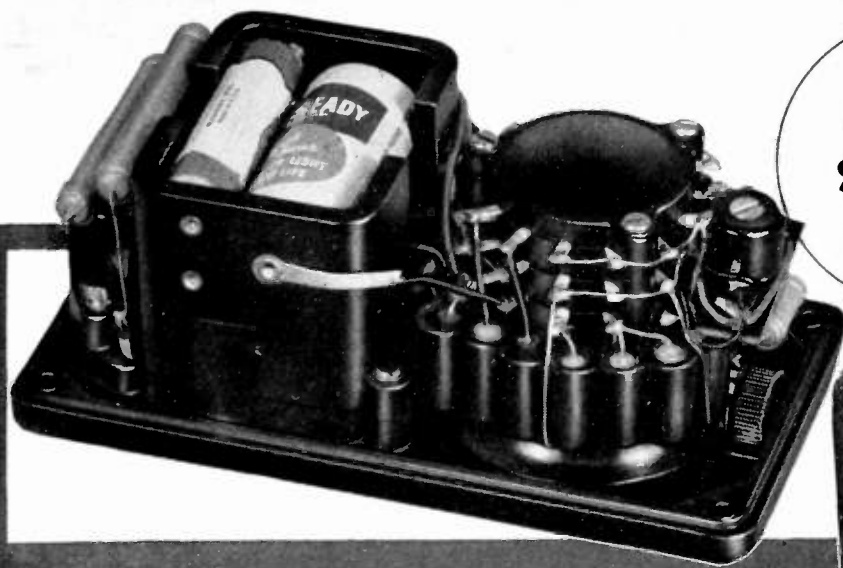

MODEL  
666-R  
**\$24<sup>50</sup>**  
U. S. A. Dealer Net

**A *New* TRIPLETT  
POCKET-SIZE  
VOLT-OHM-MIL-AMMETER**  
with self-contained Resistance  
Ranges to 3 Megohms

**Note the special  
features of this New  
handy-size tester**

- (1) **RESISTANCE RANGES** from 0-3000 Ohms (.5 Ohm low reading) to 3 Megohms, self-contained. Also A.C.-D.C. Volts to 5000, 10 ranges; and 3 Direct Current ranges.
- (2) **ENCLOSED SELECTOR SWITCH**, molded construction. Keeps dirt out, and retains contact alignment permanently.
- (3) **UNIT CONSTRUCTION**—Resistors, shunts, rectifier, batteries are housed in a molded base integral with the switch. Direct connections without cabling. No chance for shorts.
- (4) **RESISTORS** are precision film or wire-wound types, each in its own compartment.
- (5) **BATTERIES EASILY REPLACED**—Positive grip coil spring assures permanent contact. Makes replacement of batteries a simple procedure.
- (6) **STREAMLINED STYLING**. Handsomely designed, pocket-size case. Only two controls, both flush with panel.

*For Detailed Information  
See your Radio Parts Distributor or write . . .*

**TRIPLETT ELECTRICAL INSTRUMENT COMPANY • BLUFFTON, OHIO, U.S.A.**

*In Canada: Triplett Instruments of Canada, Georgetown, Ontario*



**RANGES:**

- D.C. VOLTS: 0-10-50-250-1000-5000, at 1000 Ohms/Volt
  - A.C. VOLTS: 0-10-50-250-1000-5000, at 1000 Ohms/Volt
  - D.C. MILLIAMPERES: 0-10-100, at 250 Millivolts
  - D.C. AMPERES: 0-1, at 250 Millivolts
  - OHMS: 0-3000-300,000  
..... (20-2000 at center scale)
  - MEGOHMS: 0-3  
..... (20,000 Ohms center scale)
- (Compensated Ohmmeter circuit for greatest accuracy over wide battery voltage variations.)*

*Precision first... to Last*



## Section Meetings

(Continued from page 40A)

### SEATTLE

"High-Precision Velocity Servomechanism," by G. Stoner and G. Brown, Boeing Airplane Company; March 25, 1949.

"VHF Omnidirectional Range," by W. R. Triplett, C.A.A. Engineering Division; April 22, 1949.

### SYRACUSE

"Antennas with Circular Symmetry," by W. R. LePage, Faculty of Syracuse University; March 3, 1949.

"Television," by D. W. Pugsley, General Electric Company; Film: Visit to Electronics Park; March 28, 1949.

Film: Atomic Physics; Election of Officers; May 5, 1949.

### TOLEDO

"New Developments in Communications," by R. C. Clark and J. S. Henschel, Ohio Bell Telephone Company; March 14, 1949.

"Designing Directional Broadcast Antenna Arrays," by A. R. Bitter, Consulting Radio Engineer; April 18, 1949.

### TWIN CITIES

"A New Microwave Triode," by R. M. Ryder, Bell Telephone Laboratories; April 28, 1949.

"The Radio Engineer Looks at Industrial Electronics," by E. D. Cook, General Electric Company; April 12, 1949.

"Large-Scale Operational Research in Industry as Illustrated by the Great Lakes Radar Studies," by C. M. Jansky, Jr., and S. L. Bailey, Consulting Engineers; May 9, 1949.

"A System of Remotely Controlled Broadcast Program Circuit Switching," by R. Essig, Collins Radio Company; May 18, 1949.

### WILLIAMSPORT

"Television Trends," by G. C. Larson, Westinghouse Electric Corporation; April 27, 1949.

### SUBSECTIONS

#### AMARILLO-LUBBOCK

"Ground-Controlled Approach," by J. Bratton, CAA; March 17, 1949.

"Naturally It's FM"; General Electric Film; "FM Broadcasting," by E. N. Luddy, Radio Station KFDA-FM; April 18, 1949.

#### HAMILTON

Election of Officers; Trip through Bell Telephone Company; April 18, 1949.

#### MONMOUTH

"Acoustic Lenses for Audio-Frequency Applications," by W. E. Kock, Bell Telephone Laboratories; May 18, 1949.

"Distortion in Audio Systems," by L. A. DeRosa, Federal Telecommunication Laboratory; April 20, 1949.

#### NORTHERN NEW JERSEY

"Natural Frequencies and the Potential Analogue," by W. H. Huggins, RF Components Laboratory, Air Materiel Command, Cambridge Field Station; April 13, 1949.

"Development and Performance of Television Camera Tubes," by R. S. Moore, Tube Department, RCA; Election of Officers; May 11, 1949.

#### WINNIPEG

Election of Officers; May 4, 1949.

PROCEEDINGS OF THE I.R.E. July, 1949

## ★ 2 new stars in the field

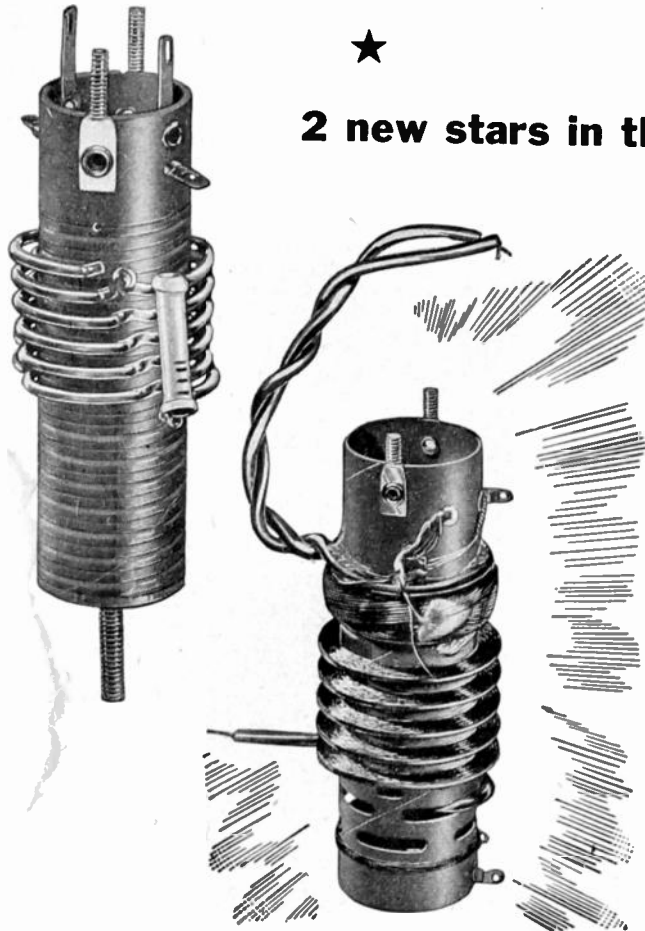

★  
For  
TELEVISION  
RECEIVERS



# Specify COSMALITE\*

Cosmalite Coil Forms give exceptional performance at a definite saving in cost to you.

Punched, threaded, notched and grooved to meet your individual specifications.

#### COSMALITE

Low cost, spirally wound paper base phenolic tubing, suitable for all coil forms in Radio and Television Receivers.

Ask us about the many various punching dies we have available.

Inquiries given quick action and specialized attention.

\*Reg. U. S. Pat. Off.

*The* **CLEVELAND CONTAINER Co.**  
6201 BARBERTON AVE. CLEVELAND 2, OHIO

PLANTS AND SALES OFFICES at Plymouth, Wisc., Chicago, Detroit, Ogdensburg, N.Y., Jamesburg, N.J.

ABRASIVE DIVISION at Cleveland, Ohio

CANADIAN PLANT: The Cleveland Container, Canada, Ltd., Prescott, Ontario

#### REPRESENTATIVES

CANADA	WM. T. BARRON, EIGHTH LINE, RR #1, OAKVILLE, ONTARIO
METROPOLITAN NEW YORK	R. T. MURRAY, 614 CENTRAL AVE., EAST ORANGE, N.J.
NEW ENGLAND	E. P. PACK AND ASSOCIATES, 968 FARMINGTON AVE WEST HARTFORD, CONN.



# BEAT the HEAT

*Specify*



## "NOFLAME-COR"

the TELEVISION hookup wire

APPROVED BY UNDERWRITERS LABORATORIES AT

**90°** CENTIGRADE \_\_\_\_\_ **600** VOLTS

Preferred by leading producers of television, F-M, quality radio and all exacting electronic equipment. All sizes, solid and stranded; over 200 color combinations.

Production Engineers: Avoid high percentage of line rejects by specifying "NOFLAME-COR" (not an extruded plastic). Insulation does not "blob" under heat of soldering iron.

- ✓ Flame Resistant
- ✓ High Dielectric
- ✓ High Insulation Resistance
- ✓ Facilitates Positive Soldering
- ✓ Heat Resistant
- ✓ Easy Stripping

✓ Also unaffected by the heat of impregnation—therefore, ideal for coil and transformer leads

RUBBER _____	75°
PLASTIC _____	80°
<b>"NOFLAME-COR" _____</b>	<b>90°</b>

*"made by engineers for engineers"*

## CORNISH WIRE COMPANY, Inc.

605 North Michigan Avenue,  
Chicago 11

15 Park Row, New York 7, N. Y.

1237 Public Ledger Bldg.,  
Philadelphia 6

MANUFACTURERS OF QUALITY WIRES AND CABLES FOR THE ELECTRICAL AND ELECTRONIC INDUSTRIES



# **AMPHENOL**

## **FIREWALL CONNECTORS**

### **Operate Continuously at Destructive Temperatures**

For aircraft firewall, jet engine, thermocouple and other high temperature installations, Amphenol offers the best heat-resistant and vibration and shockproof electrical connectors. Connectors are of a unique one-piece design manufactured of steel protected by cadmium plating. Ceramic dielectric inserts, shock mounted, protect the contacts at abnormally high temperatures.

With silver plated contacts, circuit continuity is not impaired, and selected alloys retain spring tension and function with lowest millivolt drop.

Amphenol Firewall Connectors have been subjected to the full C.A.A. requirements and have continued to operate efficiently long beyond the test time limit. Amphenol, again, has given the aircraft industry a new contribution to safety in the air. Amphenol's Firewall Connectors are also an indispensable new tool for high temperature industrial applications.

**AMPHENOL**

Write to Department J on Company letterhead for Amphenol Catalog A-1 and the supplement A-1-B, a comprehensive listing of firewall connectors.

**AMERICAN PHENOLIC CORPORATION**  
1830 SO. 54TH AVENUE  
CHICAGO 50, ILLINOIS

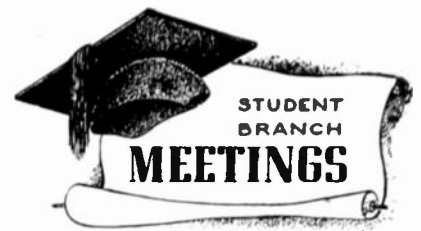

#### ALABAMA POLYTECHNIC INSTITUTE—IRE BRANCH

Business Meeting; March 28, 1949.  
Election of Officers; April 11, 1949.  
Business Meeting; April 25, 1949.  
Business Meeting; May 9, 1949.

#### UNIVERSITY OF ARKANSAS—IRE BRANCH

"Kansas City Regional Meeting," by R. Wollfolk, Student; Election of Officers; May 10, 1949.

#### UNIVERSITY OF CALIFORNIA SOCIETY OF ELECTRICAL ENGINEERS—IRE-AIEE BRANCH

After Dinner Speech, by E. S. Lee, AIEE National President; April 7, 1949.  
Inspection Field Trip; April 8 to April 14, 1949.  
"Electronic Digital Computer," by P. Morton, Faculty of University of California; April 21, 1949.

#### CARNEGIE INSTITUTE OF TECHNOLOGY—IRE-AIEE BRANCH

Election of Officers; February 21, 1949.  
Student Talks; March 7, 1949.  
Student Talks; March 14, 1949.  
Student Talks; March 18, 1949.  
Student Talks; March 25, 1949.

#### CASE INSTITUTE OF TECHNOLOGY—IRE BRANCH

"Electronic Control in Industry," by C. Mann, Westinghouse Electric Company; May 3, 1949.  
"Television—Its Mechanism and Promise," by W. L. Lawrence, Radio Corporation of America; May 17, 1949.  
"Radar and Radio in Astronomy," by J. J. Nassau, Faculty of Case Institute; April 12, 1949.

#### CLARKSON COLLEGE OF TECHNOLOGY—IRE BRANCH

Election of Officers; May 11, 1949.

#### UNIVERSITY OF COLORADO—IRE BRANCH

"Principles of Servomechanisms," by D. S. Stacey, Faculty of University of Colorado; May 11, 1949.

#### UNIVERSITY OF DETROIT—IRE BRANCH

"Radio or Television—Which?" by R. J. Jones, Radio Station WJBK; J. Eberle, Radio Station WWJ; J. F. Steadley, Radio Station WLDM; and D. Cook, Radio Station WDTR; April 26, 1949.

#### FENN COLLEGE—IRE BRANCH

"Proximity Fuzes," by H. E. Morgan, Faculty of Fenn College; Election of Officers; May 6, 1949.

#### UNIVERSITY OF FLORIDA—IRA-AIEE BRANCH

"Effects of Electric Shock on the Human Body," by W. F. Fagen, Faculty of University of Florida; April 7, 1949.

"Three-Dimensional Representation on Cathode-Ray Tube," by J. L. Youmans, Student; Election of Officers; April 28, 1949.

"Fundamentals of Electrical Protection in Generating Plants," by W. C. Cogburn, Florida Power and Light Company; May 12, 1949.

#### STATE UNIVERSITY OF IOWA—IRE BRANCH

Student Talks; March 30, 1949.  
Student Talks; April 6, 1949.  
"Familiarization with Meters," by C. Miller,

(Continued on page 46A)



# R. F. COMPONENTS—MICROWAVE—TEST EQUIPMENT



**1.25 CENTIMETER**  
 "K" BEND DIRECTIONAL COUPLER CU104/AP-54, 20 DB ..... \$49.50 ea.  
 "K" BAND FEEDBACK TO PARABOLA HORN, with pressurized window ..... \$30.00  
 MITRED ELBOW cover to cover ..... \$4.00  
 TR/ATR SECTION choke to cover ..... \$4.00  
 FLEXIBLE SECTION 1" choke to choke ..... \$5.00  
 ADAPTER, rd. cover to sq. cover ..... \$5.00  
 MITRED ELBOW and S sections choke to cover ..... \$4.50  
 WAVE GUIDE 1/2 x 1/4 per ft. .... \$1.00  
 K BAND CIRCULAR FLANGES ..... \$50¢

**10 CENTIMETER**  
 WAVEGUIDE TO 3/4" RIGID COAX "DOOR-KNOB" ADAPTER, CHOKE FLANGE, SILVER PLATED, BROAD BAND ..... \$49.50 EACH  
 WAVEGUIDE DIRECTIONAL COUPLER, 27 db, Navy type CABV-47AAN, with 4 in. slotted section ..... \$42.50  
 SQ FLANGE to rd choke adapter, 18 in. long OA 1 1/2 in. x 3 in. guide, type "N" output and sampling probe ..... \$32.00  
 "S" BAND CRYSTAL MOUNT, gold plated, with 2 type "N" connectors ..... \$12.50  
 PICKUP LOOP, Type "N" Output ..... \$27.75  
 TR BOX "Pick-up Loop" ..... \$1.25  
 POWER SPLITTER: 726 Klystron input, dual "N" output ..... \$5.00  
 MAGNETRON TO WAVEGUIDE coupler with 721-A duplexer cavity, gold plated ..... \$27.50  
 10 CM WAVEGUIDE SWITCHING UNIT, switches 1 input to any of 3 outputs, Standard 1 1/2" x 3" guide with square flanges. Complete with 115 vac or dc arranged switching motor, Mfg. Raytheon, CRP 24AAS, New and complete ..... \$150.00  
 10 CM END-FIRE ARRAY POLYRODS \$1.75 ea.  
 "S" BAND Mixer Assembly, with crystal mount, pick up loop, tunable output ..... \$3.00  
 721-A TR CAVITY WITH TUBE, Complete with tuning plungers ..... \$12.50  
 10 CM. McNALLY CAVITY Type SG ..... \$3.50  
 WAVEGUIDE SECTION, MC 445A, rt. angle bend, 5/8" ft. OA, 8" slotted section ..... \$21.00  
 10 CM OSC. PICKUP LOOP, with male Home-dell output ..... \$2.00  
 10 CM DIPOLE WITH REFLECTOR in Lucite ball, with type "N" or Sperry fitting ..... \$4.50  
 10 CM FEEDBACK DIPOLE ANTENNA, in lucite ball, for use with parabola 7/8" Rigid Coax Input ..... \$8.00  
 PHASE SHIFTER, 10 CM WAVEGUIDE, WE TYPE ES-683816, E PLANE TO H PLANE, MATCHING SLUGS ..... \$95.00  
 721A TR cavities Heavy silver plated, \$2.00 ea.  
 10 cm. horn and rotating joint assembly, gold plated ..... \$65.00 ea.  
 10 cm. right angle bend "E" or "H" plane, less flanges ..... \$17.50 ea.  
 "S" BAND "Y" JUNCTION, Sq. Flanges \$65.00  
 10 cm. waveguide to 7/8" rigid coax doorknob transition, 21" high with 8" slotted section ..... \$52.50 ea.  
 10 cm. flexible section, 4 feet long ..... \$42.50 ea.  
 10 CM FLANGES, UG65/U ..... \$8.50  
 UG65/U 10 CM. FLANGE ..... \$8.50  
 ADAPTER 1 1/2 x 3 to 1" x 2". Sq. 10 cm. Flange to Sq. 5 cm. Choke ..... \$57.50  
 KLYSTRON Mount W/Tunable matching output to type "N" Connector, Socket & tube clamp included ..... \$12.50

**3/8" RIGID COAX—3/8" I.C.**  
 Sperry 2R10G13, Gold Plated ..... \$27.50  
 Dipole assembly, Part of SCR-584 ..... \$25.00 ea.  
 Rotary Joint, Part of SCR-584 ..... \$35.00 ea.  
 RIGHT ANGLE BEND, with flexible coax output pickup loop ..... \$8.00  
 SHORT RIGHT ANGLE BEND, with pressurizing nipple ..... \$3.00  
 RIGID COAX to flex coax connector ..... \$3.50  
 STUB-SUPPORTED RIGID COAX, gold plated 5' lengths, Per length ..... \$5.00  
 RT. ANGLES for above ..... \$2.50  
 RT. ANGLE BEND 15" L. OA ..... \$3.50  
 FLEXIBLE SECTION, 15" L. Male to female ..... \$4.25  
 MAGNETRON COUPLING TO 7/8" rigid coax, with TR pickup loop, gold plated ..... \$7.50  
 FLEX COAX SECT. Approx. 30 ft. .... \$16.50  
**7/8" RIGID COAX—1/2" I.C.**  
 7/8 RIGID CDAX, Bead Supported ..... \$1.20  
 SHORT RIGHT ANGLE BEND ..... \$2.50  
 Rotating joint, with deck mounting ..... \$15.00  
 RIGID CDAX slotted section CU-80/AP ..... \$5.00

**MISCELLANEOUS**  
 Type "N" patching cord UG11/U female to UG9/U using RG5/U cable 12" long ..... \$2.25 ea.  
 AN/TPS-1B flanged nipple and insert assembly for rotary coupling ..... \$3.75 ea.  
 Pulse connector Navy type 49579 ..... \$1.50 ea.  
 Transmission line pressure gauge, 2" 15 lbs. ..... \$1.85 ea.  
 Pulse cable assembly Western Electric type D162262, 10 feet long ..... \$4.50 ea.  
 Holmdell Jack Western Electric BO-12962-D, B, \$1-102X ..... \$3.75 ea.  
 Adapter type "N" RG8/U to RG17/U or 18/U cable ..... \$4.50 ea.  
 ADAPTER TYPE "N" TO RG-71/U CONNECTOR ..... \$5.50  
 F-29/SPR-2 HIGH PASS FILTER P/O AN/APR-SAX, TYPE "N" CONNECTORS, \$12.50  
 Magnetron coupling to 7/8 rigid coax ..... \$5.00 ea.  
 Hand pumps for pressurizing transmission line with humidity indicator ..... \$12.50 ea.

**PULSE NETWORKS**  
 15A-1-400-50: 15 KV, "A" CKT. 1 microsec., 400 PPS, 50 ohms imp. .... \$42.50  
 G.E. 5E3-5-2000-50P2T, 5KV, "E" circuit, 3 sections, 5 microsecond, 2000 PPS, 50 ohms impedance ..... \$6.50  
 G.E. 53E (3-84-810: 8-2-24-405) 50P4T: 3KV, "E" CKT Dual Unit ..... \$6.50

**TEST EQUIPMENT**  
 TS-117/GP 10 CM Wavemeter Test Set, Mfg. "Sperry," 2400-3400 MC, Micrometer Adj. Coaxial cavity, 100 Mc. Max. Attenuation or Transmission Meth. Mounts Crystal Current Meter & Calib. Chart ..... \$145.00  
 VSWR Amplifier TS-12/AP, Unit 1, 3 Stages of Amplif. and Diode Rectifier W/Direct VSW. Reading on Meter, 115 Volts 60 cyc. AC Operation W/Inst. BK and CCT Diag. New ..... \$230.00  
 Slotted Line Probe and Mated Termination Including Accessories TS-12/AP Unit 2 Incl. UG81/U, CG92/U, CG917U, CG89/U, UG79/U, CG87/U, MX158/U, CG-88/U, CG90/U, UG80/U Plus Tools, New ..... \$135.00  
 Complete TS-12/AP Units 1 and 2 ..... \$350.00  
 10 CM. Echo Box CABV 14ABA-1 of OBU-3, 2890 MC, to 3170 MCS, Direct Reading Micrometer Head, Ring Prediction Scale Plus 5% to Minus 5% Type "N" Input, Resonance Indicator Meter New and Comp. W/Access, Box and 10 CM. Directional Coupler ..... \$350.00  
 3 CM. Receiver, SO-3, Complete with W.G. Mixer Assy. (723 A/B) Reg. Fil. Power Supply, 6 Stages IF (6AC7) ..... \$99.50  
 10 cm. horn assembly consisting of two 5" dishes with dipoles feeding single type "N" output. Includes UG28/U type "N" T junction and "X" Band test set TS45A, APM-3 using 723 AB oscillator. Input 115 volts single phase 60 to 800 cycles, 0 to 35 DB attenuator in use, fair condition ..... \$110.00 ea.  
 TS-268-U CRYSTAL TEST SET for checking 1N21, 1N21A, 1N21B, 1N23, 1N23A, 1N23B crystals, New ..... \$55.00  
 THERMISTOR BRIDGE: Power meter I-203-A, 10cm. inf. W.E. Complete with meter, Inter. polation chart, portable carrying case. \$72.50  
 W. E. 1138, Signal generator, 2700 to 2900 Mc. range, Lighthouse tube oscillator with attenuator & output meter, 115 VAC input, reg. Pwr. supply, With circuit diagram. .... \$50.00  
 3 cm. Wavemeter: 9200 to 11,000 mc. transmission type with square flanges ..... \$15.00  
 3 cm. stabilizer cavity, transmission type ..... \$20.00  
 3 cm. Wavemeter, Micrometer head mounted on X-band guide, Freq. approx. 7900 to 10,000 Mc. .... \$75.00  
 TS-238 GP, 10 cm. Echo box with resonance indicator and micrometer adjust cavity, 2700 to 2900 Mcs calibrated as shown ..... \$85.00  
 Bell Labs. Dual Mount mixer-beacon assemblies, 2 complete mixer-beacon mounts on gold-plated waveguide section ..... \$50.00  
 "X" band klystron mount, shielded with rough attenuator output ..... \$65.00  
 TS-108A/P DUMMY LOAD ..... \$65.00  
 3 CM. HORN AT-48/U model 710, Type "N" input, Ilvy. silver plated ..... \$6.50

**3 CENTIMETER (STD. 1" x 1/2" GUIDE, UNLESS OTHERWISE SPECIFIED)**  
 3 cm. 180° bend with pressurizing nipple \$4.00 ea.  
 3 cm. 90° bend, 14" long 90° twist with pressurizing nipple ..... \$4.00 ea.  
 3 cm. "S" curve 18" long ..... \$5.50 ea.  
 3 cm. "S" curve 6" long ..... \$3.50 ea.  
 3 cm. right angle bends, "E" plane 12" long ..... \$6.50 ea.  
 3 cm. cutter feed dipole, 1" from parabola mount to feed back ..... \$8.50 ea.  
 3 cm. directional coupler, One way waveguide output ..... \$15.00 ea.  
 TR ATR section for mounting 1B24 with 721A ATR cavity, Iris coupling flange, Choke to choke ..... \$12.50 ea.  
 APS-31 mixer section for mounting two 2K23's Beacon reference cavity 1B24 TR tube, New and complete with attenuating slugs ..... \$42.50 ea.  
 TRANSITION: 1 x 1/2 to 1 1/4 x 1/4, 14 in. L. \$8.00  
 "X" BAND PREAMPLIFIER, consisting of 2-723 A/B local oscillator-beacon feeding waveguide and TR/ATR Duplexer sect. incl. 60 mc 1B amp ..... \$67.50  
 Random Lengths wavegd. 6" to 18" Lg. \$1.10 Ft.  
 WAVEGUIDE RUN, 1 1/2" x 1/2" guide, consisting of 4 ft. section with Rt. angle bend on slating of 4 ft. section with Rt. angle bend on one end 2" 45 deg. bend other end ..... \$8.00  
 WAVEGUIDE RUN, 1 1/2" x 1/2" guide, consisting of 4 ft. long ..... \$10.00  
 "X" BAND PRESSURIZING gauge section 714 Y w/15-lbs gauge & Pressurizing Nipple ..... \$18.50  
 45 DEG. TWIST 8" Long ..... \$10.00  
 12" STRAIGHT WAVEGUIDE section choke to section, Special heavy construction, silver plated ..... \$4.50  
 15 DEG. BEND 10" choke to cover ..... \$4.50  
 5 FT. SECTIONS choke to cover, Silver Plated ..... \$14.50  
 "E" and "H" PLANE BANDS ..... \$12.50  
 BULKHEAD FEED THRU ..... \$15.00  
 5 CM.  
 2" x 1" RT. ANGLE BEND choke to cover silver plated ..... \$38.50  
 WAVEGUIDE MIXER CV-12A/APR-6 ..... \$55.00  
 RAPID W.G. FASTENING CLAMPS ..... \$5.00

**PULSE EQUIPMENT**  
 MIT. MOD. 3 HARD TUBE PULSER: Output Pulse Power: 144 KW (12 KV at 12 amp), Duty Ratio: .001 max. Pulse duration: 5, 1.0, 2.0 microsec. Input voltage: 115 v. 400 to 2400 cps. Uses 1-715-B, 1-829-B, 3-72's, 1-730 New ..... \$110.00  
 APQ-13 PULSE MODULATOR, Pulse Width .5 to 1.1 Micro Sec., Rep. rate 624 to 1348 Pps. Pk. pwr. out 35 KW, Energy 0.018 Joules \$49.00  
 TFS-3 PULSE MODULATOR, Pk. power 60 amp, 24 KV (1200 KW pk); pulse rate 200 PPS, 1.5 microsec; pulse line impedance 50 ohms, Circuit—series charging version of DC Resonance type, Uses two 705-A's as rectifiers, 115 v. 400 cycle input, New with all tubes \$49.50  
 APS-10 MODULATOR DECK, Complete, less tubes ..... \$75.00  
 APS-10 Low voltage power supply, less tubes ..... \$18.50  
 725A magnetron pulse transformers ..... \$18.50 ea.  
 Megawatt magnetron Pulse XFMR ..... \$42.50

**MICROWAVE ANTENNAS**  
 SO-3 RADAR 3 CM. Surface search antenna, Complete with 24VDC drive motor, Selsyn Gear Mechanisms, "X" Band Slotted "Peel" Reflector, Less Plumbing, \$135.00, As Shown APS-15 Antennas, New \$99.50  
 AN MPG-1 Antenna, Rotary feed type high speed scanner antenna assembly, including horn parabolic reflector, Less internal mechanisms, 10 deg. sector scan, Approx. 12" L x 4" W x 3" H, Unused (Gov't Cost—\$4500.00) ..... \$250.00  
 APS-4 3 cm. antenna, Complete, 14 1/2" dia. Cutler feed dipole directional coupler, all standard 1" x 1/2" waveguide, Drive motor and gear mechanisms for horizontal and vertical scan, New, complete ..... \$65.00

**R. F. EQUIPMENT**  
 LHR, LIGHTHOUSE ASSEMBLY Part of RT39/APG-5 & APG-15, Receiver and Transmitter Lighthouse Cavities with Assoc. TR Cavity and Type N CPLG to RCVR, Uses 2C40, 2C43, 1B27, Tunable APX 2400-500 MCS, Silver plated ..... \$49.50  
 Receiver transmitter RT-39A APG-5 10cm, gun laying RF package using 2C40 and 2C46, new, package used, less tubes ..... \$150.00 ea.  
 APS-2 10 CM RF HEAD complete with hard tube (715B) Pulser, 714 Magnetron 417A Mixer, all 7/8" rigid coax, Incl. Rcvr. Front end Beacon Lighthouse cavity 10 cm with miniature 28 volt DC & FM motor, Mfg. Bernard Rice ..... \$47.50 ea.  
 T-128/APN-19 10 cm. radar Beacon transmitter package, used, less tubes ..... \$59.50 ea.  
 SO-3 "X" band 3 cm. RF package, new, complete, including receiver unit, as illustrated on Page 337, Volume 23, RAD LAB Series ..... \$375.00 ea.  
 Pre-amplifier cavities type "M" 7410590G1 to use 446A lighthouse tube, Completely tunable, heavy silver plated construction ..... \$37.50 ea.  
 RT-32APS-6A RF HEAD, Compl. with 725A Magnetron, Magnet, Pulse XFMR, TR-ATR, 723 A/B Local OSC. and Beacon Mount, Pre-Amplifier, Used but exc. cond. .... \$97.50  
 AN/APG-15A "X" Band compl. RF head and modulator, incl. 725A magnetron and magnet, two 723A/B klystrons (local osc. & beacon), 1B24 TR, rcvr-ampl. duplexer, HV supply, blower, pulse xmr. Peak Pwr. Out: 45 KW approx. 5 to 2 micro-sec. apx. 13 KV Pk Pulse, Compl. with all tubes incl. 715-B, 829B, RK1R 73, two 72's. Compl. pkg. new ..... \$210.00

**MAGNETRONS**

Tube	Frg. Range	Pk. Pwr. Dut.	Price
2J31	2820-2860 mc.	265 KW.	\$25.00
2J21-A	9345-9405 mc.	50 KW.	\$25.00
2J22	3267-3333 mc.	265 KW.	\$25.00
2J26	2902-3019 mc.	275 KW.	\$25.00
2J27	2965-2992 mc.	275 KW.	\$25.00
2J32	2780-2820 mc.	285 KW.	\$45.00
2J37	8249-8263 mc.	5 KW.	\$35.00
2J38 Pkg.	8267-8333 mc.	87 KW.	\$35.00
2J40	9305-9325 mc.	10 KW.	\$65.00
2J49	9000-9160 mc.	53 KW.	\$85.00
2J34			\$55.00
2J61	8000-8100 mc.	35 KW.	\$65.00
2J62	2014-3010 mc.	35 KW.	\$65.00
3J31	24,000 mc.	50 KW.	\$39.50
5J30			\$25.00
714 Y			\$25.00
718DY			\$25.00
720BY	2800 mc.	1000 KW.	\$50.00
720CY			\$50.00
725-A	9345-9405 mc.	50 KW.	\$25.00
730-A	9345-9405 mc.	50 KW.	\$25.00
728 AY, BY, CY, DY, EY, FY, GY			\$50.00
700 A, B, C, D, EY, FY, GY			\$50.00
706 AY, BY, CY, DY, EY, FY, GY			\$50.00
Klystrons, 723A/B \$125.00; 707B W/Cavity 417A \$25.00		2K41	\$65.00

Gauge	Pole Diam.	Spacing	Price
4850	1/4 in.	1/4 in.	\$12.50
5200	21/32 in.	1/4 in.	\$17.50
1300	1 1/2 in.	1 1/2 in.	\$12.50
1860	1 1/2 in.	1 1/2 in.	\$14.50

ALL MERCHANDISE GUARANTEED. MAIL ORDERS PROMPTLY FILLED. ALL PRICES F.O.B. NEW YORK CITY. SEND MONEY ORDER OR CHECK ONLY. SHIPPING CHARGES SENT C.O.D. RATED CONCERNS SEND P. O.

COMMUNICATIONS EQUIPMENT CO.

131 "I" Liberty St., New York, N.Y. ATT: P. J. Plishner Cable "Comsupo" Ph. Digby 9-4124

# It's CP for COAXIAL HALF-WAVE DIPOLE ANTENNAS for two-way mobile service

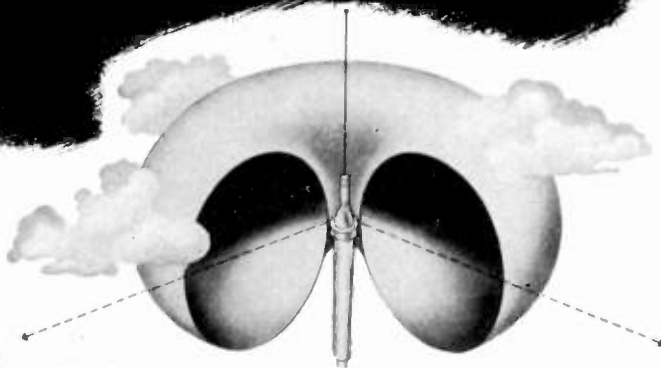

## PROVEN RELIABLE AND EFFECTIVE OVER THE YEARS

CP Antennas use one of the most effective — and elemental — forms of antennas serving radio communications. Simple physically and electrically, CP Antennas have earned a reputation for reliability.

CP Coaxial Antennas are ruggedly constructed of selected materials to give satisfactory commercial service under severe operating conditions. They are recommended for both transmission and reception. Power handling capacity is limited only by the rating of the feed line. All antennas feature rust-proof construction throughout with necessary accessories for simple, positive installation.

### Ask for your copy of CP Bulletin 106

This new bulletin, compiled by the engineering staff of Communication Products, provides complete data on CP antenna construction, as well as detailed specifications and operational information. Fully illustrated with photographs and schematic sketches. Call or write CP, now, for Bulletin 106 or literature on any of the products listed below.

### YOU CAN DEPEND ON THESE CP PRODUCTS

- ✓ LO-LOSS SWITCHES
- ✓ TEFLON TRANSMISSION LINE
- ✓ AUTO-DRYAIRE DEHYDRATORS
- ✓ COAXIAL DIPOLE ANTENNAS
- ✓ TOWER HARDWARE



*Communication Products Company, Inc.*

KEYPORT  NEW JERSEY.

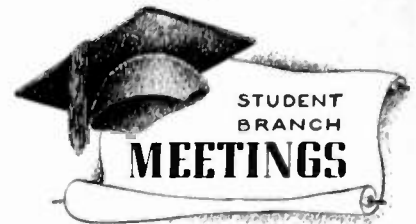

(Continued from page 44A)

Weston Meter Corporation; April 12, 1949.  
Student Talks; April 20, 1949.  
"Development of the Transistor," by R. W. Ryder, Bell Laboratories; April 25, 1949.  
Student Talks; May 4, 1949.

#### KANSAS STATE COLLEGE—IRE BRANCH

Motion Picture on Synchro Systems, by U. S. Navy; May 5, 1949. Election of Officers; May 12, 1949.

#### LAFAYETTE COLLEGE—IRE-AIEE BRANCH

"The Amplidyne in the Field of Industrial Control," by L. Conover, Faculty of Lafayette College; April 19, 1949.

Election of Officers; April 21, 1949.

"Registration of the Engineer," by C. T. Schoch, President of Pennsylvania Professional Engineer's Association; May 4, 1949.

Student Branch Picnic; May 13, 1949.

#### LEHIGH UNIVERSITY—IRE BRANCH

"Pulse Modulation," by F. Achard, Student;  
"Electronic Differentiation and Integration," by T. G. Schwarz, Student; April 27, 1949.

"Teloran," by D. Houston, Student; Election of Officers; May 19, 1949.

#### UNIVERSITY OF LOUISVILLE—IRE BRANCH

"Engineering in Broadcasting," by O. W. Towner, Radio Station WHAS; April 28, 1949.

#### MASSACHUSETTS INSTITUTE OF TECHNOLOGY— IRE-AIEE BRANCH

"Dynamic Noise Suppressor," by H. H. Scott, Herman Hosmer Scott, Inc.; Nomination of Officers; April 20, 1949.

"Evolution and Modern Application of Electric Light Sources," by L. S. Cooke, General Electric Company; April 25, 1949.

#### UNIVERSITY OF MICHIGAN—IRE-AIEE BRANCH

"Stratovision," by G. B. Saviers, Westinghouse Electric Corporation; April 20, 1949.

"Aircraft Electronic Control Systems," by D. Courter, Lear Inc.; May 11, 1949.

#### MICHIGAN STATE COLLEGE—IRE-AIEE BRANCH

"The Application of Network Theorems to Vacuum-Tube Circuits," by V. J. Spagnuolo, Student; and "Pulse Modulation Techniques," by N. H. Kramer, Graduate Student; April 14, 1949.

"The Job of a Central Station Engineer," by A. A. Johnson, Westinghouse Electric Corporation; and Film, "Atomic Hydrogen Welding"; April 20, 1949.

"Protective Devices," by E. D. Harder, Bussmann Manufacturing Company; May 18, 1949.

#### UNIVERSITY OF MISSOURI—IRE-AIEE BRANCH

Film, "Approved by the Underwriters," issued by Underwriters' Laboratories; Election of Officers; April 27, 1949.

#### UNIVERSITY OF NEBRASKA—IRE-AIEE BRANCH

"Noncyclic Lamp Flicker," by M. Kroeger, Student; Election of Officers; April 20, 1949.

"Electronic Computers," by F. Pelton, Graduate Student; May 11, 1949.

(Continued on page 47A)

# Etched TUNGSTEN WIRE

• From .0004" to  
.00015" diameter  
and even smaller

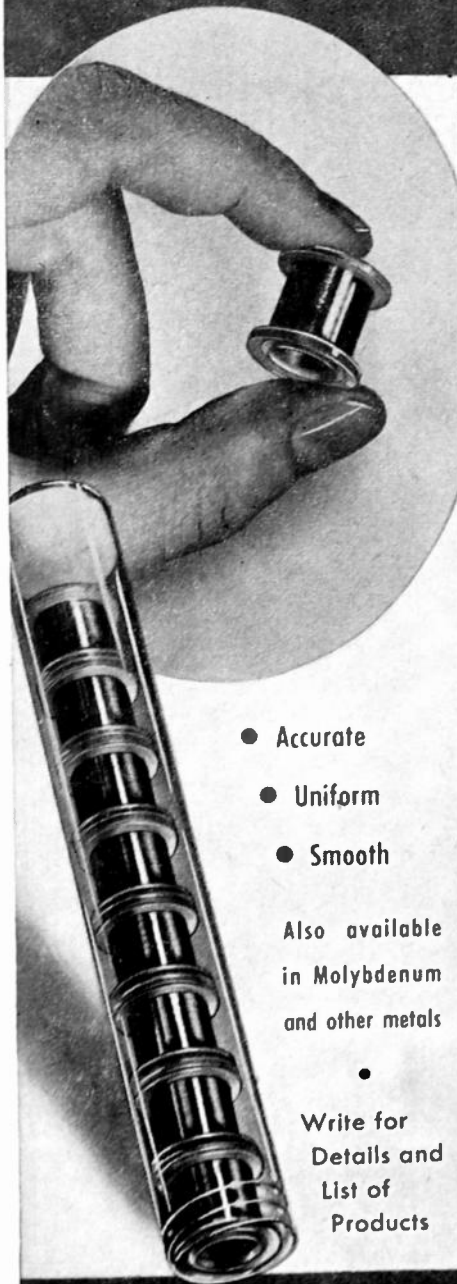

- Accurate
- Uniform
- Smooth

Also available  
in Molybdenum  
and other metals

Write for  
Details and  
List of  
Products

**SIGMUND COHN CORP.**  
44 GOLD ST. NEW YORK

SINCE  1901

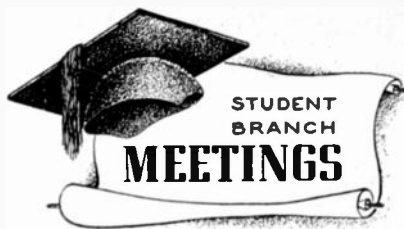

(Continued from page 46A)

#### UNIVERSITY OF NEW MEXICO—IRE BRANCH

"Reflected Power Communication," by Mr. Cassidy, Sandia Base Laboratory; January 12, 1949.  
Talk on Papers Given at AIEE Convention, by K. Cooper and G. Lagomarsini, Students; Election of Officers; May 4, 1949.

#### COLLEGE OF THE CITY OF NEW YORK— IRE BRANCH

"Job Opportunities in Television and Electronics," by G. Gram, Director of Television Training NBC; April 26, 1949.  
Election of Officers; May 17, 1949.

#### NEW YORK UNIVERSITY—IRE BRANCH

"The Reeves Analogue Computer," by M. Gerger, Student; April 30, 1949.  
"The Electro-Cardiography," by S. Reiner, Research Assistant, New York University; Election of Officers; May 11, 1949.

#### NORTH CAROLINA STATE COLLEGE—IRE BRANCH

"Radio Broadcasting Problems," by V. Duncan, Radio Station WRAL; Election of Officers; April 6, 1949.

"Varistors," by Mr. Stansel, Bell Telephone Laboratories; Election of Committee Chairmen; April 20, 1949.

"The Development of Low-Frequency Loran," by Dr. Carson, Faculty of North Carolina State College; May 4, 1949.

#### OREGON STATE COLLEGE—IRE BRANCH

"Carrier Current," by J. V. McGaughy, General Electric Company; April 27, 1949.

"Marine Radar," by Mr. Scott, Westinghouse Electric Corporation; May 3, 1949.

"Extra-High Voltage Development and Trends," by P. L. Bellaschi, Consulting Engineer; May 18, 1949.

#### UNIVERSITY OF PITTSBURGH—IRE BRANCH

"My Experiences in Radio," by J. Murray, Radio Station KQV; April 14, 1949.

#### PRATT INSTITUTE—IRE BRANCH

Election of Officers; May 5, 1949.  
Business Meeting; May 17, 1949.

#### PURDUE UNIVERSITY—IRE BRANCH

"The Engineering Considerations of Transistors," by J. A. Morton, Bell Telephone Laboratories, April 29, 1949.

#### RUTGERS UNIVERSITY—IRE-AIEE BRANCH

Nomination of Officers, May 3, 1949.  
Election of Officers; May 9, 1949.

#### SAN DIEGO STATE COLLEGE—IRE BRANCH

"Citizens' Radio Band—460-470 Mc.," by D. Swanson and B. Royce, Students; Business Meeting; April 25, 1949.

#### SOUTH DAKOTA SCHOOL OF MINES AND TECHNOLOGY—IRE BRANCH

"U. S. Army and Air Force Communication Systems," by H. Dutton, Rapid City Army Air Force Base; Election of Officers; April 20, 1949.

"Single Sideband Radio Telephony," by D. C. Bakeman, Student; May 4, 1949.

#### SOUTHERN METHODIST UNIVERSITY—IRE-AIEE BRANCH

"Sales Engineering," by Mr. Gray, General Electric Company; Election of Officers; April 29, 1949.

(Continued on page 48A)

## EXTRA-SMALL... MOISTURE-RESISTANT

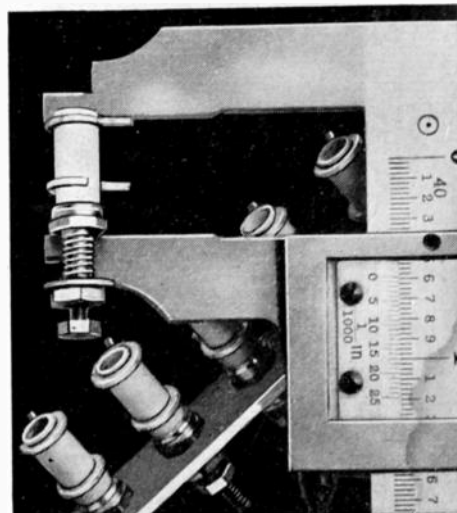





### New CTC Ceramic Coil Form Is Ideal For Many Sub-Miniature Component Applications

Standing less than 5/8" high when mounted, and with a form diameter of only 3/16", CTC's new LST ceramic coil form fits easily into small spaces and hard-to-reach locations. In addition, its coil body of silicone impregnated ceramic (grade L-5, JAN-1-10) offers the advantage of extremely high resistance to moisture and fungi, and has well developed dielectric properties.

Mounting bushings and ring-type, adjustable terminals are of brass. Bushings are cadmium plated and terminals are silver plated. The powdered iron slug is adjustable. Accommodating solenoid or pie type windings, the LST is supplied as a coil form, or wound to specifications. Depending on the type of winding, inductance changes of approximately 2 : 1 can be expected.

You'll find the LST and many other *Guaranteed Components* fully described in CTC's new Catalog #300. This big illustrated booklet is packed with helpful information. Send for it today.

		
		
Terminal Board	Double-End Lugs	Swagger

**Custom or Standard  
The Guaranteed  
Components**

**CAMBRIDGE THERMIONIC CORP.**  
456 Concord Ave., Cambridge 38, Mass.

# JOHNSON Offers-

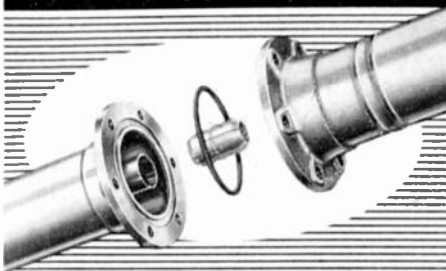

## LONG-FLANGE CO-AX LINE...

**GREATER MECHANICAL STRENGTH**  
No Brazing—No Cracking—No Distortion!  
Solder Joint Stronger Than Tubing Itself!

This is the type of copper tubing joint which has proved most successful in other applications for many years!

There is less distortion, better all-around contact—a joint that is stronger than the tubing itself!

JOHNSON hard temper, 70 ohm, and 51.5 ohm, flange type line is supplied in 20 foot lengths. Special high conductivity copper is used in both outer and inner conductors and rigid tolerances are maintained to insure precision mechanical assembly, low loss and low standing wave ratio.

The 70 ohm line is intended primarily for AM and has grade L-4 or better steatite beads. The 51.5 ohm line was designed primarily for high frequencies, has grade L-5 or better steatite and meets RMA standards for FM line. Both are fitted with flange couplings at the factory, which greatly simplifies field installation.

In addition, JOHNSON manufactures a complete line of elbows, fittings, gas equipment and hardware for the above as well as semi-flexible, soft temper line in continuous lengths up to 1200 feet in 5/16", 3/8" and 7/8". No expansion joints nor elbows are needed for the latter because of its flexibility.

The 5/16" line is especially recommended for phase sampling and other low power applications.

Whatever your co-ax requirements may be, JOHNSON — the oldest manufacturer of concentric line in the field — can meet them to your utmost satisfaction.



## Student Branch Meetings

(Continued from page 47A)

### STANFORD UNIVERSITY—IRE-AIEE BRANCH

"UHF Techniques Applied to Tetrode Transmitting Tubes," by J. McCullough, Eitel-McCullough, Inc.; April 13, 1949.

Student Paper Competition for AIEE, talks by E. Cordell, University of California; B. G. Ryland, Stanford University; and J. Ylarraz, Santa Clara University; May 10, 1949.

### SYRACUSE UNIVERSITY—IRE-AIEE

"The Engineer," by E. Lee, President of AIEE; May 4, 1949.

### UNIVERSITY OF TENNESSEE—IRE BRANCH

"Job Placement After Graduation," by C. H. Weaver, Faculty of University of Tennessee; April 19, 1949.

Election of Officers; May 18, 1949.

### UTAH STATE AGRICULTURAL COLLEGE—IRE BRANCH

"Spectograph," by M. C. Cannon, Faculty of Utah State Agricultural College; May 11, 1949.

### UNIVERSITY OF WISCONSIN—IRE BRANCH

"Electronics in Meteorology," by V. E. Suomi, Faculty of University of Wisconsin; Election of Officers; March 9, 1949.

### WORCESTER POLYTECHNIC INSTITUTE—IRE-AIEE BRANCH

Student Talks; April 14, 1949.

### UNIVERSITY OF WYOMING—IRE BRANCH

Film, "Desert Victory"; Election of Officers; May 10, 1949.



The following transfers and admissions were approved and will be effective as of July 1, 1949:

#### Transfer to Senior Member

Beasley, W. A., 14 Russel Ave., Fort Monmouth, N. J.

Davis, H., 180 Avenel Blvd., Long Branch, N. J.

Dietsch, C. G., 195 Ames Ave., Leonia, N. J.

Duncan, H. S., 1902 W. Minnehaha Ave., St. Paul 4, Minn.

Fischer, F. P., R.D. 1, Willimantic, Conn.

Grew, L. B., The Southern New England Telephone Company, New Haven 6, Conn.

Morton, J. A., Bell Telephone Laboratories, Inc., Murray Hill, N. J.

Svanacini, A. L., Monroe 4946, Depto. "A," Buenos Aires 31, Argentina

Weichbrod, J., 2525 14 St., N.E., Washington, D. C.

Zimmerman, S. W., 102 Valley Pl., Ithaca, N. Y.

#### Admission to Senior Member

Barkson, J. A., 1002 W. Oregon St., Urbana, Ill.

Bescherer, E. A., 66 Old Army Rd., Bernardsville, N. J.

Brady, R. F., 3506 Lee Blvd., Arlington, Va.

Dodd, F. L., 180 Hazelwood Ter., Rochester 9, N. Y.

Liddel, U., Office of Naval Research, Navy Dept., Washington, D. C.

Rice, P. J., Bell Telephone Laboratories, Inc., 463 West St., New York 14, N. Y.

(Continued on page 49A)

# Cannon Plug

## FOR PUBLIC ADDRESS SYSTEMS



MICROPHONES

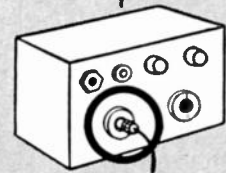

AMPLIFIERS

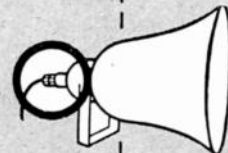

LOUD SPEAKERS



"XL" SERIES

"P" SERIES



"O" SERIES

Available at jobbers everywhere or write PA Plug Catalog. Address Dept. F-377.



3209 HUMBOLDT ST., LOS ANGELES 31, CALIF.

In Canada — CANNON ELECTRIC CO., LTD., TORONTO





(Continued from page 48A)

Rotkin, I., 7728 Emerson Rd., West Lanham Hills, Hyattsville, Md.  
 Russell, R. M., 14718 Tustin St., Sherman Oaks, Calif.

**Transfer to Member**

Ainlay, A., 153 John St., S., Hamilton, Ont., Canada  
 Beauchemin, A. K., 118 Lexington Ave., Passaic, N. J.  
 Chapman, R. F., 7130-71 Pl., Glendale, N. Y.  
 Cohn, G. I., 265 Woodland Rd., Lake Forest, Ill.  
 Cummings, M. M., 234 Fourth St., Scotia 2, N. Y.  
 Elbinger, L. P., Electrical Engineering Dept., Illinois Institute of Technology, Chicago 16, Ill.  
 George, D. E., 8414 12 Ave., Brooklyn 28, N. Y.  
 Hoff, R. S., 1225 S. Ninth St., Route 2, Gainesville, Fla.  
 Hubbard, C. L., 205 Humble Bldg., Houston, Tex.  
 Kreuger, R. E., Box 1663, Los Alamos, N. Mex.  
 Kulinyi, R. A., 167 Newman Springs Rd., Red Bank, N. J.  
 Leedom, J. N., 4543 Arcady, Dallas 5, Tex.  
 McCoy, E. W., Jr., 23 Atkins Ave., Brooklyn 8, N. Y.  
 McGaughey, P. C., 40 Jefferson Ave., Haddonfield, N. J.  
 McKinney, C. M., Jr., Rm. 218, Physics Bldg., University of Texas, Austin, Tex.  
 Pike, W. N., Chesapeake Beach, Md.  
 Sen, S. M., Svarnasan, Patna, Bankipore, India  
 Spitalny, M., 121 W. 72 St., New York 23, N. Y.  
 Stahl, R. J., 67 Northumberland Ave., Redwood City, Calif.  
 Tandan, R. K., Sunderwala Camp, Dehra Dun, India

**Admission to Member**

Beauchamp, E. P., Box N-317, China Lake, Calif.  
 Bettinson, S. F., "Kinkell," London Rd., Horn-dean, Portsmouth, Hampshire, England  
 Burfield, P. C., H.M.S. Ariel (East), Warrington, Lancashire, England  
 Bushman, F. W., 1227 S. W. 137 St., Seattle 66, Wash.  
 Croxville, W. B., 43 Stanley St., Clifton, N. J.  
 Dorsey, S. E., 308-B Independence, China Lake, Calif.  
 Finkelstein, M. B., 1234 Langham Ave., Camden, N. J.  
 Guenther, R., 28 Oceanport Ave., Long Branch, N. J.  
 Harter, J. R. R., 4953 Brandywine St., N.W., Washington 16, D. C.  
 Hertzberg, J. M., 809 Fairfax Rd., Drexel Hill, Pa.  
 Hirschl, H. P., 109 New South Head Rd., Edge-cliff, Sydney, Australia  
 Kane, R. W., 519 Brook St., Mamaroneck, N. Y.  
 Kirby, F. J., Box N-452, China Lake, Calif.  
 Mack, K. M., 21 Oaklee Village, Baltimore 29, Md.  
 Melliger, A. W., Box 15, Pleasantville, N. Y.  
 Michaelson, H. B., 33-51 73 St., Jackson Heights, L. I., N. Y.  
 Miller, C. F., Johns Hopkins University, 105 Maryland Hall, Baltimore 18, Md.  
 Minc, A., 3733 80 St., Jackson Heights, L. I., N. Y.  
 Morris, F. W., Jr., 4308 Palmero Blvd., Los Angeles 43, Calif.  
 Peterson, C. H., College of Engineering, University of Idaho, Moscow, Idaho  
 Ross, G. G., General Radio Co., 275 Massachusetts Ave., Cambridge 39, Mass.  
 Ruth, L. C., 12 N. Washington St., Hinsdale, Ill.  
 Sherman, S. M., 458 S. 27 St., Camden 5, N. J.  
 Soergel, D. G., 6920 Millbrook Blvd., St. Louis, Mo.  
 Sonkin, S., Microwave Laboratory, Stanford University, Stanford, Calif.

(Continued on page 56A)

**S.S. White MOLDED RESISTORS**



**Of particular interest to all who need resistors with inherent low noise level and good stability in all climates**

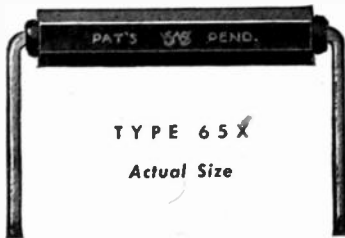

**HIGH VALUE RANGE**

**10 to 10,000,000 MEGOHMS**

This unusual range of high value resistors was developed to meet the needs of scientific and industrial control, measuring and laboratory equipment—and of high voltage applications.

**SEND FOR BULLETIN 4505**

It gives details of both the Standard and High Value resistors, including construction, characteristics, dimensions, etc. Copy with Price List mailed on request.



**STANDARD RANGE**

**1000 OHMS TO 9 MEGOHMS**

Used extensively in commercial equipment including radio, telephone, telegraph, sound pictures, television, etc. Also in a variety of U. S. Navy equipment.

**S.S. WHITE INDUSTRIAL DIVISION**  
 THE S. S. WHITE DENTAL MFG. CO. DEPT. GR, 10 EAST 40th ST., NEW YORK 16, N. Y.



**FLEXIBLE SHAFTS AND ACCESSORIES  
 MOLDED PLASTICS PRODUCTS—MOLDED RESISTORS**

*One of America's AAAA Industrial Enterprises*

**To Lower Your Production Costs**

**BEAD CHAIN multi-swage PRODUCTS**

**— ON CONTACT PINS, TERMINALS, JACKS, SLEEVES AND INSERTS**

Many of these small metal parts used today are Bead Chain Multi-Swage Products. This advanced method of producing small solid or tubular metal parts is outstandingly efficient and economical for parts of about 1/4" or less diameter and up to 1 1/2" length. Tolerances are accurately maintained. Large quantity production is usually a factor to justify fitting-up costs.

We are set-up to supply many standard items, and our Engineering Department is ready to cooperate in application of this process to special needs. Send for catalog.

**THE BEAD CHAIN MANUFACTURING CO.  
 60 Mountain Grove St., Bridgeport, Conn.**



The continued expansion of the  
**NATIONAL UNION RESEARCH DIVISION**

has created many fine positions for men interested in  
**VACUUM TUBE RESEARCH**

Our laboratories are devoted entirely to research and development work on vacuum tubes. These include cathode ray, microwave, receiving, radial beam, subminiatures, and various special tube types. We are in a position to offer an interesting job, a stable future, and ideal working conditions to men who are qualified. Men with vacuum tube or similar experience and with degrees in Physics or Engineering are needed at the present time. Recent graduates without experience but with degrees in Physics or Electrical Engineering, as well as tube or circuit technicians, are invited to apply.

Before you decide on your future connection, be sure to look into the opportunities National Union has to offer.

Send resume to: **Divisional Personnel Manager**  
**National Union Research Division**  
**350 Scotland Road**  
**Orange, New Jersey**

**PHYSICISTS  
 AND  
 ENGINEERS**

This expanding scientist-operated organization offers excellent opportunities to alert physicists and engineers who are interested in exploring new fields. We desire applicants of Project Engineer caliber with experience in the design of electronic circuits (either pulse or c. w.), computers, or precision mechanical instruments. This company specializes in research and development work. Laboratories are located in suburbs of Washington, D.C.

**JACOBS INSTRUMENT CO.**

4718 Bethesda Ave.  
 Bethesda 14, Maryland

**WANTED:  
 CAREER MEN  
 IN ELECTRONICS**

at  
**RCA VICTOR**  
 Camden, New Jersey

● Unlimited laboratory resources and facilities are waiting for top-flight men ready to assume responsibilities in handling and administering advanced projects in virtually every phase of electronics — infra-red, ultrasonic, audio and acoustic equipment; television receivers, antennas, radar, mobile communications; aviation communications and navigational aids in our Engineering Products and Home Instruments Departments at Camden, New Jersey.

These Openings Represent a permanent expansion in RCA Victor design and development activities at Camden, providing careers for men of high calibre with appropriate training and experience.

If You meet these Specifications, and if you are looking for a career which will open wide the door to the complete expression of your talents in the fields of electronics, write, giving full details, to:

**ARNOLD K. WEBER,**  
 Personnel Manager, Camden Plant  
 Box 133, RCA Victor Division  
 Radio Corporation of America  
 Camden, New Jersey



The following positions of interest to I.R.E. members have been reported as open. Apply in writing, addressing reply to company mentioned or to Box No. . . .

The Institute reserves the right to refuse any announcement without giving a reason for the refusal.

**PROCEEDINGS of the I.R.E.**

1 East 79th St., New York 21, N.Y.

**RESEARCH SCIENTISTS**

Experienced research scientists with advanced degrees and experience in physics, serodynamics, electronics, optics, mathematics, chemistry, metallurgy, or meteorology to perform supervisory research and act as permanent consulting group to engineering laboratories. Excellent opportunity for men with right qualifications. Salary \$8,000-\$14,000 bracket. Write Box 564.

**DEVELOPMENT ENGINEER**

Newly formed and rapidly expanding aeronautical instrument company located in New York Metropolitan area is seeking an instrument development engineer who is an electronics and servomechanism specialist to become Chief Engineer. Background must be well balanced in all phases of aeronautical instrument business, including laboratory and shop practice from first hand experience. Interesting salary and bonus. Box 565.

**LABORATORY TECHNICIAN**

Excellent opportunity for experienced electronics laboratory technician having experience in aircraft instruments and allied fields. Location Metropolitan New York. Experience and ability in all phases of laboratory testing and shop work desired. Salary commensurate with ability. Box 566.

**COMMUNICATIONS ENGINEERS**

Graduate communications engineers, Canadian citizens, interested in audio, radio and video frequency systems engineering. Salaries up to \$350.00 per month depending on qualifications. Location, Montreal, Canada. Box 567.

**TELEVISION ENGINEERS**

Due to wide expansion in television program of long established radio and television manufacturing company, positions are now available for engineers with 3 or more years television experience. Excellent working conditions in modern, well-equipped laboratory. Company located in northwest portion of New York State. Housing no serious problem. Salaries commensurate with ability. Box 568.

**SCIENTISTS AND ENGINEERS**

Wanted for interesting and professionally challenging research and advanced development in the fields of microwaves, radar, gyroscopes, servomechanisms, instrumentation, computers and general electronics. Scientific or engineering degrees or extensive technical experience required. Salary commensurate with experience and ability. Direct inquiries to Mgr., Engineering Personnel, Bell Aircraft Corp., P.O. Box 1, Buffalo 5, N.Y.

(Continued on page 51A)



(Continued on page 50A)

### ENGINEERS

An unusual opportunity exists for qualified engineers to participate in the growth of the industrial television field. Experience in video, pulse, electronic display and circuit techniques with good educational background required. Openings range from Junior to Project Engineers. Write to: Leonard Mautner, Vice-Pres., Television Equipment Corp., 238 William St., New York 7, N.Y.

### RADIO ENGINEERS

Outstanding opportunity with progressive, rapidly growing company for radio engineers experienced in high frequency work. An interesting, attractive future assured, but requirements of jobs must be paralleled by necessary skill. If you have a background of high frequency work, tell us about yourself in résumé giving education, experience and salary requirements. Plant located in New Jersey within commuting distance of New York City. Box 569.

### DEVELOPMENT ENGINEER

Development Engineer with at least 5 years experience in developing electronic equipment in the 100 to 1,000 megacycle range.

### DESIGN ENGINEER

Design Engineer with at least 5 years experience with electro-mechanical design problems where space and difficult service conditions are important. Ideal laboratory conditions. 5 day week, paid vacation, paid medical and surgical policy, paid hospitalization policy and paid life insurance. Located in New Jersey. Box 570.

### ELECTRONICS TEACHER

Electronics Teacher to take charge of electronics option at accredited state land grant college in Northwest. Salary to \$4800 for nine months. Write giving picture, education, experience, references, and complete personal data to Box 572.

### ELECTRICAL ENGINEER

Graduate, with several years experience in magnetic recording and audio development work. Unusual opportunity for the right person, for permanent position with long-established firm; vicinity N.Y.C. Reply giving résumé of personal data, educational background, experience, and salary desired. Write Box IRE 455, 221 W. 41 Street, New York.

### ELECTRICAL ENGINEER—PHYSICIST

Graduate electrical engineer or physicist experienced on microwaves and servo-mechanism for design and layout of electronic circuits. Write Chance Vought Aircraft, Division United Aircraft Corp., Box 5907, Dallas, Texas.

### INSTRUCTOR

There will be an opening in September for an instructor to teach electronics, transmission line and waveguide theory. Salary depends on qualifications and is up to \$5600.00 for nine months. Possibility of later appointment at lower rank and salary. Box 573.

(Continued on page 52A)

### Positions Open For:

**PHYSICISTS  
SENIOR ELECTRONIC  
ENGINEERS  
ADVANCED CIRCUIT  
DEVELOPMENT  
ENGINEERS  
SENIOR MECHANICAL  
ENGINEER  
VACUUM TUBE  
ENGINEERS**

Experienced in the development of radar, servomechanisms, computers and guided missiles to fulfill the requirements of expanding airborne projects—Experienced Tube and Circuit Engineers for increased research and advanced development programs.

Salary commensurate with experience and ability—insurance plan—paid vacations—excellent opportunity for suitably qualified personnel.

Please furnish complete resume of education, experience and salary required to:

Industrial Relations & Personnel Department, Capehart-Farnsworth Corporation, Fort Wayne 1, Indiana.

## Electronic Engineers

BENDIX RADIO DIVISION

Baltimore, Maryland

manufacturer of

**RADIO AND RADAR EQUIPMENT**

requires:

### PROJECT ENGINEERS

Five or more years experience in the design and development, for production, of major components in radio and radar equipment.

### ASSISTANT PROJECT ENGINEERS

Two or more years experience in the development, for production, of components in radio and radar equipment. Capable of designing components under supervision of project engineer.

Well equipped laboratories in modern radio plant . . . Excellent opportunity . . . advancement on individual merit.

*Baltimore Has Adequate Housing*

Arrangements will be made to contact personally all applicants who submit satisfactory resumes. Send resume to Mr. John Siega:

**BENDIX RADIO DIVISION**

**BENDIX AVIATION CORPORATION**

**Baltimore 4, Maryland**

## IF YOU ARE AN ENGINEER OR PHYSICIST WITH AN INTEREST IN PROFESSIONAL SOUND RECORDING THIS MAY BE A REAL OPPORTUNITY FOR YOU

We are a long established organization with a reputation for manufacturing the best equipment in this highly competitive field. We need immediately two (2) men who can eventually—the sooner the better—assume complete responsibility for the development and production operations in the fields respectively of ELECTRONICS and MACHINE design.

### WE OFFER:

1. An opportunity to work in a fascinating field with a young (from the standpoint of staff age) and vigorous organization that is completely receptive to new ways and ideas.
2. An opportunity to build your own job with a staff of your selection.
3. A starting salary up to \$10,000, depending upon your education and experience, and—for top men—participation in a really unusual bonus plan.

We well recognize the necessity of protecting your present connection, and assure you that all replies will be handled in complete confidence by an officer of our company. In your reply tell us what you would like to know were our positions reversed. Our employees know of this advertisement.

The Institute of Radio Engineers, Inc.

Box No. 575

1 East 79th St., New York 21, N.Y.

## Radio and Radar Development and Design Engineers

*Openings for experienced men at*  
**HAZELTINE ELECTRONICS  
CORPORATION**

Little Neck, L.I., N.Y.

Please furnish complete resume of experience with salary expected to:  
Director of Engineering Personnel

(All inquiries treated confidentially)

# Positions Open

(Continued from page 51A)

## ELECTRONIC ENGINEERS—RESEARCH ANALYST

Research and development positions open at Army Security Agency, Washington 25, D.C., in the field of electronics and mathematics. B.S. degree in appropriate field from an accredited university necessary. Salaries for electronics engineers—P-1, \$2974.80 to P-3, \$4479.60 per annum. Salaries for research analysts are P-1, \$2974.80 and P-2, \$3727.20 per annum. Positions are permanent in so far as the Agency is concerned. Those qualified communicate immediately with Chief, Army Security Agency, CSGAS-61, The Pentagon, Washington 25, D.C.



★ ★ ★ ★

## Positions Wanted By Armed Forces Veterans

In order to give a reasonably equal opportunity to all applicants, and to avoid overcrowding of the corresponding column, the following rules have been adopted:

The Institute publishes free of charge notices of positions wanted by I.R.E. members who are now in the Service or have received an honorable discharge.

### ENGINEER

B.S. in E.E., M.S. in Physics. 6 years research and development experience in electronics and underwater sound. Age 27. Married. Desires research position. Prefer east or mid-west. Box 251 W.

### TELEVISION ENGINEER

Available July, experienced television engineer, desires new station construction or small manufacturing plant. University of Pennsylvania graduate, good business man, hard worker. Prefer east. Box 252 W.

### ENGINEER

B.S.T.E. Age 32. Married. Desires position in Chicago area, associated with engineer of experience in television, radio or U.H.F. Trained in all phases of television engineering. Experienced in servicing radio, television, record changers and F. M. Box 253 W.

### TRANSFORMER ENGINEER

B.E.E. Age 27. Married. In Transformer field for 5 years. Last 3 years in design of power components. Desires position in same or allied fields. Box 254 W.

(Continued on page 53A)

## Positions Available for ELECTRONIC ENGINEERS

with

Development & Design  
Experience

in

MAGNETIC TAPE  
RECORDING

MICROWAVE  
COMMUNICATIONS

SONAR EQUIPMENTS

Opportunity For Advancement  
Limited Only By Individual  
Ability

Send complete résumé to:  
Personnel Department  
**MELPAR, INC.**  
452 Swann Avenue  
Alexandria, Virginia

## BUD announces

# ADD-a-RACK SERIES

... more panel space

... less floor area ... AT LOWER COST!



It has always been necessary to buy special racks without louvers on one side to obtain a maximum of panel space with a minimum of floor space. Now, you no longer need to buy a whole new cabinet when you want additional panel space. Through our new and exclusive Add-a-Rack series, BUD not only offers additional racks at a lower cost, but provides you with a sturdier, better looking assembly.

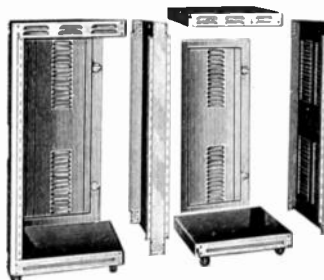

The illustration above at left shows two Add-a-Rack cabinets assembled together. The illustration above at right shows the unique and ingenious method of adding a unit to your present equipment. Instead of buying an entire new outfit, you purchase only four parts; (1) a door (2) a top (3) a bottom and (4) an Add-a-Rack coupling unit. The right (or left) hand side of your present relay rack is removed and replaced by the Add-a-Rack coupling unit; next, a top and bottom is fastened into place, and the side taken from the first rack is fastened onto the second rack which has been added. Place the additional door into position and you have two racks

properly and efficiently coupled together. In the same simple way, more racks can be added at any time and every one will be in a CONTINUOUS ONE-PIECE assembly.

This series is available in two ways. (1) a double unit consisting of two racks and the Add-a-Rack coupling unit, (2) Add-a-Rack unit, consisting of a door, a top, a bottom and an Add-a-Rack coupling unit. These units are furnished with all necessary assembling and panel mounting hardware.

BUD RC-7756 Casters will fit this unit. Casters are not included in price of cabinet.

Add-a-Rack Unit	To Add-a-Rack to	Overall Height	Panel Space	Dealer Cost
AR-1778	CR-1774	46-1/16"	36 3/4"	\$26.25
AR-1775	CR-1771	47-5/16"	42"	32.50
AR-1776	CR-1772	66-9/16"	61 3/4"	40.75
AR-1777	CR-1773	82-5/16"	77"	48.00

Complete unit, consisting of the knocked-down parts necessary for two relay racks coupled together.

	Dealer Cost
CR-1779 two coupled relay racks same size as CR-1774	\$54.75
CR-1780 two coupled relay racks same size as CR-1771	67.95
CR-1786 two coupled relay racks same size as CR-1772	83.05
CR-1799 two coupled relay racks same size as CR-1773	98.40

Prices are 10% higher west of the Mississippi River.



RELAY RACKS



CHASSIS



CONDENSERS



CHOKES



CABINETS



COILS



TEST LEADS

THESE ARE SOME OF THE 1274 ITEMS AVAILABLE FROM BUD RADIO, INC.

## BUD RADIO, INC.



2110 E. 55th ST. • CLEVELAND 3, OHIO

## Positions Wanted

(Continued from page 52A)

### ENGINEER

B.E.E. George Washington University, June 1949. Communications major. 7 years experience long distance radio. 3 years hi-speed radio-telegraph operator, 4 years supervisory capacity. Married. Age 28. Energetic, adaptable, personable. Box 256 W.

### SERVO ENGINEER

Age 31. Married. B.S. in E.E. 1946. 1 year audio experience. M.S. in E.E. 1949 with emphasis on servomechanisms. Desires position in industrial servo design. Box 257 W.

### RADIO-ELECTRONICS ENGINEER

B.S. Engineering Sciences Harvard 1943. Age 28. Married, no children. 6 years broad experience in electronics including radar and airborne magnetometer. At present Government P-3 radio engineer. Desires job in France, wife to accompany. Speaks French and Spanish fluently and a little German and Chinese. Both commercial radio licenses. Teacher of High School Physics. Box 258 W.

### ENGINEER

E.E. student, graduate June 1950. Desires position summer June 1949. Location immaterial. Have 3½ years experience as ETM in radar, sonar, loran, and other shipboard equipment. Some experience with particle accelerators, hi-vacuum gear. Also interested in ultrasonics. Box 259 W.

### ELECTRICAL ENGINEER

M.S.E.E. June 1949, The Rice Institute, communications major, minor in math. and physics. Age 25, single. 1½ years experience various geophysical equipment. Desires research or development position in Los Angeles area. Work need not be related to geophysics. Member Tau Beta Pi and Sigma Xi. Box 260 W.

### PATENT LAW CLERK

New York University June 1948 graduate with B.S.E.E. degree. Now completing 1st year evening Law School in preparation for L.L.B. degree September 1950. Desires full time position with Patent Law firm in New York City metropolitan area only. Presently employed as a technical writer on electronic and electrical equipment. Résumé on request. Box 261 W.

### ENGINEER

B.S.E.E., communications, May 1949, Oklahoma A. and M. Institute of Technology. Age 29. 4 years training and experience in Naval electronics, radar, maintenance and repairs, advanced to A.C.R.T. Desires position in electronic engineering, anywhere in U.S. References. Box 262 W.

### ELECTRONIC ENGINEER

Currently engaged in production, design and development work, desires position in New York area. Have B.E.E. am now studying for M.F.E. evenings. 2 years experience board layout and testing. 1 year with transformer manufacturer and present employer. Age 26. Married. Box 263 W.

(Continued on page 54A)

## IT'S KINGS FOR CONNECTORS

Pictured here are some of the more

widely used R. F. co-axial, U. H. F.

and Pulse connectors. They are all

Precision-made and Pressurized

when required. Over 300 types

available, most of them in stock.

Backed by the name **KINGS**—the leader in the manufacture of co-axial connectors.

Write for illustrated catalogs. Department "T"



Manufacturers of Radar, Whip, and Aircraft antennas  
Microphone Plugs and Jacks.

Radar Assemblies, Cable Assemblies, Microwave and  
Special Electronic Equipment

Pioneer in Radio Engineering Instruction Since 1927

## CAPITOL RADIO ENGINEERING INSTITUTE

An Accredited Technical Institute

ADVANCED HOME STUDY AND  
RESIDENCE COURSES IN  
PRACTICAL RADIO-ELECTRONICS  
AND TELEVISION ENGINEERING

Request your free home study or resi-  
dence school catalog by writing to:

REGISTRAR  
16th and PARK ROAD N.W.  
WASHINGTON 10, D.C.

Approved for Veteran Training



# NEW... Improved Wiring Eliminates Leakage

## TYPE 12AT & TYPE 12ATK (KIT) TRANSMISSION MEASURING SET

Range: 111 db. in 0.2 steps.  
Frequency resp.: 0.1 db. from 0 to 20 kc.  
Accuracy: 0.1 db.  
Impedance, load section: 4, 8, 16, 50, 150, 200, 500, & 600 ohms.  
Impedance, transm. set.: 50, 150, 200, 500 & 600 ohms.  
Reference level: 1mw. into 600 ohms.  
Circuit: "T", unbalanced.  
Attenuators: 10x10, 10x1 & 5x0.2 db.  
Load corr. cap.: Transm. sect. 1 w. Load section 10 w.

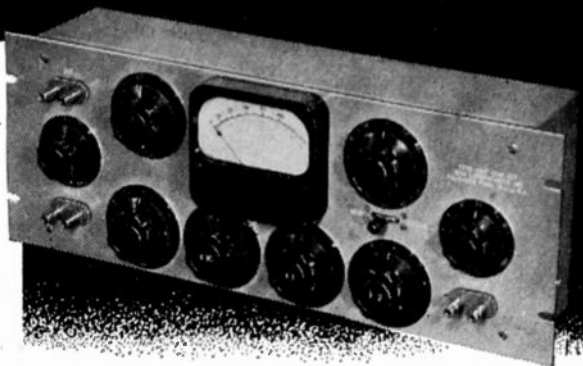

A precision Gain Set with specially developed wiring that permits no troublesome leakage and provides improved frequency characteristics. Available completely assembled, or in kit form—which permits the sale of a high accuracy instrument at a low price.

**WRITE FOR DESCRIPTIVE BULLETIN**



Manufacturers of Precision Electrical Resistance Instruments  
PALISADES PARK, NEW JERSEY

## SKL 200 MC BAND WIDTH AMPLIFIERS

### MODEL 202 WIDE BAND CHAIN AMPLIFIER



Band width — 100 KC to 200 MC. Gain — 20 db. Response —  $\pm 1.5$  db.  
Impedance — 200 ohms. Standing wave ratio — Less than 1.5 db.

The SKL model 202 aperiodic Wide-Band Chain Amplifier, employing six 6AK5 tubes, uses a traveling wave circuit to achieve its wide bandwidth. Because of mutual inductance coupling between sections of the delay lines is employed, substantially linear phase shift is achieved. With its wide pass-band and very short rise time, this amplifier offers unique advantages in the amplification of pulses, transient wave forms and other low level high frequency phenomena encountered in nuclear research, oscillography and television testing. Due to its low impedance, existing coaxial cables can be used. Due to its wide bandwidth the SKL model 202 is invaluable as an aperiodic pre-amplifier for signal generators, sweep generators, vacuum tube voltmeters and other laboratory equipment.

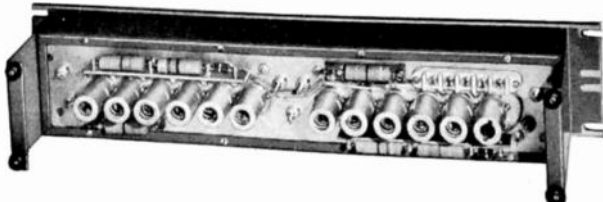

**WRITE FOR  
BULLETIN  
205 I. R.**

**SKL SPENCER KENNEDY LABORATORIES, INC.**  
186 MASSACHUSETTS AVE., CAMBRIDGE 39, MASS.

## Positions Wanted

(Continued from page 53A)

### RADIO ENGINEER

Graduating in Radio Engineering June, 1949. B.S. Age 25, married. 3½ years Army experience, fixed station installation and operation, antenna and transmission line construction. Also civilian broadcast experience. Prefer antenna or transmission line design and development. Box 264 W.

### ELECTRICAL ENGINEER

16 years experience in design, development, research in connection with electronic and electrical components such as capacitors and transformers. Desires location in New York City or immediate vicinity. B.E.E. degree and 3 years graduate work. Box 283 W.

### ENGINEER

B.E., E.E. major, University of Toledo, graduated June 1949. Age 32. Single. Technical experience Air Force communications and navigation aids. Desires position in electronics anywhere in U. S. Box 284 W.

### ELECTRONICS ENGINEER

Graduated June 1949, Polytechnic Institute of Brooklyn, B.E.E. in electronics. Member Tau Beta Pi, Eta Kappa Nu. Married. Age 22. Electronics experience in Navy. Desires position in electronic development or production. Prefer East Coast. Box 285 W.

### JUNIOR ENGINEER

B.E.E., University of Louisville, June 1949. Age 26, married, one child. First phone and Class A amateur licenses. Some teaching and broadcast experience. 3 years in Army radio intelligence. Desires position in radio or T.V. research and design. Box 286 W.

### BROADCAST ENGINEER

Specializing in broadcast station construction. 20 years experience in broadcasting & aviation radio. History & picture sent on request. Go anywhere. T. L. Kidd, P.O. Box 866, Fredericksburg, Texas.

### SENIOR ENGINEER

B.S.E.E. 8 years experience. Army electronics training at Harvard, and M.I.T. Research at Radiation Laboratory, M.I.T. Radar project officer Aircraft Radio Laboratory, Wright Field. Post-war electronic research engineer. Also broadcast installation, operation, and maintenance experience. Married, children, require family housing. Prefer west, southwest, middle-west. Box 287 W.

### JUNIOR ENGINEER

B.E.E. University of Louisville 1946, M.A. in mathematics. University of Michigan 1948. Age 24. Experience in telegraphy and amateur radio. Desires position in electronics and communications. Box 288 W.

### ELECTRONIC ENGINEER

M.E.E. expected August 1949 Polytechnic Institute of Brooklyn, B.E.E. Cooper

(Continued on page 55A)



*Especially  
designed for*

**HIGH FREQUENCIES**

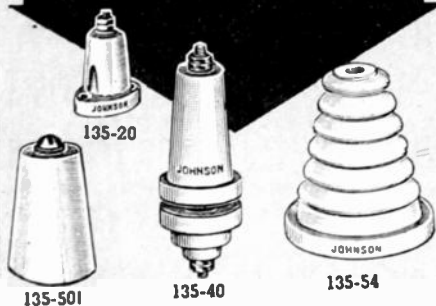

**JOHNSON  
INSULATORS**

**... ALWAYS A PERFECT CHOICE!**

Yes, JOHNSON insulators offer you a wide choice of style and size . . . advanced practical design . . . mass production economy. Proportions are logical; molding is clean cut and accurate. Hardware is high grade nickel plated brass with milled (not stamped) nuts.

**THRU-PANEL INSULATORS  
AND BUSHINGS**

High breakdown voltage rating of Johnson THRU-PANEL insulator (135-40) is due to long leakage paths. Extrusion of the steatite base passes thru mounting hole preventing internal flashover. Flat mounting surfaces with cushion washers eliminate breakage. Compression construction contributes to high mechanical strength. Available also with banana jack terminal.

Johnson lead-in bushings (135-54) cover an extremely large range of sizes and ratings, are compact and suitable for many applications.

**STAND-OFF AND CONE  
INSULATORS**

Johnson STAND-OFF insulators (135-20) feature steatite insulation and heavy breakage resistant bases for surface mounting. Johnson 500 series (135-501) is likewise steatite for better high frequency insulation. Threads are tapped directly into the ceramic. They're furnished complete with machine screws, brass and cushion washers.

See Your Johnson Jobber —  
or write for catalog.



**JOHNSON**

E. F. JOHNSON CO. WASECA, MINN.

**Positions Wanted**

*(Continued from page 54A)*

Union. Age 24. 2 years as electronic technician U.S.N. 1½ years design and development of radar receivers and microwave components. Prefer position in vicinity of New York City. Box 289 W.

**ELECTRONIC ENGINEER**

B.E.E. 1946. Age 24. 2½ years varied electronic experience including radar development work. Desires electronic development work in New York City area. Box 290 W.

**JUNIOR ENGINEER**

B.S.E.E. 1948 University of Illinois. Age 23. Married. Specialized training in television at RCA Institutes. One year experience commercial television receiver servicing. Desires position as research or development engineer. First class radiotelephone license. Box 291 W.

**JUNIOR ENGINEER**

Graduated June 1949 from Manhattan College with a B.E.E. degree. 2 years training and experience as Radio-Mechanic-Gunner in the AAF. Age 26, single. Desires employment as electrical or electronic engineer particularly in the television field, anywhere in the States. Box 292 W.

**ENGINEER-MATHEMATICIAN**

M.E.E.; B.S.E.E. (communications). B.S.E., mathematics. 1 year research in magnetic amplifiers. Fluent knowledge of German. Age 25, married, no children. Desires research or development in magnetic amplifiers, mathematical design, engineering mathematics instructorship, or technical writing. Available September 1949. New York City or vicinity preferred. Box 293 W.

**TECHNICAL WRITER-COMMUNICATIONS ENGINEER**

Technical Writer-Communications Engineer, Military Intelligence Service officer, B.S.R.E. licensed FCC, 1st class phone, amateur radio. Experienced in mobile radio telephony, X-Ray, export trade. Speaks fluently French and Spanish. Desires position in same or allied fields. Box 294 W.

**ELECTRONIC PHYSICIST**

B.A., M.A. in Physics. Harvard—M.I.T. Radar School. Radar officer 3 years. Now studying for Ph.D. at Harvard in Engineering Sciences. Age 28, married, 2 children. Desires research in electron physics. Box 295 W.

**ELECTRONIC ENGINEER**

Stanford University, B.S.E.E., communications major. Age 24. 1 year broadcasting, 2 years navy electronics experience. 1st class license. Prefer position in broadcasting or electronic development and production. Box 296 W.

*(Continued on page 56A)*

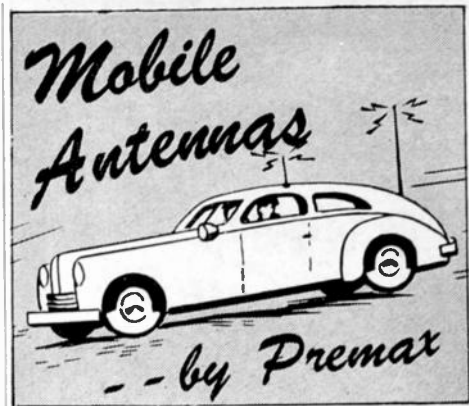

**Sturdy Whip Types  
That Stand Abuse  
and Always Get a  
Strong Signal**

For better transmission and reception, Premax Mobile Antennas have no equal. They are in wide use for police, governmental, municipal, utility and other services—where they have proven their ability to withstand the shocks and abuse which so often wrecks other types.

**In Steel or Stainless**

Premax "whip type" Antennas are available in graduated diameter and in tapered steel, cadmium-plated, and in stainless steel in varying lengths from 72" to 92". These antennas are made of solid steel of extremely high carbon content, heat-treated and oil-tempered to carefully develop physical properties. Where ordinary antennas bend or break under stress of striking tree branches, bridges, etc., Premax Antennas merely flex under the strain and immediately return to normal position. Suitable mountings available for any installation.

**Heavy Duty  
Telescoping Antennas**

Where unusually high antennas are required, such as on crash trucks, government service rigs and commercial trucks, Premax can supply telescoping tubular antennas in steel, monel or aluminum, with extended lengths up to over 35 feet. Suitable base mountings permit their use without guying.

Send for special Mobile Antenna Bulletin illustrating the various styles of Premax Mobile Antennas and mountings.

**PREMAX PRODUCTS**  
DIVISION CHISHOLM-RYDER CO., INC.

4903 Highland Ave. Niagara Falls, N.Y.

## Positions Wanted

(Continued from page 55A)

### PROJECT ENGINEER

B.E.E. 1944 Cornell, M.E.E. 1948 Polytechnic Institute of Brooklyn. H.K.N., T.B.P., Sigma Xi at Cornell. Experience in pulse circuits, wide-band I.F. amplifiers, microwaves on microwave P.T.M. relay system, microwave signal generators. F.C.C. 1st class license. Aviation radio-radar officer U. S. Navy. Desires position in television or allied field. Box 255 W.

### SALES ENGINEER

Desires selling or distributing products of electronic industries. Graduate of RCA Institutes, education at Bowdoin College, Harvard and M.I.T. in radio engineering. Holder of all FCC commercial radio licenses. 7 years experience in industry. Presently on Staff of a State College. Box 297 W.



(Continued from page 49A)

Wolcott, R. G., 11 Seventh Ave., Haddon Heights, N. J.

Zachary, R. A., Jr., 125 Shotwell Pk., Syracuse 6, N. Y.

The following admissions to Associate were approved and were effective as of June 1, 1949:

Allen, M. H., 3040 Cruger Ave., New York 67, N. Y.  
(Continued on page 57A)

**NEW!**  
*High Speed*



### RECTANGULAR COORDINATE RECORDER

AIL's Type 373 Recording System plots voltage—or the logarithm of voltage—as a function of time or of the displacement angle of a measured element. The System increases accuracy, delivers inked charts, saves time, eliminates point-by-point plotting.

Custom-built, versatile. Portable or rack-mounting construction. Voltage range: 10,000 to 1, 80 db. Max. pen speed: 40 inches, 320 db, per second.

ANTENNA PATTERNS  
LIGHT INTENSITIES  
SOUND PRESSURES  
HEAT LEVELS  
COUNTING RATES



SEND FOR FULL INFORMATION

# TINY-BUT MIGHTY!

- ★ Only 15/16" dia. x 22/64" d.
- ★ With attached switch, 49/64" d.
- ★ As tough as larger controls
- ★ 500 ohms to 5 megohms
- ★ .25 watt for linear
- ★ Standard taps @ 30 and 70% rotation



### CLAROSTAT SERIES 47 COMPOSITION CONTROLS

Despite midget size, these controls include the Clarostat Stabilized Element for on-the-button resistance values and maximum immunity to climatic conditions and long wear-and-tear. Use Series 47 controls with complete confidence in your crowded assemblies!

Available with factory-equipped switch, or without. Any type shaft. Standard 3/8-32 threaded bushing for mounting.

Remember, you sacrifice nothing in gaining that space-saving advantage with these tiny-but-mighty controls.

Ask for Bulletin No. 117.  
Let us quote on your needs.



CLAROSTAT



*Controls and Resistors*

CLAROSTAT MFG. CO., INC. • DOVER, NEW HAMPSHIRE • In Canada: CANADIAN MARCONI CO., LTD  
Montreal, P. Q. and branches

## PROJECT ENGINEERS

Real opportunities exist for Graduate Engineers with design and development experience in any of the following: Servo-mechanisms, radar, microwave techniques, microwave antenna design, communications equipment, electron optics, pulse transformers, fractional h.p. motors.

SEND COMPLETE RESUME TO EMPLOYMENT OFFICE.

**SPERRY GYROSCOPE CO.**

DIVISION OF  
THE SPERRY CORP.  
GREAT NECK, LONG ISLAND



**In only 1 SECOND!**

**COMPLETE  
AUDIO WAVEFORM ANALYSIS**  
with the

**AP-1 PANORAMIC  
SONIC ANALYZER**

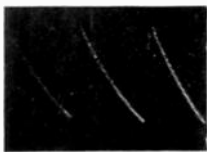

Oscillograph of wave-  
form to be analyzed

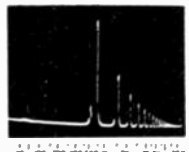

Panoramic Sonic  
Analysis of the same  
wave

Provides the very utmost in *speed, simplicity and directness* of complex waveform analysis. In only one second the AP-1 automatically separates and measures the frequency and amplitude of wave components between 40 and 20,000 cps. Optimum frequency resolution is maintained throughout the entire frequency range. Measures components down to 0.1%.

- Direct Reading
- Logarithmic Frequency Scale
- Linear and Two Decade Log Voltage Scales
- Input voltage range 10,000,000:1

AP-1 is THE answer for practical investigations of waveforms which vary in a random manner or while operating or design constants are changed. If your problem is measurement of harmonics, high frequency vibration, noise, intermodulation, acoustics or other sonic phenomena, investigate the overall advantages offered by AP-1.

Write NOW for complete specifications, price and delivery.



## Membership

(Continued from page 56A)

- Bailin, R. C., Sylvania Electric Products Inc., Emporium, Pa.  
 Barlow, D. E., 21 W. Central Ave., West Carrollton, Ohio  
 Barut, A. O., 50 Clausiusstr, Zurich 6, Switzerland  
 Bateman, L. A., 4809 Oakwood Ave., Downers Grove, Ill.  
 Battista, W., 15 W. 47 St., New York 19, N. Y.  
 Berkowitz, M. W., 70-28 174 St., Flushing, L. I., N. Y.  
 Bobera, J. A., 7914 N. Kildare, Skokie, Ill.  
 Brace, L. H., 1434 Mott St., Saginaw 21, Mich.  
 Brogle, A. P., Jr., Signal Corps Engineering Laboratories, Red Bank, N. J.  
 Bruno, A. R., 1121 New Hampshire Ave., N.W., Washington 7, D. C.  
 Campbell, E. A., 323 E. 48 St., New York 17, N. Y.  
 Cannon, A. H., c/o P.M.G. Research Laboratories, 59 Little Collins St., Melbourne, Victoria, Australia  
 Carambelas, C., 99-07 37 Ave., Corona, L. I., N. Y.  
 Casciotti, R. J., 5050 Broadway, Chicago, Ill.  
 Clark, E. G., 2229 N. Broad, Philadelphia 32, Pa.  
 Contri, A., 1150 N. LaSalle St., Chicago 10, Ill.  
 Coolidge, J. E., Pennsylvania State College, State College, Pa.  
 Day, R. G., R.D. 3, Central Square, N. Y.  
 DiCampli, B. A., 5646 Osage Ave., Philadelphia 43, Pa.  
 Dittenhoefer, H. F., 194-01B 64 Circle, Flushing, L. I., N. Y.  
 Dunham, R. M., 107 Spiers Rd., Newton Centre 59, Mass.  
 Enright, D. J., Illinois Bell Telephone Company, 208 W. Washington, Chicago 6, Ill.  
 Farrell, J. F., Box 1500, Port Arthur, Tex.  
 Ferketich, G., 6040 N. Wentrop Ave., Chicago 40, Ill.  
 Fisher, C. F., 4108 N. Kenmore Ave., Chicago 13, Ill.  
 Fishoff, L. A., Chemin de la Petite Coudraie, Gif-s-Yvette, Seine & Oise, France  
 Fribourg, F. H., Lane Rd., Caldwell, N. J.  
 Fromanger, A. L., 79 Park Row Ave., N., Hamilton, Ont., Canada  
 Goetz, J. L., 2739 First Ave., S.E., Cedar Rapids, Iowa  
 Goldberger, N., 1021 Rua Auroro, Sao Paulo, Brazil  
 Gramman, E. G., 3211 Highland Ave., Kansas City 3, Mo.  
 Greene, J. F., Box 312, Boeing Airplane Company, Alamogordo, N. Mex.  
 Grosvenor, F. R., Jr., 456 Rivenoak, Birmingham, Mich.  
 Hays, W. R., Jr., 1906 Banks, Houston 6, Tex.  
 Hemstreet, H. S., 342 Fernwood Dr., Akron 20, Ohio  
 Hicks, E. P., 3015 Sherbrooke St., W., Montreal, Que., Canada  
 Hines, H. H., 1415 Omohundro Ave., Norfolk, Va.  
 Horvath, J. S., 333 E. 16 St., New York 3, N. Y.  
 Houser, N. W., 3526 Lillie St., Fort Wayne 5, Ind.  
 James, G. F., Box 1310, Skull Cliff, Fairbanks, Alaska  
 Jepson, L., 1501 S. Second E. St., Salt Lake City, Utah  
 Jones, S. H., Box 2688, Beaumont, Tex.  
 Kamp, F. M., 1011 N. Lincoln, Liberal, Kans.  
 Keller, I., 1009 Wayne Ave., Dayton, Ohio  
 Knausenberger, G. E., 478 E. Beaver Ave., State College, Pa.  
 Kush, L., 816 W. Wells St., Milwaukee, Wis.  
 Kyser, R. H., 2901 S St., S.E., Washington 20, D. C.  
 Long, E. S., 295 Ft. Washington Ave., New York 32, N. Y.  
 Mager, J. D., 3906 Maine Ave., Baltimore 7, Md.  
 Martin, W. T., Box 408, Tularosa, N. Mex.  
 McCallum, A. J., 1528 Telephone Bldg., Kansas City, Mo.  
 Meler, A. S., 16 Clark St., Woodmont, Conn.  
 Nelson, R. A., 2016 Tulane Ave., Beaumont, Tex.  
 Odorizzi, D. J., 2631 Leland Ave., Chicago 25, Ill.  
 Otting, W. M., 1118 Maycliff Pl., Cincinnati 30, Ohio

(Continued on page 58A)

## • PRECISION • VARIABLE • RESISTORS

Features common to all T.I.C. Potentiometers

- Precious Metal Contacts
- Two Rotor Take-Off Brushes
- Adjustable Stop—360° Rotation
- Dustproof Construction
- Low Temperature Coefficient

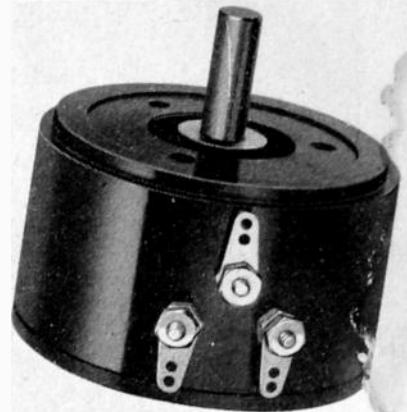

### Type RV3

- Resistance Range: 100 to 200,000 ohms
- Electrical Rotation: 315° ± 3°
- Dimensions: 3" Diameter, 1 13/16" Deep
- Power Rating: 9 watts
- Price: Total Resistance ± 5% .....\$6.00  
Total Resistance ± 1% .....\$8.00

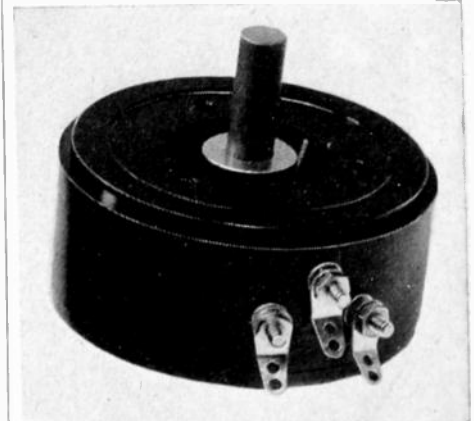

### Type RV3-5

- Resistance Range: 100 to 50,000 ohms
- Electrical Rotation: 315° ± 3°
- Dimensions: 3" Diameter, 1 5/16" deep
- Power Rating: 5 watts
- Price: Total Resistance ± 5% .....\$6.00  
Total Resistance ± 1% .....\$8.00

### For Special Applications

In addition to the above types, T.I.C. is prepared to furnish precision potentiometers designed for highly specialized applications. T.I.C. Engineers will welcome the opportunity to analyze your problem and aid in the development of potentiometers designed specifically to meet your needs.

## TECHNOLOGY INSTRUMENT CORPORATION

1058 Main Street Waltham 54, Mass.  
 ENGINEERING REPRESENTATIVES  
 Chicago, Ill.—State 2-7444; Cambridge, Mass.—Eliot 4-1751; Canaan, Conn.—Canaan 649; Rochester, N.Y.—Charlotte 3193-J; Dallas, Tex.—Logan 6-5097; Hollywood, Calif.—Hollywood 9-6305

# New! Burlington

## ILLUMINATED INSTRUMENTS

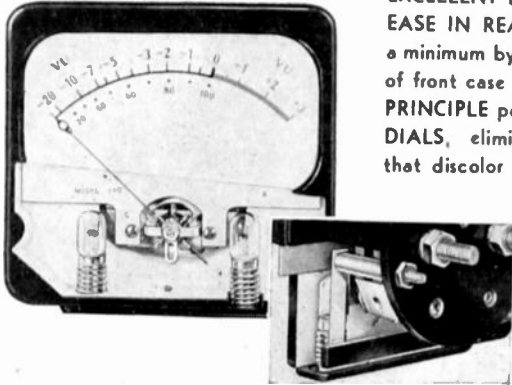

Cutaway views showing positions and connections of lamp assembly.

EXCELLENT LIGHT DISTRIBUTION affords EASE IN READING. GLARE REDUCED to a minimum by retaining COMPACT DESIGN of front case extension. REFLECTED LIGHT PRINCIPLE permits use of standard METAL DIALS, eliminating translucent materials that discolor with age and use. BULB REPLACEMENT FACILITATED by removal of single lamp assembly. Two 3.8 volt STANDARD BULBS are used and connected in series.

Available in all ranges 3 1/2" and 4 1/4" rectangular semi-flush models. Write Dept. 179 for complete details.

### BURLINGTON INSTRUMENT COMPANY BURLINGTON, IOWA



### STANDARD SIGNAL GENERATOR MODEL 84—300-1000 Megacycles

OUTPUT VOLTAGE: Continuously variable from 0.1 to 100,000 microvolts. Output impedance, 50 ohms.

MODULATION: Sine Wave: 0-30%, 400, 1000 or 2500 cycles. Pulse: Frequency, 60 to 100,000 cycles. Width, 1 to 50 microseconds. Delay, 0 to 50 microseconds. Sync. output, up to 50 volts, either polarity.

POWER SUPPLY: 117 volts, 60 cycles. (Also available for 117 volts, 50 cycles; 220 volts, 60 cycles; 220 volts, 50 cycles.)

DIMENSIONS: 12" high x 26" wide x 10" deep, overall.

WEIGHT: Approximately 135 pounds, including external line voltage regulator.

### MEASUREMENTS CORPORATION

BOONTON · NEW JERSEY



Laboratory Standards

Standard Signal Generators  
Pulse Generators  
FM Signal Generators  
Square Wave Generators  
Vacuum Tube Voltmeters  
UHF Radio Noise & Field Strength Meters  
Capacity Bridges  
Megohm Meters  
Grid-Dip Meters  
Television and FM Test Equipment

## Membership

(Continued from page 57A)

- Pachuta, J. R., 150 Robineau Rd., Syracuse, N. Y.  
Parker, N. W., Kemper Lane Hotel, Cincinnati 6, Ohio  
Peeler, R. L., Box 312, Alamogordo, N. Mex.  
Peters, W., Box 4321, Hamburg 40, Hamburg, British Zone, Germany  
Petit-Clerc, M., 1452 Newton, N.W., Washington 10, D. C.  
Rao, K. R., 56 Krishnaraja Vanam, Mysore, Mysore State, India  
Renick, M. R., Jr., 1721 24 Pl., S.E., Washington 20, D. C.  
Richards, D. E., 826 Wendel St., Houston 9, Tex.  
Robinson, C. S., General Delivery, Worland, Wyo.  
Sallet, A. P., 63 Dahlgren Pl., Brooklyn 9, N. Y.  
Satyannarayana, K., V. S. Rajagopalan & Company, Ltd., Avanaashi Rd., Coimbatore, S. India  
Scharf, E., 6236 Chestnut St., Philadelphia, Pa.  
Scheer, D., 4641 W. Congress St., Milwaukee 9, Wis.  
Spilmer, B. H., 864 "A" Ave., Coronado, Calif.  
Stoner, M. J., 2402 Military St., Port Huron, Mich.  
Stout, T. M., Dept. of Electrical Engineering, University of Washington, Seattle, Wash.  
Stribel, J. E., Box 1281, Station A, Bremerton, Wash.  
Turner, V. V., Jr., 6722 Japonica St., Houston 17, Tex.  
Weaver, W. T., 1345 VanBuren, Beaumont, Tex.  
Williamson, J. S., Jr., 2004 Magnolia Ave., Sanford, Fla.  
Winters, A., Winters Radio Laboratory, 11 Warren St., New York, N. Y.  
Wofford, D. R., 3214 Douglas Ave., Memphis 11, Tenn.  
Wood, R. W., 50 Jane St., New York 14, N. Y.  
Wright, B. G., 1439 S. 73 St., West Allis 14, Wis.  
Yacich, P. J., 1826 Independence St., New Orleans 17, La.  
Yount, W. R., 800 W. Main St., Lexington 40, Ky.  
Zakhaim, M., 40 Arlozovoff, Haifa, Israel  
Zelinski, F. P., 5020 N. Hamlin Ave., Chicago 25, Ill.

The following transfers to the Associate grade were approved to be effective as of March 1, 1949:

- Barry, L. B., 23 Graves St., Fort Richmond, S. I., 14, N. Y.  
Basacik, N., 13 S. Loomis St., Chicago, Ill.  
Birch, R. S., Jr., Morris Court Apts., Apt. 9-D, Morris & Maple Aves., Merchantville, N. J.  
Browning, J. W., Robinsonville, Miss.  
Chambers, G. S., 304 Bath St., Clifton Forge, Va.  
Chomsky, S. R., 233 East 54 St., New York 22, N. Y.  
Chong, W. S. P., 5722 Greene St., Philadelphia 44, Pa.  
Dame, R. O., 25 Highland Ct., Ukiah, Calif.  
Dlouhy, G. J., c/o I.B.M. Corp., 12 & Locust Sts., St. Louis, Mo.  
Doland, G. D., 412 W. Price St., Philadelphia 44, Pa.  
Drake, A. H., 38 Roslyn Rd., Mineola, L. I., N. Y.  
Edelsohn, C. R., 5220 Reading Rd., Cincinnati 29, Ohio  
Emmerich, L., 806 Strand, Redondo Beach, Calif.  
Fontana, J. A., Box 14, Milldale, Conn.  
Gottlieb, L. H., 6526 17 Ave., Kenosha, Wis.  
Greenwood, P. E., Jr., R.F.D. 1, Syracuse 9, N. Y.  
Grund, J. B., 114 Seventh St., Emporium, Pa.  
Heasty, C. N., Box 5500 I, Albuquerque, N. Mex.  
Horowitz, J., 2044 E. 13 St., Brooklyn 29, N. Y.  
Huebschen, R. G., 2824 A Magnolia Ave., St. Louis 18, Mo.  
Moons, A. G., 1218 Central Ave., Westfield, N. J.  
Seid, H. R., 338 Cars St., Jackson, Mich.  
Shellhammer, W. I., 300 E. San Salvador, San Jose, Calif.  
Sutton, W. R., 2224 Crenshaw Blvd., Los Angeles 16, Calif.  
Titcomb, E. C., c/o Mrs. Murray, 167 High St., Passaic, N. J.  
Wallie, T. F., Jr., 114 Summer St., West Burlington, Iowa  
Wood, R. V., 15 Linnaean St., Cambridge 38, Mass.

(Continued on page 59A)



## TEKTRONIX PLEDGES...

To serve our customers with products and policies unexcelled in the electronics industry and limited only by the current state of the art.

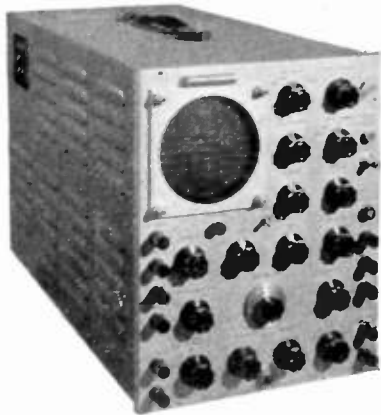

Tektronix Type 511-AD Oscilloscope  
\$845 f.o.b. Portland

### Wide Band, Fast Sweeps

The Type 511-AD, with its 10 mc. amplifier, 0.25 microsecond video delay line and sweeps as fast as .1 microsec./cm. is excellent for the observation of pulses and high speed transient phenomena. Sweeps as slow as .01 sec./cm. enable the 511-AD to perform superlatively as a conventional oscilloscope.

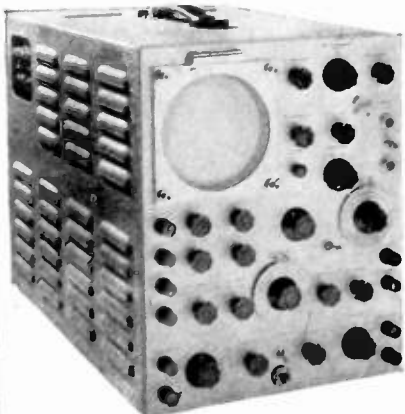

Tektronix Type 512 Oscilloscope  
\$950 f.o.b. Portland

### Direct Coupled, Slow Sweeps

The Type 512 with a sensitivity of 5 mv./cm. DC and sweeps as slow as .3 sec./cm. solves many problems confronting workers in the fields where comparatively slow phenomena must be observed. Vertical amplifier bandwidth of 2 mc. and sweeps as fast as 3 microsec./cm. make it an excellent general purpose oscilloscope as well.

### Both Instruments Feature:

- Direct reading sweep speed dials.
- Single, triggered or recurrent sweeps.
- Amplitude calibration facilities.
- All DC voltages electronically regulated.
- Any 20% of normal sweep may be expanded 5 times.

The Tektronix Field Engineering Representative in your area will be pleased to demonstrate our instruments upon request.



Cables, Tektronix

712 S.E. Hawthorne Blvd. Portland 14, Ore.

## Membership

(Continued from page 58A)

The following transfers to the Associate grade were approved to be effective as of April 1, 1949:

Abjanich, G. S., 189-24 44 Ave., Flushing, L. I., N. Y.

Alnutt, M. W., 6441 Quillan St., San Diego 11, Calif.

Anderson, J. W., Woodrow Wilson Ct., Box 913, Norman, Okla.

Benesch, E. J., 20-68 23 St., Astoria, L. I., N. Y.  
Brawner, C. A., Jr., 7026 W. Lake Dr., Dallas 14, Tex.

Briggs, R. H., 406 E. Broadway, South Bend, Ind.  
Browde, A., 819 Archer Ave., Fort Wayne 7, Ind.

Brown, J. N., 437 Hampton Ct., Falls Church, Va.  
Brunsvold, M. O., 118½ E. Main, Cordell, Okla.

Butler, G. H., 1 Montgomery Rd., Scarsdale, N. Y.  
Cahn, S. L., Askania, 341 E. Ohio St., Chicago, Ill.

Carney, D. A., 4119 Green Lea Pl., St. Louis, Mo.  
Coble, R. B., 338 West 4, Emporium, Pa.

Cowan, C. D., Box 1031, Bob Jones University, Greenville, S. C.

Dahse, C. A., Box 991, Stamford, Tex.  
Dinter, H. A., Jr., 3001 Lasker Ave., Waco, Tex.

Ellis, F. A., 25 Primrose Ter., Berea, Johannesburg, South Africa

Farris, H. W., Electrical Engineering Department, University of Kentucky, Lexington 29, Ky.

Frater, G. A., 7003 W. Good More Rd., Milwaukee 9, Wis.

Girodias, R. M., 911 Hollywood Ave., New York 61, N. Y.

Goettel, H. J., 502 S. Second St., Watseka, Ill.  
Goldwasser, J., c/o A. C. Cossor Ltd., Cossor House, Highbury Grove, London N. 5, England

Gottwald, C. H., 4011 50th, San Diego 5, Calif.

Green, J. W., c/o Geophysical Ser. Inc., 6000 Lemon Ave., Dallas 9, Tex.

Greenberg, H., 187 Center St., Ellenville, N. Y.  
Hage, G. H., 4315 W. Oregon St., Seattle, Wash.

Henagan, C. S., Jr., 3816 S. 11 Ave., Birmingham 5, Ala.

(Continued on page 60A)

# Kahle

## ELECTRON TUBE MACHINERY OF ALL TYPES

### STANDARD AND SPECIAL DESIGN

We specialize in Equipment and Methods for the Manufacture of

RADIO TUBES  
CATHODE RAY TUBES  
FLUORESCENT LAMPS  
INCANDESCENT LAMPS  
NEON TUBES  
PHOTO CELLS  
X-RAY TUBES  
GLASS PRODUCTS

Production or Laboratory Basis

Manufacturers contemplating New Plants or Plant Changes are invited to consult with us.

## KAHLE ENGINEERING COMPANY

1315 SEVENTH STREET  
NORTH BERGEN, NEW JERSEY, U.S.A.

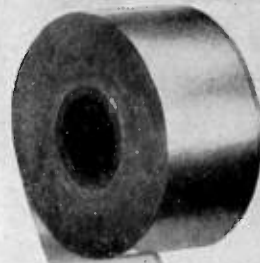

# METALLIZED CONDENSER PAPER

## by SMITH

When you use Metallized Condenser Paper, it is possible to:

1. Manufacture a one-layer condenser.
2. Save 75% space.
3. Use more economical neutral oils.
4. Use less impregnating materials.
5. Eliminate the use of foil electrodes.
6. Use simpler capacitor winding machines.
7. Eliminate breakdown effects through self-healing.
8. Obtain higher insulation resistance, higher dielectric strength.

Get all the facts on Smith Metallized Condenser Paper as it applies to your industry. A card, letter or phone call to Smith Paper, Inc., Lee, Massachusetts (telephone Lee 7) will bring you the information you seek, without obligation on your part.

Manufacturers of Condenser Papers

## SMITH PAPER, INC.

LEE, MASSACHUSETTS





# NEW T. V. IDEAS NEED ACME ELECTRIC TRANSFORMER *performance*

New engineering ideas, to advance the reception qualities of Television, need better than average transformer performance. Acme Electric engineers will assist your ideas by helping you design a transformer, exactly in accordance with your needs.

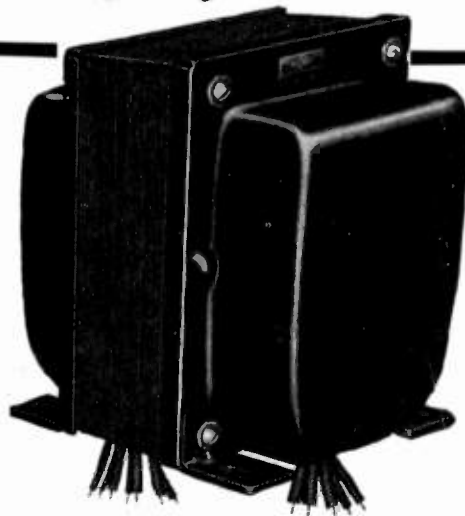

**Acme**  **Electric**  
TRANSFORMERS

**ACME ELECTRIC CORPORATION**

447 Water St. Cuba, N. Y., U. S. A.

*Only* with **CO-A-X**  
air-spaced articulated  
R.F. CABLES  
**4mmf/ft**

*Patents Regd Trade Mark*

**THE LOWEST EVER  
CAPACITANCE OR  
ATTENUATION**

We are specially organised to handle direct enquiries from overseas and can give

**IMMEDIATE DELIVERIES FOR U.S.A.**

Billed in Dollars. Settlement by your check. Transaction as simple as any local buy.

**TRANSRADIO LTD**

CONTRACTORS TO H.M. GOVERNMENT  
138A CROMWELL ROAD LONDON SW7 ENGLAND  
CABLES: TRANSRAD LONDON.

LOW ATTEN TYPES	IMPED OHMS	ATTEN db/100ft At 100 Mc	LOADING	OD"
A 1	74	1.7	0.11	0.36
A 2	74	1.3	0.24	0.44
A 34	73	0.6	1.5	0.88
LOW CAPAC TYPES	CAPAC mmf/ft	IMPED OHMS	ATTEN db/100ft At 100 Mc	OD"
C 1	7.3	150	2.5	0.36
PC 1	10.2	132	3.1	0.36
C 11	6.3	173	3.2	0.36
C 2	6.3	171	2.15	0.44
C 22	5.5	184	2.8	0.44
C 3	5.4	197	1.9	0.64
C 33	4.8	220	2.4	0.64
C 44	4.1	252	2.1	1.03

**HIGH POWER FLEXIBLE**

**PHOTOCELL CABLE**

**V.L.C. ★**

★ Very Low Capacitance cable

## Membership

(Continued from page 59A)

- Hill, F. E., 110 Englewood Ave., Detroit 2, Mich.  
Hodsdon, J. S., Cambridge St., Burlington, Mass.  
Holloman, C. J., 529 E. Palace Ct., Alameda, Calif.  
Huston, Q. E., 1330 S. Tenth St., Philadelphia 47, Pa.  
Johnson, F. H., 125 Westervelt Pl., Passaic, N. J.  
Jones, H. L., Jr., 1722 W. Beach, Biloxi, Miss.  
Klemens, W. P., 1048 Sonora, Glendale 1, Calif.  
Lindamood, T. C., 27 Brookfield Ave., Nutley, N. J.  
Lipkin, L., 3025 Richton, Detroit 6, Mich.  
Lothringer, R. C., 162 Santa Anita, Sierra Madre, Calif.  
Lundquist, G. A., 8012 Piney Branch Rd., Silver Spring, Md.  
Miller, W. A., 9-22 Alameda Dr., Oxnard, Calif.  
Nathorff, H. H., 30 W. 70 St., New York 23, N. Y.  
Pickholtz, L., 1317 Shady Ave., Pittsburgh 17, Pa.  
Rajeswari, M., 1479 Harvard St., N.W., Washington, D. C.  
Ruina, J. P., 86 Seventh Ave., Brooklyn 17, N. Y.  
Rutishauser, R. W., 6500 Lincoln Dr., Philadelphia 19, Pa.  
Sadowsky, S. S., 1225 Seneca Ave., New York 59, N. Y.  
Samson, R. L., 24 Poplar Ave., New York 61, N. Y.  
Schnert, P. J., General Delivery, Durham, N. H.  
Smith, J. K., Box 252, Rock Island, Ill.  
Spandorfer, L. M., Bell Telephone Laboratories, Bldg. T., 463 West St., New York 14, N. Y.  
Spergel, P., 342 E. 22 St., New York 10, N. Y.  
Stampalia, I. J., Jr., 9014 53 Ave., S., Apt. 503, Seattle 8, Wash.  
Stan, J., 5004 S. Kedvale Ave., Chicago 32, Ill.  
Stinchcomb, W. B., 2632 S. Seventh St., Milwaukee 7, Wis.  
Valenta, M. F., 1021 Wallace Ave., Pittsburgh 21, Pa.  
Wilder, M. K., 2743 N. 48 St., Lincoln 4, Neb.  
Wildman, A. J., 4759 N. Maplewood Ave., Chicago 25, Ill.

## AIRBORNE RADIO

FOR ALL CLASSES OF AIRCRAFT

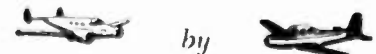

by Aircraft Radio Corporation

*Equipment for:*

- TWO-WAY VHF
- STANDARD LF RANGES (with homing loop)
- VHF OMNI RANGES
- LOCALIZERS
- GCA VOICE
- ISOLATION AMPLIFIERS (10 inputs - 2 outputs)

Name of nearest sales and installation agency on request



**Aircraft Radio Corporation**

BOONTON, NEW JERSEY

## News—New Products

These manufacturers have invited PROCEEDINGS readers to write for literature and further technical information. Please mention your I.R.E. affiliation.

(Continued from page 22A)

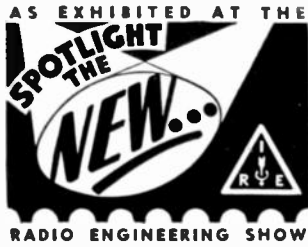

### Klystron Power and Modulation Supply

The Type 801, a universal klystron power and modulation supply, which provides for cw, square-wave, saw-tooth, or external modulation of a wide variety of klystron oscillators, is being marketed by Polytechnic Research & Development Co., Inc., 202 Tillary St., Brooklyn 1, N. Y.

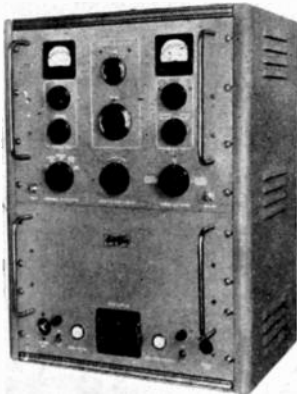

The regulated beam supply is continuously variable in two steps from  $-800$  to  $-3,600$  volts dc, and offers a choice of operation of up to 1,500 volts at 65 Ma, or up to 3,600 volts at 25 Ma.

Both coarse and fine controls are provided on the front panel for continuous adjustment of the repeller voltage over the range from  $-20$  to  $-750$  volts. These controls are individually engraved to read

#### NOTICE

Information for our News and New Products section is warmly welcomed. News releases should be addressed to Industry Research Division, Proceedings of I.R.E., Room 707, 303 West 42nd St., New York 18, N.Y. Photographs, and electrotypes if not over 2" wide, are helpful. Stories should pertain to products of interest specifically to radio engineers.

repeller voltage directly to a precision of 1 volt. Additional controls provide both for grid voltage adjustment and for variation of both amplitude and repetition rate of the modulation signal.

### Power Supply Delivers Regulation Within 1/2 Per Cent

A new compact power supply, Model 245, with regulation to within  $\frac{1}{2}$  per cent for both load and input variations, is now available for immediate delivery from Kepco Labs., Inc., 149-14 41 Ave., Flushing, L. I., N. Y.

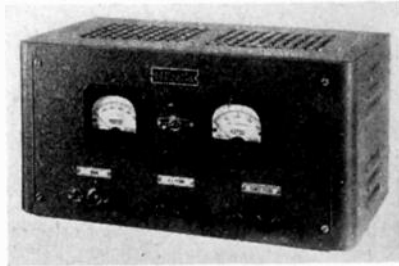

Specifications for dc output are 200 to 450 volts from 0 to 200 ma, regulated; ac output is 6.3 volts at 6 amperes, unregulated. Regulation between 200 and 450 volts for both load variation from 105 to 125 volts is better than 0.5 per cent. The dc output voltage is within 0.5 volts between 200 and 450 volts for load variations from 0 to 200 ma.



The combined features of the popular Du Mont Type 208-B have given it a greater volume of sales than any other cathode-ray oscilloscope in the world.

## The Oscilloscope that Outsells them all!

#### Versatile . . .

Type 208-B is a general-purpose cathode-ray oscilloscope, designed for both laboratory and industrial applications. Used extensively for receiver-test, strain-gage, pressure-measurement problems, and innumerable other applications.

#### Sensitive . . .

Highest gain Y-axis amplifiers in any commercial oscilloscope in its price range. Sensitivity, 10 millivolts rms per inch. Excellent low-frequency response. Recurrent sweep from 2 cps to 50,000 cps.

#### Time-tested . . .

For many successful years, the Du Mont Type 208-B has been the leader in its field. Improvements resulting from extensive field experience have been incorporated into its design.

#### Moderately priced . . .

The many applications of this instrument mean that it must meet varying budgets. Its low price and portability complete the requirements for an outstanding general-purpose oscilloscope.

Instrument Division  
ALLEN B. DU MONT LABS., INC.  
1000 Main Ave., Clifton, N.J.

**DU MONT**

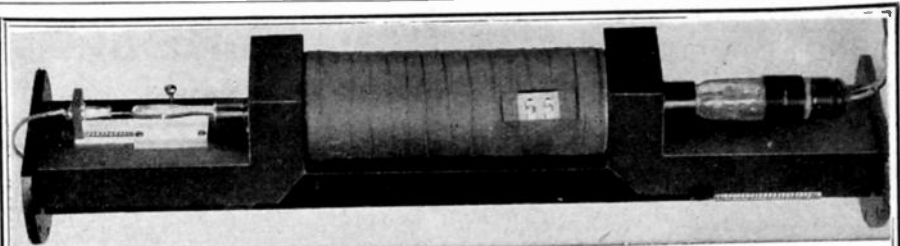

## TRAVELING WAVE AMPLIFIERS

FOR LABORATORY AND EXPERIMENTAL USE

Operates in the vicinity of 3000 Mc/sec.

#### SPECIFICATIONS

<b>BANDWIDTH:</b> 2700-3300 mc, flat to $\pm 1\frac{1}{2}$ db	<b>MODULATION LINEARITY:</b> Linear up to 0.3 watt output
<b>INPUT-OUTPUT CONNECTIONS:</b> $1\frac{1}{2}$ " x 3" S-Band wave guide	<b>BEAM VOLTAGE:</b> 2500 maximum
<b>GAIN AT 3000 MC:</b> 23 db or greater	<b>BEAM CURRENT:</b> 20 ma maximum
<b>NOISE FIGURE:</b> 35 db or better	

Focusing coils can be supplied over a reasonable range of voltages and currents

Klystrons, Traveling Wave and other Microwave Tubes designed and developed by VARIAN engineers to your specifications

## VARIAN ASSOCIATES

(Telephone: Redwood City—EMerson 8-0119)

99 WASHINGTON STREET

SAN CARLOS, CALIFORNIA

*Now You Can—*  
**Find products easily!**



**Coming in the IRE Yearbook—  
 3347 Electronic Supply Firms Listed:**

Every Firm in the alphabetical directory has address and complete line of products of interest to radio engineers is given in code numbers so you can understand what related products the firm supplies. This kind of listing gives you the most comprehensive and up-to-date picture of the company you are looking up, both as to manufactured products, and services. A cross-index provides direct reference to the page on which advertisers provide fuller information. Easy-reading type and spacing!

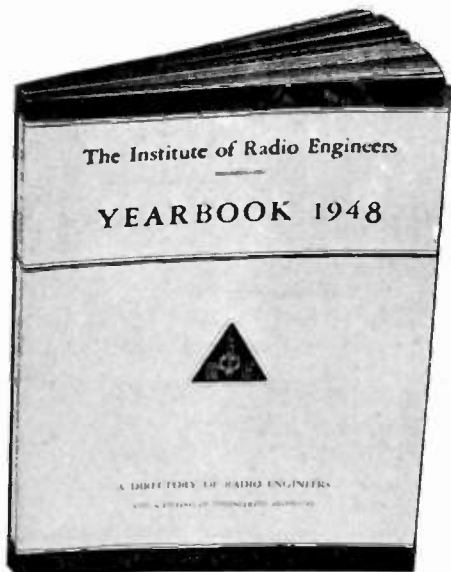

**Index of 75 Products  
 and Services**

This year, complete for companies who answered our requests, The Product Index shows ALL firms. Advertisers are given with complete addresses. A turn to alphabetical directory gives full data on the briefer listings.

Complete  
 Fast Reference  
 Understandable

Published for IRE Members  
 from Associate grade—up.  
 by  
 THE INSTITUTE OF RADIO ENGINEERS



**PROTELGRAM**

*chosen by*

**ANSLEY • EMERSON  
 FADA • FISHER • PILOT  
 SCOTT • BRUNSWICK  
 STEWART-WARNER  
 INTERNATIONAL  
 TELEVISION**

*for*

**life-size more life-like  
 television**

For complete information  
 write direct to:

North American Philips Co., Inc.  
 100 East 42nd Street  
 New York 17, New York

**NOTE THIS NAME**

**SUPER  
 RF AUDIO TV  
 COMPONENTS**

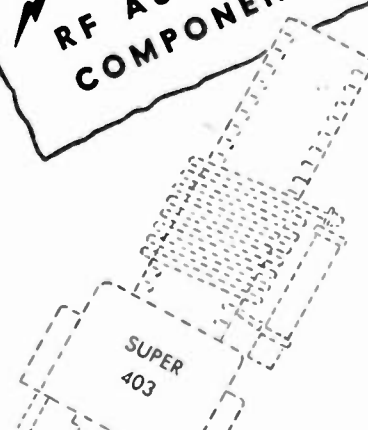

- PRECISION PRODUCED
- PERFORMANCE PROVED

**SUPER ELECTRIC PRODUCTS CORP.**  
 Pacing Electronic Progress With Ingenuity  
 1057 Summit Ave., Jersey City 7, N. J.

# INDEX AND DISPLAY ADVERTISERS

Section Meetings .....	37A
Student Branch Meetings .....	44A
Membership .....	48A
Positions Open .....	50A
Positions Wanted .....	52A
News—New Products .....	14A

## Display Advertisers

Acme Electric Corporation .....	60A
Aerovox Corp. ....	26A
Airborne Instruments Laboratory .....	56A
Aircraft Radio Corp. ....	40A, 60A
American Phenolic Corp. ....	44A
Ampex Electric Corp. ....	4A
Amperex Electronic Corp. ....	Cover II.
Antara Products .....	18A & 19A
Arnold Engineering Co. ....	24A
Astatic Corp. ....	38A

Barker & Williamson, Inc. ....	37A
Bead Chain Mfg. Co. ....	49A
Bell Telephone Labs. ....	16A
Bendix Aviation Corp. (Radio Div.) .....	51A
Bendix Aviation Corp. (Scintilla Div.) .....	14A
Blaw-Knox .....	39A
W. J. Brown .....	63A
Bud Radio, Inc. ....	52A
Burlington Instrument Co. ....	58A

Cambridge Thermionic Corp. ....	47A
Cannon Electric Development Co. ....	48A
Caphart-Farnsworth Corp. ....	51A
Capitol Radio Eng. Inst. ....	53A
Centralab .....	33A, 34A, 35A, 36A
C. P. Clare & Co. ....	25A
Clarostat Mfg. Co. ....	56A
Cleveland Container Co. ....	42A
Sigmund Cohn Corp. ....	47A
Communications Equipment Co. ....	45A
Communication Products Co. ....	46A
Cornell-Dubilier Electric Corp. ....	Cover III
Cornish Wire Co. ....	43A
Crosby Labs .....	63A

Allen B. DuMont Laboratories, Inc. 28A, 61A

Eitel-McCullough, Inc. ....	2A
Electro-Motive Mfg. Co., Inc. ....	5A
Elk Electronics .....	63A
Erie Resistor Corp. ....	7A

William L. Foss .....	63A
Freed Transformer Co., Inc. ....	13A

General Aniline & Film Corp. ....	18A & 19A
General Electric Co. ....	10A & 11A, 21A
General Radio Co. ....	Cover IV
Paul Godley .....	63A
H. L. Gordon .....	63A
Samuel Gubin .....	63A

Hazeltine Electronics Corp. ....	51A
Hewlett-Packard Co. ....	3A

International Resistance Co. ....	8A & 9A
-----------------------------------	---------

Jacobs Instrument Co. ....	50A
E. F. Johnson Co. ....	48A, 55A

Kahle Engineering Co. ....	59A
Kings Electronics .....	53A

P. R. Mallory & Co., Inc. ....	20A
Measurements Corp. ....	58A
Marion Electrical Inst. Co. ....	27A
Melpar, Inc. ....	52A
Mycalex Corp. of America .....	15A

National Carbon Co. ....	23A
National Union Radio Corp. ....	50A
North American Philips Co. ....	62A

Ohmite Mfg. Co. ....	29A
----------------------	-----

Panoramic Radio Corp. ....	57A
Premax Products .....	55A

Radio Corp. of America .....	32A, 50A, 64A
Reeves Instrument Corp. ....	22A
Paul Rosenberg .....	63A
Richard B. Schulz .....	63A

Smith Paper, Inc. ....	59A
Sorensen & Co. ....	12A
Spencer-Kennedy Laboratories, Inc. ....	54A
Sperry Gyroscope Inc. ....	56A
Sprague Electric Co. ....	6A
Stackpole Carbon Co. ....	30A
Super Electric Products Corp. ....	62A

Tech Labs. ....	54A
Technical Materiel .....	63A
Technology Instrument Corp. ....	57A
Tektronix, Inc. ....	59A
Transradio Ltd. ....	60A
Triplett Electrical Inst. Co. ....	41A
Trusco Steel Co. ....	31A

United Transformer Co. ....	17A
-----------------------------	-----

Varian Associates .....	61A
-------------------------	-----

S. S. White Dental Mfg. Co. ....	49A
----------------------------------	-----

## PROFESSIONAL CARDS

**PAUL ROSENBERG ASSOCIATES**  
*Consulting Physicists*  
 Main office: Woolworth Building,  
 New York 7, N.Y.  
 Cable Address Telephone  
 PHYSICIST WOrth 2-1939  
 Laboratory: 21 Park Place, New York 7, N.Y.

Richard B. Schulz  
**ELECTRO-SEARCH**  
 Radio-Interference Reduction;  
 Development of  
 Interference-Free Equipment,  
 Filters, Shielded Rooms  
 515 W. Wyoming Ave.,  
 Philadelphia 40, Pa.  
 GLadstone 5-5353

**TECHNICAL  
 MATERIEL CORPORATION**  
 COMMUNICATIONS CONSULTANTS  
 RADIOTELETYPE - FREQUENCY SHIFT  
 INK SLIP RECORDING - TELETYPE NETWORKS  
 453 West 47th Street, New York 19, N.Y.

**W. J. BROWN**  
*Consulting Engineer*  
**INDUSTRIAL ELECTRONICS  
 RADIO AND TELEVISION**  
 26 years active development experience  
 512 Marshall Bldg., Cleveland, O.  
 Telephone: TOWer 1-6498

**CROSBY LABORATORIES**  
*Murray G. Crosby & Staff*  
 FM, Communications, TV  
 Industrial Electronics  
 High-Frequency Heating  
 Offices, Laboratory & Model Shop at:  
 126 Old Country Rd. Mineola, N.Y.  
 Garden City 7-0284

**EDWARD J. CONTENT**  
*Acoustical Consultant*  
**Functional Studio-Theater Design**  
 FM — Television — AM  
 Audio Systems Engineering  
 Roxbury Road Stamford 8-7459  
 Stamford, Conn.

**ELK ELECTRONIC LABORATORIES**  
 Jack Rosenbaum  
 Specializing in the design and  
 development of  
 Test Equipment for the communication,  
 radar and allied fields.  
 12 Elk Street Telephone:  
 New York 7, N.Y. WOrth 2-4963

**WILLIAM L. FOSS, INC.**  
 927 15th St., N.W. REpublic 3883  
 WASHINGTON, D.C.

**PAUL GODLEY CO.**  
*Consulting Radio Engineers*  
 P.O. Box J, Upper Montclair, N.J.  
 Offs. & Lab.: Great Notch, N.J.  
 Phone: Little Falls 4-1000  
 Established 1926

**HERMAN LEWIS GORDON**  
 Registered Patent Attorney  
 Patent Investigations and Opinions  
 Warner Building 100 Normandy Drive  
 Washington 4, D.C. Silver Spring, Md.  
 National 2497 Shepherd 2433

Samuel Gubin, Electronics  
 G. F. Knowles, Mech. Eng.  
**SPECTRUM ENGINEERS, Inc.**  
*Electronic & Mechanical Designers*  
 540 North 63rd Street  
 Philadelphia 31, Pa.  
 GRanite 2-2333; 2-3135

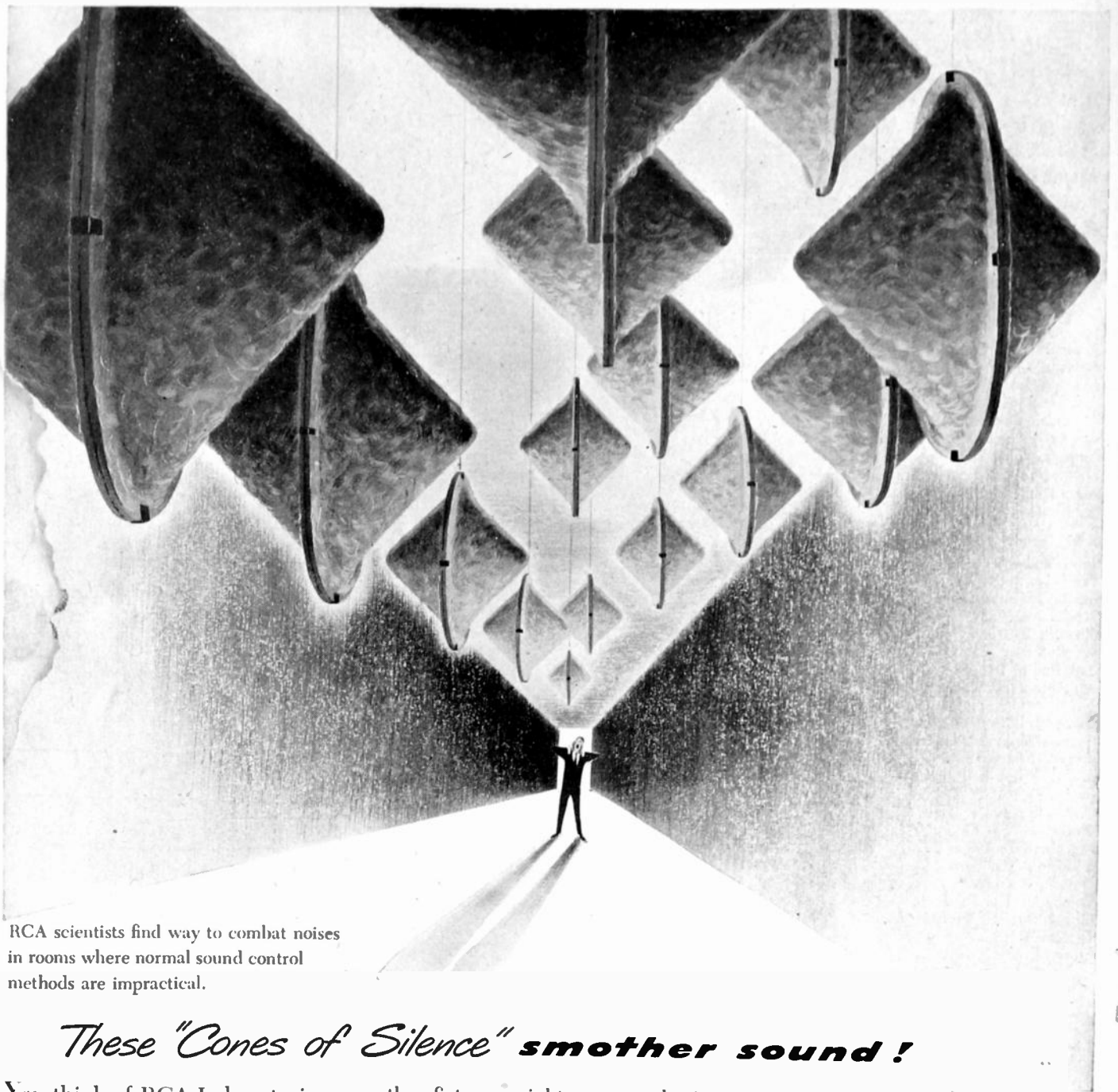

RCA scientists find way to combat noises in rooms where normal sound control methods are impractical.

## *These "Cones of Silence" smother sound!*

You think of RCA Laboratories—in part—as a place where scientists work with *sound*, for radio, television, phonographs. This is true, but they are also deeply concerned with *silence*.

One example is a recent RCA development, a way of killing clatter in places where conventional sound-conditioning—with walls or ceilings of absorbent materials—would get in your way. Overhead pipes, ducts or

other fixtures might prevent the installation of a sound-absorbent ceiling—and you wouldn't want to blanket a skylight.

RCA's invention solves the problem in this way: Cones of sound-absorbent substances are clamped together base-to-base . . . then hung in rows where not in the way. Light, inexpensive, easy to install, these "Cones of Silence" convert sound waves into heat energy, and will absorb from 60% to 75% of the clatter in a noisy room.

### **How you benefit:**

Development of this functional sound absorber indicates the type of progressive research conducted at RCA Laboratories. Such leadership in science and engineering adds *value beyond price* to any product or service of RCA and RCA Victor.

*The newest developments in radio, television, and electronics can be seen in action at RCA Exhibition Hall, 36 West 49th St., N. Y. Admission is free. Radio Corporation of America, Radio City, N. Y. 20.*



**RADIO CORPORATION of AMERICA**

*World Leader in Radio — First in Television*



VALUABLE FIRST EDITION

FREE  
ON  
REQUEST\*

JAN-C-25  
specifications

CATALOG  
No. 400

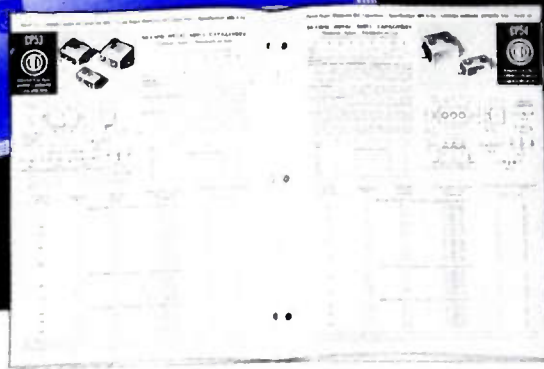
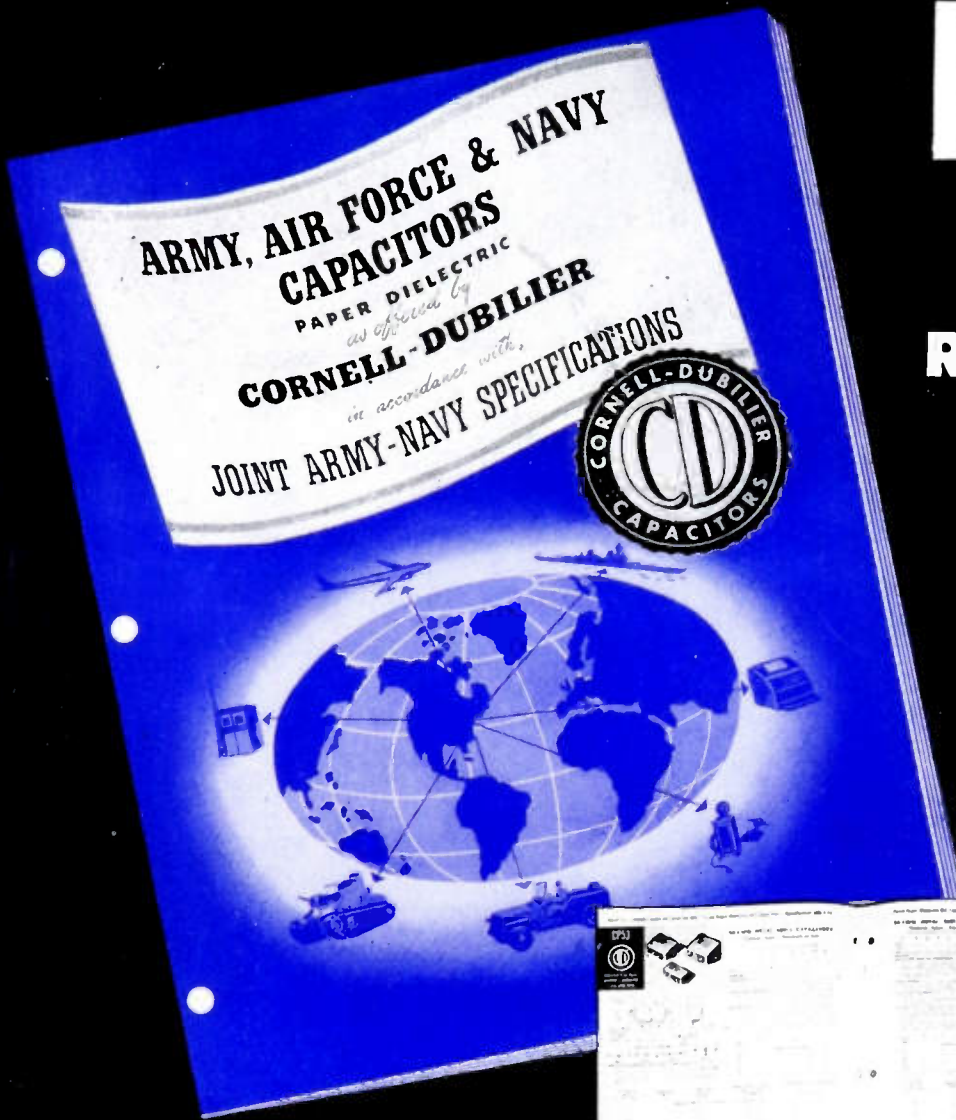

This conveniently arranged catalog illustrates and describes completely every capacitor in every case style listed in Specification JAN-C-25. All information for any given type is visible at a glance, without the annoyance of page turning or cross reference hunting. Prompt action is suggested before this first edition is exhausted.

Cornell-Dubilier Electric Corporation, Dept. M79,  
South Plainfield, New Jersey. Other plants in  
New Bedford, Worcester and Brookline, Mass.;  
Providence, R. I., Indianapolis, Ind., and subsidiary,  
The Radiart Corp., Cleveland, Ohio.

**CORNELL-DUBILIER**  
Consistently Dependable  
capacitors • vibrators  
antennas • converters

\* Please use your business letterhead when requesting this JAN-C-25 Catalog Number 400

C-D CAPACITORS—BEST BY FIELD TEST



See U.S. Pat. Off.

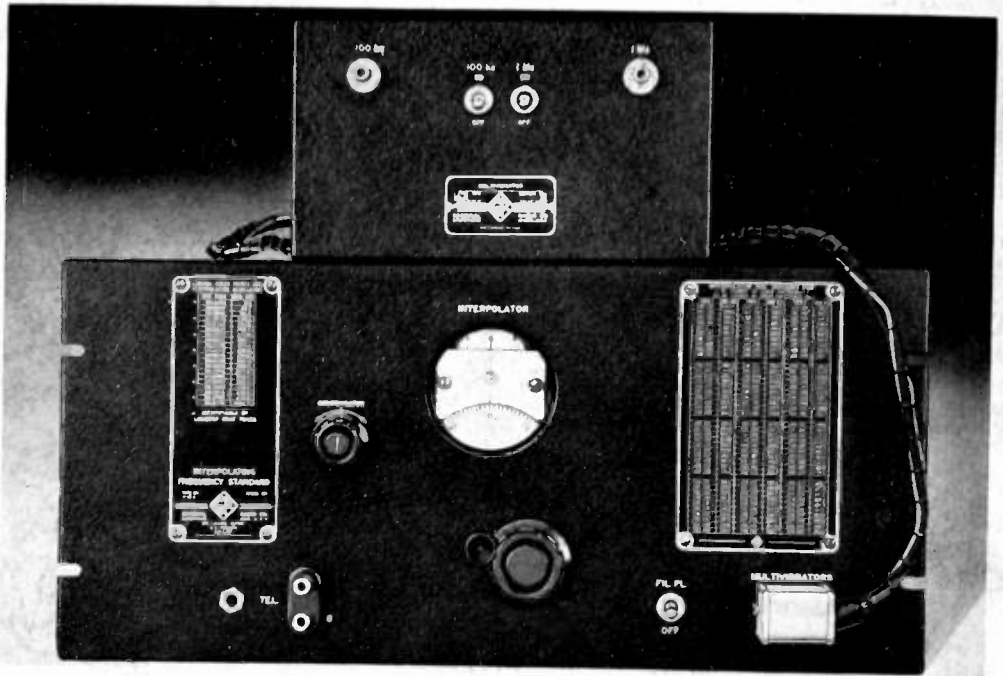

## FREQUENCY MEASUREMENTS UP TO 3,000 MC WITH ACCURACY OF $\pm 25$ PARTS PER MILLION

• Between 100 and several thousand megacycles, the present accuracy of heterodyne frequency meters ranges between 0.01 and 0.1 per cent. Continually increasing importance of frequencies within this range call for increased accuracy of measurements.

A reference standard and precise interpolation offer the simplest, most inexpensive and most direct method of increasing the accuracy of heterodyne frequency meters.

The Type 1110-A Interpolating Frequency Standard is composed of two units: a frequency standard variable over a range of 1000 to 1010 kc (1%), and a multivibrator unit for frequencies of 1 Mc and 100 kc. The frequency standard consists of a temperature-controlled 950 kc crystal oscillator, a highly-stable 50-60 kc bridge-type variable-frequency L-C oscillator, a modulator and a filter for selecting the sum of the two frequencies at the final output.

When the 100 kc multivibrator is used, the 100th harmonic has a range of 1% as the standard frequency is changed over the full range of the dial, covering 10.0 to 10.1 Mc. The multivibrator harmonics give complete frequency coverage from 100 Mc upward for the 1 Mc unit, and from 10 Mc upward for the 100 kc unit.

### FEATURES

**ACCURACY OF MEASUREMENT:** over-all accuracy is  $\pm 25$  parts per million using oscillator dial directly. If oscillator is carefully trimmed in terms of the crystal, the over-all accuracy is limited principally by the error of the crystal, or about  $\pm 10$  parts per million at room temperatures.

**SIMPLE TO CHECK ABSOLUTE ACCURACY:** harmonics of multivibrators fall at all WWV standard frequencies. With suitable receiver the absolute accuracy, including that of the 950-kc crystal, may be checked readily.

**ZERO BEAT ADJUSTMENTS:** no need for wide-band circuits or wide-band interpolating methods.

The Type 1110-A Interpolating Frequency Standard can be used for frequency measurements with high-frequency receivers provided the receiver calibrations can identify frequencies if separated by as little as 1 per cent.

**TYPE 1110-A INTERPOLATING FREQUENCY STANDARD** ..... \$725.00



### TYPE 720-A HETERODYNE FREQUENCY METER

*As a companion to the Type 1110-A instrument, this heterodyne frequency meter will be found to be particularly useful at frequencies up to at least 3000 Mc. It employs a butterfly-type tuning circuit, the oscillator frequency being continuously adjustable and direct-reading, from 100 to 200 Mc. A silicon crystal detector is used, with a 3-stage audio amplifier. The output of the amplifier operates a panel meter and a built-in loud-speaker. For head-telephone detection of weak signals, a jack is provided on the panel. The entire unit is battery-operated and completely self-contained.*

**TYPE 720-A HETERODYNE  
FREQUENCY METER** ..... \$360.00

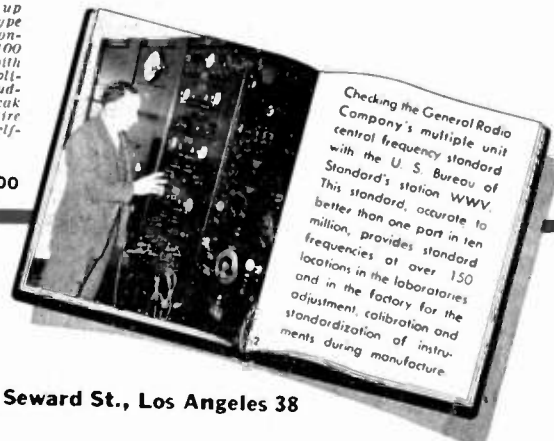

Checking the General Radio Company's multiple unit with the U. S. Bureau of Standard's station WWV. This standard, accurate to better than one part in ten million, provides standard frequencies at over 150 locations in the laboratories and in the factory for the adjustment, calibration and standardization of instruments during manufacture.



# GENERAL RADIO COMPANY

Cambridge 39, Massachusetts

90 West St., New York 6    920 S. Michigan Ave., Chicago 5    1000 N. Seward St., Los Angeles 38