

Proceedings

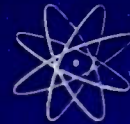

of the I·R·E

A Journal of Communications and Electronic Engineering
(Including the WAVES AND ELECTRONS Section)

February, 1947

Volume 35

Number 2

PROCEEDINGS
OF THE I.R.E.

Traveling-Wave Tubes
Theory of the Traveling-Wave Tube
Traveling-Wave Tube as Amplifier
at Microwaves
V-H-F and U-H-F Signal Ranges
Field Intensities at 45.5 and 91 Mc.
Directional Couplers
Transition Time and Pass Band

Waves and Electrons
Section

Radar Development in Canada
Naval V-H-F and U-H-F
Communication Receivers
Pulse-Measuring Automatic-
Slideback Voltmeter
"S"-Band Attenuator
Copper-Oxide and Thermionic
Voltage Doublers
Abstracts and References

Convention Program and Sum-
maries of Technical Papers Be-
gin on page 172.



Official U. S. Navy Photograph
CHARLES A. LOCKWOOD, JR.



Harris and Ewing
CHARLES R. DENNY



FREDERICK R. LACK

March 3-6
Grand Central Palace &
Hotel Commodore
New York
1947
I.R.E. National Convention
EXHIBITS
Radio Engineering Show

The Institute of Radio Engineers



FOR COMPACT HIGH FIDELITY EQUIPMENT

Ultra compact, lightweight, these UTC audio units are ideal for remote control amplifier and similar small equipment. New design methods provide high fidelity in all individual units, the frequency response being ± 2 DB from 30 to 20,000 cycles. There is no need to resonate one unit in an amplifier to compensate for the drop of another unit. All units, except those carrying DC in Primary, employ a true hum balancing unit. Effects good inductive shielding. Maximum high conductivity outer case, effects good inductive shielding. Maximum operating level +10 DB. Weight - 5 1/2 ounces. Dimensions - 1 1/2" wide x 1 1/2" deep x 2" high.



Unit shown is actual size. 6V6 tube shown for comparison only.



FOR IMMEDIATE DELIVERY

From Your Distributor

ULTRA COMPACT HIGH FIDELITY AUDIO UNITS

Type No.	Application	Primary Impedance	Secondary Impedance	± 2 DB from	List Price
A-10	Low impedance mike, pickup, or multiple line to grid	50, 125, 200, 250, 333, 500 ohms	50,000 ohms	30-20,000	\$15.00
A-11	Low impedance mike, pickup, or line to 1 or 2 grids	50, 200, 500 ohms	50,000 ohms	50-10,000 multiple alloy shield for extremely low hum pickup	16.00
A-12	Low impedance mike, pickup, or multiple line to push pull grids	50, 125, 200, 250, 333, 500 ohms	80,000 ohms overall in two sections	30-20,000	15.00
A-18	Single plate to two grids	8,000 to 15,000 ohms	80,000 ohms overall, 2.3:1 turn ratio overall	30-20,000	14.00
A-24	Single plate to multiple line	8,000 to 15,000 ohms	50, 125, 200, 250, 333, 500 ohms	30-20,000	15.00
A-25	Single plate to multiple line 8 MA unbalanced D.C.	8,000 to 15,000 ohms	50, 125, 200, 250, 333, 500 ohms	50-12,000	14.00
A-26	Push pull low level plates to multiple line	8,000 to 15,000 ohms each side	50, 125, 200, 250, 333, 500 ohms	30-20,000	15.00
A-30	Audio choke, 300 henrys @ 2 MA 6000 ohms D.C., 75 henrys @ 4 MA 1500 ohms D.C., inductance with no D.C. 450 henrys				10.00

The above listing includes only a few of the many Ultra Compact Audio Units available . . . write for more details.

United Transformer Corp.
 NEW YORK 13, N. Y.
 150 VARICK STREET
 EXPORT DIVISION: 13 EAST 40th STREET, NEW YORK 16, N. Y.
 CABLES: "ARLAB"

**They've
got**

to last L-O-N-G

... to meet Joint Army-Navy Specifications

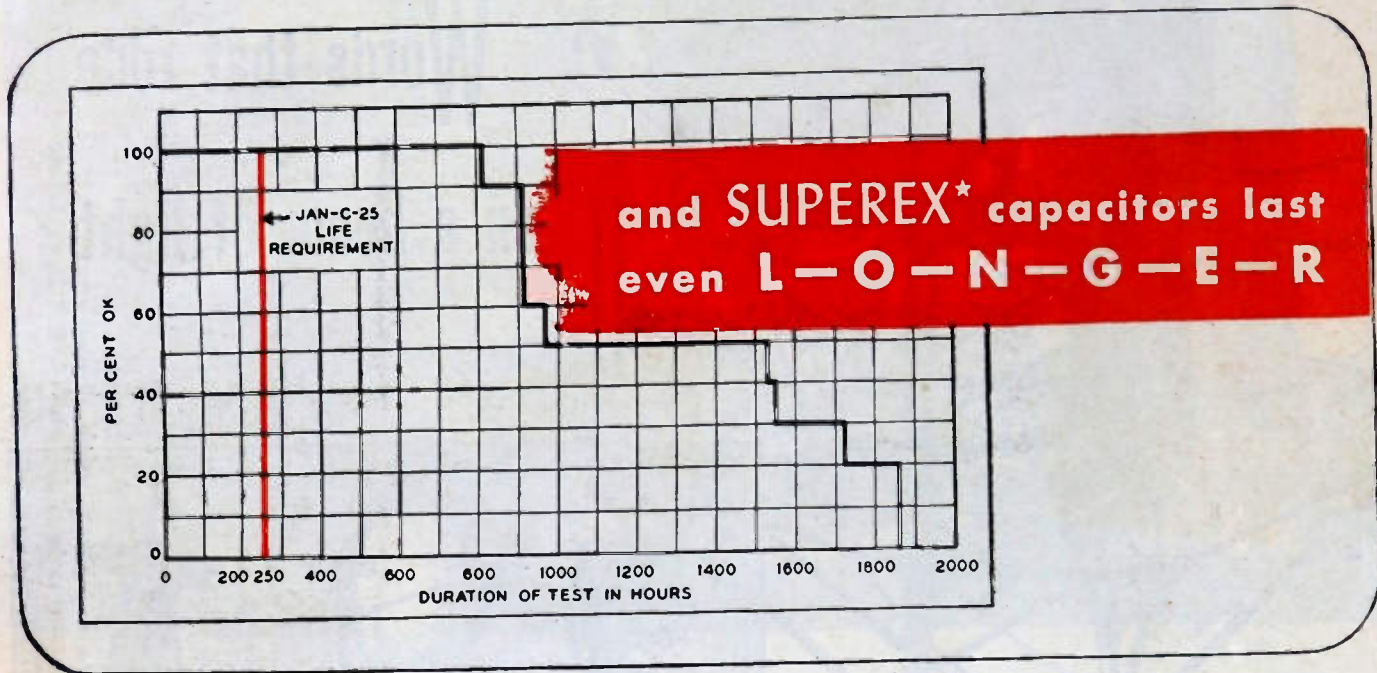

Two-hundred-fifty hours under 1.4 times rated voltage at the high temperature of 85°C is the rigid accelerated life requirement of Joint Army-Navy specifications JAN-C-25 for fixed paper capacitors.

A typical group of Solar SUPEREX* capacitors — taken at random from commercial production — was placed on a life test under these severe conditions. *Not a single failure occurred before 816 hours had elapsed.*

This is not an isolated instance. Repeated tests of SUPEREX* capacitors, taken from the commercial production line, show the same outstanding long life.

If you need the utmost in capacitor performance and "Quality Above All", write Solar Manufacturing Corporation, 285 Madison Avenue, New York 17, N. Y.

★Trade Mark

Ⓢ 1904

SOLAR CAPACITORS
"Quality Above All"



PROCEEDINGS OF THE I.R.E., February, 1947, Vol. 35, No. 2. Published monthly in two sections by The Institute of Radio Engineers, Inc., at 1 East 79 Street, New York 21, N.Y. Price \$1.50 per copy. Subscriptions: United States and Canada, \$12.00 a year; foreign countries \$13.00 a year. Entered as second class matter, October 26, 1927, at the post office at Menasha, Wisconsin, under the act of March 3, 1879. Acceptance for mailing at a special rate of postage is provided for in the act of February 28, 1925, embodied in Paragraph 4, Section 412, P. L. and R., authorized October 26, 1927.

Table of contents will be found following page 32A

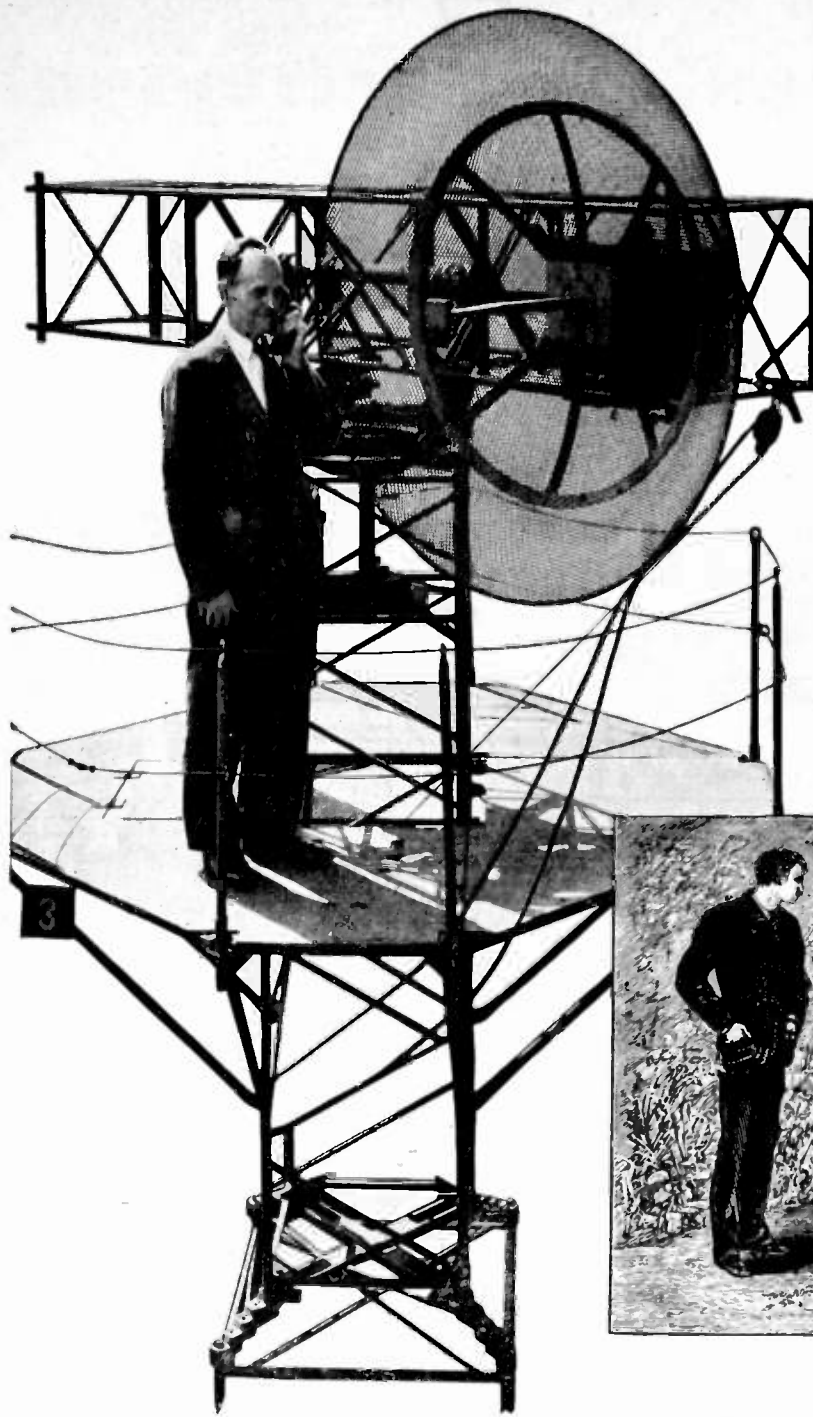

Words that rode on a beam of light

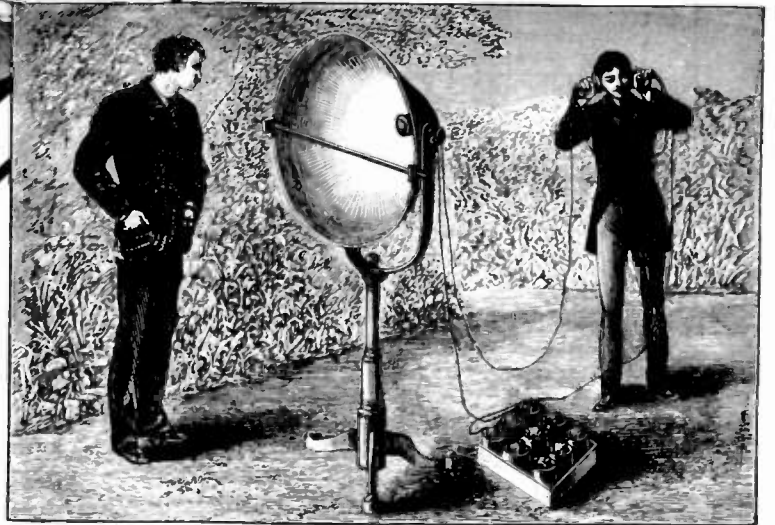

IF Alexander Graham Bell could look at the microwave antenna in the illustration, how quickly his mind would go back to his own experiments, 67 years ago!

For in 1880 the inventor of the telephone had another new idea. Speech could be carried by electric wires, as Bell had demonstrated to the world. Could it be carried also by a *light beam*?

He got together apparatus—a telephone transmitter, a parabolic reflector, a selenium cell connected to hand-phones—and “threw” a voice across

several hundred yards by waves of visible light, electromagnetic waves of high frequency.

Bell's early experiment with the parabolic antenna and the use of light beams as carriers was for many years only a scientific novelty. His idea was far ahead of its time.

Sixty years later communication by means of a beam of radiation was achieved in a new form—beamed

microwave radio. It was developed by Bell Telephone Laboratories for military communication and found important use in the European theater. In the Bell System it is giving service between places on the mainland and nearby islands and soon such beams will be put to work in the radio relay.

In retrospect, Bell's experiment illustrates once again the inquiring spirit of the Bell System.

BELL TELEPHONE LABORATORIES



EXPLORING AND INVENTING, DEVISING AND PERFECTING FOR CONTINUED IMPROVEMENTS AND ECONOMIES IN TELEPHONE SERVICE

Another Great *-hp-* Instrument



NEW *-hp-* Model 610A UHF SIGNAL GENERATOR

500 to 1350 Mc!

Here it is—a compact, highly-practical UHF signal generator for general laboratory use.

The *-hp-* model 610A Signal Generator is an outstanding addition to the *-hp-* family. It is designed to provide an extremely stable laboratory standard for tests and measurements between 500 Mc and 1350 Mc. Throughout these frequencies it supplies accurately known voltages ranging from 0.1 microvolt to 0.1 volt. R-f output may be continuous, amplitude modulated, pulsed, or square-wave modulated. Pulse length can be controlled between 2 and 50 microseconds, and pulse rate is variable from 60 to 3000 times per second.

The *-hp-* model 610A is particularly valuable in the UHF field when determining gain or alignment, antenna data or standing wave ratios. It is admirably suited to measurement of single-stage or conversion gain, signal-to-noise ratio, circuit "Q," and transmission line characteristics.

This war-born instrument, complete with post-war refinements and easy-to-operate controls, is now ready for delivery. Write today for more details of this important new *-hp-* instrument!

HEWLETT-PACKARD COMPANY
1324D PAGE MILL ROAD, PALO ALTO, CALIFORNIA



LABORATORY INSTRUMENTS FOR SPEED AND ACCURACY

Audio Frequency Oscillators Audio Signal Generators Vacuum Tube Voltmeters Amplifiers
UHF Signal Generators Wave Analyzers Frequency Meters Attenuators Frequency Standards
Square Wave Generators Electronic Tachometers Power Supplies Noise and Distortion Analyzers

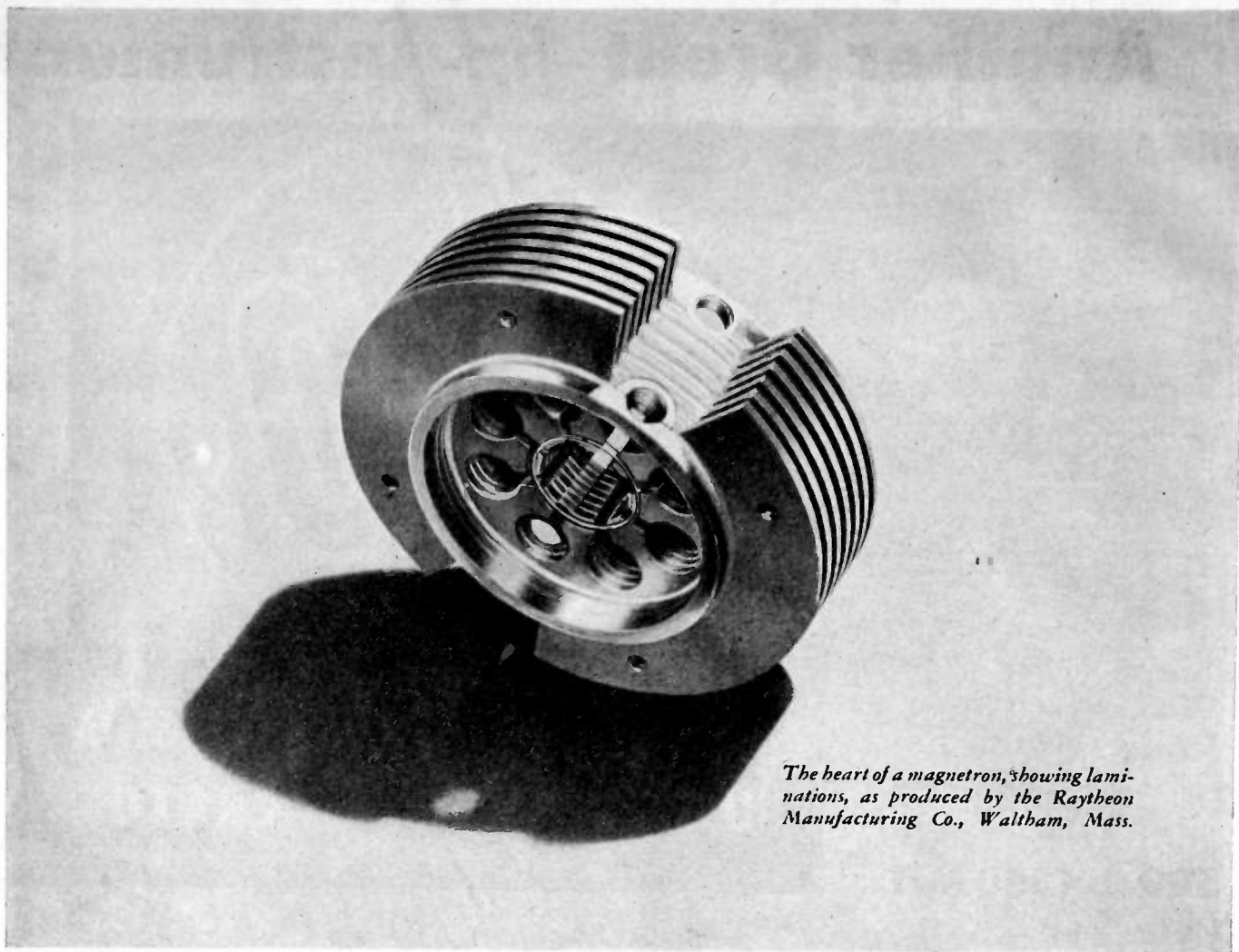

The heart of a magnetron, showing laminations, as produced by the Raytheon Manufacturing Co., Waltham, Mass.

The **MAGNETRON** again proves that **Copper Is the Metal of Invention**

THE first magnetrons produced in this country were "hogged" out of solid OFHC copper bar, a difficult process because copper in this form does not machine freely. About 100 man-hours of expert machine work were required per piece, and rejections were high. The magnetron threatened to be an almost fatal bottleneck in the radar program.

At this point Raytheon stepped in with a new idea. OFHC copper may be difficult to drill and turn with great accuracy, but it can be easily punched. The idea was to build up magnetrons of punched laminations, stacked in precision jigs, and silver-brazed in an automatic conveyor furnace. This made it possible to increase production from 100 a day to 2500, and make better tubes as well. Revere supplied much of the copper strip used by Raytheon.

This remarkable accomplishment is another example of the fact that copper is indeed "The Metal of

Invention." It lends itself easily to brand new ideas.

Revere supplies copper in its six basic types, and in many different forms, and in addition produces brasses, bronzes, aluminum and magnesium alloys, and electric welded steel tube. The Revere Technical Advisory Service will gladly cooperate with you in selecting the proper metals for electronic uses.

REVERE

COPPER AND BRASS INCORPORATED

Founded by Paul Revere in 1801

230 Park Avenue, New York 17, New York

*Mills: Baltimore, Md.; Chicago, Ill.; Detroit, Mich.;
New Bedford, Mass.; Rome, N. Y.—Sales Offices in
Principal Cities, Distributors Everywhere.*

Listen to *Exploring the Unknown* on the Mutual Network every Sunday evening, 9 to 9:30 p.m., EST.

A LONG AND STABLE LIFE...

Design and Production Developments Exclusive with Amperex Set New Stability and Performance Standards for Vacuum Condensers

Released six months ago, the new Amperex VC50 and VC25 vacuum condensers have proved themselves a real contribution in communication, dielectric heating and electro-medical apparatus. Their higher current handling ability and lower I²R losses in reduced space suggest important simplifications in equipment design. Oscillators using Amperex-developed circuits and Amperex VC capacitors meet proposed FCC stability regulations.



ALL COPPER (OFHC)
CONSTRUCTION

WIDE AREA SEALS

SHAPE AND DISPOSITION
OF ELECTRODES
MINIMIZES "HOT SPOTS"

LARGE SURFACE AREAS
TO CARRY H. F. CURRENT

AMPEREX VC-25

NO WELDS

**GENERAL CHARACTERISTICS
AMPEREX VC50**

Capacitance.....50 uuf ± 2%
Maximum Peak Voltage...30,000
Maximum RMS Current
65 Amps at 10 Mc.
40 Amps at 60 Mc.

Dimensions:
3 1/2" ± 3/32" x 2 1/2" Max.

WRITE FOR
COMPLETE TECHNICAL RATING
AND DATA SHEETS

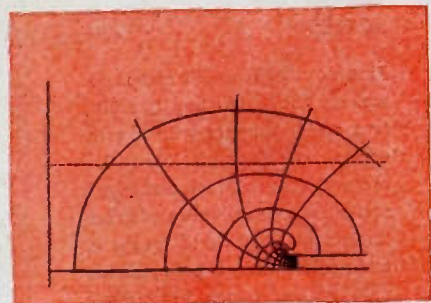

Type of equipotential and electrostatic flux lines established by probing electrolytic bath to determine shapes and disposition of electrodes. (POINT "A" IN PHOTOGRAPH)

NEW TECHNIQUES: Design and manufacturing techniques evolved for high power copper anode tubes were successfully brought to bear in developing the unusual qualities of Amperex VC50 and VC25 vacuum condensers. Unique all-copper OFHC construction, large area seals, unusual mechanical ruggedness and elimination of welds insure more efficient and economical operation.

PRIOR ART: When the vacuum condenser project was initiated in the Amperex laboratory, one of the first steps was the prolonged testing of all available types under field conditions. Concentrated high frequency fields and bottlenecks to current passage were common to all. These "hot spots" inevitably resulted in overheating, creating the risks of puncturing and distortion of the delicate balance of elements.

THE SHAPE OF THINGS: More than 200 theoretical shapes for the VC50 electrodes were tested in the electrolytic bath. Resulting lines-of-force curves dictated the shapes finally adopted. These spread the fields of force, eliminating destructive concentrations. It was discovered, also, that elements carrying high frequency current had to offer surface areas much larger than those which had contented older practice. Wires even of comparatively large diameter were found electrically insufficient and in addition, presented mechanical hazards. Elimination of current-carrying welds was indicated. Basic developments and numerous manufacturing refinements growing out of these tests were built into the Amperex VC series. They are responsible for outstanding performance records.

AMPEREX ELECTRONIC CORPORATION

25 WASHINGTON STREET, BROOKLYN 1, NEW YORK

IN CANADA AND NEWFOUNDLAND: ROGERS MAJESTIC LIMITED
11-19 BRENTCLIFFE RD., LEASIDE, TORONTO 12, ONTARIO, CANADA

Du Mont has many

Accessories

for your Cathode-Ray Equipment...

CALIBRATED SCALES

Provide a convenient means for making calibrated and quantitative measurements with a cathode-ray oscillograph. Types 216 are available in 3-inch and 5-inch rectangular coordinate scales calibrated in inches and tenths of inch; also in 5-inch polar coordinate scales. 5-inch logarithmic scales are also available for direct-reading of logarithmic decrements or Q measurements.

COLOR FILTERS

Increase contrast and relieve eye-strain by filtering out all but the desired light. Available in the 5-inch size for use with blue, green or amber screens. Made of plexiglass which fits between the calibrated scale and the face of the cathode-ray tube.

VIBRATION PICKUPS

Types VP-5 and DP-1 convert vibrations into electrical potentials which can be applied to the input circuit of the oscillograph. The response of the VP-5 is proportional to velocity; that of the DP-1 is proportional to displacement. The DP-1 is especially suited to low-frequency work.

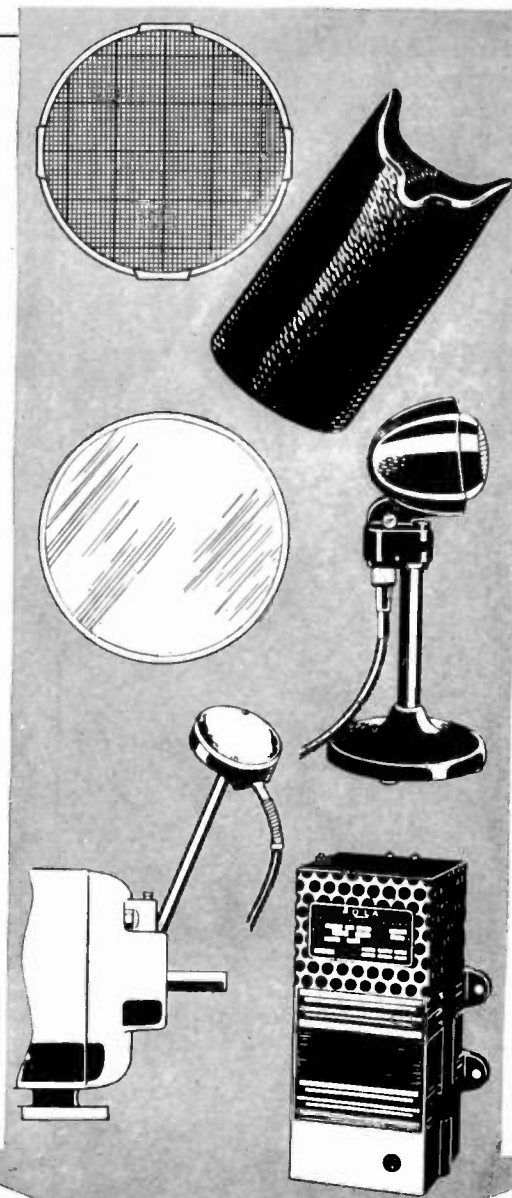

VIEWING HOOD

Use our Type 276 rubber viewing hood to shield the eyes and the tube screen when observing oscillographic patterns under unfavorable ambient light conditions. It fits any oscillograph equipped with a 5-inch cathode-ray tube.

CRYSTAL MICROPHONE

The Type 277, of unusually high impedance, is specially designed for direct connection to cathode-ray oscillograph input circuits. The directional response is practically circular in both horizontal and vertical planes at all audio frequencies.

CONSTANT-VOLTAGE TRANSFORMER

A "must" where irregularity of supply voltage interferes with the performance of oscillographic equipment. The Type 283 is designed for operation from 60-cycle, single-phase alternating current. It delivers a constant secondary-output potential of 115 volts, at loads up to 250 volt-amperes, for input-potential variations from 95 to 125 volts.

Write for descriptive literature

© ALLEN B. DUMONT LABORATORIES, INC.

DUMONT

Precision Electronics & Television

ALLEN B. DUMONT LABORATORIES, INC., PASSAIC, NEW JERSEY • CABLE ADDRESS: ALBEEDU, PASSAIC, N. J., U. S. A.



Orders Federal's FTR-3 Transmitter for "Ground-to-Clipper" Communication

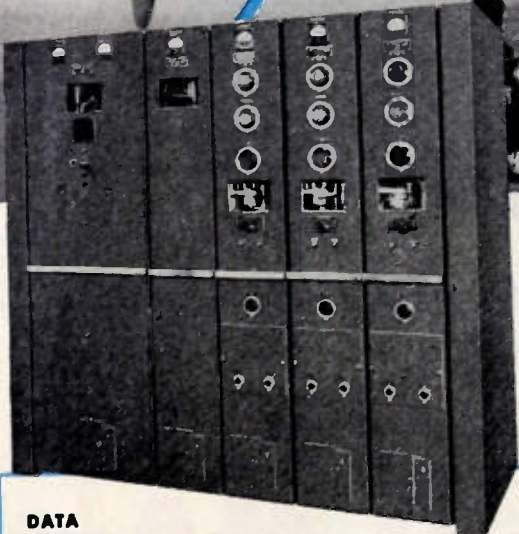

DATA

Frequency Range — 2 to 20 Mc or 250 to 750Kc.

Power Output — Nominal rating, 3 Kw (2 to 20 Mc). Nominal rating, 2.5 Kw (250 to 750 Kc).

Types of Emission — Telephone and Telegraph.

Frequency Control — Low temperature-coefficient crystals for all operating frequencies.

Frequency Response — 300 to 4000 cycles, plus or minus 3 db.

Distortion — Less than 10% at 95% modulation.

Remote Control — Transmitter on-off, channel selection, push-to-talk, and keying may be performed by remote control.

Federal's Multi-Unit Equipment Offers Many New Advantages

PAN AMERICAN WORLD AIRWAYS—another famous user of Federal's ground-station radio transmitters—picks the FTR-3 for dependable flight contact with its huge modern "Clippers".

An FTR-3 multi-unit transmitter offers unique features for greater flexibility, simplified maintenance, easy accessibility and added safety. The complete transmitter consists of three basic sections—the RF unit, modulator unit and power supply unit. These separate units may be selected and combined in a single transmitter, to provide the operating characteristics needed for any job.

Each unit is mounted on rollers and can easily be drawn out for inspection or adjustment. Access to the back of the transmitter is therefore unnecessary, greatly reducing space requirements. Complete electrical and mechanical interlocks, as well as overload and overtemperature relays, give extra protection to both the equipment and the operating personnel. For complete information write today for Bulletin A 337.

Federal Telephone and Radio Corporation

In Canada:—Federal Electric Manufacturing Company, Ltd., Montreal.
Export Distributors:—International Standard Electric Corp. 67 Brood St., N.Y. C.



Newark 1,
New Jersey

NOW

FOR THE LARGER STATION

Raytheon

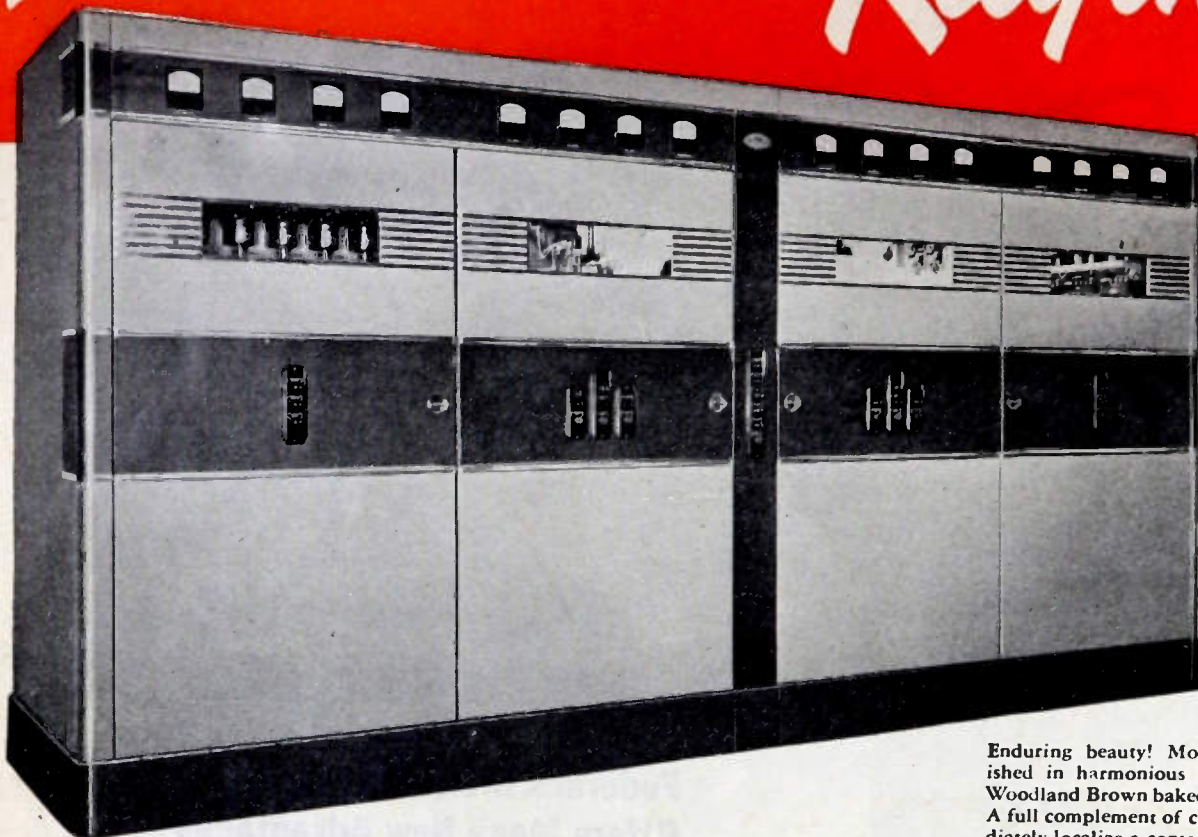

Enduring beauty! Modern functional design, finished in harmonious contrast of Dove Grey and Woodland Brown baked enamel, trimmed in chrome. A full complement of circuit indicating lights immediately localize a control circuit failure.

FEATURES

High Fidelity Signal—flat frequency response 30 to 10,000 c.p.s.—distortion less than 3% at 95% modulation—noise level minus 60 db below 100% modulation.

Low Operating Cost—simple circuit design plus quality components operated at well below capacity assure exceptionally long tube life and economical operation.

Fast, Easy Maintenance—full length doors, large compartments and improved mechanical design provide maximum convenience and accessibility.

Instantaneous Power Reduction for nighttime operation through a single switch, without program interruption.

High Stability Crystal Oscillator with transfer switch. Provision for second crystal.

Easy to Operate—centralized manual or automatic plus remote console control. Minimum number of tuning controls, sixteen meters instantly check all circuits, full complement of circuit-indicating lights, modern motor tuning.

Automatic Recycling minimizes lost air time.

Easily Meets All FCC Requirements and is fully approved.



This handsome control console gives the engineer fully automatic control of all transmitter operations plus studio switching facilities for handling emergency programs originating at the transmitter. Controls audio and monitor switching; contains VU meter and remote antenna current meter. Finished in colors to match transmitter.

DEVOTED TO RESEARCH AND MANUFACTURE

... all the basic advantages of *Design!*

Rugged and completely accessible. Compartments, large enough for a man to enter, make cleaning and servicing easy.

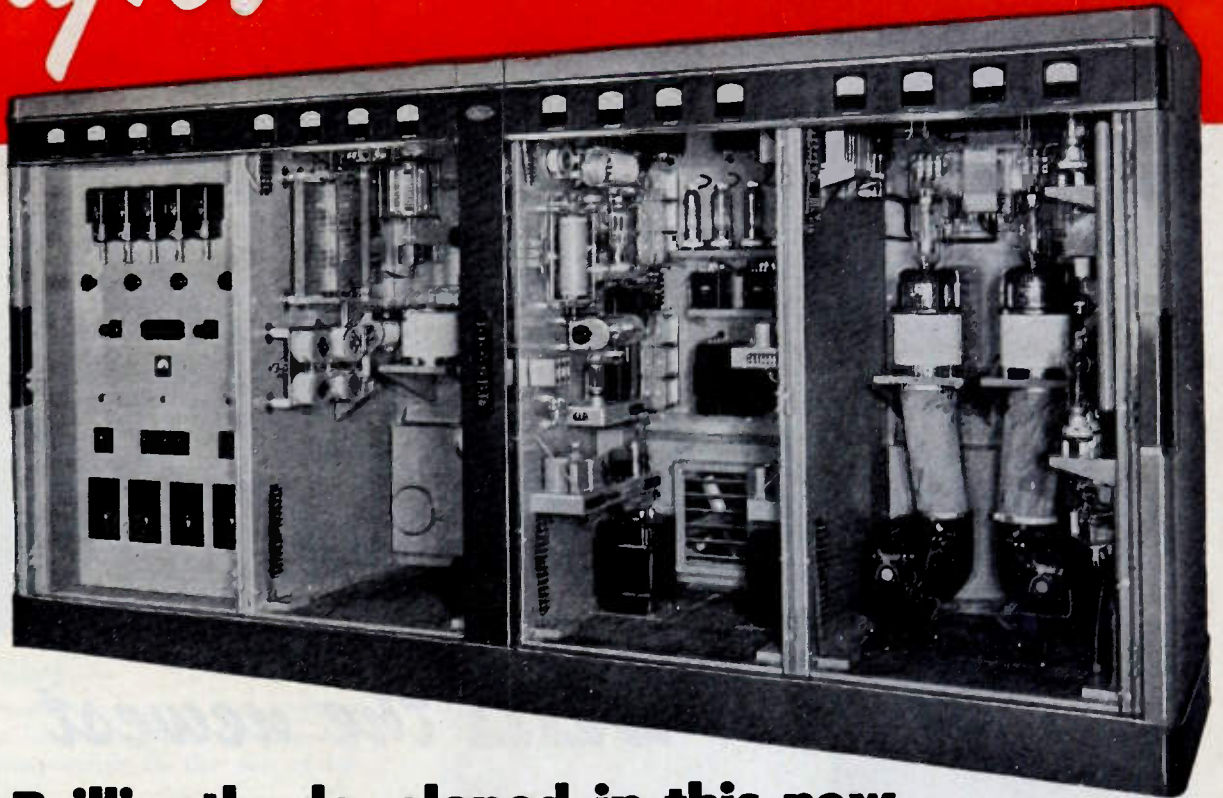

Brilliantly developed in this new

5 or 10 KILOWATT AM TRANSMITTER

Big station engineers all over the country designed this transmitter. It is custom engineered to their specifications—to give you *exactly* what you want and have asked for. That, is the advantage of Raytheon design.

For the first time—*complete* accessibility including convenient servicing from the inside of any one of the roomy compartments.

Reliability that is built into every circuit plus extra safeguards against program interruption. Control features that instantly locate a failure, meter every circuit, allow manual or automatic operation at the centralized control panel or at the remote console.

Positive safeguards to equipment are provided—double



Excellence in Electronics

protection to personnel—quiet high-velocity air cooling with an individual blower for each modulator and power amplifier tube.

The efficient high level system of modulation means real operating economy. The low initial cost will also surprise you.

Before you order *your* transmitter get all the facts on the RA-5 or 10. Write today for fully illustrated booklet containing complete technical specifications, inside views and schematic diagram.

RAYTHEON MANUFACTURING COMPANY

Broadcast Equipment Division

7475 North Rogers Avenue

Chicago 26, Illinois

FOR THE BROADCASTING INDUSTRY



finch facsimile
THE "INSTANT COURIER"

SEE *the newest
facsimile equipment*

... operating on both FM Radio and wire circuits!

BOOTH 7C MAIN FLOOR

I. R. E. SHOW

GRAND CENTRAL PALACE • NEW YORK CITY

March 3-6 Inclusive

FINCH TELECOMMUNICATIONS, INC.

10 EAST 40th STREET, NEW YORK 16, N. Y. • Factory: PASSAIC, N. J.

Impervious TO ATMOSPHERIC MOISTURE

Proof AGAINST INDUSTRIAL FUMES . . .

Unaffected BY EXTREME HEAT OR COLD

Withstand SEVERE MECHANICAL SHOCKS

. . . in short, constructed to last under the worst of operating conditions.

★ Although essentially fitted for the "tough" applications, Chicago Transformer's *Sealed in Steel* construction is being specified with increasing frequency by engineers who design electronic equipment for only average, or normal, conditions, but who, because of the vital services performed by their products, require an extra margin of dependability.

Their reasoning —

(a) Water vapor, oxygen, and carbon dioxide exist in all atmospheres; chlorine and sulphur compounds in the air of industrial localities.

(b) The action of these agents, intensified by heat and direct current potentials, corrodes copper coil windings, shortens transformer life.

(c) Moisture, even when not excessive in the air, frequently condenses on the inside of partially sealed or unsealed cases and shields as the result of variations in temperature.

Their conclusion —

It is good engineering to specify the transformers that have met with outstanding success the most rigid military tests for sealing against corrosion, have been proven to *stay* sealed in extremes of heat and cold . . . Chicago Transformers, *Sealed in Steel*.

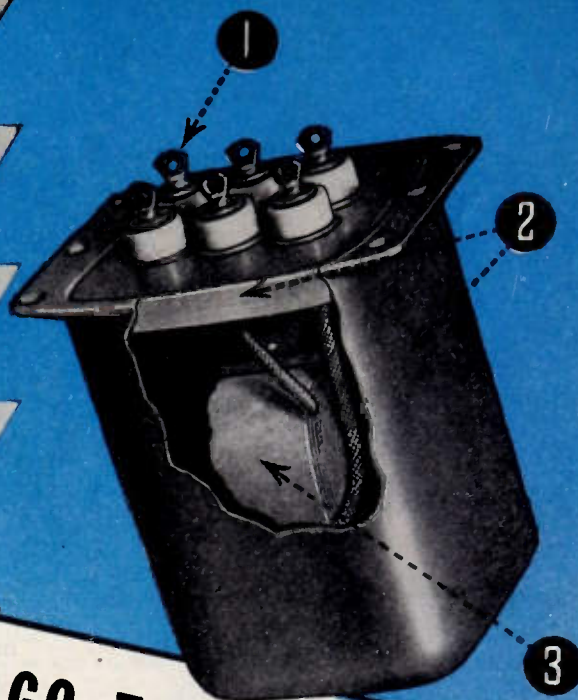

CHICAGO TRANSFORMERS
Sealed in Steel
FOR LASTING DEPENDABILITY

- 1 C.T.'s exclusive Bushing-Gasket Seal at terminals employs tough resilient gaskets to permanently seal all openings and to cushion terminals and bushings against mechanical shock or drastic changes in temperature. (No cracking because of sudden heat transfer from soldering iron to terminals during chassis assembly operation.)
- 2 Seamless, Drawn Steel Case and C.T.-innovated Deep Seal Base Cover provide a strong, impenetrable housing which, with its compact, modern, and streamlined "good looks," helps sell the equipment in which it appears.
- 3 Coil is impregnated by a process using heat and alternate cycles of vacuum and pressure. By use of vacuum, all moisture is withdrawn from the coil, while pressure and heat thoroughly impregnate it with wax or varnish. Superior to ordinary impregnation processes, this method insures that the transformer is potted without moisture trapped inside.



CHICAGO TRANSFORMER

DIVISION OF ESSEX WIRE CORPORATION

3501 ADDISON STREET • CHICAGO 18, ILLINOIS

Machineable CUNICO

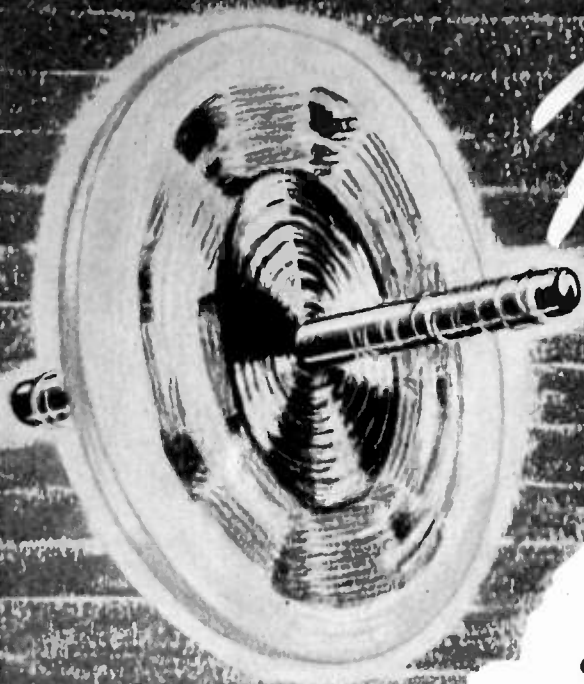

GENERATOR ROTORS CAN BE OPERATED SAFELY AT 125,000 RPM

Cunico is the newest addition to the Arnold high quality permanent magnet line. It is a copper nickel cobalt alloy which has very high coercive force. Ductile, machineable and malleable, Cunico can be fabricated into a wide variety of simple and complex designs. Drawing, cutting, machining, punching and screw machine operations are practical.

Cunico can be magnetized in any direction, and is most efficient where a large cross section is available to produce sufficient total flux. Generator rotors are a typical application. A relatively short length is required to maintain the flux because of its high coercive force.

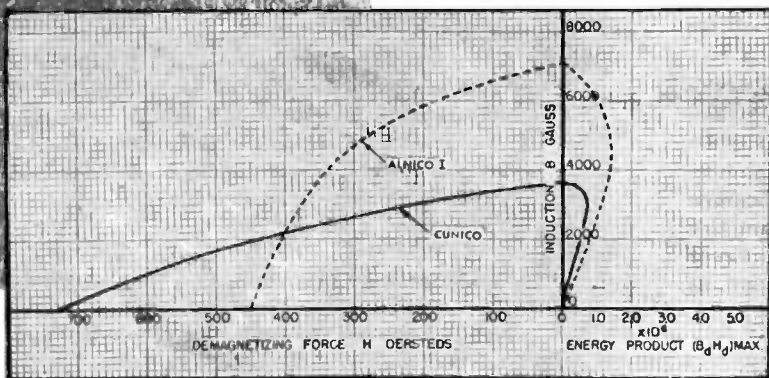

CUNICO CAN BE PRODUCED IN THE FOLLOWING SHAPES AND APPROXIMATE SIZES:

- BARS— $\frac{1}{4}$ " to 1" square
- STRIPS—2" maximum width x .015" to .312" thickness
- RODS— $\frac{1}{4}$ " to 1" in diameter
- WIRE—No. 2 to No. 24 AWG sizes
- CASTINGS—Maximum section 1" thick

Write today for details.

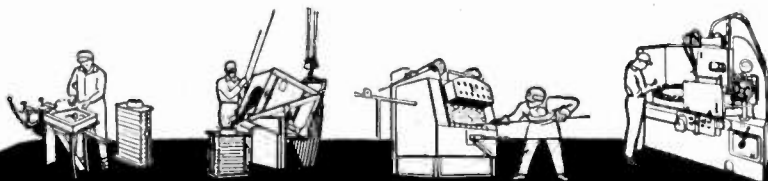

THE ARNOLD ENGINEERING COMPANY

SUBSIDIARY OF ALLEGHENY LUDLUM STEEL CORPORATION

147 EAST ONTARIO STREET, CHICAGO 11, ILLINOIS

Specialists in the manufacture of ALNICO PERMANENT MAGNETS

ARNOLD'S TECHNICAL BULLETIN

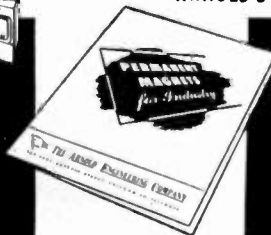

"Permanent Magnets for Industry" suggests many ways in which the war-born improvements in permanent magnets can be most valuable to you. Send for it!

NOW THE 4X500A POWER TETRODE

Now, with the new 4X500A, the advantages of the Eimac-designed tetrode are brought to the 500-watt class.

The 4X500A includes the outstanding VHF performance, stability, ruggedness, and freedom from undesirable primary and secondary grid emission that have made the Eimac 4-125A and 4-250A the obvious choice of transmitter engineers for important sockets in both low-frequency and VHF applications.



Here is a transmitter-man's tube intended to make life more simple for the transmitter engineer. The 4X500A is designed for functional application; note the nearly perfect shielding between grid and plate circuits made possible by the low-inductance

screen mounting disc which terminates in a contact ring on the envelope. The large low-inductance tubular control-grid lead within the envelope terminates at the center of the base. This design makes it easy to build coaxial tank circuits around the 4X500A. These are only two of its many features. Among others are the rugged 500-watt air-cooled anode, Eimac-processed grids, and silver-plated terminals pointed out below.

It isn't necessary to design your transmitter around promises. Eimac 4X500A tetrodes are available NOW. They'll deliver as much as 1750 watts useful output at 110 Mc. with but 25 watts driving power (two tubes). They'll deliver 3500 watts at the same frequency with 50 watts driving power (four tubes, push-pull-parallel). Complete operating information and ratings are in the technical data sheet for the 4X500A—now available on request.

- 1 External Anode, 500 watts dissipation, forced air cooled.
- 2 Control and screen grids precisely aligned—assures maximum plate efficiency and low control and screen grid currents. (Primary and secondary grid emission is positively controlled by exclusive Eimac grid processing.)
- 3 Double spiral filament—rugged, stable emission.
- 4 Hard glass envelope—ample r-f insulation.
- 5 Electron bombardment shield.
- 6 Rigid, low-inductance screen grid mount assures improved VHF operation and permanent alignment.

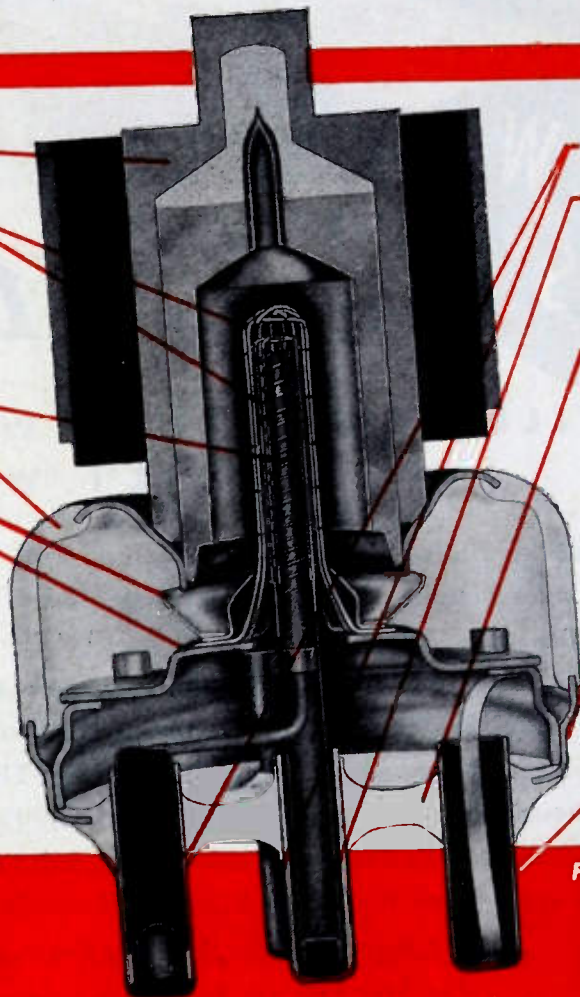

- 7 Filament terminals—heavy duty, large contact areas.
- 8 Control grid terminal—low inductance, logically placed for maximum isolation between input and output circuits. Centered for use in coaxial cavities.
- 9 Molded glass base—maintains precise alignment of all terminals for ease and simplicity of insertion in sockets. Makes possible compact design, and low inductance lead engineering. (All base terminals plus concentric screen grid terminals are silver plated for minimum r-f resistance.)
- 10 Concentric ring and pin type screen grid terminals for VHF and cavity circuits or pin sockets.

ELECTRICAL CHARACTERISTICS

4X500A POWER TETRODE

Filament: Thoriated Tungsten
Voltage . . . 5.0 volts
Current . . . 13.5 amperes

Direct Interelectrode Capacitances (Average)
Grid-Plate . . . 0.05 μ fd
Input 12.8 μ fd
Output 5.7 μ fd

Maximum D-C Plate Voltage . . . 4000 volts

Maximum D-C Plate Current . . . 350 ma.

Maximum Plate Dissipation . . . 500 watts

CROSS SECTION
EIMAC 4X500A
POWER TETRODE

Follow the leaders to

Eimac
REG. U. S. PAT. OFF.
TUBES

THE COUNTERSIGN OF DEPENDABILITY
IN ANY ELECTRONIC EQUIPMENT

EITEL-McCULLOUGH, INC., 13131 San Mateo Ave., San Bruno, Calif.
Export Agents: Frazar and Hansen, 301 Clay Street, San Francisco 11, California, U. S. A.



**YOUR NEW
STUDIOS**

..... EQUIPPED BY

Langevin

**WILL BE EXACTLY WHAT YOU NEED
EXACTLY WHAT YOU WANT**

Custom Built Langevin audio facilities for broadcast studios are designed and manufactured to fit the requirements and specifications of the individual broadcaster.

Using Langevin FM quality amplifiers as the basic building blocks, complete audio facilities, including the type console you want, can be engineered and fabricated in our "custom built" department. The Langevin service also includes on-the-job installation supervision, if desired.

In many cases a Langevin custom built audio system, tailored to fit your needs, is no more costly than a combination of standard packaged speech input units.

A Langevin Audio Facilities Engineer is always on call . . .

Let him help you with your equipment planning . . .

The Langevin Company

INCORPORATED

SOUND REINFORCEMENT AND REPRODUCTION ENGINEERING

NEW YORK, 37 W. 65 St., 23 • SAN FRANCISCO, 1050 Howard St., 3 • LOS ANGELES, 1000 N. Seward St., 38

EVERY DE MORNAY-BUDD WAVE GUIDE is Electrically Tested, Calibrated and Tagged

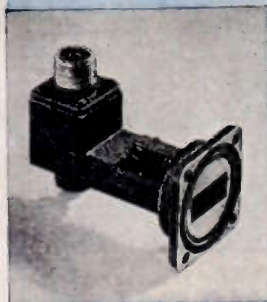

Crystal Mount DB-453



Rotating Joint DB-446



90° Elbow (H Plane) DB-433



Pressurizing Unit DB-452



Mitered Elbow (H Plane) DB-439



Uni-directional Broad Band Coupler DB-442

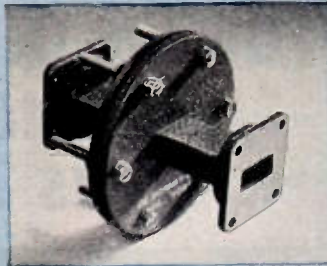

Bulkhead Flange DB-451



Uni-directional Narrow Band Coupler DB-440



90° Twist DB-435

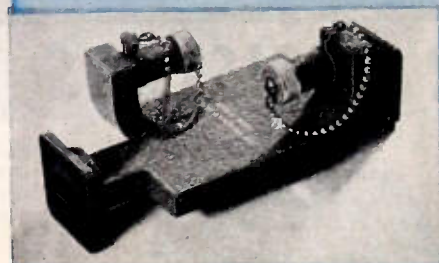

Bi-directional Narrow Band Coupler DB-441

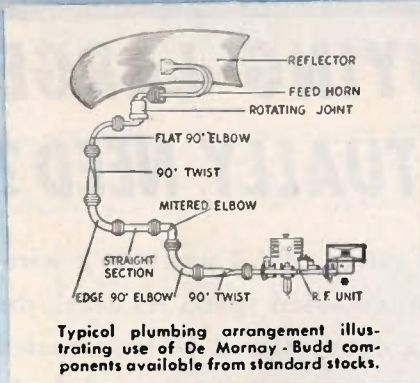

RF Radar Assembly DB-412

When you use any De Mornay-Budd wave guide assembly, you know exactly how each component will function electrically. You avoid possible losses in operating efficiency through impedance mismatches, or breakdown and arcing caused by a high standing wave ratio. (See chart below.)

De Mornay-Budd wave guides are manufactured from special precision tubing, and to the

most stringent mechanical specifications. Rigid inspection and quality control insure optimum performance.

NOTE: Write for complete catalog of De Mornay-Budd Standard Components and Standard Bench Test Equipment. Be sure to have a copy in your reference files. Write for it today.

The curve shows the manner in which the reflected power increases with an increase in the voltage standing wave ratio. The curve is calculated from the following equation:

$$\% \text{ Power Reflected} = \left(\frac{\left(\frac{V_{\max}}{V_{\min}} \right) - 1}{\left(\frac{V_{\max}}{V_{\min}} \right) + 1} \right)^2$$

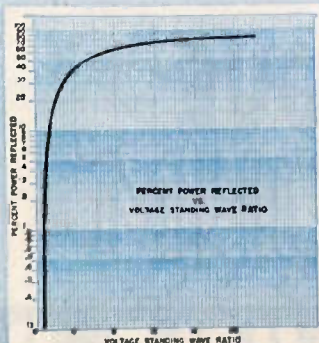

De Mornay-Budd, Inc., 475 Grand Concourse, New York 51, N. Y.

**THIS SPRAGUE
KOOLOHM...**



**...DOES THE WORK
OF AN ORDINARY
RESISTOR
THIS SIZE!**

ARE YOU BUYING LARGER RESISTORS THAN YOU ACTUALLY NEED?

The job called for an actual rating of 4.7 watts on a wire-wound resistor to be used in an enclosed space. As usual, the manufacturer planned to use a conventional 10-watt coated resistor—until a Sprague field engineer proved beyond doubt that a 5-watt Koolohm would do the trick with ample safety margin. This instance is typical of savings made possible by Koolohms. Wound with ceramic insulated wire, they dissipate heat faster, they're easier to mount—and can safely be used at full wattage ratings. Write for Catalog 10EA.

Sprague Electric Co., Resistor Division, North Adams, Mass.

**SPRAGUE
KOOLOHM**
Trademark Reg. U. S. Pat. Off.

**MOUNT
THEM
ANY WAY—
ANYWHERE**

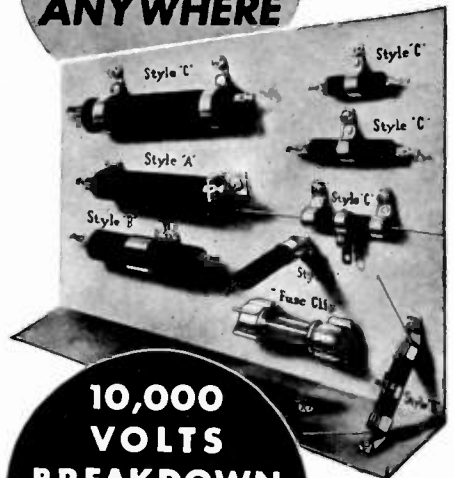

**10,000
VOLTS
BREAKDOWN
INSULATION**

From ceramic
outer shell to
ground

WIRE WOUND RESISTORS

Star performers of Western Electric's 1947 line



LOOK 'EM OVER!

Western Electric—long a leader in sound-transmission products—offers a wide range of equipment for broadcasting, program distribution, and radio communications, as well as new industrial products for use in factory and laboratory.

Advanced Design: In designing this equipment, Bell Laboratories engineers keep uppermost in their minds the needs and preferences of users.

High Quality: Whether you want a 50 kw trans-

mitter or a tiny thermistor, you can count on quality workmanship that provides quality performance.

Leadership: Today, as in the past, the Bell Laboratories-Western Electric team continues to pioneer new ideas that set the pace for tomorrow.

For full details, talk to your local Graybar Representative or write Graybar Electric Co., 420 Lexington Avenue, New York, 17, N. Y.

BROADCAST EQUIPMENT: A complete line for better broadcasting... AM or FM

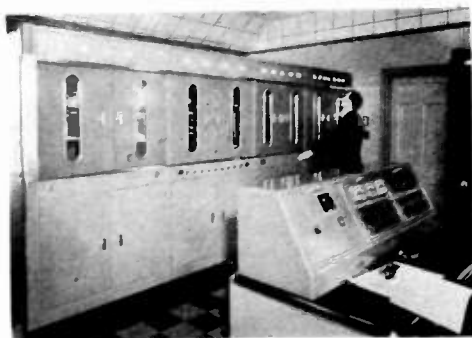

AM TRANSMITTERS: Western Electric's complete line includes 250 watt, 1 kw, 5 kw (shown), 10 kw and 50 kw units that assure high quality at low operating cost.

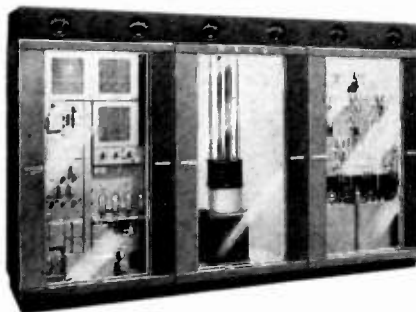

FM TRANSMITTERS: The new line of TRANS-VIEW design transmitters—250 watt, 1, 3, 10 (shown), 25 and 50 kw—is as outstanding in performance as in appearance.

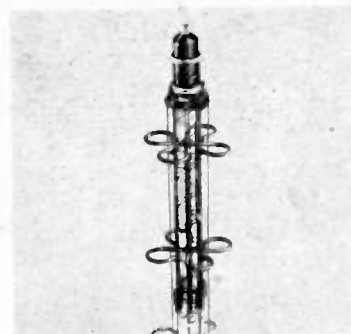

54A CLOVER-LEAF FM broadcast antenna has high efficiency and a circular azimuth pattern. For any power up to 50 kw. It's rugged, easy to install and maintain.

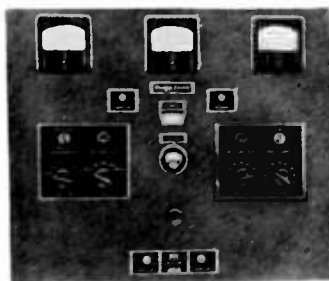

2A PHASE MONITOR makes possible quick, accurate adjustment of directional antenna arrays. Western Electric has a complete line of antenna coupling and phasing equipment.



25B SPEECH INPUT console handles AM and FM programs simultaneously. It's outstanding in performance, moderate in cost, easy to install and opens in an instant for inspection and maintenance.



22D SPEECH INPUT: A compact, lightweight portable speech input system designed to provide complete facilities for remote pickups of every kind.

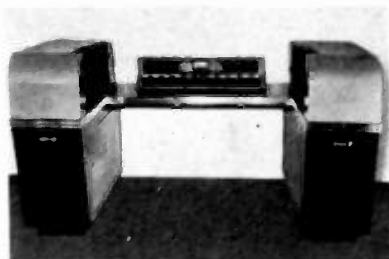

CUSTOM BUILT CONSOLES: Engineered to meet completely the requirements of any station—provide the most flexible method of program control.

RELAY SWITCHING SYSTEM: Solves difficult master control problems. It simplifies all program switching for several lines to the movement of one key.

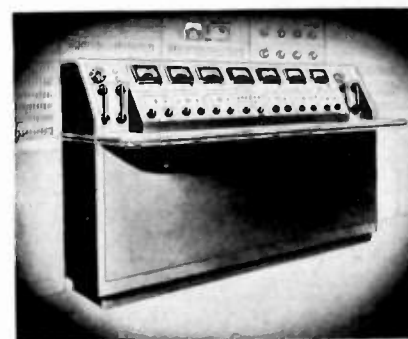

Western Electric



QUALITY COUNTS

BROADCAST EQUIPMENT



MICROPHONES: Two Cardioids—639A with 3 pick-up patterns and 639B with 6 patterns. The 640 Double-A for ultra faithful, non-directional single mike pick-ups in large studios or auditoriums. The 633A Salt Shaker—a rugged, dependable, low-cost mike for studio, remote or P.A. pick-ups.

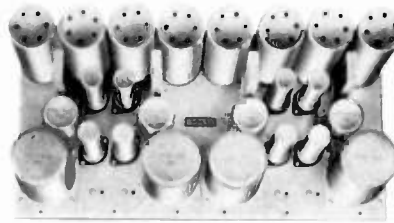

129A AMPLIFIER provides 4 electrically separate channels. Ideal for use in combination pre-mixing or booster circuit applications or can be adapted for "no gain" bridging isolation.

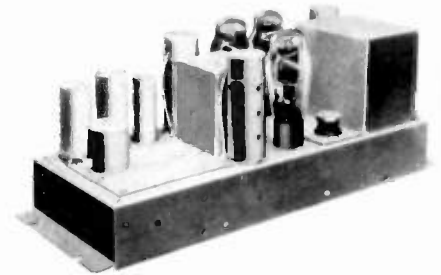

124 TYPE AMPLIFIER for monitor and audition service. Provides up to 20 watts capacity for driving high quality loudspeakers, line or modulator circuits.

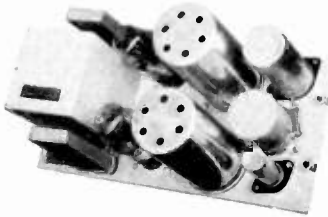

133A AMPLIFIER: A 3-purpose unit for use as a line amplifier, isolation amplifier or for general monitoring. 8 watts power output—low harmonic distortion.

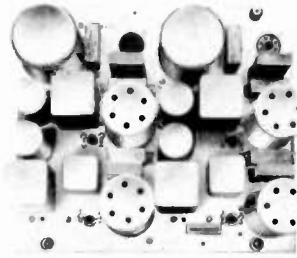

130B AMPLIFIER: Recommended for use in audio systems where it is desirable to feed two programs through a single program production unit simultaneously.

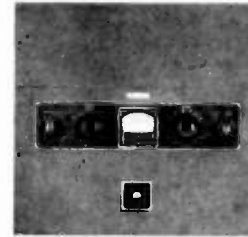

1126C AMPLIFIER: A program-operated level-governing amplifier that limits excessive peaks of modulation, protects against over-modulation and excessive input levels.

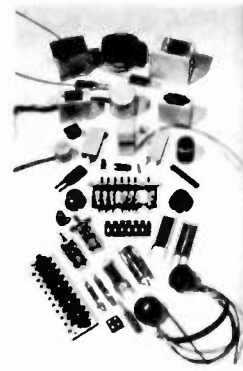

COMPONENTS: A line of transformers, plugs, jacks, cords, switches, knobs, relays, headsets and many other component parts to meet almost every need.



109 TYPE REPRODUCER GROUPS: Two models that play both vertical and lateral transcriptions. 9A Reproducer favors vertical cut—new 9B favors lateral cut.

INDUSTRIAL PRODUCTS For Engineering Control and Laboratory Work



DEPOSITED CARBON RESISTORS: Units of high stability and close tolerance, particularly suited for high frequency applications. Resistance values range from 1 ohm to 50 megohms and nominal power ratings from .15 to 600 watts for free air cooling.



THERMISTORS: a commercial line of thermal resistors with many applications in temperature measuring, control and other electronic circuit applications. Resistance decreases with rising temperature, increases with decreasing temperature.

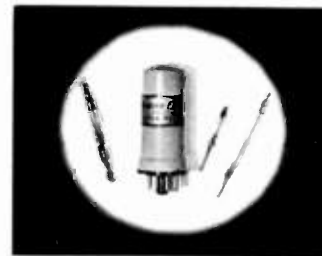

GLASS SEALED SWITCHES AND RELAYS: Suitable for commercial applications where high speed of operation, long life, high current carrying capacity and precisely repetitive operation are required.

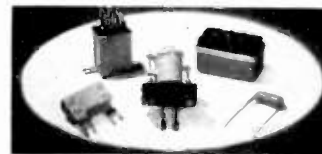

VARISTORS: Oxidized copper varistors and silicon carbide varistors are non-linear voltage sensitive elements suitable for a variety of electronic applications. Small, rugged, long-lived, low in cost.

FREQUENCY STANDARD

The new D-175730 Primary Frequency Standard is a commercial model of the primary standard built for Loran use. It is by far the most precise standard ever made available to laboratories—accurate to better than 1 part in 100,000,000.

Western Electric

PROGRAM DISTRIBUTION For Public Address and Wired Music Systems



WIRED PROGRAM CONSOLE: specially designed heart of wired program systems. Two-speed turntables with 109 Type Reproducer Groups that play both lateral and vertical cut recordings.

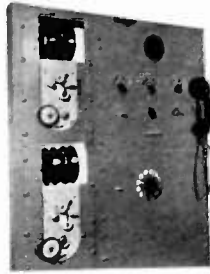

MUSIC DISTRIBUTION SYSTEM for use on trains, ships, planes. Compact control unit provides a choice of radio programs and recorded programs played by as many as four wire reproducers.



124H AMPLIFIER: packaged unit—with own a-c operated power supply for wired music subscribers. Two channels—one microphone channel and one line level input—with selector switch.



124J AMPLIFIER: a single channel line level amplifier for subscribers to wired program services. Self-contained, with own a-c operated power supply.



140A AMPLIFIER: a new three-stage push-pull a-c—d-c amplifier for wired music program service. Power output of 10 watts for a-c operation, 6 watts for d-c operation.

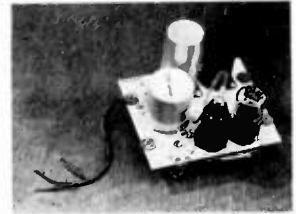

141A AMPLIFIER: a new three-stage pre-amplifier with fixed gain adjustments of 40, 50, 60 or 70 db. Can be mounted at considerable distance from power supply.

12A AMPLIFIER: a self-contained 25 watt power amplifier. When equipped with the 141A, the combination provides ample gain for use with the 109 Type Reproducer groups.

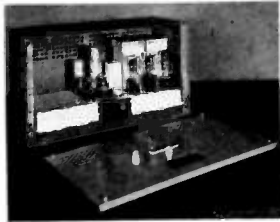

143A AMPLIFIER: similar in design to the 142A, but having a power output of 75 watts.

LOUDSPEAKERS

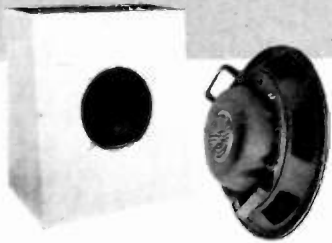

728B LOUDSPEAKER in utility cabinet: a high quality, single-unit speaker with a power handling capacity of 30 watts continuous. Covers the frequency range from 60 to 3,000 cycles, with gradual roll off to 10,000.



755A LOUDSPEAKER: this 8-inch speaker is easy to install in walls or ceilings. Light in weight, low in cost, it provides high quality single-unit reproduction of music.

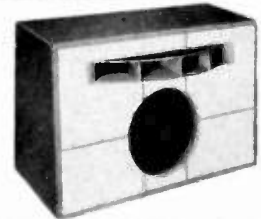

757A LOUDSPEAKER in utility cabinet: a new two-unit speaker for most faithful reproduction. Covers the frequency range from 60 to 15,000 cycles. Has a coverage angle of 90 degrees.

RADIO: for Marine and Vehicular Service

248A MARINE RADIO: a complete two-way radiotelephone equipment with 250 watt transmitter and three receivers. Instant selection of 30 pre-tuned frequencies can be made from remote control unit.



238A AND 239A MOBILE RADIO: for dependable radiotelephone communications between vehicles and any wire telephone in a system. Transmitter and receiver units are small, rugged—operate in 152-162 mc and 30-44 mc bands.



Distributed by
Graybar
OFFICES IN 95 PRINCIPAL CITIES

QUALITY COUNTS

ELECTRON TUBES

MINIATURES

MEDIUM POWER TRANSMITTING

HIGH POWER TRANSMITTING

RECTIFIERS

GENERAL PURPOSE

Western Electric

Distributed by
Graybar
OFFICES IN 95 PRINCIPAL CITIES

**QUALITY
COUNTS**

Get Western Electric's Data Bulletin on electron tubes (T-2258), giving characteristic data on more than 150 tube codes. For more details, consult your local Graybar Representative or write Graybar Electric Co., 420 Lexington Avenue, New York 17, N. Y.

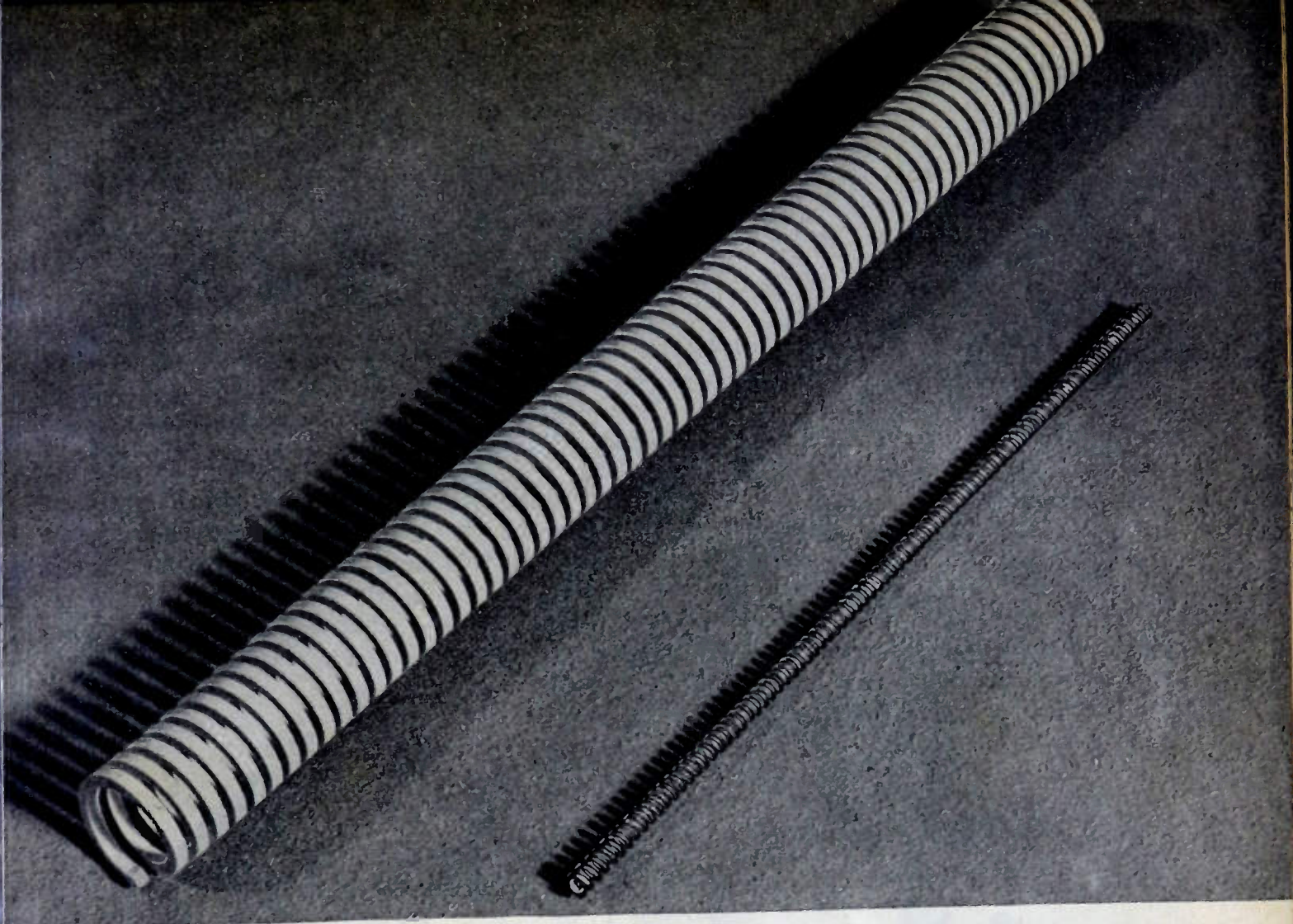

Have you a use for a **STEATITE SPRING?**

Illustrated above are steatite ceramic springs produced by the Research Division of American Lava Corporation. Pitches, lengths, inside and outside diameters can be varied within fairly wide limits. Compression and elongation limits vary only slightly with changes in size. Metallized surfaces can be supplied.

We do not know where this steatite spring may be useful. It is announced so that its availability may be known by research and engineering men in the electronic and electrical fields.

The development of this steatite ceramic spring results from American Lava Corporation's constant search

for better techniques and ceramics and new technical applications. American Lava Corporation was founded on research. Its Research Division has long been acknowledged as being far in the forefront of the industry. No other organization has such resources in trained technical men, research equipment, and facilities. No other organization has ceramic data comparable to that developed at American Lava Corporation in 44 years of constant research. Here, if anywhere, you will find the answer to any problem involving technical ceramics. We like tough problems and are ready to cooperate with you on your technical ceramic problems.

ALSiMAG

AMERICAN LAVA CORPORATION
CHATTANOOGA 5, TENNESSEE
44TH YEAR OF CERAMIC LEADERSHIP

ENGINEERING SERVICE OFFICES: ST. LOUIS, Mo., 1123 Washington Ave., Tel: Garfield 4959 • NEWARK, N. J., 671 Broad St., Tel: Mitchell 2 8159 • CAMBRIDGE, Mass., 38-B Brattle St., Tel: Kirkland 4498 • CHICAGO, 9 S. Clinton St., Tel: Central 1721 • SAN FRANCISCO, 163 Second St., Tel: Douglas 2464 • LOS ANGELES, 324 N. San Pedro St., Tel: Mutual 9076

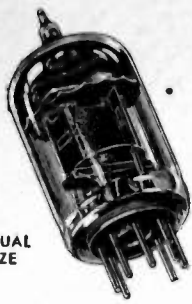

ACTUAL SIZE

... Impromptu Discussions about Miniature Tubes



"No matter how you look at it, Joe, those TUNG-SOL Miniature Tubes are a far better bet than the old larger types. Better service for the user, more compact equipment for the set builder and less storage space for the dealer are obvious advantages, but that is only the beginning.

"TUNG-SOL Miniatures stand up better under shock and vibration. You see they are more rigid . . . built with smaller, lighter parts. Then there is

the glass button base. It not only can't come loose, but it has much better dielectric properties than the old style base.

"Now take high frequency circuits. You know how important they have become. TUNG-SOL Miniatures are doing jobs you couldn't even begin to do with old fashioned tubes. The shorter

leads on the Miniature make for low lead inductance and low inter-element capacities.

"Joe, if you want your equipment to be modern you ought to consider using Miniatures. TUNG-SOL engineers will be glad to help you plan the circuits and select the tubes. You can talk to them in confidence."



TUNG-SOL LAMP WORKS, INC., NEWARK 4, NEW JERSEY
Sales Offices: Atlanta • Chicago • Dallas • Denver • Detroit • Los Angeles • New York
Also Manufacturers of Miniature Incandescent Lamps, All-Glass Sealed Beam Headlight Lamps and Current Intermittors

how **AMPHENOL** eases television's growing pains

A glance at the new Duodecal socket shown below will demonstrate the complete fulfillment of television's demand for a socket of full flexibility and highest quality for the new series Duodecal base television viewing tubes.

This is typical of the pioneering which has established Amphenol leadership in the design and manufacture of TV and FM components.

The activity of Amphenol engineers in the higher frequencies enables them to sense in advance the needs in these fields. The new Duodecal socket is but one of many such Amphenol firsts which include efficient Hi-Q tube sockets, octal angle sockets for cathode-ray and other tubes, Twin Lead parallel transmission line, FM and television receiving antennas, solid dielectric coaxial cables, and special-use cables for television color cameras and for facsimile.

Write for Data Sheets on these new products.

AMERICAN PHENOLIC CORPORATION
CHICAGO 50, ILLINOIS

FEATURES OF THE DUODECAL SOCKET

- Six locations for bringing leads out radially in one bundle assure a neat wiring harness, and minimum space requirement.
- Rear socket cap totally encloses connections, eliminating breakage at solder terminals due to flexing. Electrical shock hazard is minimized.
- An extra opening is provided for bringing high-voltage grid lead out separately when this is desirable.
- Latest wrap-around type cadmium-plated phosphor-bronze contacts provide four lines of contact on each tube pin.
- Cap and body of socket are molded black electrical bakelite.
- Spring-ring assembly eliminates screws and drive pins.



COAXIAL CABLES AND CONNECTORS • INDUSTRIAL CONNECTORS, FITTINGS AND CONDUIT • ANTENNAS • RADIO COMPONENTS • PLASTICS FOR ELECTRONICS

THORDARSON Transformers



For over half a century Thordarson has been manufacturing the finest in transformer equipment. The oldest company in the field, it has pioneered many new developments, including the superior core and coil materials now used throughout its entire line. This vigorous policy of research and development, together with an unusually high standard of production, has made the name Thordarson a guarantee of quality . . . an assurance of trouble-free performance among engineers everywhere.

Thordarson's engineering staff and Thordarson's field men are prepared to assist you with your transformer problems. We are especially equipped to handle those types of transformers which require a high degree of engineering skill and which must be built to very rigid specifications. Send us complete details as to your requirements.

P. S. Deliveries aren't too bad these days, either!

ELECTRONIC DISTRIBUTOR and INDUSTRIAL SALES DEPT.

MAGUIRE INDUSTRIES, INCORPORATED
936 N. MICHIGAN AVENUE CHICAGO 11, ILLINOIS

EXPORT SALES DIVISION • SCHEEL INTERNATIONAL, INCORPORATED
4237-39 N. LINCOLN AVE., CHICAGO 18, ILL. U.S.A. CABLE ADDRESS - HARSHEEL



A-C CAPACITORS

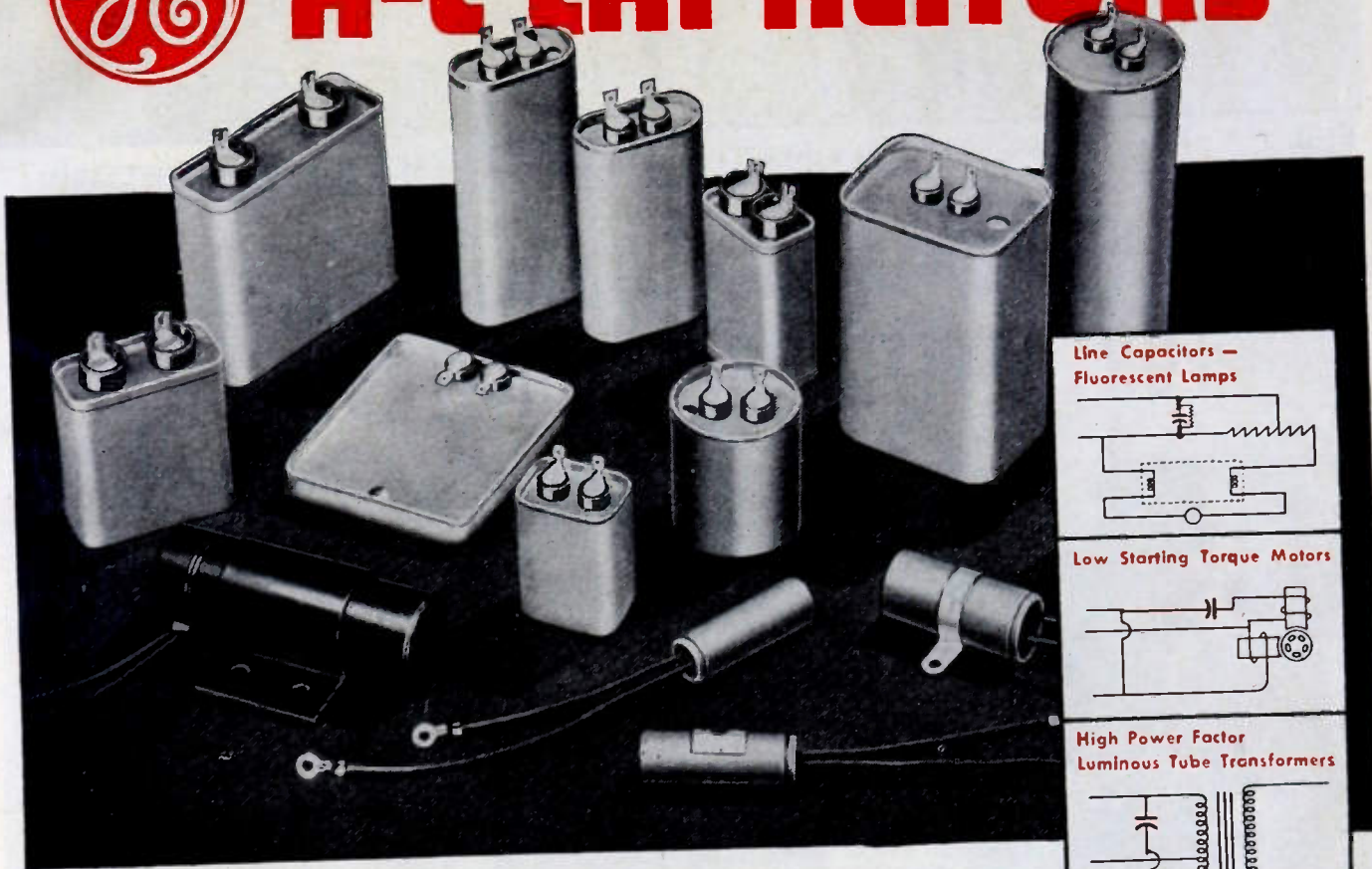

Line Capacitors —
Fluorescent Lamps

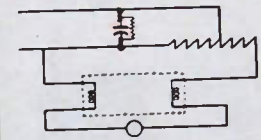

Low Starting Torque Motors

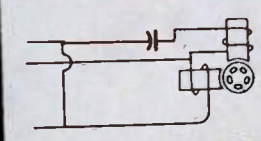

High Power Factor
Luminous Tube Transformers

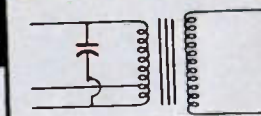

High Starting Torque Motors

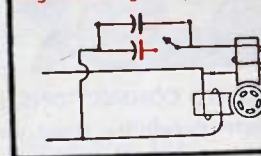

THEIR STRENGTH ADDS "STAYING POWER" TO YOUR PRODUCTS

Capacitors needn't be the weak link in your product—they can have just as much "staying power" as any other component in your equipment.

G-E capacitors have long life. One reason for this is that they are Pyranol* impregnated. Practically all moisture, air, and gas have been withdrawn from the capacitor before the Pyranol treatment takes place. The use of Pyranol also means that these capacitors can operate at high temperatures—up to 75 C (167 F) case temperature. This eliminates one of the main causes of capacitor breakdown.

Casings, available in all standard shapes, are double-rolled, or roll-crimped and soldered, sealing the capacitor hermetically. Plastic bushings, of high dielectric strength, bring out the hot-tin dipped soldered terminals.

If you are building a quality product, here's a quality a-c capacitor that you'll never have to worry about. They're available in a broad range of voltage ratings and capacities. Write for the latest Bulletin GEA-2027C. Apparatus Dept., General Electric, Schenectady 5, N. Y.

*Reg. U. S. Pat. Off.

Why Manufacturers Like G-E Capacitors

1. Their price is right.
2. You can get fast shipments.
3. The range of ratings is broad.
4. Designed for small size and light weight in all ratings.
5. Their quality is unexcelled.

GENERAL ELECTRIC

407-111-6700

SYLVANIA RESEARCH NEWS



FEB. Prepared by SYLVANIA ELECTRIC PRODUCTS INC., Bayside, L. I.

1947

INEXPENSIVE, IMPROVED ALLOY DEVELOPED FOR BETTER TUBE CONSTRUCTION

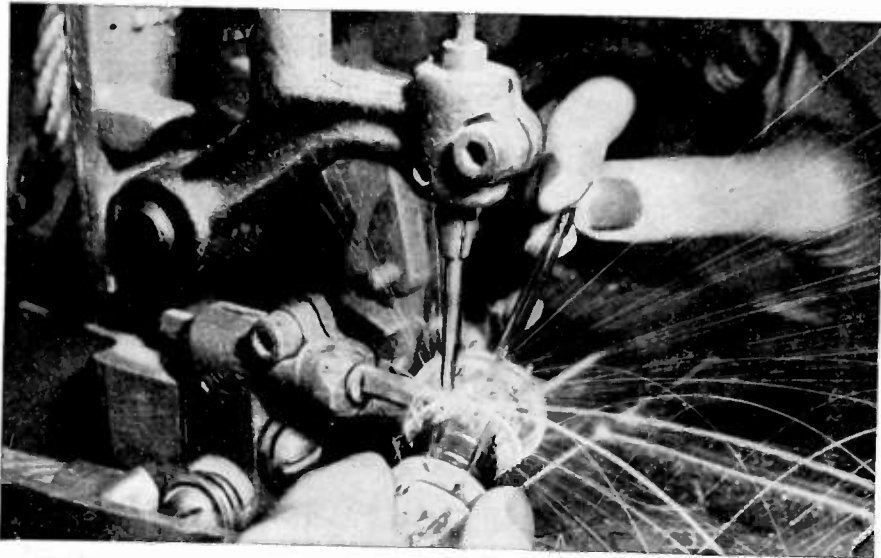

WELDING CONNECTIONS. All connections in the Lock-In Tube are welded for greater durability. Short, direct connections result in fewer joints and lower loss.



GLASS HEADERS. Small cylindrical cups of glass and metal pins are pressed into the low-loss glass base to which is joined the small glass exhaust tubing.

Sylvania's #4 Alloy Integral Part Of Superior Lock-In Tube

A specially developed metal product—#4 alloy—contributes greatly to the superiority of the Sylvania Lock-In Tube. It is inexpensive, an excellent electrical conductor, strong, and, most important of all, has a thermal expansion curve to match the all-glass header into which the #4 alloy element leads are directly brought. These same leads act as the socket pins—and are always in rigid contact with the header under varying heat conditions.

LOCK-IN MOUNT AND GLASS HEADER

IMPROVED MOUNT . . . elements are ruggedly supported on all sides. Meticulous accuracy is required to fit and weld each part to the others to become the finished mount. There are few welded joints and no soldered joints—the elements can't warp or weave.

ALL-GLASS HEADER . . . through which element leads are directly brought—low-loss and better spacing of lead wires. These leads become the sturdy socket pins—effecting a much desired reduction in lead inductance and inter-element capacity.



SYLVANIA ELECTRIC

Emporium, Pa.

MAKERS OF RADIO TUBES, CATHODE RAY TUBES, ELECTRONIC DEVICES, FLUORESCENT LAMPS, FIXTURES, WIRING DEVICES, ELECTRIC LIGHT BULBS



INFORMATION PLEASE!

Radio communication is as vital to the airways as rails are to the railroads. For high performance, dependability, and easy maintenance, WILCOX radio equipment has earned the confidence of airline personnel throughout the world. Solve your communication problems with Wilcox.

Check the Wilcox 2500 Watt 96C Transmitter For:

- 1. PERFORMANCE**—Transmitter units combine with modulator and rectifier to give either simultaneous transmission on a number of frequencies, or the selection of an individual frequency best suited to the immediate communication problem. Complete remote control.
- 2. DEPENDABILITY**—Research, engineering, and testing combined with highest quality materials result in a rugged product capable of sustained operation through all conditions of temperature, humidity, and weather.
- 3. MAINTENANCE**—All controls and components are completely accessible. Plugs and receptacles or clips make every major section readily removable. Fuses, power and telephone line terminals are located on convenient panels.
- 4. SAFETY**—The disconnect switch at base of transmitter cuts off all voltage and grounds components so unit can be serviced without affecting operation of adjacent channels.

*A request on your letterhead will bring
complete information*

Wilcox Electric Company, Inc.
KANSAS CITY, MISSOURI



NATIONAL RADIO PRODUCTS 1947

THE NEW 1947 CATALOGUE

The new National Catalogue describes hundreds of parts designed for amateur use. Many items are new, some are unique. The old favorites are there, proved and improved over the years. New or old, the products in the new National Catalogue will improve your rig.

CATALOG NO. 700

NATIONAL COMPANY, INC.
MALDEN, MASSACHUSETTS, U.S.A.



MAKING TUBES IS EASY...

If **YOU KNOW HOW!**

**AND THEY SAY...
WATCHMAKING
IS FINE WORK!**

A fine watch—delicate Italian lace—these are synonymous with superb craftsmanship. But imagine such hand-to-eye co-ordination at mass production speeds. The mount operator who assembles with a small spot welder the tiny internal parts of your Hytron tubes displays just such craftsmanship. Despite painstaking engineering and intricate machinery, it is finally her accuracy, speed, perseverance, and appreciation of fine tolerances which build Hytron quality. Assembly mistakes once sealed within a tube cannot be corrected.

That is why Hytron is so fussy about selecting and training its mount operators. Each applicant must pass exacting tests for eyesight and for finger and tweezer dexterity. Then begins a long training cycle: two months to master a single constructional step; up to two years to

develop the versatility of the expert mouter.

Every possible aid is given to the Hytron mount operator. Work simplification helps her co-ordinate smoothly and efficiently motions of eyes, hands, and feet. Parts design is simplified; supporting micas serve as templates. Welding is automatically timed. Tight spacing tolerances (.003") and frequent engineering changes prohibit widespread use of jigs and fixtures. Magnification is impracticable, because of width and depth of field. Major effort must always be to train the mouter's keen eyes and nimble fingers to assemble delicate parts to fine tolerances, despite varying materials and machine set-ups.

Yet the Hytron mouter works so effortlessly that it all looks easy. It is easy only because she has the know-how. Next time you pick up a Hytron tube, examine her handiwork.



SPECIALISTS IN RADIO RECEIVING TUBES SINCE 1921

HYTRON

RADIO AND ELECTRONICS CORP.

MAIN OFFICE: SALEM, MASSACHUSETTS



The world's largest plant devoted to the design and production of molded carbon-graphite-powdered metal specialties.

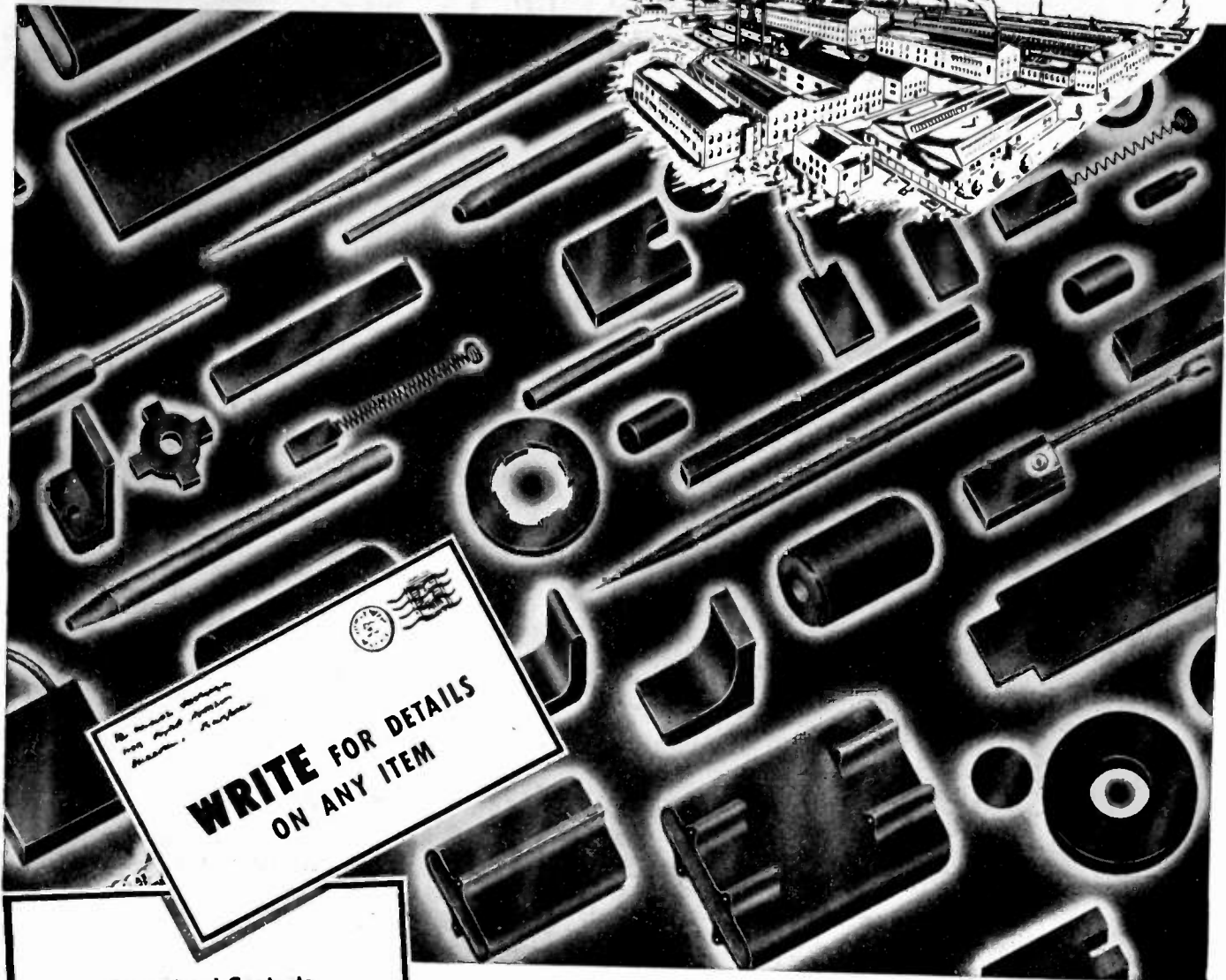

WRITE FOR DETAILS
ON ANY ITEM

Rare Metal Contacts
Brushes and Contacts
(all carbon, graphite, metal
and composition types)
Anodes • Electrodes

Bearings

Welding and Brazing Products

Carbon Pipe

Chemical Carbons

Power Tube Anodes

Sintered Alnico II

Flashlight Battery Carbons

Packing, Piston and Seal Rings

Rheostat Plates and Discs, etc.

Stackpole Electronic Products

Fixed and Variable Resistors

Iron Cores

Switches • Line, Slide,
and Rotary Action

CARBONS, GRAPHITES AND MOLDED METAL COMPOSITIONS



Here you see just a few of thousands of molded carbon, graphite, powdered metal and composition components manufactured by Stackpole. What you *don't* see is the tremendous background of engineering experience that goes into their production. And *that* makes a difference! It eliminates guesswork. It means that each particular product is made to conform EXACTLY to its own specific operating conditions. It means longer, more dependable service.

We can't sell our experience . . . you get that free. Yet it's the most valuable part of every Stackpole product you buy!

STACKPOLE CARBON CO., ST. MARYS, PENNA.

STACKPOLE

four points

TO THINK ABOUT IN CHOOSING INSULATING PAPER

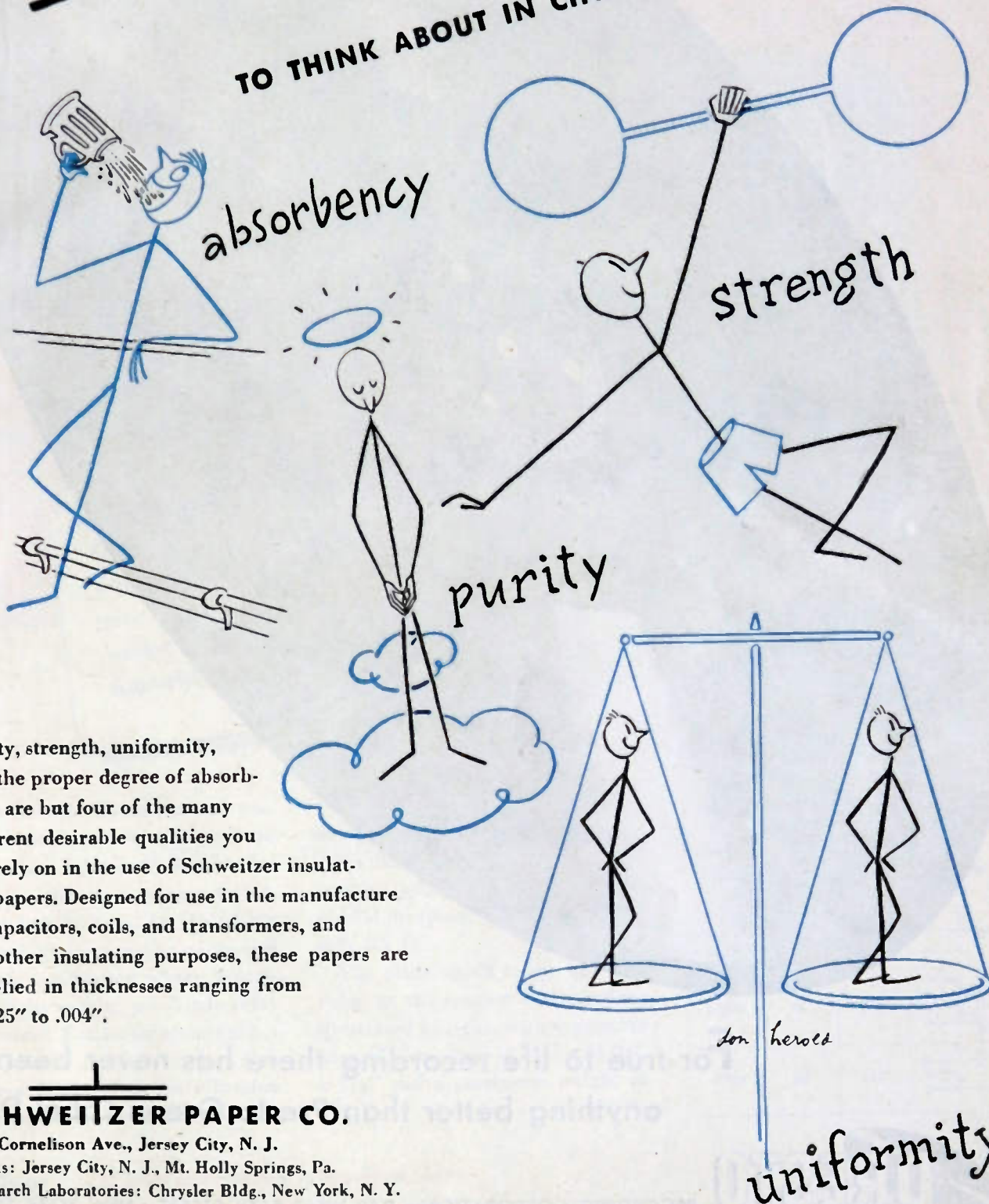

Purity, strength, uniformity, and the proper degree of absorbency are but four of the many inherent desirable qualities you can rely on in the use of Schweitzer insulating papers. Designed for use in the manufacture of capacitors, coils, and transformers, and for other insulating purposes, these papers are supplied in thicknesses ranging from .00025" to .004".

SCHWEITZER PAPER CO.

182 Cornelison Ave., Jersey City, N. J.
Plants: Jersey City, N. J., Mt. Holly Springs, Pa.
Research Laboratories: Chrysler Bldg., New York, N. Y.

SPECIALISTS IN THIN GAUGE INSULATING PAPERS

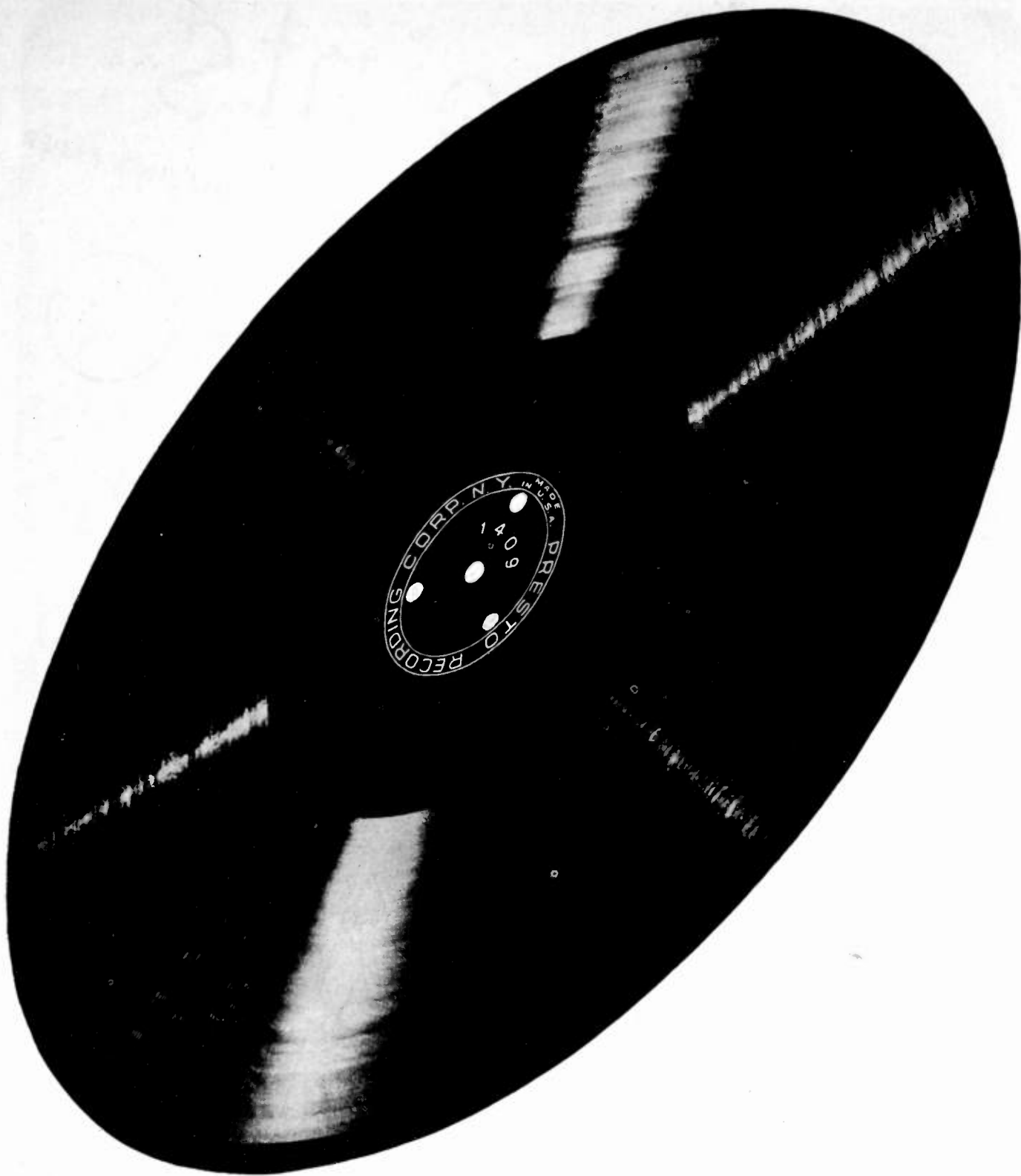

For true to life recording there has never been anything better than Presto Green Label Discs.



RECORDING CORPORATION • 242 WEST 55TH STREET • NEW YORK 19, N. Y.
Walter P. Downs, Ltd., in Canada

World's Largest Manufacturer of Instantaneous Sound Recording Equipment & Discs



miniaturized RELAYS with Steatite Insulation

No. 11638

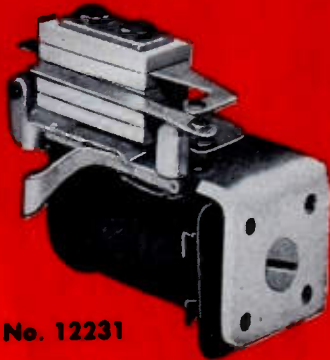
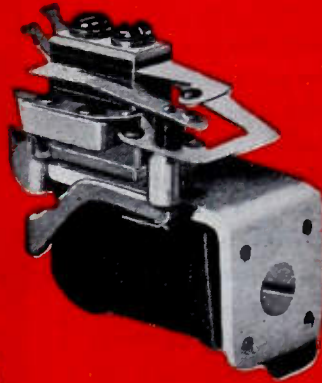

No. 12231

(SHOWN OVERSIZE
FOR CLARITY)

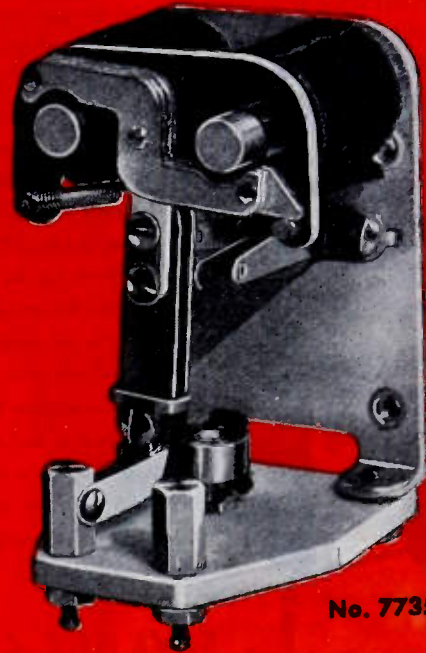

No. 7735

Originally designed for use in aircraft equipment, these **MINIATURE** relays give completely dependable operation under extreme conditions of vibration, humidity and temperature.

See A.R.C. Exhibit, Booths 40-41 A, at I.R.E. Show

The Steatite insulation and general construction of these relays makes them inherently suitable for switching circuits requiring permanently low leakage, for switching certain high frequency circuits, and for any application where a compact, light weight, yet sturdy relay is required. Particular attention has been paid to design of relays that will not "chatter" under vibration even in the un-energized position.

The antenna changeover relay shown is of unique design and provides the wide contact spacing and positive action necessary for this special purpose, for a weight of only 0.2 lb.

The other small relays are provided in the contact combinations illustrated at right, with maximum overall dimensions of $1\frac{1}{4}'' \times 11/16'' \times 1\frac{1}{4}''$ and a maximum weight of 0.07 lb.

A.R.C. NO.	RATED D.C. OPERATING VOLTAGE	D.C. RESISTANCE	CONTACT ARRANGEMENT
11975	14	90	
12232	28	300	
11914	14	90	
12231	28	300	
11638	28	300	
7735	28	112	

For price and delivery information, write

AIRCRAFT RADIO CORPORATION

708 MAIN STREET, BOONTON, NEW JERSEY



DIRECTIONAL ANTENNA EQUIPMENT FOR AM THE NEW "ISO-COUPLER" FOR FM

OTHER BROADCAST PRODUCTS

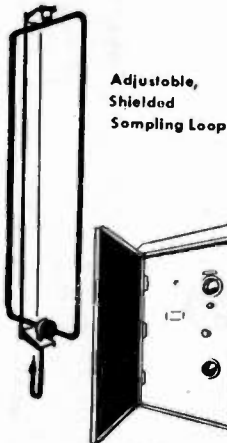

Coupling Unit

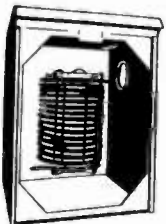

Isolation Filter



Tower Lighting Choke



Open Wire
Transmission
Line Support



JOHNSON

a famous name in Radio

Illustrated is a new phasing unit recently shipped to W G A C, Augusta, Georgia for use with their new 5 KW RCA transmitter. W G A C was the 60th station to choose JOHNSON for their directional system. This impressive total is growing at an accelerated clip—it's based on definite advantages. Your JOHNSON equipment will be more efficient because it is designed especially for your antenna system. Because it is not a "packaged" unit intended to solve everyone's problems there will be no unused components, nor will you have to add a few to meet your particular needs. JOHNSON-built cabinets will match the style and finish of your transmitter. Standardization is employed where it will not impair efficiency. For instance 90% of the major components are of standard design, and manufactured by JOHNSON. This permits an even flow of parts to your assembly job and careful control of their quality by JOHNSON engineers. No name of better reputation can appear on your phasing and antenna coupling units.

SAVE THE COST OF A SEPARATE FM TOWER!

If you are going to add FM to your existing AM facilities, quite likely you've looked at the price of a tower and wondered if the new antenna can go on top of an AM radiator. If the location is suitable and it's structurally possible, the answer is, it can and you'll never turn an easier several thousand dollars your way. The JOHNSON ISO-COUPLER announced in March of 1946 was the first commercial equipment offered to properly handle the two systems on one structure. It's designed for power up to and including 50 KW AM, and 10 KW FM. A heavy, weatherproof cabinet does away with the need of routine cleaning and uncertainties inherent in equipment exposed to the weather.

ONLY THE "ISO-COUPLER" OFFERS ALL OF THESE ADVANTAGES

1. Completely isolates AM and FM—no interaction possible.
2. Can be furnished with correcting network so that installation does not affect adjustment of present antenna coupling or directional equipment.
3. Easy to install and adjust.
4. Adjustments are efficient, broad, stable, and not affected by climatic changes.
5. Adjustments are possible at any time without disturbing coaxial lines.
6. Optimum impedance match possible for any FM frequency for 51.5 ohm line.
7. Standing wave ratio up to 2 caused by antenna can be eliminated between Iso-Coupler and transmitter.
8. Iso-Coupler can be used with any size and length of RMA standard FM line and any type of end terminal.
9. Coaxial line between Iso-Coupler and antenna can be fastened directly to AM tower, eliminating expensive line insulators and replacements.
10. Pressurizing maintenance independent of electrical adjustment.

The first ISO-COUPLER has already given many months of satisfactory service and we're in steady production.

Write to Department W for free Johnson literature today.

E. F. JOHNSON COMPANY

WASECA, MINNESOTA

POWER undistorted

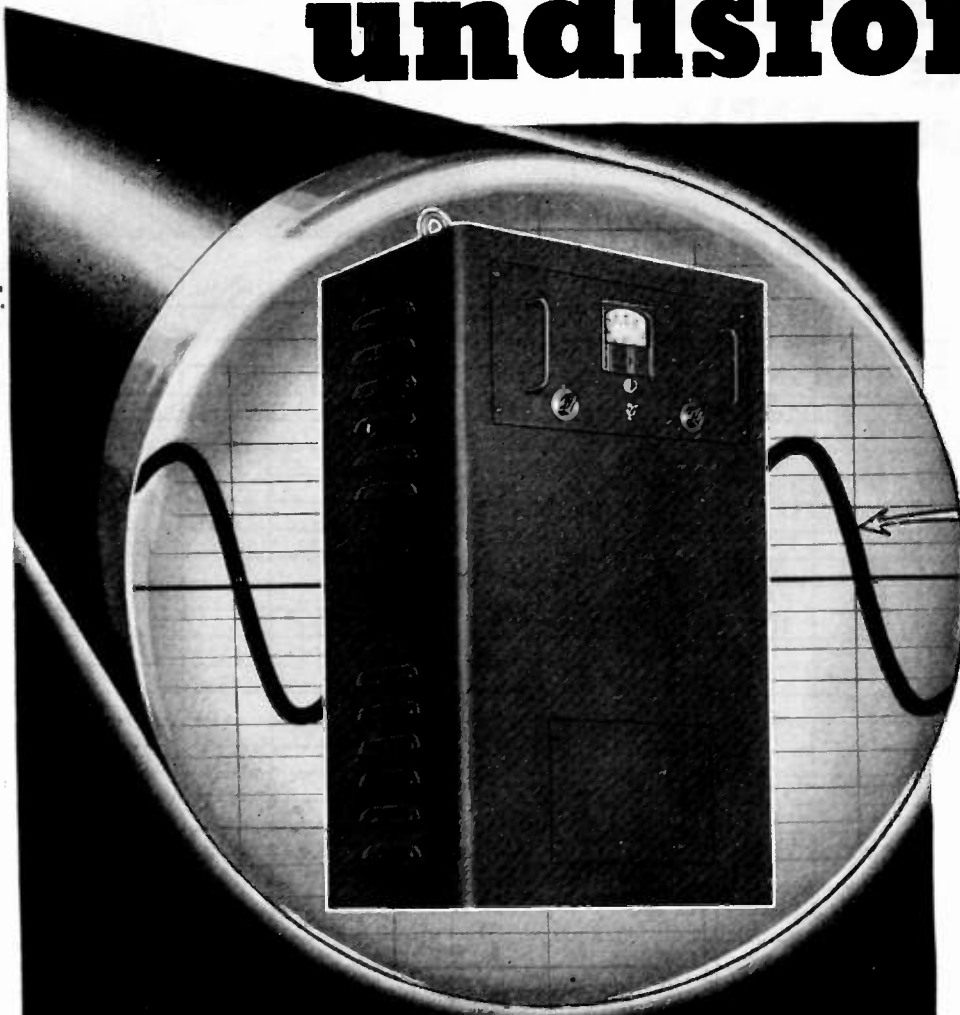

● ZERO WAVEFORM DISTORTION...a characteristic of all SECO Automatic Voltage Regulators... is not the most important but certainly a highly desirable feature in voltage regulating equipment. Please keep in mind —

Seco Automatic Voltage Regulators produce zero waveform distortion

But... zero waveform distortion is just one of the many decided advantages of SECO Automatic Voltage Regulators. A few others are listed and a more comprehensive investigation would reveal such factors as low cost per KVA — easy installation — rugged mechanical construction.

Consider these combined advantages when in need of equipment to maintain CONSTANT VOLTAGE to electrical apparatus.

SECO Automatic Voltage Regulators offer more per dollar value whether the requirement involves 1 or 100 KVA.

SECO AUTOMATIC VOLTAGE REGULATORS . . .

- RAPID CORRECTION OF LINE VOLTAGE VARIATIONS
- NO CRITICAL MECHANICAL ADJUSTMENTS
- DOES NOT AFFECT POWER FACTOR of the SYSTEM
- NOT AFFECTED BY CHANGES in the POWER FACTOR OR MAGNITUDE of the LOAD

Send for Bulletin 150 ER

The Superior  Electric Company

902 LAUREL STREET • BRISTOL, CONNECTICUT, U.S.A.

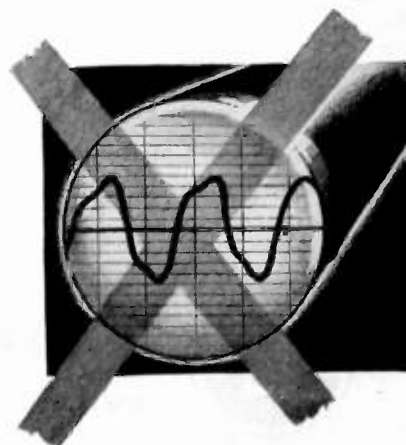

RCA PREFERRED TYPE POWER TUBES

QUICK-REFERENCE POWER-FREQUENCY TABLE



Type No.	Class	Maximum Input Power (Watts) CCS Unmodulated Class C Ratings at:											
		1.6 Mc.	7.5 Mc.	15 Mc.	25 Mc.	50 Mc.	75 Mc.	110 Mc.	150 Mc.	200 Mc.	250 Mc.	300 Mc.	600 Mc.
9C21	Triode	150000	150000	150000	105000								
9C22	Triode	100000	91000	80000	70000								
9C25	Triode	40000	40000	40000	40000	25000	25000	25000					
9C27	Triode	40000	40000	40000	40000	25000	25000	25000					
892	Triode	30000	22500	17000									
892R	Triode	18000	13500	10500									
889-A	Triode	16000	16000	16000	16000	16000	14000	11000	8000				
889R-A	Triode	16000	16000	16000	16000	13500	10000						
8D21*	Tetrode	10000	10000	10000	10000	10000	10000	10000	10000	10000	10000	10000	
7C24	Triode	5000	5000	5000	5000	5000	5000	5000					
833-A	Triode	1800	1800	1800	1750	1500	1200						
6C24	Triode	1500	1500	1500	1500	1500	1500	1500	1500				
4-125A/4021	Tetrode	500	500	500	500	500	500	500	500	425	335		
8000	Triode	500	500	500	500	400	300						
813	Beam Power	360	360	360	360	300							
8005	Triode	240	240	240	240	195							
828	Pentode	200	200	200	200	160	130						
811	Triode	155	155	155	155	155	125						
812	Triode	155	155	155	155	155	125						
826	Triode	125	125	125	125	125	125	125	125	125	125	100	
829-B*	Beam Power	120	120	120	120	120	120	120	120	120	105		
8025-A	Triode	75	75	75	75	75	75	75	75	75	75	75	75
815*	Beam Power	60	60	60	60	60	60	60	55	40			
807	Beam Power	60	60	60	60	60	50	40					
2E24†	Beam Power	40	40	40	40	40	40	40	33				
832-A*	Beam Power	36	36	36	36	36	36	36	36	36	32		
2E26	Beam Power	30	30	30	30	30	30	30	25				
802	Pentode	25	25	25	25	20	16						

*Twin type—input values per tube for push-pull operation.

†Recommended only for highly intermittent applications. Input values are ICAS ratings.

The accompanying table of ratings vs. operating frequency provides the design engineer with a simple and rapid means of choosing the most suitable RCA tubes to meet the power and frequency requirements of equipment in the design stages.

Technical Literature

Detailed data on all the types listed

are provided in the RCA HB-3 TUBE HANDBOOK. Technical bulletins covering tube types in which you are interested will be sent on request.

Application Engineering Service
RCA tube application engineers will be pleased to cooperate with you in adapting these or any other

RCA tube types to your equipment designs. Just write RCA, Commercial Engineering, Section R-52B, Harrison, N.J.

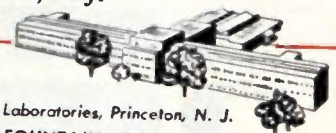

RCA Laboratories, Princeton, N. J.
THE FOUNTAINHEAD OF
MODERN TUBE DEVELOPMENT IS RCA



TUBE DEPARTMENT

RADIO CORPORATION of AMERICA

HARRISON, N. J.

PROCEEDINGS OF THE I.R.E.

(Including the WAVES AND ELECTRONS Section)

Published Monthly by

The Institute of Radio Engineers, Inc.

BOARD OF DIRECTORS, 1947

Walter R. G. Baker
President

Noel Ashbridge
Vice-President

Raymond F. Guy
Treasurer

Haraden Pratt
Secretary

Alfred N. Goldsmith
Editor

William L. Everitt
Senior Past President

Frederick B. Llewellyn
Junior Past President

1945-1947

Stuart L. Bailey
Keith Henney

Benjamin E. Shackelford

1946-1948

Virgil M. Graham
Frederick R. Lack
Donald B. Sinclair

1947-1949

Murray G. Crosby
Raymond A. Heising
William C. White

1947

J. E. Brown
Jack R. Poppele
David Smith

Harold R. Zeamans
General Counsel

George W. Bailey
Executive Secretary

Laurence G. Cumming
Technical Secretary

BOARD OF EDITORS

Alfred N. Goldsmith
Chairman

PAPERS REVIEW COMMITTEE

Murray G. Crosby
Chairman

PAPERS PROCUREMENT COMMITTEE

Dorman D. Israel
General Chairman
Edward T. Dickey
Vice General Chairman

VOLUME 35

February, 1947

NUMBER 2

PROCEEDINGS OF THE I.R.E.

Thomas A. Edison	Donald McNicol	106
Radio's Contribution to International Understanding	David Sarnoff	107
Traveling-Wave Tubes	J. R. Pierce and Lester M. Field	108
Theory of the Beam-Type Traveling-Wave Tube	J. R. Pierce	111
Correction to "Engineering Societies Council"		123
The Traveling-Wave Tube as Amplifier at Microwaves	Rudolf Kompfner	124
Very-High-Frequency and Ultra-High-Frequency Signal Ranges as Limited by Noise and Co-channel Interference	Edward W. Allen, Jr.	128
Discussion	C. M. Jansky, Edwin H. Armstrong, C. W. Carnahan, J. E. Brown, Paul A. deMars, Dale Pollack, and Edward W. Allen, Jr.	136
Field Intensities Beyond Line of Sight at 45.5 and 91 Megacycles		152
Directional Couplers	C. W. Carnahan, Nathan W. Aram, and Edward F. Classen, Jr.	160
Transition Time and Pass Band	W. W. Mumford	166
Discussion on "Some Considerations Concerning the Internal Impedance of the Cathode Follower," by Harold Goldberg	C. C. Eaglesfield	166
Correspondence:		
"Electrical Circuit Analysis Applied to Servo Problems"	Jack Avins, V. R. Briggs, and Harold Goldberg	168
"Matching Conditions in a Stub-Tuned Transmission Line"	W. G. Hoyle	169
Contributors to the PROCEEDINGS of the I.R.E.	Philip Parzen	170

INSTITUTE NEWS AND RADIO NOTES

SECTION

1947 National Convention		172
Summaries of Technical Papers		173
Committee Meetings		184
Rochester Fall Meeting		185
I.R.E. People		186
Sections		188
Books:		
"Communication Through the Ages," by Alfred Still	Reviewed by Donald McNicol	188
"Radio Tube Vade-Mecum," by P. H. Brans	Reviewed by R. S. Burnap	188
"Two-Way Radio," by Samuel Freedman	Reviewed by Ralph R. Batcher	189
"Radar—What It Is," by John F. Rider and G. C. Baxter Rowe	Reviewed by Robert M. Page	190
"Electrical Engineering," by Fred H. Pumphrey	Reviewed by Frederick W. Grover	190
"Personality and English in Technical Personnel," by Philip B. McDonald	Reviewed by Donald McNicol	190

WAVES AND ELECTRONS

SECTION

Theodore A. Hunter, Chairman, Cedar Rapids Section, 1946-1947		193
A National Research and Standardizing Laboratory		194
Radar Development in Canada	Frederick H. Sanders	195
Design of Communication Receivers for the Naval Service with Particular Consideration to the Very-High-Frequency and Ultra-High-Frequency Ranges	Thomas McL. Davis, and Emerick Toth	201
An Automatic-Slideback Peak Voltmeter for Measuring Pulses		208
An Attenuator of "S"-Band Energy	Cyrus J. Creveling and Leonard Mautner	211
Some Notes on the Copper-Oxide Rectifier and the Thermionic Tube in the Voltage-Doubling Circuit	Harry R. Meahl	213
Contributors to WAVES AND ELECTRONS Section	Ronald R. Gilmour	217
Abstracts and References		219
Section Meetings	36A Positions Open	50A
Membership	40A Positions Wanted	56A
Advertising Index	82A	

EDITORIAL DEPARTMENT

Alfred N. Goldsmith
Editor

Helen M. Stote
Publications Manager

Clinton B. DeSoto
Technical Editor

Mary L. Potter
Assistant Editor

William C. Copp
Advertising Manager

Lillian Petranek
Assistant Advertising Manager

Responsibility for the contents of papers published in the PROCEEDINGS OF THE I.R.E. rests upon the authors. Statements made in papers are not binding on the Institute or its members.

Changes of address (with advance notice of fifteen days) and communications regarding subscriptions and payments should be mailed to the Secretary of the Institute, at 450 Ahaip St., Menasha, Wisconsin, or 1 East 79 Street, New York 21, N. Y. All rights of republication, including translation into foreign languages, are reserved by the Institute. Abstracts of papers, with mention of their source, may be printed. Requests for republication privileges should be addressed to The Institute of Radio Engineers.



Traveling-Wave Tubes*

J. R. PIERCE†, SENIOR MEMBER, I.R.E., AND LESTER M. FIELD†

Summary—Very-broad-band amplification can be achieved by use of a traveling-wave type of circuit rather than the resonant circuit commonly employed in amplifiers. An amplifier has been built in which an electron beam traveling with about 1/13 the speed of light is shot through a helical transmission line with about the same velocity of propagation. Amplification was obtained over a bandwidth 800 megacycles between 3-decibel points. The gain was 23 decibels at a center-band frequency of 3600 megacycles.

INTRODUCTION

THE CHIEF limitation on bandwidth in amplifiers arises through the use of lumped capacitances. In attaining a reasonably high impedance, these are "resonated" with lumped or distributed inductances. The resonant circuit so obtained has a limited bandwidth.

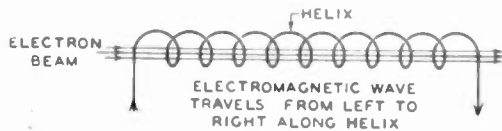

Fig. 1—Portion of the traveling-wave amplifier pertaining to electronic interaction with radio-frequency fields and radio-frequency gain.

The use of electron interaction along distributed or "wave" circuits in connection with vacuum tubes has been proposed in various patents,¹⁻⁷ and in several

instances as a means for obtaining wider bands. Sometimes interaction along lumped or "filter" types⁷ of wave circuits has been described; in other cases coaxial² and helical circuits^{2,3,5} and bent or coiled wave guides^{3,6}

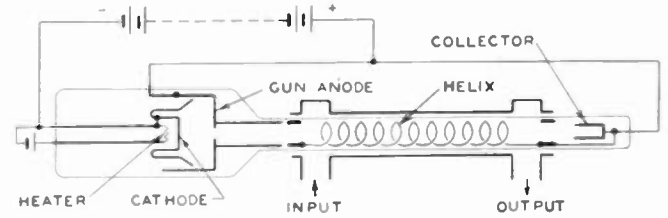

Fig. 2—Schematic of the traveling-wave amplifier tube.

were suggested. These suggestions involved the interaction of the electrons with the field at a number of nodes (in the filter type of circuit) or over a considerable distance (in the distributed circuit) so as to make up for the comparatively low impedance of the terminated wave circuit.

Recently, at the Bell Telephone Laboratories, considerable gains have been attained over an astonishingly wide band (around 800 megacycles) with a new and very simple kind of centimeter-range traveling-wave tube.⁸ The circuit of this tube consists of a fairly



Fig. 3—The traveling-wave amplifier tube.

* Decimal classification: R339.2. Original manuscript received by the Institute, July 31, 1946; revised manuscript received, December 2, 1946.

† Bell Telephone Laboratories, New York, 14, N. Y.

¹ A. V. Haeff, U. S. Patent No. 2,064,469.

² R. K. Potter, U. S. Patent, No. 2,122,538.

³ F. B. Llewellyn, U. S. Patent Nos. 2,367,295 and 2,096,460.

⁴ A. G. Clavier and Ernest Rostas, U. S. Patent No. 2,289,756.

⁵ W. Van Roberts, U. S. Patent No. 2,168,782.

⁶ Nils E. Lindenblad, U. S. Patent No. 2,300,052.

⁷ Standard Telephones and Cables, British Patents 508,354 and 533,613.

tightly wound helix down which an electromagnetic wave travels. An electron beam is shot through the helix

⁸ Early work on this general type of traveling-wave tube was done by R. Kompfner and others at the Clarendon Laboratory, Oxford, England, during the war. A description of this work was given by J. Hatton at the Fourth I.R.E. Electron Tube Conference at Yale, June 27-28, 1946. Since the preparation of this paper, a paper by Kompfner has appeared, "The travelling wave valve," *Wireless World*, vol. 52, no. 11, pp. 369-372; November, 1946.

parallel to its axis and in the direction of propagation of the wave. The circuit and beam are shown schematically in Fig. 1. It is found that, when the electron velocity is about the same as the wave velocity in the absence of the electrons, turning the electron beam on causes a power gain for wave propagation in the direction of electron motion.

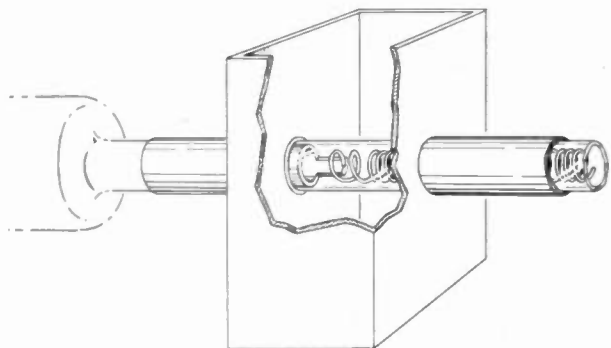

Fig. 4—Coupling between helix and wave guide.

Fig. 2 shows schematically the important parts and their arrangement in a typical traveling-wave tube. An electron beam is produced by means of the cathode and anode electrodes to the left of the tube. The beam is shot through the helix and the electrons are collected on a collector electrode at the right end of the tube. The helix itself is held about 1600 volts positive with respect to the cathode. At 1600 volts the electron gun gives a current of around 10 milliamperes; with proper focusing a substantial portion of this reaches the collector.

electron flow, a wave travels down it with about one-thirteenth the speed of light.

The ends of the helix are attached to short, straight conducting stubs parallel to the axis of the tube and close to the glass wall. These stubs in turn project from short metal collars which fit nicely in the glass envelope. The stubs attached to the input and output ends of the helix are made to project into the input and output wave guides parallel to the electric field, as shown in Fig. 4. By this means a good match between the wave guides and the helix is obtained over a considerable frequency range. The tube is shown with its circuit in Fig. 5. Input and output wave-guide feeds are connected to the short wave-guide sections through which the tube passes, by means of the flanges shown.

In operation, magnetic-focusing coils may be helpful in getting the current to the collector. A small coil forming a short lens near the gun end and a solenoid extending the length of the helix may be useful.

The following operating conditions and performance are typical for a tube such as that shown in Fig. 5:

Beam voltage	1670 volts
Cathode current	8 milliamperes
Collector current	6 milliamperes
Gain at 3600 megacycles	23 decibels
Bandwidth between 3 decibels	800 megacycles
Power output	200 milliwatts
Transmission loss with beam off	33 decibels

The astonishing and valuable feature of the tube is, of course, its extremely wide band. The gain is quite high. The efficiency is rather low, but the power output is of a magnitude useful for continuous-wave work.

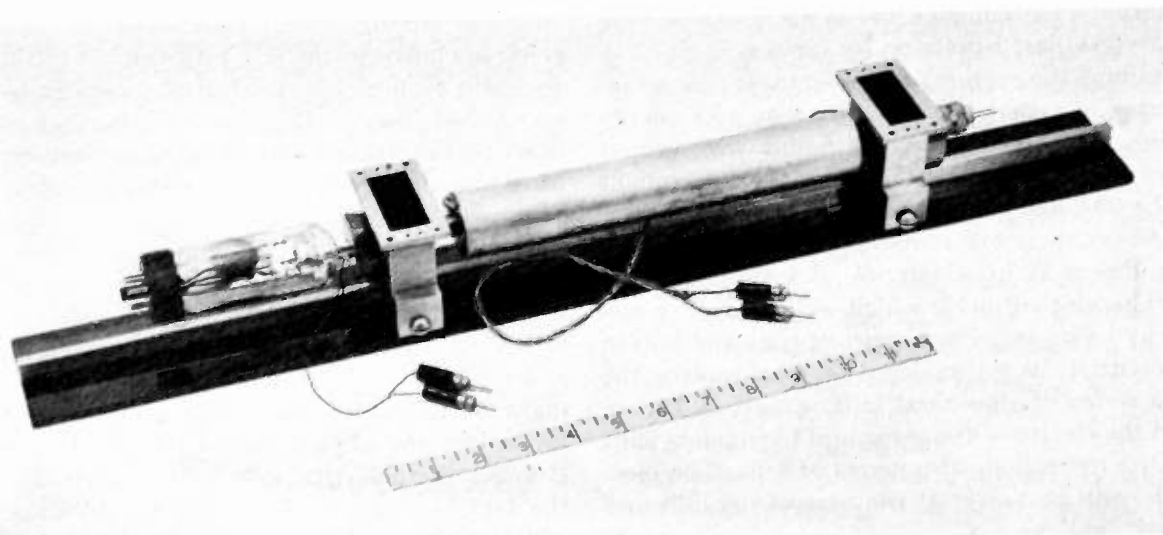

Fig. 5—Traveling-wave amplifier tube and associated circuit.

A photograph of such a tube is shown in Fig. 3. The gun assembly is visible through the glass at the bulbous end. The helix can be seen through the glass; it is held centered by four ceramic rods, which can also be seen. In the particular tube shown the helix is about 11 inches long; it is wound of such a pitch that, in the absence of

TRAVELING-WAVE ACTION

The nature of the gain is considered in detail in a companion paper.⁹ It may be explained, however, in simple terms. The helix, in the absence of the electron

⁹ J. R. Pierce, "Theory of the beam-type traveling-wave tube," *Proc. I.R.E.*, pp. 111-123, this issue.

stream, supports the propagation of a wave with an axial electric field. Such a wave may travel in either direction. It is found that in the presence of the electron stream the wave traveling against the electron motion is little affected, but the wave traveling in the direction of electron motion is broken up into three components. For a lossless helix, one of these forward waves is attenuated, one is unattenuated, and a third increases in amplitude as it travels, or has negative attenuation. On the average, the electrons travel a little faster than the increasing wave travels. The situation

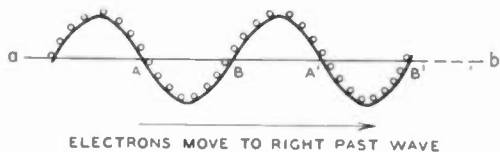

Fig. 6—Diagram explaining electron interaction in the traveling-wave tube.

reminds one of a breeze blowing past ripples in a stream; the ripples grow larger as the breeze blows them along. In the course of its traveling the input signal produces a wave on the helix and consequent ripples or "bunches" in the electron stream. These are made to increase, or are amplified, as the electron stream moves past the mixed wave of electromagnetic field and charge density, and interacts so as to reinforce this wave.

In speaking of "bunches" in the electron stream and in using the term "bunching," it should be remembered that the "bunches" are part of a wave phenomenon. The electrons forming a given bunch are continually changing, for the electrons travel faster than the wave and flow through the bunches just as water in a moving stream may flow past ripples on its surface.

It we examine the motion of the electrons past an increasing wave, we can easily see why they give energy to the wave. Suppose we move with the wave propagated down the helix, so that the crests and the troughs appear to be stationary. As the electrons go a little faster than the wave, they will move slowly past us to the right (the direction in which we and the wave are moving). The electric field, which we observe as stationary, may be regarded as a series of rises and falls in electric potential; as an analogy we may replace the wave by a series of sinusoidal hills, shown in Fig. 6, and regard the electrons as a stream of frictionless balls rolling to the right along this series of hills. The electrons (balls) will go slowly at the tops of the hills and swiftly in the valleys.

Now, imagine for a moment that the wave was not increasing as it traveled along the tube. Then, as we traveled with it, the heights of the hills and the depths of the valleys would not change with time. Suppose we consider motions of electrons between various mean points of the wave lying along the center line $a-b$ of Fig. 6. In leaving A and falling down into a valley, an electron gains just as much speed as it loses in rolling

up to B , which is on the same level as A . Thus, electrons at B travel with the same speed as electrons at A . Similarly, an electron in going up from B loses just as much speed as it gains again in falling down to A' , and thus the electron stream has the same speed at A' as at B .

Suppose, as is actually the case, that the wave increases as it travels. We, traveling with it, merely see it growing larger with time. Now, an electron falling down from A falls down a small slope, but goes up a steeper slope in reaching B , for all the slopes have increased between the time the electron leaves A and the time it reaches B . Thus, the electrons at B move *slower* than the electrons at A . Similarly, an electron going away from B climbs less of a hill than it falls down in going to A' . Thus, electrons are going *faster* at A' than at B . We see that, when the wave is increasing, the electrons go *slow* on the *up* slopes and *fast* on the *down* slopes. Where the electrons go slow, they are nearer together; where they go fast, they are further apart. Thus, the electrons are *bunched* on the *up* slopes. If we now stand still with respect to the wave, we see that these bunches are really moving rapidly in the opposing field regions of the helix, and the energy they give up serves to make the field grow as it travels along.

We have already seen that, for a wave of constant amplitude, the electrons have the same speed at A , B , and A' , but they go slow at the crests of the wave and fast in the valleys. The bunches so produced do no work against the field; they do, however, serve to change the speed of the wave, and a careful analysis shows that they make the wave go faster than the electrons. In this case our picture should have been one in which the electrons move to the left with respect to the wave. If we again assume that the electrons move faster than the wave, and also assume that the wave decreases, we find that the electrons are bunched on the *down* slopes so as to absorb energy from the wave, and give rise to an *attenuated* wave.

Our simple explanation conforms to the picture of three possible forward waves, one increasing, one unattenuated, and one attenuated, which more trustworthy analysis indicates. It also enables us to arrive at some general ideas concerning the behavior of traveling-wave tubes. We are willing at once to believe that, for a given energy traveling down the circuit, the stronger the field that acts on the electrons, the more the bunching, the more energy the bunches give up, and the greater the gain. It is found that as the frequency is increased the wave tends to cling close to the helix, and the electric intensity near the axis, where the electrons are, falls off. For this reason, we expect the gain to fall off when the frequency is increased sufficiently.

On the other hand, the gain is in the form of a negative attenuation of so many decibels per wavelength. At very low frequencies the helix will be only a few

and so we expect the gain to be low at low frequencies. We thus deduce a broad band with respect to frequency, and that is confirmed by the following asymptotic analysis gives the following asymptotic for power gain of high-gain tubes with

$$G = \frac{1}{3} \exp(2\pi\sqrt{3} CN)$$

$$C = \left(\frac{E_0^2}{(u_0/c)^2 P} \frac{I_0}{SV_0} \right)^{1/2}$$

length of helix in cycles, E_0 is the electric field strength for a power P flowing in the helix, I_0 and V_0 are the current and voltage, and v is waves per cycle.

are the direct beam current and voltage. The factor 1/9 occurs because the three forward waves are excited with equal amplitudes by the voltage applied to the helix, each constituting one-third of the applied voltage. Thus, the increasing wave starts out with one-third the voltage of the input wave, but soon grows in amplitude far beyond the unattenuated wave, the attenuated wave, and the input itself. The gain is not greatly affected by moderate loss in the helix.

ACKNOWLEDGMENT

The writers wish to acknowledge the important contributions of F. H. Best in the mechanical design and construction. W. W. Mumford has made valuable circuit contributions in the development of the tube.

Theory of the Beam-Type Traveling-Wave Tube*

J. R. PIERCE, SENIOR MEMBER, I.R.E.

A small-signal theory of the beam traveling-wave tube is presented. The equations predict three forward waves, one attenuated, and one backward wave excited by the electron stream. The waves are partly longitudinal and partly transverse. The wave propagation coefficients on voltage, current, and other properties of the transmission mode which are cut off. The cut-off transmission modes is given. Expressed in terms of the geometry and an estimate of power, the field in a transmission system due to impressed current (as in an electron stream) is given. The propagation constant and the field for the fastest mode of a helical transmission system

Γ_n = propagation constant for the n th pair of modes of the transmission system. Unforced forward waves vary as $\exp(-\Gamma_n z)$, unforced backward wave as $\exp(\Gamma_n z)$

Γ_0 = propagation constant of only mode not cut off.
 $\Gamma_0 = j\beta + jk + \alpha$

δ = an incremental propagation constant. For forward waves, $-\Gamma = -j\beta + \delta$. For backward waves, $\Gamma = j\beta - \delta$

ϵ = dielectric constant of vacuum (8.85×10^{-12} farads per meter)

η = charge-to-mass ratio of the electron e/m (1.759×10^{11} coulomb per kilogram)

ρ = first-order alternating-current linear charge density

ρ_0 = direct-current linear charge density in beam

ψ_n = twice the power in the n th mode when the longitudinal field at the position of the beam has a peak value of unity

ω = radian frequency

a = radius of beam

A = negative of loss incurred initially in establishing the increasing wave in the beam

A_1, A_2 = constants of integration of an electromagnetic field. (Section 6.2)

b = a parameter proportional to the difference between the direct-current beam velocity and the velocity of the zero-mode wave of the transmission system

B = a factor related to the increase of the increasing wave per wavelength

c = the velocity of light (3×10^8 meters per second)

GLOSSARY OF SYMBOLS

International System of Units are used. Symbols listed below. $I_0, \bar{K}_0, I_1, \bar{K}_1$ are Bessel functions as used by Schelkunoff. Γ = propagation constant of the transmission system (zero mode). In the absence of electrons, the amplitude of a forward wave varies as $\exp(-\alpha z)$, where α is a constant related to the direct-current linear charge density ρ_0 and beam velocity u_0 . $\beta = \omega/u_0$. Γ_0 = propagation constant of the zero mode. Reduction factor. (Section 5.5 only) Γ_n = propagation constant. Wave quantities vary with distance as $\exp(-\Gamma z)$

Classification: R339, XR132. Original manuscript received, July 31, 1946; revised manuscript received, August 1, 1946. Presented, New Haven Electron Tube Conference, Connecticut, June 27, 1946. General Electric Research Laboratories, New York 14, N. Y. Schelkunoff, "Electromagnetic waves," (chapter III), McGraw-Hill Book Company, Inc., New York, N. Y., 1943.

- C = gain parameter
 d = a parameter proportional to the attenuation constant of the transmission system (0 mode)
 E = electric field acting on the beam in the direction of propagation (the z direction)
 E_0 = value of E at the input ($z=0$)
 E_L = value of E at the output ($z=L$)
 E_z = a computed field identified with a part of E in Section 6.2
 F = noise figure
 G = gain in decibels
 h = a parameter proportional to the difference between the direct-current beam velocity and the natural velocity of the zero mode of the transmission system
 H = radio-frequency magnetomotive force
 $II(\gamma a)$ = a parameter related to cut-off modes
 I_0 = direct-current beam current, a positive quantity
 k = Boltzman's constant (1.37×10^{-23} joule per degree)
 L = length of transmission system
 m_1 = an admittance expressing the effect of all cut-off modes
 M = electron modulation coefficient or gap factor at input end of transmission system
 N = number of radio-frequency cycles taken by an electron to traverse the transmission system in the absence of signal ($N = \beta L / 2\pi$)
 P_n = complex power carried by the n th transmission mode
 P = power carried by the 0 mode
 P_t = thermal noise power
 q = first-order alternating electron convection current
 $\overline{q_n^2}$ = mean-squared effective noise current
 Q = parameter used in evaluating effect of cut-off modes
 r = radius vector in cylindrical co-ordinates
 R = loss in decibels of transmission system in absence of electrons
 T = absolute temperature, degrees Kelvin. (Section 5.5)
 \hat{T}, T = field distribution coefficients of the electromagnetic field. (Section 6.) T_1 applies inside current sheet and T_2 outside current sheet
 u_0 = direct-current beam velocity
 v = first-order alternating-current velocity
 V_0 = voltage specifying direct-current beam speed ($u_0 = \sqrt{2\eta V_0}$)
 δV_0 = a small charge in V_0
 x = a parameter giving real part of δ and hence proportional to gain per wavelength
 y = a parameter proportional to the imaginary part of δ and hence to the difference between the phase velocity and the direct-current electron velocity
 z = co-ordinate in the direction of propagation and of electron flow.

INTRODUCTION

IN THE beam type of traveling-wave tube, which is described in more detail in a companion paper,² an electron beam is shot along a circuit capable of propagating a slow electromagnetic wave with an electric field in the direction of electron motion. The wave has about the speed of the electrons in the beam. It is found that a wave traveling in the direction of electron flow grows with distance along the circuit; thus, when the end of the circuit near the electron source is fed from a generator and the far end of the circuit is connected to a load, the circuit and the electron stream together constitute an amplifier.

This paper presents an analysis in which the operation of the traveling-wave tube is described in terms of several possible combined space-charge and circuit waves. The propagation of the individual waves can be treated relatively simply, and the effects of varying electron speed, circuit attenuation, and space charge can be evaluated.³

In attempting to develop a wave analysis of the traveling-wave tube, a number of courses might be followed. For instance, assuming some simple circuit configuration, a direct attack along the lines followed by Hahn⁴ and Ramo^{5,6} is not out of the question. The approximations necessary in a solution of this kind would be the neglect of thermal velocities and of the discrete nature of the electron flow (which have little bearing on anything except noise and focusing problems in tubes with beam voltages above 1000), neglect of direct-current space charge (the direct-current space charge is presumed to be neutralized by positive ions) and linearizing approximations (certainly valid for very small signals). All of these approximations seem reasonable.

Were we to carry out such an electron-wave analysis of a tube with some particular type of circuit, we would find it difficult to get an explicit solution predicting the over-all performance. Hahn and Ramo encountered this difficulty in treating a system with fewer parameters. It is probable that approximations would have to be made in using the solution to predict changes in performance as various parameters were changed. Further, it is likely that the important and physically distinguishable parameters would be so enmeshed in a maze of mathematics as to obscure their significance.

Rather than attacking a particular case in this fashion, the writer has chosen to formulate the problem in more general terms. In this manner certain

² J. R. Pierce and L. M. Field, "Traveling-wave tubes," *Proc. I.R.E.*, pp. 108-111, this issue.

³ This analysis leads to the same results as that presented by J. Hatton at the Fourth I.R.E. Electron Tube Conference at Yale University, June 27, 1946. The analysis here presented covers effects not treated by Hatton.

⁴ W. C. Hahn, "Small signal theory of velocity-modulated electron beams," *Gen. El. Rev.*, vol. 42, pp. 258-270; June, 1939.

⁵ Simon Ramo "Space charge and field waves in an electron beam," *Phys. Rev.*, vol. 56, pp. 276-283; August, 1939.

⁶ Simon Ramo, "The electron-wave theory of velocity-modulation tubes," *Proc. I.R.E.*, vol. 27, pp. 757-763; December, 1939.

typical properties of traveling-wave amplifiers can be worked out. The weakness of this approach is that it does not provide a means for evaluating all of the parameters in a special practical case. The effect of various parameters of simple physical significance is, however, apparent, and this is a help in making and in evaluating the effect of some rather drastic approximations which appear to be necessary in simplifying the theory to a reasonable degree.

1. INITIAL ASSUMPTIONS

The analysis which is presented here is a small-signal analysis, in which cross products of alternating-current quantities are neglected. When these cross products are neglected, the electronic equations as well as the circuit relations become linear and the solutions of the equations will vary in the z direction (the direction of wave propagation) as $\exp(j\omega t - \Gamma z)$.

We will discuss cases in which either (a) the electron beam encounters negligible transverse fields or (b) the electron beam is constrained so that significant transverse electron motion is impossible. We can easily think of systems in which the conditions are approximated reasonably well. A thin (but not infinitely thin)⁷ beam of electrons down the center of a circuit producing an axially symmetrical field will nearly satisfy (a), and with a strong enough axial magnetic field (b) can be realized. We will further initially limit our discussion to beams in which the axial electric field can be assumed to be the same over the cross section of the beam. This can be nearly realized in the case of a thin central beam in an axially symmetrical system or a hollow cylindrical beam of larger diameter in an axially symmetrical system.

These assumptions of no transverse motion and of constant axial field throughout the beam mean that we have to deal with a one-dimensional problem. This considerably simplifies both the circuit and the electronic problems. The circuit problem is that of finding in general terms the field acting on the beam in terms of the driving current supplied by the beam. The electronic problem is that of finding the current in the beam in terms of the field acting on the beam. Combining the solutions of the two problems, we will obtain the over-all behavior of the device.

In the following attack on the circuit and electronic problems we will be guided by a good deal of hindsight in choosing significant parameters. This hindsight also enables us to choose a wave type of solution which, as it satisfies the equations involved and provides enough arbitrary constants to satisfy all boundary conditions, must be the unique solution.

2. CIRCUIT THEORY

In attacking the circuit problem, we express the total

field acting on the beam as a sum of the fields due to a number of transmission modes. These modes occur in pairs which, in the absence of impressed current, propagate in opposite directions as $\exp(j\omega t \mp \Gamma_n z)$. If the field due to an impressed alternating correction current q in the z direction can be expanded in terms of such a series of normal modes, the expansion converging, the z component of field, E , which acts along a line parallel to the direction of propagation, may be expressed⁸

$$E = q \sum_n \frac{\Gamma_n}{\psi_n^*(\Gamma^2 - \Gamma_n^2)} \quad (1)$$

We assume throughout that all alternating-current quantities vary as $\exp(j\omega t - \Gamma z)$. In (1) the excitation of pairs of modes has been added. ψ_n is a constant referring to either of the n th pair of modes. The power flow P_n for a field of intensity E is related to ψ by

$$\psi_n = \frac{2P_n}{EE^*} \quad (2)$$

We shall find ourselves concerned with systems in which there is only one pair of modes with slightly attenuated propagation, which we shall call the zero modes, with parameters $\pm\Gamma_0$ and ψ_0 , while all of the other modes are "cut off" and do not propagate. For these higher modes, Γ_n is almost wholly real and ψ_n almost wholly imaginary. Further, we shall find ourselves concerned with values of Γ nearly equal to Γ_0 . The small variations encountered in Γ will profoundly alter the excitation of the propagating mode, for the quantity $\Gamma^2 - \Gamma_n^2$ appears in the denominator of the expression for the excitation of this mode, but these small fluctuations will affect the excitation of the other nonpropagating modes very little indeed. Thus, we will not be much in error if we regard the summation

$$\sum_n \frac{\Gamma_n}{\psi_n^*(\Gamma^2 - \Gamma_n^2)}$$

over all modes except the zero mode as a constant. If

$$-\Gamma = -j\beta + \delta \quad (3)$$

where β is real and $|\delta| \ll \beta$, then this constant will be very nearly a pure imaginary, as ψ_n is very nearly a pure imaginary. With this justification we will write, excluding both zero modes,

$$\sum_n \frac{\Gamma_n}{\psi_n^*(\Gamma^2 - \Gamma_n^2)} = \frac{j}{m_1\beta} \quad (4)$$

Here β has been inserted to give m_1 the dimensions of

⁸ Expression (1) was given to the writer by S. A. Schelkunoff of these Laboratories with no guarantees as to its range of applicability or convergence. A rationalization of it in terms of more familiar concepts will be found in Appendix A.

⁷ An infinitely thin beam would result in an infinite effect due to cut-off modes (see Section 6.1).

stream, supports the propagation of a wave with an axial electric field. Such a wave may travel in either direction. It is found that in the presence of the electron stream the wave traveling against the electron motion is little affected, but the wave traveling in the direction of electron motion is broken up into three components. For a lossless helix, one of these forward waves is attenuated, one is unattenuated, and a third increases in amplitude as it travels, or has negative attenuation. On the average, the electrons travel a little faster than the increasing wave travels. The situation

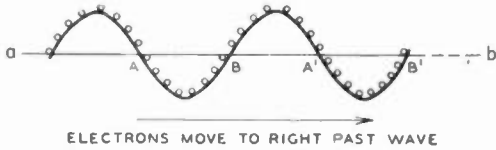

Fig. 6—Diagram explaining electron interaction in the traveling-wave tube.

reminds one of a breeze blowing past ripples in a stream; the ripples grow larger as the breeze blows them along. In the course of its traveling the input signal produces a wave on the helix and consequent ripples or "bunches" in the electron stream. These are made to increase, or are amplified, as the electron stream moves past the mixed wave of electromagnetic field and charge density, and interacts so as to reinforce this wave.

In speaking of "bunches" in the electron stream and in using the term "bunching," it should be remembered that the "bunches" are part of a wave phenomenon. The electrons forming a given bunch are continually changing, for the electrons travel faster than the wave and flow through the bunches just as water in a moving stream may flow past ripples on its surface.

If we examine the motion of the electrons past an increasing wave, we can easily see why they give energy to the wave. Suppose we move with the wave propagated down the helix, so that the crests and the troughs appear to be stationary. As the electrons go a little faster than the wave, they will move slowly past us to the right (the direction in which we and the wave are moving). The electric field, which we observe as stationary, may be regarded as a series of rises and falls in electric potential; as an analogy we may replace the wave by a series of sinusoidal hills, shown in Fig. 6, and regard the electrons as a stream of frictionless balls rolling to the right along this series of hills. The electrons (balls) will go slowly at the tops of the hills and swiftly in the valleys.

Now, imagine for a moment that the wave was not increasing as it traveled along the tube. Then, as we traveled with it, the heights of the hills and the depths of the valleys would not change with time. Suppose we consider motions of electrons between various mean points of the wave lying along the center line $a-b$ of Fig. 6. In leaving A and falling down into a valley, an electron gains just as much speed as it loses in rolling

up to B , which is on the same level as A . Thus, electrons at B travel with the same speed as electrons at A . Similarly, an electron in going up from B loses just as much speed as it gains again in falling down to A' , and thus the electron stream has the same speed at A' as at B .

Suppose, as is actually the case, that the wave increases as it travels. We, traveling with it, merely see it growing larger with time. Now, an electron falling down from A falls down a small slope, but goes up a steeper slope in reaching B , for all the slopes have increased between the time the electron leaves A and the time it reaches B . Thus, the electrons at B move *slower* than the electrons at A . Similarly, an electron going away from B climbs less of a hill than it falls down in going to A' . Thus, electrons are going *faster* at A' than at B . We see that, when the wave is increasing, the electrons go *slow* on the *up* slopes and *fast* on the *down* slopes. Where the electrons go slow, they are nearer together; where they go fast, they are further apart. Thus, the electrons are *bunched* on the *up* slopes. If we now stand still with respect to the wave, we see that these bunches are really moving rapidly in the opposing field regions of the helix, and the energy they give up serves to make the field grow as it travels along.

We have already seen that, for a wave of constant amplitude, the electrons have the same speed at A , B , and A' , but they go slow at the crests of the wave and fast in the valleys. The bunches so produced do no work against the field; they do, however, serve to change the speed of the wave, and a careful analysis shows that they make the wave go faster than the electrons. In this case our picture should have been one in which the electrons move to the left with respect to the wave. If we again assume that the electrons move faster than the wave, and also assume that the wave decreases, we find that the electrons are bunched on the *down* slopes so as to absorb energy from the wave, and give rise to an *attenuated* wave.

Our simple explanation conforms to the picture of three possible forward waves, one increasing, one unattenuated, and one attenuated, which more trustworthy analysis indicates. It also enables us to arrive at some general ideas concerning the behavior of traveling-wave tubes. We are willing at once to believe that, for a given energy traveling down the circuit, the stronger the field that acts on the electrons, the more the bunching, the more energy the bunches give up, and the greater the gain. It is found that as the frequency is increased the wave tends to cling close to the helix, and the electric intensity near the axis, where the electrons are, falls off. For this reason, we expect the gain to fall off when the frequency is increased sufficiently.

On the other hand, the gain is in the form of a negative attenuation of so many decibels per wavelength. At very low frequencies the helix will be only a few

wavelengths long and so we expect the gain to be low at sufficiently low frequencies. We thus deduce a broad gain maximum with respect to frequency, and that is what is found.

A careful analysis gives the following asymptotic expression valid for power gain of high-gain tubes with low-loss circuits:

$$G = \frac{1}{3} \exp(2\pi\sqrt{3}CN) \quad (1)$$

$$C = \left(\frac{E_s^2}{(\omega/v)^2 P} \frac{I_0}{8V_0} \right)^{1/2} \quad (2)$$

Here N is the length of the helix in cycles. E_s is the peak axial field strength for a power P flowing in the helix, ω is radian frequency, and v is waves peed. I_0 and V_0

are the direct beam current and voltage. The factor $1/9$ occurs because the three forward waves are excited with equal amplitudes by the voltage applied to the helix, each constituting one-third of the applied voltage. Thus, the increasing wave starts out with one-third the voltage of the input wave, but soon grows in amplitude far beyond the unattenuated wave, the attenuated wave, and the input itself. The gain is not greatly affected by moderate loss in the helix.

ACKNOWLEDGMENT

The writers wish to acknowledge the important contributions of F. H. Best in the mechanical design and construction. W. W. Mumford has made valuable circuit contributions in the development of the tube.

Theory of the Beam-Type Traveling-Wave Tube*

J. R. PIERCE†, SENIOR MEMBER, I.R.E.

Summary—The small-signal theory of the beam traveling-wave tube has been worked out. The equations predict three forward waves, one increasing and two attenuated, and one backward wave which is little affected by the electron stream. The waves are partly electromagnetic and partly disturbance in the electron stream. The dependence of the wave propagation coefficients on voltage, current, circuit loss, and the other properties of the transmission mode which propagates energy and the cut-off transmission modes is given. Expressions for gain and noise figure and an estimate of power output are given. Appendix A gives an expression for the field in a uniform transmission system due to impressed current (as, of an electron stream) in terms of the parameters of the transmission modes. Appendix B calculates the propagation constant and the field for unit power flow for the gravest mode of a helical transmission system.

GLOSSARY OF SYMBOLS

Meter-kilogram-second units are used.

Besides the symbols listed below, I_0 , K_0 , I_1 , K_1 are modified Bessel functions as used by Schelkunoff.¹

α = attenuation constant of the transmission system (zero mode). In the absence of electrons, the field of a forward wave varies as $\exp(-\alpha z)$

β = a phase constant related to the direct-current electron beam velocity u_0 . $\beta = \omega/u_0$

γ = a radial propagation constant

γ^2 = noise-reduction factor. (Section 5.5 only)

Γ = propagation constant. Wave quantities vary with distance as $\exp(-\Gamma z)$

Γ_n = propagation constant for the n th pair of modes of the transmission system. Unforced forward waves vary as $\exp(-\Gamma_n z)$, unforced backward wave as $\exp(\Gamma_n z)$

Γ_0 = propagation constant of only mode not cut off.

$$\Gamma_0 = j\beta + jh + \alpha$$

δ = an incremental propagation constant. For forward waves, $-\Gamma = -j\beta + \delta$. For backward waves, $\Gamma = j\beta - \delta$

ϵ = dielectric constant of vacuum (8.85×10^{-12} farads per meter)

η = charge-to-mass ratio of the electron e/m (1.759×10^{11} coulomb per kilogram)

ρ = first-order alternating-current linear charge density

ρ_0 = direct-current linear charge density in beam

ψ_n = twice the power in the n th mode when the longitudinal field at the position of the beam has a peak value of unity

ω = radian frequency

a = radius of beam

A = negative of loss incurred initially in establishing the increasing wave in the beam

A_1, A_2 = constants of integration of an electromagnetic field. (Section 6.2)

b = a parameter proportional to the difference between the direct-current beam velocity and the velocity of the zero-mode wave of the transmission system

B = a factor related to the increase of the increasing wave per wavelength

c = the velocity of light (3×10^8 meters per second)

* Decimal classification: R339.2×R132. Original manuscript received by the Institute, July 31, 1946; revised manuscript received, December 2, 1946. Presented, New Haven Electron Tube Conference, New Haven, Connecticut, June 27, 1946.

† Bell Telephone Laboratories, New York 14, N. Y.

¹ S. A. Schelkunoff, "Electromagnetic waves," (chapter III), D. Van Nostrand Company, Inc., New York, N. Y., 1943.

- C = gain parameter
 d = a parameter proportional to the attenuation constant of the transmission system (0 mode)
 E = electric field acting on the beam in the direction of propagation (the z direction)
 E_0 = value of E at the input ($z=0$)
 E_L = value of E at the output ($z=L$)
 E_z = a computed field identified with a part of E in Section 6.2
 F = noise figure
 G = gain in decibels
 h = a parameter proportional to the difference between the direct-current beam velocity and the natural velocity of the zero mode of the transmission system
 H = radio-frequency magnetomotive force
 $H(\gamma a)$ = a parameter related to cut-off modes
 I_0 = direct-current beam current, a positive quantity
 k = Boltzman's constant (1.37×10^{-23} joule per degree)
 L = length of transmission system
 m_1 = an admittance expressing the effect of all cut-off modes
 M = electron modulation coefficient or gap factor at input end of transmission system
 N = number of radio-frequency cycles taken by an electron to traverse the transmission system in the absence of signal ($N = \beta L / 2\pi$)
 P_n = complex power carried by the n th transmission mode
 P = power carried by the 0 mode
 P_t = thermal noise power
 q = first-order alternating electron convection current
 $\overline{q_n^2}$ = mean-squared effective noise current
 Q = parameter used in evaluating effect of cut-off modes
 r = radius vector in cylindrical co-ordinates
 R = loss in decibels of transmission system in absence of electrons
 T = absolute temperature, degrees Kelvin. (Section 5.5)
 \hat{T} , T = field distribution coefficients of the electromagnetic field. (Section 6.) T_1 applies inside current sheet and T_2 outside current sheet
 u_0 = direct-current beam velocity
 v = first-order alternating-current velocity
 V_0 = voltage specifying direct-current beam speed ($u_0 = \sqrt{2\eta V_0}$)
 δV_0 = a small charge in V_0
 x = a parameter giving real part of δ and hence proportional to gain per wavelength
 y = a parameter proportional to the imaginary part of δ and hence to the difference between the phase velocity and the direct-current electron velocity
 z = co-ordinate in the direction of propagation and of electron flow.

INTRODUCTION

IN THE beam type of traveling-wave tube, which is described in more detail in a companion paper,² an electron beam is shot along a circuit capable of propagating a slow electromagnetic wave with an electric field in the direction of electron motion. The wave has about the speed of the electrons in the beam. It is found that a wave traveling in the direction of electron flow grows with distance along the circuit; thus, when the end of the circuit near the electron source is fed from a generator and the far end of the circuit is connected to a load, the circuit and the electron stream together constitute an amplifier.

This paper presents an analysis in which the operation of the traveling-wave tube is described in terms of several possible combined space-charge and circuit waves. The propagation of the individual waves can be treated relatively simply, and the effects of varying electron speed, circuit attenuation, and space charge can be evaluated.³

In attempting to develop a wave analysis of the traveling-wave tube, a number of courses might be followed. For instance, assuming some simple circuit configuration, a direct attack along the lines followed by Hahn⁴ and Ramo^{5,6} is not out of the question. The approximations necessary in a solution of this kind would be the neglect of thermal velocities and of the discrete nature of the electron flow (which have little bearing on anything except noise and focusing problems in tubes with beam voltages above 1000), neglect of direct-current space charge (the direct-current space charge is presumed to be neutralized by positive ions) and linearizing approximations (certainly valid for very small signals). All of these approximations seem reasonable.

Were we to carry out such an electron-wave analysis of a tube with some particular type of circuit, we would find it difficult to get an explicit solution predicting the over-all performance. Hahn and Ramo encountered this difficulty in treating a system with fewer parameters. It is probable that approximations would have to be made in using the solution to predict changes in performance as various parameters were changed. Further, it is likely that the important and physically distinguishable parameters would be so enmeshed in a maze of mathematics as to obscure their significance.

Rather than attacking a particular case in this fashion, the writer has chosen to formulate the problem in more general terms. In this manner certain

² J. R. Pierce and L. M. Field, "Traveling-wave tubes," *Proc. I.R.E.*, pp. 108-111, this issue.

³ This analysis leads to the same results as that presented by J. Hatton at the Fourth I.R.E. Electron Tube Conference at Yale University, June 27, 1946. The analysis here presented covers effects not treated by Hatton.

⁴ W. C. Hahn, "Small signal theory of velocity-modulated electron beams," *Gen. El. Rev.*, vol. 42, pp. 258-270; June, 1939.

⁵ Simon Ramo "Space charge and field waves in an electron beam," *Phys. Rev.*, vol. 56, pp. 276-283; August, 1939.

⁶ Simon Ramo, "The electron-wave theory of velocity-modulation tubes," *Proc. I.R.E.*, vol. 27, pp. 757-763; December, 1939.

typical properties of traveling-wave amplifiers can be worked out. The weakness of this approach is that it does not provide a means for evaluating all of the parameters in a special practical case. The effect of various parameters of simple physical significance is, however, apparent, and this is a help in making and in evaluating the effect of some rather drastic approximations which appear to be necessary in simplifying the theory to a reasonable degree.

1. INITIAL ASSUMPTIONS

The analysis which is presented here is a small-signal analysis, in which cross products of alternating-current quantities are neglected. When these cross products are neglected, the electronic equations as well as the circuit relations become linear and the solutions of the equations will vary in the z direction (the direction of wave propagation) as $\exp(j\omega t - \Gamma z)$.

We will discuss cases in which either (a) the electron beam encounters negligible transverse fields or (b) the electron beam is constrained so that significant transverse electron motion is impossible. We can easily think of systems in which the conditions are approximated reasonably well. A thin (but not infinitely thin)⁷ beam of electrons down the center of a circuit producing an axially symmetrical field will nearly satisfy (a), and with a strong enough axial magnetic field (b) can be realized. We will further initially limit our discussion to beams in which the axial electric field can be assumed to be the same over the cross section of the beam. This can be nearly realized in the case of a thin central beam in an axially symmetrical system or a hollow cylindrical beam of larger diameter in an axially symmetrical system.

These assumptions of no transverse motion and of constant axial field throughout the beam mean that we have to deal with a one-dimensional problem. This considerably simplifies both the circuit and the electronic problems. The circuit problem is that of finding in general terms the field acting on the beam in terms of the driving current supplied by the beam. The electronic problem is that of finding the current in the beam in terms of the field acting on the beam. Combining the solutions of the two problems, we will obtain the over-all behavior of the device.

In the following attack on the circuit and electronic problems we will be guided by a good deal of hindsight in choosing significant parameters. This hindsight also enables us to choose a wave type of solution which, as it satisfies the equations involved and provides enough arbitrary constants to satisfy all boundary conditions, must be the unique solution.

2. CIRCUIT THEORY

In attacking the circuit problem, we express the total

field acting on the beam as a sum of the fields due to a number of transmission modes. These modes occur in pairs which, in the absence of impressed current, propagate in opposite directions as $\exp(j\omega t \mp \Gamma_n z)$. If the field due to an impressed alternating correction current q in the z direction can be expanded in terms of such a series of normal modes, the expansion converging, the z component of field, E , which acts along a line parallel to the direction of propagation, may be expressed⁸

$$E = q \sum_n \frac{\Gamma_n}{\psi_n^*(\Gamma^2 - \Gamma_n^2)} \quad (1)$$

We assume throughout that all alternating-current quantities vary as $\exp(j\omega t - \Gamma z)$. In (1) the excitation of pairs of modes has been added. ψ_n is a constant referring to either of the n th pair of modes. The power flow P_n for a field of intensity E is related to ψ by

$$\psi_n = \frac{2P_n}{EE^*} \quad (2)$$

We shall find ourselves concerned with systems in which there is only one pair of modes with slightly attenuated propagation, which we shall call the zero modes, with parameters $\pm \Gamma_0$ and ψ_0 , while all of the other modes are "cut off" and do not propagate. For these higher modes, Γ_n is almost wholly real and ψ_n almost wholly imaginary. Further, we shall find ourselves concerned with values of Γ nearly equal to Γ_0 . The small variations encountered in Γ will profoundly alter the excitation of the propagating mode, for the quantity $\Gamma^2 - \Gamma_n^2$ appears in the denominator of the expression for the excitation of this mode, but these small fluctuations will affect the excitation of the other nonpropagating modes very little indeed. Thus, we will not be much in error if we regard the summation

$$\sum_n \frac{\Gamma_n}{\psi_n^*(\Gamma^2 - \Gamma_n^2)}$$

over all modes except the zero mode as a constant. If

$$-\Gamma = -j\beta + \delta \quad (3)$$

where β is real and $|\delta| \ll \beta$, then this constant will be very nearly a pure imaginary, as ψ_n is very nearly a pure imaginary. With this justification we will write, excluding both zero modes,

$$\sum_n \frac{\Gamma_n}{\psi_n^*(\Gamma^2 - \Gamma_n^2)} = \frac{j}{m_1\beta} \quad (4)$$

Here β has been inserted to give m_1 the dimensions of

⁷ An infinitely thin beam would result in an infinite effect due to cut-off modes (see Section 6.1).

⁸ Expression (1) was given to the writer by S. A. Schelkunoff of these Laboratories with no guarantees as to its range of applicability or convergence. A rationalization of it in terms of more familiar concepts will be found in Appendix A.

admittance. m_1 will be regarded as a constant. We can now write⁹ we obtain

$$E = q \left[\frac{\Gamma_0}{\psi_0^*(\Gamma^2 - \Gamma_0^2)} + \frac{j}{m_1\beta} \right]. \quad (5)$$

3. ELECTRONIC THEORY

Let the variation of all quantities in the z direction be as $\exp -\Gamma z$. Let

$$\beta = \omega/u_0 \quad (6)$$

where u_0 is the average velocity and ω is the radian frequency. Then, from the force equation, for motion in the z direction,

$$dv/dt = (\partial v/\partial z)u_0 + \partial v/\partial t = -\eta E$$

$$v = \frac{-\eta E/u_0}{(-\Gamma + j\beta)}. \quad (7)$$

Here η is the charge-to-mass ratio of the electron. As transverse motion has been assumed negligible, there can be no force in the z direction due to magnetic fields.

Let q be the alternating convection current in the electron stream, ρ_0 be the direct-current linear charge density and ρ be the alternating-current linear charge density. Then, from the conservation of charge,

$$\begin{aligned} \partial q/\partial z &= -\partial \rho/\partial t \\ -\Gamma q &= -j\omega \rho. \end{aligned} \quad (8)$$

The first-order convection current is

$$q = \rho u_0 + v \rho_0.$$

Thus

$$\rho = (q - v \rho_0)/u_0. \quad (9)$$

The direct-current linear charge density ρ_0 can be expressed in terms of the current I_0 as

$$\rho_0 = -I_0/u_0. \quad (10)$$

Thus

$$\rho = q/u_0 + v I_0/u_0^2 \quad (11)$$

and from (6) and (8)

$$q = \frac{-j\omega(I_0/u_0^2)v}{(-\Gamma + j\beta)}. \quad (12) \quad \text{Now}$$

Combining (12) and (7), we obtain

$$q = \frac{j\omega\eta I_0 E}{u_0^3(-\Gamma + j\beta)^2}.$$

By expressing u_0 in terms of V_0 , the accelerating voltage which gives the electrons their velocity

$$u_0^2 = 2\eta V_0, \quad (13)$$

$$q = \frac{j\beta I_0 E}{2V_0(-\Gamma + j\beta)^2}. \quad (14)$$

4. COMBINED EFFECTS

In (5) we have, subject to certain assumptions, an expression giving the effect of the beam current in producing the field E . In (14) we have the effect of the field in producing the beam current. Combining these, we obtain

$$1 = \left[\frac{\Gamma_0}{\psi_0^*(\Gamma^2 - \Gamma_0^2)} + \frac{j}{m_1\beta} \right] \frac{j\beta I_0}{2V_0(-\Gamma + j\beta)^2}. \quad (15)$$

4.1 Neglect of Cutoff Modes

If I_0/V_0 is very small, the only way that the right-hand side of the equation can be made equal to unity is for Γ^2 to be nearly equal to Γ_0^2 or for Γ to be nearly equal to $j\beta$. As a matter of fact, we will find that, for the useful range of operating conditions, both of these conditions are true. Thus, we can neglect the term including m_1 which expresses the effect of the cutoff modes for very small currents I_0 . The larger m_1 is, the larger are the currents for which the term involving m_1 can be neglected. In neglecting the term involving m_1 we neglect the part of the field which is not associated with low-attenuation propagation of energy down the circuit but is due rather to local concentration of charge. Finally, if we wish to estimate the size of m_1 we may consider some simple configuration closely analogous to the actual device and in which the overall field can be evaluated. Then we can see how much of the field is *not* due to the zero mode, and so estimate the quantity we have regarded as due to a series of other modes. This is done in Section 6.1.

Neglecting the term involving m_1 , we obtain

$$\Gamma^2 - \Gamma_0^2 = \frac{j2\beta^3\Gamma_0 C^3}{(-\Gamma + j\beta)^2} \quad (16)$$

$$C^3 = \frac{I_0}{\psi_0^*\beta^2 4V_0}. \quad (17)$$

$$\frac{1}{\beta^2\psi_0^*} = \frac{EE^*}{2\beta^2 P_0^*}. \quad (18)$$

Hence, C^3 is

$$C^3 = \left(\frac{EE^*}{\beta^2 P_0^*} \right) \left(\frac{I_0}{8V_0} \right). \quad (19)$$

For low attenuations P_0 is nearly real, and hence C is nearly real. The writer believes that no serious error will be made by assuming C to be a real quantity, and *this assumption will be made henceforward*. If the expressions we obtain which contain C are examined, it will

⁹ If one desires, he may think of (5) as representing a transmission line capacitively coupled to the electron stream. This is an exact equivalence.

be found that very small changes in the phase of C will not have important practical consequences.¹⁰

5. LONGITUDINAL-FIELD SOLUTION NEGLECTING CUTOFF MODES

This section will be concerned with the solution of (16), which is the equation for purely longitudinal electron motion, neglecting space-charge effects.

5.1 No Attenuation, Special Velocity

Let us first consider the case of a lossless zero mode and an unperturbed velocity equal to the direct-current electron speed u_0 . In this case,

$$-\Gamma_0 = -j\beta. \quad (20)$$

Let us let

$$-\Gamma = -j\beta + \delta. \quad (21)$$

Neglecting higher-order terms in δ , we have, from (16),

$$\delta^3 = -j\beta^3 C^3. \quad (22)$$

The roots of this are

$$\begin{aligned} \delta_1 &= (0.866 - j0.5)\beta C \\ \delta_2 &= (-0.866 - j0.5)\beta C \\ \delta_3 &= j\beta C. \end{aligned} \quad (23)$$

These are three waves traveling to the right. The first is an increasing wave, because the positive real part of δ implies an exponential increase in amplitude with distance. It travels slower than the electrons because the phase variation in the z direction, $\exp[-j\beta(1+0.5C)z]$, is more rapid than the phase variation for electronic velocity, $\exp(-j\beta z)$. The second wave is a decreasing wave, traveling slower than the electron stream, and the third an unattenuated wave, traveling faster than the electron stream.

As (16) is of the fourth degree, there must be another wave. We obtain this by setting

$$-\Gamma = j\beta + \delta \quad (24)$$

and obtain approximately

$$\delta_4 = -j\beta C^3/4. \quad (25)$$

This is an unattenuated wave traveling to the left. As almost certainly $C \ll 1$, $|\delta_4|$ will be much smaller than $|\delta_1|$; that is, the wave traveling against the electron flow is less affected by it than the waves traveling with the electron flow.

We may now seek to find the gain of a traveling-wave tube in terms of these waves. Suppose we assume that the tube is terminated in such a way that there is no

backward wave.¹¹ From (7), (14), and (21) we obtain for the forward waves

$$v_m = \frac{-\eta E_m}{u_0 \delta_m} \quad (26)$$

$$q_m = \frac{j\beta I_0 E_m}{2V_0 \delta_m^2}. \quad (27)$$

There will be three forward waves in the tube, each contributing to the over-all alternating-current velocity v and alternating convection current q . If we assume that at the start of the tube $q=0$, then

$$\frac{E_1}{\delta_1^2} + \frac{E_2}{\delta_2^2} + \frac{E_3}{\delta_3^2} = 0. \quad (28)$$

There is some little question about the appropriate assumption concerning v at the boundary. We might have the beam enter the field varying as $\exp(-\Gamma z)$ suddenly; on the other hand, we might regard the field E as due to an impressed voltage, and imagine that the electrons will acquire a velocity some fraction M of the voltage $-E/(-\Gamma)$ in entering the field. It is interesting to assume that the electrons acquire such an increment of velocity given by

$$\begin{aligned} v &= \sqrt{2\eta(V_0 + ME/\Gamma)} - \sqrt{2\eta V_0} \\ v &= \frac{Mu_0 E}{2V_0 \Gamma}. \end{aligned} \quad (29)$$

Taking Γ in (29) as substantially equal to $j\beta$, we obtain from (26)

$$\frac{E_1}{\delta_1} + \frac{E_2}{\delta_2} + \frac{E_3}{\delta_3} = -\frac{ME}{j\beta}. \quad (30)$$

Finally, we have some initial power P started down the helix in the zero mode. This has a field E , and we must have

$$E_1 + E_2 + E_3 = E. \quad (31)$$

We can easily solve (28), (30), and (31) in terms of δ_1 , δ_2 , and δ_3 , obtaining for the amplitude of the increasing wave

$$E_1 = \frac{E[1 + jM(\delta_2 + \delta_3)/\beta]}{(1 - \delta_2/\delta_1)(1 - \delta_3/\delta_1)}. \quad (32)$$

The other components are easily found by interchanging subscripts.

Since we have already neglected terms in δ/β compared with unity, we must, to be consistent, neglect the term involving M , giving

$$E_1 = \frac{E}{(1 - \delta_2/\delta_1)(1 - \delta_3/\delta_1)}. \quad (33)$$

¹⁰ The objection might be made that in Section 5.2 it is shown that making Γ_0 complex has important consequences. Ψ_0 can have about the same phase angle as $j\Gamma_0$. Making Γ_0 complex has a serious result only because we subtract from Γ_0 an almost equal quantity, and a small change in the phase of Γ_0 can make a large change in the phase of the difference.

¹¹ This may not be quite a perfect match to the passive circuit.

For the values of the deltas given by (23) we easily see that initially

$$E_1 = E_2 = E_3 = E/3. \tag{34}$$

Now, far along the tube, E_1 will become very large compared with E_2 and E_3 . Neglecting all but E_1 , the asymptotic ratio of field at the output E_1 to field at the input E_0 for a tube L long will be

$$\frac{E_1}{E_0} = (1/3) \exp(0.866\beta CL). \tag{35}$$

The gain in decibels will be

$$G = 20 \log_{10} (E_{z1}/E_{z0}) \text{ decibels} \tag{36}$$

$$G = (A + BCN) \text{ decibels} \tag{37}$$

$$A = -9.54 \text{ decibels} \tag{38}$$

$$B = 47.3 \text{ decibels.} \tag{38}$$

Here N is the number of cycles required for an electron to traverse the transmission system in absence of signal.

$$2\pi N = \beta L. \tag{39}$$

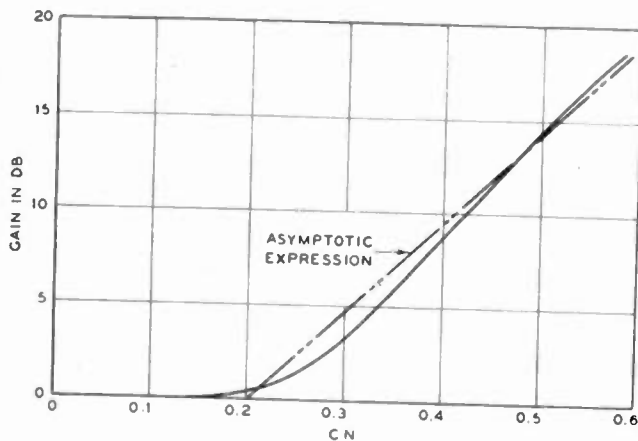

Fig. 1—Curve showing the gain of a traveling-wave tube in decibel versus the parameter C times the length of the circuit in wave lengths N . This curve is for zero circuit loss and for an electron speed equal to the wave speed in the absence of electrons.

We may wonder how good the asymptotic gain is as an approximation to an exact summation of the three wave components. The actual field at a distance L from the start will be

$$E_L = \frac{E_0}{3} \exp(-j\beta L) \{ \exp(j0.5\beta CL + 0.866\beta CL) + \exp(j0.5\beta CL - 0.866\beta CL) + \exp(j\beta CL) \}$$

$$E_L = \frac{E_0}{3} \exp(-j\beta(1-C)L) \{ 1 + 2 \cosh(0.866\beta CL) \exp(-j1.5\beta CL) \} \tag{40}$$

and

$$\left| \frac{E_L}{E_0} \right|^2 = \frac{1}{9} [1 + 4 \cosh^2 0.866\beta CL + 4 \cos 1.5\beta CL \cosh 0.866\beta CL]. \tag{41}$$

The gain according to this expression is plotted versus NC in Fig. 1. It may be seen that the asymptotic expression applies quite well when there is any appreciable gain.

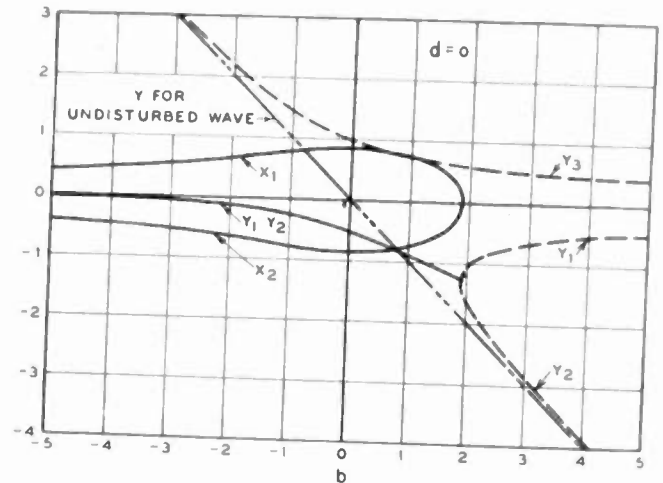

Fig. 2—Curves showing properties of the three forward waves versus b , a parameter which increases with electron speed or accelerating voltage. x is positive for increasing waves. y is negative for waves slower than electron speed and positive for waves with greater than electron speed. These curves are for the circuit-loss parameter d equal to zero (no attenuation).

5.2 Arbitrary Loss and Velocity

Starting with (16), let us assume

$$-\Gamma_0 = -j\beta - jh - \alpha \tag{42}$$

$$-\Gamma = -j\beta + \delta. \tag{43}$$

A positive value of α means a wave attenuated in traveling (in the positive z direction). A positive value of h means a wave going slower than the electrons. If we increase the speed of the electrons passing through a given circuit, h will increase, and hence h may be regarded as a measure of electron speed, or of beam voltage. If at a voltage V_0 the beam has the same speed as the unperturbed wave, then at a voltage of $V_0 + \delta V_0$

$$\frac{h}{\beta} = \frac{\delta V_0}{2V_0}. \tag{44}$$

Using (42) and (43) together with (16) we obtain, again neglecting terms in δ^2 ,

$$-2j\beta\delta + 2\beta h - 2j\beta\alpha + (h^2 - \alpha^2 - 2j\alpha h) = -2\beta^2 C^3 / \delta^2. \tag{45}$$

We will be interested chiefly in cases in which

$$|h| \ll \beta$$

$$\alpha \ll \beta$$

and hence we will neglect the quantities in the parentheses. Further, let

$$\beta C(x + jy) = \delta \tag{46}$$

$$\beta C d = \alpha \tag{47}$$

$$\beta C b = h. \tag{48}$$

We then have

$$(x^2 - y^2)(y + b) + 2xy(x + d) = -1 \tag{49}$$

$$(x^2 - y^2)(x + d) - 2xy(y + b) = 0. \tag{50}$$

These equations yield three sets of x and y , which have been called x_1, y_1 (the increasing wave) and x_2, y_2 and x_3, y_3 . They have been computed and plotted versus b for values of $d, d=0, d=0.5, d=1$, and are shown in Figs. 2, 3, and 4.

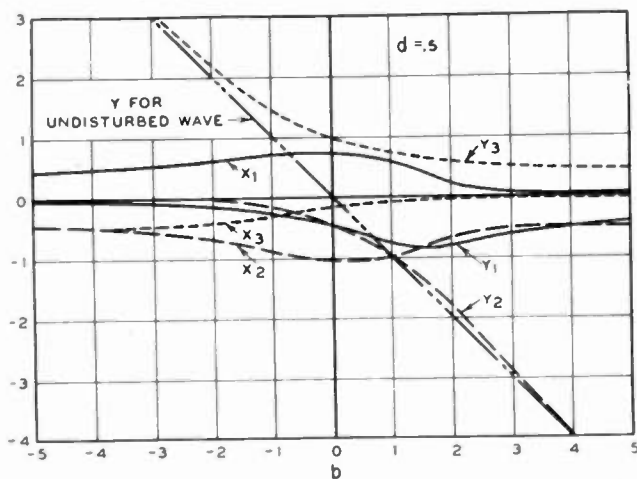

Fig. 3—Curves showing properties of the three forward waves for the circuit-loss parameter d equal to $\frac{1}{2}$.

Consider the curves for $d=1$, shown in Fig. 4. For large negative values of b (electrons slower than the

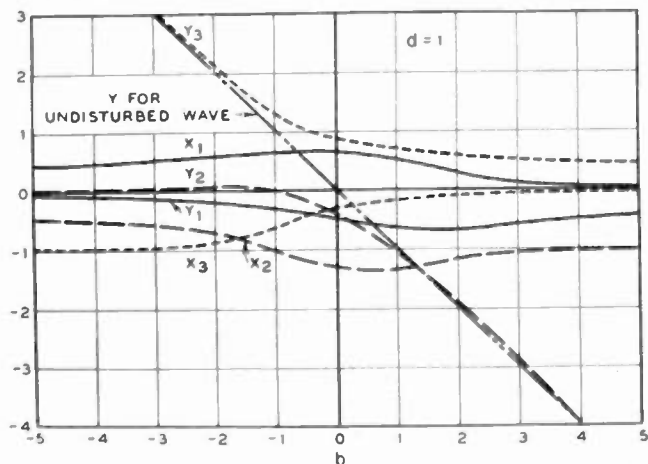

Fig. 4—Curves showing properties of the three forward waves for the circuit-loss parameter d equal to unity.

undisturbed wave) the wave specified by x_3, y_3 becomes indistinguishable from the wave in absence of electrons; the other two waves, one with a positive attenuation (negative x) and the other with a negative attenuation (positive x), approach in velocity the velocity of the electron stream (y approaches zero) and may be re-

garded as electronic rather than circuit waves. The wave with negative attenuation travels slower than the electron stream for all ranges of b . For large positive values of b , the x_2, y_2 wave becomes the circuit wave which resembles the wave in absence of electrons and x_1, y_1 and x_3, y_3 become electronic waves. x_1 remains positive (negative attenuation) for all of the range plotted.

Referring to Fig. 2, for $d=0$, we see that in the lossless case $x_1=x_2=0$ for $b>1.87$. The curves for $d=0.5$ are seen to be intermediate between those for $d=1$ and $d=0$.

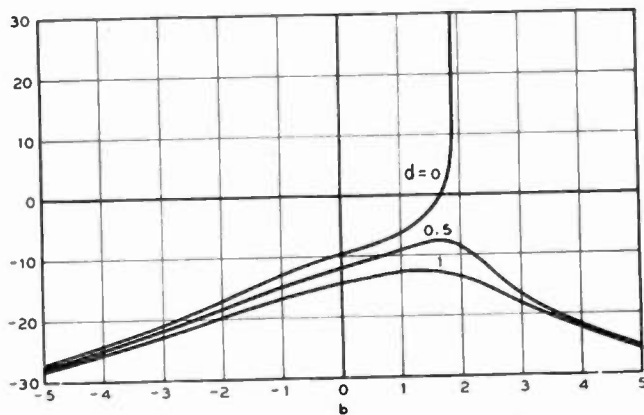

Fig. 5—Curves relating in decibels the magnitude of the increasing wave excited to magnitude of the input. The abscissa is b , the electron-speed parameter; the curves are for three values of d , the circuit-loss parameter.

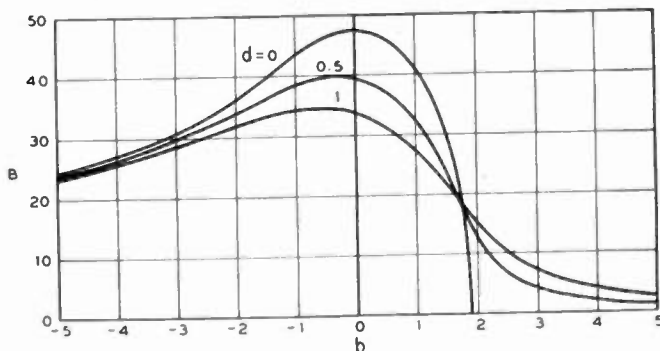

Fig. 6—Curves giving the gain in decibels per unit CN (C is the gain parameter and N is the number of wavelengths) for the increasing wave. The abscissa is b , the electron-speed parameter; the curves are for three values of d , the circuit-loss parameter.

We see that the asymptotic gain in field strength will be

$$\frac{E_L}{E_0} = \frac{E_1}{E_0} \exp(\beta C x_1 L) = \frac{E_1}{E_0} \exp(2\pi N C x_1). \tag{51}$$

Accordingly, the gain is

$$G = (A + BCN) \text{ decibels} \tag{52}$$

$$A = -20 \log_{10} |1 - \delta_2/\delta_1| |1 - \delta_3/\delta_1| \text{ decibels} \tag{53}$$

$$B = (20/2.3) 2\pi x_1 \text{ decibels.} \tag{54}$$

A and B may be obtained from curves of Figs. 2, 3, and 4. A plot of A versus b for three values of d is shown in Fig. 5 and of B versus b for three values of d in Fig. 6.

5.3 Use of the Equations

We have

$$G = (A + BCN) \text{ decibels}$$

where A and B are functions of

$$d = \alpha/\beta C$$

$$b = h/\beta C = \frac{\delta V_0}{2V_0 C}$$

The meaning of b is fairly clear. Suppose, however, we have an actual tube with a *net gain* of G decibels. The *total gain* of the increasing wave will be

$$BCN = (G - A) \text{ decibels.} \quad (55)$$

As A is negative, the total gain $G - A$ is larger than the net gain.

Suppose that the loss without electrons is R decibels. Loss without electrons is specified rather than cold loss, as we mean loss with the circuit at the same temperature as when the tube is in operation. R may best be measured as the loss for a wave going from output to input with the electrons present. We have

$$R = 20 \log_{10} \exp \alpha L$$

$$= \frac{20}{2.3} \beta C d L$$

$$R = 54.6 N C d. \quad (56)$$

In determining d and C we must choose values such that (55) and (56) are satisfied, remembering that A and B are functions of d (and of b as well) as given by Figs. 5 and 6.

5.4 Estimate of Efficiency and Output

A satisfactory large-signal analysis is yet to be made. It is possible, however, to form a rough estimate of the limiting power output from the equations already derived.

The alternating convection current q cannot exceed the direct beam current I_0 by a very large factor. Hence, if we let $|q| = I_0$ in (27), we can form an estimate of the maximum field E which can be built up in a wave having negative attenuation. This gives

$$|E| = \frac{2V_0 |\delta_m^2|}{\beta} \quad (57)$$

We have also, from (19),

$$|E| = \left(\frac{8V_0 \beta^2 P}{I_0} \right)^{1/2} C^{3/2}. \quad (58)$$

For $d=b=0$ (no loss in circuit, electron velocity that of undisturbed wave),

$$|\delta_m^2| = \beta^2 C^2. \quad (59)$$

Hence,

$$P = I_0 V_0 \frac{C}{2}. \quad (60)$$

Thus, the estimated efficiency for a tube with a lossless circuit and an electron velocity equal to that of the undisturbed wave is $C/2$.

5.5 Estimate of Noise Figure

The noise figure of the traveling-wave tube will be estimated on the basis of a noise component in the injected current I equal to shot noise reduced by some factor γ^2 which is less than unity.¹²

$$\overline{i^2} = \overline{q_n^2} = \gamma^2 2e I_0 B. \quad (61)$$

Here B is noise bandwidth. It will be assumed that $v=0$ at the beginning of the circuit. The condition on E is a little obscure. In deriving the gain expression (32) we saw that there may be an initial disturbance, described in terms of a parameter M , in the electrons getting into the wave type of the field. Strictly, we should include this. If we do, the initial value of E will certainly depend on the input termination of the circuit. The writer believes, however, that for ordinary conditions no serious error will be made by letting $E=0$ at the beginning of the circuit. If we do this, our equations will be

$$E_1 + E_2 + E_3 = 0$$

$$\frac{E_1}{\delta_1} + \frac{E_2}{\delta_2} + \frac{E_3}{\delta_3} = 0 \quad (62)$$

$$\frac{E_1}{\delta_1^2} + \frac{E_2}{\delta_2^2} + \frac{E_3}{\delta_3^2} = \frac{2V_0}{j\beta I_0} q.$$

On solving, we have

$$E_1 = \frac{2V_0}{j\beta I_0} \frac{\delta_2 \delta_3}{(1 - \delta_2/\delta_1)(1 - \delta_3/\delta_1)} q. \quad (63)$$

Or

$$|E_1|_n^2 = 2 \frac{4V_0^2}{\beta^2 I_0^2} \frac{|\delta_2 \delta_3|^2}{|(1 - \delta_2/\delta_1)(1 - \delta_3/\delta_1)|^2} \overline{q_n^2}. \quad (64)$$

The factor 2 occurs because E_1 is a peak field.

$$|E_1|_n^2 = \frac{16e\gamma^2 I_0^2 B}{\beta^2 I_0} \frac{|\delta_2 \delta_3|^2}{|(1 - \delta_2/\delta_1)(1 - \delta_3/\delta_1)|^2}. \quad (65)$$

Now, if the circuit is matched to a source at temperature T , the thermal noise power flowing into it will be

$$P_t = kTB. \quad (66)$$

Here k is Boltzman's constant and T is absolute

¹² See, for instance, B. J. Thompson, D. O. North, and W. A. Harris, "Fluctuations in space-charge-limited currents at moderately high frequencies: Part II—Diodes and negative grid triodes," *RCA Rev.*, vol. IV, p. 462 (eq. 42); April, 1940.

temperature. From (19) and (33) we see that this will excite a component of the increasing wave

$$|E_1|_i^2 = \frac{8V_0\beta^2 P_i C^3}{I_0 |(1 - \delta_2/\delta_1)(1 - \delta_3/\delta_1)|^2} \quad (67)$$

$$|E_1|_i^2 = \frac{8V_0\beta^2 C^3 kTB}{I_0 |(1 - \delta_2/\delta_1)(1 - \delta_3/\delta_1)|^2}$$

At a later point in the circuit, where E_1 predominates, the noise figure will be

$$F = \frac{|E_1|_i^2 + |E_1|_n^2}{|E_1|_i^2} \quad (68)$$

$$F = 2\gamma^2 \frac{eV_0}{kT} \frac{|\delta_2\delta_3|^2}{\beta^4 C^3}$$

If we assume a lossless circuit and an electron velocity equal to the velocity of the undisturbed wave ($d=b=0$),

$$|\delta_2\delta_3|^2 = \beta^4 C^4 \quad (69)$$

and

$$F = 2\gamma^2 \frac{2eV_0}{kT} C \quad (70)$$

In terms of volts and degrees Kelvin,

$$\frac{eV_0}{kT} = \frac{11,600V_0}{T} \quad (71)$$

The standard reference temperature for noise figure is 290 degrees Kelvin, so that

$$F = 80\gamma^2 V_0 C \quad (72)$$

We see that the chief means for obtaining good noise figure are to reduce γ^2 if possible, to use a low voltage, and to use a low gain per radian (low C), implying a small current.

6. EFFECT OF CUTOFF MODES

In endeavoring to estimate the magnitude of the error made in neglecting cutoff modes, it is first desirable to determine what is the fundamental parameter expressing the effect of cutoff modes. An effort can then be made to estimate the magnitude of this parameter.

6.1 Nature of Cutoff Mode Effect for Special Case

Let us return to equation (15). In order to avoid undue complication, we will consider only the case for $d=b=0$, that is, a lossless circuit and an electron velocity equal to the velocity of the undisturbed wave, so that

$$\begin{aligned} -\Gamma_0 &= -j\beta \\ -\Gamma &= -j\beta + \delta \end{aligned} \quad (73)$$

Assuming $b=0$ results in a pessimistic view of the effect of cutoff modes. From (15) we obtain, neglecting higher-order terms,

$$1 = \left[\frac{j\beta}{\psi_0^*(-2j\beta\delta)} + \frac{j}{m_1\beta} \right] \frac{j\beta I_0}{2V_0\delta^2} \quad (74)$$

In terms of the parameter C this can be written

$$1 = \frac{-j\beta^3 C^3}{\delta^3} - \frac{4\beta^2 C^2}{\delta^2} QC \quad (75)$$

$$Q = \frac{\psi_0^*}{2m_1} = \left[\left(\frac{E_1^2}{\beta^2 P} \right) (m_1 \beta^2) \right]^{-1} \quad (76)$$

Here P is the power transmitted by the zero (propagating) mode for a peak axial field E , and the parameter $(E_1^2/\beta^2 P)$ will be recognized from (19) as the important circuit parameter in the expression for C .

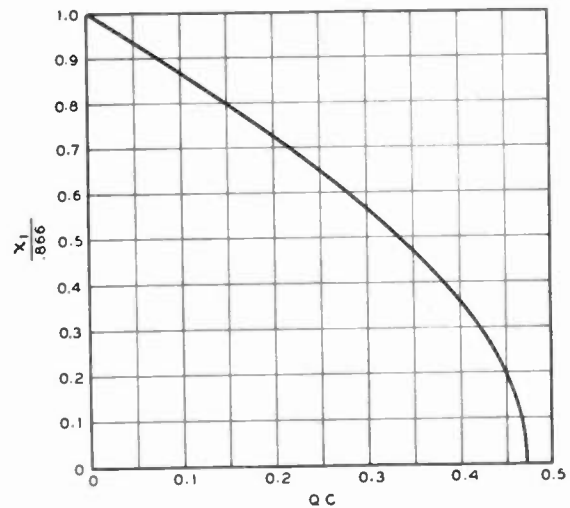

Fig. 7—Reduction of gain by cut off-modes effects. The ordinate is fractional reduction in rate of increase of the increasing wave; the abscissa is a circuit parameter Q times the gain parameter C . The curve is for zero loss and an electron speed equal to the speed of the undisturbed wave.

If we let

$$\delta = (x + jy)\beta C,$$

(75) becomes

$$(x + jy)^3 + 4QC(x + jy) + j = 0 \quad (77)$$

This yields

$$x(x^2 - 3y^2 + 4QC) = 0 \quad (78)$$

$$-y^3 + 3x^2y + 4QCy + 1 = 0 \quad (79)$$

The solution $x=0$ is uninteresting as it yields an unattenuated wave. The other solution gives

$$x^2 = 3y^2 - 4QC \quad (80)$$

$$QC = \frac{y^3 + 1/8}{y}$$

By assigning various values to y we can obtain both y and x as a function of QC . We see that there will be paired values of x , x_1 and $x_2 = -x_1$. In Fig. 7, x_1 is plotted versus QC .

6.2 Estimation of the Cutoff-Modes Parameter

In order to form a rough estimate of the space-charge parameter Q we will consider a circular cylindrical sheet of current isolated from a circuit. Using essentially the same notation as Schelkunoff (Chapter X)¹ we have

$$H_\phi = -\frac{\partial T}{\partial r} \hat{T} \quad (81)$$

$$\hat{T} = \exp(-j\beta z). \quad (82)$$

Here we take Γ as equal to $j\beta$.

Inside of the current sheet,

$$T_1 = A_1 I_0(\gamma r) \quad (83)$$

$$\gamma^2 = \beta^2 - (\omega/c)^2. \quad (84)$$

Outside of the current sheet,

$$T_2 = A_2 K_0(\gamma r). \quad (85)$$

If the total current in the sheet is q and the radius of the sheet is a , then

$$\begin{aligned} \frac{q}{2\pi a} &= H_{\phi 2} - H_{\phi 1} \\ &= \gamma(A_2 K_1(\gamma a) - A_1 I_1(\gamma a)). \end{aligned} \quad (86)$$

Also, at the radius a ,

$$\begin{aligned} E_z &= \frac{-\gamma^2}{j\omega\epsilon} A_1 I_0(\gamma a) \\ &= \frac{-\gamma^2}{j\omega\epsilon} A_2 K_0(\gamma a). \end{aligned} \quad (87)$$

Identifying E_z as the second term in (5), that is, the part of the field due to cutoff modes,

$$E_z = \frac{j\gamma^2}{2\pi\epsilon\omega H(\gamma a)} q = \frac{j}{m_1\beta} q \quad (88)$$

$$H(\gamma a) = \gamma a \left(\frac{K_1(\gamma a)}{K_0(\gamma a)} - \frac{I_1(\gamma a)}{I_0(\gamma a)} \right). \quad (89)$$

From (76) we see that in finding Q we are interested in $1/m_1\beta^2$. Usually γ can be taken as equal to β , and this has been done in passing from (89) to (90):

$$\begin{aligned} \frac{1}{m_1\beta^2} &= \frac{\beta}{2\pi\epsilon\omega H(\gamma a)} \\ \frac{1}{m_1\beta^2} &= (c/u_0) \frac{1}{2\pi\epsilon c H(\gamma a)} \\ \frac{1}{m_1\beta^2} &= (c/u_0) \frac{60}{H(\gamma a)}. \end{aligned} \quad (90)$$

The quantity $60/H(\gamma a)$ is plotted versus γa in Fig. 8.

6.3 Over-All Effect

In order to estimate the over-all effect of space charge, we must have the quantity $|E|^2/\beta^2 P$. This has been derived approximately as a function of γa and c/u_0 in Appendix B and checked experimentally.

Some operating tubes had a value of γa equal to about 2.8.

For this, the effective value of the desired parameter turns out (somewhat greater than the value on the axis) to be about

$$\frac{|E_z|^2}{\beta^2 P} = \left(\frac{c}{u_0} \right) 4.17.$$

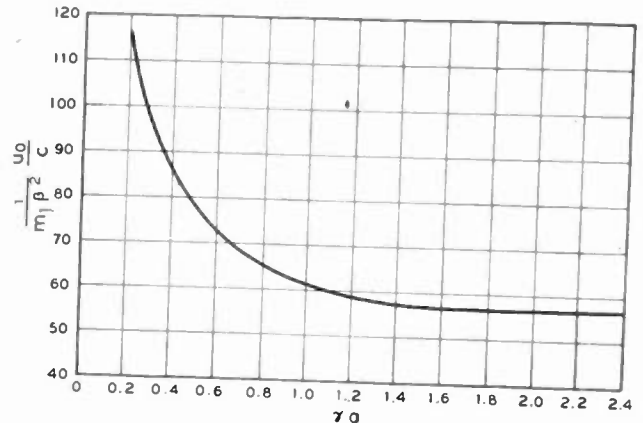

Fig. 8—Curve for use in evaluating approximately the circuit parameter Q used in connection with cutoff modes.

If we assume that the mean equivalent cylinder of current from the point of view of space charge is such that $\gamma a = 1.4$, from Fig. 8 we obtain

$$\frac{1}{m_1\beta^2} = \left(\frac{c}{u_0} \right) 57.$$

Accordingly,

$$Q = 13.7.$$

If $C=0.03$, then $CQ=0.41$, and from Fig. 7 the fractional reduction in x_1 is 0.33. As has been noted, assuming $b=0$ has given a pessimistic estimate of the effect of cutoff modes.

ACKNOWLEDGMENT

The writer wishes to express his appreciation to W. B. Hebenstreit and R. M. Ryder, who through diligence and care have eliminated many errors and contradictions from this paper.

APPENDIX A

Suppose we have a transmission system having a number of normal modes of transmission in the z direction. On the z axis the longitudinal electric field

represented by waves going to the right may be expressed (letting $E = E_r$)

$$\vec{E} = \sum_n \vec{E}_n \exp(\Gamma_n z). \tag{91}$$

The part of the field due to waves traveling to the left will be

$$\overleftarrow{E} = \sum_n \overleftarrow{E}_n \exp(-\Gamma_n z). \tag{92}$$

The Γ_n 's in (91) and (92) are the same.

The power in the n th mode flowing to the right from the plane $z=0$ may be expressed as

$$\vec{P}_n = \vec{E}_n \overleftarrow{E}_n^* \Psi_n / 2. \tag{93}$$

Similarly the power flowing to the left from the plane $z=0$ is

$$\overleftarrow{P}_n = \overleftarrow{E}_n \overleftarrow{E}_n^* \Psi_n / 2. \tag{94}$$

Here Ψ_n is twice the power carried across a plane in one direction by unit peak field in the n th mode of propagation.

Now, suppose that the modes of propagation are excited by a current I flowing an elementary distance l along the axis at the point $z=0$. Waves will travel to the right, and the field of these waves can be expressed as in (91). Waves will travel to the left, and the field of these waves can be expressed as in (92). At the point $z=0$ the field will be continuous, and we will have at this point

$$\overleftarrow{E}_n = \vec{E}_n. \tag{95}$$

The total power flowing from the current element and away in the n th mode of transmission will be

$$P_n = -I^* l \vec{E}_n / 2 \tag{96}$$

$$P_n = -I^* l \overleftarrow{E}_n / 2. \tag{97}$$

Half of this power will flow to the right and half to the left. Hence,

$$\vec{P}_n = -I^* l \vec{E}_n / 4 \tag{98}$$

$$\overleftarrow{P}_n = -I^* l \overleftarrow{E}_n / 4. \tag{99}$$

From (93) and (98) and from (94) and (99) we obtain

$$\vec{E}_n = \frac{-I l}{2 \Psi_n^*} \tag{100}$$

$$\overleftarrow{E}_n = \frac{-I l}{2 \Psi_n^*} \tag{101}$$

Suppose we have an impressed current $I(\zeta)$. Here ζ is a measure of distance in the z direction. At the point

z we will have fields due to the waves traveling to the right from current elements for which $\zeta < z$, and from waves traveling to the left from current elements for which $\zeta > z$.

From elements to the left of z , for which $\zeta < z$, we will have contributions

$$d\vec{E} = -I(\zeta) \sum_n \frac{\exp[-\Gamma_n(z-\zeta)] d\zeta}{2 \Psi_n^*} \tag{102}$$

Similarly, from elements to the right, for which $\zeta > z$, we will have contributions

$$d\overleftarrow{E} = -I(\zeta) \sum_n \frac{\exp[\Gamma_n(z-\zeta)] d\zeta}{2 \Psi_n^*} \tag{103}$$

We are interested in current distributions on the axis of the form $I(\zeta) = I \exp(-\Gamma\zeta)$, where I is, as before, the peak value of the current. From (102), then, the total forward component of the wave is

$$\vec{E} = \frac{-I}{2} \sum_n \frac{e^{-\Gamma_n z}}{\Psi_n^*} \int_{-\infty}^z \exp-(\Gamma - \Gamma_n)\zeta d\zeta. \tag{104}$$

If $Re(\Gamma - \Gamma_n) < 0$, this becomes

$$\vec{E} = \frac{I}{2} e^{-\Gamma z} \sum_n \frac{1}{\Psi_n^*(\Gamma - \Gamma_n)} \tag{105}$$

For the wave in the minus z direction, we have

$$\overleftarrow{E} = \frac{-I}{2} \sum_n \frac{e^{\Gamma_n z}}{\Psi_n^*} \int_z^{+\infty} \exp-(\Gamma + \Gamma_n)\delta d\delta. \tag{106}$$

If $Re(\Gamma + \Gamma_n) > 0$, this is

$$\overleftarrow{E} = \frac{-I}{2} e^{-\Gamma z} \sum_n \frac{1}{\Psi_n^*(\Gamma + \Gamma_n)} \tag{107}$$

Adding (101) and (102) we have the total field at z ,

$$E = I e^{-\Gamma z} \sum_n \frac{\Gamma_n}{\Psi_n^*(\Gamma^2 - \Gamma_n^2)} \tag{108}$$

The restrictions on the integrations are $Re(\Gamma - \Gamma_n) < 0$ and $Re(\Gamma + \Gamma_n) > 0$. Presumably, in any physically realizable system $Re\Gamma_n > 0$, and in case of a traveling-wave tube the restrictions might well hold. However, the writer believes that (108) is valid as used in this paper even when these restrictions do not hold, and that (108) may be regarded as a particular solution of the problem of a transmission system excited by the current distribution assumed, the other solutions being waves traveling with the natural propagation constants of the system, which are not needed in the analysis here presented.

APPENDIX B

PROPAGATION OF A WAVE ALONG A HELIX

The circuit parameter important in the operation of the tube is

$$(E_z^2/\beta^2 P)^{1/3} \quad (109)$$

$$\beta = \omega/v. \quad (110)$$

Here E_z is the peak electric field in the direction of propagation, P is the power flow along the helix, and v is the phase velocity of the wave. The quantity $E_z^2/\beta^2 P$ has the dimensions of impedance.

While the problem of propagation along a helix has not been solved, what appears to be a very good approximation has been obtained by replacing the helix with a cylinder of the same mean radius a which is conducting only in a helical direction making an angle Ψ with the circumference, and nonconducting in the helical direction normal to this.¹³

An appropriate solution of the wave equation in cylindrical co-ordinates for a plane wave having circular symmetry and propagating in the z direction with velocity

$$v = \frac{\omega}{\beta}, \quad (111)$$

less than the speed of light c , is

$$E_z = [AI_0(\gamma r) + BK_0(\gamma r)]e^{j(\omega t - \beta z)} \quad (112)$$

where I_0 and K_0 are the modified Bessell functions, and

$$\gamma^2 = \beta^2 - \left(\frac{\omega}{c}\right)^2 = \beta^2 - \beta_0^2. \quad (113)$$

The form of the z (longitudinal) components of an electromagnetic field varying as $e^{j(\omega t - \beta z)}$ and remaining everywhere finite might therefore be

$$H_{z1} = B_1 I_0(\gamma r) e^{j(\omega t - \beta z)} \quad (114)$$

$$E_{z3} = B_3 I_0(\gamma r) e^{j(\omega t - \beta z)} \quad (115)$$

inside radius a , and

$$H_{z2} = B_2 K_0(\gamma r) e^{j(\omega t - \beta z)} \quad (116)$$

$$E_{z4} = B_4 K_0(\gamma r) e^{j(\omega t - \beta z)} \quad (117)$$

outside radius a . Omitting the factor $e^{j(\omega t - \beta z)}$ the radial and circumferential components associated with these, obtained by applying the curl equation, are, inside radius a ,

$$H_{\phi 3} = B_3 \frac{j\omega\epsilon}{\gamma} I_1(\gamma r) \quad (118)$$

$$H_{r1} = B_1 \frac{j\beta}{\gamma} I_1(\gamma r) \quad (119)$$

$$E_{\phi 1} = -B_1 \frac{j\omega\mu}{\gamma} I_1(\gamma r) \quad (120)$$

$$E_{r3} = B_3 \frac{j\beta}{\gamma} I_1(\gamma r) \quad (121)$$

and outside radius a ,

$$H_{\phi 4} = -B_4 \frac{j\omega\epsilon}{\gamma} K_1(\gamma r) \quad (122)$$

$$H_{r2} = -B_2 \frac{j\beta}{\gamma} K_1(\gamma r) \quad (123)$$

$$E_{\phi 3} = B_2 \frac{j\omega\mu}{\gamma} K_1(\gamma r) \quad (124)$$

$$E_{r4} = -B_4 \frac{j\beta}{\gamma} K_1(\gamma r). \quad (125)$$

The boundary conditions which must be satisfied at the cylinder of radius a are that the tangential electric field must be perpendicular to the helix direction

$$E_{z3} \sin \Psi + E_{\phi 1} \cos \Psi = 0 \quad (126)$$

$$E_{z4} \sin \Psi + E_{\phi 2} \cos \Psi = 0, \quad (127)$$

the tangential electric field must be continuous across the cylinder

$$E_{z3} = E_{z4} \quad (\text{and } E_{\phi 1} = E_{\phi 2}), \quad (128)$$

and the tangential component of magnetic field parallel to the helix direction must be continuous across the cylinder, since there can be no current in the surface perpendicular to this direction.

$$H_{z1} \sin \Psi + H_{\phi 3} \cos \Psi = H_{z2} \sin \Psi + H_{\phi 4} \cos \Psi. \quad (129)$$

These equations serve to determine the ratios of the B 's and to determine γ through

$$(\gamma a)^2 \frac{I_0(\gamma a) K_0(\gamma a)}{I_1(\gamma a) K_1(\gamma a)} = (\beta_0 a \cot \Psi)^2. \quad (130)$$

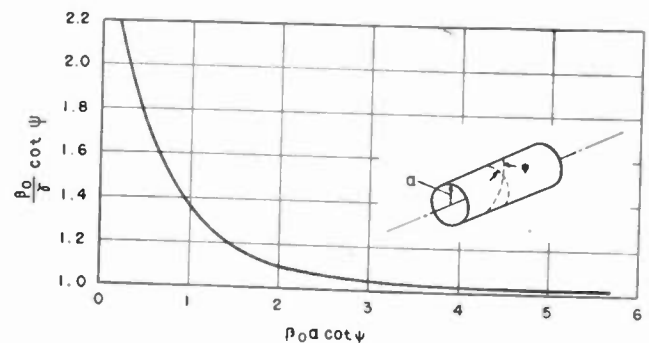

Fig. 9—Curve for propagation along a helically conducting cylinder which for a tightly wound helix roughly shows the ratio of the speed along the helical direction on the surface of the cylinder divided by the speed of light versus the radius of the cylinder in radians (based on the axial phase velocity).

Fig. 9 shows $\beta_0 a \cot \Psi / \gamma a$ plotted against $\beta_0 a \cot \Psi$ from this expression. For velocities v appreciably less than the speed of light, γ is near β ; for example, if $v = c/13$, $\gamma = 0.997\beta$. Fig. 9 shows that as $\beta_0 a \cot \Psi$ becomes large the wave propagates with about the speed of light along

¹³ This attack is very similar to the treatment of the helix by Franz Ollendorf, "Die Grundlagen der Hochfrequenztechnik," (1925), pp. 79-87. Ollendorf, however, omits some of the terms included in this analysis, and does not give an expression for the field in terms of the power.

the helical direction on the cylindrical surface. For smaller values of $\beta a \cot \Psi$ the speed of propagation along the helical direction on the cylindrical surface becomes considerably greater than the speed of light; also, the field extends far outside the helix.

We can easily express the various field components listed in (114) through (125) in terms of $H_z(0) = B_1$ and $E_z(0) = B_3$, the fields on the axis, by means of the relations between the coefficients given by (126) through (129). The argument of the Bessel functions is henceforward taken as γa unless otherwise given.

$$B_4 = \frac{I_0}{K_0} B_3 \tag{131}$$

$$B_2 = -\frac{I_1}{K_1} B_1 \tag{132}$$

$$B_3 = \frac{j\omega\mu}{\gamma} \frac{I_1}{I_0} \cot \Psi B_1. \tag{133}$$

The power associated with the propagation is given by

$$P = \frac{1}{2} \text{Re} \int E \times H^* \cdot d\tau \tag{134}$$

taken over a plane normal to the axis of propagation. This is

$$P = \pi \text{Re} \left[\int_0^a (E_{r3} H_{\phi 3}^* - E_{\phi 1} H_{r1}^*) r dr + \int_a^\infty (E_{r4} H_{\phi 4}^* - E_{\phi 2} H_{r2}^*) r dr \right] \tag{135}$$

or

$$P = \pi E_z^2(0) \frac{\beta\beta_0^2}{\gamma^2\omega\mu} \left[\left(1 + \frac{I_0 K_1}{I_1 K_0}\right) \int_0^a I_1^2(\gamma r) r dr + \left(\frac{I_0}{K_0}\right)^2 \left(1 + \frac{I_1 K_0}{I_0 K_1}\right) \int_a^\infty K_1^2(\gamma r) r dr \right] \\ = E_z^2(0) \frac{\pi}{2\eta} \frac{\beta\beta_0 a^2}{\gamma^2} \left[\left(1 + \frac{I_0 K_1}{I_1 K_0}\right) (I_1^2 - I_0 I_2) + \left(\frac{I_0}{K_0}\right)^2 \left(1 + \frac{I_1 K_0}{I_0 K_1}\right) (K_0 K_2 - K_1^2) \right] \tag{136}$$

where $\eta = 120\pi$ ohms.

Let us now write

$$(E_z^2/\beta^2 P)^{1/3} = (\beta/\beta_0)^{1/3} (\gamma/\beta)^{4/3} F(\gamma a) \tag{137}$$

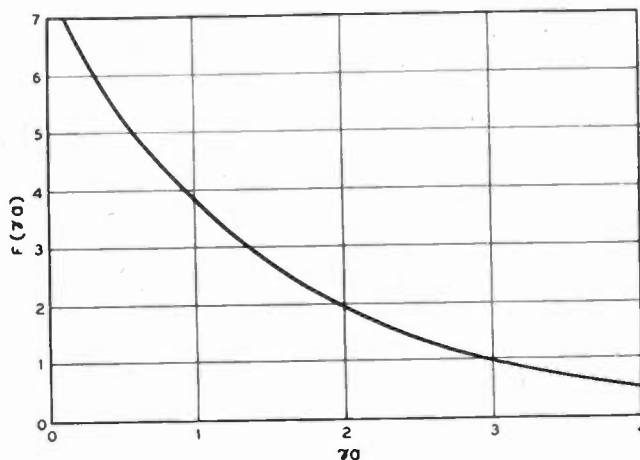

Fig. 10—Factor for obtaining the impedance parameter for helical propagation in terms of radius of the cylinder in radians (based on the axial phase velocity). The impedance parameter is given by $(E_z^2/\beta^2 P)^{1/3} = (\beta/\beta_0)^{1/3} (\gamma/\beta)^{4/3} F(\gamma a)$.

where

$$F(\gamma a) = \left(\frac{(\gamma a)^2}{240} \left[(I_1^2 - I_0 I_2) \left(1 + \frac{I_0 K_1}{I_1 K_0}\right) + \left(\frac{I_0}{K_0}\right)^2 (K_0 K_2 - K_1^2) \left(1 + \frac{I_1 K_0}{K_1 I_0}\right) \right] \right)^{-1/3} \tag{138}$$

$F(\gamma a)$ is plotted versus γa in Fig. 10. In connection with the use of this expression we should again remember that usually γ/β will be nearly unity.

As not all the electrons travel on the axis, the effective value of $(E_z^2/\beta^2 P)^{1/3}$ will be somewhat larger than this.

It is interesting to note that the factor $(E_z^2/\beta^2 P)^{1/3}$ becomes larger the smaller the velocity of the wave along the axis.

ACKNOWLEDGMENT

The writer wishes to acknowledge his indebtedness to S. A. Schelkunoff, who worked out the expressions presented here, and to R. S. Julian, who assisted in the preparation of this appendix.

Correction

The last paragraph under "Engineering Societies Council" appearing on pages 966-967 of the December, 1946, issue of the PROCEEDINGS OF THE I.R.E. should read as follows:

"I.R.E. delegates to the council are J. E. Shepherd (A'36-SM'44) and H. F. Dart (A'20-M'26-SM'43); the I.R.E. alternates are J. T. Cimorelli (S'33-A'41-SM'45) and G. B. Hoadley (A'40-SM'45).

Members of the I.R.E. who are delegates to the Coun-

cil from other societies are C. R. Keith (A'44), J. D. Schiller (A'45), and E. M. Sherwood (A'37), while alternates from other societies are: J. L. Callahan (A'21-M'31-SM'43), M. D. Hooven (A'26), and W. A. Howard (A'44).

Mention should also be made of the fact that in obtaining a charter the name of the Engineering Societies Council of New York must be changed to Technical Societies Council of New York.

The Traveling-Wave Tube as Amplifier at Microwaves*

RUDOLF KOMPFFNER†

Summary—A tube is described which is based on the principle of interaction between a traveling electric field and an electron beam traveling at about the same velocity. Experiments on the interaction and the construction of a tube run as a sensitive amplifier at a wavelength of 9.1 centimeters are given. A noise factor of 11 decibels with a power amplification of 14 were obtained with one particular tube. An investigation of the field obtaining in a helix—the structure used for slowing down the wave—is briefly described, and the main results of an approximate theory of the tube are given.

INTRODUCTION

IT WAS in 1942 that the writer first felt the need for a method which might overcome the difficulties then facing a tube of the klystron or drift-tube type when operated as a high-sensitivity amplifier at microwaves. One of the chief difficulties was connected with the transit time of electrons crossing the "working" gaps by means of which the electron beam in a klystron is energy-modulated, or by means of which energy is withdrawn from the beam. As a result of a number of conflicting requirements, it is inevitable that the energy transfer in such gaps is considerably weakened; it was a natural and perhaps obvious thought to inquire whether the energy transfer between an electron beam and electric fields traveling at the same rate as the electrons could be made more efficient than that obtaining in a klystron gap.

PRELIMINARY EXPERIMENTS AND CALCULATIONS

The first step was to find means of slowing down an electromagnetic wave to velocities corresponding to electron beams having "reasonable" voltages. (A 2500-volt beam travels approximately with one-tenth the velocity of light.) A "loaded" transmission line suggested itself as the simplest structure to build and investigate. Accordingly, in April, 1943, a coaxial transmission line was constructed, consisting of a helix of copper wire as inner conductor with a brass tube as outer conductor. From a measurement of the standing wave in this helical line it was found that the wave travels along the wire with very nearly the velocity of light, and therefore the axial component of the phase velocity of the wave is determined by the pitch of the helix over a wide range of wavelength. The attenuation α^1 of the helical line was deduced from the observed Q value when short-circuited at both ends, and the characteristic impedance Z was estimated from the standing-wave ratio on a line of known impedance connected

to the helical line at one end, the other end being non-reflectively terminated. Typical values for a 1/10th-of-the-velocity-of-light line made of No. 18 standard-wire-gauge copper wire are:

$$\alpha^1 = 2 \text{ decibels per meter}$$

$$Z = 500 \text{ ohms.}$$

At this stage a number of rough calculations were made of the performance to be expected by such a helical line when used either as "buncher" or as "catcher," on the basis of the interaction between the beam and axial fields inside the helix, or, alternatively, by means of deflection-modulation interaction between the beam and transverse fields existing in the space between helix and outer conductor. These calculations showed that it should be possible to obtain interaction many times stronger than obtainable with the conventional rhumbatron gap, subject, however, to some uncertainty regarding the actual field strength within the helix, and between the helix and the outer conductor. It was also found that there might be an actual increase in the energy of the wave as it travels along, although not much importance was attached to this aspect at the time because the calculations were only first-order calculations and very rough ones at that.

EXPERIMENTS ON THE INTERACTION BETWEEN WAVE AND BEAM

The next stage was experimental, and consisted of finding means of feeding power into and out of the helical line without interfering with an eventual electron beam. A comparatively simple structure (see Fig. 1) was found to answer quite well, the rhumbatron-like attachments enabling good matching to be obtained between input and output line on the one hand and the helical line on the other.

This structure was then adapted for evacuation, an electron gun was provided, and an electron beam shot (at first) through the space between helix and outer conductor. At the far end a fluorescent screen was placed upon which a luminous spot was formed by the electron beam. When radio-frequency power was then sent through the helix and the beam voltage adjusted to the right value the luminous spot drew out into a line, approximately in a radial direction. From the magnitude of the deflection and the amount of radio-frequency power, a value for the transverse field strength between helix and outer conductor could be deduced. This showed that the field strength under the circumstances was about one-fourth of the field that would exist if the wavelength in the helix were very

* Decimal classification: R339.2XR363.16. Original manuscript received by the Institute, August 28, 1946.

† Clarendon Laboratory, Oxford, England.

large compared with the dimensions of the helix. Next, information was obtained about the strength of the axial fields within the helix. This was done by shooting

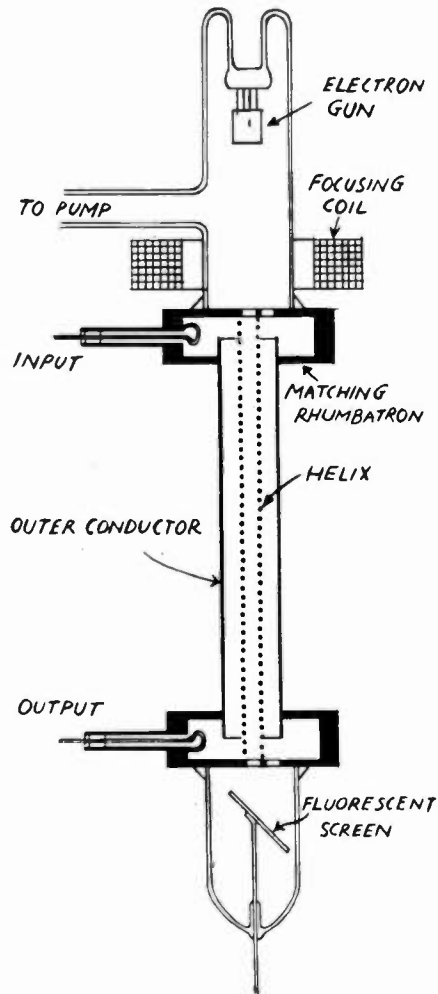

Fig. 1—Apparatus for the first experiment on the interaction between wave and beam. Helix: 21 centimeters long, No. 18 standard-wire-gauge copper wire.

the beam along the axis of the helix and measuring the maximum energy increments given to the electrons by a known amount of radio-frequency power by means of a collector biased negatively in respect of the cathode.

Thus it was found that the axial field near the axis was only about one-sixth of that obtaining close to the helix.

When the radio-frequency power emerging from the helix with the beam switched on was compared with the radio-frequency power without the beam, it was found that at a beam voltage of 2440 volts there was an increase of 49 per cent, while at a beam voltage of 2200 volts there was a decrease of 40 per cent. The beam current was of the order of 1 milliamper.

A number of observations were then made on the amount of shot noise introduced into the line by the beam. With the beam between helix and outer conductor, the noise was too small to be observed. When the beam was shot along the axis of the helix the noise was measurable, though the actual amount could only be explained on the basis of the electron beam having fluctuational components weaker by about a factor of 10 than should be expected from a perfectly random electron stream.

EXPERIMENTS ON THE TRAVELING-WAVE TUBE AS AMPLIFIER

Now, since experiment had shown that it was quite practicable to use one length of helical line, as it were, as buncher and catcher combined, a tube was designed on this principle; it is shown in Fig. 2. The intention was to make an amplifier having as good a signal-to-noise ratio (defined by the noise factor N) as possible, which at the same time provided sufficient amplification to make it worth while to have radio-frequency amplification at all. From the first approximate theory it appeared that, to satisfy these requirements, it was necessary to make the tube as long as physically possible. Accordingly, the helix was placed inside a long dimpled glass tube, the dimples supporting the helix and preventing vibrations, while the glass tube itself formed the vacuum envelope. The helix was about 66 centimeters long and of No. 18 standard-wire-gauge copper wire, wound on a $\frac{1}{4}$ -inch mandrel; and the wavelength in the tube was 7.7 millimeters, corresponding to a beam voltage of 1830 volts. (The free-space wavelength was 9.1 centimeters.) The cold-insertion loss of the tube was about 3.5 decibels, due to loss in the

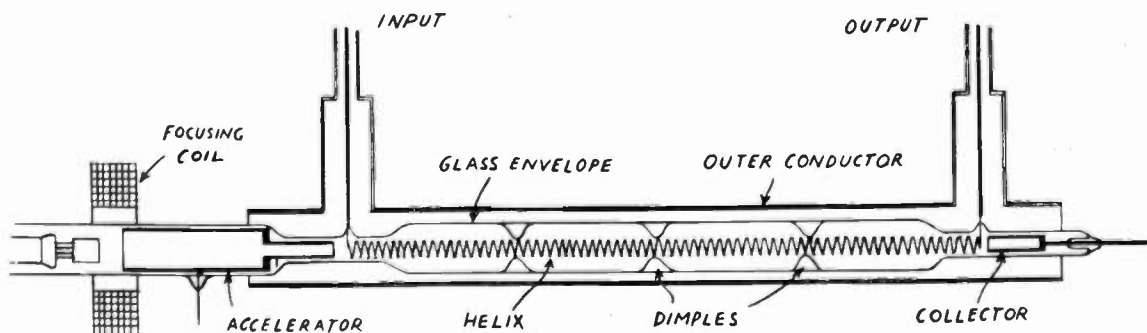

Fig. 2—Traveling-wave tube as amplifier. Helix: 66 centimeters long, No. 18 standard-wire-gauge copper wound on $\frac{1}{4}$ -inch mandrel.

copper and glass and to mismatches. A net power amplification of 6 was obtained with a beam current of 110 microamperes, and the over-all noise factor of the receiver of 16 decibels was improved to 14 decibels.

There was evidence of oscillations being present most of the time at wavelengths not far from the signal wavelength. These oscillations sometimes persisted down to beam currents as small as 20 microamperes.

It was further noticed that the noise factor of the tube depended significantly on the fraction of beam current coming right through to the collector; only when more than 90 per cent of the beam current was collected was there any improvement in the over-all signal-to-noise ratio. This is thought to be additional evidence of the existence of smoothing in the electron beam.

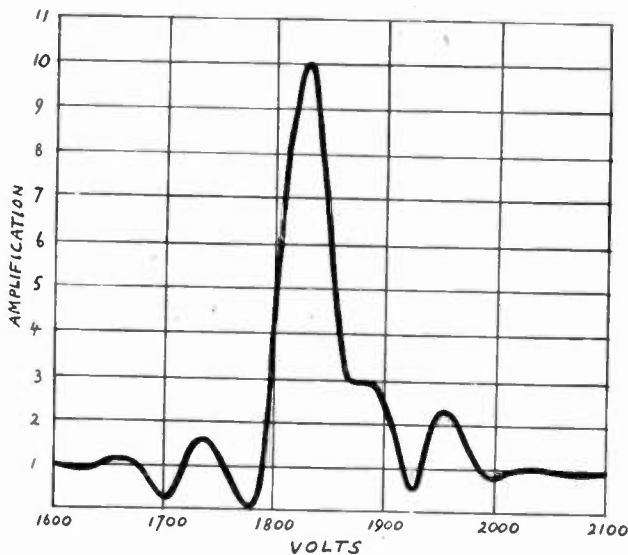

Fig. 3—Power amplification versus beam voltage.

Next, a helix of different proportions, held in a dimpled quartz tube, was tried, together with a different matching arrangement. This helix was wound of No. 22 standard-wire-gauge copper wire on a 3/16-inch mandrel with about 7 turns per centimeter, and its over-all length was 60 centimeters.

A net power amplification of 14 was obtained with a beam current of 40 microamperes coming through to the collector, out of 50 microamperes total beam current. The over-all noise factor of the receiver was then improved by 4 decibels, which corresponds to a noise factor of the tube by itself of 11 decibels. (The noise factor of the tube is defined here by the ratio of signal-to-noise at the input divided by signal-to-noise at the output.)

Since the operation of the tube depends on the fact that wave and electrons travel with about the same velocity, the beam voltage has to be controlled within narrow limits. A graph of power amplification against beam voltage is shown in Fig. 3.

The electron beam was produced by an ordinary cathode-ray-tube gun and focused by a short magnetic lens. The tube itself was surrounded by a thick soft-iron shield, periodically demagnetized to eliminate the influence of stray fields. These are extremely troublesome in the case of the traveling-wave tube, as can be expected, for the beam has to be shot, for example, through a cylinder about 70 centimeters in length and 0.45 centimeters clear internal diameter. Radial dispersion due to space charge sets a limit to the maximum current that can be passed right through to the collector, and the actual current collected is usually close to the figure given by space-charge theory.

INVESTIGATION OF THE AXIAL FIELD DISTRIBUTION IN THE HELIX

Some time was spent on an investigation of the fields existing inside a helix. A model, ten times enlarged, of an actual helix was constructed and the field distribution, excited by oscillations in the frequency interval between 375 and 120 megacycles, was investigated by means of a miniature sliding and rotating probe. The axial field at a distance r from the axis was found to agree quite well with an expression derived by Dr. H. Motz, of the Engineering Laboratory, Oxford, on the assumption that the field is quasi-static, as follows:

$$\phi(z, r) = \phi(z, r_0) \frac{I_0(2\pi r/\lambda)}{I_0(2\pi r_0/\lambda)} \sin(2\pi z/\lambda)$$

where

z = distance parallel to the axis

r_0 = mean radius of helix

λ = wavelength in the helical line

$I_0(x)$ = modified Bessel function of zero order.

An experimental plot of the axial field when the parameter $2\pi r_0/\lambda = 3.3$ is given in Fig. 4.

THEORY

The first-order theory which led to the rough calculations mentioned at the beginning of this paper was soon found to be inapplicable when the power amplification of the tube exceeded about 4, and a higher-order theory was developed based on the assumption that the complete interaction between wave and beam can be synthesized from an infinite number of actions, alternatively, of wave on beam and of beam on wave. A similar process was applied to the influence of the shot current of the electron beam on the wave. This theory neglects a number of important factors, such as the attenuation in the line and the effect of space charge, but it has been helpful in forming an estimate of the performance to be expected from a traveling-wave tube. The power amplification A is given by the following expression:

$$A = \frac{1}{9} \left[\left\{ 2 \cosh \left(\frac{\sqrt{3}}{2} z \right) + \cos \left(\frac{3}{2} z \right) \right\}^2 + \sin^2 \left(\frac{3}{2} z \right) \right] \quad (2)$$

z is a parameter given by

$$z^3 = \frac{2\pi^3 \alpha^2 Z I l^3}{V \lambda^3} \quad (3)$$

where

- α = weakening factor of axial fields
 - Z = impedance of helical line in ohms
 - I = beam current in amperes
 - l = length of tube in centimeters
 - V = beam voltage in volts
 - λ = wavelength in the helical line in centimeters.
- To obtain sufficient amplification z has to be at least 3, in which case (2) becomes approximately

$$A = \frac{1}{9} e^{\sqrt{3} \cdot z} \quad (4)$$

Similarly, for large values of z , the induced noise (voltage)² approaches

$$\frac{1}{9} \overline{V_n^2} \cdot e^{\sqrt{3} \cdot z} \cdot \frac{1}{z^2} \quad (5)$$

where

$$\overline{V_n^2} = \frac{\pi^2 \alpha^2 Z^2 l^2}{\lambda^2} \cdot 2eI\Delta f \Gamma^2 \quad (6)$$

and

e = electron charge in coulombs

Δf = bandwidth of receiver in cycles
 Γ^2 = space-charge smoothing factor of beam.

If the noise power at the input of the amplifier is put equal to $kT\Delta f$, where

k = Boltzmann's Constant

T = absolute temperature of the resistive component of the impedance into which the input is looking, then the noise factor of the tube is given by

$$N = 1 + \frac{e\Gamma^2}{kT} (2\alpha^2 Z I V^2)^{1/3} \quad (8)$$

This is seemingly independent of l , the length of the tube; however, it must not be forgotten that (8) was derived on the assumption that z is large compared with unity, and it can be shown that this assumption can only be justified for large values of l/λ .

ACKNOWLEDGMENT

The work forming the subject of this paper has been carried out for the Admiralty and is published by the permission of the Board of Admiralty. It was initiated at the Physics Department, Birmingham University, in 1942 and carried on, after a move in 1944, at the Clarendon Laboratory, Oxford University. All the investigations described in this paper were completed before the end of 1944. The writer is indebted to many people for very helpful discussions and interest. At Birmingham these were chiefly: P. B. Moon, R. R. Nimmo, J. Sayers, and G. Voglis; and at Oxford: J. H. E. Griffiths, A. H. Cooke, and B. Bleaney. Very able assistance in the actual work, experimental as well as theoretical, was given by E. E. Vickers, J. Hatton, and H. Ashcroft at various times.

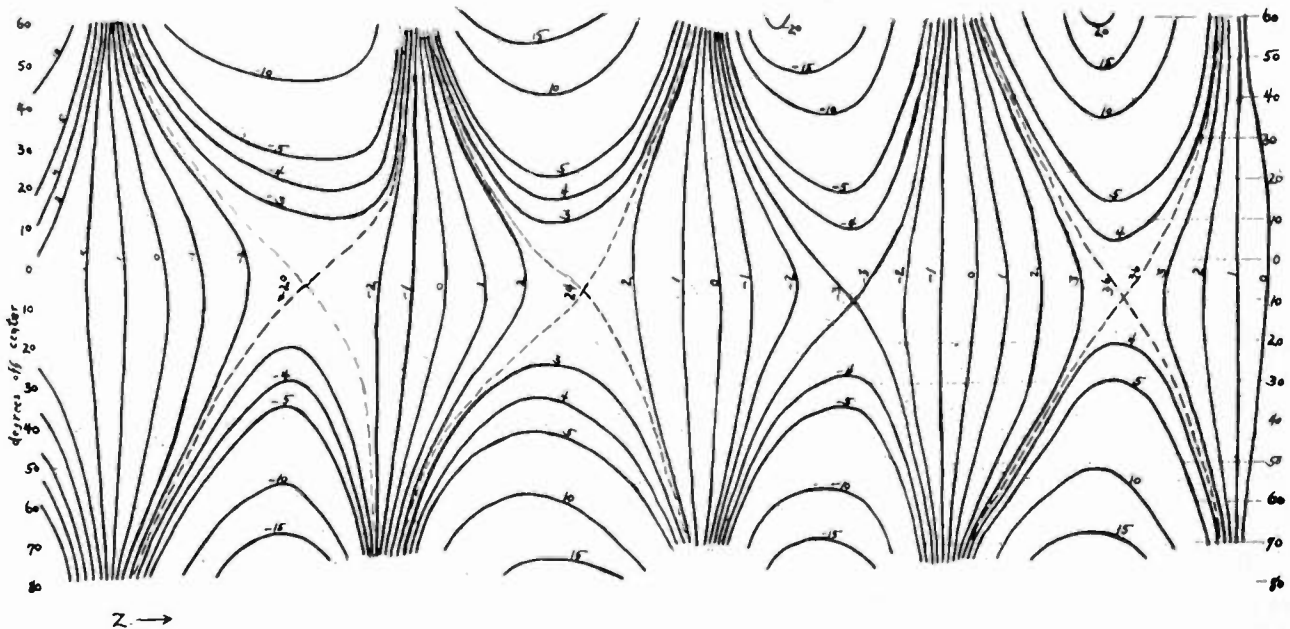

Fig. 4—Lines of equal axial field strength, $\lambda_0 = 82$ centimeters; $\lambda = 6.6$ centimeters; approximately in a plane through axis of helix. $2\pi\gamma_0/\lambda = 3.3$.

Very-High-Frequency and Ultra-High-Frequency Signal Ranges as Limited by Noise and Co-channel Interference*

EDWARD W. ALLEN, JR.†, MEMBER, I.R.E.

Summary—Theoretical ground-wave ranges for smooth-earth and standard-atmosphere conditions are shown for frequency-modulation and television broadcast services and for mobile services for frequencies between 30 and 3000 megacycles, and practical limits of antenna size and antenna gain are discussed. The effects of external noise, terrain, and penetration of buildings are considered and their probable trends with frequency are indicated, together with the need for comprehensive data for their evaluation.

A comparison is made between theoretical ground-wave and tropospheric ranges computed for 50 megacycles and the results of continuous field-intensity measurements made at various distances, from which it is concluded that theoretical ground-wave curves can be used as reliable measures of service ranges. Theoretical ground-wave curves are found not to be direct measures of probable ranges of tropospheric interference and it is suggested that a factor of 2 be applied to the station-separation distances obtained from such curves at 50 megacycles, with the probability of larger factors for higher frequencies.

Two families of curves, one for sporadic-E-layer and one for F-layer transmission, showing skip distances as a function of frequency for the frequency band under consideration, are derived from the National Bureau of Standards measurements of layer characteristics at Washington, D. C., for the purpose of estimating the occurrence of interference from one other co-channel station. The effect of increasing the number of stations is investigated, and estimates of five times the single-station interference for sporadic-E-layer and three times for F-layer interference are made.

Combining the above factors, an estimate is made of comparative service areas at 46 and 105 megacycles for frequency-modulation broadcast stations of 1 kilowatt and 340 kilowatts effective power, and the reduction in area due to the effects of external noise, hills, and station interference by bursts and sporadic-E- and F-layer propagation.

THE ABOVE subject is extremely broad, and no exhaustive treatment can be given in this paper. However, an attempt will be made to summarize the various major factors affecting radio wave propagation in the frequency range from 30 to 3000 megacycles to the extent they are known or can be predicted at the present time, and to estimate the probable service and interference ranges for broadcast and land mobile serv-

* Decimal classification: R112XR271. Original manuscript received by the Institute, February 15, 1945; revised manuscript received, April 7, 1946. Presented, Winter Technical Meeting, New York, N. Y., January 25, 1945.

The paper was originally intended as a joint paper by K. A. Norton, Office of the Chief Signal Officer, War Department, and E. W. Allen, Jr., Federal Communications Commission. A large part of the material was prepared jointly, and some of the data and conclusions were entered into the record of the Federal Communications Commission hearing on frequency allocations, Docket 6651, by Mr. Norton. He has been unable, however, to devote an appreciable amount of time to the final preparation of the paper and has insisted that the presently indicated sole authorship is proper. This has been agreed to, with some reluctance, but grateful acknowledgment is made of the valuable participation of Mr. Norton in the preparation and interpretation of data and of his many helpful suggestions as to its form of presentation.

† Federal Communications Commission, Washington 25, D. C.

ices within this part of the frequency spectrum. The theoretical ground-wave service ranges with simple antennas are first considered and the possibilities of increasing the ranges by the use of transmitting- and receiving-antenna gain are discussed. Factors which may modify the theoretical ranges are then considered in the following order: external noise levels, terrain, tropospheric-propagation effects, long-distance F layer, sporadic-E layer, and burst interference.

GROUND-WAVE RANGES

Theoretical ground-wave ranges for a smooth spherical earth of average conductivity have been computed¹ for frequency-modulation and television broadcast stations, land-station-to-mobile ranges, and mobile-to-mobile ranges throughout the frequency band under

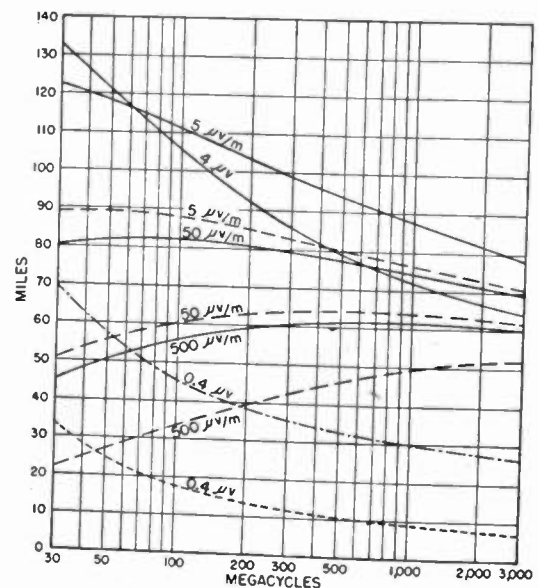

Fig. 1—The variation with frequency of ground-wave service and interference ranges.

consideration, and are plotted in Fig. 1. The solid curves show the distances in miles versus frequency to the 500-, 50-, and 5-microvolt-per-meter field-intensity contours, and to the 4-microvolt rural-receiver-input contour for broadcast stations having an effective radiated power of 50 kilowatts. The dashed curves show the distances to the 500-, 50-, and 5-microvolt-per-meter field-intensity contours of a 1-kilowatt broadcast station. For the broadcast stations the transmitting

¹ K. A. Norton, "The calculation of ground-wave field intensity over a finitely conducting spherical earth," Proc. I.R.E., vol. 29, pp. 623-639; December, 1941.

antennas are horizontal half-wave dipoles located at 1000 feet above the surrounding area. The receiving antennas are at a height of 30 feet, and for the 4-microvolt receiver-input curve a half-wave dipole antenna and a receiver input impedance of 70 ohms are assumed. The distance ranges for 250-watt land-to-mobile operation and 50-watt mobile-to-mobile operation are shown by the dash-dot and the dotted curves, respectively. For the land station, a vertical half-wave dipole 100 feet above ground is taken as a typical antenna. Mobile units are assumed to use a quarter-wave vertical antenna mounted in the center of the top of the vehicle at 6 feet above ground, with a 70-ohm receiver input.

The theoretical 4-microvolt rural-broadcast-receiver contour assumes that reception is limited by 1 microvolt of set noise, over which 2 microvolts of actual signal on the set terminals will provide a useful signal. This allows for a 6-decibel attenuation from the theoretical due to terrain and losses in the receiving antenna lead-in. It is evident that the indicated ranges can be obtained only in very quiet rural areas where the external noise and undesired-signal field strengths are less than one half as strong as the desired signal. Also, a good receiver with a low noise level and a 2-to-1 noise and co-channel rejection is required. While the assumption of a higher required receiver-input voltage will reduce the absolute values of the service ranges accordingly, the relative ranges with respect to frequency are not affected appreciably. The 0.4-microvolt mobile-receiver contours likewise provide for an additional attenuation of 6 decibels below the theoretical, and assume that 0.2 microvolts of signal at the set terminals is sufficient to override set noise of 0.1 microvolt.

The theoretical curves show that distances to the 500-microvolt-per-meter service contour of the 1-kilowatt broadcast station increase with frequency throughout the band, while for 50 kilowatts the distances increase up to about 1000 megacycles, after which a slight decrease occurs. For the 50-microvolt-per-meter service contour the change is less marked with frequency, a slight increase in distance being noted for the 1-kilowatt station up to 500 megacycles, while the maximum distance for the 50-kilowatt station occurs at about 70 to 80 megacycles. The maximum range of the 5-microvolt-per-meter interference contour occurs at 50 megacycles and decreases thereafter for the 1-kilowatt station but decreases with frequency throughout the band for a 50-kilowatt station. In general, it may be said that the protected service ranges increase and the interference range decreases with frequency. In contrast, the rural frequency-modulation broadcast range and the mobile service ranges decrease rather rapidly with frequency.

EFFECTS OF ANTENNA GAIN

If a road clearance of 10 feet is assumed for the mobile units, it will not be possible to use a top-mounted quarter-wave antenna at frequencies below 60 megacycles. Aside from directional effects, however, a bumper-

mounted antenna will be just about as effective at these frequencies as a top-mounted antenna, and will not disturb the theoretical ranges materially. Top-mounted half-wave antennas should be practical beginning at about 150 megacycles and multiple-bay antennas from 300 megacycles upward. Use of the higher frequencies will also make other types of high-gain antennas practicable. Since the signal-to-external noise ratio will vary directly with the transmitting-antenna field gain and the signal-to-set-noise ratio will vary as the product of the transmitting- and receiving-antenna field gains, it is probable that high-gain mobile antennas will be adopted above 300 megacycles in order to increase the limited range of mobile-to-mobile contact.

It will be noted that the 4-microvolt rural contour crosses the 50-microvolt-per-meter contour of a 50-kilowatt broadcast station at 600 megacycles. Consequently, at higher frequencies it appears to be expedient to protect a higher contour, or set noise rather than co-channel station interference will be the limiting factor. An alternative to increasing the contour is to assume the use of a high-gain antenna at the receiving location. Antennas with a field gain of 2.5 or more appear to be of a practical size for home use at 100 megacycles and above.²

The broadcast ranges and land-station-to-mobile range can be increased by increase of power, antenna gain, or antenna height. Theoretically, the preferred method is by increasing antenna height, as this results in an increased service range without a material increase in the sky-wave and tropospheric interference. Next in order of preference is antenna gain, as this tends to discriminate against high-angle radiation which may cause interference. However, available transmitter sites and economic factors generally result in a balance which is not optimum from the standpoint of minimizing interference. There are also certain limitations on the amount of antenna gain which can be used. First, there are practical limitations which, at frequencies below 50 megacycles, appear to limit the power gain to about a factor of 10 for a turnstile antenna. Second, the gain in the horizontal plane cannot be so great that the antenna does not provide a sufficient field in the area below the antenna.

Fig. 2 shows the results of a theoretical investigation to determine the probable limits on gain from the latter cause. In Fig. 2, the ordinates represent relative field strengths and the abscissas are the angles of radiation ϕ , 0 degrees being in the horizontal direction and 90 degrees straight downward or upward. The antennas are assumed to be elevated above an urban area which requires a signal level of 1000 microvolts per meter to overcome the ambient noise. The strength of the radiation in a particular direction which is required to produce a field of 1000 microvolts per meter at the receiving antenna is dependent upon the distance between the transmitting and receiving antennas and upon the

² "A.R.R.L. Antenna Handbook" ("Parasitic arrays"); American Radio Relay League, West Hartford, Connecticut, 1939, p. 65.

relative phases of the direct and ground-reflected waves. If we let R_ϕ be the ground-reflection coefficient at any angle ϕ and H be the antenna height, the maximum and minimum limits of the required radiation E_ϕ at the angle ϕ from the transmitting antenna to furnish a field strength E at the receiving antenna are given by the equations $E = E_\phi(1 + R_\phi)(\sin \phi)/H$, for receiving sites in which the direct and ground-reflected waves reinforce each other, and $E = E_\phi(1 - R_\phi)(\sin \phi)/H$, in which they

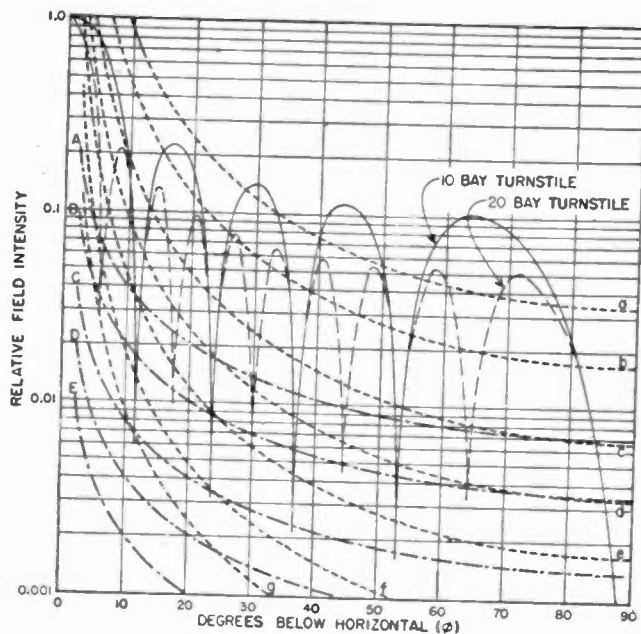

Fig. 2—Effect of vertical directivity of elevated very-high-frequency broadcast antennas on proximate service fields.

tend to cancel each other. The first formula yields the family of dot-dash curves (*A, B, C, D, E*) and the second formula yields the dashed curves (*a, b, c, d, e, f, g*) for an effective radiated power of 1 kilowatt (137.6-microvolt-per-meter free-space field at one mile) and antenna heights of 10,000, 5000, 2000, 1000, 500, 200, and 100 feet. The curves are also applicable to other powers and antenna heights in accordance with Table I. Typical conditions of effective radiated power and antenna height are confined to curves *E* and below.

Superposed on the limiting directivity curves are vertical-directivity patterns for a 10-bay turnstile (solid) and for a 20-bay turnstile (dashed) antenna. It is believed that we may neglect the deep nulls shown by the calculated patterns at large angles from the horizontal, as but a slight current unbalance in the separate bays is required to fill them materially. The zones around the antenna corresponding to these nulls will also tend to fill in, owing to reflections and reradiation from buildings and other objects. The nulls at small angles of 10 degrees or less require a much larger current unbalance to fill in, but for high antennas the radiation in this part of the pattern may be directed beyond the area of high noise level. At the lower end of the frequency band under consideration the direct and ground-reflected waves do not cancel for small angles, so that the solid lines

more nearly represent the limiting conditions. The limits are well below the 20-bay pattern, and it may well be that the limitations on directivity will be practical

TABLE I
ANTENNA HEIGHTS VERSUS EFFECTIVE RADIATED POWER
FOR 1-MICROVOLT-PER-METER FIELD

Curve	1 Kilowatt	25 Kilowatts	100 Kilowatts	400 Kilowatts
A	10,000	50,000	100,000	200,000
B	5,000	25,000	50,000	100,000
C	2,000	10,000	20,000	40,000
D	1,000	5,000	10,000	20,000
E	500	2,500	5,000	10,000
F	200	1,000	2,000	4,000
G	100	500	1,000	2,000

rather than theoretical throughout the band under consideration. However, as the frequency increases there will be an opportunity for employing types of transmitting antennas other than the turnstile to which present practical difficulties may not apply.

EXTERNAL NOISE LEVELS

Having compared theoretical ground-wave service and interference ranges for the band under consideration, the major factors which are expected to modify the theoretical predictions will be considered in the following order: external noise levels, terrain, tropospheric-propagation effects, long-distance *F*-layer and sporadic-*E*-layer interference, and bursts.

The 50-microvolt-per-meter contour for frequency modulation and the 500-microvolt-per-meter contour for television were chosen so as to give the required protection from average values of external noise encountered in rural areas. These contours may therefore be modified upward or downward in accordance with the experience as to noise levels to be encountered on the various frequencies.³

The 4-microvolt contour is based upon the assumption that the external noise level is so low that the internal receiving-set noise is the limiting factor. The presence of external noise of sufficient value to become the limiting factor rather than set noise will change the slope of the curve to conform more nearly to the slopes of the 5-microvolt-per-meter and 50-microvolt-per-meter curves, the absolute distances being dependent upon the external noise levels encountered at various frequencies. External noise will likewise reduce the mobile service ranges to a greater extent at lower frequencies. However, present information indicates that the residual service ranges will continue to be considerably greater at the lower end of the band.

TERRAIN

Irregularities in terrain, such as hills and buildings, are expected to cast deeper shadows at the higher frequencies, but much work remains to be done to

³ R. W. George, "Field strength of motorcar ignition between 40 and 450 megacycles," Proc. I.R.E., vol. 28, pp. 409-412; September, 1940.

evaluate these effects. This is believed to be especially important for mobile services where mobile transmitting antennas, and frequently the land-station antennas, are not elevated above immediately surrounding buildings. For elevated broadcast antennas the shadows will tend to fill in behind buildings by reason of reflections from buildings beyond the shadow. Shadows behind hills in rural areas probably will not fill in as well as behind city buildings, and it is expected that somewhat more difficulty may be found in serving hilly areas at the higher frequencies.

There is evidence which indicates that frequencies around 100 megacycles do not penetrate buildings and other structures as well as do frequencies at the lower end of the band.⁴ Whether this trend will continue with increasing frequency is not known, but it is quite possible that, when the wavelengths become short in comparison to openings which are surrounded by closed conducting circuits (steel building skeletons, metal window and door frames, etc.), the penetration may improve with increasing frequency. The poorer penetration at some frequencies will affect not only the field strengths of the desired signals but also the field strengths of undesired signals and of noise, if the noise source is removed some distance from the receiving point. It does not appear to be possible to predict what effect differences in penetration will have upon the ratios of desired to undesired signal and signal to external noise which are obtainable with an inside antenna at typical receiver locations. The only answer lies in making comprehensive surveys of signal and noise field strengths at receiver locations. If, as a result of such surveys, it is established that poorer penetration exists at some frequencies but that signal-to-external-noise ratios are not appreciably affected thereby, it is evident that at some locations with low signal intensity it will be necessary to use an outside antenna to overcome receiver noise for a frequency with poor penetration, whereas an inside antenna would be usable for a frequency with good penetration. Only quantitative measurements can establish whether this condition will occur within the protected contours at any given frequency.

TROPOSPHERIC EFFECTS

Present knowledge of tropospheric effects does not extend over much of the band under consideration. Continuous recordings of frequency-modulation and television stations have been made by the Federal Communications Commission over a period of about two years. A year's recordings of frequency-modulation stations made at four distances were analyzed to determine the fields exceeded for 0, 10, 50, and 90 per cent of the time, the 100-per cent value being below

noise level in each case. These fields were reduced to equivalent values for 1 kilowatt radiated from a half-wave antenna at 500 feet and plotted at the proper distances in relation to K. A. Norton's theoretical ground-wave and tropospheric-wave curves in Fig. 3. The theoretical ground-wave curves agree with the measured

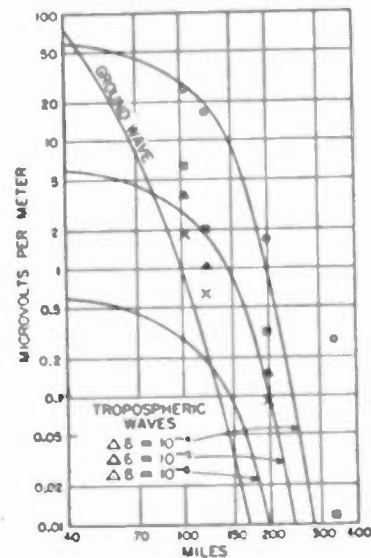

Fig. 3—Tropospheric-wave and ground-wave field intensity versus distance.

Frequency: 50 megacycles
Antenna heights: 500 feet; 300 feet
Polarization: horizontal
Power: 1 kilowatt

Ground constants $\left\{ \begin{array}{l} \sigma = 5 \times 10^{-11} \text{ electromagnetic units} \\ \epsilon = 15 \end{array} \right.$

Tropospheric layer height: 1.5 kilometers
Measured 50 per cent hourly values, 1943-1944:

- Maximum value
- ◻ Value exceeded 10 per cent of time
- △ Value exceeded 50 per cent of time
- × Value exceeded 90 per cent of time

values exceeded for more than 90 per cent of the time, and appear to be a relatively reliable measure of service ranges. The maximum measured values greatly exceed the theoretical, so that, in order to protect adjacent stations, the distance to the 5-microvolt-per-meter interference contour may need to be doubled. Measured values at 72 megacycles were also found to verify the theoretical service ranges. The fields were somewhat more variable than at 46 megacycles, so that the interference range should be increased by something more than a factor of 2.⁵

Quantitative data similar to the above are not available on higher frequencies. The experiences of amateurs on 112, 224, and 400 megacycles represent probably the best published data. The 112-megacycle reports are in agreement with the trend indicated at 44 and 72 megacycles; namely, the greater variability of the tropospheric effects with increasing frequency and the necessity for greater station separation to prevent interference due to tropospheric signals. Under favorable tropospheric conditions and with high transmitter and/or receiver locations, amateur stations have been

⁴ L. F. Jones, "A study of the propagation of wavelengths between three and eight meters," *Proc. I.R.E.*, vol. 21, pp. 349-386; March, 1933.

R. S. Holmes and A. H. Turner, "An urban field strength survey at thirty and one hundred megacycles," *Proc. I.R.E.*, vol. 24, pp. 755-770; May, 1936.

⁵ "Report on VHF field strength measurements 1943-1944," Federal Communications Commission Mimeo 77785; Federal Communications Commission Docket 6651, Exhibit No. 4.

heard over distances between 350 and 400 miles at 112 megacycles.⁶ The long-distance-contact records are less at 224 and 400 megacycles, but this may be due to the lesser activity and to equipment development rather than to a change in the trend of tropospheric effects.

F-LAYER INTERFERENCE

The best data on this subject are the regular ionosphere measurements which have been made for many years at the National Bureau of Standards' laboratories near Washington, D. C., and more recently at a very

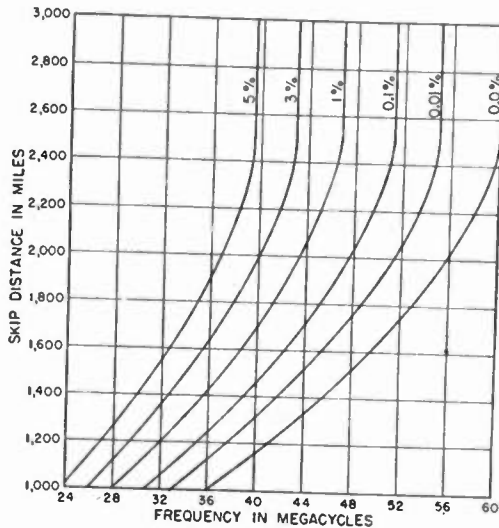

Fig. 4—*F*-layer interference: skip distance versus frequency for various percentages of the listening hours, six A.M. to midnight.

large number of other points throughout the world. These recent measurements have been made by the Interservice Radio Propagation Laboratory under the joint control of the Army and Navy. The Washington measurements have been made throughout a period including the maximum of one phase of the sunspot cycle. The published data⁷ for Washington of monthly average values during the months October through March of the three winters centered about the previous sunspot maximum (1936–37, 1937–38, and 1938–39) were corrected for daily variations and analyzed so as to express critical frequencies as a percentage of the listening hours, 6 A.M. to midnight, solar time. Using methods formulated by the Bureau of Standards, the critical frequencies (maximum frequency reflected at vertical incidence) were converted to values of maximum usable frequency versus distance. These data are plotted in Fig. 4.

Assume a frequency-modulation station operating on 44 megacycles during the maximum of the last sunspot cycle. Then, according to Fig. 4, *F*-layer reflections would not have been expected at distances less than 1320 miles. However, *F*-layer transmissions would have been expected at all distances greater than 2060 miles for 1 per cent or more of the listening hours or for

⁶ E. P. Tilton, "On the ultrahighs," *QST*, vol. 25, pp. 54–55; October, 1941.

⁷ Published in Proc. I.R.E. for the periods in question.

a total of 723 hours during the last sunspot cycle. On a frequency higher than 60 megacycles, however, *F*-layer transmissions would not have been expected at any distance provided the transmission path had its midpoint near Washington, D. C. It has been found that the ionosphere directly over many of the other ionospheric recording stations would be expected to support much higher-frequency transmissions than the ionosphere over Washington. It is estimated that the frequencies shown in Fig. 4 should be increased by 15 per cent when considering conditions applicable to interference throughout the United States. In other words, the present 40-megacycle marking on the horizontal scale should be renumbered 46 megacycles, the 60-megacycle marking should be 69 megacycles, etc. The foregoing analysis of conditions during the last sunspot cycle will not apply strictly to future conditions, since the numbers and intensities of the sunspots vary from cycle to cycle. There is also a reversal in sunspot polarity on alternate cycles, which may have some effect.

Fig. 4 applies to the estimated interference via the *F*-layer from a single co-channel station. To what extent will an increase in the number of stations on a single channel increase the expected time of interference? Assume a 46-megacycle station in New York City with six co-channel stations of about the same power located at Athens, London, Georgetown, Bogota, San Francisco, and Honolulu. Fig. 5 is a section of a world map showing the paths under consideration. The Georgetown, Bogota, and San Francisco paths are 2500 miles in length, and transmission is assumed via one reflection point at the *F* layer. The Athens, London, and Honolulu paths involve two reflections at the layer. For simplicity's sake, the assumption will be made that the *F*-layer conditions do not vary between the latitudes represented by the northernmost reflection or control⁸ point (2) and the southernmost control point (4). This is not in accordance with the facts but will provide an approximation which is believed to be on the conservative side, if average conditions for the United States are used. The vertical lines on the map are meridians of longitude at 15-degree intervals, so that they are separated by one hour's difference in time. Each meridian is marked at the bottom with the New York time corresponding to noon at the meridian. Assume a winter day near the sunspot maximum on which four hours of interference would be experienced from one station at 2500 miles, beginning at noon at the control point and continuing until 4 P.M. at the control point. For the Athens-New York circuit, the interference at New York would begin at noon at

⁸ This is not the "control-point" method of predicting propagation via *F* layer, in which points 1250 miles distant from the transmitter and receiver determine the maximum usable frequency for paths greater than 2500 miles in length. The control-point method and the effects of latitude on maximum usable frequencies were classified material at the time of presentation of the paper and could not be discussed in detail.

[This footnote was added by the author subsequent to completion of the discussion accompanying this paper.—Editor]

the westernmost of the two control points (1) and end at 4 P.M. local time at the easternmost point. These times correspond to about 10:20 and 10:50 New York time, yielding 30 minutes of interference as shown by the duration chart at the bottom of Fig. 5. The duration of interference can be similarly estimated for the other paths, which when totaled gives about 7½ hours of interference as against 4 hours for one station. Similar analyses for other periods of expected interference from a single station will show that the ratio of multistation to single-station interference increases somewhat with decreasing times of single-station interference. This is expected to increase the ratio slightly when estimating the over-all percentage of time throughout the sunspot cycle, so that the multistation interference may finally be about three times the estimated single-station interference.

SPORADIC-E-LAYER INTERFERENCE

Again the best data available for determining the practical importance of these transmissions at various frequencies are the systematic observations of the ionosphere made by the Interservice Radio Propaga-

particular year was chosen for analysis since it was for this year that the sporadic-E-layer field intensities of station WGTR were measured at several Federal Communications Commission monitoring stations. An analysis of similar data obtained at two other ionosphere stations at widely separated points in the United States and for the same period of time yielded very nearly

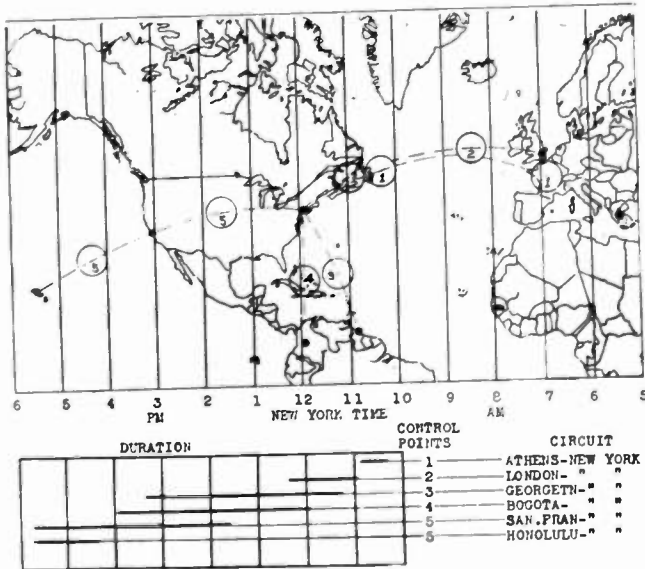

Fig. 5—Estimated increase in F-layer interference due to a plurality of co-channel stations.

tion Laboratory. Fig. 6 shows sporadic-E-layer skip distance as a function of frequency for various percentages of the listening hours during the year September, 1943, through August, 1944, estimated from vertical-incidence measurements of sporadic-E-layer critical frequencies made near Washington, D. C., on frequencies of 3, 5, and 7 megacycles. The curves were arrived at by extrapolating for vertical incidence frequencies above 7 megacycles, in accordance with the logarithmic decrease in occurrence with frequency as determined by the measurements at 3, 5, and 7 megacycles, and applying the standard method of computing skip distances for normal E-layer transmission. This

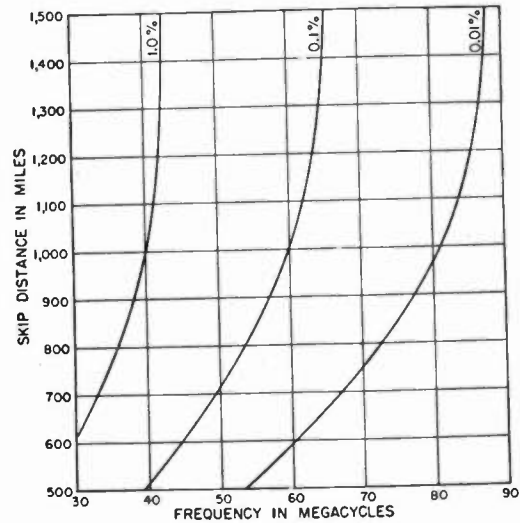

Fig. 6—Sporadic-E-layer interference: skip distance versus frequency for various percentages of the listening hours, six A.M. to midnight.

identical results. The Washington data, which are available throughout one phase of the sunspot cycle, did not indicate any systematic variations throughout this last cycle, but did indicate that the conditions for the period analyzed were about average. Consequently, Fig. 6 is believed to represent a reasonably good estimate of the percentage of time that a single frequency-modulation or television station would be expected to interfere with another similar station on the same frequency at the distances shown. At 43 megacycles interference is expected between 0.1 and 1.0 per cent of the time for distances between 600 and 1400 miles. The field intensities at which interference occurs at these percentages of time are treated in a succeeding section.

In an effort to obtain an estimate of the effect of increasing the numbers of stations on the occurrence of sporadic-E interference, Fig. 7 was prepared. This is a map of the central and eastern parts of the United States on which has been located the E-layer reflection points (1), (2), (3), (4), for the paths over which station WGTR was measured at the Federal Communications Commission monitoring stations at Atlanta, Laurel, Allegan, and Grand Island. Reflection points (A) and (I) are also shown for paths by which interference might be caused to a Kansas City station by stations located in nine cities 800 miles from Kansas City and 300 miles or more from the adjacent cities. A reliable estimate of the interference to be expected at Kansas City under the assumed conditions will require an extended analysis of available data which has not been possible to date, together with further knowledge of the mechanism

of sporadic-*E* reflections. However, a simplified analysis may permit an educated guess as to what may be expected.

Over the period September, 1943, through August, 1944, sporadic-*E* fields of 25 microvolts per meter were recorded for 1.71 per cent of the time for path (1), 0.05 per cent for path (2), 0.39 per cent for path (3), and 0.55 per cent for path (4). There was some overlap in

over each path, is at an average latitude. Interference from ten to fifteen additional stations spaced at other distances from Kansas City will, of course, add materially to the over-all time of expected interference. Considering all the factors, it appears probable that a midwestern station with twenty co-channel stations may experience interference amounting to five or more times the estimated interference for a single path.



Fig. 7—Estimated increase in sporadic-*E*-layer interference due to a plurality of co-channel stations.

the times during which transmission occurred, the combined time being 2.23 per cent for all paths, against 2.70 per cent for the arithmetic sum. Thus three additional paths with a total of 0.99 per cent added 0.52 per cent to the occurrence over path (1). This appears to indicate that three additional paths with control points of comparable distance from point (1) and each having 1.71 per cent would have raised the multipath interference to 4.40 per cent. Applying the ratio to the Kansas City case of nine paths, each over a distance likely to give 1.71 per cent occurrence of sporadic *E*, we obtain a total of 8.89 per cent. Considered solely from the standpoint of probability, the ratio 52/99 which applies to the case of three additional stations with small percentages of interference is too high for eight additional stations each causing a larger percentage of interference, assuming comparable spacings between control points. Increased control-point spacing in any direction will tend to increase the ratio because of the apparently random nature of the sporadic-*E*-layer at times.⁶ Increased spacing east and west should increase the ratio owing to systematic diurnal effects. For the present it will be assumed that latitude effects are canceled, since control point (1), which has been used to estimate quantitatively the interference

SPORADIC-*E*- AND *F*-LAYER FIELD STRENGTHS

Fig. 8 shows curves of the variation of tropospheric, sporadic-*E*-layer, and *F*-layer field strengths with time and distance for station WGTR, Paxton, Massachusetts, at 44.3 megacycles. The tropospheric curves shown in Fig. 8 were prepared from the data used in Fig. 3, and their effect on theoretical service and interference ranges has already been discussed in connection with that figure. The *F*-layer curve is a theoretical curve of the variation of *F*-layer median field intensities, and the intensity at any distance approximates the free-space field at one mile, 2540 millivolts per meter,

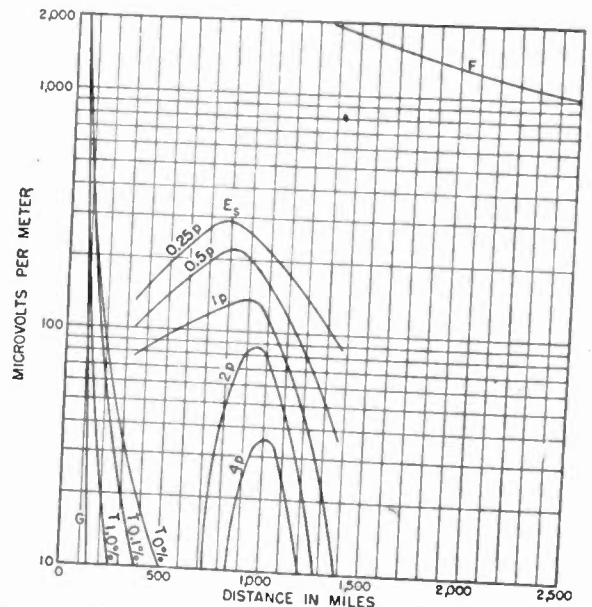

Fig. 8—Ground-wave, tropospheric wave, sporadic-*E*-layer sky-wave, and *F*-layer sky-wave field intensities for frequency-modulation station WGTR at Paxton, Massachusetts.

Free-space field at one mile = 2540 microvolts per meter
Antenna height = 1600 feet.

G = Ground wave

$\left. \begin{array}{l} T_{0\%} \\ T_{0.1\%} \\ T_{1\%} \end{array} \right\}$ = Tropospheric-wave field intensities exceeded for the percentages of time indicated

$E_s(n\%)$ = Sporadic-*E*-layer sky-wave field intensities exceeded for n times the percentages of the time shown in Fig. 6

F = *F*-layer sky-wave intensity

divided by the distance in miles. For sporadic-*E* fields, the data recorded at each of the four recording points previously mentioned were analyzed to determine the percentages of time during which the fields exceeded various intensity levels. From these data and the skip-distance curves of Fig. 6, a family of curves *E_s* were computed. Each curve is labeled with a factor by which

the percentages of time shown by Fig. 6 must be multiplied in order to obtain the percentages of time for which the indicated intensities occur. Thus the curve $1p$ shows expected field strengths versus distance for the percentages of time predicted by the curves of Fig. 6, the maximum occurring at about 900 miles. For lesser percentages of time ($0.25p$ and $0.5p$) higher field strengths will occur and for greater percentages of the time ($2p$ and $4p$) weaker fields will occur at a given distance.

INTERFERENCE FROM BURSTS

The measurements made at the same four Federal Communications Commission monitoring stations from several high-powered frequency-modulation stations over a two-year period indicate that negligible interference will be caused to the 50-microvolt-per-meter protected contour from this source.⁵ Although not entirely free of this interference, reasonably good service may be possible to about the 5- or 10-microvolt-per-meter contour. If the bursts are caused by meteoric ionization, which is the present assumption, the numbers, amplitudes, and average durations should decrease with frequency. This is in agreement with such observations as we have made on the aural channels of television stations and with observations of other persons at frequencies down to about 10 megacycles.^{9,10}

COMPARISON OF SERVICE AREAS AT 46 AND 105 MEGACYCLES

Having considered individually certain factors which affect the service ranges to be expected in the band under consideration, the combined effect of these factors on frequency-modulation broadcast service areas will now be considered. Fig. 9 presents a comparison of the service areas to be expected at 46 and 105 megacycles for transmitting stations having a 500-foot antenna. The receiving antennas are at 30 feet in each case, and a 6-decibel reduction in the received field is allowed for irregularities in terrain, line loss, etc.

The figures in the top row show the theoretical coverage over smooth earth for a large station with an effective radiated power of 340 kilowatts. The inner circle of each figure represents the primary service area to the 50-microvolt-per-meter contour, within which it is desired to protect the signal from interference by other stations. The primary area at 46 megacycles is slightly larger than at 105 megacycles. The outer circle at 46 megacycles and the middle circle at 105 megacycles represent the service limits obtainable in very quiet rural areas with external noise sufficiently low so that set noise is the limiting factor, with good receivers capable

of delivering a usable signal with a 2-microvolt input, and with negligible interference from other stations. The extra 46-megacycle area at 105 megacycles. By the use of multiple-element Yagi receiving antennas at 105 megacycles, an extra rural area approximating three fourths of the 46-megacycle rural area may be obtained. The middle row of figures gives a similar comparison for a station with an effective radiated power of 1 kilowatt.

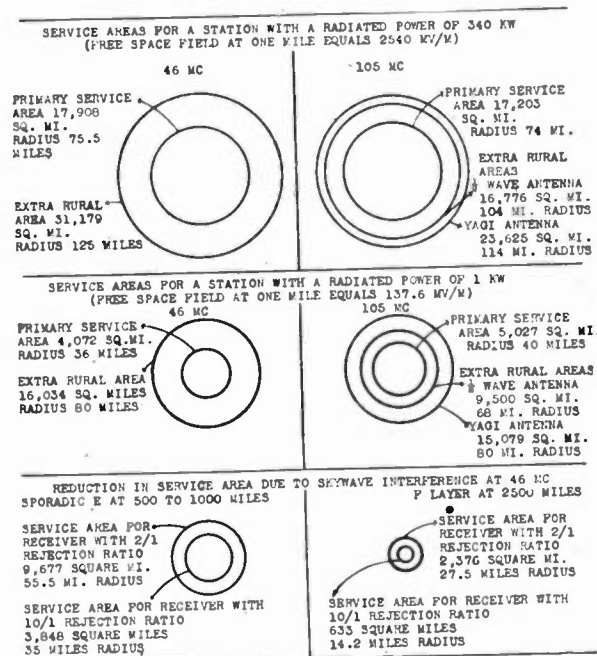

Fig. 9—Comparison of frequency-modulation service areas available on 46 and 105 megacycles.

In this case, the 105-megacycle primary area is the larger, with the total area at 46 megacycles equal in size to the 105-megacycle area for Yagi receiving antennas.

Owing to shadow effects, coverage within the primary and rural areas is likely to be somewhat more spotty at 105 megacycles than at 46 megacycles. External noise levels will also eliminate large portions of the rural areas, and external noise of a given intensity will become effective against the areas obtainable with the Yagi antenna before it affects the areas obtainable with a half-wave receiving antenna. The tendency to reduce the 105-megacycle area to a greater extent should be offset somewhat, but not completely, by the decrease in external noise level with frequency. The assignment of other stations to the same channel will limit the useful area to the 50-microvolt-per-meter contour, if they are close. If the co-channel stations are distant, the extra rural areas will be affected by burst interference at 46 megacycles and probably, to a lesser extent, at 105 megacycles. At 46 megacycles sporadic *E*-layer and *F*-layer interference from distant stations is expected to affect both primary and rural areas seriously at certain times.

⁹ J. A. Pierce, "Abnormal ionization in the E Region of the ionosphere," *Proc. I.R.E.*, vol. 26, pp. 892-908; July, 1938.

¹⁰ T. L. Eckersley, "Analysis of the effect of scattering in radio transmission," *Jour. I. E. E. (London)*, Wireless Section, vol. 15, pp. 74-93; June, 1940.

Referring to the left figure of the bottom row on Fig. 9, residual areas for a broadcast station are shown for conditions of sporadic-*E* interference which are expected for 0.1 per cent of the time from a single co-channel station of equal power or for 0.5 per cent or more of the time for a fully utilized channel.¹¹ The larger station sustains a reduction in its primary area of 46 per cent for good receivers with a 2-to-1 rejection ratio and 78 per cent for an average receiver with a 10-to-1 rejection ratio. The 1-kilowatt station sustains a reduction in primary area of 5 per cent for an average receiver. A good receiver will still give service beyond the 50-microvolt-per-meter contour for these conditions of interference and will permit reduction in service area for an estimated 0.05 per cent of the time for a fully utilized channel.

¹¹ The estimated interference of 0.5 per cent of the time for full channel occupancy was subsequently realized to be too conservative for the following reasons. The interfering field intensity required to limit the service to the indicated contours is 100 microvolts per meter when the desired and undesired station each have 340 kilowatts effective radiated power. This corresponds to the level exceeded by the 1p curve of Fig. 8 between distances of 600 to 1000 miles. The percentages of time during which this will occur for individual stations located at different distances is determined by reference to Fig. 6. At 46 megacycles the percentages of time range from 0.1 per cent at 625 miles to 0.5 per cent at 1000 miles for a single interfering station, as determined by logarithmic interpolation between the curves. Increasing the number of stations per channel to about twenty has been estimated to increase the total interference to a station in the Midwest to about five times the interference from a single station at a distance of 800 to 900 miles, which gives a total of about 2 per cent of the time during which the service will be limited to the designated area.

The effect of *F*-layer sky-wave interference is shown in the right figure of the bottom row on Fig. 9. At 46 megacycles this is expected to occur about 5 per cent of the time for a single co-channel station, with an increase to 10 or 15 per cent for a fully utilized channel. The occurrence of this condition at 105 megacycles is expected to be negligible. The large station suffers reductions in area of 86 and 96 per cent for good and average receivers, respectively. The corresponding reductions for the small station are 41 and 84 per cent, respectively. In order to reduce the sky waves from stations separated by 2500 miles to the point where mutual protection will be given to the best receiver at the 50-microvolt-per-meter contour, the effective radiated power of each must be limited to 200 watts.

In addition to contrasting the expected conditions of interference on 46 and 105 megacycles, Fig. 9 shows the importance of using a receiver which is capable of rejecting a strong interfering signal. Tests on several commercial models of frequency-modulation receivers have indicated that single-limited models may require a desired signal more than ten times as strong as the undesired in order to obtain an acceptable output, while the best double-limited receiver tested required about three to one. The service areas obtainable with the good receiver having a 2-to-1 rejection ratio are therefore larger than are obtainable with any of the receivers tested.

Discussion

C. M. Jansky:¹ The paper, "Very-High-Frequency and Ultra-High-Frequency Signal Ranges as Limited by Noise and Co-channel Interference," published under the name of E. W. Allen, Jr., is one of the most important ever presented to The Institute of Radio Engineers. This is because it constitutes a presentation to the scientific world of a large portion of the technical evidence upon which rested the decision of the Federal Communications Commission to uproot frequency-modulation broadcasting from the allocation it previously had in a band of frequencies in the vicinity of 50 megacycles and to assign this service instead to a band in the vicinity of 100 megacycles.

The writer served as chairman of Panel 5 on frequency-modulation broadcasting of the Radio Technical Planning Board (RTPB) which was charged with the responsibility of preparing and presenting to the Federal Communications Commission the radio industry's proposal with respect to the technical requirements for an adequate frequency-modulation broadcasting allocation structure. The recommendation of the industry, supported almost unanimously in RTPB, was to the effect that the frequency-modulation broadcast band

should be expanded upward from its original position in the vicinity of 50 megacycles. The decision of the Commission was to move the band to frequencies in the vicinity of 100 megacycles. Space does not permit a complete review of the history of this issue, but nevertheless an understanding of the paper and technical comment will be greatly enhanced if the reader has some general knowledge of the attendant circumstances.

As originally prepared for presentation at the Winter Technical Meeting of The Institute of Radio Engineers held at New York City, January 24-27, 1945, the paper, according to an appended note, was intended as a joint presentation by K. A. Norton, formerly an employee of the Federal Communications Commission, and E. W. Allen, Jr. Admittedly, the material was prepared jointly and contains data and conclusions entered into the record of the Federal Communications Commission Hearing on Frequency Allocations, Docket 6651, by Mr. Norton. Therefore, very properly, comment upon the paper can and should recognize not only the joint responsibility for the material but also its relevancy to the proceedings before the Commission.

It is well recognized that the science of radio propagation is one of great complexity. As the writer has stated,

¹ National Press Building, Washington 4, D. C.

"It is unfortunate that, throughout the entire range of frequencies extending from 40 to 110 megacycles, data with respect to *all* of the phenomena of importance are not only meager but the interpretations which must be made to express the results in terms of interference and service areas are extremely complicated, frequently requiring assumptions of unproven validity and not easily understood by those who have not devoted years of study to the subject." (Page 6, Brief on behalf of Panel 5, FM Broadcasting, of the RTPB.)

In reply to an inquiry addressed by Panel 5 to Dr. J. H. Dellinger, Chief of the Radio Section of the United States Bureau of Standards, and Chief of the Inter-service Radio Propagation Laboratory of the United States Government, Dr. Dellinger recommended that frequency-modulation broadcasting be kept in the vicinity of 50 megacycles and said, "It may also be stated that no frequencies are free from transmission vagaries." This leads to the logical conclusion that, in determining which of two bands is best for a particular service, it is necessary to weigh the relative importance of all the various detrimental effects which are present *to a greater or less degree* in both bands. In the case at hand we need to concern ourselves only with the propagation effects upon potential service of three transmission vagaries, namely: (1) F_2 -layer phenomena, (2) sporadic- E -layer phenomena, and (3) tropospheric phenomena. Of course, of prime importance are the comparative characteristics of the propagation medium to transmit radio waves over given distances even assuming the complete absence in the two bands of the vagaries listed above.

Briefly, when this paper is stripped of the data and argument purporting to justify the conclusions drawn by the author or authors, it will be found that their contention is (1) in general, the field intensities produced over given distances in the absence of transmission vagaries are at least as satisfactory near 100 megacycles as near 50 megacycles, (2) that tropospheric phenomena, while admittedly more detrimental at the higher band, are not of sufficient importance to materially affect the result, but (3) the severe interference effects of sporadic- E - and F_2 -layer phenomena are of such importance that the possibilities of securing adequate rural coverage near 50 megacycles are not nearly so great as near 100 megacycles. Therefore, they imply and conclude that the frequency-modulation broadcast band should be near 100 megacycles.

In contrast, it was the opinion of the group of well-recognized propagation scientists called upon by Panel 5 for assistance in formulating its proposals (1) that the detrimental effects of sporadic- E - and F_2 -layer phenomena were being grossly exaggerated by Messrs. Norton and Allen; (2) that, in addition, a fundamental error had been made in determining the importance of F_2 -layer phenomena which vitiated the conclusion drawn regarding their effect; and (3) there was at least a strong probability that the detrimental effects of tropospheric

phenomena near 100 megacycles were being much underestimated. This feeling with respect to tropospheric phenomena has been amply justified by field studies which have been made since the proceedings were started, and the contention that the basic propagation characteristics of 100 megacycles were substantially as satisfactory for large-area rural coverage as at 50 megacycles has been disproved.

Now that the veil of military secrecy has been lifted from the classified record taken at the hearing held March 12 and 13, 1945, the attention of the scientific world should be directed to the testimony of Dr. J. H. Dellinger, eminent authority in this field, who stated: "Nobody is interested in a lot of data but in what the data show. In this case, with what interference the data indicate and how the interference compares with that existing in other frequencies—that brings us to the question of why Mr. Norton's conclusions are different from mine. The reason is because, implicitly if not explicitly, of a *very considerable exaggeration of the effect of ionospheric interference*. Ionospheric interference is very little at either 50 or 100 megacycles. . . . *It is very little at either*. So that the elaborate demonstrations that it is many times less at 100 megacycles than at 50 megacycles are *pointless*" (emphasis added). The record shows that a large majority of those qualified to express opinion on the subject are in agreement with Dr. Dellinger.

The Findings of Fact released by the Federal Communications Commission in this proceeding show that the decision made by the Commission to shift the band assigned to frequency-modulation broadcasting from 50 to 100 megacycles rests almost entirely upon technical evidence which scientific opinion of the highest qualification has characterized as "pointless."

The writer will leave to others the evaluation of the effects of moving the frequency-modulation broadcast band upon a nascent industry. However, there are lessons of great value to the radio engineer in this proceeding which should not remain buried in the voluminous compilations of detailed testimony and argument.

It is unfortunate that throughout the entire history of radio communication it has been necessary to make allocations to the various radio services in the absence of truly adequate scientific data concerning radio propagation. It is equally unfortunate that where allocation mistakes are made they are lasting in effect and never can be completely corrected. As the writer stated in the Brief in support of the position taken in Panel 5, already referred to, "This is because man, by his ingenuity and inventiveness as time progresses, can design and build new and improved devices for the transmission and reception of radio waves but he can do nothing to control the characteristics of the transmission medium which connects the transmitter and the receiver." (Page 6.)

Since, in this country, the responsibility for final decision in matters of this sort rests upon courts and

regulatory bodies the members of which are usually men without scientific training, it is of the highest importance that those who presume to speak with authority on scientific subjects do so with complete objectivity. To illustrate, the absence of knowledge on specific points should never become an excuse for ignoring those points and conclusions drawn should be strictly limited to what is justified by the data available. Again quoting the Panel 5 Brief, "Therefore, the responsibility resting upon those who presume to speak with authority and finality is very great. The adequacy of their data, thoroughness and objectivity of analysis, and the validity and completeness of their conclusion become matters of far greater importance than would be the case if the subject were simple." (Page 6.)

Unless radio engineers meet the full requirements of objectivity in presenting their findings and conclusions, in the final analysis they cannot expect to have much influence in shaping public policy affecting the art which they developed.

Edwin H. Armstrong:² What the first part of the paper which has appeared under Mr. Allen's name undertakes to do is to present as physical fact the calculated ranges of ultra-high-frequency transmissions based upon certain assumptions, without either apprising the reader what these assumptions really are or furnishing him with any supporting experimental data. It is in point to examine the bases on which the results are arrived at.

It appears that one of the conditions underlying the calculation of what is referred to as the theoretical "ground-wave" service range is the assumption of the existence of a standard atmosphere over the entire path of transmission. It further appears that the effect of this standard atmosphere to refract or bend the waves downward beyond the horizon is taken into account with other factors to predict the field strength at a given point. It also appears that, while fields of an intensity greater than that corresponding to the calculations for a "standard atmosphere" are contemplated, the possibility of substandard conditions is not considered.

No doubt, as an analytical exploration of what might happen in some world where weather changes are unknown and where the atmosphere of that world maintained a constant, unchanging relation to the assumptions made, the predicted values might be of some interest. But in the realities of the present world in which, unfortunately, we have to do our engineering, it is necessary to contend with a more complicated set of facts than were taken into account in these calculations.

It is unimportant in discussing the point of the paper that we understand exactly how the factors involved operate. The thing that is important is recognition of

the fact that what is referred to as a "ground wave," and which is represented as being something that is always there with a field strength that may be increased in intensity but not decreased by the effect of the "troposphere," is not, in fact, a ground wave at all as that term is generally understood. It is, instead, a wave dependent on meteorological conditions whose effects on transmission are complex and whose exact relationship to the received field strength beyond the horizon cannot quantitatively be set down.

Anyone who has had a transmitter of sufficient power on the air in the very-high-frequency or ultra-high-frequency ranges to produce receivable signals well beyond the horizon over the terrain of this world knows the extraordinary extent of the variation of intensity below, as well as above, the predicted "ground wave" value. Anyone who has compared the fading at 40 and 100 megacycles knows that the effect of meteorological changes produce larger variations in the higher frequencies. And anyone who has had experience with a broadcast service knows that it is the bottom of the fade, or the "drop out," and not the average or some long-time statistical value which determines the minimum boundaries of a broadcast service. Calculations based upon the assumption of a standard atmosphere are utterly useless in determining the answer to this very practical question, as the writers of the paper would very soon have learned had they taken the trouble to put a high-power station in operation and observe the field strength well beyond the horizon. But, quite oblivious to the realities of the situation, the writers proceed, on the basis of this statistical treatment resting on a series of unsound assumptions, to the vital comparison made in the second part of the paper.

What the second part of the paper undertakes to do is to make a comparison of interference ratios on the two specific frequencies of 46 and 105 megacycles. This comparison is made on the premise of the theoretically calculated "ground wave" for 105 megacycles giving perfect coverage 100 per cent of the time over its area (because it is assumed to be so) against a similarly calculated service area for 46 megacycles as indented by sporadic-*E*- and *F*₂-layer ionospheric interference. The interference values predicted for *F*₂ transmission are unsupported in any way by experimental evidence of actual received signal levels and are based on vertical-incidence measurements made by the Bureau of Standards and the Interservice Radio Propagation Laboratory, plus certain assumptions made by the writers. The sporadic-*E* interference is said to be based on the experimental evidence of recorded signal strengths and upon theoretically predicted values extracted from vertical-incidence measurements made by the organizations referred to above. The experimental and predicted results for this kind of interference have been stated to be in close agreement.

A considerable amount of experimental evidence is available concerning *F*₂-layer transmission that is not

² Columbia University, New York 27, New York.

in accord with the conclusions of the paper, but it is not necessary to consider it here insofar as the end result of the subject of the paper is concerned. It is now conceded that, at least as far as the United States is concerned, such transmission is not an important factor above 50 megacycles and the former predictions of the possibility of F_2 -layer transmission up to 120 megacycles have been withdrawn.

The real question, therefore, from the practical broadcast standpoint, resolves itself into an evaluation of the relative effects of sporadic- E interference in the outer ranges of a 50-megacycle transmission, versus the absence of signal in those ranges during the greater fading periods of a 100-megacycle signal. In this evaluation there enters, of course, the effect of terrain, the importance of which seems to have been overlooked.

It is not possible to determine quantitatively the loss of service due to the absence of signal because of the lack of data of any sort in the paper concerning either fading or the ratio of the fading on the low and high band at points beyond the horizon. This matter has, however, been covered in a presentation before the Institute by C. W. Carnahan, and much experimental data bearing on this part of the problem will be available with the publication of that paper.³

It is possible, however, on the basis of the data furnished in the present paper, to examine the conclusions which are reached about the other part of the problem, that is, the extent of sporadic- E interference. These conclusions are summarized by Allen's Fig. 9. Examining this figure for the worst case of sporadic- E interference, that is, interference between high-power stations on the lower frequency (the interference over the service areas of low-power stations may be considered practically non-existent), we find the following results given for interference between two Paxton-type stations. These stations are assumed to have a radiated power of 340 kilowatts at a 500-foot antenna height. We find that on the basis of reported measured sporadic- E interference levels the predicted primary service radius of 75½ miles for this type of station is reduced to 55½ miles for 1/10th of 1 per cent of the time for the critical distance of 500 to 1000 miles for interference from a single frequency-modulation station.

The above time of interference is predicated on operation on 46 megacycles. Examining further the occurrence of sporadic- E interference, we find it stated that it decreases logarithmically with respect to frequency, and the curves of Allen's Fig. 6 are plotted on this basis. It follows from this figure that the removal of the Paxton-type transmitter from an allocation in the vicinity of 46 megacycles to a frequency about 10 megacycles higher would result in a decrease of the interference time to above one-fifth of the above value, so that the service range would be indented from 75 to

55 miles by this form of interference for 1/50th of 1 per cent of the time.

It is stated that, if twenty stations of the Paxton type were operating on the same wavelength within the United States, the interference time for a single station would be increased five-fold. So it follows that, when twenty Paxton-type stations were all operating on the same channel in the vicinity of 55 megacycles, interference may be expected in the outer 20 miles of the normal 75-mile service range 1/10th of 1 per cent of the time. As a possible 50 channels out of an assigned 100 should normally be available for the use of high-power stations, it is interesting to speculate on the question of how many years removed we are from the realization of 1000 Paxton-type stations as a practical actuality!

Pointless as it is to pretend that the vagaries of ultra-high-frequency transmission could be predicted with the accuracy we are here discussing, it is in order to point out that there is a real effect not taken into account in the paper that serves to decrease still further the interference time.

During the summer months transmission efficiency rises sharply, so that the so-called 50-microvolt line is then at a substantially greater distance from the station than during the colder months of the year. Sporadic- E transmission is concentrated almost entirely during the months when this expanded tropospheric range is realized. As a consequence, there follows an automatic reduction within the normal service range of the amount of sporadic- E interference to figures below those given above.

Although there are a number of other factors that have an important bearing on the problem, attention has been called to a sufficient number of absurdities in the method of approach to an engineering problem to make it unnecessary to go further. The variables involved are so many that the abandonment of the time-honored approach of at least "listening to the signals" and its replacement by the approach of the "armchair geographer" is an incredible thing. It is more incredible that anyone should have paid any attention to it, and with this statement we could ordinarily let the matter rest.

There is, however, an extraordinary piece of legerdemain in the paper to which attention must be called because its purpose is obviously to preserve the fallacy that propagation questions of the sort we are dealing with are now a sort of exact science where coming events can be predicted and calculated with the precision we attribute to some of the older arts.

This engineering skulduggery appears in connection with the sporadic- E predictions, and attention must be called to it because Mr. Allen does not appear to be aware of its existence in the paper bearing his name. His Fig. 6 shows the sporadic- E -layer skip distance as a function of frequency for various percentages of time during the year September, 1943, through August, 1944, estimated from measurements of sporadic- E -layer

³ C. W. Carnahan, N. W. Aram, and E. F. Classen, "Field intensities beyond line of sight at 45.5 and 91 megacycles," *Proc. I.R.E.*, pp. 152-159, this issue.

critical frequencies made in Washington, D.C. It is stated that this figure is believed to represent a reasonably good estimate of the percentage of time that a single frequency-modulation station would be expected to interfere with another similar station on the same frequency at the distances shown. From this figure we find that the transmission over the Paxton-Atlanta path, which has its midpoint near Washington, would be supported about four-tenths of 1 per cent of the time. We also find that this theoretical prediction is not at all in accord with the experimental results reported for the reception of the Paxton signals at Atlanta, where levels in excess of 25 microvolts were recorded for 1.71 per cent of the time during which observations were made.

Here are grounds for questioning either the accuracy of the experimental results or the application of the predicted methods of Fig. 6. The paper does not do this, nor does it call attention to the disagreement between the two. Instead, the discrepancy is concealed by the ingenious device of the so-called "p" curves of Fig. 9, in which the 400 per cent difference between the observed time of transmission and the theoretically expected time is brought into agreement by introducing multiplication factors for the various field intensities. Mr. Allen appears to have been unaware of this juggling of the two into agreement, for during the discussion of the paper he said:

"I want to say that in reference to the curves which were shown for sporadic E, and which were predicted curves from data measured at vertical incidence by the National Bureau of Standards, using the accepted methods of extending critical frequencies at vertical incidence to maximum usable frequency versus distance, and correlating the data which was measured at Atlanta over a distance of 900 miles from Paxton, when we measured the percentage of time during which the signal exceeded 25 microvolts per meter and correlated it with the data which were extracted from the records of the National Bureau of Standards, we obtained a phenomenal, I might say, correlation over the years which we recorded."

Of course correlation was obtained. The experimental and the "extracted" results were made to correlate!⁴

C. W. Carnahan and J. E. Brown:⁵ That fading exists on frequencies above 30 megacycles for receiving points beyond the horizon has been known for at least fifteen years, as has also the fact that the prevalence and severity of this form of interference increases with frequency. While the author takes some cognizance of this in his discussion of tropospheric effects, the impression is given that a tropospheric component causes only an *increase* in field intensity over the ground-wave value, and never a decrease.

As a matter of record, the Federal Communication Commission's own measurements on frequencies of 84 and 107 megacycles⁶ have shown that, at a distance of

⁴ For the sake of the record it is here noted that Mr. K. A. Norton, then listed as the co-author of the paper, took part in the discussion and the presentation of this paper and made no correction of Mr. Allen's statement.

⁵ Zenith Radio Corporation, Chicago, Illinois.

⁶ Federal Communications Commission Docket 6651, January 18-19, 1946.

70 miles from the transmitters, the amount of time during which the signal is lost due to fading is so great that an adequate broadcast service is impossible. In fact at 107 megacycles the signal was entirely absent for 20 per cent of the time, disappearing for hours at a time on successive days. Assuming 50 kilowatts radiated power on these frequencies, the fields predicted from Norton's curves were many times greater than the 4 microvolts per meter postulated by the author as adequate for rural broadcast service.

We understand that the author was requested to publish this paper in its original form. This is unfortunate, since a study of the above measurements indicates how meaningless are estimates of broadcast service beyond the horizon based on Norton's curves for the minimum field intensities without taking account of fading. The presentation of this one-sided picture at this time is doubly unfortunate since frequency-modulation broadcast services are about to be inaugurated in all parts of the world, and this paper will be used as a basis for the selection of frequencies.

As a result of the Zenith and Federal Communications Commission's measurements in 1945, we know now that at distances of 70-75 miles, and with radiated powers of 50 kilowatts, the fading on the old frequency-modulation band is not sufficient to impair rural service greatly, while the fading in the new band is so bad that no adequate service can be expected.

The service range in the new frequency-modulation band will be determined entirely by the fading characteristics at these frequencies, and not by the ground-wave field intensities as obtained from Norton's curves. Unfortunately, measurements so far made have not established the distance at which fading in the new band will be reduced to a satisfactory level, but an estimate of 60 per cent reduction in service area over that of the old band is reasonable.

The author, in his discussion of the effect of sporadic-E- and F-layer interference unfortunately leaves the impression that the new frequency-modulation band will be entirely free of interference. Actually, as we now know, in going to the new frequency-modulation band we have merely exchanged long-distance interference, which exists for only several months out of the year, for the much worse interference due to fading which exists practically every day.

Paul A. de Mars:⁷ The paper, "Very-High-Frequency and Ultra-High-Frequency Signal Ranges as Limited by Noise and Co-channel Interference," published under the name of E. W. Allen, Jr., purports to summarize the various major factors affecting radio wave propagation in the frequency range from 30 to 3000 megacycles to the extent to which they are known or can be predicted and to establish the probable service and interference ranges for broadcast and land mobile services within this part of the frequency spectrum.

⁷ 1469 Church Street, N.W., Washington 5, D. C.

This paper was originally prepared for presentation at the Winter Meeting of The Institute of Radio Engineers at New York City, January 24-27, 1945, as a joint presentation by K. A. Norton, formerly employed by the Federal Communications Commission, and E. W. Allen, Jr. This paper contains data and conclusions entered into the record of the F.C.C. hearings on frequency allocations, Docket No. 6651, by Mr. Norton.

The author treats the extremely broad subject by first presenting ground-wave service ranges based upon theoretical considerations and later touches lightly upon tropospheric propagation effects and terrain as factors which modify the theoretical ranges. There then

quote to explain tropospheric variations in signal intensities. Furthermore, variations in signal intensities result from reflection and refraction from air-mass boundaries and other meteorological irregularities. The dependence of radio propagation on the weather increases as the frequency increases and the variation in signal intensity increases as the distance from the transmitter increases. Beyond the horizon the major factor affecting signal intensities is the effect of the troposphere.

The effect of the troposphere on signal intensities in the broadcast band is shown in Figs. 1, 2 and 3, which were prepared by the writer. Fig. 1 shows the signal

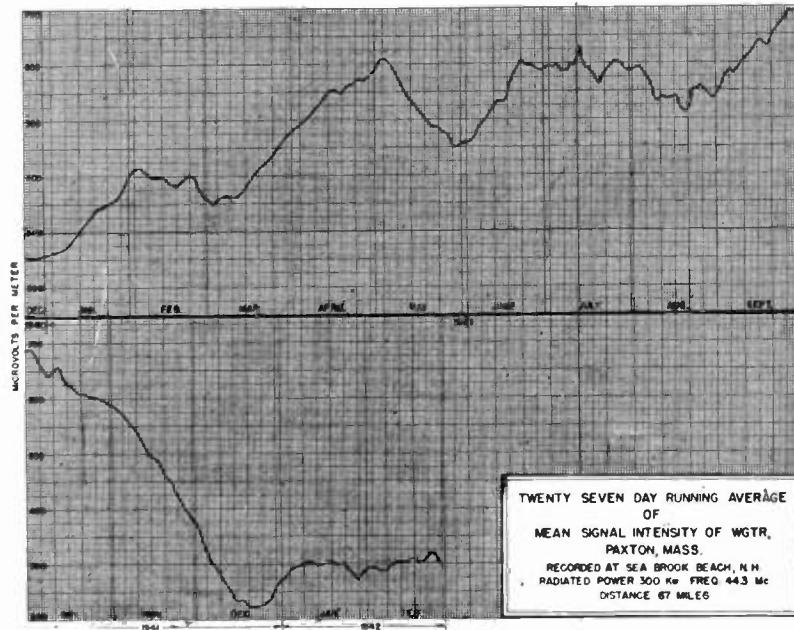

Fig. 1

follows a more detailed treatment of long-distance *F*-layer and sporadic-*E*-layer and burst interference.

The scope of these comments will be limited to Mr. Allen's treatment of the effect of the troposphere and terrain on the service range of broadcast stations.

Although the conditions underlying the calculations of the so-called ground-wave ranges are not clearly set forth, it appears that these are based upon a smooth spherical earth with uniform ground constants and a standard atmosphere in which the dielectric constant of the air varies uniformly as the height above the earth increases. The average bending of the radio waves due to refraction in the standard atmosphere is included by assuming that the effective radius of the earth is increased to four-thirds of its actual value. It has long been known that atmospheric refraction can and does cause very large and persistent fluctuations in signal strengths and operating ranges in the frequencies under discussion. The meteorological origins of these effects are complex and varied and occur in some form all over the earth's surface. The concept of an equivalent earth's radius to account for reflection is totally inade-

quately to explain tropospheric variations in signal intensities. Furthermore, variations in signal intensities result from reflection and refraction from air-mass boundaries and other meteorological irregularities. The dependence of radio propagation on the weather increases as the frequency increases and the variation in signal intensity increases as the distance from the transmitter increases. Beyond the horizon the major factor affecting signal intensities is the effect of the troposphere.

The effect of the troposphere on signal intensities in the broadcast band is shown in Figs. 1, 2 and 3, which were prepared by the writer. Fig. 1 shows the signal

intensities in microvolts per meter of Yankee Network's broadcast station WGTR, Paxton, Massachusetts, recorded at Seabrook Beach, New Hampshire, for a fourteen-month period from December, 1940, through February, 1942. WGTR at that time operated on a frequency of 44.3 megacycles with an effective radiated power estimated at 300 kilowatts. The airline distance from the transmitter to Seabrook Beach is 67 miles. The signal intensities plotted are average values obtained by plotting the running average for twenty-seven days. It will be noted that with twenty-seven day smoothing the seasonal effect of atmospheric refraction is very clearly indicated. The predicted signal intensity using the ground-wave signal-range curves adopted by the Federal Communications Commission would be about 400 microvolts per meter. The actual measured signal intensities are found to be distributed above and below this value, indicating that the tropospheric effects produce both superstandard and substandard propagation conditions. The Seabrook recordings further show that, even when twenty-seven day averages are used to obtain mean values, substandard

propagation conditions exist for long periods of time, in this case about 40 per cent. Because of the observed physical fact that the variation in signal intensity increases with frequency, a similar curve based upon recordings over the Paxton-Seabrook path on a frequency of 100 megacycles would show a greater departure from values predicted on theoretical considerations.

The inner boundary of a broadcast service is determined by the minimum value of fading signals, and the interference to other stations is determined by the maximum intensity of fading signals. Fig. 2 presents a graphic representation of (1) the signal intensity versus

of signal-intensity measurements and recordings, many of which were made by the Federal Communications Commission at its own measuring stations. Portions of the curves of Fig. 2 extend beyond ranges at which signal intensities measurements have been made. The extrapolation has been made in accordance with empirical methods which are believed to yield substantially correct values for the distances shown. Included in the data upon which these curves are based are the values of signal intensities obtained in the tests made by the Zenith Radio Corporation, which covered a comparison of the fading on the 42- to 50-megacycle band and the

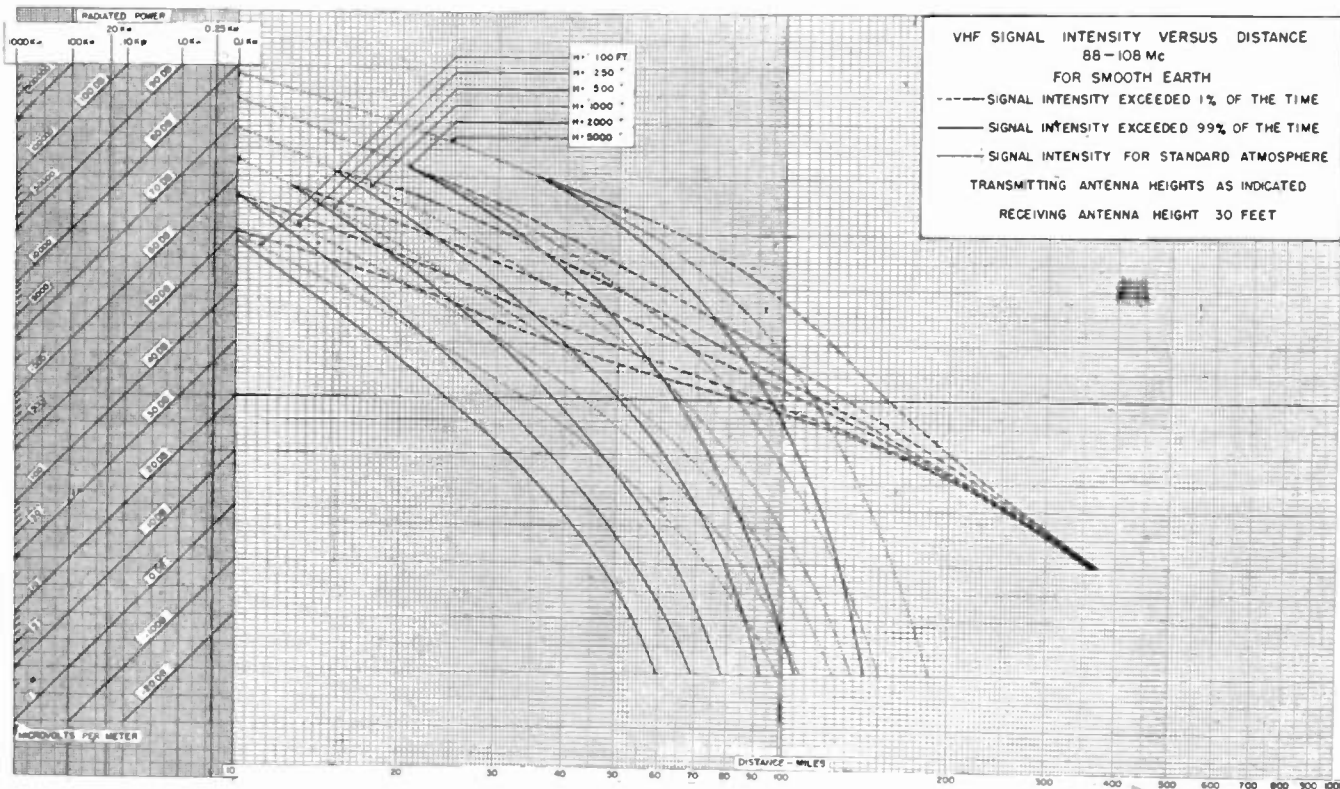

Fig. 2

distance exceeded 1 per cent of the time, (2) the signal intensity exceeded 99 per cent of the time, and (3) the signal intensity calculated on the assumption of a smooth spherical earth, uniform ground constants, and a standard atmosphere. In order to avoid confusion the effect of terrain is not included, and the signal intensities shown on Fig. 2 represent those that would result over a smooth earth. A scale is provided which permits signal intensities to be evaluated from radiated powers from 0.1 kilowatt to 1000 kilowatts in terms of decibels above 1 microvolt per meter, and also in microvolts per meter for antenna heights from 100 feet to 5000 feet. The theoretical signal intensities were taken from the Federal Communications Commission's ground-wave signal-range curves for frequency-modulation broadcast stations in the 88- to 108-megacycle band. The curves representing signal intensities exceeded 1 and 99 per cent of the time have been derived from a large number

88- to 108-megacycle band at points beyond the horizon. These tests have been covered in a presentation before the Institute by C. W. Carnahan and an evaluation of the results will be available with the publication of that paper.³

Fig. 3 presents the same information as Fig. 2 except that the boundary curves of the fading ranges are for the signal intensities exceeded for 10 and 90 per cent of the time.

While it is conceded that sufficient data are not available at this time to present these curves as a precise representation of the variation of signal intensity versus distance in this frequency band, they do, however, clearly reflect and show the effect of the troposphere on broadcast signal intensities. The reader is invited to compare the curves of Figs. 2 and 3 with Fig. 3 of Mr. Allen's paper. His presentation creates the impression that the effect of the troposphere is to cause

only signal intensities greater than would be predicted by standard atmosphere. This conclusion is misleading and is not in accord with observations and measurements in any portion of the frequency band under consideration.

The quasi-optical characteristics of the frequencies above 30 megacycles were recognized by the early experimenters and have been well known for the last fifteen years. The shadow loss behind hills is considerable at the lowest frequency and this loss increases with the frequency. In practice the shadow effect of hills results in signal intensities being less by varying

lation broadcast stations by allowing a factor of 6 decibels for the combined effect of terrain and antenna transmission-line losses.

In a large portion of the densely populated areas of this country, such as the Eastern and Northeastern portions and the West Coast, the effect of terrain on a substantial portion of the population within the proposed service area of broadcasting stations is to decrease the signal intensities to only a small fraction of that predicted by theoretical curves.

Fig. 4 is a nomographic chart for estimating the probable magnitude of the shadow loss due to irregu-

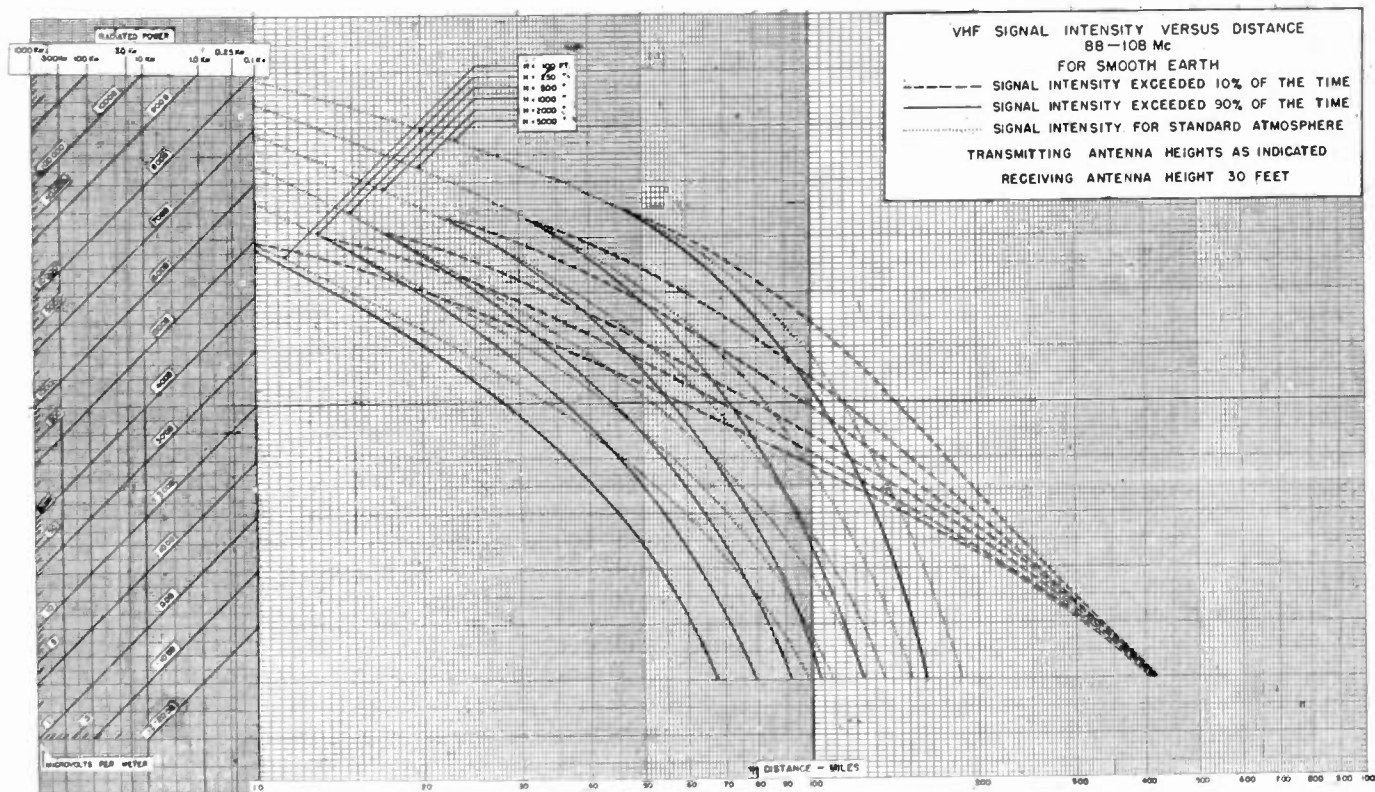

Fig. 3

amounts, depending upon the degree of irregularity of the terrain, than those predicted by theoretical calculations which assume a smooth earth.

Mr. Allen disposes of the effects of irregularities of terrain such as hills and mountains by stating that they are expected to cast deeper shadows at higher frequencies but that much work has to be done to evaluate these effects. He then speculates at considerable length on the relative penetrating effect with respect to frequency of buildings without arriving at any definite conclusions.

At the time Mr. Allen wrote his paper there was ample information available to permit accurate evaluation of the effect of terrain. Had he taken advantage of available information the effect of terrain would never have been given the treatment that it was accorded in the paper under discussion, which merely disposes of this major effect on the service range of frequency-modu-

larities in terrain. This chart was contained in the publication entitled "Propagation Curves," October, 1944, by Division 15 of the National Defense Research Committee. Although at that time a restricted publication, it was available to Mr. Allen. This publication has since been declassified. The information contained therein was prepared for the National Defense Research Committee by the Bell Telephone Laboratories, Inc. The method of obtaining the probable magnitude of the shadow loss behind a hill is readily understood from an examination of Fig. 4. It will be noted that, at distances of one-quarter to one-half mile behind hills of from 50 to 150 feet above the surrounding terrain, shadow losses of 6 decibels or more are obtained, and that for distances of a mile or two behind elevations up to 1,000 feet, losses of the order of 20 to 30 decibels are encountered. Measurements generally confirm the predictions of the shadow losses shown in Fig. 4. In practice,

where multiple irregularities exist the losses tend to exceed those predicted, especially at the higher frequencies.

The assumptions that Mr. Allen makes in his paper are so far from the true facts that the conclusions he draws therefrom must be in error. Since there is contained in this paper the substance of the technical evidence upon which rested the decision of the Federal Communications Commission to re-allocate frequency-modulation broadcasting from its previous allocation in a band of frequencies in the vicinity of 45 megacycles and to assign this service to a band in the vicinity of 100 megacycles, it is evident that this paper is one of the most important ever presented to this Institute. It merits the most careful consideration and critical analysis of the scientific world.

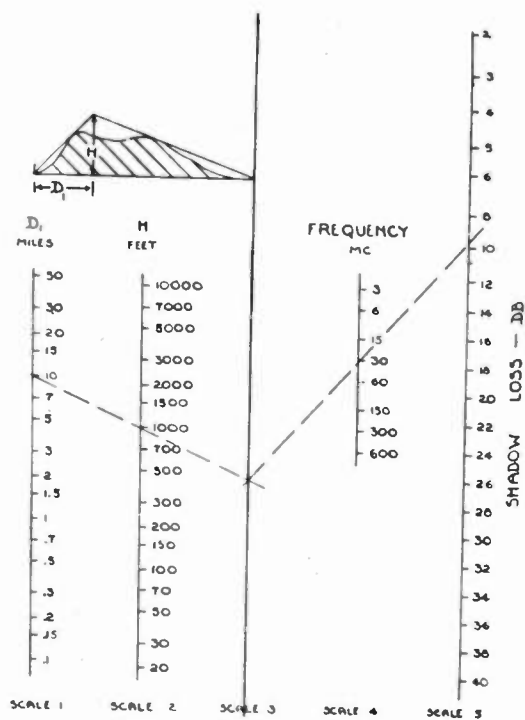

Fig. 4—Shadow loss.

Dale Pollack:⁸ My first comment on the Allen paper is on the use of field intensity at the antenna, rather than voltage at the receiver (or antenna) terminals for the establishment of service ranges. This is, I believe, deceptive. I do not agree with Allen and Norton that the criterion of a good service is better expressed in terms of microvolts per meter than in terms of microvolts. When receiver noise is the limitation on range, I think Allen will agree that microvolts at the receiver terminals is the only proper criterion for comparison of one frequency against another. When other factors (such as ambient noise, or undesired signals) are limitations, then either signal strength or voltage are equally good criteria. The ratio of desired to undesired signals, mathematically, if not experimentally, will be identical measured in either way. Therefore, since in the only

⁸ 352 Pequot Avenue, New London, Connecticut.

instance in which a preference exists, that preference is for voltage measurements, the emphasis should be placed on voltage data and not on microvolts per meter, as in the Allen paper.

The Allen paper sets up standards for coverage based on certain field intensities (500, 50, and 5 microvolts per meter, depending upon the class of service), irrespective of frequency. Since the voltage pick-up from the type of antenna which is likely to be used reduces as the frequency increases, the performance of the higher frequencies will suffer. I myself may install a directional antenna (if Allen compels me to by moving my favorite stations to the high band), but the typical listener certainly will not fuss with a rotating beam. The comparison, to be impartial, must be based on equal voltages at the antenna terminals at the different frequencies, not on field intensities. Allen, in effect, admits this when he states "... at higher frequencies it appears to be expedient to protect a higher contour, or set noise rather than co-channel station interference will be the limiting factor." He then proceeds to ignore this rule.

My second comment has to do with the accuracy of the computations themselves. In Allen's Fig. 1, the distance to the 50 microvolts per meter line (for the 1000-foot, 50-kilowatt transmitter) is almost independent of frequency. This distance is about 80 miles, twice optical. If this is true, a directional antenna having the same physical dimensions at 10 centimeters as one at 10 meters should develop approximately the same voltage at the receiver terminals. It seems unreasonable to me. Has anyone dared to space microwave relay stations much farther apart than optical?

I have replotted the high-power data of Allen's Fig. 1 in Fig. 5, giving field intensity against range for three frequencies. The curves intersect at between 1.5 and 2 times line-of-sight. This is contrary to my own experience with such computations, which always have shown intersections at less than line-of-sight distances. At between 1.2 and 1.5 times line-of-sight the 10-centimeter field intensity is heading straight up. It is difficult to believe that the 10-centimeter field is going to be so much stronger than the 7-meter field at 1.3 times line-of-sight, as the curve indicates will be the case. Is it appropriate to ask if the Allen-Norton curves have been checked by an independent authority?

The third point I wish to make is one which was first made by Norton in his testimony before the Federal Communications Commission at the January, 1946, hearing. In his statement Norton attempted to reconcile the Zenith propagation tests with his calculations. He calculated the effect of hills and valleys between the transmitting and receiving antennas and stated "... the 550-foot rise in terrain between transmitter and receiver ... has the effect of decreasing the calculated ground-wave field in the ratio of 10 to 1 on 98 megacycles. The corresponding decrease on 46 megacycles is only in the ratio of 5 to 1. Thus we see that

comparatively small systematic deviations in the terrain cause relatively larger variations in the expected ground-wave field intensity at points well beyond the line of sight." Thus a hill between transmitter and receiver has reduced the 98-megacycle field by twice as much as it has reduced the 46-megacycle field.

Norton implies further that a valley between the two points would have the reverse effect (as might be expected qualitatively). He then states that for general allocation studies the curves for smooth terrain should be used, since it is equally likely that the transmitter and receiver will be at higher or lower levels than the intervening terrain. It is here that Allen and Norton err. Average conditions are not the criteria in propagation work.

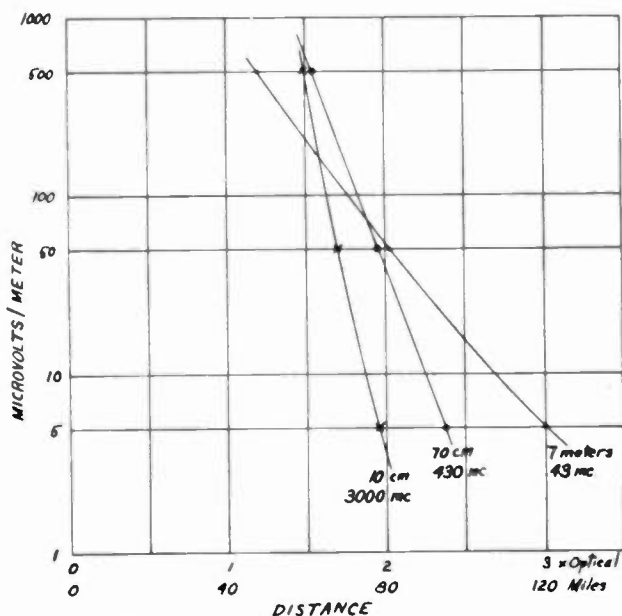

Fig. 5—Replot of part of Allen's Fig. 1. Antenna heights, 1000 and 30 feet. Power, 50 kilowatts. Horizontal half-wave antenna.

I will try to make this point clearer. Consider two receiver locations, at the same distance from the transmitter, near the extreme service range but off in different directions. In one direction a valley intervenes, in the other, a hill. For the receiver beyond the valley, while a 98-megacycle signal will have been increased more than a 46-megacycle signal, both signals will be strong and reception will be good on either band. For the receiver behind the hill, however, at 98 megacycles the signal will have been reduced more than at 46 megacycles and, since we are dealing with marginal signals, we will have reception at the low frequency and not at the high. It is unnecessary to worry about receivers beyond the valleys. They will have good signals irrespective of frequency. The case to be concerned about is that of the receiver beyond the hill, for which, by Norton's own testimony, the high frequencies will be attenuated more than the low.

There are many other points which are open to question in the Allen paper. These have been raised by others and presumably will be presented by them.

As Jansky remarked at the discussion held at the Winter Technical Meeting on January 27, 1945, it is important to "draw a sharp line between facts and interpretation of facts." In very-high-frequency propagation, too few facts are known. Allen and Norton are better able to discuss these few facts than perhaps anyone else. Their interpretation of the facts, however, I believe to be contrary to experience. It is regrettable that their interpretations have been used as the basis for allocations which will hamper the development of frequency modulation for some time to come.

Edward W. Allen, Jr.:⁹ Concerning Major Armstrong's allegation of skulduggery in the predictions of the field intensities to be expected for sporadic-E-layer interference, Mr. Norton and I went over the method of analysis with him for both E- and F-layer predictions in October, 1944, prior to the presentation of the paper. The curves included in the present paper (Fig. 8) were presented at the meeting, yet the Major elects to interpret the general statement made in the discussion at the meeting and quoted by him as belying the accuracy of the curves. As I recall it, the statement was made in response to a query as to the reliability of the method of extrapolating the Bureau of Standards vertical incidence measurements, not as to the reliability of the measurements made by the Federal Communications Commission. The statement was based upon a study which I had made of the month-to-month correlation of our measured values with the extrapolation of the Bureau of Standards values, in which I had found a remarkable agreement in the upward and downward trends. The actual number of minutes of occurrence for any month given by the two methods need not be in exact agreement in order to obtain correlation, for, as with any fading signal, these are a function of the reference level at which the analysis is made. In order to expect numerical agreement, analysis of the Federal Communications Commission recordings should be made at a level consistent with the sensitivity of the Bureau of Standards pulse-measuring apparatus; that is, at 140 microvolts per meter for 340 kilowatts, or about 7 microvolts per meter for a 1-kilowatt pulse transmitter, which seems to be a reasonable figure. You will recall that I made a change in the description of Fig. 8 in order to clarify the method of arriving at the sporadic-E intensity curves.

It remains to be seen whether experience will bear out the statements made by Messrs. Carnahan and Brown as to the relative service areas in the old and new frequency-modulated bands, based on a few short-time measurements made during that part of the year when tropospheric effects are at or near a maximum. It should be pointed out that the estimate is not as to an actual reduction in service area, but a reduction in the area in which service is possible in locations where

⁹ Federal Communications Commission, Washington 25, D. C.

ambient noise and station interference are not a problem and where the set owner uses a simple doublet rather than an antenna of comparable size for the two bands. Fig. 9 of my paper recognizes an approximate reduction of 50 per cent in the extended rural area and of 30 per cent in the over-all area when simple doublet receiving antennas are employed, assuming undisturbed fields of values predicted by Norton's curves.

Their estimate of 60 per cent reduction in service is apparently not based on measurements but on Major Armstrong's unsupported estimate that a 100-mile radius can be obtained at 46 megacycles with a 1000-foot transmitting antenna irrespective of tropospheric fading. According to data furnished by RCA, which was placed in the record of the allocations hearing, fading on 43 megacycles during October and November, when propagation is above average, appeared to be too severe at Riverhead on a receiving antenna 60 feet above ground to give good service from Mount Asnebumsket, 1600 feet above sea level and 103 miles distant. Some 20 miles of this path are over sea water, and the fading was undoubtedly much less than would have occurred over a land path of similar length and with lower antennas. On the basis of Mr. Carnahan's own analysis of the Zenith and the Federal Communications Commission's data, service at 70 to 75 miles for a 35-kilowatt station on 45 megacycles is marginal rather than satisfactory. If it is assumed, for the sake of argument, that a 70-mile radius is average for 45 megacycles, a 60 per cent reduction in area would result in an effective radius of 45 miles at 100 megacycles. The measurements made for the Federal Communications Commission by the RCA Laboratories at Princeton, at a distance of 45 miles from transmitters in New York City, show that there is little difference in the fading of 43, 84, and 107 megacycles at this distance, so that an estimate of 60 per cent reduction in area on this basis appears to be entirely unreasonable.

Relative to the question of international allocations of frequencies, it was apparent to those familiar with world-wide ionospheric conditions that the 42- to 50-megacycle band was even less suitable for frequency modulation in certain other areas of the world than in the United States, so that the upward move of frequency modulation has improved rather than deteriorated its outlook in this respect. In this regard I should like to call attention to the 4000-kilometer F_2 -layer maximum-usable-frequency predictions for November, 1946,¹⁰ in which frequencies of 42 to 44 megacycles are shown for 50 degrees North latitude in the United States, and frequencies up to 62 megacycles for other parts of the world. These are monthly average figures and a frequency distribution of plus or minus 10 per cent may occur around the average frequency.

¹⁰ Ref. CPRL-D24, Basic radio propagation predictions for November, 1946, Superintendent of Documents, U. S. Government Printing Office, Washington 25, D. C.

Mr. de Mars' curves of very-high-frequency signal-intensity versus distance are very interesting and are a significant contribution to present knowledge of the effects of the troposphere on very-high-frequency propagation. While I am in agreement qualitatively with the results of his study, I feel that the tropospheric curves are somewhat low as compared to the standard atmosphere curves. It has been our experience and the experience of others in the field that the standard-atmosphere or undisturbed value will be exceeded by instantaneous values of tropospheric field for about 60 to 90 per cent of the time, depending upon frequency, antenna height, distance, terrain, time of year, and other factors, whereas the undisturbed value seems to approximate the median or 50 per cent value for some of his curves. This error may be due to a comparison of actual measured tropospheric data with smooth-earth theoretical undisturbed values such as appeared in some of the data furnished to Mr. de Mars. While Mr. de Mars' statement, that the inner boundary of a service area is determined by the minimum value of fading signals, is undoubtedly correct, it should not be inferred that a comparison between the undisturbed and the minimum curves of his Figs. 2 and 3 represents a comparison of the relative signal ranges at 50 and 100 megacycles. Fading below the undisturbed values occurs also at 50 megacycles, and only adequate data at both frequency ranges, similarly analyzed, will provide such a comparison.

Relative to Mr. de Mars' comment on Fig. 3 of my paper, I should like to reiterate that the tropospheric field values shown are taken from actual measurements. The data were analyzed in terms of hourly median values rather than instantaneous values. Since the distances shown are all in the region where rapid fading occurs for a majority of the time, analysis on an instantaneous basis could readily lead to a different result. If the fading of instantaneous values over short periods of time follows a Rayleigh or similar distribution in which fading below the median value is more pronounced than above the median, the values derived from an analysis on an instantaneous basis will be lower than on an hourly median basis, as indicated by the data presented by Mr. de Mars.

Since the shadow-loss nomograph presented by Mr. de Mars was classified at the time of presentation of the paper, no reference could, of course, be made to it. It is based on diffraction theory, and, while it provides a good guide in cases where the diffracted field is the major component of received field, it oversimplifies the general problem in that it takes no account of other contributions such as scattering and reflections (see original text accompanying the nomograph), which in general will be greater at 100 megacycles and may more than offset the 2 decibels difference in the diffracted fields at 50 and 100 megacycles. In such surveys as we have made, directly comparing 50 and 100 megacycles coverage, no systematic difference in shadow effects

has been observed between the two bands. In addition, the use of this nomograph presupposes a knowledge of the terrain in question and it is not a measure as to what shadow loss may be expected on the average, in the absence of data on average terrain conditions. In view of the insuperable task of working out a detailed allocation, examining the terrain in each case and obtaining an average terrain factor, it became necessary to make a reasonable assumption in this regard. Perhaps the assumption was too low, but the relative effect at the two frequencies is apparently not too different for given terrain conditions.

Referring to Mr. Pollack's comments on the use of field intensities rather than microvolts available at the receiver terminals as a basis of comparison of the relative ranges of two frequencies, it should be stressed that the determining factor is the available signal-to-noise ratio or desired-to-undesired-signal ratio in any case. For receiver noise, the receiver terminal voltage ratio at two frequencies is a proper measure only if the receiver noise figure is the same at the two frequencies; otherwise, a comparison of the two signal-to-noise ratios should be used. It has been conventional to express ambient noise and station interference in terms of field strengths (see reference 4), so that a simpler and more direct measure of the available signal-to-noise ratio is obtained by using the same units for the desired field. This makes it unnecessary to specify antenna characteristics, line losses, line impedance, etc. In microwave work it has become conventional to express signals and noise in terms of power, and at some future date this may also be applied to the lower ultra-high-frequency and perhaps very-high-frequency ranges.

As to the accuracy of the computations, the curves of Fig. 1 are in agreement with the field-intensity versus distance curves which have appeared in several of Mr. Norton's papers and which have been adopted as Federal Communications Commission standards. The basic curves were very thoroughly checked before publication, and such recent calculations as we have made have not revealed any systematic errors. Consequently, I believe that the calculations will be found to be correct.

Edwin H. Armstrong:² Mr. Allen's discussion contains some very important statements. It is now admitted that the theory of a minimum "ground-wave" level which is present at all times is not correct. It is likewise admitted that it is a mistake to analyze recordings on an hourly median basis and that they must be analyzed on a basis of instantaneous values if the analysis is to have any relation to what the listener actually hears.

We have come indeed a long way from the Federal Communications Commission hearing when I testified to the depth of fading observed by me years ago on a 70-mile 117-megacycle transmission and Mr. Allen questioned whether my receiver was operating properly.

However, there is still no frank facing of the situa-

tion as it actually exists, because in the final paragraph of Mr. Allen's discussion it is reiterated, in insisting on the accuracy of the Norton propagation curves, that his computations have been checked and that no *systematic* errors have been revealed. That is not the point. The calculations can be quite in order but error will still have been committed. That error consists in applying results obtained from calculations based on totally inadequate assumptions to the solution of a problem where the facts of life bear no relation to the assumptions made.

The measurements of field strength made simultaneously at Andalusia, Pa. (70 miles), and Princeton, N.J. (40 miles), on some transmissions from New York City by the Federal Communications Commission and the RCA Laboratories, respectively, illustrate the situation perfectly. Transmission was observed on 46, 83, and 107 megacycles during the period of August and September, 1945. The transmission paths are coincidental.

On 83 megacycles there were five identical hours when the hourly average at the 70-mile point was higher than that measured at the 40-mile point. There were eleven additional hours when the 70-mile point may have been higher, but due to the recorder running off scale at Andalusia the exact level remains indeterminate. There were still eleven more hours when the 70-mile signal level averaged 50 per cent or more of the 40-mile average, making a total of 27 abnormal hours in 51 days of operation.

The same phenomena was observed on 107 megacycles. It did not appear on 46 megacycles.

Such changes in hourly averages at Andalusia (83 megacycles) as from over 160 microvolts per meter (off scale) for 8-9 A.M. to 4.6 microvolts per meter for 1-2 P.M., from over 161 microvolts per meter (off scale) for 8-9 A.M. to 6.3 microvolts per meter for 1-2 P.M., and from 160 microvolts per meter at 9-10 A.M. to 1.8 microvolts per meter for 11-12 A.M.—to select only a few days at random—show how utterly meaningless it is to talk of the accuracy of computations when one has first to learn how to write a formula for the weather, an undertaking which I believe has not yet successfully been accomplished.

Predicted value for the above-mentioned transmission is approximately 8.9 microvolts per meter. The above hourly averages do not, of course, reflect the depths of the fades.

Turning now to the question of the hocus pocus in connection with the sporadic-E predictions, Mr. Allen's explanation does not explain. The caption of his Fig. 6 is as plain as the English language can make it. It is entitled: "Percentage of the time and the number of hours during the period September, 1943, through August, 1944, for which the sporadic-E-layer skip distance was less than the value shown for particular frequencies."

After describing the methods of deriving these curves

from the vertical-incidence measurements of the critical frequencies and pointing out that they appear not to be affected by the sunspot cycle, the statement is made: "Consequently Fig. 6 is believed to represent a reasonably good estimate of the percentage of time that a single frequency-modulation or television station would be expected to interfere with another similar station on the same frequency at the distances shown." This is a plain statement that you either have transmission or you do not, depending on whether or not the layer supports it, for no one would lump two services dissimilarly vulnerable to interference, such as frequency modulation and television, in the same breath were an intensity factor involved.

Mr. Allen's explanation that the curves of Fig. 6 are to be taken as representative of the number of hours that a 140-microvolt signal would come through from Paxton forces the following conclusion. The title of Fig. 6 and the statement above referred to, and most particularly with respect to television, is meaningless, since under the standards of television service of a 500-microvolt limit and 100-to-1 signal-to-disturbance ratio, a 5-microvolt sporadic-*E* transmission would cause interference. For the transmission under consideration this would certainly occur on the basis of the Commission's measurements for a period of 5- to 10-fold the time of transmission indicated on Fig. 6.

If anyone cares to take the trouble to read the record of the proceedings before the Federal Communications Commission he will, I believe, find my previous explanation of the reason for the *p* curves to be the correct one. I did not raise the question when Mr. Allen presented this paper before the Institute for the reason that at that time the discrepancy between the predicted and actual times of transmission and the use of the *p* curves to conceal it had not then been discovered.

There is one further statement to which attention ought to be called. Mr. Allen refers to my "unsupported estimate that a 100-mile radius can be obtained at 46 megacycles with a 1000-foot transmitting antenna irrespective of tropospheric fading." My statement was based on observation of transmission from Alpine to a point in Haddonfield, New Jersey, 100 miles away, where the signals were observed for a period of three years. The estimate is likewise supported by a recently published report issued by the British Broadcasting Corporation, prepared by Mr. H. L. Kirke, Director of Research of the British Broadcasting Corporation Engineering Division. It is likewise supported by the experience of others.

Note is made herewith that my discussion of the duration and extent of sporadic-*E* interference was based on Mr. Allen's Fig. 9 as it was originally presented to the Institute and as it stands in the paper today.

For the sake of the record, attention is called to the fact that footnote 11 in Mr. Allen's paper on page 136 appeared as a part of the paper after all discussion had

been concluded. It does not change the basis of my criticism nor its conclusions.

C. W. Carnahan and J. E. Brown:⁶ Mr. Allen objects to our estimate of a 60 per cent reduction in service area for the new band. Assuming a 70-mile radius at 45 megacycles, a 60 per cent reduction in service *area* at 100 megacycles would decrease this radius to 55 miles, not 45 miles. As to the measurements quoted, while there was little fading on the high frequencies at Princeton, which is almost within line of sight of the high New York antennas, the fading at Andalusia, Pa., a distance of 72 miles, far exceeded any tolerable value, while the low-band signal was still acceptable. The high-band signals completely deteriorated in the 28 miles between Princeton and Andalusia, and our estimate of 55 miles as the outer limit of the service area is certainly not unreasonable.

Most engineers do not have the time or the facilities for reading the entire record of the Hearings before the Federal Communications Commission on the frequency-modulation allocations. If they did they would know that the data collected in the Milwaukee-Deerfield tests only substantiates what every propagation expert who testified before the Federal Communications Commission has found, namely, that you do not get the reliable coverage at 100 megacycles that you do at 50 megacycles.

Mr. Allen in his comment states "... it was apparent to those familiar with world-wide ionospheric conditions that the 42- to 50-megacycle band was even less suitable for frequency modulation in certain other areas of the world than in the United States. ..." It is strange indeed that the British have reopened their television service in the 40- to 50-megacycle range. The Federal Communications Commission has authorized television in this same range, and undoubtedly other countries will do the same. It would appear that the matter of long-distance transmission is of no great concern, or television, which is much more susceptible to interference than frequency-modulation would not be expected to work satisfactorily in this part of the spectrum. It would appear from the record that no one in the whole world but Mr. Allen and Mr. Norton is worried about this long-distance transmission.

Paul A. de Mars:⁷ In his discussion Mr. Allen states that he is in agreement qualitatively with the very-high-frequency signal-intensity versus distance curves presented with my discussion of his paper. He admits that the inner boundary of a service area is determined by the minimum value of a fading signal. He acknowledges that the analysis of signals on an hourly median basis does not yield correct results to evaluate the service to broadcast listeners.

It is felt that the importance of this subject merits examination in detail of Mr. Allen's discussion in order to clarify some of the statements contained therein.

Mr. Allen states in reference to the above-mentioned curves (Figs. 2 and 3 of my discussion) that he feels the tropospheric curves are somewhat low as compared to the standard atmosphere curves. In support of this opinion Mr. Allen states: "It has been our experience, and the experience of others in the field, that the standard atmosphere or undisturbed value will be exceeded by instantaneous values of tropospheric field for about 60 to 90 per cent of the time, depending upon frequency, antenna height, distance, terrain, time of year, and other factors, whereas the undisturbed value seems to approximate the median or 50 per cent value for some of these curves." One can hardly disagree with this statement because it covers too much territory and is protected by too many qualifications, except to point out that the seeming approximate correspondence of the undisturbed values (standard-atmosphere curves) with median or 50 per cent values is not necessarily a fact. Mr. Allen has no right to assume that it is a fact unless the distribution of the instantaneous field intensities is stated to be, or is known to be, about the same above and below the median value. Mr. Allen concedes that if actual measured tropospheric field intensities are analyzed in terms of instantaneous values rather than hourly median values, the results will differ from those shown in Fig. 3 of his paper, and will correspond more with the data presented in my discussion.

Examination of the family of curves in question discloses that every factor mentioned by Mr. Allen above is taken into consideration and is clearly designated in the legend. The curves mean just what their designation says they mean.

Mr. Allen then continues to state: "This error may be due to the comparison of actual measured tropospheric data with smooth-earth theoretical undisturbed values such as appeared in some of the data furnished to Mr. de Mars." "This error" refers to what, in Mr. Allen's mind, is the seeming approximation of the standard atmosphere curves to the median or 50 per cent value for some of my curves. Assumption that "error" exists is not supported by Mr. Allen's statements because, as shown in the foregoing, a fact has been assumed that is not true. Here, as in all other fields, mistaken conclusions inevitably result unless the facts are true.

The reader is warned by Mr. Allen quite unnecessarily that it should not be inferred that a comparison between the undisturbed and the minimum curves of my Figs. 2 and 3 represent a comparison of the relative signal ranges at 50 and 100 megacycles. Nothing in the text of my discussion or in the titles of the curves can possibly be construed as tending to lure the reader into such a misunderstanding.

At this point comparison is invited of Figs. 2 and 3 of my discussion, with which Mr. Allen is now in qualitative agreement, with his Fig. 3 in the light of the above. The reader should understand by now that the actual service range, which is determined by the mini-

um signal, can be markedly less than that predicted by theoretical ground-wave curves which represent only the assumed standard atmosphere condition and fail to take into consideration the fluctuations of signal intensity that accompany meteorological changes.

In that portion of my discussion of Mr. Allen's paper relative to the effects of terrain, I limited my comments to the shadow losses behind hills. Mr. Allen admits that the nomograph, presented as Fig. 4 of my discussion, is a good guide in estimating these losses in cases where the diffracted field is the major component of the received field. It is recognized that under certain very special conditions the field intensity behind a hill may be greater than would be obtained if the terrain between the antennas were level ground. It is found, however, that in general intervening hills cause a loss in field intensity. Also, scattering and reflections from nearby hills near the straight-line path may have an appreciable effect. In some cases a stronger signal may be obtained by devious routes than can be expected by diffraction over the straight-line path. Experience shows, however, that these exceptional cases occur too infrequently to be of importance in considering the coverage of a broadcast service. Such exceptions are, in fact, hard to find in practice and may be fairly considered to be curiosities.

Experience supports the opinion that in general the major component of the signal behind hills would be the diffracted field and that Fig. 4 is, therefore, a good practical guide in estimating the magnitude of shadow loss. This being the case, Mr. Allen's allowance of 6 decibels for the combined effect of terrain and antenna transmission-line loss is totally inadequate.

This conclusion is supported by my own observations and measurements in the hilly and mountainous terrain of New England and by measurements made by the Radio Corporation of America. It is also supported by a recently published report issued by the British Broadcasting Corporation, prepared by Mr. H. L. Kirke, Head of the Research Department of the BBC Engineering Division.

Mr. Allen's failure to present a practical estimate of broadcast service ranges in the very-high-frequency band is not readily understood. As stated earlier, the dependence of the signal intensities on weather and the effect of terrain were observed and accurately reported many years ago. This information was available to Mr. Allen. About this there can be no question because exhibits quantitatively presenting the effect of the troposphere and terrain in the 40- to 50-megacycle band were introduced into the record at the frequency-modulation hearing before the Federal Communications Commission in March, 1940.

Three of these exhibits merit presentation in order that there may be no question that the true facts were known at the time Mr. Allen prepared his paper. Figs. 6 and 7 were prepared by me and were introduced as exhibits with accompanying testimony in behalf of FM

Broadcasters, Inc., for whom I was at that time directing the preparation and presentation of that organization's technical testimony.

nection with the application of the Yankee Network, Inc., for a 50-kilowatt experimental frequency-modulation broadcast station on the summit of Mount Wachusett in Princeton, Massachusetts. The propagation curves shown thereon were derived from field-intensity measurements from a transmitter on the summit of Mount Wachusett. These measurements were made to determine accurately the effect of terrain because at that time the opinion of A. D. Ring, then Assistant Chief Engineer, Broadcast Division, of the Federal Communications Commission, was that the 40- to 50-mega-

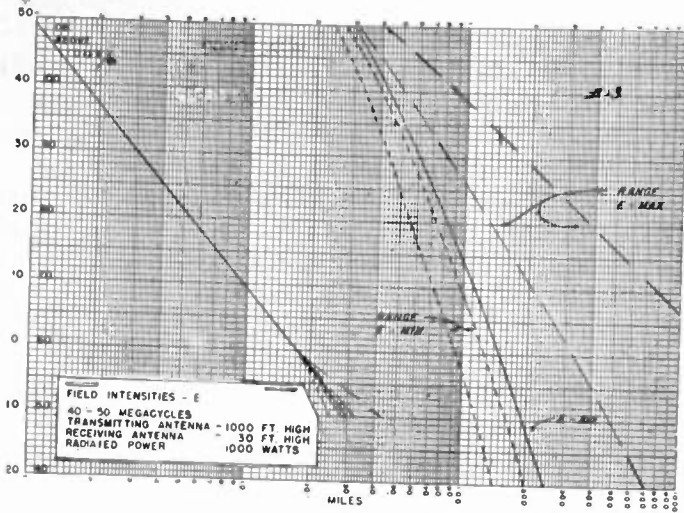

Fig. 6

Fig. 6 purports to show the effect of the troposphere on the signal-intensity versus distance, antenna height, and radiated power shown. The solid curve represents the signal-intensity versus distance derived from meas-

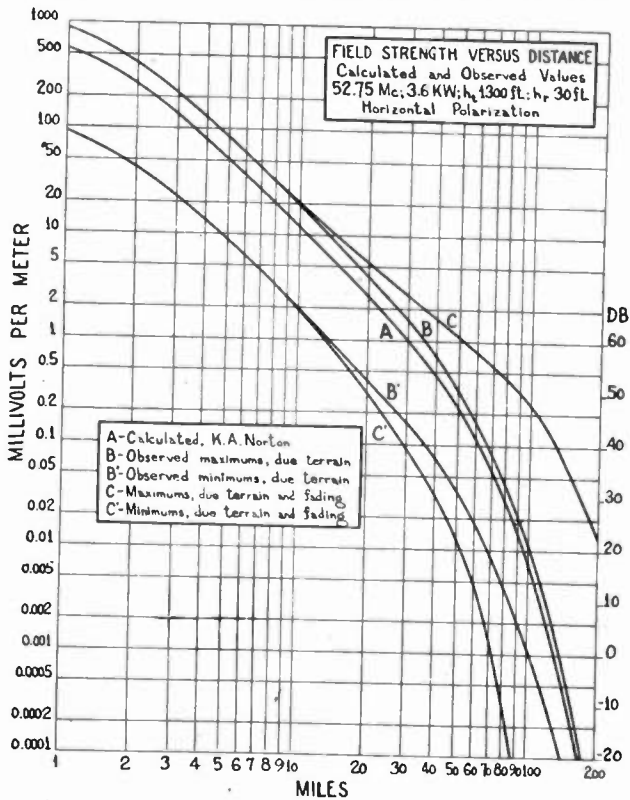

Fig. 7

urements made under what were believed to be average meteorological conditions. The dotted curves show the range of fluctuating signal intensities under substandard atmospheric conditions. The dashed curves show the range of fluctuations of signal intensities under superstandard atmospheric conditions.

Fig. 7 was originally prepared in June, 1937, in con-

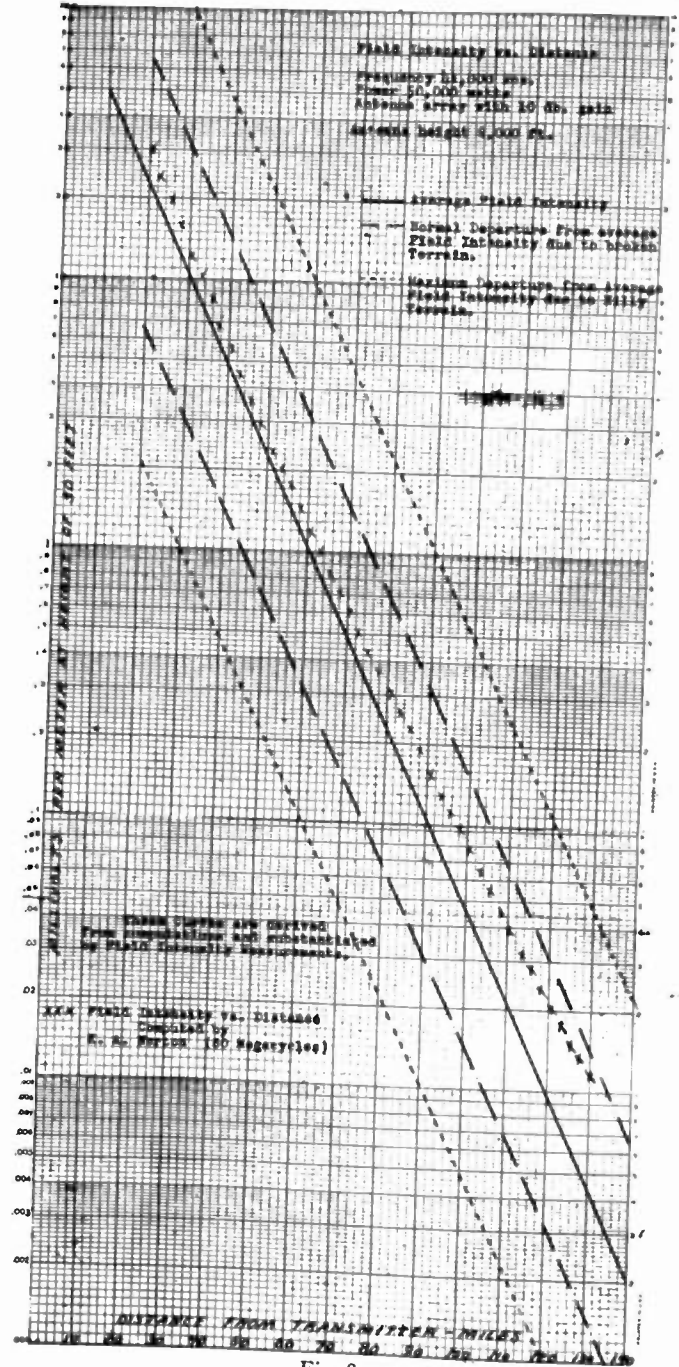

Fig. 8

cycle band could not provide service behind hills. These propagation curves were adopted by FM Broadcasters, Inc., and were presented by me to show the effect of terrain. K. A. Norton's theoretical ground-wave curve

for 50 megacycles was added to permit ready comparison. The significance of these curves lies in the magnitude of the range of signal intensities observed due to the effect of terrain and to the fact that signals fall far below the theoretical calculated values.

Fig. 8 was introduced at the hearing by Dr. H. H. Beverage in behalf of the Radio Corporation of America. Presented in this figure are curves showing the observed effects of terrain and fading and K. A. Norton's theoretical calculated ground-wave curve.

The fundamental accuracy of Figs. 6, 7 and 8 have never been attacked on the record. Not even when Fig. 6 was again presented to the Federal Communications Commission in the closed hearing on March 13, 1945, Docket 6651, was its accuracy questioned.

It is believed that fundamental defects in Mr. Allen's treatment of this subject have been pointed out which establish that his conclusions concerning broadcast service ranges are inaccurate and misleading.

Dale Pollack:⁸ Allen's reply to my comment on the use of field intensities rather than microvolts at the receiver terminals is very much to the point. The paper would have been less misunderstood if it had conformed.

Since Allen does not answer my other two points, I have no further comment.

E. W. Allen, Jr.:⁹ I feel that Major Armstrong is making an unwarranted assumption in his statement, "It is now admitted that the theory of a minimum ground-wave level which is present at all times is not correct," and Mr. deMars also in subscribing to it. I do not recall having advocated such a theory. The problem is one of determining whether theoretical curves, which take into account a fixed value of atmospheric refraction obtained under "standard-atmosphere" conditions, can be used as a reliable prediction for expected service and interference ranges in the very-high-frequency portion of the spectrum. While furnishing a perfect service would require consideration of the minimum signal from the desired station and the maximum signal from an undesired station, assuming that the fading is not coordinated, practical standards usually involve some compromise, so that a determination must be made as to an acceptable percentage of time during which the signal must exceed a minimum service level and lie below a tolerable interference level. The problem thus becomes a statistical one which is susceptible of several methods of attack. The most direct one is to analyze all available data on an instantaneous-field-strength basis. This method becomes cumbersome when large amounts of data are to be handled, and in the past we have adopted the procedure of determining separate distributions for long-period and short-period variations and then combining the two in order to evaluate the over-all distribution. This method has worked well for ionospheric propagation in the standard broadcast band, and there is no apparent reason why it cannot be applied successfully in the very-high-frequency and

ultra-high-frequency bands for tropospheric fields. Burrows, Decino and Hunt¹¹ found that the distribution of instantaneous fading follows a normal law, which is symmetrical with respect to the median value, rather than the Rayleigh or some other asymmetric law, and this has been substantiated by more recent data. Knowing the law of the distribution of instantaneous fields for short time periods, the over-all variation can be obtained by the proper treatment of the hourly median fields. Using this type of analysis, I reached the conclusion that the "standard-atmosphere" curves could be used for the prediction of service ranges, since they were exceeded for more than 90 per cent of the time. There was no finding that the minimum fields were equal to or above the predicted values, as these fields were at or below the recorder noise levels. While more recently available data indicate that the above analysis gave results which were somewhat high as compared to analysis on an instantaneous basis, and that short-period instantaneous distributions obtained at a particular frequency and distance will not hold true at another frequency or distance, it does not follow that the method of attack is in error. One further probable reason for the high field-intensity values obtained in the above analysis is that the majority of the data were for afternoon and evening hours.

Relative to the alleged discrepancy between the measurements made by the Federal Communications Commission and the sporadic-*E* skip-distance curves computed from the National Bureau of Standards data, my explanation of the reasons for the differences in the observed data are simple and straightforward and I believe they need no further expansion. The skip-distance terminology is conventional for use in both *E*- and *F*-layer propagation, and I think that most engineers with experience in the matter will agree that it is a good guide as to when transmission can be expected but that actual periods of communication or of interference will depend upon receiver sensitivity or interference level and upon transmitter power. That is our experience in connection with the measurement of sporadic *E*-layer propagation and is supported by the reports of reception of the London television signals via *F* layer. The interference level for both frequency modulation and television at the outermost protected contour is the same, 5 microvolts per meter, so I see no error in a joint reference to the two services, even though the interference ratios are different, as well as the signal contours at which interference occurs. The residual areas for television will be less than shown in my Fig. 9, just as the service area for television is less than for frequency modulation at a given radiated power.

I fail to find any substantiation of Major Armstrong's estimate of a 100-mile service radius, under conditions of tropospheric fading, in the report of British Broadcasting Corporation Field Trials on Frequency Modulation, by H. L. Kirke. The service-area tables take no

¹¹ C. R. Burrows, A. Decino, and L. E. Hunt, "Stability of two-meter waves," *PROC. I.R.E.*, vol. 26, pp. 516-528; May, 1938,

account of tropospheric effects, but are apparently based on Norton's curves, with appropriate values of required field intensity selected so as to overcome ignition noise and effects of terrain. The listening tests at distances up to 120 miles were made in the evening, when tropospheric fields are usually higher than average, but in no case can be taken as proof that a useful signal level will be exceeded for an acceptable percentage of the time at that distance. Antenna heights of 1000 feet or more will be the exception rather than the rule, and the average height is likely to be near 500 feet. Under these conditions I am inclined to agree with Mr. de Mars' estimate of a range of 70 to 75 miles at 50 megacycles. Present data indicate that the range at 100 megacycles will be somewhat less, but I do not feel that they are sufficiently comprehensive and reliable to make a real prediction as to what reduction will occur. Messrs. Carnahan's and Brown's estimate of a 55-mile radius is believed to be somewhat pessimistic, but even if this proves to be the case the resulting reduction in service area will be 40 per cent rather than the 60 per cent reduction which they estimated originally. Such estimates in the reduction of service areas do not apply to the majority of cases because the close spacing of stations, arising from the demand for facilities, will result in limitation of area by co-channel and adjacent-channel interference, rather than by failure of the signal from fading. On the other hand, the duplication will greatly increase the amount of interference within the protected area from sky-wave signals in the 50-megacycle band.

With regard to the reopening of British television on 41 and 45 megacycles, rather than on a higher frequency, I believe that a study of the situation will reveal that the primary consideration was the utilization of presently available television transmitting and receiving equipment, rather than the propagation characteristics of various frequencies. While the reception of

the London television signals at Riverhead, Long Island, has entered into the discussions by way of comparison between experience and Bureau of Standards predictions for the last sunspot maximum, the probability of interference between 40 and 50 megacycles across the North Atlantic has not appeared to be too serious, as the path lies near the auroral zone and maximum usable frequencies are likely to be much lower than for other paths over which interference may be encountered. It is the areas of high maximum usable frequencies which constitute the principal problem of F_2 -layer interference to this and other countries adjacent to such areas.

In making my comment upon the curves in Mr. de Mars' Figs. 6 and 7, the only assumption required, and I feel it to be a reasonable one, was that the data which he used in preparing his curves followed the same laws as the data which I have available to me. There appears to be good agreement generally between the data and the curves as to the range of fading, but the absolute values still appear to be low as compared to the standard-atmosphere curves, when both are based on smooth-earth conditions.

In his discussion of shadow effects Mr. de Mars loses sight of the fact that the comparison of service areas in my Fig. 9 was not made for hilly or mountainous conditions but upon an assumption of average conditions. The loss of additional areas due to shadow effects behind hills was discussed in the text, with greater losses expected at the higher frequencies. The nomograph submitted by Mr. de Mars shows a consistent 2-decibel difference in field intensity between the shadow loss on 50 and 100 megacycles, so that, even if the effects of scattering are neglected, the larger losses behind hills will apply almost to the same degree for both frequencies. Our experience has been that scattering does have a large effect and that there is no systematic difference between frequencies which is readily identifiable with features of terrain.

Field Intensities Beyond Line of Sight at 45.5 and 91 Megacycles*

C. W. CARNAHAN†, SENIOR MEMBER, I.R.E., NATHAN W. ARAM†, MEMBER, I.R.E.,
AND EDWARD F. CLASSEN, JR.‡

Summary—This paper presents the results of a field-intensity monitoring project initiated by the Federal Communications Commission during the summer of 1945. Field intensities on 45.5 and 91 megacycles from transmitters at Richfield, Wisconsin, were continuously monitored for a period of two months at Deerfield, Illinois, over a transmission path of 76 miles. The data is analyzed in terms of the average median field intensities and their diurnal variation.

* Decimal classification: R271. Original manuscript received by the Institute, March 6, 1946; Rochester Fall Meeting, November 12, 1945; Cosmic Terrestrial Research Laboratory, Needham, Mass.; Washington Section, January 14, 1946; presented, 1946 Winter Technical Meeting, January 24, 1946, New York, N. Y.; Chicago Section, February 15, 1946.

† Zenith Radio Corporation, Chicago, Illinois.

‡ Formerly, Zenith Radio Corporation, Chicago, Illinois; now, Radio Engineering Laboratories, Chicago, Illinois.

The number of hours of unsatisfactory broadcast reception due to fading is estimated for both frequencies, assuming representative transmitter power and receiver sensitivity. Comparison is made with similar analyses of data obtained by the Federal Communications Commission in the measurement of field intensities on 46.7, 83.75, and 107 megacycles at Andalusia, Pennsylvania.

INTRODUCTION

IN MAY OF 1945 the Federal Communications Commission elicited the aid of various interested parties in making a number of field-intensity recordings on the old frequency-modulation broadcast band, 42 to 50 megacycles, and the proposed new band, 88 to 108 megacycles. These tests were to furnish more

information on comparative propagation conditions on these two frequency bands. Most of the program was abandoned at the end of June, 1945, when the Commission decided to allocate the higher band to frequency modulation without waiting for the results of the propagation tests.

The test setup between transmitters at Richfield, Wisconsin, and recorders at Deerfield, Illinois, was continued, however, and it is the purpose of this paper to present the results found during the recording period of two months, between July 20 and September 21, 1945.

DESCRIPTION OF TRANSMITTERS

The transmitters used were WMFM, the Milwaukee Journal station, at 45.5 megacycles and an experimental transmitter, W9XK, at 91 megacycles, both located at Richfield, Wisconsin.

The 45.5-megacycle antenna was a horizontally polarized two-bay turnstile with a power gain in the direction of the receiving station of 1.23. The antenna center was 508 feet above the average elevation of the transmission path. The effective radiated power in the direction of Deerfield was constant at 35 kilowatts during the recording period.

The 91-megacycle antenna was a horizontally polarized 60-degree corner reflector, with a power gain of 10 in the direction of Deerfield. The antenna center was 468 feet above average elevation. The effective radiated power towards Deerfield varied between 2.5 and 10 kilowatts during the recording period. Both transmitters were under the supervision of P. B. Laeser of WTMJ.

DESCRIPTION OF TRANSMISSION PATH

Fig. 1 shows a profile graph of the path between transmitters and recorders. The terrain is gently rolling, with no pronounced topographical features. The total distance was 76.3 miles. The transmitter site was on a hill, 1060 feet above sea level, or 278 feet above the average elevation of the transmission path. The average elevation for this transmission path was determined in accordance with the standards of good engineering practice of the Federal Communications Commission.¹

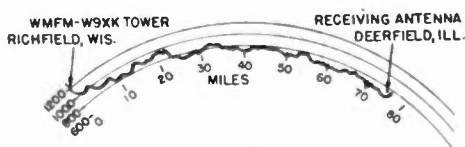

Fig. 1—Profile graph of the terrain between Richfield, Wisconsin and Deerfield, Illinois. The optical horizon from the transmitting antennas was at 25 miles from Richfield.

A different method of effective height calculation is prescribed in later standards of the Commission.² In

¹ F.C.C. "Standards of Good Engineering Practice Concerning High Frequency Broadcast Stations," June 29, 1940 (41831), and "Proposed Standards of Good Engineering Practice Concerning FM Broadcast Stations," July 11, 1945 (83399).

² F.C.C. "Standards of Good Engineering Practice Concerning F-M Broadcast Stations," September 20, 1945.

this method, only distances between 2 and 10 miles are considered in determining the "average-terrain" level, above which the antenna height is computed. In our opinion, this later method is less accurate than the one we used, especially for distances greater than ten miles, because (a) terrain characteristics beyond ten miles are disregarded, and (b) the effects of azimuthal variation of terrain are completely disregarded. While this method may be suitable for calculation of average coverage at short range, it appears unsatisfactory for prediction of ground-wave propagation at distances involved in rural-service frequency-modulation stations.

The optical horizon for this path and antenna heights was approximately 25 miles.

DESCRIPTION OF RECORDING LOCATION AND EQUIPMENT

The receiving station at Deerfield, Illinois, was maintained by the Zenith Radio Corporation. The recorders were located in the second floor of a residence situated on a slight rise, overlooking a school playground in the direction of the transmitters, and there were no trees immediately in the transmission path.

The receiving antennas were half-wave folded dipoles mounted on ten-foot masts supported by guyed twenty-foot towers. Exploration of the area revealed no appreciable standing waves. Fig. 2 is a photograph of the receiving location looking from the transmitter, and Fig. 3 shows the 45.5-megacycle antenna. For the transmission lines, 300-ohm molded two-wire cable was used, supported by guys leading directly to the recorders.



Fig. 2—View of the building and antenna towers of the monitoring station at Deerfield, Illinois, looking from the transmitters.

The monitoring equipment consisted of a Hallcrafters S-27 receiver on 45.5 megacycles, and a Hallicrafters S-36 receiver on 91 megacycles. This latter receiver is a military version of the S-27 and has essentially the same circuit. Both receivers were modified for recording as recommended by the Federal Communications Commission. Esterline-Angus recorders, Ferris 18C signal generators for calibration, and voltage regulators were used in conjunction with both receivers.

Radio-frequency stages with balanced 300-ohm inputs were added to each receiver. To take care of signal variations, H-section attenuators were placed between each antenna and receiver input, wired to band switches so that they could be connected or disconnected. An

additional permanent attenuator section was found necessary with the 45.5-megacycle receiver to bring the signals within recording range.

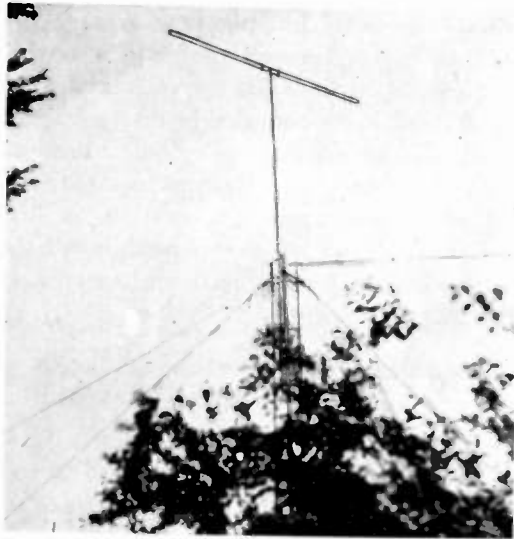

Fig. 3—Close-up view of the 45.5-megacycle half-wave folded dipole, used for monitoring.

Double-throw switches were placed before the attenuators to switch the receivers from the antenna lead-ins to the calibrating signal generators, which were wired in permanently with 150-ohm resistors between each generator terminal and the switch. The circuit of the 91-megacycle receiver was the same except for the omission of the second attenuator section.

Calibrations were put on the tapes at the beginning of each record. These calibrations were checked at frequent intervals, and if appreciable change was observed, an additional calibration was recorded. Calibrations were also recorded whenever the attenuator switch was changed.

REDUCTION OF DATA

The tape recordings give the microvolts at the antenna lead-ins, by comparison with the signal-generator calibrations. To relate these values to the actual field intensities at the antennas it is necessary to determine the recorder calibration constants, the factors by which the tape readings in signal generator microvolts must be multiplied to give the field intensities at the antennas.

The accepted method for determining this constant is to set up by means of a test oscillator a constant field with the correct polarization at the antenna. The intensity of this field is then measured by replacing the receiver antenna with the antenna of a field-intensity meter. The value of field intensity so obtained is compared with the signal-generator output required to give the same indication on the recorder.

If the receiving antenna, transmission line, and input circuit are perfectly balanced to ground, the measured recorder calibration constant should be independent of the polarization of the wave from the test oscillator. In the Deerfield arrangement it was found necessary to eliminate as completely as possible any vertical com-

ponent in the test field before consistent results could be obtained. With the best arrangement of test oscillator, which turned out to be a half-wave dipole fed by a Ferris 18C signal generator, some variation of recorder constant with oscillator position was still noted. The final values decided upon were the averages of the results of three different positions.

Field intensities were measured independently by W. K. Roberts of the Federal Communications Commission and by P. B. Laeser of WTMJ. Two RCA Type 301 field-intensity meters were used, and the meter calibrations were checked by S. L. Bailey, of Jansky and Bailey, using his standard field oscillator.

The variation of recorder constant with test-oscillator position raised the possibility that the constant for the actual signals might be different. To check this, simultaneous fast recordings of the 45.5-megacycles signal were made, using the 45.5-megacycle recorder and a field-intensity meter with its dipole mounted on the 91-megacycle tower. Comparing the signal peaks for a period of fifteen minutes, the recorder constant obtained was found to be 20 per cent lower than with the test oscillator. Since the two antenna locations had been previously found to differ with regard to field intensity from the test oscillator by just this amount, it was concluded that this test was a satisfactory check on the recorder calibration procedure.

Since the 45.5-megacycle transmitter is a representative broadcast transmitter, it was decided to correct the 91-megacycle field intensities for assumed operation with the same power radiated at 91 megacycles. The power input to the 45.5-megacycle transmitter during most of the test was 50 kilowatts. Assuming an amplifier efficiency of 60 per cent, a transmission-line efficiency of 95 per cent, and an antenna power gain of 1.23, the effective radiated power on 45.5 megacycles was

$$50 \text{ kilowatts} \times 0.60 \times 0.95 \times 1.23 = 35 \text{ kilowatts.}$$

This value was confirmed by the reading of a radio-frequency vacuum-tube voltmeter previously calibrated during a field-intensity survey.

The effective power radiated toward Deerfield on 91 megacycles was determined indirectly in a manner which requires some explanation. A direct measurement of the power at the 91-megacycle antenna was made by E. H. Armstrong and C. M. Jansky. A half-wave dipole was suspended at a distance of two wavelengths from the radiator and the current at the center of the dipole was measured on a Weston meter which had been carefully calibrated at 91 megacycles. The result was used in a computation by S. L. Bailey, taking into account the proximity effect of the measuring dipole, to give the effective radiated power. These computations are shown in the Appendix. With the same power input as used in the direct measurement, the reading of a simple monitoring diode meter on the ground near the tower was noted. The monitoring diode meter was calibrated against relative field intensity by

placing an RCA Type 301 field-intensity meter a mile away from the tower, and then reading both meters simultaneously as the power input to the transmitter was varied. These calibrations were required, since the power input to the transmitter varied throughout the test period.

Having the monitoring diode reading for the measured value of radiated power, and the calibration of the diode in terms of relative field strength and power input, it was then possible to determine the effective radiated power as a function of the power input. As an example, an input power of 2.08 kilowatts gave a relative field strength of 9.2 on the 301 meter. The direct measurement gave 2.68 kilowatts effective radiated power for a relative field strength of 4.7, this latter value being obtained from the curve of diode readings versus relative field intensity. Then the effective radiated power at 2.08 kilowatts input was computed as $2.57 \text{ kilowatts} \times (9.2/4.7)^2 = 10.3 \text{ kilowatts}$.

SUMMARY OF RESULTS

The daily tape recordings on both frequencies were studied in detail, and the hourly median values of the field intensities, or the values of field intensity which were just exceeded for thirty minutes out of an hour, were estimated for each hour recorded. The 91-megacycle field intensities were then corrected for an assumed effective radiated power of 35 kilowatts. All field intensities quoted in the text and figures assume this power on both frequencies.

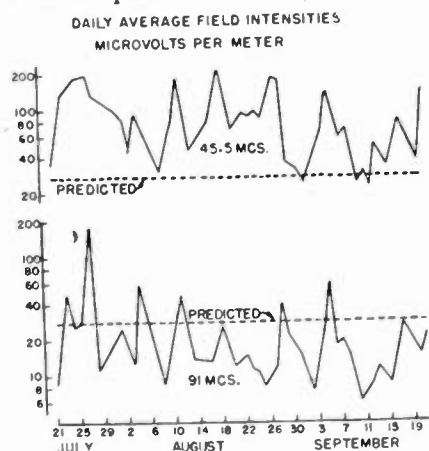

Fig. 4—Plots of daily averages of median hourly field intensities showing variations over the recording period. Predicted values are 26.9 microvolts per meter at 45.5 megacycles and 24.9 microvolts per meter at 91 megacycles.

Fig. 4 shows median hourly field intensities averaged over each day of operation for an effective radiated power of 35 kilowatts. The dotted lines indicate the values predicted using the F.C.C. curves and the data already given on effective antenna heights and distance. The predicted values were 26.9 microvolts per meter at 45.5 megacycles, and 24.9 microvolts per meter at 91 megacycles.

It will be seen that the 45.5-megacycle intensity is well above the predicted value for most of the time, while the 91-megacycle intensity is below.

These curves show the variation typical of tropospheric propagation for this time of year. The peaks and valleys are due to weather changes, and it will be seen that, in general, the trend of the intensities at the two frequencies agree quite well.

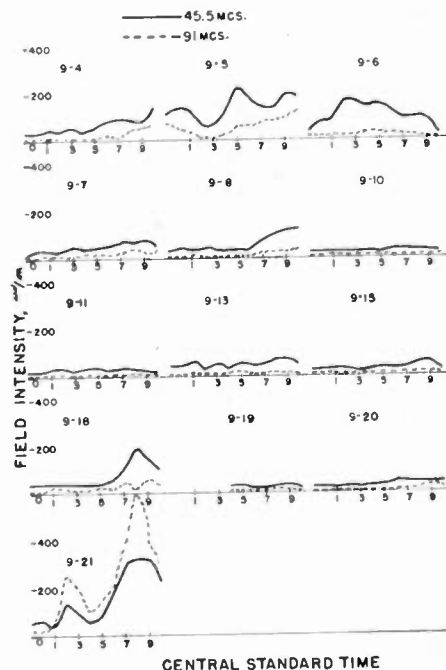

Fig. 5—Daily variation of median hourly field intensities for the last thirteen days of the recording period. Note the high fields on 91 megacycles for September 21.

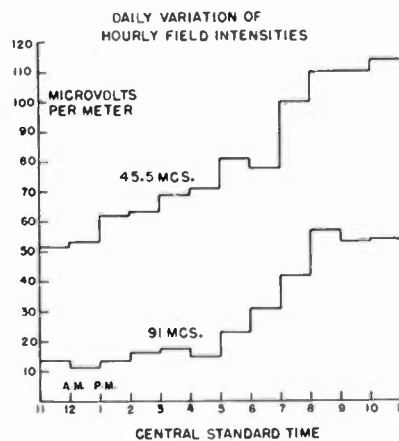

Fig. 6—Daily variation of median hourly field intensities, averaged over the entire recording period.

Fig. 5 shows the hourly median field intensities plotted against time of day for part of the recording period. These curves again emphasize the variable nature of tropospheric signals, not only from day to day, but in the course of a day. The agreement in trends on the two frequencies is not so apparent here. Of particular interest is the behavior on September 21. There was a strong temperature inversion present on this day, and the 91-megacycle field intensity exceeded that of the lower frequency for most of the day. This condition prevailed on several of the recording days and agrees with the theory that, in propagation through atmospheric ducts formed by temperature inversions, greater field intensities are found at higher frequencies

because of better reflection conditions within the duct.

In Fig. 6 are plotted the hourly median field intensities averaged over the entire recording period, against time of day. The 45.5-megacycle field intensity shows a more or less steady rise during the day, with a variation of two to one between 11 A.M. and 11 P.M., Central Standard Time. The 91-megacycle signal remains low and fairly constant from 11 A.M. to 5 P.M. and then rises to five times this value between 5 P.M. and 11 P.M.

Figs. 7 and 8 shows the same average fields plotted on a logarithmic scale, with maximum and minimum values added to show the extent of variation on the two frequencies. The spread between the highest and lowest hourly median field intensities is about 35 times on 45.5 megacycles against 200 times on 91 megacycles.

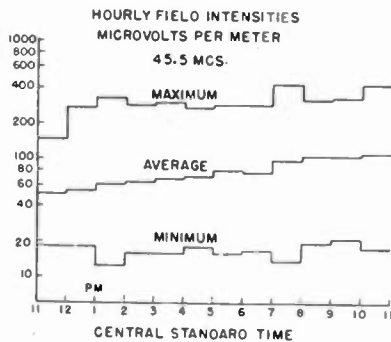

Fig. 7—Daily variation of median hourly field intensities at 45.5 megacycles, averaged over the entire recording period, showing the variation between maximum and minimum hourly values.

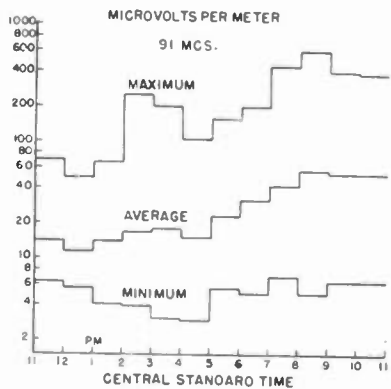

Fig. 8—Daily variation of median hourly field intensities at 91 megacycles, averaged over the entire recording period, showing the variation between maximum and minimum hourly values.

Since this test was set up to secure comparative data on the relative service afforded by the two frequency bands for frequency-modulation broadcasting, the recordings have been analyzed in terms of the performance of typical home receivers operating on both frequencies.

The hypothetical receivers were assumed to operate with half-wave dipole antennas and lossless transmission lines, with no mismatching. It was assumed that signals of 10 microvolts induced in the antenna would be sufficient for satisfactory limiting in the receiver. This is a conservative figure for a good broadcast receiver.

To obtain an induced signal of 10 microvolts at 45.5 megacycles requires a field intensity of 5 microvolts

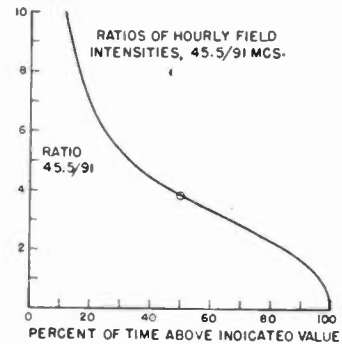

Fig. 9—The time distribution of the ratios of the simultaneous median hourly field intensities on 45.5 and 91 megacycles.

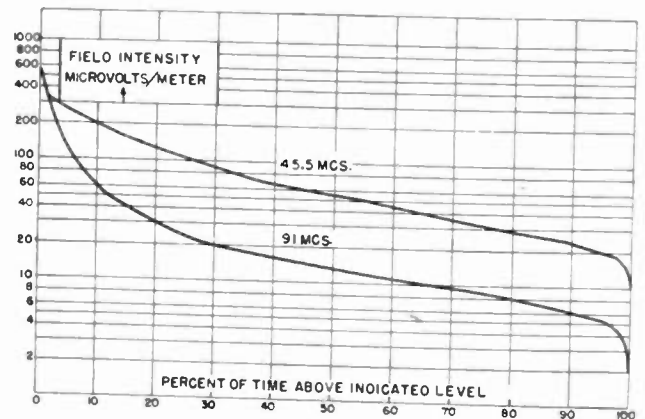

Fig. 10—The time distribution of the recorded median hourly field intensities. Effective radiated power is 35 kilowatts for both frequencies.

Fig. 9 shows the time distribution of the ratios of simultaneous hourly median field intensities. For 50 per cent of the total recording time the 45.5-megacycle field intensity was four times the 91-megacycle intensity.

The time distributions of the actual field intensities are shown in Fig. 10. The median values for the entire recording periods are given by the intersections of the curves with the 50 per cent abscissa. These figures are 54 microvolts per meter at 45.5 megacycles, or 200 per cent of the predicted ground-wave value of 26.9 microvolts per meter and 13 microvolts per meter at 91 megacycles, or 52 per cent of the predicted value of 24.9 microvolts per meter.

per meter, since the effective antenna length at this frequency is about two meters. To get the same signal at 91 megacycles requires a field of 10 microvolts per meter, because the effective antenna length is halved.

Assuming 35 kilowatts effective radiated power for a typical broadcast transmitter, the curves of Fig. 10 give some information on how well the minimum levels for typical receivers would be met, under the conditions of the test. From them we see that as far as average fields are concerned the minimum field of 5 microvolts per meter at 45.5 megacycles was obtained 100 per cent of the time, while at 91 megacycles the field was below the required 10 microvolts per meter for 35 per cent of the time.

The average signal is only part of the story, however. Fig. 11 shows sections of tape with simultaneous recordings of both field intensities. The sharp spikes represent fast fades. When these fades go below the minimum required intensity, the program disappears for intervals of ten or twenty seconds. These periods when the signal disappears have been termed "dropouts."

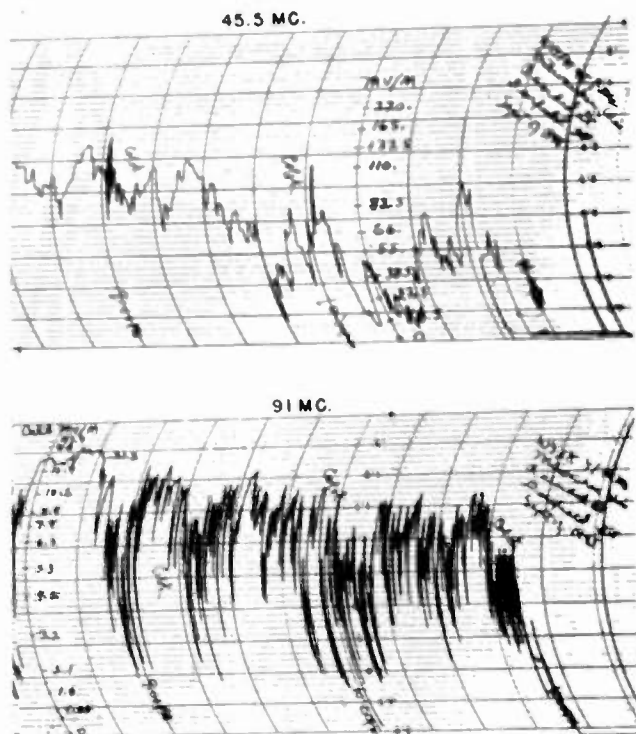

Fig. 11—Representative simultaneous tape sections on the two frequencies for comparison of the prevalence and degree of fading on the two frequencies.

The recorder tapes on both frequencies were analyzed in detail for the frequency of occurrence of dropouts. It is difficult to set a standard for satisfactory service, so it was decided that one dropout per hour would be considered unsatisfactory.

With this definition of unsatisfactory service it was found that, on 45.5 megacycles, 87 per cent of the total recording hours were satisfactory, while on 91 megacycles only 27 per cent of the total hours were free from dropouts. A further breakdown of the dropout situation revealed that in 90 per cent of the unsatisfactory hours on 91 megacycles the signal was below the minimum for at least 5 per cent, or three minutes, out of each hour, and for 50 per cent of the unsatisfactory hours it was below the minimum for 50 per cent, or thirty minutes out of each hour. On 45.5 megacycles, one half of the unsatisfactory hours had only several dropouts per hour, and in the other half the number of minutes lost out of an hour did not exceed six.

As part of the recording program the Federal Communications Commission monitored field intensities from transmitters in New York on 46.7, 83.75, and 107 megacycles, at Andalusia, Pennsylvania, a distance

of 71 miles. The F.C.C. report on these measurements is available.³

Through the kindness of the Commission's engineers, Zenith Radio Corporation was furnished with copies of the recorder tapes and the hourly median values obtained from them. This made possible a direct comparison between the Deerfield and Andalusia measurements.

Table I shows the median field intensities, predicted and measured, for the two Deerfield frequencies and the two lower Andalusia frequencies, all corrected for 35 kilowatts effective radiated power at the transmitters. The median field intensities were averaged over the Deerfield recording period, from 11 A.M. to 11 P.M., Central Standard Time.

TABLE I

Frequency, megacycles	Recorder location	Theoretical field, microvolts per meter	Measured field, microvolts per meter	Per cent of of theoretical field
45.5	Deerfield	26.9	54	200
46.7	Andalusia	77.5	35.3	45.5
83.75	Andalusia	56.8	41	72.2
91	Deerfield	24.9	13	52.2

The comparison shows fair agreement on the high frequencies, considering that in the Andalusia tests the antenna heights were greater and the distance shorter, so that predicted field intensities were two to three times greater than at Deerfield.

There is a pronounced disagreement between the observed percentages of theoretical fields at the lower frequencies. Assuming that this is due to site errors, the two measurements may represent the two extremes.

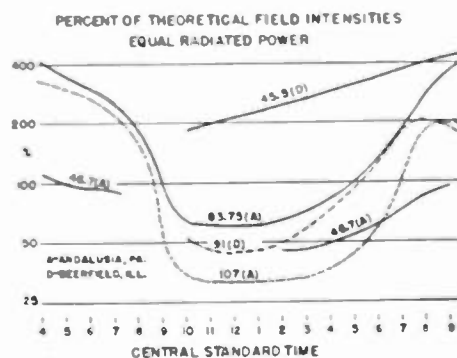

Fig. 12—Daily variation of median hourly field intensities on transmissions recorded at Deerfield, Illinois, and Andalusia, Pennsylvania, averaged over entire recording period and expressed as percentages of theoretical values for equal radiated power.

The Andalusia recordings were continuous from 4 A.M. to 9 P.M., C.S.T., except for the 46.7-megacycle frequency, which made it possible to show the diurnal variation over a complete day. Fig. 12 shows a combined plot of the average hourly median field intensities for both locations, assuming equal radiated power. The

³ Exhibit 650 of the Proceedings Before the Federal Communications Commission at Washington, D. C., January 18, 1945, in the matter of: "Allocation of Frequencies, etc." Docket No. 6651.

characteristic diurnal variation of tropospheric signals is clearly shown by these curves. High field intensities are found in the late afternoon and night hours, when temperature and humidity inversions build up, and low values are found in the middle of the day, when turbulence removes the inversions.

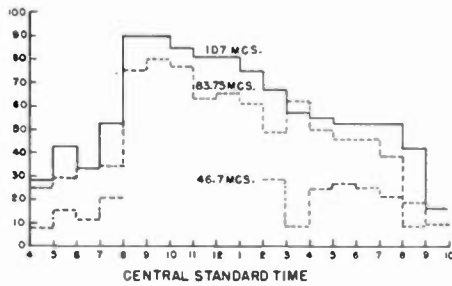

Fig. 13—Daily variation of percentage of total recorded hours having at least one dropout during the hour, for frequencies recorded at Andalusia, Pennsylvania, assuming 35 kilowatts effective radiated power.

Of particular interest is the downward progression of signal intensity with increasing frequency in this critical middle period of the day. During this period fading is a maximum, which tends to further degrade the service on the higher frequencies.

Fig. 13 shows the results of an analysis of the Andalusia recording from a dropout viewpoint. As in the Deerfield analysis, 35 kilowatts radiated power, half-wave dipole receiving antennas, and a minimum induced voltage of 10 microvolts was assumed. The prevalence of dropouts on the two high frequencies during the major part of the day was so great as to render broadcast service completely impossible.

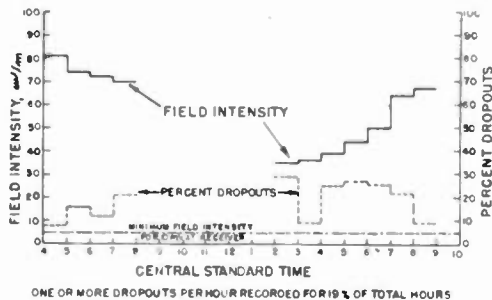
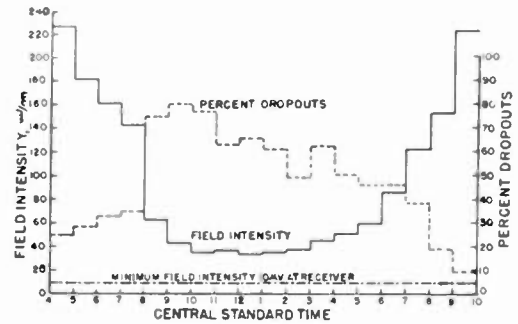

Fig. 14—Daily variation of hours unsatisfactory due to dropouts at Andalusia, Pennsylvania, on 46.7 megacycles, together with average median hourly field intensities, assuming 35 kilowatts effective radiated power.

It has been suggested that raising the power on the high frequencies will overcome these fading difficulties. Figs. 14, 15, and 16, where the percentage dropout curves are plotted together with the field strength for the three Andalusia frequencies, refute this idea. During the hours when the 46.7-megacycle transmitter was on, the field intensities at 83.75 and 107 megacycles were two to three times greater than that on 46.7 megacycles, but percentages of hours unsatisfactory because of the dropouts were larger by the same factors. To overcome the greater depth of fading on the high frequencies by raising the power is clearly uneconomical. In

fact, the Andalusia recordings on 107 megacycles suggest that it would be practically impossible, since for several days the 107-megacycle signal disappeared into the noise level of the receiver for six or seven hours in the middle of the day.



ONE OR MORE DROPOUTS PER HOUR RECORDED FOR 49% OF TOTAL HOURS. SIGNAL BELOW MINIMUM FOR MORE THAN 5% OF ONE HOUR FOR 24.5% OF TOTAL HOURS.

Fig. 15—Daily variation of hours unsatisfactory due to dropouts at Andalusia, Pennsylvania, on 83.75 megacycles, together with average median hourly field intensities, assuming 35 kilowatts effective radiated power.

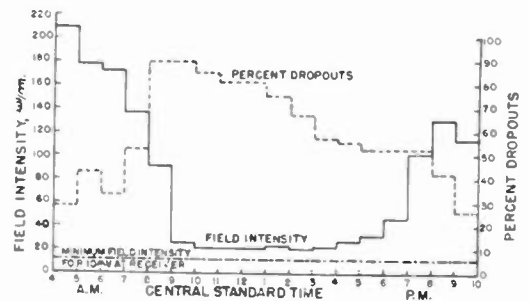

ONE OR MORE DROPOUTS RECORDED PER HOUR FOR 59% OF TOTAL HOURS. SIGNAL AT NOISE LEVEL FOR 12.2% OF TOTAL HOURS. SIGNAL BELOW MINIMUM FOR 5% OF ONE HOUR FOR 30.6% OF TOTAL HOURS.

Fig. 16—Daily variation of hours unsatisfactory due to dropouts at Andalusia, Pennsylvania, on 107 megacycles, together with average median hourly field intensities, assuming 35 kilowatts effective radiated power.

DISCUSSION

While it will take many more measurements such as those described here to establish conclusively the average fields to be expected at these distances and frequencies, it is felt that certain conclusions can safely be drawn from the measurements. These are:

1. Actual measurements on tropospheric field intensities depart widely from predicted fields of surface ground waves.

2. Loss of service due to fading will render a frequency-modulation broadcast service in the 88 to 108 megacycle band practically impossible at distances of the order of 70 miles, while service in the 42 to 50-megacycle band is, on the whole, satisfactory at these distances.

3. In assessing the service value of a given frequency at distances where tropospheric propagation is encountered, the minimum field intensity during the middle period of the day should be considered as the deciding factor, along with extent of fading during this period. The median field intensity has no meaning if, during four or five hours out of the day, the received signal is unsatisfactory.

APPENDIX

NOTES ON MEASUREMENT OF POWER FROM A 60-DEGREE CORNER REFLECTOR USING A DIPOLE PROBE

The following computations were made by S. L. Bailey of Jansky and Bailey, Washington, D. C.

The mutual impedance between two antennas $\frac{1}{2}$ -wavelength long spaced 2 wavelengths is, very nearly,

$$Z_{12} = 9/+90^\circ \text{ ohms.}$$

Now, in a system of this type (Fig. 17 (a)) we can write

$$\begin{aligned} E_1 &= I_1 Z_{11} + I_2 Z_{12} \quad \text{and} \\ 0 &= I_1 Z_{12} + I_2 Z_{22} \end{aligned} \quad (1)$$

where Z_{11} and Z_{22} are the self impedances of elements (1) and (2), respectively, and Z_{12} is the mutual impedance. It is safe to assume that the impedance of a

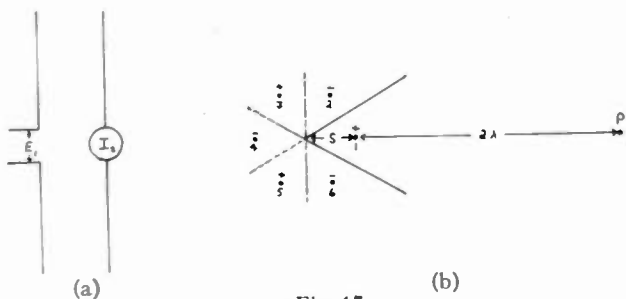

Fig. 17

self-resonant dipole having finite cross-section is very nearly 68 ohms nonreactive.

$$E_1 = I_1 \times 68 + I_2 \times 9/+90^\circ \quad (2)$$

$$0 = I_1 \times 9/+90^\circ + I_2 \times 68 \quad (3)$$

$$Z_1 = \frac{E_1}{I_1} = 68 + \frac{I_2}{I_1} \times 9/+90^\circ \quad (4)$$

but, from (3),

$$\frac{I_2}{I_1} = -\frac{9/+90^\circ}{68} \quad (5)$$

$$\begin{aligned} Z_1 &= 68 - 1.2/+180^\circ \\ &= 69.2 \text{ ohms} \end{aligned} \quad (6)$$

which means that the resistive component of the driven element is raised slightly for this spacing. For 1 kilowatt in element (1),

$$I_1 = \sqrt{\frac{1000}{69.2}} = 3.80 \text{ amperes.} \quad (7)$$

Calculating the magnitude of I_2 from (5), $I_2 = 3.80 \times 9/68 = 0.502$ ampere. (Note: This neglects any resistance added by the meter in element (2). If appreciable, this may be taken into account by modifying Z_{22} accordingly.)

As a check on the above, we know that 1 kilowatt in a $\frac{1}{2}$ -wavelength dipole produces a free-space field of 137 millivolts per meter at one mile or 0.137 volts per meter. Inasmuch as the free-space field varies inversely as the distance, we can calculate for any frequency the free-space field at the receiving dipole.

At 91 megacycles, 1 wavelength = 10.8 feet = 3.3 meters.

At 91 megacycles, 2 wavelengths = 21.6 feet.

Hence, the field at a dipole 2 wavelengths away is

$$\frac{5280}{21.6} \times 0.137 \text{ volts per meter} = 33.5 \text{ volts per meter.}$$

The receiving dipole is $3.3 \times \frac{1}{2} \times 0.95$ meters long or 1.57 meters and the effective length is $0.636 \times 1.57 = 1.0$ meter. Therefore, the induced voltage is $33.5 \times 1.0 = 33.5$ volts and the current $33.5/68 = 0.495$ amperes, which compares with 0.502 amperes by the former method. A value of 0.50 amperes is a satisfactory value.

Now, considering a 60-degree corner reflector, we can calculate the gain in the forward direction by the method of images. The spacing S (Fig. 17(b)) of the driver element from the corner was 0.4 wavelength. Using the method of images, we find that at a great distance the amplitudes and phase relations of the driven element and the five images for the 0.4-wavelength condition are as follows:

$$\begin{aligned} \text{Driven element (1)} &= +1.0/0^\circ \\ \text{Image (2)} &= -1.0/-72^\circ \\ \text{Image (3)} &= +1.0/-216^\circ \\ \text{Image (4)} &= -1.0/-288^\circ \\ \text{Image (5)} &= +1.0/-216^\circ \\ \text{Image (6)} &= -1.0/-72^\circ \end{aligned}$$

The vector sum of these is 2.62/126 degrees.

We may now consider the effect of proximity of the dipole probe on the indicated power radiated. The vector fields from the driven dipole and the five images are modified both as to amplitude and phase, and have the following values:

$$\begin{aligned} \text{Driven dipole (1)} &= +1.0/0^\circ \\ \text{Image (2)} &= -0.9/-82^\circ \\ \text{Image (3)} &= +0.76/-225^\circ \\ \text{Image (4)} &= -0.715/-288^\circ \\ \text{Image (5)} &= +0.76/-225^\circ \\ \text{Image (6)} &= -0.9/-82^\circ \end{aligned}$$

The vector sum of the above is 2.24/104.2 degrees, which may be compared directly with the value of 2.62/126 degrees which was obtained for a great distance. Thus the actual power in the direction of the probe is $(2.62)^2/(2.24)^2 = 1.37$ times as great as that indicated by the received current.

It has been shown that the current in a half-wavelength dipole 2 wavelengths from a driven dipole in free space radiating 1000 watts would be 0.5 ampere.

The received current in Milwaukee at the time of the tests was 0.7 ampere. Then the power in the beam is given by the following:

$$1000 \times \left(\frac{0.7}{0.5}\right)^2 \times 1.37 = 2680 \text{ watts.}$$

Directional Couplers*

W. W. MUMFORD†, SENIOR MEMBER, I.R.E.

Summary—The directional coupler is a device which samples separately the direct and the reflected waves in a transmission line. A simple theory of its operation is derived. Design data and operating characteristics for a typical unit are presented. Several applications which utilize the directional coupler are discussed.

INTRODUCTION

WHENEVER a transmission line is used to convey radio-frequency power from one point in a system to another, a knowledge of the power contained in the direct and the reflected waves is of fundamental importance. It is possible to obtain this knowledge indirectly by employing a calibrated traveling detector to measure the voltage-standing-wave ratio, from which the direct and the reflected powers may be calculated. A more straightforward and direct measurement can be accomplished by utilizing a device which samples these waves separately and causes output powers proportional to each to appear in two separate power meters. This device has attracted considerable attention and has been called by various names, such as: stationary standing-wave detector, directive tap, directional tap, wave selector, directive pickup, and, finally, directional coupler.¹ The last-mentioned name has been generally agreed upon and accepted by representatives of the major research and development groups in the United States.

The directional coupler¹ usually takes the form of two adjacent wave guides or coaxial lines with one or more coupling elements between them. One of these lines is the main line, or primary line, referred to above. A small fraction of the energy in this line is transferred, through the coupling elements, to the secondary line. When the two lines are otherwise thoroughly shielded, the ratio of the powers that flow in the two lines depends upon the physical size, the number, and the spacing of the coupling elements. Since all of these factors can be controlled and held constant, a high degree of stability is insured. This property is especially important in applications which require high values of attenuation.

Because of its remarkable properties, the directional coupler is a useful tool for laboratory and production testing and is an invaluable aid to the operators in the field.

In this paper typical design data and characteristics are presented, after an elementary and approximate explanation of operation is given.

TWO-ELEMENT DIRECTIONAL COUPLER

A schematic diagram of a two-element directional

* Decimal classification: R142X R320.51. Original manuscript received by the Institute, March 6, 1946; revised manuscript received, May 6, 1946.

† Bell Telephone Laboratories, Holmdel, N. J.

¹ A type of directional coupler is described by A. A. Pistolkors and M. S. Neumann, *Electrosvyaz*, vol. 9, p. 9; April, 1941. It is discussed by G. W. O. Howe, *Wireless Eng.*, vol. 20, p. 365; August, 1943.

coupler is given in Fig. 1, which shows two adjacent transmission lines coupled together weakly at two places by means of simple link circuits. The primary line is driven by a generator and is terminated in an arbitrary

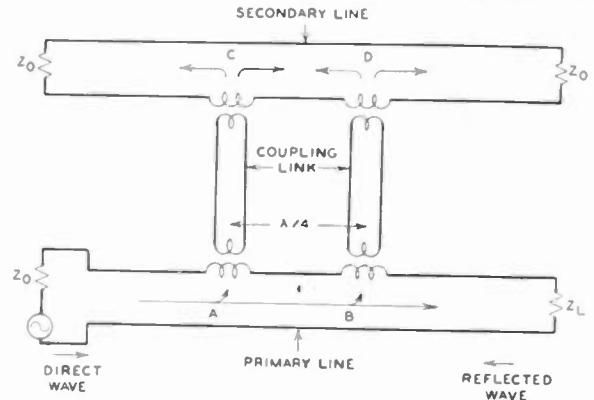

Fig. 1—Schematic diagram of a two-element directional coupler.

load impedance, Z_L . There exists a direct wave traveling from left to right, and a reflected wave traveling from right to left. We shall consider first only the direct wave. At point *A*, a small portion of this wave passes from the primary line into the link circuit and thence into the secondary line at point *C*. Here it sets up two waves traveling in opposite directions toward the ends of the secondary line, which are both terminated in impedances which match the characteristic impedance. Likewise, at point *B*, a small portion of the direct wave in the primary line is fed into the secondary line through the coupling link *BD*. At point *D*, therefore, two waves are also set up in the secondary line, one of which travels to the left, and one to the right. Hence we have two waves traveling in each direction in the secondary line. The two waves traveling to the right will be in phase and will therefore reinforce each other, since the paths *ACD* and *ABD* are of the same length. The two waves traveling to the left will cancel and give zero current in the left-hand termination if the path *ABDC* is a half-wavelength longer than the path *AC*, i.e., if the spacing between the coupling links is a quarter wavelength.

As for the reflected wave in the primary line, it can be shown, through a similar line of reasoning, that the current flowing in the secondary line will cancel to the right and reinforce to the left if the distance *d* is a quarter wavelength. Thus we have a directional coupler in which the power dissipated in the right-hand end is proportional to the direct wave, while the power in the left-hand end is proportional to the reflected wave. The coupling links themselves need not be confined to loops, as indicated in Fig. 1, but may take the form of probes or of coupling orifices.

The bandwidth of the two-element directional coupler will now be investigated. To do this we will use the well-known transmission-line equations and then see how a

larger number of elements can be made to improve the bandwidth. In order to simplify the analysis, let us make the following assumptions:

- (1) The secondary line is perfectly terminated in its characteristic impedance at each end.
- (2) The primary line is terminated in an arbitrary impedance Z_L .
- (3) The energy in the secondary line is very small compared with that in the primary line.
- (4) The discontinuities introduced in the lines by the coupling elements are negligible.
- (5) The phase velocity is the same in both lines.
- (6) The phase shifts in the coupling elements are identical.
- (7) Each coupling element is responsive to current and not responsive to voltage.
- (8) The transmission lines are lossless.

Under these assumptions, we represent the current in the primary line at any point x by the relation

$$I(x) = Pe^{j(2\pi x)/\lambda} + Qe^{-j(2\pi x)/\lambda} \quad (1)$$

The first term represents the reflected wave and the second term the direct wave, the reflection coefficient being P/Q .

Letting $x=0$ at point A and $x=d$ at point B (see Fig. 1) we have for the currents in the primary line at points A and B

$$I_A = P + Q \quad (2)$$

$$I_B = Pe^{j(2\pi d)/\lambda} + Qe^{-j(2\pi d)/\lambda} \quad (3)$$

Two waves traveling to the left are induced in the secondary line by the coupling links AC and BD , respectively, and the resulting current is given by the relation

$$I_s^- = \alpha I_A e^{j(2\pi x)/\lambda} + \alpha I_B e^{j[2\pi(x-d)]/\lambda} \quad (4)$$

where α is the complex ratio of the secondary to the primary current at each of the two coupling points.

Inserting in (4) the values of the currents at A and B as given in (2) and (3), we have

$$I_s^- = 2\alpha e^{j(2\pi x)/\lambda} \left(P + Qe^{-j(2\pi d)/\lambda} \cos \frac{2\pi d}{\lambda} \right) \quad (5)$$

In a similar way it can be shown that the current flowing to the right in the secondary line is given by the relation

$$I_s^+ = 2\alpha e^{-j(2\pi x)/\lambda} \left(Pe^{j(2\pi d)/\lambda} \cos \frac{2\pi d}{\lambda} + Q \right) \quad (6)$$

The physical significance of (5) and (6) can be obtained from Fig. 2. The current flowing to the right in the secondary line is made up of two components. One is proportional in amplitude to the direct wave and this proportionality is independent of the spacing between the coupling elements. This is represented by the straight line across the top of the graph of current versus d . The amplitude of the other component is proportional to the reflected wave times the cosine of $2\pi d/\lambda$ and is represented by the cosine curve labeled "reflected wave." Hence, the output to the right of D

is relatively independent of the reflection coefficient over quite a wide band of frequencies.

On the other hand, the two components flowing to the

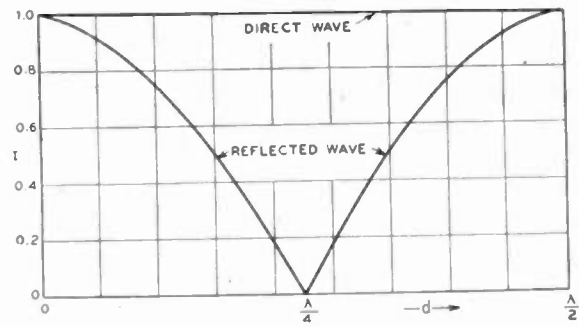

Fig. 2—Calculated response curves for a two-element directional coupler.

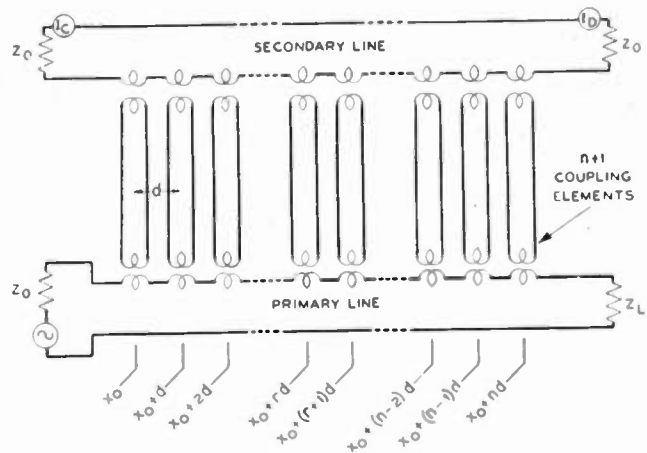

Fig. 3—Schematic diagram of a multielement directional coupler having $n+1$ coupling elements.

left in the secondary line are proportional respectively to the reflected wave and cosine $2\pi d/\lambda$ times the direct wave. When $d = \lambda/4$, the output is proportional to the reflected wave only and the magnitude of the reflection coefficient $|\rho|$ can be obtained by taking the ratio of the outputs to the left and to the right. However, when the wavelength is changed so that the spacing is not exactly a quarter wavelength, there will be some current flowing in the left-hand termination even though the primary line is perfectly terminated. The ratio of this current to the current flowing in the right-hand termination when the primary line is perfectly terminated is called the directivity of the directional coupler. Good directivity is required in order to measure small reflected waves, and it is evident from the curve of Fig. 2 that in the case of the two-element directional coupler this holds only for a narrow band of frequencies. This fact emphasizes the need for directional couplers which are more independent of frequency.

MULTIELEMENT DIRECTIONAL COUPLERS

That wider bands can be obtained by using more than two coupling elements will now be shown. Consider the general case, in which there are a number, $n+1$, of coupling elements equally spaced a distance d along the

lines, (see Fig. 3). If all the simplifying assumptions are applied as before, the current component in the secondary line at the r th element due to the coupling at the r th element is

$$I_{(z_0+r d)} = \alpha_r (P e^{j(2\pi(z_0+r d)/\lambda)} + Q e^{-j(2\pi(z_0+r d)/\lambda)}). \quad (7)$$

Each of these components will cause a current to flow at the last coupling element, where $x = x_0 + nd$. To evaluate the total current here, all the components are retarded by an angle, $(2\pi/\lambda)(n-r)d$, corresponding to the phase shift in traveling the distance between the r th and the n th coupling elements. Summing all these currents, then, we have

$$I_D = P e^{j(2\pi z_0/\lambda)} \sum_{r=0}^{r=n} \alpha_r e^{j(2\pi/\lambda)(2r-n)d} + Q e^{-j(2\pi/\lambda)(z_0+nd)} \sum_{r=0}^{r=n} \alpha_r. \quad (8)$$

We are at liberty to choose any values of α_r , whatsoever. Suppose we make

$$\alpha_r = \alpha_0 \frac{n!}{r!(n-r)!}. \quad (9)$$

In other words, we choose to taper the current coupling factors according to the coefficients of the binomial expansion. Then making use of the relation

$$Re \sum_{r=0}^{r=n} \frac{n!}{r!(n-r)!} e^{j(2\pi d/\lambda)(2r-n)} = 2^n \cos^n \frac{2\pi d}{\lambda}. \quad (10)$$

We have for the total current at D

$$I_D = \alpha_0 2^n P e^{j(2\pi z_0/\lambda)} \cos^n \frac{2\pi d}{\lambda} + \alpha_0 2^n Q e^{-j(2\pi/\lambda)(z_0+nd)}. \quad (11)$$

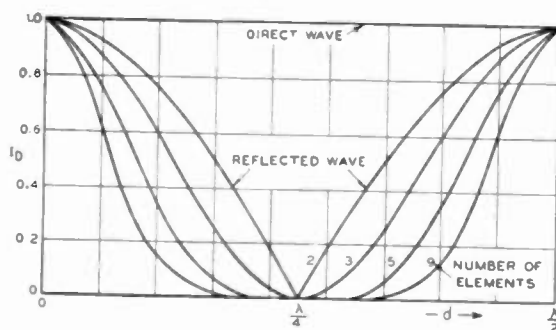

NUMBER OF ELEMENTS	RESPONSE TO REFLECTED WAVE
2	$\cos \frac{2\pi d}{\lambda}$
3	$\cos^2 \frac{2\pi d}{\lambda}$
5	$\cos^4 \frac{2\pi d}{\lambda}$
9	$\cos^8 \frac{2\pi d}{\lambda}$

Fig. 4—Calculated response curves for directional couplers having 2, 3, 5, and 9 coupling elements tapered according to the binomial coefficients.

The significance of this result is illustrated in Fig. 4, which shows the calculated response curves of directional couplers with 2, 3, 5, and 9 elements. ($n = 1, 2, 4$, and 8). From this it is seen that the directivity holds for

wider and wider bands as the number of elements is increased. The following table illustrates this point. The first column gives the number of coupling elements, which are tapered according to the binomial coefficients. The second, third, and fourth columns give the calculated percentage deviations from the midband frequency over which the directivity is 20, 30, and 40 decibels, respectively.

TABLE I

Number of elements	Per cent frequency deviation for directivity of		
	-20 decibels	-30 decibels	-40 decibels
2	6.3 per cent	2 per cent	0.6 per cent
3	20.2 per cent	11.3 per cent	6 per cent
5	38 per cent	27.6 per cent	20 per cent
9	54 per cent	45 per cent	38 per cent

The values of bandwidth given in this table are optimistic, since they are based on an idealized theory. In the practical case the values will be diminished not only because the coupling elements are finite, but also because small unavoidable errors exist in any mechanical structure. The effects of these can be counteracted to some extent, however, by deliberately inserting appropriate compensating elements in the lines.

It should likewise be kept in mind that, in view of the original assumption that the energy flowing into the secondary line is small compared with that in the primary line, there is a limitation on the minimum attenuation that can be attained.

DESIGN DATA

The general theory outlined above applies to all types of transmission lines, such as open-wire lines, coaxial lines, and wave guides. The coupling from the primary line to the secondary line may be accomplished by probe antennas, loops, or orifices. In designing directional couplers it is, of course, necessary to know first the manner in which the coupling elements respond to the currents and voltages in the primary line. Coupling elements which respond to both the voltage and current are in themselves directional, and the degree of this directivity is usually dependent upon the size of the element. Hence, in the construction of tapered multihole directional couplers, it is less complicated to use coupling elements that respond only to current or only to voltage. Coupling elements which meet these requirements include small probes, narrow slots, and holes in the narrow side of rectangular wave guide. Coupling elements which are likely to respond to both current and voltage include large holes in coaxial lines and round holes in the broad side of rectangular wave guides.

C. F. Edwards of these Laboratories has measured the coupling properties of a round hole in the narrow side of a rectangular wave guide, and the data are given in Fig. 5. The ratio, in decibels, of the powers flowing in either one of the terminations of the secondary and in the termination of the primary line is plotted against the hole diameter in inches. Similarly, for a narrow slot

across the wide face of a rectangular wave guide, data taken by C. F. Crandell of these Laboratories and the Southwestern Bell Telephone Company are given in Fig. 6. The curves given in both of these figures apply

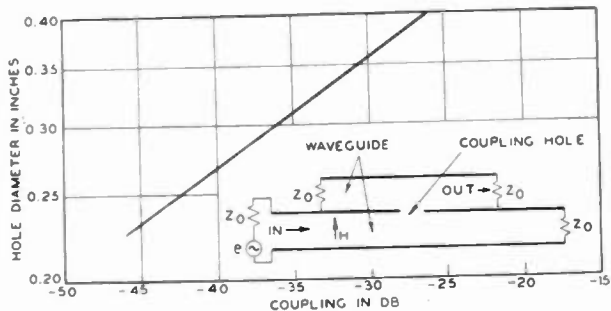

Fig. 5—Coupling ($10 \log_{10} P_{out}/P_{in}$) versus hole diameter, for round holes in the narrow side of $\frac{1}{2} \times 1$ -inch rectangular wave guide. $\lambda_0 = 3.33$ centimeters. The wall thickness is 0.106 inch.

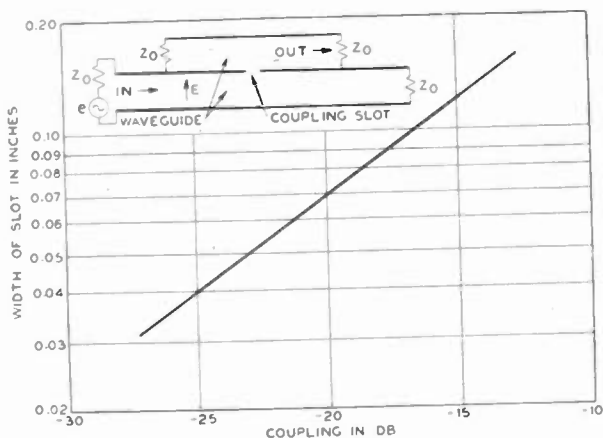

Fig. 6—Coupling ($10 \log_{10} P_{out}/P_{in}$) versus slot width for narrow slots across the wide face of 1×2 -inch rectangular wave guide. $\lambda_0 = 7.4$ centimeters. The wall thickness is 0.128 inch.

only to the particular wavelengths, guide sizes, and wall thicknesses for which the data were taken. For other than these two particular cases, similar data can be obtained. Reasonably good directional couplers can be designed from such curves, but if higher values of directivity are sought, then the compensating elements should be added.

TYPICAL CHARACTERISTICS

A three-element directional coupler designed by C. F. Edwards to have 20-decibel attenuation exhibited the properties that are plotted in Fig. 7. The current coupling factors $\alpha_0, \alpha_1,$ and α_2 followed the binomial expansion coefficients 1, 2, 1 (for $n+1=3$) and since the total attenuation was to be 20 decibels, α_0 was determined from the relation obtained from (11).

$$20 \log (\alpha_0 2^n) = -20 \text{ decibels} \quad (12)$$

or, with $n=2$

$$20 \log \alpha_0 = -32 \text{ decibels.} \quad (13)$$

From the 1, 2, 1 taper we have

$$20 \log \alpha_1 = -26 \text{ decibels} \quad (14)$$

$$20 \log \alpha_2 = -32 \text{ decibels.} \quad (15)$$

The hole sizes that correspond to these attenuations are, according to Fig. 5, 0.340, 0.403, and 0.340 inches, respectively. It is seen from the data that the atten-

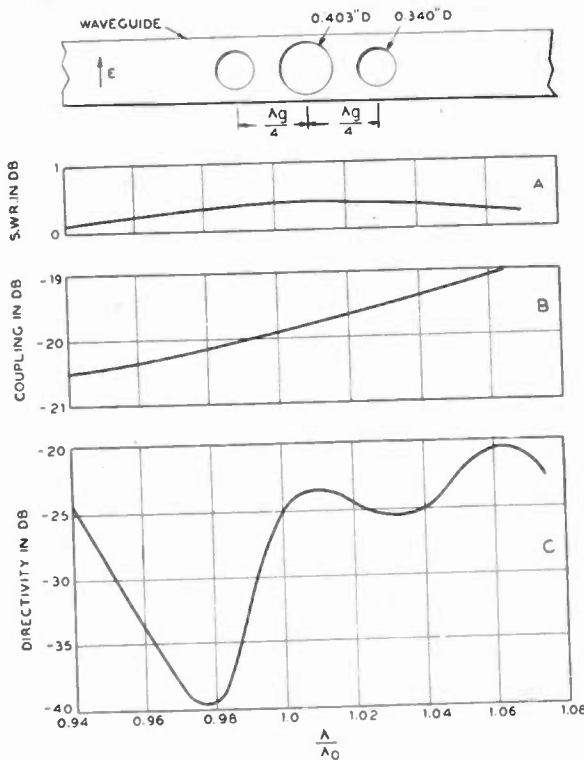

Fig. 7—Measured characteristics of a three-element directional coupler in $\frac{1}{2} \times 1$ -inch wave guide. $\lambda_0 = 3.33$ centimeters. (a) Input standing-wave ratio when primary is terminating in z_0 . (b) Coupling ($10 \log_{10} P_{out}/P_{in}$). (c) Directivity versus wavelength.

uation at midband (19.9 decibels) was within 0.1 decibel of the desired value. The attenuation varied less than ± 1 decibel over a ± 6 per cent bandwidth and the directivity was better than -20 decibels over this band. The discontinuity in the primary line caused less than 0.4-decibel standing-wave ratio.

APPLICATIONS

The directional coupler may be used in a "match meter," as shown in Fig. 8. As the name implies, it is here desired to determine the impedance-match condition of a load equipped with a matching tuner. This is

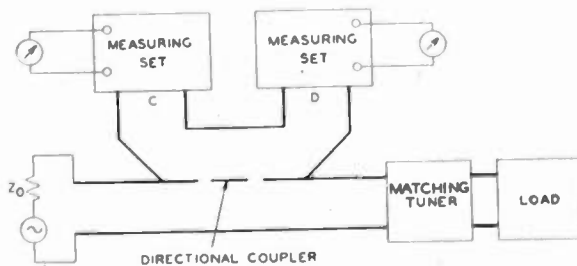

Fig. 8—Schematic diagram showing a "match meter," using a directional coupler.

done by observing the output of first one end and then the other of the secondary line. The ratio of the two outputs is the magnitude of the reflection coefficient of the

load impedance. If an impedance match is desired, the tuner ahead of the load impedance is adjusted for minimum output at the left end of the secondary line. The best adjustment is reached very quickly, since the operator knows at once whether an improvement is made or not; whereas formerly, when the operator relied upon a traveling detector to determine the conditions of mismatch, the beneficial or detrimental effect of an adjustment was not known by the operator until after taking some readings on the traveling detector.

The match meter, when used in conjunction with an adjustable impedance transformer, makes it possible to adjust quickly a number of different components to a specific impedance. First, this transformer is inserted in the primary line ahead of the specified load impedance and then it is adjusted, with the aid of the match meter, to transform the specific load impedance into the characteristic impedance of the primary line. Under these conditions, of course, the output at the left end of the secondary line is very low. Next, the component whose impedance is to be adjusted is attached to the transformer in place of the specific impedance. The component has associated with it a tuner, and this is adjusted until the output at the left end of the secondary line is a minimum. It then follows that the component presents to the transformer the same impedance as the specified impedance.

Probably the chief use of the directional coupler has been that of an attenuator. In this application it has found use as a pad for injecting the beating-oscillator voltage into the first detector, for sampling the outgoing pulse for automatic-frequency-control purposes, for sampling and measuring high-powered pulses, and for attenuating low powers in standard-signal generators.

When used for injecting the beating-oscillator voltage into the first detector it has the advantage that, because of its directivity, the impedance of the signal source is not seen by the beating oscillator. In some systems this impedance is a large mismatch and its bad effects are thus avoided.

In automatic-frequency-control circuits on high-powered systems, a reliable and well-shielded attenuator is needed in order to obtain a suitably small sample of the transmitted pulse. High values of attenuation are necessary in order to reduce the level to such a value that it can be impressed safely on the automatic-frequency-control converter. The directional coupler provides a convenient and dependable method of obtaining this attenuation. The automatic-frequency-control crystals can be located at one end of the secondary line and the beating oscillator can be located at the other end. This arrangement isolates the beating oscillator from the outgoing pulse, and also prevents stray incoming signals from reaching the automatic-frequency-control converter.

For measuring high powers, the directional coupler may be used as illustrated in Fig. 9. Here a relatively high-powered oscillator feeds the primary line, which is

terminated in an absorbing load impedance. A portion of the direct wave flows to the right in the secondary line and feeds a power meter. Simple and accurate measuring devices such as thermistors, which respond

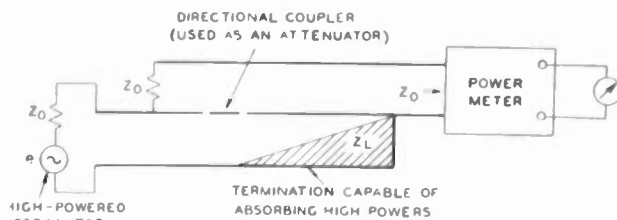

Fig. 9—Schematic diagram showing a power-measuring setup using the directional coupler as an attenuator.

to powers in the milliwatt range, are available for use in the power meter. Hence, if the average power of the oscillator is 500 watts, the directional coupler should have 57 decibels attenuation to cut this down to 1 milliwatt. If this amount of attenuation were incorporated in an attenuator which absorbed almost all of the power, the temperature rise would be appreciable. The temperature coefficient of the absorbing attenuator would have to be known, as well as the temperature and its gradient along the attenuator, in order to measure the power of the oscillator by that means. Whereas, in the suggested method in which the nonabsorbing directional coupler is used, the large temperature rise takes place in the absorbing termination and hence does not affect the attenuation of the directional coupler.

The use of the directional coupler in a signal generator for making low-level signal tests on receivers is illustrated in Fig. 10. This shows an oscillator feeding

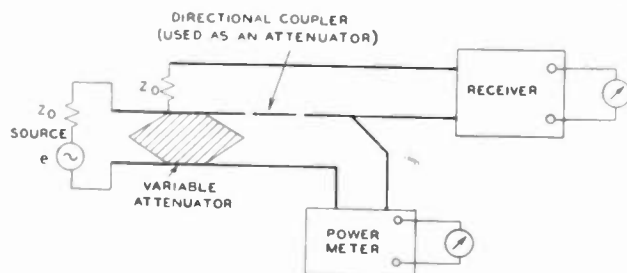

Fig. 10—Schematic diagram showing a signal generator using the directional coupler as an attenuator.

the primary line of a directional coupler through a variable attenuator which controls the amount of power flowing into a power-measuring device. A small part of this power is transferred to the secondary line, which is connected to the input of the receiver to be tested. A typical use might be that of making a noise-figure measurement of a receiver by comparing the noise and signal outputs. When the output due to noise alone is equalled by the output due to signal alone, the signal power and equivalent noise power are equal. The signal power necessary to produce this output is very small. For example, in the case of a receiver with a bandwidth of 5 megacycles and a noise figure of 10 times, the input signal power which would double the deflection on a

square-law output meter amounts to only 0.2 microwatt. If the power measuring device is responsive to 1 milliwatt, then the attenuation through the directional coupler needs to be 97 decibels. Obviously, to be of value, an attenuator with this much attenua-

In Fig. 12 are shown some of the directional couplers which were developed in these Laboratories for use on several different equipments.² One is a detachable coaxial directional coupler, by which the ratio of the direct and reflected waves is obtained by reversing the position of the unit on the primary transmission line. In wave-guide circuits it is sometimes more convenient to use two separate directional couplers for sampling the two waves. This arrangement is called a "bidirectional" coupler, and four types of these are shown in the Fig. 12. The one at the top is equipped with a switch for connecting the measuring set to either one of the secondary lines. There is a calibrated attenuator inserted in one of these secondary lines, the one in which the direct wave is sampled. By adjusting this attenuator so that the two output powers are equal, the reflection coefficient of the load impedance of the primary line is read directly from the calibrated attenuator.

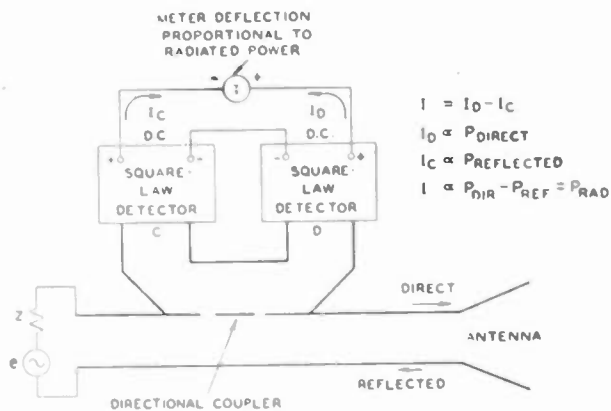

Fig. 11—Schematic diagram of a power meter for measuring radiated power directly.

tion must be extremely stable and well-shielded. The directional coupler meets these stringent requirements.

One more interesting application will be mentioned; namely, its use in a power meter which reads transmitted power directly. This scheme is shown in Fig. 11. The directional coupler is inserted between the generator and the antenna. The right and left ends of the secondary line are terminated in square-law detectors; hence the direct currents are proportional to the direct

CONCLUSION

Because directional couplers enable one to measure separately the direct and reflected waves in a transmission line, they are useful in "match meters" for tuning a given component to any prescribed impedance-match condition. In this application their useful bandwidth is limited, but this may be increased by using more coupling elements. As attenuators they are stable under extreme operating conditions and reasonably independent of frequency. When used in conjunction

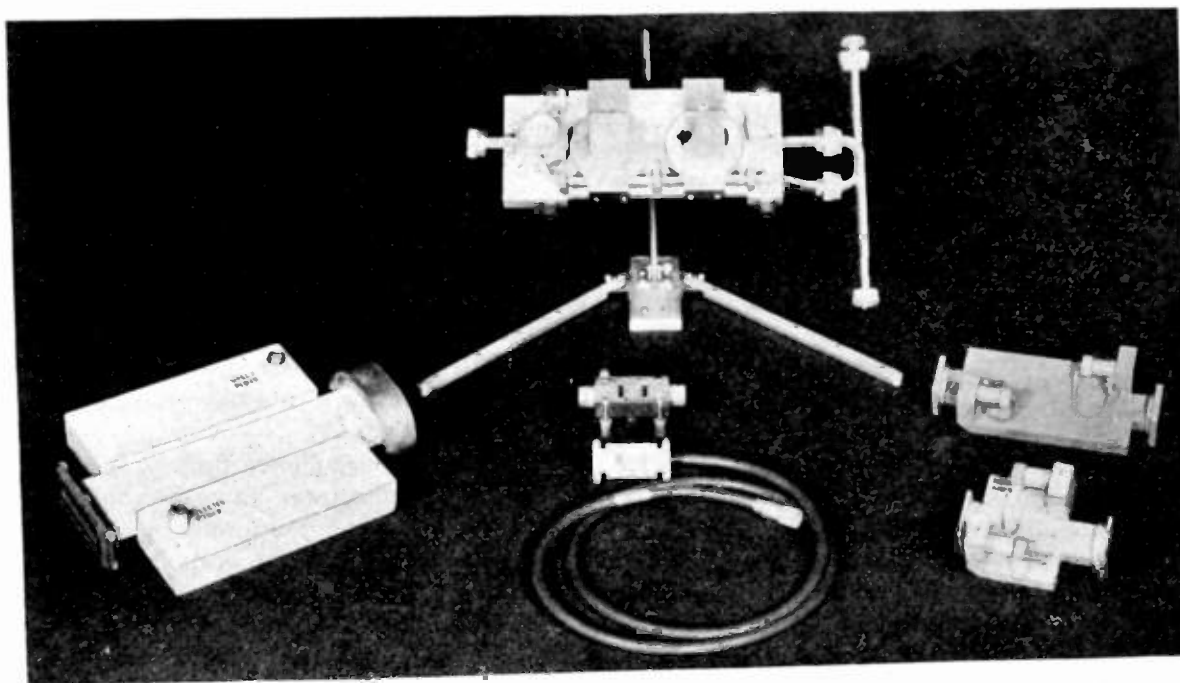

Fig. 12—Typical directional couplers.

and reflected powers, respectively. Connecting the direct-current outputs of the detectors in opposition, the total current is the difference of the two currents. This, in turn, is proportional to the difference between the direct power and the reflected power, which is the transmitted power.

with two square-law detectors, a direct-reading meter can be made for determining the transmitted power of a transmitter.

² E. I. Green, H. J. Fisher, and J. G. Ferguson, "Techniques and facilities for radar microwave testing," *Bell Sys. Tech. Jour.*, vol. 25, p. 435; July, 1946.

Transition Time and Pass Band*

C. C. EAGLESFIELD†

Summary—A note on the relation between transition time and pass band when these are statistically defined; this approach avoids the "ideal filter."

IT IS often convenient to estimate the "step response" of a network from its amplitude characteristic. The usual rough rule is that the greatest slope of the step response is equal to twice the bandwidth. (The greatest slope is used as a measure of the transition time.)

This is frequently justified¹ by considering a network with arbitrary amplitude and phase characteristics; uniform amplitude from zero frequency to a certain frequency, and thereafter zero amplitude; and uniform phase shift.

There are several objections to this. The characteristics are physically impossible and mathematically incompatible, and lead to a step response which is not zero for negative time (which is contrary to the conditions of the problem). Also, and perhaps even more important, there is no indication of how the pass band is to be estimated in practice from the known amplitude characteristic of a network.

The object of this note is to point out that there is a way of defining the pass band and the transition time so that there is a simple relation between them. The definitions are statistical; the numerical relation between the two quantities is the same as is usually quoted.

The argument is as follows. If the current in an admittance² subjected to a voltage which is a Heaviside unit step is $f(t)$ (t being measured from the beginning of the step); and the admittance as a function of the angular frequency ω is expressed by $\phi(j\omega)$; then $f'(t)$ and $\phi(j\omega)/\sqrt{2\pi}$ are Fourier transforms,³ so that by a well-known property of such transforms⁴

$$\int_{-\infty}^{+\infty} |f'(t)|^2 dt = \int_{-\infty}^{+\infty} \left| \frac{\phi(j\omega)}{\sqrt{2\pi}} \right|^2 d\omega.$$

This can be modified: $f(t)$ and its derivatives are zero for t negative and are essentially real; for the integral on the left, the modulus sign may be removed, and the lower limit changed to zero.

* Decimal classification: R143. Original manuscript received by the Institute, April 5, 1946; revised manuscript received, July 15, 1946.

† Mullard Radio Valve Company, Bournemouth, Hants, England.

¹ E. A. Guillemin, "Communication Networks," John Wiley and Sons, New York, N. Y., 1935, vol. 2, chap. 11, p. 477.

² Impedance may be substituted for admittance in this sentence, if voltage is put for current and vice versa.

³ See p. 468 of footnote reference 1.

⁴ Widder, "The Laplace Transform," Princeton University Press, 1941, chaps. 5 and 6, p. 406.

The integrand on the right is an even function of ω : the lower limit may therefore be changed to zero if a factor 2 is inserted. Thus

$$\int_0^{\infty} [f'(t)]^2 dt = \frac{1}{\pi} \int_0^{\infty} |\phi(j\omega)|^2 d\omega. \quad (1)$$

The value of $f(t)$ when t is very large is given by $\phi(j\omega)$ when ω is very small.⁵ This can be written as

$$f(\infty) = \phi(0). \quad (2)$$

If we now define ω_c and τ by

$$\omega_c = \int_0^{\infty} \left| \frac{\phi(j\omega)}{\phi(0)} \right|^2 d\omega \quad (3a)$$

$$\frac{1}{\tau} = \int_0^{\infty} \left[\frac{f'(t)}{f(\infty)} \right]^2 dt. \quad (3b)$$

Then, by (1) and (2),

$$\tau = \pi/\omega_c = 1/2f_c. \quad (4)$$

Under suitable conditions ω_c can be regarded as a critical frequency defining the pass band, and τ can be regarded as a transition time.

The definitions (3a) and (3b) have meaning only if $\phi(0)$ and $f(\infty)$ are not zero. Also (2) is correct only if the network is dissipative, which will be so for any physical network.

The matter may be more easily understood by considering a simple example. For this purpose take an amplifier chain consisting of a number n of tubes, each with the same mutual conductance g and very high anode alternating-current resistance. The coupling impedance Z between tubes is a resistance R in shunt with a capacitance C .

This case has been chosen because it is easy to work out, and the results are in terms of tabulated functions. Since the interest is in the results (as illustration of the formulas), the details of the work are omitted.

The transfer impedance from input to output is

$$(gZ)^n$$

where

$$\frac{1}{Z} = \frac{1}{R} + jC\omega.$$

⁵ E. J. Berg, "Heaviside's Operational Calculus," McGraw-Hill Book Company, New York, N. Y., 1936.

Thus

$$\phi(j\omega) = (g/C)^n \frac{1}{(\alpha + j\omega)^n}$$

where

$$\alpha = 1/RC$$

so that

$$\left| \frac{\phi(j\omega)}{\phi(0)} \right|^2 = \frac{1}{(1 + \omega^2/\alpha^2)^n}$$

and we get

$$\omega_c = \alpha \frac{\sqrt{\pi}}{2} \frac{\Gamma(n - 1/2)}{\Gamma(n)}$$

$$\sim \frac{\alpha}{2} \sqrt{\frac{\pi}{n}} \text{ for } n \text{ very large,}$$

and also

$$\left| \frac{\phi(j\omega_c)}{\phi(0)} \right| \rightarrow e^{-\pi/8} (\approx 0.675)$$

for n very large.

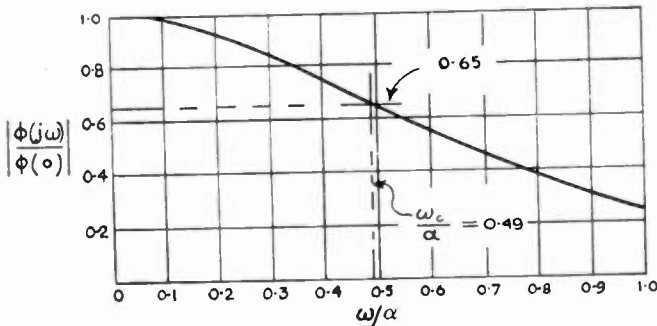

Fig. 1—The amplitude characteristic of a four-stage low-frequency amplifier, the coupling impedances being a resistance R shunted by a capacitance C ($\alpha = 1/RC$). The critical frequency ω_c , as defined in the text, is shown.

These equations determine the amplitude characteristic. The step response is given by

$$\frac{f'(t)}{f(\infty)} = \alpha e^{-\alpha t} \frac{(\alpha t)^{n-1}}{(n-1)!}$$

$$\frac{f(t)}{f(\infty)} = \int_0^{\alpha t} e^{-t'} \frac{t'^{n-1}}{(n-1)!} dt'$$

so that $f(t)/f(\infty)$ is the incomplete gamma function, fully tabulated by Karl Pearson.⁶

There is no difficulty in calculating the amplitude characteristic and the step response for any value of n ; Figs. 1 and 2 show the result for $n = 4$. As will be seen,

the amplitude characteristic is 0.65 of its maximum at the point where $\omega = \omega_c$. τ has been inserted on the step response in such a way as to give about the greatest transition during τ . The transition is about 0.9.

It is clear that for this particular case τ is a very reasonable measure of the transition time, and ω_c of the pass band.

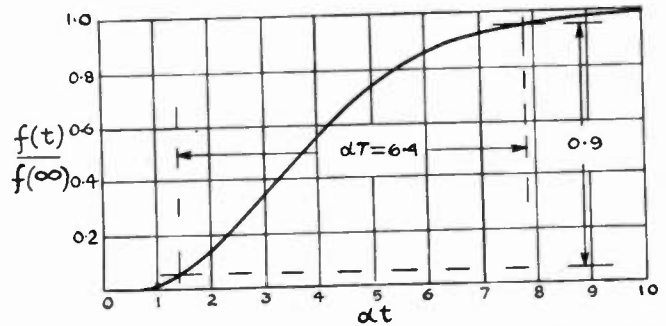

Fig. 2—The “step response” of the amplifier of Fig. 1. The transition time τ , as defined in the text, is shown.

It seems likely that this will be so for any smooth transition. But the existence of ω_c and τ is not sufficient to show the form of the transition. To attempt to estimate the transition from a knowledge of the amplitude characteristic alone is dangerous: cases can well be imagined, particularly where the transition is very oscillatory, for which τ will not be a good measure of the transition time. It is probable that for such cases the amplitude characteristic will have pronounced dips and humps. It seems a reasonable supposition that a smooth transition will correspond to a smooth amplitude characteristic, but it is a gamble.

There is another point that needs considering. It has been pointed out that the definitions of ω_c and τ break down if $\phi(0) = f(\infty) = 0$. When this is so, there is no permanent transition.

However, there are many cases in which a transition is made to a state which, while not permanent, lasts a very long time compared to the time of transition. An example is the amplifier already considered. In writing down the equations, the practical point has been neglected that there would in fact be blocking capacitors between the stages. A practical amplifier would not give a permanent transition, and its amplitude characteristic would be zero at zero frequency. But if the coupling capacitors were very large their effect would be negligible except at very low frequencies, and the duration of the second state would be very long. It is thus only necessary to take $|\phi(j\omega_1)|$ and $f(t_1)$ in place of $\phi(0)$ and $f(\infty)$, where ω_1 is small but not zero and t_1 large but finite. It is difficult to justify this formally, but the interpretation in practice is simple.

In conclusion, while the justification on these lines of a rule connecting pass band and transition time is not without difficulty, it does avoid the pitfalls of the “ideal network.”

⁶ Karl Pearson, “Tables of the Incomplete Gamma-Function,” Cambridge University Press, 1938.

Discussion on

“Some Considerations Concerning the Internal Impedance of the Cathode Follower”*

HAROLD GOLDBERG

Jack Avins:¹ Dr. Goldberg derives a number of useful general expressions which describe the maximum conductive input range. Implicit in the discussion of some of these relations is the assumption that e_{c0} remains fixed at an arbitrary value as the other variables, particularly R and G_m , are varied and their effect on the maximum input range noted. For many applications, however, one cannot determine the maximum input range without first establishing the optimum value of e_{c0} which exists just before the negative step voltage is applied. Thus the optimum initial value of e_{c0} is itself a function of R as well as being a function of any of the other variables that may be indicated by the problem, and as the variables are changed, e_{c0} should be given a corresponding initial value which is optimum for each set of values. For example, if grid current is not permissible, then it is informative to assume that the initial value of e_{c0} corresponds to the tube operating at zero bias before the negative step voltage is applied. Other restrictions may be placed upon the initial value of e_{c0} depending upon such factors as the permissible grid current, plate dissipation, etc.

Frequently the maximum output range is of interest. The output range can be determined by multiplying the general expression for the input range in Dr. Goldberg's paper by the amplification of the cathode follower. Unlike the conditions which obtain for maximum input range, maximum output range occurs for a value of RG_m which is usually appreciably larger than unity.

With reference to the last sentence in the paragraph following (32) on page 780, when RG_m is unity, the input range is equal to the initial voltage across the cathode capacitor, but the cathode capacitor discharges to only approximately half of this initial voltage.

V. R. Briggs:² I was glad to see that the paper had been revised since the October, 1944, National Electronics Conference, as it has been made clearer and certain errors have been corrected. However, I wish to make the comments contained in the following paragraphs.

Dr. Goldberg did not mention that in most cases the operating range is limited at both ends; at one end due to tube cut-off, and at the other excursion it is usually limited to the zero grid voltage point.

If the case of a triode cathode follower loaded with a resistance shunted by a capacitor and with step func-

tions applied to the grid is analyzed graphically, it may be more easily understood and will bring up additional points. The usual load line may be drawn, which will be the static load line, and the operating point may be found on this load line. Now if a step function of voltage is applied between grid and ground, since the voltage between the plates of a capacitor cannot be changed instantaneously, all of this change in potential will appear between grid and cathode. This means that a line of constant anode-to-cathode voltage may be drawn on the plate family through the operating point, and the instantaneous change in grid voltage will follow this line. So, then, the limits between which the internal impedance is approximated by $1/G_m$ are the points at which this line of constant anode-cathode voltage goes through: (1) zero anode current, (2) zero grid voltage. This puts a limit on input and consequently output amplitude for which the low input impedance is available. From the point on this constant-anode-voltage line to which the step function takes the grid voltage, this voltage will change exponentially toward a new point on the static load line.

Now, if sine waves are applied between grid and ground, the same limitation in amplitude will apply if the frequency is high enough. This brings up the point that the frequency response of the follower is a function of amplitude. This will be true to a slight extent even though the aforementioned limits are not exceeded. This is due to the change in transconductance. It is possible that this phenomenon has been mystifying at times.

Another point worth noting is that placing the operating point in the center of the linear portion of the static load line does not put it in the position midway between the two limits on the constant-anode-voltage line, and if symmetrical operation is desired the bias must be decreased.

Harold Goldberg:³ The discussions submitted by Major Avins and Mr. Briggs are appreciated. The paper would have been of greater value had they been available prior to publication.

The discussion by Mr. Briggs requires no comments other than to commend his graphical method for determining the operation with a step function. This method is exact, of course, since it does not idealize the tube parameters.

* Proc. I.R.E., vol. 33, pp. 778-782; November 1945.

¹ 107 Abbott Street, Staten Island 5, N. Y.

² Gilfillan Brothers Inc., Los Angeles, Calif.

³ Bendix Radio Division, Bendix Aviation Corporation, Baltimore, Md. Formerly, Stromberg-Carlson Company, Rochester, N. Y.

With regard to the points brought up by Mr. Avins, the assumption that e_{c0} may be arbitrarily fixed is justified by the fact that it may be made to have any desired value, in certain cases, by using the proper value of E^* as soon as all of the other circuit parameters have been fixed. It is true that for a fixed value of E^* , e_{c0} is not independent of the circuit parameters. The question of whether or not e_{c0} has an optimum value depends on one's point of view. The assumption of grid current as a limiting condition does fix the value of e_{c0} in terms of the other parameters. The input conductive range for this condition is

$$E_2 = E_b / (\mu + RG_m).$$

Other conditions involving peak emission, plate dissipation, etc., might also be derived.

The paper should have discussed the maximum output range as well. This range may be derived by multiplying the general expressions by the gain of the follower, $R_c G_m$. When no limitation is placed on e_{c0} the

maximum output step voltage becomes

$$R_c^2 E^* / RR_p \text{ or } e_{c0} R_c / R.$$

The usefulness of the alternative forms depends on the point of view. Both expressions are valuable when the follower is used to drive a transmission line.

The condition that no grid-current flow leads to two alternative expressions for the maximum output excursion. These are

$$E_b / [\mu(1 + 1/RG_m) + (2 + RG_m) + RG_p] \text{ or } E_b R_c / (R + R_p).$$

The latter expression is of course the simplest. If a terminated transmission line of characteristic impedance Z_0 is the load and the grid current condition has been imposed, the best tube for the purpose is one with a low value of R_p .

The last sentence in the paragraph following equation (32) is in error. The cathode capacitor discharges to approximately half of the initial voltage.

Correspondence

Electrical Circuit Analysis Applied to Servo Problems

Mr. Ferrell¹ is to be congratulated for demonstrating so clearly the ease with which the methods of electrical circuit analysis can be applied to the solution of servo problems. The emphasis on the mathematical similarity of the electrical and mechanical quantities is particularly desirable. One could only wish that he had enlarged upon this similarity and shown that it can be extended to laboratory "models" and that, by varying the circuit parameters in such electrical "models," much information can be obtained about the probable effects of similar variations in their mechanical counterparts. The variation of electrical factors is, of course, much more easily accomplished.

It might be well to point out that there are, in many instances, fundamental differences in behavior between the two systems shown in Figs. 1 and 2 of Ferrell's paper. Take as an example the case where each system is driving a combined friction and inertia load (in practice, a common type). Neglecting transient effects, for any one position of the input shaft the output shaft of the system in Fig. 1 has a fixed velocity while the output shaft of the other system has a fixed position. His suggestion that the phrase "direct current" be applied to an unvarying mechanical velocity would be applicable only in the first case. In the second, a constant direct current corresponds to an unvarying position. Furthermore, this is true only under certain restricted load conditions.

In a paper written mainly for electrical engineers, Mr. Ferrell might also have mentioned the effects of nonlinear distortion in mechanical parts of the system. This distortion has an important bearing on both error and stability in the servo system. Since it is a type of nonlinear distortion not commonly found in electrical circuits, a brief description of how it arises, and of its effects, may be of interest.

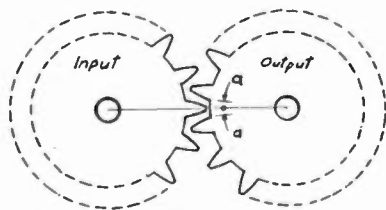

Fig. 1

We will consider only the simple case in which a set of gears forms part of the mechanical transmission and (as is usually the case) there is "lost motion" or "backlash" between them, as illustrated in Fig. 1, exaggerated for the sake of clarity.

It can be seen that the output shaft does not, in general, follow exactly the motion of the input shaft; that is, the relationship is nonlinear. Consider the effect when a system of the type shown in Fig. 2 of Ferrell's paper is connected to a friction load. The result for a sine-wave input motion, large in comparison to the amount of backlash, is plotted here in Fig. 2. (For an input motion less than a the output is zero.) From this it will be seen that Ferrell's statement to the effect that gears can be ignored as we ignore transformers is not entirely correct. Gear ratio and gear friction can be ignored in the

same way as we ignore transformer ratio and losses, but the effect of backlash in a set of gears has no counterpart in a transformer.

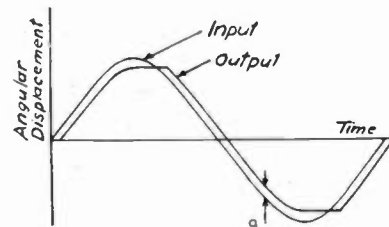

Fig. 2

The equivalent effect can be obtained in an electrical circuit by the arrangement shown in Fig. 3. If a sine-wave input be applied to this circuit, with a resistance load on the output terminals (corresponding to a mechanical system with a friction load), and the input and output voltage plotted,

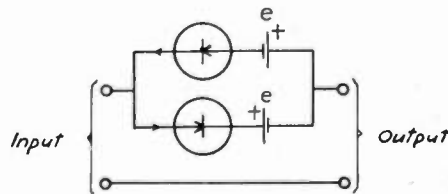

Fig. 3

the results will be exactly as in Fig. 2, with positive voltage substituted for motion in one direction and negative voltage for the opposite motion. The "lost voltage" e corresponds to the lost motion a of the mechanical system. The relation between e and a can be readily determined by static measurement.

¹ E. B. Ferrell, "The servo problem as a transmission problem," Proc. I.R.E., vol. 33, pp. 763-767; November, 1945.

In a servo system of the type shown in Fig. 2 of Ferrell's paper, the insertion of this device in the electrical part of the circuit has approximately the same effect as altering the amount of backlash in the mechanical part. Since e can be varied, we can now, in effect, readily vary the backlash. To do this mechanically is often very difficult.

Analytically, the effects of this nonlinear element are somewhat intractable (as with many nonlinear devices). This is especially true when, for the resistance load so far considered, we substitute a combination of inductance and resistance, representing the usual mechanical load composed of inertia and friction. Combined with the system stiffness, they comprise an oscillatory circuit. The greatest value of the arrangement is in the experimental determination of the maximum allowable e , and hence a , to meet given specifications of stability and error. Economically, this is often of great importance.

It might be mentioned that the effects of backlash on system stability and error are not mitigated by the addition of negative feedback. The effects of backlash on system stability and error are too lengthy for inclusion here. Suffice it to say that the conditions given by Ferrell should be looked on as the minimum necessary.

In closing, it might be pointed out that backlash is only one source of distortion in

the mechanical system, though it is usually the most important source. Other effects, such as shaft twist under load, bearing eccentricity, etc., are usually relatively small.

W. G. HOYLE
1487 Mountain Street
Montreal, Quebec
Canada

Matching Conditions in a Stub-Tuned Transmission Line.

In a lossless line (Fig. 1) of admittance Y_0 , which we assume equal to 1 and thus normalizing all admittances, the condition for maximum power transfer to the load Y_2 , which is matched to the line by means of a stub of admittance jB , is that for any point

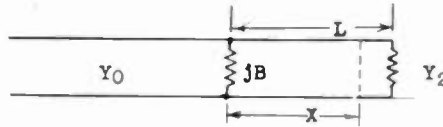

Fig. 1

to the left of the stub, the admittance looking to the left and right be Y_0 . For points to the right of the stub, we shall show the following:

If Y_L and Y_R are the admittances looking to the left and right, respectively, then

$$\frac{Y_L + Y_R}{1 + Y_L Y_R} = \frac{2}{2 + B^2}$$

Thus, there is a quantity which is constant to the right of the stub. This corresponds to Y_0 to the left of the stub. The proof is as follows:

In a matched line,

$$1 = jB + \tanh(P + jGL) \quad (1)$$

$$Y_L = \tanh(Q + jGX) \quad (2)$$

$$Y_R = \tanh(P + jG(L - X)) \quad (3)$$

where $\tanh P = Y_2$, $\tanh Q = 1 + jB$, and $G = \text{phase constant}$. Hence,

$$\begin{aligned} \tanh(P + Q + jGL) &= \frac{Y_L + Y_R}{1 + Y_L Y_R} \\ &= \frac{(1 - jB) + (1 + jB)}{1 + (1 - jB)(1 + jB)} \end{aligned}$$

which proves the theorem. Furthermore, since Y_L is the conjugate of Y_R , it is a simple matter to derive a similar expression in terms of conductance and susceptance.

PHILIP PARZEN
De Mornay-Budd, Inc.
475 Grand Concourse
New York 51, N. Y.

Contributors to the Proceedings of the I.R.E.



J. R. PIERCE

J. R. Pierce (S'35-A'38-SM'46) was born at Des Moines, Iowa, on March 27, 1910.

He received the B.S. degree in electrical engineering from the California Institute of Technology in 1933 and the Ph.D. degree in 1936. Since 1936 he has been a member of the technical staff of the Bell Telephone Laboratories, where he has worked on various vacuum-tube problems.

❖

Lester M. Field was born on February 9, 1918 at Chicago, Illinois. He received the B.S. degree from Purdue University in 1939,

and the Ph.D. degree from Stanford University in 1944. He was acting instructor in 1941, and acting assistant professor from 1942 to 1944 in electrical engineering at Stanford University.

In 1944 Dr. Field joined Bell Telephone Laboratories as a member of the magnetron



LESTER M. FIELD

development group and later the electron dynamics group of the physical research department. In September, 1946, Dr. Field returned to Stanford University as acting associate professor of electrical engineering. He is a member of the American Physical Society, Tau Beta Pi, and Sigma Xi.

Rudolf Kompfner was born in Vienna on May 16, 1909. He attended the Realschule and Technische Hochschule in Vienna, and was graduated from the faculty of architecture in 1933. In 1934 he came to England to continue his study in architecture privately, and became the director of a building firm in 1937. Throughout these years he devoted much of his spare time to television, radio, and physics.

Dr. Kompfner entered the Admiralty service in 1941 as temporary experimental officer, taking up duty first in the physics department at Birmingham University. Since 1944 he has been associated with the Clarendon Laboratory at Oxford University, London, England.



RUDOLF KOMPFFNER



EDWARD W. ALLEN, JR.

Edward W. Allen, Jr. (M'44) was born on February 14, 1903, at Portsmouth, Virginia. He received the B.S. degree in electrical engineering from the University of Virginia in 1925, and the LL.B. degree from George Washington University in 1933.

From 1925 to 1927 Mr. Allen was employed by Westinghouse as a student engineer and research assistant. He joined the Chesapeake and Potomac Telephone Company, Washington, D. C., in 1928 as engineering assistant. From 1930 to 1935 he worked for the United States Patent Office as junior and assistant patent examiner in telephony, telegraphy, facsimile, and television. Since 1935 Mr. Allen has been associated with the Federal Communications Commission as assistant chief of the technical information division in the engineering department. He is a member of Tau Beta Pi.



C. W. Carnahan (A'34-SM'45) was born at Berkeley, California, on July 4, 1907. He received the A.B. degree at Stanford University in 1927, and the degree of M.A. in physics in 1931. From 1927 to 1930 he was instructor in physical science at Fresno State College, Fresno, California. From 1931 to 1933 he was a research engineer with Farnsworth Television Laboratories. From 1933 to 1940 he was research engineer with the Hygrade Sylvania Corporation, at Salem, Massachusetts, and St. Mary's, Penn-



C. W. CARNAHAN



NATHAN W. ARAM

sylvania. Since 1940 he has been a member of the research staff at Zenith Radio Corporation, Chicago, Illinois.



Nathan W. Aram (S'39-A'41-M'45) was born on October 5, 1916, at Moline, Illinois. He attended Augustana College from 1935 to 1937, and Purdue University from 1937 to 1939, receiving the degree of B.S.E.E. from this institution in 1939. He attended Northwestern University Graduate School from 1941 to 1944. He was a radio operator at station WHBF in 1937, and at television station W9XK from 1937 to 1939. Since 1939, he has been with the Zenith Radio Corporation, Chicago, Illinois, working with television and frequency-modulation transmitters and antenna design. He is a member of Eta Kappa, and an associate of Sigma Xi.



Edward F. Classen, Jr., was born on October 28, 1917, in Chicago, Illinois. He attended Wayland Academy and Junior College in Beaver Dam, Wisconsin, Beloit College in Beloit, Wisconsin, and Armour Institute of Technology in Chicago. He was associated with the Zenith Radio Corporation from 1936 until January 1946, in the engineering department. During that time he was associated with Zenith's frequency-modulation station WWZR and their television station W9ZXV. At present he is en-



EDWARD F. CLASSEN



W. W. MUMFORD

gaged as a sales engineer for REL Equipment Sales, Inc., Midwest outlet of Radio Engineering Laboratories, Inc.



W. W. Mumford (A'30-SM'46) was born on June 17, 1905, at Vancouver, Washington. In 1930 he received the B.A. degree from Willamette University.

In 1923 Mr. Mumford served as a radio operator on the United States Coast Guard Cutter *Algonquin*. He was a clerk-operator and manager for the Western Union Telegraph Company from 1924 to 1926. From 1928 to 1930, he was an assistant at the Oregon State Highway Testing Laboratories. Since 1930 he has been in the radio research department of the Bell Telephone Laboratories at Holmdel, New Jersey.



C. C. Eaglesfield was born on June 28, 1906, at Swansea, Wales. He received the B.A. degree in mechanical sciences from the University of Cambridge in 1928. From 1929 to 1932 he was a research engineer in the laboratories of Standard Telephones and Cables in London and Paris. Since 1932 he has been a research engineer in the laboratories of the Mullard Radio Valve Company in London, where he is now in charge of a group working on television and high-frequency research.

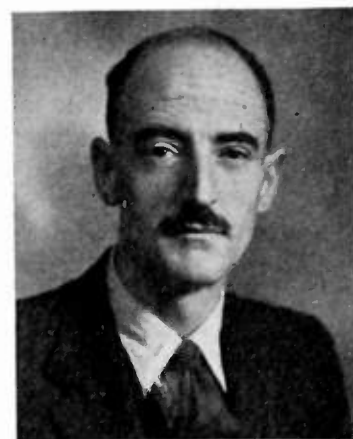

C. C. EAGLESFIELD

Extensive Plans Set for 1947 I.R.E. National Convention March 3, 4, 5, and 6 in New York

THIS is to be one of the most consequential Winter Technical Meetings in the history of the I.R.E.! William C. Copp, chairman of the Exhibits Committee, reports that over one hundred and fifty manufacturers have requested booths occupying the first and second floors of the Grand Central Palace (see list of exhibitors on page 183). Thanks to the availability of additional space at the Palace, manufacturers of radio and electronic equipment will present the most extensive "latest-in-electronic-developments" show in the history of the Institute.

Professor Ernst Weber, chairman of the Technical Program Committee, promises an array of one hundred and twenty-two technical papers of an extremely high caliber on subjects of vital interest to electronic and radio engineers. Except for Monday morning and Wednesday afternoon, eight sessions will be presented each day in the two auditoriums at Grand Central Palace and in the ballrooms of the Hotel Commodore (see program below for times and locations).

Set for Wednesday afternoon is a special session—a sociological approach to engineering and its place in society, entitled, "The Engineering Profession." This new-type session is in keeping with the philosophy

of the Institute—relating the great strides of the engineering profession with the social requirements of the world as a whole.

The annual banquet is to be held in the Grand Ballroom of the Hotel Commodore, 7:00 P.M., March 5. Guest speaker will be Charles R. Denny, chairman of the Federal Communications Commission. F. R. Lack, vice-president of Western Electric Company, will act as toastmaster. The Institute Medal of Honor, the Morris Liebmann Memorial Prize, the Browder J. Thompson Memorial Award, and fellowships given by the Institute will be announced at the banquet.

The President's Luncheon (Tuesday noon) will honor the incoming president, Dr. W. R. G. Baker. He will be introduced by Dr. Llewellyn, toastmaster and retiring president of the Institute. Vice-Admiral Lockwood will be the guest speaker.

Third social feature of the Convention will be the Monday evening (6 P.M.) "get-together" over cocktails at the Commodore—for old friends and business associates of the engineering profession.

There will be no registration fee for I.R.E. members; registration fee for nonmembers will be \$3.00.

PROGRAM

Monday, March 3, 1947

- 9:00 A.M.—5:30 P.M.—Registration at Hotel Commodore and Grand Central Palace
- 9:30 A.M.—12:30 P.M.—General Meetings
- 10:00 A.M.—5:00 P.M.—
Sections Committee Meeting.
Morning, Hotel Commodore
Afternoon, Grand Central Palace (with luncheon)
- 12:00 NOON—Opening of the Radio Engineering Show at Grand Central Palace.
- 12:00 NOON—9:00 P.M.—Radio Engineering Show, Grand Central Palace
- 2:30 P.M.—5:00 P.M.—"Particle Accelerators for Nuclear Studies" and "Electronic Measuring Equipment," Main and West Ballrooms, Hotel Commodore. "Radar Communication Systems" and "Frequency-Modulation Reception," Auditoriums I and II, Grand Central Palace.
- 6:00 P.M.—Cocktail Party, Hotel Commodore

Tuesday, March 4, 1947

- 9:00 A.M.—5:30 P.M.—Registration
- 10:00 A.M.—12:30 P.M.—"Aids to Navigation" and "Nucleonics Instrumentation," East and West Ballrooms, Hotel Commodore. "Microwave Components and Test Equipment" and "Television A," Auditoriums I and II, Grand Central Palace.
- 12:00 NOON—9:00 P.M.—Radio Engineering Show, Grand Central Palace

Tuesday, March 4, 1947 (cont.)

- 12:45 P.M.—President's Luncheon, honoring Dr. Baker; Grand Ballroom, Hotel Commodore. Vice-Admiral Charles Andrew Lockwood, Jr., U. S. Navy will speak on "Electronics in Submarine Warfare." Guest of Honor: Dr. Baker. Toastmaster: Dr. Llewellyn.
- 2:30 P.M.—5:00 P.M.—"Television B" and "Electronic Digital Computers," East and West Ballrooms, Hotel Commodore. "Power-Output Vacuum Tubes" and "Circuit Theory," Auditoriums I and II, Grand Central Palace.

Wednesday, March 5, 1947

- 9:00 A.M.—5:30 P.M.—Registration
- 9:00 A.M.—6:00 P.M.—Radio Engineering Show, Grand Central Palace
- 10:00 A.M.—12:30 P.M.—"Electronic Controls and Applications" and "Aids to Air Navigation and Traffic Control," East and Main Ballrooms, Hotel Commodore. "Microwave Techniques and Measurements" and "Broadcasting and Recording," Auditoriums I and II, Grand Central Palace.
- 2:30 P.M.—4:30 P.M.—"The Engineering Profession with Particular Reference to Radio and Electronics." Main Ballroom, Hotel Commodore.
Chairman, Walter R. G. Baker, president, I.R.E.
A. "Liberal Education of the Engineering Profession," Harry S. Rogers, president, Polytechnic Institute of Brooklyn.

- B. "Relation of the Engineering Profession to Industry," Charles B. Jolliffe, executive vice-president, Radio Corporation of America.
- C. "Relation of the Engineering Profession to Science," Edward U. Condon, director, National Bureau of Standards.

7:00 P.M.—Annual I.R.E. Banquet (dress optional), Hotel Commodore. Speaker: Mr. Charles R. Denny, chairman, Federal Communications Commission. Toastmaster: Mr. F. R. Lack, vice-president, Western Electric Company Awarding of the Medal of Honor, the Morris Liebmann Memorial Prize, the Browder J. Thompson Memorial Award, and Fellowship Awards.

Thursday, March 6, 1947

- 9:00 A.M.— 5:30 P.M.—Registration
- 10:00 A.M.—12:30 P.M.—"Oscillator-Circuit Theory" and "Basic Electronics Research," East and West Ballrooms, Hotel Commodore. "Wave Propagation and Antennas" and "Relay and Pulse-Time Systems of Communication," Auditoriums I and II, Grand Central Palace.
- 12:00 NOON—9:00 P.M.—Radio Engineering Show, Grand Central Palace
- 2:30 P.M.— 5:00 P.M.—"Receiver Circuits" and "Vacuum Tubes and Gas Rectifiers," East and West Ballrooms, Hotel Commodore. "Antennas" and "Wave-Guide Techniques," Auditoriums I and II, Grand Central Palace.

Women's Activities

Monday, March 3, 1947

- 9:00 A.M. Registration
- 2:00 P.M. Sightseeing trip of New York (uptown and residential (2 hours)) \$2.30

Tuesday, March 4, 1947

- 11:00 A.M. A Radio Broadcast
- 10:30 and 11:00 A.M. Behind the Scenes at R. H. Macy's (2 hours) (20 in each group) (hostesses will arrange to take you to lunch (dutch treat))
- 1:30 P.M. Behind the Scenes at R. H. Macy's
- 2:00 P.M. Behind the Scenes at R. H. Macy's
- 2:30 P.M. Empire State Building \$1.00
- 3:30 P.M. to 5:30 P.M. Tea—I.R.E. Headquarters Building

Wednesday, March 5, 1947

- 10:00 A.M. Cloisters or United Nations Trip \$2.00
- 11:00 A.M. A Radio Broadcast (Hostesses will arrange to take you to lunch)
- 2:30 P.M. "Call Me Mister" or "Happy Birthday." Matinee (only 125 tickets) \$2.40

Thursday, March 6, 1947

- 10:30 A.M. Museums—Shopping—Brass Town—Statue of Liberty
- 1:00 P.M. Luncheon and Fashion Show—Plaza Hotel \$3.60

SUMMARIES OF TECHNICAL PAPERS

NOTE

No papers are available in preprint or reprint form nor is there any assurance that any of them will be published in the PROCEEDINGS OF THE I.R.E., although it is hoped that many of them will appear in these pages in subsequent issues.

Particle Accelerators for Nuclear Studies

1. PARTICLE ACCELERATORS FOR NUCLEAR STUDIES

G. W. DUNLAP

(General Electric Company, Schenectady, New York)

The history of accelerators is traced from the discovery of charged particles, through the development of the cascade rectifier, Van de Graaff generator, cyclotron, betatron, linear accelerator, synchrotron, and synchro-cyclotron. The distinguishing characteristics and uses of these are listed and the present trend toward higher energy units is reviewed.

2. FREQUENCY-MODULATION CYCLOTRON

W. SALISBURY

(Collins Radio Company, Cedar Rapids, Iowa)

The frequency-modulation cyclotron accelerates nuclear particles to velocity for

which the relativistic mass increase throws them out of resonance with a fixed-frequency oscillator. The need for radio-frequency fields between large conductors implies high-Q circuits for economy of operation. The problems arising in the production of these fields with a frequency variation of 40 per cent or more at a cyclical rate up to a few thousand times per second open a new region for the radio engineer.

3. THE BETATRON

T. M. DICKINSON

(General Electric Company, Schenectady, New York)

A statement of the basic principles of the betatron is presented and the requirements of the associated electronic circuits required for successful operation are discussed. Typical circuits which meet these requirements are described.

4. A 70-MILLION-ELECTRON-VOLT SYNCHROTRON

A. M. GUREWITSCH, H. C. POLLOCK, R. V. LANGMUIR, F. R. ELDER, AND J. P. BLEWETT

(General Electric Company, Schenectady, New York)

A 70-million-electron-volt synchrotron built by the General Electric Company under a Naval Office of Research contract is described. The phenomenon of phase stability, which is of importance in synchrotron machines, is briefly discussed, and differences between betatron and synchrotron principles are pointed out. Some design de-

tails and performance data of the 70-million-electron-volt machine are given.

5. THE LINEAR ACCELERATOR

J. C. SLATER

(Massachusetts Institute of Technology, Cambridge, Massachusetts)

The linear accelerator consists of a wave guide loaded so that the phase velocity of electromagnetic waves equals the velocity of the particles which are therefore continuously accelerated, a power source to set up a high electromagnetic field, and a source of particles. A microwave accelerator for electrons will be discussed.

Electronic Measuring Equipment

6. A METHOD OF DETERMINING AND MONITORING POWER AND IMPEDANCE AT HIGH FREQUENCIES

J. F. MORRISON AND E. L. YOUNKER (Bell Telephone Laboratories, Inc., New York, N. Y.)

A method and newly developed devices for determining and monitoring power and impedance levels in transmission lines at high frequencies will be explained. Practical considerations influencing accurate determination of power and impedance levels are analyzed, and the previous and newly developed methods of monitoring these important quantities under changing conditions of load are compared.

7. THEORY OF MEASUREMENT OF DIELECTRIC PROPERTIES AT 10,000 MEGACYCLES PER SECOND

C. V. LARRICK

(General Electric Company,
Hanford, Washington)

Mathematical formulas for use in measuring the loss factor and dielectric constant of dielectric materials at 10,000 megacycles are derived.

It is demonstrated that the dielectric properties may be extracted once a measurement of admittance is made, and formulas both for coaxial and for wave-guide equipments are derived.

8. A COAXIAL-LINE DIODE NOISE SOURCE FOR ULTRA-HIGH FREQUENCY

H. JOHNSON

(RCA Laboratories Division, Radio Corporation of America,
Princeton, New Jersey)

A developmental diode of coaxial-line construction is described which is readily adapted to wide-range coaxial-line circuits over most of the ultra-high-frequency range with a maximum transit-time reduction of noise of 3 decibels. Operation of the diode as a standard noise source provides a particularly simple means of measurement of receiver noise factors.

9. A NEW REACTANCE-TUBE DISTORTION AND NOISE METER

C. W. CLAPP

(General Electric Company, Schenectady,
New York)

A new distortion and noise meter covering the range from 50 to 15,000 cycles per second is described. The instrument utilizes a bridged-T rejection filter employing a reactance tube circuit of novel design in place of the inductance arm. Other applications for the reactance-tube circuits are suggested.

10. CATHODE-RAY PRESENTATION OF THREE-DIMENSIONAL DATA

O. H. SCHMITT

(Airborne Instruments Laboratory, Inc.,
Mineola, New York)

Electrical information in three variables is transformed by relatively simple electrical means into two different cathode-ray images which, when presented separately to the two eyes, yield a vivid three-dimensional picture. Flexibility in choice of co-ordinate systems, scale of presentation, and observers' viewpoint makes this general technique widely applicable.

Radar and Communication Systems

11. SHIPBOARD RADAR FIRE CONTROL FROM THE SYSTEM VIEWPOINT

ROBERT M. PAGE AND
JOHN B. TREVOR, JR.

(Naval Research Laboratory,
Washington, D. C.)

The task before the system engineer is to follow the flow of target information from

the search radar, which originally detects the target, through the various steps by which the original low-precision target-position information is finally transformed into high-precision gun orders. The factors affecting data accuracy at each step of the process are discussed.

12. SYSTEM CONSIDERATIONS IN THE DESIGN OF VERY-HIGH-FREQUENCY AND SUPER-HIGH-FREQUENCY COMMUNICATION CIRCUITS

E. FUBINI

(Airborne Instruments Laboratory, Inc.,
Mineola, New York)

The problem of determining the optimum frequency and type of modulation for a particular communication channel is considered in its broad outline. Some of the parameters for the optimum design of the system are calculated. Examples of comparisons between different frequency channels and different systems of modulation are given.

13. PORTABLE MILITARY COMMUNICATION SET

CHESTER E. SHARP

(Coles Signal Laboratory, Red Bank,
New Jersey)

A detailed description is given of the design features embodied in oscillator cavities and a single-antenna radio-frequency radiating system which enable simultaneous transmission and reception over an integral but highly portable radio communication set operating from 2000 to 2400 megacycles. Interference-free amplitude-modulation communication is shown to be obtainable at these frequencies with exceedingly simple circuits.

14. CARRIER-CURRENT DIALING OVER LONG-DISTANCE TELEPHONE CIRCUITS

IMRE MOLNAR

(Automatic Electric Company,
Chicago, Illinois)

A carrier telephone system suitable for automatic operation has been developed. Connections are established and dial pulses extended through the carrier associated with the voice-transmission channel. The paper will discuss this system, with brief description of general features and transmission characteristics and details of the newly developed signaling systems, including data on its operating performance.

15. CESIUM-VAPOR LAMPS IN INFRARED COMMUNICATION

M. C. BEESE

(Westinghouse Electric Corporation,
Bloomfield, New Jersey)

During the war there arose a need for a secret communication system using an infrared beam of light as the carrier for voice and code signals. A cesium-vapor lamp was developed which formed the modulated source of a searchlight-beam transmitter with a range of about 8 miles. Operating characteristics and construction details will be given for several sizes of lamps.

Frequency-Modulation Reception

16. FREQUENCY-MODULATION DETECTOR SYSTEMS

B. D. LOUGHLIN

(Hazeltine Electronics Corporation,
Little Neck, L. I., New York)

The general performance characteristics of frequency-modulation detector systems, with a brief mention of the specific characteristics of systems using grid-bias limiters, locked oscillators, and ratio detectors, are reviewed. This is followed by the analysis of new detector systems with details of their general performance characteristics. One detector system has a variable-level threshold and one has no distinct threshold.

17. BROAD-BAND FREQUENCY-MODULATION DETECTOR FOR MULTI-CHANNEL COMMUNICATION

W. J. ALBERSHEIM

(Bell Telephone Laboratories, Inc.,
New York, N. Y.)

To meet the wide-band and low-distortion requirements for a multichannel frequency-modulation receiver, limiters, coupling networks, slope circuits, and demodulators were engineered as a unit. Distortion was maintained less than 1 per cent with 5-megacycle swings and 15-decibel input-level fluctuations. Suppression of amplitude modulation was enhanced by push-pull detection. The slope of circuits utilized the distributed reactance of coaxial lines.

18. A METHOD FOR MEASURING THE INSTANTANEOUS FREQUENCY OF A FREQUENCY-MODULATION OSCILLATOR

L. E. HUNT

(Bell Telephone Laboratories, Inc.,
New York, N. Y.)

The frequency-modulation signal is compared with a calibrated continuous-wave signal. This is done by gating the two signals alternately into a frequency-modulation detector and observing the oscilloscopic pattern produced. The horizontal line thus formed by the continuous-wave oscillator is shifted vertically by varying the frequency, and may be lined up with prominent parts of the frequency-modulation pattern which appear simultaneously.

19. A VARIABLE-PHASE-SHIFT FREQUENCY-MODULATED OSCILLATOR

O. E. DELANGE

(Bell Telephone Laboratories, Inc.,
New York, N. Y.)

This oscillator consists of a broad-band amplifier, the output of which is fed back to the input through an electronic phase-shifting circuit. The instantaneous frequency is controlled by the phase shift through this latter circuit. True frequency modulation is obtained, in that frequency deviation is directly proportional to the instantaneous amplitude of the modulating signal and independent of modulation frequency.

20. LINEARITY IN A TUNED-TRANSFORMER FREQUENCY DISCRIMINATOR

H. R. SUMMERHAYES, JR.
(General Electric Company,
Schenectady, New York)

An analysis is made of the linearity of response of a frequency-discriminator circuit. The effect of deviation from linearity in producing audio distortion when demodulating a frequency-modulated signal is discussed. A description is given of the design and testing methods for a low-distortion discriminator used in a frequency-modulation station monitor.

Aids to Navigation

21. RELATIONS BETWEEN BANDWIDTH, SPEED OF INDICATION, AND SIGNAL-TO-NOISE RATIO IN RADIO NAVIGATION AND DIRECTION-FINDING

H. BUSIGNIES AND M. DISHAL
(Federal Telecommunication Laboratories,
New York, N. Y.)

Theoretical and experimental results obtained in the last few years in direction finders and radio aids to navigation are considered. The relation between speed of position determination, bandwidth, noise, and radio-frequency stability indicates that bandwidths 100 times too large are commonly used. The naviglobe system and loran are also discussed.

22. TARGETS FOR MICROWAVE RADAR NAVIGATION

SLOAN D. ROBERTSON
(Bell Telephone Laboratories, Inc.,
New York, N. Y.)

The effective echoing areas of certain radar targets can be calculated, while other more complicated structures have been investigated experimentally. This paper considers a number of practical targets with emphasis on trihedral and biconical corner reflectors. Especially designed targets of high efficiency may be of aid to radar navigation.

23. A COMPARISON OF INTERROGATION BY SEARCH RADARS AND BY SEPARATE INTERROGATORS IN PULSE TRANSPONDOR SYSTEMS

F. A. DARWIN
(Hazeltine Electronics Corporation,
Little Neck, New York)

Marked similarity between transponder-interrogators and search radars is pointed out, as well as the differences desirable in their characteristics. Features of a single equipment performing both functions are outlined, concluding that, for adequate traffic-handling capacity with minimum complexity, radars are best used as radars, with separate, servile, interrogators in co-operation.

24. LOW-FREQUENCY LORAN

V. S. CARSON, S. SEATON, M. ROTHMAN, AND
M. POMERANTZ
(Watson Laboratories, Red Bank,
New Jersey)

The theory and operation of low-fre-

quency loran is described. A comparison of its operation with standard loran and an evaluation of the relative merits of each system is presented. Part II of this paper summarizes operational results achieved with this system and discusses many problems and effects which have been observed in Arctic operations.

25. ELIMINATION OF PRECIPITATION STATIC

W. H. BENNETT
(National Bureau of Standards,
Washington, D. C.)

Space-charge limitation of current generally prevents existing devices from eliminating severe static, and the polyethylene-inserted antenna wire which has been proposed is open to serious objection. A more nearly ideal solution will be presented and its physical characteristics analyzed.

Nucleonics Instrumentation

26. NUCLEONICS INSTRUMENTATION

V. C. WILSON
(General Electric Company,
Schenectady, New York)

Emphasis will be placed upon the problem and requirements of electronic instruments in the fields of nuclear research and engineering, pile and other process control, and health protection. A brief description of some of the new instruments will be given for purposes of illustration.

27. PROPORTIONAL COUNTERS AND GEIGER COUNTERS

S. KORFF
(New York University, Washington Square,
New York, N. Y.)

Proportional counters are built for the purpose of distinguishing between neutrons, alpha particles, electrons, protons, or gamma rays, and for counting the numbers of each. Geiger counters, and coincidence combinations, and anticounters will be described and discussed. Operations and applications will be stressed.

28. CLOUD CHAMBERS

G. C. BALDWIN
(General Electric Company,
Schenectady, New York)

The cloud chamber employs preferential condensation of supersaturated vapor about ions produced by energetic charged particles to reveal the individual history of each particle's passage through a gas. Techniques of cloud-chamber operation and methods by which a particle's nature is determined from its track in a cloud chamber will be discussed with illustrative photographs taken in experiments with the 100-million electron-volt betatron at Schenectady.

29. APPLICATIONS OF THE VIBRATING-REED ELECTROMETER

W. P. JESSE
(Argonne National Laboratory,
Chicago, Illinois)

This instrument, developed by Palevsky, Swank, and Grenchik, is of the dynamic-capacitor type, suitable for measuring small

currents or charges. An alternating-current component is generated by a magnetically driven vibrating reed which constitutes the lower plate of the capacitor. This alternating-current component is amplified, rectified, and degeneratively fed back to the oscillating system. The background current of the instrument is about 10 to 17 amperes. Applications of this instrument to nuclear work will be discussed.

30. PULSE AMPLIFIERS FOR IONIZATION DETECTION

MATTHEW SANDS
(Massachusetts Institute of Technology,
Cambridge, Mass.)

The equivalent circuits of ionization detectors and the pertinent characteristics of electrical pulse counters are discussed. A pulse amplifier is considered as a coupling device between the two. Desirable properties and possible methods of achieving them are described. Gain, stability, pulse shaping (bandwidth), and signal-to-noise ratio are covered.

Microwave Components and Test Equipment

31. EXPERIMENTAL DETERMINATION OF HELICAL-WAVE PROPERTIES

C. C. CUTLER
(Bell Telephone Laboratories, Inc.,
New York, N. Y.)

The properties of the wave propagated along a helix used in the traveling-wave amplifier are discussed. A description is given of measurements of field strength on the axis, field distributions around the helix, and the velocity of propagation. It is concluded that the actual field in the helix described is about 10 per cent stronger than would be predicted from the relations developed by J. R. Pierce for a hypothetical helical surface.

32. A STABILIZED MAGNETRON FOR BEACON SERVICE

C. P. VOGEL, J. S. DONAL, JR., B. B. BROWN,
C. L. CUCCIA, AND W. J. DODDS
(RCA Victor Division, Radio Corporation
of America, Lancaster, Pa.)

The 2J41 is a stabilized, tunable, pulsed magnetron, designed for 9310-megacycle portable beacon equipment. The power output is 300 watts peak at 0.3 per cent duty. The tube is of header construction with the magnetic inserts at cathode potential. Frequency stabilization is obtained by use of an external cavity permanently coupled to the output circuit of the tube.

33. COUPLED CIRCUITS USED AS TUNABLE BAND-PASS FILTERS IN THE ULTRA-HIGH-FREQUENCY AND MICROWAVE REGIONS

R. O. PETRICH
(Airborne Instruments Laboratories, Inc.,
Mineola, New York)

Tunable over-coupled circuits suitable for use as preselectors in the ultra-high-frequency and microwave regions are described.

Electrical and mechanical design characteristics are given, and techniques employed in tuning and matching over a 2-to-1 frequency range are discussed. Ganged coaxial resonators are employed, with aperture-type inter-circuit coupling.

34. BROAD-BAND VERY HIGH-FREQUENCY AMPLIFIERS

A. M. LEVINE AND M. G. HOLLOBAUGH
(Federal Telecommunication Laboratories, Inc., New York, N. Y.)

Problems encountered in the design of wide-band intermediate-frequency amplifiers, are described. These amplifiers are novel in that the center frequencies are somewhat higher than those usually encountered, being located in the region above 100 megacycles. Considerations of choice of tube types, comparisons between various coupling means including the use of inverse feedback, and performance are covered.

35. THE MEASUREMENT OF DELAY DISTORTION IN MICROWAVE REPEATERS

D. H. RING
(Bell Telephone Laboratories, Inc., New York, N. Y.)

The delay distortion which is present in wide-band amplifiers with flat amplitude response is examined to determine the precision required for significant measurements. It is found that a precision of better than 0.001 microsecond in relative delay measurements is desirable.

Measuring equipment operating in the intermediate-frequency range from 50 to 80 megacycles with the required precision is described.

Television A

36. SYNCHRO-LITE FOR TELEVISION FILM PROJECTORS

L. C. DOWNES AND J. F. WIGGIN
(General Electric Company, Schenectady, New York)

It has been customary in motion-picture projectors for television to make use of a continuous source of light interrupted by a mechanical shutter. The pulsed light source discussed in this paper accomplishes the desired result electronically without the use of mechanical shutters. A gas-discharge flash lamp is used. Its timing is accurately controlled by a television synchronizing signal.

37. VIDEO-FREQUENCY NEGATIVE-FEEDBACK AMPLIFIERS

M. G. HOLLOBAUGH, J. A. RADO, AND A. M. LEVINE
(Federal Telecommunication Laboratories, Inc., New York, N. Y.)

The use of negative feedback in lieu of complex coupling networks to obtain wide-band high-gain amplification is applied to amplifiers for video frequencies. A general theory is developed, giving figures of merit which permits comparison with other types of video-frequency-amplifier circuits. Experimental results for several types of actual amplifiers using the principles stated are described.

38. RADIO-FREQUENCY PERFORMANCE OF SOME RECEIVING TUBES FOR TELEVISION

ROBERT COHEN
(RCA Laboratories, Harrison, New Jersey)

Several receiving-type tubes may be used to advantage in television receivers designed to tune all 13 channels. This paper discusses the performance of these tube types in radio-frequency amplifiers mixers, and local-oscillator applications. Both push-pull "balanced" circuits and single-ended "unbalanced" circuits are discussed. Data are presented for over-all gain, noise, image rejection, and oscillator frequency stability. These data are taken at two respective points in the band: 60 and 200 megacycles.

39. A THEORY OF MULTISTAGE WIDE-BAND AMPLIFIER DESIGN

W. E. BRADLEY
(Philco Corporation, Philadelphia, Pennsylvania)

A technique of great flexibility and power in the design of multistage wide-band amplifiers, developed in the course of television research between 1938 and 1941 in the laboratories of the Philco Corporation, is described. The method is especially applicable to amplifiers in which the individual stages are sufficiently simple so that the algebraic expression for stage gain is easily calculable.

40. RECENT ADVANCES IN THE DESIGN OF INTERMEDIATE-FREQUENCY AMPLIFIERS FOR TELEVISION RECEIVERS

CLEE MARSH
(Allen B. DuMont Laboratories, Passaic, New Jersey)

A survey is made of the factors to be considered in the design of a video intermediate-frequency system. New factors and problems introduced by the use of the higher intermediate frequencies are discussed. Some practical systems are described and compared from the standpoint of performance and manufacture. No attempt is made to recommend any particular amplifier system.

Television B

41. CATHODE-RAY TUBES AND OPTICAL SYSTEMS

H. RINIA, J. DEGIER, AND P. M. VANALPHEN
(N. V. Philips' Gloeilampenfabrieken, Eindhoven, Holland)

A compact projection system utilizing a small cathode-ray tube and modified Schmidt optics is described. The small tube-neck permits efficient focusing and deflection with high accelerating potential. A 12x16-inch picture is obtained by a linear magnification of 8.5. A simple process for producing the correction plate is described.

42. HIGH-VOLTAGE UNIT AND DEFLECTION CIRCUIT

J. HAANTJES, G. J. SIEZEN, AND F. KERKHOFF
(N. V. Philips' Gloeilampenfabrieken, Eindhoven, Holland)

A voltage-tripling interruption-type high-voltage unit utilizing feedback for

stabilization is described. Newly developed magnetic material improves the efficiency and reduces the transformer size. All high-voltage components are sealed in an insulating medium. Some circuit developments adaptable to direct viewing or projection television are also described.

43. CATHODE-RAY FLYING-SPOT SCANNER FOR TELEVISION SIGNAL GENERATION

R. D. KELL AND G. C. SZIKLAI
(RCA Laboratories Division, Radio Corporation of America, Princeton, New Jersey)

One of the primary requirements in television development is a standard high-quality video signal source on which one may rely for good resolution, high signal-to-noise ratio, freedom from spurious signals, etc. While a monoscope signal fulfills this requirement, it provides only one picture. The use of a high-voltage kinescope with a short-persistence phosphor and multiplier photocells permits the construction of a flying-spot slide projector providing an excellent video signal from a wide variety of subjects.

44. GAS-DISCHARGE-TUBE TELEVISION DEFLECTION SYSTEMS

K. R. WENDT
(RCA Laboratories Division, Radio Corporation of America, Princeton, New Jersey)

A new horizontal-deflection power-output system is described which uses thyatron tubes. The principle of operation, which is quite different from that used heretofore, is described, and the new and old systems compared. The thyatron system obtains its power from the 300-volt supply at a reduced current drain. It supplies a direct-current power as an output at a low voltage and high current which may be used elsewhere in the receiver.

45. AN IMPROVED COUNTER-TIMER FOR TELEVISION

C. E. HALLMARK
(Farnsworth Television and Radio Corporation, Fort Wayne, Indiana)

A master timer employing two cascaded counter circuits accomplishing the usual 525-to-1 frequency division is described. It is shown that, due to the use of an improved linear counter, the higher count-down ratio does not result in any decrease in stability. The linear counter is described in detail. It is shown that, for a given stability, the count-down ratio of this type counter may be extended indefinitely, subject only to practical engineering limitations.

Electronic Digital Computers

46. THE ELECTRONIC DIGITAL COMPUTER

J. W. FORRESTER
(Massachusetts Institute of Technology, Cambridge, Massachusetts)

A discussion of the nature of electronic digital computers, with mention of early attempts and existing systems. A general block diagram of a computer of the modern

proposed types, and an outline of fundamental computer operations of input, arithmetic, storage, and output, will be given as a basis for following papers.

47. INPUT MECHANISMS FOR ELECTRONIC DIGITAL COMPUTERS

S. N. ALEXANDER

(National Bureau of Standards, Washington, D. C.)

Criteria for acceptable input mechanisms are established and suggestions for standardization of systems presented. The application of commercially available equipment such as teletype to the problem is discussed. Recently developed input systems and special materials used therein are described.

48. ELECTRONIC COMPUTING

H. H. GOLDSTINE

(The Institute for Advanced Study, Princeton, New Jersey)

The speaker will show how arithmetical operations and the switching of numbers and control of computation can be realized by means of vacuum-tube circuits. The interrelation between the engineer and mathematician in the development of computing instruments will also be discussed briefly.

49. THE SELECTRON—A TUBE FOR SELECTIVE ELECTROSTATIC STORAGE

JAN A. RAJCHMAN

(RCA Laboratories Division, Radio Corporation of America, Princeton, New Jersey)

The selectron, conceived primarily for the inner memory of a digital electronic computer, is a tube for storing several thousand on-off signals. Electrons from an extended source are intercepted by two orthogonal sets of spaced parallel conductors creating a checkerboard of windows, internally connected in such combinations that, by applying on-off voltages to a relatively small number of sealed-in leads, the flow of electrons can be controlled through individual windows.

50. APPLICATIONS OF ELECTRONIC DIGITAL COMPUTERS

PERRY CRAWFORD

(Special Devices Division, Office of Naval Research, Washington, D. C.)

A discussion of computer applications, including scientific calculations, wave propagation, and aerodynamics. Comments will be made on the future relation of analogue and digital computers, and also on the possible engineering application of electronic digital computers to automatic process and factory control, air traffic control, and business calculations.

Power-Output Vacuum Tubes

51. SCREEN-GRID TRANSMITTING AMPLIFIER TUBES FOR OPERATION UP TO 500 MEGACYCLES

W. G. WAGENER

(Eitel-McCullough, Inc., San Bruno, California)

Some of the limitations in tube and circuit design in the very-high- and ultra-high-

frequency regions are reviewed, and the expedients necessary to correct these limitations are presented for the case of screen-grid beam-power amplifier tubes.

The design considerations are illustrated by reference to new transmitting tetrodes, not as yet generally available, but which include tubes capable of stable high-gain amplifier service in conventional circuits as high as 500 megacycles.

52. A NEW FREQUENCY-MODULATION AND TELEVISION POWER AMPLIFIER TUBE AND ITS ASSOCIATED GROUNDED-GRID CAVITY CIRCUIT

H. D. WELLS AND R. I. REED

(General Electric Company, Schenectady, New York)

A new tube design and an associated grounded-grid cavity circuit are described which are suitable for frequency-modulation and television power amplifiers. The tube is a water-cooled triode of ring-seal construction especially adapted for grounded-grid operation. In frequency-modulation use at 108 megacycles, a pair of these tubes will deliver more than 10 kilowatts of power.

53-A. FREQUENCY MODULATION AND CONTROL BY ELECTRON BEAMS

LLOYD P. SMITH AND C. SHULMAN

(RCA Laboratories Division, Radio Corporation of America, Princeton, New Jersey)

53-B. A FREQUENCY-MODULATED MAGNETRON FOR SUPER-HIGH FREQUENCIES

G. R. KILGORE, C. SHULMAN, AND J. KURSHAN

(RCA Laboratories Division, Radio Corporation of America, Princeton, New Jersey)

53-C. A ONE-KILOWATT FREQUENCY-MODULATED MAGNETRON FOR 900 MEGACYCLES

J. S. DONAL, JR., R. R. BUSH, C. L. CUCCIA, AND H. R. HEGBAR

(RCA Laboratories Division, Radio Corporation of America, Princeton, New Jersey)

General formulas for the effect of electron beams on resonant systems in terms of frequency shift and change in Q are derived from the point of view of lumped circuits and from a general electromagnetic field standpoint. It has been experimentally found that the use of controlled electron beams for changing frequency is ideally suited for frequency modulation or automatic frequency stabilization of continuous-wave multicavity magnetrons.

Designs of 25-watt, 4000-megacycle and of 1-kilowatt, 900-megacycle continuous-wave multicavity magnetrons are described in which this principle is incorporated.

54. NEW TECHNIQUES IN GLASS-TO-METAL SEALING

JOSEPH A. PASK

(Westinghouse Electric Corporation, Bloomfield, New Jersey)

A powder-glass method of making glass-to-metal seals has been developed. The tech-

nique consists of grinding the glass, suspending it in a suitable agent, applying this to the metal, which is prepared for glassing under controlled conditions, and fusing the powder. The sealing process then becomes similar to a glass-to-glass seal without danger of overoxidation of the metal.

55. DETERMINATION OF THE MUTUAL HEATING OF HELICAL FILAMENTS

M. YOUNDIN

(Amperex Electronic Corporation, Brooklyn, New York)

Design charts for straight or hairpin-shaped filaments are available. However, these charts cannot be used directly for the design of helical filaments unless the mutual or self-heating of the helix can first be evaluated. In this paper the mutual heating of a given helical coil is evaluated as a fraction of the power required to operate an equivalent straight length of filament wire at the same temperature.

Circuit Theory

56. PHASE AND AMPLITUDE DISTORTION IN LINEAR NETWORKS

M. J. DI TORO

(Microwave Research Institute, Polytechnic Institute of Brooklyn, Brooklyn, New York)

In linear phase networks with finite amplitude bandwidth, the step-response build-up time is inversely proportional to the amplitude bandwidth. In all-pass networks with phase distortion, the step-response build-up time is finite because of finite phase bandwidth. Certain relations between phase and amplitude bandwidths are shown necessary to avoid transient-response overshoot arising from excessive phase distortion.

57. CORRELATION OF NETWORK FREQUENCY RESPONSE AND SQUARE-WAVE SHAPE

REUBEN LEE

(Westinghouse Electric Corporation, Baltimore, Maryland)

Square waves usually suffer some degradation of the wave shape in passing through a network. This degradation may be evaluated either by square-wave analysis or in terms of the network frequency response, provided due allowance is made for phase shift. This paper gives the wave shape output of commonly used networks when the frequency response is known.

58. COMPENSATION OF PHASE SHIFT AT LOW FREQUENCIES

F. MCGEE

(Federal Telecommunication Laboratories, Inc., New York, N. Y.)

A mathematical analysis of low-frequency phase shift in a resistance-coupled amplifier is presented. Some approximate formulas suitable for design work are developed. These formulas are simpler than previously published formulas and more accurate than graphs representing the existing formulas. A new method of compensation, which allows for simultaneous compensation

of cathode, screen, and coupling phase shifts, is described.

59. PARABOLIC LOCI OF COUPLED CIRCUITS

SZE HOU CHIANG

(Watson Laboratories, Cambridge Field Station, Cambridge, Massachusetts)

It is pointed out that the reciprocal of the system gain function E_1 , or its equivalent, of two-mesh tuned coupled circuits when plotted in E_2 complex plane leads to parabolic loci under certain restrictions. The simple geometric properties of parabolas will facilitate the design work and may throw new lights as to the applications and limitations of the coupled circuits in different fields, electrical or nonelectrical.

60. RECIPROCITY FAILURE IN CRYSTAL NETWORKS

L. APKER, E. TAFT, AND J. DICKEY

(General Electric Company, Schenectady, New York)

From the theory of nonlinear circuits, the loss of a converter network depends on the direction of propagation of power through it. This effect, termed reciprocity failure, has been measured by double-heterodyne methods. The results agree with those predicted from measured crystal constants. Crystals with large nonlinear capacitance have been measured by a new method and have shown failure of both signs.

Electronic Controls and Applications

61. ELECTRONIC CONTROL IN INDUSTRY

GEORGE M. CHUTE

(General Electric Company, Detroit, Michigan)

While electronic circuits are usually thought of as applying to low-power devices, they have in recent years been applied to the control of units developing thousands of kilowatts. The use of electronic circuits in motor control, welding, and similar applications is discussed, as is the operation of amplitude-type circuits for control of large amounts of mechanical power.

62. VARIABLE RADIO-FREQUENCY-FOLLOWER SYSTEM

R. F. WILD

(The Brown Instrument Company, Division of Minneapolis-Honeywell Regulator Company, Minneapolis, Minnesota)

A novel type of follower system is discussed, operated by keyed variable radio frequencies. The wide-band characteristics of the tuned-radio-frequency discriminators are given. Design considerations are given pertaining to stability, freedom from drift, sensitivity, accuracy, choice of bandwidth and operating frequencies, and adjustment of zero setting and span.

63. CONTINUOUS RECORDING SENSITIVE MAGNETOMETER

R. F. SIMMONS

(Airborne Instruments Laboratory, Inc., Mineola, New York)

A device of great value in geophysical prospecting consists of an airborne magne-

tometer capable of indicating a departure from the average value of the earth's magnetic field of one part in 100,000. The instrument described utilizes a saturated-core magnetometer maintained parallel to the ambient field by additional units of the same type.

64. THREE-DIMENSIONAL REPRESENTATION ON CATHODE-RAY TUBES

CARL BERKLEY

(Allen B. DuMont Laboratories, Inc., Passaic, New Jersey)

A procedure for the representation of functions of a number of variables on the screen of a cathode-ray tube is developed. This may take the form of an oblique perspective picture. Applications in the fields of mathematics, radar, electromagnetic theory, mechanical measurements, topographic surveying, and meteorology are described.

65. NEW ELECTRONIC WIRING TECHNIQUES

CLEDO BRUNETTI

(National Bureau of Standards, Washington, D. C.)

Several methods of printing electronic circuits are treated, including the silk-screen process, spraying, painting, stamping, photographic, and others. This comparatively new art utilizes well-known basic techniques. Performance of several types of printed circuits under various conditions of temperature, humidity, aging, and electrical loading is discussed.

Aids to Air Navigation and Traffic Control

66. TRENDS IN AIR NAVIGATION

HARRY DAVIS

(Watson Laboratories, Red Bank, New Jersey)

This paper discusses the international progress of design and test of long- and short-range air navigational aids. The most important electronic aids, including distance-measuring equipment, ground surveillance radar, and the omnirange are described. The role of electronic aids in the philosophy of air navigation is discussed, and the status of international standardization is presented.

67. THE FUNCTION OF AIR-TRAFFIC CONTROL

WARREN D. WHITE

(Airborne Instruments Laboratory, Inc., Mineola, New York)

The need for air-traffic control as distinct from navigation aids and landing systems is discussed and some of the deficiencies of the present system of traffic control are reviewed. A brief outline of some of the functions which a satisfactory traffic-control system must provide is given.

68. HAZELTINE LANAC SYSTEM (LAMINAR AIR NAVIGATION ANTICOLLISION)

KNOX McILWAIN

(HazelTine Electronics Corporation, Little Neck, L. I., New York)

Lanac, an integrated challenger-replier

system for collision-avoidance and short-distance navigation, permits display optionally on L or PPI oscilloscopes or meters. Planes obtain their locations (distance, direction, and altitude) relative to ground stations and other planes, with controllers continuously apprised concerning equipped planes. Operational results in 30,000 miles of flights are discussed.

69. FIRST TESTS ON NAVAR SYSTEM FOR AERIAL NAVIGATION AND AIR-TRAFFIC CONTROL

H. BUSIGNIES AND P. A. ADAMS

(Federal Telecommunication Laboratories, Inc., New York, N. Y.)

The basic philosophy of navar consists of visually presenting aircraft movements with suitable identification and altitude information to the pilot and ground controller. Data will be presented on the omnidirection range and distance-measuring phases of navar, as revealed by flight tests of the first simplified experimental equipment.

70. THE APPLICATION OF MICROWAVES TO THE GUIDANCE AND CONTROL OF AIRCRAFT

JOSEPH LYMAN AND

GEORGE LITCHFORD

(Sperry Gyroscope Company, Inc., Garden City, L. I., New York)

Pulse and continuous-wave technique and compared as they apply to guidance, control, and surveillance of air traffic. Continuous-wave technique for securing distance and azimuth from a ground station to multiple aircraft are described. The resultant display provides a co-ordinate system for air-traffic organization and guidance to closely spaced landings.

Microwave Techniques and Measurements

71. PRECISION MEASUREMENTS OF IMPEDANCE MISMATCHES IN WAVE GUIDE

A. F. POMEROY

(Bell Telephone Laboratories, Inc., New York, N. Y.)

A method is described for determining accurately the magnitude of the reflection coefficient caused by an impedance mismatch in wave guide by measuring the ratio between incident and reflected voltages. The novel feature consists of canceling all spurious voltages in the measuring equipment. The canceling voltage is introduced through a hybrid equipment. The canceling voltage is introduced through a hybrid junction. Reflection coefficients of any value less than 0.05 (0.86-decibel standing-wave ratio) can be measured to an accuracy of ± 2.5 per cent.

72. A COAXIAL-LINE SUPPORT FOR 0 TO 4000 MEGACYCLES

RANDOLPH W. CORNES

(Sperry Gyroscope Company, Inc., Garden City, L. I., New York)

Stub and spaced-bead center-conductor supports for rigid coaxial lines restrict the use of the lines to narrow frequency bands. The experimental and theoretical work done

in designing a broad-band undercut bead support is described and a method given for calculating the bandwidth. A typical microwave application is discussed which has a voltage-standing-wave ratio of less than 1.025 for 0 to 4000 megacycles.

73. POWER LOADS AT VERY- AND ULTRA-HIGH FREQUENCIES

A. G. KANDOIAN AND R. A. FELSENHELD,
(Federal Telecommunication Laboratories Inc., New York, N. Y.)

Dummy loads for frequency-modulated, television, and radar transmitters are described which utilized distributed-circuit constants for power-dissipation elements. The application of resonators, antennas, and transmission-line principles results in simple, compact, and rugged loads capable of operation with high power dissipation and over a wide frequency band. With water cooling, average powers of the order of tens of kilowatts can be handled.

74. DIRECT-READING WAVEMETERS

G. E. FEIKER AND H. R. MEAHL
(General Electric Company,
Schenectady, New York)

A line of direct-reading wavemeters operating over the wavelength range of 5 to 80 centimeters (the frequency range of 6,000 to 375 megacycles) is described. Two types of wavemeters are included: a laboratory-type searching wavemeter and a field-type precision wavemeter. The theory applicable to the major design features is also presented.

75. THE OPERATIONAL BEHAVIOR OF A MAGNETRON MICROWAVE GENERATOR WHEN COUPLED TO A LONG TRANSMISSION LINE

W. C. BROWN

(Raytheon Manufacturing Company,
Waltham, Massachusetts)

A simplified equivalent circuit of the magnetron and load is derived. The input impedance to the transmission line is examined as a function of frequency and terminating impedance. The reactive component of the impedance is then combined with the reactive components of the magnetron to determine the resonant frequency of the system. Under certain conditions, more than one resonant frequency is possible. The system performance which may result is discussed.

Broadcasting and Recording

76. PROPAGATION CHARACTERISTICS OF THE ULTRA-HIGH-FREQUENCY (480- TO 920-MEGACYCLE) TELEVISION BAND

WILLIAM B. LODGE

(Columbia Broadcasting System, Inc.,
New York, N. Y.)

Results are given of nine months of field tests to determine the coverage of the Columbia Broadcasting System color-television transmitter (W2XCS) operating on 490 megacycles in New York City. A general investigation of radio wave propagation characteristics at 490 and 700 megacycles was also conducted which proved the feasibility of rendering a satisfactory color-television

broadcast service by use of frequencies in the 480- to 920-megacycle band.

77. THEORETICAL AND PRACTICAL ASPECTS OF FREQUENCY-MODULATION BROADCAST ANTENNA DESIGN

PHILLIP H. SMITH

(Bell Telephone Laboratories, Inc.,
New York, N. Y.)

The theoretical and practical considerations involved in the design of frequency-modulation broadcast transmitting antennas will be discussed. This will be followed by an explanation of the structural assembly, radiating elements, and associated feed system used in cloverleaf antennas. Both calculated and measured data on field-intensity patterns, array gain, and impedance-frequency characteristics will be shown.

78. MONITORING EQUIPMENT FOR FREQUENCY-MODULATION BROADCASTING

MARTIN SILVER

(Federal Telecommunication Laboratories, Inc., New York, N. Y.)

Equipment suitable for monitoring the performance of frequency-modulation broadcast transmitters in the band from 88 to 108 megacycles is described. Separate frequency and modulation monitors are employed. The equipment meets, and in many aspects surpasses, the Federal Communications Commission requirements. Noise and distortion measuring capabilities are 80 and 60 decibels, respectively, below the fully modulated condition. The frequency monitor will measure frequency variations to within 100 cycles under fully modulated conditions.

79. ULTRA-HIGH-FREQUENCY MULTIPLEX BROADCAST SYSTEM

A. G. KANDOIAN AND A. M. LEVINE

(Federal Telecommunications Laboratories, Inc., New York, N. Y.)

An experimental eight-channel high-fidelity multiplex broadcasting system which has been developed and operated during the past year will be discussed. Multiplex operation is achieved by time-sharing pulse-time modulation. The operating frequency is 930 megacycles. The description and operating characteristics of the major components, including modulator, transmitter, antenna system, and receiver, will be given.

80. FIELD MEASUREMENTS ON MAGNETIC RECORDING HEADS

DONALD L. CLARK AND LYNN L. MERRILL

(Stromberg-Carlson Company,
Rochester, New York)

A method is described for measuring relative values of the magnetizing force along the path traversed by the recording medium in passing through a magnetic recording or reproducing head. A method for calculating the frequency response of a reproducing head from field-distribution data is presented. Calculated and measured results are compared. The recording process is discussed, and correlation between field distribution and performance of a recording head is indicated.

Oscillator Circuit Theory

81. LIMITATIONS OF THE SUPER-REGENERATIVE CIRCUIT

H. STOCKMAN

(Cambridge Field Station, Army Air Forces,
Cambridge, Massachusetts; formerly,
Cruft Laboratory, Harvard University,
Cambridge, Massachusetts)

The superregenerative circuit gained tremendously in importance during the war, particularly as part of beacon and identification-of-friend-or-foe equipment. This paper describes prerequisites for research work on superregeneration, some viewpoints on superregeneration theory, and some of the important applications. Limitations of the circuit are pointed out and conclusions drawn.

82. THEORY OF AMPLITUDE-STABILIZED OSCILLATORS

PIERRE R. AIGRAIN AND EVERARD M. WILLIAMS

(Carnegie Institute of Technology,
Pittsburgh, Pennsylvania)

A general theory of amplitude-stabilized oscillators is described and merits of various regulating elements, such as lamps and thermistors, are compared in terms of an asymptotic amplitude-stability factor. A new circuit is described which permits stabilization at a very low level with continuous adjustment of amplitude.

83. SYNCHRONIZATION OF OSCILLATORS

R. D. HUNTOON AND A. WEISS

(National Bureau of Standards,
Washington, D. C.)

Oscillator synchronization behavior is explained in terms of the variation of its frequency with changes in load impedance. Mutual interaction of 2 to N oscillators is treated briefly. The theory is applied to a number of practical applications including: linear voltmeter, amplitude-modulation demodulator, frequency-modulation demodulator, and synchronous amplifier.

84. OPERATING CHARACTERISTICS OF COUPLED-CIRCUIT OSCILLATORS

D. K. CHENG

(Watson Laboratories, Cambridge Field
Station, Army Air Forces,
Cambridge, Massachusetts)

Coupled-circuit oscillators exhibit certain operational peculiarities. This paper investigates the wavelength and loading characteristics, the "drag-loop" phenomenon, the branch of oscillation instability, the region of oscillation stoppage, and the best conditions of operation. Under suitable adjustments, they can be used to produce wide-band frequency modulation.

Basic Electronics Research

85. THE ELECTRONIC RESEARCH SPONSORED BY THE OFFICE OF NAVAL RESEARCH

E. R. PIORE

(Office of Naval Research,
Washington, D. C.)

The philosophy and the basis of operation

*Wed
Mon*

of the Office of Naval Research in supporting fundamental and basic research in the field of electronics in laboratories outside the naval establishment will be discussed. The current program, broken down into propagation, the interaction of radio radiation and matter, the physics of components, systems, and instrumentation, will be presented. Deficiencies in the program will be indicated.

86. SPHERICAL ABERRATION OF COMPOUND MAGNETIC LENSES

L. MARTON

(National Bureau of Standards, Washington, D. C.; formerly, Stanford University, California)

K. BOL

(Stanford University, California)

A reduction of the spherical aberration of strong electron lenses can be achieved by a strong lens as a virtual-image former and transforming the image into a real one by one or more weak lenses. Calculations are carried out for bell-shaped magnetic fields of the axial field distribution $H(z) = H_0/1 + (z/a)^2$, and numerical values of the achieved reduction of the aberration are given.

87. FIELD EMISSION ARC AS AN ELECTRON SOURCE

C. M. SLACK AND D. C. DICKSON

(Westinghouse Electric Corporation, Bloomfield, New Jersey)

A source of electrons of extremely high capacity is obtained by striking an arc between two closely spaced electrodes in a high vacuum. Such a source depends on metallic ions vaporized from the electrodes to relieve space charge and has an extremely rapid deionization time. Some control of tube characteristics can be obtained by varying electrode design spacing. Its principal uses to date have been for short-time pulse applications.

88. RESPONSE OF A THERMIONIC VACUUM TUBE TO THE SUDDEN APPLICATION OF AN EXTERNAL VOLTAGE

EDWARD H. GAMBLE

(Microwave Research Institute, Polytechnic Institute of Brooklyn, Brooklyn, New York)

From a computation of the initial space-charge distribution before voltage is applied, one may determine the build-up of the current in a diode upon application of an external voltage. One may determine the transition from the initial distribution to that associated with the temperature-limited and space-charge-limited cases, in addition to the thermionic emission at weak fields.

89. NOISE-SUPPRESSION CHARACTERISTICS OF PULSE MODULATION

S. MOSKOWITZ AND D. D. GRIEG

(Federal Telecommunication Laboratories, Inc., New York, N. Y.)

The results of tests conducted to determine empirically the signal-to-noise ratio

improvement obtained by the use of several types of pulse modulation are discussed. In addition to inherent noise-reducing properties, pulse modulation allows the use of noise-suppression circuits. Tests made with fluctuation-noise and impulse interference in conjunction with limiters and differentiators are described.

Wave Propagation and Antennas

90. A STUDY OF TROPOSPHERIC RECEPTION AT 42.8 MEGACYCLES AND METEOROLOGICAL CONDITIONS

G. W. PICKARD AND H. T. STETSON

(Massachusetts Institute of Technology, Cambridge, Massachusetts)

Field-intensity measurements of station W2XMN, 42.8 megacycles, at a distance of 167 miles closely follow surface refraction. Frontal passages affect reception least when the front parallels the transmission path. Fields correlate with surface temperatures along the path. Low wind velocities with wind direction parallel to the path favor high fields.

91. RESULTS OF MICROWAVE PROPAGATION TESTS ON A 40-MILE OVERLAND PATH

A. L. DURKEE

(Bell Telephone Laboratories, Inc., New York, N. Y.)

This paper gives the results of a series of microwave radio propagation tests over an unobstructed 40-mile overland path. The purpose of the tests was to investigate the transmission characteristics of such a path at centimeter wavelengths over a long period of time. Statistics on the transmission results at wavelengths ranging from 1.25 to 42 centimeters are given. The tests extended over a period of about two years.

92. A METHOD OF RAPID CONTINUOUS MEASUREMENT OF ANTENNA IMPEDANCE OVER A WIDE FREQUENCY RANGE

H. V. COTTONY

(National Bureau of Standards, Washington, D. C.)

An electrically driven recording milliammeter is mechanically coupled to the tuning shaft of a wide-band, constant-current, balanced-output generator. An antenna or any other two-terminal network, when connected to the terminals of the generator, will develop a voltage proportional to the absolute value of its impedance. A vacuum-tube voltmeter records continuously the impedance versus frequency.

93. A PHASE-FRONT PLOTTER FOR CENTIMETER WAVES

HARLEY JAMS

(RCA Laboratories Division, Radio Corporation of America, Princeton, New Jersey)

In the centimeter-wave region it is not unusual to have an antenna, dish, or horn across which the phase of the radiation should be constant or should vary in some predetermined manner. To test such behavior a device including several lengths of

wave guide, some rotary joints, a crystal detector, and a plotting probe was evolved. This material is used to compare a signal tapped off the wave guide leading to the antenna with one picked up by the probe moved in the field of the antenna.

94. RAPIDLY MOVING IONOSPHERIC CLOUDS

H. W. WELLS

(Carnegie Institution of Washington, Washington, D. C.)

Rapidly moving ionospheric clouds and other unusual ionospheric movements which occur in very short periods of time have been detected during magnetic and ionospheric storms. The application of a new moving-picture technique has led to the detection of these rapid movements which have been hitherto unrecorded. These phenomena will be demonstrated in the motion-picture films to be presented as a part of the paper.

Relay and Pulse-Time Systems of Communications

95. CONSIDERATIONS OF MOON-RELAY COMMUNICATIONS

D. D. GRIEG, H. METZGER, AND E. WAER

(Federal Telecommunication Laboratories, Inc., New York, N. Y.)

The use of the moon as a passive repeater for high-frequency radio transmission is discussed. Consideration is given to the various factors entering in establishing communication via moon echoes. These factors include problems such as cosmic noise, doppler shift, and special astronomical effects. The bandwidth, power, and signal-to-noise considerations are given for two cases: one, idealizing smooth moon, and two, rough moon.

96. EXPERIMENTAL STUDIES OF A REMODULATING-REPEATER SYSTEM

W. M. GOODALL

(Bell Telephone Laboratories, Inc., New York, N. Y.)

This paper describes tests made on an experimental microwave frequency-modulation system suitable for broad-band relay communication. A microwave reflex oscillator is used for the transmitting unit and a superheterodyne is used for the receiving unit. A repeater consists of a receiver and a transmitter connected together at base band or video frequency. Experiments with a recirculating loop are described.

97. EXPERIENCES WITH MULTIPATH TRANSMISSIONS AT VERY-HIGH FREQUENCY, ULTRA-HIGH FREQUENCY, AND SUPER-HIGH FREQUENCY

F. P. MORF

(Coles Signal Laboratory, Red Bank, New Jersey)

Microwave radio relay equipment was operated in California from San Francisco to San Diego. Severe fading was encountered. Evidence was obtained that this fading was due to cancellation of transmitted signals arriving over paths of different lengths. Methods of operation were found which minimize this type of fading.

98. MULTIPLEX EMPLOYING PULSE-TIME AND PULSED FREQUENCY MODULATION

H. GOLDBERG AND C. C. BATH
(Bendix Radio, Baltimore, Maryland)

An investigation of the simultaneous transmission of two channels over a single carrier by means of multiplex employing pulse-time and pulsed frequency modulation shows such multiplex to be practicable. Cross modulation can be kept down to acceptable limits. Such operation doubles the number of channels possible on a single carrier using time-division multiplexing.

99. MULTIPLEX MICROWAVE RADIO APPLIED TO TELEPHONE SYSTEMS

T. H. CLARK

(Federal Telecommunication Laboratories, Inc., Nutley, New Jersey)

Recent developments in microwave radio as applied to telephone systems are discussed. Ultra-high and super-high frequencies show promise of great utility for routine toll circuits, short overwater carriers, island hopping, and routes over difficult terrain. Various types of microwave multiplex systems are emerging, and their advantages and disadvantages will be presented, together with their applications to telephone operating systems.

Receiver Circuits

100. SYNCHRONOUS DETECTORS

J. G. REID, JR.

(National Bureau of Standards, Washington, D. C.)

Vacuum-tube voltage indicators synchronously gated by an alternating voltage from an external source are examined as a means of improving signal-to-noise ratio. The frequency selectivity, phase selectivity, and influence of gating wave form are considered. Applications, particularly to instrument amplifiers for measuring extremely small voltages, are discussed.

101. A WIDE-BAND 550-MEGACYCLE AMPLIFIER

RAYMOND O. PETRICH

(Airborne Instruments Laboratory, Inc., Mineola, New York; formerly, Radio Research Laboratory, Harvard University, Cambridge, Massachusetts)

A 2C43 triode is used at 550 megacycles in a grounded-grid amplifier circuit with an impedance-transforming band-pass filter in the output to give a gain of 10 decibels for a bandwidth of 20 megacycles. The equivalent circuit is analyzed to determine the conditions for maximum gain.

102. A COMPACT ELECTROMECHANICAL FILTER FOR THE 455-KILOCYCLE INTERMEDIATE-FREQUENCY CHANNEL

ROBERT ADLER

(Zenith Radio Corporation, Chicago, Illinois)

A compact metallic ladder of mechanically resonant elements, linked by compli-

ant members and coupled to electrical circuits by magnetostrictive terminations, transmits uniformly within a 4-to-14 kilocycle band with very rapid attenuation outside. Data for design and performance in a receiver are given. The filter is adapted to economical production.

103. RECEIVER SENSITIVITY AT THE HIGHER FREQUENCIES

JOSEPH M. PETTIT

(Stanford University, California; formerly, Airborne Instruments Laboratory, Mineola, New York)

The standard definition and philosophy of receiver sensitivity in terms of receiver gain are reviewed. Limitations imposed by circuits and tube noise are pointed out. Two alternative methods of defining sensitivity are proposed in which account is taken of both gain and noise. Test methods and equipment are discussed.

Vacuum Tubes and Gas Rectifiers

104. BEAM-DEFLECTION CONTROL FOR AMPLIFIERS AND MIXERS

Part I—High-Transconductance Design Considerations

G. R. KILGORE

(RCA Laboratories Division, Radio Corporation of America, Princeton, New Jersey)

The attainment of high transconductance and high ratios of transconductance to current and capacitance by means of deflection control is discussed. Limitations in design imposed by current density are considered, and expressions are derived for the maximum transconductance and transconductance-to-capacitance ratio attainable at high frequencies. A simple, effective gun system is described which combines focusing and deflection.

Part II—Mixer Tubes for Ultra-High Frequency

E. W. HEROLD, C. W. MUELLER, AND H. A. FINKE

(RCA Laboratories Division, Radio Corporation of America, Princeton, New Jersey)

Rectangular-cross-section beams of high current density and low current were used to build deflection mixers for 300 to 3000 megacycles. Phase-reversal frequency conversion was used and, in some designs, secondary multiplication. Over-all receiver noise factors between 7 and 10 decibels were achieved below 1200 megacycles; the tubes had high gain, wide bandwidth, and freedom from local-oscillator radiation.

105. A NEW 100-WATT TRIODE FOR 1000 MEGACYCLES

W. P. BENNETT, E. A. ESCHBACH, C. E. HALLER, AND W. R. KEYE

(RCA Victor Division, Radio Corporation of America, Lancaster, Pa.)

The design and development of a 100-watt grounded-grid triode for operation at full ratings to 1200 megacycles is described. Unusual mechanical design features have

been co-ordinated with the electrical characteristics to achieve a tube capable of excellent performance at ultra-high frequencies which can be manufactured by production-line methods.

106. A STUDY OF MICROPHONICS IN A SUBMINIATURE TRIODE

V. W. COHEN AND A. BLOOM

(National Bureau of Standards, Washington, D. C.)

The simple theory of the triode has been applied to a calculation of the effect of motion of the tube elements on the plate current. The effect has been evaluated for a subminiature filamentary triode and these values compared with experiment. Other causes of microphonic response are proposed and have been investigated in part. Experimental techniques are discussed for making repeated tests on individual tubes.

107. DESIGN OF GAS-FILLED COLD-CATHODE TUBES

G. C. RICH

(Sylvania Electric Products, Inc., Flushing, L. I., New York)

Beginning with Townsend's equation representing conditions for breakdown in a cold-cathode, gas-filled diode, equations which may be used in the design of practical plane triodes are developed. This is accomplished by a rearrangement of Townsend's equation to give breakdown voltage in terms of cathode-surface sensitivity, gas pressure, and electrode spacing, assuming uniform field. The resulting equation is then applied to the grid-cathode region and the grid-anode region of a plane-electrode configuration.

108. RECENT ADVANCES IN HIGH-VOLTAGE RECTIFIERS FOR TELEVISION RECEIVERS

GEORGE BAKER

(Chatham Electronics, Newark, New Jersey)

The special requirements of tubes for this service are reviewed and new designs to attain them are shown. Methods are described for removing from the metal electrodes and from the walls of the glass envelope small quantities of gas which were found to affect the rectifying characteristics and tube life. The operation of oxide-coated and of thoriated-tungsten emitters in strong electric fields is discussed.

Antennas

109-A. FUNDAMENTAL LIMITATIONS OF SMALL ANTENNAS

HAROLD A. WHEELER

(Consulting Radio Physicist, Great Neck, New York)

A capacitor or inductor operating as a small antenna is theoretically capable of intercepting a certain amount of power, independent of its size. The practical efficiency relative to this ideal is limited by the "radiation power factor" given by a simple formula, which is about the same for capacitors and inductors of the same volume.

109-B. HELICAL ANTENNA FOR CIRCULAR POLARIZATION

HAROLD A. WHEELER

(Consulting Radio Physicist,
Great Neck, New York)

A helical coil radiates a wave of circular polarization in a doughnut pattern, if the area and pitch of the turns are properly related to the radianlength of the wave. This type of antenna offers television the advantages of circular polarization in suppressing echoes from reflecting surfaces.

110. RADIATION PATTERNS OF THICK END-FED ANTENNASC. H. PAGE, R. D. HUNTOON, AND
P. R. KARR(National Bureau of Standards,
Washington, D. C.)

Experimentally obtained directivity patterns for thick antennas excited near one end are shown and some of their properties discussed. The patterns all have a characteristic "lean" away from the feed point. For antennas in the form of thick cylinders the measured patterns are found to agree with those computed from a simple linear current distribution consisting of a standing-wave component and a traveling-wave component.

111. A NEW TYPE OF BROAD-BAND ZERO-DRAG AIRCRAFT ANTENNA

ARTHUR DORNE AND JOSEPH MARGOLIN

(Airborne Instruments Laboratories, Inc.,
Mineola, New York)

For some purposes zero-drag aircraft antennas must have radiation patterns which are similar to those obtained from a stub. Such patterns, although not produced by a linear slot, are obtained from a symmetrically excited annular slot. Antennas of this type have been designed to be broad-band and of sizes that are practical at microwave frequencies.

112. CIRCULARLY POLARIZED ANTENNAS

W. SICHAK AND S. MILAZZO

(Federal Telecommunication Laboratories,
Inc., New York, N. Y.)

A convenient and consistent terminology

is suggested for circularly polarized waves. Various general properties of these waves are developed. The possibility is demonstrated that two circularly polarized antennas may be blind to each other, unless both antennas have the same screw sense. Elliptically polarized waves are also examined.

113. AIRCRAFT-ANTENNA-PATTERN MEASURING SYSTEM

O. H. SCHMITT

(Airborne Instruments Laboratory, Inc.,
Mineola, New York)

Spherical radiation patterns for aircraft antennas in the 5-to 1000-megacycle range are automatically drawn in standard polar-co-ordinate form using inexpensive metal-clad scale-model airplanes fitted with scale-model antennas and illuminated with microwave radiation correspondingly scaled in frequency.

Wave-Guide Techniques**114. AN ADJUSTABLE WAVE-GUIDE PHASE CHANGER**

A. G. FOX

(Bell Telephone Laboratories, Inc.,
New York, N. Y.)

A wave-guide phase changer is described which makes use of circularly polarized waves to provide a continuously adjustable change in phase of transmitted power. This process can be made to take place with negligible loss of power. Fundamental principles of the scheme will be demonstrated.

115. DEVELOPMENTS IN BROAD-BANDING OF MICROWAVE PLUMBING COMPONENTS

J. H. VOGELMAN

(Watson Laboratories, Red Bank,
New Jersey)

This paper will investigate the basic principles involved in the design of broad-band plumbing components for use with wave guides and coaxial lines up to the frequency range of 30,000 megacycles with special consideration given to crystal mixers and holders. Newly developed components will be discussed. Performance and characteris-

tics and operational features will be evaluated. Also, trends and possible future designs will be briefly discussed.

116. A CONSIDERATION OF DIRECTIVITY IN WAVE-GUIDE DIRECTIONAL COUPLERS

S. ROSEN AND J. T. BANGERT

(Bell Telephone Laboratories, Inc.,
New York, N. Y.)

A hypothesis is developed for the directivity characteristics of wave-guide directional couplers having two, four, and eight coupling orifices in the common narrow wall of the couplers. Formulas based on H. A. Bethe's theory of orifice coupling are derived and design curves are presented with supporting experimental data. Interaction and proximity effects are considered.

117. ELECTRICAL MEASUREMENTS ON TRANSMISSION CAVITY RESONATORS AT 3-CENTIMETER WAVELENGTHS

M. S. WHEELER

(Westinghouse Electric Corporation,
Bloomfield, New Jersey)

The electrical characteristics of a resonant cavity may conveniently be defined by its resonant frequency, loaded Q , and insertion loss. An interesting method has been devised to measure the resonant frequency of a transmission device to 1 part in 200,000, which at the same time suggests a means of obtaining the loaded Q but with much less precision. Insertion loss is measured by the method of substitution.

118. DESIGN OF A RESONANT CAVITY FOR FREQUENCY REFERENCE IN THE 3-CENTIMETER RANGE

R. R. REED

(Westinghouse Electric Corporation,
Bloomfield, New Jersey)

The requirements of a resonant cavity for use as a frequency reference is discussed. The "nosed-in" design is briefly considered and a comparison of calculated and experimental resonant frequencies given. The actual design of the 1Q22-24 series is evolved with attention given to shock, vibration, methods of mounting, temperature compensation, and other factors.

The Institute of Radio Engineers

1947 NATIONAL CONVENTION

Hotel Commodore—New York, N. Y.—March 3, 4, 5, and 6, 1947

GENERAL COMMITTEEJAMES E. SHEPHERD
*Chairman*PHILIP F. SILING
*Vice-Chairman*EDWARD J. CONTENT
ELIZABETH LEHMANN
JACK R. POPPEL

B. E. SHACKELFORD

AUSTIN BAILEY
GEORGE W. BAILEY
STUART L. BAILEYEDITH E. WRIGHT
Secretary
FREDERICK R. LACK
Finance
ELWOOD K. GANNETT
Institute Activities
WILLIAM O. SWINYARD
Section Activities
RICHARD D. CAMPBELL
*Registration*E. FINLEY CARTER
Hospitality
MRS. F. B. LLEWELLYN
Women's Activities
ERNST WEBER
Technical Program
RODNEY D. CHIPP
Facilities
JAMES W. McRAE
*Printed program*HELEN M. STOTE
Proceedings Liaison
VIRGIL M. GRAHAM
Publicity
DORMAN D. ISRAEL
Exhibit Requirements
WILLIAM C. COPP
Exhibit Manager
LEO L. BERANEK
*Acoustic Requirements*HENRY F. SCARR
Hotel Arrangements
GEORGE McELRATH
Banquet
A. B. CHAMBERLAIN
President's Luncheon
EDMOUR F. GIGUERE
Cocktail Party

Rochester Fall Meeting



John W. Van Allen, RMA general counsel, S. Capell, president, Canadian RMA; W. R. G. Baker, president, 1947, I.R.E.; W. L. Everitt, president, 1945, I.R.E.; Frederick B. Llewellyn, president, 1946, I.R.E.; and Bond Geddes, vice-president RMA.

Eight hundred and more engineers who registered, and many others who did not register, attended the annual Fall Meeting at Rochester, November 13-15, 1946. As is customary at these annual get-togethers of the elite of the radio engineering fraternity, numerous technical papers dealing with the advanced and practical art were given; there was much discussion in the intimate Fall Meeting manner, and some of the new products with which engineers will work during the coming year were displayed.

There were two high lights of the three-day session. One was the presentation, twice, of a 25-minute 16-millimeter Kodachrome movie of the Able and Baker day blasts at Bikini through the courtesy of Captain C. L. Engleman, U.S.N., Electronics Co-ordinating

Officer of Operation Crossroads, and D. G. Fink, a member of Captain Engleman's staff during the Bikini period.

The second event of significance was the presentation of a Fall Meeting plaque to Professor W. L. Everitt in recognition of his leadership in Institute of Radio Engineers' matters. It will be remembered that it was during his 1945 term as president that the plans for a permanent home for the headquarter staff took shape and were brought to a successful end by the purchase of a building at 1 East 79 Street in New York City, the present home of the Institute.

Dr. Everitt is the fifth recipient of Fall Meeting honors, the others being W. R. G. Baker, L. C. F. Horle, Ralph Hackbush, Keith Henney, and L. A. DuBridg.



Virgil M. Graham, chairman, Rochester Fall Meeting Committee, Ralph A. Hackbusch vice-president, 1944, I.R.E.



Dr. Everitt receives Fall Meeting Plaque.

I.R.E. People



Warren Kay Vantine

LAURENCE G. CUMMING

LAURENCE G. CUMMING

On December 3, 1946, Laurence G. Cumming (A'27-SM'46) assumed the duties of technical secretary of The Institute of Radio Engineers. Born in Hampton, Virginia, in 1902, he attended the Massachusetts Institute of Technology.

While still at M.I.T. he was a broadcast engineer for Boston Edison, and later co-designer and chief engineer of the Boston Evening Transcript's station WBET. From there he went to WBZ-WBZA as assistant plant manager and maintenance engineer. A pioneer amateur since 1916, he still operates under the calls W1BV and W1FB. Upon the introduction of sound pictures Mr. Cumming attended the Western Electric acoustic training course and subsequently became affiliated with Paramount-Publix. From 1934 to 1936 he was engineer-in-charge of radio for the Metropolitan District Commission of Massachusetts, engaged in research, the final data of which was presented to the F.C.C. in Washington; he was issued three patents as the result of this work.

In 1938 Mr. Cumming joined the Army Signal Corps where he was engaged in the joint Army-Navy planning for the coast de-



F. S. BARTON

fenses of New England. His work included the design and installation of a new high-speed message center and several transmitting plants, new design and rehabilitation of existing equipments, and the installation and operation of primary-frequency-standard measuring equipment.

In 1940 he was ordered to active naval duty as a lieutenant. Given command of the establishment and maintenance of most naval shore communication and air-navigational equipment in the First Naval District, he supervised the installation of this equipment at a number of naval air stations and also modified and installed the remote-control features in others. In 1942 he was detailed as technical aide to the commander of the Navy's first airborne task force, a unit devoted to pioneering remote electronic controls; in 1944 he was ordered to the Radar Section, Readiness Division of the office of the Commander-in-Chief, United States Fleets; and later to the Bureau of Aeronautics, as engineer-in-charge of Project Cadillac, an assignment second only to the Manhattan District Project in priority and involving systems engineering of a high order. His last active naval-duty assignment was in the Planning Division, Electronics Section of the Office of Naval Research, under the Office of the Secretary of the Navy, where he was engaged in major research and development projects on the mechanisms and devices of scientific warfare, in the field of electronics and in systems employing microwave techniques, including the study of wave propagation and supplementary work in meteorology and telemetering. He has been physically retired from active duty in the rank of commander, and is still a member of the United States Naval Reserve.

F. S. BARTON

F. S. Barton (F'35), who has served since 1941 with the British Air Commission in Washington as director of radio engineering and, later, as director of Technical Services to the British Supply Office, has returned to London to accept an appointment as a Chief Scientific Officer in the Ministry of Supply.

In his new capacity Dr. Barton will be responsible for the direction, under Air Marshal Coryton and Sir Ben Lockspeiser, of the radio research and development program of the Ministry in so far as it is concerned with the Royal Air Force and the Ministry of Civil Aviation. The main experimental establishments associated with this work are the Telecommunications Research Establishment at Malvern, and the radio department of the Royal Aircraft Establishment.

Dr. Barton wishes to take this opportunity to express his appreciation for the constant help and understanding which he and his British colleagues received from their American colleagues in the radio engineering profession throughout the war. At the Ministry of Supply, 40 Stratton Street,



PETER C. SANDRETTO

London W.1, he will look forward to renewing his acquaintance with any of his friends on this side of the Atlantic who have cause to visit Great Britain.

PETER C. SANDRETTO

Peter C. Sandretto (A'30-M'40-SM'43) has joined the staff of the International Telecommunication Laboratories, Inc., as assistant director of the aviation department. Entering military service in 1942, Mr. Sandretto rose to the rank of Lieutenant Colonel and held various important posts. Following his assignment as chief of the electronics section at the Army Air Forces Proving Ground Command, he served as chief of the electronics section of the Army Air Forces, Pacific Ocean Area (later United States Army Strategic Air Force), and was awarded the Bronze Star for his work there.

L. W. CHUBB

The John Fritz Medal and certificate, the highest award in engineering, has been awarded to Dr. Lewis Warrington Chubb



L. W. CHUBB

I.R.E. People



FREDERICK E. TERMAN

serves on the National Advisory Committee on Aeronautics, conducting a large research program on jet propulsion.



FREDERICK E. TERMAN

Frederick E. Terman (A'25-F'37) was one of 29 top-ranking American scientists elected to membership in the National Academy of Sciences last spring. Membership in the Academy is generally considered the highest honor that can be conferred upon a scientist.

Dr. Terman was graduated from Stanford University as top man in the class of 1920 and received the E.E. degree there two years later. He holds the D.Sc. degree from the Massachusetts Institute of Technology. On the Stanford faculty since 1925, he was executive head of the electrical engineering department from 1937 to 1944 when he became dean of the engineering school. Dr. Terman served for nearly four years as director of wartime research on counterradar at the government's radio research laboratory at Harvard University where hundreds of scientists worked on one of the war's super-secrets—the development of measures to counteract enemy radar. The new dean returned to Stanford in 1945.

In 1941 he had the honor of being elected the first president of the Institute of Radio Engineers from west of the Atlantic seaboard.



WILLIAM F. FRANKART

Announcement of the appointment of William F. Frankart (A'41-M'46) as senior radio project engineer has been made by Lear, Incorporated, Grand Rapids, Michigan. Early in his career he joined the Farnsworth Radio and Television Corporation of Fort Wayne, Indiana, as project engineer, going from that organization to the Aireon Manufacturing Corporation of Kansas City, Kansas, as assistant chief engineer. He later became a design engineer for Air Associates, Inc., of California, and prior to his new position was chief radio engineer of Precision Specialties, Inc., of Los Angeles.



CARL J. PENTHER

Carl J. Penther (A'29-SM'45), after four years' military leave, has returned to the Shell Development Company's laboratories, Emeryville, California.

Assigned to the Signal Corps engineering laboratories during the war, Major Penther served successively as contracting officer, project officer on sound and light equipment, executive officer of the Eaton-town Signal Laboratory, and on the engineering staff of the laboratories' commanding officer at Bradley Beach, New Jersey.



CARL J. PENTHER

Mr. Penther, past chairman of the San Francisco Section, has been active for many years in the educational program of The Institute of Radio Engineers, and at the time of his separation from the Army he was a member of the Program Committee of the New York Section's Monmouth chapter.



JOHN M. VAN BUREN, HARRY W. HOUCK, JERRY B. MINTER

Announcement has been made by the Measurements Corporation, Boonton, New Jersey, of the re-election of John M. van Beuren (A'44) as chairman of the board of directors, and of Harry W. Houck (A'19-M'28-SM'43) and Jerry B. Minter (A'38) as members of the board.

Mr. Houck, president and general manager, joined the organization in 1941. He is a pioneer in the radio industry and recipient of the Armstrong Medal for radio engineering achievement.

Mr. Minter, vice-president and chief engineer of the company, is one of its founders.



WILLIAM F. FRANKART



cBahrach

JOHN M. VAN BUREN

(M'21-F'40), director of the Westinghouse research laboratories. The award was made "for pioneering genius and notable achievements during a long career devoted to the scientific advancement of the production and utilization of electrical energy."

Dr. Chubb's contributions to the knowledge of magnetic properties of iron and iron alloys, and his improvements in the design of electrical machinery and in the measurements of electrical and magnetic quantities, have greatly influenced the development of the electric arts during the past thirty years. He has to his credit about two hundred patents in electrical, mechanical, chemical and electrochemical, and welding fields, and for instruments. Serving in World War I as a member of the Naval Consulting Board, Dr. Chubb's work included submarine detection methods, improvements in gas masks, sound ranging for directing shells, explosives, and numerous other subjects. In World War II, he contributed greatly to the development of the atomic bomb. He also



Books

Communication Through the Ages, by Alfred Still

Published (1946) by Murray Hill Books, Inc., 232 Madison Avenue, New York 16, N. Y. 189 pages + 7-page index + 4-page chronological table. 24 illustrations. 5½×8½ inches. Price, \$2.75.

As to the scope of this informative and useful book, although the author states (page 164) "... this book is written for the layman, no attempt will be made to provide the engineer or technician with information of value to him in the practice of his art," students will find in its pages a clear, running story of the development and practice of communication from ancient times to the present. Particularly graphic are the chapters which set forth the human need for communication of ideas in all ages, and the methods keeping pace with the growth of social and business intercourse the world over.

In describing particular systems of communication, such as wire telegraphy and submarine-cable signaling, where the author, because of space limitations, condenses the text, he appends footnote references to published textbooks which contain authoritative detail information on these subjects. The author makes a point of interest to engineers by noting that whatever technical improvements were made in telegraphy from Morse's time (1844) until the advent of the telephone 32 years later (aside from attempts to employ chemically treated tape reception) were, in the main, clever arrangements of electromagnets. This would include duplex and quadruplex Morse working. This is a new book and can be recommended as an authoritative, easily read review of the art of communication suitable for students in elementary schools, and for the layman.

DONALD McNICOL
25 Beaver St.
New York 4, N. Y.

Radio Tube Vade-Mecum (1946), Sixth Edition, by P. H. Brans

Published (1946) by Editions Techniques P. H. Brans, 28 rue du Prince Leopold—Anvers (Borgerhout), Antwerp, Belgium. Obtainable in the United States from Editors and Engineers, 1300 Kenwood Rd., Santa Barbara, Calif. 232 pages+xii pages. 688 illustrations. 7½×10½ inches. Price, \$2.50.

Brans' Radio Tube Vade-Mecum (hand-book) contains technical information arranged in compact tabular form on well over 3000 different tubes manufactured in Europe, Russia, and the United States. In addition, it cross references about 4000 more type designations to similar types covered in the tables. Only seven pages of editorial matter are used; these cover instructions to the reader in the use of the tables. The rest of the book is broken down into eight tables as follows: I—Tube Characteristics, 112 pages, approximately 1200 types; II—British Tubes, 40 pages, about 1100 types;

SECTIONS

Chairman

Secretary

	ATLANTA February 21	M. S. Alexander 2289 Memorial Dr., S.E. Atlanta, Ga.
H. L. Spencer Associated Consultants 18 E. Lexington Baltimore 2, Md.	BALTIMORE	G. P. Houston, 3rd 3000 Manhattan Ave. Baltimore 15, Md.
Glenn Browning Browning Laboratories 750 Main St. Winchester, Mass.	BOSTON February 20	A. G. Bousquet General Radio Co. 275 Massachusetts Ave. Cambridge 39, Mass.
I. C. Grant San Martin 379 Buenos Aires, Argentina	BUENOS AIRES	Raymond Hastings San Martin 379 Buenos Aires, Argentina
H. W. Staderman 264 Loring Ave. Buffalo, N. Y.	BUFFALO-NIAGARA February 19	J. F. Myers Colonial Radio Corp. 1280 Main St. Buffalo 9, N. Y.
J. A. Green Collins Radio Co. Cedar Rapids, Iowa	CEDAR RAPIDS	Arthur Wulfsburg Collins Radio Co. Cedar Rapids, Iowa
A. W. Graf 160 N. La Salle St. Chicago 1, Ill.	CHICAGO February 21	D. G. Haines Hytron Radio and Electronic Corp. 4000 W. North Ave. Chicago 39, Ill.
J. D. Reid Box 67 Cincinnati 31, Ohio	CINCINNATI February 18	P. J. Konkle 5524 Hamilton Ave. Cincinnati 24, Ohio
H. C. Williams 2636 Milton Rd. University Heights Cleveland 21, Ohio	CLEVELAND February 27	A. J. Kres 16911 Valleyview Ave. Cleveland 11, Ohio
E. M. Boone Ohio State University Columbus, Ohio	COLUMBUS February 14	C. J. Emmons 158 E. Como Ave. Columbus 2, Ohio
Dale Pollack 352 Pequot Ave. New London, Conn.	CONNECTICUT VALLEY February 20	R. F. Blackburn 62 Salem Rd. Manchester, Conn.
R. M. Flynn KRLD Dallas 1, Texas	DALLAS-FT. WORTH	J. G. Rountree 4333 Southwestern Blvd. Dallas 5, Texas
J. E. Keto Aircraft Radio Laboratory Wright Field Dayton, Ohio	DAYTON February 20	Joseph General 411 E. Bruce Ave. Dayton 5, Ohio
N. J. Reitz Sylvania Electric Products, Inc. Emporium, Pa.	DETROIT February 21	Charles Kocher 17186 Sioux Rd. Detroit 24, Mich.
E. M. Dupree 1702 Main Houston, Texas	EMPORIUM	A. W. Peterson Sylvania Electric Products, Inc. Emporium, Pa.
H. I. Metz Civil Aeronautics Authority Experimental Station Indianapolis, Ind.	HOUSTON	L. G. Cowles Box 425 Bellaire, Texas
R. N. White 4800 Jefferson St. Kansas City, Mo.	INDIANAPOLIS	M. G. Beier 3930 Guilford Ave. Indianapolis 5, Ind.
J. R. Bach Bach-Simpson Ltd. London, Ont., Canada	KANSAS CITY	Mrs. G. L. Curtis 6003 El Monte Mission, Kansas
Frederick Ireland 950 N. Highland Ave. Hollywood 38, Calif.	LONDON, ONTARIO	G. L. Foster Sparton of Canada, Ltd. London, Ont., Canada
	LOS ANGELES February 18	Walter Kenworth 1427 Lafayette St. San Gabriel, Calif.

Chairman

L. W. Butler
3019 N. 90 St.
Milwaukee 13, Wis.

J. C. R. Punchard
Northern Electric Co.
1261 Shearer St.
Montreal 22, Que., Canada

J. T. Cimorelli
RCA Victor Division
415 S. Fifth St.
Harrison, N. J.

L. R. Quarles
University of Virginia
Charlottesville, Va.

D. W. R. McKinley
211 Cobourg St.
Ottawa, Canada

Samuel Gubin
4417 Pine St.
Philadelphia 4, Pa.

W. E. Shoupp
911 S. Braddock Ave.
Wilkesburg, Pa.

Francis McCahn
4415 N.E. 81 St.
Portland 13, Ore.

A. E. Newlon
Stromberg-Carlson Co.
Rochester 3, N. Y.

S. H. Van Wambeck
Washington University
St. Louis 5, Mo.

David Kalbfell
941 Rosecrans Blvd.
San Diego 6, Calif.

E. H. Smith
823 E. 78 St.
Seattle 5, Wash.

H. S. Dawson
Canadian Association of
Broadcasters
80 Richmond St., W.
Toronto, Ont., Canada

M. E. Knox
43-44 Ave., S.
Minneapolis, Minn.

F. W. Albertson
Room 1111, Munsey Bldg.
Washington 4, D. C.

W. C. Freeman, Jr.
2018 Reed St.
Williamsport 39, Pa.

K. G. Jansky
Bell Telephone Laboratories,
Inc.
Box 107
Red Bank, N. J.

C. W. Mueller
RCA Laboratories
Princeton, N. J.

A. R. Kahn
Electro-Voice, Inc.
Buchanan, Mich.

W. A. Cole
323 Broadway Ave.
Winnipeg, Manit., Canada

MILWAUKEE

MONTREAL, QUEBEC
March 12

NEW YORK
March 5

NORTH CAROLINA-VIRGINIA

OTTAWA, ONTARIO
February 20

PHILADELPHIA
March 6

PITTSBURGH
March 10

PORTLAND

ROCHESTER
February 20

ST. LOUIS

SAN DIEGO
March 4

SAN FRANCISCO

SEATTLE
March 13

TORONTO, ONTARIO

TWIN CITIES

WASHINGTON
March 10

WILLIAMSPORT
March 5

SUBSECTIONS

MONMOUTH
(New York Subsection)

PRINCETON
(Philadelphia Subsection)

SOUTH BEND
(Chicago Subsection)
February 20

WINNIPEG
(Toronto Subsection)

Secretary

E. T. Sherwood
9157 N. Tennyson Dr.
Milwaukee, Wis.

E. S. Watters
Canadian Broadcasting Corp.
1440 St. Catherine St., W.
Montreal 25, Que., Canada

J. R. Ragazzini
Columbia University
New York 27, N. Y.

J. T. Orth
4101 Fort Ave.
Lynchburg, Va.

W. A. Caton
132 Faraday St.
Ottawa, Canada

A. N. Curtiss
RCA Victor Division
Bldg. 8-9
Camden, N. J.

C. W. Gilbert
52 Hathaway Ct.
Pittsburgh 21, Pa.

A. E. Richmond
Box 441
Portland 7, Ore.

K. J. Gardner
111 East Ave.
Rochester 4, N. Y.

N. J. Zehr
1538 Bradford Ave.
St. Louis 14, Mo.

Clyde Tirrell
U. S. Navy Electronics Labo-
ratory
San Diego 52, Calif.

F. R. Brace
955 Jones
San Francisco, Calif.

W. R. Hill
University of Washington
Seattle 5, Wash.

C. J. Bridgland
Canadian National Telegraph
347 Bay St.
Toronto, Ont., Canada

Paul Thompson
4602 S. Nicollet
Minneapolis, Minn.

G. P. Adair
Federal Communications
Commission
Washington 4, D. C.

S. R. Bennett
Sylvania Electric Products,
Inc.
Plant No. 1
Williamsport, Pa.

Lloyd Hunt
Bell Telephone Laboratories,
Inc.
Box 107
Deal, N. J.

A. V. Bedford
RCA Laboratories
Princeton, N. J.

A. M. Wiggins
Electro-Voice, Inc.
Buchanan, Mich.

C. E. Trembley
Canadian Marconi Co.
Main Street
Winnipeg, Manit., Canada

Books

III—Tube Comparison Chart, 19 pages, some 4000 types; IV—Tube Replacement Chart, 10 pages, about 1900 types; V—Tube Sockets, 689 diagrams; VI—Russian Tubes, 5 pages, 130 types; VII—Allied Army Tubes covering British Army, Navy, and Air Force designations; with a separate section on commercial designations corresponding to the old United States Signal Corps designations; and VIII—German Army and Italian Army Tubes, 8 pages, 147 types.

The emphasis is primarily on small tubes, particularly those for receiving purposes. No information on cathode-ray tubes is included and although some transmitting tubes are covered, they are, in general, low-power types. The book, which is now in its sixth edition, is evidently intended chiefly to assist the European serviceman who is faced with a stupendous task of identifying tube types. In this country, for those interested in examining trends in foreign-tube characteristics or, more especially, in servicing the many foreign-made receivers imported by returning veterans, the book is a convenient and helpful reference. The editor has brought together, in a single volume, material from a large number of sources not ordinarily available here. The presentation, of course, follows European practices but these should not prove difficult for those familiar with tube terminology, although it is well to remember that slope (S) expressed in milliamperes per volt has to be multiplied by 1000 to convert it to transconductance in micromhos.

R. S. BURNAP
RCA Victor Division
Radio Corporation of America
Harrison, New Jersey

Two-Way Radio, by
Samuel Freedman

Published (1946) by Ziff-Davis Publishing Co., 350 Fifth Avenue, New York 1, N. Y. 468 pages+38-page index+xxii pages. 128 illustrations. 6½×9½ inches. Price, \$5.00.

A review of the basic methods of point-to-point communication, including descriptions of the equipment that is prevalently used in the particular fields, and the frequencies that are used, operating ranges, power requirements, antenna systems, and licensing details.

The book describes and covers both mobile and fixed stations, amplitude- and frequency-modulation equipment, low-frequency induction radio, and guided carrier systems. Various types of applications are covered, such as railroads, police, fire, forestry, highway, and public transportation, marine, aeronautical, and personalized uses.

Chapters are devoted to the selection of portable and mobile power sources and to the problems of maintenance and repair. The book as a whole provides an excellent review of the field of special purpose communications.

RALPH R. BATCHER
Caldwell Clements
New York, N. Y.

Books

Radar—What It Is, by John F. Rider and G. C. Baxter Rowe

Published (1946) by John F. Rider, Inc., 404 Fourth Ave., New York 16, N. Y. 80 pages. 63 illustrations. 8½×11 inches. Price, \$1.00.

As indicated by its title, the book probes the mysteries of radar for the average non-technical reader. This purpose is served so well as to render it of little interest to the student of engineering, for whom it certainly was not intended. Most noticeable among the characteristics so classifying this work is its repetitious style, which is designed to penetrate the most reluctant comprehension.

Not only are the scientific mysteries of radar denuded of all appearance of technicality, but representative equipments of nearly all classes of radar are briefly described, and some appreciation of the significance of the part played by radar in World War II is given, particularly as related to its employment by the United States Army and the Army Air Forces. An attempt to give similar coverage of United States Navy radar falls somewhat short of the apparent goal, particularly in regard to naval fire-control radar.

For the nontechnical reader the book should prove to be very readable, as well as profitable reading. To this end it is enhanced by excellent illustrations, and after most of the text is forgotten, the little man with a horn and a stopwatch will remain to haunt the memory with every mention of the word "Radar." It is a new book, well organized and consistent within itself, and although it may sometimes outrage the sensibilities of the technical perfectionist, it should be quite successful in creating in its intended readers a feeling of mastery of the subject of radar, with all its bewildering terminology. It is as up to date as can be permitted by a still war-conscious military censorship.

ROBERT M. PAGE

United States Naval Research Laboratory
Washington 20, D. C.

DR. DELLINGER I.R.E. REPRESENTATIVE

At the November 6, 1946, meeting of the Board of Directors it was recommended and unanimously approved that Dr. J. H. Dellinger be reappointed as Institute Representative for the American Documentation Institute, Inc.

CANADIAN CIVIL SERVICE MEDAL

The second 1946 medal of the Professional Institute of the Civil Service of Canada has been awarded to the workers of the radio branch of the National Research Council, as a group. The first of these medals was awarded Walter A. Rush, a member of the Professional Institute.

Electrical Engineering, by Fred H. Pumphrey

Published (1946) by Prentice-Hall, Inc., 70 Fifth Ave., N. Y. 359 pages+9-page index+xiv pages. 259 illustrations. 6½×9½ inches. Price, \$5.35.

This is one of the Prentice-Hall Electrical Engineering Series, edited by W. L. Everitt, and is written to provide a textbook in electrical engineering for students specializing in other fields.

The first half of the book is intended to furnish the basic theory for the understanding of the applications illustrated in the latter half.

The theoretical foundation material includes such a wide range of subjects as the fundamentals of direct-current circuits and elementary alternating-current theory, the essentials of direct-current and alternating-current generators and motors, and the basic electronic-tube principles. To compress so much into a compass of only two-hundred pages is no mean accomplishment, and the author is to be congratulated on his choice of material and the clearness and conciseness of his treatment.

The latter half of the book on the applications of the theory covers such diverse fields as electric heating, welding, electrochemical processes, electric-motor applications, illumination, electrical methods of industrial measurements, power economics, and maintenance and electric communication.

In this part of the book the basic principles are well emphasized, but in some instances the explanation of the illustrative material lacks detail. Particularly is this true in the comments on the photographs. The author is too much handicapped by limitations of space. It may well be urged that such a large subject as electrical communication can not be adequately treated in such a survey.

This latter half of the book, however, may well serve as foundation material in a course where the instructor is prepared to amplify on this foundation.

FREDERICK W. GROVER
Union College
Schenectady, N. Y.

Personality and English in Technical Personnel, by Philip B. McDonald

Published (1946) by D. Van Nostrand Co., Inc., 250 Fourth Ave., New York, N. Y. 424 pages+viii pages. 5½×8½ inches. Price, \$3.75.

The scope of this excellent book includes two closely related subjects. While the entire 424 pages of text are directed to engineering students and to young engineers in their early years of employment in industry, throughout the work there is a clearly presented program of study designed to improve English writing and speaking. Young engineers are vitally interested in procuring and holding jobs. In this book engineers whose progress or lack of progress is discouraging may discover surprising reasons for the frustration and failure experienced.

Professor McDonald catalogs the pitfalls of loose economic thinking and, for young engineers, emphasizes the virtues of open-mindedness, objective thinking, and individual initiative. Where formal education appears at fault the author does not spare the instructors, believing that teachers do not often enough drill students in recognizing similarities as distinguished from differences, especially in research.

For the needs of a rounded education the author does not only identify books for study, but tells what the books contain, presenting the material in its humanistic aspect. Recognizing that there is a vast present need for improvement in writing and speaking ability the author incorporates in his book several chapters containing sound advice. This is a new book, is very readable and up to date. The decision not to include an index may have been warranted in a book essentially in the nature of a series of lectures but there are so many valuable historical facts of science presented to which readers will desire to refer later, that this lack is sensed, when, having finished the book, the reader places it among his reference works.

DONALD MCNICOL
25 Beaver St.
New York 4, N. Y.

DELAYS MAY OCCUR— PLEASE WAIT!

It is intended that the PROCEEDINGS OF THE I.R.E. shall reach its readers approximately at the middle of the month of issue. However, present-day printing and transportation conditions are exceptionally difficult. Shortages of labor and materials give rise to corresponding delays. Accordingly, we request the patience of our PROCEEDINGS readers. We suggest further that, in cases of delay in delivery, no query be sent to the Institute unless the issue is at least several weeks late. If numerous premature statements of nondelivery of the PROCEEDINGS were received, the Institute's policy of immediately acknowledging all queries or complaints would lead to severe congestion of correspondence in the office of the Institute.

SUBJECT FOR CONVENTION TECHNICAL SESSION

At the November 6, 1946, meeting of the Board of Directors, Dr. Everitt moved to accept the Executive Committee's recommendation that one of the technical sessions of the 1947 National Convention cover the subject, "The Professional and Social Status of Engineering," under the following titles: Liberal Education of the Engineering Profession, Opportunities for the Young Engineer, and the Relation of the Engineering Professional to Science and Industry. The recommendation was unanimously approved.

RADIO CONTRIBUTIONS TO AIRPLANE GUIDANCE

In connection with a recent series of demonstrations given in Indianapolis before an international group of representatives of the aviation industry, W. L. Webb (A'35-SM'44), director of engineering and research of the Bendix Radio Division of the Bendix Aviation Corporation, spoke on the timely topic of "Toward Safe and Automatic Flight." The technical substance of Mr. Webb's discussion follows: "It is my intention to present a philosophy regarding the use and development of systems for radio aids to air navigation. These lead to the eventual *manual, or automatic, flight and control of an aircraft from one landing point on an airfield to the landing point on another airfield.* We all know that this must be accomplished before air travel will be safe and on schedule. *Without safety and without schedules* being maintained, air travel cannot become the industry that it should be. I should like to call my philosophy 'the building-block philosophy.' Many new kinds of navigation and flight control equipment have been developed in the past few years. These equipments represent the *building blocks* from which new systems will be built and upon which new operational procedures will be based.

"Technically all of the necessary building blocks for a number of satisfactory systems are known and available. For many reasons, but primarily the *economic* one, it will not be *possible to adopt and use a completely new over-all system.* The operation and engineering direction of my firm is based upon this philosophy.

"It is our opinion that the navigation and control of aircraft will not be revolutionized in any predetermined period by the adoption and concurrent development of a completely new system. Rather, there will be *orderly progress* through improvements and additions to systems now in use. This has been true in most industries in the past.

"Orderly change and improvement will be accomplished by the assembly of new building blocks into systems, which as ideas are not completely new. In each period such improvement is never accomplished earlier because some of the necessary devices were missing. Many methods and inventions to accomplish automatic flight, instrument landing, air-traffic control, and navigation of aircraft, have been known for years. But practical systems could not be developed because of missing building blocks. Automatic and continuous indication of position in flight and ideas for accomplishing it are not new. It has been *only recently* that the *proper devices* have become available to allow the development of an operable system.

"Examples of what we choose to call the building blocks for a system which you may decide upon are such equipments as the *automatic direction finder, distance-measuring equipment, radio ranges of all types including localizers, glide path, hyperbolic systems, remote indicating magnetic compass, radar, ground radar, and responder beacons.* Certain data are needed for the navigation of an aircraft. Each of the building blocks furnishes a part of these data or assists in furnishing it.

"The automatic direction finder furnishes, first, an easily interpreted indication of the location of a reference point such as a radio station, relative to the heading of the aircraft. The relative bearing of the automatic direction finder when combined with the heading of the aircraft gives an indication of *track, heading, and relative bearing*



W. L. WEBB

on a *single* indicator. Such a combined indicator is very desirable and useful and is another of the building blocks. The idea for constructing and using such an indicator is not new. But stable remote indicating magnetic heading equipment was not available as another building block until recently.

"The *omnidirectional range* is another of the building blocks which furnishes track data in the form of an azimuth angle. The DME furnishes distance to a reference point. With track and distance the position of the aircraft is known.

I. R. E. MEMBERS ON JOINT COMMITTEE OF NAB AND RMA

Closer co-operation on major radio problems, including the development of new frequency-modulation and television services is the objective of a new joint committee established by the National Association of Broadcasters and the Radio Manufacturers Association. The committee includes T. A. M. Craven (F'29), W. R. G. Baker (A'19-F'28), Walter Evans (M'36-SM'43-F'45), and E. A. Nicholas (A'16-SM'46).

PROSPECTIVE AUTHORS

The Institute of Radio Engineers has a supply of reprints on hand of the article "Preparation and Publication of I.R.E. Papers" which appeared in the January, 1946, issue of the PROCEEDINGS OF THE I.R.E. AND WAVES AND ELECTRONS. If you wish copies, will you please send your requests to the Editorial Department, The Institute of Radio Engineers, Inc., 1 East 79 Street, New York 21, New York, and they will be sent to you with the compliments of the Institute. It would be greatly appreciated if your requests were accompanied by a stamped, self-addressed envelope.

"Another building block which can be added to the omnirange and DME is a *computer* to furnish heading and track data. It permits flight on any predetermined off-set track automatically.

"Colonel Cutrell's now famous seventeen months of actual operation of the Army All-Weather Route in New England is well known. He had no system as such. He used two nondirectional beacons with his aircraft automatic direction finders. Localizer and glide path (SCS 51), and GCA were used complement one another. Finally, high-intensity runway lights and approach lights were provided.

"Of 206 approaches with ceilings less than 200 feet and/or visibility less than one half mile, there were 167 successful landings made. The remaining 39 missed approaches, entirely due to dense ground fog, could undoubtedly have been finished if one more building block had been provided. This is fog dispersal equipment such as Fido.

"However, this does not solve the problem by any means as all aircraft cannot be so equipped and *operational procedures and techniques must be developed* to obtain scheduled, safe, and rapid movement of all types of air traffic. In my opinion, the problem of air-traffic control for a large volume of air traffic in congested areas is the most difficult of all. *Not only must the scheduled, well-equipped, and well-disciplined airliners be controlled, but the undisciplined, meagerly equipped, small, slow aircraft must be controlled,* in such a way that there are no delays in any kind of weather and collisions are prevented. The actual adoption or use of any system must of necessity be influenced by economic considerations. In other words, even though an ideal and practical completely new system were proposed today, it would be impossible for the industry to agree today that, say, five years from now, the new system would go into effect and all old equipment would be obsoleted and replaced. *This would be impossible for at least two reasons.* First, because of *cost,* second, *by the time the agreed upon time was reached many new developments* would be available which would make the agreed upon system obsolete. Rather, I shall repeat: There must be an orderly progress through improvements and additions to systems already in use.

"It is my sincere hope that all of us can contribute in some way to the solution of the most difficult problem of all. This is the safe control of aircraft of all types at various speeds in the vicinity of highly congested areas.

"*We do not propose* that flight and control of aircraft be made *completely automatic* even though it is technically possible. Rather, each phase of the over-all problem should be solved in the best way possible. This must take into consideration *not only safety and schedules but also the economy* of the operation. Many jobs can be done more safely and economically by trained and skilled human beings. But others can be done more precisely and safely by automatic equipment. In all cases the best method will be selected consistent with profitable operation. Such a system will bring about a large volume of safe and economical air travel."

THE INSTITUTE AND THE RADIO INDUSTRY

At the Rochester Fall Meeting, W. R. G. Baker (A'19-F'28), president of The Institute of Radio Engineers, director of engineering of the Radio Manufacturers Association, and vice-president in charge of electronics of the General Electric Company, addressed a session on the nature and magnitude of the accomplishments of the radio-and-electronic field, and the normal relationships and scopes which he deemed appropriate for The Institute of Radio Engineers and the engineering department of the Radio Manufacturers Association. Dr. Baker's comments are of such fundamental and instructive nature that they are here presented: "Today radio is just half as old as the automobile. It is 25 years old. In a very real and specific way radio and the automobile have complemented each other. For the past 25 years these two products of American ingenuity and enterprise have expanded the horizon and raised the sights of millions of people throughout the world. They have torn down the barriers of distance, language, and custom. They have made it possible for people thousands of miles apart to know and understand each other. Today some 20,000,000 American families own at least one automobile. Today some 34,000,000 families own at least one radio receiver. Today more than 8,000,000 automobiles are equipped with radio receivers.

"To have compressed such great advances into the span of one lifetime is most certainly a great accomplishment. I suppose we should like to flatter ourselves by thinking that this great progress was due to some element of genius peculiar to the modern mind. Actually such progress is so rapid—only 25 years for the radio industry—that the true reason seems to me to be that we no longer wait on genius. Instead we put our faith in the organized efforts of just ordinary men.

"I want particularly to call your attention to the words 'organized efforts of just ordinary men' for the subject I want to discuss is that of engineering associations. I especially want to consider the functions and relations of the two associations with which we as engineers are concerned—I.R.E. and R.M.A.

"Let us attempt to find an analogy which will illustrate, perhaps somewhat crudely, the basic relations between these organizations. Industrial organizations generally have large research departments and a multiplicity of what we may term product-design departments. Now there are probably as many types of research organizations as there are directors of research. In fact the word research itself can be interpreted to have a multiplicity of meanings. In general, however, a research organization seldom, if ever, produces ideas, products, or anything else which can be sold directly to the consuming public. It is never confronted with the question of whether the product is in such a form as to take its place along with similar products of competitive manufacture in a system already rendering a service to the consuming public. The research laboratory is freed from any system

consideration. It and its members can, are, and probably should be individualistic. They are perhaps explorers who cut, to suit themselves, the path to new knowledge, leaving to the product engineers to see that the path is widened into a road suitable to take its place in a system and capable of carrying the vehicles and loads necessary to serve the public.

"A research department, we may say, is founded on an organization of individualism. It is seeking the new knowledge—that type

Minutes of Technical Committee Meeting

MODULATION SYSTEMS

Date.....November 1, 1946
Place.....McGraw Hill Building
New York, New York
Chairman.....M. G. Crosby

Present

M. G. Crosby, *Chairman*

R. A. Berg	D. M. Hill
H. S. Black	V. D. Landon
F. L. Burroughs	B. D. Loughlin
C. C. Chambers	C. T. McCoy
W. F. Goetter	Bertram Trevor
D. D. Grieg	William Tuller

J. W. Wright

The name of this committee was changed from "Technical Committee on Frequency Modulation" to "Technical Committee on Modulation Systems." The next business was the assignment of various magazine publications to individual committee members for study and selection of information for the yearly progress report. Following this there was a detailed discussion of the list of modulation definitions as submitted by the subcommittee on pulse definitions. It was suggested that the definitions as given may be at variance with certain past usage, such as in National Defense Research Council work or in foreign circles. It was therefore agreed that the subcommittee meet before the next meeting of the main committee for reconsideration of the pulse-modulation definitions and the other modulation definitions which were set aside.

NATIONAL ELECTRONICS CONFERENCE

At the conclusion of the 1946 National Electronics Conference in Chicago, W. O. Swinyard (A'37-M'39-SM'43-F'45), president, announced that plans were being laid to hold the 1947 conference at the Edgewater Beach Hotel probably during the first week in November.

Members of the management group for the 1946 conference included Dr. J. E. Hobson (M'45), chairman of the board of directors; Professor E. H. Schulz (A'38-SM'46), secretary; and Professors A. B. Bronwell (A'39-SM'43), and R. E. Beam (S'37-A'41-SM'44), vice-presidents.

Cosponsors of the 1946 conference were Illinois Institute of Technology, Northwestern University, University of Illinois, and the Chicago Sections of The Institute of Radio Engineers and the American Institute of Electrical Engineers. The Chicago Technical Societies Council co-operated in the sponsorship.

of knowledge and idea which is generated only by individuals. I suppose we might cite as examples the work of the great physicists—such as Rutherford, Compton, and Millikan.

"I.R.E. is individualistic; that is, the engineer represents himself only and not his company. Because in I.R.E. the engineer is the unit, he pays his own way. The I.R.E. is the vehicle whereby the individual is kept abreast of the technological advances in his chosen profession. It is the vehicle whereby the engineer as an individual tells his profession what he has done to advance the art—what paths to new knowledge he has cut through the unknown.

"I.R.E. is his association.

"I like to look upon the engineering department of R.M.A. as an organization of engineers specializing in conversion. By this I mean the conversion of abstract technical advances into a higher standard of living, and the conversion of the ideas of individuals into products suitable for mass production. This naturally includes the conversion of a 25-year-old idea so that today at least 34,000,000 families own at least one radio receiver.

"In the engineering department of R.M.A., the engineer is acting as the representative of his company and therefore the company pays. Some individualism is retained, but basically the viewpoint of the engineer must sweep a wider horizon, a horizon which includes at least one element of not too much importance to the individualistic research worker... an innocent-looking piece of paper on which the figures must be black—a profit-and-loss statement.

"To illustrate the fundamental difference between these two organizations, let us assume that in order to commercialize a system such as television there is needed the agreement of the industry on a suitable intermediate frequency. Problems such as these affect all of the companies in the industry.

"In the first place, commercialization cannot take place unless such an agreement is reached, and second, the cost of the product may be influenced by the decision. This, then, requires co-ordinated action by the engineers representing these companies. These engineers as individuals may all start with a different idea, but they know that the end result must be agreement arrived at either through a compromise acceptable to all concerned or an industry acceptance based on the rule of the majority. In theory at least, in such instances the needs of the industry predominate over the individual.

"Certain facts are crystal clear. There is no basis for misunderstanding or competition between these organizations. Both have great and important responsibilities and clearly delineated fields of operation. In every way these two organizations are truly complementary and must remain so if the maximum end result—better service to the public—is to be achieved.

"The Institute of Radio Engineers is the professional society for the engineers of our industry.

"Perhaps one might say that the Radio Manufacturers Association Engineering Department is the 'practical' society for a large portion of the same engineers."



Theodore A. Hunter

Chairman, Cedar Rapids Section, 1946–1947

Theodore A. Hunter (A'45–M'45–SM'46) was born December 5, 1900, at Dike, Iowa. He received the B.S. degree in electrical engineering from the University of Iowa in 1923, the M.S. degree in physics in 1924, and the professional E.E. degree in 1931.

While attending college, Mr. Hunter took an active part in campus pioneer radio work, and he also engaged in early work on extremely high-gain amplifiers for nerve-current measurements and other medical work. Having spent some time as research assistant in varied fields, he has published numerous articles. After leaving college, Mr. Hunter became a transmission-line inspector for the Northwestern Bell Telephone Company, and later joined the Crosley Radio Corporation to supervise loudspeaker development. He then served as an instructor at the University of Pittsburgh for a time, and later, for several years, at the Rose Polytechnic Institute.

Following a period of semiretirement, during which he engaged in consulting work with police radio systems, he became associated with the Collins Radio

Company at Cedar Rapids, Iowa, in 1940. There he developed the Navy Model TCS series transmitter, one of the mainstay mobile transmitters used by the Allies. Later, Mr. Hunter became interested in the design and construction of extremely stable master oscillators, and has achieved remarkable results in this field. He has written articles on the subject and presented papers dealing with oscillators before several of the I.R.E. sections. He is at present continuing this work in addition to supervising the development of amateur radio equipment being produced by the firm.

Mr. Hunter is a member of Sigma Xi, a past member of the American Physical Society, and a member of the Iowa Engineering Society. During the year 1944, he became the prime mover behind the formation of the Cedar Rapids Section of The Institute of Radio Engineers. He is primarily responsible for the rapid growth and solid organization of this section, of which he is now Chairman. He enjoys the unusual distinction of being one of the few, if not the only member of the Institute, who is a charter member of more than one section.

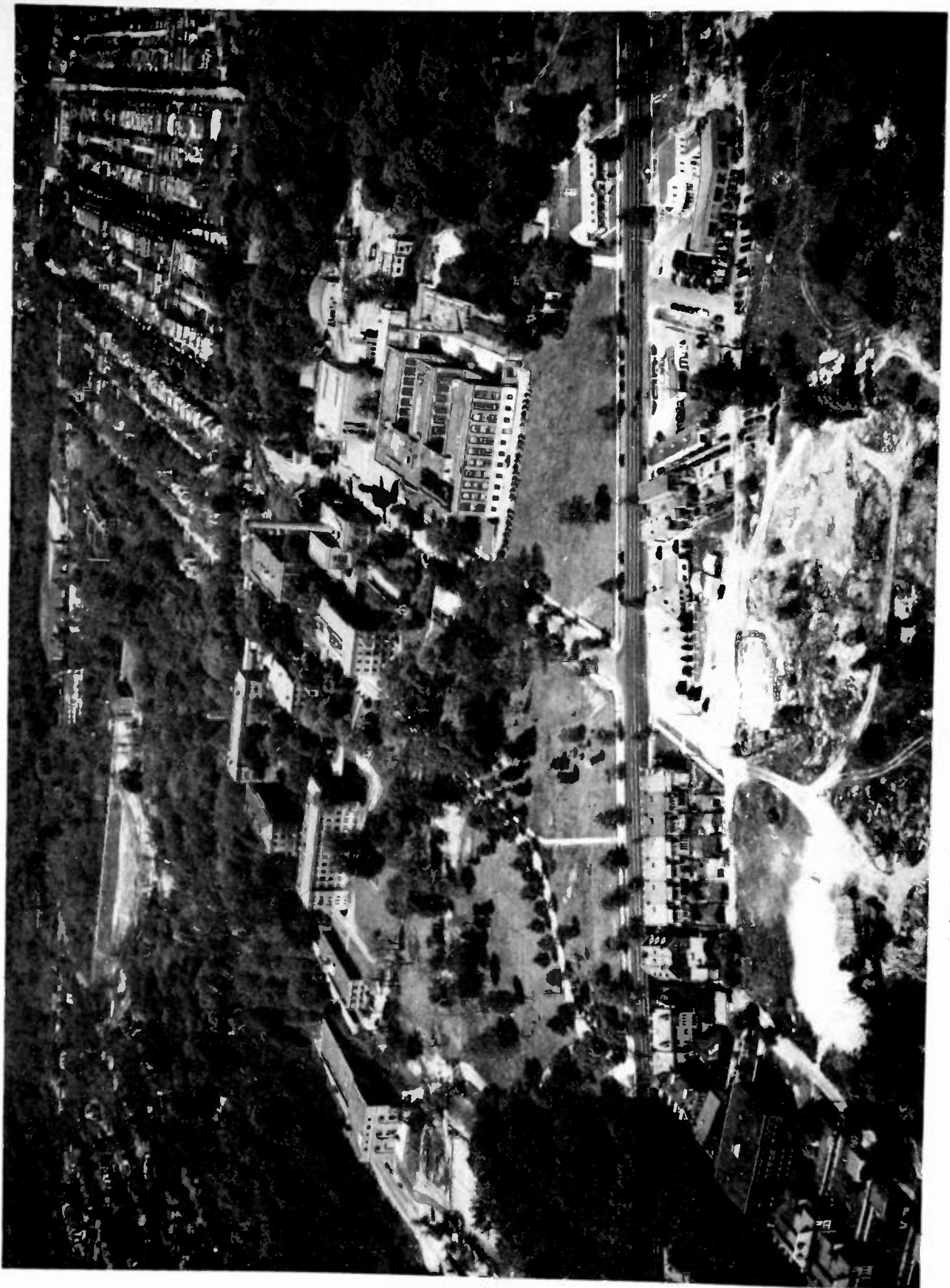

Army Air Corps

A NATIONAL RESEARCH AND STANDARDIZING LABORATORY

The laboratory of the National Bureau of Standards, located at Washington, D. C., provides basic standards of measurement in many fields, and houses numerous Federal research projects.

Radar Development in Canada*

FREDERICK H. SANDERS†

Summary—A very brief outline is given of early developments in the radar field up to the time of the arrival of the Tizard mission in the United States in 1940. Descriptions are given of early radar development in Canada, followed by a brief outline of sets developed later by the National Research Council and produced by Research Enterprises Limited.

INTRODUCTION

THE WORK of the early pioneers in the radar field, both in Great Britain and the United States, has had much publicity, and it is not the purpose of this paper to repeat it in any detail. To the question, "Who was the first in the radar field?" the only true answer is that many workers in many different fields contributed to the present advanced state of the art. The use of bursts of energy for distance measurement dates back at least as far as the "toothed-wheel" experiment of Fizeau and has been used extensively in the acoustic field for many years. Pilots of ships have been feeling their way through fog for generations by the use of blasts from their foghorns. The ultrasonic depth sounder and submarine detector are modern adaptations of this basic acoustic method. The work of Appleton on the measurement of ionospheric heights and that of Breit and Tuve on radio pulses were all-important steps in the development of radar technique.

the British, the extreme vulnerability of the British Isles to air attack lent impetus to the adoption of the system by the military authorities. We know now that as early as 1933 the British research group could not only detect aircraft at considerable distances through darkness, cloud, fog, etc., but, what is vastly more important, that they could determine accurately the location of an unknown aircraft in three dimensions under these conditions.

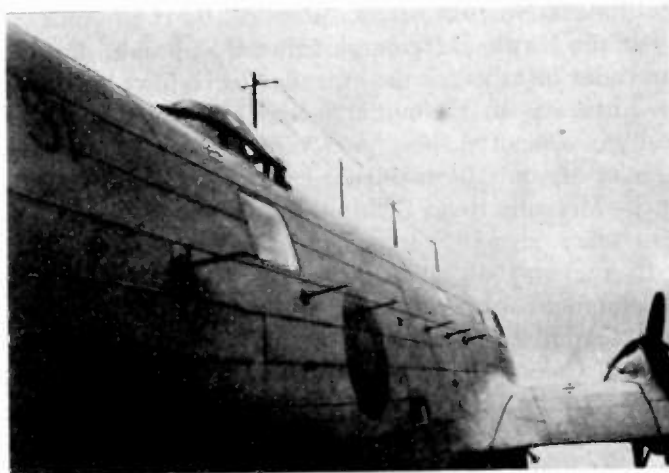

Fig. 2—Long-range ASV antennas installed on Royal Canadian Air Force aircraft in 1941.

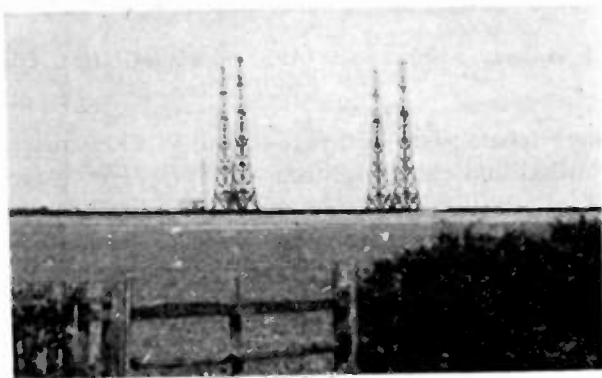

Fig. 1—CH towers in England. This view is mainly of historical interest, since it was taken early in 1939.

In the period preceding the war both British and American workers were independently pursuing approximately the same techniques at about the same time. In Great Britain it was Watson Watt and his Radio Research Board group who pressed radar, or RDF, development so successfully, while in the United States both Navy and Army laboratories were developing similar devices for specific applications. In the case of

In the period intervening between 1934 and war, both the development and production of this new weapon were pursued intensively, with the result that by 1939 Britain had a fairly extensive chain of long-range warning stations along her coasts. As is now well-known, it was these "Chain Home" or CH stations which were later to foil Hitler's plans for the smashing of Britain by providing advance warning to the Royal Air Force, so that Churchill's famous "few" were always off the ground and waiting when the Luftwaffe arrived. It is perhaps not so well known that the British had many other types of radar for air, ground, and naval use developed and, in many cases, in substantial production. These included "ASV" for the detection of ships from patrol aircraft, "AI" for intercepting enemy fighters, "GL" for directing heavy anti-aircraft batteries, "CD" for coast-defense fire control, and "IFF" for identification. These sets all operated at wavelengths which, by modern radar standards, were relatively long and in consequence somewhat limited in their application and effectiveness. They nevertheless played important parts in the early phases of the war.

EARLY DEVELOPMENTS

In early 1939, at the invitation of the British Government, Canada sent a group from the National

* Decimal classification: R537. Original manuscript received by the Institute, December 28, 1945; revised manuscript received, October 23, 1946.

† National Research Council, Ottawa, Ontario, Canada.

Research Council and the Royal Canadian Air Force to learn of a new and "most secret" weapon. Soon after the return of this group—actually before the declaration of war—the Services and the National Research Council had preliminary plans laid for the adaptation of radar to the defense of Canada.

On its radio program the National Research Council started in with four scientists and a half-dozen technicians—a group which was finally to grow to well over two hundred. Two main avenues of approach were undertaken: first, the construction of specific sets for the Royal Canadian Air Force and the Canadian Army; second, the development of high-frequency radio techniques and the modification of British constructional methods to North American practice. By the summer of 1940, the National Research Council had an all-Canadian radar installed at the entrance to Halifax harbor as an auxiliary to the underwater detecting devices already in operation. Many new circuits had already been developed, and 10-centimeter equipment was operating at the Metcalfe Road Field Station as early as March of that year.

In August, 1940, a landmark in North American radar development was established by the arrival of the Tizard Mission. This was a group which included Sir Henry Tizard, Colonel F. C. Wallace, J. D. Cockcroft, R. H. Fowler, and others. The importance of this visit was as follows:

(1) It marked the beginning of a pooling of British and American knowledge of the art. Britain contributed some revolutionary devices, such as the cavity magnetron and the "micropup" pulsed triode, plus a vast store of practical operational experience. The United States had the radar knowledge of the Naval Research Laboratory and Camp Evans Signals Laboratory, plus such outstanding figures in high-frequency research as Southworth and Friis of Bell Telephone Laboratories, Barrow of the Massachusetts Institute of Technology, Hansen, the Varians, and many others.

(2) A "Radiation Laboratory" was to be established at the Massachusetts Institute of Technology, an institution which was to expand until ultimately over 2000 workers were engaged in microwave research and development.

(3) The British were to obtain the aid of the United States' vast mass-production capacity.

(4) From the Canadian viewpoint it marked the start of a really large radar effort, as the British asked specifically for the National Research Council to develop—and Canada to build in quantity—a new anti-aircraft set for the defense of Britain. As a result, the newly formed Crown company, Research Enterprises, Limited, intended originally to build only optical equipment, was expanded in scope to take care of radar manufacture in Canada.

A brief deviation from general history seems desirable to cover the two first projects undertaken in Canada for the British, as these served to pave the way for Can-

ada's later extensive radar contribution. The first was the anti-aircraft fire control or GL set referred to above; the second, an air-to-surface-vessel or ASV set requested at approximately the same time.

The British had already in operation certain anti-aircraft fire-control sets known as GL Mk. I and GL Mk. II. These were mobile Army units, designed to provide accurate data for the use of heavy anti-aircraft batteries. They provided very good range data, but because of their relatively low frequencies, 50 to 70 megacycles, their bearing accuracies were mediocre and their elevation data quite unreliable. It was obvious that a set having highly directional antenna beams was required and, since the set had to be mobile, this meant a very high radio frequency, probably in the thousands of megacycles. The General Service specifications called for



Fig. 3—Accurate-position-finder (APF) unit of the GL III C, taken at Leaside in early 1942.

a range accuracy of ± 50 yards up to 18,000 yards, with azimuthal and elevation accuracies of $\pm \frac{1}{4}$ of 1 degree. This information was to be provided smoothly so that it could be used by existing mechanical anti-aircraft predictors and, in addition, the set was to provide its own early warning up to 60,000 yards or so.

The British cavity magnetron, which had been brought over by Wallace and Cockcroft of the Tizard Mission, together with the Bell Laboratories silicon-crystal mixer gave promise of a 10-centimeter radio-frequency system, but not even the British were prepared to say what antenna gains were required or what ranges, if any, were attainable with 10-centimeter radiation. As a result of Cockcroft's general outline of requirements, given in October, 1940, the Canadian GL—christened the GL III C—was started immediately. Certain definite decisions had to be made at once in order to get manufacture of the larger mechanical components in motion.

Since nothing was known then about the feasibility of putting microwaves through a rotating joint, it was decided that the accurate-position-finder or APF unit would consist of a power-driven rotatable cabin housing

all the radio gear and supporting the antennas. The early-warning or zone-position-indicator unit (ZPI) was chosen as a 175-megacycle unit in a fixed trailer with rotatable antenna. Two heavy trucks for towing purposes and for housing the Diesel power unit, cables, spares, etc., completed the convoy. These mechanical



Fig. 4—Zone-position-indicator (ZPI) unit of the GL III C, taken at Leaside in early 1942.

features "froze" much of the design before the end of 1940, and before the New Year the radio designers were at work on the development of transmitter, receiver, antennas, transmission lines, sweeps, displays, integrators, electromechanical controls, etc. The story of the next few months is one of alternating pessimism and optimism. At times it was highly doubtful if the 10-centimeter frequency would give the desired ranges. Very close contact was maintained with the Radiation Laboratory, whose staff were getting equally uncertain results at 10 centimeters. A great deal of the work was of necessity carried on in the open fields of the Metcalfe Road Station during the rigors of an Ottawa winter. Frozen ears and stalled cars added spice of a sort. By March, however, it was definitely established that a Lockheed Hudson aircraft could be followed to 20,000 yards and the GL III C became definitely a microwave radar—the first of its type to be mass-produced in the world.

A successful demonstration of the complete GL convoy was staged in June, 1941, for Canadian, British, and United States Services—a bare seven months after the first statement of detailed requirements. In December a second set was ready and was taken to England by National Research Council personnel. On the production end, Research Enterprises Limited engineers were working feverishly and had a number of production prototype sets ready for field trials early in 1942.

In the case of the ASV, the requirement was to produce a set completely interchangeable with the British model without drawing in any way on Britain's precious stock of supplies or components. Working only from sketches made during the one-half day in late 1940 that a British prototype was available to them, Research Enterprises Limited engineers developed the required set using North American components almost exclusively. To provide the essential British-type components, such as the VT90 transmitting tube, low-loss "telcothene" cables, special Royal Air Force connectors, etc., Canadian component manufacturers were called in and shortly were producing the required parts. A Research Enterprises Limited prototype of the set was ready in February, 1941, and by the early summer production models were being shipped. Some of these early models were rushed to the United States to serve as prototypes for United States manufacturers, and the well-known Philco ASE (Army SCR 521) was a close reproduction of the Research Enterprises ASVC or "RA."

During the period immediately following the completion of the laboratory GL III C prototypes, the National Research Council radio group expanded rapidly and was reorganized early in 1942 as the Radio Branch. The staff was divided into groupings for specific development projects, and Navy, Army, and Air Force subdivisions were established.

NAVAL RADAR

Following several early search sets operating in the 200-megacycle region, the Navy group developed, at



Fig. 5—The main rack and remote PPI of the RXF/268.

very short order, a 10-centimeter shipborne search radar very similar to the British Admiralty pattern 271 set. This was manufactured on a small scale for the Royal Canadian Navy. It was succeeded by a 3-centimeter search set, the RXF/268, requested by the British Admiralty. This set was another instance where the

British placed full reliance on Canadian development and gave National Research Council and Research Enterprises Limited full responsibility for developing an essential equipment. The RXF/268 was a compact but powerful search radar for small craft. While its antenna had an aperture of only 30 by 5 inches, its transmitter developed 50 kilowatts peak output and its search range on surface craft compared very favorably with that of much bulkier sets. An order for 2000 of these sets was placed by the Admiralty on Research Enterprises Limited, and of this order 1600 were actually manufactured. Early production sets were used by British motor-torpedo-boat craft in Channel operations and by larger craft for convoy duty on the North African run. A certain number were modified by the attachment of a larger antenna and proved very effective in detecting submarines equipped with the "Schnorkel" breathing apparatus. At the present time RXF/268 sets

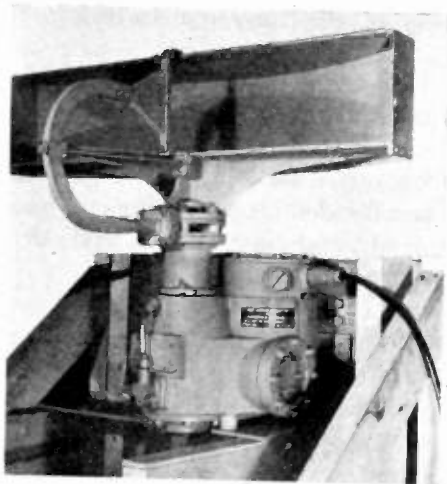

Fig. 6—The antenna and rotator unit of the RXF/268.

are being used on both British and Canadian commercial ships as a navigational aid, pending the development of a civil marine radar.

ARMY RADAR

While the GL III C was under development, a smaller group had been working on a 200-megacycle coast defense or CD set for the control of heavy coastal batteries. The Army group took over the final site installation of this radar and had it operating on the Eastern coast early in 1942. The set, which provided range data accurate to ± 50 yards and bearing data to $\pm 1/10$ of a degree, promptly proved its worth by locating and directing to safety several ships which were off-course and approaching rocks in heavy fog. While the set was never produced in quantity, it is estimated that many times its total development costs were recovered in shipping saved.

The obvious advantages in antenna size which would result from a microwave frequency led immediately afterwards to the development of the CDX, a 10-centi-

meter model of the CD. This set made use of many of the GL III C chassis and components, thereby effecting a very material saving in manufacturing time and cost.

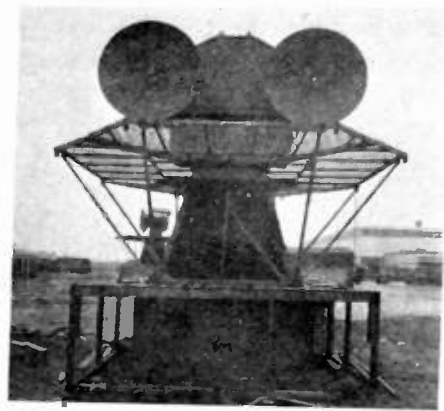

Fig. 7—The antenna and radio-frequency section of the CDX coast-defense radar set for control of coastal batteries.

The CDX was equipped with its own "co-ordinate converter" which provided automatically the target location as seen from the battery position. Another special feature was a method of detecting and reporting range and bearing of shell splashes without interrupting the smooth tracking of the target. This set was factory-produced in small numbers and was installed at a number of coastal points. It was followed by a 10-centimeter version of the old ZPI (zone position indicator) of the GL III C. The microwave frequency eliminated most of the weaknesses of the 175-megacycle mode!—in



Fig. 8—The display console of the CDX set.

particular interference, ground clutter from large objects off the direct line of sight, and, to a great extent, jamming dangers. It was a quite unique set in two respects: first, the antenna was a two-dimensional waveguide array steerable in the vertical plane; and second, it was almost completely "tropicalized," incorporating all hermetically sealed components, glass-braid wire sheathing, and other fungus-proof insulating materials, plus a built-in air-conditioning unit for the cab.

Concurrently with the development of the radars, interrogation equipments of the IFF Mk. III type were designed to suit each individual radar set. These were manufactured under the designation RH—RH6 for GL III C, RH7 for CDX, etc.

AIR-FORCE RADAR

Because of Royal Canadian Air Force policy in regard to airborne radar, this section devoted its efforts largely to long-range early-warning equipments for ground use. Starting with high-powered sets in the 3-meter frequency region, the section shortly turned to microwave



Fig. 9—Long-range early-warning station. The height-finding or VEB array can be seen on the side of the tower.

frequencies and developed an MEW or microwave early-warning radar on 10 centimeters. As the result of some excellent work at McGill University on slotted-waveguide antennas, the multidipole type of antenna favored by the Radiation Laboratory was abandoned in favor of the slotted type, and a long-range radar was developed which gave ranges up to 150 miles or so on bomber aircraft. At about this time enemy submarines appeared in the Gulf of St. Lawrence and an intensive effort was made to produce a set suitable for locating submarines at long ranges from shore stations. The MEW was modified and became the MEW/AS, a 10-centimeter set utilizing an 18-foot slotted wave guide at the focus of a 6-foot horizontal parabolic cylinder.

The transmitter developed 300 to 400 kilowatts peak power and gave ranges quite satisfactory to the military authorities. A number of these sets were rushed to completion in the model shops of the National Research Council and were installed at various shore locations on the Gulf. Some of these sets are now in operation on a trial basis as airport control sets.

The problem of height-finding on aircraft received a great deal of attention, and was solved in the earlier days of development by a 3-meter linear array mounted vertically on a 200-foot tower. This variable elevation beam (VEB) was steered by end-feeding the array and modulating the frequency. While operationally satisfactory, it was discarded in favor of a microwave height finder, the MHF, which utilized a vertical slotted-waveguide antenna, scanned mechanically by an oil motor.

RADAR PRODUCTION

While the National Research Council's Radio Branch was expanding its research and development facilities,

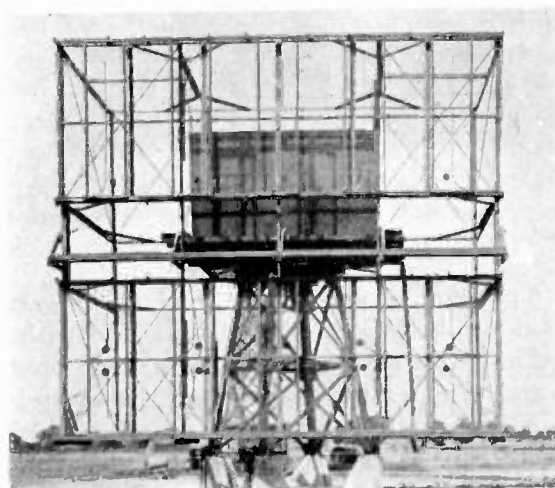

Fig. 10—Antennas of the RWG ground-control-interception radar set.

the radar division of Research Enterprises Limited grew in a startling manner and soon had a strength of nearly 4000 employees. In addition to mass production of National Research Council sets such as the GL III C, CDX, RXF/268, etc., Research Enterprises engineers undertook to adapt several British designs to North American components and practice. The RA or ASVC has already been mentioned. At the request of the Royal Canadian Air Force, Research Enterprises Limited produced a Canadian version (RW) of the British CHL (Chain Home for low-flying aircraft) and a dual-purpose set, the RWG, which combined the CHL with a ground-controlled-interception (GCI) radar. This latter was a 175-megacycle set utilizing a large billboard array. By means of a second antenna array, fairly satisfactory height-finding was accomplished. This RWG set was supplied in quantity to the

Royal Canadian Air Force and to the United States Army Air Forces. In early 1942 several of these sets were rushed to the Canal Zone for warning and fighter-control use.

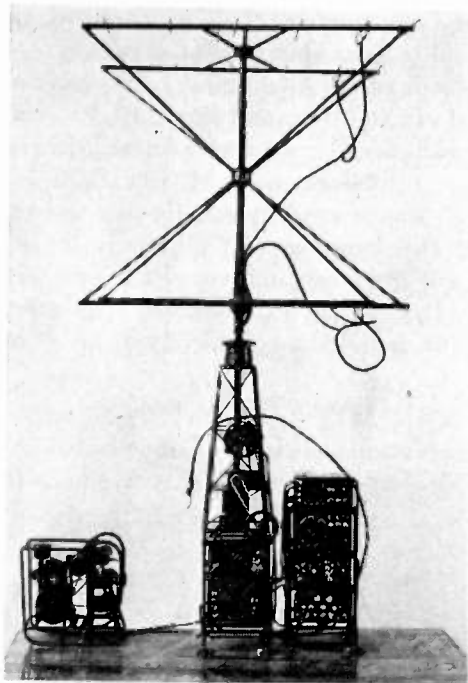

Fig. 11—Photograph of a model of the RAW or SCR-602 radar presented to Lt. Col. W. E. Phillips, president of Research Enterprises Limited.

An adaptation of the British LW (light-warning) radar was the RAW (SCR-602) which was rushed to completion for the United States Army and produced in quantity. The set was used quite extensively in the Pacific in the period when American manufacturers were striving to expand their own production facilities to meet the urgent demands of the Army and Navy.

A request from the British Ministry of Aircraft Production for a mobile GCI led to the construction at Research Enterprises Limited of a 50-centimeter interception-control set designated the RWM. This set used tilting 10-foot parabolic mirrors mounted on a small steel tower. All units, including transmitter, receiver, displays, interrogation equipment, antenna mountings, dual power units, and spares for six months' operation, made up a convoy of eight trucks, a unit which was self-sufficient in all ways. Some of these units reached

Burma in early 1945, but the end of hostilities prevented the set from seeing active service in any quantity.

CONCLUSION

The foregoing gives a rough outline of the types of equipment developed and manufactured in Canada between 1939 and the summer of 1945. The Radio Branch of the National Research Council, aided by university and Service personnel, developed approximately a dozen types of radar which were actually mass-produced, plus



Fig. 12—Mobile ground-control-interception set: the RWM convoy deployed for operation. The radar antennas are in the right foreground with the IFF antenna in the background.

twenty or so which were built in small quantities in the laboratory shops to meet specific Service requirements. At the plant of Research Enterprises Limited nearly two hundred million dollars worth of radar was built and shipped to the fighting forces of the various United Nations. To quote a few of the larger contracts, Research Enterprises Limited produced 665 GL III C's, 665 RH6's, 4500 ASV's, 670 SCR-602's, 155 RWG's, 1600 RXF/268's, 70 RWM's, and 7000 of the AYP radio altimeter. Of the total two hundred million dollar output, only the RCA-developed AYP was of non-Canadian design. While the manufacturing facilities which produced this notable output have naturally been reduced to suit peacetime requirements, the research staff of the National Research Council Radio Branch is continuing at approximately its wartime level. At the present time it is engaged in both fundamental research and in the solution of specific postwar problems in air and marine navigation, ionospherics, cathode-ray direction finding, and ultra-high-frequency communication.

Design of Communication Receivers for the Naval Service with Particular Consideration to the Very-High-Frequency and Ultra-High-Frequency Ranges*

THOMAS McL. DAVIS†, SENIOR MEMBER, I.R.E., AND EMERICK TOTH†

Summary—This paper points out some of the unusual requirements of naval shipborne receivers which result from their operation on antennas which are necessarily placed in close proximity to numerous transmitting antennas, and the further requirement that numerous receivers must, in some cases, operate from the same physical antenna. In many cases, the entire shipboard antenna system for both transmitters and receivers may be considered electrically as a single antenna with various degrees of coupling between its several parts. This condition places severe requirements on preselector design if cross modulation, spurious responses, and first-oscillator radiation are to be minimized or avoided. At the beginning of the war, the Navy's standard receivers, covering up to about 30 megacycles, incorporated designs that were quite acceptable in these respects. Little progress, however, had been made in the provision of receiving equipment possessing these characteristics for the higher frequencies.

The development described in this paper resulted in models which were closely copied in production and gave comparable performance in the very-high-frequency range to that realized at the lower frequencies. It also provided a design which is adaptable to a wide range of frequency coverage by the simple expedient of providing preselectors for the desired ranges together with change of intermediate-frequency transformers as may be required for specific applications. The sectionalized construction makes this a possible field alteration. The arrangement of components provides accessibility for repair and maintenance, while technician training is greatly reduced by the adoption of a common standardized chassis design for receivers covering several ranges. This standardization also reduces the cost of production and the overhead expense of distribution and maintenance of spare parts.

INTRODUCTION

ALTHOUGH the subject of this paper has to do with receivers, and more especially, receivers for naval communications in the very-high-frequency and ultra-high-frequency part of the spectrum, the treatment of the subject will be quite generally applicable to any superheterodyne type of receiver in any part of the spectrum where conventional vacuum tubes may be employed.

The difference between receivers to be operated at the higher frequencies in the range of 100 to 400 megacycles and in the broadcast band of 500 to 1500 kilocycles is largely due to the special requirements imposed by channeling and, as regards the preselector, the limi-

tations inherent in conventional vacuum tubes available for use at these frequencies.

The differences between commercial broadcast receivers and Navy receivers, aside from the necessity for general ruggedness and ability to withstand shock, vibration, and climatic conditions, are in the circuits and their treatment as necessitated by unusual operational requirements.

Before discussing the Navy receivers, it may be in order to consider the operational requirements of a typical receiver on one of the larger ships, or even on a smaller ship when that ship is a part of a task force of possibly hundreds of ships in rather close formation from a radio standpoint, and with the further possibility that such a force may be accompanied by an air force even greater in number. As radio is an important tool in all of these craft at all times, and especially under action conditions, reliable operation must be expected and the receiver design must anticipate all of the interference that may result from the multitudinous radio emissions during such action, as well as that which the enemy may throw in for good measure.

In the case of a single ship there may be numerous radio transmitting systems in operation, with various types of emission and various power levels. Generally, the radiators for these systems, together with the receiving antennas, are bunched about a single mast, and, as height is important, there is a great concentration of antennas in the vicinity of the yard arm. This is only natural, as the modern ship has but one, or at the most, two masts with favorable height. With this bunching of antennas, it must be expected that the receiving antennas will, at times, deliver interfering voltages to the receivers from local transmitters which may reach the order of tens or even hundreds of volts. The order of volts is not uncommon, and the order of millivolts is of frequent occurrence.

This situation imposes design considerations which usually can be neglected for most other services, yet are vital to the success of naval operation afloat and call for more tuned circuits in the preselector assembly than might otherwise be required. The number of circuits, their arrangement and treatment, require particular consideration if cross modulation, image and spurious responses, blocking, and other forms of interference are

* Decimal classification: R361.113XR565. Original manuscript received by the Institute, March 1, 1946; revised manuscript received, May 6, 1946. Presented, 1946 Winter Technical Meeting, New York, N. Y., January 26, 1946.

† Naval Research Laboratory, Washington, D. C.

to be minimized to a degree that will assure reasonable reliability of communication.

The scope of this paper will be limited to consideration of the intermediate-frequency and preselector circuits of the receiver. The preselector, as referred to herein, comprises all of the circuits within the receiver which precede the intermediate-frequency amplifier, and although the treatment of these circuits has a more direct bearing upon the subject of this paper than the rest of the receiver, the channeling in the very-high-frequency and ultra-high-frequency bands requires rather special consideration of the intermediate-frequency system.

INTERMEDIATE-FREQUENCY-AMPLIFIER DESIGN

The intermediate-frequency-amplifier system design is dictated by several practical considerations of selectivity and gain. The ideal intermediate-frequency amplifier would have a "nose" width of twice the allowable combined drift of the transmitter and receiver involved in the over-all communication system, with infinitely steep sides, so that the selectivity curve would be substantially a rectangle. This is, however, not realizable in practice. Considering the possible preselector selectivities (cross modulation, overload, etc.), a weak-signal intermediate-frequency selectivity ratio (bandwidth at 60 decibels down on the selectivity curve divided by the width at 6 decibels down from maximum response) of 2.5 to 3.0 is satisfactory, since with existing channeling in the very-high-frequency and ultra-high-frequency bands it normally provides at least 60 decibels discrimination against an adjacent channel. A set of six double-tuned coupled-circuit transformers used in cascade provides a selectivity ratio over-all of about 2.5 at critical coupling, or about 2.7 to 3.0 for the more desirable condition of somewhat less than critical coupling. Experience indicates that the over-all voltage amplification at any one center frequency, as measured between the first and second detectors, should generally be 100,000 times or somewhat less if freedom from undesirable regenerative effects is to be avoided. Thus it becomes possible to consider standardization of very-high-frequency and ultra-high-frequency intermediate-frequency amplifier systems, on the basis of always using six cascaded double-tuned intermediate-frequency transformers designed somewhat below critical coupling, with five intermediate-frequency amplifier tubes providing individual-stage voltage amplifications of ten times each, or a total over-all voltage amplification of 100,000 times. With remote-cutoff amplifier tubes having maximum transconductance values of 5000 micromhos, transformers having resonant tank impedances of about 4000 ohms each will be required, a value readily obtainable in production structures at frequencies up to at least 30 megacycles.

The limitations imposed by present (and future) very-high-frequency and ultra-high-frequency channel assignments make it imperative that the intermediate-

frequency amplifier have a frequency stability in kilocycles much better than the preselector, particularly as regards shift in center frequency and bandwidth of the amplifier with change in temperature, humidity, gain control (or automatic volume control), line voltage, etc. Over-all frequency shifts will, of course, be summations of the preselector and intermediate-frequency amplifier shifts.

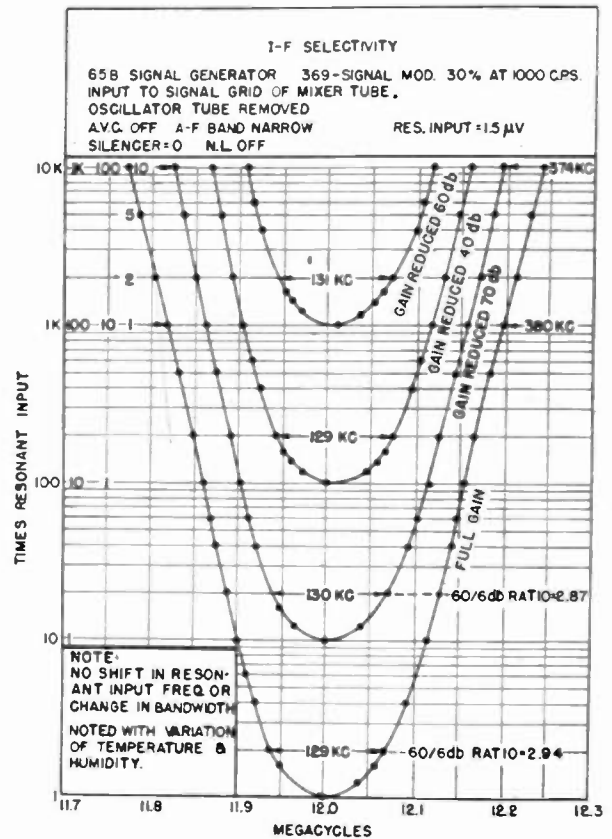

Fig. 1—Over-all selectivity of the 12-megacycle intermediate-frequency amplifier.

Fig. 1 shows the selectivity characteristics obtained with a typical 12-megacycle intermediate-frequency amplifier (voltage amplification of over 100,000 adaptable to receivers up to 160 megacycles, at various gain levels ranging from full gain to 60 decibels below full gain. The center shift with this range in gain variation is considerably less than 5 kilocycles and the bandwidth change is likewise less than 5 kilocycles at 6 decibels down. Center shift with 50 degrees centigrade change in ambient temperature has been found to be within the range of instrument error, which would not exceed 4 kilocycles, and relative humidity change from 30 to 95 per cent and line-voltage changes of ± 10 per cent produce no measurable shifts.

One of the characteristics normally desired in Navy communication receivers is the ability to trim the intermediate-frequency system over-all at a single alignment frequency, with no particular regard for order of trimmer adjustment. This requirement has been realized in this amplifier.

The high degree of temperature stability has been obtained by employing an iron-dust-core transformer structure with fixed silver-mica tank capacitors, this structure having built-in compensating characteristics which make temperature-compensating capacitors unnecessary. In addition, suitable means have been incorporated for maintaining the bandwidth of the transformer constant despite relative motion of the iron-dust cores during the trimming operation. The small center shift with change in gain (and also with change in line voltage) is due mainly to the large tank capacitance (250 micromicrofarads) required for a 4000-ohm transformer of 125 kilocycles bandwidth at 12 megacycles,

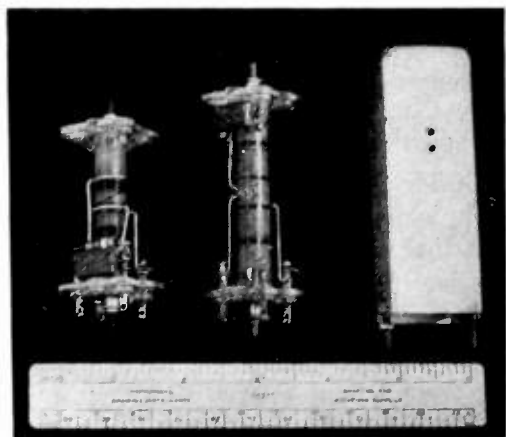

Fig. 2—Left—30-megacycle intermediate-frequency transformer. Center—12-megacycle transformer. Right—shield can for 12-megacycle transformer unit.

while relatively long leakage paths and suitable wax coating protect the transformer structure against the effects of humidity variations. Fig. 2 shows the construction of a 12-megacycle center, 125-kilocycle bandwidth transformer, and also a 30-megacycle center, 2-megacycle bandwidth unit. The wire of the coils is wound in grooves, with each primary and secondary coil split into two sections to provide the constant bandwidth feature with variations in core positioning. Tank capacitors are mounted directly on terminal studs inside the transformer shields, so that as little tank current circulates outside the transformer proper as possible. The entire structure is self-supporting without any cement or other adhesives to secure the coils, even before soldering. Each transformer is so mounted on the chassis that the shield may be removed readily without unsoldering or dismantling the transformer proper, to facilitate inspection or repair.

It may, therefore, be considered that the intermediate-frequency requirements of the receiver have been quite well taken care of by rather conventional and well-developed designs.

PRESELECTOR DESIGN

In preselector designs acceptable for the Naval Service, it has been found that at least two tuned circuits

must be provided ahead of the first tube, that the first circuit must be well shielded from all other radio-frequency circuits except for intentional coupling to the antenna and succeeding circuit, and that the input tuned circuit to the radio-frequency tube must couple only to the grid of that tube. The latter feature is usually accomplished by double shielding between the input and output circuits of the radio-frequency tube, which tube is double-ended so that its control-grid terminal can extend into the input-circuit compartment. The best possible by-passing of the screen-grid, cathode, and all other low-radio-frequency potential elements to ground is most essential. These precautions are not only most helpful in obtaining the maximum selectivity the circuits employed are capable of providing, but are essential in minimizing the first-oscillator power fed to the antenna, which may be radiated to violate security and interfere with other near-by receivers. The Navy has set a maximum limit of 400 micromicrowatts of first-oscillator power as measured at the antenna-input terminals when fed into a matched load. Reduction below this limit is very desirable if the radiation from one receiver is not to interfere with another on the same ship. Although the ideal in this latter respect has not been fully realized because of the size, weight, and complexities involved, the 400-micromicrowatt level has, in general, been satisfied; for instance, within the very-high-frequency band, one type of the better production receivers averages less than 1.0 micromicrowatt.

The other two circuits in the preselector gang of a simple noncrystal-controlled receiver are the first-detector and oscillator circuits. Although the nature of the Navy's interference problem might theoretically indicate that more circuits are desirable, their practicability of production is somewhat questionable. This is particularly true in the 200- to 400-megacycle band, where conventional tubes of the acorn or miniature varieties used as radio-frequency amplifiers average little or no more than unity amplification after the circuit compromises resulting from tracking, tube loading effects, and fixed couplings over the required two-to-one frequency range have been realized.

With the tuning range reduced to a ratio of about 1 to 1.46 and with the frequency coverage 110 to 160 megacycles, the tracking difficulties are greatly reduced, the couplings can be made with less compromise, there is less tube loading on the circuits (hence, a more favorable circuit Q), and an appreciable gain can be realized.

Fig. 3 shows the selectivity obtained in a typical preselector having three ganged circuits tuned to the received frequency, which in this case was 118.7 megacycles. Two of the circuits preceded the radio-frequency amplifier tube, while the third was the plate load of the radio-frequency amplifier prior to the mixer grid. This curve was taken from a production preselector and indicates practical limits for this type of operation. This graph indicates that an average ganged Q of around 100

per circuit has been attained, which is about the maximum that is acceptable for economical production, particularly when the ganged tuning elements cover their range in 90 degrees of rotation. Although no graphs are shown for other frequencies, measurements for image response at the other frequencies indicated that a 90-decibel or better image attenuation was realized with a 12-megacycle intermediate frequency throughout the range of 110 to 160 megacycles. The intermediate-frequency rejection was such that no receiver output was detected with 2 volts input at 12 megacycles, and no

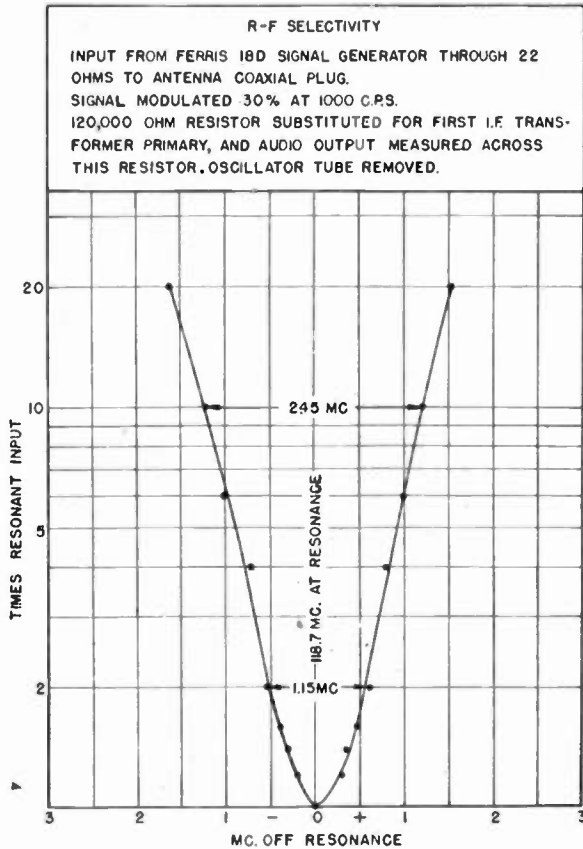

Fig. 3—Typical selectivity of three ganged preselector circuits at 118.7 megacycles.

observable cross-modulation or overload effects were detected for interference-signal inputs up to 75 volts. The oscillator power fed to the antenna jack into a matched load was appreciably less than 1 micromicrowatt. In this range, performance comparable to that expected at the lower frequencies has been realized.

The next band to be described involves greater difficulty, as the frequency and tuning ratio both are increased. The design requirements called for a coverage of 200 to 400 megacycles without crystal control. The tuned-circuit elements were of first consideration, as no commercial capacitors were available to permit this wide coverage when used in circuits which were capable of satisfactory ganging, tracking, linearity of tuning, and practicable adaptation to mechanical control with pre-

cision tuning and reset, and with no sliding contacts in the capacitor structure.

Other factors which were of obvious importance were small, compact, and sturdy elements, no possible uncontrolled resonant absorption circuits in the structure, maximum angular rotation of the capacitor with straight-line-frequency variation, minimum stray couplings to elements outside of the intended radio-frequency current paths, minimization of radio-frequency potential differences in the so-called ground plane upon which the elements are mounted and to which all by-pass capacitors return, provision for tracking the capacitors and trimming both the capacitance and inductance elements of the tuning circuits, and provision of a structure which could be reproduced by practical production methods with uniformity and without violation of the previously mentioned requirements.

TUNED-CIRCUIT DESIGN

These considerations led to the basic design, as shown in Fig. 4, in which the inductive elements are nothing more than U-shaped members mounted at their base directly upon a flat ground plane, these members to be

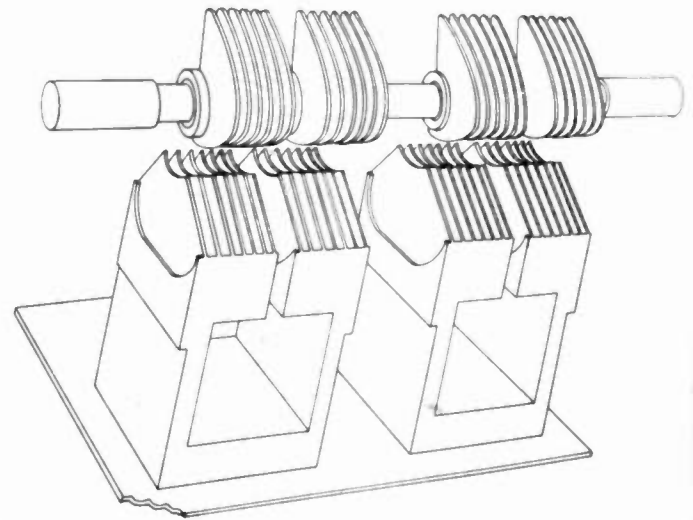

Fig. 4—Basic design of tuned-circuit elements for the 200- to 400-megacycle preselector.

sufficiently sturdy to support the stator plates of the variable tuning capacitor. It was thought that possibly the U members might be made an integral part of a casting which included the ground plate. In that event, the raised portion at the base of the U would still be considered desirable, as the coupling to the ground plate would be reduced due to the current nearly all following the inner dimensions of the U. The two sections of the rotor are conductively tied together, thus giving a split-stator type of capacitor without sliding contacts. The shaft is either of insulating material or at least is broken up by insulators for isolation from companion tuned circuits.

With this basic idea, the design was started with the usual fabrication methods. Fig. 5 shows the result of this fabrication for a single tuned-circuit assembly. The

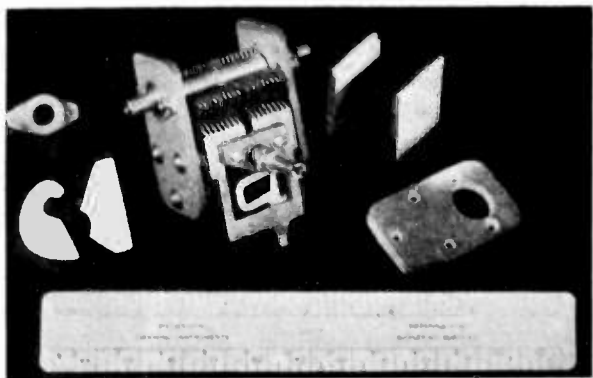

Fig. 5—200- to 400-megacycle tuned-circuit elements. *Left*—Bearing and capacitor plates. *Center*—Complete assembly, showing inductance and capacitance trimmers. *Right*—Inductor element and end plate.

capacitor plates were shaped to provide close to straight-line-frequency variation for 240 degrees of rotation. The unit is self-contained with ball bearings. The shaft is of steel with an insulating section which, in practice, is complemented by further insulation in the drive coupling employed. The little loop which is located at the bottom of the U can be rotated for inductance trimming by the absorption principle.

As shown in Figs. 5 and 6, a rather novel type of trimmer capacitor is provided consisting of a cylindrical

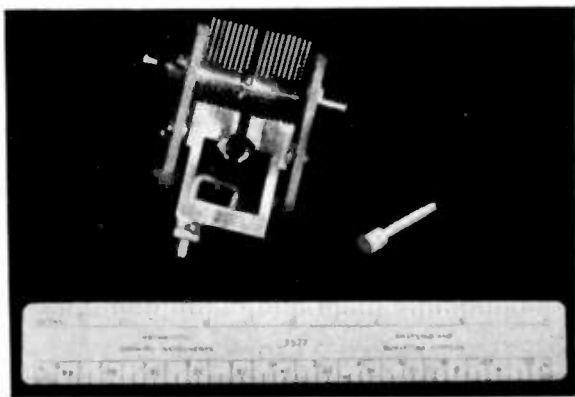

Fig. 6—Reverse view of 200- to 400-megacycle tuned-circuit assembly, with titanium-dioxide-compound coated plastic capacitance trimmer slug.

metallic slug covered with a plastic having a titanium-dioxide filler to increase its dielectric constant, which is fed on a screw into the cylindrical opening formed at the base of the two capacitor stator sections. This structure and location places the trimmer in a position of approximately maximum current when the rotor plates are disengaged and it possesses much less inductance than the tuning capacitor itself. It is so designed that appreciable current does not flow through the screw mounting.

Fig. 7, although not drawn for the specific purpose, shows the tuning range and linearity that was realized in a preselector employing these elements.

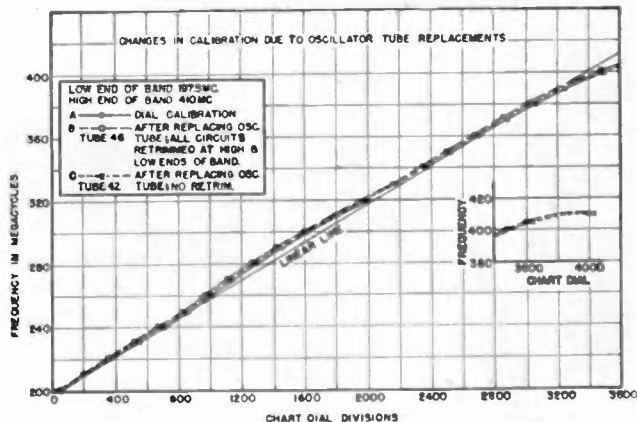

Fig. 7—Preselector tuning linearity and variations with tube replacement.

Four of these units were mounted in a preselector, as shown in Fig. 8. (The antenna tuned circuit, being under the chassis, may be seen in Fig. 12.) The tuned circuits, from left to right, are the oscillator, detector or mixer (radio-frequency-amplifier plate load), and the circuit feeding the radio-frequency-amplifier grid. The antenna circuit, which is not visible in this view, is mounted below the chassis and is coupled to the circuit preceding the radio-frequency-amplifier tube by a strap which

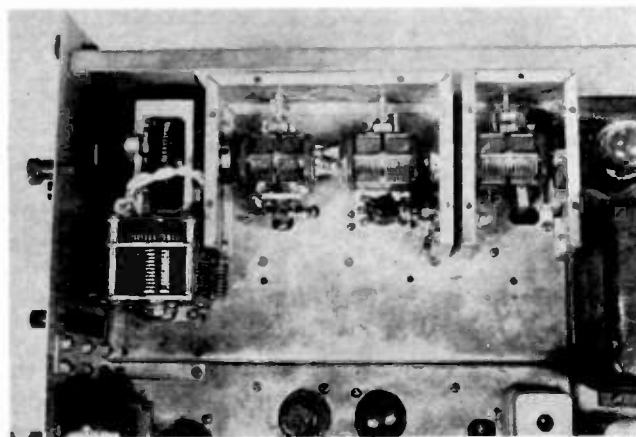

Fig. 8—Top view of experimental 200- to 400-megacycle preselector.

passes through the oval hole in the chassis. This arrangement gives the required separate shielding of the antenna circuit and the other radio-frequency tuned circuits.

It will be observed that the only connection from the first two radio-frequency circuits to the acorn radio-frequency-amplifier tube is to the tube's grid pin, which extends into the radio-frequency-circuit compartment.

Fig. 9 gives another view of the same structure and may serve to clarify some of the details.

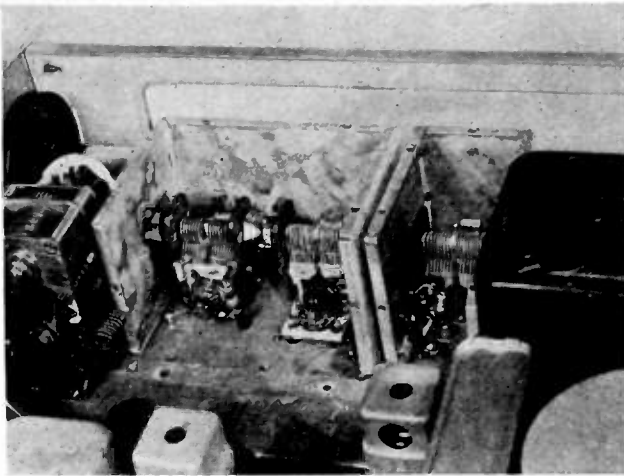

Fig. 9—Top oblique view of preselector.

Fig. 10 is a wiring diagram of the circuits of the preselector and is almost self-explanatory because of its essential simplicity. The capacitors in the tuned circuits shown as nonvariable are of the compensating type to effect frequency stabilization with varying temperature. The oscillator is of the Hartley variety, using a type 955 or preferably a 6F4 triode, and is inductively coupled to the mixer by proximity, with additional compensating coupling via the choke, which may be identified in Fig. 9 as the coil which bridges the insulator on the

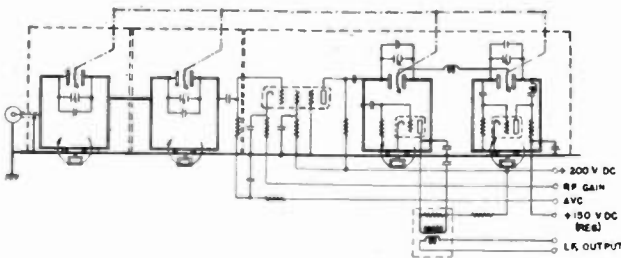

Fig. 10—200- to 400-megacycle preselector circuit diagram.

flexible coupling between the oscillator and mixer tuning capacitors. The type 956 remote-cutoff pentode is employed as a radio-frequency amplifier to minimize cross modulation.

This preselector, together with the receiver assembly of which it is a part, was developed early in the war and was the forerunner of several designs which followed. It was selected for discussion in this paper because of its simplicity of structure, and yet it possesses many of the features of the others requiring special consideration, and can be made in less space with better isolation of circuits than many other designs which employ more conventional components.

The wide frequency range covered in the preselector and the low input impedance of tubes at these frequencies necessarily result in sacrifices in gain and Q of the circuits involved. The image attenuations indicated that a ganged Q of from 45 to 65 per circuit was realized in the model. The voltage amplification of the radio-frequency-amplifier stage averaged less than unity with the tubes (type 956) available at the time of construction.

The oscillator tuned circuit was made of silver-plated in var and the other circuits of silver-plated brass. The oscillator was compensated by a small 3-micro-microfarad shunt temperature-compensating capacitor, to obtain as much stability with temperature variation as possible. The worst condition measured for stabilized points after moisture-condensation effects had disappeared was at 372.5 megacycles, where the total oscillator frequency change was 100 kilocycles or 0.0267 per cent for a change of 60 degrees centigrade from -20 to $+40$ degrees (0.00044 per cent per degree centigrade). At 243.5 megacycles, the change was 0.00023 per cent per degree centigrade. The frequency variation due to a humidity change of from 30 to 92 per cent at 40 degrees centigrade was 0.025 per cent at 235 megacycles and 0.04 per cent at 360 megacycles.

When production was planned in this general frequency range, contractors, in the interest of speed, were desirous of obtaining their components from component manufacturers. Because of the pressure of war, the new techniques required for the production of these tuning elements were never developed and, after many conferences and the production of several models, a variable capacitor unit following more conventional design was produced, one form of which is shown in Figs. 11 and 12.

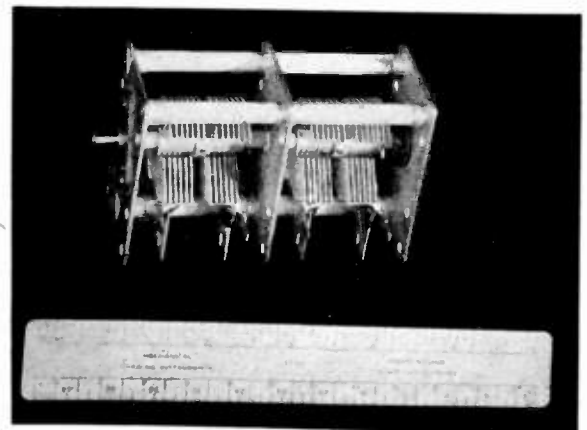

Fig. 11—Side view of experimental two-gang ultra-high-frequency tuning capacitors.

This structure embodies a self-contained capacitor element with plates shaped similarly to the original. Wide tabs are furnished at the base to which the

inductor member is secured. The trimmer capacitor emerged in the rather conventional form of an air-dielectric split-stator unit, the size being materially increased. The longitudinal supports, as well as the capacitor shaft, are ceramic rods.

CONSTRUCTION

To go back to the original model, Fig. 13 shows the base of the complete receiver with the shield-cover plates removed. The antenna tuned circuit can be seen

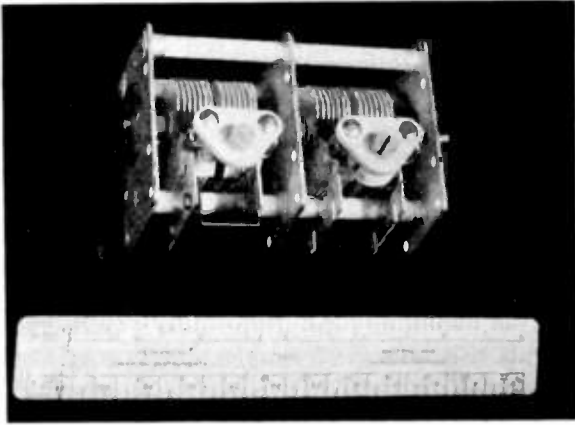

Fig. 12—Reverse side view of gang-tuning capacitor, showing trimmer capacitors and with inductor members attached to left-hand capacitor unit.

at the rear of the preselector unit surrounded by a shield. The can between the antenna circuit and the front of the unit contains the first intermediate-frequency transformer. The twisted pair leading diagonally across to a terminal board mounted on the intermediate- and audio-frequency section of the receiver conducts the intermediate frequency at low impedance to a transformer in the intermediate- and audio-frequency chassis.

The other features of this receiver cannot be discussed in limited space. It will be observed, however, that the receiver is designed in three basic parts, the power unit at the rear and the intermediate- and audio-frequency unit in the larger front portion, with the preselector unit alongside. This design was planned to form the basis for a standard line of receivers in which the power unit would be common to all, the intermediate- and audio-frequency unit likewise common except for possible change of intermediate-frequency transformers, and the preselector to be designed for the frequency coverage desired.

Two of the receivers, which can now be identified due to their unclassified status and which were produced in

quantity, using this chassis except for the preselectors and other slight modifications to adapt them for special applications, were the models RCK and RDO. Several sets of intermediate-frequency transformers have

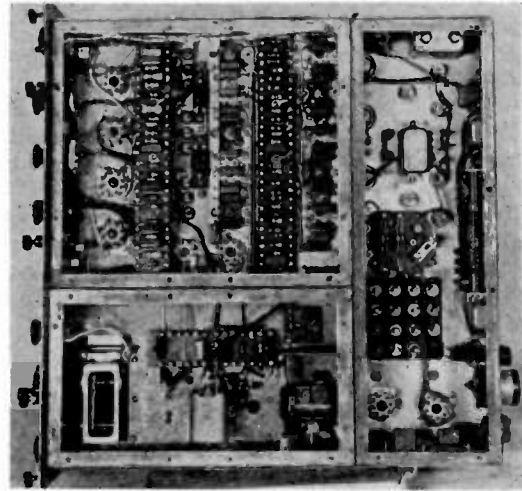

Fig. 13—Bottom view of complete experimental receiver chassis with bottom shields removed.

been designed for several midband frequencies having a 6-decibel nose width of from 0.125 to 2.00 megacycles, all having approximately the same 60-to-6-decibel skirt-to-nose ratios and stabilities similar to those given

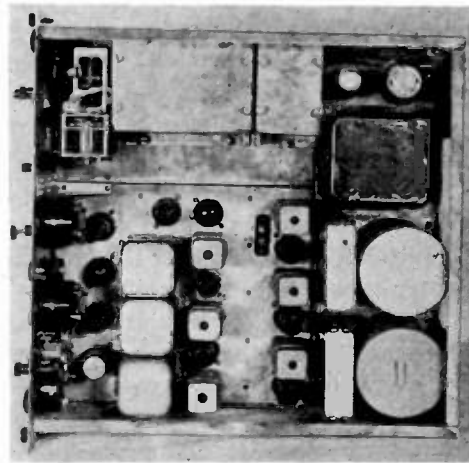

Fig. 14—Top view of complete receiver chassis.

for the 12-megacycle unit previously described and shown in Fig. 1.

Fig. 14 shows a top view of the chassis with the preselector shields in place.

An Automatic-Slideback Peak Voltmeter for Measuring Pulses*

CYRUS J. CREVELING†, MEMBER, I.R.E., AND LEONARD MAUTNER†, MEMBER, I.R.E.

Summary—An automatic-slideback-type vacuum-tube voltmeter designed for measuring the peak voltage amplitude of recurrent video pulses is described. The slideback is made automatic through the use of a suitable amplifier and rectifier, the output of which is used to bias off a diode to the peak amplitude of the pulse to be measured.

The effects of wave form and duty cycle of pulses on the accuracy of the device are considered, as well as modifications which can be used to decrease the inherent error due to diode capacitance. In addition, means of extending the voltage ranges and increasing the input impedance are discussed.

INTRODUCTION

WITH THE increased application of pulse techniques in radio engineering, the use of vacuum-tube voltmeters for pulse measurements has become widespread. When dealing with sine waves or square waves, the usual vacuum-tube peak voltmeters are accurate and adequate. For measuring the amplitude of short-duration pulses, however, these voltmeters are inaccurate, and a well-designed cathode-ray oscilloscope has been required for accurate measurements. There are occasions, however, where the weight and size of an oscilloscope are objectionable, and a simple, light-weight vacuum-tube voltmeter suitable for pulse measurement is very useful.

The types of pulses encountered in different applications vary, and this fact limits the utility of a pulse voltmeter, since no information as to the actual wave form of the pulse is obtained. Such a meter will read the peak voltage of relatively wide flat-topped pulses, but where sharp peaks or narrow pulses are encountered, an error will result. This is because of the fact that the energy in a narrow pulse may be insufficient to allow the peak rectifier associated with the voltmeter to charge up to the maximum amplitude of the pulse.

The voltmeter described herein was designed to minimize the error encountered in measuring pulses at low duty cycles (duty cycle being defined as the ratio of the pulse width to its repetition period) at the same time using resistance elements of sufficiently low value to remove field troubles due to leakage.

In the conventional types of vacuum-tube voltmeter, the design usually includes a diode rectifier (often built into a low-capacitance probe) and a means for measuring the rectified-voltage output. The direct-current voltage measurement is commonly accomplished using either a direct-reading circuit or a "slideback" means

wherein the rectified voltage is compared to a variable direct-current voltage in a bridge circuit, manual adjustment being made for a null reading. Both methods require that the peak rectifier charge to the full pulse amplitude during the pulse, which may be difficult to do within the design limitations. In addition, the direct-reading method requires frequent zero-setting, while the "slideback" scheme is tedious to use for repeated measurements.

The meter to be discussed may be described as being of the "slideback" type; however, its operation is automatic and requires no manipulation other than selection of the proper voltage range. The circuit employs a series diode which fails to pass an incoming pulse when its bias exceeds the incoming pulse amplitude. The operation of the circuit can be seen from the diagram of Fig. 1. A positive pulse applied to the input terminals of the device is passed by the diode and is amplified and rectified.

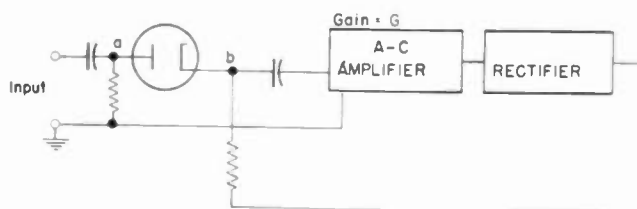

Fig. 1—Block diagram of the automatic-slideback vacuum-tube voltmeter.

The rectified voltage is returned as bias for the diode in such a sense as to reduce the conduction of the diode. Thus the voltage wave form passed by the diode becomes a feedback error voltage which is used to bias off the source of error voltage fed to the amplifier. A direct-current voltmeter connected between point *b* and ground will therefore read essentially the peak amplitude of the pulse. If the amplification used were infinite, the bias voltage would become equal to the signal voltage, and no current would be passed by the diode. Practically, this is of course impossible. However, using reasonable values of amplification the "error voltage" passed by the diode can be made quite small.

DESIGN CONSIDERATIONS

The considerations entering into the design of this instrument were (1) weight, (2) size, (3) duty-cycle capabilities, (4) accuracy, and (5) use of components suitable for field use.

The weight and size of the voltmeter were to be kept at a minimum for use in portable equipment. Since the voltmeter was to be part of a larger test set, no estimate of its unit weight and size is available. For duty-cycle

* Decimal classification: R243.1. Original manuscript received by the Institute, December 6, 1945; revised manuscript received, May 13, 1946.

† Naval Research Laboratory, Office of Naval Research, Washington, D. C. Work covered in this paper by L. Mautner, affiliated with the Radiation Laboratory of the Massachusetts Institute of Technology, was done at the Naval Research Laboratory.

capabilities, the unit was expected to measure the amplitudes of video pulses whose duration was between 1 and 50 microseconds occurring at rates from 50 to 4000 cycles per second. This corresponds to duty cycles of 0.005 and 20 per cent, respectively. Voltage amplitudes of from 0.5 to 200 volts were to be read with accuracies of ± 10 per cent up to 2.0 volts and ± 5 per cent from 2.0 to 200 volts. The most troublesome design

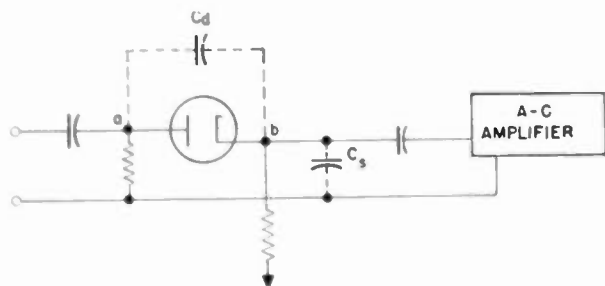

Fig. 2—Diagram illustrating diode capacitance error.

requirement to meet was the limitation on value of resistors. Resistors of less than 1.0 megohm in value were preferred because it is difficult to maintain the value of higher resistances in field use under conditions of high humidity, tropical use, etc. In addition, such resistors, when practical, require a large mounting space, are bulky, and consequently are to be avoided.

The restriction of low duty-cycle operation is one that is particularly binding upon the common shunt-diode vacuum-tube voltmeter, commercial varieties of meters

latter fact would contribute to repetition-rate sensitivity in this application.

Several factors need to be considered in the design of an automatic-slideback-type circuit, such as (1) effect of diode capacitance, (2) effect of contact potentials, initial velocities, etc., (3) input impedance, and (4) effect of varying duty cycle. These factors will be considered in turn. With reference to Fig. 1, if the input voltage as measured at point *a* is E_a and the voltage at point *b* is E_b , then for an amplifier whose gain is G we can write, ideally,

$$E_b = G(E_a - E_b) \tag{1}$$

or

$$E_b = E_a \left(\frac{G}{G+1} \right) \tag{2}$$

The actual meter reading will be equal in value to E_b , and less than E_a by an amount δ , where

$$\delta = E_a - E_b = \frac{E_a}{G+1} \tag{3}$$

Hence the meter reading will be less than the true voltage; it will be equal to the true voltage multiplied by the factor

$$\left[\frac{1}{1 + \frac{1}{G}} \right] \tag{4}$$

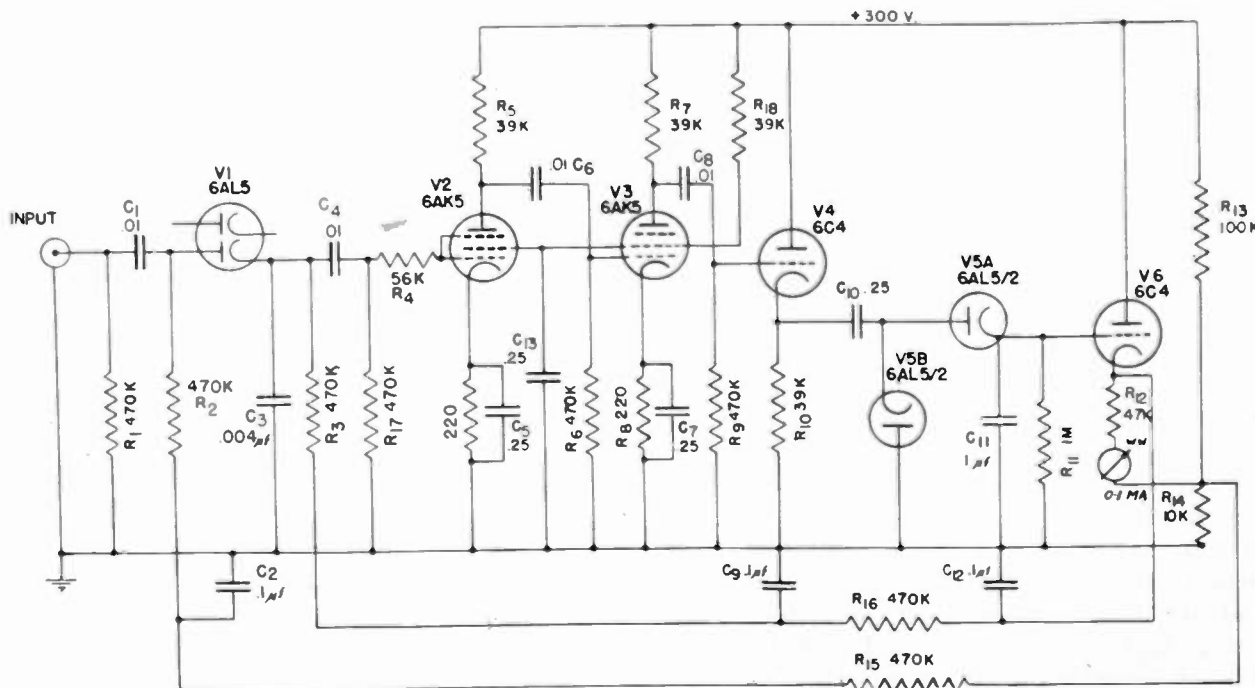

Fig. 3—Schematic diagram of a peak voltmeter for positive pulses.

often employing up to 50-megohm resistors in the time-constant network. In these meters, too, the effect of the source impedance will be felt in trying to charge up the capacitance in the diode-rectifier load impedance. This

If $G = 100$, then the inherent slide-back error will be 1 per cent.

The value of E_b , however, may be increased by direct capacitance leak-through. With reference to Fig. 2, if the

plate-to-cathode capacitance of the diode is C_d and the shunt capacitance from point b to ground is C_s , then the component of E_b due to such leak-through is

$$E'_b = \frac{C_d}{C_s + C_d} E_a. \quad (5)$$

The component E'_b can be reduced by making C_s large compared to C_d , and in one version of the design this is purposely done. This feature has the additional advantage of "stretching" incoming pulses somewhat, and makes the peak rectifier which measures the value of the amplified error signal have a less difficult task for low values of duty cycle.

It should be borne in mind that if the amplifier did not tend to integrate the error signal at all, but faithfully reproduced a portion of the input pulse, then the peak rectifier would give a diminished output for very

The introduction of a varying duty cycle will cause an increased error for very low duty cycles (with very narrow pulses), where the peak rectifier does not have sufficient time to charge properly. With large duty cycles the introduction of a direct-current restorer on the input is advisable to prevent a shift in the alternating-current axis; this is also indicated in Fig. 4.

DESIGN OF TYPICAL PRACTICAL INSTRUMENTS

Fig. 3 shows the circuit diagram of a relatively simple and useful version of the peak voltmeter. It has sufficient gain to limit the error to less than ± 6 per cent due to changes in duty cycle with the pulse-repetition frequency varying from 50 to 5000 pulses per second, and pulse duration varying from $\frac{1}{2}$ to 15 microseconds.

The slide-back diode V_1 is one section of a 6AL5. Only one section is used to minimize hum pickup from cath-

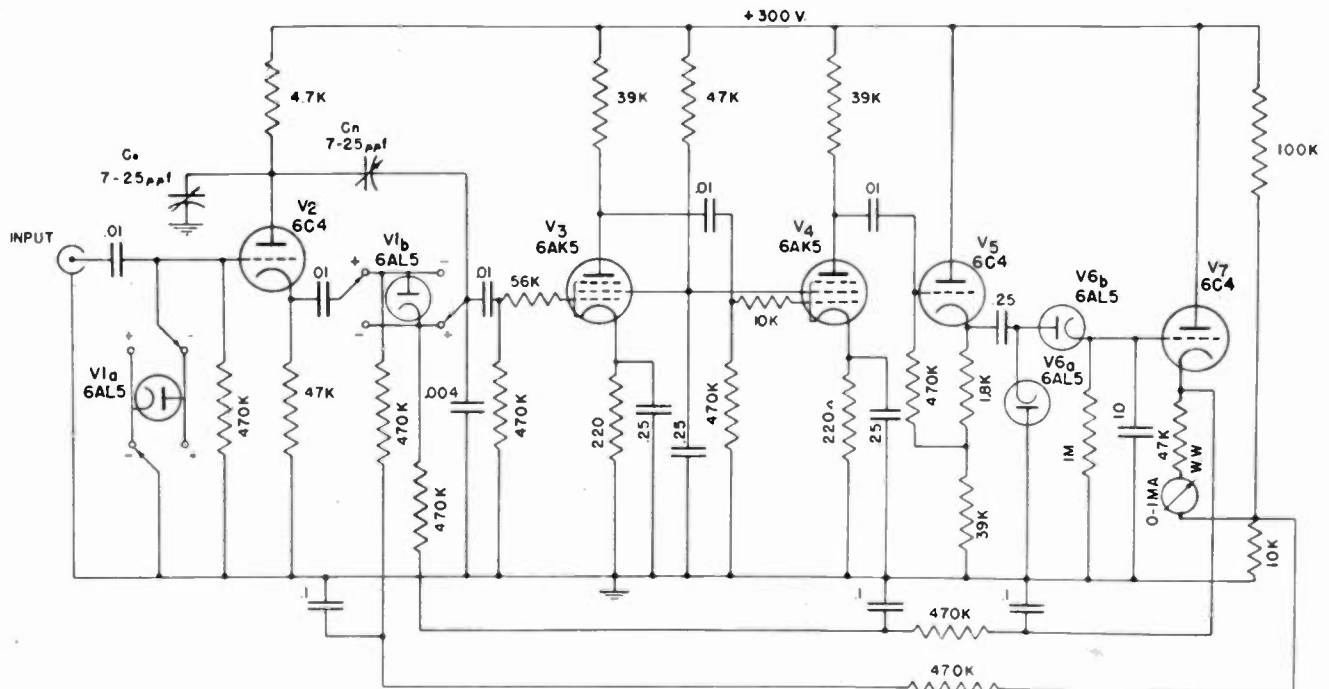

Fig. 4—A more refined circuit of a peak voltmeter for positive and negative pulses.

low duty cycles. This would tend to lower the effective over-all value of G , and thus increase the meter error. Hence it is desirable for the amplifier to distort the error signal by integration of the pulse error voltage.

Another means of reducing the diode-capacitance error is to employ a combination cathode-follower and inverter input stage, as part of a neutralizing bridge. The circuit is shown in Fig. 4. This circuit possesses the added advantage of increased input impedance, which aids in meeting design condition (3). The simple circuit will, of course, provide a lower input impedance.

The adverse effect of contact potentials and initial velocities can be substantially corrected by returning the plate of the diode to a suitable direct-current potential, as is shown in the circuit diagram (Fig. 3). Fig. 4 shows an improved circuit with the cathode-follower input stage.

ode to heater. Hum is further reduced by biasing both anode and cathode of V_1 positive, by the voltage divider R_{13} and R_{14} .

C_3 and R_3 have a discharge time-constant of 1900 microseconds which has the effect of lengthening pulses appearing at the cathode of V_1 . This reduces the high-frequency requirements of amplifiers V_2 and V_3 .

V_2 has a "grid stopper" of 56,000 ohms to prevent excessive grid current when input pulse voltages increase more rapidly than the bias can build up on the diode.

V_{6A} is one-half of a 6AL5 and acts as a peak rectifier for the positive pulses appearing at the cathode of V_4 . The other half, V_{6B} , is used as a direct-current restorer for high duty-cycle operation.

V_6 is a direct-current amplifier making possible the use of a 1000-ohms-per-volt meter.

The cathode return of V_6 is made to a positive potential of about 30 volts (junction of R_{13} and R_{14}) so that it is cut off until a signal is impressed on the input.

AN IMPROVED VERSION

Shown in Fig. 4 is a circuit which has been modified to reduce error due to diode capacitance and to permit the measurement of pulses from a source of relatively high internal impedance. It can also be switched to measure either positive or negative pulses.

Its accuracy should be within ± 2 per cent over the range of from 25 to 10,000 pulses per second, pulse duration varying from 0.5 to 15 microseconds, at 0 to 50 volts full scale.

In this circuit the amplifiers must work with a negative pulse input as well as a positive one. For this reason, the cathode follower V_6 must be biased to the middle of its characteristic by returning the grid return to a tap on the cathode resistor. It will then amplify positive or negative pulses.

It should be borne in mind that circuits of this type, involving feedback from output to input, even though such feedback is decoupled, require that some care be taken in layout and wiring to avoid oscillation. The authors have found that successive models embodying changes in physical design usually require slight adjustment of some component values. Those having the greatest effect on circuit stability are C_3 , C_9 , R_4 , and R_{16} in Fig. 3. In cases where these will not effect stability, the gain of the amplifier may have to be reduced by lowering the value of R_6 or R_7 or by removing C_5 or C_7 .

The basic circuit is limited to a range of from 0 to 50 volts; to operate at higher ranges, a simple compen-

sated ladder-type attenuator is recommended. For measuring pulses of very small amplitude, it is usually convenient to use an amplifier preceding the voltmeter input. Such an amplifier should be designed to properly pass the pulses to be measured with low distortion of pulse shape.

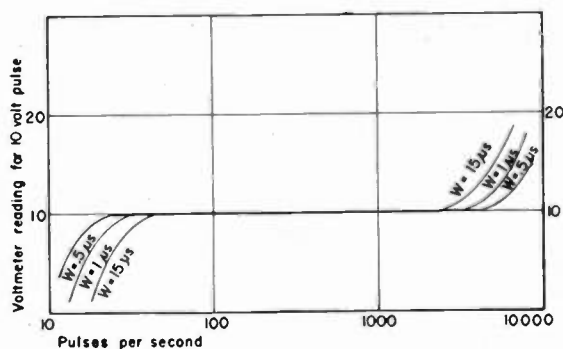

Fig. 5—Calibration curve for the circuit of Fig. 3.

The accuracies of the circuits described herein were measured by comparing the simultaneous reading of the peak voltmeter with that of an oscilloscope, the pulses being supplied from a laboratory source. Since the standard pulse was applied directly to the vertical plates of the oscilloscope, it could be calibrated from a direct-current source. Pulse width was measured on the oscilloscope by means of intensity-modulated calibration marks spaced at either 0.1-microsecond or 1-microsecond intervals, and having an accuracy of 0.25 per cent. Pulse-repetition frequency was measured by a pulse counter having an accuracy of the order of 5 per cent. A calibration curve for the circuit of Fig. 3 is shown in Fig. 5.

An Attenuator of "S"-Band Energy*

HARRY R. MEAHL†, SENIOR MEMBER, I.R.E.

Summary—The development of an attenuator having a minimum attenuation of 10 decibels or less and a maximum of 25 decibels or more, together with characteristics suitable to an accessory to a precision wavemeter for field use with "S"-band Army aircraft beacon systems, is described. Both theory and operation are presented.

THEORY

IT IS DESIRABLE to divide the "S"-band attenuator shown in Fig. 1 into three parts for the purpose of analysis: an adjustable-length coaxial input line, an adjustable-length wave guide operating below cutoff frequency, and a fixed-length coaxial output line. The greater part of the attenuation occurs in the adjustable-length wave guide and can be calculated on the basis of field decay in a cylindrical wave guide

below cutoff frequency, as follows:

$$\alpha^1 = 8.686 \frac{2.405}{a} \sqrt{1 - \left(\frac{f}{f_c}\right)^2} \text{ decibels per centimeter}$$

where

a = radius of wave guide in centimeters

f = operating frequency, cycles per second

f_c = cutoff frequency = $(1.15 \times 10^{10})/a$ cycles per second.

For this attenuator $a = 0.47$ centimeter and $\alpha = 42$ decibels per centimeter.

The attenuation, if any, which takes place in the variable-length input line is caused by the impedance mismatch at the input to the attenuating section. Its magnitude is, therefore, affected by the length of transmission line connected to it, as well as by the setting of the attenuator and the operating frequency.

Any attenuation which takes place in the fixed-

* Decimal classification: R396. Original manuscript received by the Institute, December 7, 1945; revised manuscript received, April 23, 1946.

† General Electric Company, Schenectady, N. Y.

‡ S. Ramo and J. R. Whinnery, "Fields and waves in modern radio," p. 313, John Wiley and Sons, Inc., New York, N. Y., 1944.

length output line is also caused primarily by impedance mismatch, but at the input to the wavemeter with which the attenuator is used. Its magnitude is therefore affected by the wavemeter tuning and the operating frequency. A small attenuation, approximately 1 decibel, is caused by the resistive element shown in Fig. 2, whose primary function is to reduce the effect of the attenuator upon the wavemeter tuning, as shown by Fig. 3.

DEVELOPMENT

The problem of obtaining an attenuator for this application which needs only the calibration indicated in the summary at first appeared too easy to require development. However when an obvious means was tried, the connection of a section of coaxial line of adjustable length in parallel with the input circuit of the

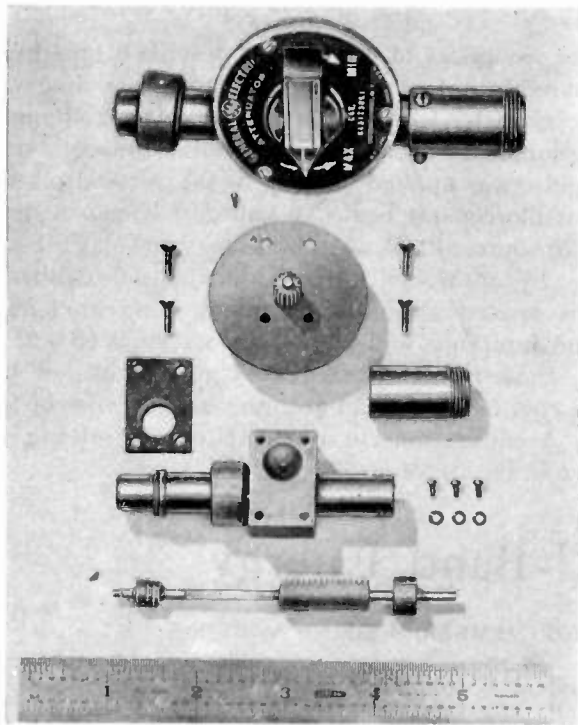
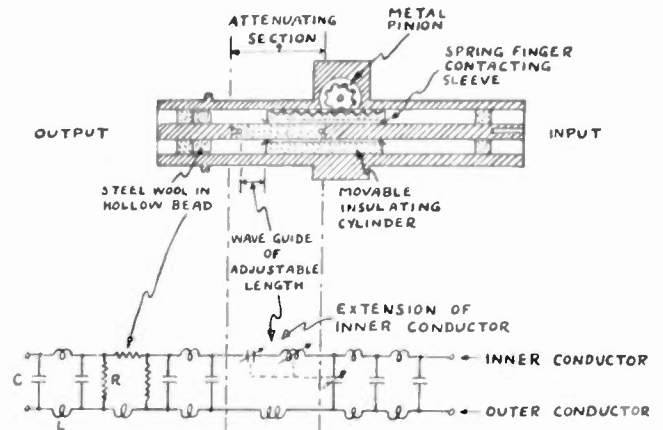

Fig. 1—Microwave attenuator.

wavemeter, it failed. The failure was not in meeting the attenuation specifications, but in meeting them without affecting the accuracy of the wavemeter too much. Since the wavemeter had to be accurate within 0.033 per cent, reactions which are negligible in many systems were too large to allow in this application. The principle of operation of the above attenuator is that an adjustable reactance can be caused at the point of connection by adjusting the length of the short-circuited section of line. This reactance is reduced approximately to zero when the adjustable line is one-half wavelength long, and therefore greatly attenuates the signal reaching a load located within one-quarter wavelength of the point of connection.

Since this first attenuator was primarily reactive in nature, several presumably resistive-type attenuators

were made and tested. They were also sections of coaxial line but were connected in series with the wavemeter input, and high-loss materials, such as polyiron and steel wool, were introduced between the inner and outer conductors through a slot in the outer conductor to



SCHEMATIC DIAGRAM

Fig. 2—Principle of operation.

cause the attenuation. However, these also reacted too much on the wavemeter. A typical frequency characteristic of these attenuators is shown in Fig. 3.

Following these failures, an attenuator made of a section of coaxial line having an adjustable-length gap in the inner conductor and connected in series with the wavemeter was developed by S. C. Clark, Jr. The mechanical details of this design, which has been proved satisfactory by both mechanical and electrical tests and also by use in the field, are shown at the bottom of Fig. 1. Examination of the inner conductor shown just above the steel scale and Fig. 2 will reveal the manner in which the device operates. If the attenuator were assembled with the parts in the positions shown, it would have maximum attenuation, because the adjustable gap in the inner conductor which

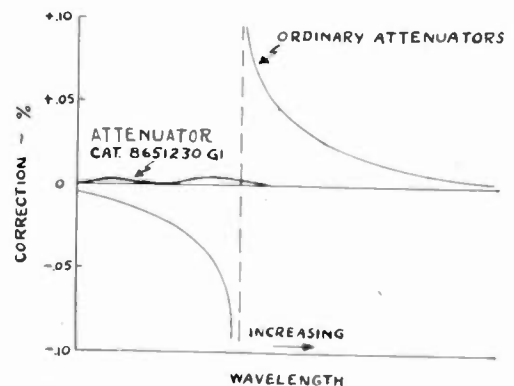

Fig. 3—Comparison of reaction on wavemeter.

changes that section of the coaxial line into a section of wave guide operates below cutoff frequency, and hence into an attenuating section, has its maximum length. The polystyrene cylinder with teeth cut in it is the adjustable element. It carries a metal sleeve which maintains contact with the inner conductor at the end

toward the black bead and extends out over the polystyrene insert in the inner conductor. Thus the length of the attenuating section is reduced when the polystyrene cylinder is driven away from the black bead by turning the pinion which meshes with the rack formed by the teeth in the polystyrene cylinder. The polystyrene insert in the inner conductor is simply a mechanical support. The bead at the left is composite, being made of a solid polystyrene bead with a hollow bead filled with steel wool cemented to it. The black bead at the right and the solid polystyrene bead at the left are the mechanical supports for the assembly.

OPERATION

This attenuator, as should be expected, has a very low real insertion loss. In fact, the insertion of this attenuator when set for minimum attenuation in some systems

has been found to cause the wavemeter response to increase. In most cases however, the minimum attenuation, the effective insertion loss, has been approximately 6 decibels. The maximum attenuation was more than 50 decibels. The effect on wavemeter tuning versus wavelength was satisfactory, as shown in Fig. 3, even for this application where an accuracy within 0.033 per cent had to be maintained. It gave smooth control of wavemeter response, a 10-to-1 change having been obtained from rotating the attenuator knob 16 degrees. In addition, it is small, sturdy, electrically self-shielded, and protected from dirt and moisture.

This attenuator can be used for the smooth control of the flow of "S"-band power wherever any reactive-type attenuator is applicable. Its power-handling capabilities are at least as good as those of the RG-8U cable with which it is usually used, i.e., 90 watts average.

Some Notes on the Copper-Oxide Rectifier and the Thermionic Tube in the Voltage-Doubling Circuit*

RONALD R. GILMOUR†, ASSOCIATE, I.R.E.

Summary—The voltage-doubling circuit is again investigated in this paper. The employment of this circuit and the copper-oxide rectifier is due to a consideration of the demands imposed on the unit described. The tube and the copper-oxide rectifier are thus compared in this circuit.

Expressions are derived in as simple a manner as possible. Graphs of performance are presented. The application of this circuit to radio transmitters and receivers is discussed. It is realized that some of the facts are well known, but the comparisons are found to be somewhat easier if they are quoted.

INTRODUCTION

THIS WORK is the result of an attempt to design a portable source of direct current which would have to respond rather satisfactorily to certain unique demands. Since this rectifier is required to operate off a 50-cycle source, all tests mentioned in this paper were made with this input frequency.

This rectifier is chiefly intended to operate the Wheatstone bridge, particularly in connection with underground-cable faults.

The test results are compared with those of Waidelich.¹

DESIGN REQUIREMENTS

The requirements established for the rectifier were as follows:

- (a) portability; i.e., considerations of weight, size, and mechanical or physical strength of components;

* Decimal classification: R366.34. Original manuscript received by the Institute, July 25, 1945; revised manuscript received, February 19, 1946.

† Test Department, Corporation Electricity Department, Cape Town, South Africa.

¹ D. L. Waidelich, "The full-wave voltage-doubling rectifier circuit," *PROC. I.R.E.*, vol. 29, pp. 554-559; October, 1941.

- (b) capability of supplying 40 milliamperes when the load has any value between 500 ohms and 5000 ohms; i.e., the terminal potential drop variable between 20 and 200 volts;
- (c) ability to withstand sudden short-circuit currents; this occurs occasionally during underground-cable tests when the fault suddenly breaks down completely during the test;
- (d) reasonably pure output; i.e., low percentage of ripple.

The weight of a tube is well in its favor, irrespective of the type of circuit in which it is employed, and since, in this case, only 40 milliamperes at 200 volts are required, a high-vacuum tube such as a type 80 or 5Z3 or 5Z4 would suffice.

As for the copper-oxide rectifier, the following points have to be considered at this juncture:

- (a) no filament transformer winding required—a favorable point;
- (b) robustness—also favorable;
- (c) reverse conduction—inherently unfavorable;
- (d) dependence on temperature—also unfavorable.

Since this power source is intended largely for field work, it becomes a portable one; hence, a small but robust unit is desired, in which case the metal rectifier is supported by (a) and (b) above. Since the only load intended is a Wheatstone bridge, in which the rectifier is operating for relatively short periods at a time, points (c) and (d) become of minor importance. It was decided, therefore, that the copper-oxide rectifier would be more suitable for the above purpose.

Full-wave rectification was chosen, since the percentage ripple is lower than that of the half-wave type

for corresponding conditions. The choice of the voltage-doubling circuit is due to the following analysis.

Assuming a sinusoidal input-voltage wave form, let the required direct-current output effective voltage = V ; let the input voltage = E_{rms} . Then

$$E_{rms} = \frac{V}{0.636} \times 0.707 = 1.11 V$$

and this is the value of the transformer secondary pressure if a bridge circuit is used, and if the center-tapped method is employed, then the full transformer secondary pressure = 2.22 volts (root-mean-square).

In the voltage-doubling circuit $V/E_{max} = 2$, in which case the secondary pressure of the transformer supplying the input to the rectifier becomes (0.353 V) volts (root-mean-square).

During cable-fault localizing, it is well known that sometimes the fault resistance (if any) can break down completely during a test; i.e., the value of the fault resistance may have an initial one of even 5000 ohms collapsing to probably zero during the test. It has been shown¹ that, in the doubling circuit, the value of the short-circuit current is a function of the capacitance. It was decided, therefore, that the voltage-doubling circuit would be an advantage for the type of work mentioned, as the relatively lower input voltage is desirable, and moreover the current-limiting effect of the capacitors under short-circuit conditions is a definite advantage during cable testing.

The following tests and comparisons were made on the unit which was subsequently constructed.

SHORT-CIRCUIT CURRENT

As already shown,¹ the average short-circuit current is given by the expression

$$I_{ave} = 4fCE_{max} \quad (1)$$

but

$$I_{avo} = \frac{2}{\pi} I_{max} \quad (2)$$

and substituting 2 in 1,

$$I_{max} = 2\pi fCE_{max}$$

or

$$I_{rms} = \sqrt{2}\pi fCE_{rms} \quad (3)$$

The curves in Fig. 1 were taken experimentally, (A) following Ohm's law. The equation for curve (B), which is drawn for a constant output current of 40 milliamperes, can be represented by the simple equation

$$y = 0.018x + 32$$

where y = alternating-current input voltage and x = load resistance in ohms, and, when x = zero, y = 32.

Now, since the value of the capacitors used in this unit were 4 microfarads each, and the short-circuit

current is 40 milliamperes, the input voltage, according to (3), is

$$E_{rms} = \frac{40 \times 1000}{2 \times 3.14 \times 50 \times 4} = 31.85 \text{ volts.}$$

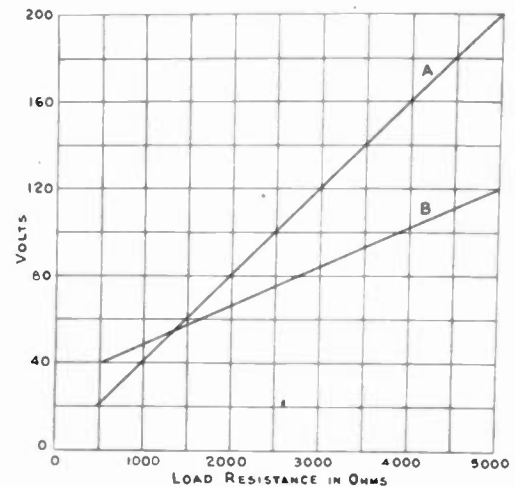

Fig. 1—Graph of load against input voltage of "doubler" unit.

(A) Output terminal volts (Ohm's law)

(B) Input volts (root-mean-square)

Output current maintained at a constant value of 40 milliamperes
 $C = 4$ microfarads (each capacitor)

CURRENT RATIO

The most suitable instruments to use for measuring the input current are of the thermal and high-grade moving-iron types. Rectifier types of milliammeters are liable to errors due to distortion. The instrument used in this case was a precision laboratory-type thermal milliammeter. The results agreed with those obtained

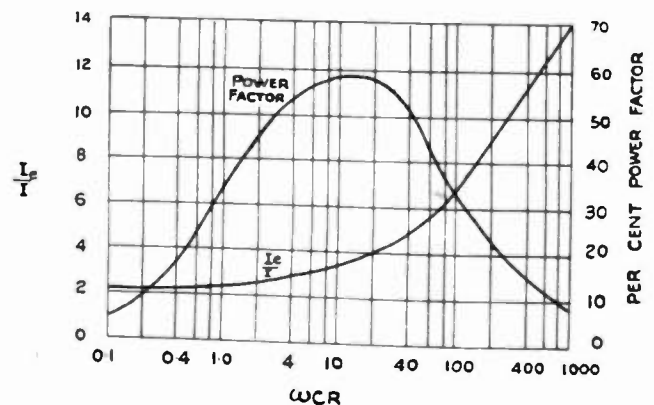

Fig. 2—The ratio of the effective input current to the average output current (I_e/I) and the input power factor.

by Waidelich. To mention one particular test, the current ratio was found to be 3.5 for the following conditions:

- input = 140 milliamperes (effective)
- output = 40 milliamperes (effective)
- load = 5000 ohms.

Since $C = 4$ microfarads, the parameter ωCR is 6.28.

Now if we examine Fig. 2, which is a reproduction of Fig. 6 in footnote reference 1, it will be observed that 6.28 on the abscissa does correspond with a value of approximately 3.5 on the I_e/I graph.

VOLTAGE RATIO

Again agreement was reasonable between the copper-oxide and vacuum-tube doubler circuits, when comparing the ratio between the mean output direct-current voltage and the peak value of the input voltage.

The "no-load" direct-current voltage was measured with an electrostatic voltmeter, but the above ratio was about 1.95, although ωCR is infinity. It will be noticed from Waidelich's curve (Fig. 3, which is a reproduction of his IR/E_m curve, Fig. 4 of footnote reference 1), that a ratio of 2 is attained when $\omega CR = 1000$. Replacing the electrostatic instrument by a precision moving-iron type the resistance of which is 60,000 ohms, the reading was 330 volts for an input of 125 volts root-mean-square, i.e., a peak value of 177 volts; whence $330/177 = 1.86$.

Under these conditions, $\omega CR = 75.5$, which in Fig. 3 corresponds with 1.85, approximately.

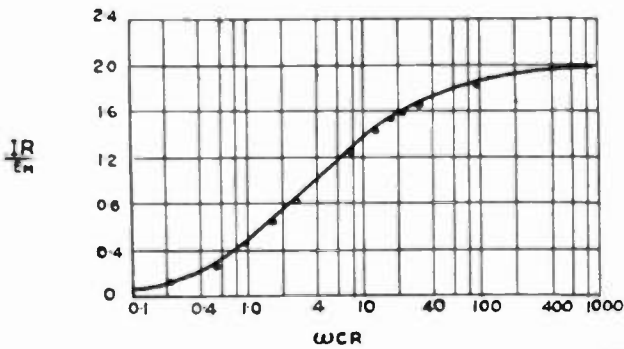

Fig. 3—The ratio of the output average voltage to the maximum value of the alternating supply voltage (IR/E_m).

PERCENTAGE RIPPLE

No actual analysis was made in this connection, but consulting the curves of Shade² and applying them to this unit, the percentage ripple would appear to be as follows.

Fig. 4 (which is an extract of Fig. 7 in footnote reference 2) shows the relationship between percentage ripple and the parameter ωCR , for a voltage doubler. Curve (a) is taken because, although there is no series resistance, the resistance of the copper-oxide rectifiers can have any value up to about 2500 ohms (see later section on resistance characteristics). Curve (a) is drawn for a percentage of $|R_s|/R_L = 10$, whereas in the case of (b) this is drawn for a percentage of $|R_s|/R_L = 0.1$ where $|R_s|$ = tube resistance (root-mean-square equivalent) plus external resistance.

Then, since $C = 4$ microfarads, the percentage ripple for this unit can be taken to be of the order of (a) 14 per cent when the load resistance is 5000 ohms; and (b) 35 per cent when the load resistance is 1000 ohms. The tube resistance, of course, being replaced by the resistance of the copper-oxide unit for the purpose of using the quantity $|R_s|$ above.

² O. H. Shade, "Analysis of rectifier operation," PROC. I.R.E., vol. 31, pp. 341-362; July, 1943.

INPUT POWER FACTOR

This quantity was determined from the ratio of watts to volt-amperes. The actual values of power factor obtained were relatively higher than those in Fig. 2. To cite a particular test, the readings were as follows: wattmeter = 13.1; milliammeter = 140 milliamperes; volts = 125, all measured at the input to the rectifier. Therefore, the calculated power factor is 76 per cent. The load resistance = 5000 ohms, and again $C = 4$ microfarads; hence, $\omega CR = 6.3$, approximately, which on the curve in Fig. 2 corresponds with 58 per cent. It may be well to mention that the thermal milliammeter was used again, and the wattmeter was finally checked against a torsion-head laboratory standard

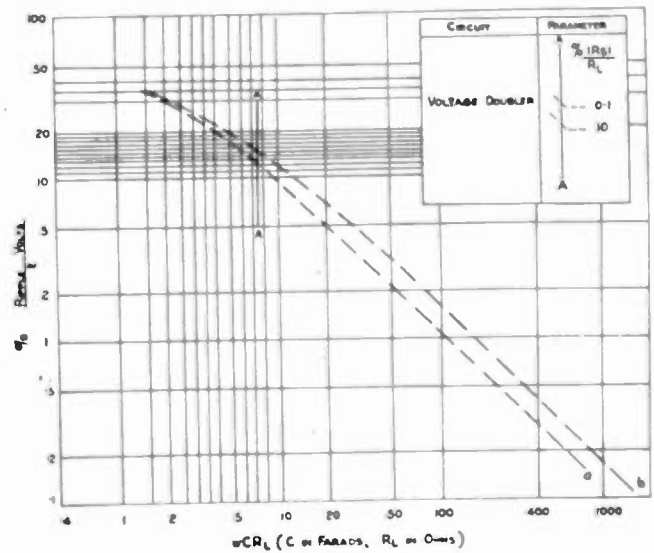

Fig. 4—Root-mean-square ripple voltage of voltage-doubling circuit.

instrument. It is not necessary to mention all the possible sources of error in a wattmeter, as these are generally known, but all these were provided for in the above tests.

RESISTANCE CHARACTERISTICS

It is well known that the "forward" and "reverse" resistance of a copper-oxide rectifier is difficult to define or to determine. An approach to this has been made by Hughes³ to a certain extent, and it is evident that the "forward" resistance decreases as the current increases. In this connection, the vacuum tube behaves in a more satisfactory manner. The mercury-vapor tube is unique in that it maintains a constant voltage drop, irrespective of current changes; i.e., the greater the load the better is the efficiency of the circuit.

It is interesting to note that, in the copper-oxide rectifier, the efficiency of the circuit also increases with the load, since its resistance decreases. Therefore, in this respect the copper-oxide rectifier is in a sense similar to a mercury-vapor tube.

The resistance of each of the rectifier arms used in the

³ E. Hughes, "Copper-oxide rectifiers in ammeters and voltmeters," Jour. I.E.E. (London), vol. 75, p. 453; October, 1934,

unit mentioned in this paper was estimated as follows: an ohmmeter having a full-scale deflection of 2 milliamperes was used. The reading obtained was 2500 ohms; this reading is approximately one quarter of full scale (full scale=zero ohms). Therefore the current passing through the rectifier during this measurement=0.5 milliampere. The normal working current is in the order of 40 milliamperes.

Now according to Hughes' empirical relationship, the current and resistance are connected as follows:

$$R = KI^{-0.8}$$

where K is a constant. It will be seen, therefore, that according to this expression the resistance is about 75 ohms for a current of 40 milliamperes.

This concluded the investigations, as most engineers are aware of the limitations of each type of rectifier.

CONCLUSIONS

The vacuum tube is relatively smaller in size and lighter in weight but more fragile than the copper-oxide rectifier, which has largely been responsible in the advancement of modern alternating-current multi-range measuring instruments.

Broadly speaking, the vacuum-tube and the copper-oxide rectifiers are similar as far as radio and electrical considerations are concerned. The chief dissimilarity is in their resistance characteristics.

Provided the copper-oxide rectifier is not loaded too heavily, it has a reasonably long life. The tube, which can also survive for a long time, appears to be capable of better behavior on and after overloading. However, the copper-oxide rectifier suffers from reverse conduction and depends strongly on temperature. In this connection more elaborate precautions are necessary, whereas practically none are necessary with the vacuum tube. However, these rectifiers are now being used by certain undertakings for high-powered transmitters. With regard to its use in the voltage-doubling circuit, it has given satisfactory performance as a source of direct current for the plates of the tubes in the ordinary commercial broadcast receiver. Normally, a ripple percentage of 5 is quite tolerable in this apparatus, and if 16-microfarad capacitors are used, good performance can be expected.

Regarding radio transmission, two points should be mentioned:

(a) In radiotelephony, ripple of 1 per cent or less is the maximum that can be tolerated for pure quality, indicating rather large capacitors for voltage doubling.

(b) In radiotelegraphy, a slightly higher ripple percentage is permissible for pure notes but it has been found in low-powered transmitters (say, 100 watts) that "chirpy" signals usually result from capacitive-input rectifiers. Also, the sudden rise in voltage each time the telegraph key is opened is undesirable.

Apart from the satisfactory performance of the copper-oxide rectifier as employed in the unit discussed in this paper, in its application to field work and sometimes being subjected to heavy manual and electrical demands, it can be mentioned that a certain well-known firm has experienced good service from it in a voltage-doubling circuit used for "electrostatic precipitation."

In large power stations the copper-oxide rectifier is sometimes employed in certain auxiliary circuits, especially protective, which only operate under certain conditions. The rectifiers have to respond immediately a voltage is applied, in which case a thermionic tube would be a disadvantage as it only begins to conduct after the filament has attained a definite temperature, during which interval valuable time may be lost.

APPENDIX

The expressions representing various quantities associated with the voltage-doubling circuit have already been derived.¹ An attempt is now made to derive some of these in a more simple manner. For the purpose of making the expressions of more practical value it will be assumed that the capacitors are fully discharged during each half cycle, although this is not really the case.

The time taken to charge each capacitor to E_{\max} is $I/4f$ seconds (where f is the supply frequency) and Q (ampere-seconds) = C (farads) $\times E$ (volts) i.e., $I \times t = C \times E$, from which $I = CE/t$. Therefore, $I = 4fCE$ amperes (since $t = I/4f$ seconds) which in the voltage-doubler circuit represents the input current.

Since the energy stored in a capacitor is given by

$$\frac{1}{2}CE^2 \text{ watt-seconds,}$$

the input power can be given by

$$\frac{\frac{1}{2}CE^2}{\frac{I}{4f}} = 2fCE^2 \text{ watts.}$$

If V = output terminal potential drop, R = the load resistance in ohms, and assuming 100 per cent efficiency in addition to the assumption that the capacitors fully discharge during each half cycle, the following approximation is obtained (I = load current):

$$\frac{V^2}{R} = 2fCE^2 \text{ or } I^2R = 2fCE^2$$

from which

$$I = \sqrt{\frac{2fCE^2}{R}}$$

which, although not accurate, has been found to be a rather useful expression.

Contributors to Waves and Electrons Section



FREDERICK H. SANDERS

Frederick H. Sanders received the B.A. degree in physics from the University of British Columbia in 1928 and the Ph.D. degree from the University of California in 1932. From 1934 to 1939 he was technical assistant to the Director, Division of Physics and Engineering, National Research Council, Ottawa, and worked in the field of ultrasonics. He was the leader of the microwave development group at the National Research Council from 1939 to 1943, and from 1943 to 1946 he served as assistant to the Vice-President at Research Enterprises Limited, Leaside, Ontario. He is now scientific assistant to the President, National Research Council, Ottawa.

Dr. Sanders is a member of the American Physical Society, the Canadian Association of Professional Physicists, and the Professional Institute of the Civil Service of Canada.



THOMAS McL. DAVIS

Thomas McL. Davis (M'28-SM'43) was born at Farmington, Maine, August 17, 1890. He was in the United States Navy from 1910 to 1919, serving in the capacities of radio operator, maintenance, design and supervision on battleship and fleet flagship staffs. From 1913 to 1914 he was an operator at New York Navy Yard, and from 1918 to 1919 he served as assistant radio officer at the Washington Navy Yard. He entered civil service in October, 1919, and was assistant to the civilian in charge from 1919 to 1921. Mr. Davis then became the civilian in charge of receiver, wavemeter, and associated equipment design and test until September, 1923, when he was transferred to the Naval Research Laboratory. He had been head of the radio receiver section of NRL since 1926.



EMERICK TOTH

Emerick Toth was born June 26, 1905, at New York, New York. He received the B.S. degree in electrical engineering from the Newark College of Engineering in 1927. From 1927 to 1929 he was associated with the Bakelite Corporation as assistant research physicist. He worked on radio receiver research, development, and design with the Bell Telephone Laboratories, Wired Radio, DeForest Radio Company, Hygrade-Sylvania Corporation, Pilot Radio Corporation, and Bendix Radio Corporation from 1929 to 1938. He joined the staff of the receiver section, radio division, of the Naval Research Laboratory in 1938, and has served as associate head of the section from 1941 to date.



Cyrus J. Creveling (M'46) was born in Bloomsbury, New Jersey, on March 5, 1918, and received the B.E.E. degree from the University of Florida in 1941. His undergraduate work was done while a co-operative student with the Florida Power and Light



CYRUS J. CREVELING

Company, Miami, Florida, and he was employed by this company as a junior engineer after graduation.

Mr. Creveling was appointed a Second Lieutenant in the Signal Corps, November, 1941, and sent to Great Britain as a member of the electronics training group. There he attended the course for ordnance mechanical engineers at the Military College of Science, Bury, Lancashire, and then was stationed at the Telecommunications Research Establishment, Malvern, Worcestershire, developing microwave radar test equipment. In 1944 he was transferred to the office of the Chief Signal Officer in Washington and stationed at the Naval Research Laboratory as a member of the Combined Research Group, in the test equipment section. He was released to inactive duty in the Officers Reserve Corps in May, 1946, and is now a member of the Security Systems Section of the Naval Research Laboratory.



Leonard Mautner (M'46) was born on October 30, 1917, in New York, New York. He received the degree of B.S. in electrical



LEONARD MAUTNER

engineering from the Massachusetts Institute of Technology in 1939. He did graduate study at the Stevens Institute of Technology from 1940 to 1941 and at the Massachusetts Institute of Technology in 1942.

In 1939 Mr. Mautner was an illuminating engineer at the Macbeth Daylighting Corporation in New York City, later joining the Army Signal Corps as radio engineer. In 1942 he joined the television department of the National Broadcasting company, and when broadcasting was curtailed because of the war, he became a staff member of the Radiation Laboratory at the Massachusetts Institute of Technology. Here he was a member of the indicator group, developing a variety of indicator units for radar equipment. In 1944 Mr. Mautner was asked to

serve as a Radiation Laboratory member of the Combined Research Group at the Naval Research Laboratory, Washington, D. C., where he took charge of the display section. In this capacity, he supervised the development of all of the display and interconnection equipment for the Mark V IFF/UNB project. Since 1945, he has been with the Allen B. DuMont Laboratories where he is in charge of the development of television video equipment.

Mr. Mautner is a member of the Eta Kappa Nu association, and has been active on a number of RMA and I.R.E. committees relating to television.

❖

Harry R. Meahl (A'28-M'45-SM'46) was born on March 16, 1905, at Jamesport, Missouri. He received the B.S. degree in electrical engineering from Washington State College in 1927. From 1927 to the present date he has been employed by the General Electric Company and is at this time associated with the general engineering and consulting laboratory of that company.

❖

Ronald R. Gilmour (A'40) was born at Paarl, C. P., South Africa on January 2, 1917. He was educated at the Boy's High School, Rondebosch, C. P., and then spent six months in the Gilmour Engineering Works at Muizenberg, where he obtained practical training in electrical and radio engineering.

After four years at the Cape Technical

College in Cape Town he was graduated in electrical engineering, obtaining distinctions in mathematics and electrotechnics. During this time Mr. Gilmour was on the staff of the meter and instrument testing section of the electricity department of the Cape Town Corporation, becoming senior tester engaged in various electrical measurements and standardization, and in January, 1943, was promoted to assistant meter and testing superintendent of the same department.

Prior to the war Mr. Gilmour made an extensive study of radio and spent four active years in amateur transmission, contacting many countries.

He is an Associate of the South African Institute of Electrical Engineers, a Member of the Association of Scientific Workers of Southern Africa, and of the South African Radio Relay League.



HARRY R. MEAHL



RONALD R. GILMOUR

Abstracts and References

Prepared by the National Physical Laboratory, Teddington, England, Published by Arrangement with the Department of Scientific and Industrial Research, England, and *Wireless Engineer*, London, England.

Acoustics and Audio Frequencies	219
Aerials and Transmission Lines	219
Circuits and Circuit Elements	220
General Physics	222
Geophysical and Extraterrestrial Phenomena	222
Locations and Aids to Navigation	223
Materials and Subsidiary Techniques	224
Mathematics	225
Measurements and Test Gear	225
Other Applications of Radio and Electronics	227
Propagation of Waves	228
Reception	228
Stations and Communication Systems	229
Subsidiary Apparatus	229
Television and Phototelegraphy	230
Transmission	230
Vacuum Tubes and Thermions	231
Miscellaneous	232

The number at the upper left of each Abstract is its Universal Decimal Classification number and is not to be confused with the Decimal Classification used by the United States National Bureau of Standards. The number in heavy type at the top right is the serial number of the Abstract.

ACOUSTICS AND AUDIO FREQUENCIES

- 534.2-14 1
Transmission, Reflection, and Guiding of an Exponential Pulse by a Steel Plate in Water: Part 2 — Experiment—M. F. M. Osborne and S. D. Hart. (*Jour. Acous. Soc. Amer.*, vol. 18, pp. 170-184; July, 1946.) Part 1 (Theory) was abstracted in 3560 of 1945, with brief reference to the present experimental work.
- 534.22-13 2
The Velocity of Sound: a Molecular Property—E. G. Richardson. (*Nature* (London), vol. 158, pp. 296-298; August 31, 1946.)
- 534.26 3
The Diffraction of Sound Pulses: Part 1 — Diffraction by a Semi-Infinite Plane; Part 2 — Diffraction by an Infinite Wedge; Part 3 — Note on an Integral Occurring in the Theory of Diffraction by a Semi-Infinite Screen; Part 4 — On a Paradox in the Theory of Reflexion—F. G. Friedlander. (*Proc. Roy. Soc. A.*, vol. 186, pp. 322-344, 344-351, 352-356, and 356-367; September 24, 1946.)
- 534.321.9:621.396.9 4
Radar in Nature—T. Roddam. (*Wireless World*, vol. 52, pp. 286-288; September, 1946.) The nature of the mechanism by which a bat produces supersonic pulses was described in 258 of 1946 (Hartridge). Its performance is here considered, with a theoretical discussion of the requirements of a radar model using supersonic waves in air.
- 534.84 5
Improvement in the Acoustics of Reinforced Concrete Buildings by the Oelsner Method—(*Tech. Wet. Tijdschr.*, vol. 14, p. 14; January-March, 1945.) In Flemish. Summary of a paper in *Ingenieur-og-Bygningvoesen*, February 10, 1943.
- 621.317.75.029.3:532.593 6
A Frequency Analyser Used in the Study of Ocean Waves—Barber, Ursell, Darbyshire, and Tucker. (See 203.)

NOTE: The Institute of Radio Engineers does not have available copies of the publications mentioned in these pages, nor does it have reprints of the articles abstracted. Correspondence regarding these articles and requests for their procurement should be addressed to the individual publications and not to the I.R.E.

- 621.395.61:534.43 7
Tuned-Ribbon Pickup—W. F. Leidel, Jr., and N. E. Payne. (*Elec. Ind.*, vol. 5, pp. 67-69, 101; October, 1946.) Describes a variable-reluctance type of gramophone pickup in which the armature is supported by a tensioned ribbon. Extremely low mass and a flat response up to 10,000 cycles are claimed.
- 621.396.615.11 8
A Simple "Wien Bridge" Audio Oscillator—H. T. Sterling. (*QST*, vol. 30, pp. 29-32; October, 1946.) Details of the theory of operation show that the oscillator has a good waveform and a uniform output amplitude with respect to frequency. Practical circuits are given for (a) an oscillator having a variable range from 15 cycles to 150 kilocycles, and (b) an oscillator having ten spot frequencies between 20 cycles and 20 kilocycles.
- 621.395.625.6 9
16-mm. Sound-on-Film Recorders—J. Neil. (*Elec. Eng.*, vol. 18, pp. 309-312; October, 1946.)
- AERIALS AND TRANSMISSION LINES
- 621.315.2:621.317.33.029.63 10
The Measurement of Cable Characteristics at Ultra-High Frequencies—Jones and Sear. (See 175.)
- 621.315.21.029.4/6:621.317.33 11
Characteristics of R. F. Cables—Stamford and Quarmby. (See 174.)
- 621.315[.211.2+].22 12
Mineral-Insulated Metal-Sheathed Conductor—F. W. Tomlinson and H. M. Wright. (*Jour. I. E. E.* (London), Part II, vol. 93, pp. 325-335; August, 1946. Discussion, pp. 336-340.) Powdered magnesium oxide is a very satisfactory insulating material. Its dielectric constant is 3.6 and power factor 0.0005. Copper-covered cable with this insulator is suitable for transmission at frequencies up to several hundred megacycles. Properties, applications, and methods of manufacture and installation of such cables are discussed.
- 621.315.232.014.1 13
[Current] Rating of Cables in Ducts—C. C. Barnes. (*Elec. Times*, vol. 110, pp. 583-586; October 31, 1946.) Tables and graphs are given for calculating the rating, which is lower owing to heat effects than for other forms of installation.
- 621.317.336 14
Impedance Matching with an Antenna Tuner—G. G. (*QST*, vol. 30, pp. 38-40; October, 1946.)
- 621.392 15
On the Eigen-Values of an Electromagnetic Waveguide—T. Kahan. (*Compt. Rend. Acad. Sci.* (Paris), vol. 222, pp. 380-381; February 11, 1946.) The behavior of a straight waveguide of rectangular cross section is illustrated by means

of the special case of a square cross section. The form of the vector-potential and nodal surfaces (which divide the guide into electrically distinct portions) is considered for some of the simpler possible modes.

621.392.2 16
On the Propagation of Waves in Curved Guides—M. Jouguet. (*Compt. Rend. Acad. Sci.* (Paris), vol. 222, pp. 537-538; March 4, 1946.) The method of perturbation can be used to determine the deformation of E_0 or H_0 in cylindrical guides even when the conductivity σ of the walls is finite. The perturbation terms remain small provided that the curvature C does not exceed a value independent of σ for E_0 waves and a much smaller value, decreasing to zero as σ increases indefinitely, for H_0 waves. The E_0 waves are stable; the phase velocity and attenuation factor (dependent on σ) are independent of curvature to a second-order approximation. For a perfectly conducting guide the H_0 wave is unstable; for large C and σ a solution still exists but differs radically from the H_0 wave. For rectangular guides, an analogous method yields an approximate formula easier to use than the exact formula obtained by the Bromwich-Borgnis method. If the walls are perfect conductors, the phase velocity is not modified (to a second-order approximation) by the curvature, and both E_0 and H_0 approximation waves are stable.

621.392.43 17
Conditions of Termination in a Waveguide—T. Kahan. (*Compt. Rend. Acad. Sci.* (Paris), vol. 222, pp. 535-537; March 4, 1946.) A proof that if a waveguide is terminated by a semitransparent cavity whose length is an odd number of quarter wavelengths, no standing waves are produced whatever the mode of vibration. For definition of semitransparent cavity see 1795 of 1946.

621.392.43.082.7 18
Note on a Reflection-Coefficient Meter—N. I. Korman. (*Proc. I.R.E. AND WAVES AND ELECTRONS*, vol. 34, pp. 657-658; September, 1946.) The reflection coefficient of a network N terminated by an impedance Z_L is defined as $r = Z_0 - Z_L / Z_0 + Z_L$ where Z_0 is an impedance such that the current through an indicating device V is zero. It is deduced that the indication of V will be proportional to r if (1) N is a linear, bilateral, passive network, (2) Z_0 is a physically realizable impedance, and (3) the output impedance of N equals Z_0 .

621.392.5 19
Equalized Delay Lines—Kallmann. (See 41.)

621.396.67 20
New B.B.C. Mast—(*Elec. Rev.* (London), vol. 139, p. 643; October 25, 1946, *Electrician*, vol. 137, p. 1078; October 18, 1946.) Improved reception of the British Broadcasting Corporation Home Service program on 342.1 meters was made possible from September 29,

1946, by the use of a new 500-foot vertical radiator (with adjustable-capacity loading) erected at Brookman's Park.

621.396.67 21
Aerials—W. Buys. (*Tech. Wet. Tijdschr.*, vol. 14, pp. 6-13, 29-41, and 63-72; January-March, April-June, and July-September, 1945. In Flemish.) Summarizes theory and practice up to 1941.

621.396.67 22
The Calculation of Auxiliary Functions for Straight Receiving Aerials of Any Height—J. Müller-Strobel and J. Patry. (*Helv. Phys. Acta*, vol. 17, no. 6, pp. 455-462; 1944.) An extension of 3527 of 1945 to aerials of any length compared with the wavelength, but assuming constant field strength along the aerial.

621.396.67.011.2 23
Simplifications in the Consideration of Mutual Effects between Half-Wave Dipoles in Collinear and Parallel Orientations—K. J. Affanasiev. *PROC. I.R.E. AND WAVES AND ELECTRONS*, vol. 34, pp. 635-638; September, 1946.) Simple expressions for the mutual impedance which do not involve the S_i and C_i functions are derived. They are in close agreement with the more exact results of Carter (1932 Abstracts, p. 585) for aerial separations greater than one wavelength. For parallel λ^2 dipoles with spacing D the modulus of the mutual impedance is given as $60\lambda/\pi D \Omega$.

621.396.674 24
Radiation from Large Circular Loops—E. B. Moullin. (*Jour. I.E.E.* (London), vol. 93, pp. 345-351; Part III, September, 1946.) A calculation of the radiation resistance and polar diagram of loops of any radius at a large distance. The field can, by suitable choice of radius, be made zero in the equatorial plane or at any angle of elevation. "It is shown that the 'high-angle' radiation can be sensibly removed by using two concentric and coplanar loops having suitably chosen radii; but with this disposition the current must be supplied to both loops and it is impracticable to induce one current from the other. The 'high-angle' radiation can also be much reduced by the use of two similar coaxial large loops in parallel planes, and this offers a disposition which may be useful in practice."

621.396.674.011.2 25
Special Aspects of Balanced Shielded Loops—L. L. Libby. (*PROC. I.R.E. AND WAVES AND ELECTRONS*, vol. 34, pp. 641-646; September, 1946.) An analysis of the impedance of the screened loop aerial in terms of an equivalent uniform transmission-line section. In a numerical example concerning a circular loop of 1-foot diameter, the theoretical resonant frequency (79.4 megacycles) is found to be within 5 per cent of the measured value.

621.396.677:621.397.5 26
Rhombic Antennas for Television—J. Minter. (*Elec. Ind.*, vol. 5, pp. 58-61; October, 1946.) Design data for aerials receiving horizontally polarized signals in the ranges 44 to 215 and 480 to 920 megacycles with polar diagrams for various lengths of side. A forward inclination of the rhombic is used to lower the main lobe.

621.396.678 27
A New Kind of Skyhook—D. T. Ferrer and W. G. Bairn, Jr. (*QST*, vol. 30, pp. 24-25; October, 1946.) A description of a "kytoon" having the advantages of both a kite and a balloon. The casing is made of light nylon fabric and the bladder of neoprene. The kytoon when delated can be carried in a package 14 inches long and 3 inches in diameter. It is used for erecting aerials at mobile stations in a short time.

621.396.67(02) 28
Currents in Aerials and High Frequency Networks [Book Review]—F. B. Piddock. Oxford Univ. Press, 97 pp., 8s.6d. (*Phil. Mag.*, vol. 36, p. 730; October, 1945.) "... no one interested in aerial theory can afford to neglect this hitherto unpublished account." See also 1182 of 1946.

CIRCUITS AND CIRCUIT ELEMENTS

621.3:519.241.6 29
An Extension of Campbell's Theorem of Random Fluctuation—R. S. Rivlin. (*Phil. Mag.*, vol. 36, pp. 688-693; October, 1945.) Campbell's theorem giving the mean-square deviation of the response $(y-y_0)$ of a linear system to a large number of identical random events is extended to the case in which the events are dissimilar, and the quantity $(y-y_0)^2$ is also calculated. In an addendum the result obtained by Rice for $p=3$ in the case of identical events is shown to agree with that of the present paper.

621.3.015.1:621.396.012.8 30
Differentiation of a Voltage—J. Görner. (*Arch. Tech. Messen*, pp. T77-78; July, 1940.) Consideration of RCL, RC, transformer and choke circuits and electromechanical methods.

621.316.313.025 31
A.C. Network Analyzer—N. H. Meyers and N. R. Schultz. (*Gen. Elec. Rev.*, vol. 49, pp. 34-40; September, 1946.) A general description of the analyzer is given. It may be used for determining physical entities from equivalent circuits in problems of the following types:—(a) short circuits, (b) transient stability, (c) steady-state stability, (d) shunting and out-of-step operation of electrical machinery, (e) torsional oscillations, (f) electromagnetic cavity resonators, and (g) Schrödinger equation of atom structure.

Once a particular equivalent circuit has been determined, it can be set up on the analyzer; readings of current, voltage and power then correspond to certain physical entities in the physical system for which the equivalent circuit has been obtained.

621.316.86:546.281.26 32
Silicon Carbide Non-Ohmic Resistors—Ashworth, Needham, and Sillars. (See 141.)

621.316.974:621.318.4.017.31 33
Power Loss in Electromagnetic Screens—C. F. Davidson, R. C. Looser, and T. C. Simmonds. (*Wireless Eng.*, vol. 23, pp. 315-316; November, 1946.) Discussion of the formula derived by C. A. Siocos (2716 of 1946) for the eddy-current density in a plane sheet due to an inductor of finite length. It agrees with the formula derived by the writers (see 1077 of 1946) and is more convenient when the inductor is a solenoid.

621.317.336 34
Impedance Matching with an Antenna Tuner—G. G. (*QST*, vol. 30, pp. 38-40; October, 1946.)

621.318.323.2.042.15 35
Permeability of Iron-Dust Cores—G. W. O.H., H. W. Lawson, and R. E. Burgess. (*Wireless Eng.*, vol. 23, pp. 291-292 and 313-315; November, 1946.) An editorial discussion of various permeability formulas proposed by Doebke and Howe, and the letters from H. W. Lawson and R. E. Burgess which inspired it. Lawson investigates, theoretically, the permeability for three arrangements of particles: (1) uniform distribution of aligned cubes, (2) random distribution of aligned cubes, and (3) uniformly distributed spheres. The results are tabulated and compared with the experimental values of Legg and Given (4424 of 1940) which are much higher at large iron concentrations. Reasons for this discrepancy are discussed.

Burgess comments on Howe's formula (1933

Abstracts p. 173) at small iron concentrations, suggests reasons for the discrepancy between this theory and measurement, and draws attention to L. Page's work (1176 of 1942) which provides satisfactory agreement for large iron concentrations.

621.385:621.3.011.2 36
Negative Resistance Circuit Element—G. A. Hay. (*Wireless Eng.* vol. 23, pp. 299-305; November, 1946.) The possibility of making the dynatron available for dynamic resistance measurement up to 100 megacycles is considered. After a review of previous work, the optimum operating conditions and the equivalent circuit of the dynatron are considered. Measurements of the low-frequency value of the negative resistance (R_n) by a bridge method and of the high-frequency value (R_0) by a tuned circuit method are described. The ratio $\epsilon = R_n/R_0$ is investigated up to 100 megacycles after removing a spurious effect due to resonances in the voltage supply leads. It is concluded that ϵ lies between 0.95 and 1.05 up to 50 megacycles. At higher frequencies the effects of dielectric loss, transit time, and tube-lead inductances limit the usefulness of the dynatron.

621.385.831.012.8 37
Equivalent Noise Representation of Multi-Grid Amplifier Tubes—R. Q. Twiss and E. J. Schremp. (*Phys. Rev.*, vol. 69, p. 696; June 1-15, 1946.) North's results for noise generated by multigrid amplifier tubes are extended to the case where there are arbitrary impedances in all the electrode leads. Equations for a pentode are given. Summary of American Physical Society paper.

621.392 38
Unification of Linear Network Theory—J. D. Weston. (*Jour. I.E.E.* (London), vol. 6, pp. 4-14; January-February, 1946.) "The concern of this paper is not so much to present new concepts as to achieve a unification of old ones in a consistent scheme." The axioms of projective geometry fall into pairs, so that either member of a pair can be converted into the other by interchanging certain words (correlatives). Associated, therefore, with each theorem derived from the axioms is a valid correlated theorem which may be written down from inspection of the first. There is similar quality in the six axioms (restatements of the laws of Kirchhoff, Ohm, Coulomb, and Neumann) applicable to linear, invariant networks having lumped-circuit parameters and in which the currents and potentials are steady or slowly varying. "In virtue of this [dual] correspondence it is possible to halve the number of axioms required, provided we add to them the Principle of Duality."

The correlative terms are listed (e.g., junction and mesh; admittance and impedance; current and fall of potential) and it is shown how they may be used to group the network theorems into pairs. An outline of the application of the above principles to field theory is given, in which H and jE/M and jP are the pairs of correlatives. "It is important to notice... that the same general principles apply to any dynamical system, the axioms of which can be formulated in an analogous way."

621.392.001.1 39
Node-Pair Method of Circuit Analysis—W. H. Huggins. (*PROC. I.R.E. AND WAVES AND ELECTRONS*, vol. 34, pp. 661-662; September, 1946.) It is claimed that the confusion and duplication of the impedance and admittance treatments of circuit analysis could be avoided by greater use of the node-pair method, particularly for tube systems. "The node-pair quantities are the most natural and consistent with those already used in everyday measurements."

- 621.392.5 40
Note on a Parallel-T Resistance-Capacitance Network—A. Wolf. (PROC. I.R.E. AND WAVES AND ELECTRONS, vol. 34, p. 659; September, 1946.) Formulas are developed for the performance of a four-terminal parallel-T resistance-capacitance network which serves for the elimination of a given frequency. It is shown that an unsymmetrical form of the network is advantageous when a high degree of frequency discrimination is desired.
- 621.392.5 41
Equalized Delay Lines—H. E. Kallmann. (PROC. I.R.E. AND WAVES AND ELECTRONS, vol. 34, pp. 646-657; September, 1946.) The decrease in delay time due to decrease in effective inductance of the coil when the wavelength along the line becomes comparable with the length of the line may be compensated by an increase in the capacitance. This capacitance may be artificially increased by copper strips on the outside of the central coiled conductor, insulated from it, from each other, and from earth. Automatic compensation due to the self-capacitance of the coil may suffice with high-impedance lines.
 The technique of measurement of delay and transmission characteristics is discussed and it is concluded that most of the transmission losses at the higher frequencies occur in the insulation of wire forming the coil. The measurement of input impedance and the matching of the line to source and load are also discussed.
 Practical delay lines are described including some with sectional windings. There is a short discussion of the delay in low-pass filters with lumped parameters.
- 621.392.5 42
Network Synthesis, especially the Synthesis of Resistanceless Four-Terminal Networks—B. D. H. Tellegen. (Philips Res. Rep., vol. 1, pp. 169-184; April, 1946.) For a two-terminal network, the 'order' is defined as the order of the differential equation of the free vibrations when its terminals are connected by a resistance. This concept is extended to four-terminal networks, and possible types of resistanceless network for various orders are discussed.
- 621.392.5 43
Determination of a Class of Coupled Circuits with N Degrees of Freedom, Having the Same Natural Frequencies as a Given Assemblage of N Coupled Circuits, and such that each Mesh also has the Same Total and Coupling Self-Inductance as the Corresponding Mesh of the Given Assemblage—M. Parodi. (Compt. Rend. Acad. Sci. (Paris), vol. 222, pp. 379-380; February 11, 1946.) A continuation of 2501 of 1946. The self-inductance condition is satisfied by requiring one of the matrices involved in the earlier theory to be of a special type.
- 621.392.5:621.316.722.078.3 44
The Theory of the Non-Linear Bridge Circuit—G. N. Patchett. *Jour. I.E.E.* (London), part III, vol. 93, p. 343; September, 1946.) Discussion of 867 of 1946.
- 621.392.5:621.316.722.078.3:621.326[1+.3]/4 45
The Characteristics of Lamps as applied to the Non-Linear Bridge, Used as the Indicator in Voltage Stabilizers—G. N. Patchett. (*Jour. I.E.E.* (London), part III, vol. 93, pp. 305-322; September, 1946.) The effect of ambient temperature and vibration on the usefulness of various types of lamp in direct-current bridges is considered. "Experimental and mathematical results are given for the response time of various lamps when used in this circuit. Methods of overcoming this delay by means of suitably designed capacitance-resistance networks are given, together with experimental results." See also 867 of 1946.
- 621.392.52 46
The Universal Characteristics of Triple-Resonant-Circuit Band-Pass Filters—K. R. Spangenberg. (PROC. I.R.E. AND WAVES AND ELECTRONS, vol. 34, pp. 629-634; September, 1946.) "The universal insertion loss versus frequency characteristics of a band-pass filter composed of one, two, or three lossless resonant circuits in a loosely coupled cascade connection between a source and a load impedance are given. The effects of load and source coupling and of intermesh coupling upon pass-band insertion-loss variations and upon bandwidth are discussed."
- 621.392.52 47
Double-Derived Terminations—R. O. Rowlands. (*Wireless Eng.*, vol. 23, pp. 292-295; November, 1946.) Extension of an earlier method (872 of 1946) of terminating complementary filters at their common ends so that the real part of the image impedance is that of a double-derived section. The technique now described permits a wider choice of attenuation function for a prescribed impedance function.
- 621.392.52.015.3 48
Transient Response of Filters—C. C. Eaglesfield. (*Wireless Eng.*, vol. 23, pp. 306-307; November, 1946.) Analysis of the response of a 6 element symmetrical filter section to a sudden application of $\cos \omega_0 t$, on the assumption that the pass-bandwidth is small compared with the central frequency. Equation (7) for the envelope of the output voltage has the same form as Tucker's empirical equation (see 1188 of 1946) but there is a discrepancy between the numerical results which is not fully understood.
- 621.392.52.091 49
The Effect of Incidental Dissipation in Filters—E. A. Guillemin. (*Electronics*, vol. 19, pp. 130-135; October, 1946.) A theoretical paper which presents "a method of ascertaining the effect of these losses on propagation factor, reflection factor and interaction factor." Approximate formulas are developed for the various portions of a low-pass filter characteristic. It is shown how to extend the results to more complicated networks.
- 621.394/.397].645.34 50
A Variation on the Gain Formula for Feedback Amplifiers for a Certain Driving-Impedance Configuration—T. W. Winternitz. (PROC. I.R.E. AND WAVES AND ELECTRONS, vol. 34, pp. 639-641; September, 1946.) An expression is obtained for the gain when the source impedance is the only one across which the feedback voltage is developed. This expression is then used to obtain the response, to a Heaviside unit step, of differentiating and integrating amplifiers and a sweep amplifier driving a cathode-ray tube with magnetic deflection.
- 621.394/.396].645.015.33 51
Pulse Transmission in Amplifiers—A. E. Newlon. (*Electronics*, vol. 19, pp. 116-121; October, 1946.) An experimental investigation carried out with long pulses at a carrier frequency of 460 kilocycles. The results may be 'scaled' to cover much shorter pulses. The rounding of the leading edge and the increase in length of the pulse are determined for transmission through amplifiers having various steady-state response characteristics; simple expressions are derived empirically for the pulse distortion in terms of such characteristics. The transmission properties of amplifiers employing single- and double-tuned circuits are compared.
- 621.396.611:518.61 52
Calculation of the Electromagnetic Field, Frequency and Circuit Parameters of High-Frequency Resonator Cavities—H. Motz. (*Jour. I.E.E.* (London), part III, vol. 93, pp. 335-343; September, 1946.) The wave equation $\Delta\phi + (\omega^2/c^2)\phi = 0$ is replaced by a system of difference equations which for free vibrations are soluble only for the 'proper' values of ω/c . A method for finding the least value of ω/c without solving a determinantal equation is described. The sharp corners of klystron resonator boundaries present a special problem. The analytic behavior of the fields near such sharp corners is allowed for, in a manner well suited to the relaxation method of solving the equations; the computation work is thereby reduced. Once the field components and the resonant frequency are found, the beam impedance and the damping constant are easily determined.
- 621.396.611:534.014.2 53
An Experimental Investigation of Forced Vibrations in a Mechanical System having a Non-Linear Restoring Force—C. A. Ludeke. (*Jour. Appl. Phys.*, vol. 17, pp. 603-609; July, 1946.) The apparatus is capable of generating and recording forced vibrations; and the experimental waveforms are compared with the theoretical results given by three graphical methods due to Martienssen (*Phys. Z.*, vol. 11, pp. 448-460; 1910), den Hartog (*Jour. Frank. Inst.*, vol. 216, pp. 459-473; October, 1933), and Ranscher (*Jour. Appl. Mech.*, vol. 5, pp. A169-A177; 1938). In all cases, the waveforms of the resulting motion are nearly sinusoidal as long as the frequency of the observed motion is the same as the frequency of the disturbing force; but for a certain kind of nonlinearity the frequency of the forced vibration can be made a submultiple (e.g. 1/3 or 1/5) of that of the driving force.
- 621.396.611.3 54
Universal Optimum-Response Curves for Arbitrarily Coupled Resonators—P. I. Richards. (PROC. I.R.E. AND WAVES AND ELECTRONS, vol. 34, pp. 624-629; September, 1946.) Generalized analysis of the frequency response of a source and sink linked by n coupling elements and n resonators, with the restrictions that (1) all the elements are lossless, (2) the coupling circuits are not resonant near the central frequency f_0 , (3) all the resonators have their resonant frequency near f_0 , and (4) the desired bandwidth Δf is small compared with f_0 .
 The overall loss M has the form $10 \log(1+Z)$ decibels where Z is a polynomial of degree $2n$ in x and where $x = (f-f_0)/\Delta f$ and f is any frequency. There is only one optimum form for Z giving maximum off-bank rejection with $M \leq M_0$ (the allowed loss) in the pass band. This is $Z = d[T_n(2x)]^2$ where $d = [\text{antilog}_{10}(M_0/10) - 1]$, and $T_n(2x)$ is the Tchebycheff polynomial of degree n .
- 621.396.615.11 55
A Simple "Wien Bridge" Audio Oscillator—Sterling. (See 8.)
- 621.396.615.17 56
Multivibrator Circuits—N. W. Mather. (*Electronics*, vol. 19, pp. 136, 138; October, 1946.) Basic types collected for reference, showing waveforms at different points, methods of injecting synchronizing signals, and frequency-determining equations.
- 621.396.616.029.64 57
Buzzer Signal Generator for 3000 Mc—(*Electronics*, vol. 19, p. 140; October, 1946.) A buzzer produces radio-frequency pulses of complex waveform which pass through a coaxial cable and a coupling loop to a resonator tunable from 1000 to 3500 megacycles. The output is controlled by a piston attenuator.

- 621.396.645 58
Preventing Self-Oscillation in Tetrode Amplifiers—P. D. Frelich. (*QST*, vol. 30, pp. 22-23, 112; October, 1946.) The grid must be driven from a source of low impedance, e.g., a cathode follower. Practical details of a typical circuit are given.
- 621.396.645 59
Transoceanic Radio Amplifier—C. F. P. Rose. (*Bell Lab. Rec.*, vol. 24, pp. 326-329; September, 1946.) A description of the Western Electric D-158974 amplifier, the frequency of which can be rapidly changed between 4.5 and 23 megacycles and which can operate for 22 hours a day.
The amplifier has one stage employing four 25-kilowatt tubes connected in a push-pull bridge-neutralized circuit with the two tubes on each side of the circuit connected in parallel. The outdoor power plant transforms the three-phase input of 4160 to 230 volts for the low-voltage equipment and to 13,000 volts for the three-phase high-voltage rectifier.
- 621.396.645.35 60
Gas-Tube Coupling for D.C. Amplifiers—F. Iannone and H. Baller. (*Electronics*, vol. 19, pp. 106-107; October, 1946.) "Combining a cathode follower with a gas diode gives a stable and efficient coupling network." The grid of the cathode follower is connected directly to the anode of the driver stage, while the isolating gas tube is in the cathode circuit of the cathode follower.
- 621.397.645 61
Video Amplifier H.F. Response: Part 1—*Wireless World*, vol. 52, pp. 301-302; September, 1946.) The procedure for determining the optimum circuit values for the shunt-corrector circuit is given, together with several examples. See part 2 below.
- 621.397.645 62
Video Amplifier H.F. Response: Part 2—*Wireless World*, vol. 42, pp. 333, 334; October, 1946.) The procedure is explained for finding circuit values (a) for the flattest frequency response, and (b) for critical damping, given the drop in response required at a known maximum frequency, or the response required at a known time after the onset of a pulse and the total circuit capacitance. See part 1 above.
- 621.392:517.432.1(02) 63
Heaviside's Electric Circuit Theory [Book Review]—H. J. Josephs. Methuen, London, 115 pp., 4s 6d. (*Wireless World*, vol. 52, p. 332; October, 1946.) See also 2535 of 1946.
- 621.396.67(02) 64
Currents in Aerials and High Frequency Networks [Book Review]—Pidduck. (See 28.)
- GENERAL PHYSICS
- 530.162 65
On Onsager's Principle of Microscopic Reversibility—H. B. G. Casimir. (*Philips Res. Rep.*, vol. 1, pp. 185-196; April, 1946.) Onsager's theory of reciprocal relations in irreversible process is summarized and the fluctuations in the parameters of an adiabatic system are evaluated in a general form. The theory is applied to a number of simple examples: the thermomolecular pressure difference, the conduction of heat in crystals, and the conduction of electricity of solids, considered in terms of an arbitrary four-pole.
- 535.13+621.396.11 66
On an Interpretation of the Propagation of E.M. Waves and Its Consequences—Haubert. (See 218.)
- 535.241.4 67
"Foot-Lambert" Unit of Picture Brightness—(*Elec. Ind.*, vol. 5, pp. 57, 111; October, 1946.) Definition of the term, and its adoption in the television industry.
- 535.343.4+538.569.4.029.64+621.396.11.029.64]:551.57 68
The Absorption of 1-Cm Electromagnetic Waves by Atmospheric Water Vapor—Kyhle, Dicke, and Beringer. (See 219.)
- 535.343.4+621.317.011.5+621.396.11.029.64]:546.171.1 69
The Inversion Spectrum of Ammonia—W. E. Good. (*Phys. Rev.*, vol. 70, pp. 213-218; August 1-15, 1946.) For a preliminary account see 3236 of 1946.)
- 536:621.3.012.8 70
Thermal Inductance—R. C. L. Bosworth. (*Nature*, (London), vol. 158, p. 309; August 31, 1946.) Earlier theory suggested that there are no inductances in the equivalent circuits of a thermal system because of the absence of oscillatory phenomena. Further theoretical and experimental investigation shows that transients in a fluid system with convection currents can only be explained by postulating an inductance corresponding to the kinetic energy of the currents.
- 537.122:[537.312.62+538.224] 71
Diamagnetism and Superconductivity of a Collective Electron Assembly—W. Band. (*Proc. Camb. Phil. Soc.*, vol. 42, part 3, pp. 311-327, October, 1946.)
- 537.122:538.3 72
The Classical Equations of Motion of an Electron—C. J. Eliezer. (*Proc. Camb. Phil. Soc.*, vol. 42, part 3, pp. 278-286; October, 1946.)
- 537.222.1 73
The Two-Dimensional Electric Field of a Single Semi-Infinite Rectangular Conductor—N. Davy. (*Phil. Mag.*, vol. 36, pp. 694-705; October, 1945.) The equipotentials and lines of force inside and outside a charged semi-infinite rectangular conductor are investigated theoretically and experimentally and their distribution shown in diagrams. The electric intensities, surface densities, total charges, capacitances, and mechanical forces on an external object are discussed, and special cases of a semi-infinite thin plate and an infinitely narrow hollow conductor are considered.
- 537.226:62 74
Theoretical Physics [of Dielectrics], in Industry—Fröhlich. (See 124.)
- 537.291 75
Influence of Space Charge on the Bunching of Electron Beams—L. Brillouin. (*Phys. Rev.*, vol. 70, pp. 187-196; August 1-15, 1946.) The application of the Llewellyn method of integration to electron motion within plane structures, taking account of space charge effects, is described. The conditions for bunching, i.e., intersection of trajectories, are investigated by this method for the cases of (1) a conventional plane diode, (2) a diode with given initial electron velocity (with sinusoidal velocity modulation as a special case), (3) a plane magnetron, and (4) a plane magnetron with velocity modulation. In the last case it is shown that multiple intersections occur with strong magnetic fields.
- 537.5:621.385.18.029.64 76
Conductivity of Electrons in a Gas at Microwave Frequencies—H. Margenau. (*Phys. Rev.*, vol. 69, p. 698; June 1-15, 1946.) "Using the energy distribution law, the complex conductivity is calculated as function of electron density, gas pressure and frequency of the field." The results are applied to transmitter-receiver switches. See 3818 of 1946. Summary of American Physical Society paper.
- 537.531+539.165 77
Calorimetric Experiment on the Radiation Losses of 2-Mev Electrons—W. W. Buechner and R. J. Van de Graaff. (*Phys. Rev.*, vol. 70, pp. 174-177, August 1-15, 1946.)
- 538.691 78
Apparatus showing the Path of an Electrified Particle in a Magnetic Field—J. Loeb. (*Compt. Rend. Acad. Sci.* (Paris), vol. 222, pp. 488-490; February 25, 1946.) If a light flexible wire is placed in any given magnetic field, the ratio of the (direct) current carried to the tension can be chosen so that it assumes the shape of the trajectory of a given charged particle in the same field. For example, a silver wire of diameter 2.10^{-3} centimeters carrying a current of 500 milliamperes and with a tension of 18 dynes represents a particle charged to 10,000 volts. The method can be applied to the study of (a) the motion of charged particles in the earth's magnetic field, (b) finding pairs of image points for magnetic electron lenses, and (c) the movement of ions in apparatus used in nuclear chemistry.
- 539.16.08 79
A Report on the Wilson Cloud Chamber and Its Applications in Physics—N. N. Das Gupta and S. K. Ghosh. (*Rev. Mod. Phys.*, vol. 18, pp. 225-290; April, 1946.) A comprehensive account of recent developments in the design and use of the apparatus, with particular reference to its application to the study of cosmic rays. The physics of drop formation is also discussed. There is an extensive bibliography included.
- 546.3+669 80
Electrons and Metals: Part 2—The Nature of a Metal—Hume-Rothery. (See 145.)
- 530.145(02) 81
Philosophic Foundations of Quantum Mechanics [Book Review]—Reichenbach. (See 339.)
- 537+538(075.3) 82
Principles of Physics. Vol. 2: Electricity and Magnetism [Book Review]—F. W. Sears. Addison-Wesley Press, Cambridge, Massachusetts, 1946, 434 pp., \$5.00 (*Science*, vol. 104, pp. 112-113; August 2, 1946.) Written for a two-year elementary course. "A genius for clear explanations runs through . . . the whole series. . . . The usual welter of units and viewpoints is brought here into a lucid, teachable orderliness." Volumes 1 and 3 were published in 1945.
- 537.591(042) 83
Kosmische Strahlung [Book Review]—W. Heisenberg (Editor). Springer, Berlin, 1943. (*Schweiz. Arch. Angew. Wiss. Tech.*, vol. 12, p. 104; March, 1946.) Reprints of lectures given at the Max Planck Institute, Berlin. ". . . in highly concentrated form, the best review of the properties of cosmic radiation hitherto published."
- GEOPHYSICAL AND EXTRA-TERRESTRIAL PHENOMENA
- 523.2:621.396.9 84
Radar Measurement of Inter-Planetary Distances—(See 105.)
- 523.2:621.396.9:621.396.1 85
Astronomical Radar—Clarke. (See 106.)
- 523.72:621.396.822.029.62 86
Circular Polarization of Solar Radio Noise—E. V. Appleton and J. S. Hey. (*Nature* (London), vol. 158, p. 339; September 7, 1946.) Application of the magneto-ionic theory to the radiation of electromagnetic waves from sunspots shows that such radiation (solar noise) should be circularly polarized. This result was experimentally verified for noise from sunspots on a frequency of 85 megacycles. See also 323 of 1946 (Appleton) and 1825 of 1946 (Hey: Stratton) and 87 and 89 below.
- 523.72:621.396.822.029.62 87
Origin of Solar Radiation in the 1-6 Metre Radio Wave-Length Band—K. O. Kiepen-

heuer. (*Nature* (London), vol. 158, p. 340; September 7, 1946.) It is claimed that the oscillation of electrons in circular orbits under the influence of the magnetic field in the neighborhood of a sunspot is sufficient to explain the increased radiation of solar noise from these regions. Also 86 and 89.

523.72:621.396.822.029.62 88

Polarization of Solar Radio-Frequency Emissions—D. F. Martyn. (*Nature* (London), vol. 158, p. 308; August 31, 1946.) Observations were made at Canberra on 200 megacycles of the large sunspot group at the end of July, 1946. Four Yagi arrays in two perpendicular sets spaced by wavelength/4 in the line of sight were used to accept only one sense of circular polarization. The (power) ratio of right-handed polarization to left-handed was about 7:1 before the group reached the solar meridian, but became 1:5 after the group had crossed it. Magneto-ionic theory shows that in both cases the "extraordinary" ray is stronger than the "ordinary." See also 1823 of 1946 (Pawsey, Payne-Scott, and McCready) and 3252 of 1945 (Southworth).

523.72:621.396.822.029.62 89

Solar Radiation on 175 Mc/s—M. Ryle and D. D. Vonberg. (*Nature* (London), vol. 158, pp. 339-340; September 7, 1946.) By the use of two aerial systems spaced several wavelengths apart, solar radiation on a frequency of 175 megacycles has been observed even on days of low sunspot activity. The method is analogous to Michelson's interference method of measuring stellar diameters. On the occasion of the passage of a large sunspot, the approximate diameter of the source of radiation was found to correspond with that of the visual spot. The circular polarization of the radiation from the spot was confirmed. See also 86 and 87 above, and 1823 of 1946 (Pawsey, Payne-Scott, and McCready).

523.74/.75]:550.385 90

Magnetic Storms and Solar Activity, 1945—(*Observatory*, vol. 66, p. 225; February, 1946.) Statement of sunspot numbers, positions, and sizes, with number and intensity of solar flares. Eleven geomagnetic storms were recorded; there was little tendency of a recurrence at 27-day intervals as in the recent sunspot minimum epoch.

532.746:[550.385+621.396 91

Sunspots and Radio—H. S. Jones (*Observatory*, vol. 66, pp. 326-327; August, 1946.) Lecture by the Astronomer Royal on the history and characteristics of sunspots, and the consequent radio fade out, radio noise, and magnetic storms.

523.747:550.38 92

On the Coincidence of Short Period Magnetic Activity and the Appearance of Faculae on the Sun—M. Burgaud. (*Compt. Rend. Acad. Sci.* (Paris), vol. 222, pp. 563-564; March 4, 1946.) It is suggested, as a result of examining past records, that geomagnetic disturbances of gradual commencement are connected with the growth, or rather the birth, of faculae. Tables are given comparing geomagnetic disturbances with the appearance of calcium flocculi for January-February, 1925, and for 1920-1931.

537.591 93

Cosmic Rays and Their Origin—A. C. B. Lovell. (*Endeavour*, vol. 5, pp. 74-79; April, 1946.) "This article gives a brief description of recent work and of previous experiments." The nature of the incident radiation from space is discussed together with the ensuing collision processes.

537.591 94

Cosmic Radiation above 40 Miles—S. E. Golian, E. H. Krause, and G. J. Perlow.

(*Phys. Rev.*, vol. 70, pp. 223-224; August 1-15, 1946.) Cosmic-ray data at heights of 200,000 to 350,000 feet have been obtained by apparatus contained in a V-2 rocket. A number of counters in the warhead were made to transmit results to the ground by multichannel radio equipment. The counters were arranged to provide data on showers and coincidences, one set being shielded by lead. Provisional results are given.

537.591 95

On the Production of Penetrating Ionizing Particles by the Non-Ionizing Component of Cosmic Radiation—P. J. G. de Vos and S. J. du Toit. (*Phys. Rev.*, vol. 70, pp. 229-230; August 1-15, 1946.)

537.591 96

The Power Spectrum of the Cosmic-Ray Cascade Component—E. P. Ney. (*Phys. Rev.*, vol. 70, pp. 221-222; August 1-15, 1946.)

539.16.08 97

A Report on the Wilson Cloud Chamber and Its Applications in Physics—Das Gupta and Ghosh. (*See* 79.)

550.38 98

Induction Effects in Terrestrial Magnetism: Part 2—The Secular Variation—W. M. Elsasser. (*Phys. Rev.*, vol. 70, pp. 202-212; August 1-15, 1946.) For part 1 see 1834 of 1946; see also 958 of 1942.

550.38 99

On the Origin of Terrestrial Magnetism—Y. P. Bulahevich. (*Bull. Acad. Sci.* (U.R.S.S.), sér. géogr., géophys., vol. 8, nos. 2 and 3, pp. 93-95; 1944. In Russian.) According to Haalck's theory the existence of temperature and pressure gradients in the crust of the earth causes a partial movement of electrons from the central part of a metallic nucleus towards its periphery. The rotation of the redistributed charges, owing to the diurnal rotation of the earth, causes the appearance of the magnetic field. A formula is given for the magnetic moment M in which a coefficient β is determined by equating M to an observed value. Haalck's theory is based on erroneous conceptions of the behavior of electrons in a metal and if β is calculated from theoretical considerations instead of an empirical comparison, the formula for M will give a value 10^{14} times too low.

551.509 100

Weather Forecasting—H. B. Brooks. (*Electronics*, vol. 19, pp. 84-87; October, 1946.) A brief account of the methods and equipment used by the United States Army for the measurement of wind velocity at high levels in the atmosphere, and of the application of centimeter-wave radar apparatus to storm detection. The importance of these techniques in weather forecasting and in reducing flying risks is indicated.

551.510.535:621.396.11 101

The Effect of the Ionosphere on Radio Communication—McNicol. (*See* 220.)

624.13 102

Soil Compaction, Moisture, and [load] Bearing Value—A. H. Gawith. (*Jour. Inst. Eng.*, (Australia), vol. 18, pp. 109-115; June, 1946.)

LOCATION AND AIDS TO NAVIGATION

519.2 103

On the Location of a Point on a Plane by Cross Bearings from Three Known Points—M. I. Yudin. (*Bull. Acad. Sci.* (U.R.S.S.), sér. géogr. géophys., vol. 8, nos. 2 and 3, pp. 96-102; 1944. In Russian.) Experience has shown that in plotting on a chart the position of a point in a plane by taking bearings from dif-

ferent known points, the most effective results are obtained when these observations are taken from three such points. Because of errors in observations, the straight lines drawn from the three points will not intersect at a single point, but form a small triangle. In the present paper equations are derived for determining the most probable position O' of the observed point within the area of the triangle, and for calculating the quadratic error of such a determination. This is compared with the quadratic error for the case when two observations only are made. The advantages of using three observation points are discussed and methods are indicated for the most rational selection of the observation points. In conclusion, a graphical method for determining O' is described.

The method discussed has wide applications in artillery practice and in geodesic surveys. It is also used in radio direction finding and for various other purposes such as determination of the wind from three angles of drift of an aeroplane. For an extension of this paper see 2959 of 1946.

621.396.9 104

The Evolution of Radiolocation—R. A. Watson-Watt. (*Jour. I.E.E.* (London), part I, vol. 93, pp. 374-382; September, 1946.) A general historical survey of British radar development, delivered at the Institute of Electrical Engineers Radar Convention, March, 1946. Fundamental scientific research, the British radio industry, and the needs of the Royal Air Force all vitally affected radar development; the interplay of operational and technical experience and opinion, and close collaboration between scientists and Service users might be called the real secret weapon. A few 'technical milestones' briefly described were: monostatic working; first radar responder system; rotating beams; precision range- and direction-finding; airborne and shipborne radar; the plan-position indicator; common aerial for transmission and reception; the "memory tube"; hyperbolic navigation; development of centimeter technique; terrain discrimination; unorthodox visibility and radar detection of clouds; and location of V-2 sites.

In conclusion, tribute is paid to the radio industry's achievements under 'crash programme' conditions, and some outstanding land, sea, and air uses of radar as a weapon of war are mentioned.

621.396.9:523.2 105

Radar Measurement of Inter-Planetary Distances—(*Observatory*, vol. 66, no. 830, pp. 193-194; February, 1946.) Successful radar detection of the moon suggests the use of radar to measure interplanetary distances more accurately. Milne's kinematic relativity theory assumes that astronomical distances are thus measured.

621.396.9:523.2:621.396.1 106

Astronomical Radar—A. C. Clarke. (*Wireless World*, vol. 52, pp. 321-323; October, 1946.) A description of United States Signal Corps work on radar echoes from the moon using a parabolic aerial array, and a discussion of the possibility of obtaining echoes from the nearer planets or the sun by pulse methods using either microwave or optical frequencies. Future applications of lunar reflection for point-to-point radio transmission are suggested.

621.396.9:534.321.9 107

Radar in Nature—Roddam. (*See* 4.)

621.396.9:621.385.832 108

Skiatron—(*See* 302.)

621.396.93 109

Naval Airborne Radar—L. V. Berkner. (*PROC. I.R.E. AND WAVES AND ELECTRONS*,

vol. 34, pp. 671-706; September, 1946.) "Requirements in the early months of the war were fulfilled by meter-wave radar using lobe-switching techniques. The development of microwave radar gave enormous impetus to airborne applications and produced advanced types for air-to-air interception, high- and low-altitude bombing, reconnaissance, submarine search, and many specialized applications. The sharp beam produced by microwave radiation with relatively small antennas makes microwave techniques particularly adaptable to aircraft use and provides a vastly improved display permitting installation with low aerodynamic drag. Several types of airborne radar are briefly described and illustrated. Fundamental problems of design are reviewed. Related problems such as size, weight, and performance at high altitude are considered and solutions are discussed. Several types of display particularly suited to aircraft use, such as PPI, B, O, and G are illustrated. Utilization, applications, and advantages of auxiliary devices, such as computers, beacons, delay circuits, etc., are discussed. Solutions to systems problems introduced by use of a multiplicity of electronic gear within the aircraft are reviewed. The limitations and advantages of airborne radar as a solution to future aircraft problems are briefly considered."

621.396.93 110

Airborne Search Radar—J. H. Cook. (*Bell. Lab. Rec.*, vol. 24, pp. 321-325; September, 1946.) The American ASH or AN/APS-4 airborne radar equipment has a bombshaped unit containing the aerial, power circuits, transmitter and receiver. It weighs 150 pounds (with associated units) and hangs in a standard bomb-rack under the wing of the aircraft. The wavelength is 3.2 centimeters, and beamwidth 6 degrees. The beam is scanned horizontally over 150 degrees once or twice per second. The equipment is used for ground scanning or to determine the relative elevation of another aircraft. Reports of its operational use are included.

621.396.93 111

Radar for Carrier-Based Planes—C. B. Barnes. (*Electronics*, vol. 19, pp. 100-105; October, 1946.) Details of the APS-4 lightweight radar equipment operating on about 9375 megacycles. The equipment is suitable for search and interception roles while provision is also made for beacon operation. In each application type-B display is used (slant range, and azimuth on a Cartesian graticule) in interception operation there is special provision for simultaneous indication of the angle of elevation of the target on the display tube.

621.396.933 112

Radio Aids to Civil Aviation—(*Engineering* (London), vol. 162, p. 254; September 13, 1946.) An editorial dealing with the visit of delegates of the Provisional International Civil Aviation Organization to inspect British equipment already in operation for controlling aircraft, and other experimental apparatus. Methods demonstrated included short-range supervision of flight and control of aircraft outside the approach zone, using very-high-frequency voice telephony and long-distance communication associated with teleprinters. Demonstrations were also given of radar methods of aircraft control, Babs and Gee. For another account see *Electrician*, vol. 137, p. 718; September 13, 1946.

621.396.933.2 113

On the Error in the Determination of the Median Plane of a Radio Beacon in a Tilted Airplane—K. F. Niessen. (*Philips Res. Rep.*, vol. 1, pp. 161-168; April, 1946.) The electric field from a vertical radiator situated on the ground has a radial as well as a vertical com-

ponent at an elevated receiving point such as an aircraft. The effect of this on the accuracy of air-navigation systems having spaced vertical radiators is considered. It is shown that bearing errors will occur if the aircraft aerial responds to nonvertical electric fields, e.g., when the aircraft banks.

621.396.9(02) 114

Introduzione alla Radiotelemetria Radar [Book Review]—U. Tiberio. Editore Rivista Marittima, Rome, 1946, 277 pp., 300 lire. (*Nature* (London), vol. 158, pp. 288-289; August 31, 1946.) "... an account of the Italian research on radar from 1935 until the end of hostilities. The treatment [of elementary principles] is simple and lucid."

621.396.932(02) 115

Radio Aids to Navigation [Book Notice]—[United States.] Hydrographic Office publ. no. 206, 1946, 463 pp., \$2.00. (*U.S. Govt. Publ.*, no. 617, p. 667; June, 1946.)

MATERIALS AND SUBSIDIARY TECHNIQUES

531.788 116

An Easily Constructed All-Metal Vacuum Gauge—R. T. Webber and C. T. Lane. (*Rev. Sci. Instr.*, vol. 17, p. 308; August, 1946.)

531.788.7 117

Radio-Active Ionization Gauge—National Research Corporation. (*Jour. Sci. Instr.*, vol. 23, p. 247; October, 1946.) The replacement of the usual hot filament by a radium pellet as a source of ionization results in a smaller liability to zero drift and the coverage of a greater range of pressure. There is a loss of sensitivity at low pressures.

533.5 118

A Vacuum 'Lead-in'—H. Herne. (*Jour. Sci. Instr.*, vol. 23, p. 244; October, 1946.) A current of up to 50 amperes had to be passed through a metal base plate into a high-vacuum chamber. A metal-rubber antivibration bush was used as an insulator; the outer metal cylinder of the bush was soft-soldered to the base plate, and the inner one to a solid conductor which would carry the required current.

535.5:621.3.032.53 119

Theory and Practice of Glass-Metal Seals: Part 1-3—A. J. Monack. (*Glass Ind.*, vol. 27, pp. 389, 420, 446, 476; and 502, 528; August-October, 1946.)

535.37:535.61-15 120

Development of Infrared Sensitive Phosphors—B. O'Brien. (*Jour. Opt. Soc. Amer.*, vol. 36, pp. 369-371; July, 1946.)

535.37:535.61-15 121

On Infrared Sensitive Phosphors—F. Urbach, D. Pearlman, and H. Hemmendinger. (*Jour. Opt. Soc. Amer.*, vol. 36, pp. 372-381; July, 1946.)

535.37:535.61-15 122

Preparation and Characteristics of Zinc Sulfide Phosphors Sensitive to Infrared—G. R. Fonda. (*Jour. Opt. Soc. Amer.*, vol. 36, pp. 382-389; July, 1946.)

535.371.07:621.385.832 123

Long Persistence C. R. Tube Screens—R. Feldt. (*Elec. Ind.*, vol. 5, pp. 70-71; October, 1946.) A comparison of the persistence of the trace in DuMont tubes with the P² screen (green single layer) and the P⁷ screen (blue ZnS.Ag and yellow ZnCdS.Cu) under various conditions of voltage, writing speed, and ambient illumination. Curves and a table of results are given.

537.226:62 124

Theoretical Physics [of dielectrics] in Industry—H. Fröhlich. (*Nature* (London), vol.

158, pp. 332-334; September 7, 1946.) The behavior of electrons in crystalline solids is discussed theoretically with particular reference to the properties of dielectrics. In insulators the occupied energy bands in the atoms are completely filled, while conduction in metals is associated with incompletely filled bands. Dielectric breakdown occurs when electrons are continuously raised to higher energy levels until internal ionization occurs. Dielectric strength increases with temperature up to a critical temperature at which collisions between electrons become important; dielectric strength decreases with further temperature increase. Dielectric loss is due to the phase lag between the motion of elementary dipoles and the applied field.

537.226.3+621.315.611.011.5 125

The Relation between the Power Factor and the Temperature Coefficient of the Dielectric Constant of Solid Dielectrics: Part 1—M. Gevers. (*Philips Res. Rep.*, vol. 1, pp. 197-224; April, 1946.) "The ratio of the temperature coefficient to... $\tan \delta$ at a given temperature and frequency is nearly the same for most solid dielectrics." This cannot be explained by existing theories, such as those of Pellat, von Schweidler, Wagner, Debye, Gyemant, and others which are summarized. A bibliography of 44 items is given. Later articles will describe the experimental technique, and give a theoretical explanation of the result quoted.

538.22:546.77 126

Magnetic Anisotropy of Molybdenite at Different Temperatures—A. K. Dutta. (*Indian Jour. Phys.*, vol. 19, pp. 225-234; December, 1945.)

538.652:62 127

Magnetostriction in Industry Processes—F. Sloane. (*Elec. Ind.*, vol. 5, pp. 74-76, 101; October, 1946.) A general survey of the physical principles, and of magnetostriction oscillators.

538.662.13:537.228.1 128

The Lower Curie Point of Ferro-Electric Salts—H. M. Barkla. (*Nature* (London), vol. 158, pp. 340-341; September 7, 1946.) In a constant electric field the electric moment of ferroelectric salts analogous to potassium dihydrogen phosphate remains unchanged in passing through the lower Curie point.

546.287 129

Take a Grain of Sand—H. C. E. Johnson. (*Sci. Amer.*, vol. 175, pp. 105-107; September, 1946.) Elementary survey of silicones and their uses in liquid, rubber, or resin form.

546.621:620.193.2 130

Study of the Oxidation of Aluminium by Air at Ordinary Temperatures, by Measuring the Potential of [Electrolytic] Dissolution—P. Morize and P. Lacombe. (*Compt. Rend. Acad. Sci.* (Paris), vol. 222, pp. 658-659; March 18, 1946.) For pure electrolytically polished aluminium the potential is -1.20 volts. Exposure to air causes a fall which increases with time at a rate dependent on atmospheric humidity: the value of the potential indicates the thickness of the oxide layer.

546.72 131

Preparation and Magnetic Properties of the Compound Fe₃N—C. Guillaud and H. Creveaux. (*Compt. Rend. Acad. Sci.* (Paris), vol. 222, pp. 1170-1172; May 13, 1946.)

551.582:620.19 132

Climate and the Deterioration of Materials—C. E. P. Brooks. (*Quart. Jour. R. Met. Soc.*, vol. 72, pp. 87-97; January, 1946.) The relation of air temperature to that of exposed surfaces or containers is explained. Temperature

and moisture effects on materials are considered in general terms, and a rough index of their relative seriousness in various regions is plotted on a world chart.

620.197(213):621.396.6.045 133
Tropicalizing [Transformers and Chokes]—O. P. Scarff. (*Wireless World*, vol. 52, pp. 312-313; September, 1946.) See also 134 below.

620.197(213):621.314.045 134
Impregnated Windings [for "Tropicalizing" Transformers]—T. Williams; R. Burkett. (*Wireless World*, vol. 52, pp. 345-346; October, 1946.) Correspondence on 133 above.

621.314.63 135
Metal Rectifier Developments—Possible Applications of Titanium Dioxide—Hensch. (See 248.)

621.315[211.2+.22] 136
Mineral-Insulated Metal-Sheathed Conductors—Tomlinson and Wright. (See 12.)

621.315.6+[621.39:371.3] 137
I.E.E. Radio Section Address: Part 1—Training Courses; Part 2—Dielectric Developments—Jackson. (See 314.)

621.315.61 138
The Transformation of Anatase into Rutile—T. Nguyen. (*Compt. Rend. Acad. Sci.* (Paris), vol. 222, pp. 1178-1179; May 13, 1946.)

621.315.612.3.029.6 139
Steatite for High Frequency Insulation—J. M. Gleason. (*Jour. Brit. Instn. Radio Eng.*, vol. 6, pp. 20-32; January-February, 1946.) Reprint of 3059 of 1945.

621.315.617.3 140
Film-Forming Materials Used in Insulation—(*Jour. I.E.E.* (London), part III, vol. 93, p. 344; September, 1946.) Report of Institution of Electrical Engineers Radio Section discussion led by C. R. Pye: for other accounts see 641 and 352 of 1946.

621.316.86:546.281.26 141
Silicon Carbide Non-Ohmic Resistors—F. Ashworth, W. Needham and R. W. Sillars. (*Jour. I.E.E.* (London), part I, vol. 93, pp. 385-401; September, 1946.) Discussion pp. 401-405.) An integrating paper, discussing the properties and construction of these resistors, and the characteristics of single contacts between silicon carbide crystals. A method of calculating currents and voltages in circuits involving these resistors is given in an appendix, and their uses, limitations, and specification are considered.

621.357.1:620.192.43 142
Electrolytic Detection of Small Amounts of Lead in Brass or Zinc—D. McLean. (*Nature* (London), vol. 158, p. 307; August 31, 1946.) The local cell set up between the lead and the ground mass during electrolytic polishing produces a 'moat' around the lead particles which can be identified microscopically.

621.357.8:669.018.2.21 143
Anodizing and Its Uses in Engine Construction—N. D. Tomashov. After Treatment of Aluminium—Alloy Castings—E. Carrington. Anodizing—A Commentary—P. Smith. (*Light Metals*, vol. 9, pp. 429-438; and pp. 439-450, 515-516; August and October, 1946.)

666.1:62 144
New Glass Compositions for Industry—(*Electronic Eng.*, vol. 18, p. 299; October, 1946.) Note on recent work by the British Thomson-Houston Co. on glasses for the lamp and radio tube industry, including "C40" for sealing to Kovar, a leadless glass for sealing to iron, and phosphate glasses. Expansion viscosity and

annealing properties are also being fundamentally investigated.

669+546.3 145
Electrons and Metals: Part 2—The Nature of a Metal—W. Hume-Rothery. (*Metal Ind.* (London), vol. 69, pp. 343-346; October 25, 1946.) Twenty-fifth instalment of a series; written as a discussion between a young scientist and an older metallurgist on co-valent bonds.

669:061.6 146
Metallurgical Research—(*Electrician*, vol. 137, pp. 1139-1140; October 25, 1946.) An account of a new laboratory built at the Bilston works of Joseph Sankey Ltd. for research on cold-rolling processes, the fundamental nature of ferromagnetism, testing of sheet steels, and production control.

669.295/.296 147
Titanium and Zirconium—W. J. Kroll and A. W. Schlechten. (*Metal Ind.* (London), vol. 69, pp. 319-322; October 18, 1946.) Properties and extraction methods.

669.35.5.55 148
Electrical Resistance Alloy—(*Engineering* (London), vol. 162, p. 211; August 30, 1946.) The physical properties of a new copper base resistance alloy "Kumanal." Its specific resistance is $41 \times 10^{-6} \Omega$ centimeters and varies little between 20 and 350 degrees centigrade.

679.5 149
Polytetrafluoroethylene—M. M. Renfrew and E. E. Lewis. (*Ind. and Eng. Chem.*, vol. 38, pp. 870-877; September, 1946.) A full account of the electrical, mechanical, and chemical properties of this new plastic. It will withstand 300 degrees centigrade and is not brittle at low temperatures. The dielectric constant is 2.0 and the power factor less than 0.0002 at frequencies up to 3000 megacycles. When subject to an electric arc, the plastic does not form a conducting carbon track but is reduced to a volatile gas. It is used for high-frequency electrical insulation and in equipment for handling hot corrosive liquids.

679.5 150
Progress in Plastics: Parts 1 and 2—A. E. Williams. (*Engineer* (London), vol. 182, pp. 206-207 and pp. 229-232; September 6, and 13, 1946.)

681.2.085:621.972.6 151
Improved Methods of Illuminating Instrument Dials—H. Huxley. (*Jour. Sci. Instr.*, vol. 23, pp. 234-237; October, 1946.) Methods involving the leading of light in perspex can be used to give maximum uniformity of dial illumination with minimum extraneous light.

621.315.614.72(02) 152
Varnished Cloths for Electrical Insulation [Book Review]—H. W. Chatfield and J. H. Wredon. J. and A. Churchill, London, 1946, 255 pp., 21s. (*Gen. Elect. Rev.*, vol. 49, p. 62; September, 1946. *Wireless World*, vol. 52, p. 307; September, 1946.) One of the authors is employed by a varnish manufacturer, and the other by an electrical manufacturer. See also 3648 of January.

MATHEMATICS

512.52 153
Interpolation with the Aid of a Plot of First Differences—G. S. Fulcher. (*Jour. Appl. Phys.*, vol. 17, pp. 617-628; July, 1946.)

518.5 154
Differential Analyzer—(*Elec. Ind.*, vol. 5, pp. 62-66, 100; October, 1946.) A general description, with photographs, of the Massachusetts Institute of Technology equipment. Mechanical integrators are used with servo-operated capacitor bridges for transmitting

the information electrically between integrators. Punched tape is used for automatic control of the equipment. For a full description see 361 of 1946.

518.61 155
Calculation of the Electromagnetic Field, Frequency and Circuit Parameters of High-Frequency Resonator Cavities—Motz. (See 52.)

518.61 156
Calculation of the Magnetic Field in Dynamo-Electric Machines by Southwell's Relaxation Method—H. Motz and W. D. Worthy. (*Jour. I.E.E.* (London), part II, vol. 93, pp. 379-382; August, 1946.) Discussion of 658 of 1946.

519.2 157
On the Location of a Point on a Plane by Cross Bearings from Three Known Points—Yudin. (See 103.)

519.2 158
The Resultant of a Large Number of Events of Random Phase—Domb. (See 278.)

519.241.6:621.3 159
An Extension of Campbell's Theorem of Random Fluctuations—Rivlin. (See 29.)

534.014.2:621.396.611 160
An Experimental Investigation of Forced Vibrations in a Mechanical System having a Non-Linear Restoring Forces—Ludeke. (See 53.)

621.317.727:514 161
A Simple Potentiometer Circuit for Production of the Tangent Function—R. Hofstadter. (*Rev. Sci. Instr.*, vol. 17, pp. 298-300; August, 1946.)

51(075):621.396 162
Basic Mathematics for Radio Students [Book Review]—F. M. Colebrook. Iliffe and Sons, London, 1946, 270 pp., 10s. 6d. (*Electronic Eng.*, vol. 18, p. 293; September, 1946.) "... the subject is presented with the lucidity we expect from this well-known contributor to radio technical journals." See also 3338 of 1946.

518.2(083):517.564.4 163
Tables of Associated Legendre Functions [Book Review]—Mathematical Tables Project. Columbia University Press, New York, N.Y., 1945, 303 pp., \$5.00. (*Phil. Mag.*, vol. 36, pp. 729-730; October, 1945. See also 1279 of 1946.)

519.21(02) 164
An Experimental Introduction to the Theory of Probability [Book Review]—J. E. Kerrich. Einar Munksgaard, Copenhagen, 1946, 98 pp., 8.50 kroner. (*Nature* (London), vol. 158, p. 360; September 14, 1946.)

MEASUREMENTS AND TEST GEAR

538.12:621.3.08 165
Production of Uniform and Constant Magnetic Fields for Measurement Purposes: Parts 1 and 2—H. Neumann. (*Arch. Tech. Messen.*, pp. T128-129 and T138-139; November and December, 1940.) Parts 3 and 4 were noted in 2823 of 1942.

538.214.082.1 166
Apparatus for Measuring Magnetic Moments—G. N. Rathenau and J. L. Snoek. (*Philips Res. Rep.*, vol. 1, p. 239; April, 1946.) The specimen whose susceptibility is required is suspended in a magnetic field such that the restoring force on the specimen for small displacements is proportional to the displacement. Measurement of the period of oscillation with and without the magnetic field enables the susceptibility to be deduced.

549.514.51:620.1 167
Quartz Crystal Testing Instrumentation—

D. S. Dickey. (*Instruments*, vol. 19, pp. 9-11; January, 1946.) Describes the use of recording instruments for production testing of the variation of crystal frequency and activity with temperature.

621.317 168
The History and Development of the British Scientific Instrument Industry—Barron. (See 315.)

621.317:621.396.6.004.67(73) 169
Measuring Equipment in American Radio Repair Workshops: Parts 1 and 2—G. Keinath. (*Arch. Tech. Messen.*, pp. T120 and T132-133; November and December, 1940.) The noteworthy features of this equipment are (1) flexibility, (2) limited accuracy, (3) convenience in use (4) portability, and (5) cheapness. The article considers in some detail with diagrams and circuits: (a) high-resistance direct-current voltmeters, (b) capacitance meters, (c) tube testers, (d) vibrator testers, (e) test oscillators, (f) universal receiver tester, and (g) oscilloscopes.

621.317.2:621.396.623 170
Notes on Field Laboratory Design—Matthews. (See 228.)

621.317.2:621.397.5 171
TV [Television] Test Equipment—Hunter. (See 268.)

621.317.2:621.397.5 172
A Television Pattern Test Generator—Inskip. (See 267.)

621.317.3:621.392 173
Waveguide Measurements—G. Ashdown. (*Electronic Eng.*, vol. 18, pp. 318-319; October, 1946.) A description of a 10,000-megacycle wave-guide test bench whose main components are: a short length of wave guide carrying a klystron oscillator, a launching aerial, a 10-decibel attenuator, a coaxial-line wavemeter, and a standing-wave detector.

621.317.33:621.315.21.029.4/.6 174
Characteristics of R.F. Cables—N. C. Stamford and R. B. Quarmby. (*Wireless Eng.*, vol. 23, pp. 295-298; November, 1946.) A technique of measurement at 600 megacycles, for coaxial or twin cables developed at Manchester University. The cable is magnetically coupled to an oscillator at one end and left open at the other. The variations of input current, measured by a thermojunction, are observed as short lengths and are cut from the open end. The phase constant is then determined from the lengths at which successive minima of current occur. The attenuation constant is found by comparing the outputs of short and long line lengths for equal inputs when the power measuring device is matched to the line. Characteristic impedance is measured by substituting a $\lambda/4$ section of air-spaced coaxial line whose characteristic impedance is varied (by variation of the diameter of the inner conductor) until the matched condition is restored.

621.317.33.029.63:621.315.2 175
The Measurement of Cable Characteristics at Ultra-High Frequencies—F. Jones and R. Sear. (*Jour. Brit. Instn. Radio Eng.*, vol. 5, pp. 154-169; August-September, 1945. Discussion pp. 170-172.) "The paper describes the two main methods of impedance measurement at frequencies above 100 megacycles which are in general use, and their application to the determination of cable characteristics, with particular attention to the work of the authors.

"A preliminary account is given of the various conditions in which cables can be measured, and which are applicable to both of the methods described.

"An outline of the theory of the standing-

wave method is given, together with a general description of the equipment required. Attention is paid to coned connectors for the attachment of the cable to the measuring line, and the errors liable to be incurred by their use.

"The theory and equipment for the resonance line method are described, and an account is given of several investigations that have been conducted in order to extend its usefulness. These include the measurement of twin cables, the effect on cable attenuation values of reactive discontinuities at the junction of measuring line and cable and at internal supports in the line, the direct determination of the characteristic impedance of measuring lines, and the radiation and reactive effects which occur at their open ends.

"The application of the resonance-line method to the determination of dielectric power factor is discussed, and a method is described which permits greater accuracy than has been obtained up to the present."

621.317.372:621.315.2 176

End Leakage in Cable Power-Factor Measurement—A. Rosen. (*Jour. I.E.E.* (London), part II, vol. 93, pp. 383-386; August, 1946.) In direct-current measurements of the insulation resistance of cables a simple guard wire is used to eliminate the effects of leakage at the cable ends. This guard wire has been modified to make it effective for alternating-current measurements when used in conjunction with a suitable bridge; end leakage error is thereby completely avoided.

621.317.374.029.6 177

A Microwave Dielectric Loss Measuring Technique—W. R. MacLean. (*Jour. Appl. Phys.*, vol. 17, pp. 558-566; July, 1946.) The dielectric loss is measured by determinations of the Q -factor of a resonator partially filled with the sample. The method is restricted to the determination of small loss factors, and requires a preliminary approximate determination of the dielectric constant. The sample is placed inside the resonator as a dielectric core which confines the field almost entirely to the dielectric. Double sample technique is used to eliminate dominant spurious losses. Detuning for the half-power points in the determination of the Q -factor is accomplished by large movement of a small rod, whose characteristics as a tuning element can be calculated.

621.317.374.029.6 178

A New Method for Measuring Dielectric Constant and Loss in the Range of Centimeter Waves—S. Roberts and A. von Hippel. (*Jour. Appl. Phys.*, vol. 17, pp. 610-616; July, 1946.) The closed end of a rectangular wave guide is covered by a slab of the material, the dielectric constant of which is deduced from measurements of the standing-wave pattern in the guide, determined by means of a sliding crystal-tube probe. Certain previous sources of error are eliminated in this method. The paper gives a description of the apparatus, the theory of the method, and results for various solid and liquid dielectrics at 25 degrees centigrade for wavelength equals 6 centimeters.

621.317.374:519.283 179

Quality Control [of Dielectric Material] by Means of H.F. Currents—P. Toulon. (*Compt. Rend. Acad. Sci.* (Paris), vol. 222, pp. 543-544; March 4, 1946.) Describes methods of measurement of dielectric loss by means of a Q -meter.

621.317.384:621.314.2 180

A Device for the Measurement of No-Load Losses in Small Power Transformers—L. Medina. (*Proc. I.R.E.* (Australia), vol. 7, pp. 13-16; September, 1946.) The magnetizing component of the exciting current is canceled by means of a variable shunt capacitance, and the no-load-loss current is measured by a rectifier-type microammeter in conjunction with a

filter arrangement tuned to the fundamental frequency of the supply voltage. It is a method for production testing and the accuracy is 5 to 10 per cent; circuit details are given for a practical instrument.

621.317.7 181
Developments in Electrical Measuring Instruments—(*Engineering* (London), vol. 162, pp. 234-235; September 6, 1946.) Comment on 3351 of 1946.

621.317.7.082.7.029.63:621.315.212 182
Standing-Wave Indicator—G. E. Feiker. (*Gen. Elec. Rev.*, vol. 49, pp. 43-46; September, 1946.) The indicator consists of a slotted section of coaxial line with an adjustable outer conductor so that a probe may be driven by a rack and pinion arrangement along the line. Its operating frequency is of the order of 3000 megacycles. Methods are explained for using it to measure (a) standing-wave ratio, (b) complex impedance, (c) net power flow, and (d) attenuation.

621.317.72+.784 183
A Precision A.C./D.C. Comparator for Power and Voltage Measurements—G. F. Shotton and H. D. Hawkes. (*Jour. I.E.E.* (London), part II, vol. 93, pp. 314-319; August, 1946. Discussion, pp. 320-324.) The sources of error common to dynamometer wattmeters are briefly reviewed, and a new instrument for measuring alternating-current power and voltage by direct comparison with a standard direct-current potentiometer is described.

621.317.727 184
Self Balancing Potentiometer—(*Elec. Ind.*, vol. 5, p. 79; October, 1946.) A 'slide-back' arrangement using a galvanometer and a double photocell in a tube-bridge circuit, drawing less than 0.01 microampere from the source. It measures potentials between 100 microvolts and 1 volt; it will produce a maximum drop of 10 volts across an output load of 2000 Ω .

621.317.733:621.326 185
A Method of Measuring the Current Distortion and Phase-Angle Due to a Non-Linear Impedance—G. M. Petropoulos. (*Beams Jour.*, vol. 53, pp. 320-323; September, 1946.) A sinusoidal voltage is applied and a suppression method using a Wheatstone bridge arrangement is employed. The nonlinear impedance of incandescent lamps causes current distortion, the distortion factor and phase angle increasing with applied voltage, but its magnitude is not considered of practical importance.

621.317.76 186
A Standard of Frequency and Its Applications—C. F. Booth and F. J. M. Laver. (*Jour. I.E.E.* (London), part I, vol. 93, pp. 417-418; September, 1946.) Summary of 2973 of 1946.

621.317.784.029.6 187
Air-Flow U.H.F. Watt-Meter—Z. W. Wilchinsky and R. H. Kyser. (*Electronics*, vol. 19, pp. 128-129; October, 1946.) "Description of a laboratory-type instrument, suitable for calibration of general-purpose wattmeters. A tungsten-filament dissipative element [in an evacuated envelope] is inserted as the central conductor in a section of coaxial transmission line." The operating wavelength is about 30 centimeters at power levels up to about 20 watts. The temperature rise of the air passing the load is measured by thermocouples. Calibration at mains frequency is recommended. The chief drawback of the instrument is "that several minutes may be required for a steady state to be obtained."

621.317.79:621.396.9 188
Production of Airplane Radar Speeded by New Testing Technique—F. P. Wight. (*Bell Lab. Rec.*, vol. 24, pp. 330-334; September,

1946.) Description of test apparatus and methods designed by the Western Electric Laboratories as an integral part of the production program for certain airborne radar units. The tests included determination of wave shapes, amplitudes, frequencies, and bandwidths, and checks of general circuit performance and mechanical alignment.

621.317.794.029.6 189

Bolometers for V.H.F. Power Measurement—E. M. Hickin. (*Wireless Eng.*, vol. 23, pp. 308–313; November, 1946.) "In this method the power is dissipated in a resistor having a large temperature coefficient (an indicator) which forms one arm of a Wheatstone bridge. By direct-current power substitution the indicator may be calibrated and then one measurement of resistance will give the power in the load.

Some details are given of indicators and circuits to deal with powers from a few microwatts to a few watts at frequencies up to 10,000 megacycles. The limitations of the method and possible sources of error are discussed.

The construction of power indicators is treated in detail: the CV95 using a 0.01-millimeter tungsten wire in *vacuo*, or in an inert gas to given increased power rating, and the possible use for the filament of Wollaston wire (Pt coated with Ag), carbon or iron is described.

621.362 190

Schwarz Thermopiles—A. Hilger Ltd. (*Jour. Sci. Instr.*, vol. 23, p. 246; October, 1946.) A new design, said to have unusually high sensitivity and speed and to be more robust than previous types.

621.384.5.08 191

The Properties of Glow Tubes and Their Applications for Measurement Purposes—A. Glaser. (*Arch. Tech. Messen*, pp. T136–137; December, 1940.)

621.392.43.082.7 192

Note on a Reflection-Coefficient Meter—Korman. (*See* 18.)

621.396.61/.62]016.2.081.4.029.6 193

Specification of Receiver Sensitivity and Transmitter Power Output at Ultra-High Frequencies—L. S. Schwartz. (*Proc. I.R.E. and Waves and Electrons*, vol. 34, p. 663; September, 1946.) Plea for specifying receiver sensitivity in terms of decibels below 1 watt and for calibrating signal generators in terms of available power. Similarly, transmitter power may for consistency, be specified in decibels above 1 watt.

621.396.611.21:529.78 194

The Measurement of Time—H. Spencer Jones. (*Endeavour*, vol. 4, pp. 123–130; October, 1945.) Includes an account of the applications of crystal clocks at the Royal Observatory. Their advantages and disadvantages compared with other types are discussed. The need for operating crystal clocks in groups with regular intercomparison is stressed. A "declmal counting chronometer" with a 10-microsecond unit of time is briefly described. See also 3388 of 1946 (Booth).

621.396.615.11 195

Thermistor-Regulated Low-Frequency Oscillator—L. Fleming. (*Electronics*, vol. 19, pp. 97–99; October, 1946.) Design considerations and detailed description of a phase-shift oscillator covering the frequency range 0.9 to 10,000 cycles in four bands. A direct-coupled cathode follower is included in the feedback chain, while a separate cathode follower is used at the output stage. The feedback thermistor has a time constant of about one second, which sets the low limit to the frequency range covered.

621.317.733.025(02) 196

Alternating Current Bridge Methods [Book Review]—B. Hague. Pitman (London), sixth edition, 1945, 616 pp., 30s. (*Beama Jour.*, vol. 53, p. 329; September, 1946.) "This new edition, like its predecessor should be in the hands of all engineers and students who have an interest in bridge methods."

OTHER APPLICATIONS OF RADIO AND ELECTRONICS

531.714.7:621.317.39 197

Electronic Micrometer for Thin Materials—(*Electronics*, vol. 19, pp. 190, 198; October, 1946. Permits continuous production measurement of wire diameter and strip thickness. The material passes an aperture illuminated by a scanning spot which throws a shadow on a photocell. The size of the shadow determines the voltage signal in the load resistor of the photocell.

535.61—15 198

Radioactive Infrared Detector—(*Electronics*, vol. 19, pp. 142, 146; October, 1946.) Radioactive material contained in the detector charges a viewing screen and makes it sensitive to incoming infrared radiation reflected on to it by a periscope device. It permits the detection of infrared radiation but not the identification of objects.

621.314.67:621.385.38:621.365 199

Grid-Controlled Rectifiers for R.F. Heating—B. Boyd. (*Electronics*, vol. 19, pp. 125–127; October, 1946.) Control of the direct-current output voltage is obtained by varying the phase of an auxiliary alternating-current supply on the thyatron grid. The application of this control system to a 100-kilowatt power supply is described.

621.316.578.1:774 200

A Timer for Photo-Printing—N. Phelp and F. Tappenden. (*Electronic Eng.*, vol. 18, pp. 300–301; October, 1946.) A two-tube electronic switch is "controlled by the exponentially decreasing potential difference across the terminals of a capacitance shunted by a discharging resistance," whose value determines the exposure time.

621.316.923:623.95 201

Fuzes for Electronic [magnetic] Mines—(*Electronics*, vol. 19, pp. 162, 166; October, 1946.)

621.317.39 202

The "Aquatator"—(*Electrician*, vol. 137, pp. 1073–1074; October 18, 1946.) Brief description of the performance of two instruments for the accurate detection and measurement of the moisture content in a wide range of solid materials and emulsions.

621.317.75.029.3 203

A Frequency Analyser Used in the Study of Ocean Waves—N. F. Barber, F. Ursell, J. Darbyshire, and M. J. Tucker. (*Nature* (London), vol. 158, pp. 329–332; September 7, 1946.) The records of water pressure with which the analyzer is fed are in the form of a black trace of variable width on a white background. Such a record is attached to the perimeter of a wheel 30 inches in diameter which is rotated at a speed of several revolutions per second and scanned by a photocell. The amplified output from the photocell is fed to a vibration galvanometer, the motion of which is recorded on a trace forming the frequency spectrum. As the speed of rotation of the wheel is allowed to diminish continuously and naturally under the action of friction, the various frequency components present in the original record "glide" in turn through the resonant frequency of the galvanometer. Satisfactory resolution of harmonics up to the order of sixty has been achieved.

621.365.5 204

Volman-Stivin High-Frequency Induction Hardening Machines—(*Machinery* (London), vol. 69, pp. 498–500; October 17, 1946.) Automatic or semi-automatic machinery for hardening special alloy-steel and carbon-steel components by induction heating methods. Plant is available with powers up to 200 kilowatts for handling work ranging from small components up to workpieces four feet in length such as crankshafts and camshafts.

621.365.5:621.3.018.41 205

The Effect of Frequency in Induction Heating—R. A. Nielson. (*Electronic Eng.*, vol. 18, pp. 320–322; October, 1946.) A simple approximate formula is derived for the power dissipation in a cylinder heated in a long solenoid. Increasing frequency decreases the necessary current or number of turns. The limitation is occurrence of arcing.

621.38.001.8 206

Electronics—Servant or Fad?—Weiller. (*See* 318.)

621.38.001.8 207

[Electronic] Machine-Tool Contour Controller—J. M. Morgan. (*Electronics*, vol. 19, pp. 92–96; October, 1946.)

621.38.001.8:551.576 208

Remote Cloud Indicator—(*Electronics*, vol. 19, p. 162; October, 1946.) Instrument developed in Britain for attaching to a barrage balloon to indicate when the balloon is flying in cloud. Strips of metal foil separated by very thin mica sheets are bridged by moisture when in cloud, thus firing a thyatron operating a transmitter.

621.38.078:538.56.029.6 209

Will Industrial Electronic Control Use Microwaves?—W. C. White. (*Gen. Elec. Rev.*, vol. 49, pp. 8–11; September, 1946.) A simple radio-frequency oscillator is described, consisting of a cavity resonator with output up to 1 watt at a frequency of 3000 megacycles, together with a detector unit comprising a half-wave dipole, silicon crystal detector, and microammeter.

Demonstration technique is then discussed for (a) directivity and propagation through metallic and nonmetallic objects, (b) reflection and polarization, (c) standing waves, and (d) use of waveguides.

The object is to make properties peculiar to microwaves more familiar to nonradio engineers: their application will probably be similar to that of present photoelectric relay devices.

621.383.001.8:535.61—15 210

The Development of Infrared Technique in Germany—V. Křížek and V. Vand. (*Electronic Eng.*, vol. 18, pp. 316–317, 322; October, 1946.) Resistance photocells were thought to be the best type of detector. Thallium sulphide or lead sulphide are the best materials for wavelengths up to 5 microns. An infrared image projected on a photocathode could be converted into a viable image on a fluorescent screen. An infrared iconoscope used a semiconducting layer whose resistance changed with the intensity of illumination. An electron mirror is also described. These infrared devices will probably be appreciably cheaper than radar equipment for safeguarding transport against collision.

621.385.38.078 211

Simplified Thyatron Motor Control—H. H. Leigh. (*Gen. Elec. Rev.*, vol. 49, pp. 18–27; September, 1946.) Basic types of control are explained, and typical applications specified.

621.396.611.21:529.78 212

The Measurement of Time—Jones. (*See* 194.)

- 621.396.619.018.41:621.384 213
Mechanical Frequency Modulation System as Applied to the Cyclotron—F. H. Schmidl. (*Rev. Sci. Instr.*, vol. 17, pp. 301–306; August, 1946.)
- 621.396.9:623.26 214
Metal Detectors—Cinema-Television Ltd. (*Jour. Sci. Instr.*, vol. 23, pp. 244–245; October, 1946.) An adaptation of the Mark IV mine detector involving eddy-current or magnetic coupling between two coils.
- 621.396.9:629.135.053.2 215
Radio-Beam Speedometer for Aircraft—(*Electronics*, vol. 19, p. 170; October, 1946.) The times at which the aircraft crosses three parallel radar beams at right angles to its path are signaled to a central recording station. The aircraft speed is deduced from the known distance between the beams.
- 622.19:621.396 216
The Propagational Method of Radio Prospecting: A. — Subterranean Methods—V. Fritsch. (*Arch. Tech. Messen*, pp. T134–135; December, 1940.) The measurement of the absorption of radio waves passing through or into a mountain provides information on the properties (conductivity and dielectric constant) of the material. The propagation path is chosen to be about 100 meters for rocks of good conductivity and may be longer for materials such as granite. The variation of relative field-strength with frequency provides the "radiogeological curve" which usually has a minimum at some frequency which depends on the material.
 The effects of geological inhomogeneities and of the disposition of the transmitter and receiver (with particular reference to multiple propagation paths) are discussed. A brief reference to the reflection method of measurement is made. See also 3710 of January.
- 621.365.5(02) 217
High-Frequency Induction Heating [Book Review]—F. W. Curtis. McGraw-Hill, New York, N. Y. 1944, 235 pp., 249 figs., 16s. 6d. (*Electronic Eng.*, vol. 18, p. 324; October, 1946.) "... a thoroughly practical, lavishly illustrated work which incorporates all the major developments of recent years."
- PROPAGATION OF WAVES**
- 621.396.11+535.13 218
On an Interpretation of the Propagation of E.M. Waves and Its Consequences—A. Haubert. (*Compt. Rend. Acad. Sci. (Paris)*, vol. 222, pp. 539–541; March 4, 1946.) Schelkunoff's concept of the characteristic impedance of a medium (see 803 of 1938) has suggested the author's consideration of atmospherics in terms of the wave-guide formed by the ground and the ionosphere.
 Formulas for reflection and transmission coefficients at a boundary between two media are derived, which by use of complex quantities can be extended to conducting media, but only reduce to the Fresnel formulas when the media are dielectrics of equal permeability. The conception of the apparent permittivity of an ionized gas can be replaced by that of a uniformly distributed shunt admittance.
- 621.396.11.029.64+535.343.4+538.569.4.029.64]:551.57 219
The Absorption of 1-cm Electromagnetic Waves by Atmospheric Water Vapor—R. L. Kyhl, R. H. Dicke, and R. Beringer. (*Phys. Rev.*, vol. 69, p. 694; June 1–15, 1946.) The position (1.34 centimeters) and width (0.11 centimeter⁻¹) of the absorption line were determined using a radiometer due to R. H. Dicke. These results agree with Van Vleck's predictions but the absolute absorption is greater. See also 3396 of 1946 (Beringer). Summary of American Physical Society paper.
- 621.396.11:551.510.535 220
The Effect of the Ionosphere on Radio Communication—R. W. E. McNicol. (*Proc. I.R.E. (Australia)*, vol. 7, pp. 14–20; August, 1946.) A very general lecture on the formation and structure of the ionosphere, and the choice of radio frequency for transmitting under prevailing conditions. Measurements of ionospheric characteristics, such as virtual height, critical frequency, and absorption are briefly discussed, and illustrations of ionospheric storms and fade-out effects are included.
- 621.396.11:551.510.535 221
Short-Wave [Ionospheric] Forecasting—T. W. Benington. (*Wireless World*, vol. 52, pp. 292–295; September, 1946.) A continuation of 3721 of January describing how the predicted average maximum usable frequency (MUF) can be determined for a transmission path of any length, in any part of the world, for every hour of day for the month, from the contour charts compiled from the critical frequency measurements.
- RECEPTION**
- 621.396./397]:621.004.67 222
The Servicing of Radio and Television Receivers—(*Jour. I.E.E. (London)*, part III, vol. 93, pp. 362–363; September, 1946.) Summary of Institution of Radio Engineers Radio Section discussion led by R. C. G. Williams. It was considered that, while a good grounding in principles was essential for servicing technicians, familiarity with the practical technique of fault-finding was exceedingly important.
 Standardization of components was desirable to reduce the number of parts a repairer had to stock. The provision by the manufacturer of more information in handbooks and circuit diagrams was suggested. Test equipment requirements were considered. See also 2686 of 1946.
- 621.396.62 223
Tendencies in the Design of the Communication Type of Receiver—G. L. Grisdale and R. B. Armstrong. (*Jour. I.E.E. (London)*, part III, vol. 93, pp. 365–378; September, 1946. Discussion, pp. 378–384.) "A critical survey of the nature of the design problems and the solutions adopted in typical receivers, rather than ... detailed design information in connection with any particular feature."
 In general, superheterodyne circuits are used with one or two signal-frequency circuits and an intermediate frequency of 400 to 700 kilocycles. Double-superheterodyne circuits are also used and give improved image-signal rejection characteristics.
 The problem of input coupling for obtaining optimum signal to noise ratio is considered and treated mathematically in an appendix and it is found that optimum conditions exist when the first circuit impedance is greater than the aerial feeder impedance. Curves are given of noise factor in terms of receiver input impedance, aerial impedance and detune ratio.
 Consideration is given to the design of the frequency-change oscillator to minimize frequency instability due to variation of supply voltage and changes in circuit parameters due to humidity, temperature, and mechanical vibration.
 Among other topics discussed are the intermediate-frequency circuit (including crystal resonator circuits), the low-frequency circuit, automatic gain-control and noise-limiter systems, crystal calibrators, electrical band-spreading and power supply systems.
 Future developments are considered to include proofing against extremes of temperature, climatic and humidity variations, the reduction in size of components and receivers as a whole and increased facilities for performance checking.
- 621.396.621 224
Looking Over the Postwar Receivers—B. G. (OST, vol. 30, pp. 48–49; October, 1946.) A description of the receiver type RME-45 shows that it is "built along conventional lines: one stage of radio-frequency amplification, converter and two stages of intermediate-frequency amplification, with the crystal filter between the converter and first intermediate-frequency stage, diode second detector, beat-frequency oscillator, noise limiter, and two stages of audio amplification."
- 621.396.621.53 225
Tubeless Converter for New F.M. Band—H. A. Audet. (*Electronics*, vol. 19, pp. 140, 142; October, 1946.) Frequency-modulation receivers may be converted for the new 88-to 108-megacycle band by using the original local oscillator to supply radio-frequency to the germanium crystal mixers to be added between the aerial and the first detector.
- 621.396.621.54 226
Superhet Tracking Formulas—J. Marshall. (*Electronics*, vol. 19, pp. 202, 214; October, 1946.) A method is explained for calculating with sufficient accuracy the capacitance and inductance values needed for packing and trimming various types of superheterodyne receiver. Design procedure is also explained in seven stages.
- 621.396.622:621.396.619.018.41 227
Single-Stage F.M. Detector—W. E. Bradley. (*Electronics*, vol. 19, pp. 88–91; October, 1946.) The circuit comprises a special heptode tube, the first control grid and cathode of which form the electrodes of an oscillator arranged to give pulse output at intermediate frequency. A heavily damped tuned circuit in the anode circuit is reactively coupled to the oscillator, while the frequency-modulation output from the intermediate-frequency chain is applied to the second control grid. It is shown that the mean anode current is amplitude-modulated with the intelligence contained in the frequency-modulation signal.
- 621.396.623:621.317.2 228
Notes on Field Laboratory Design—A. C. Matthews. (*Radio*, vol. 30, pp. 18–19; August, 1946.) Built to simulate the average user's home conditions as closely as possible, and equipped for testing and comparing receivers.
- 621.396.82.029.6 229
Elimination of Interference-Type Fading at Microwave Frequencies with Spaced Antennas—R. Bateman. (*Proc. I.R.E. and Waves and Electrons*, vol. 34, pp. 662–663; September, 1946.) This type of fading, due to tropospheric changes which alter the path length of the direct wave or the wave reflected from the ground, may be eliminated by diversity reception on suitably spaced aeriels. An alternative scheme is to radiate a very narrow beam such that the wave reflected from the ground is small, or to use a system such that there is a gap between two lobes in the direction of the ground-reflected wave.
- 621.396.822:621.396.619.16 230
Pulse Distortion: the Probability Distribution of Distortion Magnitudes Due to Inter-Channel Interference in Multi-Channel Pulse-Transmission Systems—D. G. Tucker. (*Jour. I.E.E. (London)*, part III, vol. 93, pp. 323–334; September, 1946.) If the probability distribution of pulse distortion magnitudes in a multichannel pulse-transmission system is adequately considered, considerable economies in design may be made. An analysis of inter-channel interference distortion is given, and it is shown how to determine the probability distribution for interference of equal amplitudes from two adjacent channels on two or more links in tandem. On a typical multichannel

video-frequency telegraph system with two links in tandem, only about one pulse in a thousand is distorted more than half the maximum amount; the corresponding probabilities for other typical systems are much less. It is, therefore, evident that the basis of design should be not the maximum distortion but a fraction of it, perhaps between $\frac{1}{2}$ and $\frac{1}{3}$.

621.397.823 231
The Noise Suppressor in the V114 [Television Set]—Fairhurst. (See 274.)

STATIONS AND COMMUNICATION SYSTEMS

621.396.029.63/.64 232
Hyper-Frequency Radio—J. M. A. Lenihan. (*Jour. Brit. Instn. Radio Eng.*, vol. 4, pp. 178-186; October-December, 1944. Discussion, pp. 186-189.) A survey of problems and techniques involved at wavelengths below 30 centimeters, where conventional oscillators fail. The devices used include positive grid triodes, and cavity resonators. The principles of operation of these oscillators are outlined; the most efficient and widely used are the klystron and the magnetron for which methods of modulation are given. Reception and the application of wave-guides are briefly discussed, and future ultra-high-frequency developments forecast. A selected bibliography of 33 items is given (p. 189).

621.396.1.029.6:523.2 233
Astronomical Radar—Clarke. (See 106.)

621.396.4.029.6 234
336 Channels for V.H.F.—(*Electronics*, vol. 19, pp. 150, 154; October, 1946.) Brief description of equipment shown to the Physical Society in 1946. 336 channels were frequency-controlled to ± 10 kilocycles during transmission and reception by only three crystals, selection being made remotely by means of numbered or lettered dials.

621.396.619.018.41 235
A Review of Wide-Band Frequency-Modulation Technique—C. E. Tibbs. (*Jour. Brit. Instn. Radio Eng.*, vol. 4, pp. 85-119; June-September, 1944. Discussion, pp. 119-129.) The basic theory of frequency modulation is first outlined and the form of the frequency spectrum derived. The improvement in signal-to-noise ratio resulting from the use of frequency modulation is discussed and illustrated graphically, and the effects of increasing the frequency deviation, the use of pre-emphasizers and the suppression of a weaker signal by a stronger one are explained.

It is shown that selective fading during propagation of a frequency-modulated signal can lead to serious distortion and that a system operating over an ionospheric path would, therefore, be unsatisfactory. Most frequency-modulated systems operate in the very-high-frequency band with a stacked dipole or 'turnstile' transmitting aerial array and a simple dipole receiving aerial.

Transmitter features peculiar to this form of modulation are discussed, including the modulator originally designed by Armstrong and one incorporating a reactance tube. Two types of station monitor are described, with a signal generator suitable for test work. The general design of a suitable receiver is given, with details of a typical limiter circuit, double-tuned circuits, phase-difference discriminators, and a tuning indicator. A bibliography of 28 items is appended.

621.396.619.16+621.396.61.029.64 236
Army No. 10 Set—(*Wireless World*, vol. 52, pp. 282-285; September, 1946.) Description of the ultra-high-frequency sender, a split-anode magnetron with the segments arranged cylindrically about the cathode as axis, the receiver and the aerial system. A miniature triode is

used as a local oscillator, with a crystal as the first detector, in the superheterodyne receiver. The aerial system comprises a waveguide matching section connected to a flexible waveguide, with a reflector placed before its open end, brought through the center of a parabolic mirror. For previous articles on this set see 470 and 2706 of 1946.

621.396.619.16 237
Pulse Terminology—W. A. Bentley: "Cathode Ray." (*Wireless World*, vol. 52, pp. 311-312; September, 1946.) Discussion of the proper terminology for various types of pulse modulation, arising out of 2006 of 1946 ("Cathode Ray").

621.396.619.16:621.396.822 238
Noise and Pulse Modulation—T. Roddam. (*Wireless World*, vol. 52, pp. 327-329; October, 1946.) Pulse-position modulation, with constant amplitude pulses and a constant number of pulses per second, would appear to give a noise-free communication system, since reception depends only on the position of the leading edge of each pulse. Considerations of bandwidth, however, show that this is untrue, and a value for the ratio of bandwidth to highest modulation frequency is obtained for the signal-to-noise ratio to be an improvement over amplitude-modulation systems. Examples of typical pulse systems show an improvement of up to 30 decibels. The effect of impulsive noise is also considered. See also 2006 of 1946 ("Cathode Ray") for basic principles of pulse modulation.

621.396.619.16:621.396.97 239
Pulse Time Multiplex System Tested at New York Demonstration—(*Telegr. Teleph. Age*, vol. 64, pp. 15-18; October, 1946.) Outline description of a system employing pulse-time modulation, with notes on a recent demonstration in which eight programs of various types (ordinary broadcast, facsimile, teleprinter, recording of music, etc.) were dealt with simultaneously. The pulse-repetition frequency for each channel is 24,000 per second. A width of 9 kilocycles is available on each channel for modulation purposes; each channel may carry low definition information (such as high-speed Morse) on a number of subchannels defined by appropriate tone filters. The demonstration was carried out at a frequency of 930 megacycles (peak power 800 watts), omnidirectional and paraboloid type serials being used respectively at transmitter and receiver. See also 3049 of 1946 (Grieg).

621.396.7 240
H.M.S. "Boxer"—G. M. Bennett. (*Wireless World*, vol. 52, pp. 324-326; October, 1946.) Fitted with equipment designed for fighter direction over sea and shore, this British warship has six high-power radar sets of various ranges with associated interrogators and beacons. Other installations include transmitters and receivers for use in all frequency bands, direction-finding equipment and a W/T homing beacon. Sets can be operated without mutual interference and data are collated in a central control room.

621.396.82:621.396.1 241
Interference Considerations Affecting Channel-Frequency Assignments—M. Reed and S. H. Moss. (*Jour. I.E.E. (London)*, part III, vol. 93, pp. 355-361; September, 1946.) A study is made of the mutual interference problems which arise when a number of stations transmitting continuous-wave signals and having the same frequency tolerance share a given frequency band. On the assumption that the transmitters are grouped into a number of channels spread over the frequency band, it is shown that, for a given receiver selectivity specified by its gate width, no practical advantage is gained by having a spacing of the chan-

nel frequencies less than by a value which is about 75 per cent of the nominal transmitter-tolerance bandwidth, although (except over a limited region when the receiver gate is wider than the transmitter tolerance) a spacing equal to this bandwidth should not be exceeded. For a given separation between channels it is demonstrated that, in general, the interference falls with reduction of the receiver gate width.

621.396.97(4) 242
Broadcasting in Europe—(*Jour. Brit. Instn. Radio Eng.*, vol. 6, pp. 33-40 and 41-46; January-February and March-May, 1946.) A summary of discussions held by various sections of the British Institution of Radio Engineers on a plan suggested by the Radio Industry Council in July, 1945, for a complete reallocation of broadcast frequencies throughout Europe (See 3667 of 1945.)

621.396.97(058) 243
"Broadcasting" Year Book, 1946 [Book Review]—Broadcasting Publications Inc., Washington, D. C., 580 pp. (*Wireless World*, vol. 52, p. 332; October, 1946.) A reference book containing the Federal Communications Commission broadcasting regulations and directories of United States, Canadian, and South American stations.

SUBSIDIARY APPARATUS

538.652:62 244
Magnetostriction in Industry Processes—Sloane. (See 127.)

621-526 245
Theory of Servo Systems, with Particular Reference to Stabilization—A. L. Whiteley. (*Jour. I.E.E. (London)*, part II, vol. 93, pp. 353-367; August, 1946. Discussion, pp. 368-372.) Methods are described for achieving stability in continuous-control servo systems. Stability may be improved by the insertion of passive networks at the input end of the system to give approximations to derivatives and/or integrals of error which may be used to modify the performance characteristics. Feedback methods may often be used similarly. To assist calculations of constants of the added stabilizing networks, standard forms, which have been found to apply to widely different electric servos, are tabulated. A summary of this paper was noted in 2013 of 1946.

621-526 246
Dynamic Behavior and Design of Servomechanisms—G. S. Brown and A. C. Hall. (*Trans. A.I.E.E. (Elec. Eng.)*, July, 1946, vol. 68, pp. 503-522, July, 1946. Discussion, pp. 522-524.)

621-526:621.313.28 247
A New Torque Motor—A. E. Adams and D. Waloff. (*Electronic Eng.*, vol. 18, p. 308; October, 1946.) For servo applications. The normal rotating armature is replaced by gyratory motion of a low-inertia armature so that starting and stopping are almost instantaneous. The gyratory motion is transformed into rotation in the output shaft by a single stage of planetary gearing.

621.314.63 248
Metal Rectifier Developments—Possible Applications of Titanium Dioxide—H. K. Henisch. (*Electronic Eng.*, vol. 18, pp. 313-315; October, 1946.) The three main problems are: (a) producing the conducting material consistently, (b) making the semiconductor as a thin film, and (c) the nature of the best electrodes.

621.315.21.029.4/.6]:536.4 249
The Power Rating (Thermal) of Radio Frequency Cables—R. C. Mildner. (*Jour. I.E.E. (London)*, part I, vol. 93, p. 414; September, 1946.) Summary of 3066 of 1946.

- 621.315.668.2 250
Steel Tower Economics—P. J. Ryle. (*Jour. I.E.E.*, (London) part I, vol. 93, pp. 407-409; September, 1946.) Summary of an Institution of Radio Engineers paper. See also 3067 of 1946.
- 621.316.86:546.281.26 251
Silicon Carbide Non-Ohmic Resistors—Ashworth, Needham, and Sillars. (See 141.)
- 621.317.755 252
A New Oscilloscope with D.C. Amplification—J. H. Reyner and F. R. Milsom. (*Electronic Eng.*, vol. 18, pp. 297-299; October, 1946.) A general purpose instrument designed so that (a) all frequencies from zero to the megacycle region can be handled, (b) the image is sharply defined and completely steady, (c) instantaneous positioning at any part of the screen is provided, (d) any part of the trace can be expanded, (e) the various controls are independent, and (f) performance is consistent, and the instrument has long life. Methods of achieving these objectives are explained.
- 621.318.323.2.042.15 253
Permeability of Iron-Dust Cores—G.W.O.H., Lamson, and Burgess. (See 35.)
- 621.318.4.017.31:621.316.974 254
Power Loss in Electromagnetic Screens—Davidson, Looser, and Simmonds. (See 33.)
- 621.394.652:621.394.141 255
A Deluxe Electronic Key—W. R. De Hart. (*QST*, vol. 30, pp. 17-23; September, 1946.) An electronic circuit for automatic keying and monitoring purposes. The apparatus consists of two units: (a) a multivibrator which gives an output of dots or dashes depending on the position of an operating key; and (b) a keying amplifier, monitoring oscillator, and loud-speaker. The system has the advantage that no mechanical device is included.
- 621.396.615.17 256
Laboratory Pulse Generator with Variable Time Delay—D. R. Scheuch and F. P. Cowan. (*Rev. Sci. Instr.*, vol. 17, pp. 223-226; June, 1946.) A biased multivibrator ("flip-flop") can be adjusted so that the output pulse occurs at any described interval between 2 and 850 microseconds after the input. Output pulse width is adjustable between 1 and 40 microseconds. Input signals of arbitrary waveform may be used at frequencies up to 100 kilocycles. At 10 kilocycles the minimum sine wave input signal to operate the instrument is 0.2 volt. The delayed pulse is delivered at low impedance with maximum amplitude 150 volts. Block and circuit diagrams are given and fully explained.
- 621.396.68:621.397.5 257
30 kV Power Supply—H. C. Baumann. (*Elec. Ind.*, vol. 5, pp. 77-78; October, 1946.) Details of a voltage trebler circuit giving 100 microamperes at 30 kilovolts. It has a push-pull oscillator at 300 kilocycles with a 350-volt plate supply, and a radio-frequency transformer with separate secondaries for the high voltage and the rectifier filaments.
- 621.396.681 258
A Simple Battery Operated High Voltage Supply—L. E. Williams. (*Rev. Sci. Instr.*, vol. 17, pp. 296-297; August, 1946.) The audio frequency from a blocking oscillator is transformed to a high voltage and is rectified by a diode to give an output of more than 1000 volts at 100 microamperes. The battery supply is 90 volts at about 15 milliamperes and a variable resistance in series with this battery adjusts the voltage output. (Appears similar to 3539 of 1940 [Burgess].)
- TELEVISION AND PHOTOTELEGRAPHY**
621.396.681.4 259
"Foot-Lambert" Unit of Picture Brightness—(See 67.)
- 621.385.832.032.2 260
Magnetic Focusing and Deflection—Rawcliffe and Dressel. (See 303.)
- 621.385.832.032.2 261
Comparison of Electrostatic and Electromagnetic Deflection in Cathode-Ray Tubes—(See 304.)
- 621.397.26 262
Electronic Newspaper—(*Gen. Elec. Rev.*, vol. 49, pp. 49-50; September, 1946.) In a trial next year, four 9½-inch by 12-inch pages of text or photographs will be relayed by frequency-modulation broadcasting stations to facsimile receivers during transmissions lasting 15 minutes. See also 3444 of 1946.
- 621.397.26 263
Method of Transmitting Sound on the Vision Carrier of a Television System—D. I. Lawson, A. V. Lord, and S. R. Kharbanda. (*Jour. Telev. Soc.*, vol. 4, pp. 239-250; June, 1946.) See 3091 of 1946 and back references.
- 621.397.26 264
A Method of Transmitting Sound on the Vision Carrier of a Television System—D. I. Lawson, A. V. Lord, and S. R. Kharbanda. (*Jour. I.E.E.*, (London) part I, vol. 93, pp. 415-416; September, 1946.) Summary of 3091 of 1946.
- 621.397.4:621.394.64.029.64 265
Facsimile over 4000-Mc Relay System—(*Electronics*, vol. 19, pp. 146, 150; October, 1946.) An experimental two-way radio relay system, with repeater stations, has been used for transmitting various types of intelligence including facsimile transmission of text and photographs using a 4.8-kilocycle bandwidth.
- 621.397.5 266
System Standards—(*Elec. Ind.*, vol. 5, pp. 72-73; October, 1946.) Reference data and standards currently in use for the information and guidance of television design engineers.
- 621.397.5:621.317.2 267
A Television Pattern Test Generator—F. A. Inskip. (*Jour. Telev. Soc.*, vol. 4, pp. 255-256; June, 1946. Discussion, p. 257.) The unit is portable and is modulated to give a simple pattern on a cathode-ray-tube screen. The tuning range is 30 to 60 megacycles with calibration points at 45 and 41.5 megacycles so that the sound section of the receiver can also be checked. A circuit diagram is given, and the procedure for testing receivers and sound explained.
- 621.397.5:621.317.2 268
TV (television) Test Equipment—P. H. Hunter. (*Elec. Ind.*, vol. 5 pp. 49-51, 108; October, 1946.) There is a particularly urgent demand for a "... synthetic video pattern generator capable of producing various types of test patterns on television receiver screens for the evaluation of their over-all performance." Design trends are discussed, and existing equipment reviewed.
- 621.397.5:621.396.677 269
Rhombic Antennas for Television—Minter. (See 26.)
- 621.397.5(44) 270
Television in France—(*Jour. Telev. Soc.*, vol. 4, pp. 224-225; March, 1946.) An abstract of a report by the Combined Intelligence Objective Sub-Committee, which describes visits to the Compagnie des Compteurs, Montrouge, and to the studios of the R.D.F. At the former a 400-line projection on a screen 6 by 4 feet was seen, the quality being comparable with that from Alexandra Palace. Iconoscopes were employed for all cameras: owing to the shortage of mica the mosaic was deposited on oxidized aluminium sheet. Demonstrations of both a
- 1050- and a 450-line system were seen, the increase in entertainment value with the 1050-line system being most marked. Electrostatic lenses were used in all the iconoscopes, but magnetic lenses were used in the projection tubes.
- The transmitter in the Eiffel Tower belonging to R.D.F. was damaged by the Germans before they left, and will probably not be in operation for two years. R.D.F. has a large television studio built to the order of the Germans and in which all the equipment is German and made by Fernseh A. G. Demonstrations of film transmission with a 441-line interlaced system gave very good definition and a quality comparable with film transmission from Alexandra Palace. Three additional studios were under construction. See also 2741 of 1946.
- 621.397.621 271
Line Scanning Systems for Television—A. M. Spooner and E. E. Shelton. (*Electronic Eng.*, vol. 18, pp. 302-307; October, 1946.) Formulas are derived for the time-base wattage of electrostatic and electromagnetic deflecting systems. A 'figure of merit' is obtained for deflecting coils, and its experimental measurement considered. The importance of each variable involved, such as illumination, anode voltage, beam current, and tube shape, is considered, and the relative merits of various scanning coils deduced.
- 621.397.621:621.397.645 272
Electromagnetic Frame Scanning—W. T. Cocking. (*Wireless World*, vol. 52, pp. 289-291; September, 1946.) A linear framescan can be obtained economically only by compensating for the nonlinearity of the coupling to the scan coils by the tube curvature. See also 3086 of 1946 (Cocking).
- 621.397.645 273
Video Amplifier H.F. Response: Part 1—(See 61 and 62.)
- 621.397.823 274
The Noise Suppressor in the V114 [Television Set]—H. A. Fairhurst. (*Murphy News*, vol. 21, pp. 244-246; October, 1946.) Suppression for noise pulses shorter than the periodic time of the highest audio frequency is obtained by a series diode in which a backing potential is derived from the audio signal through a circuit of time constant less than that corresponding to the maximum audio frequency but greater than the noise-pulse duration.
- TRANSMISSION**
- 621.396.13:621.394.65 275
Frequency Shift Keying Techniques—C. Buff. (*Radio*, vol. 30, pp. 14, 30; August, 1946.) The change in bias of a reactance tube, connected across the tuned circuit of a 200-kilocycle oscillator, produces the desired frequency shift. The gain in signal-to-noise ratio is experimentally estimated as 11 to 20 decibels better than for on-off keying. Circuit and design data are included. See also 2306 of 1946 (Peterson, et al.)
- 621.396.61 276
A Medium-Power Bandswitching Transmitter—R. M. Smith. (*QST*, vol. 30, pp. 13-21, 108; October, 1946.) A crystal oscillator, arranged for five alternative crystals is connected directly to a type 807 amplifier on the 80- and 40-meter amateur bands or through a type 6N7 frequency multiplier into the 807 amplifier on the 20- and 10-meter bands. The final amplifier uses a type 4-125A beam tetrode with an input of 375 watts for continuous wave or 270 watts for telephonic operation.
- 621.396.619.018.41:621.385.5 277
Phasitron F.M. Transmitter—F. M. Bailey and H. P. Thomas. (*Electronics*, vol. 19, pp. 108-112; October, 1946.) Describes in detail

the mode of operation of the phasitron (see also 1405 and 2767 of 1946) and its application to a 250-watt transmitter covering the frequency range 88 to 108 megacycles. The phasitron output frequency is multiplied by 432 to give carrier frequency. Inductive tuning is employed in the output tank circuit of the transmitter, the entire frequency range being covered without changing coils or taps.

VACUUM TUBES AND THERMIONICS

- 519.2 278
The Resultant of a Large Number of Events of Random Phase—C. Domb. (*Proc. Camb. Phil. Soc.*, vol. 42, pp. 245-249; October, 1946.) "Rayleigh's method of deducing the probability distribution of the amplitude of the sum of n equal vibrations of random phase is generalized to the case when the amplitude of each vibration is a definite function of its phase. The same method is applied to the shot effect and it enables the distribution of random noise to be obtained. Campbell's theorem and its generalizations can then be deduced from this."
- 537.291 279
Influence of Space Charge on the Bunching of Electron Beams—Brillouin. (See 75.)
- 537.533.8:621.385.1.032.216 280
Dissociation Energies of Surface Films of Various Oxides as determined by Emission Measurements of Oxide Coated Cathodes—H. Jacobs. (*Phys. Rev.*, vol. 69, pp. 692-693; June 1-15, 1946.) Summary of American Physical Society paper.
- 537.533.8:621.385.1.032.216 281
Enhanced Thermionic Emission from Oxide Cathodes—J. B. Johnson. (*Phys. Rev.*, vol. 69, p. 702; June 1-15, 1946.) After bombardment by a short pulse of electrons, the thermionic activity of a cathode in the temperature range for emission can remain abnormally high for many microseconds. Summary of American Physical Society paper.
- 537.533.8:621.385.1.032.216 282
Secondary Emission of Thermionic Oxide Cathodes—J. B. Johnson. (*Phys. Rev.*, vol. 69, p. 693; June 1-15, 1946.) The number, δ , of secondary electrons emitted per primary, rises with primary energy from 1 at about 30 electron volts to a maximum of 4 to 10 at 1200- to 1500-electron volts. When cold, the oxide has a higher δ but acquires a surface charge which limits the escape of secondaries. δ decreases with increased temperature and the reported exponential increase with temperature (see 1925 of 1939, Morgulis and Nagorsky) is attributed to a temporary increase in thermionic activity. Summary of American Physical Society paper.
- 537.533.8:621.385.1.032.216 283
The Poisoning of Oxide Cathodes by Gold—J. Rothstein. (*Phys. Rev.*, vol. 69, p. 693; June 1-15, 1946.) The experimental technique is described. It is concluded that "Au readily migrates (diffuses) over (BaSrCa)O and Ni, that Au inhibits emission, and that suitable thermal gradients can alter Au concentration and restore emission. It seems likely that Au exerts its maximum inhibiting effect when present at the outer surface of the oxide." Summary of American Physical Society paper.
- 537.533.8:621.385.1.032.216 284
Dissociation Energies of Surface Films of Various Oxides as determined by Emission Measurements of Oxide Coated Cathodes—H. Jacobs. (*Jour. Appl. Phys.*, vol. 17, pp. 596-603; July, 1946.) When an electron achieves a critical kinetic energy in moving from cathode to an oxide-coated anode, a dissociation of the oxide results. Liberated oxygen returning to the cathode reduces emis-

sion. This critical energy was found to be equivalent to the heats of formation of the oxides bombarded.

- 621.314.632 285
Small Deviations from Diode Behavior in Crystal Rectification—K. F. Herzfeld. (*Phys. Rev.*, vol. 69, p. 683; June 1-15, 1946.) Assuming that the mean free path of the electrons in the blocking layer is large but not infinite, compared with the thickness of the layer it is found that the dependence of current on voltage is slightly less than in the pure diode theory. Summary of American Physical Society paper.
- 621.326[1+.3/.4]:621.392.5:621.316.722.078.3 286
The Characteristics of Lamps as Applied to the Non-Linear Bridge, used as the Indicator in Voltage Stabilizers—Patchett. (See 45.)
- 621.384.5.08 287
The Properties of Glow Tubes and Their Applications for Measurement Purposes—Glaser. (See 191.)
- 621.38.16 288
A High-Power Rising-Sun Magnetron—A. Ashkin. (*Phys. Rev.*, vol. 69, p. 701; June 1-15; 1946.) A mode separation of a rising-sun magnetron is independent of anode length. Tubes with long anodes have been constructed to give a peak power of 1 megawatt for a wavelength of 3 centimeters with output efficiency of about 45 per cent. Summary of American Physical Society paper.
- 621.385.16 289
"Crown of Thorns" Tuning of Magnetrons—S. Sonkin. (*Phys. Rev.*, vol. 69, p. 701; June 1-15, 1946.) Description of a mechanically tunable vane-type magnetron for which linear tuning up to 10 per cent was obtained. The causes and elimination of variations in power output with wavelength are discussed. Summary of American Physical Society paper.
- 621.385.16 290
Space-Charge Frequency Dependence of a Magnetron Cavity—M. Phillips and W. E. Lamb, Jr. (*Phys. Rev.*, vol. 79, p. 701; June 1-15, 1946.) A correction to the resonant frequency due to a thin layer of space charge surrounding the cathode is given "by a resonance type formula about the cyclotron frequency $eB/2\pi m$." A small amplitude theory is used based on a single-stream steady state, and is limited to low-level oscillations. Summary of American Physical Society paper.
- 621.385.16 291
Energy Build-Up in Magnetrons—L. P. Hunter. (*Phys. Rev.*, vol. 69, p. 700; June 1-15, 1946.) Analysis of the law of build-up and its dependence on load, initial noise level and cavity Q . Summary of American Physical Society paper.
- 621.385.16 292
One Centimeter Rising Sun Magnetrons with 26 and 38 Cavities—A. V. Hollenberg, S. Millman, and N. Kroll. (*Phys. Rev.*, vol. 69, p. 701; June 1-15, 1946.) Summary of American Physical Society paper.
- 621.385.16:621.396.615.14.029.63/.64 293
The Magnetron as a Generator of Centimeter Waves: Parts I and 2—J. B. Fisk, H. D. Hagstrum, and P. L. Hartman. (*Bell Sys. Tech. Jour.*, vol. 25, pp. 167-263 and 264-348; April, 1946.) In Part 1 the fundamentals of the magnetron are discussed. A general picture is given of the nature of the electronic mechanism, and of the role played by the radio-frequency circuit and load. The second part gives a description of tests on a British 10-centimeter, 10-kilowatt, 8-resonator magnetron which led to the development of radar magnetrons for wavelengths of 20 to 45 centimeters with peak power up to 700 kilowatts; the introduction of strapping improved efficiency greatly at the higher powers. Tunable magnetrons were first investigated at this wavelength, but later also for wavelengths of 3 centimeters. Variations of the British design resulted in a series of magnetrons with powers up to 1 milliwatt for a wavelength of 10 centimeters. Then came magnetrons with wavelengths of 3 centimeters for airborne and marine applications, while finally for wavelengths of 1 centimeter the 3J21 "rising sun" magnetron was developed. Details of design, production problems, and general performance of all these magnetrons are given together with a short account of work on cathode design.
- 621.385.16.029.63 294
New Magnetron Designs for Continuous Operation in the Decimeter Wave Range—D. A. Wilbur. (*Phys. Rev.*, vol. 70, p. 118; July 1-15, 1946.) Two devices to eliminate cathode back heating from high-frequency operation of split-anode magnetron are described, in which multigap operation is attained together with an easily tunable external tank circuit. (1) Only two segments of the multigap are used, the remainder being replaced by a single electrode maintained at zero radio-frequency potential. (2) A multiplicity of electrodes is used mounted internally on a conducting helix. Abstract of an American Physical Society paper.
- 621.385.16.032.21.029:63 295
A 10-Kilowatt Magnetron with Water-Cooled Cathode—R. V. Langmuir and R. B. Nelson. (*Phys. Rev.*, vol. 70, p. 118; July 1-15, 1946.) A simple split-anode magnetron delivering over 10 kilowatt continuous wave at 60 per cent efficiency and tuning from 560 to 625 megacycles was developed for radar jamming. The efficiency is comparable with that of multiple-anode types. The cathode operates by secondary emission, and is water-cooled; the best secondary-emission surface found was made of a magnesium alloy. Abstract of an American Physical Society paper.
- 621.385.16.032.22 296
Development of the Rising Sun Magnetron Anode Structure—S. Millman and A. Nord-sieck. (*Phys. Rev.*, vol. 69, p. 701; June 1-15, 1946.) With very-short waves the mode separation of magnetrons by strapping becomes difficult and expensive. An alternative method is to make the resonator cavities alternately large and small with resonant wavelength ratio between 1.5 and 2.5. The mode spectrum, and the advantages and limitations of these magnetrons are discussed. Summary of American Physical Society paper.
- 621.385.16.032.22 297
Theory of the Rising-Sun Magnetron Anode—N. Kroll and W. E. Lamb, Jr. (*Phys. Rev.*, vol. 69, p. 701; June 1-15, 1946.) The method is analogous to that of Clogston for a symmetric anode. Maxwell's equations can be solved for both the cathode-anode space and the side resonators for a specified boundary tangential electric field. Resonance is determined by the continuity of the average magnetic field at the junctions. The method may be extended to other structures. Summary of American Physical Society paper.
- 621.385.18.029.64:537.5 298
Conductivity of Electrons in a Gas at Microwave Frequencies—Margenau. (See 76.)
- 621.385.831.012.8 299
Equivalent Noise Representation of Multi-Grid Amplifier Tubes—Twiss and Schremp. (See 37.)
- 621.385.832+621.397.331.2 300
Simplification of Cathode-Ray Tube Design

by the Application of the Theory of Similitude—H. Moss. (*Jour. Telev. Soc.*, vol. 4, pp. 206-219; March, 1946. Discussion on p. 228.) A discussion of "the application of the general theories of scale, dimensional homogeneity, and energy conservation to cathode-ray tube design. From these simple bases it is shown that many important deductions can be drawn about the general form which the tube geometry should assume."

The following four rules form the basis of the "relaxation" methods of cathode-ray tube design. The first three are quite rigorous within their limiting postulates. The fourth has some theoretical justification, but the main support is experimental.

(1) Principle of voltage similitude: in any electron optical system, in which space charge is negligible, and in which the electrons start from rest, the electron trajectory is unaltered by multiplication of all electrode potentials by a constant factor k . The transit time between any two fixed points in the system varies as $1/\sqrt{k}$.

(2) Principle of geometrical similitude: in any electron optical system in which the total current flow is constant, the shape of the field and of the electron trajectory is unaltered by multiplication of the size of all the bounding electrodes by a constant factor k . The transit time between corresponding points in the two systems is proportional to k .

(3) Spot size/crossover size relationship: if the crossover and spot are formed in regions of the same potential, then spot size = crossover size \times geometrical magnification (M). More generally, if V_1 is the crossover potential, and V_2 the spot potential, then spot size = crossover size $\times M \sqrt{V_1/V_2}$.

(4) Dependence of crossover size on voltage on crossover forming electrode: to a close approximation, in any system where the space charge is negligible, the crossover diameter is inversely proportional to the square root of the potential on the crossover-forming electrode.

Proofs of these principles are given, and they are applied to some specific problems including the design of projection tubes.

621.385.832:535.371.07 301
Long Persistence C.R. Tube Screens—Feldt. (*See* 123.)

621.385.832:621.396.9 302
Skiatron—(*Electronics*, vol. 19, pp. 216, 220; October, 1946.) A short account of a lecture by P. G. R. King at the Institution of Electrical Engineers Radiolocation Convention, already noted in 2404 of 1946.

621.385.832.032.2 303
Magnetic Focusing and Deflection—D. Rawcliffe and R. W. Dressel. (*Elec. Ind.*, vol. 5, pp. 52-56, 111; October, 1946.) Focus magnets have the advantages of light weight and stability with respect to temperature but generally give a focus inferior to that obtained with focus coils. Air-core and iron-core deflection coils are designed to overcome the distortion in a display pattern due to the curvature of the tube screen, nonuniformity of the magnetic field and inductive and capacitive coupling between the various points of the coils.

621.385.832.032.2 304
Comparison of Electrostatic and Electromagnetic Deflection in Cathode-Ray Tubes—(*Jour. I.E.E.* (London), part III, vol. 93, p. 364; September, 1946.) Summary of Institution of Electrical Engineers Radio Section discussion led by E. W. Bull and V. A. Stanley. It was pointed out that defocusing with beam deflection was greater with electrostatic deflection because the electron beam underwent energy changes in the deflecting field. Electrostatic tubes suffered from trapezium distortion. The effects of gaseous ions were less with elec-

trostatic deflection. Less energy was required to scan an electrostatic tube.

The use of mixed magnetic and electrostatic deflection, the difficulties of aligning deflection and focusing coils when replacing magnetic tubes, and the question of deflection methods for oscillograph purposes were also discussed. (For another account see *Jour. Telev. Soc.*, vol. 4, p. 264; June, 1946.)

621.395.622:621.396.619.018.41 305
Single-Stage F.M. Detector—Bradley. (*See* 227.)

621.385(02) 306
Inside the Vacuum Tube [Book Review]—J. F. Rider. J. F. Rider Publisher Inc., New York, N.Y., \$4.50. (*Proc. I.R.E.* (Australia), vol. 7, p. 37; September, 1946.) "The aim in his [the author's] numerous well known works has been to cover one subject at a time, dealing mainly with fundamentals and starting from ground level."

MISCELLANEOUS

001.891 307
Research Problems of the Smaller Firm—(*Electrician*, vol. 137, p. 1140; October 25, 1946.) Brief summary of address by Sir Edward Appleton.

002:001.81 308
The Preparation of Technical Papers—W. E. Clegg. (*Jour. Instn. Eng.* (Australia), vol. 18, pp. 135-139; June, 1946.) Paper presented before the Juniors and Students' Section of Newcastle division. A bibliography of 11 items is given.

061.6 309
The National Physical Laboratory at Teddington—(*Nature* (London), vol. 158, pp. 361-363; September 14, 1946.) A review of its work as seen on the first post-war open day.

614.825 310
Dangerous Electric Currents—C. F. Dalziel. (*Trans. A.I.E.E.* (*Elec. Eng.*), vol. 65, pp. 579-584; August-September, 1946.) A general account of the physiological effects and the factors determining their magnitude, of the passage of electric currents through the body. Illustrative results of particular tests applied to certain animals and to man are included.

620.197(213):621.396.6.045 311
Tropicalizing [Transformers and Chokes]—Scarff. (*See* 133.)

620.197(213):621.314.045 312
Impregnated Windings [for Tropicalizing Transformers]—Williams; Burkett. (*See* 134.)

621.3(091):51 313
Notable Electrotechnical Forecasts—C. Grover. (*Distrib. Elec.*, vol. 19, pp. 180-182; October, 1946.) A historical review of the contribution of mathematics to the development of electrical theory and forecasting of phenomena.

621.39:371.3]+621.315.6 314
I.E.E. Radio Section Address: Part 1—Training Courses Part 2—Dielectric Developments—W. Jackson. (*Elec. Rev.*, (London), vol. 139, p. 609; October 18, 1946.) *Electrician*, vol. 137, pp. 1065-1066; October 18, 1946.) Summaries of Chairman's inaugural address.

621.317 315
The History and Development of the British Scientific Instrument Industry—S. L. Barron. (*Beama Jour.*, vol. 53 pp. 325-328; September 1946.) Abridged version of a lecture delivered at the Stockholm Exhibition of British Scientific Instruments, 1946.

621.317.785 316
Trends in Measurements—L. J. Matthews. (*Elec. Times* vol. 110, p. 603; October 31,

1946.) Summary of inaugural address of the Chairman to the Institution of Electrical Engineers Measurements Section dealing particularly with recent developments of consumers' alternating-current meters.

621.327.43:628.971.6 317
Dimming Fluorescent Lighting—H. A. Miller. (*Elec. Rev.* (London), vol. 139, pp. 457-458; September 20, 1946.) The possible circuits discussed are (a) series resistance, (b) variable-voltage auto-transformer, (c) saturable reactor control, and (d) thyatron control. Diagrams are given for each.

621.38.001.8 318
Electronics—Servant or Fad?—P. G. Weiller. (*Instruments*, vol. 19, pp. 2-8; January, 1946.) Verbatim account of a lecture in which the advantages and disadvantages of electronic control and measuring devices for industrial applications are discussed. It is stressed that very careful prior consideration is necessary to decide whether such a device is likely to provide a practicable and economic solution to the problem in hand. Several instructive examples are described!

621.396:371.3 319
Aids to [Radio] Training—M. G. Scroggie. (*Wireless World*, vol. 52, pp. 303-304; September, 1946.) A review of an exhibition of equipment used in the teaching and training of Royal Air Force personnel in the operation and maintenance of radio and radar apparatus.

654.19(41) 320
Broadcasting in Great Britain—(*Nature* (London), vol. 158, pp. 314-315; August 31, 1946.) Abstract of the White Paper on Broadcasting Policy which justifies the renewal of the British Broadcasting Corporation's Royal Charter for 5 years from January 1, 1947.

530.145(02) 321
Philosophic Foundations of Quantum Mechanics [Book Review]—H. Reichenbach. University of California Press, Berkeley and Los Angeles California; Cambridge University Press, London, 1944, 182 pp., \$3. (*Nature*, (London), vol. 158, pp. 356-357; September 14, 1946.)

621.3(031) 322
Whittaker's Electrical Engineer's Pocket Book [Book Review]—R. E. Neale (Editor). *See* 3835 of 1946.

621.394/.395(021) 323
A Handbook of Telecommunication (Telephony and Telegraphy over Wires) [Book Reviews]—B. Cohen. Pitman, London, 437 pp., 30s. (*Elec. Rev.*, (London), vol. 139, p. 652; October 25, 1946.)

621.396(075) 324
An Experimental Course in the Fundamental Principles of Radio [Book Review]—R. H. Humphrey. Pitman, London, 194 pp., 12s. 6d. (*Electronic Eng.*, vol. 18, p. 292; September, 1946.)

621.396(075) 325
Radio Communications [Book Reviews]—W. T. Perkins and R. W. Barton. George Newnes, London, 312 pp., 12s. 6d. (*Elec. Rev.* (London), vol. 139, p. 296; August 23, 1946; *Wireless World*, vol. 52, p. 307; September, 1946. "... primarily a manual of the 'question and answer type,' intended for students. ...")

621.396.3(075) 326
Handbook of Technical Instruction for Wireless Telegraphists [Book Review]—H. M. Dowsett and L. E. Q. Walker. Iliffe and Sons, London, eighth edition, 660 pp., 30s. (*Electronic Eng.*, vol. 18, pp. 292-293; September, 1946.) "... It is an essential requirement for passing the P.M.G. Certificate and can be confidently recommended to all prospective wireless telegraphists."

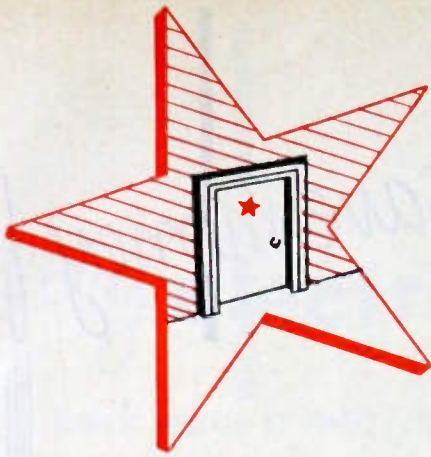

It's PERFORMANCE that COUNTS

*On the assembly line or in the laboratory
Visual Alignment Techniques insure better
performance.*

HIGH FREQUENCY VISALGEN Model 205 TS

1. Frequency range from 100 kc to 20 mc.
2. Linear frequency sweep deviation adjustable from 0 to 900 kc peak to peak.
3. Vernier frequency control of 100 kc allows zero beat calibration of main tuning dial or for vernier frequency deviation about main dial frequency setting.
4. Output impedance 1 ohm to 2,500 ohms.
5. Voltage regulated supply for internal oscillators.

LOW FREQUENCY VISALGEN Model 204 TS

1. Frequency range from 20 kc to 500 kc.
2. Linear frequency sweep deviation adjustable from 0 to 70 kc peak to peak.
3. Low pass filter in the output to minimize spurious output frequencies.
4. Output impedance constant 200 ohms.
5. Output attenuation: 5-step ladder type — 20 db per step.

OSCILLOSCOPE Model 188 TS

1. New simplified circuit for use with either model Visalgen.
2. Simplified for visual alignment work.
3. Compact design — light weight.
4. Immediately available, also available with either model Visalgen complete in one cabinet.

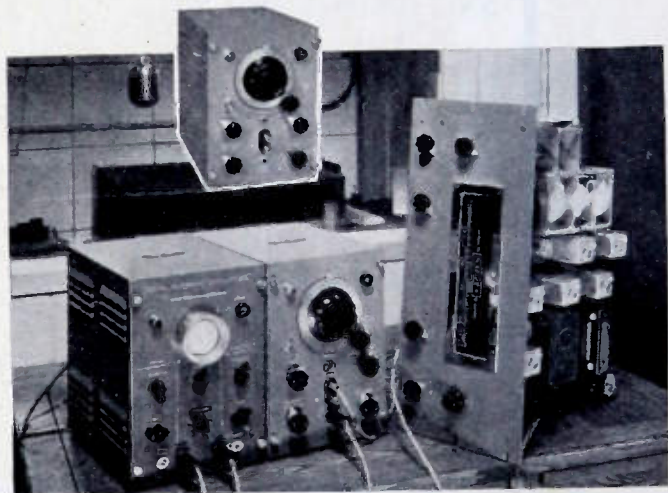

Visalgen Model 205 TS being used with 188 TS oscilloscope to align Harvey Hi-Fidelity FM Receiver.

Inset: New Low Frequency Visalgen Model 204 TS



HARVEY RADIO LABORATORIES, INC.
456 CONCORD AVENUE • CAMBRIDGE 38, MASSACHUSETTS

This **Free** book can save money for

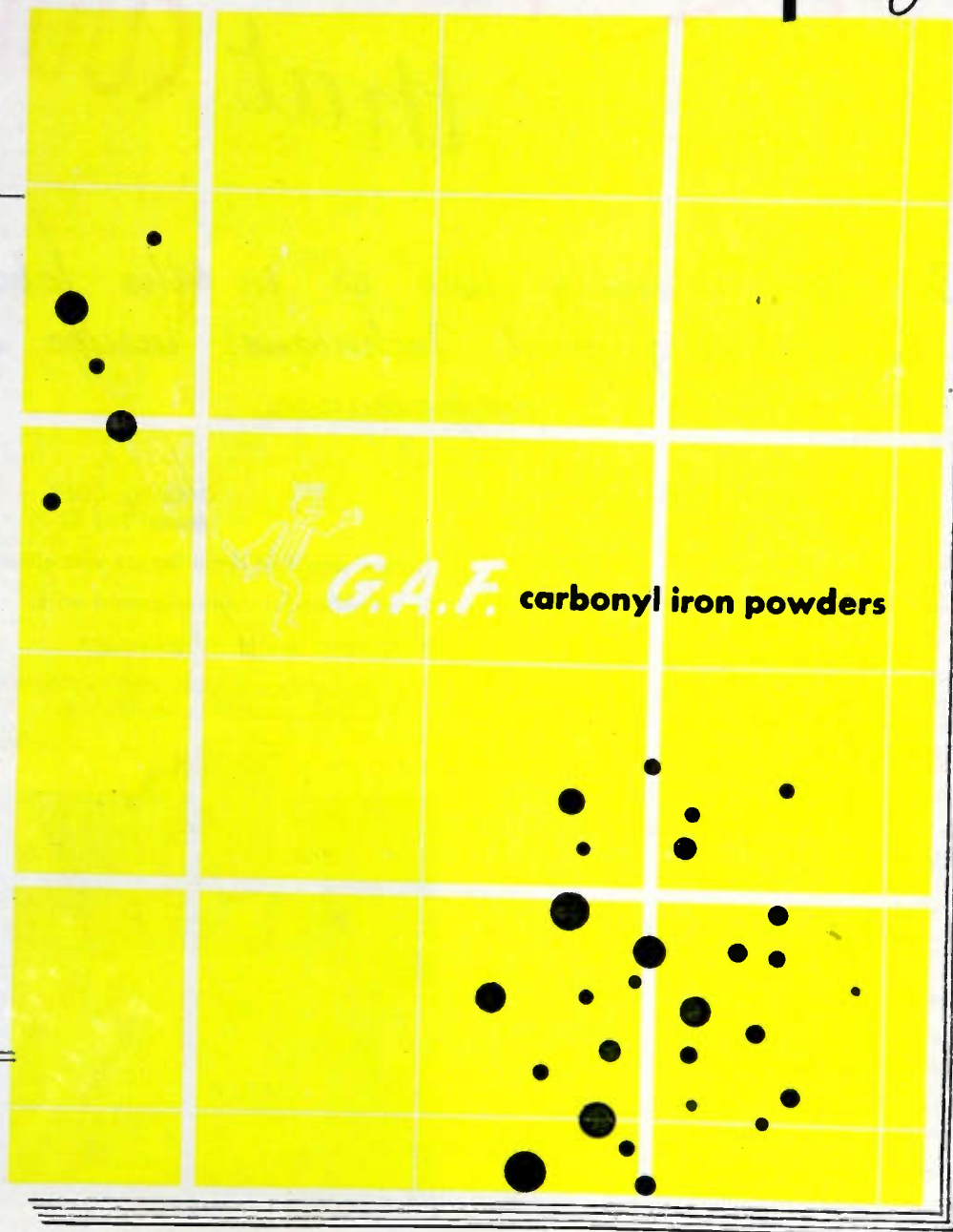

G.A.F. carbonyl iron powders

General Aniline & Film Corporation

every electronics manufacturer

Look what it tells you about the practical core material—Carbonyl Iron Powder

CONTENTS

How Carbonyl Iron Powders are Made
Microphotographs of Carbonyl Iron Powder
Properties of Carbonyl Iron Powders
Chemical Composition
Particle Size and Density
Electro Magnetic Constants
Comparisons with Other Magnetic Powders—

- a. flux density
- b. core density
- c. iron packing fraction

“HP” Carbonyl Iron Powder

- a. physical characteristics
- b. electro magnetic characteristics
- c. “Q” values

Carbonyl Iron Powders in High Frequency Cores

- a. relative “Q” values of 5 grades
- b. comparison with air-cored coils

Effective Permeability of High-Frequency Iron Cores

Types of Cores Made with Carbonyl Iron Powder

Carbonyl Iron Powders in Powder Metallurgy

Behavior at High Temperatures

Formulae Frequently Used in Connection With Iron Cores

A List of Papers Relating to Powdered Iron and Its Applications

Index

how to get maximum stability

what powder is best for inductance tuning?

how to save up to 60% on coil winding wire

how to get coil “Q” values 170% higher than in air-cored coils

where Carbonyl Iron Powders are used

Send for it!

Mail this coupon today →

To: General Aniline & Film Corporation
Special Products Sales Division, Dept. 1
270 Park Avenue, New York 17, N. Y.

Please send me a free copy of “G.A.F. Carbonyl Iron Powders.”

Name _____

Address _____

City _____ State _____

NOTE: If you visit the Institute of Radio Engineers show at Grand Central Palace in New York, March 3-6, you are invited to stop at the G.A.F. Carbonyl Iron Powder exhibit.



Brush Low-Cost Paper Tape Means Magnetic Recording for Everyone!

No matter what type of magnetic recorder you design, the low cost, excellent fidelity and uniformity of Brush Paper Tape make it your best-all-round recording medium. With this new development by the pioneer and leader in the field of magnetic recording you can bring magnetic recording to the great mass market of all America! Brush Paper Tape will be furnished you either in bulk in varying widths or 1225 ft. 1/4-inch wide on a metal reel.

Look at these advantages of Brush Paper Tape . . .

- Easy to handle
- Extreme low-cost
- Can be edited...spliced
- Greater dynamic range
- Minimum wear on heads
- Excellent high frequency reproduction at slow speed
- Permanent . . . excellent reproduction for several thousand play-backs

Other Brush developments in magnetic recording components include Brush Plated Wire and vastly improved Tape and Wire Recording Heads and Cartridges.

Write today for further information



The Brush Development Company
3405 Perkins Avenue • Cleveland 14, Ohio



ATLANTA

"Radar Testing with the Echo Box," by William A. Edson, Georgia School of Technology; November 22, 1946.

BALTIMORE

"German Electronics Equipment," by N. J. Granger, Intelligence Section, Signal Corps, Washington, D. C.; November 12, 1946.

BOSTON

"The Reduction of Background Noise in the Reproduction of Music from Records," by H. H. Scott, Technology Instrument Corporation; December 19, 1946.

CEDAR RAPIDS

"Loudspeaker-Design Trends," by H. Knowles, Jensen Manufacturing Company; December 11, 1946.

Election of Officers; December 11, 1946.

CHICAGO

"Symposium on Frequency-Modulation Receiver Design," by N. P. Case, Hallicrafters; December 13, 1946.

"Antennas and Input Circuits," by N. W. Aram, Zenith Radio Corporation; December 13, 1946.

"Radio-Frequency Circuits, Mixers, Oscillators, Automatic-Frequency-Control and Intermediate-Frequency Circuits," by L. Hershey, Hallicrafters; December 13, 1946.

"Limiters and Frequency Detectors," by M. Hobbs, Scott Radio; December 13, 1946.

CLEVELAND

"Circular Polarization," by J. Dogosy and H. Norweb, United Broadcasting Company; November 14, 1946.

COLUMBUS

"Description and Demonstration of the Ohio Bell Mobile Radiotelephone System," by E. D. Guernsey; December 13, 1946.

CONNECTICUT VALLEY

"Microwaves and Radar," by A. O. Perrine, Bell Telephone Laboratories; October 24 and 25, 1946.

"Television Receiving Sets—Direct Viewing and Projection," by A. Wright, Radio Corporation of America; November 14, 1946.

"Pulsers—General Radar Theory," by H. Doolittle, The Machlett Company; December 5, 1946.

DETROIT

"Aircraft Communications Receiver Development," by E. A. Jensen, United Airlines; December 20, 1946.

"Noise-Limiter Receiver Circuits," by G. J. C. Andresen, Goodyear Research Foundation; December 20, 1946.

Election of Officers; December 20, 1946.

EMPORIUM

"Servomechanisms," by Professor Tarplay, Penn State College; December 6, 1946.

"A Four-Channel Electronic Switch," by Dr. Albers, Penn State College; December 6, 1946.

"Problems Involved in Teaching Electronics," by Professor Stavely, Pennsylvania State College; December 6, 1946.

"Motional Transconductance in Vacuum Tubes," by A. H. Waynick, Pennsylvania State College; December 6, 1946.

"The Institute Has Grown Up," by G. W. Bailey, Executive Secretary, Institute of Radio Engineers; December 12, 1946.

Election of Officers; December 12, 1946.

(Continued on page 38A)



50

YEARS OF PROGRESS

This new year of 1947 marks the completion of a half-century of devotion to the design, production, improvement and application of X-ray and other electron tubes. Pioneers fifty years ago, we are still pioneering, and in that earnest spirit pledge for the years to come still greater achievements in the electron art, increasing and broadening its service to the Public Health, to Industry, and to Communications.

MACHLETT LABORATORIES, INC., SPRINGDALE, CONNECTICUT

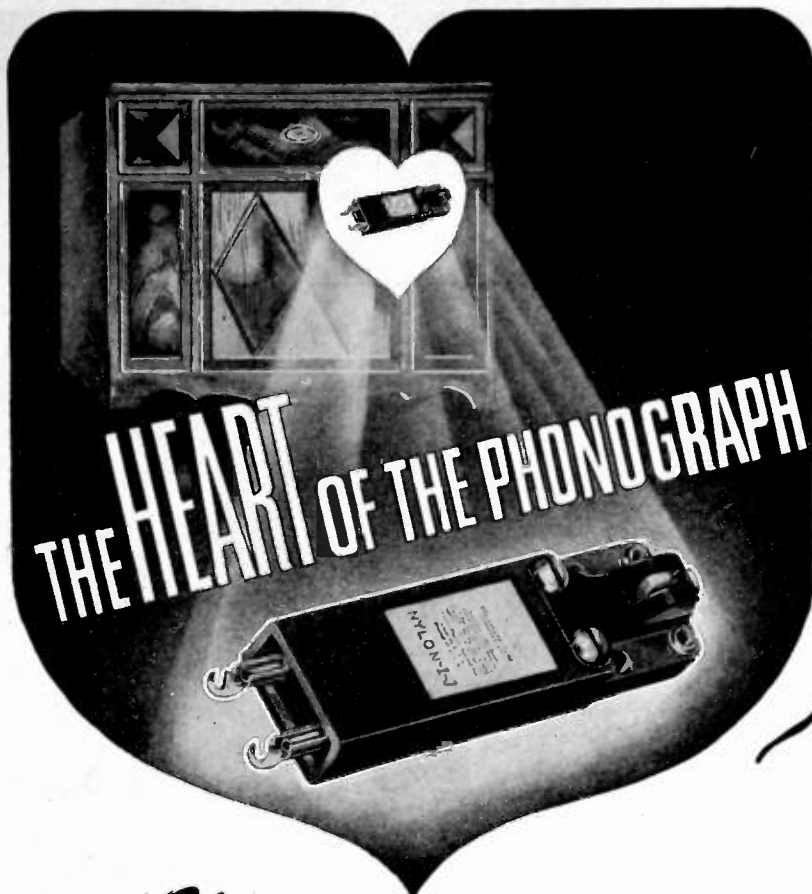

No other part of a modern phonograph is so important as the small crystal cartridge mounted in the pickup or reproducer arm. This cartridge is the pulsating heart of the instrument and upon the degree of efficiency of its operation depends the quality of reproduction.

It is not surprising, therefore, that many radio-phonograph manufacturers and engineers are expressing intense interest in Astatic's new Nylon 1-J Phonograph Pickup Cartridge. Designed with Nylon Chuck and MATCHED, sapphire-tipped, knee-action Nylon Needle, this cartridge improves performance with respect to needle life and frequency response, suppresses mechanical resonance, improves tracking at low needle pressure and reduces record wear. Other important advantages and details concerning Astatic's new Nylon Cartridge are given in special literature now available.



Visit your Radio Parts Jobber or Write for New Catalog.



(Continued from page 36A)

HOUSTON

"Radioactivity," by G. Herzog, Acting Consultant for the Schlumberger Well Surveying Corporation and The Texas Company; December 16, 1946.

INDIANAPOLIS

"Air Traffic Control," by J. Hilton and H. I. Metz, Civil Aeronautics Authority; December 13, 1946.

"Television Problems," by J. Smith, Wright Engineering Company; and M. G. Beier, P. R. Malloy Company; December 13, 1946.

"Frequency-Modulation—Amplitude-Modulation Applications," by S. Tarzian, Tarzian Associates; December 13, 1946.

"Interpretation of Instrument Readings," by F. Gross, Civil Aeronautics Authority; December 13, 1946.

"Vibrator Power Supplies and their Components," by T. Rosser, Senn Corporation; December 13, 1946.

LONDON, ONTARIO

"Nuclear Physics," by R. C. Dearle, University of Western Ontario; December 13, 1946.

LOS ANGELES

"A Central Signal System for Testing Receivers in Production," by F. Miller, Packard-Bell Company; November 21, 1946.

"The Traveling-Wave Amplifier," by L. M. Field, Stanford University; November 21, 1946.

MILWAUKEE

"Electrical Control for Resistance Welding," by E. J. Lempel, A. O. Smith Corporation; November 13, 1946.

"Coaxial Lines," by C. R. Cox, Victor J. Andrew Company; November 27, 1946.

"Dividing the Fruits of Progress," by W. E. Wickenden, Case School of Applied Science; December 18, 1946.

MONTREAL

"Television," by R. D. Kell, Radio Corporation of America Laboratories; December 4, 1946.

NORTH CAROLINA-VIRGINIA

"Tubes for Television," by C. M. Hoyer, Radio Corporation of America Laboratories; November 22, 1946.

OTTAWA

"Some Aspects of German Radar," by J. T. Henderson, National Research Council; December 10, 1946.

PORTLAND

"Antenna for Frequency-Modulation Broadcasting," by H. Singleton, Singleton and Bernard; November 25, 1946.

"Infrared Detection," by R. T. Ellickson, Reed College; November 25, 1946.

ST. LOUIS

"Present Status of Sound-Recording Apparatus and Techniques," by C. E. Harrison, Technisonic Recording Laboratories; December 19, 1946.

SAN DIEGO

"Broad-Band Antennas for Radio Communication Circuits," by J. Jacoby, Navy Electronics Laboratory; December 3, 1946.

TORONTO

"Measurements (Frequency-Modulation and Others)," by J. G. Minter, Measurements Corporation; December 9, 1946.

(Continued on page 40A)



These Allen-Bradley Honeycomb Cartons keep the fixed resistor leads always straight

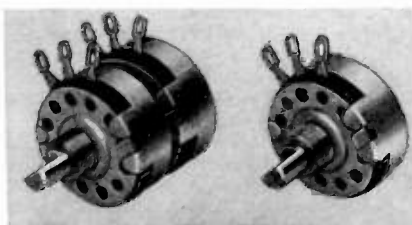

TYPE J BRADLEYOMETERS
in 1, 2, and 3 section types

For continuously adjustable resistors—in 1, 2, or 3 section types—specify Type J Bradleyometers. They meet any resistance-rotation curve specification... and, being solid-molded, there is no change due to age or use. Furnished with line switch if desired.

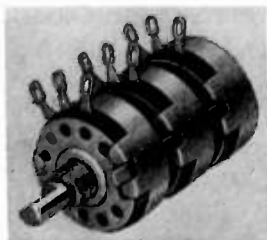

You know how messy it is to pick fixed resistors from a pan of tangled units. No matter how carefully your operators work, resistor leads became bent.

But most serious are the loss of production and the irritation to assemblers when they fumble with tangled component parts. To avoid these problems, use Bradley-unit resistors. They come in handy honeycomb cartons that keep all leads straight.

And all leads are "differentially" tempered to prevent sharp bends near the resistor. Leads are quickly and easily formed to fit any spot in your chassis.

Bradleyunits are small in size but "tops" in load and life tests. Under continuous loads of 200% load for 100 hours, or under 100% load for 1000 hours, resistance change is less than 5%. Allen-Bradley Co., 114 W. Greenfield Avenue, Milwaukee 4, Wis.

ALLEN-BRADLEY
FIXED & ADJUSTABLE RADIO RESISTORS
 QUALITY

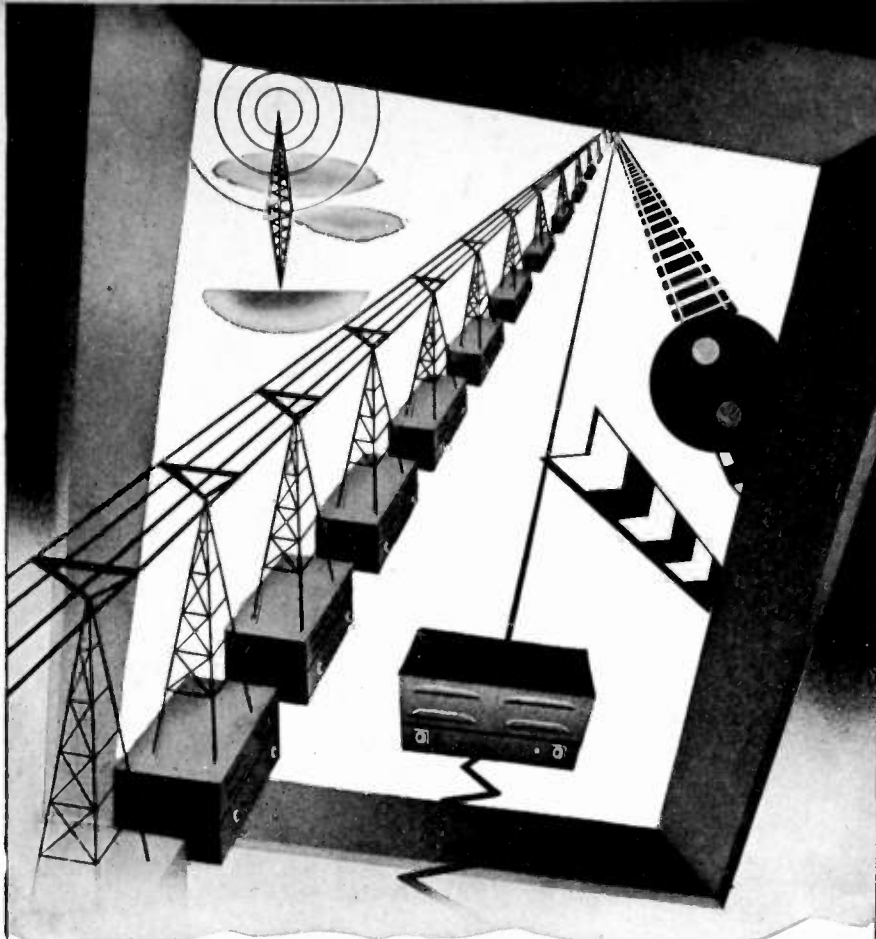

A MILLION MILES OF STRAIGHTENED VOLTAGES *Without Moving a Muscle*

Sorensen Voltage Regulators guarantee many miles of speed with safety by constantly and automatically stabilizing voltages that operate vital communications equipment on surface and air transportation lines.

Wire and radio contact systems depend upon quick, accurate response to even the smallest variation to attain peak performance. No moving parts in a voltage regulator means no time consuming adjustments, no wear and a minimum of maintenance.

These are just a few reasons why Sorensen Voltage Regulators are chosen as the perfect power guardian for the millions of miles of communications so essential to safe transportation.

Investigate the many advantages of Sorensen regulators applied to your unit. Write today for your copy of the new, complete Sorensen catalog M-P. It is filled with schematic drawings, performance curves, photos and contains in detail, "Principles of Operation."

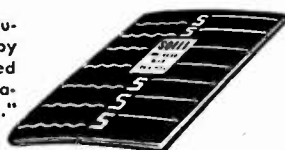

SORENSEN & COMPANY, INC.
STAMFORD, CONNECTICUT

A LINE OF STANDARD REGULATORS FOR LOAD RANGES UP TO 30 KVA.
SPECIAL UNITS DESIGNED TO FIT YOUR UNUSUAL APPLICATIONS.



(Continued from page 38A)

WASHINGTON

"Symposium on Frequency-Modulation Antennas," by S. L. Bailey, Jansky and Bailey; R. F. Holtz, Radio Corporation of America; A. G. Kandolan, Federal Telecommunication Laboratory Inc.; J. F. Morrison, Bell Telephone Laboratories; and M. W. Scheldorf, General Electric Company; November 22, 1946.

"Important Events and Developments which have taken place in the Field of Radio over the Past Fifty Years," by A. H. Taylor, Naval Research Laboratory; December 9, 1946.

Election of Officers; December 9, 1946.

WILLIAMSPORT

"Growth and Development of the Institute," by G. W. Bailey, Executive Secretary, Institute of Radio Engineers; December 11, 1946.

SUBSECTIONS

PRINCETON

"Germanium Semiconductors, Their Properties, Electrical Properties and Application," by K. Lark-Horovitz, Purdue University; December 4, 1946.



The following transfers and admissions were approved on January 7, 1947:

Transfer to Senior Member

Boymel, B. R., 5912-14 St., N.W., Washington 11, D. C.

Deisinger, D. A., 27 Munroe St., West Long Branch, N. J.

Fenton, A. N., 2418 Manning Ave., Los Angeles 34, Calif.

Galbraith, R. A. H., 393 Daly Ave., Ottawa, Ont., Canada

Hammerschmidt, A. L., 28 Beech St., Floral Park, N. Y.

Hutton, W. G., R.F.D. 3, Brecksville, Ohio

Jeffers, C. L., 514 W. Lynnwood Ave., San Antonio 1, Texas

Kidd, C. S., Radio and Research Section, P and T Branch, 63 HQ CCG (BE), Z.E.O. Hamburg, B.A.O.R.

Kofoed, M. J., Department of Electrical Engineering, Oregon State College, Corvallis, Oregon

McConnell, R. A., 151 Center Ave., Emsworth, Pittsburgh 2, Pa.

Mercer, W. R., 27 Gilmore Rd., Belmont 78, Mass.

Overmier, E. E., 20 W. Sixth St., Emporium, Pa.

Peck, A. G., 38 Beechwood Ave., Manhasset, L. I., N. Y.

Schotel, G., Zoeterwoudsche, Single 14, Lelden, The Netherlands

Tulauskas, L., 72 N. Fenton Ave., Indianapolis 1, Ind.

Watson, H. B., Clinton Rd. and Stewart Ave., Garden City, L. I., N. Y.

Yerian, C. S., 201 Maple Rd., Syracuse 9, N. Y.

Admission to Senior Member

Davidson, W. F., 4 Irving Place, New York, 3, N. Y.

Redington, J. H., 324 Cornelia St., Boonton, N. J.

Ross, A. E., Dept. of Mathematics, University of Notre Dame, Notre Dame, Ind.

Russ, R. B., 1559 Kingston Ave., Schenectady 8, N. Y.

White, G. E., 200 St. Pauls Rd., N., Hempstead L. I., N. Y.

(Continued on page 42A)

MYKROY

Extends a cordial invitation . . .

You are cordially invited to visit Booth No. 27 at the I.R.E. Show where Mykroy products will be exhibited by Electronic Mechanics, Inc.

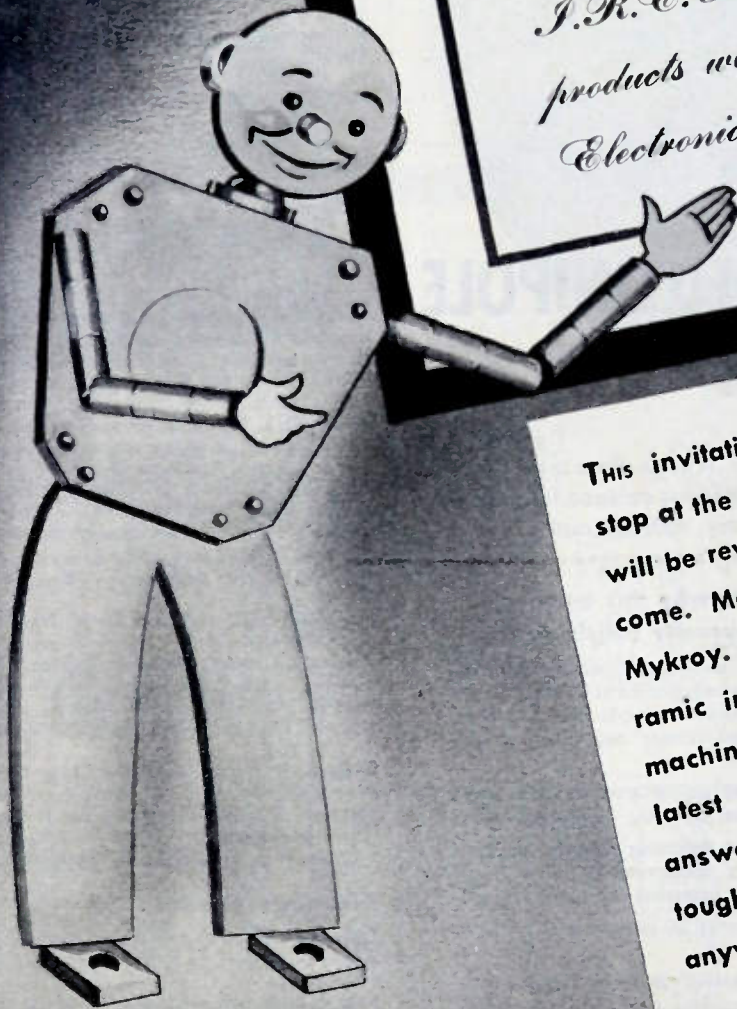

THIS invitation really is cordial. Your stop at the Electronic Mechanic's booth will be rewarded with a friendly welcome. Meet the men who engineer Mykroy. See this perfected Mica Ceramic insulation on display, in both machined and molded form. See the latest moldings. We may have the answer to some of your particularly tough insulation problems. Drop in anyway and say hello!

MYKROY IS SUPPLIED IN SHEETS AND RODS . . . MACHINED OR MOLDED TO SPECIFICATIONS

***MADE EXCLUSIVELY BY**

ELECTRONIC MECHANICS
INC.

**70 CLIFTON BOULEVARD • CLIFTON, NEW JERSEY
Chicago 47: 1917 NO. SPRINGFIELD AVENUE.. TEL. Albany 4310**

Export Office: 89 Broad Street, New York 4, N. Y.

Immediately Available

**AT
LONG
LAST!**

THE ANDREW FOLDED UNIPOLE

Greeted with a flood of orders when introduced last year, the popular Andrew Folded Unipole Antenna now is flowing off the production line at a rate which permits immediate shipment from stock.

Used for transmitting and receiving in the 30 to 44 MC and 72-76 MC frequency ranges, it easily outperforms other antennas selling at sev-

SEND IN YOUR ORDER NOW

eral times its price. Here is the ideal communications antenna for police, fire, forestry, railroad and aviation services.

Here's why this antenna is unusually satisfactory:

- Perfect impedance matching eliminates tricky adjustment of loading. Users report transmitter loads the same on antenna and dummy, regardless of line length.
- Improved signal strength over ordinary coaxial or other dipole antennas.
- Grounded radiating element provides static drain, improving signal to noise ratio and minimizing lightning hazard.
- Weighs only 20 pounds with clamps. Easy to install.
- Inexpensive. Antenna costs only \$60.00, mounting clamps \$6.00, transmission line adaptor kit \$6.00 (specify size and type of line).

For effective solutions to your antenna problems consult Andrew Co., designers, engineers and builders of antenna equipment. Expert factory installation service available.

ANDREW CO.
363 EAST 75th STREET • CHICAGO 19



(Continued from page 40A)

Transfer to Member

- Almas, S. L., 13200 Strathmoor St., Detroit 27, Mich.
- Brelmer, S., Hilversum, 362 G. V. Amstelstraat, The Netherlands
- Curtis, C. V., 3628 Gladstone Blvd., Kansas City 1, Mo.
- Dalasta, F., 415 Woodland Ave., Emporium, Pa.
- Doucette, A. R., 1917 Columbia Ave., Swissvale, Pittsburgh, 18, Pa.
- Duncan, H. S., 1902 W. Minnehaha Ave., St. Paul 4, Minn.
- Eller, D. L., Box 73, Antiaircraft Artillery School, Fort Bliss, Texas
- English, W. C., 2878 N. Clark St., Chicago 14, Ill.
- Freedman, J. L., 35 Wales St., Dorchester 24, Mass.
- Hinton, W. R., 3 Village Way, E. Rayners Lane, Middlesex, England
- Horton, C. E., Room 466, Bldg. 5, General Electric Co., Schenectady, N. Y.
- Jensen, G. L., 100 S. Columbus St., Arlington, Va.
- Lamb, J. F., Electrical Engineering Department, University of Missouri, Columbia, Mo.
- Martin, A. E., 226 W. 137 St., New York 30, N. Y.
- Mason, C. W., 141 N. Vermont Ave., Los Angeles 4, Calif.
- Medill, J. W., 136 Malden Ave., La Grange, Ill.
- Moore, A. H., Naval Research Laboratory, Bellevue, Anacostia 20, D. C.
- Myers, J. J., Department of Electrical Engineering, University of Illinois, Urbana, Ill.
- Pizzuti, F. D., 3800 Carpenter Ave., New York 67, N. Y.
- Randles, W. C., R.F.D. 5, Box 280H, Tampa, Fla.
- Ratynski, M. V., Army Air Base, Watson Laboratories, Red Bank, N. J.
- Richards, P. A., R.F.D. 5, Lancaster, Pa.
- Ruplenas, R. J., General Radio Co., 275 Massachusetts Ave., Cambridge 39, Mass.
- Ryland, B. G., 772 Harvard Ave., Menlo Park, Calif.
- Savory, W. A., 1 John St., Englewood Cliffs, N. J.
- Schneberger, R. J., Westinghouse Research Laboratories, East Pittsburgh, Pa.
- Schwab, D., 32-37-42 St., Astoria, L. I., N. Y.
- Showers, R. M., 200 S. 33 St., Philadelphia 4, Pa.
- Sickels, W. H., Jr., 32 N. Main St., Dayton, Ohio
- Slinkman, R. W., 4 E. Sixth St., Emporium, Pa.
- Stahl, P. D., 1700 Bathgate Ave., New York 57, N. Y.
- Stambaugh, J. C., 4954 Chestnut St., Philadelphia 39, Pa.
- Taylor, E. H., 500 S. Clinton St., Chicago 7, Ill.
- Toward, T., BM/TWD, London, W. 1, England
- Wilhelm, J. F., 134 E. Clay St., Lancaster, Pa.
- Williams, J. A., 132 Washington St., Long Branch, N. J.
- Williams, M. A., 500 Winslow St., Long Beach 4, Calif.
- Wylle, T. C., Strathburn, R.F.D. No. 1, Glencoe, Ont., Canada.
- Zygmunt, H. J., 201 Talbot Ave., Braddock, Pa.

Admission to Member

- Ackerman, J. C., Box 180, R.F.D. 2, Neptune, N. J.
- Adkins, A. W., Jr., 36 S. Hedges St., Dayton 3, Ohio
- Alty, R. L., Box 62, Alexandria, Va.
- Andrews, J. R., c/o W. T. Holmes, 2614 Grove Ave., Richmond 20, Va.
- Bohike, P. G., c/o Sylvania Electric Products, Inc., 34-10 Linden Place, Flushing, L. I., N. Y.
- Chandler, H. M., Jr., Engineering Bldg., Princeton University, Princeton, N. J.
- Clark, T. C., 200 Mt. Pleasant Ave., Newark 4, N. J.
- Clemans, C. S., Indian River Broadcasting Co., 204 S. Second St., Fort Pierce, Fla.

(Continued on page 44A)

TYPE TS-56

Screw Type. For applications where wires must be attached and detached quickly and conveniently at intervals. Supplied plain or marked to customers' specifications. Also available with Knurled Head screws.

Contacts—Brass, cadmium plated
Screws—Steel, cadmium plated
Plates— $\frac{1}{16}$ " XP Phenolic sheet

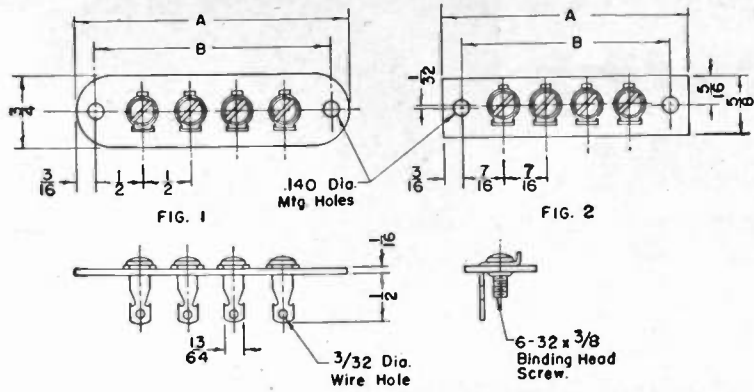
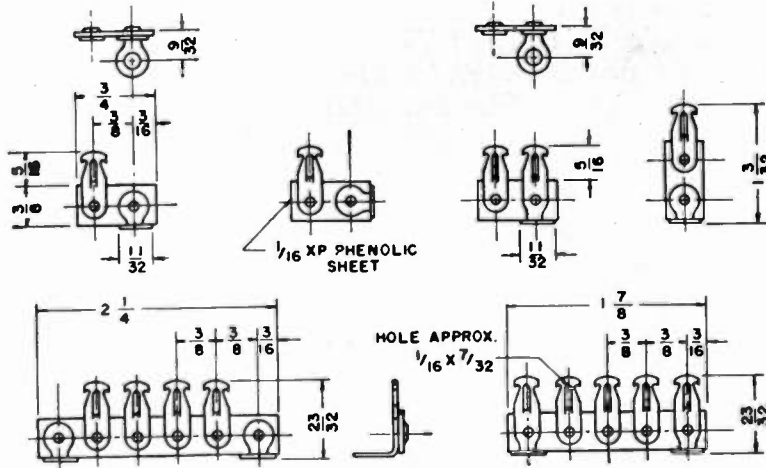

FIGURE NO.	CATALOG NO. BINDING HEAD SCREW	CATALOG NO. KNURLED HEAD SCREW	NO. OF TERMINALS	OVERALL LENGTH 'A'	MTG. HOLES CENTERS 'B'
1	8513	8523	1	1 3/8	1
1	8514	8524	2	1 7/8	1 1/2
1	8515	8525	3	2 3/8	2
1	8516	8526	4	2 7/8	2 1/2
1	8517	8527	5	3 3/8	3
1	8518	8528	6	3 7/8	3 1/2
1	8519	8529	7	4 3/8	4
1	8520	8530	8	4 7/8	4 1/2
1	8521	8531	9	5 3/8	5
1	8522	8532	10	5 7/8	5 1/2
2	8706	8711	1	1 1/4	7/8
2	8710	8712	2	1 11/16	1 5/16
2	8610	8713	3	2 1/8	1 3/4
2	8707	8714	4	2 9/16	2 3/16
2	8708	8715	5	3	2 5/8

EBY TERMINAL STRIPS

TYPE TS-58

Tie Point. Used throughout industry for tying in a wide variety of components. Available in any combination of terminals or brackets as shown up to and including 14. Holes are spaced $\frac{3}{16}$ " apart with $\frac{3}{16}$ " between end holes and edge of board. Terminals available with elongated hole for threading or notched for wrap-around assembly. Plates are of XP Phenolic sheet.



.140 DIA	.167 DIA	.140 DIA	.167 DIA			.140 DIA	.167 DIA
PART 8392 BRASS CAD. PL.	PART 8478 BRASS CAD. PL.	PART 8472 STEEL HOT TIN	PART 8479 STEEL HOT TIN	PART 8381 BRASS CAD. PL.	PART 8473 STEEL HOT TIN	PART 8388 STEEL HOT TIN	PART 8480 STEEL HOT TIN

HUGH H.
EBY
INCORPORATED

18 West Cheltenham Avenue
Philadelphia 44, Pa.

S.S. WHITE FLEXIBLE SHAFTS



FOR *Smooth, Sensitive* REMOTE CONTROL
OVER SHORT DISTANCES OR LONG - -

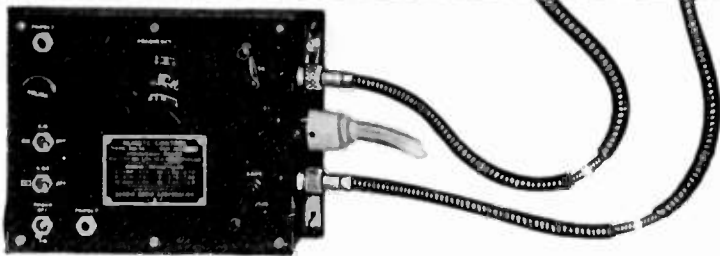

Variable elements are common to many electronic circuits. In many cases these elements require manipulation from points more or less remote from the equipment in which they are housed.

For this service, S.S. White remote control flexible shafts are specially designed and ideally suited. They are characterized by a minimum of angular deflection under load and by practically equal deflection for either direction of rotation. When properly applied they operate as easily and smoothly as a direct connection.

Through the use of simple gearing in conjunction with the shafts, any required degree of sensitivity can be obtained, regardless of distance. For example, S.S. White remote control shafts have long been used for tuning aircraft radio and directional equipment with entirely satisfactory operation in lengths up to 50 feet and more.

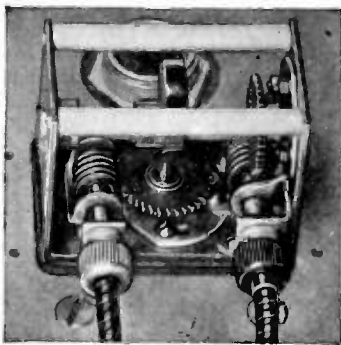

Showing two remote control flexible shafts connected to a Radio Compass Loop through worm gearing. Note that the shafts are connected to the worms, which reduces the load on the shafts and makes them easier to operate.

FOR FULL FLEXIBLE SHAFT DATA see the S.S. White Catalog in Sweet's Catalog File for Product Designers or write us for BULLETIN 4501. Copy mailed on request.

S.S. WHITE INDUSTRIAL DIVISION
THE S. S. WHITE DENTAL MFG. CO. DEPT. G 10 EAST 40TH ST., NEW YORK 16, N. Y.

FLEXIBLE SHAFTS • FLEXIBLE SHAFT TOOLS • AIRCRAFT ACCESSORIES
SMALL CUTTING AND GRINDING TOOLS • SPECIAL FORMULA BURNERS
MOLDED RESISTORS • PLASTIC SPECIALTIES • CONTRACT PLASTICS MOLDING

One of America's AAAA Industrial Enterprises



(Continued from page 42A)

- Council, O. R., 920 Cherry St., Kansas City, Mo.
Davies, H., 36 Jefferson Ave., Hasbrouck Heights, N. J.
Durant, J. V., 4637 N. Dixie Drive, Dayton 5, Ohio
Fox, N. S., Princeton Ave., Metedeconk, N. J.
Gantt, R. R., 4424 Bryn Mawr, Dallas 5, Texas
Gaudreau, H. L., c/o Submarine Signal Co., 111 W. John St., Seattle 99, Wash.
Gunn, D. W., 795 Union Commerce Bldg., Cleveland, Ohio
Harris, J. B., 65 Gurney Court Rd., St. Albans, Hertfordshire, England
Johns, L. T., 750 Huron Rd., Cleveland 15, Ohio
Lanier, H. F., 4089 Minnesota Ave., N.E., Washington 19, D. C.
Maher, R. A., c/o Radio Corporation of America, 711 Fifth Ave., New York, N. Y.
McKay, K. G., Bell Telephone Laboratories, Murray Hill, N. J.
Merten, D. J. S., Eldico, Inc., 44-31 Douglaston Pkwy., Douglaston, N. Y.
Milton, L. A., 511 Linwood Ave., Buffalo 9, N. Y.
Moore, G. E., Bell Telephone Laboratories, Murray Hill, N. J.
Price, G. A., Jr., 222 Fifth Ave., Asbury Park, N. J.
Rogers, T. A., 6015 W. Colgate Ave., Los Angeles 36, Calif.
Sanderson, R., 7 Leasowes Ave., Coventry, England
Scott, J. C. W., 68 Carling Ave., Ottawa, Ont., Canada
Shanklin, J. P., 700 Cedarcroft Rd., Baltimore 12, Md.
Sherwood, R. M., 4512 Del Mar Ave., San Diego 7, Calif.
Sinback, W. R., 1305 Farragut St., N.W., Washington, D. C.
Slater, H. C., 1945 Bidwell Way, Sacramento, Calif.
Smith, H. C., 19 Sidmouth Rd., Low Fell, County Durham, England
Stuart-Williams, R., 180 Northenden Rd., Sale, Manchester, England
Swartzel, K. D., 89 Amherstdale Rd., Buffalo 21, N. Y.
Tarbell, G. E., 15 Donino Ave., Toronto 12, Ont., Canada
Taylor, P., 1608 Craig St., Corpus Christi, Texas
Todd, S. R., 4711 Woodlawn Ave., Chicago, Ill.
Traver, H. A., Pennic, Edmonds, Morton and Barrows, 247 Park Ave., New York 17, N. Y.
Verzuh, F. M., Massachusetts Institute of Technology, Cambridge 39, Mass.
Whitehead, E. A., General Electric Co., 235 Montgomery St., San Francisco 4, Calif.
Wickline, B. D., 5834 N. Glenwood Ave., Chicago 40, Ill.
Zbar, P. B., 59 Johnson Ave., Brooklyn, N. Y.

Admission to Associate

- Alexovits, A. A., 36 Oakland Ave., Jersey City 6, N. J.
Alonso Fernandez, L., M. Asunta 330, San Martin, FCCA, Argentina
Ares, M., Donado 4684, Buenos Aires, Argentina
Babbit, E. B., 3841 Roberts, Kansas City 1, Mo.
Backinoff, B., 610 Ovington Ave., Brooklyn 9, N. Y.
Balhorn, D. W., 141-35 St., N.E., Cedar Rapids, Iowa
Bania, S. E., 156 Third Ave., Long Branch, N. J.
Bartik, W. J., 6421 Chelwynde Ave., Philadelphia 42, Pa.
Bashara, N. M., 1327 "H" St., Lincoln, Nebraska
Becchetti, F. J., 512 W. 136 St., New York, 31, N. Y.
Benolt, J. C., Buchanan Heights, Valparaiso, Ind.
Bergara, F. C., Diaz Velez 4071, Buenos Aires, Argentina
Berriman, M., 854 E. Broad St., Columbus, Ohio
Berry, R. J., 206 Ninth St., N.E., Washington 2, D. C.
Bremmer, P., 306 N. Gladstone Blvd., Kansas City 1, Mo.

(Continued on page 46A)

Original Recording For

BILLIONTH RECORD



Audio Devices, Inc., will display its products in Booth No. 435 at the I.R.E. Show, Grand Central Palace, New York, March 3-6.

... on **audiograms**

Recently in Camden, N.J., where the Victor Talking Machine Company was founded some 48 years ago, the billionth R.C.A. Victor Record was produced, thus marking a milestone in the history of the company, as well as the record industry.

For this history-making record, the Victor Division of the Radio Corporation of America chose two of John Philip Sousa's stirring marches, "Semper Fidelis" and "The Stars and Stripes Forever," played by the Boston

Symphony Orchestra under the direction of Serge Koussevitsky. And for the discs, on which the original sound recording was made, they chose Audiograms.

For the original sound recording in the phonograph record and electrical transcription industries—for master discs used in processing—for sound recording and reproduction in radio broadcasting and motion picture studios—Audiograms hold a place of eminent leadership.

AUDIO DEVICES, INC., 444 Madison Avenue, New York 22, N.Y.

Export Department: Rocke International Corp., 13 E. 40th Street, New York 16, N.Y.

Audiograms manufactured in the U. S. A. under exclusive license from PYRAL, Paris.



they speak for themselves **audiograms**

4.2 VOLTS OUTPUT*!!

DIRECT CONNECTION TO PENTODE OUTPUT TUBES!

... and only 1½ oz. needle force

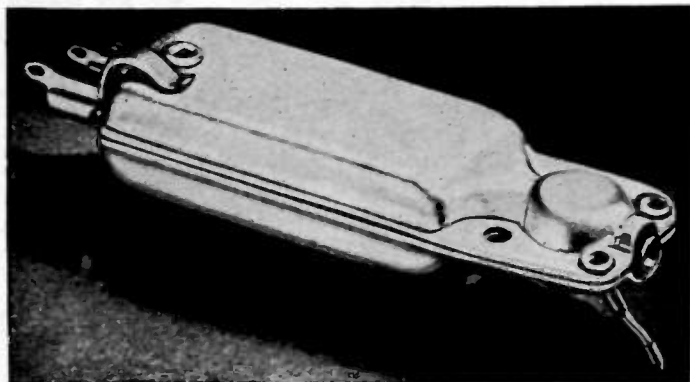

WITH THE NEW SHURE

W56A

Lever-Type Crystal Pickup Cartridge

List Price \$5.45

AND



THE NEW SHURE

96A

Crystal Phonograph Pickup

List Price \$7.10

MADE POSSIBLE THROUGH THE SHURE LEVER SYSTEM • HERE'S HOW IT WORKS:

The crystal is driven by a lever which improves the transmission of needle chuck torque into the crystal. This results in higher output and greater needle compliance. High needle compliance gives a "freedom of action" flexibility to the needle that means faithful tracking, and clearer, fuller tone qualities.

The lever arrangement absorbs the full impact of sudden jars to the cartridge or needle; this in turn gives relative shock immunity to the crystal—minimizing strain or breakage.

WHAT THE 96A DOES FOR YOU: It makes possible the saving of one stage of amplification, and it permits the use of a long-life precious-tip needle with a high-output pickup. Such a light-weight tone arm means that the records and needles will last much longer. The 96A "Glider" is less susceptible to floor vibrations, improves the playing of warped records, and is especially suitable for Vinylite records.

(*) 1000 cycle Audiotone record level using Full-Tone needle. About 3.5 volts using flexible needles. Voltage output on peaks reaches 40 volts!

WRITE FOR NEW CATALOGS 155-1 and 156-1

Patented by Shure Brothers and licensed under the Patents of the Brush Development Company

SHURE BROTHERS, INC.

Microphones and Acoustic Devices

225 West Huron Street, Chicago 10, Illinois
Cable Address: SHUREMICRO



(Continued from page 44A)

- Brown, R. L., Jr., 224 N. Third St., Buckroe Beach, Va.
Byrne, P. J., c/o Engineering Department G.P.O., St. John's, Newfoundland
Campbell, J. R., 1818 Mooberry St., Columbus 9, Ohio
Carapellotti, L. T., 631 Moore St., Philadelphia 48, Pa.
Carterette, A. A., Jr., 2119 N.W. 47 Terrace, Miami, Fla.
Cassiet, A. H., Cucha-cucha 458 1°E, Buenos Aires, Argentina
Chappell, K. L., 37 Parkholme Ave., Guelph, Ont., Canada
Charles, W. K., 3316 San Marino St., Los Angeles 6, Calif.
Cherry, M., 376 Ashford St., Brooklyn 7, N. Y.
Cherry, W. L., Jr., 1235 Shermer Rd., Northbrook, Ill.
Clark, R. R., 1308 Washington Ave., New York 56, N. Y.
Clark, T. G., 93-54 Queens Blvd., Rego Park, N. Y.
Clayton, W. I., 4126j N. Sheridan Rd., Chicago 13, Ill.
Crosby, H. J., Box FAETU, Ault Field, NAS Whidbey Island, Wash.
Cyphers, J. A., 6317 Jackson St., Pittsburgh 6, Pa.
Dachin, N. V., Av. Alvear 4456 Dep. 4, Buenos Aires, Argentina
Diemer, F., Enzenbuhlstrasse 51, Zurich 8, Switzerland
Dixon, E. D., 26 E. Main St., Centerburg, Ohio
DuBois, H. E., Livonia, N. Y.
Dunkelman, L., 1447 Somerset Place, M.W., Washington 11, D. C.
Ellis, R. I., 97 Sobel Court, Fox Hills, Staten Island 4, N. Y.
Eney, I. N., Ridge Pike, R.F.D. 2, Norristown, Pa.
Easler, W. O., Buchanan Heights, Valparaiso, Ind.
Fessler, A. L., 326 W. Fairview Ave., Dayton 5, Ohio
Fowler, T. D., 469 Dufferin Ave., London, Ont., Canada
Gabelman, I. J., 377 Vernon Ave., Brooklyn 6, N. Y.
Galione, W. J., 94-65—46 Ave., Elmhurst, N. Y.
Geddes, L. A., 3562 Shuter St., Montreal 18, Que., Canada
Goeller, L. F., Jr., 617 S. Sycamore St., Petersburg, Va.
Gomez, L. L., Casilla Correo 5230, Comodoro Rivadavia, Chubut, Argentina
Gonzalez Ross, J., Mejico 1056-3° Depto 16, Buenos Aires, Argentina
Goulder, M. E., 634 Maplewood Ave., Columbus, Ohio
Grater, V. M., 2711 Brighton Ave., Los Angeles 7, Calif.
Guimaraes, A., Tomas Diago 684, Montevideo, Uruguay
Hamm, W. J., St. Mary's University, San Antonio 7, Texas
Harding, E. W., Ballistic Research Laboratory, Aberdeen Proving Ground, Md.
Harding, R. L., Hotel St. George, Brooklyn 2, N. Y.
Hayes, J., 27 Princes Rd., Great Yarmouth, Norfolk, England
Hickenlooper, M. M., 73 Forrester St., S.W., Washington 20, D. C.
Hillmann, D. A., 82 Randolph Rd., White Plains, N. Y.
Hollister, R. H., 2069 Eastern Blvd., Cedar Rapids, Iowa
Hughes, W. A., 2329 Thayer St., Evanston, Ill.
Hull, L. C., 3308 Fifth Ave., Richmond 22, Va.
Ibani, H. F., Cramer 1540, Buenos Aires, Argentina
Iglesias, A., 4-434 La Plata, Argentina
Imbimbo, T., Independencia 2170, Mar del Plata, F.C.S.
Ingalls, R. S., Valpo Tech Trailer Court, Valparaiso, Ind.

(Continued on page 48A)

USE STANDARD PARTS — SAVE TIME AND MONEY

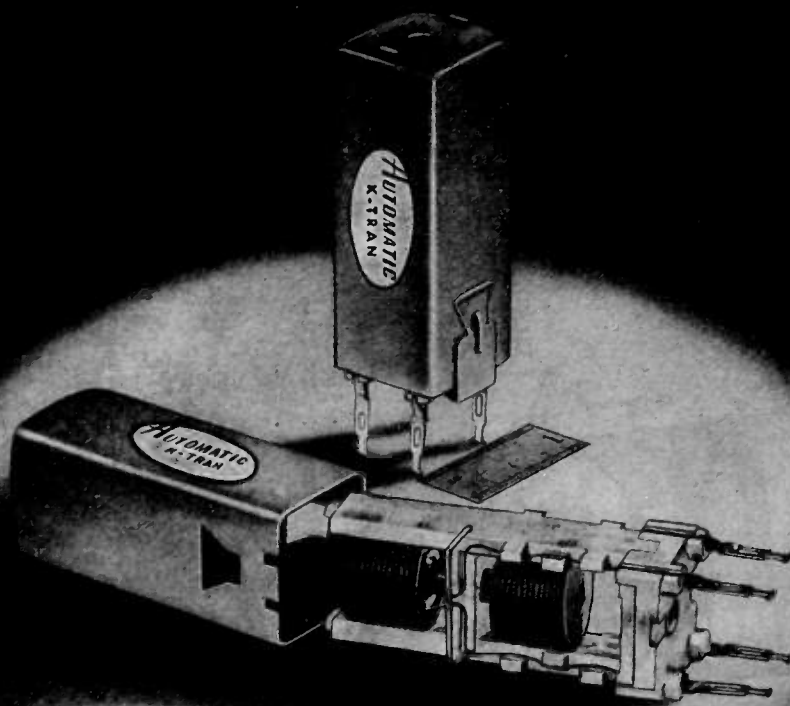

U N I V E R S A L !

The Automatic K-TRAN is as standard as a resistor or mica condenser.

One of a few standardized types will meet almost any I. F. Transformer requirement in any radio set. Large stocks of a multiplicity of types are eliminated. Procurement problems on I. F. Transformers vanish. Shipments from stock eliminate months of waiting for material.

Use K-TRAN *throughout* your line!



MASS PRODUCTION COILS & MICA TRIMMER CONDENSERS

900 PASSAIC AVE.

EAST NEWARK, N. J.

For Better Jobs
 . . . where SPACE is
 "AT A PREMIUM"

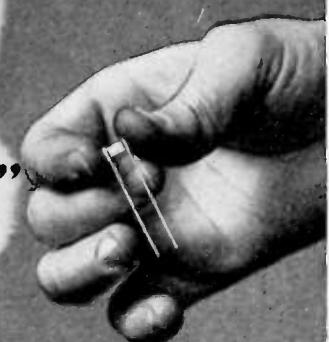

Hi-Q

CERAMIC CAPACITORS

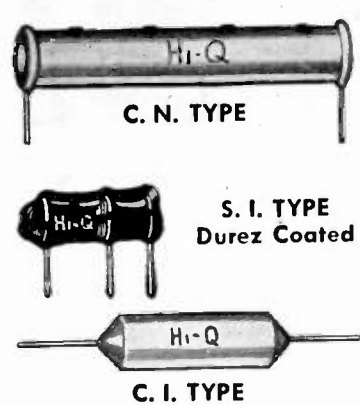

Unusually high capacitance in relation to physical dimensions make Hi-Q ceramic capacitors the ideal components for use where space is extremely limited. Recognized stability insures dependable performance through years of service. Individually tested for accuracy of physical dimensions, temperature coefficient, power factor and dielectric strength. Available with axial leads (CI type); parallel leads (CN type); Durez coated (SI type). An experienced engineer will be glad to consult with you on your requirements.

OTHER COMPONENTS



Hi-Q ELECTRICAL REACTANCE CORPORATION

FRANKLINVILLE, N. Y.



(Continued from page 46A)

- Ivans, W. S., Jr., 3130 Udal, San Diego 6, Calif.
- Jewell, E. J., 410 Parkview Blvd., Lake Orion, Mich.
- Johler, J. R., 3149 Buena Vista Terrace, S.E., Washington 20, D. C.
- Johnson, H. C., 83 Como Ave., St. Paul 3, Minn.
- Jolley, N. A., CAA A-62, Washington 25, D.C.
- Kelleher, R. L., 15 Palmyra St., Winthrop 52, Mass.
- Kelly, E. L., 605 Hazel St., Glendale 1, Calif.
- Kozan, F. J., 803 Third Ave., N.E., Waseca, Minn.
- Kramm, H. L., 3316 Forest Ave., Kansas City 3, Mo.
- Lanford, W. E., 609 N. Broad St., Winston-Salem, N. C.
- Lansing, L. M., 459 King St., London, Ont., Canada
- Leeper, C. S., 2300 Seabright Ave., Long Beach 6, Calif.
- Libertino, P., Quintana 4822, Buenos Aires, Argentina
- Lund, G. W., 35 Aurora Ave., St. Paul 2, Minn.
- Maken, G., 34 Metropolitan Oval, Parkchester, New York 62, N. Y.
- Marchese, J. H., 20 York St., Hartford 6, Conn.
- Martinez Pardo, E., 1496 Centenera, Buenos Aires, Argentina
- Mendelowitz, M., 27 Oxford Rd., Parktown, Johannesburg, South Africa
- Miller, L. A., 607 Kelton Ave., Columbus, Ohio
- Moore, H. H., 3611 Benton Blvd., Kansas City 3, Mo.
- Morton, O. L., Box 4212, Houston 14, Texas
- Munoz de Toro, A., S. Diego and S. Nicolas, Villa Diego, FCRPB, Argentina
- Oelrich, M. C., 6 Rodger Young, Los Angeles 27, Calif.
- Peffer, J. C., WTAR Radio Corp., Bank of Commerce Bldg., Norfolk 10, Va.
- Peterson, F. V., 3920 Wellington Rd., Los Angeles 43, Calif.
- Pierson, J. E., Armament Test N.A.S., Patuxent River, Md.
- Price, R. L., 922 N. Grove Ave., Oak Park, Ill.
- Rehler, K. M., 1544 1/2 Richmond Ave., Columbus 3, Ohio
- Ryan, E. H., 3118 Snyder Ave., Brooklyn 26, N. Y.
- St. John, E. E., Box 105, Oak Ridge, Tenn.
- Schoenfeld, G., 34-15-89 St., Jackson Heights, L. I., N. Y.
- Sen, B. B., 138 Harishmukherjee Rd., Calcutta 25, India
- Shaw, L. L., 230 W. 21 St., New York 11, N. Y.
- Shiren, N. S., 215 E. Broadway, Long Beach, L. I., N. Y.
- Shulman, J., 600 Logan St., Brooklyn 8, N. Y.
- Speer, T. J., Department of Communications, APO 235, c/o Postmaster, San Francisco, Calif.
- Spencer, N. A., 159 College St., Buffalo, N. Y.
- Sturm, F. L., R.F.D. 8, Box 502, South Richmond, 24, Va.
- Swail, J. C., 11 Ellerdale Rd., Montreal 29, Que., Canada
- Tafuri, M. L., 300 St. Marks Ave., Brooklyn 17, N. Y.
- Talwalkar, K. B., c/o E. T. Department, Nowrosjee Wadia College, Poona, India
- Tennant, O. A., 3515 Sixth Ave., Des Moines, Iowa
- Thiessen, P. I., 146 Massachusetts Ave., Boston 15, Mass.
- Tobolowsky, J. L., Western Electric Co., 120 Broadway, New York 5, N. Y.
- Trachtenberg, R., 1413 Princess Ave., Camden, N. J.
- Trinter, V. E., 622 Minck Drive, Columbus 9, Ohio
- Tucker, F. L., 275 Massachusetts Ave., Cambridge 39, Mass.
- Turner, H. G., Box 308, Petersburg, Va.
- Vastel, J. F., Place de la Victoire, Rostrenen, Cotes du Nord, France
- Walter, J. C., 950 Addison St., Chicago 13, Ill.

(Continued on page 60A)

Aviation Engineers

The Aviation Engineering Section of RCA is actively engaged in the design and development of Airborne Radar, Loran, Shoran, Altimeters, and other navigational aids, Communications Equipment, and additional types of Airborne Electronic Devices. These diversified activities, resulting from the extensive RCA research and development facilities, require increasing our staff of experienced Electrical and Mechanical Engineers. New members would be associated with the present staff, a few of the outstanding of whom are:

R. R. Welsh, Manager Aviation Engineering	H. M. Hucke, Manager Aviation Sales
O. B. Cunningham	J. T. McLamore
J. D. Woodward	C. G. Seright
J. M. Hertsberg	

Write to:

National Recruiting Division
Radio Corporation of America
Camden, New Jersey

BELMONT RADIO CORPORATION of Chicago NEEDS SEVERAL ELECTRONIC ENGINEERS

Development and Research Engineers, Seniors and Juniors, well versed in all phases of RF circuits wanted. VHF or Microwave experience desirable. Top-notch applicants with Engineering degree or equivalent background for this type of work only will be considered. Chicago Area residents preferred, top salary, steady position, 40-hour week, occasional field trips. Appointment by letter only. Give background experience, educational and employment history. Address letter to Research Division, Belmont Radio Corporation, 5921 W. Dickens Ave., Chicago 39, Illinois.

WANTED *Electronic Engineer*

By development laboratory of fifty-year-old manufacturing concern located in western New York. Graduate with several years experience in radar, navigation, fire control, servo or similar systems. Must have extensive knowledge of circuit fundamentals and be able to design circuit and apparatus for implementing broad new systems and to carry the work through prototype and pilot model stages.

Box No. 448.

The Institute of Radio Engineers

1 East 79 Street, New York 21, N.Y.



The following positions of interest to I.R.E. members have been reported as open. Apply in writing, addressing reply to company mentioned or to Box No. ...

The Institute reserves the right to refuse any announcement without giving a reason for the refusal.

PROCEEDINGS of the I.R.E.

1 East 79th St., New York 21, N.Y.

PRODUCTION ENGINEER

Experienced in glass machinery products and technique. Also, fluorescent chemicals and coating application to glass. Excellent opportunity. Write, giving full details in first letter. Box 453.

RADIO ENGINEER

Graduate radio engineer for research and development work on high frequency antennas and transmission line. Firm is a progressive subsidiary corporation of one of the nation's largest radio manufacturers, and is located in the Middle West. Salary to be commensurate with qualifications of accepted person. Box 454.

PATENTS

Patent department of large industrial corporation requires experienced patent attorneys or agents, at least one with electronic background, for expanding research effort. Minimum supervision. Office in New York suburb, Southwest Connecticut. Box 455.

SENIOR ENGINEERS

Several capable men needed for:

1. Advanced electronic circuit and systems development.
2. Servo-mechanisms, hydraulic, pneumatic, electric.
3. Gyromechanisms and other instrumentation.
4. Microwave techniques, plumbing, antennas, radomes, etc.
5. Magnetic circuit design (good all-round electrical background).
6. General mechanical component design, airborne radar.

Qualifications: Several years commercial experience in one or more of above, good educational background.

Positions Offer: Permanence, top salaries, and opportunities for increased responsibility for men who can produce.

Work: Large guided missile program. All phases—study, research, development, product design for production.

Organization: Progressive, stable, under engineering management.

Applications: Handled, of course, in confidence. Give enough information in your first letter to warrant interview. Apply to Personnel Department, Raytheon Manufacturing Company, Foundry Avenue, Waltham 54, Mass.

ELECTRICAL AND ELECTRONIC ENGINEERS

You are invited to investigate opportunities in electronics and electrical engineering at this laboratory. We are organ-

(Continued on page 52A)

Drives TELEVISION FINAL STAGE ...and Excels because



- ★ Frequency (at max ratings) ranges up to 220 mc, covering both television video and FM bands.
- ★ Power output is substantial—see text below.
- ★ Designed directly for grounded-grid circuits, with high- μ characteristics that give high power gains.
- ★ Complete internal shielding, plus ultra-compact construction, result in low plate-filament capacitance—making neutralization easy, where required.
- ★ Thoriated-tungsten filament SAVES, calling for minimum filament power.
- ★ Forced-air cooling assures convenient station installation.
- ★ RING-SEAL terminals enable tube to be "plugged in" quickly—their generous contact area also promotes h-f circuit efficiency.

New



v-h-f

POWER TRIODE GL-5513

ELECTRICAL CHARACTERISTICS

Filament voltage	6.3v
Filament current	32 amp
Amplification factor	87

Interelectrode capacitances:

Grid-plate	8.7 mmfd
Grid-filament	21.1 mmfd
Plate-filament	.11 mmfd
Type of cooling	forced-air

MAX RATINGS, CLASS B R-F POWER AMPLIFIER, VIDEO SERVICE, SYNCHR. PEAK CONDITIONS

Plate voltage	3,000 v
current	1.2 amp
input	3,300 w
dissip.	1,200 w

MAX RATINGS, CLASS C TELEGRAPHY

Plate voltage	4,000 v
current	1 amp
input	3,600 w
dissip.	1,200 w

TYPE GL-5513 has a tube output in excess of 2 kw (Class C telegraphy), with power gain of approximately 10 when operated as a grounded-grid amplifier. In Class B video service, under synchronizing peak conditions, output exceeds 1 kw, with approximate power gain of 8 in grounded-grid service.

This capable new triode, besides its application to television transmitters for both the video and FM bands, is directly suited to dielectric-heating service employing the high and very-high frequencies. Here the tube's low filament-power requirements are of special value, contributing to simple, economical transformer and circuit design.

As a rule, the GL-5513 requires no neutralization in grounded-grid

circuits, but when this is needed, a small amount of cross-neutralization will suffice. Modern engineering is evident not only in the tube's electrical characteristics, but also in its compact structure—in its trim and efficient radiator design—in the fact that all external metal parts are silver-plated to provide better contact surfaces—and in the ring-type fernico metal-to-glass seals used throughout.

Help in applying G.E.'s new GL-5513 triode to new equipment now on your drawing-boards, gladly will be furnished by General Electric tube engineers. Telephone or write your nearest G-E electronics office, or communicate with *Electronics Department, General Electric Company, Schenectady 5, New York.*

GENERAL ELECTRIC

161-P1-0850

FIRST AND GREATEST NAME IN ELECTRONICS

EXPANDING ORGANIZATION

Wants Junior and Senior

RADIO ENGINEERS

for Research and Development
Work in UHF Field

TOP SALARIES . . . EXCELLENT CONDITIONS

Capable men will find initiative and ability appreciated and rewarded in this medium-size, progressive organization. Management-within-plant provides real opportunity to work projects from start to finish . . . and a future just as big as you can make it. These are not just ordinary jobs, but highly desirable opportunities for immediate careers.

Applications are invited from key men, research and production engineers experienced on UHF test equipment, industrial electronics or similar work.

Working conditions are ideal in modern, fully-equipped plant, and with every facility for carrying out projects under your direction. Plant is located in attractive, east-central New Jersey within an hour's ride from New York City and near the New Jersey shore.

Write us in detail concerning yourself—your experience and your accomplishments. If possible, telephone us for an appointment. Needless to say, your application will be held in strictest confidence.



Larvie Laboratories

RADIO ENGINEERS AND MANUFACTURERS
MORGANVILLE, N. J.

SPECIALISTS in the Development and Manufacture of UHF Equipment



(Continued from page 50A)

ized as a department in a large college located in a Middle Atlantic state, and are engaged in research and development. Members of our research staff are appointed with academic rank. Some are teaching, although this is not a condition of employment. Box 449.

TELEVISION ENGINEER

Wanted by well-known manufacturer of television radio receivers. To be service manager for New York area. Write fully, giving experience and salary requirements. Box 450.

MATHEMATICIAN

With knowledge of electrical and mechanical means of solving equations, to work on computer development with New York City concern. Additional knowledge of servo systems desirable. Box 452.

CIVIL ENGINEERS

The College of Applied Science, Syracuse University, is seeking candidates for two positions in its Department of Civil Engineering. It is desired that each applicant have the following qualifications:

1. At least a Master's degree in Civil Engineering.
2. Some experience as a teacher in the field of civil engineering, including courses such as mathematics, engineering mechanics, strength of materials, and hydraulics.
3. Two or more years' experience with civil engineering organizations such as consulting firms, Public Works Departments, etc., with some degree of responsible charge.
4. Age range preferred, 28 to 40 years.

Address correspondence to: Donald E. Stearns, Professor of Civil Engineering, College of Applied Science, Syracuse University, Syracuse 10, N.Y.

PHYSICIST

With M.S. or Ph.D. degree, and training in both nuclear physics and electronics. Write in detail, stating qualifications, to Personnel Office, RCA Laboratories, Princeton, N.J.

INSTRUCTORS

To teach radio engineering. Must have B.S. in E.E. or Physics, or equivalent; 5 years experience in commercial electronics work. Knowledge of microwaves desirable. Write, giving full details regarding education and experience, to Personnel Department, Spartan School of Aeronautics, Tulsa, Oklahoma.

PHYSICISTS AND ELECTRICAL ENGINEERS

Unusual opportunities in recently organized research group for work in broad fields of radio, radar, telemetering, servo-mechanisms, and gyroscopes. Excellent openings for experienced physicists with good training in fundamentals. Please reply, giving experience and education, including transcript of college record, to: Engineering Personnel Office, North American Aviation, Inc., Municipal Airport, Los Angeles 45, California.

(Continued on page 54A)

Can **YOUR** equipment
absorb this **JOLT?**

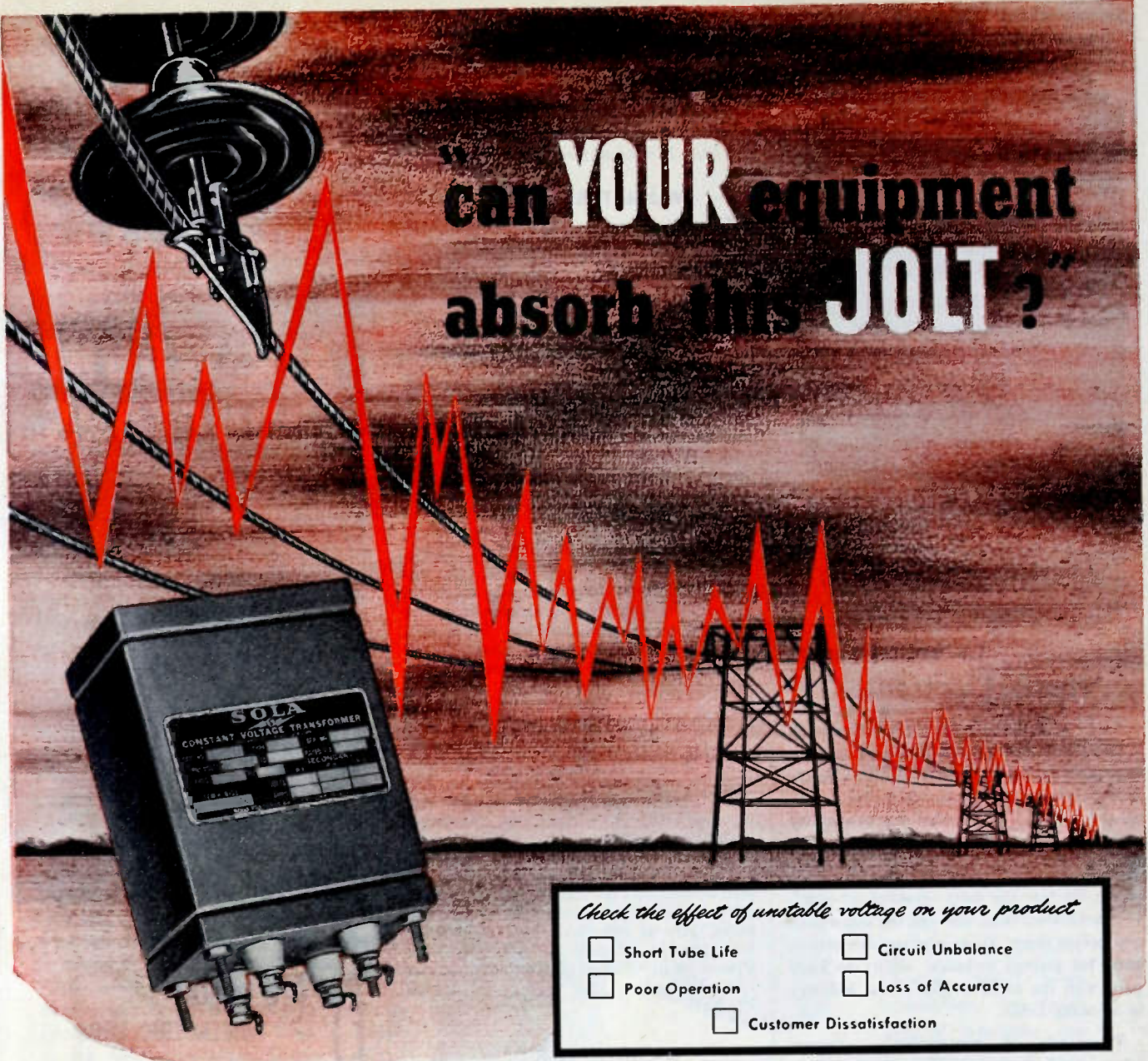

Check the effect of unstable voltage on your product

<input type="checkbox"/> Short Tube Life	<input type="checkbox"/> Circuit Unbalance
<input type="checkbox"/> Poor Operation	<input type="checkbox"/> Loss of Accuracy
<input type="checkbox"/> Customer Dissatisfaction	

THERE ARE NO VOLTAGE PROBLEMS WHEN A SOLA CONSTANT VOLTAGE TRANSFORMER IS A "Built-in Component"

Check! . . . before the equipment leaves your plant. Can it stand violent voltage fluctuations, sometimes as great as 30%, and still perform as you intended it should?

It is not necessary, you know, to saddle your customer with the responsibility of providing stable operating voltage. You can do it for him at an actual saving, both in original cost and maintenance, by including a SOLA Constant Voltage Transformer as a "built-in" component.

There are 31 standard types of SOLA Constant Voltage Transformers, several specifically designed for chassis mounting, available in capacities from 10VA to 15KVA. If none are adaptable to your requirements, special units can be custom designed to your exact specifications.

Whether your product is designed for home, science or industry—Constant Voltage is your problem. May we recommend the solution?



This book provides the answer to your Constant Voltage problem.
Ask for
Bulletin KCV-102

SOLA *Constant Voltage*
TRANSFORMERS

Transformers for: Constant Voltage • Cold Cathode Lighting • Mercury Lamps • Series Lighting • Fluorescent Lighting • X-Ray Equipment • Luminous Tube Signs
Oil Burner Ignition • Radio • Power • Controls • Signal Systems • etc. **SOLA ELECTRIC COMPANY, 2525 Clybourn Avenue, Chicago 14, Illinois**
Manufactured in Canada under license by FERRANTI ELECTRIC LIMITED, Toronto

FORMULA for SUCCESS

"CREI training builds into the student a usable, working knowledge of practical radio engineering. It develops that sure confidence in his own ability which enables him to go after the better jobs — and get them".

CREI Offers the Advanced Technical Training that is necessary to Advance in Radio Electronics

CREI practical home study courses in Radio-Electronics and Television Engineering will supplement your present radio experience with the advanced, modern technical training that can lead you to security and a better-paying job.

Ours is an intensive program, but one which fits into the most crowded schedule. It is for those, only, who see the opportunities before them; those who see this urgent need for trained technical ability to keep pace with the rapid strides of the industry in so many fields.

Thousands of professional radiomen have enrolled for CREI training since 1927. Many of them are men who are holding responsible positions today . . . many are looking into the future with the foresight and ambition to prepare for the better jobs ahead.

The CREI story can be important to you . . . and to EVERY MAN who is seeking a way to improve his position in the radio field. Write us today for our booklet and pertinent facts as they apply in your own case. Please state briefly your education, radio experience and present position.

"Since 1927"

CAPITOL RADIO

ENGINEERING INSTITUTE

An Accredited Technical Institute

E. H. Rietske, President

Dept. PR-2, 3224-16th St., N.W.

Washington 10, D.C.

Member of National Home Study Council—National Council of Technical Schools—and Television Broadcasters Association



(Continued from page 52A)

TRANSLATORS—PART-TIME

Foreign language articles, papers, patents, etc. Qualified readers state languages, technical subjects. Accurate Translation Service, 711 Woodward Building, Washington 5, D.C.

ENGINEERS—PHYSICISTS

Prominent communications development organization in metropolitan area has openings for men experienced in microwave systems development; UHF and VHF transmission, receiver and antenna circuits; and electro-mechanical design. Write details. Box 444.

PATENT ENGINEER

Good pay while you learn. An unusual opportunity for a young electrical engineer or physicist to receive intensive training as a patent solicitor for a substantial Texas corporation. Gives details of experience, education, draft status, salary expected. Box 445.

RADIO ENGINEERS

Air King has openings for graduate engineers with senior experience on AM and FM broadcast receiver design. Applicants must be schooled in measuring techniques and capable of establishing competent specifications for Vendors' guidance on a quantitative basis. Right men should be sufficiently capable to work on their own. Write or wire, giving full particulars of experience, salary desired, etc., to Mr. Frank A. Hinners, Vice President in Charge of Engineering, Air King Radio Co., 1523 63rd St., Brooklyn 19, N.Y.

ENGINEERS (SENIORS)

ELECTRICAL. Several positions open for men with UHF experience.

MECHANICAL. Several positions open for men with radar design experience. Allen B. Du Mont Laboratories, Inc., 2 Main Avenue, Passaic, N.J.

ENGINEER—EXECUTIVE

We need a top-flight executive to direct the engineering efforts of our young, expanding electronic manufacturing organization. Box 447.

DEVELOPMENT ENGINEERS

Brooklyn engineering and manufacturing company, established in naval fire control and precision instrument work, requires qualified engineers for servo-mechanism and related development program. Positions require mature, responsible engineers with analytic as well as laboratory background, and 5 years' experience in fundamental development work. Facility in applied mathematics and advanced circuit development requisite. Starting salary commensurate with experience, and subsequent rewards commensurate with accomplishment. Box 456.

Specify



AIR-WOUND INDUCTORS



for

- LOWER DIELECTRIC LOSS
- GREATER ADAPTABILITY IN MOUNTING
- LIGHTER WEIGHT
- EASIER TAPPING
- LESS CHANCE OF BREAKAGE

All types, shapes and sizes including turrets for modern Radio-Electronic needs.

BARKER & WILLIAMSON

Dept. IR-27, 237 FAIRFIELD AVE., UPPER DARBY, PA.

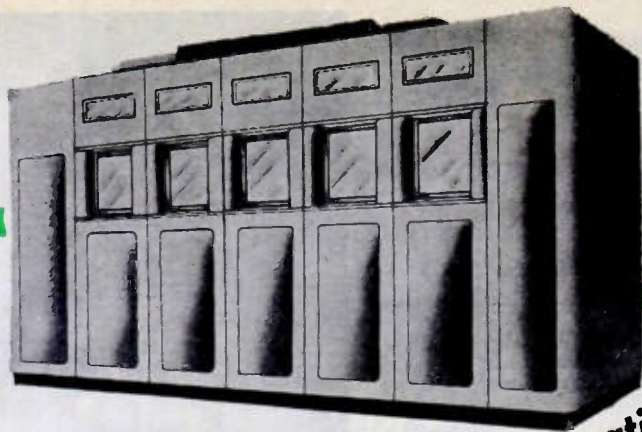

Television Transmitter

This unit is manufactured to furnish ranges of 250 watts and upwards, and in power ranges coinciding with power tube development. Individual bays of additional power can be incorporated as needed. Except where additional bays may be required, however, the complete unit can be controlled by a single licensed operator.

maximum operating efficiency
with minimum personnel!

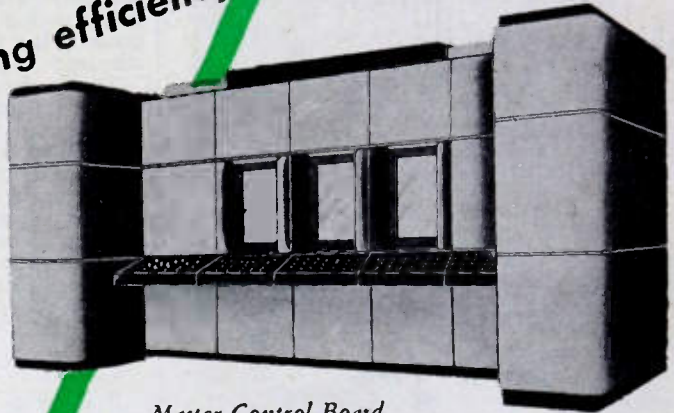

Master Control Board

This unit includes five video channels, or as many as desired. It also includes dissolving, shading, blanking controls. Simplicity of design enables the master control board to be operated by a single technician. A sync generator and monoscope are integral parts of this unit.

SHERRON
Television Studio and Transmitting Equipment!

Efficient operation by a minimum of personnel! That is the achievement of the improvements both in technical details and design which distinguish Sherron Television Studio and Transmitting Equipment. Unnecessary controls and duplication of executive supervision are eliminated . . . All Sherron equipment is designed, developed and manufactured to the individual manufacturer's specifications.



Audio Control Console

In this Sherron unit all controls are centrally located. Under usual conditions, a single control operator can meter and monitor the aural program with complete ease. Ordinarily, this unit may be adjacent to the studio control console. Thus, the control operator may receive aural instructions from the program director or, if remotely located, by inter-communication.

A cordial invitation to visit our factory is extended to all IRE members attending the IRE convention.



Studio Control Console

This unit is especially designed to afford exclusive control to the program director in charge of the broadcast. The director need not be a technician. His sole concern is the quality of the broadcast. He does not operate the controls but transmits his instructions, by inter-communication, to the master control and studio camera men.



SHERRON ELECTRONICS CO.
 Division of Sherron Metallic Corporation
 1201 FLUSHING AVENUE • BROOKLYN 6, NEW YORK

MICRODIMENSIONAL
WIRE & RIBBON
FOR VACUUM TUBES



Wires drawn to .0004" diameter.

Ribbon rolled to .0001" thickness.

Special Alloys for individual requirements.

WRITE for list of stock alloys.

SIGMUND COHN & CO.
44 GOLD ST. NEW YORK

SINCE 1914

★ ★ ★ ★ ★

Positions Wanted By Armed Forces Veterans

In order to give a reasonably equal opportunity to all applicants, and to avoid overcrowding of the corresponding column, the following rules have been adopted:

The Institute publishes free of charge notices of positions wanted by I.R.E. members who are now in the Service or have received an honorable discharge within a period of one year. Such notices should not have more than five lines. They may be inserted only after a lapse of one month or more following a previous insertion, and the maximum number of insertions is three per year. The Institute necessarily reserves the right to decline any announcement without assignment of reason.

ENGINEER

B.S. in E.E. Graduate work, Princeton, M.I.T. Three years, engineer with aircraft company, design group leader. Two years, naval officer, Armed Forces Radio Service station installation at 50KW. Now commercial manager radio station. Desires position as technical engineer, executive, or sales engineer. Good writer. Minimum salary, \$6500. Box 68W.

ELECTRICAL ENGINEER

B.E.E., 1942. Age, 26; married. 3½ years civilian experience UHF development and production; 1 year servo-systems development with Army Air Forces. Desires position in environs of New York City. Box 69W.

PART-TIME WORK

High British research qualifications; lecturing experience, radio, geophysics. Lately, Admiralty radar representative in U.S.A. Can undertake abstracting, literary, or other work in England, in spare time. Box 70W.

ELECTRICAL ENGINEER

B.E.E. Brooklyn Polytechnic, 1942. Eta Kappa Nu. Six months development UHF receivers. Three years U. S. Army, installation and operation of medium-powered radio transmitting stations. One year factory engineering in the manufacture of cathode-ray tubes. Desires development work in radio or electronics. Resumé upon request. Box 71W.

SALES ENGINEER

12 years experience electronic engineering and sales; 5 years Navy, supervising installation and maintenance radio and radar; 2 years geophysical engineering. Successful sales background. Some college. Desires sales position with responsible company. Age, 30; married. Box 72W.



ENGINEER

B.S. in E.E. Graduate study. Age, 25; married. 3 years civilian development experience in MAD, receivers, and radar. Present duty, radar equipment development. Available, January 1, 1947. Box 54W.

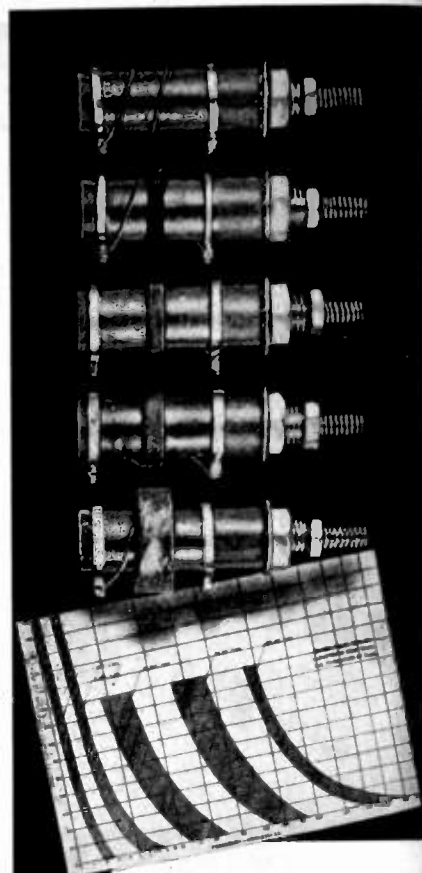
(Continued on page 58A)



This graph shows frequency ranges covered by each unit. Write us for your full-size copy.

-  Turret Lug
-  Split Lug
-  Double-end Lug
-  Swager
-  Terminal Board
-  HPB Crystal

Five Standard Slug-Tuned LS3 Coils Cover ½ to 184 mc

For strip amplifier work, the compact (1¼" high when mounted) LS3 Coil is ideal. Also for Filters, Oscillators, Wave-Traps or any purpose where an adjustable inductance is desired.

Five Standard Windings — 1, 5, 10, 30 and 60 megacycle coils cover inductance ranges between 750 and 0.065 microhenries.

CTC LS3 Coils are easy to assemble, one ¼" hole is all you need. Each unit is durably varnished and supplied with required mounting hardware.

SPECIAL COILS

CTC will custom-engineer and produce coils of almost any size and style of winding... to the most particular manufacturer's specifications.

Consult CTC for
Three-Way
Component Service

Custom Engineering... Standardized Designs...
 Guaranteed Materials and Workmanship
CAMBRIDGE THERMIONIC CORPORATION
 456 Concord Avenue, Cambridge 38, Mass.

here's the
true operator's
transmitter

-----BACKED BY THE
OPINIONS OF FM OPERATORS
IN 56 CITIES IN 22 STATES

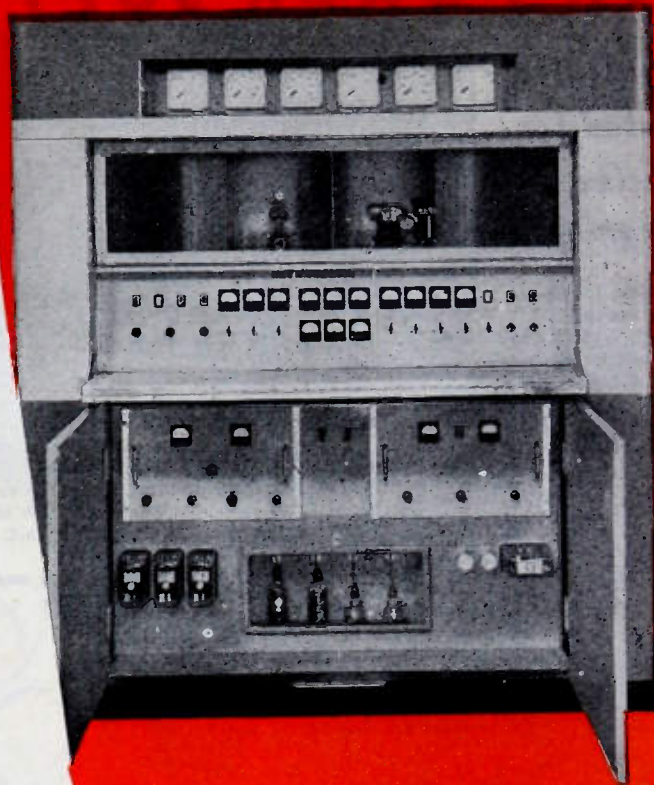

Smartly styled M transmitters (in two-tone blue and gray) are built in lightweight aluminum cabinets to facilitate portability and rapid installation.



May 1942
May 44
Oct 1944
July 46
237
33
29
37

Here's the answer to many of your hopes . . . an FM transmitter packed with the features you want most, as revealed by an extensive survey among station owners and operators throughout the country.

In this survey, 96% wanted a roomy transmitter . . . one with complete, fast and easy accessibility. This important feature shows up in many ways in the Westinghouse FM transmitters:

Example: you can service any tube quickly from easily-opened front panels.

Example: high-voltage rectifier tubes can be checked visually, any time, through glass panels.

Example: oscillator-driver-audio and center frequency control units are built on standard relay rack chassis and equipped with plug-in

connectors for easy removal.

Making your job easy is a keynote of the entire Westinghouse FM design. Meters and indicating instruments are at eye level. All overload protection is fuseless. And to place the transmitter in operation it is only necessary to connect the audio input, r.f. transmission line and input power supply.

This improved design is the product of another vital fact: the unmatched experience of Westinghouse engineers in actual station operation of five FM and six AM stations. Get the facts today from your nearest Westinghouse office. Westinghouse Electric Corporation, P. O. Box 868, Pittsburgh 30, Pennsylvania.

J-02082-A



This new book gives you the complete picture story of the operating advantages built into Westinghouse transmitters and the way operators approved them. Ask for your copy of B-3829.

Westinghouse
PLANTS IN 25 CITIES . . . OFFICES EVERYWHERE



Electronics at Work

TWIN POWER SUPPLY

**Electronically
Regulated for
Precise
Measurements**



Two independent sources of continuously variable D.C. are combined in this one convenient unit. Its double utility makes it a most useful instrument for laboratory and test station work. Three power ranges are instantly selected with a rotary switch:

- 175-350 V. at 0-60 Ma., terminated and controlled independently, may be used to supply 2 separate requirements.
- 0-175 V. at 0-60 Ma. for single supply.
- 175-350 V. at 0-120 Ma. for single supply.

In addition, a convenient 6.3 V.A.C. filament source is provided. The normally floating system is properly terminated for external grounding when desired. Adequately protected against overloads.

Twin Power Supply Model 210
Complete \$115.00 F.O.B. Chicago
Dimensions: 16" X 8" X 8" Shipping Wt. 35 lbs.
(Other types for your special requirements)

- Output voltage variation less than 1% with change from 0 to full load.
- Output voltage variation less than 1 V. with change from 105 to 125 A.C. Line Voltage.
- Output ripple and noise less than .025 V.



FURST ELECTRONICS

Dept. P-2, 800 W. North Avenue, Chicago 22, Illinois

PRACTICAL WORKING TOOLS FOR THE ENGINEER

UP TO
THE
MINUTE!

ELECTRONIC ENGINEERING HANDBOOK

For radio-electronic specialists this Caldwell-Clements book provides a convenient, authentic source of formulas and principles, as well as the latest in electronic applications. Electrical operating and executive engineers will find here the solutions to many production problems. Easily understood by anyone with a knowledge of basic electrical principles and simple circuits. Free from involved mathematical explanations. Section I covers Vacuum Tube Fundamentals; Section II, Electronic Circuit Fundamentals; Section III, Electronic Applications; Section IV, Vacuum Tube Data.

456 Pages • \$4.50
560 Illustrations

ELECTRONIC CONTROL HANDBOOK

Here are all the essential data necessary to determine the worth of an electronic control device; a dependable guide toward your taking advantage of the cost-cutting, production-speeding, quality-control possibilities of electronic devices. Gives you facts to intelligently balance the advantages of electronics against mechanical and other methods of control. Easily understood without advanced knowledge of electronics. Section I, Basic Elements of Control; Section II, Conversion Elements; Section III, Electronic Modification Circuits; Section IV, Activation Elements; Section V, Control Applications.

Both books 6x9 inches, bound in limp leatherette covers, open conveniently flat.

350 Pages • \$4.50
Hundreds of Illustrations

CALDWELL-CLEMENTS, INC.

480m Lexington Ave. (INC) New York 17, N. Y.

Publishers to the electronic industries since 1925

Send books checked below. If not satisfied, I will return books to you within five days. Otherwise I will remit payment.

- ELECTRONIC ENGINEERING HANDBOOK \$4.50
 ELECTRONIC CONTROL HANDBOOK \$4.50

Name.....
Address.....
City and State.....
Company Name.....

Once You Get These
Books in Your Hands
You'll Always Have
Them at Your Fingertips

NO RISK—
5 DAY APPROVAL

Positions Wanted

(Continued from page 56A)

ENGINEER

B.E.E. Cooper Union. Age, 24; married. Radar training, Harvard-M.I.T. 26 months signal corps radar officer; 10 years licensed radio amateur, class "A" license. Interested research or development on radar or communications equipment, New York City or vicinity. Julian D. Hirsch, 18 Edgewood Park, New Rochelle, N.Y.

PRACTICAL ENGINEER

Technician, with general knowledge of radio engineering principals. Fifteen years radio work, mostly broadcast construction and maintenance. Age, 37. Desires work as assistant to experienced professional engineer. Box 55W.

ELECTRICAL ENGINEER

B.S. in E.E. University of Kansas, 1942. Age, 25; single. One year experience design of HF and VHF portable radio equipment. Forty-five months Signal Corps experience with telephone and teletype inside-plant equipment and multi-channel VHF radio link equipment. Box 56W.

COMMUNICATION ENGINEER

Commander U.S.C.G. Graduate U. S. Coast Guard Academy, 1933. M.S. in Communication Engineering, Harvard, 1942. Varied radio and electronic experience. Desires position in the Boston area. Available December. Box 57W.

ENGINEER

Master of Electrical Engineering. Age, 37; single. Desires suitable position in international engineering sales. Fluent French, German, Italian; some Spanish. Good appearance and personality. Foreign fields preferred. Box 58W.

ENGINEER

B.E.E. Age, 23; single. 2 years industrial experience; 1 year UHF research. Desires position New York City or environs, preferably in UHF field. Available January. Box 59W.

RADIO OR SALES ENGINEER

Bowdoin, M.I.T., Corpus Christi Navy electronics training, four years officer, aviation electronics duties. R.C.A. Institute Technology, manufacturing and broadcasting experience. Project engineer M.I.T. Radiation Laboratory. Box 61W.

ELECTRONIC DEVELOPMENT— INSTRUCTOR

B.E.E. 1943, Cooper Union, UHF graduate theory. Studying N.Y.U. evenings. 1 year civilian experience UHF development. Organized and instructed Army radar school. Civilian radio instructing. Desires part-time instructing, research, or development. Box 40W.

BEGINNING ENGINEER

B.S. in E.E. Tufts College. Age, 22; single. 1 year experience in the installation and maintenance of teletype equipment in the Navy. Box 41W.

SALES ENGINEER

Completed Navy Officer Radar Course at Bowdoin College and M.I.T. Member of Tau Beta Pi, Eta Kappa Nu. Age, 23. Desires position with Mid-West firm along lines of engineering administration or sales engineering. Box 42W.

(Continued on page 60A)

Announcing a brand new miniature capacitor

The "HI-KAP"

made with Centralab's original Ceramic-X!

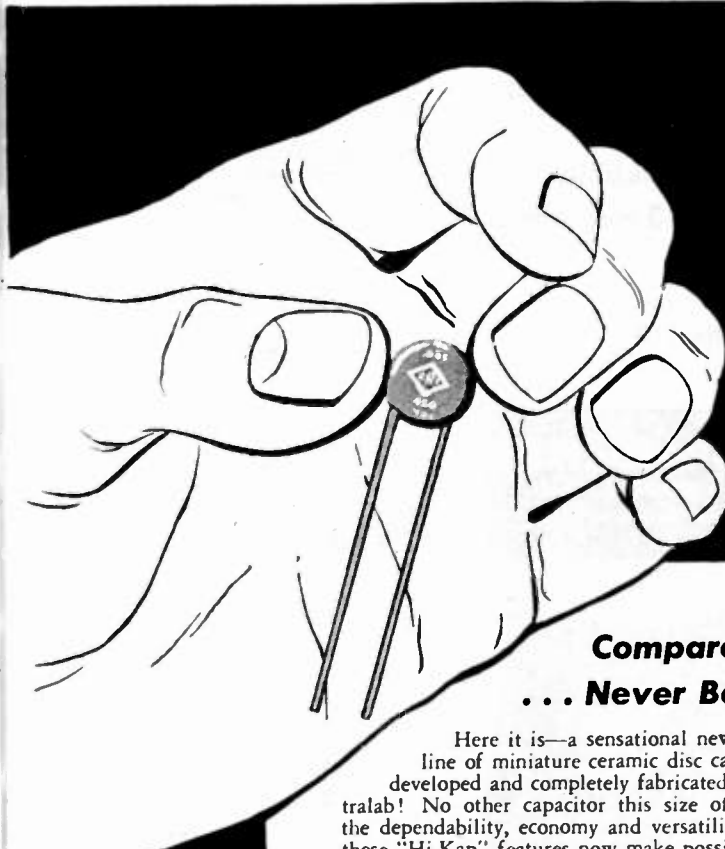

Look at "HI-KAP" Performance, Ratings, Convenience of Design!

Diameter (Max. O. D.)	$\frac{5}{8}$ "
Thickness (Maximum)	$\frac{5}{32}$ "
W. V. D. C.	450
Guaranteed Min. Capac.	.005
Flash Test V. D. C.	900
Weight (Average)	1 gm. .035 oz.

Other capacity values available. Inquire now!

**Compare these Exclusive "HI-KAP" Features
... Never Before Available in Small Capacitors!**

Here it is—a sensational new quality line of miniature ceramic disc capacitors, developed and completely fabricated by Centralab! No other capacitor this size offers you the dependability, economy and versatility which these "Hi-Kap" features now make possible:

RELIABILITY: Permanent Ceramic-X stability assures utmost reliability in small physical size and low mass weight. Impervious to moisture.

CONVENIENCE: Convenient placement of 22-gauge leads permits low inductance connections on almost any appropriate capacitor application.

CAPACITY: "Hi-Kaps" are rated at a guaranteed *minimum* capacity for applications where close tolerances are unnecessary. Lowest minimum ca-

capacity will be exceeded by substantial amount on all units.

CONSTRUCTION: Pure silver electrodes bonded to permanent Ceramic-X with a tensile strength of 3000 lbs. per sq. in. High strength leads soldered directly to electrodes. Flat plate design assures low internal inductance.

INSULATION: Entire "Hi-Kap" unit is covered with a phenolic coating plus special impregnation to provide extra protection against voltage breakdown, mechanical damage and humidity. No further treatment required for export equipment (tropical use).

For complete information, write for Bulletin 933.

ACTUAL
SIZE
SHOWN
ABOVE



Ceramic Trimmers
Bulletin 630



Ceramics
Bulletin 720



Variable Resistors
Bulletin 697

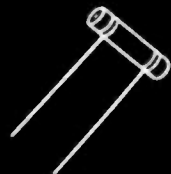

Ceramic Capacitors
Bulletin 630



Selector Switches
Bulletin 722

Centralab
Division of GLOBE-UNION INC., Milwaukee

DECADE AMPLIFIER

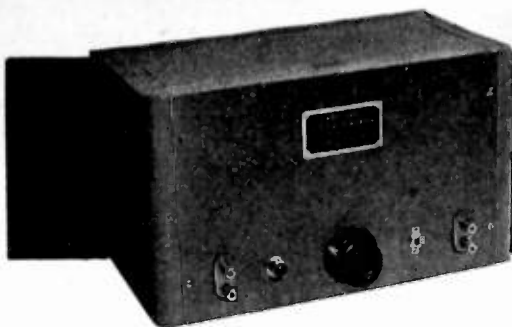

A stable, calibrated, high gain amplifier.

- Gain of 100x, 1000x, or 10000x.
- Frequency range 10 cycles to 1000 kilocycles within 1Db.
- Feedback stabilization on first two ranges.
- Fully regulated power supply for additional stability.
- Output impedance 25 ohms; input impedance 3 megohms.
- Will deliver 50 volts or 7 milliamperes.

Write for Bulletin 11D

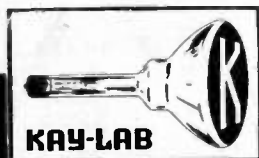

KALBFELL LABORATORIES

941 ROSECRANS ST. • SAN DIEGO 6, CALIF.
Manufacturers Representatives are invited to reply.

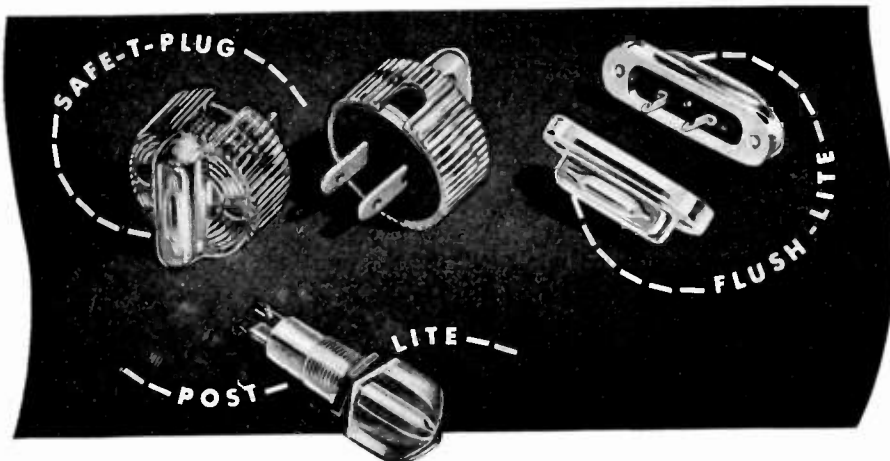

YOU CAN SEE IT'S ON

WITH LITTELFUSE NEON INDI-GLOWS!

Littelfuse neon-glow Flush-Lites and Post-Lites assure quick orientation in the dark, locate instruments, switches, etc., on radar, television, communication and aircraft panels. As on-off indicators on radios, electric stoves and other electrical appliances they are approved by Underwriters' Laboratories, and last 15,000 hours or more.

Neon-glow Safe-T-Plugs, built like standard plugs for use on non-thermostatically controlled electrically heated appliances, glow when the appliance is on, and are required by Underwriters' Laboratories and most insurance companies to reduce fire hazard.

For details request Littelfuse Catalog No. 9.

LITTELFUSE



Incorporated

4763 N. RAVENSWOOD AVE.

CHICAGO 40, U. S. A.

MITE-T-LITE • SWITCH-LITE • IGNITION-FRITZ • NEON INDICATORS • SWITCHES • CIRCUIT BREAKERS • FUSES, MOUNTINGS AND ACCESSORIES

Positions Wanted

(Continued from page 58A)

JUNIOR ENGINEER

B.S. in Engineering, majored in electrical. Desires position in New York area in communications or UHF field. Age, 23. Ensign U.S.N.R. (inactive). Box 44W.

PRACTICAL ENGINEER

B.S. in E.E. Illinois Institute of Technology, final tested, as U.S.N. inspector, all types radar at Western Electric Company, Chicago, 1941-44. As Lt. (j.g.), installed GCA fixed blind-landing radar unit in Florida. Ham, 12 years. Holds commercial phone 1st. Age, 28; married. Details on request. Box 45W.

ENGINEER

3½ years E.E. Age, 31; married. Varied and colorful naval radio career. Radiotelegraph and radiotelephone first-class licenses since 1940. Prefers joining small progressive concern. Box 46W.

ELECTRONICS ENGINEER

B.E.E., 1943. Army radar officer, trained M.I.T. Desires research development or testing in electronics New York area. Age, 25. Henry L. Pernick, 1120 Wyatt St., Bronx 60, N.Y.



(Continued from page 48A)

Ward, W. H., 4685 Homer Ave., S.E., Washington 20, D. C.

Watkin, J. R., 452 Dorinda St., London, Ont., Canada

Whittaker, G. A., Box 440, Anchorage, Alaska
Whiting, W. K., 1210 N. Rolfe St., Arlington, Va.
Wilson, D. R., 2336 S. Boeke St., Kansas City 3, Kan.

Wine, R. E., TSBPE 8, Wright Field, Dayton, Ohio
Wood, R. W., 809 Sargent St., San Francisco 25, Calif.

Woodland, P. C., 1322 Bookness St., Midland, Mich.

Young, H. R., 319 Eldon Ave., Columbus 4, Ohio.

News—New Products

These manufacturers have invited PROCEEDINGS readers to write for literature and further technical information. Please mention your I.R.E. affiliation.

Miniature Motor

A miniature horsepower motor which can operate on as little as 30 milliwatts power has been announced by Alni Corporation, 10 East 52 St., New York 22, N. Y. These direct-current motors are manufactured with different field coil windings and various bearing designs for individual applications. It is stated that these "Minimotors" will operate in any position and will self-start in only one direction, regardless of polarity reversal. Motor size is approximately 2"×2"×1" and weighs but two ounces.

(Continued on page 64A)

WATERMAN

DOES IT AGAIN!!

A NEW PORTABLE INDUSTRIAL & TELEVISION **POCKETSCOPE**

MODEL S-11-A



AN OSCILLOSCOPE OF UNUSUAL VERSATILITY AND UTILITY...

LIGHT... COMPACT... EFFICIENT

A 3-inch oscilloscope for measuring AC and DC
... Amplifiers for vertical and horizontal de-
flection as well as intensity ... Linear time sweep
from 4 cycles to 50 kc with blanking of return
trace ... Sensitivity up to 100 mv/in ... Fidelity
up to 350 kc through amplifiers ... Attenuators
for AC as well as for DC ... Push-pull ampli-
fiers ... Anti-astigmatic centering controls ...
Trace expansion for detail observations.

Direct connections to deflecting plates and intensity grids
accessible from rear ... Retractable light shield ... Detachable
graph screen ... Handle ... Functional layout of controls.

Light weight: 8 3/4 lbs. ...
Portable size: 11" x 7" x 5" ...

\$99 F.O.B. PHILA.

WATERMAN PRODUCTS CO.
INCORPORATED
PHILADELPHIA 25, PENNSYLVANIA

... and the
**GENERAL PURPOSE
POCKETSCOPE**
MODEL S-10-A
Widely known, widely
used by engineers, in-
dustry, amateurs and
laboratories for con-
venient, efficient and
accurate testing and
measuring requirements
... an instrument of ver-
satile application and de-
pendable performance.
\$66 F.O.B. PHILA.

A Ballantine ELECTRONIC VOLTMETER

For every requirement

ALL MODELS HAVE THE
SIMPLIFIED
LOGARITHMIC
SCALE

STANDARD
Model 300



Ideal for the *Accurate* measurement of AC voltages in the Audio, Supersonic, Carrier Current and Television ranges.

Use of Logarithmic voltage scale assures uniform accuracy of reading over whole scale while permitting range switching in decade steps.

Each Voltmeter equipped with an output jack so that the instruments can be used as a high-gain stable amplifier.

SPECIFICATIONS

MODEL 300

RANGE—.001 to 100 volts.
FREQUENCY—10 to 150,000 cycles.
ACCURACY—2% of any point on scale.
AC OPERATION—110-120 volts.

MODEL 304

RANGE—.001 to 100 volts.
FREQUENCY—30 c.p.s. to 5.5 megacycles
ACCURACY—.5 DB.
AC OPERATION—110-120 volts.

MODEL 302

RANGE—.001 to 100 volts
FREQUENCY—5 to 150,000 cycles.
ACCURACY—2% at any point on scale.
DC OPERATION—self-contained batteries.

Send for Bulletin for further description



Model 304
R-F
VOLTMETER

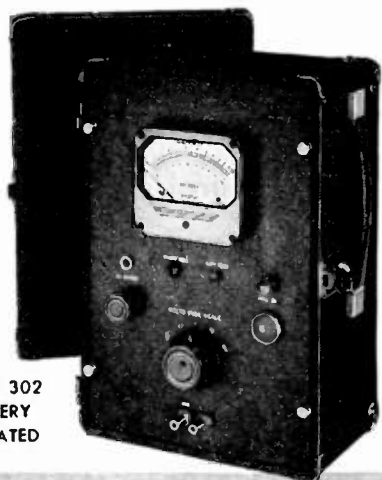

Model 302
BATTERY
OPERATED



BALLANTINE LABORATORIES, INC.

BOONTON, NEW JERSEY, U. S. A.



Here's the
INSIDE
STORY

★ Clarostat originated and pioneered the tube-type or plug-in resistor. And Clarostat is still the only one offering these features:

- MICA SUPPORT FOR WINDINGS
- GLASOHMS FOR MAIN LOADS
- POSITIVELY CENTERED SUPPORT WINDINGS CANNOT SAG OR SHORT
- POSITIVELY CHAR-PROOF THROUGH-OUT
- ADEQUATE SAFETY FACTOR

Remember this inside story when buying or specifying tube-type resistors. Don't be satisfied with less! Bulletin No. 107, with complete engineering data, sent on request.



CLAROSTAT MFG. CO., Inc. · 285-7 N. 6th St., Brooklyn, N. Y.

QUIET
please!



MALLORY Carbon Controls Operate Noiselessly... and *that's only part of the story*



When you specify a Mallory carbon control for that radio you're designing, you won't get complaints about the loudspeaker rattling or thumping—about the control itself developing "scratch-itis." Mallory carbon controls are practically noise-proof. Careful selection of materials and a unique technique of processing resistance elements take care of *that*.

Noiseless operation is just one reason—but far from the only one—why you expect more and get more from Mallory carbon controls. Check the list of features tabulated below. Then—contact our district sales office or write us direct. Special engineering help, of course, is available, too.

... Only Mallory Carbon Controls Offer All These Features ...

Low "Hop-Off" Resistance . . . Minimum Short-Out Resistance . . .
Smooth-Operating Silver Alloy Contactor . . . High Humidity Resistance
. . . Low Noise Level . . . Extremely Accurate Taper Construction . . .
Non-Distorting, Non-Loosening Assembly Construction . . . Spring Pressure
Terminals, Smooth Bearing Surfaces, Mallory Spring Alloy Contact
Arms, Self-Lubricating Elements—all contributing to longer life.

P. R. MALLORY & CO. Inc.
MALLORY RESISTORS
(FIXED AND VARIABLE)

P. R. MALLORY & CO., Inc., INDIANAPOLIS 6, INDIANA

YOU CAN NOW GET THESE DAILY ESSENTIALS

INSTRUMENT & TESTER SWITCHES

12-14 and 20 position.
Shorting; non-shorting
1-6 decks.

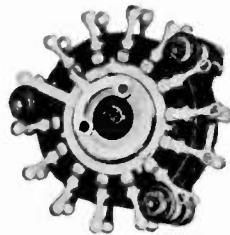

(SS-14-2)

OPERATING TEMPERATURE TESTERS

Automatically compensated,
typical range for ovens,
0-650°F.



(32-JPI)

400 CYCLE PORTABLES

Accuracy to $\pm 0.3\%$; pocket
size metal case; other ranges.



(33-FP9-400 cy.)

VACUUM-TUBE FREQUENCY METERS

Accuracy, $\pm 0.25\%$; six
specific bands, to 3600 cps.
No drift.

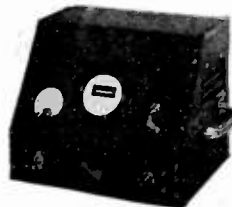

(39-VTF)

MOST COMPACT FREQUENCY METERS

Matches standard $2\frac{1}{2}$ " panel
instruments. 60, 120 cps.

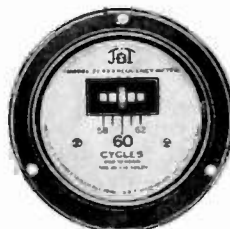

(21-FX-60 cy.)

ELAPSED TIME—FREQUENCY METERS

$3\frac{1}{4}$ " mounting; encourages
periodic servicing and tube-
life checking.



(31-FE)

MULTIPLE RANGE PORTABLES

Standard—4 frequency groups
at 3 voltages. Many special
order variations.



(60-FP)

POTENTIOMETER-PYROMETERS

Measures and follows tem-
peratures continuously after
initial balancing.



(70-PO)

... many of these, and others from the J-B-T line, are now stocked by leading jobbers.

See us at Booth 81B
at the Radio Engineering Show, March 3-6, 1947

J-B-T INSTRUMENTS, INC.

423 CHAPEL STREET • NEW HAVEN 8, CONNECTICUT

News—New Products

These manufacturers have invited PROCEEDINGS readers to write for literature and further technical information. Please mention your I.R.E. affiliation.
(Continued from page 60A)

Thickness Gage

A portable, self-contained instrument designed to measure thickness from one side only is manufactured by Branson Instruments, Inc., Joe's Hill Road, Danbury, Conn. The "Audigage" Thickness Gage, Model FMSS-4, may be applied to problems of thickness determination of steel, aluminum, brass, copper, glass and other materials, and covers a thickness range of from $\frac{1}{8}$ " to 12".



The "Audigage" utilizes a crystal-type gage head, powered by a frequency-modulated electronic oscillator. When the vibrating crystal is applied to a wall surface, mechanical resonance of the wall thickness can be produced directly below the crystal. The fundamental frequency at which the wall section will resonate is directly proportional to the velocity of the sound in the material and inversely proportional to thickness.

Studio Recorder

Recently made available by Presto Recording Corp., 242 West 55 St., New York 19, N. Y., is their Model 14-B, Recording Turntable, embodying very close speed-regulation, exceptional reduction of mechanical vibration, and ease of operation.

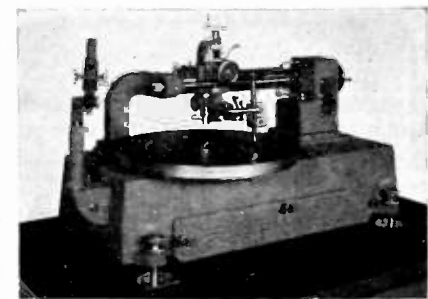

Designed to operate at either of the two standard record speeds, any one of five groove pitches, in-out or out-in, may be easily selected. Vertical or lateral cutting heads are readily attached.

(Continued on page 65A)

News—New Products

These manufacturers have invited PROCEEDINGS readers to write for literature and further technical information. Please mention your I.R.E. affiliation.
(Continued from page 64A)

FM Signal Generator

A new frequency-modulated signal generator, Type 202-B, has just been released by Boonton Radio Corp., Fanny Road, Boonton, N. J. This instrument covers the frequency range from 54 to 216 megacycles and is provided with two frequency deviation ranges, 0-80 kilocycles and 0-240 kilocycles for frequency modulation, as well as 30% and 50% calibrations for amplitude modulation.



An internal audio oscillator having eight fixed frequencies between 50 cycles and 15 kilocycles may be conveniently switched for either frequency or amplitude modulation. By the use of an external audio-frequency oscillator simultaneous frequency-modulation and audio-modulation may be obtained for checking the performance of limiter stages and ratio detectors.

Booster Amplifiers

Two booster amplifiers have been made available by the David Bogen Co., 663 Broadway, New York 12, N. Y., known as the G050 and G0125, capable of delivering 50 and 125 watts respectively. Two transmitter Type 807 tubes in push-pull with multi-stage inverse feedback provide high power output with excellent regulation within one decibel from 20 to 20,000 cycles, it is claimed.

Input impedance is 500,000 ohms with provision for balanced-line zero-level input for use on telephone lines. Oil-filled input filter condenser, preset volume control, standby relay provision and tube-regulated screen supply are some of the features of these new amplifiers.

(Continued on page 66A)



Photo courtesy Pacific Division Bendix Aviation Corp., North Hollywood, Calif. Transmitter-Receiver Unit for mobile communication equipment.
Model LTR-1



Integral Clamp

Cannon Electric Exhibiting with Harvey Radio at I.R.E. National Convention, March 3 through 6, 1947.

QUALITY ELECTRICAL CONNECTORS IMPROVE OPERATION AND SELLING FEATURES OF ANY EQUIPMENT...

An axiom of the electrical equipment industry receiving greater and greater acceptance is "No equipment is better than its electrical connections." Cannon Electric has long taken pride in furnishing connectors for quality equipment. These vital parts are recognized by manufacturers as "musts"—such as the Collins and Bendix new equipment shown here. Many other prominent firms specify Cannon Plugs because "Equipped with Cannon Plugs" means quality connections.

Two-channel Transmitter, 17E-2. Specially designed for executive planes.

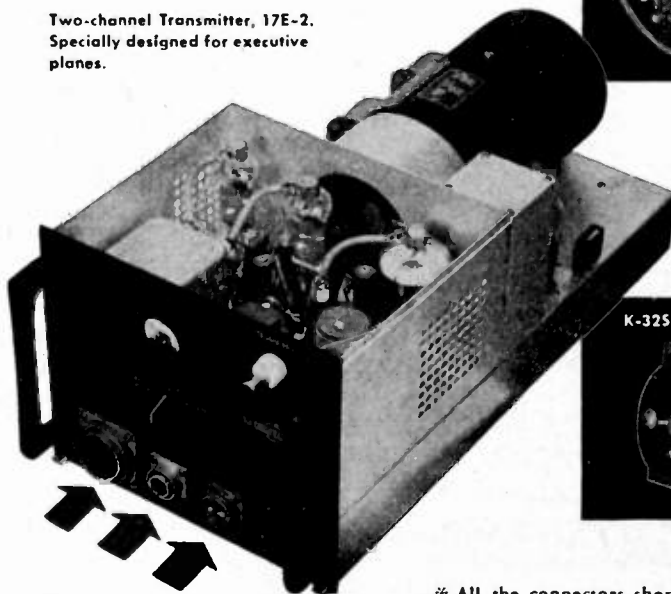

RK-22 Plug

Photo courtesy Collins Radio, Cedar Rapids, Iowa.



K-325L Receptacle

* All the connectors shown in the transmitters are type "K." If you wish a bulletin covering these fittings, write Cannon Electric Development Co., Dept. 1-120, 3209 Humboldt Street, Los Angeles 31 Calif. for Type "K" Bulletin, or contact our representatives located in principal cities of the U. S. A.

CANNON ELECTRIC DEVELOPMENT COMPANY
LOS ANGELES 31, CALIF.
In Canada—Toronto, Ont.



SINCE 1915

A NEW BOOK!

by **Donald McNicol**
(PAST PRESIDENT OF THE I.R.E.)



The Fascinating Story of

How Radio Grew AND THE MEN WHO HELPED IT GROW

Institute of Radio Engineer members will find special interest in RADIO'S CONQUEST OF SPACE—first, because it was written by I.R.E. past president Donald McNicol who has lived through this exciting period and, second, because it deals in large part with men and technical developments with which many of them are personally familiar.

WHAT WAS DONE—AND HOW

Actually, RADIO'S CONQUEST OF SPACE represents spot-reporting and first hand behind-the-scenes knowledge of the vast radio industry that has grown up in the span of a single lifetime. It tells what was done—how it was done—by whom it was done. No story of scientific progress is more enthralling than this one—particularly to engineers who themselves are participating in a furtherance of the work. Covers the subject from "Electricity, the Forerunner" to the latest phases of the fast expanding Radio art. Illustrated, 374 pages. Price \$4 (foreign \$4.35). Available for immediate delivery.

MHB

ANOTHER NEW BOOK!

COMMUNICATION THROUGH THE AGES—the third of a trilogy by Alfred Still—is another book of foremost interest to radio engineers. Here, in fascinating, easily read style, Mr. Still reviews the entire brilliant history of man's efforts to communicate with others—from sign language to television. 201 pages. Illustrated. \$2.75 (foreign \$3).

USE THIS HANDY COUPON!

Dept. IR-27, Murray Hill Books, Inc.
232 Madison Ave., New York, N.Y.

Enclosed find \$ for book(s) checked; or, send C.O.D. (in U.S.A. only) for this amount plus postage.

RADIO'S CONQUEST OF SPACE, by McNicol. \$4 (foreign \$4.35)

COMMUNICATION THROUGH THE AGES, by Still. \$2.75 (foreign \$3)

Name

Address

City & Dist. No.

State

New . . . Improved ATTENUATORS by TECH LABS

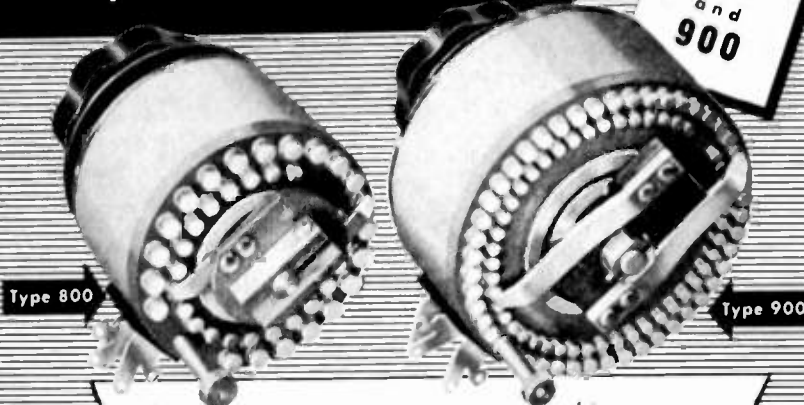

"New Times—New Modes", says old proverb. These new attenuators were born to meet new war-created demands. They represent a new medium frame size: Type 800 (2 1/4" dia.) and a larger size: Type 900 (3" dia.). The Type 800 is supplied as potentiometer, rheostat, ladder and T-pod up to 20 steps. The larger size Type 900 is similarly furnished with up to 45 steps. Write for new bulletin.



Manufacturers of Precision Electrical Resistance Instruments
337 CENTRAL AVE. • JERSEY CITY 7, N. J.

News—New Products

(Continued from page 65A)

Replacement Rectifier

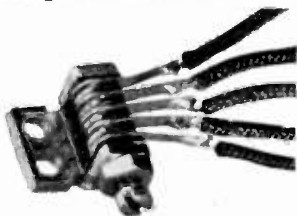

Depending upon how two or more of its five leads are utilized, a new "universal" replacement rectifier recently announced by Bradley Laboratories, Inc., 82 Meadow Street, New Haven 10, Conn., offers a multitude of circuit variations.

The three-inch flexible leads are color-coded and pre-soldered to prevent overheating during assembly. Any unused leads are simply clipped off after the circuit has proved satisfactory. Pellets are gold-coated to combat aging and instantaneous loads several times rated voltage or current can be handled.

Plant Expansions

...At Cambridge, Mass., by General Radio Company, a four-story addition, totaling 30,000 square feet for additional manufacturing capacity.

(Continued on page 68A)

for every photo tube application

there is a High Sensitivity

RAULAND VISITRON



There is a Rauland VISITRON available for every phototube application . . . for industrial electronic control devices, sound-on-film, research and development. For high sensitivity, uniformity and dependability, Rauland VISITRONS are the preferred phototubes.

Specify VISITRON . . . and be sure! Send for valuable Rauland VISITRON Catalog—it's yours for the asking.

THE RAULAND CORPORATION
CHICAGO 41, ILLINOIS

RADIO **Rauland** RADAR
SOUND • COMMUNICATIONS • TELEVISION

**THE SINGLE DRIVER SHOWN
WILL FIT AND DRIVE EVERY
BOLT AND SCREW ON THIS PAGE!**

THEY ARE **REED & PRINCE**
RECESSED HEADS...

*why
change
drivers
in
the
MIDDLE
of
a
job?*



REED & PRINCE MFG. CO.

WORCESTER, MASS.

CHICAGO, ILL.

**THIS IS THE
TRANSFORMER
DESIGN...**

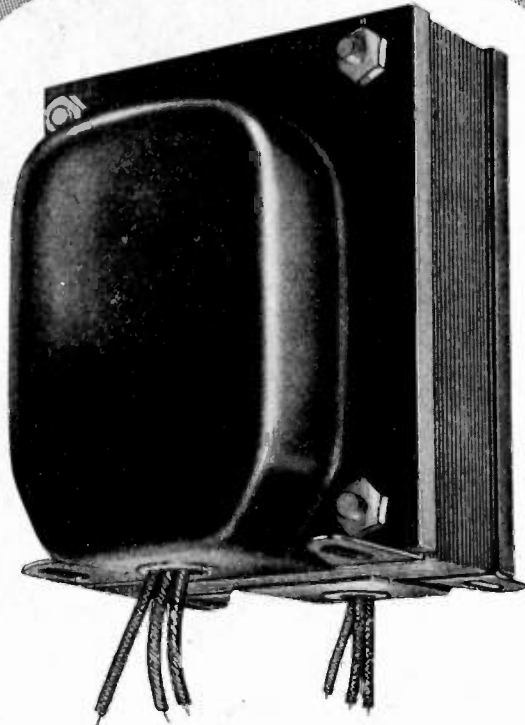

**... THAT GUARANTEES
FINEST PERFORMANCE**

This is one of the basic Acme Electric transformer designs that has the mechanical features and basic physical appearance to provide for better than average performance. End bells protect coils from accidental damage. Leads may be brought out through bottom, front, sides or top to meet the requirements of the installation. Available in ratings from 35 VA to 500 VA. Send specifications to Acme Electric transformer engineers and enjoy the cooperation that has enabled manufacturers of electronic and radio products to improve performance through better transformer design. Bulletin 168 gives all details.

ACME ELECTRIC CORPORATION
TRANSFORMER ENGINEERS

44 Water St.

CUBA, N.Y.

Acme  **Electric**

News—New Products

These manufacturers have invited PROCEEDINGS readers to write for literature and further technical information. Please mention your I.R.E. affiliation.

(Continued from page 66A)

Type 4X500A Tetrode



Another high-power-gain tetrode rated at 500 watts of plate dissipation has been announced by **Eitel-McCullough, Inc.**, 1016 San Mateo Ave., San Bruno, Calif. Known as Type 4X500A, its performance at maximum ratings is applicable up to 110 megacycles. The compact design and unique lead arrangement enable the tube to be used in cavity circuits or in conventional pin-type sockets. It is an external-anode type tube requiring forced-air cooling. This new "Eimac" tube features low-grid drive, controlled-grid emission, high-power gain, and stability.

**Sub-Miniature Thyatron
Tube**

A sub-miniature thyatron tube designed specifically for amateur and intermittent service, the RK61, is now being manufactured by the Special Tube Section, of **Raytheon Manufacturing Co.**, 55 Chapel St., Newton 58, Mass. For remote control circuits, particularly radio control of model aircraft and boats, the RK61 is ideal in applications requiring extreme economy of space, weight and battery drain.

This tube is designed for use as a self-quenching super-regenerative detector which will operate a high resistance relay in the anode circuit upon reception of a radio signal. It must always be operated with sufficient series resistance in the anode circuit to limit the anode current to the maximum rated value of 1.5 milliamps. The useful life of the tube depends upon the anode current and may be prolonged by operating the tube with as low an anode current as possible.

(Continued on page 70A)

NEW SYLVANIA G-M TUBES

... FOR DETECTION AND MEASUREMENT OF RADIOACTIVITY!

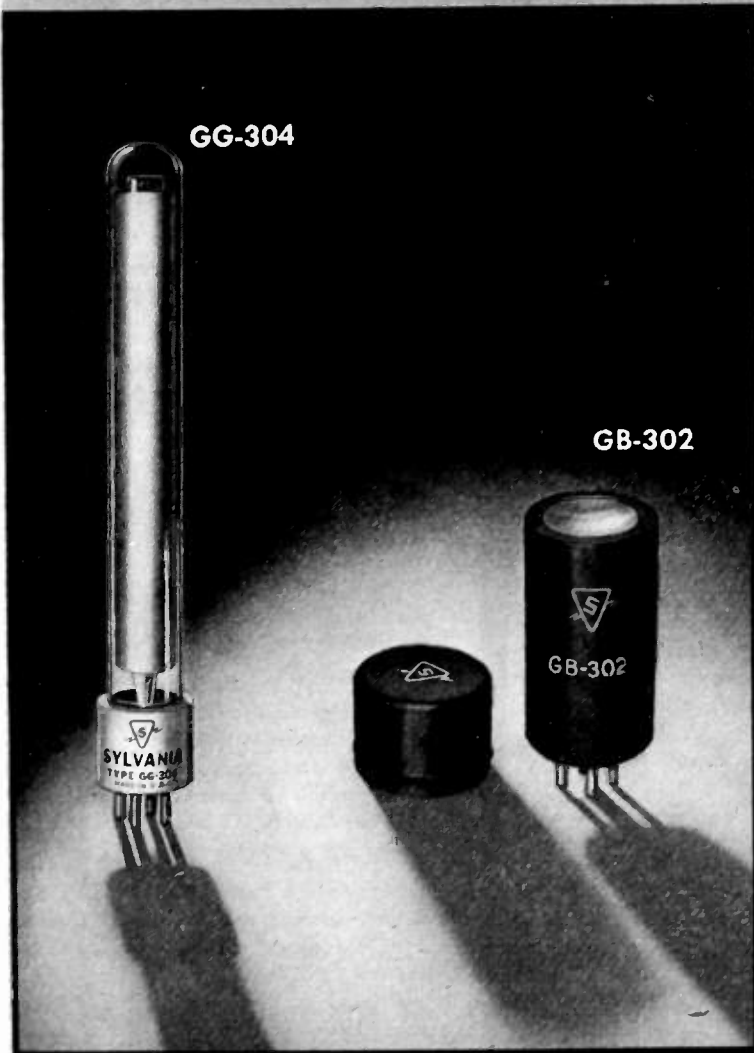

For the first time, counter tubes of *stable, uniform characteristics* are now available for practical use in the field of radioactivity.

Formerly, tubes of this type were hand-made — delicate, variable products of the laboratory glass-blower. Through Sylvania research and development, vacuum tube production techniques have now been adapted to their manufacture, with the resulting advantages of stability during tube life, and uniformity from tube to tube.

Use of Sylvania laboratory and manufacturing techniques enables the external quench circuit tubes to be produced in quantity, to bring the customer the advantages of stability and much longer life.

FEATURES

LONG LIFE UNIFORMITY
DEPENDABILITY STABILITY
CONVENIENCE

APPLICATIONS OF SYLVANIA GEIGER-MUELLER TUBES

Sylvania Tube GB-302 is a beta-ray counter, utilizing a thin but rugged window of metal foil. It is extremely sensitive to the beta-radiation of the majority of available radioactive isotopes.

The GB-302 will be particularly valuable in tracer techniques, and is also well adapted to medical diagnostic and therapeutical uses.

Sylvania Tube GG-304 is the gamma-ray counting companion to the GB-302. It is useful in radiological safety surveys and other applications where gamma radiation must be efficiently measured. In addition, Sylvania Tube GG-304 can be used for cosmic ray studies, especially in coincidence work.

Write for full details.

SYLVANIA ELECTRIC

Electronics Division . . . 500 Fifth Avenue, New York 18, N. Y.

MAKERS OF ELECTRONIC DEVICES: RADIO TUBES; CATHODE RAY TUBES; FLUORESCENT LAMPS; FIXTURES; WIRING DEVICES; ELECTRIC LIGHT BULBS

News—New Products

These manufacturers have invited PROCEEDINGS readers to write for literature and further technical information. Please mention your I.R.E. affiliation.

(Continued from page 68A)

Recent Catalogs

••• On Tube Testers, Polymeter, and Modulation Meter (three separate bulletins), by **Sylvania Electric Products, Inc.**, 500 Fifth Avenue, New York 18, N. Y. Bulletins No's. 139, 134, and EC-28, respectively.

••• A reference booklet identifying suitable socket and tube cap connectors for each of some 800 types of electronic tubes, by **E. F. Johnson Co.**, Waseca, Minn.

••• A cross-index guide of Volume Controls of leading manufacturers, by **Claro-stat Manufacturing Co., Inc.**, 130 Clinton Street, Brooklyn 2, N. Y.

••• On color in Electromagnetic Energy, by **Sun Chemical Corp.**, 100 Avenue of the Americas, New York 13, N. Y.

••• On Shipboard Radar Equipment, by **Radiomarine Corporation of America**, 75 Varick St., New York 13, N. Y. Booklet No. CR-101.

••• On Silicone Fluids for Use in High Vacuum Diffusion Pumps, by **Dow Corning Corporation**, Midland, Mich. Pamphlet No. DC 702-703.

••• A Handbook of Technical Data on Springs containing data on design, load deflection, and proper methods of specifying springs, by **Accurate Spring Mfg. Co.**, 3811 W. Lake St., Chicago 24, Ill.

••• On Resistors, Choke Plates, Heating Elements, and Special Windings, by **Resistors, Incorporated**, 2241 So. Indiana Ave., Chicago 16, Ill. Catalog No. 87.

Interesting Abstracts

••• On "Test Equipment for Carrier Telephony Maintenance" and "Theory and Design of Velocity Modulator Tubes," in two recent issues of *Philips Technical Review* of the **Philips Laboratories, Inc.**, 100 East 42 St., New York 17, N. Y.

New Enterprises

••• **Fikot Products**, 409 Pearl St., New York 7, N. Y., will manufacture wafer-thin selenium rectifiers.

••• **Supreme Transmitter Corp.**, 280 Ninth Ave., New York 1, N. Y., will manufacture standard and special transmitters for communication services.

••• **Aluminum Solder Corp.**, 10 E. 52 St., New York 22, N. Y., will manufacture an aluminum solder which does not require a flux or flux substitute.

(Continued on page 72A)



ESTABLISHED 1906

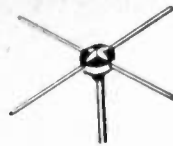
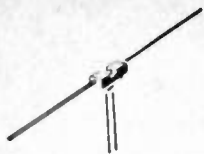
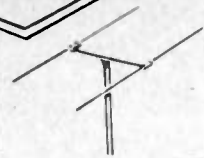

ANTENNA SYSTEMS for USERS of PRIVATE BRANDS

We manufacture the following, under private labels and trademarks:

AUTOMOBILE ANTENNAS . . . every variety, including types that can be raised and lowered from inside the car.

RESIDENTIAL ANTENNAS . . . AM and FM, for homes, stores and multi-family buildings. Complete lines of noise-reducing systems incorporating latest patented developments of coupling transformers.

FM, AM and TELEVISION . . . Dipoles with or without reflectors, folded dipoles, turnstile, radiating types and other combinations for roof, sidewall and other mountings.

MARINE ANTENNAS . . . Collapsible and transmitting types for every purpose.

For POLICE and other mobile units . . . roof-top antennas for ultra-high frequencies.

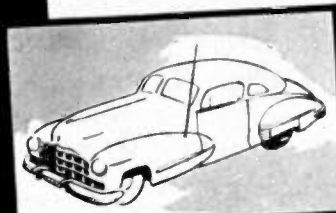

WE INVITE INQUIRIES AND CONSULTATIONS.

L. S. BRACH MFG. CORP.

200 CENTRAL AVENUE NEWARK, 4 N. J.



WORLD'S OLDEST AND LARGEST MANUFACTURERS OF RADIO ANTENNAS AND ACCESSORIES

We can supply from stock, quantities of resistors, (insulated, wire wound, and precision) in all ohmages, potentiometers, AN connectors, meters, bathtub condensers, high voltage oil filled condensers and various other electronic material of interest to engineers for their laboratory requirements. A visit to our premises may not only prove to be of interest but also most profitable.

EDLIE ELECTRONICS INC.

135 Liberty Street, New York 6, N.Y.

BR 7-4859

BLIND SPOTS IN MANAGEMENT TRAINING

THOUSANDS OF EXECUTIVES
HAVE OVERCOME THEIR DEFICIENCIES
THROUGH THIS OUTSTANDING COURSE
IN BUSINESS ADMINISTRATION

In this dynamic age, where is the executive who knows all the answers?

For every day sees American business and industry pushing forward to new frontiers...revolutionizing the practices and methods of yesterday, and posing new and complicated problems for tomorrow.

Never has there been a time when executives must be freer from the handicaps of blind spots in business knowledge.

For example:

If you are an expert in Production, and one day destiny calls upon you to assume broader responsibilities...will you be prepared to handle the reins with a firm grip?

Will you also know the essentials of Marketing...Accounting...Finance? Or will they be "Greek" to you, leaving you floundering and uncertain...dependent upon others to make decisions you would confidently make if your training was more comprehensive?

Not only in the higher altitudes of management, but down, also, through the lower executive levels, men are much better equipped for heavier responsibilities when they know the basics underlying ALL business and industry operations.

Covers Four Great Fundamentals

Since 1909, the Alexander Hamilton Institute has helped thousands of major and minor executives to overcome their deficiencies in essential business knowledge. And as a result has assisted them in moving up to more important duties and higher salaries.

The Institute's Modern Business Course and Service thoroughly covers all four of the great fundamentals of business—Production, Accounting, Finance and Marketing.

Brought to you either in your home or your office, this time-saving Course supplies the information and training that is required for sound business management and progress to top positions.

Since the Alexander Hamilton Institute was founded more than 430,000 men have availed themselves of Institute training in business adminis-

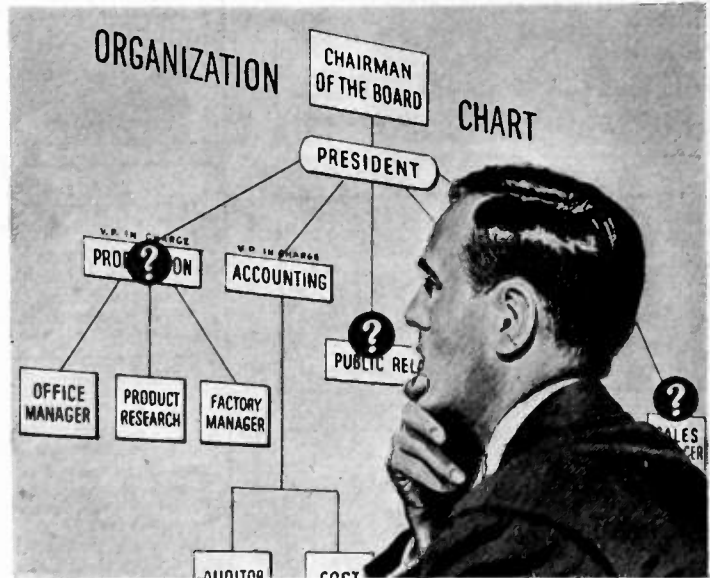

tration. The roster of those who have been trained by this method includes many of the most successful businessmen and industrialists in this country and in Canada.

Companies and corporations in many lines of business have been so impressed with the value of this course in developing skilled executive material, they frequently suggest it to men of promise, often paying all or part of the fee.



This Modern Business Course and Service of the Alexander Hamilton Institute is fully described in a 64-page booklet entitled, "Forging Ahead in Business." We will gladly send you a copy without cost or obligation if you are interested. Simply send in the coupon below.

ALEXANDER HAMILTON INSTITUTE

Dept. 525, 71 West 23rd Street

New York 10, N. Y.

Canada: 54 Wellington St., W., Toronto 1, Ont.

ALEXANDER HAMILTON INSTITUTE

Dept. 525, 71 West 23rd Street, New York 10, N. Y.

In Canada: 54 Wellington Street, West, Toronto 1, Ont.

Please mail me, without cost, a copy of the 64-page book—
"FORGING AHEAD IN BUSINESS."

Name

Firm Name

Business Address

Position

Home Address

Professional Cards

W. J. BROWN

Electronic & Radio Engineering Consultant
Electronic Industrial Applications, Commercial and Broadcasting Transmitter and Receiver Design, Test Equipment, etc.
23 years experience in electronic development
P.O. Box 5106, Cleveland, Ohio
Telephone, Yellowstone 7771

EDWARD J. CONTENT

Acoustical Consultant
and

Audio Systems Engineering, FM Standard Broadcast and Television Studio Design.
Roxbury Road Stamford 3-7459
Stamford, Conn.

STANLEY D. EILENBERGER

Consulting Engineer
INDUSTRIAL ELECTRONICS

Design—Development—Models
Complete Laboratory and Shop Facilities
6309-13—27th Ave.
Kenosha, Wis. Telephone 2-4213

HERBERT A. ERF

Architectural Acoustics
Consultant

STUDIO DESIGN
Standard Broadcast—FM—Television
Cleveland 15, Ohio
3868 Carnegie Avenue EXpress 1616

SAMUEL GUBIN

Consulting Engineer

Transmitting Equipment, Industrial Electronics
17 years of design experience
affiliated with
SPECTRUM ENGINEERS, INC.
Philadelphia 4, Pa. EV 6-7950

DAVID C. KALBFELL, Ph.D.

Engineer — Physicist

Complete laboratory facilities
Industrial instrumentation and control
Broadcast engineering and measurements
941 Rosecrans St. Bayview 7303
San Diego 6, California

FRANK MASSA

Electro-Acoustic Consultant

DEVELOPMENT PRODUCTION DESIGN
PATENT ADVISOR
ELECTRO-ACOUSTIC & ELECTRO-MECHANICAL
VIBRATING SYSTEMS
SUPERSONIC GENERATORS & RECEIVERS
3393 Dellwood Rd., Cleveland Heights 18, Ohio

ROBERT E. McCOY

Consulting Engineer

Electrical Design and Theory
DC to UHF

Rt. 1, Box 367A, Gresham, Oregon

ALBERT PREISMAN

Consulting Engineer

Television, Pulse Techniques, Video Amplifiers, Phasing Networks, Industrial Applications
Affiliated with
MANAGEMENT TRAINING ASSOCIATES
3308-14th St., N.W. Washington 10, D.C.

JAMES R. WALKER, B.S.E.E., M.S.

Consultant on Industrial Electronic Applications and Electrical Devices for Physical Measurements

Complete Lab. Facilities
856 Pallister, Detroit, Mich.
Phone MA 1243

HAROLD A. WHEELER

Consulting Radio Physicist

Radio-Frequency Measurements
Special Antenna Problems
Wideband Amplifiers and Filters
259-09 Northern Boulevard
Great Neck, New York Imperial 646

Paul D. Zottu
Consulting Engineer
Industrial Electronics

High Frequency Dielectric and Induction Heating Applications, Equipment Selection, Equipment and Component Design, Development, Models.
272 Centre St., Newton, Mass. BIG-9240

News—New Products

(Continued from page 70A)

Microwave Spectroscope

Radar waves from 1.2 to 1.6 centimeters in length have found a new use in a microwave spectroscope developed for the analysis of chemical substances. Like the infra-red spectroscope, to which it is analogous, the microwave spectroscope can identify the more complicated molecules such as hydrocarbons without the laborious chemical processes involved in breaking them down and analyzing their various components, according to the Westinghouse Electric Corp., Pittsburgh 30, Pa.

Identification of whole molecules is accomplished by beaming microwaves through the vapor of the substance to be analyzed. Certain frequencies of these microwaves are absorbed by those molecules which they cause to rotate in resonance. Molecules of different substances absorb a different series of frequency. Thus for each substance there is a characteristic pattern of absorption lines which, when projected electronically on a screen, present an easily identifiable fingerprint of the vapor under investigation. The limitations of the microwave spectroscope are not yet known, but it promises to be a very valuable tool in the study of molecules and even of the atomic nuclei within the molecule.

(Continued on page 80A)

You are invited to visit the

COSMALITE EXHIBIT

I. R. E. RADIO ENGINEERING SHOW
EXHIBIT BOOTH 421

COSMALITE, a spirally laminated paper base PHENOLIC TUBE
Trade mark registered

IS PRODUCED IN TWO TYPES . . .

#96 Cosmalite—for coil forms in all standard broadcast receiving sets.
SLF Cosmalite—for permeability tuners

ADVANTAGES INCLUDE . . .

High Quality—attractive, low-cost production—with quick delivery.
Visit our Exhibit or write for complete details.

The **CLEVELAND CONTAINER Co.**
6201 Barborton Avenue Cleveland 2, Ohio

PRODUCTION PLANTS also at Plymouth, Wis., Ogdensburg, N.Y., Chicago, Ill., Detroit, Mich., Jamesburg, N.J.

PLASTICS DIVISIONS at Plymouth, Wis., Ogdensburg, N.Y. ABRASIVE DIVISION at Cleveland, Ohio
New York Sales Office—1186 Broadway, Room 223

IN CANADA—The Cleveland Container Canada Ltd., Prescott, Ontario

Products include: Spirally wound kraft and fish paper coil forms and condenser tubes.

THE TRUSTY TRIO FOR

Tough Jobs



**TURNER
99**



**TURNER
999**



**TURNER
U9S**

Severe operating conditions are a "push-over" for Turner Dynamic mikes. Their accurate pickup and smooth natural response to voice and music is not affected by climate or temperature. Built-in ruggedness enables them to stand up and deliver under abuse that renders an ordinary microphone useless. Typical of Turner Quality are Models 99, 999, and U9S. Professionals both in appearance and performance they will give added efficiency to your operations. Find out more about these Turner Dynamics.

MODEL 99 DYNAMIC

Used by broadcast stations, large city police departments, and specified as standard equipment by internationally known manufacturers. Will not blast from close speaking. Case fits any standard microphone stand and adjustable saddle gives semi- or non-directional operation. Response is flat within ± 5 db from 40-9000 cycles. Level: 52db below 1 volt/dyne/sq. cm. at high impedance. Gun metal type finish. Complete with 20 ft. removable cable set in a choice of 30-50 ohms, 200 ohms, 500 ohms, or high impedance.

MODEL 999 BALANCED LINE DYNAMIC

Same style and finish as Model 99. Equipped with Balanced Line features for critical applications and professional results under all conditions. Has voice coil and transformer leads insulated from ground and microphone case. Line is balanced to the ground. Response is flat within ± 5 db from 40-9000 cycles. Level: 52db below 1 volt/dyne/sq. cm. at high impedance. Complete with 20 ft. balanced line low capacity removable cable set with 3-pin polarized locking connection in a choice of standard impedances.

MODEL U9S DYNAMIC

Four Impedances at Your Fingertips

Whatever impedance you need—50 ohms, 200 ohms, 500 ohms or high impedance—you can get it quickly and easily with the turn of the switch on Turner U9S. This flexible unit handles toughest jobs. Same precision engineering and rugged construction as Model 999 with built-in multi-impedance transformer. Response is flat within ± 5 db from 40-9000 cycles. Level: 52db below 1 volt/dyne/sq. cm. at high impedance. Complete with 20 ft. removable cable set.

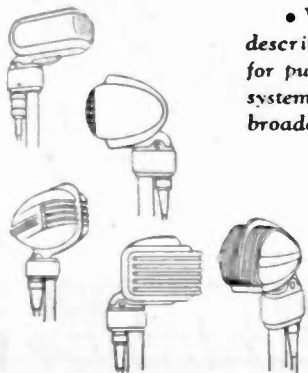

• Write for complete literature describing all Turner Microphones for public address, recording, call system, amateur and commercial broadcast, and special applications.

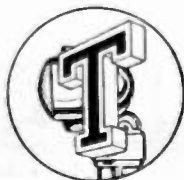

THE TURNER COMPANY

909 17th Street N. E. • Cedar Rapids, Iowa

Microphones **BY TURNER**

Licensed under U.S. patents of the American Telephone and Telegraph Company, and Western Electric Company, Incorporated.

FACTS about Capacitors



TOBE

Oil-Mites

"OIL-MITES" . . . Types OM and OMT

These compact capacitors are designed for filter and bypass applications in equipment which must withstand extremes of vibration and humidity. They are constructed in die-cast aluminum cases and are hermetically sealed in accordance with normal thermal cyclic and humidity requirements of specified JAN-COS.

The cases in which Tobe Oil-Mites are furnished are generally smaller than those called for in JAN-COS specifications. The reduced size is achieved with no sacrifice of performance or life characteristics by using mineral oil as an impregnant. When it is essential for design, "Oil-Mites" can be hermetically sealed in non-vacuum housings containing electrolytic capacitors.

Facility to hot vaporize insulator in vacuum is obtained by the use of a reversible lead-down bracket with which the capacitor can be oriented in either an upright or an inverted position. This type of mounting permits capacitors to be mounted in minimum clearance space. "Oil-Mites" can also be oriented in mounting brackets for convenient gang mounting.

Tobe "Oil-Mites" are unimpregnated and fitted with terminals of such characteristics that they are stable as to impedance and power factor through temperature range of -55°C to $+125^{\circ}\text{C}$. See graphs on page 32.

Specifications

Impregnated mineral oil
Case material: aluminum
Terminal: brass, steel, non-magnetic (see special or special) can be furnished if hold-down required in electronic housings
Terminals: non-removable (brass) copper solder lugs riveted in plastic housings
Formed lead cap leads between all adjacent surfaces in terminal assembly, terminal lug solder terminals can be furnished if specified
Case seal: drawn base telescoped in case and seal drawn all around
Die finish: smooth cover all
Mounting type: number, voltage and capacitance (see page 12) and terminal identification and stamped on case
Accuracy: tolerance $\pm 20\%$ below 1 mfd.
Dielectric loss: product of $\tan \delta$ and frequency
Insulation Factor: less than 0.005 at 1000 cycles per second
Temperature: T_r maximum 67°C to plus 125°C
(A.I.E. Specification C-25)

Type Number	Capacitance	MM	Case Size
OM-104	100 VOLTS DC		
OMT-104	100 VOLTS DC		
OM-402	50 VOLTS DC	6.0	B
OMT-402	50 VOLTS DC	6.0	B
OM-403	50 VOLTS DC	2.0	B
OMT-403	50 VOLTS DC	2.0	B
OM-404	50 VOLTS DC	0.8	A
OMT-404	50 VOLTS DC	0.8	A
OM-405	50 VOLTS DC	0.4	A
OMT-405	50 VOLTS DC	0.4	A
OM-406	50 VOLTS DC	0.2	A
OMT-406	50 VOLTS DC	0.2	A
OM-407	50 VOLTS DC	0.1	A
OMT-407	50 VOLTS DC	0.1	A
OM-1009	100 VOLTS DC		
OMT-1009	100 VOLTS DC		
OM-1010	100 VOLTS DC	0.3	B
OMT-1010	100 VOLTS DC	0.3	B
OM-1011	100 VOLTS DC	0.1	B
OMT-1011	100 VOLTS DC	0.1	B
OM-1012	100 VOLTS DC	0.05	B
OMT-1012	100 VOLTS DC	0.05	B

When type designations are followed by letters as shown above, capacitors embodying the general structural features indicated on this page can be furnished in a wide variety of wire, crimp, mounting styles and terminal styles. See pages 12 through 15.

To meet special design requirements, capacitors in other voltages, not listed here, can be furnished in styles OMa and OMT.

TOBE

CANTON, MASSACHUSETTS

This Handbook

gives 40 pages of dimensions, housings, terminal structures, mounting provisions, and electrical ratings, as well as performance characteristics of capacitors for diversified applications in the production of electrical apparatus. The Filterette section offers detailed data and specific recommendations for selection of approved units to quell radio noise from more than 80 common electrical devices which create troublesome interference. The 1946 TOBE Catalog represents a real effort to satisfy the current needs of electronics engineers with a lucid, concise collection of data on capacitors.

IRE

Tobe Deutschmann Corp.
Canton, Massachusetts
Please send the new TOBE Catalog to:

NAME _____ TITLE _____
FIRM _____
STREET AND No. _____ STATE _____
CITY _____

YOU need this CATALOG

MAIL this coupon Today

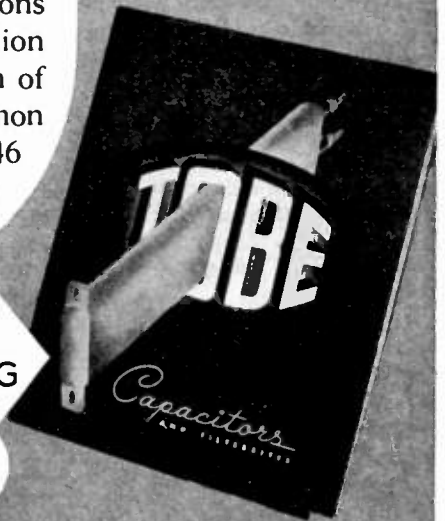

TOBE DEUTSCHMANN Corporation
CANTON, MASSACHUSETTS

THE PROBLEM:

How to simplify modern electronic instruments --- get better control with fewer control units?

THE ANSWER:

THE BECKMAN Helipot

(trademark of the HELical POTentiometer)

— almost 12 Times* the Resistance Control in Same Panel Space as Conventional Potentiometers!



Cutaway view of the Helipot

ON PRODUCT after product the story is the same — the Helipot is revolutionizing potentiometer applications, simplifying control operations, and even making possible advanced electronic instruments impractical with other types of potentiometers. Widely used on precision electronic instruments during the war, the Helipot is an entirely *new* type of potentiometer which every electronic manufacturer and user should investigate.

HIGH LINEARITY—as a result of fulfilling large wartime requirements for ultra-precision circuit controls, Helipots are mass-produced with linearity tolerances of one tenth of one percent—and even less!

PRECISE SETTINGS—Because of the many-times-longer slide wire, settings can be made with an accuracy impossible with single turn units.

WIDE RANGE—By coiling a long potentiometer slide wire into a helix, the Helipot provides many times the range possible with a single turn unit of comparable diameter and panel space.

LOW TORQUE—Of special interest for power-driven applications —the Helipot has unusually low torque characteristics. The 1½" Helipot, for example, is available with a torque of only 1 inch/ounce.

Briefly, here's the Helipot principle... whereas a conventional potentiometer consists of a *single* coil of resistance winding approximately 4" long, the Helipot has a potentiometer wire approximately 46" long coiled *helically* into a case which requires *no more panel space* than the conventional unit. By means of a simple guide, the slider contact follows the helical path of the resistance winding from end to end as a single knob is rotated. Result... almost *twelve* times the amount of control — far greater accuracy, finer settings, greater range — at *no increase in panel space requirements!*

Let us study your potentiometer applications and suggest how the Helipot can be used — possibly already is being used by others in your industry — to simplify control operations, get greater accuracy and range, and increase the utility of modern electronic equipment. No obligation, of course. Write today outlining your problems.

*HELIPOTS ARE AVAILABLE IN 3 STANDARD SIZES:

TYPE A—5 watts, incorporating 10 helical turns and a slide wire length of 46 inches, case diameter 1¼", is available with resistance values from 25 ohms to 30,000 ohms.

TYPE B—10 watts, with 15 helical turns and 140" slide wire, case diameter 3¼", is available with resistance values from 100 ohms to 100,000 ohms.

TYPE C—2 watts, with 3 helical turns and 13½" slide wire, case diameter 1¾", available in resistances from 5 ohms to 10,000 ohms.

The Type B is also available in special sizes of 25 and 40 helical turns, with resistances ranging from 500 ohms to 300,000 ohms, and containing more than 100,000 change-of-resistance steps.

*Data above are for the standard Type A unit.

Send for the New Helipot Booklet!

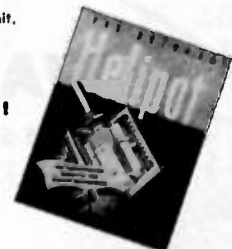

THE **Helipot** CORPORATION, 1011 MISSION STREET, SOUTH PASADENA 6, CALIFORNIA

PUTTING ELECTRONICS TO WORK
with
Government Owned Surplus

To help you incorporate the many advantages of electronics in your business, the War Assets Administration is making available its enormous inventory of tubes and equipment now.

Qualified distributors all over the country have been appointed by WAA to represent it. In every field where electronic application has proved its worth, these distributors maintain inventories and have the technical "know-how" to service your needs.

Get in touch with your nearest distributor and see how government-owned war surplus can help you—electronically. Or—if it is more convenient—write to

ELECTRONICS DIVISION
OFFICE OF AIRCRAFT DISPOSAL

WAR ASSETS ADMINISTRATION

425 Second St., N.W.

Washington 25, D. C.



Millions and millions of electronic tubes are at your disposal. Pictured are some of the types which are available to you.

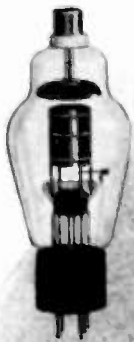

RECTIFYING
(NO. 866A)



CATHODE RAY
(NO. 38P1)



TRANSMITTING
(NO. 815)

VOLTAGE REGULATOR
(NO. VR150)



RECEIVING
(NO. 6SK7)

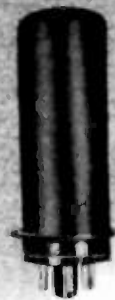

RECEIVING
(NO. 6L6)

tubes! tubes! tubes!

"NO ELECTRONIC DEVICE IS BETTER THAN ITS TUBE"

880

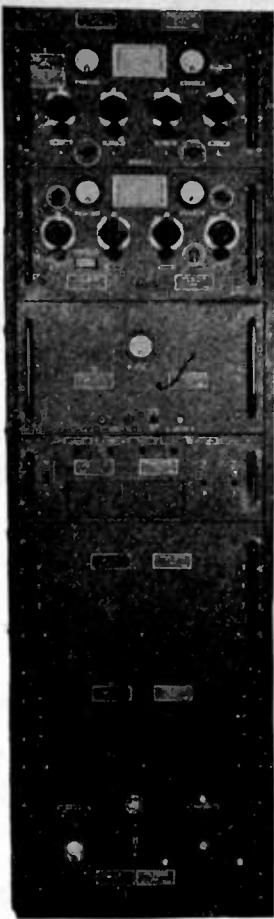

Transmitter

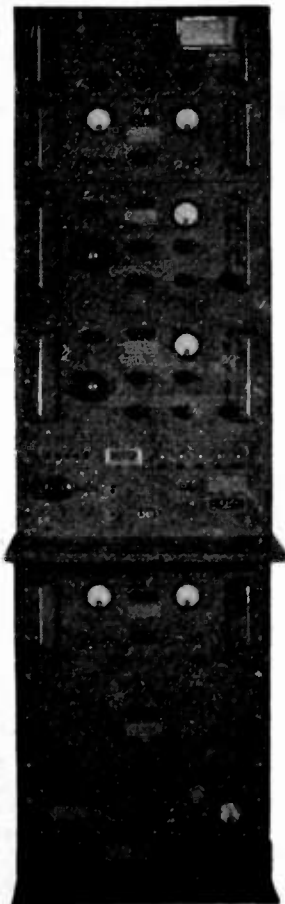

Receiver

MODERN COMMUNICATION and PRODUCTION

depend on

Electronics

Today—virtually all methods of high-speed communication use electronic tubes. In the industrial field, heating, welding and various methods of control are being done better and faster because of electronics. From big broadcasting stations to tiny hearing aids—from induction heating to voltage regulation—the science of electronics is playing a major role in industry.



Microphone

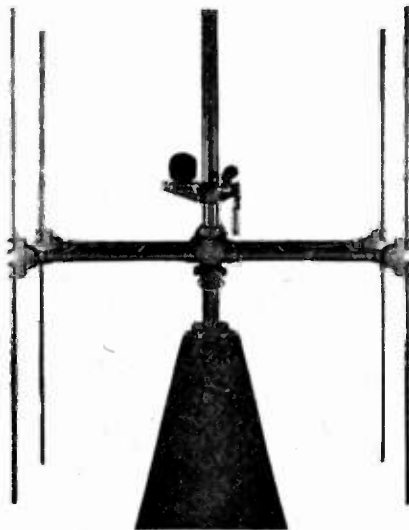

Matching Stub and Antennae

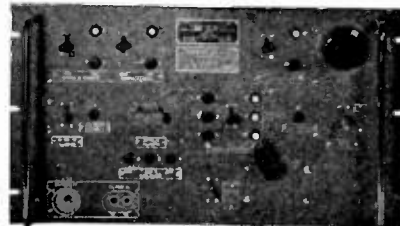

Control Unit



Headset

these Authorized Distributors will serve you:

Listed here are the names and locations of WAA appointed distributors. Not all of them will have complete stocks but it will pay you to consult them on your electronic problems.

Automatic Radio Mfg. Co., Inc.
120 Brookline Avenue
Boston 15, Massachusetts

Communication Measurements Laboratory
120 Greenwich Street
New York 6, New York

Tobe Deutschmann Corporation
Canton, Massachusetts

Electronic Corporation of America
353 West 18th Street
New York 19, New York

Electro-Voice, Inc.
Buchanan, Michigan

Emerson Radio & Phonograph Corporation
123 Duane Street
New York 7, New York

Essex Wire Corporation
1601 Wall Street
Ft. Wayne 6, Indiana

General Electric Company
Building 267-1 River Road
Schenectady 5, New York

Hammalund Mfg. Company, Inc.
460 West 34th Street
New York 1, New York

Hoffman Radio Corporation
3741 South Hill Street
Los Angeles 7, California

Hytran Radio & Electronics Corporation
76 LaFayette Street
Salem, Massachusetts

E. F. Johnson Company
206 Second Avenue S. W.
Waseca, Minnesota

Newark Electric Co., Inc.
242 West 55th Street
New York 19, N. Y.

Majestic Radio & Television Corporation
125 West Ohio Street
Chicago 10, Illinois

Raytheon Manufacturing Company
60 East 42nd Street
New York 17, New York

Smith-Meeker Engineering Company
125 Barclay Street
New York 7, New York

Sylvania Electric Products, Inc.
Emporium, Pennsylvania

Technical Apparatus Company
165 Washington Street
Boston 8, Massachusetts

Tung-Sol Lamp Works, Inc.
95 Eighth Avenue
Newark 4, New Jersey

American Condenser Co.
4410 Ravenswood Avenue
Chicago 11, Illinois

WAR ASSETS ADMINISTRATION

A UNITED STATES GOVERNMENT AGENCY
FOR THE DISPOSAL OF SURPLUS PROPERTY

880

STANDARD SIGNAL GENERATOR

MODEL

65-B

RANGE

75 KC

to

30 MC

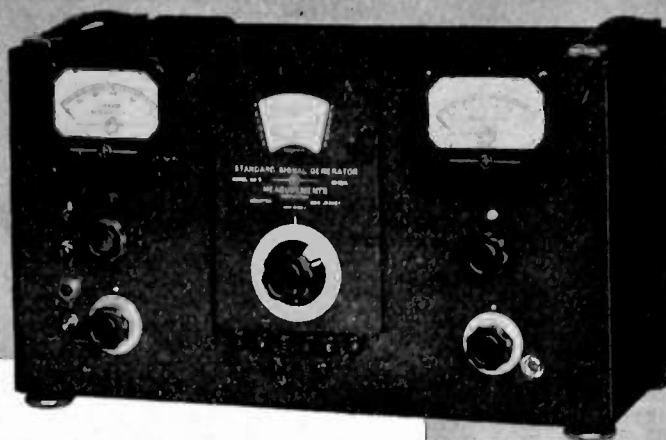

Individually Calibrated Scale

OUTPUT: Continuously variable, .1 microvolt to 2.2 volts.

OUTPUT IMPEDANCE: 5 ohms to .2 volt, rising to 15 ohms at 2.2 volts.

MODULATION: From zero to 100%. 400 cycles, 1000 cycles and provision for external modulation. Built-in, low distortion modulating amplifier.

POWER SUPPLY: 117 volts, 60 cycles, AC.

DIMENSIONS: 11" high, 20" long, 10 1/4" deep, overall.

WEIGHT: Approximately 50 lbs.

Catalog on request

MANUFACTURERS OF
 Standard Signal Generators
 Pulse Generators
 FM Signal Generators
 Square Wave Generators
 Vacuum Tube Voltmeters
 UHF Radio Noise & Field Strength Meters
 Capacity Bridges
 Megohm Meters
 Phase Sequence Indicators
 Television and FM Test Equipment

MEASUREMENTS CORPORATION
 BOONTON NEW JERSEY

News—New Products

These manufacturers have invited PROCEEDINGS readers to write for literature and further technical information. Please mention your I.R.E. affiliation.

(Continued from page 72A)

Crystal Diode

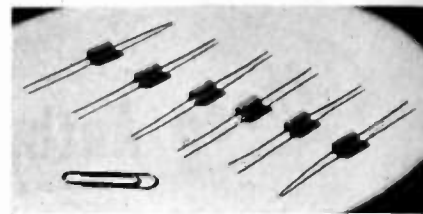

A germanium crystal diode, with a safe-forward current of 0.05 amps. and a safe-back voltage of 60 volts for radio and television receiver and other equipment applications, has been developed by the Electronics Department of **General Electric Compay**, Syracuse, N. Y. Feature of the new diode, which will serve as a rectifier, modulator, detector or voltage regulator, is the point-to-plane contact between a micro-sharp platinum wire and the face of a specially-processed germanium crystal.

Midget Capacitors

Midget, self-healing capacitors stated to be of approximately one-fourth the weight and one-third the size of conventional designs now in use have been developed by **Solar Manufacturing Corp.**, 285 Madison Ave., New York 17, N. Y., to meet the increasing demand for small capacitors to fit into the new ultra-compact electronic devices being placed on the market. The new capacitors achieve their tiny size through the use of self-healing metallized paper construction instead of the standard multi-paper and foil construction.



The new metallized paper capacitors, having a 25 to 100 millimicron-thick aluminum film deposited on the paper, are being produced in pilot-plant quantities, and soon will be in mass production, each unit built to specifications for desired applications. It is said that should a weak spot develop in the dielectric, the resulting arc discharge removes the weakness and, at the same time, vaporizes the aluminum film around the weak spot, clearing the fault.

HUGE STOCKS!

TRANSMITTING AND SPECIAL PURPOSE TUBES

WRITE FOR NEWARK'S LIST OF TUBES

Make Newark your source, too, for all needed radio and electronic parts. Brisk, competent service assures quick delivery.

• VISIT OUR BOOTH AT THE IRE SHOW

NEWARK NOW AGENTS OF WAR ASSETS ADMINISTRATION

Newark has been appointed agents of the War Assets Administration for transmitting and special purpose electronic tubes.

HUGE STOCKS! WIDE SELECTION!

This means that you can now get prompt Newark service on the previously hard-to-get tubes, priced at a fraction of their original cost. Make Newark your headquarters for tubes — whether it's for experimental work or production runs.

ACTING AS AGENTS FOR WAR ASSETS ADMINISTRATION UNDER CONTRACT WAS(p) 7-167

NEW YORK
 Offices & Warehouse
 242 W. 55th St., N.Y. 19

NEWARK TELEPHONE
 Circle 6-4060
ELECTRIC COMPANY, INC.

New York City Stores: 115-17 W. 45th St. & 212 Fulton St.

• MAIL AND PHONE ORDERS FILLED PROMPTLY

• WRITE: 242-N WEST 55th STREET, NEW YORK CITY

How you will benefit by using the Collins 30K-2

Ground Station Radio Transmitter



The new Collins 30K-2 embodies certain design features that are of outstanding benefit to owners who employ radio communication from point to point, ground to plane, or shore to ship. This 250 watt radio transmitter can be pretuned to any two frequencies between 2.0 mc and 30.0 mc. Relay operation of all r-f circuits, including antenna tuning, provides instantaneous frequency shift.

A speech clipper in the audio circuit raises the effective modulation level and emphasizes the speech sounds that produce intelligibility. The effectiveness is especially noticeable on congested frequency channels and under adverse atmospheric conditions. The 30K-2, when the speech clipper is in operation, has a signal output comparable to that of transmitters with normal modulation and a much larger power output.

Because the r-f carrier is fully utilized, the power consumption of the 30K is comparatively small for the results achieved. Maximum power demand is

approximately 1250 watts from a 115 volt a-c single phase power source. Nominal r-f power output is 300 watts on cw or 250 watts on voice transmission.

Installation of the 30K-2 is extremely simple. No time consuming, expensive operations are required. Just connect it to a power source and attach the antenna. The transmitter output network will accommodate a wide variety of antennae and transmission lines. A remote control unit is available. For complete details of this new and versatile radio transmitter, write for an illustrated bulletin.

IN RADIO COMMUNICATIONS, IT'S . . .



COLLINS RADIO COMPANY, CEDAR RAPIDS, IOWA

11 West 42nd Street, New York 18, N. Y.

458 South Spring Street, Los Angeles 13, California

PREMAX

You Can Solve Your Vertical Radiator

Problem With a Premax

RADIO ANTENNA

Premax provides both the Tubular Metal Adjustable and Non-Adjustable styles of Antennas and the "Whip" types with mountings for mobile installations. Premax equipment will meet the rigorous demands which are made upon antennas in both civilian and commercial installations.

STEEL ANTENNAS

Premax Tubular Steel Antennas are made of high-tensile, copper-nickel steel tubing, heavily electro-plated and highly resistant to corrosion. Sectional models from 12' to 33' in height.

MONEL ANTENNAS

Premax Monel Antennas are built up of multiple sections of cold-drawn monel tubing. Available in adjustable and non-adjustable Antennas of various heights.

ALUMINUM ANTENNAS

Premax Aluminum Antennas combine great strength with light weight and are made up of sections of hard-drawn seamless tubing, engineered to withstand high wind velocities and shocks.

MOBILE ANTENNAS

Premax Mobile (whip) Antennas are designed of an extremely high carbon content solid steel, heat-treated and oil-tempered—ideal for police, fire, emergency vehicle and special services.

ANTENNA MOUNTINGS

Premax Antenna Mountings for Vertical Antennas and Mobile installations combine extreme durability with the high resistance so necessary in every type of radio installation.

Get the new Premax Antenna and Mounting Catalog . . . or the Premax Antenna Manual . . . from your radio jobber.

Premax Products

Division of Chisholm-Ryder Co., Inc.
4713 Highland Ave., Niagara Falls, N.Y.

INDEX AND DISPLAY ADVERTISERS

Sections Meetings	36A
Membership	40A
Positions Open	50A
Positions Wanted	56A
News—New Products	60A

DISPLAY ADVERTISERS

Acme Electric Corporation	68A	J-B-T Instruments, Inc.	64A
Aircraft Radio Corporation	29A	E. F. Johnson Co.	30A
Allen-Bradley Company	39A		
American Lava Corp.	17A	David C. Kalbfell	72A
American Phenolic Corp.	19A	Kalbfell Laboratories	60A
Amperex Electronic Corp.	5A		
Andrew Co.	42A	Langevin Co.	14A
Arnold Engineering Co.	12A	Lavoie Laboratories	52A
Astac Corp.	38A	Littelfuse, Inc.	60A
Audio Devices, Inc.	45A		
Automatic Mfg. Corp.	47A		
		Machlett Laboratories, Inc.	37A
Ballantine Labs., Inc.	62A	Maguire Industries, Inc.	20A
Barker & Williamson	54A	P. R. Mallory & Co., Inc.	63A
Bell Telephone Laboratories	2A	Frank Massa	72A
Belmont Radio Corp.	50A	Robert E. McCoy	72A
L. S. Brach Mfg. Co.	70A	Measurements Corp.	80A
W. J. Brown	72A	Murray Hill Books, Inc.	66A
Brush Development Co.	36A		
		National Co., Inc.	24A
Caldwell-Clements, Inc.	58A	Newark Electric Co.	80A
Cambridge Thermionic Corp.	56A		
Cannon Electric Development Co.	65A	Albert Preisman	72A
Capitol Radio Engineering Institute	54A	Premax Products	82A
Centralab	59A	Presto Recording Corp.	28A
Chicago Transformer	11A		
Clarostat Mfg. Co.	62A	Radio Corporation of America	32A, 49A, 50A, 84A
Cleveland Container Co.	72A	Rauland Corporation	66A
Sigmund Cohn & Co.	56A	Raytheon Mfg. Co.	8A, 9A
Collins Radio Co.	81A	Reed & Prince Mfg. Co.	67A
Edward J. Content	72A	Revere Copper & Brass, Inc.	4A
Cornell-Dubilier Electric Corp.	Cover III		
		Schweitzer Paper Co.	27A
DcMornay-Budd, Inc.	15A	Sherron Electronics Co.	55A
Tobe Deutschmann Corp.	74A	Shure Brothers, Inc.	46A
Allen B. DuMont Labs., Inc.	6A	Sola Electric Company	53A
		Solar Manufacturing Corp.	1A
Hugh H. Eby, Inc.	43A	Sorensen & Company, Inc.	40A
Edlie Electronics, Inc.	70A	Sprague Electric Company	16A
Stanley D. Eilenberger	72A	Stackpole Carbon Company	26A
Eitel-McCullough, Inc.	13A	Superior Electric Co.	31A
Electrical Reactance Corp.	48A	Sylvania Electric Products, Inc.	22A, 69A
Electronic Mechanics, Inc.	41A		
Herbert A. Erf	72A	Tech Labs	66A
		Tung-Sol Lamp Works, Inc.	18A
Federal Telephone & Radio Corp.	7A	Turner Company	73A
Finch Telecommunications, Inc.	10A		
Furst Electronics	58A	United Transformer Company	Cover II
General Aniline & Film Corp.	34A, 35A	James R. Walker	72A
General Electric Company	21A, 51A	War Assets Administration	76A, 77A, 78A, 79A
General Radio Co.	Cover IV	Waterman Products Co., Inc.	61A
Samuel Gubin	72A	Western Electric Company	Facing Page 16A
		Westinghouse Electric Corp.	57A
Alexander Hamilton Institute, Inc.	71A	Harold A. Wheeler	72A
Harvey Radio Laboratories, Inc.	33A	S. S. White Dental Mfg. Co.	44A
Helipot Corporation	75A	Wilcox Electric Company, Inc.	23A
Hewlett-Packard Co.	3A		
Hytron Radio & Electronics Corp.	25A		
		Insulation Mfgs. Corporation	83A
		International Tel. & Tel. Corp.	7A
		Paul D. Zottu	72A

5th

among the features of

DIEFLEX VARNISHED TUBING PRODUCTS

is...

COMPLETENESS OF LINE



COMPLETE IMPREGNATION



FLEXIBILITY



NON-FRAYING

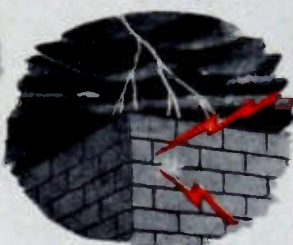

DIELECTRIC STRENGTH



GOOD PUSH-BACK QUALITY

THE use of Dieflex varnished tubings and sleeveings offers a big advantage in production because the correct grade, color, and size can easily be chosen from the complete line available. Every piece of Dieflex tubing or sleeveing is saturated with oleoresinous impregnating type baking varnish, and each one has the inherent advantages of extreme flexibility, smooth inside bore, and other excellent electrical and physical qualities illustrated on this page.

Dieflex tubing products are available with either a cotton or glass braided sleeveing base to meet every insulating requirement. Available promptly from stock. Specify "Dieflex" to get the advantages of this superior tubing product.

DIEFLEX PRODUCTS LIST

MADE WITH BRAIDED COTTON SLEEVEING BASE

- VTA Grade A-1 Magneto Grade Varnished Tubings
- VTA Grade B-1 Standard Grade Varnished Tubings
- VTA Grades C-1 and C-2 Heavily Coated Saturated Sleeveings
- VTA Grade C-3 Lightly Coated Saturated Sleeveings
- Heavy Wall Varnished Tubings and Saturated Sleeveings

MADE WITH BRAIDED GLASS SLEEVEING BASE

- VTA Grade A-1 Magneto Grade Varnished Fiberglas Tubings
- VTA Grade C-1 Extra Heavily Saturated Fiberglas Sleeveings
- VTA Grade C-2 Heavily Saturated Fiberglas Sleeveings
- VTA Grade C-3 Lightly Saturated Fiberglas Sleeveings
- Silicone-Treated Fiberglas Varnished Tubings and Saturated Sleeveings



SMOOTH INSIDE BORE



UNIFORMITY OF PRODUCT

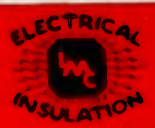

INSULATION MANUFACTURERS CORPORATION

- CHICAGO CLEVELAND DAYTON
- MILWAUKEE MINNEAPOLIS
- DETROIT PEORIA

Distributed by



TRI-STATE SUPPLY CORPORATIONS

- LOS ANGELES
- SAN FRANCISCO
- SEATTLE

INSULATION AND WIRES INCORPORATED

- ST. LOUIS ATLANTA HOUSTON
- DETROIT BLUEFIELD
- BOSTON NEW YORK



No moisture can seep through the seams of these raincoats—thanks to the electronic sewing machine developed at RCA Laboratories.

A sewing machine...without a needle or thread!

Since mankind first began to sew, say 15,000 years ago, seams have always meant "needle and thread."

But when new thermoplastic materials came along—specially developed for waterproof coverings such as raincoats—ordinary "needle and thread" seams wouldn't do because of their tiny holes.

Now—thanks to research at RCA Laboratories—goods made of thermoplastics are "sewn" by electrons and the seams are as strong as the material itself!

This will make possible dozens of brand-new uses for these inexpensive and durable thermoplastic materials. Even today they provide perfect packages for foods, meats

and drugs because they are completely watertight, airtight and transparent. You've probably seen thermoplastic raincoats, tobacco pouches, shower curtains . . .

Research, such as resulted in the electronic sewing machine, is reflected in all RCA products. When you buy an RCA Victor radio or television receiver or anything bearing the name RCA, you enjoy a unique pride of ownership in knowing that you possess one of the finest instruments of its kind that science has yet achieved.

Radio Corporation of America, RCA Building, Radio City, New York 20 . . . Listen to The RCA Victor Show, Sundays, 2:00 P. M., Eastern Time, over the NBC Network.



The electronic sewing machine "welds" seams in thermoplastic materials. Anyone interested in manufacturing this instrument can obtain information by simply writing to RCA, RCA Building, Radio City, New York 20, N. Y.



RADIO CORPORATION of AMERICA

breaking the back of the break-even point!

The break-even point in most businesses breaks the heart of management. Costs must come down. The race to be competitive is on in earnest.

If a steady flow of dependable capacitors to your assembly lines will help to put your break-even point in its proper place, call on C-D. We've specialized in capacitors for 37 years. We've made no less than 250,000 different types! Typical of this versatility are the capacitors illustrated below.

It's still possible that we've never made

the precise capacitor you require. But our engineers "can do". And they will! For a better product—for lower production costs—put our experience to work for you.

Catalog of standard types available on request. Your specifications for special capacitors are solicited. Cornell-Dubilier Electric Corporation, South Plainfield, New Jersey. To meet your capacitor needs promptly and efficiently, C-D operates plants in New Bedford, Providence, Worcester and Brookline.

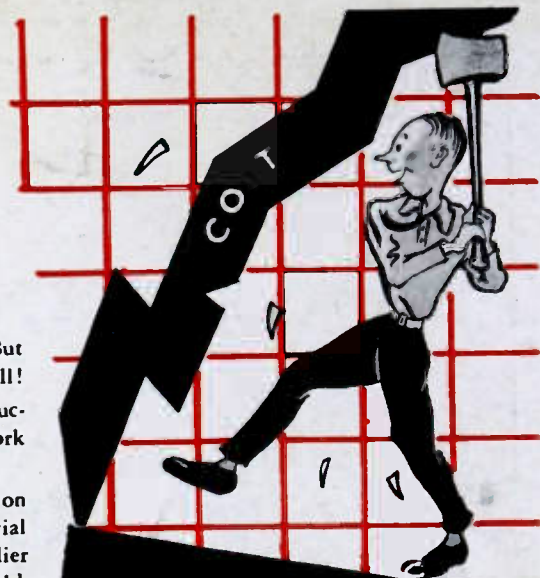

CORNELL-DUBILIER
world's largest manufacturer of
CAPACITORS

MICA • DYKANOL • PAPER • ELECTROLYTIC CAPACITORS



A FEW OF THE CAPACITORS WE HAVE MADE TO ORDER

1



2



3

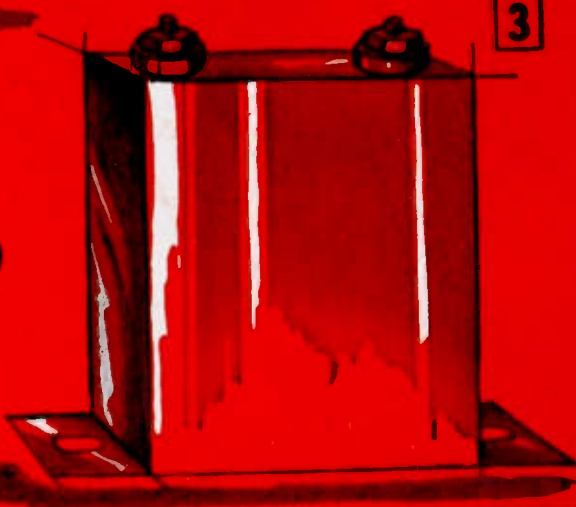

CAPACITOR #1—A series of capacitors designed for television requirements. Hermetically sealed, Dykanol impregnated and filled. Capacity range from .005 to .05 mfd. at voltages from 2,000 to 3,500 DC. Diameter remains 1", length varies with capacity.

CAPACITOR #2—This special capacitor is essentially for high frequency plate-blocking applications. Capacity ratings of 100 and 1,200 mmfd. at 10,000 V.D.C. Extremely high r. f. current rating with respect to its size. Ceramic construction with wide path base mounting terminal.

CAPACITOR #3—Designed and produced for a manufacturer of business machines. Capacitive-resistive type of spark suppressor unit. Dykanol impregnated. Hermetically sealed and provided with two insulated terminals for efficient assembly into parent equipment.

FOR ROUTINE MEASUREMENTS

of

- INDUCTANCE
- CAPACITANCE
- RESISTANCE

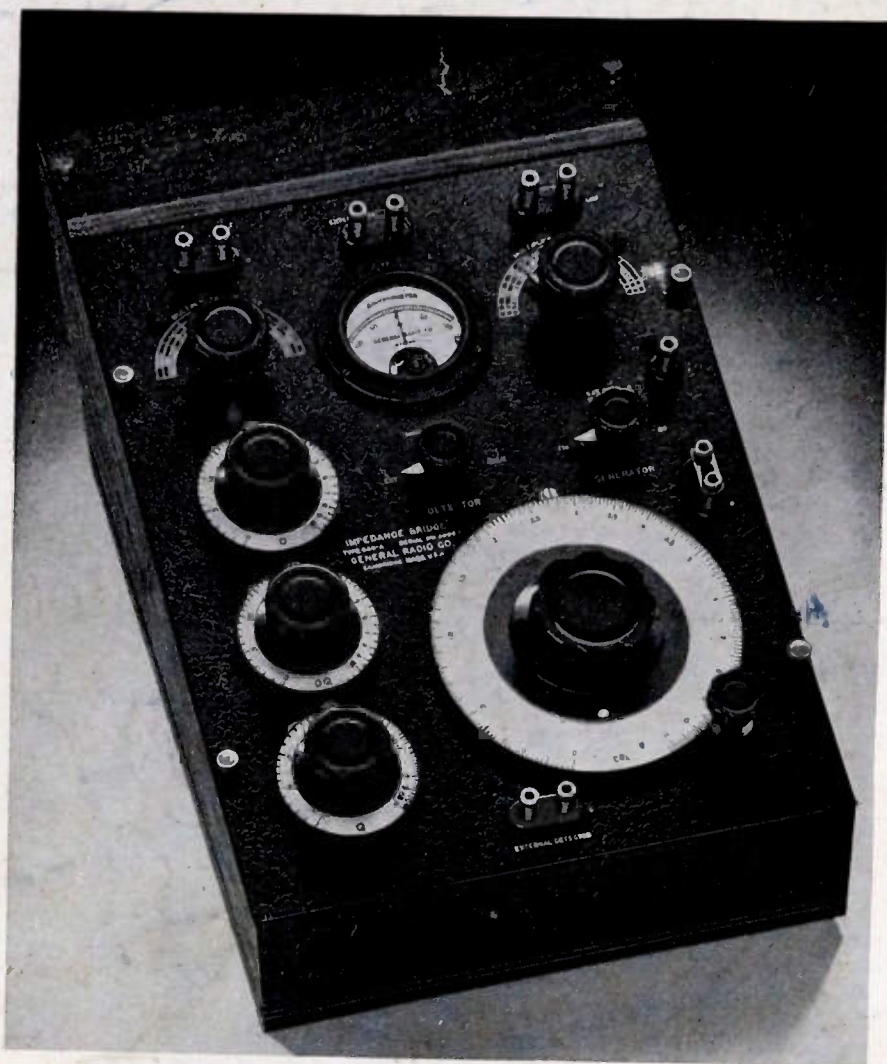

TYPE 650-A

Impedance Bridge

\$220

NO laboratory, in which any electrical equipment is used, is complete without this bridge. Completely self-contained, portable, and accurate enough for most routine measurements, the popular Type 650-A Impedance Bridge is always set up and ready to use. With it you can measure these basic quantities over these very wide ranges—**INDUCTANCE:** 1 microhenry to 100 henrys; **CAPACITANCE:** 1 micromicrofarad to 100 microfarads; **RESISTANCE:** 1 milliohm to 1 megohm. In addition it measures **DISSIPATION FACTOR (R/X)** from .002 to 1, and **STORAGE FACTOR (X/R or Q)** from .02 to 1,000.

The bridge includes built-in standards, batteries, a 1,000-cycle tone source for a-c measurements, a zero-center galvanometer null indicator for dc and terminals for a headset for 1,000-cycle null detection.

Provision is made for use of an external generator for measurements over a wide range from a few cycles to 10 kilocycles.

Direct-reading dials add greatly to the ease and rapidity with which measurements can be made with this universal bridge.

WRITE FOR COMPLETE INFORMATION



GENERAL RADIO COMPANY

Cambridge 39,
Massachusetts

90 West St., New York 6

920 S. Michigan Ave., Chicago 5

950 N. Highland Ave., Los Angeles 38