

# Proceedings



of the

# I · R · E

AND

## WAVES AND ELECTRONS

*R. M. Nelson*

### REPORTS of the Theory, Practice, and Applications of Electronics and Electrical Communication

- Radio Communication • Sound Broadcasting • Television • Marine and Aerial Guidance •
- Tubes • Radio-Frequency Measurements • Engineering Education • Electron Optics •
- Sound and Picture Electrical Recording and Reproduction •
- Power and Manufacturing Applications of Radio-and-Electronic Technique •
- Industrial Electronic Control and Processes • Medical Electrical Research and Applications •

WINTER TECHNICAL MEETING, NEW YORK, N.Y.

January 23, 24, 25, and 26, 1946

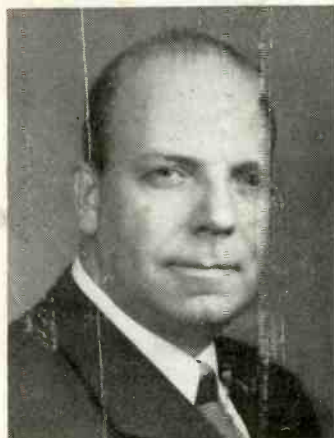

WILLIAM L. EVERT  
PRESIDENT, 1946



FREDERICK B. LLEWELLYN  
PRESIDENT, 1946

## JANUARY, 1946

Proceedings of the I.R.E.

Volume 34

Number 1

Modulated-Wave Amplification

Cavity Transverse Modes

R-F Spectrum Analyzers

Waves in Antennas

Standing-Wave Phase Errors

### Waves and Electrons

Volume 1

Number 1

Preparation of I.R.E. Papers

U-H-F Radio Range

Television-Image Optical Studies

U-H-F Cable Manufacture

# The Institute of Radio Engineers





## BEFORE THE WAR

Accepted as the foremost manufacturer of quality transformers to the communications industry.



## DURING THE WAR

The largest manufacturer of communications transformers in the world.



## POSTWAR

Still leading the field in high quality transformers for broadcast applications, specialty fields and volume users.



*United Transformer Corp.*

150 VARICK STREET

NEW YORK 13, N. Y.

EXPORT DIVISION: 13 EAST 40th STREET, NEW YORK 16, N. Y. CABLES: "ARLAB"





**WL57B**  
Mey Vapor Reifer for 22 operation



**WL-895R**  
Used in final stage of 50 K.W. Broadcast transmitters



**WL-473**  
For F.M., Standard Broadcast, and R. F. Heating Applications.



**WL-678**  
15,000 volt grid controlled Rectifier for power supplies.



**WL-891R**  
Forced Air Cooled Tube for Radio Transmitting and R. F. Heating Applications.

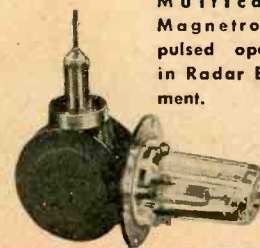

**2J31**  
Multicavity Magnetron for pulsed operation in Radar Equipment.

**WL-417A**

Reflex Klystron for use as local oscillator in U. H. F. equipment.

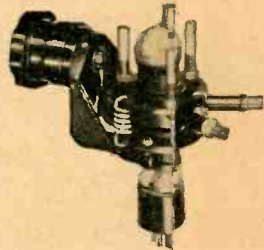

**W-532A**  
Sparkgap for voltage protection and for T-R use

## WESTINGHOUSE

### Electronic tube "know-how" will help you solve your electronic tube problems

No matter whether your electronic tube needs are for low frequency, high frequency, low power or high power applications, Westinghouse can serve you.

The ingenuity of Westinghouse tube engineers is illustrated by the types shown, which were developed for a wide variety of civilian and military applications. These tubes range from the midget 1B24 used in microwave equipment, to the giant WL-895R used in broadcasting

and RF heating.

When you are designing or modifying your equipment it will pay you to consult these Westinghouse engineers. They will be glad to discuss your problems with you.

The newest Westinghouse electronic tubes will be exhibited at the next IRE Convention. Be sure to see them.

Electronic Tube Sales Department, Westinghouse Electric Corp., Bloomfield, N. J.

# Westinghouse

## *Electronic Tubes at Work*

TUNE IN: John Charles Thomas, Sunday, 2:30 P. M., EST—NBC.  
Ted Malone—Monday through Friday, 11:45 A. M., EST—ABC.



**1B24**  
T-R tube for use between transmitter and receiver in Radar Equipment.



**WL-530**  
Oscillator tube for generating high power at ultra high frequencies.



*"I can even recognize your voice!"*



*At last!* A mobile FM receiver with a **NATURAL** voice quality  
... the **FM-39X**, engineered by **KAAR!**

Here is the FM receiver that users of emergency communications have waited for so long! A receiver that brings in the low as well as the high tones, rounding out the voice so that you can readily recognize who is speaking!

The FM-39X is a fitting companion for the remarkable 50 and 100 watt **INSTANT-HEATING** KAAR FM mobile transmitters which were recently announced. The over-all voice quality through the KAAR transmitter and receiver is

such a distinct improvement that it will be a revelation to anyone who has had previous experience with FM radiotelephones. In fact, decidedly finer voice quality is obtained even when this new receiver is used with other makes of FM transmitters.

The receiver has two r. f. stages instead of the usual one, resulting in better signal-to-noise ratio and greater discrimination against spurious signals. For full details, write for Bulletin 24-45.



**KAAR ENGINEERING CO.**

PALO ALTO • CALIFORNIA

Export Agents: FRAZAR AND HANSEN, 301 Clay St., San Francisco, Calif.

Engineered by the Pioneers of **INSTANT HEATING** FM and AM transmitters





# BLUEPRINT

**YOUR MOVES  
WITH**

## **ALLIANCE MOTORS**

The Model RR Intermittent duty is enclosed reversible control motor-split phase resistor type, 60 cycles, 24 or 117 volts, with or without gear reduction.

The Model MS is shaded pole induction type for any A.C. voltage from 24 to 250 and frequency of 40, 50 or 60 cycles. Starting torques from one-half ounce inch at 10 watts input, to two ounce inches at 36 watt input.

New uses—electronic and electric controls, time, temperature, pressure and humidity controls, coin operated phonographs, drink and merchandise dispensers, fans, valves and blowers, door openers, signals, motion displays, movie projectors and scores of industrial applications.

**MINIATURE MOTORS THAT  
MAKE 'EM MOVE!**



Motion . . . instant action . . . compact pin-points of concentrated power—that's what you have in *ALLIANCE Miniature Motors*.

They're compact stand-by power stations, ready to obey and deliver just the right amount of power and drive where and when needed.

Where your plans call for continuous or intermittent action, remote actuation, starting, stopping and reversing, there's probably an Alliance motor already engineered and available in quantities, at low unit cost, to do the job!

**WHEN YOU DESIGN—KEEP**

# alliance

**MOTORS IN MIND**

**ALLIANCE MANUFACTURING COMPANY • ALLIANCE, OHIO**  
Alliance Tool and Motor Ltd., Toronto 14, Canada



# 3D23

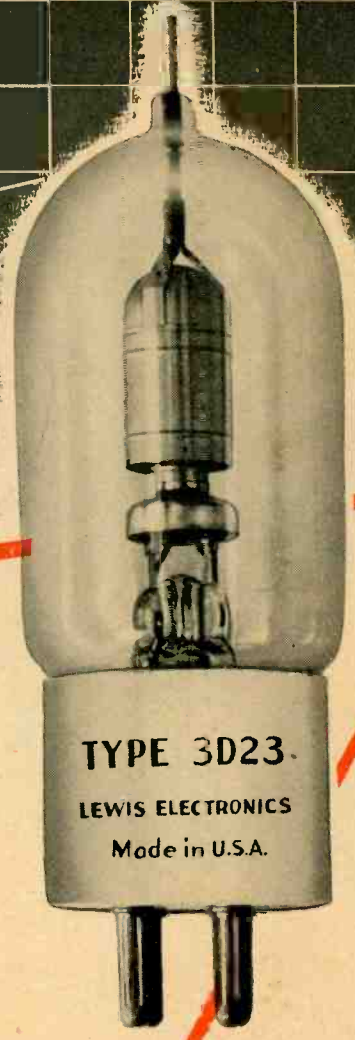
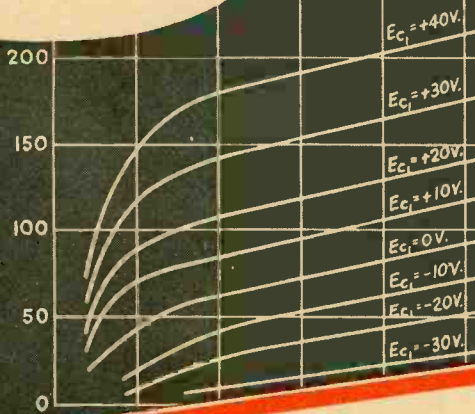

*This is the Tube you have been seeking to install in your postwar transmitters*

**A remarkable new TETRODE for fixed or mobile operation**

- Filament Voltage . . . . . 6.3 AC or DC Volts
- Filament Current . . . . . 3.0 Amperes
- Amplification Factor . . . . . 65
- Mutual Conductance . . . . . 2,750
- Plate Dissipation . . . . . 35 Watts
- Medium 4 Pin Ceramic Base
- Maximum Power Output . . . . . 130 Watts
- Approx. Driving Power . . . . . 4.5 Watts

**Inter-Electrode Capacities**

- Input to Plate . . . . . .2 MMFD
- Input, 6.5 MMFD . . . . . Output, 1.8 MMFD

Licensed under R. C. A. Patents

Catalog Sheet and Tubes Now Ready for Distribution

**Lewis at Los Gatos**  
Manufacturers of all types of transmitting tubes — from 35 Watt West Coast type triodes to 35 kilowatt external anode, multi-grid tubes.— A new member of the Aireon family.

**Lewis Electronics, Los Gatos, Calif.**  
SUBSIDIARY OF **Aireon** MANUFACTURING CORPORATION



# Aireon

## Cinaudagraph Speaker

*... The Speaker  
of Tomorrow, TODAY*

The Aireon Cinaudagraph Speaker is a product of deft engineering, vast experience, daily profound research and proven performance. It has an international reputation for tone, stamina and perfection. The plus features that you get in Aireon Cinaudagraph Speakers are inherent—born of the highest standards of inspection and use of the finest materials. You'll need these extra—these plus factors to help you do the better job you now require.

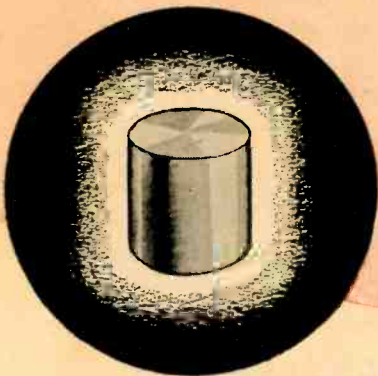

(ALNICO 5)

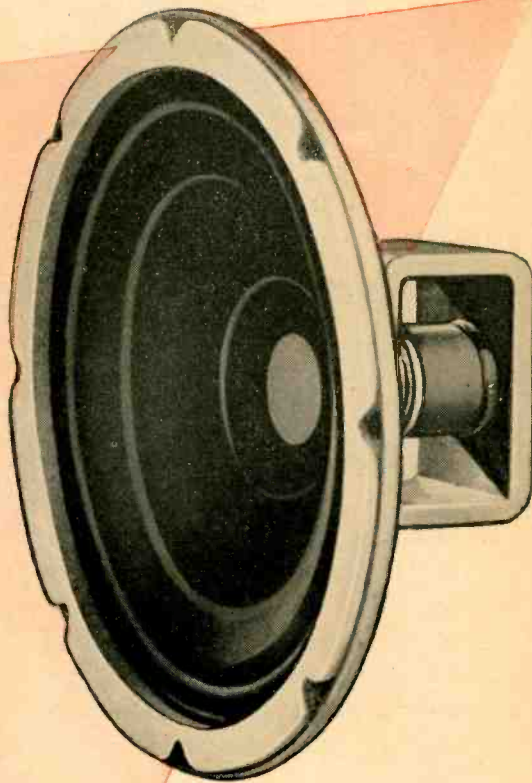

All P. M. Models of Aireon Cinaudagraph Speakers use Alnico 5, the miracle metal that gives you 4 times the performance without size or weight increase. No set-up is complete without at least one—write for information, today.

### Cinaudagraph Speakers, Inc.

Subsidiary of **Aireon** Manufacturing Corporation

3911 SOUTH MICHIGAN AVENUE, CHICAGO





**Continental-Diamond**  
*Engineered Dielectric Materials*  
*for a Better*  
**TOMORROW** ★

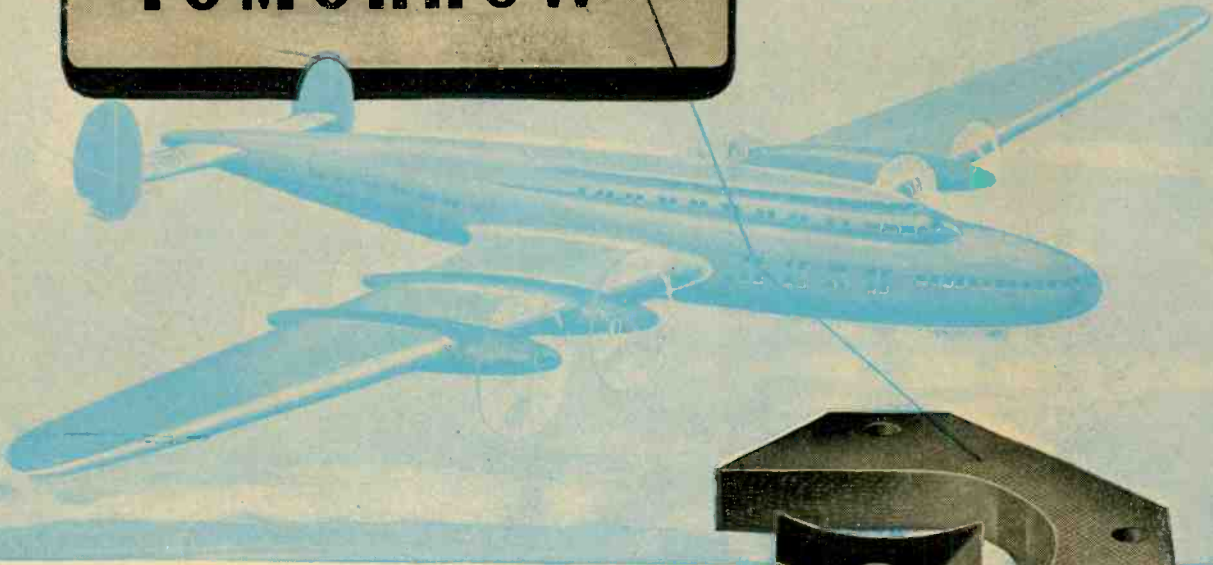

Illustrated is a DILECTO fabric base laminated phenolic part used in airborne electrical equipment. Since this part is subject to severe mechanical stresses and is also an insulator it must be strong and remain stable under vibration, high humidity and temperature extremes. DILECTO meets all these requirements, with a wide margin of safety.

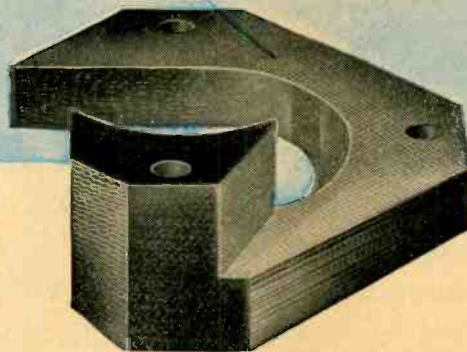

C-D Dielectric materials are engineered to meet specific electrical and mechanical problems. There are standard grades developed as a result of experience gained during 50 years of serving manufacturers in every industry. These standard grades can, however, be modified to meet particular problems. Combinations of the different C-D NON-metallic materials can also be made to provide required combinations of properties. C-D technicians will be glad to study your "What Material" problems and suggest solutions.

KL-45

**C-D PRODUCTS**

**The Plastics**

DILECTO—A Laminated Phenolic.  
 CELORON—A Molded Phenolic.  
 DILECTENE—A Pure Resin Plastic Especially Suited to U-H-F Insulation.  
 HAVEG—Plastic Chemical Equipment, Pipe, Valves and Fittings.

**The NON-Metallics**

DIAMOND Vulcanized FIBRE  
 VULCOID—Resin Impregnated Vulcanized Fibre.

MICABOND—Built-Up Mica Electrical Insulation.

**Standard and Special Forms**  
 Available in Standard Sheets, Rods and Tubes; and Parts Fabricated, Formed or Molded to Specifications.

**Descriptive Literature**

Bulletin GF gives Comprehensive Data on all C-D Products. Individual Catalogs are also Available.

**DISTRICT OFFICES**

NEW YORK 17 • CLEVELAND 14 • CHICAGO 11  
 SPARTANBURG, S. C. • SALES OFFICES IN PRINCIPAL CITIES

WEST COAST REPRESENTATIVES  
 MARWOOD LTD., SAN FRANCISCO 3

**IN CANADA:**

DIAMOND STATE FIBRE CO. OF CANADA, LTD., TORONTO 8

**Continental - Diamond** FIBRE COMPANY

Established 1895.. Manufacturers of Laminated Plastics since 1911—NEWARK 48 • DELAWARE





*Announcing*  
**THE NEW**  
**SPERRY Microline\***

As a reading glass aids visual search, so MICROLINE test and measurement equipment provides means for making all measurements at microwave frequencies.

Sperry announces a comprehensive line of microwave test and measurement equipment for labora-

tory and field use. The new line... the MICROLINE... is the outgrowth of years of research and experience in modern microwave techniques beginning with the development of the Klystron.

Write our Special Electronics Department for further information.

- Available now:**
- WAVEMETERS • WATTMETERS
  - BARRETTOR ELEMENTS AND MOUNTS
  - DIRECTIONAL COUPLERS
  - KLYSTRON SIGNAL SOURCES
  - STANDING WAVE DETECTORS
  - ATTENUATORS
  - IMPEDANCE MATCHING EQUIPMENT
  - WAVEGUIDE AND COAXIAL COMPONENTS

Visit the Sperry booth at the I.R.E. Convention

\*TRADE MARK

**SPERRY GYROSCOPE COMPANY, INC.** GREAT NECK, N. Y.



*Division of the Sperry Corporation*

★  
 LOS ANGELES • SAN FRANCISCO • SEATTLE • NEW ORLEANS  
 CLEVELAND • BROOKLYN • HONOLULU

**GYROSCOPICS • ELECTRONICS • RADAR • AUTOMATIC COMPUTATION • SERVO-MECHANISMS**



**RECEIVER MANUFACTURERS:**

# RCA TEST EQUIPMENT

## to help speed your television-receiver production

**I**F your television-receiver program has been held up because of inadequate test and measuring equipment, here's the answer. RCA will begin to deliver the instruments shown here in 60 to 90 days. They are not experimental or first post-war models, but service-tested equipment—developed before the war and perfected as a result of RCA's extensive television-research and manufacturing work during the war for the armed forces.

With items 1 through 4, a complete video signal can be produced, making it possible to measure and adjust accurately the focus, contrast, resolution, and scanning linearity of your television receivers.

Items 5 through 8 are other instruments we believe you will also find useful in easing your laboratory and testing problems.

An early indication from you of your test and measuring requirements will assure prompt delivery of this hard-to-get equipment.

### **1 MONOSCOPE CAMERA**

Produces a fixed television signal for aligning and testing equipment such as television receivers, transmitters, and monitors. The signal is produced by scanning a stationary pattern mounted permanently inside the monoscope tube. It is designed for rack mounting for use with the distribution amplifier and the synchronizing generator (items 2 and 4). The filament supply is self-contained, but a separate regulated plate supply is required. The 580-C unit (item 3) is ideal for this purpose.

### **2 DISTRIBUTION AMPLIFIER (TYPE TA-1A)**

For use with the synchronizing generator and monoscope camera. Applications include: transmission over coaxial lines of pictures and synchronizing signals to various locations, feeding signals from program line to monitors, for isolating distributed pulses, as a mixer to combine synchronizing with picture signals to form the complete video signal. Designed for standard rack mounting, the unit requires a regulated plate supply.

### **3 REGULATED POWER SUPPLY (TYPE 580-C)**

For supplying the plate power required by the monoscope camera and distribution amplifier. Regulation is better than .25 per cent over the range between 50 and 400 milliamperes; output voltage is adjustable between 250 and 300 volts; output ripple is lower than .012 per cent of the d-c output voltage. This unit may also be used for general-purpose work around the laboratory. Designed for standard rack mounting.

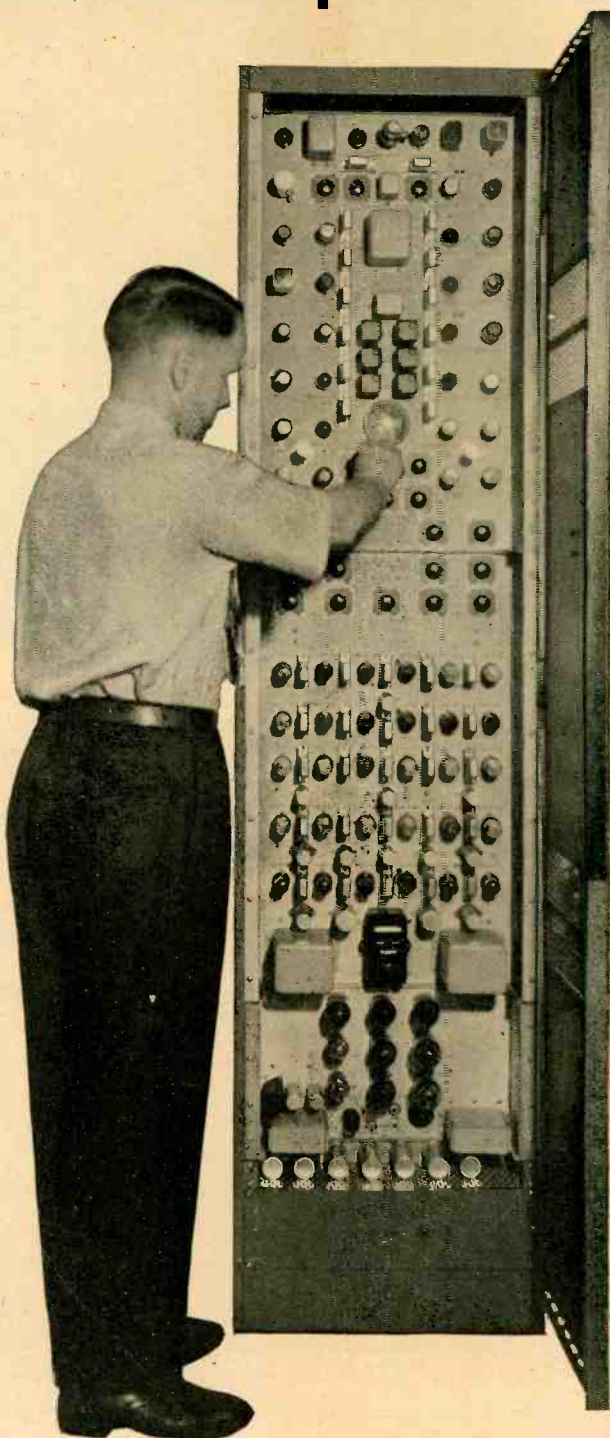

(TYPE TG-1A)

### **4 SYNCHRONIZING GENERATOR**

Ideal for design and production testing of television receivers, and for application work in experimental laboratories engaged in television work. Provides "synchronizing" pulses of suitable wave shape and frequency for the production, in conjunction with camera equipment, of 525-line interlaced television signals. It keys together the scanning beams of the camera Iconoscope and the receiver Kinescope to form a perfectly synchronized picture. Conforms with proposed FCC Standards of Good Engineering Practice.

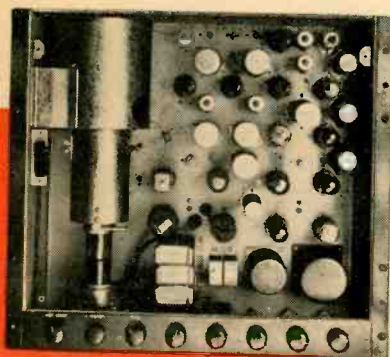



# AVAILABLE SOON



## 5 VIDEO SWEEP GENERATOR (TYPE 711-A)

A quick, accurate, convenient means of testing and adjusting wide-band video amplifiers. When this generator is connected to the input of a video amplifier, and the output of the amplifier is connected to an oscilloscope, a trace is produced on the screen that accurately shows the amplifier's dynamic-frequency characteristic. The lower-output-frequency limit of this unit is normally set at 100 kc, and the high frequency at 8 mc (but the latter can be easily adjusted to any frequency between 2 and 9 mc). The sweep to high frequency and return is smoothly accomplished in one cycle of the powerline frequency.



## 6 HIGH-FREQUENCY, WIDE-BAND SWEEP GENERATOR (TYPE 709-B)

When used in conjunction with an oscilloscope, this instrument will help you save time in accurately aligning the i-f and r-f stages of wide-band receivers. Stage-by-stage alignment is practical as the generator output voltage is continuously variable between .001 and .4 volts RMS over the entire frequency range. A calibration marker permits constant checking of band-width characteristics.



## 7 U-H-F SIGNAL GENERATOR (TYPE 710-A)

Provides an r-f signal of a known frequency and amplitude for easily obtaining the data needed to check the performance of high-frequency devices. This instrument provides smooth and complete attenuation throughout its range, plus precision frequency control. Output frequencies from 370 to 560 mc—just right for citizens' radio-phone and other development work within these bands.

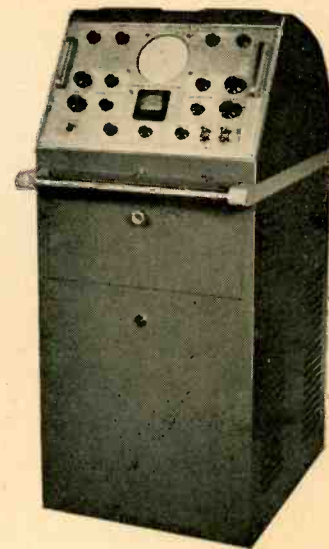

## 8 LABORATORY-TYPE OSCILLOSCOPE (TYPE 715-B)

Especially designed to permit close examination of extremely short, sharp-fronted pulses and other unusual wave forms. Produces steady, clear traces even with random recurrence of signal. Some of its advantages for modern development work include: Extended range (flat to 11 megacycles), triggered sweep (individually triggered by each signal), time-base marker (one microsecond intervals), input calibration meter (to permit direct determination of amplitude of any voltage component in signal), and many other new features.

### HERE'S A QUICK WAY TO GET DETAILS

Radio Corporation of America  
Test and Measuring Equipment Section  
Box T9083C, Camden, N. J.

Please send me complete data on the RCA products corresponding to the numbers circled:

1    2    3    4    5    6    7    8

Name \_\_\_\_\_ Title \_\_\_\_\_

Company \_\_\_\_\_

Address \_\_\_\_\_

City \_\_\_\_\_ Zone \_\_\_\_\_ State \_\_\_\_\_



**RCA TEST AND MEASURING EQUIPMENT**

**RADIO CORPORATION of AMERICA**

**ENGINEERING PRODUCTS DIVISION, CAMDEN, N. J.**



# The Mark of Quality



The initials "CRL" in the Diamond stand for Centralab

They are an integral part of the Centralab name, and for more than a quarter of a century, have represented the utmost in engineering skill and precision . . . the height of manufacturing perfection.

Both in original equipment and in replacements, the symbol "CRL" is the Mark of Quality.

. . . Always specify Centralab.

Ceramic High Voltage Capacitors  
Bulletin 814

## Centralab

Division of GLOBE-UNION INC., Milwaukee

PRODUCERS OF

Ceramic High Voltage Capacitors  
Bulletin 814



Ceramic Trimmers  
Bulletin 895



Variable Resistors  
Bulletin 697



Tubular Ceramic Capacitors  
Bulletins 630 and 586



Selector Switches  
Bulletin 722



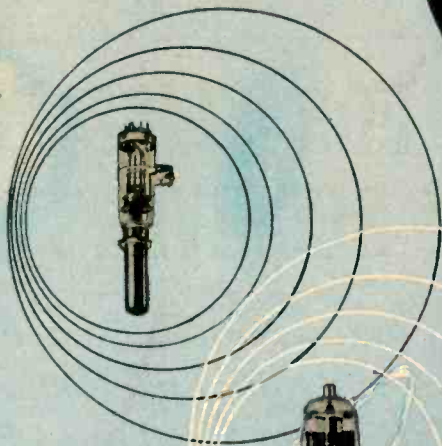

# transmitting tube protection

**ADLAKE RELAYS  
SEALED IN GLASS  
with CALLITE  
'MOLY' WIRE**



Callite molybdenum wire is selected because it has the qualities required for efficient glass sealing and does not amalgamate with the mercury in the relay.

Callite carefully processes molybdenum to obtain high purity ductile wire and sheet. Callite's Type 400 Molybdenum Wire is available in five types, each grade especially processed for its intended application as heater elements, filament mandrels, side rods, hooks, grids, tube and lamp supports.

Molybdenum wire is only one of Callite's complete range of metallurgical components for electrical and electronic manufacture. It will pay you to investigate our tungsten and molybdenum products of all kinds. Callite Tungsten Corporation, 544 Thirty-ninth St., Union City, N. J. Branch Offices: Chicago, Cleveland.

*The Adlake plunger-type mercury relay serves to protect transmitter tubes from high plate voltage. The Adlake Model 1040's contact mechanism is hermetically sealed in an armored glass cylinder—proof against dirt, dust, moisture and explosive atmospheres. The Adams & Westlake Company uses Callite molybdenum wire as a lead wire which is sealed through the glass.*



# Callite

**SPECIALISTS IN HARD GLASS LEADS, WELDS, TUNGSTEN AND MOLYBDENUM WIRE, ROD AND SHEET, FORMED PARTS AND OTHER COMPONENTS FOR ELECTRON TUBES AND INCANDESCENT LAMPS; ELECTRICAL CONTACTS OF TUNGSTEN, MOLYBDENUM, SILVER, PLATINUM, PALLADIUM AND ALLOYS OF THESE METALS; THERMOSTATIC BI-METALS.**



# SYLVANIA NEWS

ELECTRONIC EQUIPMENT EDITION

JAN. Published by SYLVANIA ELECTRIC PRODUCTS INC., Emporium, Pa. 1946

## NEW T-3 TUBE FILLS NEED FOR SMALLER UNIT IN TINY BROADCAST RECEIVERS

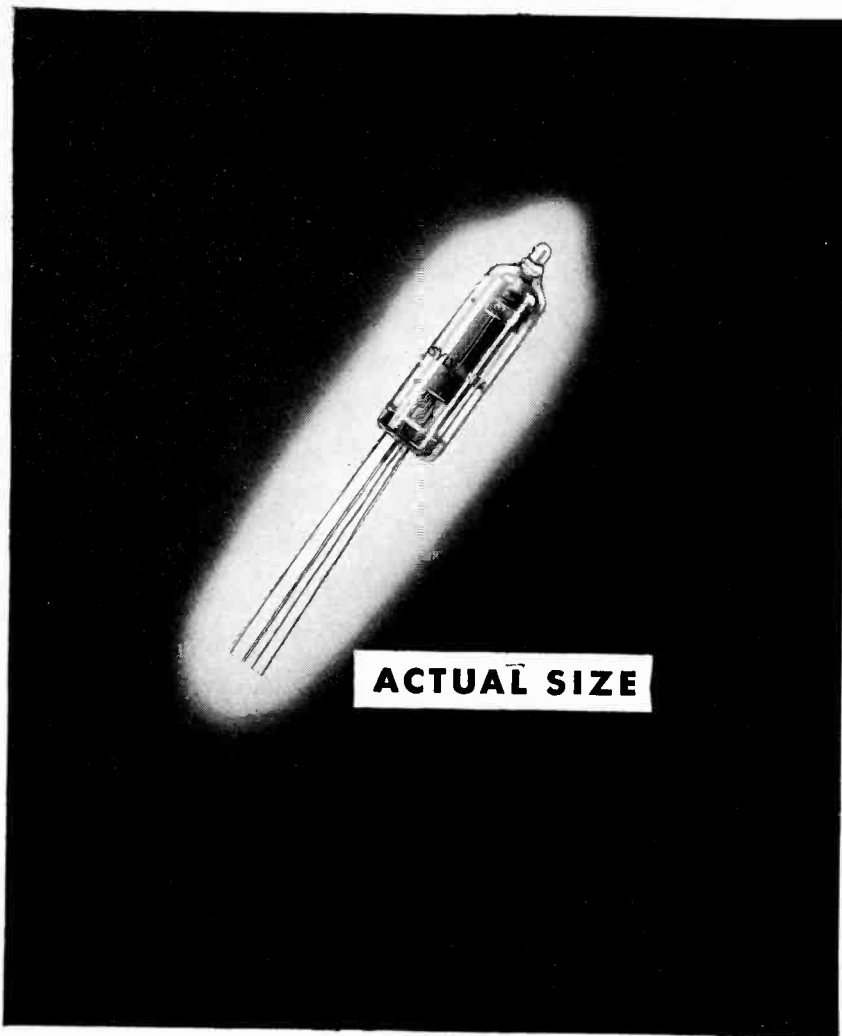

*For any further details, or questions you may want answered about this tiny, sturdy vacuum tube, do not hesitate to write or call Sylvania Electric Products Inc., Emporium, Pa.*

### *Commercial Version of Proximity Fuze Tube Is Rugged. Has Long Life*

Following Sylvania Electric's recent announcement about the sensationally small vacuum tube—originally developed for the now-famous proximity fuze transceiver—have come many inquiries concerning this super-midget.

#### **SET MAKERS ESPECIALLY INTERESTED**

Since the commercial version of the "war-baby" is being produced, many set manufacturers are extremely interested in its qualities — with a view toward making radios about the size of the average wallet or package of cigarettes, miniature walkie-talkie sets and other units.

This new tube, then, is being made in a low-drain filament type and is able to operate at 1.25 volts. This takes advantage of a new, small battery developed during the war which, of course, is a further aid in the manufacture of remarkably small radio sets.

#### **WILL BE AVAILABLE FOR ALL TYPES**

Future designs of this versatile tube can be incorporated in radios ranging in size from tiny pocket sets up to deluxe receivers. It has a life of hundreds of hours, is rugged and exceptionally adaptable to operation at high frequencies.

# SYLVANIA ELECTRIC

Emporium, Pa.

MAKERS OF RADIO TUBES; CATHODE RAY TUBES; ELECTRONIC DEVICES; FLUORESCENT LAMPS. FIXTURES, WIRING DEVICES; ELECTRIC LIGHT BULBS



# CONSTITUTIONAL AMENDMENT



## REGIONAL-REPRESENTATION PLAN

**THE INSTITUTE OF RADIO ENGINEERS**  
INCORPORATED

330 WEST 42ND STREET  
NEW YORK 18, N. Y.



# The Institute of Radio Engineers

INCORPORATED

330 West 42nd Street  
New York 18, N. Y.

April 24, 1946

## Constitutional-Amendment Ballot REGIONAL-REPRESENTATION PLAN

### To Fellows, Senior Members, Members, and Voting Associates:

The Board of Directors proposes changes in the Institute's Constitution. They are hereby submitted for voting. After marking this ballot, place it in the small blank envelope enclosed, seal this envelope and place it in the larger self-addressed envelope enclosed, write your signature on the outer envelope where indicated, and mail to the Institute office. The ballots must reach the Office of the Institute on or before July 15, 1946, to be counted.

By authorization of the Board of Directors

Raymond F. Guy, *Chairman*  
Constitution and Laws Committee

For some time the Board has been aware that geographically distant members have in many cases felt isolated and unable to participate in many activities of the Institute. It has shared their desire to overcome the handicap of geographical separation and has considered carefully and at length all possible corrective measures directed toward making the Institute and its activities more useful and indispensable to them.

The Board has been particularly desirous of effecting means whereby distant members could be more adequately represented in the management of the Institute. Within the framework of the present Constitution the Board has attempted to create regional representation and toward this end has selected candidates for elective offices on the basis of both their general qualifications and their geographical locations. The appointments to Directorships by the Board have also been dictated by both considerations. But a plan for a more satisfactory procedure has become increasingly desirable as the Institute has grown, particularly during the last several years.

At the February 7, 1945, Board meeting a Committee was appointed and instructed to submit recommendations for a plan which would insure direct and continuing participation in the management of the Institute through regional representation on the Board of Directors. The Committee submitted a plan which met with general favor. It was submitted to the Sections Chairmen for comment and the Constitution and Laws Committee was instructed to prepare appropriate amendments to the Constitution and Bylaws. This plan has been carefully considered and developed for over a year and it is now submitted for voting with the conviction that any defects which develop could be easily corrected. The plan constitutes a marked departure in the Institute's method of electing representatives and warrants the careful study and consideration of each voting member.

### HOW THE REGIONAL-REPRESENTATION PLAN WOULD FUNCTION

All voting members of the Institute now have the opportunity to vote for a candidate for every elective office. All Directors are now Directors-at-Large. Under the Regional-Representation plan the Board of Directors would designate regions in the United States and Canada, and elsewhere at its discretion. As heretofore, all voting members of the Institute would continue to vote for President, Vice-President, and elected Directors-at-Large. But the members of each region would, in addition, acting as an autonomous group, nominate and elect their own representative who would thereby become a member of the Board of Directors.



The addition of seven or more Regional Directors would provide more equitable representation than is now obtained and would make it desirable to reduce the number of appointed Directors and elected Directors-at-Large. Such a reduction is provided for in these proposed amendments. The governing body of the Institute would thus change. The number of appointed Directors and Directors-at-Large would be reduced from 5 to 3 and from 9 to 6, respectively. The present and proposed Board of Directors is shown below:

***Present***

President  
 Vice-President  
 Senior Past President  
 Junior Past President  
 Secretary  
 Treasurer  
 Editor  
 9 Elected Directors-at-Large  
 5 Appointed Directors

***Proposed***

President  
 Vice-President  
 Senior Past President  
 Junior Past President  
 Secretary  
 Treasurer  
 Editor  
 6 Elected Directors-at-Large  
 3 Appointed Directors  
 7 or more Regional Directors  
 23 or more

21

The adoption of the Regional-Representation plan would be effected by the amendments to the Constitution described herein. These amendments provide for the following:

- a. Division of the United States and Canada, and other areas at the discretion of the Board of Directors, into consecutively numbered Regions which would be specified in the Bylaws.
- b. Creation of the new office of Regional Director. Nominees for this office would live in the Region which nominates them and would be nominated and elected exclusively by voting members living in the Region which nominates them. When elected they would thereby become members of the Board of Directors for a two-year term.
- c. Reduction of the number of Directors-at-Large by 5.
- d. Addition of two Board members to the number constituting a quorum making a total of 8.
- e. Inclusion by the Board of the mailing to Regional voters of the names of their chosen candidates for Regional Director, calls for nominations by petition, mailing of ballots to Regional voters, counting of ballots, and notification of elections, all in accordance with the general routine followed for existing elective offices.
- f. Elections in even-numbered Regions in even-numbered years and in odd-numbered Regions in odd-numbered years.
- g. Creation for each Region of a Regional Committee, the duties of which would include the nomination of at least one candidate for the office of Regional Director for its Region.

It is possible that the organization and procedure for the Regional Committees could be changed to advantage, from time to time, as we gained experience in operation under the Regional-Representation plan. To facilitate such changes as may prove desirable, without resorting to the more cumbersome procedure of amending the Constitution, it is proposed to specify in the Bylaws the organization and procedure of the Regional Committees. In order that each voting member may be fully informed on all details of the plan, the Bylaws which the Board contemplates adopting are shown in full below. Voting members wishing to comment on these proposed Bylaws are invited to send their comments to the Chairman of the Constitution and Laws Committee.

**BYLAWS WHICH THE BOARD CONTEMPLATES ADOPTING IF  
 THE REGIONAL REPRESENTATION PLAN IS APPROVED**

**Nomination and Election of Regional Directors**

Each Region shall contain a Regional Committee nominally consisting of the Regional Director, the senior past Regional Director, and the Chairman and senior past Chairman of each Section in the Region. The functions of

the Regional Committee shall be the nomination, every two years, of at least one candidate for the office of Regional Director, and discussion and suggestions concerning the affairs of the Sections comprising the Region. Members of the Regional Committee shall be members *ex-officio* of the Executive Committees of their Sections.

Pending installation of the first Regional Director of each region, the Chairman of the largest Section in the Region shall act as Chairman *pro tem*. The Chairman *pro tem* shall appoint a Secretary-Treasurer *pro tem* who shall act until the Secretary-Treasurer of the Regional Committee is appointed.

The Regional Director shall be Chairman of the Regional Committee and shall appoint a Vice-Chairman from the membership of the Committee. The Chairman of the Regional Committee shall appoint a Secretary-Treasurer from members of the Region for a two-year term concurrent with that of the Chairman. The duties of the Secretary-Treasurer shall include correspondence, the keeping of the minutes of the Committee meetings, mailing notices, the keeping of financial records and the submission of a report at the end of each year, and such other duties as are assigned to him by the Chairman. The Secretary-Treasurer shall not be a voting member of the Committee.

Each Regional Committee during election years shall submit to the Board of Directors by May first the names of at least one qualified nominee for the office of Regional Director. Each candidate shall be a member of and live in the Region from which he is nominated and shall be a Fellow or Senior Member of the Institute. To qualify, each candidate shall indicate to the Regional Committee his acceptance of the nomination. The Board shall submit these names for voting with those of other candidates for office on or before September first. The candidates for each office receiving the highest number of votes will be elected. Only votes from members of his Region shall be counted in electing a Regional Director.

Each member of the Regional Committee shall be of Member, Senior Member, or Fellow grade in the Institute. Vacancies, except for Regional Director, shall be filled by appointment by the Executive Committee of the Section in which the vacancy exists. The term of office shall be one year concurrent with the term of office of the Section officers.

The Regional Committee shall hold at least one meeting per year at which a quorum shall be necessary for the transaction of business of the Committee. The Chairman or, in his absence, the Vice-Chairman of the Regional Committee shall be responsible for calling the necessary number of Regional Committee meetings. A quorum shall consist of at least one third of the members of the Committee and shall include representatives from at least half the Sections in the region.

Regions which fail to maintain reasonable activity shall at the discretion of the Board, be dissolved and the Sections may be absorbed into other regions.

The term of office of Regional Directors shall be two years and shall begin at the annual meeting of the Board of Directors.

General expenses incurred by the Regional Committee in corresponding, mailing notices, etc., shall be defrayed by the Sections in the Region on a basis proportional to membership. The Regional Committee shall for this purpose make assessments on the Sections when necessary and subject to consent of the Executive Committees of the Sections.

The Sections and the Regions shall make such arrangements as they deem appropriate in defraying the expenses of their representatives in attending meetings.

## CONSTITUTIONAL AMENDMENTS SUBMITTED FOR VOTING

The Regional-Representation plan will be adopted or rejected depending upon the votes cast for the proposed Constitutional Amendments specified hereinafter. For adoption, at least twenty per cent of all members qualified to vote must do so and at least seventy five per cent of all votes cast must be favorable. The plan has been discussed at Section meetings, has been considered, and overwhelmingly endorsed by the Sections' officers and has been unanimously approved by the Board of Directors.

The Constitutional changes proposed are included in one group which must be accepted or rejected in full.



This is necessary because they are interdependent and partial acceptance could result only in an impracticable situation. Each proposed change is explained in detail.

## SPECIFICATION OF PROPOSED CONSTITUTIONAL AMENDMENTS

### Article V, Section 1

The present Article V, Section 1, is shown below at the left. It may be noted that the specified Board of Directors consists of 21 persons. Under the Regional-Representation Plan the number of Regional Directors may become as high as 12 or more. Added to the present total of 21 this would make a total of 33 or more. A Board of Directors that large is considered quite unnecessary and disadvantageous. With the new Regional Directors there would be no need for the present number of elected and appointed Directors. It is therefore proposed to reduce the number of elected Directors-at-Large from 9 to 6, reduce the number of appointed Directors from 5 to 3, and include the Regional Directors in a modified Article V, Section 1, as shown below at the right.

#### *Present*

The governing body of the Institute shall be the Board of Directors and shall consist of the President, Vice-President, Secretary, Treasurer, Editor, nine elected Directors, five appointed Directors, and the two most recent past Presidents.

#### *Proposed*

The governing body of the Institute shall be the Board of Directors and shall consist of the President, Vice-President, Secretary, Treasurer, Editor, six Directors elected-at-large, three appointed Directors, one Regional Director elected by each Region, and the two most recent past Presidents.

### Article V, Sections 2 and 3

The present Article V, Sections 2 and 3, are shown below at the left. It is desirable to specify the term of the Regional Directors with the terms of the other Directors. It is proposed to do so in this change but to include also certain improvements in these Sections.

It is proposed to confine Section 2 to a specification of the Corporate Officers of the Institute. As now written this Section incorrectly classifies Directors as Officers. Directors are not Corporate Officers unless elected or appointed to a Corporate Office.

It is proposed to include in Section 3 the specification of the terms of all Corporate Officers and the Directors. The proposed Sections 2 and 3 are shown below at the right.

#### *Present*

Sec. 2—Except for the elected Directors, the terms of all Officers shall be for one year each.

#### *Proposed*

Sec. 2—The Corporate Officers of the Institute shall be the President, Vice-President, Secretary, Treasurer, and Editor.

#### *Present*

Sec. 3—The terms of the elected Directors shall be for three years each.

#### *Proposed*

Sec. 3—The terms of office for Directors elected-at-large shall be for three years, for appointed Directors one year, for Regional Directors two years, and for all officers one year, except as provided in Article VII, Section 1.

### Article V, Section 6

A new section is proposed for Article V in which there would be a definition and specification creating the new office of Regional Director. The proposed Section 6 is shown below. In determining the grouping of the Sections, to form Regions, the Board of Directors will solicit and give full consideration to the recommendations of the Sections. Any problems which arise will be carefully studied and solved insofar as possible through consultation with the leaders of the Sections concerned.

## *Proposed*

Sec. 6—The United States and Canada, and other areas at the discretion of the Board of Directors, shall be divided into Regions, which shall be specified in the Bylaws. The Board of Directors and be designated a Regional Director in the number of Regions, as it deems desirable,

and number the Regions with consecutive numbers. The voting members of each Region shall elect one representative who shall thereby become a member of the Board of Directors and be designated a Regional Director.

## **Article VI, Section 2**

The present Board of Directors includes 21 persons and Article IV, Section 2, shown below at the left, specifies that six members are necessary to constitute a quorum. Under the Regional-Representation plan the number of Directors would be increased. It is proposed to increase correspondingly from six to eight the number of members required to constitute a quorum. The proposed Section 2, as modified, is shown below at the right.

### *Present*

The Board of Directors shall manage the affairs of the Institute. An annual report shall be made to the members on the activities and finances of the Institute.

Six members of the Board of Directors shall constitute a quorum.

### *Proposed*

The Board of Directors shall manage the affairs of the Institute. An annual report shall be made to the members on the activities and finances of the Institute.

Eight members of the Board of Directors shall constitute a quorum.

## **Article VII**

The heading of Article VII is unnecessarily long and does not include any reference to Regional Directors which are referred to in the proposed modifications of its Sections. The present heading is shown below at the left and a proposed new and simplified heading is shown below at the right.

### *Present*

NOMINATION AND ELECTION OF PRESIDENT, VICE-PRESIDENT, AND THREE DIRECTORS, AND APPOINTMENT OF SECRETARY, TREASURER, EDITOR, AND FIVE DIRECTORS

### *Proposed*

NOMINATION, ELECTION, AND APPOINTMENT OF OFFICERS AND DIRECTORS

## **Article VII, Section 1, Paragraph 1**

Under the Regional-Representation Plan, each Regional Committee would notify the Board of Directors of its choice of qualified candidates for Regional Director. The Board would then notify the members of the respective Regions concerning those candidates and entertain nominations by petition. It is proposed to add to Section 1, Paragraph 1, provisions for the Board to function for the Regions in the manner described. The present Section 1, Paragraph 1, is shown below at the left and the proposed modified Section 1, Paragraph 1 is shown below at the right.

### *Present*

On or before July first of each year, the Board of Directors shall submit to qualified voters a list of nominations containing at least one name each for the office of President and Vice-President and at least six names for the office of elected Director and shall call for nominations by petition.

### *Proposed*

On or before July first of each year, the Board of Directors shall submit to qualified voters a list of nominations containing at least one name each for the office of President and Vice-President, at least four names for the office of Director elected-at-large, the names of all nominees for the office of Regional Director, and shall entertain nominations by petition for all of the offices specified.



## Article VII, Section 1, Paragraph 2

The Board wishes to provide that candidates for the office of Regional Director may be nominated by petition. Only members living in a Region are qualified to vote for a Regional Director for that Region. It is necessary to insure that only such qualified resident voting members are also qualified to sign nominating petitions for their Region. It is proposed to accomplish this by modifying Section 1, Paragraph 2, as follows.

### *Present*

Nominations by petition may be made by letter to the Board of Directors setting forth the name of the proposed candidate and the office for which it is desired he be nominated. For acceptance a letter of petition must reach the executive office before twelve o'clock noon on the last weekday prior to August fifteenth of any year and shall be signed by at least thirty-five voting members.

### *Proposed*

Nominations by petition may be made by letter to the Board of Directors setting forth the name of the proposed candidate and the office for which it is desired he be nominated. For acceptance a letter of petition must reach the executive office before twelve o'clock noon on the last weekday prior to August fifteenth of any year and shall be signed by at least thirty-five voting members qualified to vote for the office of the candidate nominated.

## Article VII, Section 1, Paragraph 4

Article VII, Section 1, Paragraph 4, specifies that the Board shall submit ballots to all voting members for the election of the President, Vice-President, and elected Directors. It is proposed to modify this paragraph to include ballots to the qualified voting members of each Region by which they could vote for their candidates for Regional Director. The present Section 1, Paragraph 4, is shown below at the left and the proposed modified Section 1, Paragraph 4, is shown below at the right.

### *Present*

On or before September first, the Board of Directors shall submit to the voting members as of August fifteenth, a list of nominees for the offices of President, Vice-President, and elected Director, the names of the nominees for each office being arranged in alphabetical order. The ballots shall carry a statement to the effect that the order of the names is alphabetical for convenience only and indicates no preference.

### *Proposed*

On or before September first, the Board of Directors shall submit to all voting members as of August fifteenth, a list of nominees for the office of President, Vice-President, and Director elected-at-large, and shall submit to all such voting members of each Region a list of their nominees for the office of Regional Director, the names of the nominees for each office being arranged in alphabetical order. The ballots shall carry a statement to the effect that the order of the names is alphabetical for convenience only and indicates no preference.

## Article VII, Section 1, Paragraph 5

Under the present Constitution there are nine elected Directors each of whom has a three-year term. These elections are staggered so that only three Directors are elected each year. Under the Regional-Representation plan it is proposed to reduce the number of Directors elected-at-large from nine to six and elect only two per year. Section 1, Paragraph 5, would have to be modified to be consistent with this change and would have to be modified further to include provisions for Regional Directors. The present Section 1, Paragraph 5, is shown below at the left and the proposed modified Section 1, Paragraph 5 is shown below at the right.

### *Present*

Voting members shall vote for the candidates whose names appear on the list of nominees by written ballots in plain sealed envelopes, enclosed within mailing envelopes marked "Ballot" and bearing the member's written

### *Proposed*

Voting members shall vote for the candidates whose names appear on the list of nominees, by written ballots in plain sealed envelopes, enclosed within mailing envelopes marked "Ballot" and bearing the member's written

signature. No ballots within unsigned outer envelopes shall be counted. No votes by proxy shall be counted. Only ballots arriving at the executive office before twelve o'clock noon on the last weekday prior to October twenty-fifth shall be counted. Ballots shall be checked, opened, and counted under the supervision of the Tellers Committee between October twenty-fifth and the first Wednesday in November. The result of the count shall be reported to the Board of Directors at its first meeting in November and the nominees for President and Vice-President and the three nominees for Director receiving the greatest number of votes shall be declared elected. In the event of a tie vote the Board shall choose between the nominees involved.

signature. No ballots within unsigned outer envelopes shall be counted. No votes by proxy shall be counted. Only ballots arriving at the executive office before twelve o'clock noon on the last weekday prior to October twenty-fifth shall be counted. Ballots shall be checked, opened, and counted under the supervision of the Tellers Committee between October twenty-fifth and the first Wednesday in November. The result of the count shall be reported to the Board of Directors at its first meeting in November and the nominees for President and Vice-President, the two nominees for Director elected-at-large, and the nominees for each office of Regional Director receiving the greatest number of qualified votes shall be declared elected. In the event of a tie vote the Board shall choose between the nominees involved.

### Article VII, Section 1, Paragraph 6

It is proposed to add a new paragraph to Section 1 to accomplish the following:

- a. Safeguard the requirements for nominees and qualified voters for Regional Director.
- b. Stagger election years among the Regions to insure an adequate number of continuing Board members.
- c. Adjust initial terms of Regional Directors to place the staggered election plan into operation.
- d. Assure full terms for Regional Directors, despite changes which might be made by the Board in the status of a Region.
- e. Provide for appointments to fill Regional-Director vacancies.
- f. Specify that the organization and procedure of the Regional Committees shall be specified in the Bylaws as required.

The proposed new Article VII, Section 1, Paragraph 6 is shown below.

#### *Proposed*

Nominees for the office of Regional Director shall be members of and live in the Regions which nominate them. They shall be elected by the voting members of the Institute in the Region. The Regional Directors from even- and odd-numbered Regions shall be chosen by the Regions in even- and odd-numbered years, respectively. In placing the Regional-Representation Plan into operation, or when new Regions are established, or when changes are made in Regions, candidates for the office of Regional Director may be nominated and elected for one-year terms as required to ensure representation during the period preceding their normal election years.

No Regional Director shall have his term shortened by changes in Regions. Each Region shall have a Regional Committee whose duties shall include making at least one nomination for Regional Director from its Region during election years. In the event a Regional Director dies, is unable to serve, or is disqualified by removal from the Region, the Regional Committee shall appoint a Regional Director for the unexpired portion of the term. The organization and procedure of the Regional Committees for nominating candidates for Regional Director shall be defined in the Bylaws.

### Article VII, Section 2

The proposed reduction of the number of appointed Directors from five to three requires a modification of Section 2. The present Section is shown below at the left and the proposed modified section is shown below at the right.

#### *Present*

The five appointed Directors, Secretary, Treasurer, and Editor shall be appointed by the Board of Directors at its annual meeting to serve until the next annual meeting.

#### *Proposed*

The three appointed Directors, Secretary, Treasurer, and Editor shall be appointed by the Board of Directors at its annual meeting to serve until the next annual meeting or until their successors are appointed and accept.

All proposed changes in Article V, Sections 1, 2, 3 and 6, Article VI, Section 2, and Article VII, Sections 1 and 2, comprise the constitutional provisions for the Regional-Representation Plan. Vote for or against the plan in the spaces provided on the ballot.





ALCO has been awarded for the fifth time the Army-Navy "E" Award for continued excellence in quantity and quality of essential war production.

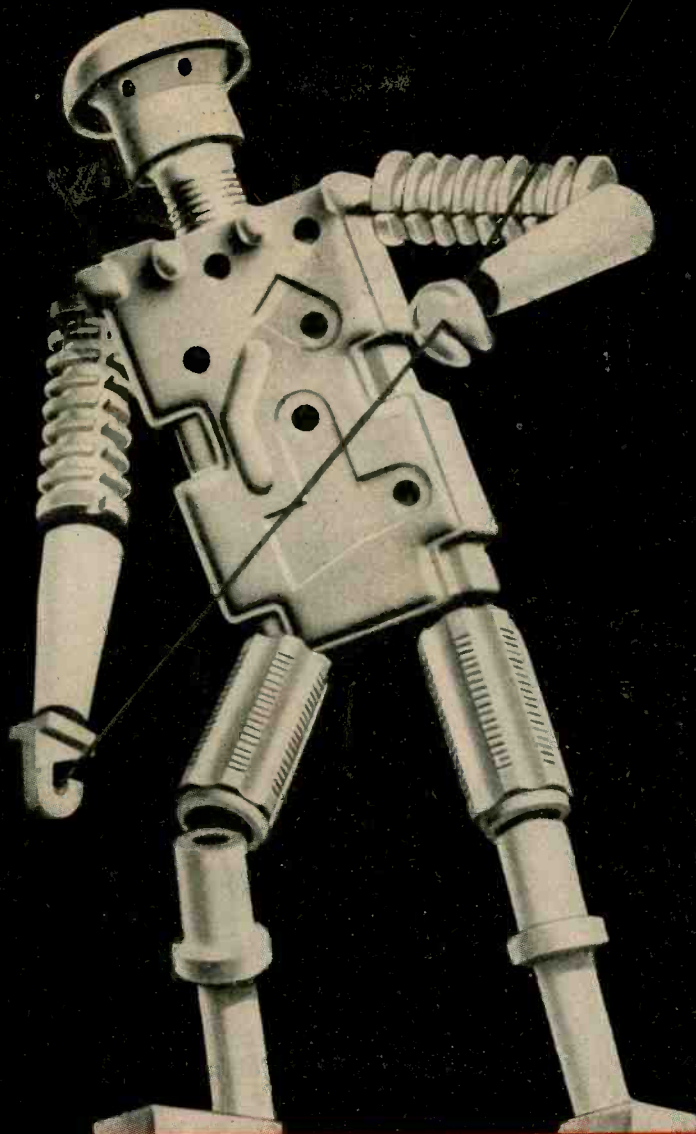

# MASTER OF POWER AND HEAT

**M**ANY of the brilliant advances in electronics made during the war, including extensive use of ALSIMAG Steatite Ceramics in radio, radar, communications, controls and high frequency heating, will be carried forward into peace-time products of *quality*.

Of prime importance to the efficiency and stability of high frequency circuits is insulation whose composition and strength is master of both power and heat.

Permanent in their hardness, strength and rigidity, ALSIMAG Steatite Ceramic Insulators are not subject to distortion, warping or shrinking.

Exceptionally Low Loss Factor, High Dielectric Strength and High Resistivity.

Let us prove that ALSIMAG will meet your requirements.

**AMERICAN LAVA CORPORATION**

Chattanooga 5, Tennessee

43RD YEAR OF CERAMIC LEADERSHIP

**Quality to Highest  
Known Standards  
Large Production  
Facilities  
Research and  
Engineering  
Collaboration**

## ALSIMAG

TRADE MARK REGISTERED U. S. PATENT OFFICE

## CERAMICS

# 11 CAPACITOR

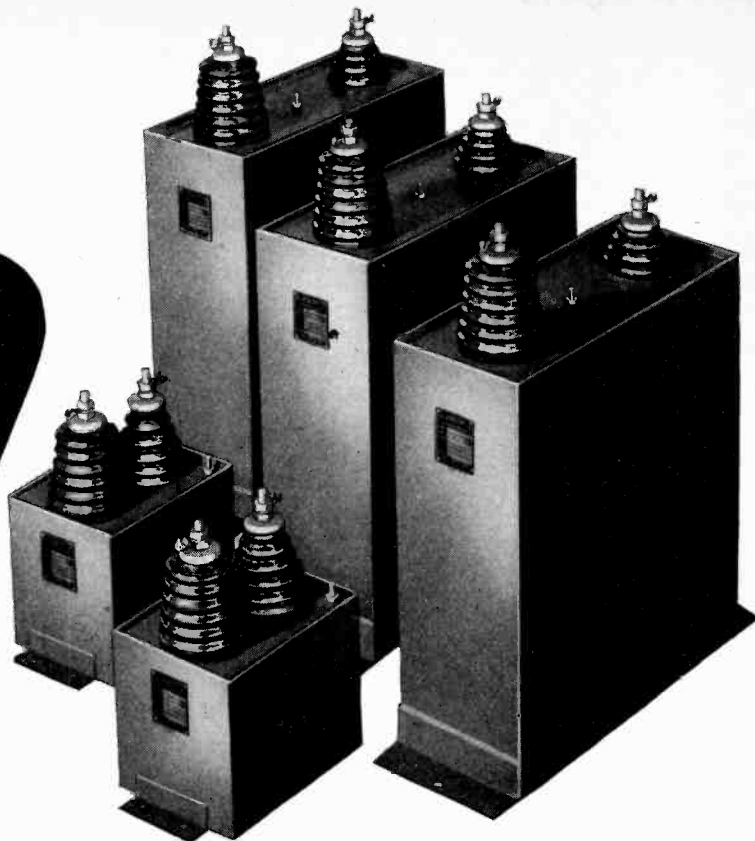

# READNAUGHT'S

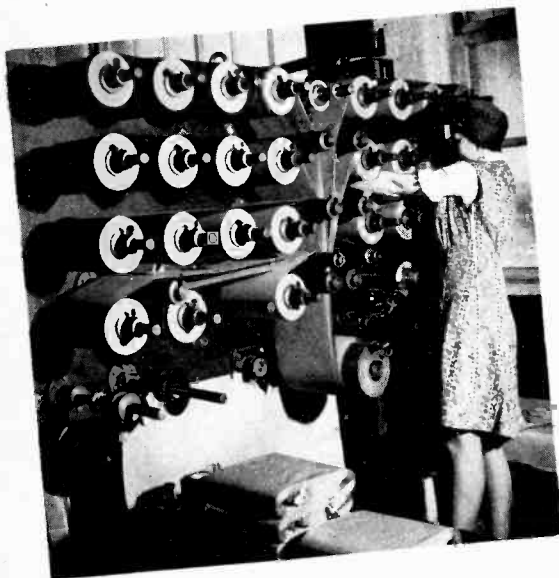

● Interested?  
Write for detailed literature.

● Outstanding production equipment in the hands of Aerovox craftsmen, accounts for these veritable capacitor dreadnaughts. In exacting services such as radio transmitters, heavy-duty electronic equipment, and in the electric power field, these units have won citation after citation for exceptional ruggedness.

Such ruggedness stems from the Aerovox winding facilities second to none. Special winding machines insure that the multi-layered sections are uniformly and accurately wound under critically-controlled tension. Also, a system of impregnation tanks, pumps and control equipment guarantees the necessary drying after vacuum impregnation that is positively unexcelled by any impregnation process anywhere.

Hermetically-sealed welded steel containers; heavy-duty porcelain insulators; cork gaskets and pressure sealing; non-ferrous metal hardware; silver-soldered joints; sturdy mounting means—these are the externals of these capacitor dreadnaughts. Standard listings of Type 20 up to 50,000 v. D.C.W. Capacitances from 0.1 to 10 mfd.



# Capacitors

INDIVIDUALLY TESTED

AEROVOX CORPORATION, NEW BEDFORD, MASS., U. S. A.

SALES OFFICES IN ALL PRINCIPAL CITIES

Export: 13 E. 40 ST., NEW YORK 16, N. Y. • Cable: 'ARLAB' • In Canada: AEROVOX CANADA LTD., HAMILTON, ONT.



# Wilcox Type 99A Transmitter

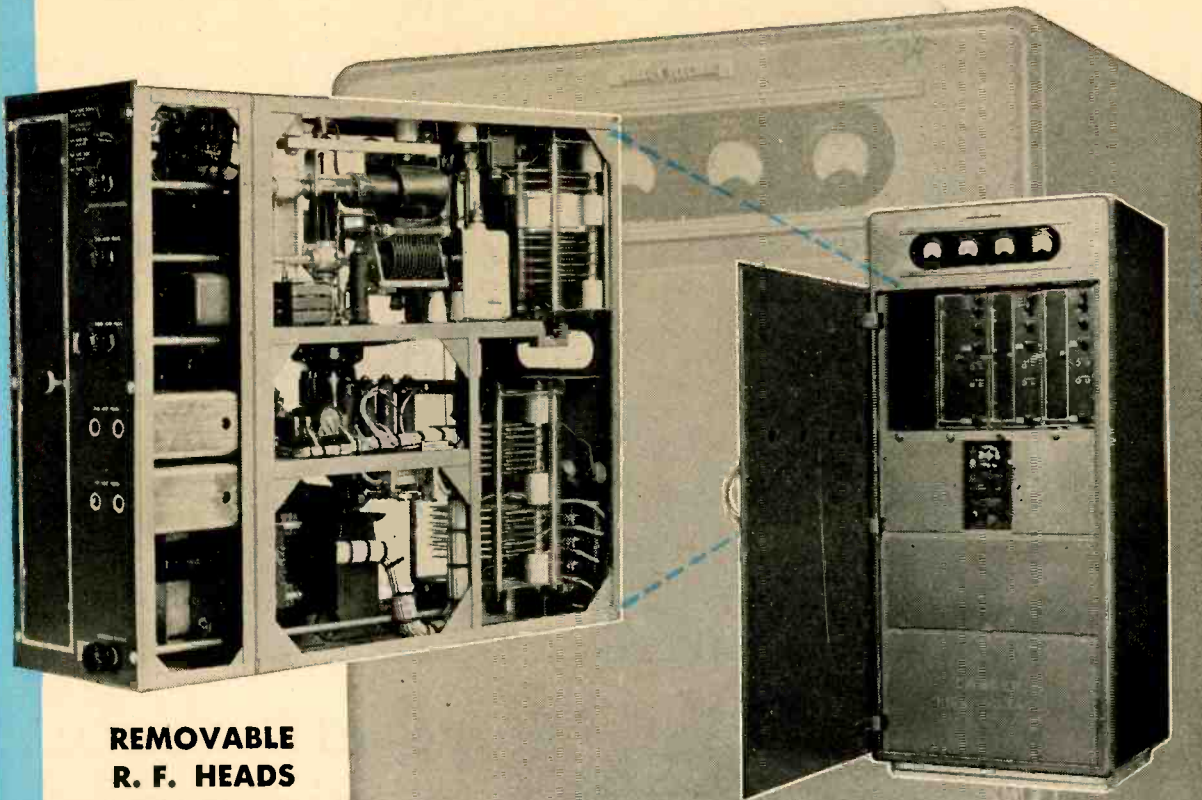

## REMOVABLE R. F. HEADS

All radio frequency circuits are included in the 2-20 Mc. R.F. head shown above. All connections to the transmitter cabinet are by means of plugs and receptacles.



A medium power transmitter, designed particularly for aeronautical service. Equally adaptable to other fixed services. Check these features for their application to your communication problems:

- ★ Four transmitting channels, in the following frequency ranges:  
125-525 Kc. Low Frequency  
2-20 Mc. High Frequency.  
100-160 Mc. Very High Frequency.  
Other frequencies by special order.
- ★ Simultaneous channel operation, in following maximum combinations:  
3 Channels telegraph.  
2 Channels telephone.  
1 Channel telephone, 2 Channels telegraph.
- ★ Complete remote control by a single telephone pair per operator.
- ★ 400 Watt plus carrier power.
- ★ Low first cost. Removable radio frequency heads are your protection against frequency obsolescence.
- ★ Reliability backed by two years of engineering research, one year of actual field operation.
- ★ Available with all-steel, or wood pre-fabricated transmitter house complete with primary power, antenna, and ventilation fittings.
- ★ Not a "post-war plan," but a field-tested transmitter now in production.

An inquiry on your letterhead outlining your requirements will bring you complete data.

## WILCOX ELECTRIC COMPANY, INC.

Manufacturers of Radio Equipment

Fourteenth and Chestnut      Kansas City, Missouri

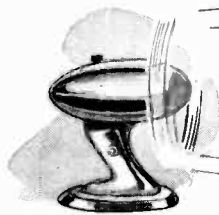

more efficient  
...in miniature

The old, slow motion belt driven fan was of questionable value as a breeze maker. Perhaps its best service was that of chasing flies with fluttering streamers. Then came the modern high speed electric fan. Like the miniature electronic tube, it is an outstanding example of the current trend toward increased efficiency in miniature.

TUNG-SOL Miniature Tubes are a part of the trend to smaller component parts. They are a factor in reducing the over-all size of equipment. Shorter leads with low inductance, and low capacity with high mutual conductance make the miniature tube ideal for high frequency circuits. The smaller elements weigh less, tending to reduce the effects of vibration. The smaller size also makes possible a

more rigid construction. This reduces the possibilities of element distortion.

To aid in the creation of new electronic equipment and in the improvement of old, TUNG-SOL engineers will draw upon their experience and work with manufacturers in the designing of circuits and in the selection of tubes. Of course your plans will be held in strictest confidence.



ACTUAL SIZE

# TUNG-SOL

*vibration-tested*

**ELECTRONIC TUBES**

**TUNG-SOL LAMP WORKS INC., NEWARK 4, NEW JERSEY**  
Sales Offices: Atlanta • Chicago • Dallas • Denver • Detroit • Los Angeles • New York  
Also Manufacturers of Miniature Incandescent Lamps, All-Glass Sealed Beam Headlight Lamps and Current Intermittors





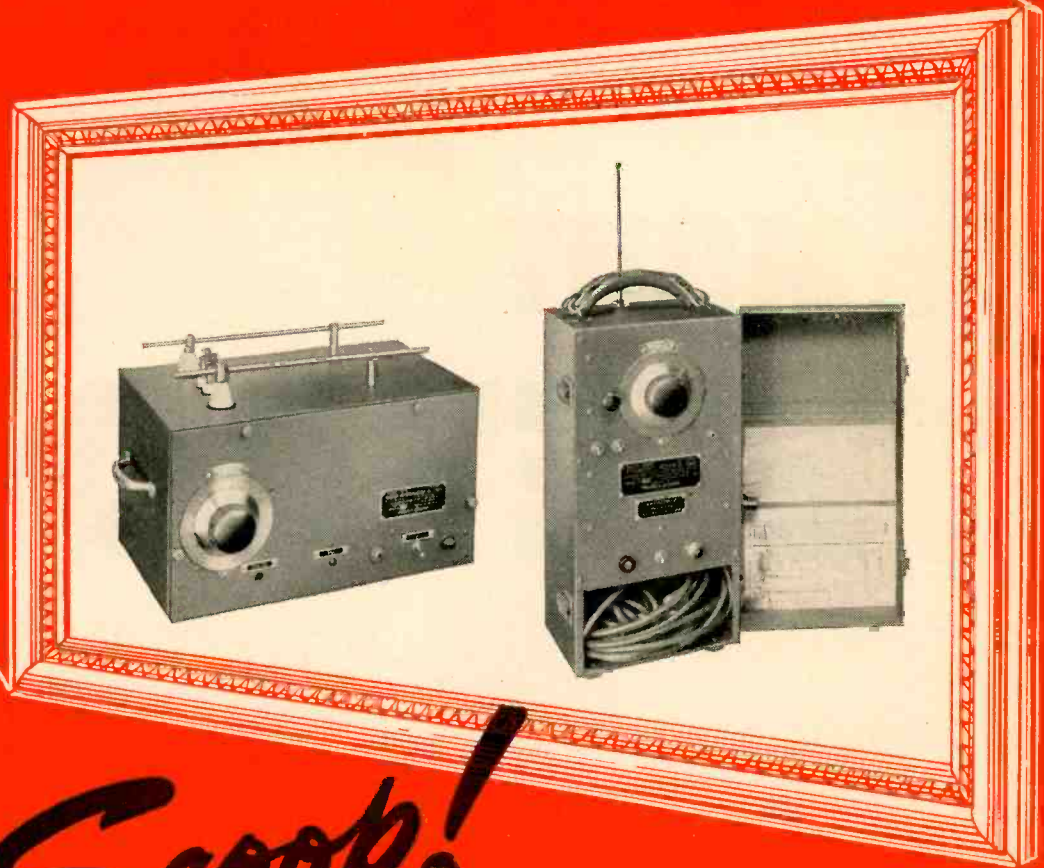

*Scoop!*

Left: Radio Modulator BC-423. High frequency signal generator operating from 195 to 205 mc., modulated at approximately 5000 cycles. Ruggedly built in steel case. Designed so that it can be re-adapted to many applications. Can be used as high frequency receiver, transceiver or frequency meter. Good for lab demonstrations requiring low power, ultra high frequency generator. Can be converted to 2½ or 1¼ meter receiver.

Right: Frequency Meter BC-438. Ultra-high frequency signal generator operating from 195 to 205 mc. with crystal calibration. Aluminum chassis in steel case. Removable nickel plated 19" telescopic antenna. Use as high frequency receiver or transmitter. Can be converted to cover any frequency range. Takes dry batteries for portable use. Precision tuning control makes it ideal for "on the nose" ECO transmitter control unit.

## hallicrafters RADIO

THE HALLICRAFTERS CO., AGENT FOR RFC UNDER CONTRACT SIA-3-24  
MANUFACTURERS OF RADIO AND ELECTRONIC EQUIPMENT

THESE VALUABLE ITEMS *Available Now*  
or very soon. Write, wire or phone for further information • head phones • test equipment • component parts • marine transmitters and receivers • code practice equipment • sound detecting equipment • vehicular operation police and command sets • radio beacons and airborne landing equipment.

### CLIP THIS COUPON NOW

RFC DEPARTMENT 407, HALLICRAFTERS  
5025 West 65th Street • Chicago 38, Illinois

Send further details on merchandise described above

Send listings of other available items

Especially interested in \_\_\_\_\_

STATE \_\_\_\_\_

NAME \_\_\_\_\_

CITY \_\_\_\_\_ ZONE \_\_\_\_\_

ADDRESS \_\_\_\_\_

**DIRECT-VIEWING TELEVISION  
RECEPTION AT ITS BEST, SPELLS**

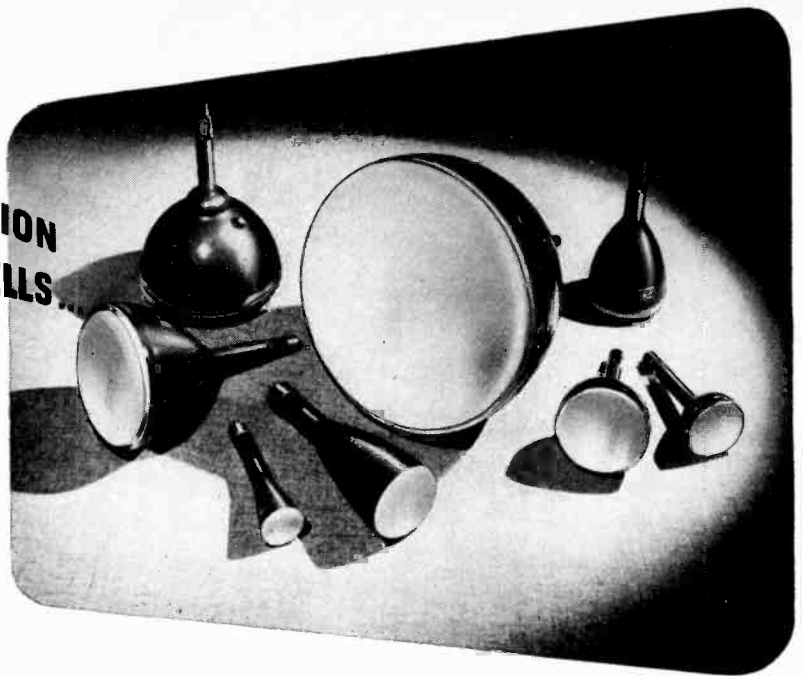

**Du MONT**

# TELETRONS\*

## WHY DIRECT-VIEWING TELEVISION RECEPTION?

*Because . . .*

- Excellent pictorial resolution due to minimum spot size.
- Higher brilliance and better contrast range for vivid pictures.
- Wide-angle viewing, accommodating the largest audience for given screen size.
- Lower accelerating voltage, which means less costly receiver power supply.
- Simplicity of the focusing system, since it is entirely electronic.
- Longer tube life and therefore lower operating cost.
- Previous objections to curvature of face have been overcome by design of essentially flat-faced bulbs.
- DuMont offers the larger image tubes for adequate screen sizes and the greatest receiver value.

► *It's all in the tube* when dealing with direct-viewing television reception. The image is viewed directly as scanned. No mirrors or lenses; no dust or dirt to dim the image; no realignments ever required. The complete device for image reproduction is permanently set and sealed at the plant.

DuMont has led in the development and production of large-image cathode-ray tubes for television (Teletrons) in all sizes and types.

DuMont Teletrons make direct-viewing practical, logical, and truly economical.

► *Interested? Our engineers are ready to collaborate in fitting the right Teletron to your particular problem. Technical data on request.*

Remember, DuMONT also makes other types of cathode-ray tubes, oscillographs, television receivers and television transmitting equipment.

\*REG. TRADE-MARK

© ALLEN B. DUMONT LABORATORIES, INC.

**DUMONT**

*Precision Electronics & Television*

ALLEN B. DUMONT LABORATORIES, INC., PASSAIC, NEW JERSEY • CABLE ADDRESS: ALBEEDU, PASSAIC, N. J., U. S. A.





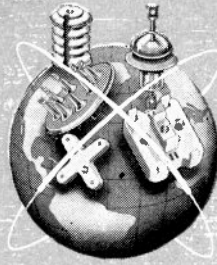

For the NEW YEAR... Good Judgment says... STANDARDIZE on

# STUPAKOFF CERAMICS

*and Gain these Advantages:*

**IMPROVED PRODUCTS.** Many products require correctly engineered ceramic parts of highest quality for satisfactory performance and long service life. Stupakoff has the skill, experience and ability to produce such parts, thus helping you improve your products.

**FASTER ASSEMBLY.** The dimensional accuracy and sturdy structure of Stupakoff Ceramic parts help speed your fabrication processes. They fit exactly into the space provided for them, and provide correct spacing for parts assembled to them.

**GREATER SATISFACTION.** You will find fewer rejects, and greater overall quality and satisfaction when you standardize on STUPAKOFF CERAMICS!

Products for the World of Electronics

Export Department, 13 E. 40th Street  
New York 16, N.Y.

Cable Address: ARLAB, all codes

Proceedings of the I.R.E. January, 1946

**STUPAKOFF CERAMIC  
& MANUFACTURING COMPANY**

**LATROBE, PENNSYLVANIA**

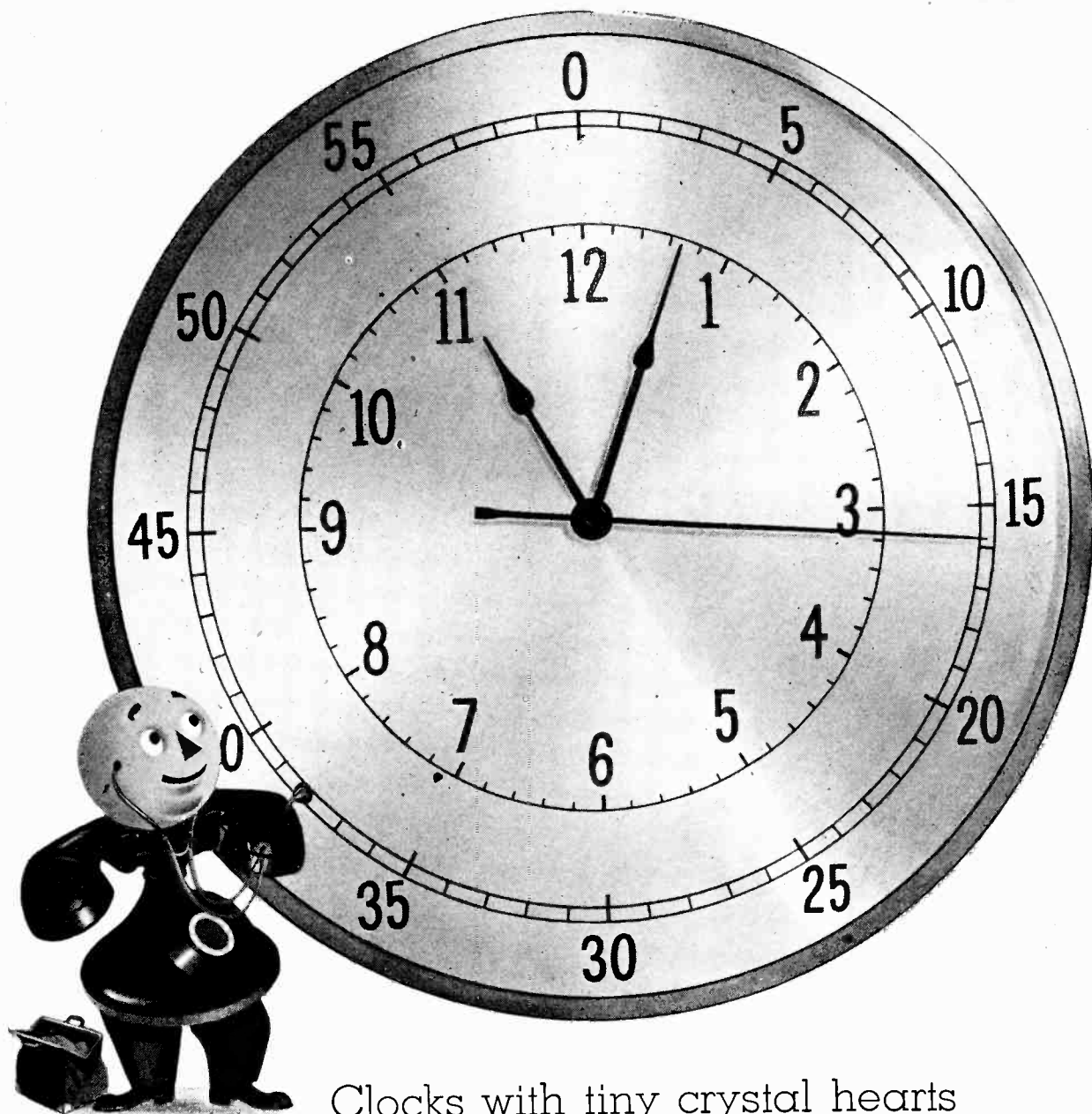

## Clocks with tiny crystal hearts that beat 100,000 times a second

CRYSTAL HEARTS beat time in Bell Telephone Laboratories, and serve as standards in its electronics research. Four crystal clocks, without pendulums or escapements, throb their successive cycles without varying by as much as a second a year.

Precise time measurements may seem a far cry from Bell System telephone research, but time is a measure of frequency, and frequency is the foundation of modern communication, whether by land lines, cable, or radio.

These clocks are electronic devices developed by Bell Laboratories, and refined over years of research. Their energy is supplied through vacuum tubes, but the accurate timing, the controlling heart of the clock, is provided by a quartz crystal plate about the size of a postage stamp.

These crystal plates vibrate 100,000 times a second, but their contraction and expansion is submicroscopically small—less than a hundred-thousandth of an inch. They are in sealed boxes

to avoid any variation in atmospheric pressure, and their temperatures are controlled to a limit as small as a hundredth of a degree.

Bell Laboratories was one of the first to explore the possibilities of quartz in electrical communication, and its researches over many years enabled it to meet the need for precise crystals when war came. The same character of research is helping to bring ever better and more economical telephone service to the American people.



**BELL TELEPHONE LABORATORIES** *Exploring and inventing, devising and perfecting for continued improvements and economies in telephone service.*



# New!

## Series 200

# A RELAY BY GUARDIAN with Interchangeable Coils

### BUILT IN TWO PARTS

★ Two basic parts—a coil assembly and a contact assembly—comprise this simple, yet versatile relay. The coil assembly consists of the coil and field piece. The contact assembly consists of switch blades, armature, return spring, and mounting bracket. The coil and contact assembly are easily aligned by two locator pins on the back end of the contact assembly which fit into two holes on the coil assembly. They are then rigidly held together with the two screws and lock washers. Assembly takes only a few seconds and requires no adjustment on factory built units.

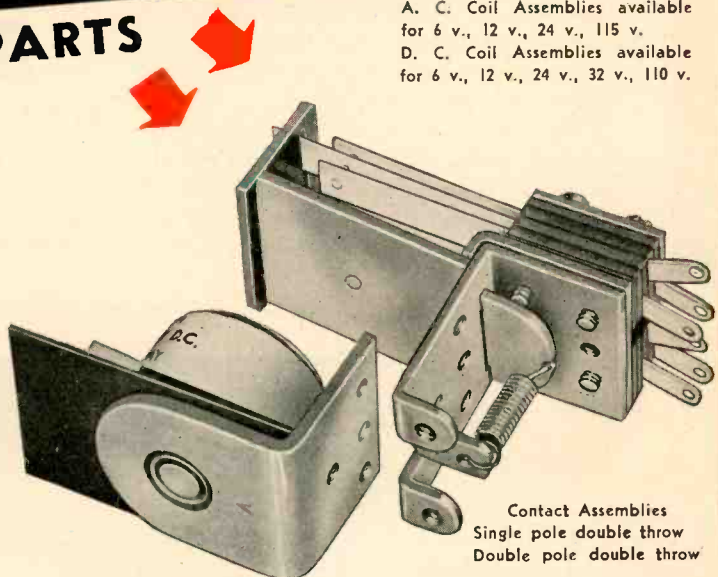

Series 200 Relay

A. C. Coil Assemblies available for 6 v., 12 v., 24 v., 115 v.  
D. C. Coil Assemblies available for 6 v., 12 v., 24 v., 32 v., 110 v.

Contact Assemblies  
Single pole double throw  
Double pole double throw

## On Sale at Your nearest jobber NOW!

See it today! . . . this amazing new relay with interchangeable coils. See how you can operate it on any of nine different a-c or d-c voltages—simply by changing the coil. Ideal for experimenters, inventors, engineers.

### TWO CONTACT ASSEMBLIES

The Series 200 is available with a single pole double throw, or a double pole double throw contact assembly. In addition, a set of Series 200 Contact Switch Parts, which you can buy separately, enables you to build dozens of other combinations. Instructions in each box.

### NINE COIL ASSEMBLIES

Four a-c coils and five d-c coils are available. Interchangeability of coils enables you to operate the Series 200 relay on one voltage or current and change it over to operate on another type simply by changing coils.



*Your jobber has this sensational new relay on sale now. Ask him about it. Or write for descriptive bulletin.*

**GUARDIAN**  **ELECTRIC**  
1628 A W. WALNUT STREET CHICAGO 12, ILLINOIS  
A COMPLETE LINE OF RELAYS SERVING AMERICAN INDUSTRY

# REVERE FREE-CUTTING COPPER ROD ... INCREASES ELECTRONIC PRODUCTION

SINCE its recent introduction, Revere Free-Cutting Copper has decisively proved its great value for the precision manufacture of copper parts. Uses include certain tube elements requiring both great dimensional precision, and exceptional finish. It is also being used for switch gear, high-capacity plug connectors and in similar applications requiring copper to be machined with great accuracy and smoothness. This copper may also be cold-upset to a considerable deformation, and may be hot forged.

Revere Free-Cutting Copper is oxygen-free, high conductivity, and contains a small amount of tellurium, which, plus special processing in the Revere mills, greatly increases machining speeds, makes possible

closer tolerances and much smoother finish. Thus production is increased, costs are cut, rejects lessened. The material's one important limitation is that it does not make a vacuum-tight seal with glass. In all other electronic applications this special-quality material offers great advantages. Write Revere for details.

## REVERE

COPPER AND BRASS INCORPORATED

Founded by Paul Revere in 1801

Executive Offices: 230 Park Avenue  
New York 17, N. Y.

Mills: Baltimore, Md.; Chicago, Ill.; Detroit, Mich.; New Bedford, Mass.; Rome, N. Y.—Sales Offices in principal cities, distributors everywhere

 Listen to Exploring the Unknown on the Mutual Network every Sunday evening, 9 to 9:30 p. m., EST.

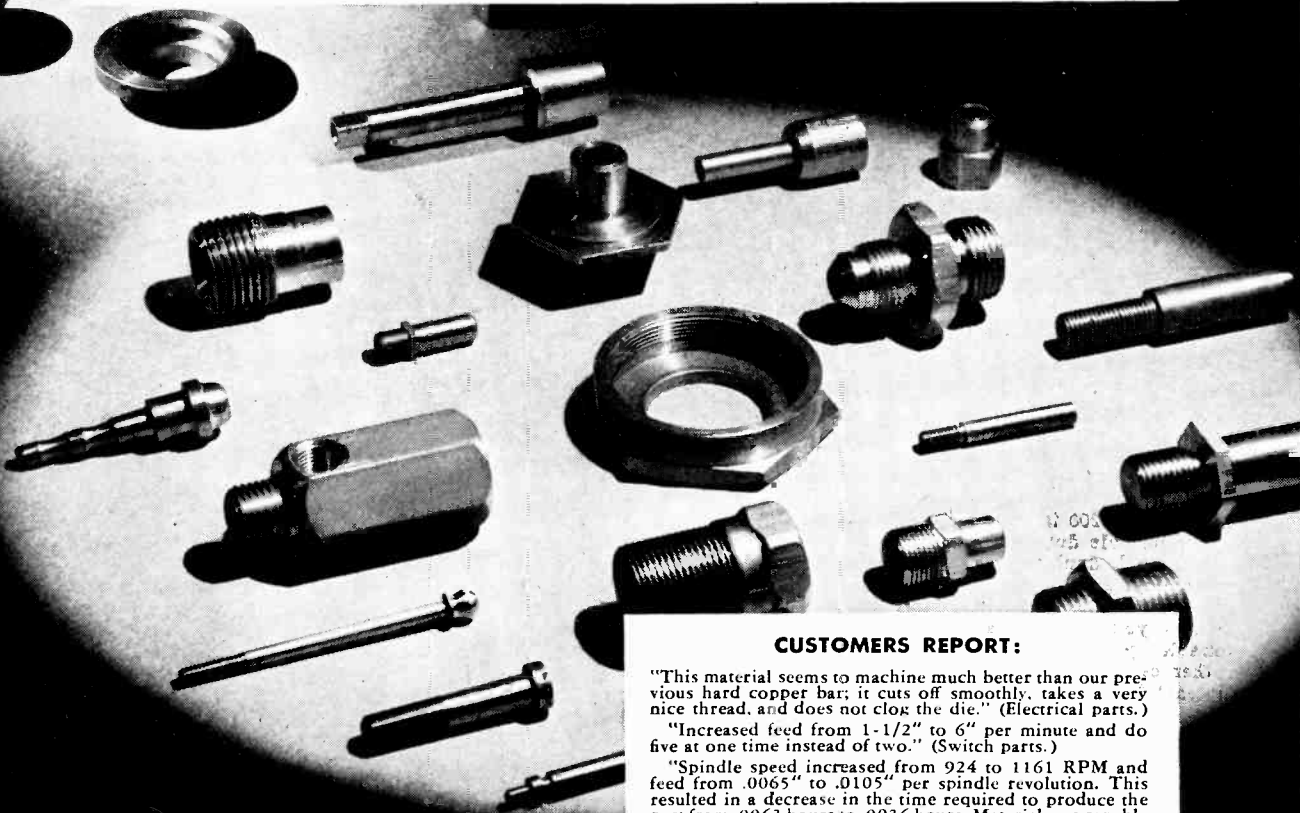

### CUSTOMERS REPORT:

"This material seems to machine much better than our previous hard copper bar; it cuts off smoothly, takes a very nice thread, and does not clog the die." (Electrical parts.)

"Increased feed from 1-1/2" to 6" per minute and do five at one time instead of two." (Switch parts.)

"Spindle speed increased from 924 to 1161 RPM and feed from .0065" to .0105" per spindle revolution. This resulted in a decrease in the time required to produce the part from .0063 hours to .0036 hours. Material was capable of faster machine speeds but machine was turning over at its maximum. Chips cleared tools freely, operator did not have to remove by hand." (Disconnect studs.)



# Still your best choice for **V-H-F**

● Pre-war pioneers, the HY75, HY114B, and HY615 offered new conceptions of low-cost efficiency on the very high frequencies. Radio amateurs, who did so much to open up these frequencies, piled up innumerable long distance transmitting and receiving records with the tubes. The HY75 and HY615 powered wartime WERS nets of amateurs almost exclusively

● A.R.R.L. and Radio handbooks have always been lavish in using the HY75, HY114B, and HY615 in equipment they described. The Abbott TR-4 transmitter-receiver contributed much to the fame of the HY75 and HY615. Maximum ratings up to 300 mc. (efficient circuit design permits even higher frequencies) spell continued popularity on the new "ham" bands.

● Popularity of this famous trio has not been confined to amateur circles. In all important war laboratories, the tubes were widely used. During many invasion thrusts in the Pacific, the HY75 and HY615 gave the Navy dependable intership communications. The HY75 design led to the Hytron 2C26A — r.f. pulse output tube of IFF (identification friend or foe), standard Army and Navy equipment for planes in combat areas. Developed from the HY615, the Hytron E1148 was in practically every British vehicular transmitter. The HY114B found its place in radar test equipment.

● Wherever real power output from small triodes is required on v-h-f, the HY75, HY114B, and HY615 still are your best choice. They fill a gap between "acorns" and miniatures which have limited power capabilities and larger triodes which cost much more. Brief data can give but a thumbnail sketch. You can best appreciate their superiority by putting the HY75, HY114B, and HY615 to work in your sockets.



## HYTRON V-H-F TRIODES

The HY75, HY114B, and HY615 are v-h-f triodes particularly suited as r.f. oscillator-amplifiers and as high sensitivity superregenerative detectors for fixed, mobile, or portable receivers, transmitters, transceivers, or transmitter-receivers. All three tubes feature short connection leads, low interelectrode capacitances, plate and grid connections to twin top caps, convenient octal bases, and a maximum operating frequency of 300 mc. for full plate input. Note in the HY75: low-loss lava insulation, rigidly supporting—for maximum resistance to shock and vibration—the graphite anode, vertical-bar grid, and instant-heating helically-coiled filament. The tiny HY114B and HY615 are capable respectively of 1.4 and 4 watts Class C output. The 1.4-volt filament of the HY114B makes it ideal for battery-operated portables.

CHARACTERISTIC	HY75	HY114B	HY615
Filament Potential (volts)	6.3	1.4	6.3
Filament Current (amps.)	2.6	0.155	0.175
Type of Filament	Thor.	Oxide	Cath.
Plate Potential (max. volts)	450	180	300
Plate Current (max. ma.)	80	12	20
Plate Dissipation (max. watts)	15	1.8	3.5
Grid-to-Plate Cap. (mmfd.)	3.8	1.3	1.6
Grid-to-Cathode Cap. (mmfd.)	1.6	1	1.4
Plate-to-Cathode Cap. (mmfd.)	0.6	1	1.2
Max. Operating Frequency (mc.)	300	300	300
Maximum Height (inches)	3 <sup>7</sup> / <sub>8</sub>	2 <sup>1</sup> / <sub>2</sub>	2 <sup>3</sup> / <sub>8</sub>
Maximum Diameter (inches)	1 <sup>7</sup> / <sub>8</sub>	1 <sup>3</sup> / <sub>8</sub>	1 <sup>3</sup> / <sub>8</sub>
Class C Power Output (watts)	21	1.4	4



OLDEST MANUFACTURER SPECIALIZING IN RADIO RECEIVING TUBES

# HYTRON

RADIO AND ELECTRONICS CORP.



MAIN OFFICE: SALEM, MASSACHUSETTS

Try it!  
Compare it!

**\$129\***  
AMATEUR NET  
LESS SPEAKER

# HQ-129-X

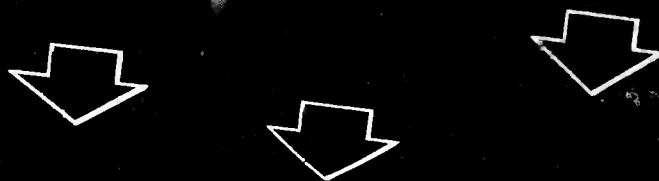

Price subject  
to change  
without notice.

Frequency  
31—.54  
Megacycles

Try — then compare, and you'll agree that this professional receiver is an outstanding value. It is built by craftsmen who specialize in communication equipment. The HQ-129-X has endless improvements which are fully described in an eight-page booklet . . . Write today for complete technical information.



# HAMMARLUND

THE HAMMARLUND MFG. CO., INC., 460 W. 34<sup>TH</sup> ST., NEW YORK 1, N. Y.  
MANUFACTURERS OF PRECISION COMMUNICATIONS EQUIPMENT



# COMPRESSOR AMPLIFIERS



Compressor Amplifier E-165

## BY PRESS WIRELESS

- RAPID COMPRESSION** Less than 0.5 millisecond
- FLAT COMPRESSION CHARACTERISTICS** Output rises only 2.5 db for 20 db input above compression threshold
- FAST COMPRESSION RELEASE** 250 and 750 milliseconds
- LOW DISTORTION** ½% or less below compression threshold  
Less than 1½% with 15 db compression
- LOW NOISE LEVEL** 60 db below output level at compression threshold
- FREQUENCY RESPONSE** Within ±1 db from 50-10,000 cps.
- AMPLIFICATION** 45 db

Standard 19 Inch Rack Mounting

Operates from 110/115 volts, 50/60 cycles AC

Send for free data sheet

## PRESS WIRELESS, INC.

Executive and Sales Office, 1475 BROADWAY, NEW YORK 18

PARIS · NEW YORK · CHICAGO · LOS ANGELES · LONDON · HAVANA  
RIO DE JANEIRO · MONTEVIDEO · MANILLA · BERNE · SANTIAGO DE CHILE



Awarded to  
the Hicksville,  
L. I. plant for outstanding  
achievement in war pro-  
duction.

### OPPORTUNITIES

Opportunities in present & postwar work for Senior and Junior Graduate Engineers.

Phone, call or write, stating experience, education, etc.

Personnel Department,  
Manufacturing Division,

**PRESS WIRELESS, INC.**

1475 Broadway  
N. Y. C. - 18





**SERVES**

**THE ELECTRONIC**

**INDUSTRY**

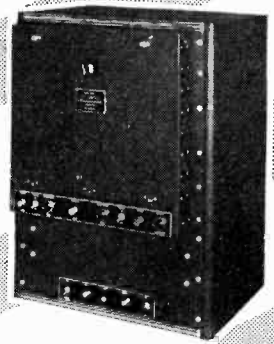

**ROTOBRIDGE**



**CML 1500**



**CML 1100**

**CML 1110**

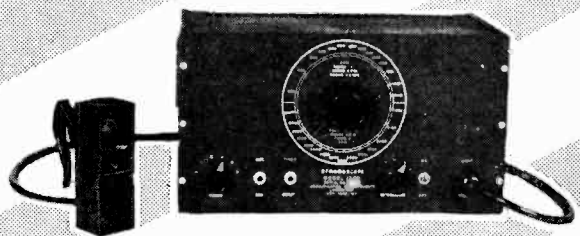

**CML 1200**

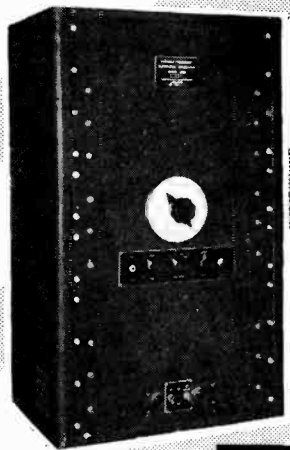

**CML 1420**

CML serves with ideas . . . with engineering ability . . . with the kind of foresight that develops equipment to meet tomorrow's experimental and production needs. Just as CML units made their efficiency felt in wartime needs, so will they contribute to the requirements of this fast-moving industry's peacetime future. BULLETINS AVAILABLE.

CML will be at the convention with a cordial welcome to all visiting I.R.E. members.

**COMMUNICATION MEASUREMENTS LABORATORY**  
**120 GREENWICH STREET, NEW YORK 6, N. Y.**

# NOW in PRODUCTION FOR EARLY 1946 DELIVERY

## *Federal's Complete FM Broadcast Equipment*

**STUDIO EQUIPMENT • FM TRANSMITTERS • ANTENNAS AND TOWERS**

With production now under way, Federal will deliver 1 and 3 KW FM Transmitters early in 1946...delivery of the 10 and 50 KW following shortly thereafter...featuring the latest in design, circuits, tubes and technique for unsurpassed operations in the new 88-108 mc. band.

Available with these transmitters will be complete associated equipment—from microphone to antenna—entire FM Broadcasting Systems...supplied by one experienced and dependable

source—Federal...for more than three decades a leading contributor to radio progress.

Federal engineers are ready to consult with you...help plan every step of your installation...and then stay with the job until your station is in completely satisfactory operation. And Federal assumes full responsibility for the performance of its equipment.

Call in Federal now...be among the first on the air with the finest in FM Broadcasting.

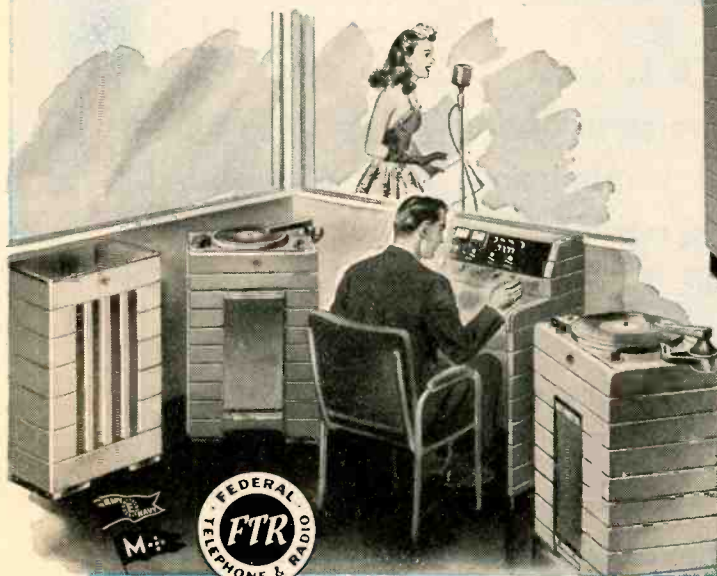

Write for brochure "Complete FM... by Federal" descriptive of Federal's complete FM Radio Broadcast Equipment from microphone to antenna.



## *Federal Telephone and Radio Corporation*



Newark 1, N. J.



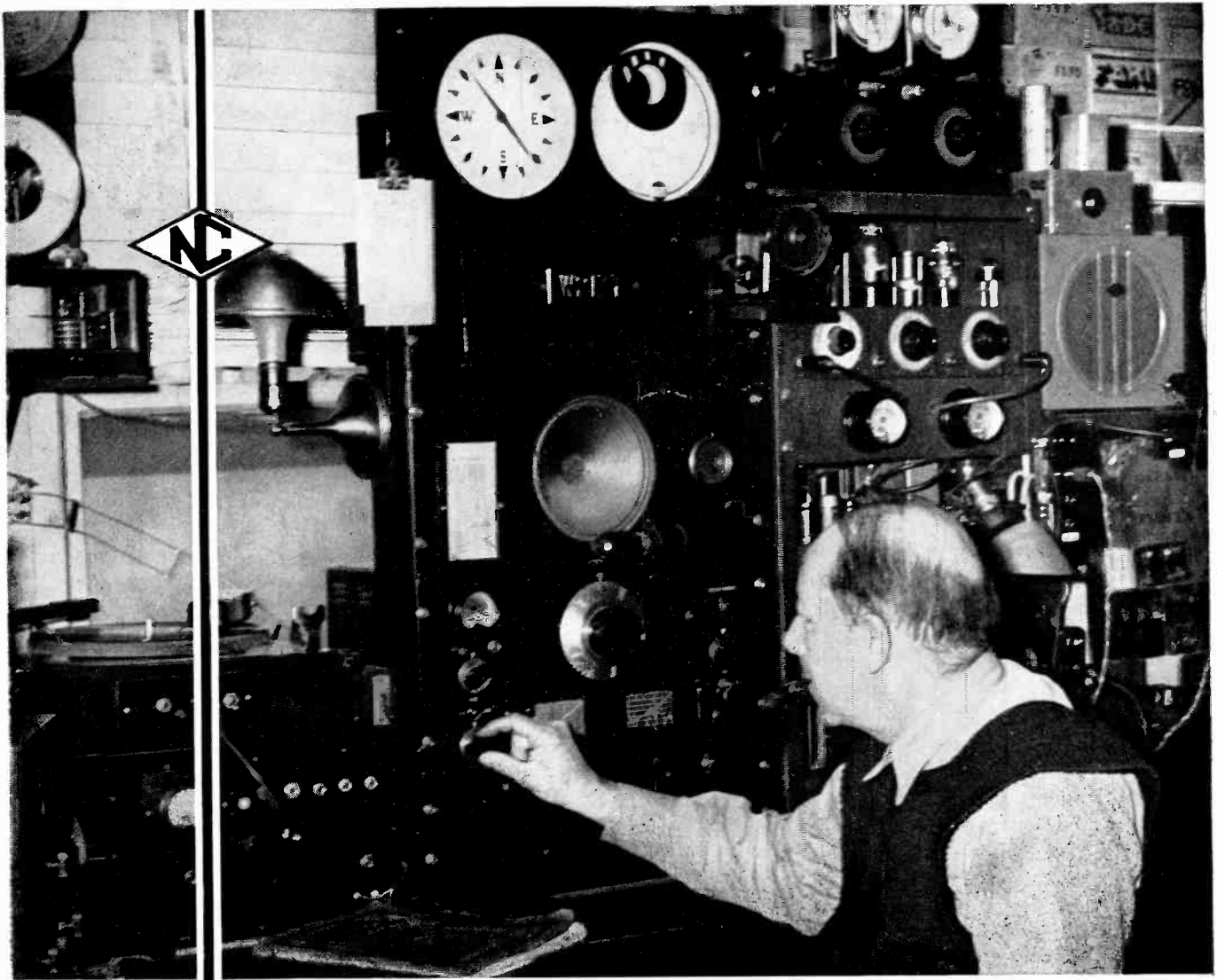

**C**APTAIN HORACE L. HALL, U.S. Merchant Marine, retired, at his home in Springfield, L.I., N.Y., made daily recordings of transmissions from Australia, for more than four years, missing but four days. The apparently harmless news broadcasts kept the Australian Government in New York and Washington informed of every phase of the progress of the war, by a pre-arranged code.

The National HRO, used for this remarkable accomplishment is the first ever to have been shipped into the New York area and is over ten years old.

**NATIONAL COMPANY INC., MALDEN, MASS.**

# MICA CERAMIC INSULATION

*Molded* TO YOUR SPECIFICATIONS

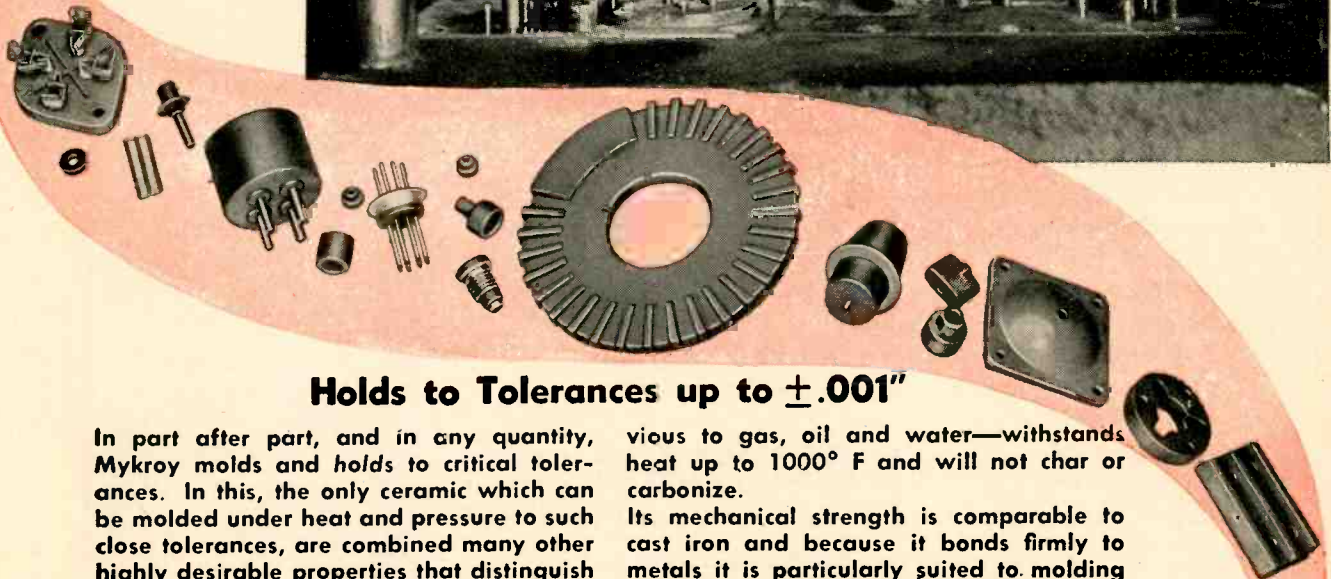

## Holds to Tolerances up to $\pm .001''$

In part after part, and in any quantity, Mykroy molds and holds to critical tolerances. In this, the only ceramic which can be molded under heat and pressure to such close tolerances, are combined many other highly desirable properties that distinguish Mykroy from all other types of insulating materials.

Unique in the class of glass-bonded mica ceramics, Mykroy possesses electrical characteristics of the highest order which do not shift under any conditions short of actual destruction of the material itself. Furthermore it will not warp—is imper-

vicious to gas, oil and water—withstands heat up to 1000° F and will not char or carbonize.

Its mechanical strength is comparable to cast iron and because it bonds firmly to metals it is particularly suited to molding parts with metal inserts. Even where price is a factor it competes with many standard insulating materials of lower electrical properties.

For improved performance and better quality in your new products investigate the many advantages of Mykroy. Write for samples and full information.



MADE EXCLUSIVELY BY

**ELECTRONIC MECHANICS INC.**

70 CLIFTON BLVD., CLIFTON, N. J.  
CHICAGO 47; 1917 N. Springfield Ave., Tel. Albany 4310  
EXPORT OFFICE: 89 Broad Street, New York 4, New York



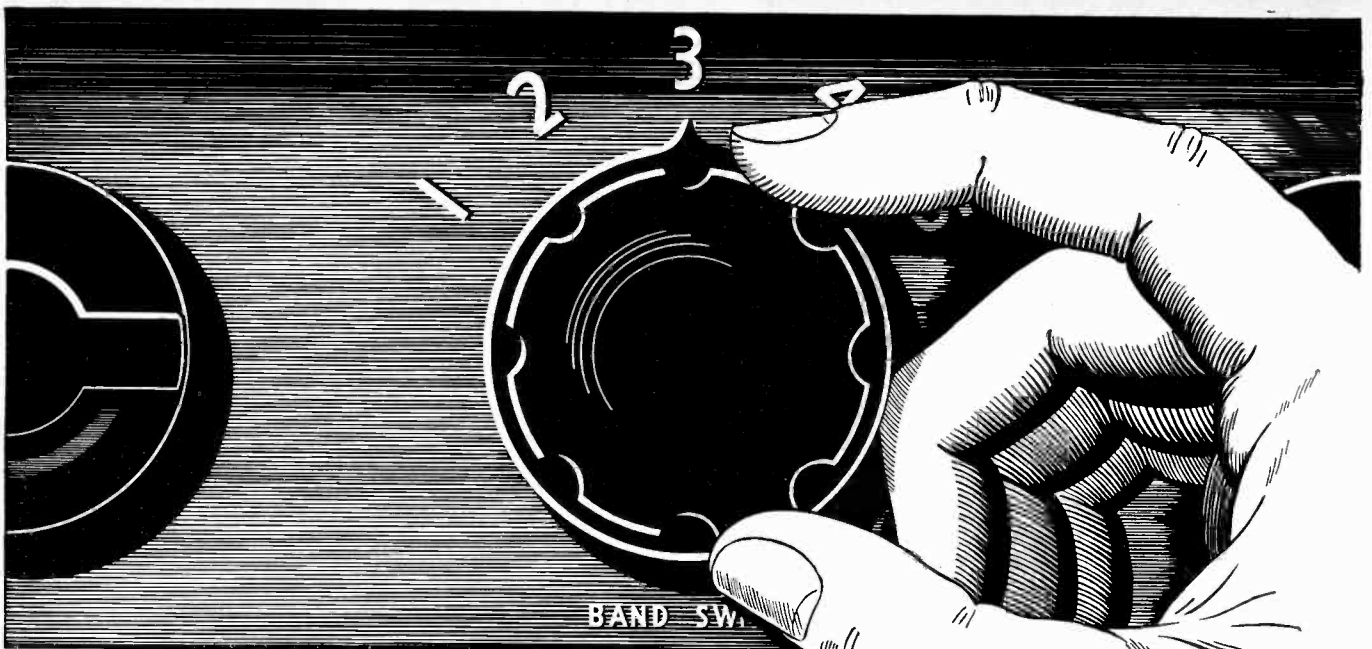

## For easier bandswitching use the 257B Gammatron!

The HK-257B beam pentode, originated by Heintz and Kaufman engineers, facilitates the design, construction, and operation of multi-band transmitters since it requires very little driving power and no neutralization.

The wiring diagram below shows a transmitter capable of operating on all amateur bands from 10 to 160 meters. A single 6V6 metal tube in the oscillator circuit drives the r.f. amplifier to its full output. The precise internal shielding of the HK-257B makes neutralization unnecessary.

Write today for complete data on the 257B Gammatron, a versatile tube capable of very high frequency operation.

### HEINTZ AND KAUFMAN LTD.

SOUTH SAN FRANCISCO • CALIFORNIA



Export Agents: M. Simon and Son Co., Inc.  
25 Warren Street • New York City

KEEP IT UP...BUY WAR BONDS

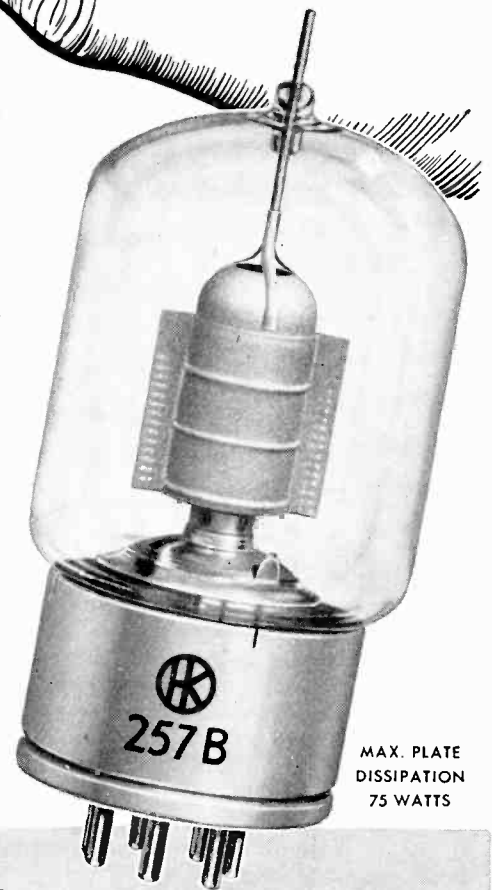

MAX. PLATE  
DISSIPATION  
75 WATTS

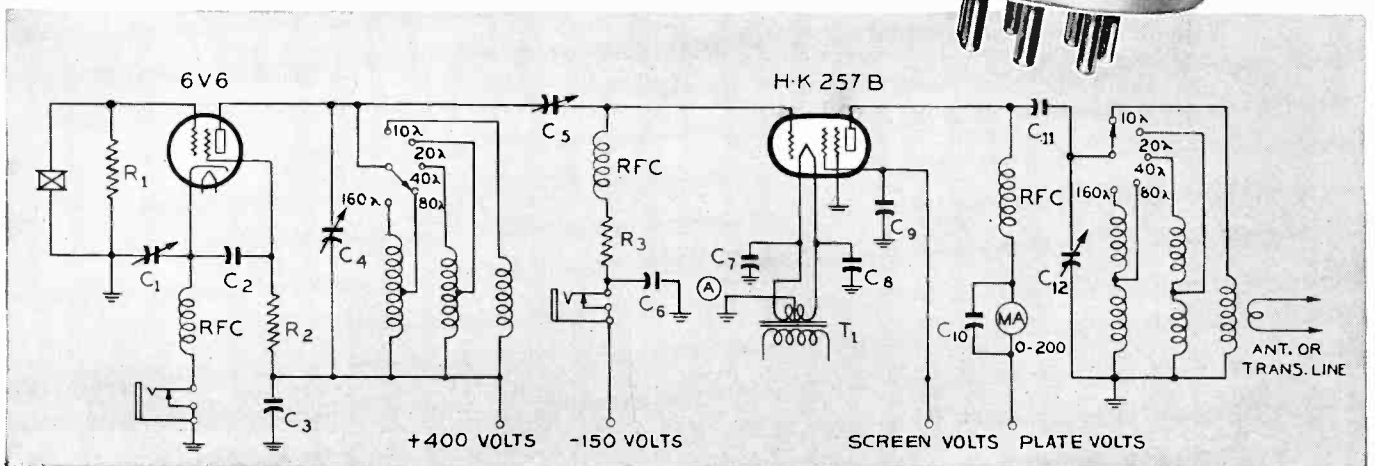

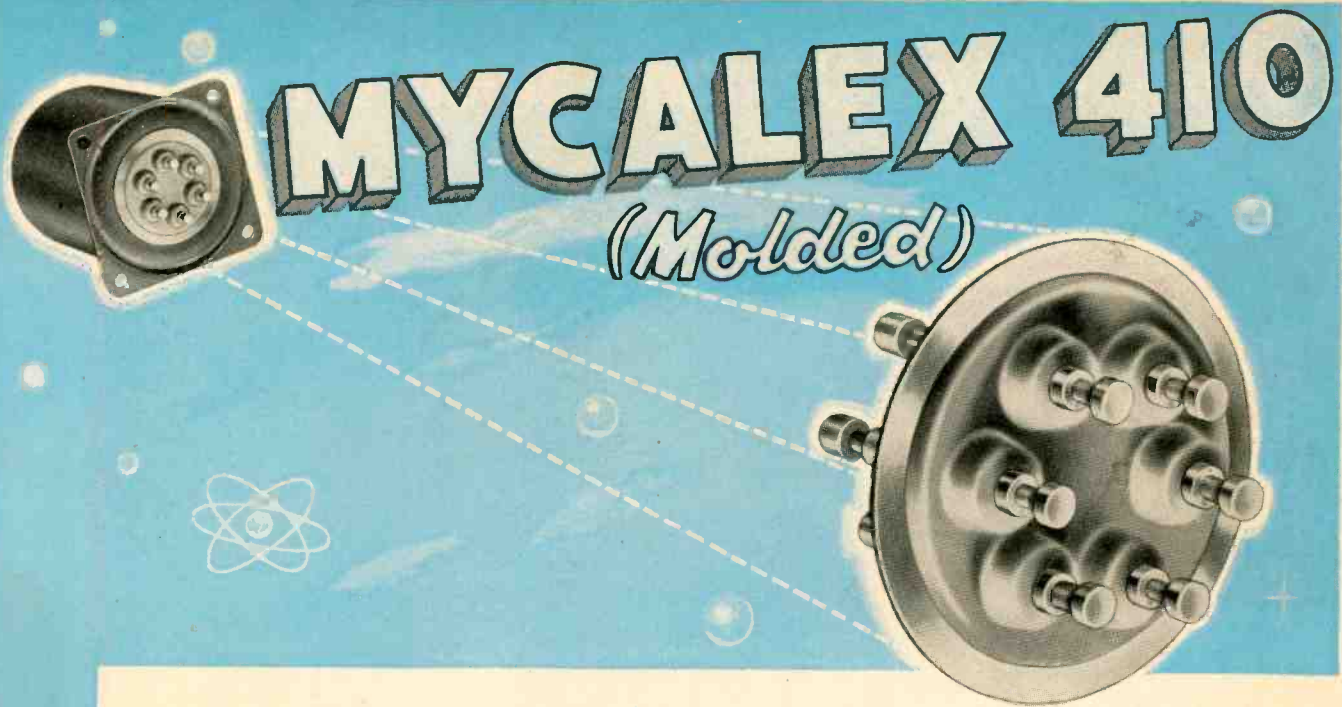

# MYCALEX 410

(Molded)

UNITED TRANSFORMER CORPORATION  
 150 VARICK STREET NEW YORK 13, N. Y.  
 November 3, 1945

Mycalex Corp. of America  
 30 Rockefeller Plaza  
 New York 20, N. Y.  
 Attention: Mr. Jerome Taishoff

Gentlemen:

We have conducted the following test on the two-six terminal molded mycalex assemblies you submitted:

- 1 - Meg test - 500 megohms
- 2 - Place in oven at 40°C for 8 hours
- 3 - Place in hot sodium chloride at 65°C for 1 hour
- 4 - Place in cold sodium chloride at 0°C for 1 hour
- 5 - Leave overnight in salt water at room temperature 20°C
- 6 - Meg test - infinity test

This test was repeated three times. At the end of the test the unit was tested for leakage and showed a small amount. This amount was within the limitations imposed by the Army Signal Corps. After the assemblies had dried for about 15 minutes they indicated no leakage. We consider these terminals to be extremely satisfactory for hermetic sealing purposes.

We wonder what would happen if these same 6 terminals were compressed into a smaller diameter assembly? We would greatly appreciate receiving samples of your single terminal assemblies.

Yours very truly,  
*S. W. Levy*  
 S. W. Levy  
 Chief Production Engineer

## MAKES "EXTREMELY SATISFACTORY HERMETIC SEAL" REPORTS

*United Transformer Corp.*

Are you seeking a hermetic seal for transformer terminals? Do you want a low loss, high frequency insulating material that will bond to metal and give positive assurance against oil leakage and the damaging effects of moisture?

Then read the United Transformer Corporation report made after tests of MOLDED MYCALEX in conjunction with Monel Metal in this application. The results speak for themselves.

For 25 years MYCALEX has been known to engineers the world over as the "most nearly perfect high frequency low loss insulation." Now, in highly perfected form, MYCALEX offers new opportunities for product improvement.

Specify MYCALEX where low loss factor and high dielectric strength are required. Our engineers are at your service.



**MYCALEX CORPORATION OF AMERICA**  
 "Owners of 'MYCALEX' Patents"  
 Plant and General Offices, CLIFTON, N. J. Executive Offices, 30 ROCKEFELLER PLAZA, NEW YORK 20, N. Y.



# Short Waves Demand Small Dimensions



ACTUAL SIZE. RCA Leads the Way In Metal, Glass and Miniature Electron Tubes

## IN TUBES, RCA MINIATURES ARE THE ANSWER for FM—for Television—for HF Communications

Consider these advantages of RCA Miniature Tubes for high-frequency applications:

**HIGH GAIN**—Lower inter-electrode capacitances and reduced lead inductance values improve circuit performance.

**LOW LOSS**—The short, low-resistance element leads serve as the contact pins; these, with the glass button seal provide a low-loss base.

**LESS SPACE**—Small dimensions of tubes permit closer spacing of components on a smaller chassis.

**PREFERRED TYPES**—Mass production is concen-

trated on a few types that meet all normal design requirements, resulting in higher tube quality at lower prices.

RCA tube application engineers are ready to consult with manufacturers on any problems, concerning the use of electron tubes—metal, miniature, or glass. For technical information on RCA tubes, write RCA Commercial Engineering Department, Section D-18A, Radio Corporation of America, Harrison, N. J.

**THE FOUNTAINHEAD OF MODERN TUBE DEVELOPMENT IS RCA**



**TUBE DIVISION**

**RADIO CORPORATION of AMERICA**

**HARRISON, N. J.**

BOARD OF DIRECTORS, 1945

William L. Everitt  
*President*

Hendrik J. van der Bijl  
*Vice-President*

Raymond A. Heising  
*Treasurer*

Haraden Pratt  
*Secretary*

Alfred N. Goldsmith  
*Editor*

Lynde P. Wheeler  
*Senior Past President*

Hubert M. Turner  
*Junior Past President*  
1943-1945

Wilmer L. Barrow  
Frederick B. Llewellyn  
Harold A. Wheeler  
1944-1946

Raymond F. Guy  
Lawrence C. F. Horle  
William C. White  
1945-1947

Stuart L. Bailey  
Keith Henney  
B. E. Shackelford

1945  
E. Finley Carter  
Lewis M. Clement  
Ralph A. Hackbusch  
Donald B. Sinclair  
William O. Swinyard

•  
Harold R. Zcamans  
*General Counsel*

George W. Bailey  
*Executive Secretary*

William H. Crew  
*Assistant Secretary*

•  
BOARD OF EDITORS

Alfred N. Goldsmith  
*Editor*

•  
PAPERS COMMITTEE

Frederick B. Llewellyn  
*Chairman*

•  
PAPERS PROCUREMENT COMMITTEE

Dorman D. Israel  
*General Chairman*

Edward T. Dickey  
*Vice General Chairman*

# Proceedings

*of the* I·R·E

*Published Monthly by*

The Institute of Radio Engineers, Inc.

VOLUME 34

January, 1946

NUMBER 1

1946.....	Frederick B. Llewellyn	2 P
A New Method of Amplifying with High Efficiency a Carrier Wave Modulated in Amplitude by a Voice Wave.....	Sidney T. Fisher	3 P
The Transverse Electric Modes in Coaxial Cavities.....	Robert A. Kirkman and Morris Kline	14 P
Radio-Frequency Spectrum Analyzers.....	Everard M. Williams	18 P
Principal and Complementary Waves in Antennas.....	S. A. Schelkunoff	23 P
Probe Error in Standing-Wave Detectors.....	William Altar, P. B. Marshall, and L. P. Hunter	33 P
Contributors to the PROCEEDINGS.....		45 P
Advertising Index.....		86 A

WAVES AND ELECTRONS follows after page 46 P.

EDITORIAL DEPARTMENT

Helen M. Stote  
*Publications Manager*

Ray D. Rettenmeyer  
*Technical Editor*

Winifred Carrière  
*Assistant Editor*

William C. Copp  
*Advertising Manager*

Lillian Petranek  
*Assistant Advertising Manager*

Responsibility for the contents of papers published in the PROCEEDINGS rests upon the authors. Statements made in papers are not binding on the Institute or its members.



Changes of address (with advance notice of fifteen days) and communications regarding subscriptions and payments should be mailed to the Secretary of the Institute, at 450 Alnaip St., Menasha, Wisconsin or 330 West 42nd Street, New York 18, N. Y. All rights of republication, including translation into foreign languages, are reserved by the Institute. Abstracts of papers, with mention of their source, may be printed. Requests for republication privileges should be addressed to The Institute of Radio Engineers.

Copyright, 1946, by The Institute of Radio Engineers, Inc.





1946

F. B. LLEWELLYN, PRESIDENT-ELECT—1946

NOT surprising is the growth of the Institute of Radio Engineers during the past few years. The part played by radio and electronics during the war is, in itself, sufficient explanation. More important than the effect of numbers, however, is the increased attention by the public at large to the accomplishments and also to the opinions of engineers. This is a situation that places a very direct and important responsibility both upon the engineer as an individual and upon the technical and professional societies through which his viewpoints are expressed.

Two doors are before us. The one discloses a future where the engineers are plodding along, solving the technical problems as they appear, but taking no part in their broad impact upon the civic and economic factors of the day. In some ways it is a comfortable setting, but not an inspiring one, and the part of the engineer is little more than that of a more or less intelligent robot.

The other door opens on a much wider horizon, but in this case the engineers are assuming their whole responsibilities, as true Sons of Martha, not only in dealing with the strictly technical aspects of their problems, but also in guiding the destiny and application of their work. It is by no means a cloistered environment, but one where commercial, industrial, and economic factors are prominent in the scene. The engineer is required to deal with intangibles and with human nature, where the problems are much more difficult to solve than when confined to inanimate matter.

Yet is there any question which door we should enter? By training and temperament, engineers are capable of providing leadership in broad fields and they should recognize this responsibility. Engineers and scientists

who, together, formulate our technical advances, must and should participate actively in their subsequent use and application. It is the duty of every engineering organization to promote that participation by every means available.

Among the plans in this direction that have been formulated during the past few years is a proposed reorganization of our Board of Directors in a way to obtain a broader representation and to shift its administrative functions to the Executive Committee and the Executive Secretary, clearing the way for a more comprehensive consideration of issues and general policy.

Another departure in the same direction is the inclusion of "WAVES AND ELECTRONS" in our publications. This is expected to provide an expanded medium for the expression of engineering opinion on the social and civic applications of technical progress and on the function of engineers in carrying out those applications.

Of major importance also, are the plans for promoting the interchange of ideas among specialists within restricted fields, between specialists in different fields, and finally between different engineering groups and Societies. Under these categories come the sponsorship of specialized conferences by the Technical Committees, the formation of a Speakers' Bureau at the Headquarters office, and the promotion of co-operation with other engineering Societies, both in the Sections and at Headquarters.

These and other means are needed to carry the program ahead, and the active participation of every engineer is necessary for its accomplishment. With past performance as an incentive, can there be any doubt of the future? I wish that every engineer who can participate in Institute activities would write to me or to the Institute office, with a statement of his special inclinations.



# A New Method of Amplifying with High Efficiency a Carrier Wave Modulated in Amplitude by a Voice Wave\*

SIDNEY T. FISHER†, SENIOR MEMBER, I.R.E.

*Summary*—This paper describes a new high-efficiency amplifier circuit with a quantitative analysis of its operation. This circuit operates by dividing the wave in several sections, amplifying each section separately and recombining the sections in the output to produce a larger wave of the original form. The circuit has special application to controlled-carrier systems and relatively high efficiencies are obtained, the comparison with conventional arrangements being most favorable at low modulation levels.

## INTRODUCTION

THE PROBLEM of a high-efficiency linear amplifier is one with which radio engineers have been concerned for 25 years. Power amplifiers for either unmodulated or frequency-modulated carrier waves operate with such high efficiency, of the order of 75 per cent, that no considerable improvement is necessary. A power amplifier for a carrier wave modulated in amplitude by a speech wave still presents an outstanding problem, and it is the purpose of this paper to develop a general line of attack on the problem.

Several solutions have previously been offered. The most wide-spread arrangement in use today is the class C radio amplifier modulated at high level by a class B audio amplifier. Other more complex arrangements in less common use are the Chireix "out-phasing modulation" method, and the Doherty high-efficiency circuit.

## THE LINEAR-AMPLIFIER PROBLEM

When a wave containing amplitude modulation is to be amplified, the amplification must be closely linear. A conventional class B amplifier is linear, and when operated continuously at its maximum capacity, such an amplifier will have an efficiency of the order of 66 per cent. An amplitude-modulated wave has a value on peaks of modulation of twice the carrier value, so that a class B linear amplifier transmitting such a wave must have a maximum capacity twice that of the carrier wave unmodulated. Since, over any considerable period of time a voice modulating wave has a very low average value, we are not far wrong in considering the efficiency of the circuit for the carrier wave alone as its actual performance. The efficiency of the class B amplifier is about proportional to the root-mean-square value of the wave being transmitted by it, so that we have in conventional linear amplifiers intended for transmitting a carrier wave amplitude-modulated by a speech wave, and

where the modulation may reach 100 per cent, an average efficiency of only about 33 per cent. This means that, (for every watt delivered to the antenna, about two watts of power is dissipated as heat at the anodes of the output tubes.)

Two disadvantages are immediately apparent: first, the cost and difficulty of providing this relatively large amount of direct-current power at high voltage are considerable; and second, unduly large power-amplifier tubes must be employed in order safely to dispose of this amount of heat.

Aside from the question of efficiency of the power amplifier for the conventional transmission method, another factor should be considered. In an amplitude-modulated system, three major components are contained in the output wave; the carrier wave and two sideband waves. The two sidebands are equal in power, and together contain one half of the power contained in the carrier wave, for continuous maximum modulation. In other words, a radio transmitter with an unmodulated carrier of 100 watts, at maximum modulation transmits 150 watts, of which 25 watts is contained in the lower sideband, and 25 watts in the upper sideband. Telephonic speech may be assumed to have an average value of about 20 per cent of the maximum value over any considerable period of time. The total power in the two sidebands is, therefore, for average telephonic speech, not one half the power in the unmodulated carrier, but is given by the following expression:

$$\frac{\text{Sideband power for telephonic speech}}{\text{Unmodulated carrier power}} = \frac{1}{2} \times \frac{1}{5^2} = \frac{1}{50}$$

This means then that, for the 100-watt unmodulated carrier, the average sideband power over some period would be about 2 watts.

Since the intelligence is wholly contained in the sidebands and not in the carrier, the real efficiency of such a system is seen to be surprisingly low. Suppressed-carrier and controlled-carrier systems have been suggested and put to use in a wide variety of applications but have heretofore suffered from a rather fundamental disadvantage. If, for example, the amplitude of the carrier wave in a radio transmitter is adjusted by a circuit operating from the envelope of the audio modulating wave, so that for all values of the modulating wave the percentage modulation is kept close to 100 per cent, then in the conventional class B linear amplifier, which is required to raise this wave to a high power level, the efficiency will not be 33 per cent. Actually, it will be

\* Decimal classification: R 355.7. Original manuscript received by the Institute, January 11, 1945; revised manuscript received, July 17, 1945.

† F. T. Fisher's Sons, Ltd., Consulting Engineers, Montreal, Canada.



very much less, because the average value of such a wave will be much less over a period of time than the average value of the wave in a conventional system, which is very close to the unmodulated carrier wave. If we again assume the average value of the telephonic speech wave is about 20 per cent of the peak value, then in such a system we will have a carrier wave which has an average value of 20 per cent of the maximum carrier which the system will transmit, and this wave will therefore have  $1/25$  of the power of the maximum carrier rating.

Taking the case of the transmitter with 100-watt unmodulated carrier, the control of the carrier wave to maintain substantially complete modulation for all values of the audio modulating wave will not affect the peak rating which the power-amplifier stage must have, and we incur the serious disadvantage that this output stage will operate at an average power level of about  $1/25$  of its peak power rating. The over-all efficiency will therefore be very low (of the order of a few per cent) and the apparent advantage obtained by a controlled-carrier system has largely been offset by the low efficiency of the linear power amplifier which must be employed.

In the high-efficiency circuit of Doherty, linear amplification is obtained at an efficiency of around 60 per cent, which is very nearly twice the efficiency of the conventional class B modulated-wave amplifier. This efficiency of 60 per cent is the same order of efficiency as is achieved by a class C carrier amplifier modulated at high level by a class B audio amplifier, and the choice between the two systems lies in the practical details of components, ease of adjustment, and first cost, which for any individual application may be quite different for the two approaches to the problem. We have previously noted that, based on average speech, the sideband power is only about 2 per cent of the unmodulated carrier power, so that if we take the ratio of sideband power to direct-current input to the power-amplifier stage (which is actually a true statement of the utility of the conversion which we obtain in the power-amplifier stage of a radio transmitter) then it is seen that the true efficiency lies between 1 and 2 per cent, and we are back to the same order of efficiency as is obtained in a controlled-carrier system using a conventional class B linear amplifier. A controlled-carrier system using a Doherty or Chireix amplifier will have better efficiency than this, although the efficiency will still be in the region below 10 per cent, and for many applications where tuning over a frequency band is required, the complexity of these circuits is prohibitive.

#### PROPOSED CIRCUIT

On consideration of these facts, it is realized that this problem, one of the most important in all radio engineering because of the large use of radio transmitters for aircraft and other mobile uses where weight, size, tube

cost, and power requirements are serious considerations, requires a completely new attack. It is believed that the proposal which follows is a basically correct approach to the problem.

The anode dissipation in a vacuum tube goes to a low value when either the anode current is reduced to a low value without exceeding the allowable anode voltage, or the anode voltage is reduced to a low value without exceeding the maximum anode current. It will be obvious that the wave form which fulfills both these conditions will be transmitted with maximum efficiency, and that this wave form is a square-topped wave. In such a wave, the energy is completely contained in rectangular pulses which rise instantaneously from zero to the maximum value, and drop to zero from this maximum value instantaneously. The energy is therefore transmitted wholly during the time at which the maximum allowable anode current is being transmitted, and under this condition the ratio of voltage drop across the load to voltage drop across the tube is a maximum. If signaling systems were called upon to transmit only such wave forms, of constant amplitude, we would then have linear power amplifiers which would operate with an efficiency of the order of 90 per cent, using conventional tubes. It appears that a successful approach to the actual problem can be developed from this simple statement.

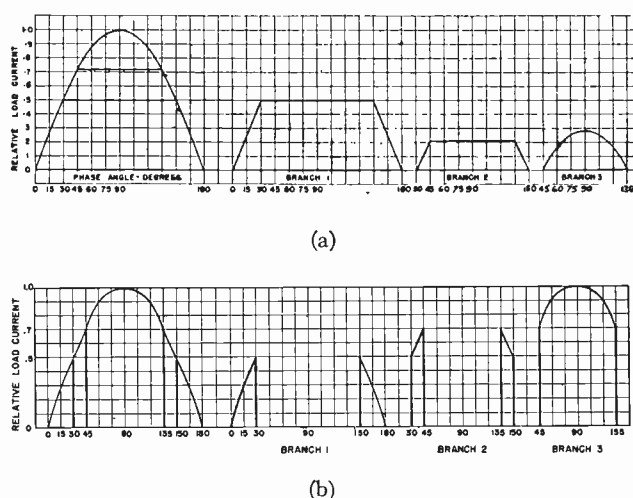

Fig. 1—Division of sinusoidal wave into sections, each of which can be amplified with higher efficiency than the original wave.

The solution to the problem resolves itself into changing the actual signal wave to the form in which it can be transmitted with the highest efficiency; that is, having it approach a square-topped wave as nearly as possible. Fig. 1 shows two ways in which this can be done. The wave can be divided into a number of sections, horizontally (Fig. 1(a)) or vertically (Fig. 1(b)), that is, on either an amplitude basis or a time basis. The method to be proposed therefore consists of the following steps: (1) Subdivision of the wave into components that approximate the optimum, rectangular wave form; (2) Amplification of these components separately in vacuum-

tube amplifiers; (3) Recombination of the separate components in the output circuit of the amplifiers so as to reproduce the original wave at a higher power. That is to say, high-efficiency amplification is achieved by dividing the wave on an amplitude basis into several sections, in practical cases, about three; transmitting each of the sections through a power amplifier whose peak allowable current is that of the section being transmitted, and then combining the three sections at the output by connecting the three amplifier branches to a common load circuit so that the original wave form is again obtained. This arrangement results in some circuit complexity, but increases by a large factor the plate-circuit efficiency of the amplifier. It also reduces the required tube complement, with a corresponding reduction in weight and size of the associated apparatus, since the increase in efficiency chiefly manifests itself in a reduction of the amount of power dissipated at the anodes of the power amplifiers.

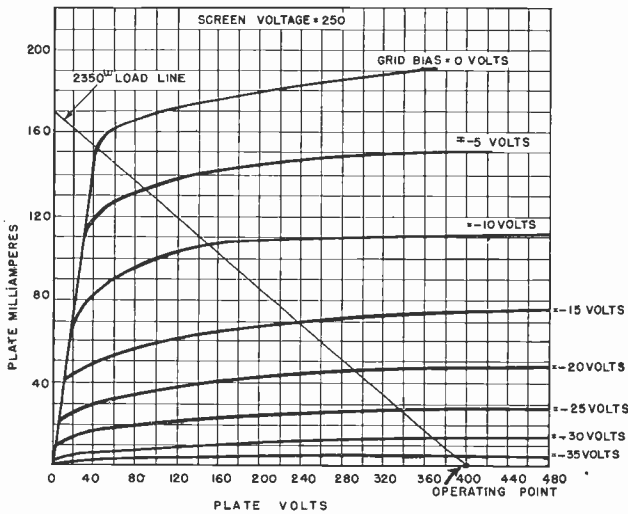

Fig. 2—Plate-current—plate-voltage characteristic of typical small beam tetrode, showing low voltage drop across tube at high values of plate current.

CIRCUIT OPERATION

An approximate way of regarding the system proposed is to think of it as a series of class C amplifiers, whose inputs are driven by different sections of the wave, the sections being selected by a combination of grid bias and grid drive in an arrangement which can be termed an "amplitude filter." Each branch then amplifies the section of the wave which it receives with higher efficiency and higher output than that with which it could handle the whole wave, and the sections of the group are combined in the output circuit so that a linear relation is obtained between input and output.

A reference to Fig. 2 demonstrates in a qualitative way the major point involved. This illustration shows the plate characteristic, and Fig. 3 shows the grid-voltage—plate-current characteristic of a typical small transmitting tube. When the tube is operated as a

class B amplifier into the rated load impedance, the plate current rises along the load line to a maximum value which is determined by the allowable anode heating and the allowable cathode current. It will be noted for the tube whose characteristics are given, that when the grid is driven to zero voltage, the maximum operating point for this tube, 10 per cent of the plate voltage appears across the tube, and 90 per cent across the load. That is to say, at this point the tube is transmitting

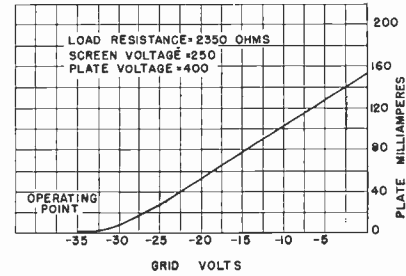

Fig. 3—Grid-voltage—plate-current characteristic of the tube of Fig. 2.

power at an instantaneous efficiency of 90 per cent. However, when the tube transmits a sine wave or a signal-modulated wave, only a small part of the energy is transmitted at, or near, this high-efficiency point, and most of the energy content of the wave is transmitted at much lower efficiencies; a sine wave being transmitted with about 60 per cent, and a modulated wave with about 35 per cent over-all efficiency. It will be apparent that this tube would transmit a square-topped wave with an efficiency of 90 per cent, so that for a given plate dissipation the tube would have a power output for the square-topped wave about four times greater than for the sine wave, and about six and one-half times greater than for the carrier wave 100 per cent modulated by a signal.

This leads to the present proposal of dividing the sine wave or modulated wave into a series of pulses, each of which has a form more nearly approaching the required

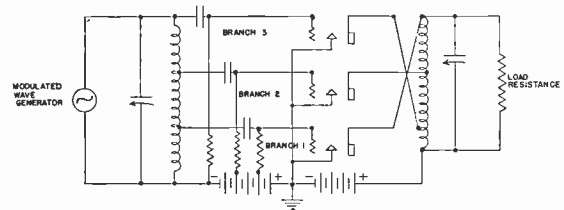

Fig. 4—Schematic circuit of a three-branch linear amplifier, with the grid drive and grid bias individually adjusted for each branch.

rectangular form, amplifying these pulses through separate power amplifiers whose peak allowable currents are the same as the maximum value of the pulses, and then recombining the pulses in a common load circuit to form the original wave form.

In practice this rather roundabout method has been found to work out with surprising ease. Fig. 4 shows an outline circuit of a three-branch modulated-wave linear

amplifier. Each of the three branches has its grid drive and grid bias individually adjusted so that the branches transmit current in sequence and not simultaneously. Branch 1 is biased at cutoff, so that it operates as a conventional class B amplifier. It receives the lowest grid drive. Branch 2 is biased beyond cutoff, and it has

branch 1 immediately starts to draw plate current, since it is biased to class B operation. As the wave advances it reaches a point, shown as a relative grid voltage of 1.0 and a relative load current of 0.5, where the peak allowable current of branch 1 tube is reached. At this point, the grid commences to draw current and biases itself back due to the direct voltage set up across the grid leak. At the same time the plate current of branch 1 decreases abruptly because at this point in the wave branch 2 has started to draw plate current and is delivering power to the load from a higher voltage source than does branch 1. Similarly, as the wave advances, branch 3 draws plate current and branch 2 at this point has its plate current abruptly reduced. The same process takes place in a reverse order when the wave has passed its maximum value and decreases again to zero. It will be seen that each tube operates linearly over a range of amplitude for which it delivers power, and nonlinearly outside this range. The three groups of pulses are delivered in sequence to the load resistance, and the way in which they combine is shown in Fig. 6. It might be mentioned that the illustrations shown are copies of oscilloscope patterns in an experimental amplifier.

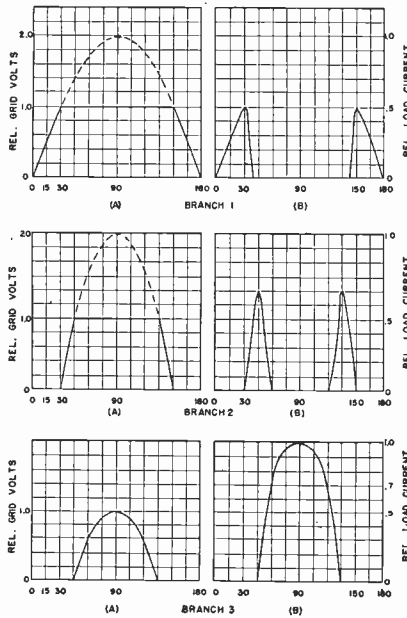

Fig. 5—Division of input wave through a three-branch amplifier.

a greater grid drive. Branch 3 is biased to about twice cutoff, and it has the highest grid drive. These three branches are connected to the load through a common plate coil, and their load impedances are adjusted about

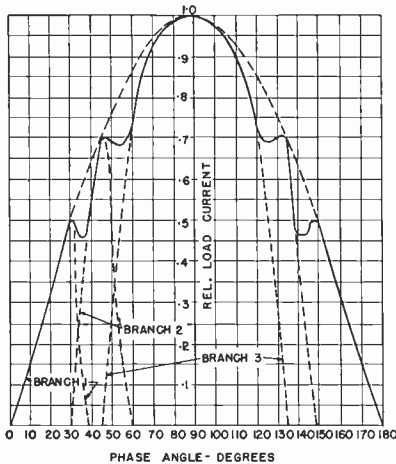

Fig. 6—Recombination of the wave sections of Fig. 5 in the output circuit of a three-branch amplifier.

in inverse proportion to the grid drive. Branch 1 has the highest load impedance, branch 2 an intermediate load impedance, and branch 3 a load impedance about one half that of branch 1.

The operation of this circuit can now be described with reference to Figs. 5 and 6. As the wave commences,

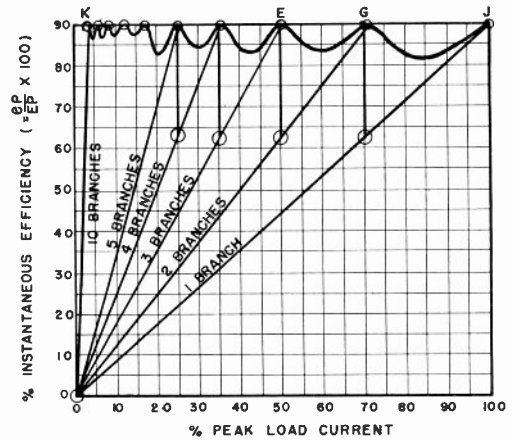

Fig. 7—Per cent instantaneous efficiency plotted against per cent peak load current, for the transmission of a sine wave through amplifiers of different numbers of branches.

It will be noticed that the recombined wave has, for a three-branch arrangement, an appreciable content of the ninth harmonic. Other distortion products are almost entirely lacking. In any radio-frequency application it is, of course, rather easy to reduce the ninth harmonic by any factor desired; and where this circuit is used for audio frequencies, the harmonic content can be reduced about as desired by the application of negative feedback.

EFFICIENCIES OBTAINED IN NEW CIRCUIT

It will be apparent that the efficiency of this circuit is high, even for low values of the wave being transmitted, since the instantaneous efficiency rises to about 90 per cent as the maximum current in each branch is reached. This is shown in Fig. 7, which is a plot of per



cent instantaneous efficiency against per cent peak load current for the transmission of a sine wave. For the conventional class B amplifier the efficiency is assumed to be proportional to the peak load current, rising to a value of about 90 per cent at 100 per cent of the allowable current. The plot shows how this efficiency curve varies as circuits of varying numbers of branches are used. In each case for which the data is given on this figure, the power ratio in successive branches is 2 to 1; that is, a 3-decibel separation. For a three-branch circuit, for example, the case illustrated by the previous wave-form curves, the instantaneous efficiency rises to 90 per cent at 50 per cent of the maximum load current, and the efficiency does not depart far from this value right up to the maximum power from the over-all circuit. For waves of low amplitude, the efficiency of this circuit is therefore quite good, and in fact is the same for waves of half the maximum amplitude as the efficiency of a conventional class B amplifier for waves of maximum amplitude. If as many as ten branches are used, then the efficiency of the

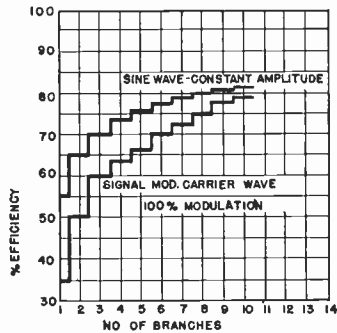

Fig. 8—Per cent efficiency of transmission of a sine wave and of a carrier wave 100 per cent modulated by a sine wave, through amplifiers of different numbers of branches. In each case, succeeding branches have a 3-decibel difference in output power.

circuit for waves of 4.4 per cent of the maximum amplitude is the same as the efficiency of the conventional circuit for waves of the maximum amplitude, and for waves of amplitude higher than 4.4 per cent, the efficiency steadily improves to a value in excess of 80 per cent for waves of the maximum amplitude.

Fig. 7, which was obtained experimentally, is further explained by Fig. 8, which shows the efficiency obtained in amplifiers of different numbers of branches in which 3-decibel separation exists between the branches. The efficiencies are shown both for a sine wave of constant amplitude, and for a signal-modulated carrier wave with 100 per cent modulation, and were derived experimentally using the tube whose characteristics are shown in Figs. 2 and 3. Based on this data, it appears that, for normal applications involving speech modulation, an arrangement of about three or four branches gives the practical compromise between efficiency and circuit complexity in the case of either type of wave. It is likely that for amplification of audio frequencies the greater complexity of the circuit, because of the impos-

sibility of tuning the load, would dictate a smaller number of branches, either two or three. In the audio-frequency case, the "amplitude-filter" arrangement is not so readily obtained by the adjustment of grid drive and grid bias of the power amplifiers, and for such applications it will occasionally be necessary to have separate signal-shaping driver stages, each power-ampli-

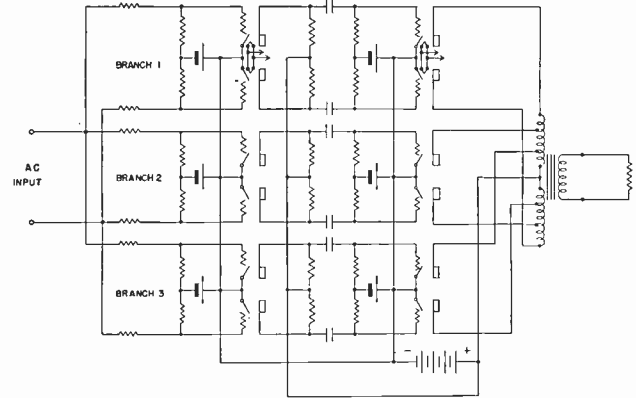

Fig. 9—Schematic circuit of a three-branch audio-frequency amplifier, with separate "signal-shaping" stages.

fier stage operating as a conventional class B amplifier. Such a circuit for a push-pull three-branch audio-frequency amplifier is shown in Fig. 9. In this case the division of the signal into sections is accomplished by small driver tubes which accomplish their function by individual adjustments of the grid drive, grid bias, and plate load.

APPLICATION TO CONTROLLED-CARRIER SYSTEMS

It is apparent that the linear-amplifier system described, whose efficiency remains relatively high for low amplitudes of the transmitted wave, has special advantages to offer as a power amplifier for a signal-modulated wave in which the carrier is either controlled

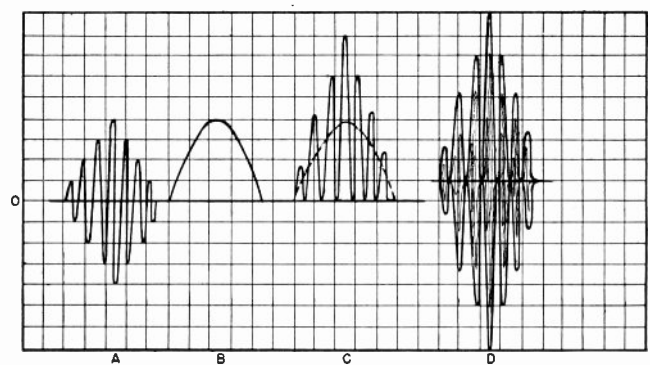

Fig. 10—Wave forms obtained in the operation of a controlled-carrier modulator.

so as to keep the per cent modulation substantially constant and high, or in which the carrier is suppressed. Since suppressed-carrier systems are of rather a special nature and require special receivers, consideration of a controlled-carrier system is of more interest in the present application. In a controlled-carrier system, in general

it is not necessary to use special receivers, and the transmission is essentially no different from constant-carrier systems.

The usual way in which a controlled-carrier system operates is to derive from the audio-frequency modulating wave a unidirectional pulse which has the form of the envelope of the audio-frequency wave. Thus in Fig. 10, the input wave *A* is rectified and filtered to provide the unidirectional pulse *B*. This pulse is then added to the original wave to form the unidirectional wave *C*. It is this wave which is introduced into the system ahead of the modulated-wave amplifier. This wave is applied to the modulated amplifier in such a way that, when no speech current exists, carrier is transmitted at only a very low level, say 5 per cent of the maximum capacity of the system. When speech current is applied, the carrier is increased proportionately to this current so that the output wave consists of a voice-modulated carrier wave whose modulation is substantially complete for all amplitudes of the voice wave. Such a wave is shown as *D* in Fig. 10. Since average voice modulation is only about 20 per cent, it is seen that the range of amplitudes of the output wave will vary, not in a ratio of 2 to 1 as in the conventional transmitter, but in a ratio of, say, 30 to 1, with the average amplitude about one fifth of the peak amplitude instead of about one half the peak amplitude as is the case in a conventional system. It will be recognized that these factors are responsible for the low efficiency of conventional linear amplifiers in controlled-carrier systems, and that the ability of the circuit outlined in the previous paragraphs to sustain its efficiency at low amplitude will be of great value for this type of transmission. For example, to consider again a transmitter with an unmodulated output of 100 watts, if this carrier is so controlled that it drops to, say, 5 watts in the absence of modulation, it will rise to a total value of 150 watts, averaged over an audio-frequency cycle, for 100 per cent modulation. Considering average modulation as 20 per cent, the average power content of the carrier plus the sidebands will be somewhat more than 6 watts. This value would be 6 watts if the carrier were completely suppressed during silent periods, but the constant carrier output of 5 watts combined with the modulation gives an average carrier plus sideband output of about 10 watts. This output power will be generated in a three-branch amplifier with an efficiency of around 30 per cent. This can be determined by applying the data of Fig. 7 to the wave form *D* of Fig. 10. That is to say, the direct-current input to this output stage will be about 33 watts for telephonic speech. This compares with the case of the conventional class B amplifier operating on a controlled-carrier system where, under similar conditions, the direct-current input is of the order of 200 watts, or of the class C carrier-amplifier modulated by the class B audio amplifier using a constant carrier where the direct-current input is about 300 watts.

## CONCLUSIONS

On a basis of direct-current power input, this arrangement therefore appears to have an advantage of at least 5 to 1 over circuits now in use, and in some cases this improvement might be 10 to 1. It is possible that these advantages will not in all cases be obtained in practical apparatus due to the greater circuit complexity, but substantially the improvement to be expected should be obtained. A further point is that with this circuit the total power dissipation of the output stage is now considerably reduced. For instance, in the example cited above, the power to be dissipated by the anodes of the power-amplifier tubes for average telephonic speech is about 23 watts. The power to be dissipated by the anodes of the power amplifier in a controlled-carrier system, using a conventional class B power stage is about 190 watts, and in an output stage in which a class C amplifier is plate modulated by a class B audio amplifier, it is about the same. The anode dissipation in the system described is therefore only about 15 per cent of that obtained in conventional systems, and the tube complement employed is of correspondingly smaller capacity.

## PRACTICAL VARIATIONS OF BASIC CIRCUIT

A large number of variations of this basic idea is obviously possible. Only the "vertical" division of the wave has been considered. "Horizontal" division is also possible, in which all branches may transmit current simultaneously; this would involve a bridge or hybrid-coil arrangement in the output, so that the branches could supply current simultaneously to the load, without mutual coupling. Both series and shunt plate-supply arrangements should be considered. In place of the "signal-shaping" arrangement employing adjustments of grid drive and grid bias to set up the sections of the wave, the plate current of one branch can be utilized to "trigger" the grid bias of the succeeding branch. By using a divided direct-current power supply, the branches can be arranged in parallel or in series to deliver power to a single load impedance, instead of the divided load described. The adaptations of this circuit to a modulated amplifier and to an oscillator are straightforward.

Special tubes, having a higher ratio of plate current to plate dissipation than those currently used, will have particular value in this circuit. New forms of tubes, employing multiple grids or multiple anodes, with heat interchange between the anodes, appear to have useful possibilities.

The foregoing material gives a qualitative description of the operation of the new circuit as a linear amplifier. A thoroughgoing theoretical analysis is hardly justified at this stage in the development of the art, since the textbooks provide an adequate background for this and most other configurations of the familiar circuit elements. Following the text is a series of appendixes,

written by E. S. Kelsey, which presents an analytical treatment of this circuit, together with comparisons of it with conventional and other high-efficiency circuits.

#### ACKNOWLEDGMENT

I am indebted to Mr. C. B. Fisher, of F. T. Fisher's Sons, Ltd., Montreal, who worked over the proposal in its early stages and first put it into a sound theoretical and practical form. Wing Commander K. R. Patrick, O.B.E., of the R.C.A.F. was of great assistance on the experimental side. Mr. E. S. Kelsey, research engineer, of electronics division, Northern Electric Company, Ltd. of Montreal, has prepared the appendixes that follow, and his keen insight into physical problems, together with his facility in analysis, have been of the greatest possible value.

#### APPENDIX I

##### EFFICIENCY OF AN AMPLIFIER FOR SIGNALS OF ARBITRARY WAVE FORM

In this appendix, formulas will be derived for the theoretical efficiency of an amplifier when the signal is of arbitrary wave form. Two conditions of plate supply require consideration; namely, constant-voltage series feed, and constant-current parallel feed. By applying the principle of duality, it will not be necessary to carry the analysis through for both cases, as the two circuits are duals and the equations for the two cases are similar, with currents and voltages interchanged.

##### Instantaneous Efficiency

With series feed, let  $E_B$  be the direct-current power-supply voltage,  $e_P$  the plate voltage, and  $e_T$  the voltage at the load terminals. Then

$$E_B = e_P + e_T.$$

Let the plate current be  $i_P$ ; if the load is connected directly in the plate circuit, this will equal the load current and the instantaneous power input and output will be

$$p_1 = E_B i_P$$

$$p_2 = e_T i_P$$

giving for the instantaneous efficiency

$$\frac{p_2}{p_1} = \frac{e_T}{E_B}. \quad (1)$$

If a transformer is used between the plate circuit and the load with a transformation ratio

$$n = e_T/e_L$$

the efficiency, neglecting transformer loss, will be

$$\frac{p_2}{p_1} = \frac{ne_L}{E_B}. \quad (2)$$

##### Efficiency for Complete Signal Wave

If a signal pulse of one polarity extends from time  $t=0$  to time  $t=T$  the total energy input is

$$W_1 = \int_0^T p_1 dt = E_B \int_0^T i_P dt.$$

Assuming for generality that a transformer is used having a transformation ratio  $n$

$$W_1 = \frac{E_B}{n} \int_0^T i_L dt. \quad (3)$$

Let the load resistance be  $R_L$  and the maximum values of load voltage and load current be  $E_M$  and  $I_M$ , respectively. The total energy output is

$$W_2 = \frac{E_M}{I_M} \int_0^T i_L^2 dt \quad (4)$$

and the efficiency is

$$\frac{P_2}{P_1} = \frac{W_2}{W_1} = \frac{nE_M}{E_B I_M} \frac{\int_0^T i_L^2 dt}{\int_0^T i_L dt}. \quad (5)$$

Let  $I_{AV}$  and  $I_{RMS}$  be the average and root-mean-square values of the load current over the time interval 0 to  $T$ . Then

$$\frac{P_2}{P_1} = \left( \frac{nE_M}{E_B} \right) \left( \frac{I_{RMS}^2}{I_M I_{AV}} \right). \quad (6)$$

The first term  $nE_M/E_B$  depends upon how nearly the plate-voltage drop at maximum load voltage (the difference between  $E_B$  and  $nE_M$ ) can be brought to zero. It will be convenient to have a name and symbol for this factor and it will therefore be called the voltage-utilization factor  $A$ . That is,

$$A = \frac{nE_M}{E_B}. \quad (7)$$

In terms of this factor, (3) becomes

$$W_1 = \frac{E_M}{A} \int_0^T i_L dt. \quad (8)$$

The second term depends only on the wave form. An alternative form for this function can be derived in terms of the ratio  $i_L/I_M$ . Writing  $u$  for this ratio, (8) and (4) become

$$W_1 = \frac{E_M I_M}{A} \int_0^T u dt \quad (9)$$

$$W_2 = E_M I_M \int_0^T u^2 dt \quad (10)$$

giving

$$\frac{P_2}{P_1} = \frac{W_2}{W_1} = A \frac{\int_0^T u^2 dt}{\int_0^T u dt}. \quad (11)$$



Since  $u$  is less than or equal to unity,  $u^2$  is less than or equal to  $u$ . Therefore the function

$$\left(\frac{I_{\text{RMS}}^2}{I_M I_{\text{AV}}}\right) \equiv \frac{\int_0^T u^2 dt}{\int_0^T u dt} \leq 1. \quad (12)$$

It can equal unity only for a rectangular wave pulse in which  $i = I_M$  and  $u = 1$  for the entire pulse.

#### Constant-Current Parallel Feed

The formula corresponding to (6) for efficiency in the case of constant-current parallel feed is

$$\frac{P_2}{P_1} = \left(\frac{n' I_M}{I_B}\right) \left(\frac{E_{\text{RMS}}^2}{E_M E_{\text{AV}}}\right). \quad (13)$$

The transformation ratio  $n'$  is the ratio of input current to load current, and the factor  $n' I_M / I_B$  is the ratio of load current to supply current. If we call this factor the current-utilization factor  $A'$ , it will be maximized by having the anode current (the difference between  $I_B$  and  $n' I_M$ ) as small as possible at maximum load current.

For a purely resistive load the wave-form functions for the series and parallel feed cases are equal; that is,

$$\left(\frac{E_{\text{RMS}}^2}{E_M E_{\text{AV}}}\right) = \left(\frac{I_{\text{RMS}}^2}{I_M I_{\text{AV}}}\right). \quad (14)$$

## APPENDIX II

### AMPLIFIER EFFICIENCY WITH TIME SUBDIVISION OF WAVE

#### General Formulas

Assume that at times  $T_1, T_2 \dots T_K$ , etc., the amplifier load is switched from branch 1 to 2, 2 to 3,  $\dots$   $K$  to  $K+1$ , etc. Two cases will be considered; namely, load-impedance switching as illustrated in Figs. 4 and 9, and supply-voltage switching as illustrated in Fig. 11. It will be noted that the circuit using supply-voltage

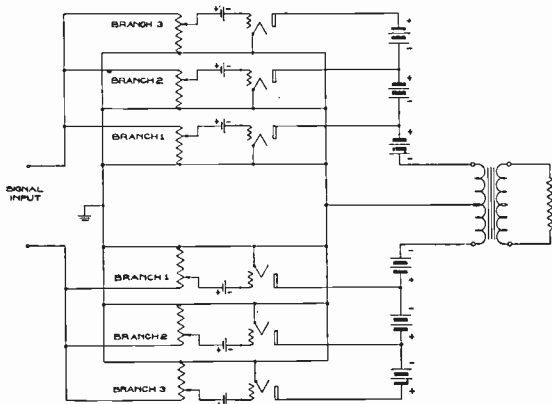

Fig. 11—Schematic circuit for switching supply voltage.

switching is not so convenient, as it requires the use of a power supply in which both terminals are above ground potential.

Let  $E_{MK}$  be the maximum load voltage during the

time interval  $t = T_{K-1}$  to  $t = T_K$  that branch  $K$  is operating, and let

$$E_{MK}/E_M = V_K$$

in which  $E_M$  is the maximum load voltage for the entire wave. It should be noted that  $V_K$  is less than unity for all branches except the one operating on the peak voltage  $E_M$ .

By (7) of Appendix I, if neither load-impedance nor supply-voltage switching were used, the voltage-utilization factor  $A_K$  for the  $K$ th branch would be

$$A_K = \frac{n E_{MK}}{E_B} = V_K A.$$

If it is assumed that the maximum voltage-utilization factor can be the same for all branches, then either the supply voltage can be decreased by the factor  $V_K$ , or the voltage-transformation factor increased by the reciprocal of this factor. That is, either

$$\frac{E_{RK}}{E_B} = V_K \quad (15)$$

or

$$\frac{n_K}{n} = \frac{1}{V_K}. \quad (16)$$

In either case, this will make the voltage-utilization factor for the  $K$ th branch equal to  $A$ . That is

$$\frac{1}{V_K} \left(\frac{n E_{MK}}{E_B}\right) = \left(\frac{n_K E_{MK}}{E_B}\right) = \left(\frac{n E_{MK}}{E_{BK}}\right) = A. \quad (17)$$

By (8) the energy input to the  $K$ th branch during the time interval  $t = T_{K-1}$  to  $t = T_K$  will be

$$W_{1K} = \frac{E_{MK}}{A_K} \int_{T_{K-1}}^{T_K} i_L dt. \quad (18)$$

If  $A_K$  is made equal to  $A$  either by reducing  $E_B$  to  $E_{BK}$  or by increasing  $n$  to  $n_K$ , the energy input becomes

$$W_{1K} = \frac{V_K E_M}{A} \int_{T_{K-1}}^{T_K} i_L dt. \quad (19)$$

Thus the energy input required during the time interval  $T_{K-1}$  to  $T_K$  has been reduced compared with that required with a conventional amplifier by the factor  $V_K$ .

#### Application to a Triangular Wave

Consider a triangular-shaped wave, that is, one in which the voltage and current increase linearly with time from zero to a maximum and then decrease linearly to zero again. During the phase of increasing current let

$$i_L = mt$$

and let  $i_L$  reach its maximum value at  $t = T_M$  so that

$$I_M = m T_M.$$

Using (8) of Appendix I, the energy input without branch subdivision would be

$$W_1 = \frac{E_M}{A} \int_0^{T_M} mtdt$$

$$W_1 = \frac{E_M I_M T_M}{2A} \quad (20)$$

and the energy output either with or without branch subdivision will be, by (4)

$$W_2 = \frac{E_M}{I_M} \int_0^{T_M} m^2 t^2 dt$$

$$W_2 = \frac{E_M I_M T_M}{3} \quad (21)$$

Therefore, without subdivision, the efficiency is

$$\frac{W_2}{W_1} = \frac{2}{3} A = 67 A \text{ per cent.}$$

Assume now that the load is switched from branch 1 to branch 2 when  $i = V_1 I_M$ . The time at which  $i$  reaches this value is  $T_1 = V_1 T_M$ . Using (19), the input to branch 1 will be

$$W_{11} = \frac{V_1 E_M}{A} \int_0^{T_1} i_L dt$$

$$W_{11} = W_1 V_1^3 \quad (22)$$

Similarly, the energy input to branch 2 will be

$$W_{12} = \frac{E_M}{A} \int_{T_1}^{T_M} i_L dt$$

$$W_{12} = W_1 (1 - V_1^2) \quad (23)$$

This gives for the total energy input

$$W_{11} + W_{12} = W_1 (1 - V_1^2 + V_1^3) \quad (24)$$

By differentiating with respect to  $V_1$  it will be found that for a minimum  $V_1 = 2/3$ . Using this value for  $V_1$  gives for the energy input 0.85  $W_1$  and for the efficiency 78.3  $A$  per cent.

#### Difference Equation for Determining Optimum Subdivision of Triangular Wave

The energy input for the  $K$ th branch will be

$$W_{1K} = \frac{E_K}{A} \int_{T_{K-1}}^{T_K} i dt$$

$$W_{1K} = \frac{E_M I_M T_M}{2A} (V_K^3 - V_{K-1}^2 V_K) \quad (25)$$

and for the  $(K+1)$ th branch

$$W_{1,K+1} = \frac{E_M I_M T_M}{2A} (V_{K+1}^3 - V_K^2 V_{K+1}) \quad (26)$$

The combined energy input to the  $K$ th and  $(K+1)$ th branches is

$$W_{1K} + W_{1,K+1} = W_1 (V_K^3 - V_{K-1}^2 V_K + V_{K+1}^3 - V_K^2 V_{K+1}).$$

If  $V_{K+1}$  and  $V_{K-1}$  are considered as fixed and  $V_K$  as

variable, the value of  $V_K$  which will result in minimum energy input into the two branches is found by differentiating with respect to  $V_K$  and equating to zero. This gives

$$3V_K^2 - V_{K-1}^2 + 2V_K V_{K+1} = 0. \quad (27)$$

If  $V_K$  is assigned the value required to satisfy this equation, it can then be considered as a difference equation expressing the condition to be satisfied for minimum power input and maximum efficiency.

Transposing, we have

$$V_{K+1} = \frac{3}{2} V_K - \frac{1}{2} \frac{V_{K-1}^2}{V_K}.$$

A more convenient form for this difference equation can be obtained as follows: Let

$$\frac{V_{K+1}}{V_K} = Q_K.$$

Then

$$Q_{K+1} = \frac{3}{2} - \frac{1}{2Q_K^2}. \quad (28)$$

With two branches  $Q_1 = 1/V_1$ . Since  $V_1$  has already been determined,  $Q_1$  is known and values of successive  $Q$ 's are readily calculated. The first five are

$$Q_1 = 1.500$$

$$Q_2 = 1.278$$

$$Q_3 = 1.194$$

$$Q_4 = 1.15$$

$$Q_5 = 1.12.$$

#### Power-Input and Output Formulas

A formula for the total energy input to  $N$  branches subdivided for optimum efficiency can be obtained as follows:

Let the energy input be

$$\sum_1^N W_{1K} = C_N \frac{E_N I_N T_N}{2A} \quad (29)$$

where the coefficient  $C_N$  is to be determined. For  $N-1$  branches we have

$$\sum_1^{N-1} W_{1K} = C_{N-1} V_{N-1}^3 \left( \frac{E_N I_N T_N}{2A} \right)$$

$$= \left( \frac{C_{N-1}}{Q_N^3} \right) \left( \frac{E_N I_N T_N}{2A} \right) \quad (30)$$

and for the  $N$ th branch

$$W_{1N} = \frac{E_N I_N T_N}{2A} \left( 1 - \frac{1}{Q_{N-1}^2} \right) \quad (31)$$

Equating (29) to the sum of (30) and (31) gives

$$C_N = \left( \frac{C_{N-1}}{Q_N^3} + 1 - \frac{1}{Q_{N-1}^2} \right).$$

Differentiating gives, for a minimum value of  $C_N$ ,

$$Q_{N-1} = \frac{3}{2} C_{N-1}$$

so that

$$C_N = \frac{2}{3} \frac{1}{Q_N}. \quad (32)$$

Substituting in (29) gives

$$\sum_1^N W_{1K} = \frac{2}{3} \frac{W_1}{Q_N}. \quad (33)$$

From (21) and (29) the efficiency with optimum subdivision is

$$\frac{W_2}{W_1} = \frac{2}{3} \frac{A}{C_N} = \frac{A}{Q_N}. \quad (34)$$

The power input to the  $K$ th branch, from (31), is

$$W_{1K} = W_1 V_K^3 \left\{ 1 - \frac{1}{Q_{K-1}^2} \right\} \quad (35)$$

and the power output, by integration of (4), is

$$W_{2K} = W_2 V_K^3 \left\{ 1 - \frac{1}{Q_{K-1}^3} \right\}. \quad (36)$$

#### Theoretical Results for 1000-Watt Amplifier—Triangular Wave

Table I gives theoretical efficiencies, branch-voltage factors, and power distribution between branches, calculated from the foregoing formulas with from one to five branches. The voltage-utilization factor  $A$  was taken as 0.9, and the output power as 1000 watts in all cases.

TABLE I

One Branch—Efficiency 60 per cent						
Power Input—watts						Total
Power Output—watts						1670
Plate Dissipation—watts						1000
						670
Two Branches—Efficiency 70.5 per cent						
	Branch 1	Branch 2	Total			
Voltage Factors ( $V_k$ )	0.67	1.00				
Power Input—watts	490	930	1420			
Power Output—watts	300	700	1000			
Plate Dissipation—watts	190	230	420			
Three Branches—Efficiency 75.4 per cent						
	Branch 1	Branch 2	Branch 3	Total		
Voltage Factors ( $V_k$ )	0.47	0.78	1.00			
Power Input—watts	240	440	650	1330		
Power Output—watts	140	340	520	1000		
Plate Dissipation—watts	100	100	130	330		
Four Branches—Efficiency 78.5 per cent						
	Branch 1	Branch 2	Branch 3	Branch 4	Total	
Voltage Factors ( $V_k$ )	0.44	0.66	0.84	1.00		
Power Input—watts	140	265	375	500	1280	
Power Output—watts	85	200	300	415	1000	
Plate Dissipation—watts	55	65	75	85	280	
Five Branches—Efficiency 80.4 per cent						
	Branch 1	Branch 2	Branch 3	Branch 4	Branch 5	Total
Voltage Factors ( $V_k$ )	0.38	0.57	0.73	0.87	1.00	
Power Input—watts	90	170	260	320	410	1250
Power Output—watts	60	130	205	265	340	1000
Plate Dissipation—watts	30	40	55	55	70	250

#### Application to a Sinusoidal Wave

Let the load current during the time interval  $t=0$  to  $t=T_M$  be

$$i_L = I_M \sin \frac{\pi}{2} \left( \frac{t}{T_M} \right) = I_M \sin \theta. \quad (37)$$

The input energy will be

$$W_1 = \frac{2}{\pi A} E_M I_M T_M \quad (38)$$

and the output energy

$$W_2 = \frac{1}{2} E_M I_M T_M \quad (39)$$

giving for the efficiency without subdivision

$$\frac{W_1}{W_2} = \frac{\pi A}{4}. \quad (40)$$

Next assume subdivision between two branches with change-over occurring at  $i = \sin(\pi/2\alpha) = \sin \theta_\alpha$  so that  $T_1 = \alpha T_M$ . The input energy for branch 1 will be

$$W_{11} = W_1 (1 - \cos \theta_\alpha) \sin \theta_\alpha$$

and for branch 2

$$W_{12} = W_1 \cos \theta_\alpha$$

giving for the total input

$$W_{11} + W_{12} = W_1 (\sin \theta_\alpha - \sin \theta_\alpha \cos \theta_\alpha + \cos \theta_\alpha).$$

By differentiation it will be found that for maximum efficiency  $\theta_\alpha = 45$  degrees so that the voltage factor  $V_1$  is 0.707.

Table II gives efficiencies and voltage factors for various values of  $\theta_\alpha$ . In each case the factor  $A$  was taken as 0.9.

TABLE II  
EFFICIENCY OF TWO-BRANCH CIRCUIT WITH SINUSOIDAL WAVE

$\theta_\alpha$	Voltage Factor	Efficiency
Degrees		Per Cent
0	0	70.7
15	0.26	72.5
30	0.50	75.8
45	0.71	77.5
60	0.87	75.8
75	0.97	72.5
90	1.00	70.7

#### Difference Equation for Determining Optimum Subdivision of Sinusoidal Wave

Proceeding as in the case of the triangular wave, the energy input to the  $K$ th branch is found to be

$$W_{1K} = \frac{2}{\pi A} E_M I_M T_M [\sin \theta_n (\cos \theta_{n-1} - \cos \theta_n)].$$

The energy input to the  $K$ th and  $(K+1)$ th branches is

$$W_{1K} + W_{1,K+1} = \frac{2}{\pi A} E_M I_M T_M [\sin \theta_n (\cos \theta_{n-1} - \cos \theta_n) + \sin \theta_{n+1} (\cos \theta_n - \cos \theta_{n+1})].$$



Differentiating with respect to  $\theta_n$  and equating to zero gives, for minimum energy input,

$$\cos \theta_n \cos \theta_{n-1} - \cos 2\theta_n - \sin \theta_n \sin \theta_{n+1} = 0 \quad (41)$$

from which

$$\sin \theta_{n+1} = 2 \sin \theta_n - \frac{1 - \cos \theta_n \cos \theta_{n-1}}{\sin \theta_n}. \quad (42)$$

*Power Output per Branch*

The power output of the  $K$ th branch will be

$$W_{2K} = \frac{E_M}{I_M} \int_{T_{K-1}}^{T_K} I_M^2 \sin^2 \left( \frac{t}{T_M} \cdot \frac{\pi}{2} \right) dt$$

$$W_{2K} = \frac{E_M I_M T_M}{\pi} \left[ (\theta_K - \theta_{K-1}) - \frac{\sin 2\theta_K - \sin 2\theta_{K-1}}{2} \right]. \quad (43)$$

*Theoretical Results for 1000-Watt Amplifier—Sinusoidal Wave*

Table III gives theoretical efficiencies, branch-voltage factors and power distribution between branches, calculated from the foregoing formulas with from one to five branches. The factor  $A$  was taken as 0.9 and the output power as 1000 watts throughout.

*Effect on Power Input of Finite Time Interval for Branch Switching*

The change-over from branch to branch will not in practice be instantaneous. In order to examine the effect that may be expected from a finite time interval for the transfer, let us assume that the power input into branch

$K$  falls at a uniform rate from  $W = E_K I_A$  at  $t = T_K - \Delta T$  to 0 at  $t = T_K + \Delta T$ , and that the power in branch  $K + 1$  increases uniformly from 0 at  $t = T_K - \Delta T$  to  $E_{K+1} I_B$  at  $t = T_K + \Delta T$ .

It follows that the power input to branch  $K$  during the transition interval is

$$p_K = E_K \left( \frac{I_A}{2} + \frac{t - T_K}{\Delta T} \cdot \frac{I_A}{2} \right).$$

The energy input during the interval will be

$$\int_{T_K - \Delta T}^{T_K + \Delta T} p_K dt = E_K I_A \Delta T.$$

Similarly, the energy input to branch  $K + 1$  during the same interval will be

$$\int_{T_K - \Delta T}^{T_K + \Delta T} p_{K+1} dt = E_{K+1} I_B \Delta T.$$

The total energy input will be

$$\Delta W_1 = (E_K I_A + E_{K+1} I_B) \Delta T.$$

With instantaneous change-over, the energy input during the same time interval, assuming that  $I$  changes linearly during the short time interval, would be

$$\Delta W_1' = \left[ E_K \left( \frac{I_A + I_K}{2} \right) + E_{K+1} \left( \frac{I_K + I_B}{2} \right) \right] \Delta T.$$

Let  $I_K - I_A = I_B - I_K = \Delta I$ . Then the difference in energy input due to the finite time interval of change-over will be

$$\Delta W_1 - \Delta W_1' = \left( \frac{E_{K+1} - E_K}{2} \right) \Delta I \cdot \Delta T.$$

Thus a small increase in energy input or a drop in efficiency may be expected during the transition interval. Since the filter in the power-supply circuit tends to prevent fluctuations in power input, the drop in efficiency can be expected to be reflected mainly in a momentary drop in output during the switching interval. This is indicated in Fig. 6.

It will be noted that, although the actual efficiencies achieved in practice, as shown in Fig. 8, are less than the theoretical values derived in this Appendix, the rapid increase in efficiency obtained with the first two or three branches followed by a less marked improvement with additional branches is quite similar in the two cases

A study of the voice-modulated wave is being made, and it is hoped to present supplementary data on the most desirable subdivision and the improvement in efficiency to be expected with voice waves in a later paper.

TABLE III

One Branch—Efficiency 70.6 per cent						Total
Power Input—watts						1412
Power Output—watts						1000
Plate Dissipation—watts						412
Two Branches—Efficiency 77.4 per cent						Total
	Branch 1	Branch 2				
Voltage Factor ( $V_k$ )	0.71	1.00				
Power Input—watts	293	1000				1293
Power Output—watts	182	818				1000
Plate Dissipation—watts	111	182				293
Three Branches—Efficiency 80.3 per cent						Total
	Branch 1	Branch 2	Branch 3			
Voltage Factor ( $V_k$ )	0.57	0.83	1.00			
Power Input—watts	138	319	790			1247
Power Output—watts	90	240	670			1000
Plate Dissipation—watts	48	79	120			247
Four Branches—Efficiency 82.4 per cent						Total
	Branch 1	Branch 2	Branch 3	Branch 4		
Voltage Factor ( $V_k$ )	0.485	0.71	0.88	1.00		
Power Input—watts	81	174	289	666		1210
Power Output—watts	52	134	237	577		1000
Plate Dissipation—watts	29	40	52	89		210
Five Branches—Efficiency 83.8 per cent						Total
	Branch 1	Branch 2	Branch 3	Branch 4	Branch 5	
Voltage Factor ( $V_k$ )	0.43	0.63	0.785	0.91	1.00	
Power Input—watts	57	114	174	263	586	
Power Output—watts	34	85	144	223	514	
Plate Dissipation—watts	23	29	30	40	72	

# The Transverse Electric Modes in Coaxial Cavities\*

ROBERT A. KIRKMAN† AND MORRIS KLINE†

**Summary**—Some thought on the transverse electric modes in resonant coaxial cavities labeled  $TE_{1,0,1}$ ,  $TE_{1,0,2}$ ,  $TE_{2,0,1}$ ,  $TE_{3,0,1}$ , etc., by Barrow and Mieher<sup>1</sup> suggested several conclusions which are perhaps implicit in their paper but which deserve explicit consideration. In addition, the notation and the diagrams of the electric field configurations of these modes, as presented in that reference, cause misconceptions and confusion which subsequent papers and even textbooks are perpetuating.<sup>2</sup> Actually, the transverse electric modes whose middle subscript is zero do not exist. They are limiting cases and are approached by the fields of the coaxial modes  $TE_{1,1,1}$ ,  $TE_{1,1,2}$ ,  $TE_{2,1,1}$ ,  $TE_{3,1,1}$ , etc., respectively, as the ratio of the radii of the inner and outer conductors approaches 1. Several facts about the behavior of these modes for varying values of this ratio are presented. In particular, for a given mode, the resonant frequency of a coaxial cavity decreases as the ratio increases. In the case of a cavity of infinite length (i.e., a wave guide) the corresponding wavelengths (i.e., the critical wavelengths of the guides) approach the circumference of the cavity divided by the first subscript of the mode. Physical and mathematical arguments confirm these conclusions and make clear to what extent the Barrow and Mieher diagrams of the modes  $TE_{1,0,1}$ ,  $TE_{1,0,2}$ , etc., are representative of actual coaxial modes. The practical importance of the transverse electric coaxial modes in ultra-high-frequency work is emphasized.

## INTRODUCTION

THE TRANSVERSE electric modes of coaxial cavities are usually designated by the notation  $TE_{1,1,1}$ ,  $TE_{2,1,1}$ , etc., and, in general, by  $TE_{l,m,n}$  or  $H_{l,m,n}$  wherein the subscripts  $l$ ,  $m$ , and  $n$  have both mathematical and physical significance. The mathematical significance centers in the fact that the calculation of the resonant frequencies of a coaxial cavity of given dimensions uses the roots of the equations

$$J_l'(x)Y_l'(\rho x) - J_l'(\rho x)Y_l'(x) = 0 \quad (l = 0, 1, 2, 3, \dots) \quad (1)$$

where  $J_l'$  and  $Y_l'$  ( $=N_l'$ ) are the derivatives with respect to their arguments of the  $l$ th order Bessel functions of the first and second kind, respectively, and  $\rho$  is the ratio of the radii  $a$  and  $b$  of the inner and outer conductors of the cavity. Hence, the first subscript  $l$  in the notation  $TE_{l,m,n}$  states the order of the Bessel functions of the first and second kind which must be used to calculate the resonant frequency of that mode; that is, it selects the  $l$  value in (1). The second subscript  $m$  in the designation of the mode denotes the order of magnitude of that root of (1) which is used to calculate the resonant frequency. The third subscript  $n$  is merely a coefficient in the argument of a trigonometric function which enters into the expressions for the electric and magnetic fields inside the cavity.

The physical significance of these subscripts is usually purported to be as follows: At any point in a cavity (and at a given instant) the electric field has a definite

direction and magnitude. This electric field vector can be resolved into three independent components. In the case of a coaxial cavity, the directions of these components are chosen to be (1) along the circle through the point and concentric with the inner and outer conductors, (2) along the radius through the point, (3) along a line running through the point and lengthwise along the cavity. These components are usually designated as  $E_\phi$ ,  $E_r$ , and  $E_z$  because cylindrical co-ordinates are employed to study the field mathematically. The subscript  $l$  of  $TE_{l,m,n}$  is supposed to denote physically the number of full periods of sinusoidal variation in  $E_r$  along any circle concentric with the inner and outer conductors. The subscript  $m$  is supposed to denote the number of half periods of sinusoidal variation in  $E_\phi$  along a radius. The subscript  $n$  denotes the number of half periods of sinusoidal variation in  $E_z$  along the length of the cavity.

In view of the mathematical meanings of the subscripts  $l$ ,  $m$ ,  $n$ , the notation  $TE_{1,0,1}$ ,  $TE_{2,0,1}$ , etc., is mystifying because the calculation of the resonant frequencies of cavities of given dimensions supporting such modes would call for the zeroth roots of (1) whose roots in order of magnitude are usually designated as first, second, third, etc. Moreover, while the pictures of the electric fields of these modes as presented by Barrow and Mieher are consistent with the physical meanings usually offered for the subscripts  $l$ ,  $m$ , and  $n$  the pictures are strictly inconsistent with facts of electromagnetic theory. Finally, the physical meanings usually assigned to the subscripts  $l$ ,  $m$ , and  $n$  do not appear to be applicable to all coaxial electric field configurations.

For these reasons it was decided to survey the transverse electric modes in coaxial cavities and, in particular, to study the variation in the electric fields of these modes as the ratio of the radii of the inner and outer conductors is varied. The results of this survey do clear up the above difficulties.

## THE VARIATION IN THE ELECTRIC FIELDS OF THE $TE_{l,m,n}$ MODES WITH THE RATIO OF THE RADII

The mathematical functions which represent the three electric components and the three magnetic components of the electromagnetic field of the various modes inside a resonant coaxial cavity involve the roots<sup>3</sup> of (1). For example, the expressions for the field in a coaxial cavity supporting the  $TE_{2,1,1}$  mode involve the first root of that member of (1) corresponding to  $l=2$ . Since both  $J_l'(x)$  and  $Y_l'(x)$  are infinite series, these roots are not readily obtainable even for a definite value of  $\rho$ , the ratio of the radii. Yet, the variation in these roots with  $\rho$  is precisely what is required in order to study the variation in the modes with changing ratio of the radii. Graphing must be utilized.

<sup>3</sup> F. Borgnis, "Die Konzentrische Leitung als Resonator," *Hochfrequenz- und Elektroakustik*, vol. 56, pp. 47-54; August, 1940.

\* Decimal classification: R116. Original manuscript received by the Institute, June 7, 1945; revised manuscript received, September 17, 1945.

† Signal Corps Ground Signal Agency, Evans Signal Laboratory, Belmar, N. J.

<sup>1</sup> W. L. Barrow and W. W. Mieher, "Natural oscillations of electrical cavity resonators," *Proc. I.R.E.*, vol. 28, pp. 184-191; April, 1940.

<sup>2</sup> R. I. Sarbacher and W. A. Edson, "Hyper and UHF Engineering," John Wiley and Sons, Inc., New York, N. Y., 1943, p. 390.

The graphical procedure has been considerably simplified by Truell<sup>4</sup> and Fig. 2 of his paper shows, with appropriate changes in notation, the variation of  $x_{l,1}$ ; that is, the first root of (1), with  $\rho$  the ratio of the radii  $a$  and  $b$  of the inner and outer conductors.

To study the variation in the transverse electric modes with varying  $a/b$  let us select the  $TE_{3,1,1}$  mode as an illustration. When  $a/b$  is 0, we have the pure cylindrical cavity rather than the coaxial one. The electric fields of  $TE_{l,m,n}$  modes in cylindrical cavities are known and are given by Barrow and Micher, among others. The field of  $TE_{3,1,1}$  is reproduced in Fig. 1 for comparison with later figures.

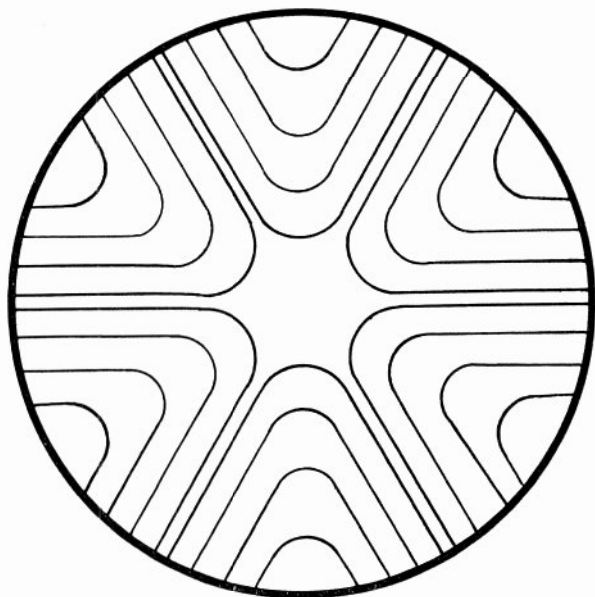

Fig. 1—Electric field for  $TE_{3,1,1}$  mode in a perfect cylinder.

When  $a/b$  is small, the field inside the coaxial cavity is much like the field inside the cylinder, except that a few of the electric lines terminate on the inner conductor. In fact, the first root of (1) for small  $\rho$ , i.e., small  $a/b$ , is practically the first root of  $J_l'(x)=0$ , ( $l=0, 1, 2, \dots$ ), the equations whose roots play the same part for cylindrical cavities that the roots of (1) do for coaxial cavities. Hence it follows from the mathematical expressions in Borgnis<sup>5</sup> that the field in the coaxial cavity is, for small  $a/b$ , nearly the same as in a cylindrical cavity. The larger the center conductor the fewer electric lines loop back without touching it and the more go directly to the inner conductor (see Fig. 4).

Let us pay close attention to the case where the radius of the inner conductor approaches the radius of the outer one (Fig. 2). If a metal sheet is placed inside a cavity so that it is perpendicular at any point to the electric line through that point, the field will not be disturbed. Hence, we may cut the cavity of Fig. 2 by means of imaginary sheets  $cd$ ,  $ef$ ,  $gh$ , etc., into a number of nearly rectangular cavities without disturbing the field. Because the component of the electric field which parallels

the inner and outer conductors is zero or small almost everywhere in the cavity, we have in each "rectangle" approximately the field which exists in a true rectangular cavity carrying the  $TE_{1,0,1}$  mode.<sup>6</sup> In the true rectangular cavity, if the electric lines are vertical, the vertical dimension is arbitrary though the horizontal dimensions are not. Hence, in the coaxial cavity with the inner radius  $a$  nearly equal to the outer radius  $b$  independence of the dimension  $b-a$  is practically attained. However, since the coaxial cavity consists of "rectangles" side by side, the circumference of the cavity is still decisive in determining the resonant frequency.

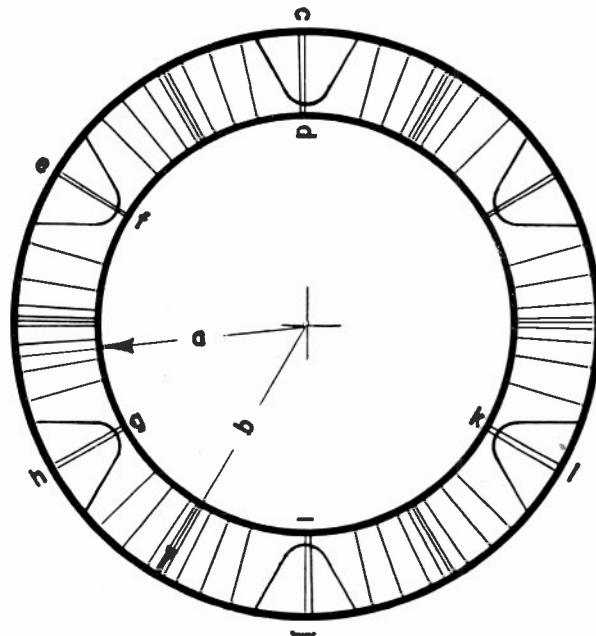

Fig. 2—Electric field for coaxial  $TE_{3,1,1}$  mode with  $a$  nearly equal to  $b$ .

#### CONCLUSIONS ON THE LIMITING WAVELENGTH AS $a/b$ APPROACHES 1

The analysis of the electric field in a coaxial cavity for which  $a/b$  approaches 1 in terms of rectangles leads directly to conclusions about the limiting wavelength. Before stating them, let us shift the burden of the discussion from cavities to wave guides. With increasing length, the transverse dimensions of a resonant cavity approach the critical or cutoff dimensions of a guide with the same cross-sectional shape carrying the same mode. Hence a discussion of guides is, in effect, a discussion of cavities.

In a guide of rectangular cross section carrying the  $TE_{1,0}$  mode, one dimension is arbitrary and the critical size for the other is one half the free-space wavelength. As Fig. 2 shows, increasing  $a/b$  in the coaxial guide tends to produce, in each half-period variation of the radial component of the electric field, the same field as exists in the  $TE_{1,0}$  mode of a rectangular guide. (There are six half-period variations in Fig. 2, the number being always  $2l$ .) The critical value of the circumference for the  $TE_{l,1}$  modes of a coaxial guide with  $a/b$  nearly 1

<sup>4</sup> R. Truell, "Concerning the roots of  $J_n'(x)N_n'(kx) - J_n'(kx)N_n'(x) = 0$ ," *Jour. Appl. Phys.*, vol. 14, pp. 350-352; July, 1943.

<sup>5</sup> See equations (2) and (6), pp. 48-49 of footnote reference 3.

<sup>6</sup> See, for example, Fig. 6.3, of footnote reference 2.



should therefore be  $2l$  free-space half wavelengths or, for a fixed circumference, the critical wavelength in the  $TE_{l,1}$  modes approaches the circumference divided by  $l$ .

Calculation supports the conclusion drawn in the preceding paragraph. The critical wavelength for a coaxial guide carrying the  $TE_{l,1}$  mode<sup>7</sup> is

$$\lambda_0 = \frac{c}{f_0} = \frac{2\pi b}{x_{l,1}} \quad (2)$$

Fig. 2 of Truell's paper shows that  $x_{3,1}$ , for example, approaches 3 as  $a/b$  approaches 1. Hence the critical wavelength approaches  $1/3$  of the circumference.<sup>8</sup>

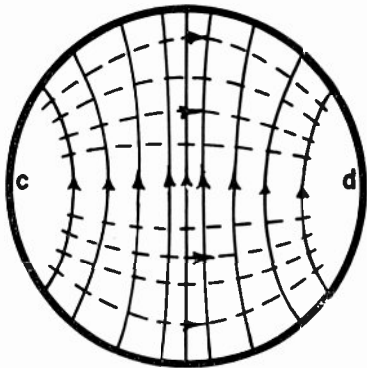

Fig. 3—Electric (solid) and magnetic (broken) lines for  $TE_{1,1}$  mode of a circular guide.

As Truell's Fig. 2 illustrates,  $x_{l,1}$  decreases as  $a/b$  approaches 1. (Note that his  $k$  is the reciprocal of our  $\rho$ .) It follows from (2), then, that with a fixed outer circumference by increasing  $a/b$  we increase the critical wavelength; i.e., the guide is able to pass more frequencies. Thus decreasing the size of the guide in this manner has an effect opposite to decreasing the outer circumference or to decreasing the length in a cavity.

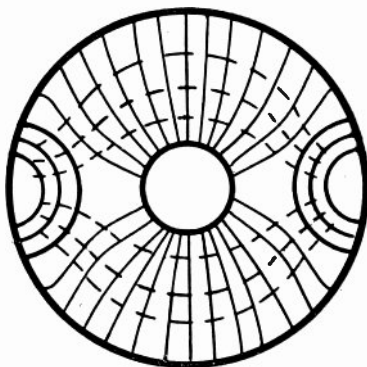

Fig. 4—Electric (solid) and magnetic (broken) lines for  $TE_{1,1}$  mode of a coaxial guide.

It is instructive to view and confirm physically what happens when the inner conductor increases in size. The closed magnetic loops which are present in all wave-

<sup>7</sup> See equation (3) of footnote reference 1.

<sup>8</sup> One can assume at once that a coaxial wave guide in which the two radii are almost equal is practically a rectangular guide, and apply formulas for rectangular guides. This is done by S. A. Schelkunoff, "Electromagnetic Waves," D. Van Nostrand Co., Inc., New York, N. Y., 1943, p. 391. However, one should not be misled by the procedure adopted there into believing that there exist additional modes which are obtained by letting  $m=0$ ; i.e., that  $TE_{l,0}$  modes exist which are distinct from the  $TE_{l,1}$  modes. (See the next section of this paper.)

guide and cavity modes are incompressible below a minimum "dimension" of a half wavelength. They do not permit themselves to be "squeezed" into narrower regions. Consider, for example, the  $TE_{1,1}$  mode. When  $a/b$  is 0 the guide is cylindrical and the field is as shown in Fig. 3. The magnetic lines are directed out toward the reader at  $c$ , flow across the front, and head into the guide again at  $d$ . Hence the diameter of the guide cannot be less than one-half wavelength. As a matter of fact, the minimum diameter for this mode is  $0.586 \lambda$ . The introduction of an inner conductor into the guide forces the magnetic loops to flow around it as shown in Fig. 4. Moreover, the loops curve more nearly into the shape of the outer circumference as the inner conductor is increased in size. This curvature permits a longer wavelength. The limiting case as the inner conductor increases calls for two loops, one above and one below the inner conductor, each loop about one-half wavelength

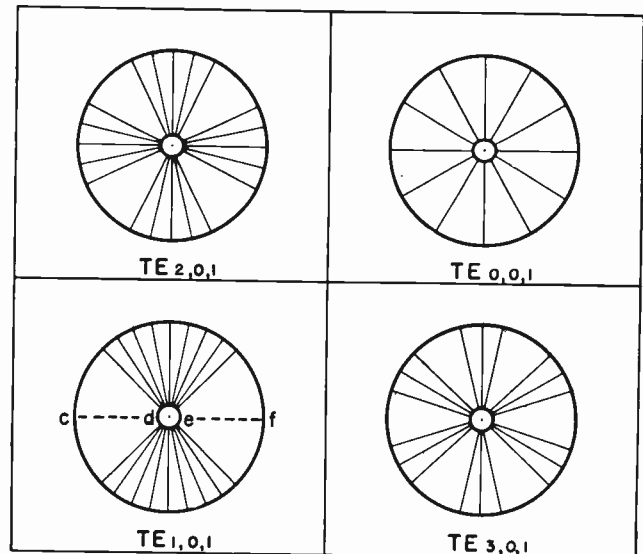

Fig. 5—Electric field lines of some transverse electric coaxial modes as portrayed by Barrow and Mieher.

in size, and each running along one portion of the circumference. Hence, the latter should be two half wavelengths long, which is the conclusion reached in the preceding paragraph.

It need not be remarked, perhaps, that the above discussion of the  $TE_{3,1,1}$  coaxial cavity mode and the corresponding  $TE_{3,1}$  guide mode applies to all the  $TE_{l,1,n}$  coaxial cavity and corresponding guide modes.

#### The $TE_{1,0,n}$ Modes of Barrow and Mieher

It is now clear as to where the modes labeled  $TE_{1,0,1}$ ,  $TE_{2,0,1}$ , and  $TE_{3,0,1}$  by Barrow and Mieher and reproduced in Fig. 5 fit into the scheme of things. They are approximate representations of the  $TE_{1,1,1}$ ,  $TE_{2,1,1}$ , and  $TE_{3,1,1}$  modes, respectively, and are attained *practically only* for large  $a/b$ . The subscript 0, though descriptive of the field in that there is practically no variation in the component of the electric field paralleling a circle concentric with the inner and outer conductors as one proceeds radially, is nevertheless misleading.

There are mathematical and physical arguments which show that the fields in Fig. 5 are not, and undoubtedly were not intended to be, taken as exact descriptions. In cylindrical co-ordinates, the electric field inside a cavity can be resolved into the three components  $E_\phi$ ,  $E_r$ , and  $E_z$ . For the transverse electric modes,  $E_z$  is zero everywhere in the cavity. According to Fig. 5, the component  $E_\phi$  which parallels circles concentric with the inner and outer conductors must also be zero. Now solution of Maxwell's equations for the field inside the cavity, under the conditions that  $E_z$  and  $E_\phi$  are identically zero everywhere inside, shows that the resonant frequency should not change with the mode. Yet the resonant frequencies which Barrow and Mieher give for these modes, in the particular cavity they used, are 344 megacycles for the (1, 0, 1) mode, 475 megacycles for the (2, 0, 1) mode, and 611 megacycles for the (3, 0, 1) mode. Indeed a check on their calculations shows that Barrow and Mieher obtained these frequencies by treating the  $TE_{l,0,n}$  modes as  $TE_{l,1,n}$  modes and by using equation (1).

A physical argument for the contention that the diagrams in Fig. 5 are not exact is illuminating. Consider the  $TE_{1,0,1}$  mode. According to the illustration, it should be possible to insert conducting sheets along the cavity passing through  $cd$  or  $ef$  or both, without disturbing the field. But if sheets were present, lines of force approaching them closely would be compelled by the usual boundary condition to curve and terminate upon the sheets (Figs. 2 and 4); or we might resort to a convention of electric field theory and say that electric lines act like stretched elastic bands; hence some will shorten themselves by curving and meeting lines symmetric with respect to  $cd$  and  $ef$ .

#### THE PRACTICAL IMPORTANCE OF THE COAXIAL TRANSVERSE ELECTRIC MODES

It is urged that the coaxial transverse electric modes be clearly understood because of their relation to the principal or  $TE_{0,0,1}$  mode (Fig. 5) which is commonly used in resonant coaxial lines, and which is but one special case of the infinite number of modes which can be sustained in a resonant coaxial cavity. If the frequency is low, the dimensions of the usual resonant coaxial line are such that other modes are not sustained. But as the frequency increases, particularly if the diameter of the inner conductor becomes comparable to that of the outer one, the resonant line may readily sustain the higher transverse electric modes; i.e., the  $TE_{l,1,n}$  modes. The similarity of the fields (one has but to compare the fields in Fig. 5) makes it likely that the device designed to propagate the principal mode will also propagate the higher modes when they can be sustained.

As an example, a coaxial line whose outer radius is 2 centimeters will, of course, resonate in the principal

mode of a 3000-megacycle wave. But it may also resonate in the  $TE_{1,1,1}$  mode if the inner radius is greater than 0.6 of the outer radius. The higher the frequency the less the inner radius need be, or the greater the possibility of still higher modes being sustained. In view of the fact that frequencies much higher than 3000 megacycles are now well within the range of experimental work, the likelihood of a coaxial line sustaining or transmitting several modes where only one is intended is by no means negligible.

The introduction of these higher modes can, of course, produce intolerable effects. Even in a simple device like

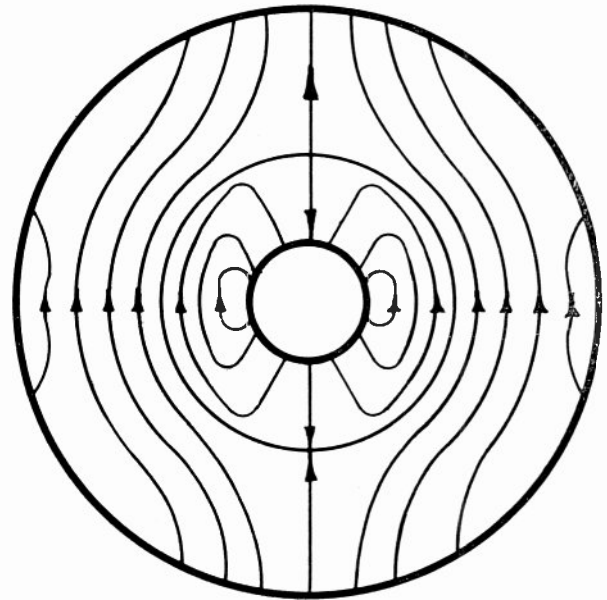

Fig. 6—Higher transverse electric coaxial mode  $TE_{1,2,1}$ , when  $a/b$  is between 0.2 and 1.

a wavemeter employing a resonant coaxial line, the peaks or dips of the principal mode may no longer be recognizable if higher modes are present or appear in the line as its length is altered by the usual tuning means.

It may be remarked finally that the  $l, m, n$  notation used in describing the modes of cavities has its limitations. Whereas the mathematical meanings still hold precisely, the physical meanings suggested by Barrow and Mieher<sup>9</sup> cannot be applied too literally. Reference to Figs. 1, 3, and 4 will show that the physical meaning assigned to the second subscript  $m$  does not hold for all radial paths. Moreover, various physical pictures must be associated with the same set of subscripts. As an example, the field shown in Fig. 6, and which is given by Borgnis<sup>10</sup> is the one we must associate with  $TE_{1,2,1}$  as long as the ratio of  $a$  to  $b$  is at least 0.2. For ratios less than 0.2 the field has more variations in it. Even in the case pictured it is difficult to decide what the  $m$  value should be.

<sup>9</sup> See p. 185 of footnote reference 1.

<sup>10</sup> See p. 53 of footnote reference 3.

# Radio-Frequency Spectrum Analyzers\*

EVERARD M. WILLIAMS†, SENIOR MEMBER, I.R.E.

**Summary**—The resolving power of radio-frequency spectrum analyzers of the continuously tuned type is defined as the width in frequency, at points 3 decibels down, of the trace of a continuous-wave signal. The optimum resolving power is  $1.3\sqrt{F/T}$ , in which  $F$  is the frequency band scanned, and  $T$  the period of one scan. Traces of pulse-modulated, frequency-modulated, and amplitude-modulated signals are illustrated to show effect of resolving power.

## INTRODUCTION

IN THE absence of a standard definition, the term “radio-frequency spectrum analyzer” is considered to apply to a device which provides a description of signal distribution and sideband structure in a selected radio-frequency band in the form of a plot of amplitude versus frequency. In the parallel field of optics, spectrum analysis by means of spectroscopes is conducted for “the investigation of substances or bodies by means of their spectra”;<sup>1</sup> in radio, it is assumed that spectrum analysis is applied to the investigation of radio signals by means of the traces observed on the radio-frequency spectrum analyzer.

In an optical spectroscope, all frequencies in a selected band are received simultaneously and split into groups. In an analogous manner a radio-frequency band can be divided into groups and analyzed by a series of fixed-tuned receivers staggered in frequency throughout the band. Although such devices provide more readily interpreted and reliable indications than the type to be described, their use is infrequent because of the multiplicity of circuits required.

Radio-frequency spectrum analysis may also be accomplished by the continuous tuning of a selective receiver through the spectrum band under study, examining each frequency group in turn for the existence of signals, rather than all groups in the band simultaneously. Such devices have been manufactured for some years and when used with synchronized cathode-ray-tube presentations are described commercially as “panoramic”<sup>2</sup> receivers. This paper is concerned only with the latter type of spectrum analyzer.

Fig. 1 shows the block diagram of a typical continuously tuned spectrum analyzer, a superheterodyne receiver periodically tuned over a band together with a synchronized display device. The oscillator control

causes the oscillator frequency to vary approximately linearly in time so that the receiver tunes linearly over

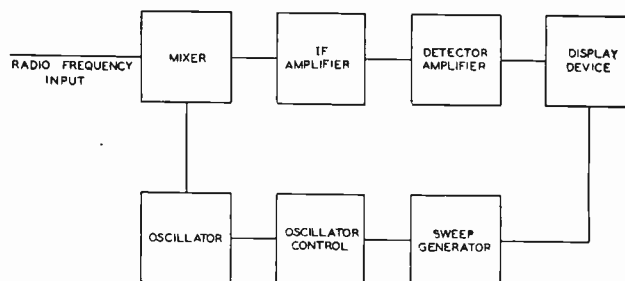

Fig. 1—Continuous-tuning spectrum analyzer.

the spectrum under examination. At the completion of a tuning sweep, the oscillator makes a rapid return to the original starting frequency during an interval in which the display device is blanked. The tuning cycle is then repeated. In many cases, the mixer is also tuned to inhibit spurious responses. In operation, the mixer output presents to the intermediate-frequency amplifier all continuous signals within the range of the analyzer with a superposed linear wide-range frequency variation added to any modulation originally in the signals. Separation of the band into individual signals occurs as the linear frequency variation causes these signals, in sequence, to tune through the intermediate-frequency-amplifier passband, and the degree of signal separation is determined entirely by the intermediate-frequency-amplifier properties. It is the purpose of this paper to discuss the “resolving,” or signal separating powers, of continuously tuned spectrum analyzers, and the paper is concerned entirely with the phenomena encountered in the intermediate-frequency amplifier.

Because of the periodic sweep the intermediate-frequency-amplifier response in a spectrum analyzer can be expressed as the sum of the responses to a series representing the expansion into components of the cyclically frequency-modulated signal. The response can also be treated as a transient one, in which each transient rises and decays entirely during a single sweep period, because the case in which the transient persists from one complete tuning cycle to the next is one in which a (resolutionless) continuous display is produced, and is therefore trivial.

Neither method of analysis yields useful results for a generalized system. A particular intermediate-frequency-amplifier response for specific sweep widths can

\* Decimal classification: R388XR361. Original manuscript received by the Institute, March 14, 1945; revised manuscript received, June 14, 1945. Presented, 1945 Winter Technical Meeting, New York, N.Y., January 26, 1945.

† Carnegie Institute of Technology, Pittsburgh, Pa.

<sup>1</sup> Webster's Collegiate Dictionary, Fifth Edition.

<sup>2</sup> Product of Panoramic Radio Corporation, New York, New York.



be computed (albeit tediously) and some form of generalized curves may eventually be available. However, experimental studies of the relation between resolving power and intermediate-frequency-amplifier bandwidth result in surprisingly simple empirical relations which have been widely applied in designs. These involve the following factors, for which convenient definitions have been chosen:

**Resolving Powers ( $S$ ):** This is the displayed width, in terms of frequency, at the 3-decibel-down points, of a continuous-wave signal. Thus an analyzer which presents a continuous-wave signal as a "pip" 10 kilocycles wide at the 3-decibel-down points would be said to have a resolving power of 10 kilocycles. Fig. 2 shows a typical trace used in determining resolving power. Two equal unmodulated signals differing in frequency by  $S$  defined in this manner would be barely separable.

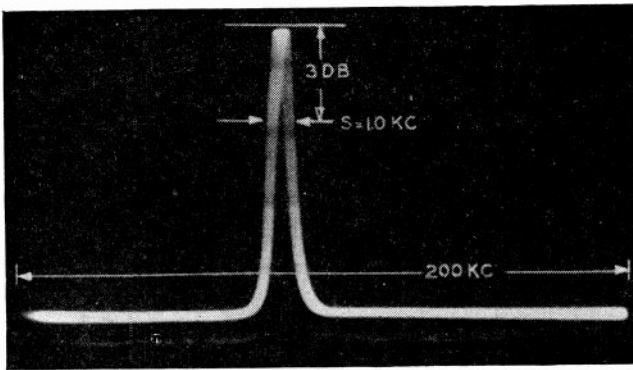

Fig. 2—Construction for determining resolution.

**Intermediate-Frequency-Amplifier Bandwidth ( $\Delta f$ ):** For consistency this is defined as the width, in cycles per second, of the intermediate-frequency selectivity curve between 3-decibel-down points.

**Sweep Bandwidth of the Spectrum Analyzer ( $F$ ):** This is the difference of maximum and minimum frequencies between which the analyzer tunes and it is assumed that this band is traversed linearly in time.

**Sweep-Time Interval ( $T$ ):** This is the time interval of one displayed sweep from minimum to maximum frequency (or vice versa if the direction of displayed frequency is from maximum to minimum) and does not include the return-trace time.

Experimentally it is found that maximum resolving power for a spectrum analyzer is very nearly

$$S = 1.3 \sqrt{\frac{F}{T}} \quad (1)$$

and that this resolving power is realized for intermediate-frequency-amplifier bandwidths  $\Delta f$  in the vicinity of

$$\Delta f = \sqrt{\frac{F}{2T}} \quad (2)$$

A somewhat intuitive analysis for a single resistance-inductance-capacitance circuit provides a substantiation for the dependence of bandwidth and resolving power on  $\sqrt{F/T}$  alone.

If a tuned circuit is excited by a linearly frequency-modulated signal (of very much greater deviation than the bandwidth of the circuit) the resulting impulse consists of two components: (a) that at the natural circuit frequency; and (b) that at the instantaneous applied signal frequency.

If the circuit  $Q$  is very low, the transient (a) decays so rapidly that the output is a faithful trace of the normal intermediate-frequency-amplifier curve. If the circuit  $Q$  is very high, the response (a) is important. Its time is dependent on the circuit time constant and successive increases in  $Q$  beyond a certain point increase the time constant so much as to decrease resolution. Therefore it appears reasonable that the choice of a circuit bandwidth in which the time of steady-state response (b) is equal to the transient (a) rise and decay time (both times for 3-decibel-down points) should result in maximum resolving power.

For instance, let a frequency band  $F$  be swept in a time interval  $T$ . The bandwidth  $\Delta f$  (in cycles per second) of a single circuit tuned to frequency  $f_c$  is, from standard selectivity curve,

$$\Delta f = \frac{f_c}{Q} \quad (3)$$

between 3-decibel points.

The circuit response at the instantaneous applied frequency will then occur during a time

$$\Delta t_1 = \frac{\Delta f}{F} \times T = \frac{f_c T}{QF} \quad (4)$$

The circuit transient time constant for a variable-frequency applied signal is unknown; if, however, it is assumed approximately that for a fixed-frequency signal, the 3-decibel decay time  $\Delta t_2$ , is determined from

$$\frac{R}{2L} \Delta t_2 = -\log_e 0.707 \quad \text{or} \quad \Delta t_2 \approx \frac{Q}{2\omega}$$

For a rise and decay of 3 decibels, the time is  $\Delta t_3 = Q/\omega$ .

If  $\Delta t_1$  is equated to  $\Delta t_3$  the bandwidth of the circuit is found to be

$$\Delta f = 0.56 \sqrt{\frac{F}{2T}} \quad (5)$$

The similarity of (2) and (5) needs no further comment.

#### EFFECT OF RESOLUTION ON SIDEBAND TRACES

As would be anticipated, it is found that the ability of a spectrum analyzer to show sideband structure is measured by the resolving power and sidebands of equal

amplitude differing in frequency by  $S$  can be distinguished on an analyzer trace. If amplitude of adjacent sidebands is not equal, somewhat greater resolving power is required for their separation because of the masking of the smaller signal by the larger adjacent signal.

Modulated signal traces for resolution lower than that necessary for sideband separation are of considerable interest, particularly in the case of pulsed signals, as shown by the following analysis for a simplified circuit.

Let a series resistance-inductance-capacitance circuit tuned to a natural angular frequency  $\omega_r$  be excited by a carrier of fixed angular frequency  $\omega_a$  pulsed on and off at angular frequency  $\omega_m$  with a pulse of duration  $d$ . The response to the first pulse is of the form

$$i = K_1 e^{-Rt/2L} \cos(\omega_r t + \psi) + K_2 \sin(\omega_a t + \phi) \quad (6)$$

( $K_1, K_2, \psi, \phi$  determined by circuit constants and  $\omega_a$ ).

In the interval between the end of this first pulse and the incidence of the second there will remain only transient terms of frequency  $\omega_r$ , and up to this time there is no dependence of transient amplitude upon pulse-repetition rate because the circuit has been excited by but a single pulse. If the transient from the first pulse is effectively decayed at the incidence of the second, the response to the second pulse will be exactly equal to that of the first. If, on the other hand, only a slight decay takes place between pulses, successive pulses will result in the modification of terms such as  $K_1$  in (6) by amplitude functions of  $\omega_a - \omega_r/\omega_m = n$ , an integer, corresponding to the usual relation, in which the sideband separation is the modulation frequency. Thus, in general, a tuned circuit is not capable of distinguishing (resolving) pulse-modulated-signal sidebands unless the transient resulting from each pulse persists at least until the next pulse appears. Fig. 3 illustrates the trace of a pulsed signal in which sidebands are resolved.

When the transient decay between pulses is large no sidebands are resolved; there may, however, be a well-defined pulse envelope. Consider the resistance-inductance-capacitance circuit for which (6) was developed; if the resistance is zero this reduces to

$$i = \frac{E}{z} \left( -\frac{\omega_r}{\omega_a} \sin \phi \sin \omega_r t + \cos \phi \cos \omega_r t - \cos[\omega_a t + \psi] \right) \quad (7a)$$

and for values of  $R$  very near zero, it is approximately,

$$i \approx \frac{E}{z} \left[ \epsilon^{-Rt/2L} \left( -\frac{\omega_r}{\omega_a} \sin \phi \sin \omega_r t + \cos \phi \cos \omega_r t - \cos(\omega_a t + \psi) \right) \right] \quad (7b)$$

At the end of time  $d$ , the pulse ceases. There will be no transient after this time if at the instant of pulse termination, the current  $i_d$  and the charge

$$q_d = \int_0^d i dt$$

are zero. For (7a) this is the case for

$$\omega_r \approx \omega_a \quad \text{and} \quad \omega_r d - \omega_a d = 2n\pi \quad (8)$$

or

$$f_r - f_a = \frac{n}{d},$$

where  $n$  is an integer.

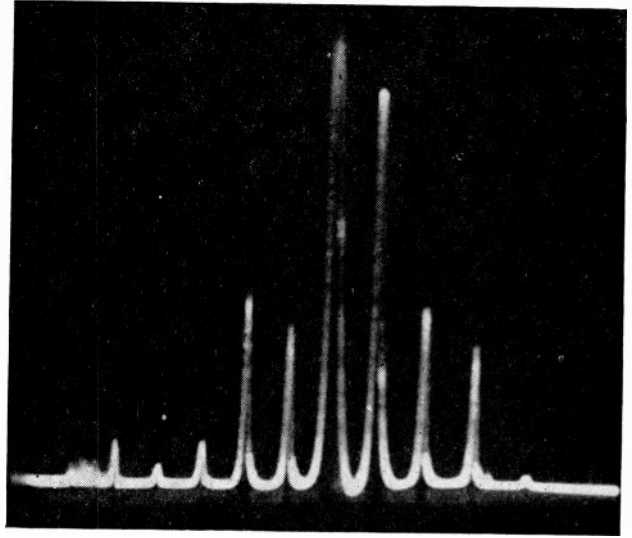

Fig. 3—Pulse-modulated signal of 75,000 pulses per second;  $F=1$  megacycle;  $S=10$  kilocycles;  $T=1/40$  second; pulse duration = 3 microseconds.

Although with (7b) there can be no simultaneous zeros of current and charge, a minimum  $i_d$  and  $q_d$  are reached for approximately the same condition (8) which is the usual relation, locating the nulls for the sideband envelope, following the form of the function  $\sin x/x$ . Appearance of the sideband envelope on the trace is therefore dependent only on the transient-response persistence for each individual pulse, and the sideband envelope cannot be distinguished on the analyzer trace if the term  $\epsilon^{-Rt/2L}$  is very much less than 1. With short pulses the duration of a single pulse may be a small fraction of the interval between pulses and a rate of decay in an intermediate-frequency amplifier which is excessive for sideband resolution may easily be sufficiently low to permit sideband-envelope resolution. An estimate of the resolving power required to show this sideband envelope may be obtained by assuming an allowable decay and calculating the corresponding resolving power for the simple resistance-inductance-capacitance circuit.

If the allowable decay is assumed to be 10 decibels, the pulse duration  $d$  should be

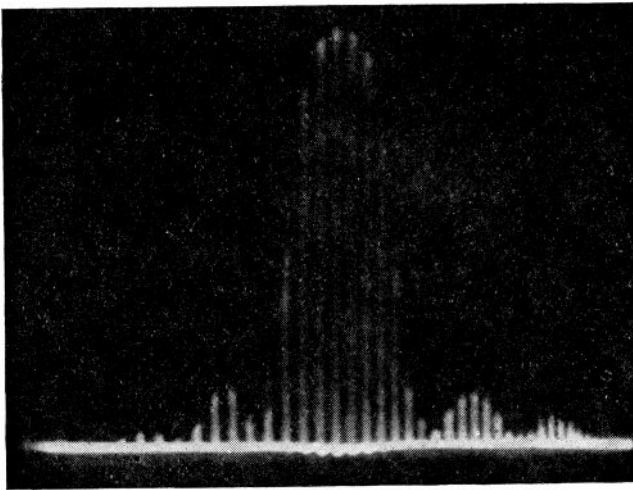
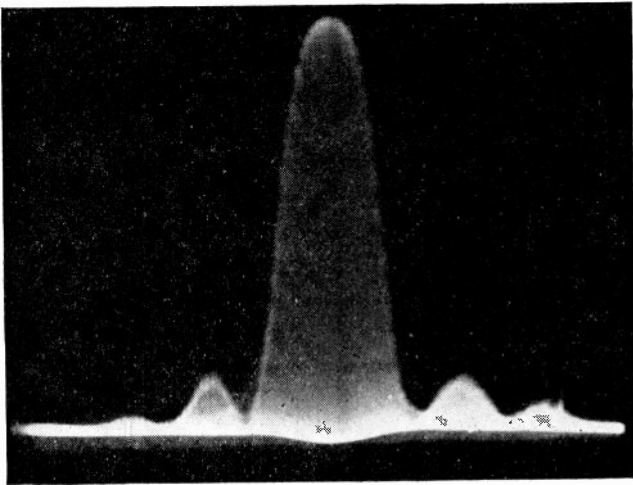

Fig. 4—Pulses of 14 microseconds;  $F=300$  kilocycles;  $S=10$  kilocycles;  $T=1/40$  second.  
(Top): 5000 pulses per second.  
(Bottom): 1600 pulses per second.

$$d < \frac{2L}{R} \log_e \frac{1}{10}$$

or

$$d < \frac{4.6L}{R}$$

If

$$Q = \frac{f}{\Delta f} \quad \text{and} \quad \Delta f = \sqrt{\frac{F}{2T}}$$

the duration  $d$  must be

$$d < 1.02 \sqrt{\frac{T}{F}}$$

or the frequency separation  $F_s$  of nulls in the sideband envelope is

$$F_s > 1.96 \sqrt{\frac{F}{T}} \quad (9)$$

for sideband-envelope resolution. Equation (9) is so

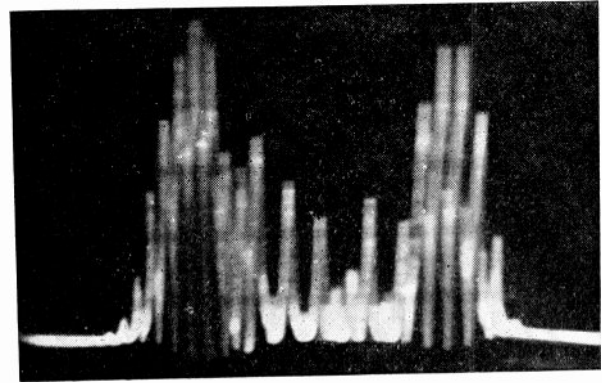

Fig. 5—Frequency-modulation signal, 200-kilocycle deviation; 20-kilocycle modulation;  $S=10$  kilocycles;  $F \approx 700$  kilocycles;  $T=1/40$  second.

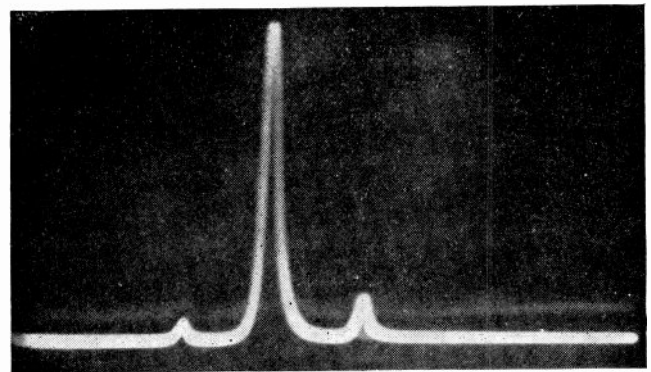

Fig. 6—Amplitude-modulation signal, 50-kilocycle modulation;  $F=300$  kilocycles;  $S=10$  kilocycles;  $T=1/40$  second.

nearly the same as (1) that the difference in coefficient may be attributed to inaccuracies in assumptions and this conclusion is substantiated by experimental results. Fig. 4 illustrates two cases in which the sideband envelope is very well defined although individual sidebands are not resolved. In these illustrations the pulse rate was synchronized at a sweep-rate harmonic to facilitate photography. The vertical "spikes" should not be confused with sidebands, for which the horizontal separation is far too great. Each "spike" is a pulse and the time interval between pulses is equal to the sweep-time interval on the screen.

When resolution is very coarse, pulse-signal traces are decidedly ambiguous, except in the extreme cases (very coarse resolution) in which pulse signals appear as a single trace, "bobbing" up and down.

The traces of frequency-modulated (or phase-modu-



lated) and amplitude-modulated signals are not amenable to as straight-forward an explanation as those of pulse-modulated signals. In addition, neither angular-modulated- nor amplitude-modulated-signal sidebands are characterized by the regular (smooth) envelope of the pulse-modulated signal and conditions which would result in sideband resolution with pulse signals yield only

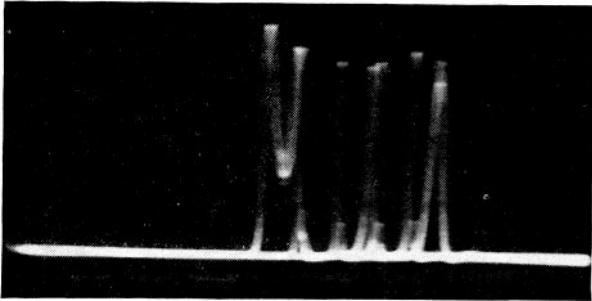

Fig. 7—Frequency-modulation signal, 35-kilocycle deviation, 2000-cycle modulation;  $F=300$  kilocycles;  $S=10$  kilocycles;  $T=1/40$  second.

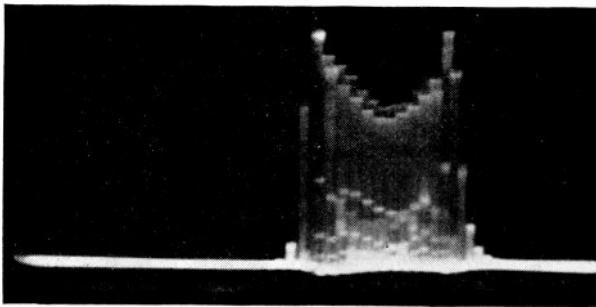

Fig. 8—Frequency-modulation signal, 50-kilocycle deviation, 150-cycle modulation;  $F=300$  kilocycles;  $S=10$  kilocycles;  $T=1/40$  second.

“quasi” or smoothed versions of the true envelope unless the sidebands are also resolved.

Experimentally it has been observed that, if the condition (1) is met, both amplitude- and angular-modulated signals will show clear sideband structures. Figs. 5 and 6 show such frequency-modulated and amplitude-modulated signals. If the resolving power is sufficiently coarse to include the signal and all its sidebands, frequency-modulated signals will appear as “pips” of

constant amplitude, oscillating in position. Similarly amplitude-modulated signals will appear as “pips” constant in position and oscillating in amplitude.

For resolving power intermediate between the above and that of (1) frequency-modulated signals show a number of oscillating “pips” with a quasi envelope as in Figs. 7 and 8. Amplitude-modulated signals show a single “pip” serrated in envelope as in Fig. 9. These serrations represent the changes in amplitude caused by modulation taking place during the time the signal is in the pass band of the analyzer.

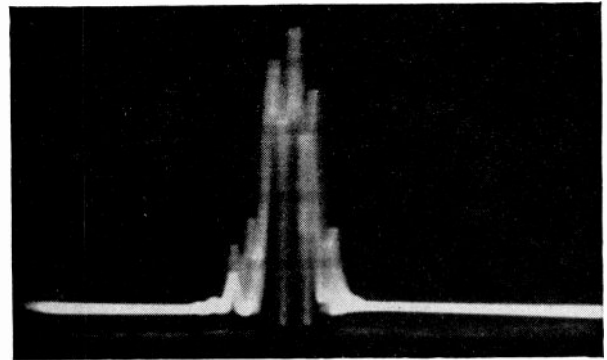

Fig. 9—Amplitude-modulation signal, 16-kilocycle, modulation 40 per cent;  $F=100$  kilocycles;  $S=10$  kilocycles;  $T=1/40$  second.

#### LIMITATIONS OF SPECTRUM ANALYZERS

It is feasible to design recording spectrum analyzers for any desired resolving power, since the sweep rate may be made as low as necessary. Spectrum analyzers with cathode-ray-tube presentation are limited to sweep rates which permit reasonable visual persistence and fall into two classes.

1. Narrow-band (not more than 100 kilocycles) devices tracing true signal-sideband structure of signals modulated at audible or higher rates.

2. Devices scanning bands 1 megacycle or more in width. These are capable only of showing signal sidebands with signal modulation frequencies substantially higher than voice frequencies, and therefore cannot be relied upon for more than an indication of signal frequency, although in specific instances sideband resolution or envelope resolution may occur.

# Principal and Complementary Waves in Antennas\*

S. A. SCHELKUNOFF†, FELLOW, I.R.E.

**Summary**—In response to an increased interest in mathematical aspects of antenna theory, this paper presents details of analysis of cylindrical and other nonconical antennas as a supplement to a previous paper<sup>1</sup> containing the outline of the method and the main results. In the course of the present discussion the theory of principal waves on cylindrical conductors is extended to include the case in which the diameter is not small compared with the wavelength.

## INTRODUCTION

NOT VERY long ago, Dr. L. Brillouin and I spent some time discussing the antenna theory and the discrepancies between impedance values obtained<sup>2</sup> from a solution of the Oseen-Hallén approximate integral equation and from a direct approximation to the solution of Maxwell's equations.<sup>1</sup> The discrepancies are explained in the companion paper<sup>3</sup> where it is shown that the approximations involved in the integral equation are justified, that insufficient accuracy of Hallén's first approximation to the solution leads to a degradation of subsequent approximations, and that the revised procedure<sup>4</sup> employed by Miss Marion C. Gray should and does lead to a better series. It is difficult to overemphasize the importance of a proper choice of the fundamental parameter in the reciprocal powers of which one is naturally led to expand the current distribution in the antenna. This parameter is not uniquely defined by the mathematical equations and its choice controls the goodness of the approximation consisting of only the first two or three terms of the expansion.

In order to complete our discussion of the fundamentals of antenna theory, this paper presents mathematical details of the other analysis of cylindrical antennas which is based on representation of the field around the antenna in terms of appropriate solutions of Maxwell's equations. The present paper should be regarded as a supplement to the paper<sup>1</sup> already referred to, which contains a suggestive outline of the method, actual results, and their interpretation, for antennas of several shapes, but treats in detail only conical antennas. Besides yielding a solution of the antenna problem, this method leads to an attractive physical picture

of the phenomenon of radiation and focuses one's attention on similarities as well as dissimilarities between antennas and transmission lines. It should be stressed that this analogy can be made *a posteriori*, after the nature of the solution has been examined in the light of Maxwell's equations, and should not be confused with *a priori* assumptions of the analogy in some earlier work. In this early work an intuitive analogy had been made between antennas and ordinary idealized transmission lines admitting *only one* transmission mode; but it was subsequently discovered<sup>1</sup> that antennas can be regarded only as transmission lines with several modes of transmission of which, however, one, the "principal" mode, dominates the rest.

## STRUCTURE OF THE SOLUTION

In contrast with the method employed by Oseen and Hallén,<sup>5</sup> in which attention is concentrated at once on the current in the antenna, our method depends on the analysis of the field around the antenna and subsequent determination of the current associated with this field. The analysis is carried out in spherical co-ordinates, and for this reason the space is divided into the antenna region (1) and the remainder (2) with a spherical boundary between the two, Fig. 1. The reason for subdivision is that the boundary conditions on the axis of the antenna  $\theta=0, \pi$  are different for the two regions. In the

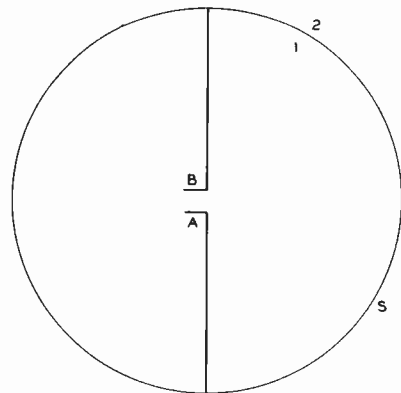

Fig. 1—Division of space into the antenna region (1) and the external region (2);  $S$  is the sphere centered at the input terminals and passing through the ends of the antenna.

external region (2) the solution should not be singular on the axis; this condition leads to a possibility of expressing the most general field in region (2) as a series of *integral* spherical harmonics. On the other hand, in

<sup>5</sup> E. Hallén, "Theoretical investigations into the transmitting and receiving qualities of antennas," *Nova Acta Uppsala*, ser. IV, vol. 11, pp. 1-44; November, 1938.

\* Decimal classification: R120. Original manuscript received by the Institute, June 18, 1945; revised manuscript received, August 20, 1945.

† Bell Telephone Laboratories, New York, N. Y.

<sup>1</sup> S. A. Schelkunoff, "Theory of antennas of arbitrary size and shape," *Proc. I.R.E.*, vol. 29, pp. 493-521; September, 1941.

<sup>2</sup> Ronald King and F. G. Blake, Jr., "The self-impedance of a symmetrical antenna," *Proc. I.R.E.*, vol. 30, pp. 335-349; July, 1942.

<sup>3</sup> S. A. Schelkunoff, "Concerning Hallén's integral equation for cylindrical antennas," *Proc. I.R.E.*, vol. 33, pp. 872-878; December, 1945.

<sup>4</sup> Marion C. Gray, "A modification of Hallén's solution of the antenna problem," *Jour. Appl. Phys.*, vol. 15, pp. 61-65; January, 1944.

region (1) the axis is excluded by the antenna and although the solution is permitted to have singularities on the axis, it is required to satisfy certain boundary conditions on the surface of the antenna. This leads to a representation of the solution in terms of *fractional* spherical harmonics. The method is particularly suitable to biconical antennas. For other shapes, the method is still practicable when the transverse dimensions of the antenna are small, in which case the antenna becomes a "cone with slowly varying angle", and the solution may be expressed as a series of "perturbed" fractional spherical harmonics.

Having expressed the solutions in the regions (1) and (2) as series with arbitrary coefficients, we find that the requirement of continuity of the field at the boundary sphere  $S$  furnishes enough equations for determination of all these coefficients except one. This last unknown is expressed in terms of the impressed voltage.

The next step in the breakdown of the field into component parts is a representation of the field in the antenna region as the sum of the principal and complementary waves. The simplest way to explain the nature of the principal waves is to say that these are the waves which would be generated in an infinitely long antenna. An outward-moving wave is generated by the source at  $A, B$  and an inward-moving wave could be generated by reflection from a conducting sphere concentric with  $A, B$ . These are the waves in which electric lines run substantially along the meridians, Fig. 2; exactly along

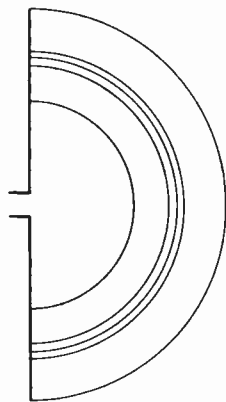

Fig. 2—Electric lines of force in principal waves.

the meridians for the biconical antenna. These are the waves which are exactly transverse electromagnetic waves in the case of the biconical antenna and very nearly transverse electromagnetic in other cases. These are the waves which correspond to the well-known waves along parallel wires, coaxial cylinders, and other "two-conductor transmission lines."

For a finite antenna the field, consisting of principal waves alone, will not satisfy the continuity requirements at the boundary sphere  $S$  since in region (2) there is no

principal wave to match. In fact, all waves in region (2) have a *radial* electric intensity and the condition of continuity is satisfied by adding a proper *complementary* field in region (1) which also possesses a radial electric intensity. This added field is required, therefore, in consequence of the sudden termination of the wires. Its presence expresses the fact that the reflection of the boundary sphere is not uniform, for otherwise we should have had merely a principal reflected wave (as when the sphere is a perfect conductor). At first it may seem strange that we should speak of reflection from a purely geometric boundary. We could dispose of it as a peculiarity of the co-ordinate system we are using, as an attribute of mathematics rather than as a disclosure of the underlying physical reality; but there is more to it than this. If we apply a voltage across  $A, B$  for a very brief interval of time, a thin spherical electromagnetic bubble is generated. The bubble will expand outwards and the mechanism of its expansion is given by Huygens' principle or its more complete form known as the induction theorem.<sup>6</sup> This simple movement persists until the forward boundary of the bubble reaches the end of the antenna, when the disturbance becomes "aware of" the altered conditions ahead. Naturally, this awareness manifests itself first near the wire and there the reflection is the greatest. It is in this respect that the present case differs from that of a uniform change in the characteristics of the medium over the entire wave front.

Thus the principal feature of the method is: waves in infinitely long antennas are considered first; subsequently, the complementary waves are included to express the effect of sudden termination of the wires, particularly with regard to uneven reflection at the wave front passing through the end of the antenna.

All this constitutes the background both for the subsequent mathematical analysis and for the physical interpretation of the results. For further ideas on this subject, the reader is referred<sup>7,8</sup> to the literature.

#### PRINCIPAL WAVES

In everything that follows, we assume perfect conductors and dielectrics because our main concern is radiation. For a double cone, Fig. 3, it is easy to find the exact solution of Maxwell's equations for principal waves; thus

$$H_{\phi}^{+} = \frac{I^{+}e^{-i\beta r}}{2\pi r \sin \theta}, \quad E_{\theta}^{+} = \frac{60I^{+}e^{-i\beta r}}{r \sin \theta}, \quad \beta = 2\pi/\lambda,$$

<sup>6</sup> S. A. Schelkunoff, "Electromagnetic Waves," D. Van Nostrand Co., Inc., New York, N. Y., 1943, p. 399.

<sup>7</sup> J. C. Slater, "Microwave Transmission," McGraw-Hill Book Company, New York, N. Y., 1941, pp. 219-232.

<sup>8</sup> Simon Ramo and John R. Whinnery, "Fields and Waves in Modern Radio," John Wiley and Sons, Inc., New York, N. Y., 1944, pp. 482-491.



$$H_{\phi}^- = \frac{I^- e^{i\theta r}}{2\pi r \sin \theta}, \quad E_{\theta}^- = -\frac{60I^- e^{i\theta r}}{r \sin \theta}; \quad (1)$$

the remaining components of the field are equal to zero. In the antenna theory we shall be concerned with the *transverse voltage*,  $V(r)$ ; that is, the line integral of  $E$  along a typical meridian

$$V(r) = \int_{\psi}^{\pi-\psi} r E_{\theta} d\theta, \quad (2)$$

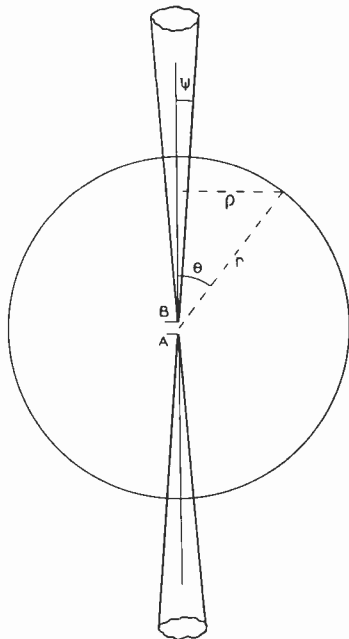

Fig. 3—A biconical antenna.

and with the current  $I(r)$  in the upper cone,

$$I(r) = 2\pi r \sin \theta H_{\phi} = 2\pi r \sin \psi H_{\phi}. \quad (3)$$

If we write the expressions for  $V$  and  $I$ , we shall find that they are exactly the same as for a uniform transmission line with the following characteristic impedance:

$$K = 120 \log \cot (\psi/2) \simeq 120 \log (2/\psi). \quad (4)$$

The approximation is for small values of the cone angle  $\psi$ .

In fact, if we introduce into Maxwell's equations our definition of the principal wave (in the present case  $E_r = E_{\phi} = H_r = H_{\theta} = 0$ ) and  $V$  and  $I$  from (2) and (3) in the place of  $E_{\theta}$  and  $H_{\phi}$ , the following equations are obtained after suitable integrations

$$\frac{dV}{dr} = -i\omega LI, \quad \frac{dI}{dr} = -i\omega CV, \quad (5)$$

$$L = (\mu/\pi) \log \cot (\psi/2), \quad C = \pi\epsilon/\log \cot (\psi/2). \quad (6)$$

Equations (5) hold, in fact, for principal waves on any pair of coaxial cones, Fig. 4, or even for any pair of cones with a common apex, Fig. 5; only the values of  $L$

and  $C$  are different. If we remove the common apex of the cones to infinity, we shall find that a coaxial pair of cylinders is a limiting case of coaxial cones and the pair of parallel wires is a limiting case of diverging cones shown in Fig. 5.

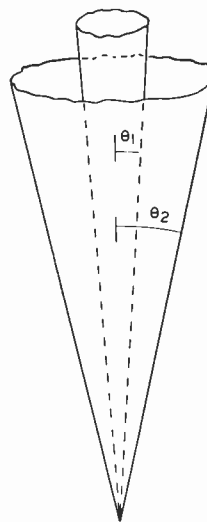

Fig. 4—Coaxial cones with a common apex.

It should be noted that the transverse voltage defined by (2) is equal not to the difference of scalar retarded potentials at the ends of the corresponding meridian but

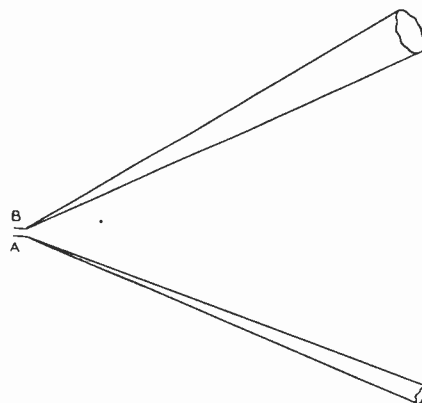

Fig. 5—Cones with a common apex.

to the difference of scalar electric potentials of the kind which appear in the theory of spherical waves.<sup>6</sup> In this theory the retarded potentials would be very cumbersome and for this reason are not used.

The field intensities (1) become infinite as  $r$  approaches zero; but  $V$  and  $I$  remain finite. In this respect the principal waves differ from the complementary waves. Infinite voltages are required for generation of *progressive* complementary waves by a point source and

very large voltages in the case of a source of finite but small dimensions. We shall return to this topic in the next section.

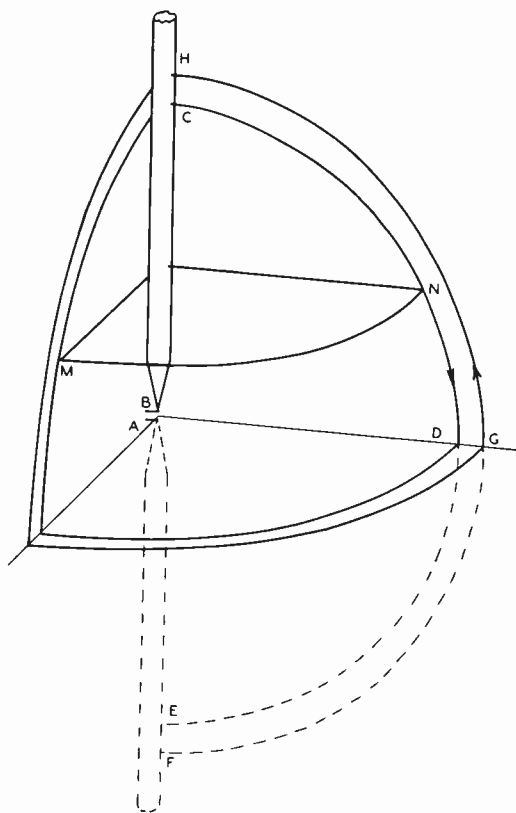

Fig. 6—A cylindrical antenna with tapered input terminals.

If the conductors are nonconical but of such proportions (Fig. 6) that the electric lines should nearly coincide with the meridians, we expect that equations (5) and (6) will be nearly correct if we assume that the cone angle  $\psi$  is varying continuously with  $r$ ; thus

$$\psi = \sin^{-1}(a/r), \quad (7)$$

where  $a$  is the radius of the conductor where it is intercepted by the sphere of radius  $r$ . While this is practically obvious, some questions may be raised unless a few details are supplied. We can start either with Maxwell's differential equations or apply the fundamental laws directly. Thus, applying Faraday's law of the electromotive force to the curvilinear rectangle  $CDEFGIIC$ , Fig. 6, we have

$$\frac{dV}{dr} = -i\omega\mu \int_{\psi}^{\pi-\psi} H_{\phi} r d\theta. \quad (8)$$

Applying Ampère-Maxwell's law of the magnetomotive force to a typical magnetic line  $MN$ , we obtain

$$H_{\phi} = \frac{I(r) + 2\pi i\omega\epsilon r^2 \int_{\psi}^{\theta} E_r \sin \theta d\theta}{2\pi r \sin \theta}. \quad (9)$$

This equation expresses the equality of the magnetomotive force  $(2\pi r \sin \theta)H_{\phi}$  round the magnetic line and the total radial electric current through the spherical segment bounded by this line. The first term  $I(r)$  is the conduction current in the upper conductor at the place where it cuts the sphere and the second term is the radial displacement current. If we neglect the latter, which we are entitled to do in the case of principal waves, we shall obtain the leading equations in the sets (5) and (6). Substituting from (9) into (8) we have

$$\frac{dV}{dr} = -i\omega LI + \beta^2 r^2 \int_{\psi}^{\pi-\psi} \frac{d\theta}{\sin \theta} \int_{\psi}^{\theta} E_r \sin \theta d\theta. \quad (10)$$

This is the exact equation.

In order to obtain the second transmission equation, we start with the following equation from Maxwell's set:

$$-i\omega\epsilon r E_{\theta} = \frac{\partial}{\partial r} (r H_{\phi}) \quad (11)$$

and substitute from (9); thus

$$-i\omega\epsilon r E_{\theta} = \frac{1}{2\pi \sin \theta} \frac{dI}{dr} + \frac{\partial}{\partial r} \left[ \frac{i\omega\epsilon r^2}{\sin \theta} \int_{\psi}^{\theta} E_r \sin \theta d\theta \right]. \quad (12)$$

Integrating from  $\theta = \psi$  to  $\theta = \pi - \psi$  and substituting from (2), we have

$$-i\omega\epsilon V = \left( \frac{1}{\pi} \log \cot \frac{\psi}{2} \right) \frac{dI}{dr} + \frac{d}{dr} \int_{\psi}^{\pi-\psi} \frac{i\omega\epsilon r^2}{\sin \theta} d\theta \int_{\psi}^{\theta} E_r \sin \theta d\theta. \quad (13)$$

Finally dividing by the coefficient of  $dI/dr$ , we obtain

$$\frac{dI}{dr} = -i\omega CV - i\omega C \frac{d}{dr} \int_{\psi}^{\pi-\psi} \frac{r^2 d\theta}{\sin \theta} \int_{\psi}^{\theta} E_r \sin \theta d\theta. \quad (14)$$

This time the exact equation contains the derivative of the correction term in (10).

Since the application of this equation is contemplated only when  $\psi$  is small,  $\cot(\psi/2) \simeq 2/\psi \simeq 2r/a(r)$  where  $a(r)$  is the radius of the conductor; furthermore  $r \simeq z$  so that (6) becomes

$$L = \frac{\mu}{\pi} \log \frac{2r}{a(r)} = \frac{\mu}{\pi} \log \frac{2z}{a(z)},$$

$$C = \frac{\pi\epsilon}{\log [2r/a(r)]} = \frac{\pi\epsilon}{\log [2z/a(z)]}. \quad (15)$$

The last terms in (10) and (14), which we will neglect, are at least of the order of the square of the radius while the remaining terms depend upon the logarithm of the radius.

The other extreme arises in the case of cylindrical antennas, Fig. 7, or other antennas of revolution, in the immediate vicinity of a *line source*,  $MN$ . As the radius of the line source increases, a wedge is approached, Fig. 8. The voltage is applied between the edges  $AC$

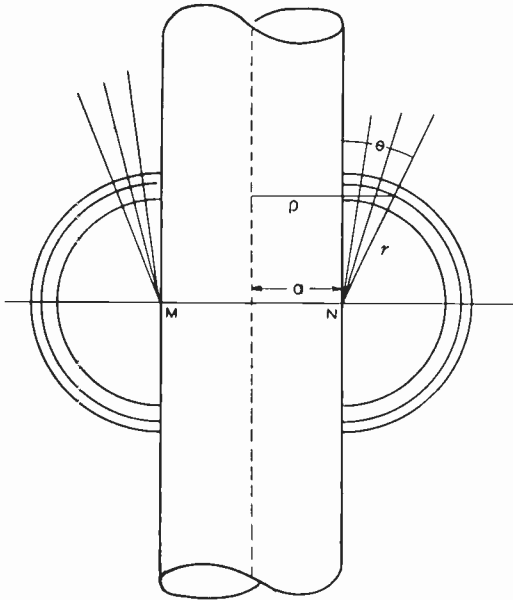

Fig. 7—A co-ordinate system suitable for cylindrical conductors.

and  $BD$  (which are assumed to be very close). In this case we still have equations (5) with  $r$  being the distance from the line halfway between the edges; the values of  $L$  and  $C$  per unit length along  $AC$  are

$$L = \pi\mu r \quad C = \epsilon/\pi r. \quad (16)$$

The intermediate case presents the greatest mathematical difficulties. The most natural co-ordinate system would be that formed by the equipotential surfaces, with the two conductors being kept at constant potentials, and two orthogonal families of surfaces passing through the lines of electric force; then we should try to express the relationship between the voltage along the electric line of force and the current in the form analogous to (10) and (14), with  $L$  and  $C$  having their static values and residual terms when required. Unfortunately the equations become quite complicated.

In the case of cylindrical conductors, we have an alternative which possesses certain advantages, Fig. 7. One of the co-ordinates  $r$  is taken to be the distance from the "origin circle"  $MN$ ; half planes issuing from the axis of the cylinder are designated by the azimuth angle  $\phi$  as in spherical and cylindrical co-ordinates; and  $\theta$  is the angle made by the generators of the cylinder with a typical radius in a  $\phi$  plane. In these co-ordinates the field equations become

$$\begin{aligned} E_r &= \frac{P}{2\pi i\omega\epsilon r^2} \frac{\partial\Psi}{\partial\theta}, & E_\theta &= -\frac{P}{2\pi i\omega\epsilon r} \frac{\partial\Psi}{\partial r}, \\ H_\phi &= \frac{\Psi}{2\pi\rho} = \frac{P\Psi}{2\pi r}, & P &= \frac{r}{a + r \sin\theta}, \end{aligned} \quad (17)$$

$$\frac{\partial}{\partial r} \left( P \frac{\partial\Psi}{\partial r} \right) + \frac{1}{r^2} \frac{\partial}{\partial\theta} \left( P \frac{\partial\Psi}{\partial\theta} \right) = -\beta^2 P\Psi.$$

From the last equation we obtain

$$\begin{aligned} \frac{\partial^2\Psi}{\partial r^2} + \beta^2\Psi &= -\frac{\partial}{\partial r} (\log P) \frac{\partial\Psi}{\partial r} - \frac{1}{r^2} \frac{\partial^2\Psi}{\partial\theta^2} \\ &\quad - \frac{1}{r^2} \frac{\partial}{\partial\theta} (\log P) \frac{\partial\Psi}{\partial\theta}, \end{aligned} \quad (18)$$

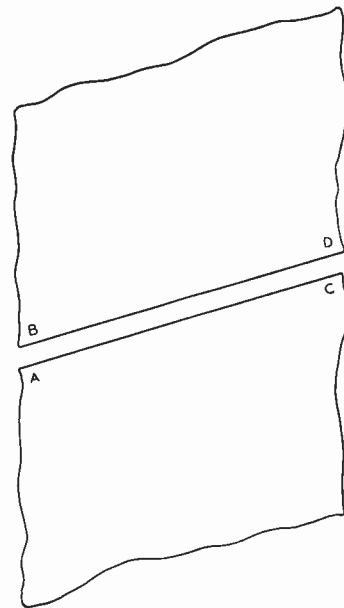

Fig. 8—A portion of a biplanar radiator.

where

$$\begin{aligned} \frac{\partial}{\partial r} (\log P) &= \frac{a}{r(a + r \sin\theta)}, \\ \frac{\partial}{\partial\theta} (\log P) &= -\frac{r \cos\theta}{a + r \sin\theta}. \end{aligned} \quad (19)$$

The solution for principal waves is the one in which  $\Psi$  is nearly independent of  $\theta$  so that  $E_r$  is nearly zero everywhere. In the first approximation we ignore the last two terms in (18) and obtain

$$\frac{\partial^2\Psi}{\partial r^2} + \beta^2\Psi = -\frac{a}{r(a + r \sin\theta)} \frac{\partial\Psi}{\partial r}. \quad (20)$$

If  $r$  is small compared with  $a$ , then



$$\frac{\partial^2 \Psi}{\partial r^2} + \beta^2 \Psi = -\frac{1}{r} \frac{\partial \Psi}{\partial r}; \quad (21)$$

in this case  $\Psi$  is a Bessel function of order zero and the field is nearly that for a wedge formed by two half planes. If  $r$  is large compared with  $a$ , the right-hand side of (20) can be neglected and  $\Psi$  is an exponential function. In this case, the field is given by expressions of the type (1) and equations (5) and (15) apply even if  $a$  is large. The function  $\Psi$  is substantially independent of  $\theta$  when  $r$  is very much smaller than or very much greater than  $a$ ; the greatest variation with  $\theta$  occurs in the vicinity of  $r=a$  where the coefficient of the last term in (20) varies from  $(-1/a)$  at  $\theta=0, \pi$  to  $(-1/2a)$  at  $\theta=\pi/2$ .

We are now in a position to determine the values of  $L$  and  $C$  for principal waves on a cylinder of any radius, except for the corrections for a small electric intensity in the direction of wave propagation. Thus in the present case equation (8) becomes

$$\frac{dV}{dr} = -i\omega\mu \int_0^\pi r H_\phi d\theta. \quad (22)$$

On the other hand,  $\Psi = I$  and substituting from (17) we have

$$\frac{dV}{dr} = -\frac{i\omega\mu I}{2\pi} \int_0^\pi \frac{rd\theta}{a+r\sin\theta}; \quad (23)$$

therefore

$$L = \frac{\mu}{2\pi} \int_0^\pi \frac{rd\theta}{a+r\sin\theta}. \quad (24)$$

Similarly,  $C$  is obtained from an equation corresponding to (2) and from (17). It turns out that  $LC = \mu\epsilon$ . Carrying out the required integration, we find that in free space

$$\begin{aligned} \sqrt{L/C} &= \frac{240r/a}{\sqrt{1-(r^2/a^2)}} \tan^{-1} \sqrt{\frac{a-r}{a+r}}, & r < a, \\ &= 120, & r = a, \\ &= \frac{240r/a}{\sqrt{(r^2/a^2)-1}} \log \frac{\sqrt{r+a} + \sqrt{r-a}}{\sqrt{2a}}, & r > a, \\ &= \frac{240r/a}{\sqrt{(r^2/a^2)-1}} \tanh^{-1} \sqrt{\frac{r-a}{r+a}}, & r > a. \end{aligned} \quad (25)$$

In a dielectric medium other than vacuum, we should multiply (25) by  $\sqrt{\mu/\epsilon}/120\pi$ . Fig. 9 represents  $\sqrt{L/C}$  as a function of  $r/a$  in the intermediate region where the simple formulas (15) and (16) are inapplicable. The dotted curves show the behavior of the simple formulas in this region.

The integrals of  $\sqrt{L/C}$  play an important role in the theory. These integrals are

$$\begin{aligned} &\int_r^a \sqrt{L/C} dr \\ &= 240a \left[ \sqrt{1-(r/a)^2} \tan^{-1} \sqrt{\frac{a-r}{a+r} - \frac{a-r}{2a}} \right], & r < a; \\ &\int_a^r \sqrt{L/C} dr \\ &= 240a \left[ \sqrt{(r/a)^2-1} \tanh^{-1} \sqrt{\frac{r-a}{r+a} - \frac{r-a}{2a}} \right], & r > a. \end{aligned} \quad (26)$$

We are also in a position to appraise the magnitude of the error we make when we neglect the radial electric intensity, that is, the last term in (10). At first sight, it may appear that the error increases with  $r$ ; but the reference to equations (17) and (20) shows that the error decreases with  $r$  when  $r$  is fairly large<sup>9</sup> compared with  $a$ .

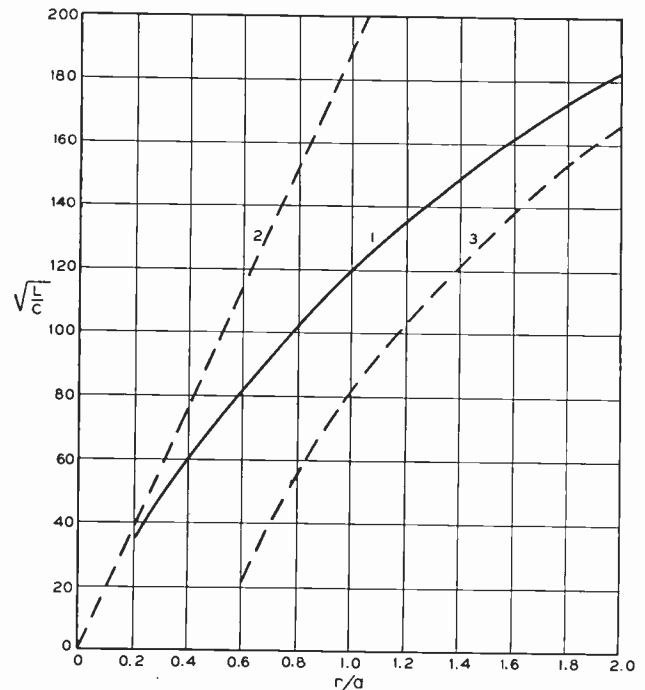

Fig. 9—The nominal characteristic impedance ( $\sqrt{L/C}$ ) as a function of  $r/a$  (see Fig. 7). Curve (1) represents equation (25); curve (2) represents  $\sqrt{L/C} = 60\pi r/a$ , an approximation when  $r$  is small compared with  $a$ ; curve (3) represents  $\sqrt{L/C} = 120 \log (2r/a)$ , an approximation when  $r$  is large compared with  $a$ .

Thus if  $\theta \neq 0, \pi$ , the magnitude of  $E_r$  varies inversely as  $r^{-4}$ ; if  $\theta = 0, \pi$ ,  $E_r$  seems to vary as  $r^{-3}$  but then it is actually equal to zero because of the boundary. Hence the last term in (10) varies as  $r^{-2}$  or more precisely as  $a\lambda/r^2$ .

The spherical system of co-ordinates and the system shown in Fig. 7 seem to be the most suitable co-ordinates in the solution of the antenna problem by the present

<sup>9</sup> In this case there is little difference between  $r$  as defined in Fig. 7 and the distance  $r$  from the center of the spherical co-ordinate system employed in (10).

method. One might suppose that spheroidal co-ordinates would be particularly suited to spheroidal conductors; but this does not happen to be the case. In the first place, the spheroidal functions receiving the greatest attention in the literature correspond to certain particular distributions of the impressed voltage over the entire spheroid. These special solutions correspond to natural radial modes of propagation rather than to traveling waves on the spheroid. The required solution for a concentrated source is then constructed from these special solutions and the analysis resembles that usually employed in the problem of the vibrating string. On the other hand, the present method is based on traveling waves and is analogous to that usually employed in the transmission-line theory. Naturally, there must exist spheroidal functions to represent traveling waves; but their theory has not been developed as yet. The needed functions are those solutions of

$$(1 - u^2) \frac{d^2 M}{du^2} + (k^2 - \omega^2 \mu \epsilon l^2 u^2) M = 0 \quad (27)$$

which are singular at  $u = \pm 1$ ; they do not promise to be particularly simple and on the whole the spherical co-ordinates seem to be more suitable for thin spheroids treated by the present method.

#### COMPLEMENTARY WAVES

In a sense, principal waves belong to the conductors, since nothing quite like them exists without the conductors. A generator of infinitesimal size imbedded in a homogeneous dielectric medium will produce no field if the electromotive force is finite. We must have a conducting wire connected to each terminal before we can hope to create a finite field and the principal waves are the waves that make the difference.

A generator of finite size creates waves in a perfectly homogeneous medium and these waves are merely modified when conductors are connected to the terminals of the generator. Such waves may be said to belong to the medium. Consider, for example, circularly symmetric fields, and suppose that  $\theta$  is the angle made by a typical radius with the axis of symmetry. If the medium is homogeneous, the dependence of the field on  $\theta$  is represented by the Legendre function  $P_n(\cos \theta)$ , where  $n$  is a positive integer. If we place thin wires along the axis, then  $n$  becomes a fraction such that the difference from an integer approaches zero with the reciprocal of the logarithm of the radius of the wire.

For a biconical antenna such "complementary" waves are expressed quite simply in terms of spherical co-ordinates. The field intensities satisfy the following equations:

$$\frac{\partial}{\partial r} (rE_\theta) = -i\omega\mu(rH_\phi) + \frac{\partial E_r}{\partial \theta}, \quad (28)$$

$$\frac{\partial}{\partial r} (rH_\phi) = -i\omega\epsilon(rE_\theta), \quad (29)$$

$$E_r = \frac{1}{i\omega\epsilon r^2 \sin \theta} \frac{\partial}{\partial \theta} [\sin \theta (rH_\phi)], \quad (30)$$

$$\begin{aligned} \frac{\partial^2}{\partial r^2} (r^2 E_r) = & -\omega^2 \mu \epsilon (r^2 E_r) \\ & - \frac{1}{r^2 \sin \theta} \frac{\partial}{\partial \theta} \left[ \sin \theta \frac{\partial (r^2 E_r)}{\partial \theta} \right]. \end{aligned} \quad (31)$$

Equation (31) possesses one simple solution, namely  $E_r = 0$ ; this yields the principal waves. The complementary waves are defined by

$$r^2 E_r = R(r)\Theta(\theta), \quad (32)$$

where at the surface of the cone

$$\Theta(\psi) = \Theta(\pi - \psi) = 0. \quad (33)$$

In particular we are interested in the case in which  $\Theta(\theta)$  satisfies the following condition

$$\Theta(\pi - \theta) = -\Theta(\theta), \quad (34)$$

corresponding to the symmetrical current distribution in the antenna. It turns out<sup>1</sup> that

$$\Theta(\theta) = \frac{1}{2} [P_\nu(\cos \theta) - P_\nu(-\cos \theta)], \quad (35)$$

where for small values of  $\psi$

$$\begin{aligned} \nu = 2n + 1 + \frac{1}{\log(2/\psi)} = 2n + 1 + \frac{120}{K}, \\ n = 0, 1, 2, \dots \end{aligned} \quad (36)$$

The dependence of the field on the radial co-ordinate is expressed by

$$\begin{aligned} \frac{\partial}{\partial r} (rE_\theta) = & - \left[ i\omega\mu + \frac{\nu(\nu+1)}{i\omega\epsilon r^2} \right] (rH_\phi), \\ \frac{\partial}{\partial r} (rH_\phi) = & - i\omega\epsilon (rE_\theta). \end{aligned} \quad (37)$$

The solutions of these equations can be expressed in terms of Bessel functions.

For other than biconical antennas, we allow  $\psi$  and therefore  $\nu$  to be a function of  $r$

$$\psi = a(r)/r, \quad \nu = 2n + 1 + 1/\log [2r/a(r)]. \quad (38)$$

We now have all the functions needed for representation of the field within the antenna region, and our next task is to match this field to the field outside this region.

#### MATCHING OF WAVES AT THE BOUNDARY SPHERE

There are at least two methods for matching the fields at the boundary sphere  $S$  of regions (1) and (2), Fig. 1.

One is the method of successive approximations based on the following considerations:

1. In the first approximation we neglect the complementary waves. When taken together with the vanishing of current at the ends of the antenna, this implies also the vanishing of the magnetic intensity over the boundary sphere. This boundary condition leads to an equation for two arbitrary constants in the general expression for principal waves. The second equation is obtained from the boundary condition at the generator where the impressed voltage is supposed to be given. Thus we obtain a field which satisfies all the boundary conditions in region (1) but which is discontinuous at  $S$ . This step yields strictly sinusoidal current distributions for biconical antennas, and nearly sinusoidal distributions for antennas of other shapes.

2. The next step is to determine the field of the above-found current distribution by the retarded potential method. In this way we obtain a field which is continuous at the boundary sphere  $S$  and which fails to satisfy the boundary conditions at the surface of the antenna because the tangential component of the electric intensity will not vanish there. This is a well-known fact which has caused a great deal of uneasiness in the past. It should not have, since no approximation can possibly satisfy *all* requirements of the problem; if it did, it would be the exact solution. The important thing is the magnitude of the error and not merely an indication that there is an error.

3. Having carried out the second step, we expand one of the field components at the boundary sphere in terms of wave functions appropriate to region (1). This will insure that the vanishing of the tangential electric intensity will be re-established at the surface of the antenna; but the continuity conditions at  $S$  will be broken automatically. The new field in the antenna region yields a new current distribution in the antenna.

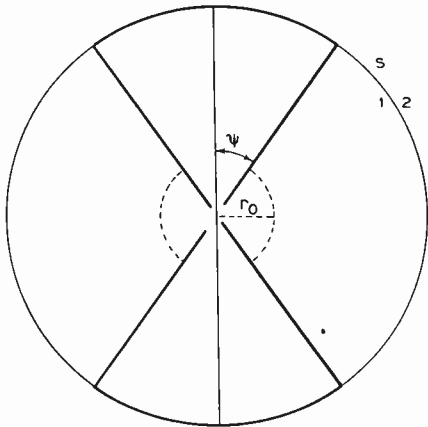

Fig. 10—A biconical antenna of large angle  $\Psi$ .

Steps (2) and (3) are then repeated *ad infinitum*. In the original antenna paper, the process was discon-

tinued with step (3). There, besides the principal current, we found the term inversely proportional to the average characteristic impedance of the antenna. The next two steps would have yielded a term varying inversely as the square of the average characteristic impedance.

Another method leads to a system of linear algebraic equations with an infinite number of unknowns. In theory the method is very simple. In region (1) the field is expressed as an infinite series of wave functions satisfying the boundary conditions on the antenna; in region (2) the field is expressed as an infinite series of spherical harmonics of integral degree; and the conditions at the boundary between the two regions furnish the necessary equations for calculation of the coefficients in the series. Thus in region (1) we have

$$rH_\phi = a_0 f_0^+(r, \theta) + b_0 f_0^-(r, \theta) + \sum_{n=1}^{\infty} a_n f_n(r, \theta),$$

$$i\omega\epsilon r E_\theta = -a_0 \frac{\partial f_0^+(r, \theta)}{\partial r} - b_0 \frac{\partial f_0^-(r, \theta)}{\partial r} - \sum_{n=1}^{\infty} a_n \frac{\partial f_n(r, \theta)}{\partial r}; \quad (39)$$

and in region (2)

$$rH_\phi = \sum_{n=0}^{\infty} A_n \widehat{K}_{2n+1}(i\beta r) P_{2n+1}^1(\cos \theta),$$

$$rE_\theta = - \sum_{n=0}^{\infty} \sqrt{\mu/\epsilon} A_n \widehat{K}'_{2n+1}(i\beta r) P_{2n+1}^1(\cos \theta), \quad (40)$$

$$\widehat{K}_n(x) = (2x/\pi)^{1/2} K_{n+1/2}(x).$$

When  $r=l$ ,  $H_\phi$  and  $E_\theta$  must be continuous. One way of expressing this condition is to equate (39) and (40) for a sequence of angles  $\theta = k\pi/2^{m+1}$ ,  $k=1, 2, 3, \dots, 2^m$ , where  $m \rightarrow \infty$ . If the antenna has a conducting portion in the boundary sphere, Fig. 10, then over this portion  $E_\theta$  as given by (40) should vanish. Perhaps, the best way of assuring this is to expand into spherical harmonics the function equal to  $E_\theta$  as given by (39) over the non-conducting part of the boundary sphere and equal to zero over the rest of the sphere. The procedure is simplified by the fact that  $P_{2m+1}^1(\cos \theta)$  form an orthogonal set of functions. In this way we express  $A_n$ 's in terms of  $a_n$ 's; and then we match  $H_\phi$ . When the set of functions  $f_n(r, \theta)$  is orthogonal, we can expand  $H_\phi$  as given by (40) in the usual way and express  $a_n$ 's in terms of  $A_n$ 's. Thus linear homogeneous equations connecting  $a_n$ 's are obtained. One linear nonhomogeneous equation is obtained from the condition at the source ( $r=0$ ): the integral  $-\int r E_\theta d\theta$  should equal the impressed voltage.

In the above outline we have assumed that the source of power is infinitesimal. It is for this reason that we

have only one set of functions  $f_n(r, \theta)$  to deal with in the antenna region. If the source is of finite dimensions, we have to divide our space into *three* regions: the generator region, the antenna region, the external space. In this case the voltage alone is not sufficient for complete determination of the field because the series in (39) becomes

$$rH_\phi = a_0 f_0^+(r, \theta) + b_0 f_0^-(r, \theta) + \sum_{n=1}^{\infty} [a_n f_n(r, \theta) + b_n g_n(r, \theta)]. \quad (41)$$

The added set of coefficients  $b_n$  will be determined from the boundary conditions at the sphere separating the generator from the antenna region. The nature of the functions  $g_n(r, \theta)$  is such that the coefficients  $b_n$  approach zero as the radius  $r_0$  of the generator region approaches zero. Furthermore  $g_n(r, \theta)$  decreases as  $r/\lambda$  increases; hence, for small values of  $r_0/\lambda$ , the added field is strictly local and substantially *electrostatic*.

The exact solution of the antenna problem is seen to depend on our ability to obtain exact wave functions for the antenna region, and then on our ability to solve the infinite system of linear algebraic equations. For biconical antenna of arbitrary angle, Fig. 10, the necessary functions are products of Bessel and Legendre functions with fractional orders. Thus for the antenna region ( $r \leq l, \psi \leq \theta \leq \pi - \psi$ ) we write

$$\begin{aligned} a_0 e^{-i\beta l} + b_0 e^{i\beta l} &= \sum_{n=0}^{\infty} A_n v_{n,0} \widehat{K}_{2n+1}(i\beta l), \\ a_{v_m} \widehat{J}_{v_m}(\beta l) &= \sum_{n=0}^{\infty} A_n v_{n,m} \widehat{K}_{2n+1}(i\beta l), \\ v_{n,0} &= -\frac{P_{2n+1}(\cos \psi)}{\log \cot(\psi/2)}, \\ v_{n,m} &= \frac{\int_{\psi}^{\pi/2} \left( \frac{d}{d\theta} P_{2n+1}(\cos \theta) \right) \sin \theta \frac{d}{d\theta} [P_{v_m}(\cos \theta) - P_{v_m}(-\cos \theta)] d\theta}{\int_{\psi}^{\pi/2} \left( \frac{d}{d\theta} [P_{v_m}(\cos \theta) - P_{v_m}(-\cos \theta)] \right)^2 \sin \theta d\theta}. \end{aligned} \quad (46)$$

$$\begin{aligned} rH_\phi &= \frac{a_0 e^{-i\beta r} + b_0 e^{i\beta r}}{\sin \theta} + \sum_{n=1}^{\infty} a_{v_n} \widehat{J}_{v_n}(\beta r) \frac{d}{d\theta} [P_{v_n}(\cos \theta) - P_{v_n}(-\cos \theta)], \\ rE_\theta &= \frac{\eta a_0 e^{-i\beta r} - \eta b_0 e^{i\beta r}}{\sin \theta} + i\eta \sum_{n=1}^{\infty} a_{v_n} \widehat{J}'_{v_n}(\beta r) \frac{d}{d\theta} [P_{v_n}(\cos \theta) - P_{v_n}(-\cos \theta)], \end{aligned} \quad (42)$$

$$\widehat{J}_{v_n}(x) = (\pi x/2)^{1/2} J_{v_n+1/2}(x), \quad \eta = \sqrt{\mu/\epsilon};$$

where the summation is extended over the roots of the following equation:

$$P_{v_n}(\cos \psi) = P_{v_n}(-\cos \psi). \quad (43)$$

If the cone angle  $\psi$  is small, the roots are approximately

$$v_n \simeq 2n - 1 + \frac{1}{\log(2/\psi)}, \quad n = 1, 2, 3, \dots \quad (44)$$

The functions

$$\frac{1}{\sin \theta}, \quad \frac{d}{d\theta} [P_{v_n}(\cos \theta) - P_{v_n}(-\cos \theta)]$$

form an orthogonal series.

Expanding  $IE_\theta(l)$  in the series of associated Legendre functions  $P_{2n+1}^1(\cos \theta)$  and equating the coefficients to those in (40), we obtain

$$\begin{aligned} A_m \widehat{K}'_{2m+1}(i\beta l) &= (-a_0 e^{-i\beta l} + b_0 e^{i\beta l}) u_{0,m} - i \sum_{n=1}^{\infty} a_{v_n, m} \widehat{J}'_{v_n}(\beta l) a_{v_n}, \\ u_{0,m} &= -\frac{4m+3}{2(m+1)(2m+1)}, \\ a_{v_n, m} &= \frac{4m+3}{2(m+1)(2m+1)} \int_0^{\pi/2} \left[ \frac{d}{d\theta} P_{2m+1}(\cos \theta) \right] \sin \theta \frac{d}{d\theta} [P_{v_n}(\cos \theta) - P_{v_n}(-\cos \theta)] d\theta. \end{aligned} \quad (45)$$

Expanding  $III_\phi(l)$  as given by (40) in the series of associated Legendre functions appropriate to the antenna region, we have

At  $r=0$ , we have

$$2\eta(a_0 - b_0) \log \cot(\psi/2) = -V, \quad (47)$$

where  $V$  is the impressed voltage.

Thus we have obtained a system of linear algebraic equations (45), (46), and (47). Infinite systems (like most problems for that matter) are solved by successive approximations. When the angle  $\psi$  is small, it is easy to determine the first approximation to the  $A_n$ 's. We merely let  $\psi=0$ , calculate the distant field, and compare it with (40). Starting with this set, we calculate  $a_{v_m}$  from (46) and then we calculate  $A_n$  from (45). On the other hand, if  $\psi$  is nearly  $\pi/2$ , we assume  $a_{v_n}=0$  in



the first approximation; then we obtain  $A_m$  from (45) and recompute  $a_{v_n}$  from (46). In any case the procedure is perfectly straightforward although the amount of labor involved in carrying out successive integrations would be prodigious unless we were satisfied with just two or three approximations.

#### ANTENNAS OF SMALL TRANSVERSE DIMENSIONS

A fairly simple general solution can be obtained if we assume that the transverse dimensions of an antenna are small compared with its length as well as with the wave length. In the case of biconical antenna the voltage and current distributions are<sup>1</sup>

$$\begin{aligned} V(r) &= V(l) \left[ \cos \beta(l-r) + \frac{iZ_a}{K} \sin \beta(l-r) \right], \\ I(r) &= \frac{V(l)}{K} \left[ i \sin \beta(l-r) + \frac{Z_a}{K} \cos \beta(l-r) \right], \\ &\quad - \frac{60V(l)}{K^2} \sum_{m=0}^{\infty} \frac{4m+3}{(m+1)(2m+1)} [\widehat{J}_{2m+1}(\beta l) \\ &\quad \quad - i\widehat{N}_{2m+1}(\beta l)] \widehat{J}_{2m+1}(\beta r), \end{aligned} \quad (48)$$

neglecting (in the expression for  $I$ ) terms of the order  $1/K^3$ . In order to obtain similar expressions for antennas of other shapes, all we need to do is to include in the principal wave the terms varying as  $1/K_a$ , where  $K_a$  is the average value of  $\sqrt{L/C}$ . To this order of accuracy the complementary waves are the same for all antennas as may be seen from (36) and (37). Thus the problem of cylindrical and other nonconical antennas as compared with the problem of biconical antennas demands merely an additional solution of a system of ordinary linear differential equations with varying coefficients, namely (5) and (15). This problem has already been considered elsewhere<sup>6</sup> and the results are

$$\begin{aligned} V(r) &= V(l) \left[ \cos \beta(l-r) + \frac{iZ_a}{K_a} \sin \beta(l-r) \right. \\ &\quad - \frac{M(l) - M(r)}{K_a} \cos \beta(l+r) \\ &\quad \left. + \frac{N(l) - N(r)}{K_a} \sin \beta(l+r) \right], \end{aligned}$$

$$\begin{aligned} I(r) &= \frac{V(l)}{K_a} \left[ i \sin \beta(l-r) + \frac{Z_a}{K_a} \cos \beta(l-r) \right. \\ &\quad + i \frac{M(l) - M(r)}{K_a} \sin \beta(l+r) \\ &\quad \left. + i \frac{N(l) - N(r)}{K_a} \cos \beta(l+r) \right] \\ &\quad - \frac{60V(l)}{K_a^2} \sum_{m=0}^{\infty} \frac{4m+3}{(m+1)(2m+1)} [\widehat{J}_{2m+1}(\beta l) \\ &\quad \quad - i\widehat{N}_{2m+1}(\beta l)] \widehat{J}_{2m+1}(\beta r), \end{aligned} \quad (49)$$

where

$$\begin{aligned} K_a &= 120 \int_0^l \log \frac{2r}{a(r)} dr, \quad K(r) = 120 \log \frac{2r}{a(r)}, \\ M(r) &= \beta \int_0^r [K_a - K(r)] \sin 2\beta r dr, \\ N(r) &= \beta \int_0^r [K_a - K(r)] \cos 2\beta r dr. \end{aligned} \quad (50)$$

Integrating (50) by parts, we have

$$\begin{aligned} M(r) &= \frac{1}{2} [K_a - K(r)] (1 - \cos 2\beta r) + 60 \text{Cin } 2\beta r \\ &\quad - 60 \int_0^r \frac{a'(r)}{a(r)} (1 - \cos 2\beta r) dr, \\ N(r) &= \frac{1}{2} [K_a - K(r)] \sin 2\beta r + 60 \text{Si } 2\beta r \\ &\quad - 60 \int_0^r \frac{a'(r)}{a(r)} \sin 2\beta r dr, \\ \text{Cin } x &= \int_0^x \frac{1 - \cos t}{t} dt, \quad \text{Si } x = \int_0^x \frac{\sin t}{t} dt. \end{aligned} \quad (51)$$

These equations apply to the same order of accuracy to thin antennas of all shapes.

It would be feasible to carry out the calculations as far as terms of the order  $1/K_a^2$  are concerned, assuming that practical applications warranted the added labor. At present it appears, however, that this is not necessary if  $K_a$  exceeds 500 (and perhaps is as low as 300).

Thus we have shown how to calculate certain solutions of Maxwell's equations appropriate to antennas of various shapes and to cylindrical antennas in particular. The initial approximations can be carried out without excessive labor and yield results of the same order of accuracy for antennas of all shapes.

# Probe Error in Standing-Wave Detectors\*

WILLIAM ALTAR†, F. B. MARSHALL†, AND L. P. HUNTER†

**Summary**—Distorted patterns which are observed in standing-wave detectors with deeper probe penetrations are shown to be attributable to reflections at the probe wire. It is demonstrated that the probe, over a wide range of penetrations, acts as a simple shunt admittance across the transmission line.

The mathematical and graphical treatment developed on this basis gives a satisfactory account of observed probe patterns, and makes it possible to obtain exact readings even from badly distorted patterns. By applying the results, one is in a position to improve the sensitivity of standing-wave measurements at low-power levels without sacrifice in accuracy, simply by using much deeper probe penetrations.

## I. INTRODUCTION

REFLECTIONS caused by the probe in conventional standing-wave detectors are not negligible even with probe penetrations of the order commonly used, and they may result in noticeable distortions of the observed standing-wave pattern. These distortions should serve as a warning not to take the apparent standing-wave ratio at its face value. But since the shape of the pattern rarely receives much attention, the effect is a potential source of error. It is, therefore, of some importance to have a simple criterion for its presence and a ready method of correction. The latter will be particularly desirable when it permits us to improve the sensitivity of measurements at very low power levels without sacrifice in accuracy, simply by using much deeper probe penetrations.

The method proposed here rests on the plausible assumption that the distortions are entirely attributable to reflections at the probe wire and that the probe, insofar as it causes reflections, may legitimately be considered as a mere shunt admittance across the line. The twofold purpose of the paper is, therefore (1) an experimental verification of these assumptions; and (2) their mathematical exploitation in the form of formulas and graphical procedure. From a purely practical viewpoint the second purpose is of greater interest, yet a large portion of the paper must be devoted to the experimental verification, showing the limitations of the procedure. In view of this duplicity of purpose, the group of readers primarily interested in the application would be best served, it is felt, by having a sample computation presented in Section II, while proofs and verifications are relegated to later sections. As shown in the sample, three galvanometer readings at specified probe positions suffice for a computation of the true standing-wave ratio even from a badly distorted pattern, and furthermore, of the admittance of the perturbing probe if desired. The determination of the latter is not actually required in

routine measurements but will be used here as part of the experimental verification of the underlying assumptions.

Our experiments test the validity of these assumptions for a standing-wave detector operating in a rectangular wave guide at a wavelength of a few centimeters. In this typical case our formulas must be applied when the probe penetration exceeds 25 per cent, and they account perfectly for the observed distortions with penetrations as deep as 65 per cent. While the mathematical treatment offered here is not restricted to a particular type of transmission line, it must be realized that the specific values quoted are not directly comparable with probe penetrations in, let us say, a coaxial line where the deeper probe reaches into a stronger electric field. It is also necessary to point out that in our measurements the customary precautions for excluding all undesired frequencies were observed, and that failure to do so will cause additional distortions of a type not within the scope of our formulas.

In our measurements, the probe admittance is a function not only of the penetration but also of the tuning of the probe circuit by means of which the detector response was adjusted to a maximum value. Thus it would be almost impossible to compute the admittance, and all values quoted are empirical. However, by using two independent experimental methods for their determination, an additional check on the consistency of our theory was provided.

The most noticeable distortion of a typical pattern (Fig. 1) is the asymmetry of the maximum position relative to the minima, though this is not a necessary criterion for probe reflections. The pattern of Fig. 1 was taken with a probe penetrating 50 per cent of the guide height and with an actual power standing-wave ratio of 12.8 whereas the apparent value is only 11.0. Thus an error of 20 per cent could be incurred unless one is aware of the distortion. Also, the minimum is shifted from the true position which might cause an error in the angular position of the load point plotted in the Smith chart<sup>1</sup> by as much as 20 degrees.

Probably the simplest criterion for reflections is in terms of the separation between the minimum and each of what may be termed the two midpoints. By midpoint is meant a probe position such that the galvanometer reading  $C$  is related to the maximum and minimum readings,  $A$  and  $B$ , by the equation

$$C = \frac{2AB}{A + B} \quad (1)$$

\* Decimal classification: R116. Original manuscript received by the Institute, March 27, 1945; revised manuscript received, July 17, 1945.

† Westinghouse Electric Corporation, East Pittsburgh, Pa.

<sup>1</sup> P. H. Smith, "Transmission-line calculator," *Electronics*, vol. 12, pp. 29-31; January, 1939.

In the absence of reflections, the probe response

$$P = \frac{1}{2}[(A + B) - (A - B) \cos \phi]$$

gives a sine pattern when plotted against the probe position  $\phi$  (expressed in radians) and one verifies easily that the midpoints must be spaced at intervals

$$\eta = \pm \cos^{-1} \left[ \frac{A - B}{A + B} \right]$$

from the minimum because this reduces  $P$  to the value (1). The last equation can, therefore, serve as an experimental criterion for the absence of probe reflections. In the presence of reflections, one determines the positions of maximum, minimum, and midpoints and expresses their spacings in radians, to a scale which renders the half wavelength equal to  $2\pi$ . As shown in Appendix I, a mathematical relation between these four positions makes it possible to obtain a complete solution from the two known spacings between any three consecutive positions; for instance, between the minimum and the two midpoints. Still it will be necessary to determine the maximum value if not its position, since it enters into the definition of the midpoints. The exception where one can do completely without the maximum is

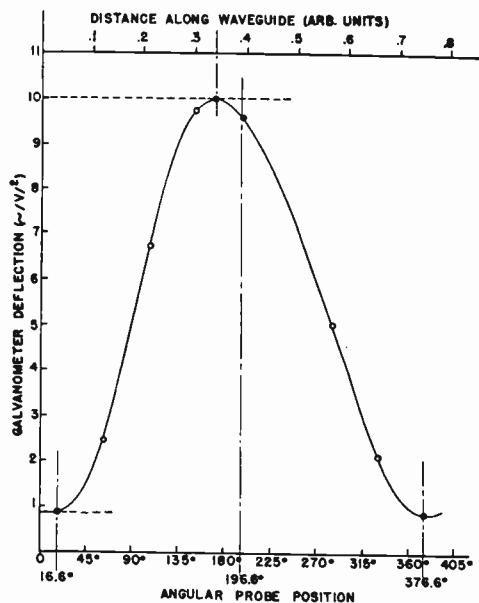

Fig. 1—Typical probe pattern. Points experimental, curves calculated.

the case of very high standing-wave ratios, where the midpoint response, according to (1), is simply twice the minimum response. This is fortunate because in this case the measurement of the maximum value would be impractical at power levels where the minimum reading has any accuracy. It turns out for very high standing-wave ratios that the probe reflections have little effect on the measured positions of minimum and midpoints because the correction terms are small of a high order.

II. SAMPLE CALCULATIONS

Let the distorted pattern be the one shown in Fig. 1.

The upper scale of abscissas represents actual distance along the wave guide in arbitrary units measured from an arbitrary position in the wave guide. The lower scale of abscissas represents angular distance along the wave guide in degrees and is based on 360 degrees between minima. We may compute the "midpoint" galvanometer deflection from (1)

$$C = \frac{2AB}{A + B} = \frac{2 \times 10.00 \times 0.87}{10.87} = 1.60$$

which enables us to read the midpoint positions from the illustration. From this illustration, therefore, we obtain the information contained in Table I.

TABLE I

	Maximum	Minimum 1	Minimum 2	Midpoint 1	Midpoint 2
Galvanometer Deflection	10.00	0.87	0.87	1.60	1.60
Angular Position (degrees)	170.0	16.6	376.6	46.6	343.0

Proceeding first by the graphical method, we draw an arbitrary circle  $C_1$  (Fig. 2(a)), with center  $D$ , on which the angular positions from the table are marked. The

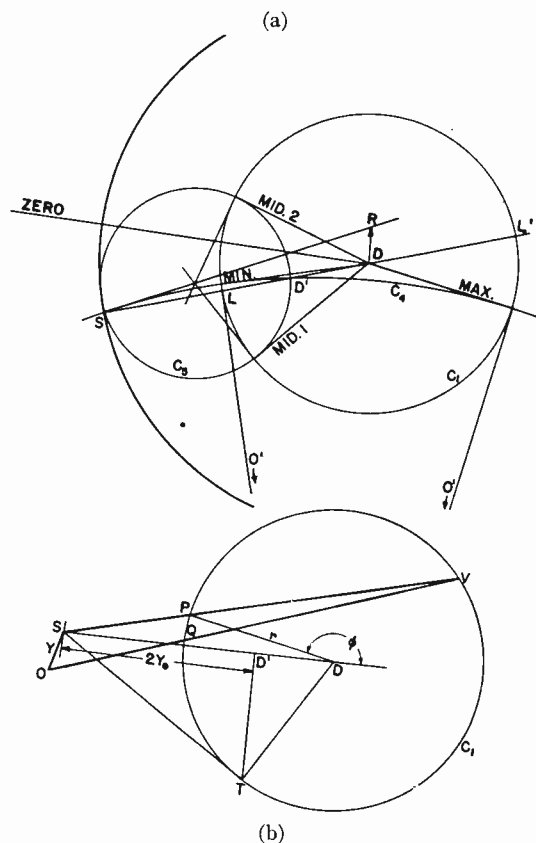

Fig. 2—Sample illustration of graphical procedure.

tangents at the maximum and minimum points intersect at  $O'$ , the center of circle  $C_4$  which is orthogonal to circle  $C_1$ . Similarly, the two tangents at the midpoint positions determine the center of circle  $C_5$  which is orthogonal to circle  $C_1$  and circle  $C_4$ . Through the outer intersection  $S$  of circle  $C_4$  and  $C_5$ , draw the circle with center  $D$ . This circle is the outer rim of the Smith chart. The point  $L$  of intersection of the line  $SD$  with





it would be indicative of zero probe response at the reference point, the reflection coefficient being unity with the minimum at the reference point. Now generally the voltage at the reference point is represented in phase and magnitude by the chart vector pointing from *S* to *P*, as can be proved in the following manner. We recall that<sup>1</sup> the contours of susceptance *B* are circles of radius  $1/B$  (Fig. 3(b)) and the conductance circles have radii  $1/(1+G)$ . From the geometry of Fig. 3(b), we have

$$\begin{aligned} &\sqrt{\left(\frac{1}{B}\right)^2 - \left(\frac{SP}{2}\right)^2} + \sqrt{\left(\frac{1}{1+G}\right)^2 - \left(\frac{SP}{2}\right)^2} \\ &= \left(\sqrt{\frac{1}{B}} + \frac{1}{1+G}\right)^2 \\ |\vec{SP}|^2 &= \frac{4}{B^2 + (1+G)^2} \end{aligned}$$

To identify this with voltage, we will consider a line of characteristic admittance  $Y_0$  terminated by  $Y$ . The ratio  $r$  of the incident *A* to the reflected *C* waves is

$$\frac{A}{C} = r = \frac{Y_0 - Y}{Y_0 + Y}$$

and the probe voltage  $V$  is

$$\begin{aligned} V &= A + C = A \left(1 + \frac{Y_0 - Y}{Y_0 + Y}\right) \\ |V| &= \left| \frac{2AY_0}{Y_0 + Y} \right| \end{aligned}$$

and letting  $Y_0$  and  $A = 1$ , we have for unit incident amplitude

$$|V|^2 = \frac{4}{|1+Y|^2} = \frac{4}{B^2 + (1+G)^2} = |\vec{SP}|^2$$

Thus the probe voltage may be represented by the length of the vector  $\vec{SP}$ . An alternative proof may be derived from first principles as follows:

Considering that the Smith chart is the complex plane of reflection coefficients  $r$  and that the short-circuit point *S* represents a reflection coefficient  $r = -1$ , ( $Y = \text{infinity}$ ) we see that the vector  $\vec{SP}$  represents the complex quantity  $(1+r)$ . On the other hand, the voltage at the reference point is the sum of the incident wave, of amplitude unity, and of the reflected wave, of amplitude and phase represented by  $r$ , and thus is given by the same complex quantity  $(1+r)$ .

At other reference points  $P', P'' \dots$  (Fig. 3(c)) the voltage is similarly given by the vectors  $\vec{SP'}, \vec{SP''}$ , etc. Thus as we move the probe in a direction away from the load, the voltage vector  $\vec{SP}$  varies as *P* rotates along the circle  $C_1$  (Fig. 3(c)) in a clockwise sense, through angles which are proportional to the probe shifts. It is permissible here to ignore the relative position of probe and generator which affects merely the phase, not the

magnitude of the probe voltage. The square of  $\vec{SP}$  is a measure of the rectified galvanometer current, the variation of which with probe position is a sine curve which may be seen by virtue of simple geometry.

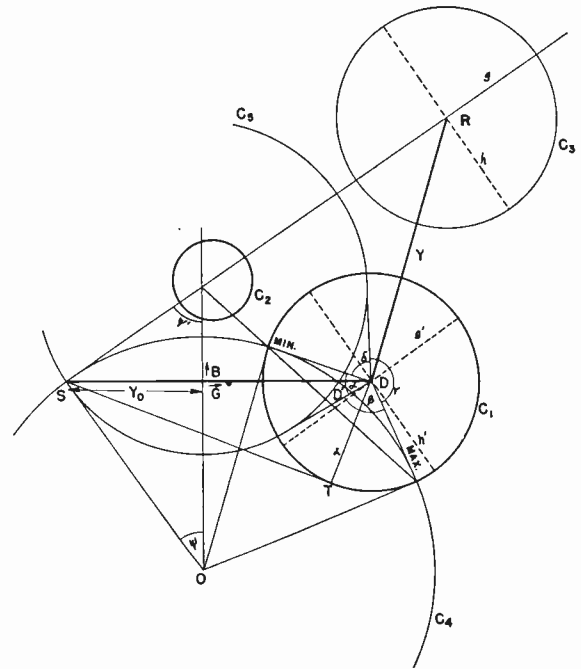

Fig. 4—Diagram representing general effect of probe admittance  $Y$ .

With a reflecting probe, circle  $C_1$  no longer represents the load locus as seen at the probe but must be transformed, point by point, in a manner allowing for a constant additive amount of probe admittance. To find the result of this transformation, it is expedient to change temporarily from the chart diagram to the complex admittance plane. This transition is effected by means of an inversion; i.e., a transformation by reciprocal radii using the point *S* as the inversion center. It is expedient to choose the unit radius of the inversion in a manner such that circle  $C_1$  as a whole remains unchanged by the transformation, its points merely changing places in pairs  $Q, Q'$  (See Fig. 3(c)). This is accomplished by choosing as the inversion unit the distance  $ST$ , *T* being the point of tangency of  $t$  and  $C_1$  (Fig. 3(c)).

Referring now to Fig. 4, which represents a superposition of the chart and admittance diagrams, let  $C_1$  and *S* have the same meaning as in Fig. 3(c). The distances between the four characteristic probe positions, expressed in radians, are designated as follows:  $\alpha$ , the distance between the minimum and the nearest midpoint;  $\beta$ , between the maximum and its nearest midpoint;  $\gamma$ , between the maximum and its farther midpoint; and  $\delta$  between the minimum and its farther midpoint. It can be shown (see Appendix I) that the four points on  $C_1$  determine four chords such that pairs of opposite chords have equal products; this means that  $\alpha, \beta, \gamma$ , and  $\delta$  follow each other consecutively. The inversion with center *S* and radius  $ST$  carries the chart (center *D*, radius  $DS$ ) into a complex plane of admittances

transforming point  $D$  into  $D'$  (obtained by drawing a line through  $T$  and perpendicular to  $DS$ ). In the admittance plane, points  $D'$  and  $S$  have the significance of plus and minus unity, respectively, and the imaginary axis passes half way between them. The real axis passes through  $S$  and  $D$ . The admittance locus is again circle  $C_1$  but its center  $D$  no longer is identical with the point of matched load,  $D'$ . Addition of the probe admittance  $\Gamma$  shifts the admittance circle  $C_1$  to a new position  $C_3$ . From  $C_3$  we find  $C_2$ , the apparent locus of operation in the chart for the moving probe position, by applying the inversion once more, using the same center  $S$ , and unity  $ST$  as before.

These geometrical operations are the equivalent of adding the admittance  $Y$  to each point of the circle  $C_1$  in the chart. We see now how the distorted probe pattern emerges from the construction of Fig. 4. As the ideal operating point (that is, in the absence of probe reflections) moves along circle  $C_1$  uniformly with changing probe position, its image on circle  $C_2$ , obtained by twice inverting as described, moves at a rate which is subject to wide variations, the vector from  $S$  to the image point being proportional to the square root of the galvanometer deflection.

#### IV. ANALYSIS OF A PATTERN

Practically, however, the problem presents itself in the reverse order, being the determination of quantities  $r$  and  $Y = G + jB$  from a measured curve of the type of Fig. 1. It is not difficult to verify that the two mid-points on circle  $C_2$  are the intersections of circle  $C_2$  and the circle with center on line  $g$  and perpendicular to  $C_2$ , and which passes through the point  $S$  (Circle  $C_6$ , Fig. 5). Since this circle is carried into the diameter  $h$  of circle  $C_3$  by the inversion, it becomes clear that the four characteristic probe positions are equally spaced on the admittance circle  $C_3$ , and consequently on the admittance circle  $C_1$ . The proof of this will be found in the Appendix IV. The lines  $g'$  and  $h'$  form a pair of orthogonal diameters of circle  $C_1$ , respectively parallel to lines  $g$  and  $h$ . The corresponding four points on the chart circle  $C_1$  must, therefore, form what is known as a harmonic set, being the intersections of  $C_1$  with two circles  $C_4$  and  $C_5$ , both perpendicular to the circle  $C_1$  and to each other. The circles  $C_4$  and  $C_5$  intersect in points  $D'$  and  $S$ ; circle  $C_4$ , being related to  $g'$  by an inversion at center  $S$ , must have radius  $SO$  perpendicular to  $g'$  and thus to  $g$ . Its tangent at  $S$  is the line  $g$  which passes through the center of the circle  $C_5$ .

The analytic problem now resolves itself into the construction of Fig. 4 from the angles  $\alpha$  and  $\beta$ . In order to obtain  $\alpha$  and  $\beta$ , the positions of the maximum, the minimum, and one midpoint between them must be measured. The actual values of the maximum and the minimum must be known in order to calculate the value of the midpoint (equation (1)) and to determine its position. The apparent standing-wave ratio does not

enter explicitly, however, in this determination of the true standing-wave ratio or the true load point in the chart. Only if it is desired to determine the probe admittance does one use the apparent standing-wave ratio explicitly.

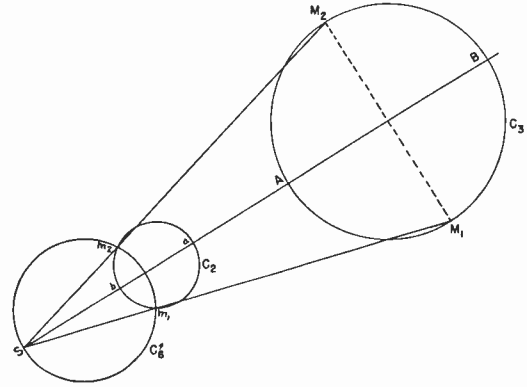

Fig. 5—Auxiliary sketch used in showing relation among maximum, minimum, and midpoint positions.

To solve the first part of the problem, a circle  $C_1$  of arbitrary radius  $r$  is drawn to a scale to be determined later. Three points separated by angles  $\alpha$  and  $\beta$  in accordance with the measured probe shifts are marked on this circle. Next, circles  $C_4$  and  $C_5$  are drawn through these points, both being perpendicular to the circle  $C_1$  and to each other as shown in Fig. 2, giving  $S$  as their intersection point. The distance  $DS$  is the outer chart radius; i.e., unity, and thus by comparison gives the true value of the reflection coefficient  $r$ , and hence the true standing-wave ratio  $1+r/1-r$ . The true chart point is obtained as the intersection of line  $SD$  and circle  $C_1$ , indicating the error in the observed minimum position. If the three characteristic points were plotted correctly, not only relative to each other but also to an assumed reference point, the chart point will also be in the correct relation to this reference point.

It is an easy matter to complete the illustration by incorporating the vector  $Y$ . The center of circle  $C_3$  is found by marking a distance  $r/r'$  from  $S$  along line  $g$  which is tangent to  $C_4$  at  $S$ . The apparent reflection coefficient

$$r' = \frac{\sqrt{A} - \sqrt{B}}{\sqrt{A} + \sqrt{B}}$$

is found from the observed galvanometer readings  $A$  and  $B$ . On the other hand, the center of circle  $C_3$  is the endpoint of vector  $Y$  plotted from  $D$  to a scale whose unity  $Y_0$  is represented by the distance  $SD'/2$ .

These constructions are straightforward and can be carried out quickly except in cases representing extreme conditions. For instance, if maximum and minimum are approximately a quarter wave apart, circle  $C_4$  becomes impractically large and the construction is awkward and inaccurate. For better than graphical accuracy, the reflection coefficient can be computed directly by means of the formulas

$$r = \frac{1 - \tan(\bar{\eta}/2)}{1 + \tan(\bar{\eta}/2)}$$

where

$$\sin \bar{\eta} = \frac{\sin \eta}{\sqrt{1 + \left(\frac{\sin \epsilon \cdot \sin \eta}{\cos \epsilon - \cos \eta}\right)^2}} \quad (2)$$

and

$$\eta = \frac{\alpha + \beta}{2} \quad \epsilon = \frac{\beta - \alpha}{2}$$

For proof, refer to Fig. 6, which is an extraction of Fig. 4, with some self-explanatory additions. From Fig. 6 it can be seen that

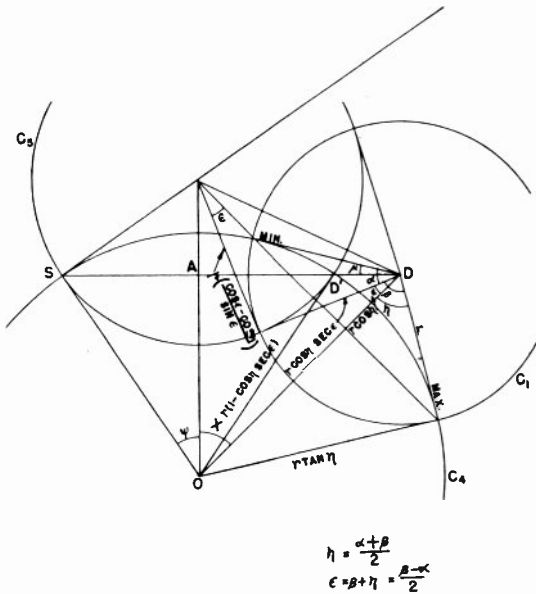

Fig. 6—Auxiliary drawing used in proof of (2) and (8).

$$\begin{aligned} \tan \psi &= \frac{(\cos \epsilon - \cos \eta) \cos \eta}{\sin \epsilon \cdot \sin \eta} \\ \sin \psi &= \frac{(\cos \epsilon - \cos \eta) \cos \eta}{\sqrt{(\cos \epsilon - \cos \eta)^2 \cos^2 \eta + \sin^2 \epsilon \cdot \sin^2 \eta}} \quad (3) \\ \cos \psi &= \frac{\sin \epsilon \cdot \sin \eta}{\sqrt{(\cos \epsilon - \cos \eta)^2 \cos^2 \eta + \sin^2 \epsilon \cdot \sin^2 \eta}} \end{aligned}$$

In order to determine the unit of the admittance scale which, in Fig. 2, is represented by the length  $SD'/2$ , we write

$$\begin{aligned} SD' &= 2r \tan \eta \cdot \sin \psi \\ &= \frac{(\cos \epsilon - \cos \eta) \sin \eta}{\sqrt{(\cos \epsilon - \cos \eta)^2 \cos^2 \eta + \sin^2 \epsilon \cdot \sin^2 \eta}} \quad (4) \end{aligned}$$

Inspection of Fig. 6 will show that the following products of distances are equal:

$$\begin{aligned} (DD')(DS) &= (DT)^2 \\ \text{or} \quad (1)(1 - 2Y_0) &= r^2 \quad (5) \end{aligned}$$

Hence we have a quadratic equation from which the reflection coefficient may be found

$$r^2 + 2r \tan \eta \cdot \sin \psi - 1 = 0 \quad (6)$$

which together with (3) leads directly to (2).

For the probe admittance one derives (Appendix II) the formula

$$Y = \frac{2}{1 - r^2} \left[ \left( \frac{r}{r'} \right) e^{i\psi} - 1 \right] \quad (7)$$

where the factor  $2/1 - r^2$  refers the admittance to the proper unit. The true minimum position is the point of intersection of the line  $SD$  and circle  $C_1$  (Fig. 6). From the triangle  $OAD$  one has

$$\sin(\eta - \mu) = \frac{OA}{OD} = \frac{OA}{r \tan \eta} \frac{r \tan \eta}{OD} = \cos \psi \cdot \sin \eta \quad (8)$$

from which one computes the angle  $\mu$  by which the minimum has been shifted as a consequence of probe reflections. The angle is counted positive toward the nearer of the two midpoints.

In concluding the general discussion, it should be mentioned that the chart point can also be determined in terms of the quantities  $\alpha$  and  $\delta$  (Fig. 4). The introduction of the angle  $\delta$  instead of  $\beta$  requires little labor, since (2) remains correct when the letter  $\beta$  in the definitions of  $\epsilon$  and  $\eta$  is replaced by  $\delta$  and the letter  $\psi$  in (3) by  $\psi'$ . Equation (8) then remains valid with the same changes. This form will be of use later when we take up the case of high standing-wave ratios.

### V. EXPERIMENTAL VERIFICATION

All measurements were performed with a standing-wave detector of standard design using a rectangular wave guide and operating at wavelengths of a few centimeters. The detector was coupled to the electric field by means of a probe wire 0.010 inch in diameter which protruded into the wave guide through a 3/32-inch slot. The arrangement of the apparatus is shown schematically in Fig. 7. At the right in the illustration is the

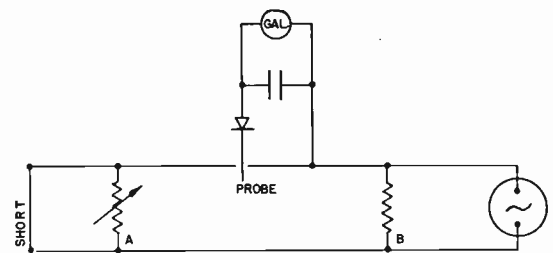

Fig. 7—Schematic arrangement showing wave detector and variable load.

generator which is buffered by the fixed attenuator  $B$ . At the left in the illustration is shown the load which consists of a variable attenuator  $A$  backed by a short circuit. The attenuator  $B$  was matched to the characteristic impedance of the transmission line, and was of such a value that the generator was always working into a nearly matched load regardless of the position or the setting of the attenuator  $A$ . The generator, a reflex klystron, was operated from a well-regulated power supply.

The standing-wave detector was completely overhauled prior to the measurements, and with a matched

load the probe response was constant within one per cent all along the length of the slot. A low-resistance, critically damped galvanometer served as the indicator of probe response. All attenuators were calibrated and the square-law response of the probe crystal was carefully checked.

acts as a shunt admittance so long as the penetration is not more than 65 per cent, and the theory presented here should thus be quite satisfactory in all practical standing-wave measurements.

In Figs. 8, 9, 10, 11, and 12 is shown the variation of probe patterns with load, the probe penetration re-

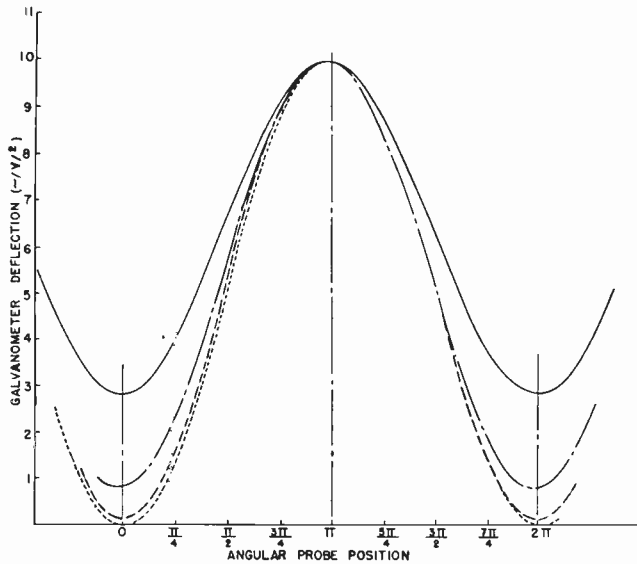

Fig. 8—Standing-wave patterns as a function of load. Curves experimental. Constant probe penetration 25 per cent.

— 0.31  
 - - - 0.56 Reflection coefficient  
 - - - 0.82  
 - - - 1.00

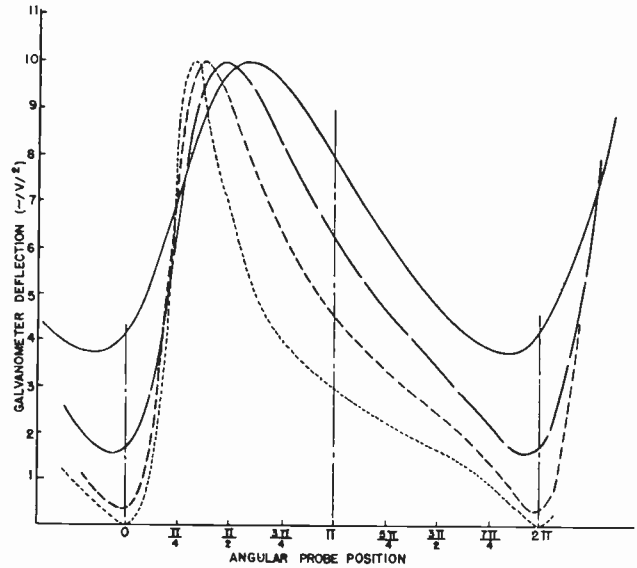

Fig. 10—Standing-wave patterns as a function of load. Curves experimental. Constant probe penetration 75 per cent.

— 0.31  
 - - - 0.56 Reflection coefficient  
 - - - 0.82  
 - - - 1.00

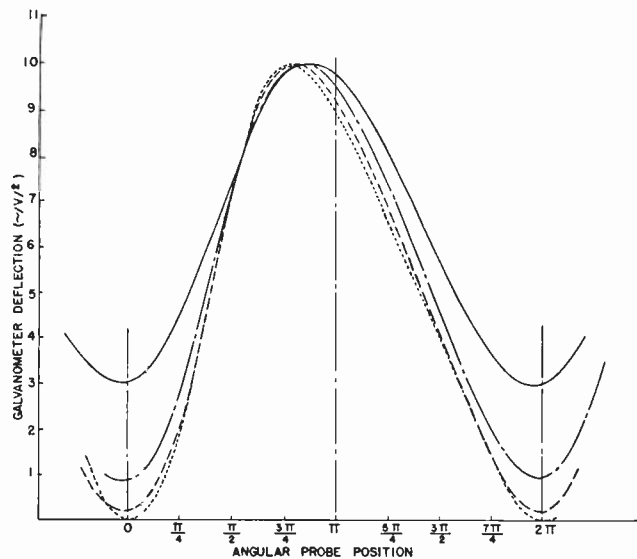

Fig. 9—Standing-wave patterns as a function of load. Curves experimental. Constant probe penetration 50 per cent.

— 0.31  
 - - - 0.56 Reflection coefficient  
 - - - 0.82  
 - - - 1.00

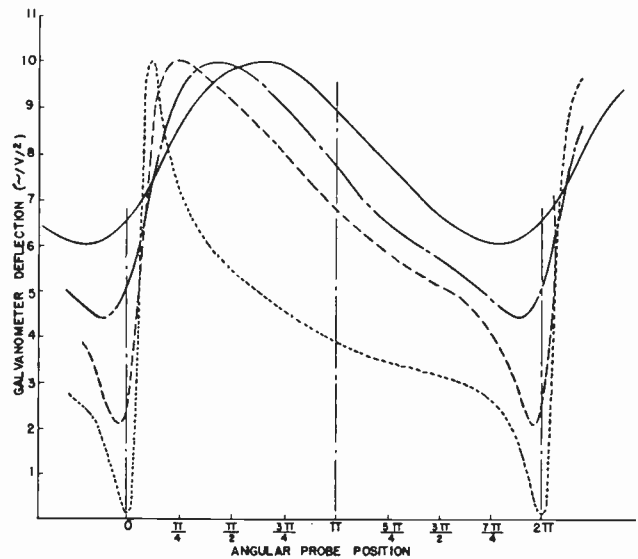

Fig. 11—Standing-wave patterns as a function of load. Curves experimental. Constant probe penetration 90 per cent.

— 0.31  
 - - - 0.56 Reflection coefficient  
 - - - 0.82  
 - - - 1.00

As a sample of the computations of Section III, the true reflection coefficient  $r$  and the probe admittance  $Y = G - jB$  have been computed for a fixed load and a number of probe penetrations, and tabulated in Table II. The load was the same as that used in Fig. 4. Probe penetration is quoted in per cent of guide height. The tabulated results bear out the contention that the probe

remaining constant. For penetrations up to 25 per cent, the shift of maximum and minimum is not noticeable (Fig. 8), but this is no longer true for penetrations between 25 and 50 per cent (Fig. 9). For penetrations exceeding 50 per cent (Figs. 10, 11, and 12) the pattern departs noticeably from a sine curve beyond the shifts of maximum and minimum.



The effect of increasing probe penetration on the pattern for a given load (Figs. 13, 14, 15, and 16) is generally to reduce the apparent standing-wave ratio. In these, as in the preceding illustrations, the appearance of more than one maximum per half wave for extremely

proximate the calculated curves most closely. The deviations are not very striking even for the larger probe penetrations of above 75 per cent, yet remind us that our assumptions should not be carried to probe penetrations beyond 65 per cent.

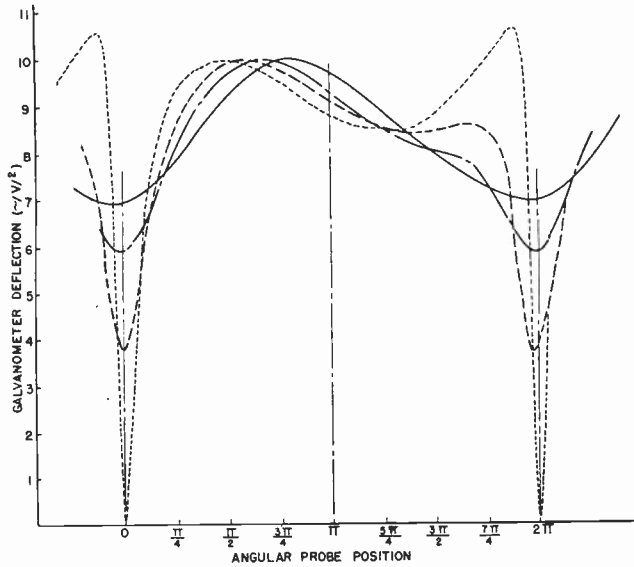

Fig. 12—Standing-wave pattern as a function of load. Curves experimental. Constant probe penetration 97 per cent.  
 — 0.31  
 - - - 0.56 Reflection coefficient  
 - · - 0.82  
 ····· 1.00

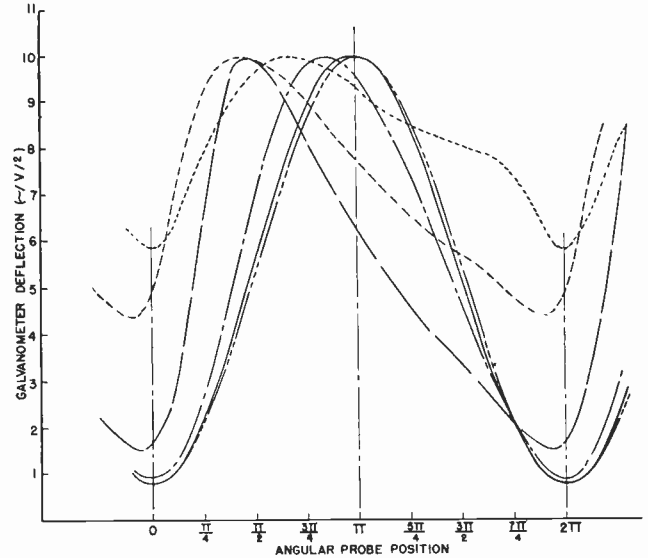

Fig. 14—Standing-wave patterns as a function of probe penetration. Curves experimental. Constant load reflection coefficient 0.56.  
 ····· 10 per cent  
 - · - 25 per cent  
 - - - 50 per cent  
 — 75 per cent  
 - - - 90 per cent  
 - - - 97 per cent

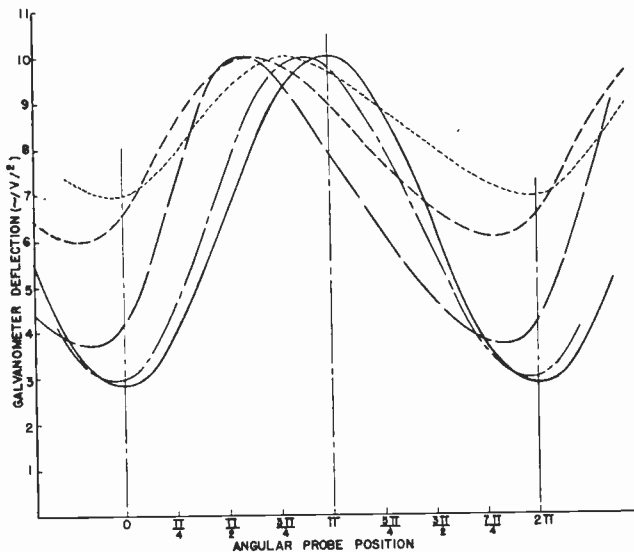

Fig. 13—Standing-wave patterns as a function of probe penetration. Curves experimental. Constant load reflection coefficient 0.31.  
 ····· 25 per cent  
 - · - 50 per cent  
 - - - 75 per cent  
 — 90 per cent  
 - - - 97 per cent  
 - - - 99 per cent

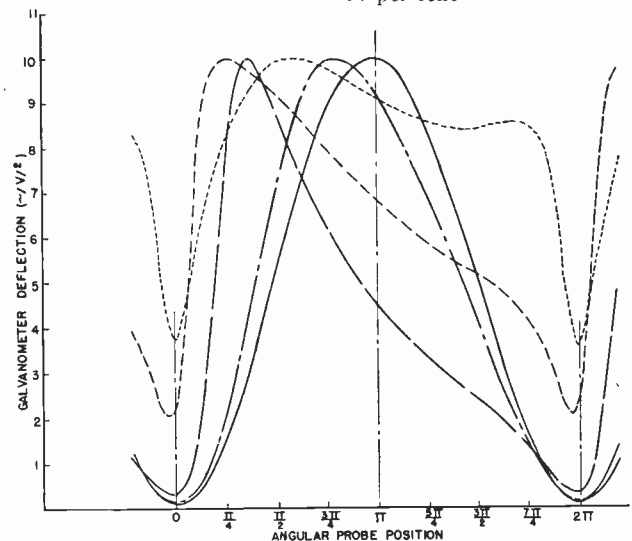

Fig. 15—Standing-wave patterns as a function of probe penetration. Curves experimental. Constant load reflection coefficient 0.82.  
 ····· 25 per cent  
 - · - 50 per cent  
 - - - 75 per cent  
 — 90 per cent  
 - - - 97 per cent  
 - - - 99 per cent

deep penetrations is clearly unaccounted for by the shunt-admittance theory and thus affords a sufficient, though not a necessary, criterion that the formulas of Section III are no longer applicable.

Fig. 17 shows four curves calculated for widely different probe admittances, together with experimental points found with probe penetrations such as to ap-

\* Table III is a compilation of all measurements. In each section, representing a constant load, the computed reflection coefficients are correct for penetrations below 65 per cent and approximately correct for 75 per cent.

The probe admittance increases rapidly with probe penetration for a given load and, contrary to what might be expected, varies also with the load when the

penetration is kept constant. This is not quite so surprising considering that the probe admittance, particularly in its conductive component, is a sensitive function of the tuning of the standing-wave detector. An attempt was made to readjust the tuning for each probe penetration so as to obtain maximum response, yet the probe admittance still showed variations independent of the penetration.

As an additional and more direct check on the computed values, the probe admittances were subjected to measurement by means of the experimental setup shown schematically in Fig. 18. The only changes compared with Fig. 7 are the added standing-wave detector between the first standing-wave detector and the buffer attenuator, as well as a carefully matched load substituted for the variable load of Fig. 7. The admittance

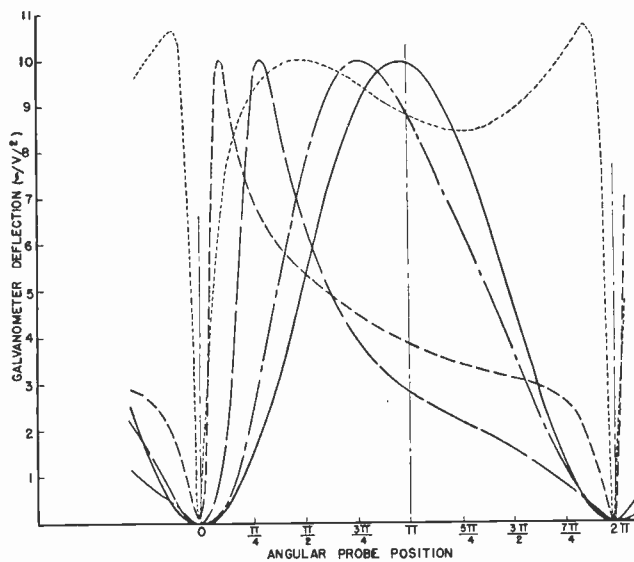

Fig. 16—Standing-wave patterns as a function of probe penetration. Curves experimental. Constant load reflection coefficient 1.00.  
 —○—○—○—○— 25 per cent  
 - - - - - × - - - - - × - - - - - × - - - - - × 50 per cent  
 —□—□—□—□— 75 per cent  
 - - - - - △ - - - - - △ - - - - - △ - - - - - △ 90 per cent  
 ..... 97 per cent

values measured with the second detector and the computed values are plotted in the Smith chart (Fig. 19), showing good agreement for a number of probe penetrations.

VI. SPECIAL CASE OF HIGH STANDING-WAVE RATIOS

For very high standing-wave ratios, the situation requires a separate discussion, since the formulas of Section III while, of course, still valid, are no longer practical. In the first place, the reading of maximum and minimum at the same power level is impractical and it is expedient to use the two midpoints and the minimum instead. The midpoints may now be taken as the probe positions with twice minimum response, separated from the minimum position by angles  $\alpha$  and  $\delta$ . We must, therefore, avail ourselves of the modified form of (2) as was mentioned at the end of Section IV.

In the second place, with increasing standing-wave

ratios, the two midpoints move closer and closer toward the minimum position and the two spacings become equal in the limit. Thus, the value of  $\epsilon$  is small and of higher order than  $\eta$ . This works toward a simplification of the formulas, the net result being the same as if reflections were ineffective. This is true, notwithstanding

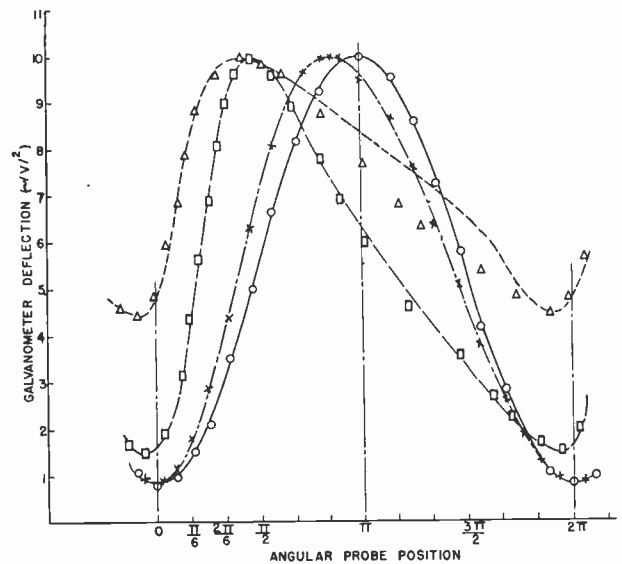

Fig. 17—Comparison of experimental and calculated patterns. Points experimental, curves calculated. Constant load reflection coefficient 0.56.

- 25 per cent
- - - - - × - - - - - × - - - - - × - - - - - × 50 per cent
- 75 per cent
- - - - - △ - - - - - △ - - - - - △ - - - - - △ 90 per cent

the fact that the true and the apparent standing-wave ratios differ considerably. The situation is best understood by considering the effect of increasing probe penetration. Starting with an ideal probe one would obtain a strictly sinusoidal pattern. As the probe admittance becomes considerable, the pattern is distorted by a shift and lowering of the maximum, and yet the distorted patterns still pass very nearly through the same

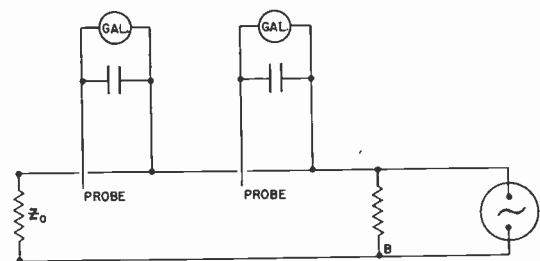

Fig. 18—Schematic diagram showing arrangement for direct measurement of probe admittance.

minimum and midpoints. For power standing-wave ratio of 400, the correction term becomes much less than 1 per cent.

A series expansion of the modified equation (2) in powers of  $\eta$  (see Appendix 5) gives

$$r = \frac{1 - \tan \eta/2}{1 + \tan \eta/2} + \frac{\epsilon^2}{2} \frac{1 + \cos \eta}{1 - \cos \eta} \frac{\tan \eta}{(1 + \sin \eta)}$$

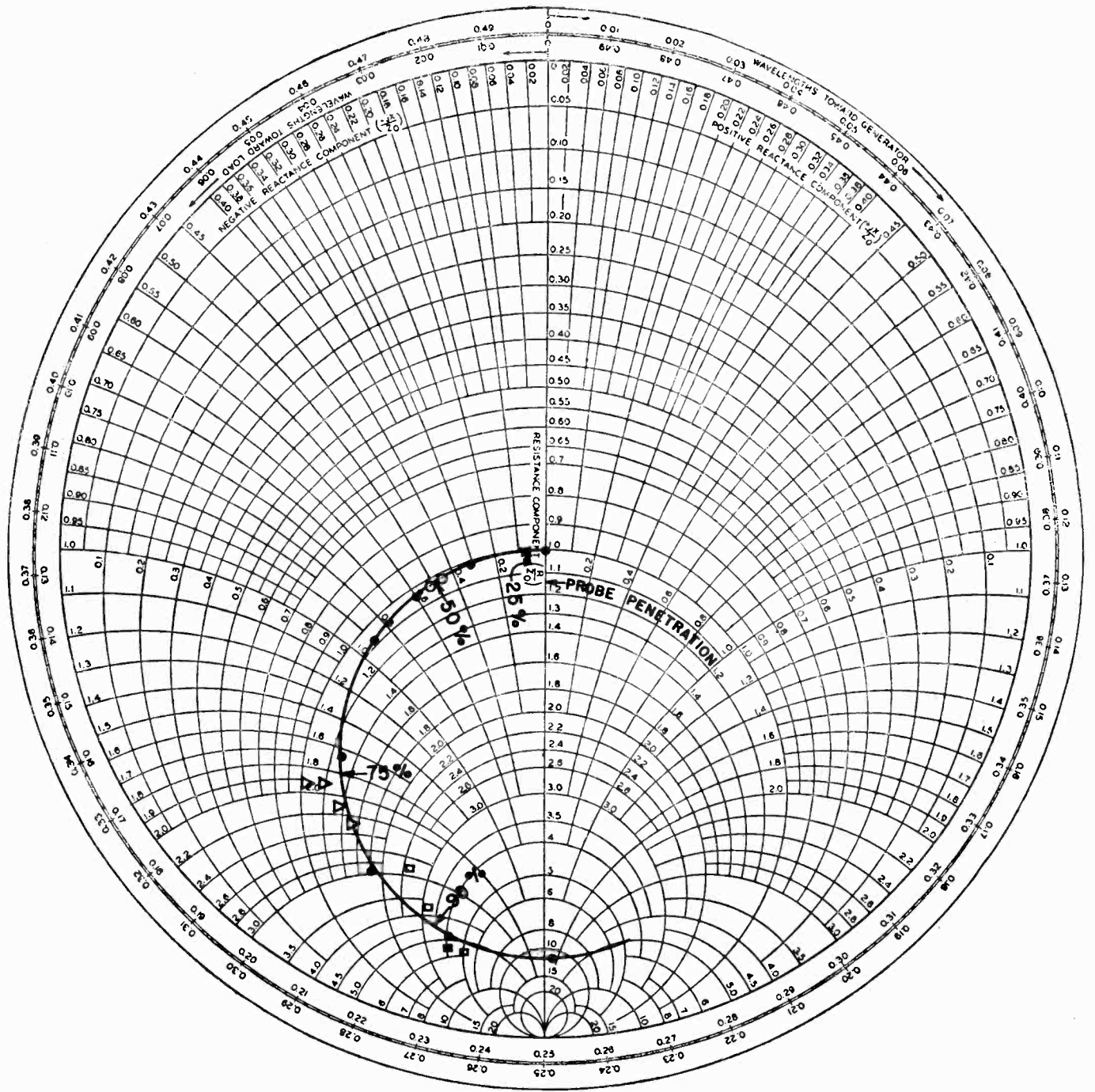

Fig. 19—Comparison of experimental and calculated probe admittances.

- = probe admittance measured
- × = probe admittance calculated 25 per cent
- = probe admittance calculated 50 per cent
- △ = probe admittance calculated 75 per cent
- = probe admittance calculated 90 per cent

and since  $\eta$  itself is small

$$1 - r = \frac{2}{1 + \cot \eta/2} - \frac{2\epsilon^2}{\eta}$$

A direct determination of  $\epsilon$  would be inaccurate owing to the smallness of  $\alpha$  and  $\delta$  plus the uncertainty attending the exact minimum position. The correction term can be found with much greater accuracy by means of the maximum position, which shows very considerable shifts even for slight asymmetry of the minimum versus midpoints. By virtue of Appendix I we can write

$$\frac{\alpha}{\delta} \cong \frac{\sin \alpha/2}{\sin \delta/2} = \frac{\sin \frac{360 - \gamma - \alpha - \delta}{2}}{\sin \gamma/2} = \cos \eta + \cot(\gamma/2) \sin \eta$$

and

$$\epsilon/\eta = \eta/2 \cot \gamma/2 + \dots$$

Finally

$$1 - r = \frac{2}{1 + \cot(\eta/2)} - \eta^3/2 \cot^2 \gamma/2 \cong \eta - \eta^2/2 - \eta^3/2 \left[ \cot^2 \gamma/2 - \frac{5}{12} \right] \quad (9)$$

Inspection of Fig. 16 shows that the angle  $\gamma$  stays well above 45 degrees for probe penetrations up to 75 per cent, so that the third-order correction term at its worst will amount to less than 3 per cent of the total  $(1 - r)$  if  $r \geq 0.90$ .

APPENDIX I

RELATION BETWEEN FOUR HARMONIC POINTS

Four points ( $A, B, C$ , and  $D$ ) in the complex plane which can by a linear transformation be transformed into four equidistant points on a circle are a harmonic set which means that the anharmonic cross ratio  $\lambda(A, C; B, D)$  of their complex values is

$$\lambda(A, C; B, D) = \frac{(A - B)(C - D)}{(A - D)(B - C)} = -1.$$

Each of the four brackets represents a cord of the circle on which the four points lie, subtending the angles  $\alpha, \beta, \gamma$ , and  $\delta$  respectively. It is then easily seen that

$$\sin \alpha/2 \sin \gamma/2 = \sin \beta/2 \sin \delta/2$$

and this is the relation sought.

APPENDIX II

COMPUTATION OF THE COMPLEX PROBE ADMITTANCE

In the triangle formed by vector  $Y$  and line  $SD$  (Fig. 4) the third side has the length  $r/r'$  and is rotated through  $\psi$ . Since the vector  $SD$  is the unit vector, we can write down the vector relation

$$1 + Y = r/r' e^{i\psi}.$$

To write down the expression for  $Y$ , it is necessary to refer it first to the proper unit  $Y_0$  which, in the illustrations, is represented by distance

$$\frac{SD'}{2} = \frac{1 - r^2}{2}.$$

(Note that line  $TD'$  in Fig. 4 is at right angles to  $SD$ .) Hence

$$G = 2/1 - r^2 \left[ \frac{r}{r'} \cos \psi - 1 \right]$$

$$B = 2/1 - r^2 \left[ \frac{r}{r'} \sin \psi \right].$$

APPENDIX III

PROOF OF FIG. 2(b)

In Fig. 4 the circle  $C_2$  was obtained by inverting the circle  $C_1$  in the point  $S$ , using  $ST$  as a radius, adding the vector  $Y$  to  $C_1$  in the rectangular admittance plane giving  $C_3$ , and then again inverting  $C_3$  at  $S$ , using radius  $ST$ . Fig. 2(b) represents exactly the same process with the exception that the vector  $Y$  is subtracted from  $S$  rather than added to  $C_1$ . Here  $C_1$  is inverted in  $S$ , using radius  $ST$  (carrying  $P$  into  $V$ ), and  $Y$  subtracted from  $S$ . This latter step leaves circle  $C_1$  in the same relation to point  $O$  as circle  $C_3$  is to the point  $S$  in Fig. 4. All that remains now is the inversion of  $C_1$  in the point  $O$  to get a circle equivalent to  $C_2$  of Fig. 4. If  $ST$  were used as radius, we would obtain a circle on the same scale as  $C_2$  but to simplify the construction we will change scales and use as inversion radius a tangent to  $C_1$  through point  $O$ . This inversion carries the point  $V$  into the point  $Q$ .

The result is, therefore, that with a true load point  $P$ , the voltage as measured with a probe of admittance  $X$ , will be proportional to the vector  $OQ$  rather than to the vector  $SP$ . We may thus compute probe patterns, if we are given the probe admittance  $Y$  and the true load-reflection coefficient  $r$ .

APPENDIX IV

EQUAL SPACING OF THE FOUR CHARACTERISTIC PROBE POSITIONS ON CIRCLE  $C_3$

Referring to Fig. 5, which is an excerpt of Fig. 4, we remember that circle  $C_2$  was obtained from circle  $C_3$  by an inversion in the point  $S$ , using radius  $ST$ . This carries points  $A, B, M_1$ , and  $M_2$  into points  $a, b, m_1$ , and  $m_2$  respectively, so that the following relation holds:

$$\overline{SA} \cdot \overline{Sa} = \overline{SB} \cdot \overline{Sb} = \overline{SM_1} \cdot \overline{Sm_1} = \overline{SM_2} \cdot \overline{Sm_2} = \overline{ST}^2. \quad (10)$$

Now the maximum of the standing-wave pattern is proportional to  $\overline{Sa}^2$ , the minimum to  $\overline{Sb}^2$ , and the midpoint (1) to

$$\frac{2 \overline{Sa}^2 \cdot \overline{Sb}^2}{\overline{Sa}^2 + \overline{Sb}^2} = \overline{Sm_1}^2 = \overline{Sm_2}^2. \quad (1)$$

In Fig. 5, if  $M_1, B, M_2$ , and  $A$  are equally spaced on circle  $C_3$ , we have by geometry

$$\overline{SM_1}^2 = \frac{\overline{SA} + \overline{SB}^2}{2} + \frac{\overline{SB} - \overline{SA}^2}{2} = \overline{SM_2}^2$$



TABLE II  
REFLECTION COEFFICIENT = 0.56  
VARIOUS PROBE PENETRATIONS

Probe Penetration	10 per cent	25 per cent	50 per cent	75 per cent	90 per cent
Maximum	10.00	10.00	10.00	10.00	10.00
Position of Maximum	0.394	0.382	0.336	0.210	0.192
Minimum	0.80	0.80	0.87	1.52	4.40
	0.038	0.035	0.033	0.013	0.000
Position of Minima	0.752	0.756	0.748	0.728	0.712
Midpoint	1.48	1.48	1.60	2.64	6.11
	0.100	0.098	0.091	0.072	0.059
Position of Midpoint	0.690	0.688	0.681	0.626	0.524
$\alpha$ (in degrees)	31	30	30	30	30
$\beta$ (in degrees)	149	144	123	72	67
$\gamma$ (in degrees)	149	154	174	208	168
$\delta$ (in degrees)	31	32	33	50	95
$\eta$ (in degrees)	90	87	76.5	51	48.5
$\epsilon$ (in degrees)	59	57	46.5	21	18.5
$r$ (calculated)	0.56	0.56	0.56	0.55	0.52
$r'$ (apparent $r$ )	0.56	0.56	0.54	0.46	0.23
$r/r'$	1.00	1.00	1.03	1.20	2.26
$\sin \psi$	0.001	0.026	0.147	0.600	0.630
$\cos \psi$	1.00	1.00	0.99	0.87	0.79
$2/1 - r^2$	2.91	2.91	2.91	2.82	2.73
$B$ (probe)	0.003	0.08	0.45	1.98	3.88
$G$ (probe)	0	0	0.06	0.12	2.14

or

$$\frac{1}{SM_1^2} = \frac{2}{SA^2 + SB^2} = \frac{1}{SM_2^2}$$

And substituting from (10) we have

$$\overline{Sm_1^2} = \frac{\sqrt{2} \overline{Sa^2} \cdot \overline{Sb^2}}{\overline{Sa^2} + \overline{Sb^2}} = \overline{Sm_2^2}$$

Which is (1'), the definition of our midpoints, thus proving that the inversion of the midpoints and the maximum and minimum give four equally spaced points on circle  $C_3$ .

APPENDIX V  
SERIES EXPANSION OF (2) FOR HIGH  
STANDING-WAVE RATIOS

From the definition of the equation for  $\bar{\eta}$  we have

$$\begin{aligned} \tan \frac{\bar{\eta}}{2} &\equiv \frac{1 - \cos \bar{\eta}}{\sin \bar{\eta}} = \frac{\sqrt{1 + \left(\frac{\sin \epsilon \cdot \sin \eta}{\cos \epsilon - \cos \eta}\right)^2} - \sqrt{\cos^2 \eta + \left(\frac{\sin \epsilon \cdot \sin \eta}{\cos \epsilon - \cos \eta}\right)^2}}{\sin \eta} \\ &= \frac{1 - \cos \eta}{\sin \eta} + \frac{\epsilon^2}{2} \frac{\sin \eta}{(1 - \cos \eta)^2} \left(1 - \frac{1}{\cos \eta}\right) = \tan \frac{\eta}{2} - \frac{\epsilon^2}{2} \frac{\tan \eta}{(1 - \cos \eta)} \end{aligned}$$

Inserting this into (2), we have

$$r = \frac{1 - \tan \eta/2}{1 + \tan \eta/2} + \epsilon^2 \frac{\tan \eta}{(1 - \cos \eta)(1 + \tan \eta/2)^2} = \frac{1 - \tan \eta/2}{1 + \tan \eta/2} + \frac{\epsilon^2}{2} \frac{1 + \cos \eta}{1 - \cos \eta} \frac{\tan \eta}{1 + \sin \eta}$$

TABLE III  
VARIOUS PROBE PENETRATIONS

(a) Reflection Coefficient = 0.31					
Probe Penetration	25 per cent	50 per cent	75 per cent	90 per cent	
Maximum	10.00	10.00	10.00	10.00	10.00
Minimum	2.81	2.94	3.70	6.00	6.00
$\alpha$ (in degrees)	54	53	51	57	57
$\beta$ (in degrees)	124	112	82	89	89
$\gamma$ (in degrees)	126	135	144	122	122
$\delta$ (in degrees)	56	60	83	92	92
$r$ (calculated)	0.31	0.31	0.30	0.25	0.25
$r'$ (apparent)	0.00	0.30	0.24	0.12	0.12
$G$ (probe)	0.00	0.04	0.09	1.49	1.49
$B$ (probe)	0.04	0.50	1.92	2.68	2.68

(b) Reflection Coefficient = 0.56					
Probe Penetration	10 per cent	25 per cent	50 per cent	75 per cent	90 per cent
Maximum	10.00	10.00	10.00	10.00	10.00
Minimum	0.80	0.80	0.87	1.52	4.40
$\alpha$ (in degrees)	31	30	30	30	30
$\beta$ (in degrees)	149	144	123	72	67
$\gamma$ (in degrees)	149	154	174	208	168
$\delta$ (in degrees)	31	32	33	50	95
$r$ (calculated)	0.56	0.56	0.56	0.55	0.52
$r'$ (apparent)	0.56	0.56	0.54	0.46	0.23
$r/r'$	1.00	1.00	1.03	1.20	2.26
$\sin \psi$	0.001	0.026	0.147	0.600	0.630
$\cos \psi$	1.00	1.00	0.99	0.87	0.79
$2/1 - r^2$	2.91	2.91	2.91	2.82	2.73
$B$ (probe)	0.003	0.08	0.45	1.98	3.88
$G$ (probe)	0	0	0.06	0.12	2.14

(c) Reflection Coefficient = 0.82				
Probe Penetration	25 per cent	50 per cent	75 per cent	90 per cent
Maximum	10.00	10.00	10.00	10.00
Minimum	0.11	0.16	0.30	2.05
$\alpha$ (in degrees)	11	11	11	12
$\beta$ (in degrees)	166	131	57	37
$\gamma$ (in degrees)	172	205	276	289
$\delta$ (in degrees)	11	13	16	22
$r$ (calculated)	0.82	0.82	0.81	0.79
$r'$ (apparent)	0.82	0.78	0.70	0.38
$G$ (probe)	0.00	0.06	0.34	4.00
$B$ (probe)	0.04	0.44	2.11	6.40

(d) Reflection Coefficient = 1.00				
Probe Penetrations	25 per cent	50 per cent	75 per cent	90 per cent
Maximum	10.00	10.00	10.00	10.00
Minimum	0.00	0.00	0.001	0.02
$\alpha$ (in degrees)	0	0	0	1
$\beta$ (in degrees)	176	140	56	20
$\gamma$ (in degrees)	184	220	304	338
$\delta$ (in degrees)	0	0	0	1
$r$ (calculated)	1.00	1.00	1.00	0.99
$r'$ (apparent)	1.00	1.00	0.98	0.91
$G$ (probe)	0.00	0.06	0.60	3.00
$B$ (probe)	0.04	0.40	2.30	5.30

# Contributors



WILLIAM ALTAR

William Altar obtained the Ph.D. degree in physics and mathematics at the University of Vienna in 1923, and later received training in electrical engineering from the Technical University in Vienna. After several years as an industrial engineer, Dr. Altar engaged in research work on wave propagation at King's College, London.

He came to the United States in 1929 as an assistant professor of physics at the Pennsylvania State College, a position which he held until 1935, when he was awarded a two-year Fellowship in chemical physics at Frick Chemical Laboratory, Princeton University. Following this study, Dr. Altar spent two years in Istanbul, Turkey, where he taught electrical engineering at Roberts College.

From 1940 to 1942 he taught electrical engineering at the Case School of Applied Science, and in 1942 became associated with the Westinghouse Research Laboratories, as an engineer engaged in work on microwaves. He is a member of the American Institute of Electrical Engineering.



Sidney T. Fisher (M'42-SM'43) was born in Edmonton, Alberta, Canada, in 1908. He

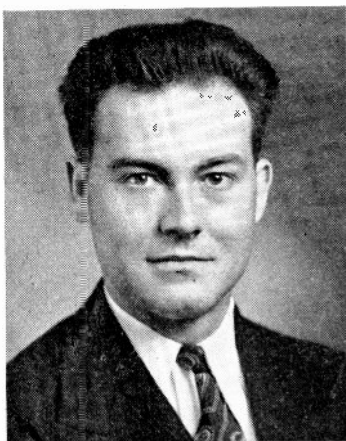

L. P. HUNTER

received the B.A.Sc. degree in electrical engineering from the University of Toronto in 1930.

During 1928 and 1929, and from 1930 to 1943, Mr. Fisher was with the special products division of the Northern Electric Company, Ltd., at Montreal, where he was engaged successively in power-tube engineering, field-engineering, and installation of public-address systems and broadcast stations, and development and design of radio- and audio-frequency equipment of all types, becoming sales engineer and development engi-

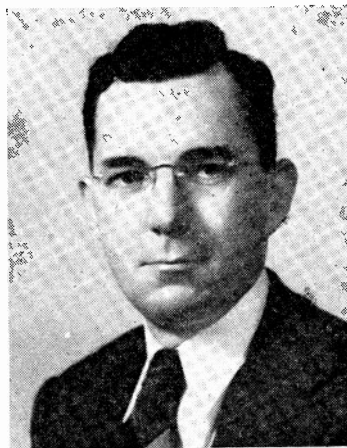

ROBERT A. KIRKMAN



neer in 1941. During this period, he was responsible for the engineering of the radio installations for Canadian-built Lancaster and Mosquito bombers. Mr. Fisher resigned from the Northern Electric Company in 1943 to organize F. T. Fisher's Sons, Ltd., consulting engineers, and has subsequently carried out engineering projects for Defence Communications, Ltd., the Royal Canadian Air Force, and other service and government groups. In 1943 he became vice-president of Rogers Electronic Tubes, Ltd., of Toronto. Since 1941, he has held a commission as Flying Officer in the Special Reserve of Officers (technical) of the R.C.A.F., and in this capacity has worked with the R.C.A.F. on air-force signals problems.

Mr. Fisher is a member of the Engineering Institute of Canada, the American Institute of Electrical Engineers, and the Acoustical Society of America.



L. P. Hunter received the B.S. degree in physics from the Massachusetts Institute of Technology, the B.A. degree from the College of Wooster, and the D.Sc. degree from Carnegie Institute of Technology, in 1942.

In 1942, Mr. Hunter joined the Westinghouse Electric Corporation, engaging in work on the physics of solids. His first assignment was a study of the behavior of the elastic constants of copper-aluminum alloys, and on crystalline rock salt near the melting



SIDNEY T. FISHER



temperature. Since that time he has been engaged in microwave development, and has done research on the Manhattan project. He is now associated with X-ray research.

Dr. Hunter is a member of the American Physical Society.



Robert A. Kirkman was born in 1915, at Portland, Oregon. He was graduated from the RCA Institutes in 1937, and has been active in amateur radio since 1931. In 1935 and 1936, Mr. Kirkman was associated with the Teleradio Engineering Corporation, in New York City, and in 1938 was employed in the New York office of the General Electric Company. He left this position to work with the City of New York, first on the radio network of the New York City Fire Department, and later with the Municipal Broadcasting System.

Since 1941 he has been connected with the Signal Corps Engineering Laboratories, at Fort Monmouth, New Jersey. He served in the radio direction-finding branch as project engineer, section engineer, and in de-



MORRIS KLINE

# Contributors



EVERARD M. WILLIAMS

development of types of radio and radar direction finders and electronic meteorological equipment.

He was elected a member of the Board of Directors of the American Radio Relay League in 1940, 1942, and 1944.

Morris Kline was born at Brooklyn, New York, in 1908. He received the B.Sc. degree in mathematics from New York University in 1930, and the Ph.D. degree in mathematics in 1936 from the same institution. From 1930 to 1936, he was an instructor in mathematics at New York University, and served as research assistant in the Institute for Advanced Study of Princeton University from 1936 to 1938, returning as an instructor in mathematics to New York University from 1938 to 1942. He lectured in the graduate division of the Hunter College from 1939 to 1940.

Dr. Kline was appointed a radio engineer in the Signal Corps Engineering Laboratories, and from 1942 to 1945, served as project engineer in charge of the development of meteorological radio direction find-

ers. He is at present assistant professor of mathematics at New York University, and consultant on mathematics to the Reeves Sound Laboratories. He is co-author of a college textbook on mathematics.

Everard M. Williams (S'36-A'41-SM '44) was born at New Haven, Connecticut, on February 2, 1915. He received the B.E. degree in 1936 and the Ph.D. degree in 1939 from Yale University. During the summer of 1937 he was employed by the General Electric Company, and during the academic year 1938 and 1939 he was the recipient of a Charles A. Coffin Fellowship from this company. From 1939 to 1942, he was an instructor in electrical engineering at the Pennsylvania State College. Since 1942 he has been development branch engineer in what is now the special projects laboratory, radio and radar subdivision, Air Technical Service Command (Army Air Forces), Wright Field, Dayton, Ohio. He is a member of Tau Beta Pi, Sigma XI, and the Society for the Promotion of Engineering Education.



S. A. SCHELKUNOFF

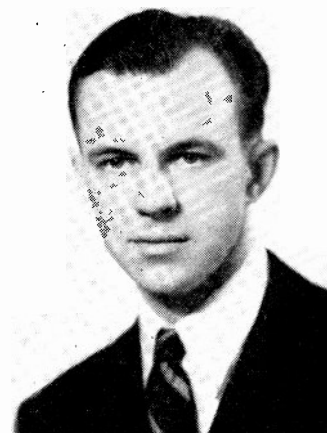

F. B. MARSHALL

F. B. Marshall was graduated from the Southern Methodist University in 1933, and subsequently received the Ph.D. degree in physics from the University of Chicago. In 1940, he became curator of exhibits at Buhl Planetarium, in Pittsburgh, Pennsylvania, and also taught physics and advanced X-ray theory at the University of Pittsburgh.

Dr. Marshall became a research engineer in electronics for the Westinghouse Electric Corporation in 1942, engaged in original work on microwaves, and is now associated with work on X-ray. He has also been actively interested in progressive education.

S. A. Schelkunoff (A'40-F'44) received the B.A. and M.A. degrees in mathematics from the State College of Washington in 1923, and the Ph.D. degree in mathematics from Columbia University in 1928. He was in the engineering department of the Western Electric Company from 1923 to 1925; the Bell Telephone Laboratories from 1925 to 1926; the department of mathematics of the State College of Washington, 1926 to 1929; and Bell Telephone Laboratories, 1929 to date. Dr. Schelkunoff has been engaged in mathematical research, especially in the field of electromagnetic theory.

# An Explanatory Statement

Concerning  
THE PROCEEDINGS OF THE I.R.E.  
and  
WAVES AND ELECTRONS

In placing before the membership of The Institute of Radio Engineers the first issue of a new, dual publication of the Institute containing *two* technical journals, rather than one as heretofore, it is believed appropriate to explain the purposes, policies, and procedures adopted for the two journals to the extent that these have been crystallized up to the present and, upon recommendation, approved by the Board of Directors.

It has long been evident that the material appearing in the PROCEEDINGS OF THE I.R.E. covered a wide range of subject matter and treatment. For convenience of reference, ease of binding, comfort in reading, adaptation to the needs of the Institute membership, and adjustment to the trends of the field of the Institute, it has seemed desirable to divide the technical material available for publication into two major groups, and to include each of these groups in a separate and conveniently usable periodical. The provision of two such diversified journals will permit the more flexible expansion or modification of each of them, and thus will doubtless enhance their utility to the membership of the Institute.

## Division of Material

The division of material between the PROCEEDINGS OF THE I.R.E., on one hand, and WAVES AND ELECTRONS, on the other hand, can be made reasonably clear in its present status through the following discussion:

Appearing in the PROCEEDINGS OF THE I.R.E. generally will be papers dealing with advanced research topics; the more advanced types of equipment and method development; mathematico-physical analyses of engineering problems; relatively advanced or abstract studies of scientific or technical matters; Standards Reports formally adopted by The Institute of Radio Engineers; adopted reports of the Technical Committees of the Institute; and other matters which are likely to be found of fundamental or basic nature.

In the pages of WAVES AND ELECTRONS, there will generally be included, according to present plans, papers dealing with current engineering developments of equipment or methods; tutorial papers covering specific aspects of radio-and-electronic engineering in an authoritative and clear form and readily usable for "refresher" purposes by our engineering readers and Student members; historical papers tracing the development of concepts or aspects of apparatus or methods



now in common use and setting forth the trends of the radio-and-electronic art, papers dealing with engineering welfare matters, including the problems, viewpoints, and aspirations of our engineering members; reports of standards adopted by organizations other than the Institute, together with the membership of the committees of such organizations responsible for the standards in question; information concerning the activities and accomplishments of the members of the Institute; intramural news items dealing with the activities of the Institute, its Sections, its Committees, its Officers, and its Staff, together with the elements of its collaboration with other learned societies; book reviews of current interest; and bibliographical abstracts in such forms as may become available.

It is to be expected that the list of items included in both the PROCEEDINGS OF THE I.R.E. and WAVES AND ELECTRONS will be expanded or modified as time goes on and experience develops methods whereby these periodicals may be made of greater service to the membership. However, the foregoing discussion indicates the nature of present plans to an extent which will enable our readers to form a judgment relative to their utility.

It should be here emphasized that high technical standards and careful editorial-review procedures will be maintained in both journals, and that papers in each of them are regarded as on an equal basis professionally. The Editorial Department of the Institute has encountered numerous and difficult problems in the preparation and issuance of this first issue of our dual technical journals. For the present, these journals will be published under a single cover, although it will be readily possible for the readers to separate these either immediately upon receipt, or at the end of each year for binding into appropriate volumes. Each journal, it will be found, has its own contents page and numbered page sequence.

#### **Comment of Readers Invited**

The future usefulness and success of both journals will be dependent in considerable measure upon the extent to which the readers of these journals convey their views to the Institute. The Editorial Department will, accordingly, be grateful for any comments which our readers may make concerning any aspect of these journals and for any suggestions as to modifications, additions, omissions, or changes in policy. The Institute of Radio Engineers and its Editorial Department exist to serve the membership, and they will best accomplish this aim if the membership is thoroughly articulate. Each reader addressing the Editorial Department may be assured that his views will be carefully considered and analyzed and, so far as is consistent with basic policy, the professional standards of the Institute, operating practicability, and a reasonable support for these viewpoints, will be put into practice. Such expressions of opinion should be addressed to the Editorial Department of the Institute at 26 West 58th Street, New York 19, New York. In the meantime, the friendly support of the membership of the Institute is earnestly solicited for the two journals which are submitted to them at this time.

# WAVES

AND

# ELECTRONS

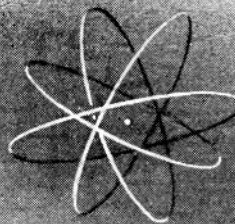
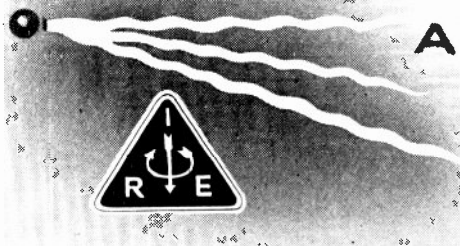

Published Monthly  
by

The Institute of Radio Engineers, Inc.

VOLUME I

January, 1946

NUMBER I

WAVES AND ELECTRONS.....	Alfred N. Goldsmith	2 W
Electronics and Communications.....	W. L. Everitt	3 W
Benjamin E. Shackelford—Board of Directors, 1945–1947.....		4 W
Preparation and Publication of I.R.E. Papers.....	Helen M. Stote	5 W
An Ultra-High-Frequency Radio Range with Sector Identification and Simultaneous Voice.....		
Andrew Alford, Armig G. Kandoian, Frank J. Lundburg, and Chester B. Watts, Jr.		9 W
A Simple Optical Method for the Synthesis and Evaluation of Television Images.....		
Robert E. Graham and F. W. Reynolds		18 W
Problems in the Manufacture of Ultra-High-Frequency Solid-Dielectric Cable.....		
A. J. Warner		31 W

### Institute News and Radio Notes

1946 Winter Technical Meeting	38 W	Sections.....	47 W
Board of Directors.....	43 W	Section Territory Assignment.....	48 W
Executive Committee.....	43 W	Canadian Radio Technical Planning Board.....	49 W
Rochester Fall Meeting.....	43 W	Notice to Sections.....	49 W
I.R.E. People.....	45 W		

### Books

“Elementary Electric-Circuit Theory,” by Richard H. Frazier.....		Reviewed by F. Alton Everest	47 W
“Proceedings of the National Electronics Conference,” Published by The National Electronics Conference, Inc.....		Reviewed by D. G. Fink	48 W
Contributors to WAVES AND ELECTRONS.....			49 W
Section Meetings.....			36 A
Membership.....			46 A
Positions Open.....			50 A
Positions Wanted.....			52 A
Advertising Index.....			86 A

PROCEEDINGS Contents on page 1 P

#### EDITORIAL DEPARTMENT

Alfred N. Goldsmith  
*Editor*

Helen M. Stote  
*Publications Manager*

Ray D. Rettenmeyer  
*Technical Editor*

Winifred Carrière  
*Assistant Editor*

William C. Copp  
*Advertising Manager*

Lillian Petranek  
*Assistant Advertising Manager*

Responsibility for the contents of papers published in WAVES AND ELECTRONS rests upon the authors. Statements made in papers are not binding on the Institute or its members.

Changes of address (with advance notice of fifteen days) and communications regarding subscriptions and payments should be mailed to the Secretary of the Institute, at 450 Ahnaip St., Menasha, Wisconsin or 330 West 42nd Street, New York 18, N. Y. All rights of republication, including translation into foreign languages, are reserved by the Institute. Abstracts of papers, with mention of their source, may be printed. Requests for republication privileges should be addressed to The Institute of Radio Engineers.

Copyright, 1946, by The Institute of Radio Engineers, Inc.

The following editorials appeared in a preliminary issue of WAVES AND ELECTRONS in July, 1945. They remain pertinent and are accordingly here reprinted, essentially in their original form.

# Waves and Electrons

A Publication of the I.R.E.

ALFRED N. GOLDSMITH, EDITOR

IN PLACING before members of The Institute of Radio Engineers and readers of its PROCEEDINGS of the I.R.E. this issue of a new publication, WAVES AND ELECTRONS, some historical and evolutionary information is properly included.

A third of a century ago, a small group of "wireless engineers" gathered with a common thought and intent. Their thought was that the nascent "wireless industry" had before it a future of untold promise; that there should be substituted in the corresponding technical field for mere trial-and-error and mysterious and confusing secrecy the frank expression of widely disseminated scientific truth; that to these ends an ethical attitude should be encouraged among the practitioners of the new profession of radio engineering; that the *common* good of the radio-engineering profession was not only the best course but also the most practical aim for farsighted workers in that field; and that to achieve these worthy and socially productive aims it was essential that there be formed a new radio-engineering society, strong in purpose, effective in execution, and worthy of the loyal and willing support of its members. Their intent was to form such a society and to give it their best thought and effort.

It was not an easy task that they voluntarily assumed in those days which are now so remote as to seem almost formless and incomprehensible to the modern and specialized worker in our field. Human reactions and frailties combined with material and financial difficulties to challenge the aspirations of those men. But the obstacles were ultimately surmounted and thus there was born our Institute of Radio Engineers.

Today, it is truly *The* Institute of Radio Engineers, the living embodiment of the professional aspirations of its members and their chosen medium for co-operative expression of their technical discoveries, plans, and proposals. Where once a handful gave their support to the Institute, there are now thousands; and thus The Institute of Radio Engineers in its fourth decade enjoys a membership far advanced into its second ten-thousand. It is world-wide in scope; fortunate in its organic unity with its many Sections in three countries; and properly encouraged by the work and standing of a national I.R.E. Council in a friendly country other than that of its origin. Its long-established publication is a recognized medium of consistently maintained standing. Its repute stands as high as its future seems bright.

For the latest decade, it has become clear that the original scope of the Institute has naturally expanded far beyond its former boundaries. The radio arts have been the ancestors of a host of technical applications of ever-increasing engineering and industrial interest and human significance. These later developments have come to be known by the generically descrip-

tive term of "electronics"—a convenient though scientifically vague designation. Perhaps the most distinctive attribute of electronic methods is the utilization, somewhere in the corresponding systems, of electrons freed from material paths, and flexibly and instantaneously controlled to produce the desired effects.

The chosen publication medium of the I.R.E. members up to this time has been the PROCEEDINGS of the I.R.E. Its pages have literally been the history of the radio and allied arts. When its successive volumes are scanned, it is found that they have presented unobtrusively, but none the less comprehensively, the basic principles, devices, and methods of electronics as well as radio. Of late, this fact has appeared with ever-increasing clarity. It has seemed fitting therefore to present on the cover page of recent issues of the PROCEEDINGS a definite statement of the scope of that publication and the more detailed topical headings covering its usual contents. This accordingly has been done.

But another type of differentiation or evolution in the publication policy and procedure of the Institute now seems appropriate. This involves the addition to its publications, in one form or another, of an assembly of material of more general, historical, or tutorial nature and in some instances of particular and timely technical interest. This new material will also deal with the communication and electronic arts.

Communication of intelligence is essentially based on waves. Whether these be the pressure waves of touch and sound, or the electromagnetic waves of light and perhaps of neural messages, they constitute our basic means of communication and thus our essential contacts as individuals with the outside universe and with each other. Electronics, as stated, is functionally an expression of electron behavior and control. And, most remarkable of all, the electromagnetic wave and the electron seem to be but two aspects or modes of action of the same underlying and fundamental unity. What could therefore be more expressive of our cosmos and its contacts with humanity, as well as certain of the most powerful agencies now available for human communication and advancement, than the title of the new I.R.E. compendium: WAVES AND ELECTRONS?

In the hope and belief that The Institute of Radio Engineers will continue to be the primary repository and dissemination means of the engineering wisdom and accomplishments of its members in war and peace, and that its publications will ever be an agency promoting a brighter and more fruitful future for mankind, there is thus added to the activities of the Institute the issuance, according to an appropriate schedule, of additional material the title of which amply indicates the scope and means of the electronic and communication fields.

# Electronics and Communications

## Their Present and Future

W. L. EVERITT, PRESIDENT, 1945

COMMUNICATION engineering has ever been the originator of new applications of electricity and enterprises associated with it. The first commercial use of electricity was in the telegraph, and more than one electrical society was either established or fostered and encouraged by the early telegraph engineers. An early commercial application of electric currents generated by changing magnetic fields was the telephone of Bell, and the first applications of electronics were by Fleming and de Forest to the detection of radio waves

Because communication engineering has many applications for small-current phenomena, it is usually the field in which new discoveries in electrical physics find their first application. Because it deals with such large ranges in power, impedance, and frequency, it requires a careful approach to the study of its phenomena to make sure that *conclusions* which may be drawn from particular experiments are based on an understanding of broad general principles.

All energy is transmitted by waves. When we apply a force (mechanical or electrical) to the driving end of a transmission system, the corresponding response is not felt immediately at the receiving end, but there is a finite time required for the effect to be propagated. If the force changes slowly, or if the transmission medium is stiff (as for instance in the connecting rod of a low-speed engine) the designing engineer pays little attention to the wave phenomena, or the finite time required for transmitting the disturbance. As the frequency is increased, approximations which neglect wave action are no longer valid.

In the early telegraph circuits, the transmission of direct currents over open wires seemed simple and straightforward. But as time went on, the telephone was invented, the lines became longer, cables with less stiffness were introduced, and higher frequencies were employed. Signal distortion became important, and a more complete theory of the travel of electrical waves along guided paths became necessary.

Coulomb studied the properties of electrons at rest (even though he did not know of their existence) and his law is the basis of our knowledge of electric fields. Ampere studied the properties of electrons in *motion*: and his law is the basis of our knowledge of the magnetic field produced by electric cur-

rents. Maxwell studied the properties of the acceleration of electrons and laid the basis for the initiation of those dynamic electric fields which do not require charges on which their lines of force terminate. He showed that the transmission of electric energy is not necessarily confined to the highways along which electric currents flow. Edison, and his successors in the electronic field, showed also that even electron currents are not necessarily confined to metallic highways. de Forest and Arnold showed the advantages for electronic traffic control of these nonmetallic gateways enclosed in the vacuum tube. From these foundations we see that our understanding of all electric phenomena is based on our knowledge of the principles connected with waves and electrons.

The war has shown what concentrated research and development and adequate financing may accomplish. The future of electronics and communications is bounded only by the ability of man to understand their principles and convert them to his uses. The engineer is essentially a builder and not a destroyer, and so the arrival of peace will stimulate him to even greater endeavors in the days to come if he is given the tools with which to work.

The primary function of The Institute of Radio Engineers is one of education. Since its organization the PROCEEDINGS has recorded most of the major advances in the electronic and communication art. It will continue to do so. As a result of the information dispensed in its pages many new developments have been initiated. The applications of these developments are spreading into many areas outside the field of communication. The expansion of principles, techniques, and applications are such that no longer can the individual engineer or scientist be well versed in them all. Therefore, a new educational function is required of the Institute in coordinating and summarizing the growth of knowledge and its application. To provide for this new function, either the recording of new advances must be restricted (which is unthinkable) or our publication activities must be expanded. I regard the advent of WAVES AND ELECTRONS as an historical event in the progress of the Institute whose significance will be recognized as the years go by and its contributions to the electrical arts expand and become of assistance to the professional workers in all the fields which it serves.





*Kaiden-Kazanjan Studio*

## Benjamin E. Shackelford

Board of Directors—1945-1947

Benjamin E. Shackelford was born on August 12, 1891, in Richmond, Missouri. He received the A.B. degree in 1912 and the A.M. degree in 1913, both from the University of Missouri. In 1916, he received his Ph.D. from the University of Chicago.

From 1912 to 1914, Dr. Shackelford assisted in the physics department of the University of Missouri, and in the summer of 1925 was the first Brush Research Fellow at the Nela Research Laboratory. The following year, he joined the staff of Westinghouse Lamp Company, where his activities included work in illumination and incandescent lamp physics. His direct connection with radio began in 1916 when he undertook the engineering development of radio tubes for the company. He became manager of the radio engineering department in 1925, and his work with Westinghouse continued for approximately five years.

He became a member of the manufacturing department, radiotron division, of the Radio Corporation of America at Harrison, New Jersey, in 1930, and in 1934

was appointed manager of the patent department, activities of which included the operation of foreign technical agreements. After serving as manager of the company's foreign license service, Dr. Shackelford transferred to New York where he became assistant to the director of research and later to the chief engineer. In 1942, he was appointed engineer-in-charge of RCA's frequency bureau. Since 1944, he has been assistant to the vice-president in charge of RCA Laboratories, and manager of the license department of the RCA International Division with particular responsibility in the field of international activities.

Dr. Shackelford is a member of the American Physical Society, the Optical Society of America, the American Institute of Electrical Engineers, the Franklin Institute, the American Association for the Advancement of Science, Sigma Xi, Gamma Alpha, and Alpha Chi Sigma. He joined the Institute of Radio Engineers as an Associate in 1923, transferred to Member grade in 1926, and became a Fellow in 1938.

# Preparation and Publication of I.R.E. Papers\*

HELEN M. STOTE†

*Summary*—The various steps in the preparation of manuscripts for publication in the PROCEEDINGS of the I.R.E. and WAVES AND ELECTRONS as well as a short explanation of the handling of papers after they are received by the Institute, are outlined. The mechanical preparation of papers and the various stages through which they progress will be treated.

## I. INTRODUCTION

TO SOME contributors to the pages of the PROCEEDINGS,<sup>1</sup> certain of the policies and procedures of the Editorial Department might seem either unnecessary or without sufficient justification. Yet, present methods of handling papers are based on long experience and on many requirements, some of which are not obvious. Further, it has always been the wish and desire of this Department to be logical, fair, and consistent in its treatment of all manuscripts submitted for consideration so that the best relations may exist between author and reader. This paper is presented in the hope that many questions which may confront or even puzzle authors may be answered.

Every publication has a broad underlying editorial policy which may differ radically from that of other periodicals, and even from those in the same field. Such policies promote coherence and consistency in style and form and thus reduce confusion or annoyance to the reader. Some few authors go so far afield from a desirable treatment of material that intensive editing of their papers is necessary (to say nothing of the required application, at times, of the simple rules of grammar and composition). Certain fundamental rules are also applicable to illustrations. It is obviously necessary that figures be presented in a clear form or the resulting printed page will lose in value to the reader.

It is one of the aims of the Institute to ensure the technical quality and originality of the papers appearing in its PROCEEDINGS. Accordingly, every manuscript received by the Editorial Department of the Institute is scrutinized by at least three members of the Papers Committee and one or more members of the Board of Editors before it is accepted for publication (or declined as unsuitable for the PROCEEDINGS). These readers carefully examine and study each paper and judge it on its likely value to the membership. Their reviews are of great benefit to the author whether the paper is finally accepted or not, for fundamental or less serious errors in manuscript are not infrequently caught, thus avoiding damage to the reputation of the author and impairment of the high quality of the PROCEEDINGS.

\* Decimal classification: R053. Original manuscript received by the Institute, August 31, 1945.

† Publications Manager, The Institute of Radio Engineers, Inc., New York, N. Y.

<sup>1</sup> In this paper "PROCEEDINGS" means PROCEEDINGS of the I.R.E. and WAVES AND ELECTRONS.

## II. THE MANUSCRIPT

Papers should be submitted in triplicate to the Editorial Department, The Institute of Radio Engineers, Inc., 26 West 58th Street, New York 19, New York. A complete set of illustrations should accompany *each* copy of the manuscript, since each paper is to be read by each of the three selected members of the Papers Committee. When three copies of the manuscript are submitted, they can go to the readers simultaneously. If only one or two copies are submitted, it is necessary to wait until they are returned to the Editorial Department before they can be forwarded to additional readers. This, obviously, delays the processing of the manuscript and the date of its publication.

The manuscript should be typed on white paper, regular letter size ( $8\frac{1}{2} \times 11$  inches), double-spaced, and with margins about three quarters of an inch to one inch in width. Only one side of the paper should be used, and each page of every copy should be carefully checked to be certain that it is completely legible and without errors or omissions. Blueprint copies and silver-print copies are not desirable because, in the mechanical editing process, it becomes necessary to use a white pencil on the blueprints or a pen on the silver prints, and the clarity of the marked corrections leaves much to be desired.

The paper should have a short title, preferably not longer than five or six words. After the title, the name of the author should follow immediately, and a footnote reference should give the author's university, governmental, or business affiliation and location. If the paper has been presented at a meeting of any kind before any organization, this should be noted either in the footnote or in the letter of transmittal which accompanies the manuscript. The name of the meeting, the place, and the exact date should all be incorporated.

The author should state in his letter of transmittal of the manuscript any plans for the publication of his paper other than in the PROCEEDINGS. He should also inform the publicity division of his organization that it is the policy of the PROCEEDINGS not to publish any paper which has appeared in English in any publication having a substantial circulation among the readers of the PROCEEDINGS. The purpose of this policy is to avoid duplication of effort and waste of material, properly to conserve the funds of the Institute. Further, if the author is aware of any earlier partial or complete anticipation of publication in any language of the work described in his paper, he should state that fact early in his paper to avoid possible confusion or misunderstanding.

A short summary should precede the body of the

paper explaining the context in brief. Footnote references and equations should not appear in the summary.

It is desirable to have division headings, but to keep the number of these within reasonable limits. Subheadings are frequently confusing to the reader and should not be employed unless absolutely necessary.

At the end of the paper, all of the captions for the figures should be typed on a single sheet. Only the first word of each caption should be capitalized. The figures themselves should not carry these captions, but only an identifying figure number. It is highly desirable that the name of the author be on each figure. This identification is particularly helpful to the Editorial Department when the manuscript and illustrations are sent in separately, and also in identifying the proper paper when the illustrations are sent to the engraver to be made into cuts for the printer. Unrelated figures should not be divided into parts unless each part is an integral part of the whole figure. All figures should be numbered in chronological order according to the first reference made to them in the text.

The footnote references should give the full name of the author, the title of the paper, the publication in which it has appeared, the volume number, the beginning and concluding pages, and the month and year of the publication. As an example: Dorman D. Israel, "Looking forward in engineering education," *PROC. I.R.E.*, vol. 23, pp. 353-355; June, 1945. References to books should give the name of the author, the title of the book, the name of the publisher, and the city, date, and year; where a particular page or chapter is referred to, this should be added. For example: V. K. Zworykin and G. A. Morton, "Television—The Electronics of Image Transmission," John Wiley and Sons, New York, N. Y., 1940, pp. 370-374. The editorial readers of the *PROCEEDINGS* feel that while in some cases a bibliography is desirable, generally speaking, it is better to indicate references within the body of the paper by means of footnotes which appear on the same page. In some cases, such as in an historical paper, a full bibliography is more desirable. Footnote references should appear in chronological order without exception. Numerals should be used in place of asterisks or daggers.

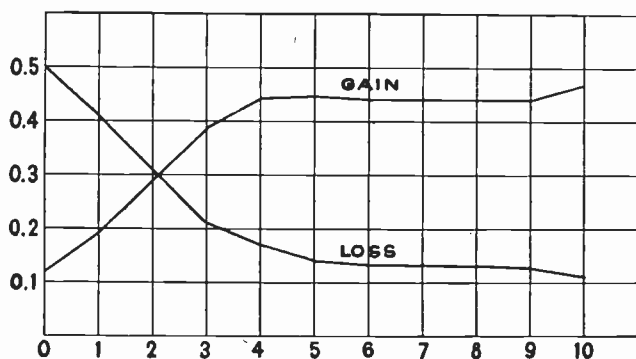

Fig. 1—Drawing made with black ink on blue cross-hatched paper with major divisions in red.

### III. ILLUSTRATIONS

Wherever possible, illustrations should be submitted on sheets  $8\frac{1}{2}$  inches by 11 inches (which is regular letter size), since the standard file cabinets used by the Editorial Department and others readily accommodate this size folder. Where larger sized paper is used, or where drawings are large and difficult to handle, there is the risk that both the manuscript and illustrations may be damaged in handling. Small illustrations or photographs may be lost if not attached to the  $8\frac{1}{2}$ - by 11-inch sheets. Extremely large illustrations are awkward to mail and are often a cause of trouble to the author and the publisher. (In some cases, the engraver makes an extra charge for the reduction of very large figures.) It should be kept in mind that most illustrations in the *PROCEEDINGS* are reduced to a maximum width of  $3\frac{1}{4}$  inches. In some extreme cases, they are made larger, but in the interest of economy in paper and in cost, the sizes are kept to the named dimension wherever possible. Therefore, all printing and symbols on the illustrations should be of such a size that, when the figure is reduced to  $3\frac{1}{4}$  inches or slightly less in width, the printing will be clear and distinct and the symbols legible. A suggested lettering size is given in the last paragraph of this section. Printing and symbols should be of the same size on all figures in any one group. Drawings should be done with black ink on tracing cloth or white paper. They should not be done with fountain-pen ink which may smear, fade, or reproduce badly. Where graph paper is used, it is desirable to use the kind which has a light-blue, cross-hatched background with the major divisions in red. In the photoengraving process, the blue drops out completely, and the red appears as black. (See Fig. 1.) Some authors submit figures on paper with yellow, green, brown, orange, or red cross-hatched paper. Such backgrounds reproduce in black with confusion and blurring of lines and lettering. (See Fig. 2.) A search was made for log-log paper with blue backgrounds and red major divisions, but the two leading companies which handle these papers do not manufacture log-log paper in these combinations. Therefore, where this paper is to be used, it is desirable to plot the chart on tracing cloth or white paper with only the major divisions indicated. Where this is impossible, and where the printing appears

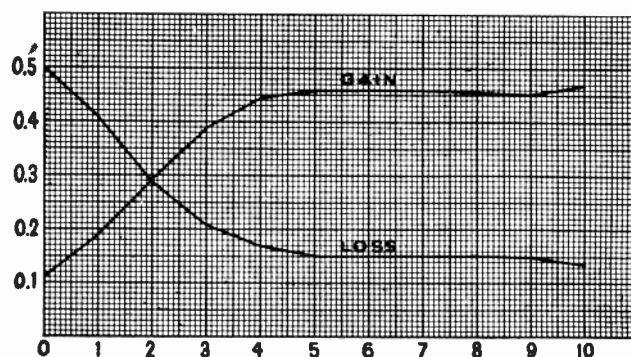

Fig. 2—Drawing made on cross-hatched paper with yellow, green, brown, orange, or red backgrounds.

on the figure itself, the author should copy the printing on small pieces of white paper and carefully paste them in the required places. When the cut is made, these letters will appear on little white "islands" and will be legible and sightly. However, one danger of this practice is that these small pieces of paper frequently fall off and are lost.

Photographs must be sharp in detail and on glossy paper. While matte-finished pictures are more artistic, much detail is lost in the photoengraving process. Any printing which necessarily is included on a photograph should be directly on it and not carried over into the white margin of the picture. The reason for this procedure is one of economy, for unless this method is used, the corresponding cut has to be made, in photoengraving terms, as a "combination half tone," and the cost is approximately twice that of an ordinary half tone.

Some commercial companies have a practice of printing a file number on the illustrations. Wherever possible, this is eliminated from the finished production; if it is impossible to "crop" it from the picture, it is necessary to have an artist airbrush it out. This extra work, of course, adds to the time element and to the cost of the cut, and is to be avoided wherever possible. Sometimes, holes are punched in the photograph itself, and these, too, are eliminated from the figure when the cut is made; or, where they interfere with the illustration itself, it is necessary to have the artist patch these holes. This patching process also adds to the cost of the cut and is not desirable. At present, the Institute does not employ an art staff to handle such special matters. Accordingly, it is necessary to send out all such work to be done by an artist. Sometimes, authors send in a rough pencil sketch. In these cases, it is necessary to return the drawing to the author for redrawing in an accepted form, and this, of course, slows up publication. Illustrations should not be mounted on heavy bristol board since such material is awkward to mail and greatly increases the postage cost.

For a drawing which is 8 by 10 inches, the lettering should be one quarter of an inch high and all other material in proportion. Figure numbers and captions should never be included on the figure itself. The author should submit with his manuscript three extra copies of his illustrations, such as blueprints or photostatic copies, so that these may be sent to the readers. He may indicate that he will supply the original drawings when he has been notified of the acceptance of his paper for publication, or he may send the original drawings at the time of submission in which case they will be kept in the files until needed.

#### IV. MATHEMATICS

Some authors are so familiar with their own handwriting and with the symbols in the equations that they do not make these as clear or definite as could be desired.

The author should, therefore, take extreme care in writing his equations so that there will be no doubt of his meaning in preparing the manuscript for use by the printer and typesetter. To avoid possible confusion, it is well for the author to write out the name of any new or unusual symbol on the margin of the paper. In the case of complex mathematical equations, he should insert parentheses, braces, and brackets where needed.

The equation number should be enclosed in parentheses and put at the far right of the equation. Equations should be numbered consecutively. Some authors start to renumber their equations with each section, or with each appendix. This practice is confusing to any later author who may use the paper as a reference.

Decimals should be preceded by a zero, such as 0.04, rather than .04.

#### V. ABBREVIATIONS

In every field, certain abbreviations and even slang terms are used. These are quite right and proper in their ordinary usage, but are believed to be unsuitable for the pages of the PROCEEDINGS. Slang and "shop talk" therefore, should not be employed. All words should be written out, (such as decibels, microvolts, megohms, and the like). The underlying reason behind this procedure is one which, until recently, was less important than usual, but is nevertheless fundamentally sound. The Institute of Radio Engineers is an international organization and has members in every part of the world who derive great benefit from the PROCEEDINGS. Many of these members have a reading knowledge of English, but may not be familiar with abbreviations or peculiarly idiomatic or popular expressions, and therefore may become confused in reading papers published in these pages unless they are formally presented. For the benefit of our foreign readers and our younger student members, the Editorial Department adheres to the strict policy of writing out abbreviations. The only exception to this is that, in tables, abbreviations occasionally may be used. Also, because of the long-established custom in all textbooks and journals, figures are always referred to as "Fig. 1," "Fig. 2," etc.

#### VI. CONTRIBUTORS SECTION

In the Contributors section, there are published formal portraits of authors. An attempt is made to keep the portraits reasonably uniform in size so that the page may present a pleasing appearance. The accompanying biographical sketch should include the author's name, date and place of birth, degrees received and dates awarded, institutions which granted them, places and dates of employment, and his affiliation with other professional, honorary, and scientific societies. A careful reading of several published biographical sketches should prove helpful in the preparation of this material.



## VII. PROCESSING A MANUSCRIPT

The author may wish to know what happens to his manuscript after it has been sent to the PROCEEDINGS for consideration.

As stated, the manuscript preferably is submitted in triplicate, and three sets of figures (blueprints, photostats, etc.), should accompany it, together with a complete set of original illustrations. The author should be certain that the manuscript is complete and he should not send additional material to be inserted later. Receipt of the manuscript is acknowledged to the author by the Editorial Department; a card is made out listing the name of the author, the title of the paper, and various other data, which card is kept active and up to date in the Editorial-Department files until final disposition has been made of the paper. A form is filled in and sent with one copy of the manuscript to the Editor for inspection. He examines the manuscript and selects the readers on the Papers Committee and the Board of Editors to whom the manuscript should be sent for review. The readers on the Papers Committee are skilled and recognized specialists in the field covered by the paper, and the member of the Board of Editors has a broad, over-all knowledge of both the field of the paper and the value of the submitted material to the PROCEEDINGS. Every attempt is made to select a variegated and impartial group of readers.

If the Editor finds that the publication of the paper might prove detrimental to the national interest, he sends the manuscript to a suitable referee or a government department for a decision in the matter. If, in the opinion of the reviewer, the manuscript falls into this class, it is returned to the author with such a notation.

When the paper appears on the desk of the Technical Editor, it is routed to the three designated members of the Papers Committee for review. When these three reviews have been received by the Editorial Department, they are sent, together with one copy of the manuscript, to the designated member of the Board of Editors. He then gives his opinion, and the whole file is sent to the Editor. The preceding steps are carried out by the Technical Editor. According to the reports of the readers, the Editor has three courses open to him: to accept the paper as it stands; to return the paper to the author for revision; or to classify it as unsuitable for publication in the PROCEEDINGS.

When a paper is accepted, the author is so informed, and any missing material is requested, such as a summary, original illustrations, captions for the figures, and a biographical sketch and photograph of the author. Where the author has previously had the last two items published in the PROCEEDINGS, he is informed of the date of their publication and requested to submit any changes which he desires to have made.

The paper is then mechanically edited. The type sizes are indicated for the printer, footnotes put in order, fig-

ures prepared for the photoengraver, and cuts made. The engineering correctness of the language and equations is carefully checked by the Technical Editor. The manuscript is edited for spelling, and the grammar is carefully checked. The Editorial Department of the PROCEEDINGS endeavors to make each paper as nearly grammatically correct as is possible, and relies for this purpose on the Second Edition of Webster's New International Dictionary, Unabridged; the Century Collegiate Handbook; and the Manual of Style, published by the University of Chicago Press. To any reader of the PROCEEDINGS, it is evident that hyphens are abundantly used. This conforms to the rules laid down by the previously mentioned books and is not arbitrary. Likewise, the usage found in the PROCEEDINGS of writing non-semi-, super-, etc., words solid is in accordance with the spelling found in Webster's dictionary.

When the manuscript has been edited and the cut proofs checked against the original figures and found to be in good order, the paper is then sent to the printer. He sets it in type and returns a galley proof to the Editor, the Technical Editor, the National Bureau of Standards, and two copies to the author. The author inserts his corrections on one of the proofs and returns it to the Editorial Department, retaining the other copy for his files. After the galley proofs have been read by the Editor, Technical Editor, Department proofreader, the author, and the printer, all corrections are made on one master galley to which is added the decimal classification assigned by the National Bureau of Standards. This classification is inserted in the first footnote of the paper, which carries an asterisk instead of a numerical designation. It is not necessary for the author to trouble himself with the decimal classification.

The scheduling of papers for publication is carried out systematically to produce balanced, instructive, and interesting issues of the PROCEEDINGS. When this has been done, all of the manuscripts scheduled to appear in that particular issue are returned to the printer, together with the additional material which appears in the section of the magazine following the technical papers. This material consists of the Contributors section, book reviews, and miscellaneous items of interest to readers of the PROCEEDINGS. The printer makes all of the necessary corrections and returns page proofs to the Editorial Department. The Associate Editor and Technical Editor check the page proof, and the Editorial Department painstakingly goes over the dummied and corrected material, comparing it with the corrected page proof submitted. All corrections are checked, and final errors are noted for the printer. This material is then returned to the printer; after he has made the additional corrections and changes, the issue is ready to go to press.

## VIII. REPRINTS

When the author receives his galley proof, he also receives a reprint-order blank and a blank for the return of his used material. Both of these should be filled in

promptly and returned with the corrected galley proof. Reprints must be ordered at the time of publication, since type may be broken immediately after the issue is run off the press. Reprints are run at the same time as the issue, but are not gathered together, trimmed, and mailed until some time later. The reason for this is that the most logical time to print the reprints is when the issue is being run. However, since reprints are manufactured on a fill-in and low-cost basis, it is not possible to have them completed immediately. In normal times, reprints were usually shipped within thirty days after publication, but, because of manpower shortages, reprints may not be shipped until sixty days after publication. The reprint bill is received some time after the copies have been shipped, and the author is then billed for the reprints.

### IX. CONCLUSION

It is hoped that the above discussion will clarify many problems in the minds of our authors, whether they have already contributed to the pages of the PROCEEDINGS or are contemplating writing a paper. The author should bear in mind that, in addition to his paper being technically sound, it is most desirable that the manuscript be presented in a clear and concise manner; and that,

physically, its appearance be attractive, (that is, clean typing on white paper, wide margins, and equations carefully written or typed), figures in good order, and footnote and figure references presented chronologically. The paper is then far easier to review and does not present a later mental hazard to the PROCEEDINGS readers. It is reasonable to presume that a carefully prepared paper, well presented, enables more prompt action in the editorial processes than one less carefully prepared.

If the prospective author will carefully study an issue of the PROCEEDINGS, he will note the results of the procedure here described. A little thought and time spent on such a survey will likely be valuable to him and, incidentally, will greatly assist the editorial readers and the Editorial Department.

The Editorial Department is at all times eager and anxious to co-operate with the author, and any questions which he may wish to ask will be answered as promptly as possible. It is deeply appreciative of the friendly and effective help of many of the authors. It exists to work for the authors and the readers and the PROCEEDINGS of the I.R.E. and WAVES AND ELECTRONS is their magazine. The Editorial Department is here for no other purpose than to serve them.

## An Ultra-High-Frequency Radio Range with Sector Identification and Simultaneous Voice\*

ANDREW ALFORD†, FELLOW, I.R.E., ARMIG G. KANDOIAN†, SENIOR MEMBER, I.R.E.,  
FRANK J. LUNDBURG†, ASSOCIATE, I.R.E., AND CHESTER B. WATTS, JR.†, ASSOCIATE, I.R.E.

*Summary*—The primary purpose of a radio range for aircraft use is to provide a reliable indication to the pilot of an airplane as to his location with respect to a predetermined course. In addition, it is very desirable to identify quickly and positively the sector in which the airplane is at any given time; i.e., whether it is east or west of an east-west radio-range station. Voice radiated omnidirectionally is also desirable for ground-to-plane communication.

The basis of the radio-range design described herein is the two-course localizer used in instrument landing. A group of three loop radiators provide two overlapping mirror-image patterns modulated at 90 and 150 cycles, respectively. A cross-pointer instrument, the vertical pointer of which is actuated differentially by the 90- and 150-cycle modulation, provides the pilot with the necessary information for orienting his plane.

### INTRODUCTION

THE PRIMARY purpose of a radio range for aircraft use is to provide a reliable aural or visual indication to the pilot as to his location with re-

A second pair of outside radiators, similar but at right angles to the first group, in conjunction with the center radiator, which is common to both the aural and visual systems, provides a keyed signal for aural sector identification. Except for the carrier radiation which is common to both the aural and visual signals, the two systems are entirely independent. Voice is radiated only by the center antenna.

The theory of the antenna system is discussed in this paper, paying particular attention to the problem of interaction between the aural, visual, and voice radiating systems. The various stages of development leading up to the final range installation at the Civil Aeronautics Administration Experimental Station in Indianapolis are given.

spect to a predetermined course. In addition, immediate and positive identification of the sector in which the airplane is at any given time; i.e., whether it is east or west of an east-west radio-range station, along with voice radiated equally in all directions from the station for communication purposes, is a very desirable feature.

The ultra-high-frequency radio-range with sector identification and simultaneous voice represents a highly specialized recent development to fulfill the above requirements. It seems desirable, therefore, to precede its

\* Decimal classification: R526.1. Original manuscript received by the Institute, April 19, 1945; revised manuscript received, August 21, 1945. Presented, Winter Technical Meeting, January 14, 1942, New York, N. Y.

† Federal Telephone and Radio Laboratories, New York, N. Y.

description with a brief discussion of past developments in this field.

#### FOUR-COURSE RANGE AND TWO-COURSE LOCALIZER

##### 1. Four-Course Radio Range

The conventional four-course range, whether of the low-frequency type used throughout the country, or the ultra-high-frequency type, has a radiation characteristic similar to that of Fig. 1. Two mutually perpendicular figure-eight patterns are radiated successively, one keyed with characteristic identification A(· -) and the other N(- ·), the two signals being interlocked. The course is determined by the merging of the two interlocked 1020-cycle signals. A steady 1020-cycle tone informs the pilot that he is in the "on-course" region; a definite A(· -) or N(- ·) indicate the side of the course on which the airplane is flying.

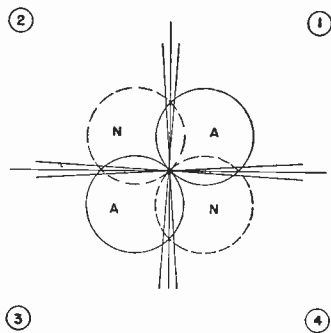

Fig. 1—Four-course radio range.

A limitation of this type of range is the identity of the "A" or "N" signals in opposite quadrants. As shown in Fig. 1, the same signal is received in quadrant 1 as in quadrant 3 (also quadrants 2 and 4). Information as to the airplane position with respect to the radio-range station is thus *not* conveyed to the pilot—a potentially serious cause of difficulty in case a pilot is lost and desires to fly to the nearest airport with a minimum of fuel consumption. The reader is referred to the indicated reference for further information on visual indication for orientation under instrument flight.<sup>1</sup>

##### 2. Two-Course Localizer

With this localizer, the type installed at Indianapolis, Indiana, some five years ago and now commonly used for instrument landing, two characteristic patterns are radiated *simultaneously* rather than successively. One pattern is modulated at 90 cycles and the other at 150 cycles. The course is determined by an indicating instrument of the zero-center type actuated by the ratio of the 90- and 150-cycle modulations. When this ratio is unity the pointer position is in the zero-center of the instrument scale, thus informing the pilot that he is "on course." Predominance of 90- or 150-cycle modulation

causes the pointer to swing to the right or left, respectively, indicating "off-course" flight.

Despite the practicability of establishing a course at least three times more sharply defined than with the four-course range, the difficulty of locating position with respect to the radio-range station remains. This will be

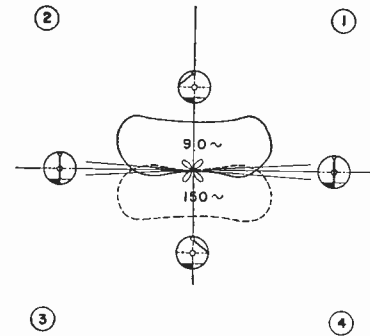

Fig. 2—Two-course localizer.

evident from Fig. 2; the same signal is received regardless of whether the airplane is in position "1" or "2" ("3" or "4"). The problem thus presented for solution was the identification of the sector at any instant so as to acquaint the pilot not only with his position with respect to the course (information which both the four-course radio range and the two-course localizer provide) but also his location with respect to the radio-range station.

#### ESSENTIAL RANGE REQUIREMENTS

Fig. 3 shows schematically the basic requirements and might represent any radio range, such as that at Indianapolis. Two indications are necessary: (1) deviation from

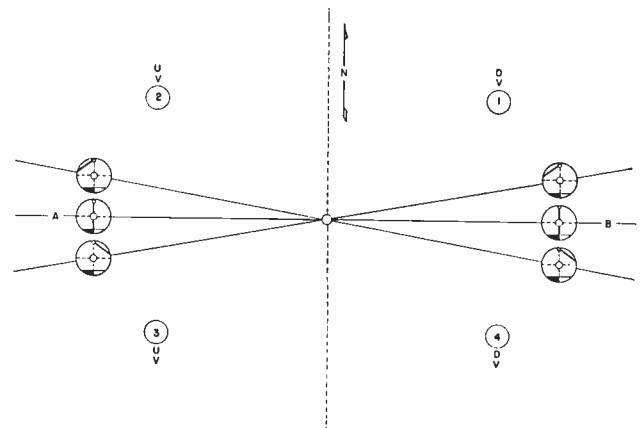

Fig. 3—Two-course radio range with sector identification and simultaneous voice.

the established course, provided visually by a zero-center type indicator which goes off scale approximately 10 degrees each side of the course; (2) aural sector identification; i.e., indication of the airplane position east or west of the radio-range station. In Fig. 3, the letter V represents voice which is radiated equally in all directions about the station.

<sup>1</sup> P. H. Redpath and J. M. Coburn, "Air Transport Navigation" Pitman Publishing Corporation, New York, N. Y., 1943, chapter 21, pp. 472-482.

METHOD OF SOLUTION

The solution of the signal problem of the two-course range with sector identification and simultaneous voice is indicated in Fig. 4. It is apparent from the preceding discussion that the two-course localizer provides a partial answer. Hence, two overlapping radiation patterns,

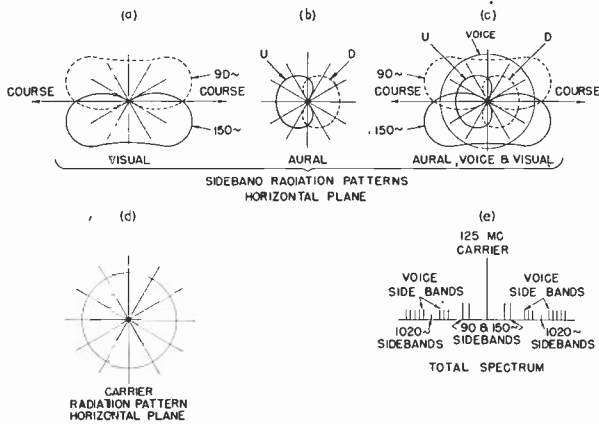

Fig. 4—Components of complete radiation.

modulated at 90 and 150 cycles, respectively, are transmitted simultaneously for the establishment of the east-west visual course (Fig. 4(a)). In addition, for aural sector identification, two radiation patterns are transmitted in immediate succession with interlocking D(- · ·) and U(· · -) characters; the first predominantly towards the east, and the second predominantly towards the west as in Fig. 4(b). Simultaneous voice, when applied, is radiated in a substantially circular pattern as illustrated in Fig. 4(c).

The complete radiation, aural, visual, and voice, is shown in Fig. 4(c), the relative sizes showing approximately the relative amplitudes of the aural, visual, and voice signals. The discussion concerning radiation patterns thus far refers to the sidebands only. By a process to be discussed shortly, the carrier which is common to the aural, visual, and voice signals is radiated in all directions as in Fig. 4(d). Under these conditions, Fig. 4(e) represents the total useful spectrum of the complete radio range.

ANTENNA PROBLEM

The visual course radiations are produced by a group of three ultra-high-frequency loop antennas. These three antennas lie on a straight line perpendicular to the visual course with equal spacings between adjacent loops. The aural course radiators constitute a similar array oriented 90 degrees with respect to the visual group, the center loop being common to both groups. Voice, visual, and aural sidebands and carrier are radiated circularly only by the common center loop. The loop antennas used are the type previously described.<sup>2</sup>

<sup>2</sup> A. Alford and A. Kandoian, "Ultra-high frequency loop antennae," *Trans. A.I.E.E., (Elec. Eng., 1940)* vol. 59, pp. 843-848; 1940; and *Elec. Comm.*, vol. 18, pp. 255-265; April, 1940.

The antenna-array problem is illustrated schematically in Fig. 5.  $S^\circ$  represents the spacing of the loops in electrical degrees. With the amplitudes and spacings indicated the total radiation  $F(\theta)$  in the horizontal plane is given by

$$F(\theta) = A \pm 2B \sin (S^\circ \sin \theta). \tag{1}$$

The choice of sign depends upon the relative phase of the outer loops with respect to the center loop and de-

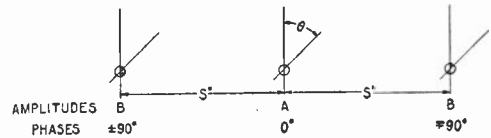

Fig. 5—Derivation of three-loop radio range.  $S^\circ$  = spacing between loops in electrical degrees  
 Radiation pattern—horizontal plane:  $F(\theta) = A \pm 2B \sin (S^\circ \sin \theta)$   
 Visual antenna array:  $A = 1$ ;  $B = 0.707$ ;  $S^\circ = 135$  degrees  
 Aural antenna array:  $A = 1$ ;  $B = 0.5$ ;  $S^\circ = 100$  degrees

termines the particular image pattern obtained; the intersection of the two mirror-image patterns along direction  $\theta = 0$  degrees and 180 degrees determines the

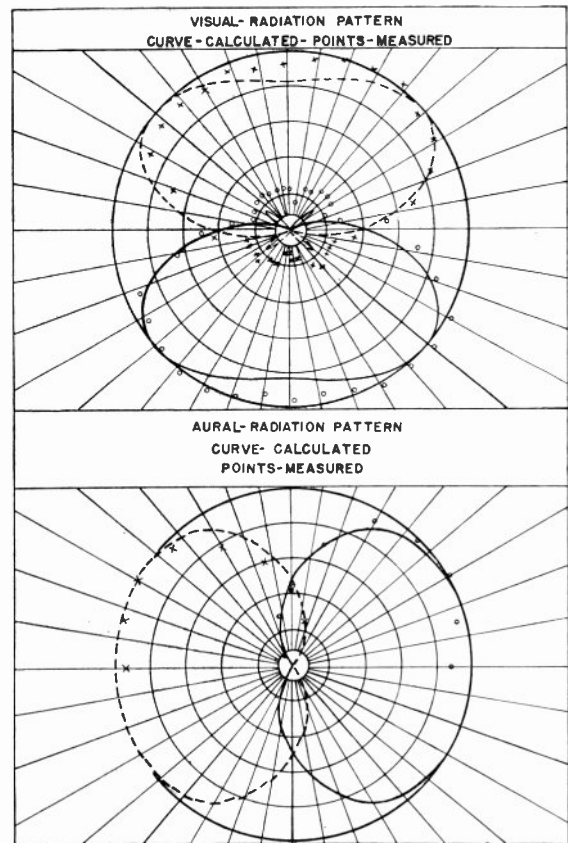

Fig. 6—Comparison of visual- and aural-radiation patterns.

established course. The first term  $A$  represents the radiation from the center loop; the second term, the radiation from the outer loops.

Equation (1) is generally applicable to overlapping radiation patterns. In this form, or slightly modified and



expanded, it may be applied to a variety of radio-range and localizer antenna arrays.

For the case of the visual and aural arrays, the requirements impose a division of power between the center and outer loops of  $A = 1$  and  $B = \frac{1}{2}$  with  $S = 120$  degrees. These values give an infinite clearance at angles of  $\pm 48.6$  degrees to either course, where clearance is defined as the ratio of the field strength of one mirror-image pattern to the other at any selected distance from the station.

Fig. 6 shows the visual- and aural-sideband radiation diagrams for the values of  $A$  and  $B$  indicated in Fig. 5. This choice of current ratios and spacings is not the one used in the final range installation, but has been included to illustrate the effect of antenna spacings and current ratios on the radiation patterns.

### 1. Aural Array

The circuit of the aural antenna system is illustrated in Fig. 7. By keying at the indicated location, the phase of the two outer loops is reversed with respect to the phase of the center loop; hence, the desired mirror-image patterns are obtained alternately. In one radio-frequency keyer position, radiation occurs predominantly

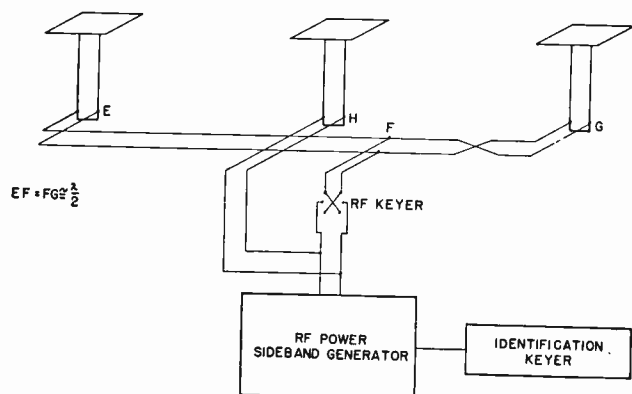

Fig. 7—Aural antenna network.

toward the east and the keyed identification is  $D$ . In the opposite position, radiation occurs predominantly towards the west and the keyed identification is  $U$ . Two separate antenna systems for radiating the two characteristic patterns consequently are avoided, inasmuch as the separate patterns are obtained at will by a simple phase reversal.

In this type of array, the problem of interaction between the various radiators must be considered. Since the outer loops have equal currents of opposite phase they do not induce any current in the center loop. The center loop, however, may excite the outer loops parasitically. This parasitic action can be controlled and made useful for certain applications. In the present case, however, it is undesirable and hence the relationship  $EF = FG \cong \lambda/2$  is maintained (Fig. 7). This places a virtual short circuit at terminals  $E$  and  $G$  for parasitic currents, and detunes these loops insofar as parasitic action is concerned.

### 2. Visual Array

Fig. 8 depicts the visual antenna system which is similar to the aural array except that its position is oriented 90 degrees from the visual position. In this case, however, the two characteristic patterns must be transmitted simultaneously, rather than successively, so that a special network is required.

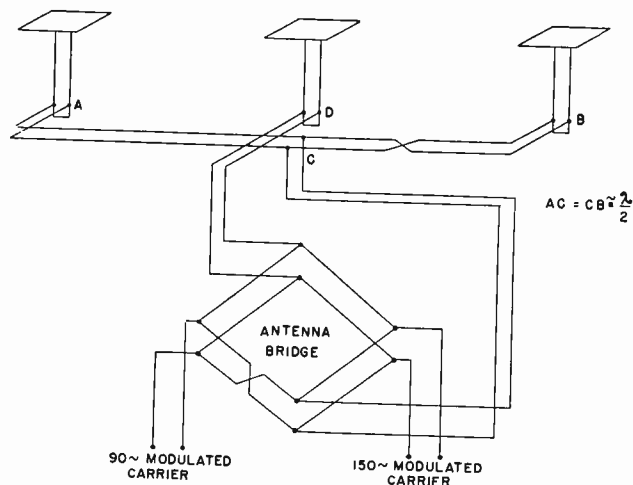

Fig. 8—Antenna network, two-course visual radio range.

This network, a transmission-line bridge, is indicated diagrammatically in Fig. 8. The 90- and 150-cycle modulations are fed into opposite terminals of the network and arrive at the center loop in phase; but because of the phase reversal in the arm of the bridge, they reach the outer loops in opposite phase. This results in the simultaneous mirror-image patterns, one with 90-cycle and the other with 150-cycle modulation.

The bridge circuit possesses another important advantage. At each of its two input terminals, in addition to the 90-cycle and 150-cycle sidebands, there is present the 125-megacycle carrier, which arrives at the respective input terminals of the bridge in phase. At the terminals leading to the outer loops, however, the carriers cancel out because of the previously mentioned phase reversal in one arm of the bridge. Contrariwise, at the center-loop terminals, the carrier is in phase and is therefore additive. Hence, no mirror-image patterns exist insofar as the carrier is concerned; the carrier is radiated only from the center loop equally in all directions. The sideband power, however, divides equally between the center and the outer antennas and makes possible the radiation patterns already described.

The transmission-line bridge thus serves three highly important functions: (a) the realization of two different radiation patterns from a single antenna array; (b) the removal of the sidebands from the carrier of two modulated waves of the same carrier frequency without any power dissipation; and (c) the radiation of the total carrier energy solely from the center loop with uniform circular distribution.

## THE VISUAL MODULATION PROBLEM

The problem of obtaining two equal sources of radio-frequency power modulated at 90 and 150 cycles, respectively, requires careful consideration. Early in the development of radio ranges it became evident that two separate transmitter output stages, each with its own modulation, was not satisfactory. This was due to the fact that variation of one output stage with respect to the other resulting from a change in tube emission, or any other reason, would alter the established course correspondingly. It was necessary, therefore, to divide the transmitter carrier output into two equal parts and modulate each half separately by means not subject to difficulties arising from change of tube emission. Mechanical modulation, consequently, was adopted.

The schematic diagram of the mechanical modulator is shown in Fig. 9. It will be seen that the transmitter

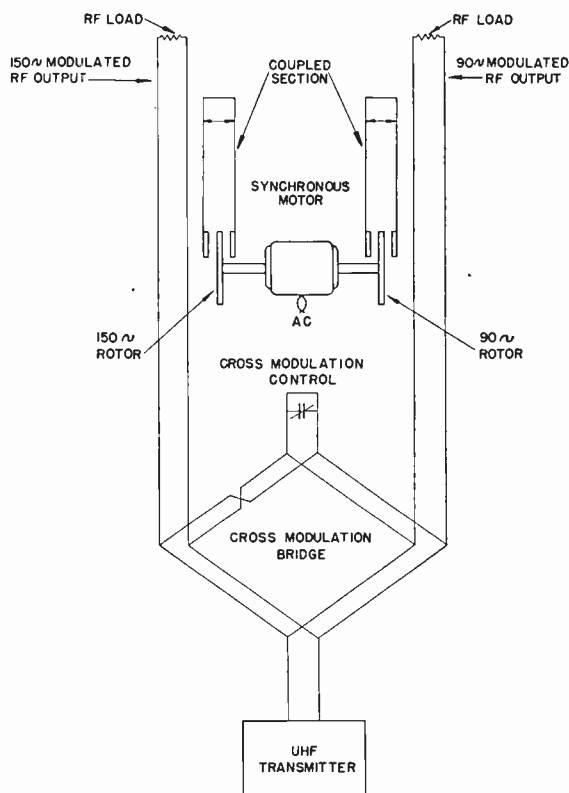
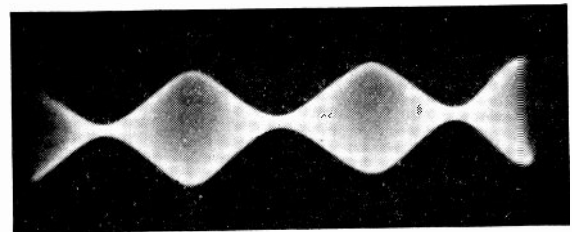

Fig. 9—Ultra-high-frequency mechanical modulator.

output is divided into two channels with a resonant quarter-wave section coupled to each. Under these conditions, the coupled sections effectively short-circuit the transmission line to the antennas.<sup>3</sup> These resonant sections are detuned periodically by 3- and 5-blade paddle wheels rotating at 1800 revolutions per minute. Thus the resulting output of each channel is modulated 100 per cent. By tuning the sections so that resonance is approached but not reached, any lesser degree of modulation may be obtained.

<sup>3</sup> Andrew Alford, "Coupled networks in radio-frequency circuits," Proc. I.R.E., vol. 29, pp. 55-70; February, 1941.

In arbitrarily dividing the output of a transmitter into two channels, special precautions are required to prevent cross modulation when the impedance of a channel varies during the modulation cycle. For this purpose the transmission-line bridge again proves to be



(a)

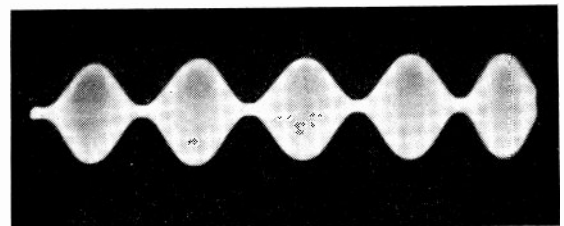

(b)

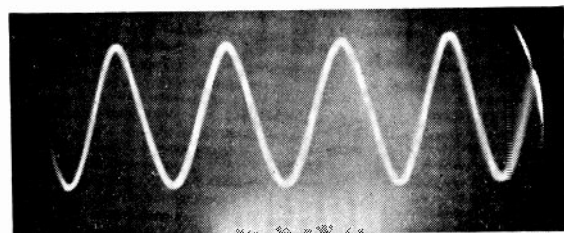

(c)

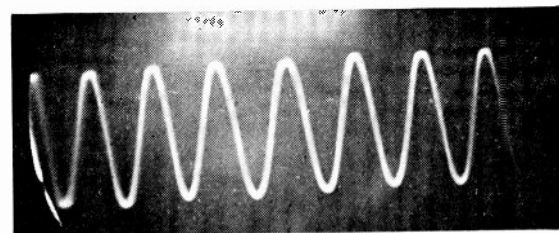

(d)

Fig. 10—Wave form from mechanical modulator.  
(a) 90-cycle modulation radio-frequency envelope  
(b) 150-cycle modulation radio-frequency envelope  
(c) Detected 90 cycles  
(d) Detected 150 cycles

a versatile tool. By varying the impedance at the terminal opposite the transmitting end, it is possible to make each branch entirely independent of the other, and hence obtain substantially zero cross modulation. It is, moreover, not difficult to show experimentally that no power need be lost in the bridge terminating network to obtain negligible, less than 1 per cent, cross modulation between channels.

The tendency prevails to associate mechanical modulation with jagged, distorted, or at least square-wave modulation rich in harmonic content. In the present case, however, this type of wave configuration is decidedly not obtained, as will be evident from Fig. 10, showing representative results. It is, in fact, not difficult to limit the total distortion of each channel to less than 10 per cent and, with somewhat more care, to less than 5 per cent.

AURAL AND VOICE MODULATION

The present method for application of aural and voice modulation is a result of several years development and experimentation. Throughout these years of growth leading to the present radio range, several methods were employed to achieve this addition. It seems logical, therefore, to describe the three major methods in the order in which they occurred.

Method I

Initially, only aural modulation without voice was used to obtain sector identification. In the adaptations

would cause "kicking" on the visual course-indicating instrument each time the aural signal was keyed. It follows, therefore, that some means must be provided to transmit only 1020-cycle sidebands for the aural signal and to make use of the already existing circularly radiated carrier from the visual-instrument course.

To accomplish these results, the aural-channel facilities employ a sideband generator giving an output predominance of sideband to carrier of 30 to 40 decibels depending upon the care exercised in adjustment. At the output of the sideband generator, a phaser is provided to obtain the correct phase relationship between the sidebands thus produced and the carrier from the main transmitter.

Since a carrier common to both the aural and visual modulation is utilized, it is not desirable to modulate the carrier in the mechanical modulator 100 per cent.

This modulation, therefore, is reduced to approximately 70 per cent and the aural signal then modulates the remaining 30 per cent.

INTERACTION PROBLEM

Method I

The block schematic diagram of method I of the two-course radio range with sector identification is shown in Fig. 11. The visual and aural loops shown in this illustration are positioned above a metallic counterpoise.

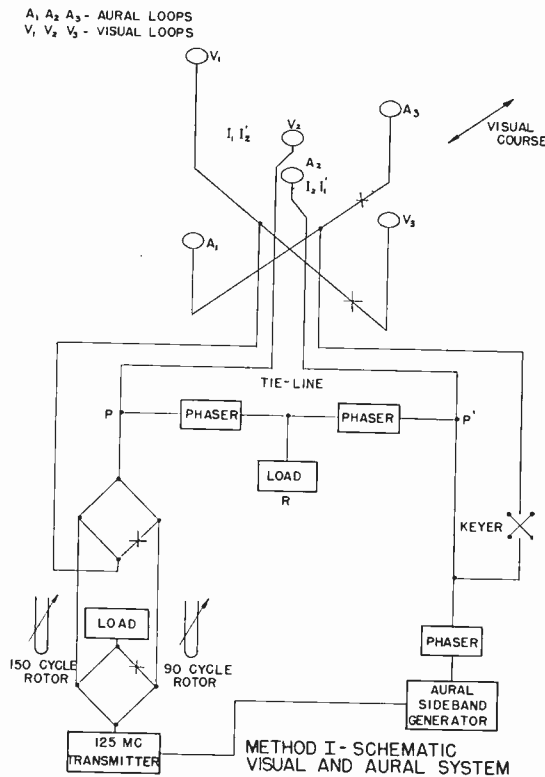

Fig. 11—Method I, schematic visual and aural system.  
 $A_1, A_2, A_3$  = aural loops  
 $V_1, V_2, V_3$  = visual loops

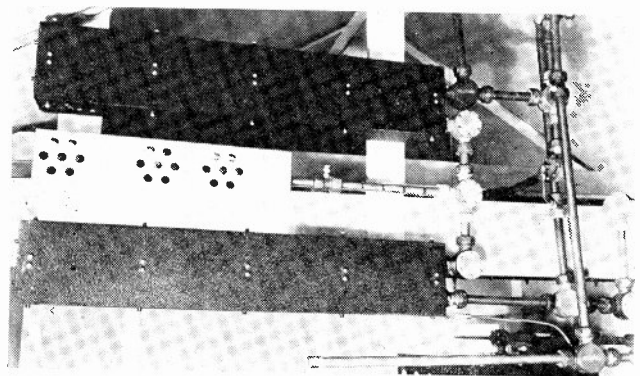

Fig. 12—Tie line used in method I to prevent interaction between aural and visual antenna systems.

The visual loops are placed a half wave above the counterpoise and the aural loops slightly more than one quarter. From previous discussion it is clear that the four outer loops induce no currents in the center loops. The center two loops, on the other hand, do not induce currents in the outer loops because these loops are detuned for parasitic current, since in Figs. 7 and 8

$$AC = CB = EF = FG \cong 180 \text{ degrees.}$$

Thus care is taken of all interaction, except that between the two center loops, one mounted above the other. The coupling between these two loops is serious because the visual signal will get into the radio-frequency relay in the aural circuit; furthermore, the aural sidebands would feed back into the mechanical modulator. Thus, a great deal of undesirable interaction

to be described later, voice is added to the total radiated spectrum.

It is evident if a separate carrier were used for the aural portion of the radio range, and the radiation directed by means of the radio-frequency relay first to the east, then to the west, the total carrier available at the receiver would fluctuate, and hence the automatic volume control of the receiver would be affected. This

between the aural and visual systems would result.

These difficulties are overcome by means of a properly designed tie line such as the one shown in Fig. 11. The installed tie line is shown in Fig. 12. The general function of the line is to borrow power from the source, and control it in phase and amplitude so as to neutralize the unwanted voltage at a specific point.

The design considerations will be clear from the following: assume the directly fed current in the visual center loop  $V_2$  (Fig. 11) is represented by  $I_1$  and the induced current in the center aural loop  $A_2$  is  $I_1'$ . If, now, a short circuit is applied along the feeder to the lower loop, it is evident that  $I_1'$  can be controlled in amplitude and to a certain extent in phase. In fact  $I_1'$  can be made negligibly small by placing the short circuit at the correct location  $P'$ . In practice, instead of an actual short circuit, a virtual short circuit is produced by means of the tie line. As a result, the top center loop is made substantially independent of the lower center loop. Conversely, point  $P$  can be located on the visual center-loop feeder in a manner such as to neutralize all the current induced in the top loop by the lower loop. The tie line, to be effective, requires a minimum of two controls: one for change of phase and another for amplitude. For phase control, some resistance is necessary in the circuit. Optimum design dictates very low power dissipation; but with negligible power loss, tuning of the line becomes critical. A power dissipation of approximately 10 per cent in the resistance load  $T$  (Fig. 11) results in adjustments that are readily made and stay put indefinitely.

Method I had the following disadvantages which resulted in its replacement by method II: (1) the tie line employed for the prevention of interaction between the center loops did not lend itself to adjustment by a maintenance man; and (2) the lower height of the outside aural loops above the metallic counterpoise gave rise to a radiated vertical component along the visual course. This vertical component occurred due to reradiation from a high current concentration induced in the metallic counterpoise below the center aural loop by the outside aural loops. In such an ultra-high-frequency radio range utilizing horizontal polarization, freedom from any vertical polarization is highly essential if the course is to be independent of the attitude of the airplane. If the course is dependent on the attitude of the airplane, a flight phenomenon known as "pushing" occurs, and the plane will zig-zag about the course in attempting to follow it.

*Method II*

A block schematic of the second method appears in Fig. 13. This differs from the previous method by the addition of voice to the system and the elimination of one center loop antenna and associated tie line.

The use of a bridge permits one antenna to be energized by two different sources without interaction between them. This ability of the bridge is utilized to

excite a single center loop by both the visual and the combined aural and voice channels,<sup>4</sup> as illustrated in Fig. 13. The bridge  $B_1$  also prevents either channel from feeding into the other.

Another bridge  $B_2$  is used to apply voice. The voice facilities consist of an additional sideband generator and modulator. A phaser is provided at the output of each sideband generator to place the sidebands in the proper phase relation with the carrier at the output of bridge  $B_1$  feeding the center antenna.

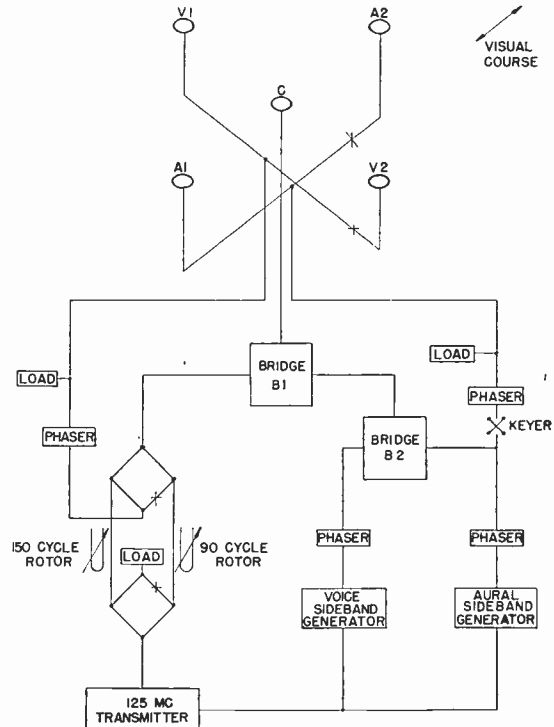

Fig. 13—Method II, schematic visual, voice, and aural system.  
 $A_1, A_2, C$  = aural loops  
 $V_1, V_2, C$  = visual loops  
 $C$  = voice loop

The voice sidebands do not feed into the aural outside antenna, due to the action of the bridge  $B_2$ . Likewise, the aural sidebands cannot reach the output of the voice generator.

Initially, the voice sideband generator was modulated by a 20-kilocycle subcarrier. This 20-kilocycle subcarrier was modulated with voice. The voice facilities were later provided with a switching arrangement to permit an instantaneous change from voice on the subcarrier to voice directly on the main carrier. This permitted a close comparison during actual flight tests. With voice directly on the main carrier, a 1020-cycle rejection and a high-pass filter were provided in the voice channel to prevent any disturbance in the visual and aural courses with voice modulation. Flight checks showed equivalent results between the two methods of voice modulation.

The loads on the outside antenna feed lines shown in Fig. 13 are used to dissipate an amount of sideband

<sup>4</sup> The use of the transmission-line bridge in this manner was first suggested by W. E. Jackson, chief of the Radio Development Section of the Civil Aeronautics Administration.



energy necessary to give the proper power ratio in the outside loops to the center loop.

Method II had one inherent disadvantage. Half of the total carrier power was dissipated in the load terminating the bridge  $B_1$ . As a consequence, method II was replaced by method III.

### Method III

The final system used utilizes an adaptation of the mechanical-modulator bridge arrangement to the aural and voice channels. The sideband generators used in the previous method have been replaced by two 35-watt radio-frequency amplifiers (No. 1 and No. 2), shown in Fig. 14. Amplifier No. 1 is modulated with voice plus

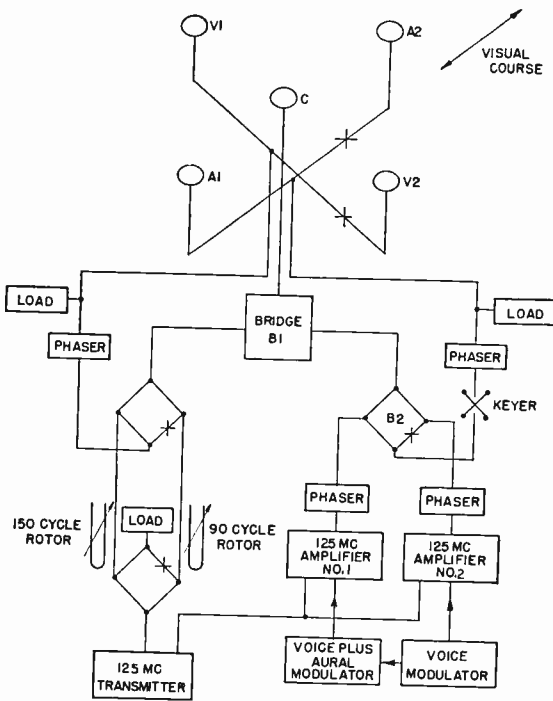

Fig. 14—Method III, schematic visual, aural, and voice system.

$V_1, V_2, C$  = visual loops  
 $A_1, A_2, C$  = aural loops  
 $C$  = voice loop

1020 cycles, while amplifier No. 2 is modulated with voice only. The percentage of voice modulation on the equal carrier outputs of each radio-frequency amplifier is the same. As a result, the voice sidebands and carriers cancel out at the terminals of bridge  $B_2$  feeding the outside aural antennas. The 1020-cycle sidebands of amplifier No. 1 divide equally between the center- and aural-antenna feed lines.

Since no crossover exists in the arms terminating in the upper junction of bridge  $B_2$ , the carriers and voice sidebands of both amplifiers add. The carrier power dissipation at bridge  $B_1$  is now a small fraction of that dissipated in Method II. The sideband generators, which require careful adjustment, have been replaced by straightforward radio-frequency amplifiers.

The percentage modulation of each channel on the carrier is approximately 50 per cent for the visual, 35 per

cent for the voice, and 15 per cent for the aural sidebands. These values were found optimum by actual flight tests.

### 125.020-MEGACYCLE MARKER

A problem which presented itself, when flight checks were begun on this radio range, was irregularity of pointer indication when the plane flew at high vertical angles with respect to the transmitting equipment. This was due to lack of directly radiated signals, since the loop antennas have substantially zero radiation vertically. The receiver in the plane, because of its automatic-volume-control characteristic, became very sensitive and picked up whatever stray signal existed and hence gave irregular pointer indication.

Several possible solutions were discussed with the Civil Aeronautics Administration personnel, and as a result, a special marker was used to overcome this difficulty. Fig. 15 shows the marker array which is fed from

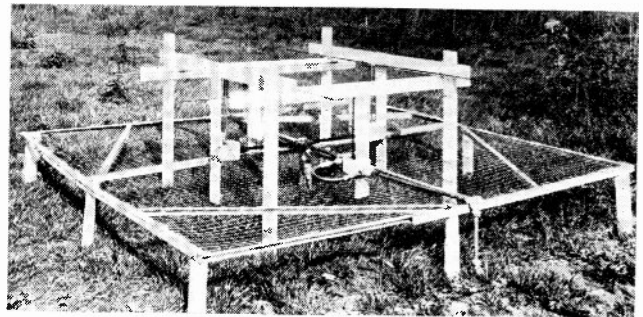

Fig. 15—125.020-megacycle marker antenna array.

an auxiliary 30-watt transmitter removed in frequency from the main transmitter by approximately 20 kilocycles. This signal has no modulation and serves merely to radiate carrier straight up in order to steady the cross-pointer indicator and silence the receiver in the airplane at high vertical angles over the radio-range station.

### EQUIPMENT

The receiver, designed for this radio range, is a Western Electric type RUM crystal-controlled 125-megacycle superheterodyne with an intermediate frequency of 10 megacycles. A high-pass filter, above 150 cycles with 1020-cycle rejection, in conjunction with a 90- and 150-cycle pass filter and a 1020-cycle pass filter, were inserted in the audio channel to separate the aural and voice signals from the 90- and 150-cycle visual signals. A more recent receiver, the Western Electric type 32A, has also been used in flight checks with very satisfactory results. The course indication is provided by a Weston cross-pointer instrument, the vertical pointer of which is utilized as illustrated in Fig. 2. The cross-pointer instrument is used in conjunction with 90- and 150-cycle pass filters in parallel. The outputs of the filters are rectified to actuate the meter. With a predominance of 90-cycle modulation, the vertical pointer deflects to the right of its "on course" or center position, while a predominance

of 150-cycle modulation swings the pointer to the left. The receiving loop antenna on the airplane is similar to the type used for instrument landing.<sup>5</sup>

Figs. 16, 17, 18, 19, and 20 show views of the complete radio range, the transmitting equipment, antennas, and the airplane equipment comprised in the radio range.



Fig. 16—Two-course radio range with sector identification and simultaneous voice, showing transmitter house, counterpoise structure, antenna house, and 125.020-megacycle marker.

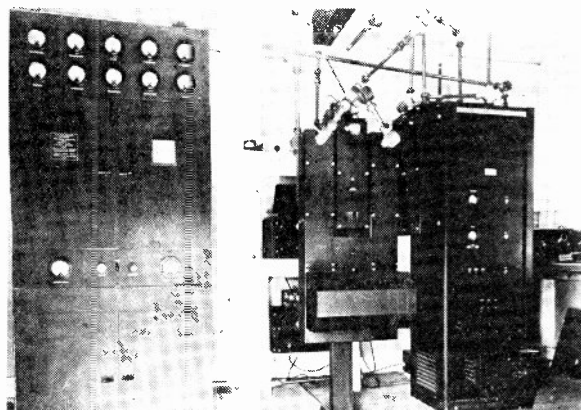

Fig. 17—Transmitting equipment, showing left to right, 125-megacycle, 300-watt transmitter, mechanical modulator, and sideband generator. Auxiliary marker transmitter is in the background.

ACKNOWLEDGMENT

The help and co-operation of the Radio Development Section of the Civil Aeronautics Administration and particularly the personnel of the Civil Aeronautics Ad-

<sup>5</sup> P. C. Sandretto, "Principles of Aeronautical Radio Engineering," McGraw-Hill Book Company, Inc., New York, N. Y., 1942, chapter III, pp. 100-165.

ministration Experimental Station of Indianapolis, Indiana, is gratefully acknowledged.

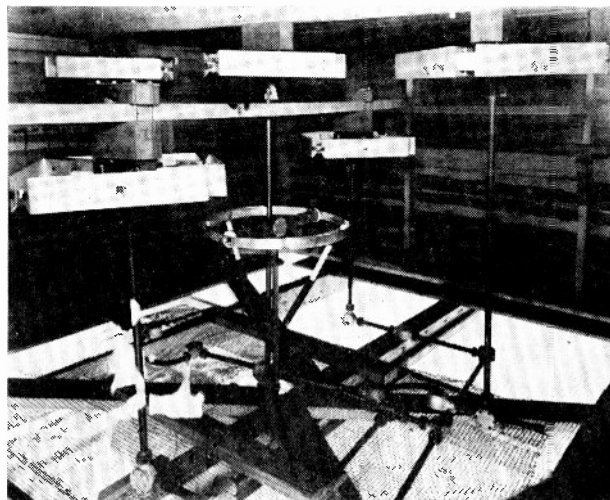

Fig. 18—Visual and aural loop antennas mounted above metal counterpoise.

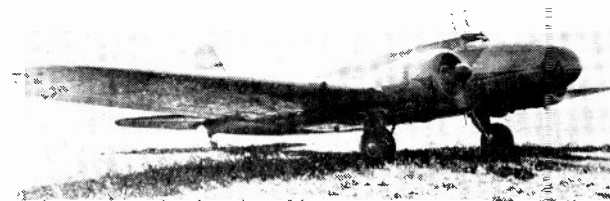

Fig. 19—Civil Aeronautics Administration Boeing used in flight checks, showing receiving loop antenna.

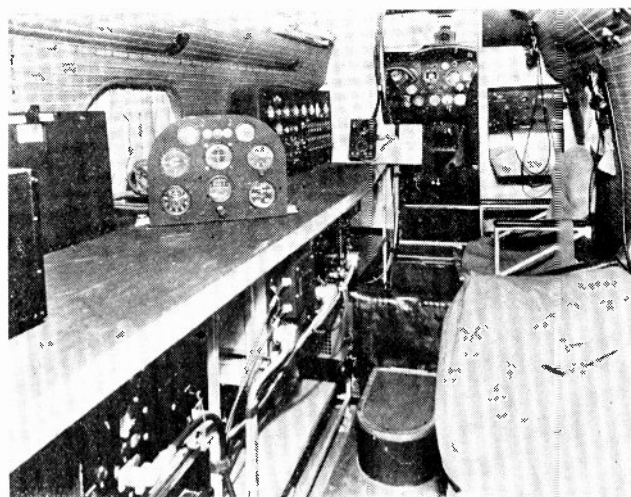

Fig. 20—Cabin view of Civil Aeronautics Administration Boeing ready for demonstration flights.

# A Simple Optical Method for the Synthesis and Evaluation of Television Images\*

ROBERT E. GRAHAM†, MEMBER, I.R.E. AND F. W. REYNOLDS†

**Summary**—A combination of a 35-millimeter motion-picture projector and a line screen enables the projection of still or motion pictures closely similar in appearance to those produced by television. This similarity of appearance is checked theoretically by an analysis of the type previously reported by Mertz and Gray in a discussion of the theory of scanning. From the analysis it is shown that five parameters of the optical-simulation system may be varied to obtain the equivalent of variations in television factors such as number of scanning lines, size and configuration of scanning apertures, and width of frequency band.

Photographs of simulated television pictures projected by this method are presented. These pictures include subject matter of general interest as well as selected subjects to illustrate the spurious detail components introduced by the television scanning process. These components produce moiré patterns, "steps" on diagonal lines, and impairment of vertical resolution. Simulation pictures projected by this method have been compared with those produced by a television system and the expected agreement observed.

Calculations are given of the diffraction effects in optical systems of this type and it is shown that the departure from geometrical theory is small in the arrangements described.

## I. INTRODUCTION

IMAGE transmission systems are often compared in terms of frequency bandwidth, number of scanning lines, and picture repetition rate. Specification of these factors sets a theoretical upper limit for the system performance. However, a number of other variables exist which may greatly influence the image quality. Among these are picture brightness, over-all tone reproduction, and the admittance characteristics of the scanning apertures. It is possible to measure these quantities, but difficult to obtain a quantitative estimate of their effects upon subjective image quality. It is therefore desirable to make subjective studies of such factors, employing real or simulated television systems.

Optical-simulation methods have been found useful in conducting these studies and in providing reproducible standards of image quality. Several methods have been suggested and used for these purposes. Engstrom<sup>1</sup> has described a method of optical simulation which uses crossed pieces of lenticular film for subdividing an image into elemental areas or picture elements. Goldmark and Dyer<sup>2</sup> have described a mechanical scanning arrangement which produces television-simulation photographs.

Baldwin<sup>3</sup> has used a motion-picture projector for simulating television images for direct viewing, the area of confusion being determined by the amount of defocusing and an adjustable aperture at the projection lens.

The method of simulation described in this paper employs an out-of-focus optical system in combination with a suitable line screen. Use of the latter enables an accurate reproduction of the spurious components which result from the strip-scanning process employed in television. It is well known that these components cause a definite loss in vertical resolution as well as occasional annoying patterns which are superposed upon the normal image. They appear as a step-like structure at oblique edges of object detail, and as moiré patterns when an array of object lines forms a small angle with the scanning direction. In previous simulation work<sup>3</sup> the effects of the spurious components upon picture sharpness have been evaluated and allowed for on the basis of subjective comparisons between out-of-focus simulation images and television images of known characteristics.

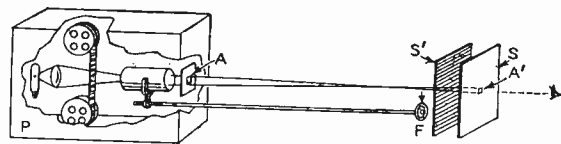

Fig. 1—Optical-simulation apparatus.

The theory underlying the line-screen method of simulation is developed at some length in this paper, and it is shown that the method is capable of accurately simulating the television process. Several examples of simulation are shown and discussed, including subject matter particularly selected to exhibit pronounced spurious patterns.

## II. DESCRIPTION OF APPARATUS

A pictorial sketch of the equipment used in the simulating process is shown in Fig. 1. A 35-millimeter motion-picture projector  $P$  projects images from ordinary film on the ground-glass screen  $S$ . A line screen  $S'$  consisting of a parallel array of alternate lines and spaces is interposed between the projector and the screen  $S$ . The projected image is focused a given distance on the near side of  $S'$  by means of the focusing control  $F$ , which

<sup>3</sup> M. W. Baldwin, Jr., "The subjective sharpness of simulated television images," *Bell. Sys. Tech. Jour.*, vol. 19, pp. 563-587; October, 1940.

\* Decimal classification: R583. Original manuscript received by the Institute, June 18, 1945. Presented, Sixteenth Annual Convention, New York, N. Y., January 11, 1941.

† Bell Telephone Laboratories, New York, N. Y.

<sup>1</sup> E. W. Engstrom, "A study of television image characteristics," *Proc. I.R.E.*, vol. 21, pp. 1631-1652; December, 1933.

<sup>2</sup> P. C. Goldmark and J. N. Dyer, "Quality in television pictures," *Jour. Soc. Mot. Pic. Eng.*, vol. 35, pp. 234-253; September, 1940.

controls the position of the projector lens. This results in an out-of-focus image on  $S$ , each subject point giving rise to a uniform<sup>4</sup> area of light  $A'$ , which is a shape replica of the projector aperture  $A$ .

The control elements of the apparatus are: (1) the degree of out-of-focus of the projected image; (2) the number of lines in the screen  $S'$ ; (3) the configuration of the aperture  $A$ ; (4) the positioning of the line screen between the projector and  $S$ ; and (5) the nature of the opacity variation found by traversing the alternate lines and spaces of  $S'$ . These factors collectively determine the simulated television picture.

Briefly, the significance of these five factors is as follows: (1) determines the general resolution level of the picture; (2) fixes the number of scanning lines in the equivalent television system; (3) determines the configuration of the television scanning apertures; (4) provides an adjustment for controlling the nature of the spurious components; and (5) determines the amplitude of the spurious components.

The pictures appearing in this paper were, except as noted, taken under the following conditions. The projector lens had a focal length of 6 inches and was used with a square aperture approximately 0.7 inch on a side. The projected image was 8 by 10 inches and was formed at an image distance of about 6 feet. The line screen contained approximately 400 black lines across the 8-inch dimension.

In projecting still pictures with the apparatus, it was found desirable to insert a water cell between the film gate and the light source to avoid excessive heating of the film. Also, film buckling was minimized by mounting the film between glass slide covers. In order to obtain a uniform light distribution across the projector aperture  $A$ , a ground-glass diffusing screen was inserted behind the film gate. For direct comparison of the simulation pictures with actual television pictures, a color match was desirable. This was attained by placing appropriate color filters behind the film gate.

### III. THEORY OF OPTICAL SIMULATION

The manner in which the optical system of Fig. 1 makes possible an accurate television simulation may be brought out by developing a mathematical expression for the transformation of the initial picture field into the final image field as seen at  $S$ . This expression will be compared with a like expression for the transformation of the subject picture produced by television systems. The similarity of result obtained in the two cases will be used to support the validity of the simulation method.

A diagrammatic sketch of the optical system is shown in Fig. 2. On the basis of geometrical theory, the light from the point of the film plane on the optical axis passes through the lens, is restricted to a ray bundle bounded

<sup>4</sup> Actually the light distribution in  $A'$  is uniform only in the absence of the line screen  $S'$ .

by the aperture  $A$ , converges to a point on the axis at the sharp-focus plane  $S''$ , and then diverges to a light spot  $A'$  on the screen  $S$ . The "confusion area"  $A'$  has the same boundary shape as the aperture  $A$ , but does not contain a uniform distribution of light because of the striation introduced by the line screen  $S'$ . Similarly off-axis points in the film plane are refocused in the plane  $S''$  and give rise to confusion areas at  $S$  similar in shape to the aperture  $A$ .

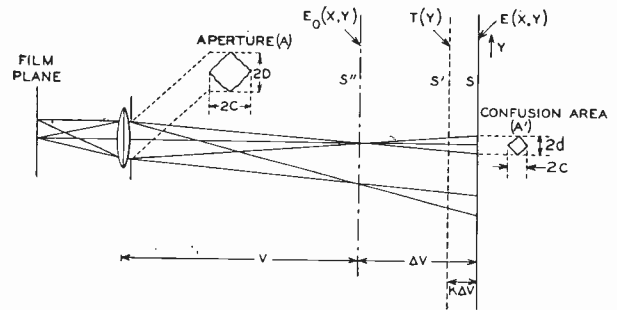

Fig. 2—Diagrammatic arrangement of optical-simulation system.

Setting up a system of axes with the  $y$  axis vertical, the  $x$  axis perpendicular to the plane of the drawing, and the origin on the optical axis; the intensity of illumination falling on the  $S''$  plane may be written as  $E_0(x, y)$ . This function represents the effective brightness distribution in the subject picture, and thus may be treated as the source picture field. The illumination intensity at  $S$  may be written as  $E(x, y)$ , this function representing the simulation picture field. Since the lines of the screen  $S'$  are oriented parallel to the  $x$  axis and are presumed to be uniform in opacity, the optical transmission of the screen may be written as a function of  $y$  alone,  $T(y)$ .

For a convenient though unnecessary approximation, it will be assumed that the increase in image magnification in going from  $S''$  to  $S$  may be neglected. This approximation is valid as long as

$$\frac{\Delta v}{v} \ll 1,$$

a condition which will be fulfilled readily in the usual case.

#### Out-of-Focus Transformation Without Line Screen

Before evaluating  $E(x, y)$  in terms of  $E_0(x, y)$  for the actual system, the simple out-of-focus transformation omitting the screen  $S'$  will be treated.

Referring to Fig. 3, any point  $x, y$  in the sharp-focus plane  $S''$  gives rise to a uniformly illuminated confusion area,  $A'$  on  $S$ . The boundary of the divergent cone of light from  $x, y$  is indicated by the solid lines. If the boundary of  $A'$  is symmetrical about an origin taken at  $x, y$  then it may be seen that the point  $x, y$  on  $S$  receives light from that portion of  $S''$  which is identical



in shape, size, and orientation with  $A'$ . The envelope cone of the rays from  $S''$  reaching  $x, y$  of  $S$  is indicated by the dotted lines.

Thus a measure of the resultant illumination intensity at a point  $x, y$  of  $S$  may be determined by summing up the contributions from  $S''$  over a region  $A'$  of  $S''$  centered at  $x, y$ . Since the contributions of points on  $S''$  are weighted according to the function  $E_0(x, y)$ , the illumination  $E(x, y)$  falling on  $S$  may be expressed as follows (neglecting constant factors):

$$E(x, y) = \iint_{A'} E_0(x + \xi, y + \eta) d\xi d\eta, \quad (1)$$

where  $\xi$  and  $\eta$  are integration variables measured on an auxiliary set of axes centered<sup>5</sup> at  $x, y$ .

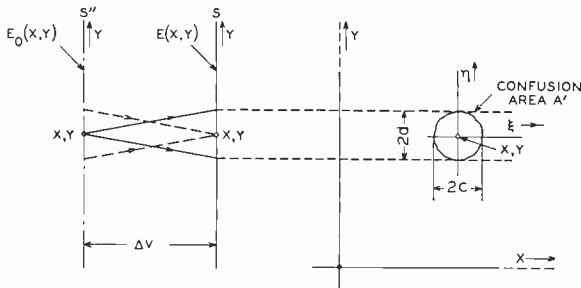

Fig. 3—Analysis of out-of-focus image transformation, without line screen.

In order to interpret (1), it is necessary to adopt some functional representation for  $E_0(x, y)$ . The form chosen here is the two-dimensional Fourier series used by Mertz and Gray.<sup>6</sup> The light distribution in the plane  $S''$  is set up as an image field as indicated in Fig. 4. The origin of axes is taken at the center of the field as previously described, and the field height and width are  $2b$  and  $2a$  respectively. Then the intensity of illumination,  $E_0(x, y)$ , may be represented at any point of the field  $S''$  by the expression

$$E_0(x, y) = \sum_{m=0}^{\infty} \sum_{n=-\infty}^{\infty} a_{mn} \cos \left[ \pi \left( \frac{mx}{a} + \frac{ny}{b} \right) + \phi_{mn} \right], \quad (2)$$

where any component  $m, n$  of the summation represents a sinusoidal variation of illumination intensity extending across the image field. The wavelength of the intensity variation is given by

$$\lambda_{mn} = \frac{1}{\sqrt{\frac{m^2}{4a^2} + \frac{n^2}{4b^2}}},$$

while the orientation of the wave front is given by

<sup>5</sup> If a variable-density film is used as the projector aperture  $A$ , rather than a shaped hole, then an aperture transmission factor  $T(\xi, \eta)$  must be introduced in the integrand of (1).

<sup>6</sup> P. Mertz and F. Gray, "A theory of scanning and its relation to the characteristics of the transmitted signal in telephotography and television," *Bell. Sys. Tech. Jour.*, vol. 13, pp. 464-515; July, 1934.

$$\tan \theta = \frac{-mb}{na},$$

$\theta$  being the angle formed with the  $x$  axis.

For mathematical simplicity, (2) may be written in exponential form as follows:

$$E_0(x, y) = \sum_{m=-\infty}^{\infty} \sum_{n=-\infty}^{\infty} A_{mn} e^{i\pi(m x/a + n y/b)}, \quad (3)$$

where

$$A_{mn} = \frac{a_{mn}}{2} e^{i\phi_{mn}}$$

and

$$A_{-m, -n} = \frac{a_{mn}}{2} e^{-i\phi_{mn}}.$$

Substituting (3) in (1), there results

$$E(x, y) = \sum_{m=-\infty}^{\infty} \sum_{n=-\infty}^{\infty} Y(m, n) A_{mn} e^{i\pi(m x/a + n y/b)}, \quad (4)$$

where

$$Y(m, n) = \iint_{A'} e^{i\pi(m \xi/a + n \eta/b)} d\xi d\eta. \quad (5)$$

Thus the result of the simple out-of-focus transformation in the absence of the line screen is to multiply each component  $m, n$  by an amplitude or "admittance" factor

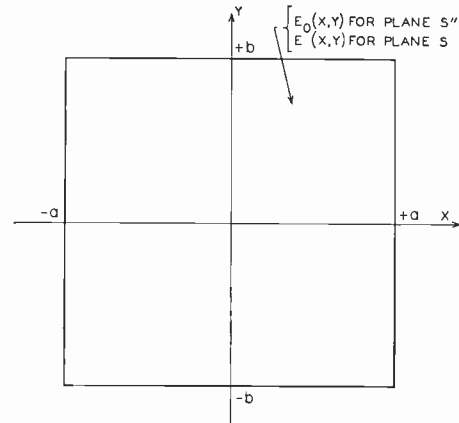

Fig. 4—Image field.

$Y(m, n)$ . In general this admittance factor as given by (5) has a decreasing amplitude with decreasing component wavelength, thereby acting as a kind of low-pass filter. For example, if  $A'$  is taken to be a rectangle of height  $2d$  and width  $2c$ , then (5) readily yields, neglecting constant factors,

$$Y(m, n) = \left( \frac{\sin \frac{\pi mc}{a}}{\frac{\pi mc}{a}} \right) \left( \frac{\sin \frac{\pi nd}{b}}{\frac{\pi nd}{b}} \right). \quad (6)$$

A plot of (6) for  $m=0$ , and  $b/d=0.707N$  is given by curve A of Fig. 6. Only positive values of  $n$  are plotted, since  $Y(0, n) = Y(0, -n)$ .

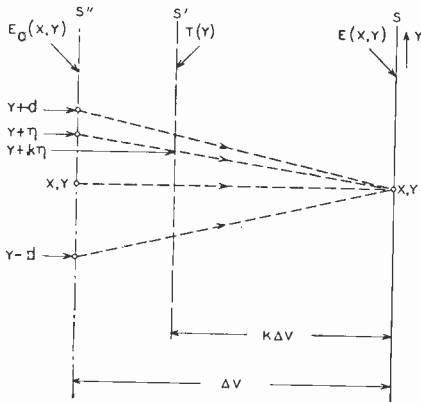

Fig. 5—Comparison of television and simulation systems.

*Out-Of-Focus Transformation With Line Screen*

Returning to the complete system, Fig. 2, including the line screen  $S'$ , the manner in which points on  $S''$  contribute to the illumination at the point  $x, y$  of  $S$  is indicated in Fig. 5. As before, the envelope of the cone of rays from  $S''$  reaching  $x, y$  of  $S$  is indicated by the dotted lines drawn from the points marked  $y+d$  and  $y-d$ , respectively. Letting  $y+\eta$  represent the ordinate

$$E(x, y) = \int_{A'} E_0(x + \xi, y + \eta) T(y + k\eta) d\xi d\eta, \quad (7)$$

where  $T(y)$  is the transmission of the screen  $S'$ . If the height of the image field  $2b$  is taken to contain exactly  $N$  black lines of the screen  $S'$ ,  $N$  being an integer; then the transmission characteristic  $T(y)$  may be written as a single dimensional Fourier series of the form

$$T(y) = \sum_{\mu=-\infty}^{\infty} T_{\mu} e^{i\pi\mu Ny/b}. \quad (8)$$

For simplicity the screen  $S'$  will be positioned symmetrically with respect to the  $x$  axis. Then the coefficients  $T_{\mu}$  will be pure real quantities and

$$T_{\mu} = T_{-\mu}.$$

Substituting (3) and (8) into (7), there results

$$E(x, y) = \sum_{m=-\infty}^{\infty} \sum_{n=-\infty}^{\infty} \sum_{\mu=-\infty}^{\infty} Y(m, n + k\mu N) \cdot T_{\mu} A_{m n} e^{i\pi(m x/a + (n + \mu N) y/b)} \quad (9)$$

where  $Y(m, n + k\mu N)$  is an admittance factor whose form is obtained by substituting  $(n + k\mu N)$  for  $n$  in (5).

Equation (9) may be rewritten as follows, neglecting a constant factor:

$$E(x, y) = \sum_{m=-\infty}^{\infty} \sum_{n=-\infty}^{\infty} Y(m, n) A_{m n} e^{i\pi(m x/a + n y/b)} + \sum_{m=-\infty}^{\infty} \sum_{n=-\infty}^{\infty} \sum_{\mu=-\infty}^{\infty} Y(m, n + k\mu N) \cdot \left(\frac{T_{\mu}}{T_0}\right) A_{m n} e^{i\pi(m x/a + (n + \mu N) y/b)}, \mu \neq 0, \quad (10)$$

where  $T_0$  is the value of  $T_{\mu}$  for  $\mu=0$ .

The first term in the right member of (10) is identical with the expression given by (4) for the out-of-focus transformation in the absence of the line screen. This term may be called the "normal detail" field, since it contains only components which were present in the original subject matter, attenuated by the admittance factor  $Y(m, n)$ .

The second term of (10), contributed by the line screen, evidently may be classified as a "spurious detail" field, since the indexes of the components do not correspond to those of the original image.<sup>7</sup>

The significance of (10) may be brought out more clearly by the fact that a component  $m, n$  of the original image field, having an amplitude  $A_{m n}$ , gives rise in the simulation image, not only to an identical component  $m, n$ , having an amplitude  $Y(m, n)A_{m n}$ ; but also to a

<sup>7</sup> However, it is possible for certain components of the spurious field to coincide in wavelength and orientation with normal-detail components.

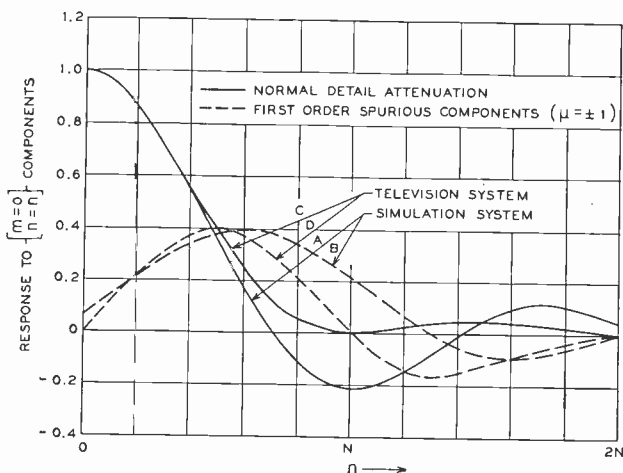

Fig. 6—Analysis of out-of-focus image transformation, with line screen.

of any point of  $S''$  within this cone, it may be seen that the contribution of the point  $x + \xi, y + \eta$  to the illumination intensity at  $x, y$  of  $S$  depends not only upon  $E_0(x, y)$  as before, but also upon the transmission of the screen  $S'$  at the point where the ray from  $x + \xi, y + \eta$  intersects it. The ordinate of this point of intersection is seen to be  $y + k\eta$ , where  $k$  is the ratio of the  $S'S$  spacing to the  $S''S$  spacing. Therefore, summing contributions over the region  $A'$ ,

set of spurious components  $m, n + \mu N$ , having amplitudes  $Y(m, n + k\mu N)$  ( $T_\mu/T_0$ )  $A_{mn}$ . Here  $\mu$  is any positive or negative integer. If the series of  $T(y)$  is rapidly convergent, as it will be if the lines and spaces of the screen are roughly equal in width, and if the transition from "line" to "space" is gradual rather than sharp,<sup>8</sup> then

$$\frac{T_\mu}{T_0} \ll 1, \quad \text{for } |\mu| > 1.$$

Under these conditions, the higher order components may be neglected, and the spurious components derived from a subject component  $m, n$  may be written as  $m, n \pm N$ , having amplitudes  $Y(m, n \pm kN)$  ( $T_1/T_0$ )  $A_{mn}$ . These expressions will be found to be similar to those of the television system.

#### IV. TELEVISION-IMAGE ANALYSIS

A two-dimensional Fourier analysis of the picture degradation imposed by television systems has been widely published.<sup>6</sup> The results of this analysis may be summarized as follows.

Assuming negligible frequency-channel limitation, the television image may be expressed by

$$E(x, y) = \sum_{m=-\infty}^{\infty} \sum_{n=-\infty}^{\infty} \sum_{\mu=-\infty}^{\infty} Y_1(m, n) Y_2(m - \mu, n + \mu N) \cdot A_{mn} e^{i\pi(m-\mu)x/a + (n+\mu N)y/b} \quad (11)$$

where  $Y_1$  and  $Y_2$  are the admittance characteristics corresponding to the transmitting and the receiving scanning apertures (or beams) respectively, and  $N$  is the number of scanning lines. If the optical confusion area  $A'$  of (5) is replaced by the aperture area of the transmitter or receiver, then  $Y_1(m, n)$  or  $Y_2(m, n)$  may be found<sup>9</sup> from (5).

As in the case of (9), (11) may be written as the sum of a normal and a spurious field. Thus,

$$E(x, y) = \sum_{m=-\infty}^{\infty} \sum_{n=-\infty}^{\infty} Y_1(m, n) Y_2(m, n) A_{mn} e^{i\pi(mx/a + ny/b)} + \sum_{m=-\infty}^{\infty} \sum_{n=-\infty}^{\infty} \sum_{\mu=-\infty}^{\infty} Y_1(m, n) Y_2(m - \mu, n + \mu N) \cdot A_{mn} e^{i\pi(m-\mu)x/a + (n+\mu N)y/b}, \quad \mu \neq 0. \quad (12)$$

The first term of (12) is the normal field, being the same as the normal field of (10) if  $Y(m, n)$  is replaced by  $Y_1(m, n)$ ,  $Y_2(m, n)$ . The second term of (12) is the spurious field, there appearing to be somewhat more differ-

ence between this term and the spurious field of (10) than was found between the two normal fields. However, the difference is not important, as will be seen.

#### V. COMPARISON BETWEEN SIMULATION AND TELEVISION FORMULAS

##### Normal-Field Comparison

Returning to the consideration of the normal fields, definite constants for the television and simulation systems will be chosen to achieve concreteness.

The television apertures will be taken as identical squares of side equal to the scanning-line pitch. The optical area of confusion  $A'$  will be taken as a square of side  $k_1$  times that of either television aperture. Also the number of black lines in the line screen will be taken equal to the number of television scanning lines.

Under these conditions we may write, from (6), the normal-field admittance factor for the television system as<sup>10</sup>

$$Y_1(m, n) Y_2(m, n) = Y_1^2(m, n) = \left[ \frac{\sin \frac{\pi m}{N}}{\frac{\pi m}{N}} \right]^2 \left[ \frac{\sin \frac{\pi n}{N}}{\frac{\pi n}{N}} \right]^2 = Y_1^2(m, 0) \cdot Y_1^2(0, n), \quad (13)$$

and the corresponding quantity for the simulation system as,

$$Y(m, n) = Y_1(k_1 m, k_1 n) = \left[ \frac{\sin \frac{\pi k_1 m}{N}}{\frac{\pi k_1 m}{N}} \right] \left[ \frac{\sin \frac{\pi k_1 n}{N}}{\frac{\pi k_1 n}{N}} \right] = Y_1(k_1 m, 0) Y_1(0, k_1 n). \quad (14)$$

Expanding  $Y_1^2(m, 0)$  in a Taylor's series,

$$Y_1^2(m, 0) = 1 - \frac{1}{3} \left( \frac{\pi m}{N} \right)^2 + \frac{2}{45} \left( \frac{\pi m}{N} \right)^4 - \dots \quad (15)$$

Similarly,

$$Y_1(k_1 m, 0) = 1 - \frac{k_1^2}{6} \left( \frac{\pi m}{N} \right)^2 + \frac{k_1^4}{120} \left( \frac{\pi m}{N} \right)^4 - \dots \quad (16)$$

Equating coefficients of  $(\pi m/N)^2$  in (15) and (16), we find  $k_1 = \sqrt{2}$ .

Substituting this value for  $k_1$  in (16), we have

$$Y_1(k_1 m, 0) = 1 - \frac{1}{3} \left( \frac{\pi m}{N} \right)^2 + \frac{1}{30} \left( \frac{\pi m}{N} \right)^4 - \dots$$

<sup>10</sup> Setting  $a=b$ , which incurs no essential loss of generality.

<sup>8</sup> The line screens used in this work were made by photographic copying of an original ruled screen. The sharpness of line-to-space transition, as well as the relative widths of line and space, may be controlled readily with this method.

<sup>9</sup> This assumes the transmission of the television apertures to be uniform within the aperture boundaries. Otherwise a factor  $T(\xi, \eta)$  must be inserted in the integrand of (5), as was pointed out in footnote reference 5 for the optical system.

which is a close approximation to (15) for the range of  $m$  which is of interest. The quality of the approximation is shown by the degree to which curve  $A$  matches curve  $C$  of Fig. 6. Thus we may write

$$Y_1(k_1 m, 0) \simeq Y_1^2(m, 0), \quad k_1 = \sqrt{2}.$$

Similarly,

$$Y_1(0, k_1 n) \simeq Y_1^2(0, n), \quad k_1 = \sqrt{2}.$$

Therefore, for the constants chosen, we may write

$$Y(m, n) \simeq Y_1(m, n)Y_2(m, n),$$

and the normal field expressions for the simulation system as given by (10), and the television system as given by (12) agree.

### Spurious-Field Comparison

Continuing with the same constants as in the preceding discussion, we proceed to an evaluation of the television-image spurious field as given by the second term of (12). The meaning of this term may be expressed in the fact that an original subject component  $m, n$  of amplitude  $A_{mn}$ , gives rise to spurious components  $m - \mu, n + \mu N$  at amplitudes  $Y_1(m, n)Y_2(m - \mu, n + \mu N)A_{mn}$ ,  $\mu$  being any positive or negative integer. The amplitude expression decreases rapidly with increasing absolute magnitude of  $\mu$ . Thus the consideration of spurious components may be confined to those for which  $|\mu| = 1$ . Accordingly, we may neglect  $\mu$  compared to  $m$  with negligible error.

The resulting spurious-component expression for the television image is  $m, n \pm N$ , at an amplitude of  $Y_1(m, n)Y_2(m, n \pm N)A_{mn}$ . This expression gives the same spurious-component indices as were found for the simulation system, so all that remains is to compare the corresponding amplitude expressions of both systems.

Omitting  $A_{mn}$  as being common to both amplitude expressions, the spurious amplitude factor for the television system with square apertures may be written as

$$Y_1(m, n)Y_2(m, n \pm N) = Y_1^2(m, 0)Y_1(0, n)Y_1(0, n \pm N).$$

The corresponding quantity for the simulation system is

$$Y(m, n \pm kN) \frac{T_1}{T_0} = Y(m, 0)Y(0, n \pm kN) \frac{T_1}{T_0}.$$

It was shown in the previous section that

$$Y(m, 0) = Y_1(k_1 m, 0) \simeq Y_1^2(m, 0), \quad k_1 = \sqrt{2}$$

so that it is sufficient to compare

$$Y_1(0, n)Y_1(0, n \pm N) \quad \text{with} \quad Y(0, n \pm kN) \frac{T_1}{T_0}.$$

There are two elements of control in the latter expression which may be used to obtain agreement of these

expressions. First, variation of the factor  $k$  (which may be remembered as determined by the positioning of the line screen) permits shifting of the expression along the axis of  $n$ . Second, the magnitude of the expression may be controlled by the factor  $T_1/T_0$ , which is determined by the nature of opacity variation across the lines and spaces of the line screen.<sup>11</sup>

Since the two expressions are fairly similar, these two adjustments permit a reasonably good agreement. A comparison is shown in Fig. 6,  $Y_1(0, n)Y_1(0, n - N)$  being given<sup>12</sup> by curve  $D$  and  $Y(0, n - kN) T_1/T_0$  (for the values  $k=0.6$ ,  $T_1/T_0=0.4$ , and  $k_1=\sqrt{2}$ ) by curve  $B$ . The divergence of the two curves for values of  $n$  above  $0.7N$  is not important because of the small amplitudes of  $A_{mn}$  found in this region. The fact that the simulation curve  $B$  does not pass through the origin, for the choice of  $k=0.6$ , means that there will be some structure showing even when the original subject matter is a flat field. However, this effect is small.

Thus we find that there is a substantial agreement between the simulation and the television system, both as to normal and spurious components, for the square apertures assumed. A similar analysis holds for other types of apertures. If the transmitter and receiver apertures are alike in configuration and size, then the optical aperture should preferably be chosen to be of the same configuration,<sup>13</sup> and the focusing adjusted so that the optical confusion area is  $\sqrt{2}$  (in linear dimensions) times that of either television aperture. The number of black lines in the line screen should always be chosen equal to the number of active scanning lines in the television system. Finally, the parameters  $k$  and  $T_1/T_0$  should be chosen to obtain a match between the curves  $B$  and  $D$  of Fig. 6; that is, between the spurious-component amplitude factors of the optical and television systems for original subject components lying parallel to the scanning lines ( $m=0$ ).

### Frequency-Channel Limitation

The foregoing has neglected the effect of a finite frequency bandwidth in the television transmission channel. That an aperture characteristic may be used to simulate an electrical low-pass filter is well known, although the simulation has its limitations where the effect of a sharp cutoff is desired. Following the usual practice in this matter, it will be assumed that the actual electrical-filter characteristic may be replaced by an equivalent one having a gradual cutoff, which in turn may be simulated by an aperture characteristic. Then,

<sup>11</sup> A convenient method of controlling the  $T_1/T_0$  ratio is to adjust, via photographic processing, the ratio of optical transmission of the "lines" and "spaces."

<sup>12</sup> Because of symmetry, only one sign of the  $\pm$  need be considered.

<sup>13</sup> The more important consideration is that the optical aperture should have the same admittance in any direction as the television apertures. For instance, the effect of a scanning beam having non-uniform transmission over its area may be closely simulated by the shaped-hole type of aperture.



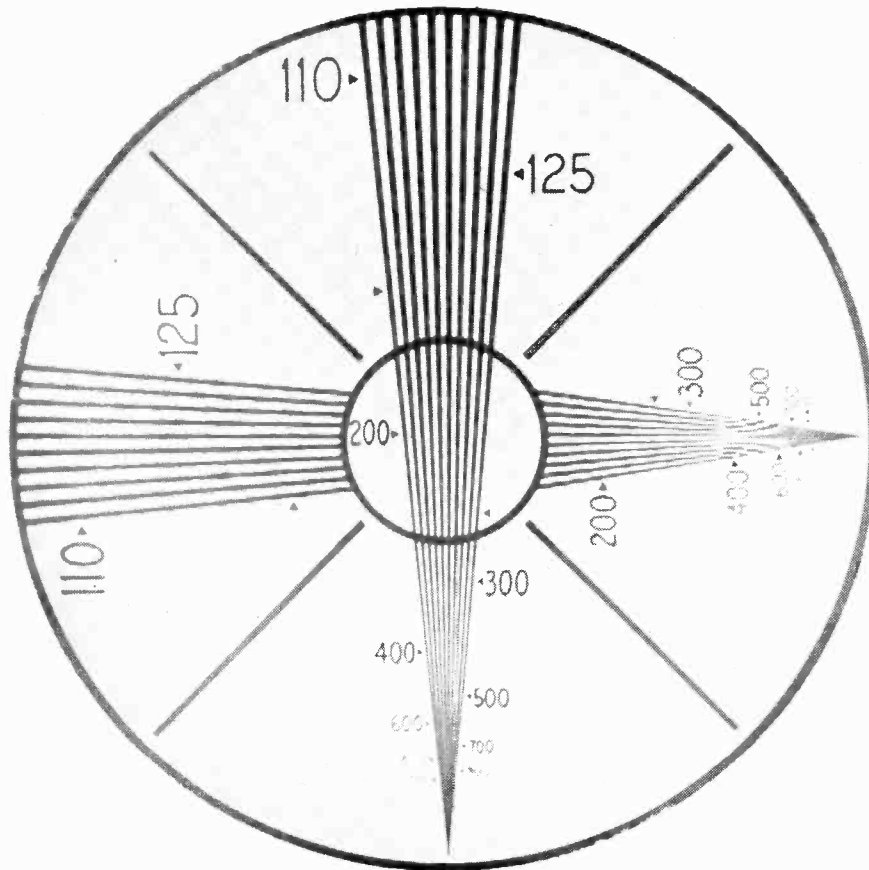

Fig. 7—Resolution diagram, with spurious structure.

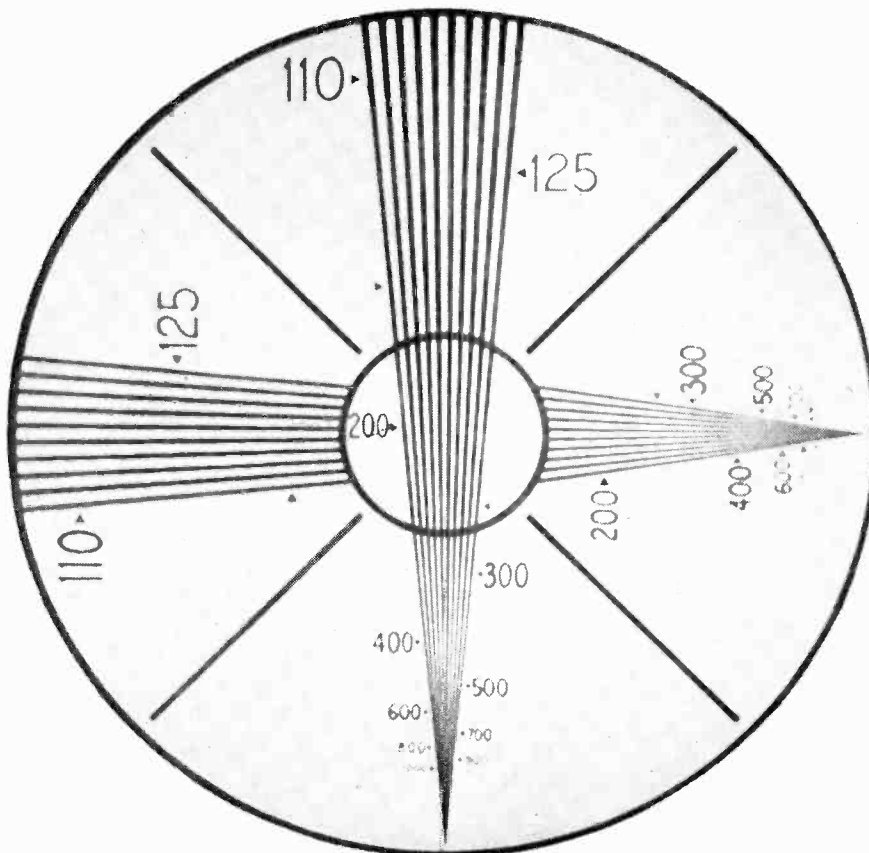

Fig. 8—Resolution diagram, without spurious structure.

since the principal effect of electrical frequency attenuation is upon the components of the image perpendicular to the scanning, the frequency limitation may be taken into account by increasing the horizontal dimension (scanning assumed horizontal) of the confusion area of the simulation system over the value arrived at from previous considerations.

This is exemplified in the square-aperture television system by the following procedure. The effect of the

$$2c'' = \sqrt{(2c)^2 + (2c)^2 + (2c')^2}.$$

## VI. DISCUSSION AND RESULTS

Photographs of simulated television pictures obtained with the apparatus of Fig. 1 are shown in Figs. 7, 9, 11, 13, and 14. In each of these pictures the scanning apertures of the equivalent television system have been taken to be squares of side equal to the scanning-line pitch. No allowance for electrical filtering has been

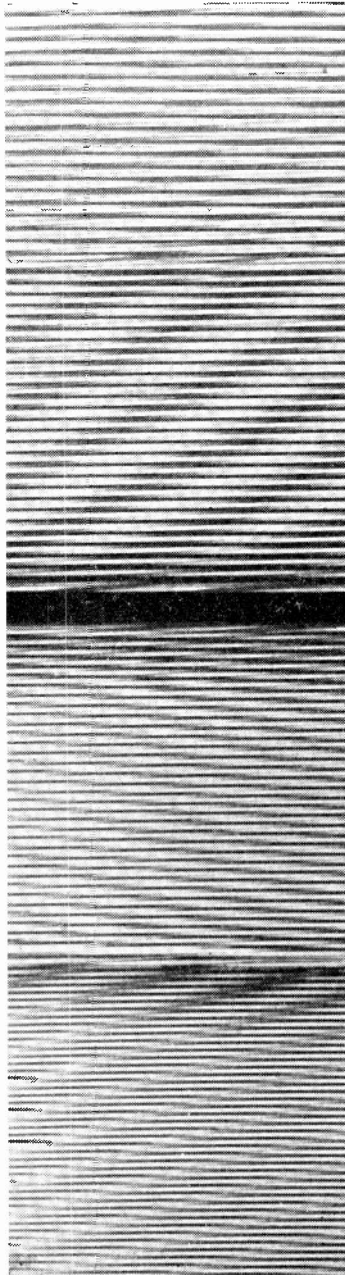

Fig. 9—Parallel lines, with spurious structure.

filter cutoff in the direction of scanning is evaluated as that due to a rectangular aperture of length (in scanning direction)  $2c'$ . Then if  $2c$  is the length of the transmitter and receiver apertures, the required horizontal dimension of the optical simulation aperture is

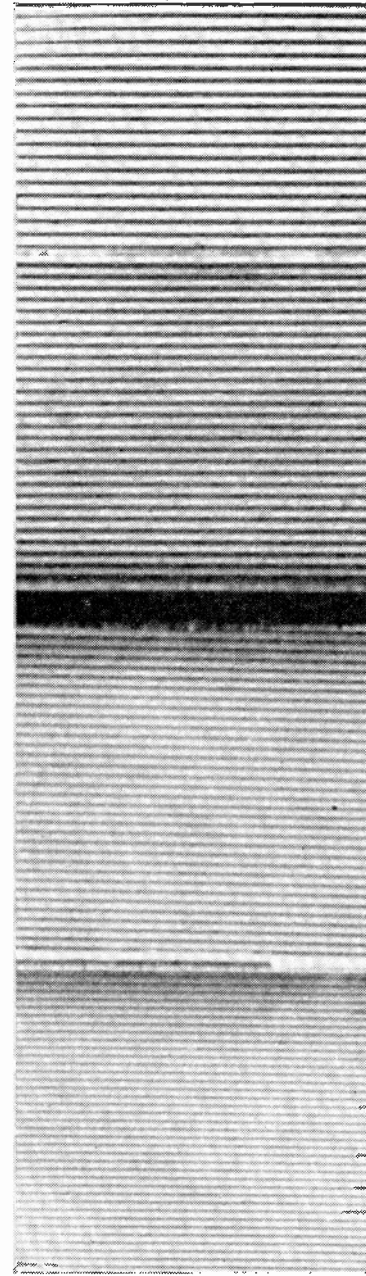

Fig. 10—Parallel lines, without spurious structure.

made, the aperture attenuation being considered as the cutoff of the television channel.<sup>14</sup> The other parameters

<sup>14</sup> Within the limitations previously pointed out, the inclusion of electrical frequency-attenuation effects would have been a simple matter. However, because of the unavoidable resolution loss in reproducing the photographs, further refinements were considered unnecessary.

are approximately those given previously for curves *A* and *B* of Fig. 6.

Fig. 7 shows a simulation picture of a resolution diagram, there being the equivalent of approximately 360 scanning lines across the height of the picture. The effect of the spurious components, as given by the second term of (10), may be seen in the steps along the lines of the horizontal wedge, in the spurious pattern in the right half of this wedge, and in the serrations appearing on the numbers. It may be observed that the resultant resolution of lines in the horizontal wedge is markedly lower than that for the vertical wedge.

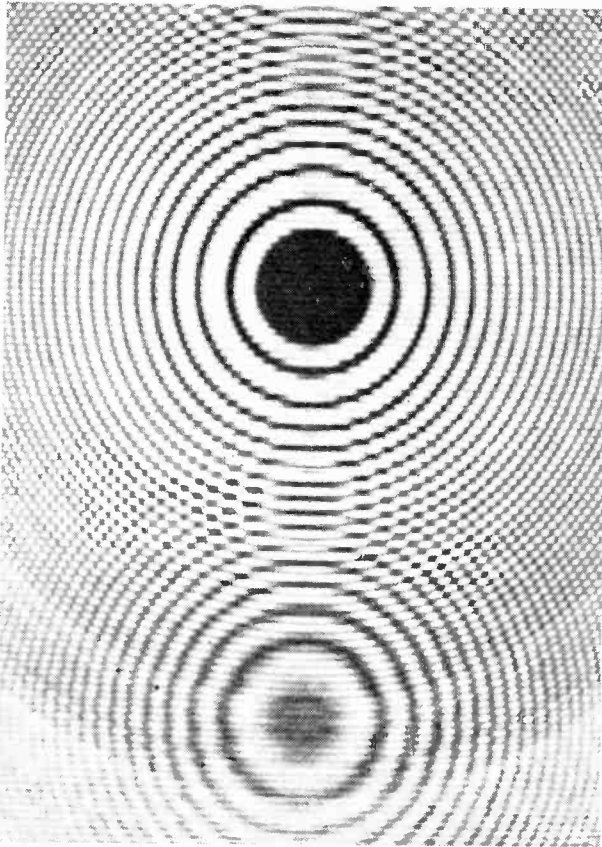

Fig. 11—Zone plate, with spurious structure.

An interesting comparison may be made between Fig. 7 and Fig. 8. Fig. 8 is a simulation picture, purporting to represent the same television picture as Fig. 7, made by using an out-of-focus optical system omitting the scanning structure. In order to take account of this omission of spurious components, the height of the figure of confusion has been increased by a factor of 1.4, an average of the factors suggested by various investigators<sup>15</sup> to take account of the vertical-resolution degradation due to scanning structure. It may be seen that a completely satisfactory equivalence factor<sup>16</sup> expressing

<sup>15</sup> See footnote reference 3. Baldwin lists the values which have been obtained for this factor.

<sup>16</sup> The estimates of this factor were usually based on the use of general subject matter, rather than the specialized type of subject used above.

the effect of the spurious components in terms of resolution degradation may be difficult to arrive at in general.

Fig. 9 is a simulation photograph of four sections of parallel lines, each having a different pitch, arranged so that the subject lines form a small angle with the scanning lines. There are approximately 400 lines contained in the picture height. Fig. 13 is the corresponding simulation picture omitting scanning structure and having a 1.4-times-greater vertical aperture.

Fig. 11 is a particularly interesting illustration of the peculiar effects arising from the spurious component field. The original subject matter was the zone plate of

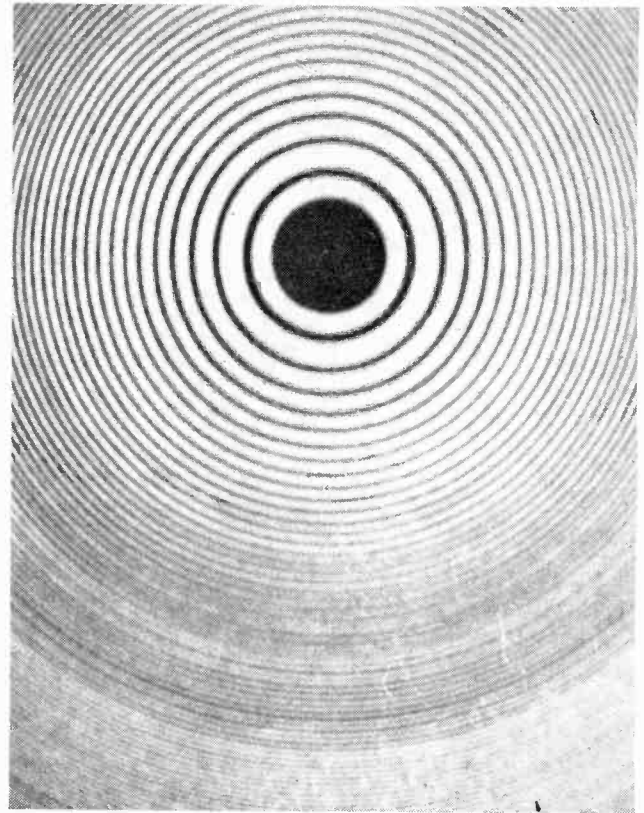

Fig. 12—Zone plate, without spurious structure.

Fig. 12, the spurious structure giving the effect of a ghost image or echo of the original.<sup>17</sup> Beats between this spurious image and the original may also be observed. The corresponding nonstructure simulation picture is shown in Fig. 12.

Figs. 10 and 11 are simulation pictures<sup>18</sup> of 441-line television pictures which have about 15 per cent vertical blanking. The scanning structure shows up throughout the outdoor scene, and is evident in the portrait of the girl, around the eyes, teeth, and hat.

Fig. 15 is an out-of-focus picture of the zone plate of Fig. 12, which illustrates the significance of aperture

<sup>17</sup> A picture similar to Fig. 11, showing a zone plate after transmission over a telephotograph system is given by Mertz and Gray. (See footnote reference 6.)

<sup>18</sup> Scene of Fig. 13 reproduced by courtesy of Loucks and Norling. Scene of Fig. 14 reproduced by courtesy of Fox Movietone News.

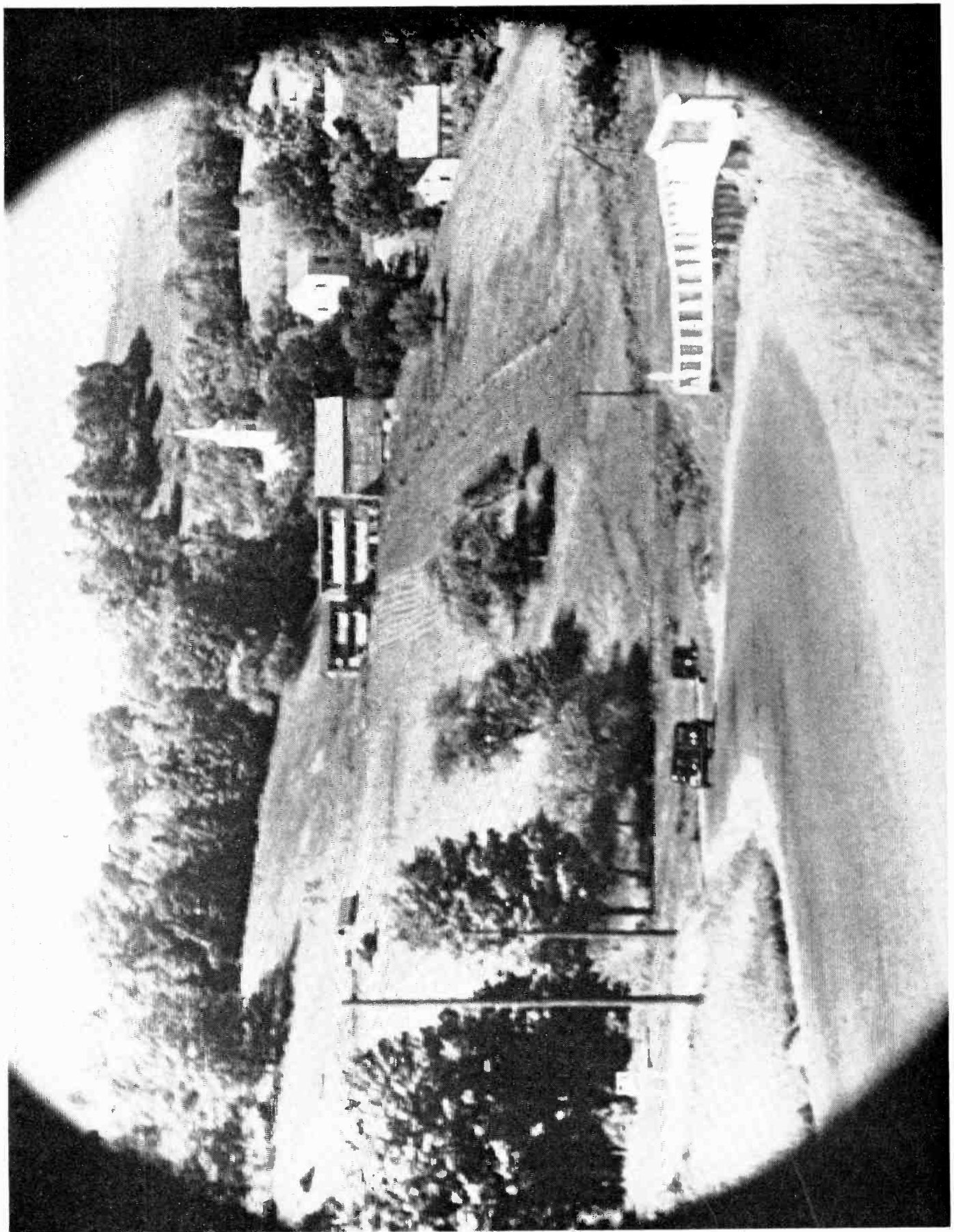

Fig. 13—Simulation picture of 441-line television picture.





Fig. 14—Simulation picture of 441-line television picture.



admittance characteristics of the type shown in curve *A* of Fig. 6. The confusion area is square and is arrayed with its sides horizontal and vertical. The "waves of sharpness," which may be seen principally along vertical or horizontal radii as the pitch of the rings diminishes, correspond to the lobes of the aperture admittance curve appearing between successive crossings of the zero axis. The first crossover point of the aperture admittance characteristic was found very useful in checking experimentally the size of confusion area. That practically no lobular resolution is visible along 45-degree radii is due to the fact that the aperture appears as diamond-shaped along these directions, the lobes of a diamond aperture admittance characteristic being very small compared to those for a square or rectangle.

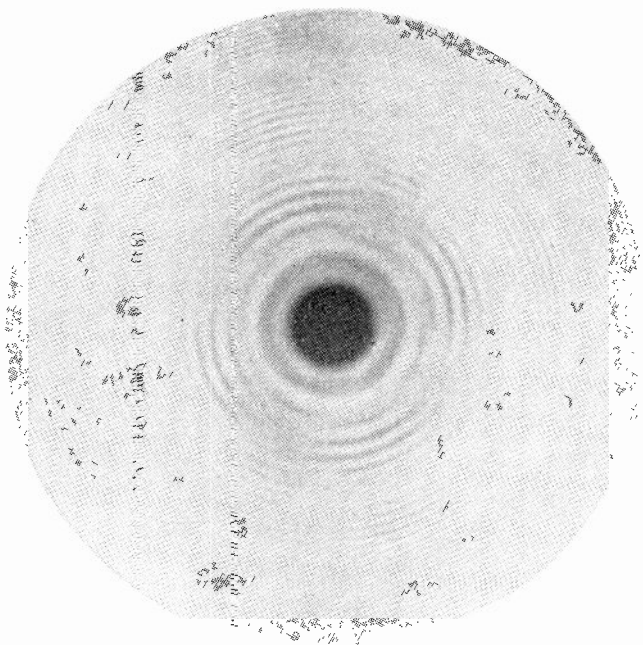

Fig. 15—Zone plate; illustration of aperture effect.

There are several alternative optical arrangements which may be used for producing simulation images similar to those discussed above. One variation, which permits the projection of large pictures viewed on a reflecting screen, is obtained by placing the line screen behind the projector lens close to the film plane. Another variation, of interest because it produces an almost exact simulation, may be obtained by using a line screen in conjunction with two out-of-focus transformations in tandem. However, this would be suitable only for photographic work, due to the low picture brightness obtained with this arrangement.

Simulations of both 240- and 441-line television pictures, still and motion, have been set up, and on numerous occasions compared with the images produced by the corresponding television systems. The fundamental similarity between the simulation and television images was strikingly apparent even at close viewing distances;

and the quantitative comparison agreed with that predicted by theory. Simulations of 525- and 625-line television images have also been made. The conversion of the simulation picture from one grade of television image to another was very simple, requiring only a change of line screens and readjustment of the focusing dial.

## VII. APPENDIX

### DIFFRACTION CALCULATION OF AN OUT-OF-FOCUS OPTICAL SYSTEM FOR A RECTANGULAR APERTURE

The geometrical theory which has been used in the paper to describe the figure of confusion of the optical system is subject to appreciable error for planes near the sharp-focus plane. In order to investigate the magnitude

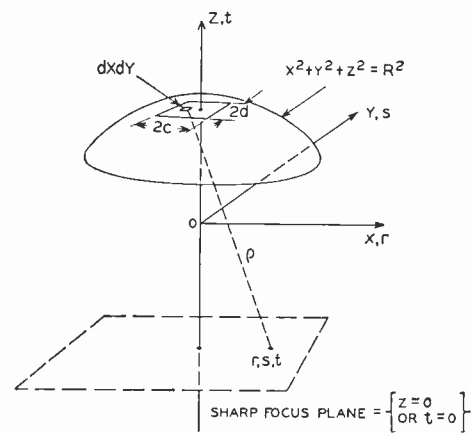

Fig. 16—Diffraction calculation of the confusion area for an out-of-focus optical system.

of the error, a diffraction calculation of the system has been made. The line screen is omitted from the calculation, since a simple estimate shows diffraction effects arising from this source to be small for the dimensions used.

The formulation of the diffraction solution follows Fig. 16. It is assumed that the wave front of the light emerging from the lens, due to a point source located on the optical axis at the film plane, is a section of a sphere with center on the optical axis at the sharp-focus plane. The radius  $R$  of the sphere is the image distance of the optical system. The active portion of the spherical wave front is that section bounded by the rectangular aperture of sides  $2c$  and  $2d$  oriented parallel to the  $x$  and  $y$  axes, respectively. Then, neglecting the varying inclination of surface elements of the sphere over the aperture boundary, the light amplitude at any point of the image space  $r, s, t$  may be written as

$$a = \iint_{\text{aperture}} \sin 2\pi \left( \frac{\tau}{T} - \frac{\rho}{\lambda} \right) dx dy,$$

where  $\rho$  = the distance from a surface element  $dxdy$  to the point  $r, s, t$ ,  
 $\tau$  = time  
 $\lambda$  = wavelength of light  
 (assumed monochromatic).

By assuming the maximum values of the variables  $x, y, r, s, t$  to be small compared to  $R$ , the following result is obtained for the light intensity at a point  $r, s, t$ . Neglecting constant factors, we find,

$$J = ([C(a_1 + a_2r) + C(a_1 - a_2r)]^2 + [S(a_1 + a_2r) + S(a_1 - a_2r)]^2) \cdot ([C(a_3 + a_2s) + C(a_3 - a_2s)]^2 + [S(a_3 + a_2s) + S(a_3 - a_2s)]^2) \quad (17)$$

where  $C( )$  and  $S( )$  are the Fresnel integrals, being given by

$$C(x) = \int_0^x \cos \frac{\pi}{2} v^2 dv,$$

$$S(x) = \int_0^x \sin \frac{\pi}{2} v^2 dv,$$

and where, for positive values of  $t$ ,

$$a_1 = c \sqrt{\frac{2t}{\lambda R(R-t)}}$$

$$a_2 = \sqrt{\frac{2R}{\lambda t(R-t)}}$$

$$a_3 = a_1 \frac{d}{c}$$

For negative values of  $t$ , the absolute magnitude of  $t$  must be used in (17) and in the following formulas.

$$a_1 = c \sqrt{\frac{2t}{\lambda R(R+t)}}$$

$$a_2 = \sqrt{\frac{2R}{\lambda t(R+t)}}$$

$$a_3 = a_1 \frac{d}{c}$$

Fig. 17 shows a plot of  $J$  in the plane  $t = -2$  inches, for  $s = 0$  and the representative values  $R = 76$  inches,  $c = d = 1/2$  inch,  $\lambda = 5000$  angstrom units. The aperture admittance corresponding to this intensity distribution is shown in Fig. 18, along with the admittance curve obtained from geometrical considerations. There is seen to be very good agreement between the two, so that the

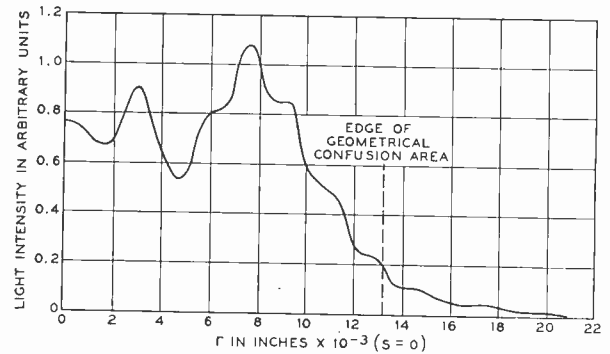

Fig. 17—Diffraction calculation. Light distribution in the out-of-focus plane  $t = -2$  produced by an axial point source in the film plane.

$R = 76$  inches  
 $c = d = \frac{1}{2}$  inch

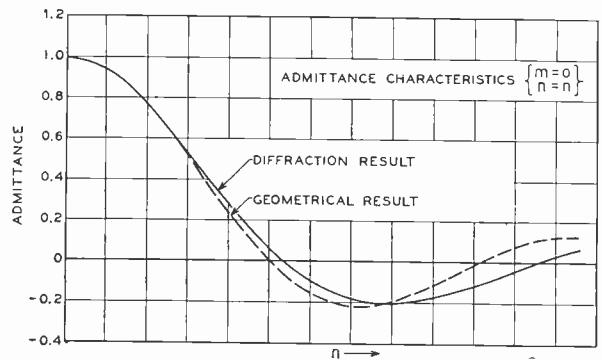

Fig. 18—Comparison of geometrical and diffraction admittance calculations. Solid curve calculated from curve of Fig. 17.

geometrical theory may be used for the given dimensions without appreciable error. For values of  $t$  less than one inch, however, the error becomes noticeable, and should be considered.

# Problems in the Manufacture of Ultra-High-Frequency Solid-Dielectric Cable\*

A. J. WARNER†

*Summary*—This paper deals with the various types of semiflexible solid-dielectric transmission lines suitable for use at ultra-high frequencies. Five general types are described, and their applications discussed. These are (a) coaxial, (b) dual, (c) dual-coaxial, (d) low-capacitance, and (e) high-impedance. Types (a) and (b) are general-purpose lines, while type (c) is used in direction-finding equipments, instrument-landing systems, etc. High-impedance cables find use in cathode-follower and special delaying circuits.

The manufacture of these transmission lines is discussed, and the various problems associated with extruding and braiding examined. The practical question of penetration of the braid into the dielectric and jacket is considered, and the recent steps taken to eliminate this problem discussed.

The contribution of the individual components of the cable to the total loss is examined, and an apparatus described which enables a direct measurement of braid resistance to be made at 150 megacycles. A typical example is given for RG-8/U cable, showing close agreement between the measured total loss of the line and the loss obtained by a summation of the individual losses of dielectric, inner conductor, and braid. The effect of varying the braid construction is demonstrated. The electrical testing of high-frequency transmission lines poses some problems, and a brief description, limited for security reasons, of the various tests and equipments is given. The author concludes by recommending immediate consideration of standardization problems in this field.

## INTRODUCTION

THE VERY rapid advances made in the electronic field in the last decade, and particularly those necessitated by the exigencies of war, have brought many new and interesting developments to fruition. For obvious reasons, many of these developments must remain closely guarded secrets until after this period of international conflict, but some of them can now be discussed in general terms, and the progress made outlined. In this paper it is proposed to deal briefly with a not very spectacular, but nevertheless highly important, component of modern electronic equipments, the ultra-high-frequency solid-dielectric cable. Such cables have now attained a noteworthy place in the components list, and are destined to play a more important role in the future.

## THE NATURE OF SOLID-DIELECTRIC LINES

One of the principal factors necessitating the development of solid-dielectric semiflexible cables was the design of electronic equipments for moving vehicles such as tanks, airplanes, and trucks; and for demountable equipments such as instrument-landing systems, direction finders, gun-directing devices, etc. These equip-

ments called for cable components that would be light, portable, easily assembled and disassembled, semiflexible, and having few (if any) maintenance problems. Not the least of the requirements, however, was the ability to obtain such cables in large quantities with the minimum of expansion of production facilities.

The standard rigid line, consisting essentially of a center conductor coaxially placed in a solid-copper tube and supported by rigid discs, washers, or spacers of dielectric material uniformly spaced, is well known. To obtain satisfactory operation of such lines, it is necessary to use somewhat complicated and expensive "plumbing" methods to join the lines to equipments and themselves, and to install a special nitrogen or inert-gas atmosphere under pressure to prevent "breathing" of the line and consequent moisture deposition inside the structure. Such an installation is costly, but, where the assembly is permanent, affords highly satisfactory operation, since it can be rigidly installed and with periodical maintenance check-ups can be expected to maintain its original qualities. The mechanical construction of these lines enables a high degree of uniformity of electrical characteristics to be obtained, and because of their rigid construction from solid conductors, the exact value of impedance and attenuation can be calculated before the line is even constructed. With semiflexible ultra-high-frequency transmission lines, however, the maintenance of uniform electrical characteristics is much more difficult, particularly when it is remembered that such lines are expected to operate over a wide temperature range,  $-40$  degrees centigrade to  $+80$  degrees centigrade, to be capable of much abuse in the field, and to be adaptable for the many different types of equipment now in use.

At the present time, semiflexible cables for ultra-high-frequency use fall into the following general types: coaxial, dual, dual-coaxial, low-capacitance, and high-impedance.

In the case of coaxial types, we have a center conductor insulated with a synthetic dielectric, a braid which acts as the return conductor and also as an electromagnetic shield, and an outer protective sheath of synthetic resin. In certain cases, especially for shipboard use, where installation in conduit is a requisite, a galvanized steel or aluminum armor is put over the sheath, which affords both mechanical protection and additional electrical shielding. The dual types are similar to the coaxial types, except that the two inner conductors are imbedded in the primary insulation. The dual-coaxial types of cables are special designs for specific problems, such as that in connecting up the antenna arrays of

\* Decimal classification: R282.1×R720. Original manuscript received by the Institute, June 4, 1945; revised manuscript received, August 25, 1945. Presented, New York Section, New York, N. Y., February 7, 1945.

† Federal Telephone and Radio Corporation, Newark, N. J.

instrument-landing systems, in certain direction-finding equipments, etc.

The low-capacitance cable consists of a center conductor held in position in a thin-walled tube of dielectric by an insulating thread spirally wound around the center conductor. Over the tube is put the usual braid and jacket. Such a design, by virtue of its relatively large volume of air, has a low effective dielectric constant, and therefore the capacitance per foot is also low.

The high-impedance type of cable is a special design for those equipments where an impedance of the order of 1000 ohms is required in the cable. Such a cable com-

the insulating material is forced by means of a rotating screw, and in which the material is brought to the right state of plasticity, a breaker-plate assembly which serves to build up pressure and to ensure that all undispersed or foreign matter is removed from the material, a cross head through which the center conductor to be insulated is fed, and a tip and die assembly which forms the insulation around the center conductor to the desired shape. The various parts of the machine can be seen by reference to Fig. 2. Although at first sight it might appear that this process is but little different from that employed in the manufacture of conventional rubber-insulated wires, the fact that we are dealing with plastic materials of higher softening point and different degrees of plasticity, necessitates machine modifications, while the necessity for maintaining a high degree of uniformity introduces manufacturing problems of no mean extent. It is obvious that, for successful service use, certain electrical parameters must be closely controlled, and of these parameters, the characteristic impedance introduces the first problem from the mechanical point of view.

Since it is desired to keep the characteristic impedance of the cable as uniform as possible and at a fixed value, the ratio of the diameter of the inner conductor to the diameter of the outer conductor must be held to a close tolerance. For most applications, it has been decided that, with a nominal impedance of 50 ohms, a tolerance of  $\pm 2$  ohms is the maximum permissible. To achieve this, it is necessary to hold the diameter of the dielectric to within  $\pm 15$  mils. Since it is necessary during manufacture to have some little leeway in tolerance, it means in practice that to keep rejections to a minimum, even tighter dimensional tolerances must be maintained. When it is recognized that this tolerance must be maintained while the cable is being produced at speeds up to 100 feet per minute, it will be appreciated that the equipments must be functioning correctly, the operators well-trained and supervised, and constant production engineering maintained.

To ensure uniform values of attenuation, and particularly to maintain the lowest values possible, the dielectric material must be rigidly inspected before use, and handled with the greatest of care to avoid contamination. Since the velocity of propagation is a function of the dielectric constant of the insulating material, care must be taken in manufacture to avoid the presence of voids or discontinuities in the dielectric and to see that the material is applied uniformly as regards density.

When the frequency of operation becomes very high, indeed, we find that additional problems are present. At these frequencies, the presence of any form of discontinuity will cause trouble due to reflections and standing waves. This may occur even though the cable is well within the tolerance values for size called for in the specification. To overcome such problems, the nature and extent of which are only just becoming very painfully apparent, the highest degree of skill will be

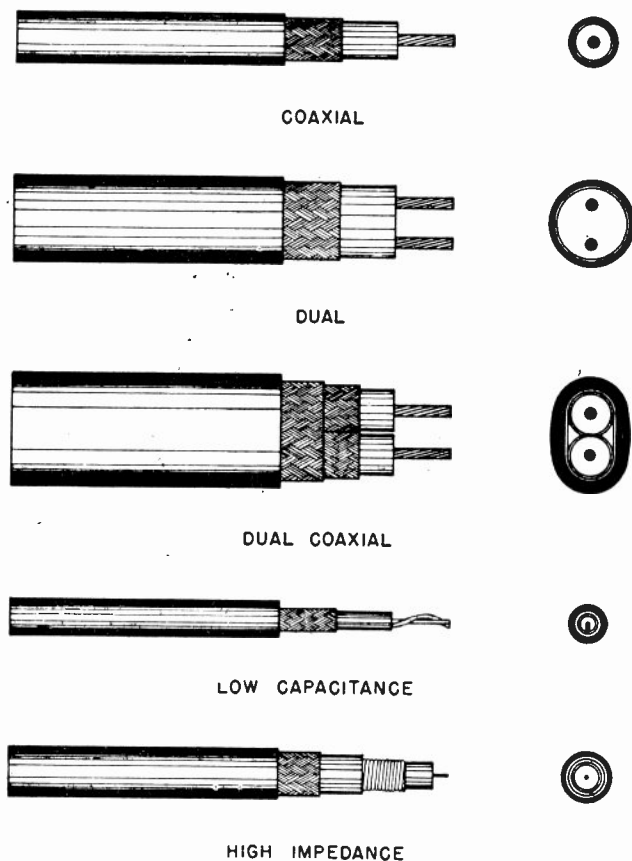

Fig. 1.—General types of ultra-high-frequency cables.

prises an inert supporting core on which is wound a close-lay spiral of enameled wire. Over this is put a synthetic insulation and then the conventional braid and sheath. Fig. 1 shows the various types of cables discussed above.

#### THE MANUFACTURE OF SOLID-DIELECTRIC CABLES

The chief operations in the manufacture of cables for use at ultra-high frequencies are those of extrusion and braiding. Extrusion is a process for forcing materials in a semisolid state through a suitable orifice such that a definite shape is obtained. The first operation in cable manufacture is the extruding of the primary insulation on the center conductor, which is done by means of a specially designed plastics extruder. Such an extruder consists essentially of a heated cylinder through which

required from all phases of engineering, the raw-material experts, the mechanical designers, and the electrical engineers.

After the extrusion of the primary insulation, the braid or outer conductor is put on by a process referred to as "braiding." Two main types of braiding machines are in operation, the so-called "Wardwell" type, and the "New England Butt" type. In the Wardwell machine we have two carriages, each having twelve bobbins containing the braid wires, rotating horizontally in opposite directions, the individual bunches of wires from the bobbins being deflected by guides to interweave them in the form of a basket weave. Such a braider is shown in Fig. 3. For large cables, the New England Butt type is often employed; here the bobbins, usually forty-eight in number, are mounted vertically and rotate in a horizontal plane around the periphery of the machine, forming a basket weave around the centrally located cable.

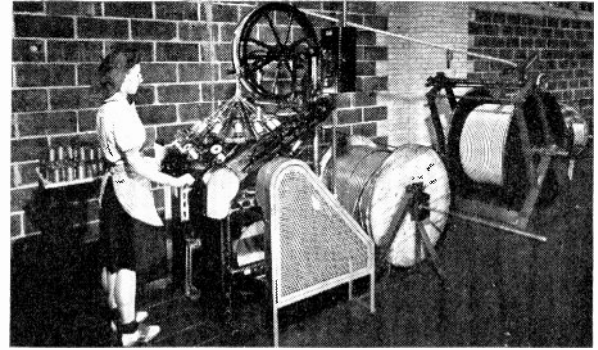

Fig. 3—Copper-wire braiding machine.

with polyethylene, the braid wires may have a tendency to imbed in the dielectric, particularly if the cable has been heated or if the braid has been designed with a relatively short lay and applied with a high tension. It is even more common for the braid wires to be imbedded

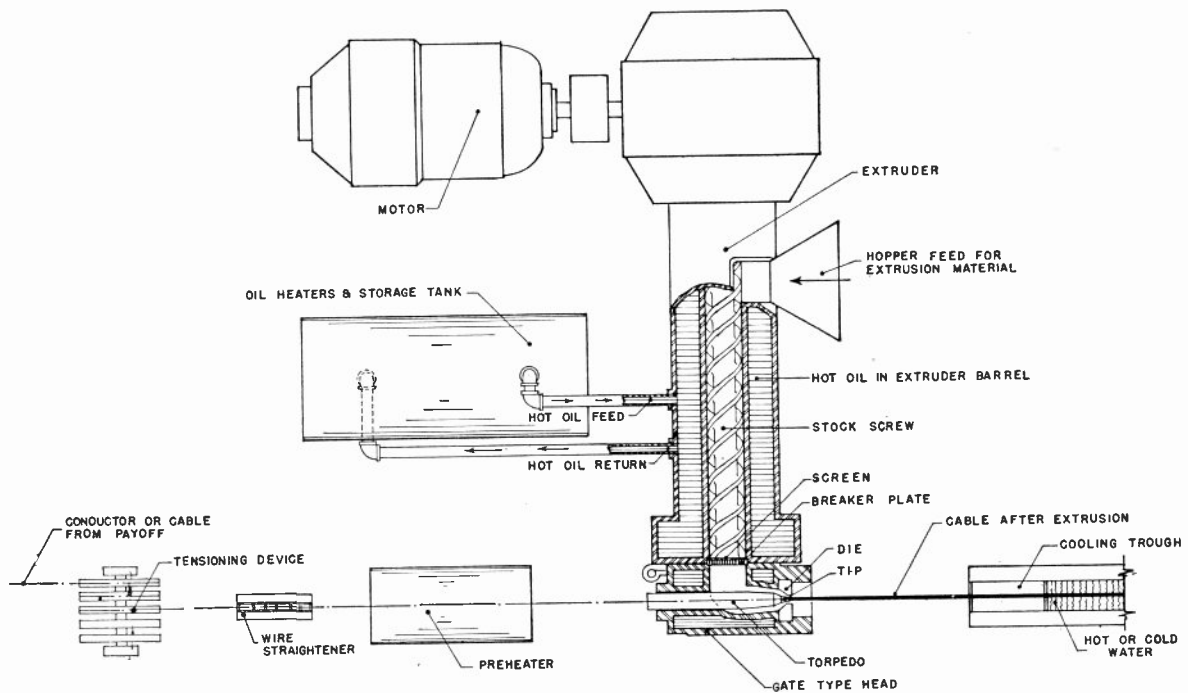

Fig. 2—Schematic cross section of extruder.

In general, apart from design characteristics, the problems in braiding are purely mechanical, and the success of good braiding depends chiefly on the care with which the individual wires are wound on the bobbins for braiding.

There is one problem concerning the braid which is of particular interest to the equipment manufacturer, and that is the adhesion or penetration of the braid to either the primary insulation or the jacket. When softer dielectrics than the polyethylene now standard were employed, it was quite common for the braid wires to be buried so deeply in the dielectric, due to the tensions exerted during braiding, that it was a matter of great difficulty to strip the braid wires back preparatory to connector assembly. It sometimes happens that even

in the jacket; this is caused by applying the plastic jacketing material to the braided wire in a very soft state and through a tip-and-die combination causing the hot plastic to be forced through the interstices of the braid. On cooling, the braid wires are often found to be completely imbedded in the jacket. In such cases, it is almost impossible satisfactorily to prepare a cable end for connector assembly. The use of special tubing tips and dies which serve to lay a tube of the protective jacketing material on the braid under the right pressure, has overcome this problem. The presence of jacketing material in the braid also serves to introduce additional attenuation losses in the line and to give it attenuation instability with flexing.

The sheath, or jacket, is applied with the same type



plastic tuber as the primary insulation, and affords neither more nor fewer problems than those discussed under that subject.

#### DESIGN COMPONENTS

One of the most important factors affecting the design of a high-frequency cable is the nature of the dielectric material to be employed. Such a dielectric has to have the lowest attainable electrical losses, and these losses must be substantially constant over a wide frequency band and a considerable range of operating temperatures. Apart from these electrical requirements, the dielectric must also be capable of installation at temperatures as low as  $-40$  degrees centigrade and yet support the weight of the center conductor at elevated temperatures of  $+85$  degrees centigrade without flow. The search for suitable materials has been going on for some considerable time, and it cannot yet be said that a completely satisfactory material has been developed. At the present moment in this country and Great Britain, the preferred insulation is polyethylene, a high-molecular-weight hydrocarbon of the paraffin series. The properties of this material are given in Table I. This material is

TABLE I  
POLYETHYLENE, AVERAGE PROPERTIES

Tensile strength, pounds per square inch	1700
Coefficient of thermal expansion	$10.5 \times 10^{-5}$
Rockwell hardness	R15
Specific gravity	0.92
Elongation, per cent	500
Heat distortion point, degrees Fahrenheit	140
Water absorption after 24-hour immersion, per cent	0.01
Dielectric strength, volts/mil, 3 to 15 mils thick	1000 to 1500
Volume resistivity, ohm-centimeters	$10^{17}$
Dielectric constant	
60 cycles	2.25 to 2.27
1000 cycles	2.25 to 2.27
1 megacycle	2.25 to 2.27
1000 megacycles	2.65 to 2.27
Power factor	
60 cycles	0.0002 to 0.0004
1000 cycles	0.0002 to 0.0004
1 megacycle	0.0002 to 0.0004
1000 megacycles	0.0002 to 0.0004

now being manufactured in large quantities, and a high degree of uniformity is obtained. Its low value of power factor (of the order of 0.00030) and its attendant low dielectric constant (approximately 2.27) are maintained over a wide range of frequencies, while its flexibility at low temperatures and its rigidity at elevated temperatures are satisfactory.

By skillful operating technique, a high degree of extrusion precision can be obtained, which enables good control of impedance and other electrical parameters of the final product to be maintained.

The center conductor of a high-frequency solid-dielectric cable is either concentric-lay, stranded, or solid, dependent upon the general considerations applying to its use. Stranded conductors are chiefly employed where the greatest degree of flexibility of the cable is required; solid conductors are generally employed where the lowest electrical losses are necessary and also where a cable is desired to have the highest value of initial corona-starting potential. In order to reduce the losses still further, it is common practice now to use silver-plated

conductors. For certain applications, it is desirable to have a cable which has a high loss per unit length, and for these cables, the center conductor usually consists of a nichrome wire. To maintain constancy of impedance, it is necessary for the center conductor to be manufactured with a high degree of uniformity, and some of the troubles of the earlier high-frequency solid-dielectric lines have been traced back to irregularities of stranding and dimensions. The braid consists of a basket weave of wires which vary in number, size, and mode of application, dependent on the size of the cable and the use to which it is to be put. For the smaller size of cables, it is usual to have 24 separate ribbons of braid wires in the construction, each ribbon comprising six to ten individual wires of no. 33 or no. 34 American Wire Gauge. The lay of the braid, or number of ribbons of wires per inch, is determined by the electrical and mechanical properties required. Since at the frequencies employed the current travels on the surface of the wires, it is obvious that the fewer the jumps the current has to make per unit length, the lower the loss. On the other hand, the shorter the lay of the braid, the more flexible is the cable, and the more it is able to withstand repeated flexings without failure or deterioration of electrical characteristics.

It must be confessed that many of the braid designs currently employed were chosen for expediency rather than from a sound engineering design, but constant improvement is being made, and it is to be hoped that we will be able in future years to design cables a little more scientifically than in the past.

Since plain copper wire has a tendency to oxidize in air and also to corrode in the presence of electrolytes such as salt, it is sometimes found advisable to use tinned-copper wires for the braid instead of plain copper wire. The presence of oxidation and/or corrosion products on copper-braid wires not only causes an increase in the electrical loss of the cable, but also gives rise to fluctuating readings on equipments due to contact-resistance variations when the cable is shifted or flexed. To lower the losses, and also to avoid this variation of contact resistance, especially for cables used as test leads in precision testing equipments, it is now quite common to use a silver-plated copper-braid wire.

In certain applications, where good shielding is required, a second braid is sometimes employed. In such double-braided cables it is usual to take advantage of the electrical properties to be obtained by the use of a long-lay braid, by employing as long a lay as practicable for the inner braid, maintaining the outer braid with a short lay for mechanical considerations. Consideration has been given, from time to time, to the use of more than two braids for additional shielding, but it has now been demonstrated that the advantages gained by the employment of a third shield are not sufficient to warrant the additional expense and problems of manufacture and installation. Such shielding problems are best

handled by investigating the over-all shielding of the individual equipments concerned.

The jacket, or sheath, acts primarily as a protection of the cable structure therein. It should be flexible, resistant to abrasion, oil, gasoline, water, hydraulic-brake fluids, etc., and should also preferably be non-inflammable. The most commonly used jacketing materials for high-frequency cables are plasticized vinyl compounds such as vinyl chloride or vinyl chloracetate, sold under the trade names of Vinylite and Geon. It has recently been found that, where the greatest degree of constancy of operation of high-frequency solid-dielectric cables is required, a special type of vinyl jacket must be employed. Such a jacket has been developed and is now in service on these special cables.

To increase the mechanical protection of lines, particularly for naval use, an outer armor is sometimes employed. This is preferably of galvanized steel, but during the wartime emergency, aluminum wire has been substituted for the galvanized steel. Such armored cables are painted with an aluminum paint to fill the interstices in the armor and thus facilitate their watertight installation through bulkheads.

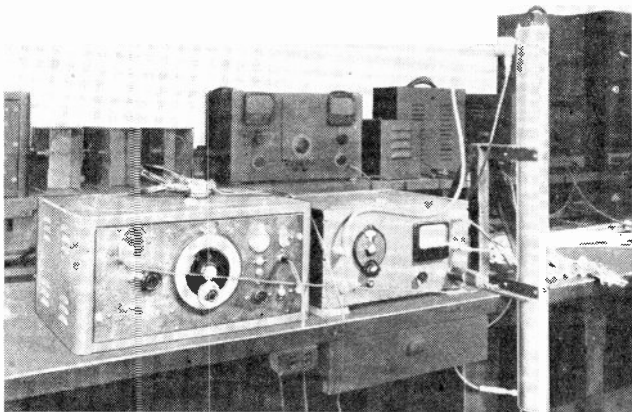

Fig. 4—Apparatus for measuring braid resistance.

Of great interest to the radio engineer is the contribution of the various components of the cable to the total measured loss or attenuation, and particularly, how this varies with frequency.

It is well known that the dielectric losses are a direct function of the electrical properties of the insulation and frequency of operation, and thus a measurement of the power factor and dielectric constant at those frequencies enables the contribution of the dielectric to the total loss to be calculated. Thus, taking polyethylene as an example: the power factor of polyethylene at 400 megacycles is 0.00030 and the corresponding dielectric constant is 2.27. The loss due to the dielectric is therefore  $\alpha_{400} = 2.78 \times \sqrt{2.27} \times 0.00030 \times 400$  decibels per 100 feet = 0.503 decibel per 100 feet. Taking a standard cable, for example RG-8/U, the measured loss of this cable at 400 megacycles is 5.0 decibels per 100 feet. The contribution to the over-all loss by the center conductor and braid is therefore 4.5 decibels per

100 feet. To separate the loss due to the center conductor from that due to the braid, and to determine the effects of changing the lay of the braid on the coverage has been a somewhat complex problem and only empirical calculations have hitherto been made. Recently, however, Muller and Nordlin of the Federal Telephone and Radio Laboratories have developed an equipment (Fig. 4) which enables such measurements to be made, and the preliminary results are very valuable for future design work. At the present moment, due to lack of suitable oscillators, it is not possible to measure at frequencies other than 150 megacycles, but it is hoped shortly to have such oscillators and to be able to extend the usefulness of the equipment. Thus, taking the standard RG-8/U cable, which has a measured attenuation at 150 megacycles of 2.60 decibels per 100 feet, the contribution of the individual components of the cable is:

Dielectric component	= 0.189 decibel per 100 feet
Center conductor	= 1.58 decibels per 100 feet
Braid	= 0.903 decibel per 100 feet
Total	2.67 decibels per 100 feet.

It will be seen that the agreement is very good.

It is a well-known practical observation that the attenuation of a transmission line can be improved by increasing the lay of the braid wires; that is, by decreasing the number of braid-wire crossovers per inch. It has also been a matter of great interest, particularly from a raw-material conservation standpoint, to determine how the wire coverage, that is the ratio of surface of the dielectric covered by the braid wires to the total surface, affects the attenuation loss. Table II shows some

TABLE II

Lay angle	Loss	Coverage	Loss
in degrees	in decibels per 100 feet	in per cent	in decibels per 100 feet
63.4	1.94	97.75	0.888
55.9	1.36	93.30	0.856
47.7	1.22	86.70	0.825
38.6	1.05	77.90	0.804
26.1	0.888		

of the results so far obtained. It will be seen that the loss due to the braid is markedly affected by the lay of the wires as would be expected, but that the per cent coverage is not a critical factor.

This particular experimental equipment will be of great use in studying the effect of different materials, such as silver-plated copper, and tinned copper versus plain copper wire, and also in studies to determine the effects of corrosion and/or flexing on the attenuation of transmission lines.

#### TESTING PROBLEMS

The testing problems encountered in high-frequency solid-dielectric cables are of two types. First, those concerned with production testing, and second, specialized

problems concerned with the particular design and utilization of the cable type.

In general, factory production testing is chiefly a problem of the application of known techniques. It is necessary, however, to devise and build test equipments which are very rugged, quick acting, and as foolproof as possible. It must also be remembered that the equipments are to be operated by persons having little, if any, electrical background, and whose knowledge of high-frequency radio problems is substantially nil. The chief factory tests made are: capacitance, velocity of propagation, characteristic impedance, attenuation, dielectric strength, initial corona-starting voltage.

Capacitance is very conveniently measured at 1000 cycles and affords no special problem since standard equipment is employed.

The velocity of propagation is usually determined by measurement of the frequency at which a known length of cable, usually  $\frac{3}{4}$  of a wavelength, resonates when terminated in an open circuit. Cables having a high attenuation cannot be measured by this method, because the resonance effects are not prominent enough to give an accurate determination. A convenient testing equipment, shown in Fig. 5, was developed by the Naval

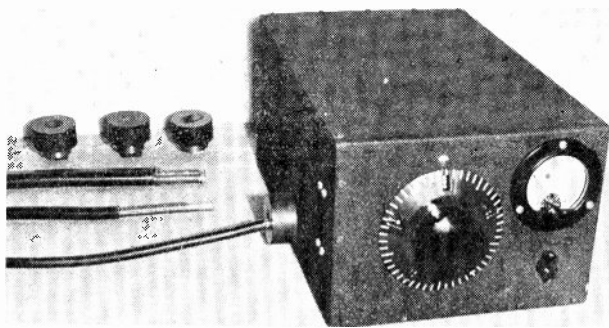

Fig. 5—Velocity-of-propagation meter.

Research Laboratories. It consists of an oscillator, variable around 100 megacycles, coupled loosely to a noninductive loop attached to one end of the cable under test. This loop is tunable by a variable trimmer capacitor. Resonance is indicated by a dip in a grid meter. In the so-called "V-P Meter," the loop circuit, and the oscillator circuit are tracked and controlled by a single dial. When the cable under test is inserted into the meter, resonance occurs and is indicated at one position only on the dial which is calibrated to read velocity of propagation directly.

The characteristic impedance is calculated from the measured capacitance and velocity of propagation by the usual formula. This calculation makes two assumptions which are justified: (1) That the effect of losses on characteristic impedance is negligible, which is true except for the lowest frequencies; (2) that the depth of penetration of current into the conductors is negligibly small, which is true for frequencies above 1 megacycle.

Fig. 6 shows the apparatus used by Federal Telephone

and Radio Corporation for the measurement of attenuation at frequencies of 100, 200, 300, and 400 megacycles. The basic design was developed by the Naval Research Laboratories but was modified to give an equipment more suitable for production use and capable of higher precision. In this method, energy from a generator is fed directly into a calibrated vacuum-tube voltmeter and subsequently through the transmission line under test into the same voltmeter, the ratio of the two voltmeter readings giving the loss of the line. A diode voltmeter operated with a large input signal is employed to minimize transit-time effects and is calibrated at 60 cycles directly in decibels. The power output of the generator is adjusted with no transmission line connected until the voltmeter reads zero decibels. The generator is coupled to the input end of the line through a pair of critically coupled tuned circuits, and the output end of the line similarly coupled to the voltmeter, the critical coupling properly terminating the line in its characteristic impedance and eliminating reflection losses. The loss in the line can then be read directly in decibels. The spiral delay lines, or high-impedance lines, have relatively high attenuation values per unit physical length, and are

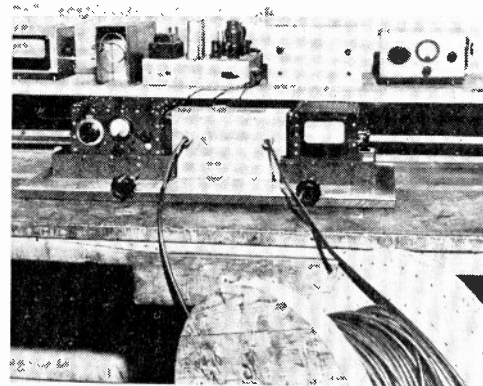

Fig. 6—Equipment for measuring the total attenuation of a transmission line.

therefore not capable of measurement on the above described equipments. An equipment, operating at 5 megacycles and measuring the resonant rise of voltage occurring when a sample of cable, an odd number of wavelengths long, is terminated in an open circuit, has been developed in our laboratories and has given very satisfactory operation. This method is based on the previous work of the Industry Service Division of R.C.A. Laboratories for use with television lines.

For cables designed for operation at high voltages, it is necessary to obtain as high an initial corona-starting potential as possible. Corona is a momentary discharge irregularly repeating at a rapid rate, and is caused by the ionization of air or other gaseous inclusions in the dielectric due to high electric-field strength. The corona-starting potential can be measured by a variety of means, but a convenient method comprises detecting the transient in the 60-cycle wave by means of an oscilloscope.

Special problems are met in the electrical testing of dual-coaxial balanced lines such as RG-23/U. Here problems of preparing lengths of cable which are electrically of the same length and which also show a high degree of electrical balance between the individual coaxials are often encountered. Fig. 7 shows a direct-reading electrical-length meter, developed by Federal Telephone and Radio Corporation, which operates on the principle that, at a fixed frequency, the input impedance of an open-circuited line is a function of the electrical length of the line. A voltage-regulated crystal-controlled gen-

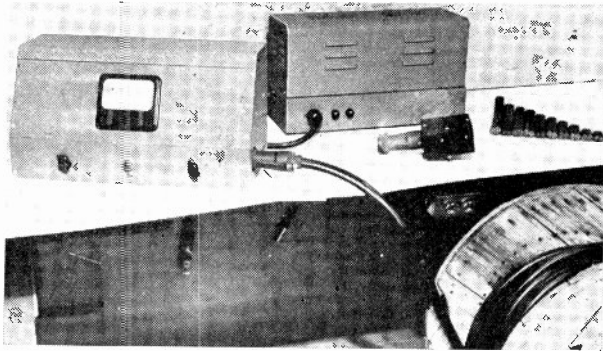

Fig. 7—Electrical-length meter.

erator applies a voltage to the input terminals of the line to be measured in series with a vacuum-tube radio-frequency milliammeter. The milliammeter is calibrated to read electrical length directly.

To determine the electrical balance of dual-coaxial lines, particularly over a frequency range, a special balance test was developed. This set applies an equal voltage to both coaxials of the line from a motor-driven variable-frequency generator which slowly scans the frequency spectrum. At the far end of the line, a balanced-input amplifier operates a recording milliammeter to record the voltage unbalance.

A study of the graph recorded reveals the degree of unbalance and the frequency at which the greatest unbalance occurs. It will be seen that the development of test equipments has kept pace satisfactorily with the problems encountered in high-frequency transmission-line testing, although much work remains to be done to complete the picture. It will be appreciated that it is not possible at this stage to discuss other testing equipments which have been developed to meet special or specific problems, or to indicate the full extent of our knowledge, but the knowledge gained during this eventful period will be put to very good purpose in the years to come.

#### FUTURE OUTLOOK

A review of the current situation in the field of high-frequency solid-dielectric cables reveals the tremendous

strides taken by a relatively inexperienced industry. The achievements of the past three years have been outstanding, but such successes must not prevent a critical examination of our present practices and theories, with an abandonment of those which fail to stand the test of scientific investigation. Certain fundamental weaknesses are already becoming apparent, and unless steps are taken to investigate these and to find solutions for them, what is now a virile section of the industry may stagnate and die, leaving other groups to find solutions to the problems along other lines.

In particular, continued research must take place into the field of dielectrics, with particular emphasis on the electrical characteristics and the operating temperature range. There are already many applications for transmission lines to operate at temperatures higher than 85 degrees centigrade, the present rating for polyethylene insulation, while the changes in characteristics observed over a temperature cycle due to the high coefficient of the thermal expansion of the same material are not very satisfactory. Braid designs, in view of recent work, can and should be modified to give the optimum mechanical and electrical properties.

One of the most important of the problems ahead is that of standardization. This must be considered not only from a national standpoint, but with an eye on international considerations, since we are now entering an era of widely expanded travel when equipments manufactured in one country will have to be serviced in another country. It will not be possible to uphold any nationalistic claims or demands in the face of a problem requiring over-all consideration, and the time is fast approaching when such problems must be tackled. A similar problem has been in the mind of industry for a number of years; namely, frequency allocation; and just as a series of conferences have been held on this subject, so must we have discussion and agreement on such problems as the impedance of cables, the maximum permissible attenuation at the various frequencies of operation, the over-all size of the cables and the connectors to be used therewith, etc. Without such standardization, the cable manufacturers will make whatever is called for by the customer and will have little inducement to study the problem deeply. The radio-equipment designer will continue to call for cables which may not constitute the best in the way of design, and the equipment installer and operator will go on decrying both. A vigorous discussion by all interested parties will clarify the position and enable the industry to go forward to even greater achievements.

The successful development of high-frequency solid-dielectric cables marks a very decided milestone in the history of radio, and it is up to the radio engineers to exploit more successfully the opportunity afforded them.



Acme Photo

HOTEL ASTOR—NEW YORK CITY  
Headquarters for 1946 Winter Technical Meeting

## 1946 I.R.E. Winter Technical Meeting Program and Highlights January 23, 24, 25, and 26, 1946 Hotel Astor, New York, N. Y.

Final plans have now been completed for what is confidently expected to be the most important I.R.E. Winter Technical Meeting in many years. When members gather from January 23 to 26 at the Hotel Astor for this first postwar meeting, they will be treated to an array of features and events that are among the most significant ever prepared for such an occasion.

Amid the crowded calendar of professional and social events, members will have at this gathering an unprecedented opportunity to orientate themselves in the postwar pattern of the electronics and radio fields, to gain

an understanding of the Industry's reconversion program, and to catch up on the newest developments, and future prospects in the field.

Space in the Radio Engineering Show, a display of unprecedented variety and importance and four times the size of any former I.R.E. Radio Engineering Show, has been fully spoken for by more than 132 firms.

The total of 171 exhibits occupying two floors and foyer space in the Hotel Astor will represent a comprehensive cross section of the Industry's newest and most important postwar products and should provide mem-



bers with much information of value and interest to them in their particular fields. The most recent list of the firms which expect to take part in the Show is given on page 42 W. The list indicates how completely the suppliers of radio engineering equipment and services are cooperating to make this year's Show an outstanding success.

The annual I.R.E. Banquet will be held Thursday, January 24, 7:30 to 10:30 P.M. in the Grand Ballroom of the Hotel Astor and the President's Luncheon, honoring the Institute's incoming president, Dr. Frederick B. Llewellyn, to be held on Friday, January 25, at 12:30 P.M. in the Grand Ballroom. The principal speakers will be Dr. Frank B. Jewett, President of the National Academy of Sciences who has accepted the invitation to address the estimated 2500 guests at the Banquet, and Mr. Edgar Kobak, President of the Mutual Broadcasting System, who will act as Toastmaster; Mr. Paul A. Porter, Chairman of the Federal Communications System, who will be the speaker at the President's luncheon, and Mr. Ronald J. Rockwell, Engineering Director, Broadcasting Division, The Crosley Corporation, who will be master of ceremonies at the Luncheon.

At Thursday evening's Banquet, the two annual I.R.E. awards will be made: The Institute Medal of Honor given in recognition of distinguished service in radio communications; and the Morris Liebmann Memorial Prize, made to a member of the Institute who has made public during the recent past an important contribution to radio communications. In addition, 12 fellowships given by the Institute will be awarded.

Another enjoyable feature, the annual Cocktail Party, to be held Friday evening from 6:30 to 8:00 P.M. in the Grand Ballroom, promises to provide a pleasant medium for the renewing of old acquaintanceships and the making of new social and business contacts.

The splendid array of important technical papers on vital electronics and radio subjects will this year take on added significance with discussion of the many remarkable war developments and newly released information on hitherto restricted items.

The subjects of the papers give some hint of their importance. They include: Military Applications of Electronics; Frequency-Modulation and Standard Broadcasting; Circuits and Theory; Television; Radio Navigation Aids; Vacuum Tubes; Microwave Vacuum Tubes; Antennas; Radar; Microwave Technique; Industrial Electronics; Communication Systems and Relay Links; Radio Propagation; Broadcast Receivers; Quartz Crystals; and Crystal Rectifiers.

This year, as has been announced, The Institute of Radio Engineers will be host at a joint meeting with the American Institute of Electrical Engineers, scheduled to be held in the Engineering Society's auditorium on Wednesday evening, January 23. Major General Leslie R. Groves, Director of the Manhattan District, which is the code name for the atomic-bomb project, will speak on "Some Electrical Engineering and General Aspects of the Atomic-Bomb Project. To accommodate any overflow attendance such as occurred last year, arrangements have been made to install a public-address system and to reserve another large meeting room in the same building.

The women guests at this Meeting will be entertained with visits to the Museum of Costume Art and Sloane's House of Years followed by luncheon and an art exhibition at the Town Hall Club, and a Television Tour of Radio City. They will also be escorted on tours through the Cathedral of St. John the Divine and Riverside Church, as well as guests at luncheon.

The complete program of events for the three-day Meeting follows.



*Greystone-Stoller*  
FRANK B. JEWETT



EDGAR KOBAK



PAUL PORTER

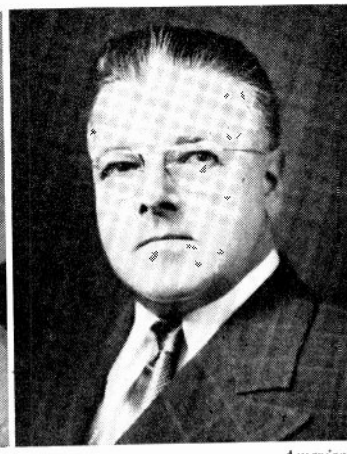

*American*  
LEWIS M. CLEMENT

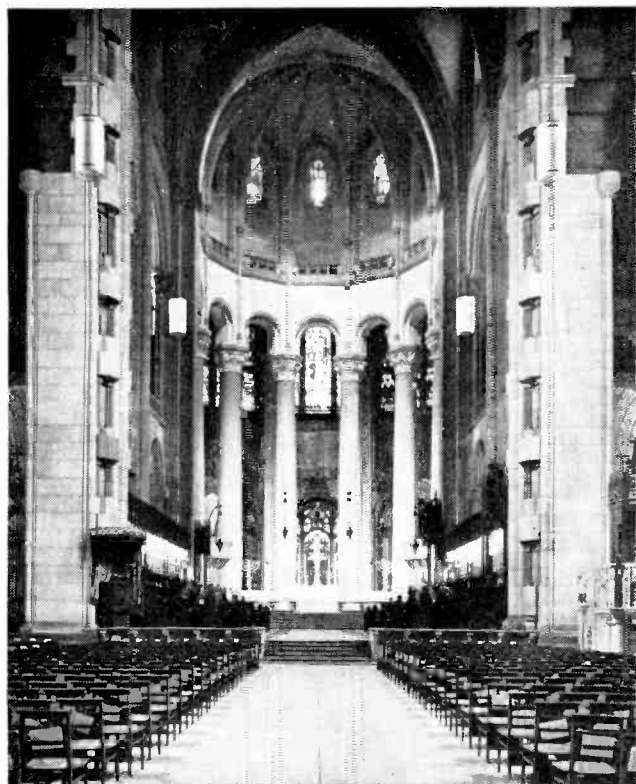

CATHEDRAL OF ST. JOHN THE DIVINE  
Sanctuary and High Altar

*Gustafson*

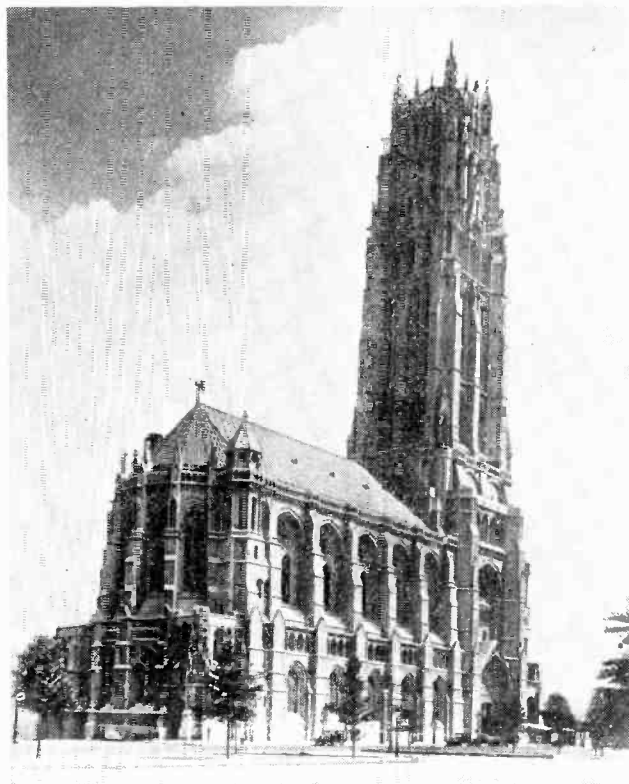

RIVERSIDE CHURCH

**Women's Program**  
(Tentative)

**Thursday, January 24, 1946**

11:00 A.M.—3:30 P.M.

Cathedral of St. John the Divine  
Luncheon, Stoddards  
Riverside Church

**Friday, January 25, 1946**

11:00 A.M.—4:00 P.M.

Museum of Costume Art—Sloane's House of Years  
Luncheon and Art Exhibition, Town Hall Club  
Television Tour of Radio City



FROM THE COLLECTION OF THE COSTUME INSTITUTE OF THE METROPOLITAN MUSEUM OF ART

# PROGRAM

## Wednesday, January 23, 1946

9:00 A.M.-5:30 P.M. Registration and Promenade Sale of Tickets  
9:30 A.M.-12:30 P.M. Annual Meeting of Coral Room Sections' Representatives  
12:30 P.M.-2:00 P.M. Luncheon for Sections' Rose Room Representatives  
2:00 P.M.-5:00 P.M. Annual Meeting of Coral Room Sections' Representatives  
4:00 P.M.-8:00 P.M. Radio Engineering Show Eighth and Tenth Floors  
8:00 P.M.-10:00 P.M. Joint Meeting of Engineering Societies A.I.E.E. and I.R.E. Building

## Thursday, January 24, 1946

8:30 A.M.-5:30 P.M. Registration and Promenade Sale of Tickets  
9:00 A.M.-7:00 P.M. Radio Engineering Show Eighth and Tenth Floors  
9:45 A.M.-10:30 A.M. Annual Meeting of The Grand Ballroom Institute of Radio Engineers, Inc.

### Technical Sessions

10:30 A.M.-12:30 P.M.

#### Group A

Grand Ballroom  
Military Applications of Electronics

#### Group C

Coral Room  
Circuits and Theory

#### Group B

Rose Room  
Frequency Modulation and Standard Broadcasting

### Technical Sessions

2:00 P.M.-5:00 P.M.

#### Group A

Grand Ballroom  
Television

#### Group C

Coral Room  
Vacuum Tubes

#### Group B

Rose Room  
Radio Navigation Aids

## Thursday, January 24, 1946

### Annual I.R.E. Banquet

Dress Optional

7:30 P.M.-10:30 P.M.

Grand Ballroom

Awarding of Medal of Honor, Morris Liebmann

Memorial Prize, and Fellowship Awards

Address of Retiring President

Speaker: Dr. Frank B. Jewett, President of the National Academy of Sciences

Toastmaster: Mr. Edgar Kobak, President of the Mutual Broadcasting System, Inc.

## Friday, January 25, 1946

9:00 A.M.-5:00 P.M. Registration and Promenade Sale of Tickets  
9:00 A.M.-10:00 P.M. Radio Engineering Show Eighth and Tenth Floors

### Technical Sessions

9:30 A.M.-12:00 NOON

#### Group A

Grand Ballroom  
Microwave Vacuum Tubes

#### Group B

Rose Room  
Antennas

## Friday, January 25, 1946

### President's Luncheon

Honoring President Frederick B. Llewellyn

12:30 P.M.

Grand Ballroom

Speaker: Mr. Paul Porter, Chairman, Federal Communications Commission

Master of Ceremonies: Mr. Ronald J. Rockwell, Engineering Director, Broadcasting Division, The Crosley Corporation

## Friday, January 25, 1946

### Technical Sessions

2:00 P.M.-5:30 P.M.

#### Group A

Grand Ballroom  
Radar

#### Group C

Coral Room  
Crystal Rectifiers

#### Group B

Rose Room  
Microwave Technique

## Friday, January 25, 1946

### Cocktail Party

6:30 P.M.-8:00 P.M.

Grand Ballroom

## Saturday, January 26, 1946

9:00 A.M.-3:00 P.M. Registration Promenade  
9:00 A.M.-2:00 P.M. Radio Engineering Show Eighth and Tenth Floors

### Technical Sessions

9:30 A.M.-12:00 NOON

#### Group A

Grand Ballroom  
Industrial Electronics

#### Group C

Coral Room  
Radio Propagation

#### Group B

Rose Room  
Communication Systems and Relay Links

# Radio Engineering Show—I.R.E. 1946 Winter Technical Meeting

- |  |   |   |
|--|---|---|
| <p>Airadio, Inc.<br/>Aircraft Marine Products, Inc.<br/>Aircraft Radio Corporation<br/>Aireon Manufacturing Corporation<br/>Alden Products Company<br/>Alpha Wire Corporation<br/>Altec Lansing Corporation<br/>American Brass Company<br/>American Lava Corporation<br/>American Phenolic Corporation<br/>American Telephone and Telegraph Company<br/>American Transformer Company<br/>Amperex Electronic Corporation<br/>Andrew Company</p> <p>Ballantine Laboratories, Inc.<br/>Alfred W. Barber Laboratories<br/>Barker and Williamson<br/>Bird Engineering Company<br/>Boonton Radio Corporation<br/>Brush Development Company<br/>H. H. Buggie and Company<br/>Burndy Engineering Company, Inc.</p> <p>Allen D. Cardwell Manufacturing Corporation<br/>Centralab, Division of Globe-Union, Inc.<br/>Cherry Rivet Company<br/>Sigmund Cohn and Company<br/>Collins Radio Company<br/>Communication Measurements Laboratory<br/>Communication Products Company, Inc.<br/><i>Communications</i><br/>Condenser Products Company<br/>Continental-Diamond Fibre Company<br/>Cornell-Dubilier Electric Corporation<br/>Corning Glass Works<br/>Cornish Wire Company, Inc.<br/>Crystal Research Laboratories, Inc.</p> <p>Daven Company<br/>DeMornay-Budd, Inc.<br/>Tobe Deutschmann Corporation<br/>Distillation Products, Inc.<br/>John C. Dolph Company<br/>Allen B. DuMont Laboratories, Inc.<br/>DX Radio Products Company<br/>Dynamic Air Engineering</p> <p>Eastern Engineering Company<br/>Eicor, Inc.<br/>Eitel-McCullough, Inc.</p> | <p>Electrical Reactance Corporation<br/>Electronic Laboratories, Inc.<br/>Electronic Mechanics, Inc.<br/>Electro-Voice, Inc.<br/><i>Electronic Industries Electronics</i><br/>Erie Resistor Corporation</p> <p>Fairchild Camera and Instrument Corporation<br/>Fansteel Metallurgical Corporation<br/>Federal Telephone and Radio Corporation<br/>Ferris Instruments Company<br/><i>F M and Television Magazine</i><br/>A. W. Franklin Manufacturing Corporation</p> <p>General Electric Company<br/>General Electronics, Inc.<br/>General Radio Company<br/>Globe Wireless, Ltd.</p> <p>Hallicrafters Company<br/>Hammarlund Manufacturing Company, Inc.<br/>Harco Tower, Inc.<br/>Frederick Hart and Company, Inc.<br/>Hewlett-Packard Company<br/>Hytron Radio and Electronics Corporation</p> <p>Industrial Instruments, Inc.<br/>Industrial Products Company<br/>Instrument Electronics<br/>Instrument Specialties Company, Inc.<br/>International Nickel Company, Inc.<br/>International Resistance Company</p> <p>J-B-T Instruments, Inc.<br/>Jefferson-Travis Corporation<br/>E. F. Johnson Company</p> <p>Karp Metal Products Company, Inc.</p> <p>Langevin Company, Inc.</p> <p>Machlett Laboratories, Inc.<br/>Madison Electrical Products Corporation<br/>Maguire Industries, Inc.<br/>Marion Electrical Instrument Company<br/>Measurements Corporation<br/>Mycalex Corporation of America</p> <p>National Company, Inc.<br/>National Research Corporation</p> | <p>National Union Radio Corporation<br/>New York Transformer Company<br/>North American Philips Company, Inc.</p> <p>J. P. O'Donnell and Sons<br/>Ohio Tool Company</p> <p>Precision Tube Company<br/>Presto Recording Corporation<br/>Press Wireless, Inc.</p> <p>Radio Corporation of America<br/><i>Radio Craft</i><br/><i>Radio Magazine</i><br/>Radio News<br/>Radio Receptor Company, Inc.<br/>Raytheon Manufacturing Company<br/>Rek-O-Kut Company<br/>Remington-Rand Inc., Electronic Div.</p> <p>Schweitzer Paper Company<br/>Selenium Corporation of America<br/>Shallcross Manufacturing Company<br/>Sherron Electronics Company<br/>Shure Brothers<br/>Sola Electric Company<br/>Solar Manufacturing Corporation<br/>Sorensen and Company, Inc.<br/>Sperry Gyroscope Company, Inc.<br/>Sprague Electric Company<br/>Stackpole Carbon Company<br/>Standard Transformer Corporation<br/>Star Expansion Products Company<br/>Stupakoff Ceramic and Manufacturing Company<br/>Superior Electric Company<br/>Superior Tube Company<br/>Sylvania Electric Products, Inc.</p> <p>Telequip Radio Company<br/><i>Television Magazine</i><br/>Turney and Beale</p> <p>U. S. Television Manufacturing Corporation<br/>United Transformer Corporation</p> <p>Ward Leonard Electric Company<br/>Western Electric Company<br/>Western Lithograph Company<br/>Westinghouse Electric Corporation</p> <p>Yardeny Engineering Company</p> |
|--|---|---|

## Technical Sessions

2:00 P.M.—4:00 P.M.

**Group A**  
Grand Ballroom  
Broadcast Receivers

**Group B**  
Rose Room  
Quartz Crystals

## Final Adjournment

4:00 P.M.

## Committee Meetings

(Open to Members of Committees Only)

## Wednesday, January 23, 1946

MORNING

Antennas  
Frequency Modulation

Radio Receivers  
Radio Wave Propagation

AFTERNOON

Circuits  
Membership  
Railway and Vehicular Communications

Research  
Television  
Vacuum Tubes

## Thursday, January 24, 1946

MORNING

Education

Standards

AFTERNOON  
Public Relations

# Institute News and Radio Notes

## Board of Directors

**November 7 Meeting:** At the regular meeting of the Board of Directors, which was held on November 7, 1945, the following were present: W. L. Everitt, president; G. W. Bailey, executive secretary; S. L. Bailey, W. L. Barrow, E. F. Carter, R. F. Guy, R. A. Heising, treasurer; Keith Henney, F. B. Llewellyn, Haraden Pratt, secretary; B. E. Shackelford, W. O. Swinyard, H. M. Turner, H. A. Wheeler, L. P. Wheeler, and W. C. White.

**Approval of Executive Committee Actions:** The actions of the Executive Committee taken at its October 3, 1945, meeting were unanimously approved.

**Annual Meeting of the Board:** The Annual Meeting of the Board of Directors will be held on January 9, 1946.

### Elections

The report of the Tellers Committee was accepted and the following nominees declared elected:

President—1946

F. B. Llewellyn

VICE-PRESIDENT—1946

E. M. Deloraine

DIRECTORS—1946-1948

W. R. G. Baker      V. M. Graham  
D. B. Sinclair

### Committee

The following were selected as members of the Appointments Committee:

F. B. Llewellyn, *Chairman*

S. L. Bailey      L. C. F. Horle  
W. L. Everitt      B. E. Shackelford  
Keith Henney      D. B. Sinclair

**Duplicate Publication of Papers:** The Board of Directors established the following policy in connection with duplicate publication of papers:

"While in general it is the policy not to publish papers which have appeared elsewhere; nevertheless, in certain cases of outstanding importance, that policy shall not be considered obligatory."

**Dr. Alfred N. Goldsmith:** The Board extended expressions of sympathy in the illness of Dr. Goldsmith with best wishes for a speedy recovery and a return to his duties.

### Browder J. Thompson

**Memorial Fund:** A check for \$4000 for the Browder J. Thompson Memorial Fund was presented and an account of the status of the Memorial program outlined.

**Award:** The Browder J. Thompson Award was established in the manner and under the specifications outlined in the letter from Dr. R. R. Law to Mr. Pratt dated October 29, 1945, part of which is as follows:

"This award shall be known as the Browder J. Thompson Memorial Prize. Its purpose shall be to stimulate re-

search in the field of radio and electronics and to provide incentive for the careful preparation of papers describing such research. The award shall be made annually to the author or joint authors under thirty years of age at date of submission of original manuscript (in case of joint authorship, all authors shall be under thirty years of age at date of submission of original manuscript) for that paper of sound merit recently published in the technical publications of The Institute of Radio Engineers which, in the opinion of the Awards Committee of the Institute, constitutes the best combination of technical contribution to the field of radio and electronics and presentation of the subject."

**RTPB:** It was unanimously approved that The Institute of Radio Engineers contribute toward the expenses of the Radio Technical Planning Board.

**Co-operation and Liaison between I.R.E. and Foreign Societies:** It was unanimously approved that the Board request the Executive Secretaries of the Institution of Electrical Engineers, London, England, and the Société Française des Radioélectriciens, Paris, France, to co-operate in publishing in the PROCEEDINGS of the I.R.E. and WAVES AND ELECTRONS and both foreign publications statements inviting visitors from engineering societies abroad to get in touch with I.R.E., the British Society, and the Société Française, and that further co-operation between the societies and the I.R.E. be carried out.

## Executive Committee

**November 7 Meeting:** The Executive Committee Meeting, held on November 7, 1945, was attended by W. L. Everitt, president; G. W. Bailey, executive secretary; S. L. Bailey, W. L. Barrow, E. F. Carter, R. A. Heising, treasurer; and Haraden Pratt, secretary.

**Membership:** Approval was given to the 371 applications for membership in the Institute as listed on page 38A of the December, 1945, issue of the PROCEEDINGS. These applications are as follows:

For Transfer to Senior Member Grade	25
For Admission to Senior Member Grade	12
For Transfer to Member Grade	76
For Admission to Member Grade	90
For Admission to Associate Grade	129
For Admission to Student Grade	39
	371

**Editorial Department:** Because of the temporary incapacity of the Editor to carry out his responsibilities, the Technical Editor, Mr. R. D. Rettenmeyer, was assigned to the special duty of Director of the Editorial Staff, reporting to the Executive Secretary.

**Yearbook:** The Yearbook will be sold to nonmembers for \$5.00.

**Broadcast Engineering Conference:** The Institute of Radio Engineers will continue co-operation with The Ohio State University and the University of Illinois and the National Association of Broadcasters in the Broadcast Engineering Conference which is to be held at the Ohio State University in Columbus, Ohio, during the week of March 18 to 23, 1946.

**I.R.E.-RMA Committee:** Raymond F. Guy, chairman of the Standards Committee, was invited as a representative of the I.R.E. to attend the meeting of the Executive Committee of the RMA Engineering Department which was held in Rochester on November 12, 1945. The recommendations of the I.R.E.-RMA Co-ordination Committee which was chiefly concerned with joint standards were accepted and approved.

## ROCHESTER FALL MEETING

Over one thousand registrants at the Rochester Fall Meeting, held on November 12 and 13, discussed their individual and industry problems and certain wartime and

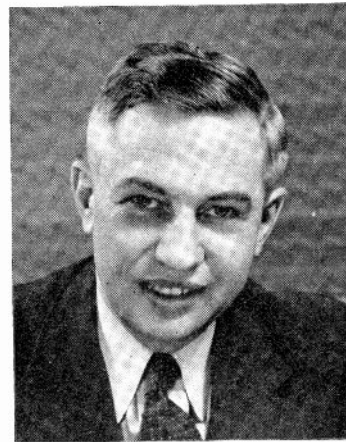

LEE A. DUBRIDGE

postwar developments. The Fall Meeting Committee awarded a plaque for distinguished service to Dr. Lee Du Bridge, director of the Radiation Laboratory, for the able manner in which he administered the vast National Defense Research Committee project which led to radar and our widespread and effective use of it during the war. At the banquet, Dr. Du Bridge outlined the capabilities and possibilities of the use of radar in a war-free world, especially in its service to navigational problems and to the safe flight landing of airplanes in all kinds of weather conditions.

The following papers were delivered to capacity audiences of those in attendance at the 1945 Meeting:

"A Coaxial Modification of the Butterfly Circuit," by E. E. Gross of General Radio Company, contained considerable information on the mechanical problems arising in



constructing measuring equipment to operate in the thousand-megacycle regions.

"The Radio Proximity Fuze," by H. Trotter, Jr., of the Eastman Kodak Company, and "Proximity-Fuze Tubes," by Marcus A. Acheson of Sylvania Electric Products, Inc., not only disclosed a great deal of data on the use of these remarkable wartime devices but went to considerable length into the construction of the miniature tubes that made the fuzes possible.

"Microwave Radar," by Donald G. Fink of *Electronics*, brought engineers up to the minute on material that has been released for discussion. This included descriptions, including illustrations, of the apparatus for applying radar on frequencies as high as 10,000 megacycles and interesting facts about the actual usage to which radar was put during the war.

"High-Quality Sound Recording on Magnetic Wire," by L. C. Holmes of Stromberg-Carlson Company, gave those present a revelation of the advances that have been made in extending the frequency range and decreasing the distortion in wire recording. Demonstrations from RCA's new "unbreakable" vinylite records indicated not only the low record noise and wide dynamic range but also the fact that there is now very little difference between disk and wire recording, provided both are done correctly.

"The Aurora and Geomagnetism," by C. W. Gartlein of Cornell University, entertained the audience with many of the still unresolved perplexities of the aurora and of the effects of magnetic storms on communication. The lecture was illustrated with many photographs, including some in color, of aurora displays.

"Recent Developments on Converter Tubes," by W. A. Harris and R. F. Dunn of the Radio Corporation of America, discussed a new oscillator mixer good at 100 megacycles and above and thus applicable to the new frequency-modulation receivers. This tube has sufficiently high transconductance to be useful at the frequency indicated and sufficient conversion transconductance to operate at a 5- to 10-microvolt input level.

"War Influence on Acoustic Trends," by Hugh S. Knowles of the Jensen Radio Manufacturing Company, revealed much of the wartime usage of acoustic equipment and materials for morale (plus and minus), for training purposes, for getting speech and other forms of intelligence into and out of regions of high ambient-noise levels plus descriptions of "Bull" horns, "squawk" boxes, and other acoustic devices.

"Germanium Crystals," by Edward Cornelius of Sylvania Electric Products, Inc., gave many details of the wartime renaissance of crystal detectors indicating that the long-dormant crystal was henceforth a device to be reckoned with, due to modern engineering.

Television was treated by D. B. Smith of Philco Corporation in his paper "Industry Standardization Work in Television" and by E. W. Engstrom of the Radio Corporation of America who presented "A Review of the Technical Status." Under the title "Comments on Existing Television Systems from the Measurement Viewpoint," Jerry Minter of Measurements Corporation proposed that the carrier of the television sys-

tem be amplitude-modulated for the picture and that the same carrier be frequency-modulated for sound; that receiver intermediate-frequency stages be matched to the transmitter characteristics resulting in over-emphasis of the low-frequency video signals and that the high frequencies be brought up to match the low frequencies by "post-emphasis." These proposals evoked considerable discussion from the floor.

Not on the official program was a paper by C. W. Carnahan of the Zenith Radio Corporation giving the results of recent measurements on the comparative efficacy of the present frequency-modulation band and the new band (100 megacycles) at distances of 75 miles. A lively discussion over frequency-modulation allocations followed the presentation of the paper.

### JOINT ELECTRON TUBE ENGINEERING COUNCIL

O. W. Pike (A'26-M'29-SM'43), chairman of the Joint Electron Tube Engineering Council, the newly formed agency of the National Electrical Manufacturers Association and the Radio Manufacturers Association, recently announced the complete organization of the Council which includes L. C. Hector (A'26-SM'43), A. Senauke (M'28-SM'43), G. R. Shaw (M'40-SM'43), and R. M. Wise (A'26-M'30-F'37). The Council approves standards before they are forwarded to NEMA and RMA and provides executive decisions as required. It also has the responsibility of guiding the seven committees established to deal with individual classes of tubes and the four committees established to co-ordinate such matters as sampling procedures, packaging, type designations, and mechanical standards.

Broad general policies and matters of financing the activities of JETEC are subject to approval of the Boards of RMA and NEMA handled by the directors of the Council who include W. R. G. Baker (A'19-F'28). Most of the work of JETEC during the past months has dealt with the needs of the Armed Services for the standardization of electron tubes necessary to the war. The Council, however, is primarily a peacetime organization and has been devoting some of its energy to postwar problems such as improved methods of defining tube types more accurately so that equipment may be designed with a better understanding of the problems of tube interchangeability.

### RADIO INDUSTRY'S WAR PRODUCTION

With a total war output of approximately 7½ billion dollars, the radio industry produced nearly twice as much radio-radar communications equipment during the war than it produced radio equipment alone for civilian use in all the years since commercial radio began about 1922. This was recently revealed by the Radio Manufacturers Association which has just received new production records of the War Production Board Radio and Radar Division.

From January, 1942, until the war ended last summer, the radio industry's war production mounted to the huge total of

\$7,220,000,000, the records show. In addition, the industry produced about \$250,000,000 in military equipment from September, 1941, until the end of that year, according to the Radio Manufacturers Association, bringing the aggregate contribution to the war effort to close to the 7½ billion mark.

Best industry and trade statistics show that in the entire period of civilian radio beginning in 1922, the total volume of radio equipment manufactured was about \$4,225,000,000, not including transmitting and communications equipment, the association announced. This is some 3¼ billion dollars less than the production total for war.



### WESTMAN AMENDMENT

The Westman Amendment, voting on an increase in membership dues, was passed by the members in August 1945.

Effective as of January 1, 1946, the new dues rate will be as follows:

Fellow.....	\$10.00
Senior Member.....	10.00
Member.....	10.00
Associate... \$10.00 and \$7.00*	
Student.....	3.00

\* \$7.00 for each year that is within the first five years of Associate membership, starting January 1, 1946. After five years the dues automatically shall be increased from \$7.00 to \$10.00. The five-year period is retroactive from January 1, 1946.

This constitutional amendment also discontinued the payment of all transfer fees and set the entrance fee at \$3.00 for all membership grades with the exception of the Student grade which does not require an entrance fee.



### THE INSTITUTION OF ELECTRICAL ENGINEERS (ENGLAND)

The Institution of Electrical Engineers has offered I.R.E. members the privilege of subscribing for its named publications at the listed prices, which are half of the normal annual rates:

#### JOURNAL

Part I (General).....	10s.6d. (\$2)
Part II (Power Engineering) ..	15s.9d. (\$3)
Part III (Radio and Communication Engineering)....	10s.6d. (\$3)

or

all three Parts together.. 31s.6d. (\$6) per annum.

#### SCIENCE ABSTRACTS

Section A (Physics Abstracts).....	17s.6d. (\$3.50)
Section B (Electrical Engineering Abstracts).....	17s.6d. (\$3.50)

or

both Sections together..... 30s.0d. (\$6)

A similar reduction (one half) on the PROCEEDINGS of the I.R.E. and WAVES and ELECTRONS in case of the IEE members will result in the special rate of \$6.00 a year (which includes \$1.00 foreign postage).



NELSON P. CASE

## NELSON P. CASE

Nelson P. Case (A'26-M'31-SM'43) has joined the staff of the Hallicrafters Company, Chicago Illinois, as chief engineer of the receiver division.

In 1924, Mr. Case was graduated from Stanford University with an A.B. degree in physics, and in 1926 he received an E.E. degree. He became active in geophysical work and held the position of assistant physicist at the Bureau of Standards, Washington, D. C., in 1928. The following year, Mr. Case was named research physicist in the department of engineering research at the University of Michigan. In 1930, he became a member of the staff of Hazeltine Electronics Corporation where he was engaged in various capacities for thirteen years, later having charge of the New York license laboratory of that organization. For the past two years, Mr. Case has been director of engineering design and development for the Hamilton Radio Corporation in New York City.

Mr. Case, holder of approximately thirty patents on radio-receiver circuits, is vice-chairman of the committee on broadcast and short-wave home receivers of the Radio Manufacturers Association's engineering department. He also serves on various other committees of this organization; namely, television receivers, systems, very-high-frequency receivers, and the executive committee of the engineering department's receiver section. Mr. Case is a member of Panel 6—Television Panel—of the Radio Technical Planning Board, a Fellow of the Radio Club of America, and a member of Phi Beta Kappa and Sigma Xi.



## E. FINLEY CARTER

E. Finley Carter (A'23-F'36) recently was elected a vice president in charge of industrial relations of Sylvania Electric Products, Inc. Previously he was chief radio engineer and later, as director of industrial relations he set up the company's industrial

relations department. He will continue to be responsible for this function.

After he was graduated from Rice Institute in 1922, Mr. Carter joined the General Electric Company as a development engineer in the development of three early high-power transmitters, WGY in Schenectady, KGO in Oakland, and KOA in Denver. He was division engineer in charge of the special development division, handling television and the facsimile development program. In May, 1929, he became director of the engineering division of United Research Corporation, a subsidiary of Warner Pictures, designing radios, circuits, and receivers.

Mr. Carter was a director of The Institute of Radio Engineers in 1945 and is an Associate member of the American Institute of Electrical Engineers.



E. FINLEY CARTER



## HERBERT J. REICH

Herbert J. Reich (A'26-M'41-SM'43), educator and author of scientific articles and textbooks, has been appointed professor of electrical engineering at Yale University, his work starting on January 1, 1946.

Dr. Reich was born on Staten Island, New York, on October 25, 1900. He received the M.E. degree from Cornell University in 1924, and the Ph.D. degree in physics in 1929. Since that time he has been on the staff of the University of Illinois, where he was professor of electrical engineering. On January 1, 1944, he was granted a leave of absence to join the staff of the radio research laboratory at Harvard University.

He has specialized in the field of electron tubes and electron-tube circuits, and has published approximately forty papers on these and related subjects in technical periodicals. He is author of "Theory and Applications of Electron Tubes," "Principles of Electron Tubes," and co-author of "Ultra-High-Frequency Techniques."

Professor Reich is a Senior Member of the Institute of Radio Engineers. He has



HERBERT J. REICH

served on the Board of Editors and several committees. During 1944, he was a Member of the Board of Directors of The Institute of Radio Engineers. He is a member of the American Institute of Electrical Engineers, the American Physical Society, the American Association for the Advancement of Science, and the Society for the Promotion of Engineering Education.



## ROBERT J. GLEASON APPOINTED COMMUNICATIONS SUPERINTENDENT

Robert J. Gleason (A'31-M'39-SM'43) recently was appointed communications superintendent of the Pacific-Alaska Division, Pan American World Airways, with headquarters in San Francisco.

Mr. Gleason, who served with the U.S. Army since September, 1942, has been released from active service, in which he was a Lieutenant Colonel. During the past three years he served successively in Alaska, in the Aleutians, where he was in charge of all airways communications and was directly responsible for the installation of all radio communications in the Aleutian chain, in India and China, where since 1944 he was in charge of the 69th Army airways communications system and the 63rd AACSG group in Kunming, China. These radio ground facilities served the 14th Air Forces under Major General Claire Chennault and the Indo-China Wing of the ATC. All "over the hump" flying between India and China was dependent on the Kunming communications center.

Originally joining Pan American in 1932, Mr. Gleason helped pioneer developments in Alaska first as chief operator in Fairbanks and later as communications superintendent for the company's operations throughout that area. He supervised the installation of communications facilities from Fairbanks to Juneau as well as fourteen of the radio stations throughout Alaska and Canada.

# I.R.E. People

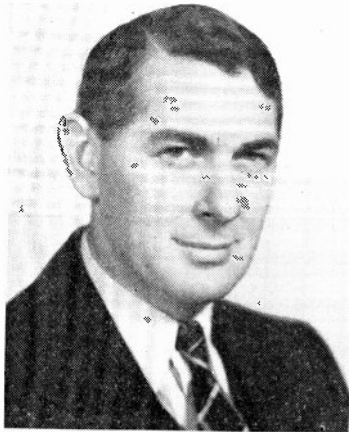

CLURE H. OWEN

## CLURE H. OWEN

Clure H. Owen (A'32) joined the general engineering department of the American Broadcasting Company on October 1, 1945, as allocations engineer.

He will study allocations problems for standard-broadcast, frequency-modulation, and television facilities; be responsible for the design of directional-antenna systems; determine the location of suitable transmitter sites; and generally work towards the improvement of network coverage. He also will co-operate with the station relations department of the American Broadcasting Company in advising affiliates regarding allocation problems. Prior to joining the American Broadcasting Company, Mr. Owen was with the Federal Communications Commission as assistant chief of the broadcast-engineering division.



## LLOYD C. SIGMON

Major Lloyd C. Sigmon (A'29) has been appointed radio communications officer for the U. S. Group Control Council at Berlin. In recognition of his services in the European Theater of Operations, Major Sigmon was awarded the Legion of Merit Medal, and was made an honorary member of the French Signal Corps for his assistance to that organization. He has also recently been given the Order of the British Empire.

In prior years, Major Sigmon attended the school of electrical engineering, Milwaukee, Wisconsin, and from 1935 to 1940, was chief engineer for KCMO, Kansas City, Missouri. He then held the position of director of engineering for KMPC, Los Angeles, California, until his entry into the Armed Services as Captain in the U. S. Army Signal Corps in 1943. Shortly thereafter, he became chief radio engineer officer for communications in the European Theater. Before June of 1944, Major Sigmon selected

the sites and directed the installation and operation of high-frequency and very-high-frequency radio stations in the United Kingdom for transatlantic and cross-channel communications in support of military operations on and after D Day. This included the planning for and implementation of the system which carried, throughout the world, the first news of the Allied invasion of the Continent.

Major Sigmon became engaged in the provision of radio communications facilities for Headquarters, European Theater of Operations, in Paris, where twelve high-power, high-frequency radio transmitting and receiving equipments were made operational within a month after that city's liberation. Upon completion of this project, he began the building of high-power mobile



LLOYD C. SIGMON

radioteletype stations to provide rapidly installed communications in support of the armies advancing in Germany. Among these is the 60-kilowatt, multichannel, suppressed-carrier, radioteletype, and radiotelephone station, whose equipment in actual operations was serviceable within twelve hours in Germany, providing the first army communications from that country to the United States.



## MAJOR ARMSTRONG TALKS ON FREQUENCY MODULATION

"Frequency Modulation is now coming into its rightful place in the communication field," said Major Edwin H. Armstrong (A'14-F'27) in an address delivered before the Cedar Rapids Section of The Institute of Radio Engineers on October 24.

Major Armstrong sketched the history of frequency modulation and compared it with amplitude modulation in regard to noise and distortion. Using charts to illustrate his talk, he said that noise and distortion are inherent in both the transmission and reception of amplitude-modulation signals, and that if pre-emphasis were used to

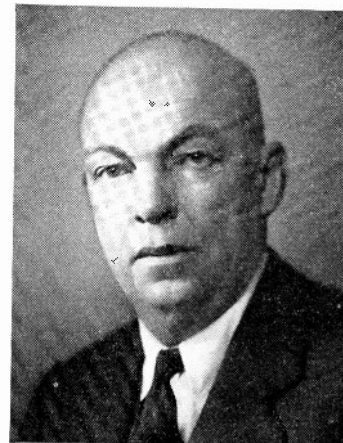

Bachrach

EDWIN H. ARMSTRONG

bring up the high audio response, distortion in amplitude-modulation is aggravated. He pointed out that the use of "exalted carrier" in an amplitude-modulation receiver greatly improves the quality of reception.

"Distortion due to multipath transmission is practically nonexistent in frequency modulation," said Armstrong. He recounted his extensive investigation into that phenomenon, and his conclusion that multipath transmission would cause distortion only in mountainous country, and then only in extremely small areas.

The Major predicted that an 80-mile radius could be served from one frequency-modulation station without the aid of booster transmitters. The variety of programs transmitted and the number of different stations required for a given locality will be about the same as the existing amplitude-modulation service.

The frequency-modulation receivers will have to be of very high quality and will be relatively expensive if they are to be capable of reproducing frequency-modulation transmissions with the high quality that is possible with frequency-modulation.

Discussing the inception of frequency modulation, Major Armstrong said that he started looking for a static eliminator back about 1914, and that he worked a little longer than most people did. He then hit upon the idea of frequency shift-keying, and from that went into frequency modulation.



## JOHN J. GUARRERA

John J. Guarrera (S'42-A'44), formerly a staff member of the Radiation Laboratory, Massachusetts Institute of Technology, is now affiliated with the engineering staff of Bernard Rice's Sons, Inc., New York, which during the war produced a wide range of electronic devices. It will continue to develop, engineer, and manufacture in the microwave, ultra-high-frequency, and radio-frequency fields.

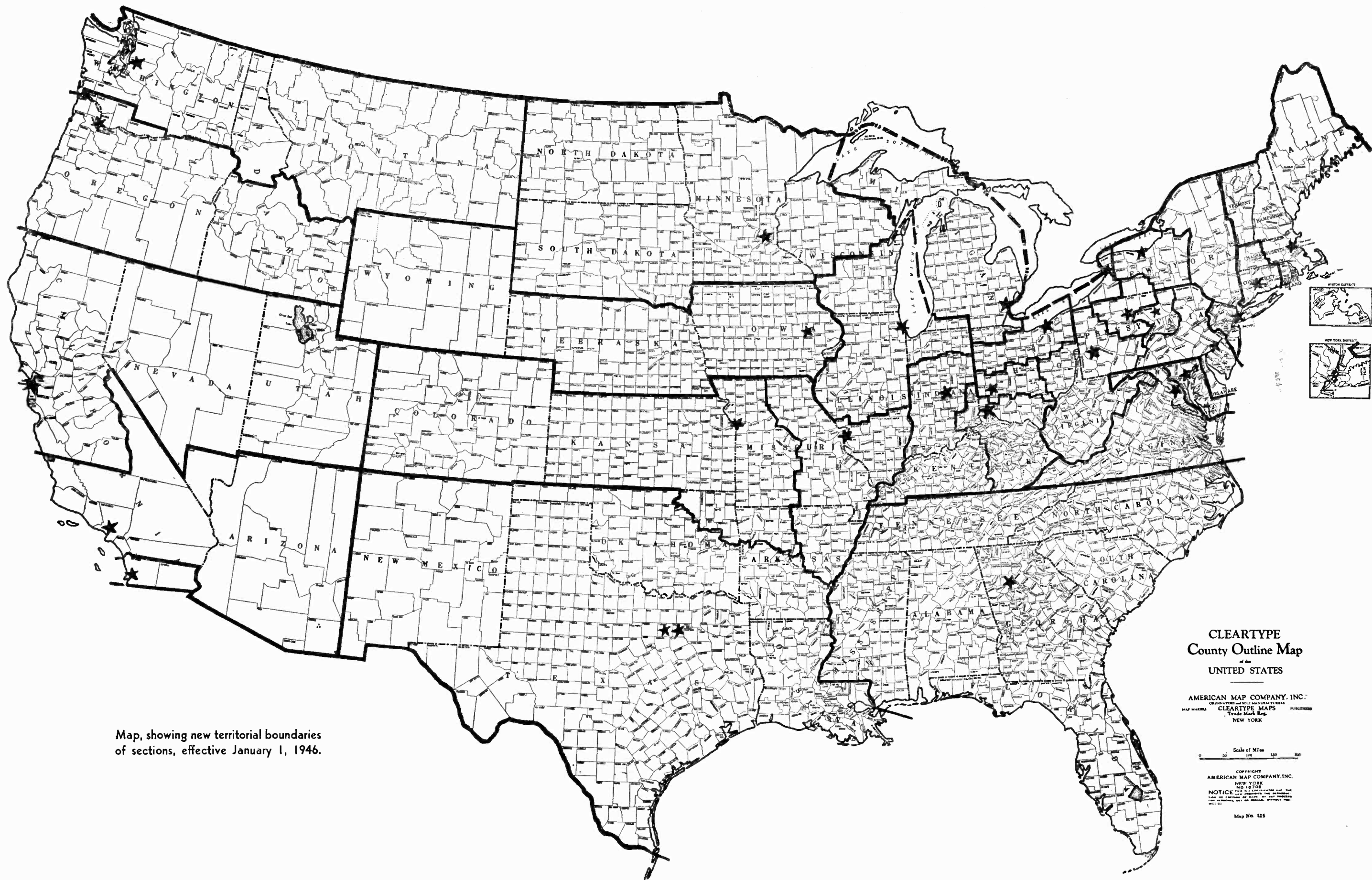

Map, showing new territorial boundaries of sections, effective January 1, 1946.

**CLEARTYPE**  
**County Outline Map**  
 of the  
**UNITED STATES**

AMERICAN MAP COMPANY, INC.  
ORIGINATORS and SOLE MANUFACTURERS  
 MAP MAKERS CLEAR-TYPE MAPS PUBLISHERS  
 Trade Mark Reg. NEW YORK

Scale of Miles  
 0 50 100 150 200

COPYRIGHT  
 AMERICAN MAP COMPANY, INC.  
 NEW YORK  
 NO. 10702  
 NOTICE: This map is published under the authority of the Copyright Act of 1909, and the Copyright Act of 1976, and is protected by the laws of the United States and other countries.

Map No. 125



# ORGANIZATION CHART

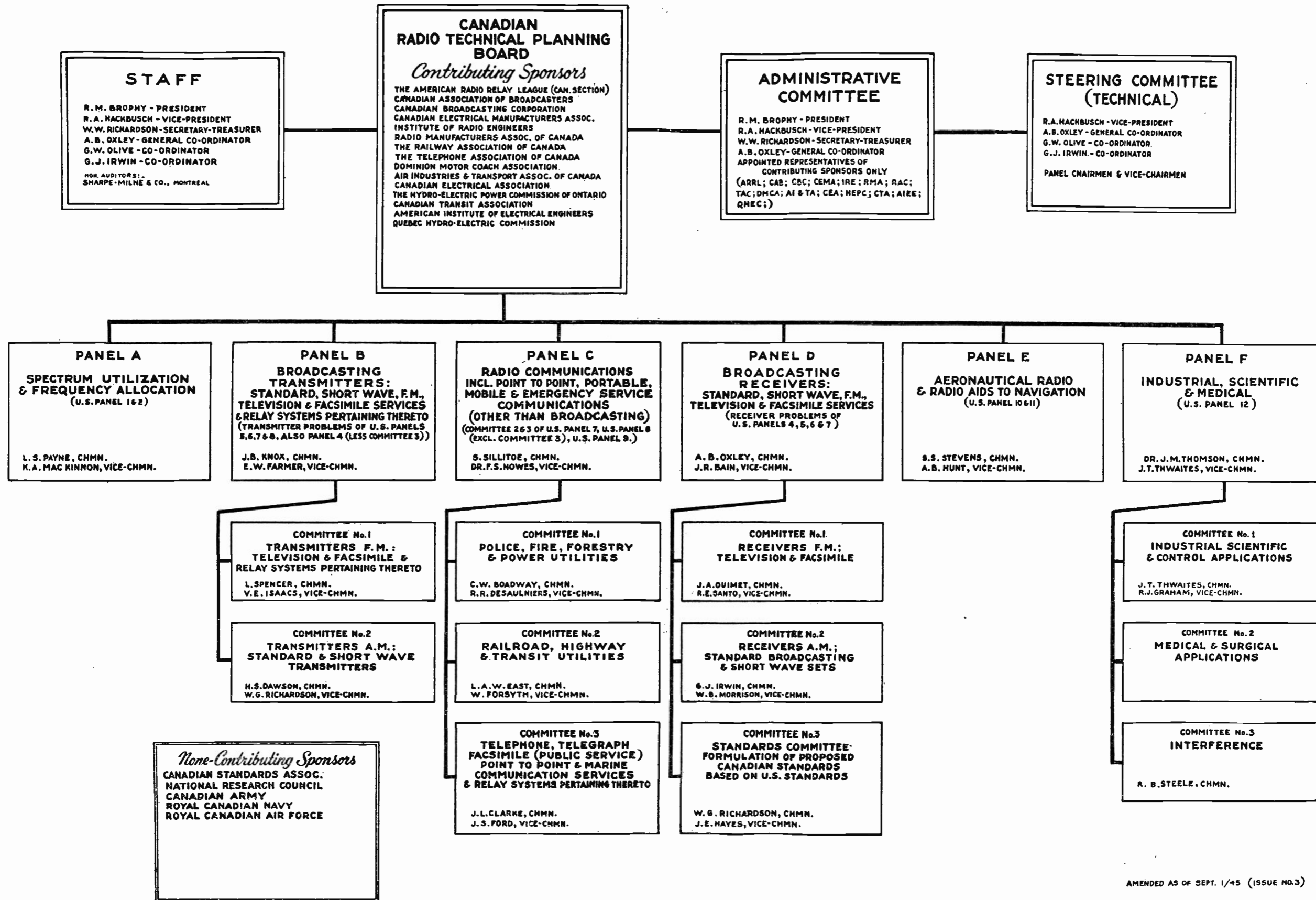



SECTIONS

Chairman		Secretary
R. A. Holbrook 146 Lawrenceville Rd. Decatur, Ga.	ATLANTA January 18	I. M. Miles 554 14 St., N.W. Atlanta, Ga.
R. N. Harmon 1920 South Rd. Mt. Washington, Baltimore, Md.	BALTIMORE	F. W. Fischer 714 S. Beechfield Ave. Baltimore, Md.
C. C. Harris Tropical Radio Telegraph Co. Box 584, Hingham, Mass.	BOSTON	A. G. Bosquet General Radio Co. 275 Massachusetts Ave. Cambridge 39, Mass.
A. DiMarco Carabobo 105 Buenos Aires, Argentina	BUENOS AIRES	H. Krahenbuhl Transradio Internacional San Martin 379 Buenos Aires, Argentina
J. M. Van Baalen 282 Orchard Dr. Buffalo 17, N. Y.	BUFFALO-NIAGARA January 16	H. W. Staderman 264 Loring Ave. Buffalo, N. Y.
F. M. Davis Collins Radio Co. 855 35 St., N.E. Cedar Rapids, Iowa	CEDAR RAPIDS	J. A. Green Collins Radio Co. 855 35 St., N.E. Cedar Rapids, Iowa
Cullen Moore 327 Potomac Ave. Lombard, Ill.	CHICAGO January 18	L. E. Packard General Radio Co. 920 S. Michigan Ave. Chicago 5, Ill.
J. D. Reid Box 67 Cincinnati 31, Ohio	CINCINNATI January 15 Engineering Society Headquarters "Sound and Hearing" John D. Reid	P. J. Konkle 5524 Hamilton Ave. Cincinnati 24, Ohio
H. B. Okeson 4362 W. 58 St. Cleveland 9, Ohio	CLEVELAND January 24	A. J. Kres 16911 Valleyview Ave. Cleveland 11, Ohio
H. W. Sundius Southern New England Tele- phone Co. New Haven, Conn.	CONNECTICUT VALLEY January 17 HARTFORD "The Motorola Walki-Talkie, Handi-Talkie and the New 152-160 Megacycle Portable Mobile Equipment" Daniel E. Noble	L. A. Reilly 989 Roosevelt Ave. Springfield, Mass.
J. D. Mathis 811 Telephone Bldg. Dallas, Texas	DALLAS-Ft. WORTH	B. B. Honeycutt 9025 Roanoak Dallas 18, Texas
L. B. Hallman 3 Crescent Blvd. Southern Hills Dayton, Ohio	DAYTON January 16 Dayton Engineers' Club "Electronic Aspects of the Geiger-Mueller Counter Tube and Spectrometer" Josef Heyd and Dexter H. Reynolds	Joseph General 411 E. Bruce Ave. Dayton 5, Ohio
L. H. Larime Technical Service, Inc. 693 Monroe St. Detroit 26, Mich.	DETROIT January 18	R. R. Barnes 1810 Sycamore Royal Oak, Mich.
N. L. Kiser Sylvania Electric Products, Inc. Emporium, Pa.	EMPORIUM February 7 "Sound Recording on Mag- netic Wire" L. C. Holmes	D. J. Knowles Sylvania Electric Products, Inc. Emporium, Pa.
H. I. Metz Civil Aeronautics Authority Experimental Station Indianapolis, Ind.	INDIANAPOLIS	V. A. Bernier 5211 E. 10 Indianapolis, Ind.
R. N. White 4800 Jefferson St. Kansas City, Mo.	KANSAS CITY	Mrs. G. L. Curtis 6003 El Monte Mission, Kansas
B. S. Graham Sparton of Canada, Ltd. London, Ont., Canada	LONDON, ONTARIO	C. H. Langford Langford Radio Co. 246 Dundas St. London, Ont., Canada

Books

Elementary Electric-Circuit Theory, by Richard H. Frazier

Published (1945) by McGraw-Hill Book Co., Inc., 330 W. 42 St., New York 18, N. Y. 424 pages+10-page index+ix pages. 267 illustrations. 5½×8½ inches. Price, \$4.00.

This book treats elementary electric-circuit theory on a general broad basis which takes advantage of the present-day overlapping of the electric-power, communications, and electronics fields. The problems, illustrative examples, and figures are carefully selected from all of these fields to give the student the broad base so important today. The book is designed to provide the technical foundation in circuit analysis in electrical-engineering courses irrespective of the expected branches of specialization.

A knowledge of physics and mathematics usually acquired by the end of the sophomore year is sufficient for successful use of this text. The author claims no great glee in going out of his way to use a sophisticated mathematical approach, nor does he cramp the development of subjects by avoiding mathematics. A familiarity with the concepts of the differential and integral calculus and a mastery of algebra and plane trigonometry are prerequisites.

The book opens with a chapter on electric-circuit definitions and concepts which establishes a common starting point in such things as the frequency spectrum, fields and circuits, circuit elements, symbols, and terminology. Resistance networks are then treated because their simplicity allows concentration on principles. Chapters on basic alternating-current concepts and complex algebra lay the foundation for the chapter on impedance networks. Nonsinusoidal waves and polyphase networks are then covered in separate chapters. The last chapter deals with the classical method of transient analysis. Abbreviated tables in the appendix supply sufficient data for the problems found at the end of each chapter. A welcome feature rarely found in such texts is reference to historical sources such as the basic works of Ampere, Joule, Ohm, Coulomb and others.

The author has done a commendable job in arrangement and exposition, especially from the pedagogical standpoint.

F. ALTON EVEREST  
Moody Institute of Science  
947 Stanford St., Santa Monica, Calif



Chairman		Secretary
Fred Ireland General Radio Co. 1000 N. Steward St. Hollywood, Calif.	LOS ANGELES January 15	Walter Kenworth 1427 Lafayette St. San Gabriel, Calif.
L. A. W. East Canadian Pacific Railway 204 Hospital St. Montreal, Que., Canada	MONTREAL, QUEBEC February 13	R. R. Desaulniers Canadian Marconi Co. Box 1690 (Place D'Armes) Montreal 1, Que., Canada
G. B. Hoadley 85 Livingston St. Brooklyn, N. Y.	NEW YORK February 6	J. T. Cimorelli RCA Victor Div. 415 S. Fifth St. Harrison, N. J.
W. A. Steel 298 Sherwood Dr. Ottawa, Ont., Canada	OTTAWA, ONTARIO January 17	L. F. Millet 33 Regent St. Ottawa, Ont., Canada
D. B. Smith Philco Corporation Philadelphia 34, Pa.	PHILADELPHIA	P. M. Craig Philco Corporation Philadelphia 34, Pa.
J. A. Hutcheson 852 N. Meadowcroft Ave. Pittsburgh 16, Pa.	PITTSBURGH January 14 Mellon Institute, 8 P.M. "Magnetic-Tape Recording" L. A. Umbach "Working with Microwaves" R. G. Plaisted and S. A. Leiner	C. W. Gilbert 52 Hathaway Ct. Pittsburgh 21, Pa.
Kenneth Johnson 5212 N.E. 73 St. Portland, Ore.	PORTLAND	C. W. Lund R.F.D. 4, Box 858 Portland, Ore.
G. R. Town Stromberg-Carlson Co. Rochester 3, N. Y.	ROCHESTER January 17	A. E. Newlon Stromberg-Carlson Co. Rochester 3, N. Y.
B. B. Miller 2356 A Lawrence St. St. Louis 10, Mo.	ST. LOUIS	N. J. Zehr 1538 Bradford Ave. St. Louis 14, Mo.
David Kalbfell 941 Rosecrans San Diego, Calif.	SAN DIEGO	Clyde Tirrell U. S. Navy Radio and Sound Laboratory San Diego 52, Calif.
David Packard Hewlett-Packard Co. Palo Alto, Calif.	SAN FRANCISCO	William Barclay 955 N. California Ave. Palo Alto, Calif.
E. H. Smith 823 E. 78 St. Seattle 5, Wash.	SEATTLE February 14	W. R. Hill University of Washington Seattle 5, Wash.
F. H. R. Pounsett Research Enterprises, Ltd. Leaside, Ont., Canada	TORONTO, ONTARIO	Alexander Bow 137 Oxford St. Guelph, Ont., Canada
H. E. Hartig University of Minnesota Minneapolis, Minn.	TWIN CITIES	M. R. Ludwig 315 E. 24 St. Minneapolis, Minn.
H. A. Burroughs Munsey Bldg. Washington 4, D. C.	WASHINGTON January 14	L. C. Smeby 4801 Connecticut Ave., N.W. Washington 8, D. C.
Harry Smithgall Sylvania Electric Products, Inc. Plant No. 1 Williamsport, Pa.	WILLIAMSPORT February 6	F. L. Burroughs 2030 Reed St. Williamsport 39, Pa.

### SUBSECTIONS

R. C. Higgy 2032 Indianola Ave. Columbus, Ohio	COLUMBUS February 8	Warren Bauer 376 Crestview Rd. Columbus 2, Ohio
P. B. Laeser 9410 Harding Rd. Milwaukee, Wisc.	MILWAUKEE	E. L. Cordes 3304 N. Oakland Ave. Milwaukee, Wisc.
L. J. Giacelleto 9 Villa Pl. Eatontown, N. J.	MONMOUTH	C. D. Samuelson 5 Russel Ave. Fort Monmouth, N. J.
W. C. Johnson Princeton University Princeton, N. J.	PRINCETON	J. G. Barry Princeton University Princeton, N. J.
H. E. Ellithorn 417 Parkovash Ave. South Bend 17, Ind.	SOUTH BEND January 17	J. E. Willson WHOT, St. Joseph and Mon- roe Sts. South Bend, Ind.

### Proceedings of the National Electronics Conference

Published (1945) by the National Electronics Conference, Inc. c/o Illinois Institute of Technology, 1951 W. Madison St., Chicago 12, Illinois. 605 pages+x pages. 389 illustrations, 9×6 inches. Price \$3.00.

To the 2000 persons who attended the first National Electronics Conference in Chicago in 1944, this book needs no introduction and little comment. It is a straightforward and carefully edited presentation of fifty-one papers presented at the conference, with brief abstracts of five others. Edited by Messrs. Dudley, Beam, and Foster, of the Conference Publications Committee, the book is divided into sections as follows: General Papers, Electron-Tube Developments, Electronic Measurements and Controls, Communication Electronics, Industrial Electronics, Electronic Aids to Medical Science, and Theoretical Electronics and Design.

It is a tribute to those who organized the Conference that such an array of material was made available, contributed by so many leading figures of the art. The material is up to date as of October, 1944, and the majority portion of it has lasting reference value. The advantage of publication in book form is manifest, not only for reference, but also to permit leisurely perusal of papers heard as well as papers missed because it was physically impossible to attend all the sessions. It is highly recommended.

DONALD G. FINK  
McGraw-Hill Publishing Co.  
New York 18, N. Y.



### SECTION TERRITORY ASSIGNMENT

Early in 1945, the Board of Directors adopted a new policy concerning Section territory in the United States. It was decided that instead of assigning a small territorial area around the city center of each section, the remaining unassigned territory of the United States would be assigned to sections. It was also planned to do the same with Canada.

The Sections' Committee met and drew up a suggested assignment. The assignment for the United States has been approved and is to take effect January 1, 1946. The proposed assignment for Canada has not yet been approved as the desires of the members and sections in that area have not been received.

The new method of assigning territory means that every member of the Institute in the United States becomes a member of some section. As such he will be on the membership list of his section and should receive notices of meetings.

The assignments were made on the basis of distance and travel habits so far as they were known to the committee. The proposed division was submitted to the Chairmen of all Sections with a request for comments. Several suggestions for changes were made and where there was some doubt about the

wisdom of the changes, polls were taken of the members residing in the areas in question. These areas have now been assigned in accordance with the majority vote received from such members. The attached map, which shows the outlines of the territories for the sections was drawn up and approved.

The assignment of all territory to sections will call for certain new operational policies upon the formation of new sections. Heretofore, the formation of most sections required only the assignment of unassigned area to the proposed new section. A few new sections have been formed which called for removing some area from an older section. Now all new sections will of necessity be carved out of present sections. However, the opportunity for the establishment of new sections will not be reduced at all. The practice followed in such establishment will be modified only to the extent of asking the new and old section officers to agree on their respective areas. If any difference in opinion exists, the Executive Committee will poll the members in any disputed area, or decide the matter upon whatever pertinent information is available.

The assignment of all territory among sections is a prelude to a proposed new arrangement for naming members of the Board of Directors. An effort is being made to have more members on the Board from sections remote from New York and plans are being formulated which it is thought will accomplish this result. Such plans envisage grouping of sections into a few large areas called "Regions" and providing these regions with a co-ordinating council and representation on the Board. In the course of time, therefore, after the necessary constitutional changes have been made, a new type of territorial division will be superimposed upon the sectional division. It is planned that each region will be composed of a number of sections with their territories. The number of these regions, and their boundaries will be determined by the Board

of Directors. In the meantime, the establishment of the new section territories will have gone into effect for a period of time that it is hoped will be sufficiently long to turn up any shortcomings that should be corrected.

It is suggested that all members refer to the map, determine how they are affected, and register any objections before the plans have been carried so far as to involve serious complications in making any changes. Suggestions for changes should be addressed to the Institute Office along with reasons therefor. A member requesting a change should give the name of his county, as the smallest division made in area is along county lines.

#### CANADIAN RADIO TECHNICAL PLANNING BOARD

Of interest to the membership of The Institute of Radio Engineers is the Organizational Chart of the Canadian Radio Technical Planning Board, as shown on the attached insert. The Canadian Council of the I.R.E. is one of the sponsor organizations of the Canadian RTPB. It is expected that the new Board will contribute constructively to the development of radio and electronics in Canada and presumably will collaborate effectively with the corresponding groups in the United States.



### Notice to Sections

#### TRANSFERS AND ADMISSIONS TO HIGHER GRADE MEMBERSHIP

In the interest of simplifying and expediting transfers and admissions to the grades of Member and Senior Member in the Institute, a procedure has been established whereby the Section Membership Committees co-ordinate the routing of reference

forms on behalf of applicants residing in the areas of the respective Sections. This procedure was outlined in President Everitt's letter of July 11, 1945, to Section Chairmen and Secretaries, and its substance is here repeated for the information of the Sections and their members.

An applicant for transfer or admission to higher grade is required to fill in an application form in which he will designate persons who will act as references. The Section Secretary or member of the Section Membership Committee who may receive such application will then forward to each of the designated references the appropriate reference form and small white envelope on which shall be inscribed the applicant's name in the space provided for this purpose. A supply of these forms and envelopes has been sent to Section Secretaries. The reference, upon completing the form, shall seal it in the white envelope, bearing his own name and address in the upper left-hand corner, and return it to that official of the Section from whom it was received. In order to maintain the confidential character of the information on the reference form, these envelopes will *not* be opened by the Sections, but, when all the responses have been received from the references pertaining to any one applicant, they shall be enclosed together with the application in the large white envelope supplied and forwarded to the I.R.E. Headquarters in New York.

Since in the past much of the delay in effecting transfers or admissions to higher membership has resulted from the length of time often required to obtain responses from references, it is felt that the handling of this phase of the work locally by the several Sections should greatly expedite the process. The establishment of this procedure is not intended in any way to preclude the former practice in which an applicant sends an application form directly to the I.R.E. Headquarters. In this case, the Headquarters office will continue to send out the necessary forms to the indicated references.

## Contributors to Waves and Electrons



ANDREW ALFORD

Andrew Alford (A'35-M'40-F'42) was born on August 5, 1904, at Samara, Russia. In 1924 he was graduated from the University of California, and from 1925 to 1927 he was a university Fellow and graduate student there. During 1927 and 1928, Mr. Alford was a teaching Fellow in physics at the California Institute of Technology. He was a research engineer with the Fox Film Corporation, West Coast division, from 1929 to 1931; a geophysical prospecting and consulting engineer from 1931 to 1934; an engineer with the Mackay Radio and Telegraph Company from 1934 to 1941; head of the air-navigation laboratory of the Federal Telephone and Radio Corporation; and head of the direction-finder and antenna division, Radio Research Laboratory, Harvard University, from 1943 to date.

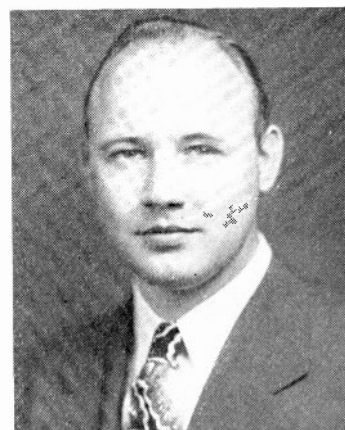

ROBERT E. GRAHAM



ARMIG G. KANDOIAN

Robert E. Graham (M'45) was born at Kansas City, Missouri, on October 4, 1916. He received the B.S. degree in electrical engineering from Purdue University in 1937. In the same year Mr. Graham joined the technical staff of the Bell Telephone Laboratories, where he has since been engaged in television research. During this period he has engaged in part-time graduate work at Columbia University.

He is an associate member of Sigma Xi and the Optical Society of America.

Armig G. Kandoian (S'35-A'36-SM'44) was born at Van, Armenia, on November 28, 1911. He received the B.S. degree in 1934, and the M.S. degree in electrical communication engineering in 1935, from Harvard University.

Mr. Kandoian became associated with the International Telephone and Telegraph Corporation in 1935, and has remained with that organization to date, working primarily on very-high-frequency and ultra-high-frequency developments dealing with antennas, radiation, measurements, link communication, and air navigation. Since 1941 he has been in the laboratories division of the Federal Telephone and Radio Corporation.

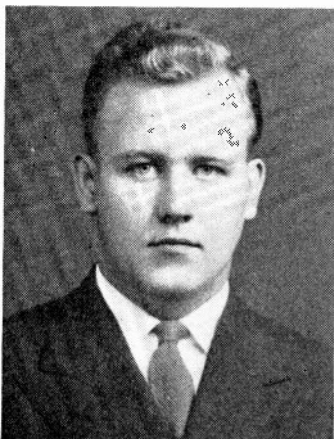

FRANK J. LUNDBERG

He is a member of Tau Beta Pi, Harvard Engineering Society, and the American Institute of Electrical Engineers.

Frank J. Lundberg (S'38-A'40) was born on December 28, 1916, at Ashton, Idaho. He received the B.S. degree in electrical engineering in 1940 from Purdue University, and from 1940 to 1941 he was a student engineer in the general engineering department of the Columbia Broadcasting System.

From 1941 to 1942 Mr. Lundberg worked in the short-wave division of the same department, and from 1942 to date he has been associated with the Federal Telephone and Radio Laboratories. Since 1943 he has been doing graduate study at Stevens Institute of Technology.

F. W. Reynolds was born at Colton, New York, on February 10, 1897. He received the B.S. degree in electrical engineering from Union College in 1919, and the Ph.D. degree in physics from Cornell Uni-

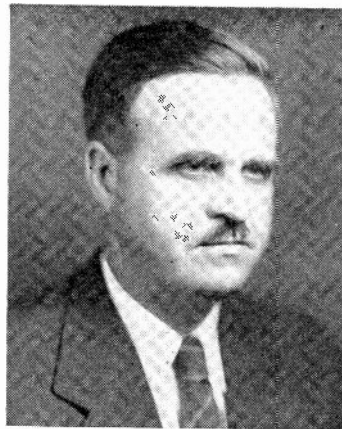

F. W. REYNOLDS

versity in 1924. He was an instructor at Union College in 1919 and 1920, and at Cornell University from 1920 to 1924. In 1924 he joined the department of development and research of the American Telephone and Telegraph Company. Since 1934 he has been a member of the technical staff of the Bell Telephone Laboratories. Dr. Reynolds has been associated with the development work in the wire transmission of pictures and in television.

He is a member of the Optical Society of America, the American Physical Society, and Sigma Xi.

Helen M. Stote was born in Colorado Springs, Colorado. She received the A.B. degree in English from Stanford University and the M.A. degree in Spanish from the University of Wisconsin. In 1929, she became an assistant to the Editorial, Advertising, and Circulation Departments of the Institute of Radio Engineers. In 1930, Miss Stote was made assistant editor, in 1943, associate editor, and in 1945, publication manager.



HELEN M. STOTE

Also, she has served as chairman of the Women's Committee for New York Conventions since 1937.

Chester B. Watts, Jr. (A'41) was born at Washington, D.C., on June 16, 1918. He received the B.S. degree in 1940 from the Massachusetts Institute of Technology. From 1940 to 1942 he was associated with the radio navigation laboratory of the Federal Telephone and Radio Laboratories, and since 1942 he has been at the Aircraft Radio Laboratory, Wright Field, Dayton, Ohio.

A. J. Warner was born on March 25, 1913, at London, England. He received the B.Sc. degree in chemistry from the University of London in 1935. He joined the staff of Standard Telephones and Cables as a metallurgical chemist in 1930, obtained a leave of absence in 1932, and returned in 1935 to the same organization, where he worked until 1940 as raw-material chemist and as research chemist on problems relating to electrical insulation.

In 1940, Mr. Warner was transferred to the New Insulators factory at Enfield, Middlesex, and in 1941, to the International Standard Electric Company. He is at present employed by the Federal Telephone and Radio Corporation, Newark, New Jersey, as technical director of the Intelin Division of the Company.



A. J. WARNER



# ANNOUNCING



## The New HAR-CAM VISUAL ALIGNMENT SIGNAL GENERATOR

This new HAR-CAM unit provides the most efficient and effective method of aligning the IF circuit of FM receivers. By use of an oscil-

lograph screen, the performance of the IF circuit is shown visually, and rapid, accurate alignment is easily accomplished.

### SPECIFICATIONS

1. Frequency range 100kc to 20mc with direct reading dial calibrated in megacycles.
2. Linear frequency sweep deviation adjustable from zero to 900kc peak to peak.
3. Vernier frequency control of 100kc allows zero beat calibration of main tuning dial or for vernier frequency deviations about main dial frequency setting.
4. Stable rf gain control independent of frequency.
5. Five-step attenuator of rf output

giving over-all voltage range of 1 microvolt to 1 volt when used in conjunction with the gain control.

6. Output impedance, 1 ohm to 2500 ohms.
7. Phone jack for aural monitoring of zero beat calibration of main tuning dial.
8. Panel jack to feed linear sweep voltage to x-axis amplifier of oscilloscope, thus synchronizing the frequency linear sweep of the generator with the spot trace on the scope screen.
9. Voltage regulated supply for internal oscillators.

10. Careful oscillator design to minimize drift.
11. Stable and proven circuit principles used throughout to insure complete reliability.
12. Size, 7" wide, 9½" high, 10½" deep. Weight, 18 pounds.

For complete information on the HAR-CAM Visual Alignment Signal Generator, write for Bulletin H-40.

## HARVEY RADIO LABORATORIES, INC.

456 CONCORD AVENUE • CAMBRIDGE 38, MASSACHUSETTS





*At your fingertips -*  
**THE COMPONENTS YOU WANT**  
*when you want them!*

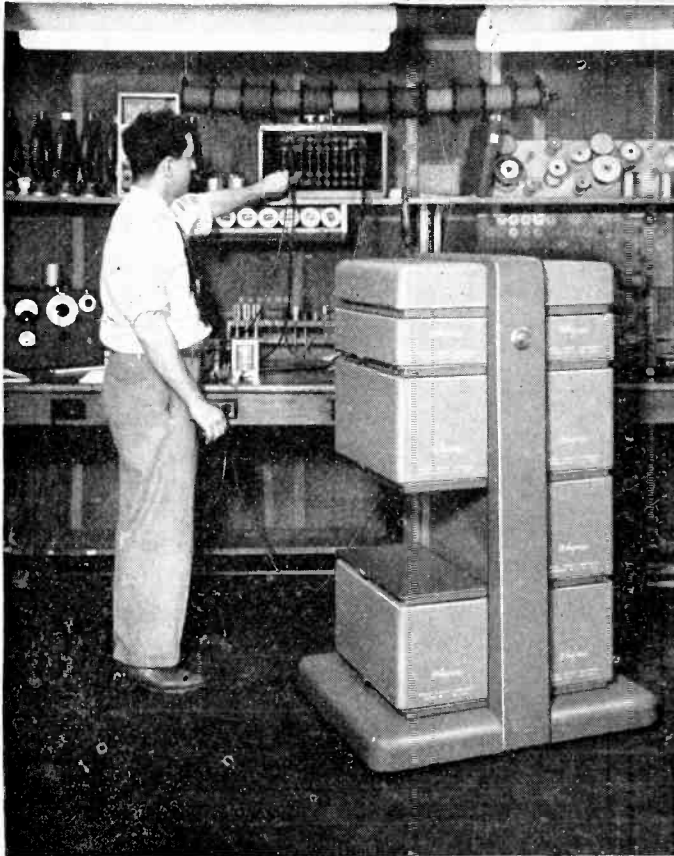

Now—at a moment's notice—you have an almost limitless number of circuit components and power sources at your command with the Harvey-Wells Decade Unit.

Entirely new and unique both in design and application, this unit saves time and expense in laboratories, schools or workshops working on DC or low frequency AC electrical circuits. A few of the possible applications are filter circuits, power supply loads, phase shift circuits, phase correction circuits, inductive or capacitive loads for testing relay contacts, resonance circuits, control circuits, voltage divider circuits, etc.

A complete technical data Booklet is now available. Send for it today.

**HARVEY - WELLS ELECTRONICS, INC.**  
**SOUTHBRIDGE, MASS.**

*Harvey* - **WELLS**

**ELECTRONICS, INC., SOUTHBRIDGE, MASSACHUSETTS**

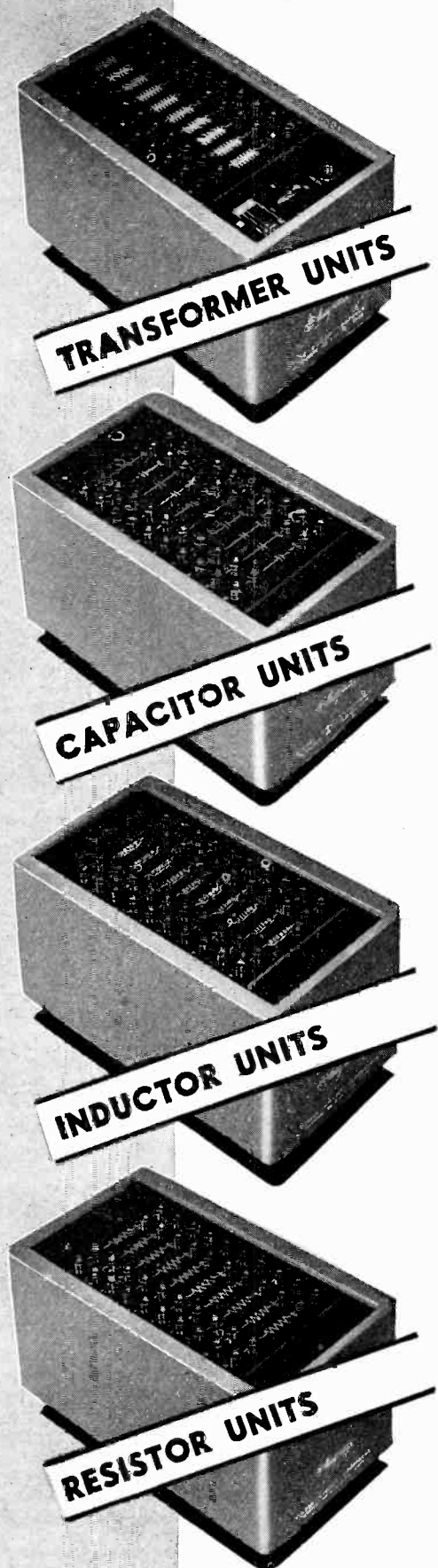

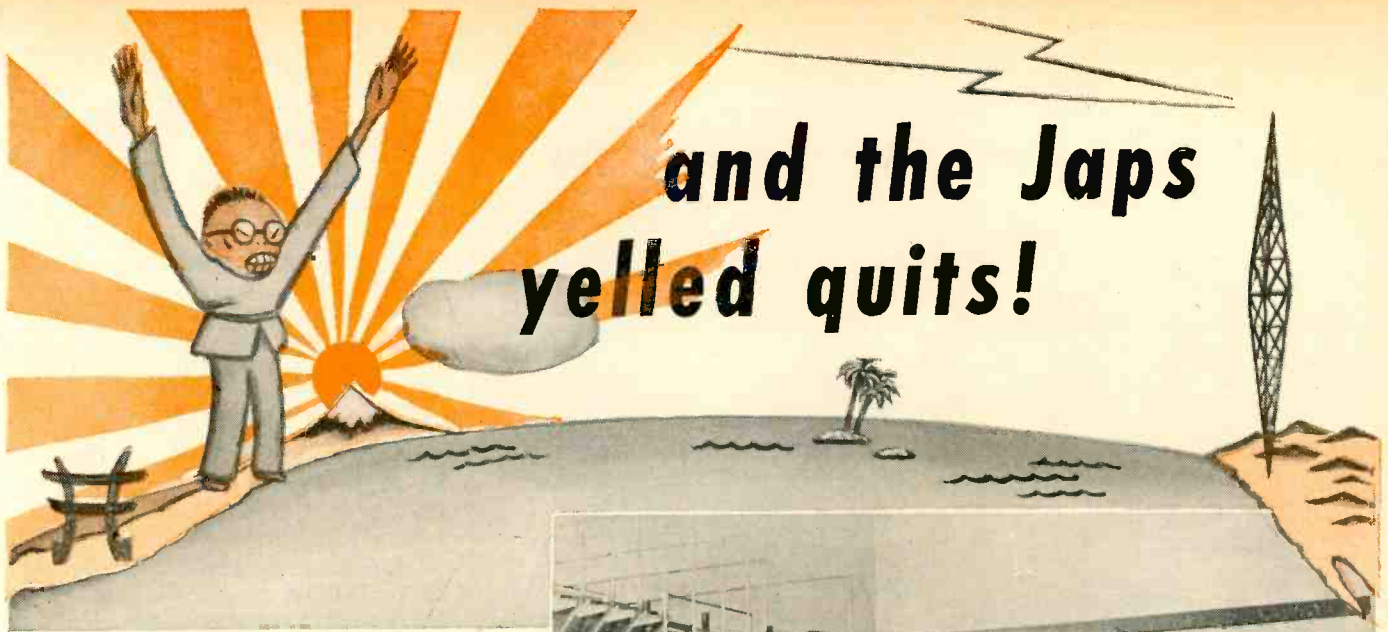

# and the Japs yelled quits!

● The OWI did a neat and decisive job with their 200 KW short wave trans-Pacific radio stations. Their Tokyo broadcasts are credited with a definite part in ending the war in the Pacific.

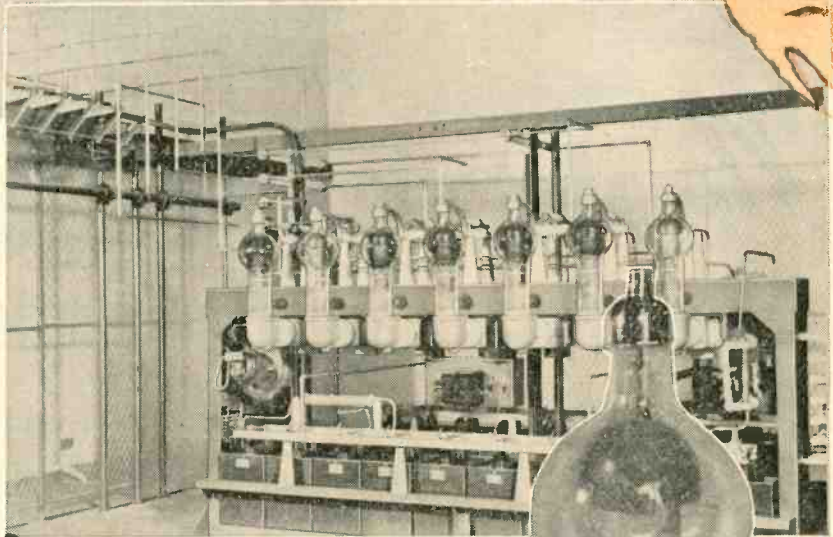

AmerTran transformers and reactors were used in the rectifier, plate and modulation circuits. The rectifier filament transformers shown here are typical of AmerTran adaptability to a unique problem. Both stations were designed and equipped by Federal Telephone and Radio Corp.

Efficiency figures for this O.W.I. installation: Overall audio frequency response of the audio amplifier—modulator equipment is within 0.5 db of the 1000 cycle level from 30 cycles to 7500 cycles at 95 per cent modulation.

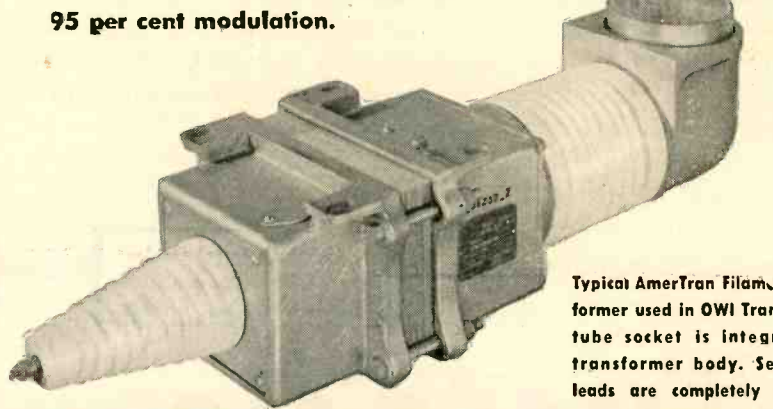

Typical AmerTran Filament Transformer used in OWI Transmitters; tube socket is integral with transformer body. Secondary leads are completely enclosed.

**AMERICAN TRANSFORMER COMPANY**  
178 EMMET STREET                      NEWARK 5, N. J.

Pioneer Manufacturers  
of Transformers, Reactors  
and Rectifiers for Electronics  
and Power Transmission



# AMERTRAN

MANUFACTURING SINCE 1901 AT NEWARK, N. J.

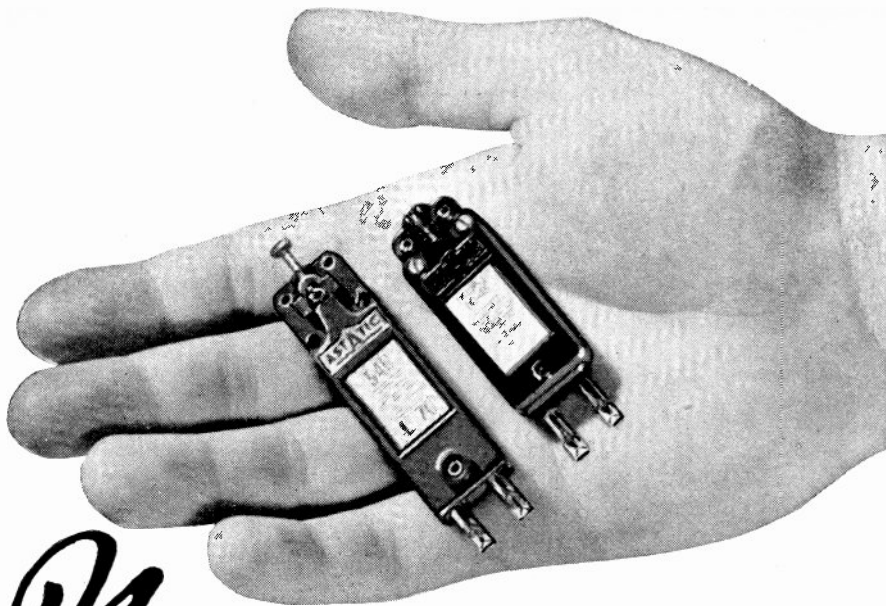

# New Astatic Cartridges

## Improve Phonograph Reproduction

**I**N TENDED for use with both automatic record changers and manually operated equipment, these new Astatic Cartridges, in MLP and L-70 Series, assure a degree of fidelity heretofore unparalleled in the reproduction of recorded sound. All new Astatic Phonograph Pickup Arms will include these finer Cartridges.

L-70 Series Cartridges are of the replaceable needle type, are designed with streamlined housing, high output voltage and low needle pressure.

MLP Series Cartridges are of the permanent or fixed stylus type and are engineered to operate at one-ounce pressure, with increased vertical compliance, higher output voltage and reduced needle talk.

*"You'll HEAR MORE  
from Astatic"*

• Astatic Crystal Devices  
manufactured under Brush  
Development Co. patents.

**THE**  
*Astatic*  
**ASTATIC CORPORATION**  
CONNEAUT, OHIO  
IN CANADA. CANADIAN ASTATIC LTD., TORONTO, ONTARIO



### ATLANTA

"The Multivibrator as a Signal Generator," by B. J. Dasher, Georgia School of Technology; May 25, 1945.

"Demonstration of New Methods of Program-Line Equalization," by Ben Akerman, WGST; June 22, 1945.

"A Description of the Developmental Frequency-Modulation Station at Tech, W4XAG," by M. A. Honnell, Georgia School of Technology; September 21, 1945.

### BALTIMORE

"Significant Aspects of Magnetic Recording," by S. J. Begun, The Brush Development Company; October 23, 1945.

### BOSTON

"Application of Circuit Theory to the Design of Servomechanisms," by A. C. Hall, Massachusetts Institute of Technology; November 16, 1945.

### BUENOS AIRES

"Quartz Crystals and Their Applications—Second part: Various Cuttings—Piezoelectric Resonators—Basic Circuits," by Alejandro Rojo, Laboratory Transradio Internacional; September 21, 1945.

### BUFFALO-NIAGARA

"Comparison of Frequency- and Amplitude-Modulated Signal Reception," by M. G. Nicholson, Colonial Radio Corporation; October 17, 1945.

"Tubes for the Proximity Fuze," by L. G. Hector, National Unio Radio Company; November 21, 1945.

### CEDAR RAPIDS

"Polyphase Broadcast Systems," by Paul Loyet, Radio Station WHO; October 18, 1945.

"Dehydration by Means of Radio Frequencies," by Mr. Himmel, President, Inter-Therm Company; October 18, 1945.

"Frequency-Modulation Falacies," by E. H. Armstrong, Columbia University; October 24, 1945.

### CHICAGO

"Frequency Modulation," by E. H. Armstrong, Columbia University; October 29, 1945.

"The Atomic-Energy Project," by Malcolm Dole, Northwestern University; November 16, 1945.

"A Very-High-Frequency Omnidirectional Radio Range," by D. M. Stuart, Civil Aeronautics Authority; November 16, 1945.

### CINCINNATI

"Atomic Energy and Nuclear Physics," by I. A. Balinkin, University of Cincinnati; September 18, 1945.

"History of the Development of the Vacuum Tube," by I. E. Mouromtseff, Westinghouse Electric Company; October 16, 1945.

(Continued on page 38A)



Not jet propelled...

but just as **NEW!**

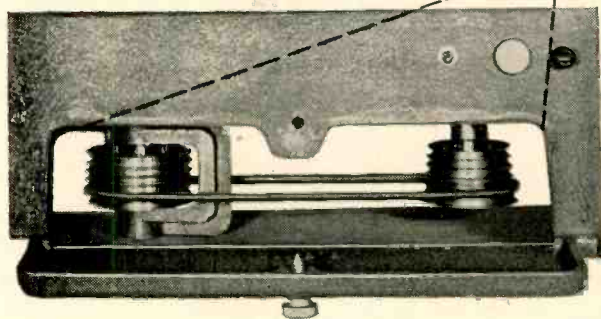

The belt on step pulleys slips instantly to any position to set cutting pitch at 96-104-112-120-128 or 136 lines per inch. Other pitches available on special order.

**P**RESTO'S newest *turntable*... for highest quality master or instantaneous recordings. The 8-D features instantaneous change of cutting pitch. An improved cutting head provides higher modulation level, more uniform frequency response and retains its calibration under all normal temperature conditions.

The heavy cast-iron turntable and mounting base insure exceptionally low background noise. Adjustable feet permit accurate leveling on bench or stand at a height to suit the operator.

**PRESTO**



**RECORDING CORPORATION**  
242 West 55th Street, New York 19, N. Y.  
Walter P. Downs, Ltd., in Canada

**WORLD'S LARGEST MANUFACTURER OF INSTANTANEOUS SOUND RECORDING EQUIPMENT AND DISCS**

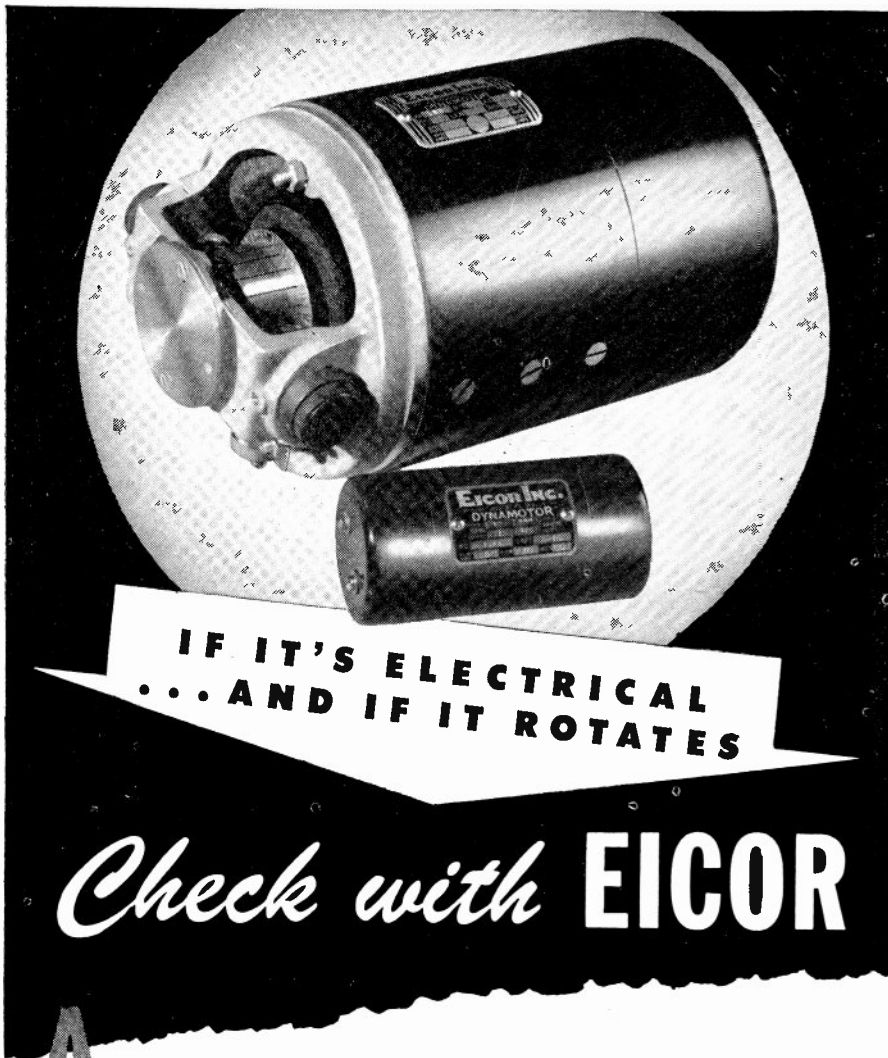

**IF IT'S ELECTRICAL  
... AND IF IT ROTATES**

*Check with* **EICOR**

**A** roster of all Eicor products, in their various types and sizes, shows an astonishing number and diversity. But of special interest to users of rotary electrical equipment is our ability to produce units unusual in design or performance . . . and do it quickly, accurately, and at reasonable cost.

Serving in an endless list of special applications, these developments include . . . the smallest commercially produced dynamotor, for 10 watts continuous output, in a 2-5/16" diameter frame and weighing only 34 ounces . . . a motor rated 1/5 hp at 3800 rpm for intermittent duty, 2-5/16" in diameter, weight 38 ounces . . . an aircraft inverter to supply output of 100 va, 400 cycle, single or three phase, in a 3" frame and unit weight of 5 3/4 lbs. . . . a .6 hp, 4000 rpm, intermittent duty motor, 4" in diameter and 9 1/2 lbs. weight . . . a dynamotor 4-1/16" in diameter which supplies 32 watts continuous output per pound weight . . . a 12 vdc motor rated 1/4 hp at 1700 rpm with 150 in. lbs. lock torque in a 5 1/4" frame.

These highlights are an indication of what EICOR has done in the past. In the days to come our creative engineering will solve similarly difficult problems involving motors, dynamotors, and generating equipment for industry. Your inquiry is invited.



**EICOR, INC.** 1501 W. Congress St., Chicago, U. S. A.  
 DYNAMOTORS • D. C. MOTORS • POWER PLANTS • CONVERTERS  
 Export: Ad Auriema, 89 Broad St., New York, U. S. A. Cable: Auriema, New York



(Continued from page 36A)

**CLEVELAND**

"Microwave Electronics," by E. U. Condon; Westinghouse Electric Company; September 29, 1945.

"Protection of Electronic Equipment and Mildewcides," by R. A. Shamel, Malinckrodt Chemical Works; October 25, 1945.

"Miscellaneous Gadgets," (in the Pacific Area), by R. A. Fox, WGAR; November 29, 1945.

**CONNECTICUT VALLEY**

"Functional Use of Music, by Harold Burris-Meyer, Muzak Corporation; November 15, 1945.

**DAYTON**

"Air-Traffic Control," by G. A. Gilbert, Civil Aeronautics Authority; November 15, 1945.

**INDIANAPOLIS**

"Organizational Structure of Engineering Department," by M. C. Batsel, RCA Victor; September 28, 1945.

"Sound-Film Control Tracks and Dynamic Range," by E. W. Kellogg; RCA Victor, September 28, 1945.

"Automatic Positioner Mechanisms," by R. W. May, Collins Radio Company; October 26, 1945.

Election of Officers; October 26, 1945.

**KANSAS CITY**

"Some Recent Developments in Frequency-Modulation Transmission," by E. H. Armstrong, Columbia University; October 25, 1945.

"Very-High-Frequency Omnidirectional Radio Range," by S. R. Anderson, Civil Aeronautics Authority Experimental Station; November 27, 1945.

**LONDON**

"Fundamental Radar Circuit Design," by H. A. Ferris, National Research Council; October 26, 1945.

**MONTREAL**

"Fundamental Radar Circuit Design," by H. A. Ferris, National Research Council; October 31, 1945.

"Pulse Techniques," by R. W. Wilton, Royal Canadian Air Force; November 15, 1945.

**OTTAWA**

"Application of High-Frequency Heating in Industry," by J. B. Knox, RCA Victor Company of Canada; October 11, 1945.

"Fundamental Radar-Circuit Design," by H. A. Ferris, National Research Council; November 1, 1945.

(Continued on page 42A)



# BENDIX *V.H.F.* RADIO

EQUIPMENT FOR THE AIRLINE GROUND STATION



## MR-71B RECEIVER

- DUAL CHANNEL
- FIXED FREQUENCY

Now—a *new* Bendix Radio Receiver engineered for the airline ground station and designed for V.H.F. (Very High Frequency) fixed frequency radio reception.

Built to the quality requirements that have made Bendix Radio products "Standards for the Aviation Industry," the MR-71B V.H.F. Radio Receiver functions on a frequency range of 118-132 Mc.—

—provides dual channel operation, extreme

sensitivity, high selectivity, excellent stability.

—incorporates positive squelch operation, rapid amplified AVC, and effective noise limiter.

—engineered so that all adjustments are available from front panel without removing unit from its rack.

For full information as to dimensions, weight, construction, electrical characteristics and service features, write the Sales Department, Bendix Radio Division, Baltimore 4, Maryland.

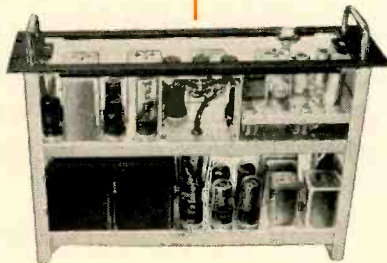

# *Bendix* Radio DIVISION

BALTIMORE 4, MARYLAND



STANDARD FOR THE AVIATION INDUSTRY

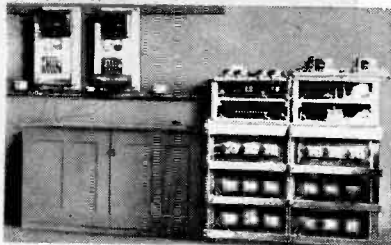

**1915.** World's first vacuum tube repeater, produced by Western Electric, made transcontinental telephone calls possible.

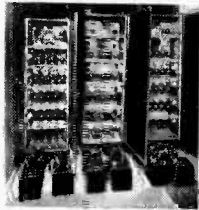

**1919.** Among the earliest P. A. amplifiers were these made by Western Electric and used at Victory Way Celebration in New York City after World War I.

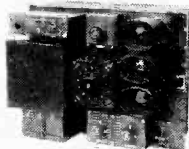

**1922.** First amplifier used generally in commercial broadcasting. Many of these 8-type amplifiers are still in use.



**1931.** Negative feedback principle introduced by Western Electric in telephone amplifiers, since applied to broadcasting and public address equipment.



**1931.** Western Electric developed this first all AC amplifier unit which eliminated batteries, made equipment more compact.



**1936.** One of the twenty 1000-watt amplifiers used in the world's largest commercial public address system at Roosevelt Raceway on Long Island.

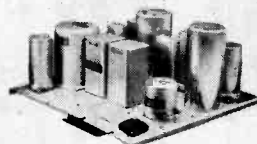

**1937.** 120-121 type Western Electric amplifiers for use in the finest audio systems for AM and FM transmission.

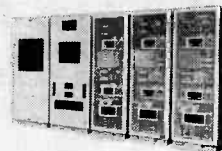

**1942.** New and improved battle announcing system amplifiers of the type that helped save the crippled carrier *Franklin*.



**1944.** 250-watt beachmaster amplifiers, used by the Navy to direct landings on Saipan, Iwo Jima, and Okinawa.

## AMPLIFIER HISTORY... Made by *Western Electric*

For more than 30 years, Western Electric has made amplifier history. The skill and ability that time alone can bring, plus experience gained producing highly specialized sound equipment for war, mean continued leadership for Western Electric in the years ahead.

**Buy Victory Bonds and hold them!**







**BIRD MODEL 63-A WATTMETER AND  
WIDE-BAND LINE TERMINATION**

*For Output Measurement*  
**VHF-UHF**

**10 TO 1500 MEGACYCLES**

Developed and proven under stress of war, this instrument is especially suited to equipment having 50-ohm coaxial transmission circuits. Solving the dual problem of power measurement and line termination, this constant-impedance instrument supplies meter readings thru thermocouples while dissipating the r-f energy in an ingenious artificial antenna. Power range 1 to 500 watts.



**NOW READY FOR PEACETIME USES!**

**COAXWITCH**

**A SELECTOR SWITCH FOR COAXIAL CIRCUITS**

This new switch was developed for airborne radar antenna switching. A 50-ohm device, it maintains a constant characteristic impedance. To retain LOW standing wave ratios and secure maximum transfer of r-f energy, specify "Coaxwitch". Available now, in two models; Model 74 for single coaxial circuits; Model 72-2 for handling two coaxial circuits simultaneously.

*Write for Catalog Pages*

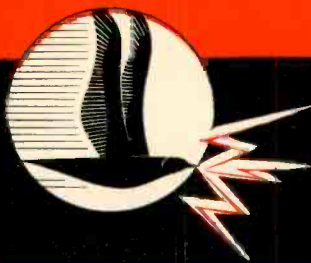
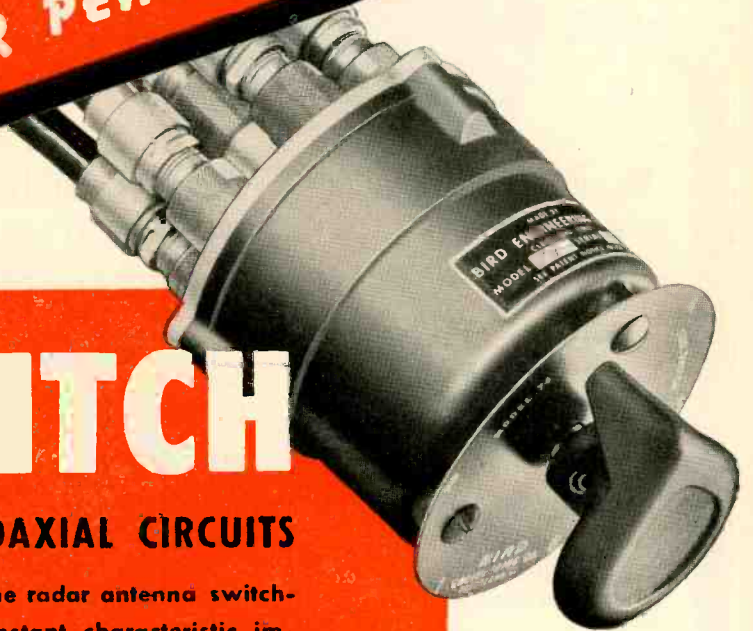

**BIRD ELECTRONIC CORPORATION**

FORMERLY BIRD ENGINEERING COMPANY

*Instrumentation for Coaxial Transmission*

**1800 EAST 38th STREET • CLEVELAND 14, OHIO**

**EXPERT HELP**  
**Now Available To You**  
 TO ASSIST YOU WITH YOUR PROBLEMS OF  
**DESIGN ENGINEERING PRODUCTION**  
 AS WELL AS THE MANUFACTURE OF  
 ALL TYPES OF PARTS IN THE FIELDS OF  
**RADIO and ELECTRONICS**

**WE MANUFACTURE**

- Radio coils
- Solenoids
- Bank-wound
- Universal
- Universal progressive
- Paper section
- Layer-wound
- Toroids

From the middle of the voice frequency to ultra-high frequency. Electronic and radio equipment of all kinds.

**ALSO**

We are equipped for turning out special sub-assembly work . . . work on complete units where allied to our various facilities as well as small punch press work . . . luging and terminal assembly . . . soldering, testing . . . original design and product design.

*We invite you to consult with us without obligation.*

**COMMUNICATION PARTS**

NOT INC.

1101 NORTH PAULINA ST. • CHICAGO 22, ILLINOIS

**WE HAVE EQUIPMENT FOR ANY TYPE OF TREATMENT:**

- Hermetic
- Wax
- Varnish-impregnating
- Baking, vacuum-impregnating
- Oil filling

We have a completely equipped laboratory with Q meters, twin-"T" bridges and special bridges . . . for frequency analyzing and prime standard of frequency.



(Continued from page 38A)

**PHILADELPHIA**

"Philco Philadelphia-to-Washington Television Relay Link," by F. J. Bingley, Philco Radio and Television Corporation; November 1, 1945.

**ROCHESTER**

"A Coaxial Modification of the Butterfly Circuit," by E. E. Gross, General Radio Company; November 12, 1945.

"The Radio Proximity Fuze," by H. Trotter, Jr., Eastman Kodak Company, November 12, 1945.

"Proximity-Fuze Tubes," by M. A. Acheson and H. K. Ishler, Sylvania Electric Products, Inc., November 12, 1945.

"Microwave Radar," by D. G. Fink, McGraw-Hill Publishing Company; November 12, 1945.

"High-Quality Sound Recording on Magnetic Wire," by L. C. Holmes, Stromberg-Carlson Company; November 12, 1945.

"The Aurora and Geomagnetism," by C. W. Gartlein, Cornell University; November 12, 1945.

"Recent Developments in Converter Tubes," by W. A. Harris and R. F. Dunn, Radio Corporation of America; November 13, 1945.

"Industry Standardization Work in Television," by D. B. Smith, Philco Corporation; November 13, 1945.

"War Influence on Acoustic Trends," by H. S. Knowles, Jensen Radio Manufacturing Company; November 13, 1945.

"Germanium Crystals," by Edward Cornelius, Sylvania Electric Products, Inc.; November 13, 1945.

"Television—A Review of Technical Status," by E. W. Engstrom, Radio Corporation of America; November 13, 1945.

"Comments on Existing Television Systems From A Measurement Viewpoint," by Jerry Minter, Measurements Corporation; November 13, 1945.

"The Future of Radar," by L. A. DuBridge, Radiation Laboratory, November 13, 1945.

**St. LOUIS**

"High-Frequency Antennas," by C. R. Cox, Andrew Company; November 29, 1945.

**SAN DIEGO**

"Aircraft Radio-Compass Receivers," by K. E. Geren, University of California Division of War Research; November 6, 1945.

"General Aspects of Use of Aircraft Radio Compasses," by Tracy Barnes, Consolidated-Vultee Aircraft Corporation; November 6, 1945.

**SAN FRANCISCO**

"Present and Future Television," by Klaus Landsberg, Television Production, Inc.; April 9, 1945.

(Continued on page 44A)



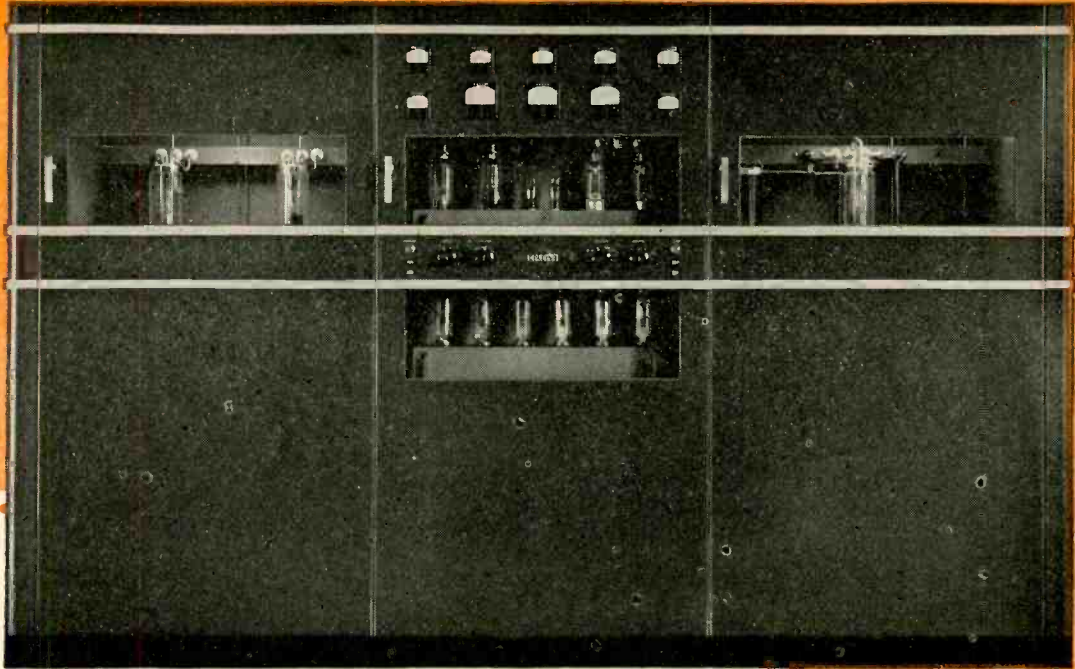

## Why WAAT bought its new 5 kw transmitter from Collins

The Bremer Broadcasting Corp., owners of WAAT, had had previous experience with Collins equipment. Mr. Frank V. Bremer, Technical Director, puts it this way:

"It is with interest and pride that I bring to your attention the performance of the Collins 20K one kilowatt AM transmitter installed at Kearny on April 14, 1941.

"This transmitter has been on the air a total of 39,000 hours, as of October 15, 1945, with a total elapsed lost time of only fifteen minutes.

"This makes a most remarkable record, since our station is on the air twenty-four hours per day, seven days per week, and it speaks well for your transmitter.

"According to the logs checked by Anthony Castellani, transmitter supervisor, the fifteen minutes total of lost air time was caused by defective bias tubes and a coupling

condenser in the audio circuit.

"At no time in the period of operation of the 20K have we had to make a refund or make up allowance to any sponsor due to lost air time.

"As director of the engineering department of WAAT and FM-WAAW, I give credit for this remarkable performance to your efficient design and to the capable operating supervision by our transmitter staff."

(Signed) Frank V. Bremer

With this background of satisfaction, the Bremer Broadcasting Corp. ordered a new 21A 5 kw AM Collins transmitter as soon as military restrictions were lifted in the fall of 1945. An illustrated bulletin, fully describing this transmitter, will be sent you on request.

FOR BROADCAST QUALITY, IT'S . . .

Collins Radio Company, Cedar Rapids, Iowa; 11 W. 42nd St., New York 18, N. Y.





**BLAW-KNOX**  
**WILL DESIGN, FABRICATE**  
**AND ERECT YOUR**  
**ANTENNA TOWERS**

Station Engineers take a load off their shoulders when their antenna problem is turned over to Blaw-Knox.

Thousands of installations, ranging from 66 ft. to 1000 ft., are ample proof that you can rely on Blaw-Knox for complete responsibility in the fabrication and erection of complete antenna systems.

**BLAW-KNOX DIVISION**  
of Blaw-Knox Company  
2037 FARMERS BANK BUILDING  
PITTSBURGH, PA.

**BLAW-KNOX VERTICAL RADIATORS**

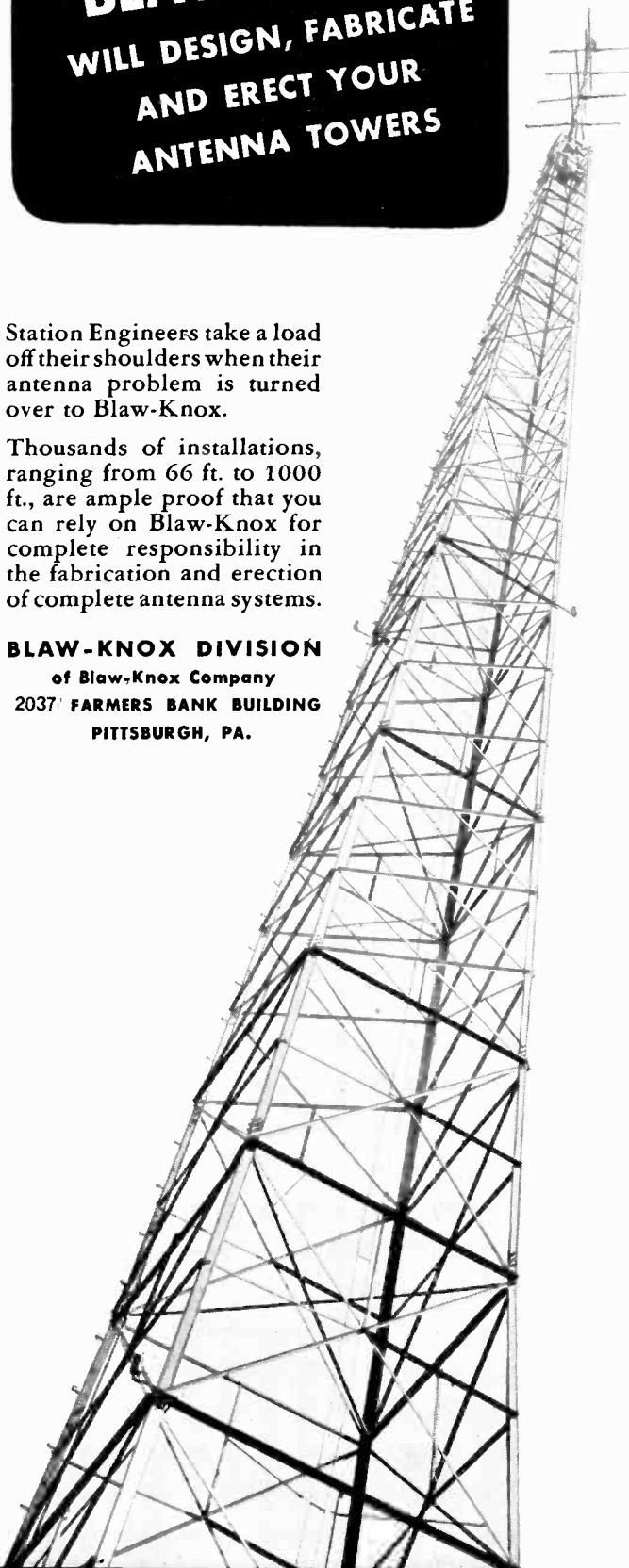

(Continued from page 42A)

"Wartime Developments of Electronics," by W. L. Everitt, President, The Institute of Radio Engineers, Inc.; April 19, 1945.

Demonstrations of Microwave Characteristics by L. F. Black, University of California; May 23, 1945.

"An American Engineer in Europe," by R. V. Howard, Associated Broadcasters; July 18, 1945.

"Television-Studio Equipment," by Harry Lupke, Don Lee Television Station; September 19, 1945.

"Television-Studio Equipment," by L. E. Reukema, University of California; October 17, 1945.

"Predicted Television Coverage in the Bay Area," by Richard Brace, Associated Broadcasting Company; November 14, 1945.

**SEATTLE**

"Current-Stabilized-Supplies," by W. R. Hill, University of Washington; November 15, 1945.

**TWIN CITIES**

"Transformers and Filters," by W. E. Lehnert, Audio Development Company; November 6, 1945.

**WILLIAMSPORT**

"The Radio Proximity Fuze," by Herbert Trotter, Eastman Kodak Company; November 14, 1945.

**SUBSECTIONS**

**COLUMBUS**

"Lecture and Demonstration of U. S. Army Radio and Radar Equipment Used by Department of Electrical Engineering Research Department," by R. B. Jacques, Ohio State University; November 4, 1945.

**PRINCETON**

"The Development of the Proximity Fuze," by R. B. Roberts, Johns Hopkins University; December 4, 1945.

**SOUTH BEND**

"Application of Carrier Current and Space Radio To Electric Company," by G. G. Langdon, American Gas and Electric Service Corporation; October 23, 1945.

"The Atomic Bomb, Its Development and Use," by Bernard Waldman, University of Notre Dame; November 15, 1945.

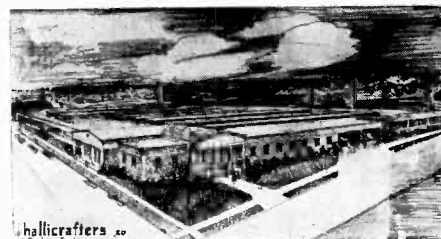

THE HALLCRAFTERS BUILDING

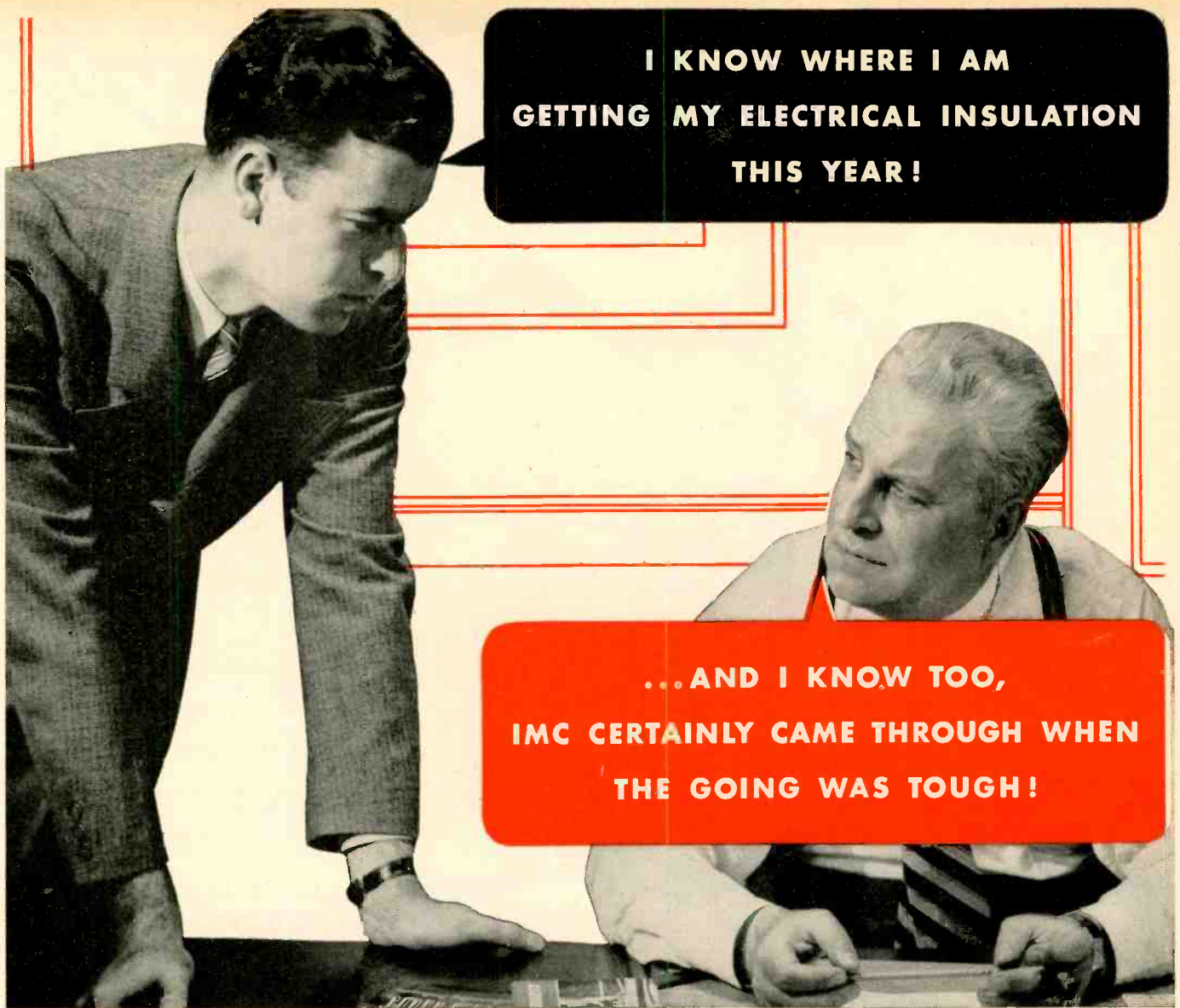

I KNOW WHERE I AM  
GETTING MY ELECTRICAL INSULATION  
THIS YEAR!

...AND I KNOW TOO,  
IMC CERTAINLY CAME THROUGH WHEN  
THE GOING WAS TOUGH!

# THEY ARE **AGREED** !...and no wonder

In-plant assistance by IMC Engineers, who know the application of electrical insulation, plus delivery service that approaches perfection, is a combination that wins.

If you have not been using this

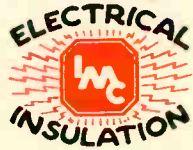

service in the past, we invite you to become acquainted. There is an IMC Engineer nearby to serve you. Write or phone office nearest to you, and we will see that he calls.

★CHICAGO 6  
565 West Washington Blvd.

★CLEVELAND 14  
1005 Leader Building

# INSULATION MANUFACTURERS CORPORATION

Representatives in:  
MILWAUKEE 2: 312 East Wisconsin Avenue  
DETROIT 2: 11341 Woodward Avenue  
MINNEAPOLIS 3: 1208 Harmon Place  
PEORIA 5: 101 Heinz Court

**IMC PRODUCTS** Macallen Mica Products—Vortex Varnished Cloth and Tapes—Varslot Combination Slot Insulation—Varnished Silk and Paper—Fiberglas Electrical Insulation—Manning Insulating Papers and Pressboards—Dow Corning Silicones—Dieflex Varnished Tubings and Saturated Sleeveings of Cotton and Fiberglas—National Hard Fibre and Fishpaper—Phenolite Bakelite—Adhesive Tapes—Asbestos Woven Tapes and Sleeveings—Cotton Tapes, Webbing, and Sleeveings—Pedigree Insulating Varnishes—Wedgie Brand Wood Wedges.





The following transfers and admissions were approved on December 5, 1945:

**Transfer to Senior Member**

- Allison, R. E., 33 Westwood Dr., Minneapolis 5, Minn.
- Caldwell, J. J., Jr., 39 Kenny Ave., Merrick, L. I., N. Y.
- Clark, T. H., Federal Telecommunications Laboratories, 500 Washington Ave., Nutley, N. J.
- Grosselfinger, W. H., Western Electric Co., 120 Broadway, New York, N. Y.
- Hall, W. M., 1357 Massachusetts Ave., Lexington 73, Mass.
- Isbister, E. J., 115 Lee Rd., Garden City, L. I., N. Y.
- Jacobs, M., 171 E. Hillcrest Ave., Dayton 5, Ohio
- Krakora, J. J., Jr., 1006 N. Leamington St., Chicago 51, Ill.
- LaForge, L. H., Jr., 52 East Dr., Livingston, N. J.
- Omer, C. L., 5904 Delmar, Mission, Kan.
- Ports, D. C., 1226 Wisconsin Ave., N.W., Washington 7, D. C.
- Robb, D. E., 264 Victor Ave., Dayton 6, Ohio
- Woodward, M. W., 8238 Belleview, Kansas City 5, Mo.
- Striker, G. O., 3612 Franklin Blvd., Chicago 24, Ill.
- Yolles, J., 257 E. Melford Ave., Dayton 5, Ohio

**Admission to Senior Member**

- Hailes, W. D., 74 Oakdale Dr., Rochester 7, N. Y.
- Johnson, H., RFD 1, Fisher Pl., Princeton, N. J.
- Pierce, J. A., 9 Ware St., Cambridge, Mass.
- Schlesman, C. H., Hotel Walt Whitman, Camden, N. J.
- Templin, E. W., 319 Lenox Ave., South Orange, N. J.
- Truell, R., Department of Physics, Cornell University, Ithaca, N. Y.
- Williams, H. P., 112, Pkwy., Welwyn Garden City, Herts., England

**Transfer to Member**

- Anderson, L. N., 67 Broad St., New York, N. Y.
- Arndt, W. R., 236 Nutmeg Rd., Bridgeport 4, Conn.
- Ayton, J., 122 E. Water St., Lock Haven, Pa.
- Balog, M., Sylvania Electric Products, Inc., Emporium, Pa.
- Beier, M. G., 3930 Guilford Ave., Indianapolis 5, Ind.
- Brantley, W. W., Maxwell Hotel, 20 and G Sts., N.W., Washington 6, D. C.
- Bruene, W. B., 1239-1 Ave., S.E., Cedar Rapids, Iowa
- Bulkley, A. W., 6907 Avondale Rd., Baltimore 12, Md.
- Buss, R. R., Radio Research Laboratory, Cambridge 38, Mass.
- Castenholz, F. E., Police Department, Muskegon, Mich.

(Continued on page 48A)



## When economy counts high

When your ultimate sales price limits the cost of each component, and you can't chisel from Moe to give to Joe . . . when time is money and seconds saved count, a very important person is the man who knows "the more economical way" to appropriate "parts" dollars.

Suppose a team of war-experienced engineers could immediately tune their thinking to your specific

transformer problem. A saving? Considerable! And deliveries could be assured to fit your production schedules. Efficient use of money? Undoubtedly!

Stamford Electric is such a source of supply. Economy never crowds out accuracy. Nor does accuracy become an apology for delays at Stamford Electric Products Co., Inc., Stamford, Connecticut.

**stamford**

*Transformers*

power • adjustable • auto • voltage regulating • step-up and step-down • plate and filament • audio input • interstage and output • modulation • driver • microphone, line and mixing transformers • filter and swinging chokes • audio reactors

# OHMITE

## RITEOHM PRECISION RESISTORS

*Non-Inductive... Pie-Wound... 1% Accurate*

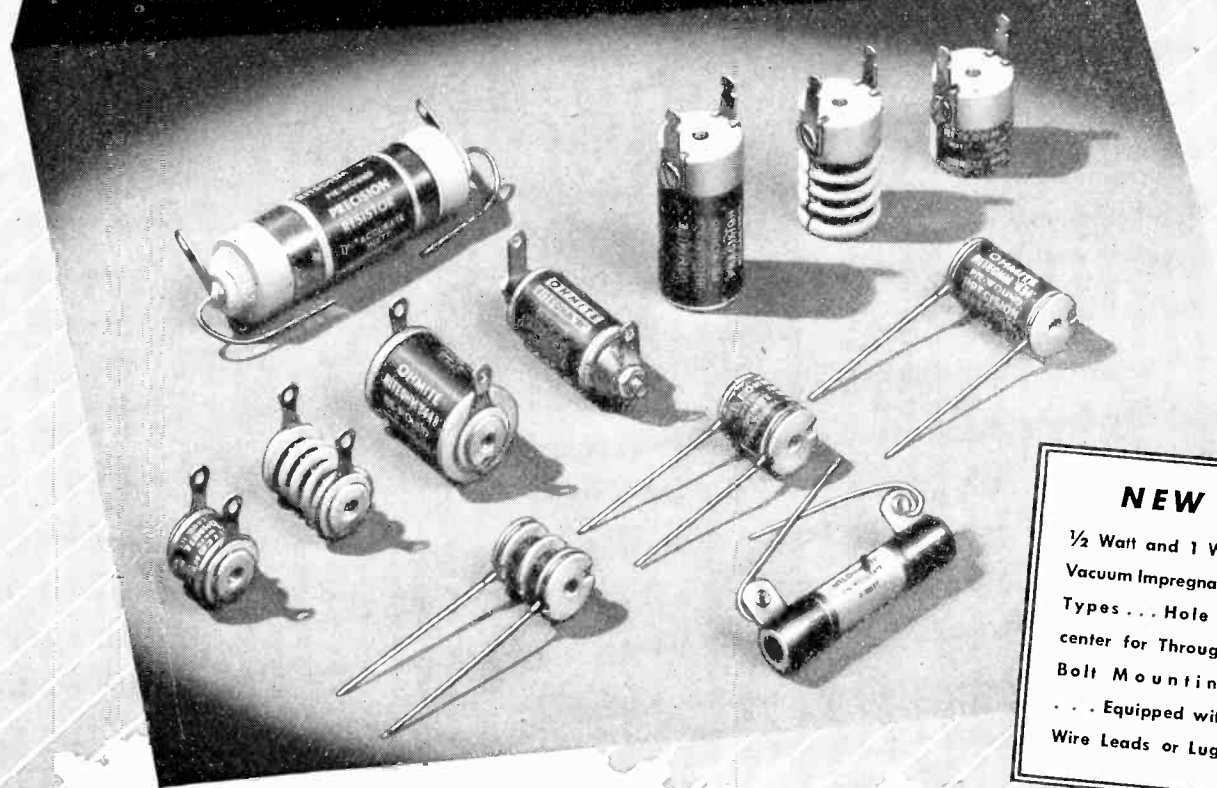

### NEW

1/2 Watt and 1 Watt  
Vacuum Impregnated  
Types... Hole in  
center for Through-  
Bolt Mounting  
... Equipped with  
Wire Leads or Lugs

### Available from Stock... or Made to Order

OHMITE presents a *new* line... a *full* line... of finer precision resistors! Every type... every size... ready for every need! Each Riteohm is designed and built with all the specialized skill and experience that have made OHMITE units the standard in this field. However critical the application... consistent accuracy and reliability are assured. In these Riteohms, you get *time-proved protection against humidity, temperature and corrosion.*

Ideal for use in voltmeter multipliers, laboratory equipment, radio and electrical test sets, attenuation pads, and in electronic devices requiring *extremely accurate* resistance components.

AVAILABLE FROM STOCK in 1/2 watt and 1 watt units in a wide range of values, in various types of mountings and terminals... or made to order. Complete line of 6 different series includes non-inductive pie-wound vacuum impregnated units... single-layer wound vitreous enameled units... and non-inductive pie-wound hermetically glass sealed units. Some units are in a range of 0.1 ohm to 2,000,000 ohms. *Get full facts today!*

OHMITE MANUFACTURING CO., 4860 Flournoy St., Chicago 44, U. S. A.

### Send for Bulletin No. 126

This handy Riteohm Bulletin makes it easy for you to select the exact units for your needs. Gives complete data... lists stock units and made-to-order units... includes dimensional drawings. Write for it now.



*Be Right with* **OHMITE**

**RHEOSTATS • RESISTORS • TAP SWITCHES • CHOKES • ATTENUATORS**



*Case Histories from the RICHARDSON files*

## POST FORMED LAMINATED PLASTICS

**Problem:** Produce an aircraft cable guard for use where the cost of hand-working metal is prohibitive. Must be light, strong, and rigid.

**Solution:** Richardson Plastics used laminated thermosetting post forming materials. Specially designed tools, plus precision production methods, resulted in a laminated INSUROK cable guard that is light, strong, rigid, economical, and easy to install.

Why not discuss your product design plans with The Richardson Company? Here you will find the expert personnel, diversified facilities, and manufacturing skill to help solve your plastics problems — whatever they may be. Write today for full details.

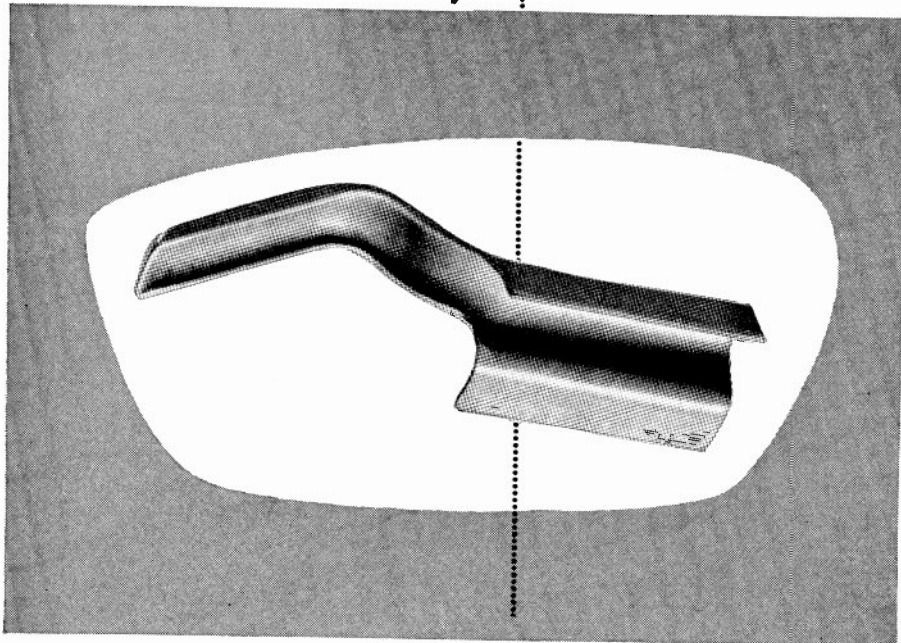

# INSUROK *Precision Plastics*

*The* RICHARDSON COMPANY

LOCKLAND, CINCINNATI 15, OHIO    FOUNDED 1858    Sales Headquarters: MELROSE PARK, ILL.

Sales Offices: NEW YORK 6 • CLEVELAND 15 • DETROIT 2

Factories: MELROSE PARK, ILL.    NEW BRUNSWICK, N. J.    INDIANAPOLIS, IND.



(Continued from page 46A)

- Clark, J. W., Bell Telephone Laboratories, 463 West St., New York 14, N. Y.  
 Cohen, M. J., 77 Massachusetts Ave., Cambridge 39, Mass.  
 Cresswell, S. G., Sylvania Electric Products, Inc., Mill Hall, Pa.  
 Crosby, C., 16 Chauncy St., Cambridge 38, Mass.  
 Fisher, W. C., RCA Victor Co., Ltd., 1001 Lenoir St., Montreal, P. Q., Canada  
 George, E. M., Y.M.C.A., 117 N. 15 St., Philadelphia, Pa.  
 Graham, M. L., Radio Corporation of America, 501 N. LaSalle St., Indianapolis 1, Ind.  
 Grantham, R. E., 3804 S. Capitol St., Washington 20, D. C.  
 Hensley, W. A., 913 Garden Dr., Baltimore 21, Md.  
 Hodgson, C. C. V., 5, Countess Dr., Denton, Newcastle-Upon-Tyne 5, England  
 Hoffman, E. H., 633 Central Ave., Ardsley, Pa.  
 Houston, C. E., 3826 Arbor, Houston 4, Texas  
 Hull, M. I., 108 Forrester St. S.W., Washington, D. C.  
 Isserstedt, G., 96 Poplar Plains Rd., Toronto, Ont., Canada  
 James, D. C., 3119 Bracken Woods Lane, Cincinnati 11, Ohio  
 Kennedy, A., 299 Innes Rd., Wood-Ridge, N. J.  
 Lanterman, W. F., National Broadcasting Co., Merchandise Mart, Chicago 54, Ill.  
 LarRieu, E. A., Jr., 1624 E. 38 St., Oakland 2, Calif.  
 Liimatainen, T. M., 1090 Parkwood Blvd., Schenectady 8, N. Y.  
 Maki, G. J., Collins Radio Co., Cedar Rapids, Iowa  
 McKenna, W. E., 2993 Yorkway, Dundalk 22, Md.  
 Millen, T. I., 16 Deer Park Cres., Toronto 12, Ont., Canada  
 Palen, H. A., 122 E. Water St., Lock Haven, Pa.  
 Parchman, J. B., 18 Whitney Ave., Floral Park, L. I., N. Y.  
 Peake, H. J., 715 S. Washington St., Alexandria, Va.  
 Penners, B. A., 3678 Voltaire St., San Diego 6, Calif.  
 Richardson, W. E., 5960 S.W. Brugger St., Portland 1, Ore.  
 Rinn, F. H., 24 S. High St., Lock Haven, Pa.  
 Schneider, A. E., 538 Rutherford Ave., Lyndhurst, N. J.  
 Shapiro, D. L., 118-53 Metropolitan Ave., Kew Gardens, L. I., N. Y.  
 Steidley, J. W., Code 911-G, Bureau of Ships, Navy Department, Washington 25, D. C.  
 Suski, H. M., Combined Research Group, Naval Research Laboratory, Anacostia Station, Washington 20, D. C.

(Continued on page 54A)

# Turner Microphones

**W**HATEVER the need for a microphone in electronic recording, P.A., sound system, and commercial or amateur broadcast work, you can assure maximum performance when you Team Up with TURNER. Precision engineered to deliver smooth, accurate reproduction of any desired sound without harmonics or distortions . . . ruggedly built to withstand severe service conditions of shock, vibration, heat, cold, humidity and altitude, TURNER Microphones are CERTIFIED to help you select the right unit for your particular job.

Before leaving the factory, each and every TURNER Microphone is given an individual sound pressure test over the entire audio band. Its performance characteristics are checked and CERTIFIED to conform with established specification standards.

Whether you need a unit with "Weighted Response" to accent intelligible speech frequencies or a unit with an even response for general purpose use, you can depend on TURNER for accurate pick-up and clear, sharp reproduction.

Write for Free Illustrated Catalog describing TURNER Microphones for both specific and general applications. Turner Engineers will be glad to offer impartial suggestions in helping you choose the right unit for your purpose.

*Certified  
Performance*

## The TURNER Company

909 17th Street, N.E., Cedar Rapids, Iowa

Licensed under U.S. Patents of the American Telephone & Telegraph Company and Western Electric Company, Incorporated.  
Crystals licensed under patents of the Brush Development Company

**TURNER** *Pioneers in the  
Communications Field*



TURNER No. 99



TURNER Hand-D



TURNER No. 33



TURNER No. 211



TURNER No. L-40



# THE MAN WE NEED IS 3 MEN—

- First: **SCIENTIST**  
with a basic background in Nuclear Physics and some knowledge of Acoustics.
- Second: **ADMINISTRATOR**  
A true leader who can inspire and coordinate the work of a substantial research staff.
- Third: **ENGINEER**  
who can translate research results into production.

**AS RESEARCH DIRECTOR**  
of a large organization devoted exclusively to acoustic instrument research and service. We are looking for a man of vision, experience and a standing which commands respect. To this exceptional man we offer commensurate rewards and the increasing opportunities of an expanding field.

Address: S. W. Pierce,  
**SONOTONE, Elmsford, N. Y.**

# ENGINEERS

MEN for design and development work on radio and television receivers.

We have openings in our laboratory for a senior and two junior engineers. Senior engineers should be graduates in electrical or communication engineering and have had industrial experience in radio or television design. Junior engineers should be graduates in electrical or communication engineering, but industrial experience is not necessarily required.

Please address Director of Engineering giving details of education, experience, and salary requirements.

**Majestic Radio &  
Television Corporation  
St. Charles, Illinois**



The following positions of interest to I.R.E. members have been reported as open. Apply in writing, addressing reply to company mentioned or to Box No. ....

The Institute reserves the right to refuse any announcement without giving a reason for the refusal.

**PROCEEDINGS of the I.R.E.**  
330 West 42nd Street, New York 18, N.Y.

## ASSISTANT CHIEF ENGINEER

Prominent Eastern radio set manufacturer requires assistant chief engineer to take complete charge of laboratory. Must be thoroughly competent in AM and FM receiver design; also television; and possess executive ability. Excellent salary and good future. Write complete qualifications and background. Box 408.

## TECHNICAL EDITOR

Skilled in servicing electronic equipment, to assist in writing and editing articles about radio repairing. Radio Maintenance Magazine, 295 Broadway, New York 7, N.Y.

## SALES ENGINEER

Graduate electrical engineer to apply and sell small fractional horsepower motors to industry. Work direct from sales office of established manufacturer in Rochester, N.Y. Manufacturer's representatives not considered. State fully education, experience, age, and salary expected. Box 322, Rochester 2, N.Y.

## RADIO ENGINEERS

For design and development of home radio receivers. Can use men with experience in design laboratories on communications and entertainment receiving sets. Call or write Mr. Frank A. Hinners, Vice President in Charge of Engineering, Air King Products, 1523 63rd St., Brooklyn 19, N.Y.

## SENIOR ENGINEER

Expanding New York radio and television manufacturer, requires man with several years thorough experience in design and production of home radio receivers. Not a temporary but a permanent opportunity. High pay. Excellent future. U. S. Television Manufacturing Corp., 106 Seventh Ave., New York 11, N.Y.

## ENGINEERS

A large midwest manufacturer has immediate openings for the following engineers:

**Senior Development Engineers.** Openings in domestic radio and television receiver development for two Senior Radio Project Engineers and one Mechanical Engineer.

**Assistant Chief Engineer.** To assume complete supervision of household and auto radio receiver development. Extensive prewar experience in above lines imperative. Television receivers will be in our line.

(Continued on page 52A)

# ENGINEERS

*For Design Work  
on Radio Receivers,  
Audio Amplifiers,  
Television*

Men with substantial commercial experience wanted, preferably those having Degrees in Electrical or Communications Engineering. Write, giving details of experience and salary expected, to:

## FREED RADIO CORPORATION

*Makers of the Famous Freed-  
Eisemann Radio-Phonograph*

200 Hudson Street  
New York 13, N.Y.

Thousands of rugged, oil-filled, oil-impregnated condensers at ridiculously low prices. Write for list! New Time Payment Plan if desired.

**BIG NEW CATALOG!**

By mailing us your name and address, you will be among the first to get a copy of our own big new catalog, plus latest announcements of new and bargain components and equipment. Write today! Address Dept. IR of nearest Newark branch.

CHICAGO  
**Newark ELECTRIC Company**  
115-117 W. 45th St. NEW YORK 19 NEW YORK 19      323 W. Madison St. CHICAGO 6



# AMPLICALL

FINEST PAGING, TWO-WAY COMMUNICATION,  
AND PUBLIC ADDRESS SYSTEMS FOR INDUSTRY

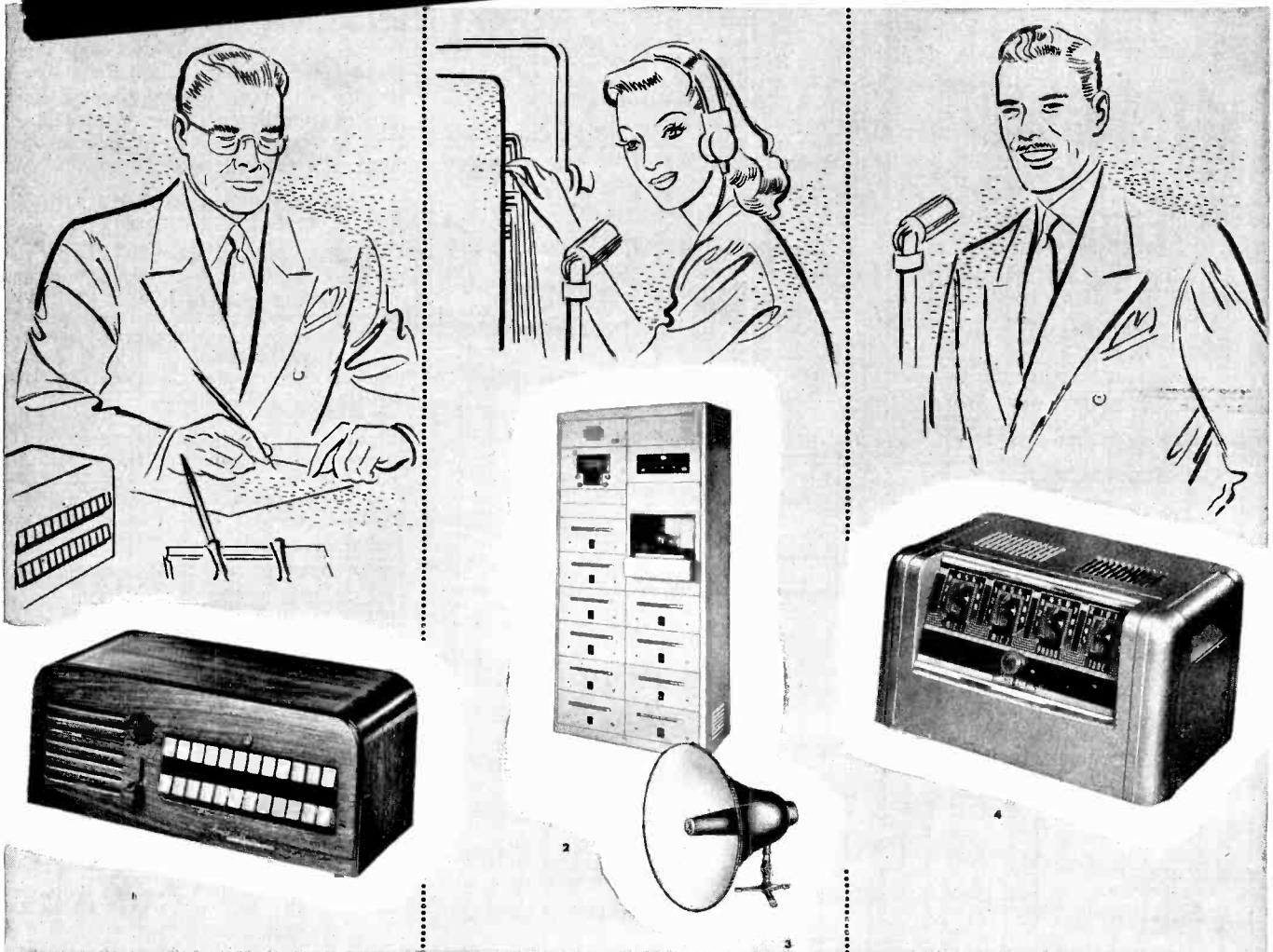

Thousands of Rauland AMPLICALL Systems are serving industry today with a performance dependability second to none! Engineering, quality materials and craftsmanship have been combined to insure AMPLICALL's dependability . . . multiple uses, flexibility of design, superb tonal quality, low maintenance cost and trouble-free operation are additional reasons for its preferred rating. Whether you need an adequate Paging, Intercommunication or Public Address System, or all three, be sure to check AMPLICALL . . . you'll find a system of the exact design and capacity to answer all of your requirements perfectly.

1. AMPLICALL Intercommunication unit, available for two-way communication between multiple stations.
2. AMPLICALL Paging Control Unit.
3. AMPLICALL Weatherproof Speaker.
4. AMPLICALL Audio Amplifier unit for laboratory, test equipment and general applications.

RADIO • RADAR • SOUND

## Rauland

COMMUNICATIONS • TELEVISION

*Electroneering is our business*

THE RAULAND CORPORATION • CHICAGO 41, ILLINOIS



# Draftsman Wanted

Also

**Designer  
Detailer  
Tracer and  
Engineer**

We are one of the largest manufacturers of a wide variety of communication and electronic equipment in the world, fully prepared and ready to go ahead with a very ambitious, expansion program as quickly as we are permitted. There will be unlimited possibilities for creative, ambitious men to advance to key positions both in research development and production field.

At present, we are producing vital equipment for our fighting forces.

Good Starting Salaries  
Exceptionally fine working conditions.

Apply Personnel Office  
8 A.M. to 5 P.M.

**FEDERAL TELEPHONE &  
RADIO CORP.**  
the Mfg. unit of the International  
Tel. & Tel. Corp.  
591 Broad St., Newark, N.J.  
WMC Rules Observed

## ★ ★ ★ Positions Wanted By Armed Forces Veterans

In order to give a reasonably equal opportunity to all applicants, and to avoid overcrowding of the corresponding column, the following rules have been adopted:

The Institute publishes free of charge notices of positions wanted by I.R.E. members who are now in the Service or have received an honorable discharge within a period of one year. Such notices must not have more than five lines. They may be inserted only after a lapse of one month or more following a previous insertion, and the maximum number of insertions is three per year. The Institute necessarily reserves the right to decline any announcement without assignment of reason.

### TECHNICIAN

Maintenance and repair, receiving and transmitting equipment. Eleven years experience. Discharged Chief Petty Officer Navy, available immediately, work anywhere. Carl Morris, P.O. 1094, Lexington, Ky.

### POSITION WITH STATION

Young man, 35 years of age, married, desires position with station contemplating expansion. Licensed since 1931. Nine years at transmitter before entering Navy. Experienced in installation and maintenance of transmitter and studio equipment. Naval experience all in materiel, VHF and FM. Los Angeles preferred. Box 1W.

## Remler Appointed as Agent for R.F.C.

... to handle and sell government owned electronic equipment released for civilian use.

Write for Bulletin Z-1 listing a wide variety of equipment covering entire electronic field.

Remler Co., Ltd. · 2101 Bryant St.  
San Francisco 11, Calif.

# REMLER

SINCE 1918

Communications · Electronics



(Continued from page 50A)

**Research Engineers.** Two research men with prewar development experience in the radio receiver or television field.

All inquiries will be treated as confidential. Reply to Box 406.

### ENGINEERS

With experience in audio circuit work for engineering development on hearing aids and associated devices. Experience on hearing aids not actually necessary. Apply to Chief Engineer, Zenith Radio Corporation, 6001 West Dickens Avenue, Chicago 39, Illinois, giving details of education, age and experience. Excellent opportunities for interested personnel.

### CHIEF MANAGING ENGINEER AND RESEARCH ENGINEERS

**CHIEF MANAGING ENGINEER** to take full charge of a division of a large manufacturing organization. Must have extensive experience in communications field, with substantial background in electronics and micro-wave research and product development. Salary \$12,000 to \$15,000.

**RESEARCH ENGINEERS** with thorough experience in electronics, and micro-wave development. Salary \$5,000 to \$6,000.

Write qualifications to Boyd King, 10 Rockefeller Plaza, New York 20, N.Y.

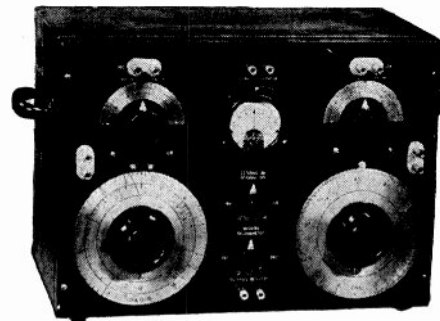

## High Accuracy

In Measuring:

- \* CAPACITANCE—RESISTANCE—INDUCTANCE
- \* STORAGE FACTOR (Q) OF COILS
- \* DISSIPATION FACTOR OF CONDENSERS

● **MODEL 200-A IMPEDANCE BRIDGE** is a portable, self contained instrument of highest quality used extensively by the Army, Navy, and many manufacturers.

The range of measurement for capacitance is 1 micro microfarad to 100 microfarads; for resistance, 1 milliohm to 1 megohm; for inductance, 1 microhenry to 100 microhenry. The accuracy on the main decade is 1% for capacitance or resistance measurements and 2% for inductance tests.

Reading obtained from 6 inch direct reading dials. All controls and connections plainly marked and conveniently located on the panel. 35-page book gives methods for many types of measurements.

### IMMEDIATE DELIVERIES

Our factory is in a position to make fast deliveries on Model 200-A and other products including precision mica condensers, binding posts, several types of AWS rheostat-potentiometers and decade and low capacity switches.

**Brown Engineering Co.**

4635 S. E. Hawthorne Blvd. Portland 15, Oregon

# LOCATE and MEASURE

FROM  
100 MC

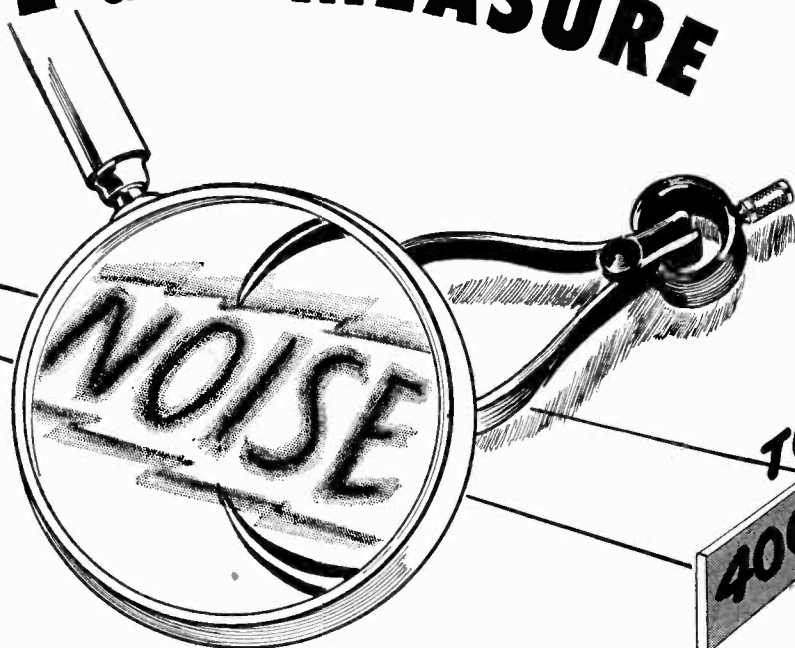

TO  
400 MC

## STODDART NOISE AND FIELD INTENSITY METER

Model NMA-4

- 100 to 400 MC in single band.
- One Microvolt sensitivity.
- Direct reading in Microvolts.
- Measures conducted and radiated noise.
- Provision for External Recording Meter.
- Measures Field Strength of Transmitters in the U.H.F. Range.
- It assists in the production of noise-free products by manufacturers.
- It locates and analyzes existing noises which interfere with radio reception.
- Its stability and accuracy enable transmitter engineers to obtain dependable field strength patterns.

Write for further information and complete technical data.

*Now available*  
FOR NON-MILITARY USE



# STODDART AIRCRAFT RADIO CO.

6644 SANTA MONICA BLVD.

HOLLYWOOD 38, CALIFORNIA

JUST PUBLISHED!

The Most Indispensable Reference in Radio-Electronics!

# Electronic Engineering Master Index

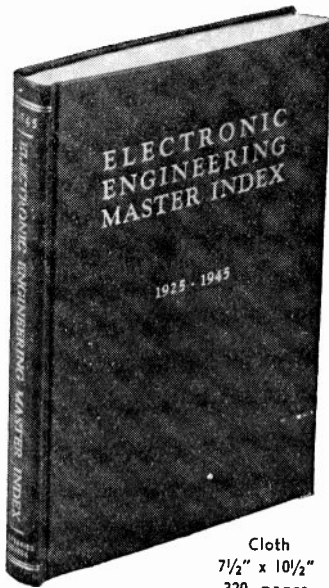

A master compilation of over 15,000 titles of texts and articles selected for their value to the research engineer, this INDEX covers the years 1925-1945 and enables you to survey twenty years of research literature on any subject in a matter of minutes!

Vitally Needed in Every Laboratory and Library

COMPLETE IN ONE VOLUME

PART I

January 1925 to  
December 1934

PART II

January 1935 to  
June 1945



PARTIAL LIST OF PERIODICALS INDEXED

Bell Laboratories Record	General Electric Review
Bell System Technical Journal	Journal of Applied Physics
Communications	Proceedings I.R.E.
Electrical Communication	Transactions of A.I.E.E.
Electronics	Radio News
Electronic Industries	R.C.A. Review
Journal of I.E.E.	Wireless Engineer

Cloth  
7 1/2" x 10 1/2"  
320 pages

A \$500 Reference Library in One Volume for \$17.50

Descriptive circular on request.

ELECTRONICS RESEARCH PUBLISHING COMPANY

2 West 46th Street

New York 19, N.Y.



(Continued from page 48A)

- Swarm, H. M., 6405—8 St. N.E., Seattle 5, Wash.  
 Thomason, J. F., 44 Cambridge Ave., Garden City, L. I., N. Y.  
 Thomforde, C. J., 1327 L Ave., N.E., Cedar Rapids, Iowa  
 Tetley, W. H., Box 2752, Carmel, Monterey County, Calif.  
 Van Dyck, K. A., Box 1644, Hq., A.T.S.C., Wright Field, Dayton, Ohio  
 Venable, D., 1421 Bolton St., Baltimore 17, Md.  
 Webb, H. D., 1306 H St., Belmar, N. J.  
 Weiss, M. E., Sylvania Electric Products, Inc., Mill Hall, Pa.  
 Wilson, L. B., 129—2 St., Garden City, L. I., N. Y.  
 Whealy, J. E., 406 Riverdale Ave., Ottawa, Ont., Canada

### Admission to Member

- Allen, A. J., University of Pittsburgh, Pittsburgh 13, Pa.  
 Anderson, P. M., 2905 Dean Blvd., Minneapolis 5, Minn.  
 Astholz, P. T., 4225 Larchmont Dr., Dayton 7, Ohio  
 Babakian, J., 184 Concord Ave., Belmont 78, Mass.  
 Balthis, D. L., 204 N. Beechwood Ave., Catonsville 28, Md.  
 Bower, M. M., R.D.F. Branch, Evans Signal Laboratory, Belmar, N. J.  
 Brown, W. C., 211 Washington Ave., Spring Lake, N. J.  
 Burcham, D. P., 6850—36 Ave. N.E., Seattle 5, Wash.  
 Butt, C., 31 Wilde Rd., Waban 68, Mass.  
 Byrnes, F. X., 1359 Chalcedony St., San Diego 9, Calif.  
 Christianson, H. J., 5833 W. Iowa St., Chicago, Ill.  
 Chute, D. H., 22 Bowker St., Lexington 73, Mass.  
 Cornet, E., 4013 Claridge St., Philadelphia 24, Pa.  
 Cottony, H. V., 1132 Curtis Ave., West Belmar, N. J.  
 Craig, F. D., Box 1421, Juneau, Alaska  
 Doughty, D. R., 4769 Kensington Dr., San Diego 5, Calif.  
 Drake, D. T., 13 Bigelow St., Cambridge, Mass.  
 Dunn, E. B., Box 63, Halifax, Va.  
 Esmond, D. C., 1515 Canora Rd., N., Town of Mt. Royal, P. Q., Canada  
 Frank, J. M., 2060 Fargo Ave., Chicago 45, Ill.  
 Gadsden, C. P., 142 Chilton St., Belmont 78, Mass.  
 Gilmartin, T., 1873 E. 17 St., Tulsa, Okla.  
 Gimble, E. G., 625 Belden St., Monterey, Calif.  
 Haney, W. L., 117 Borque St., Hull, P. Q., Canada  
 Hollis, W. C., 129—2 St., Garden City, L. I., N. Y.  
 Holt, D. L., 1312 E. 28 St., Anderson, Ind.  
 Hultquist, J. A., Fort Hill Village, Scarsdale, N. Y.

(Continued on page 56A)

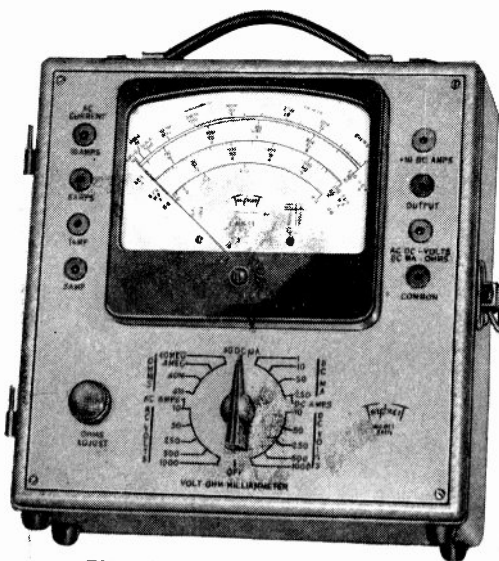

MODEL 2405

## Volt • Ohm Milliammeter

25,000 OHMS PER VOLT D. C.

STANDARDS ARE SET BY



### SPECIFICATIONS

NEW "SQUARE LINE" metal case, attractive tan "hammered" baked-on enamel, brown trim.

■ PLUG-IN RECTIFIER — replacement in case of overloading is as simple as changing radio tube.

■ READABILITY—the most readable of all Volt-Ohm-Milliammeter scales—5.6 inches long at top arc.

Model 2400 is similar but has D. C. volts Ranges at 5000 ohms per volt.

Write for complete description

# Triplet

ELECTRICAL INSTRUMENT CO.

BLUFFTON OHIO

### NEW ENGINEERING NEW DESIGN • NEW RANGES 50 RANGES

- Voltage: 5 D.C. 0-10-50-250-500-1000 at 25000 ohms per volt.  
 5 A.C. 0-10-50-250-500-1000 at 1000 ohms per volt.  
 Current: 4 A.C. 0-.5-1-5-10 amp.  
 6 D.C. 0-50 microamperes—0-1-10-50-250 milliamperes—0-10 amperes.  
 4 Resistance 0-4000-40,000 ohms—4-40 megohms  
 6 Decibel -10 to +15, +29, +43, +49, +55  
 Output Condenser in series with A.C. volt ranges

*Sensational*

**ERIE TYPE 554 CERAMIC TRIMMER**



Wherever shown, the new Type 554 Ceramic Trimmer has attracted the attention and admiration of the radio industry. First, its original and compact design, its obvious ease of installation and adjustment; later, its demonstrated superb performance—these qualities have not only aroused curiosity and interest, they have won immediate acceptance. Type 554 will be standard equipment on many receiving sets, from now on.

Note, in photograph and drawing, that the metal rotor completely covers the stator track. Contact surfaces of both rotor and stator are lapped, providing a high degree of stability, excluding dust, and keeping noise level to a minimum at high frequencies.

Capacity change is essentially constant per degree of rotation, and full range is covered in 180° rotation. Type 554 Trimmers will be available shortly in production quantities in the following capacity ranges: in zero temperature coefficient, 3-12 MMF and 5-25 MMF; in -750 parts/million/°C, 5-30 MMF and 8-50 MMF. They will also be available in an intermediate temperature coefficient. Trimmers are held firmly in place in a D-hole in the chassis by means of a multiple-tooth spring clip, furnished with the trimmer.

Specifications and capacity ranges are given in the table at right. For complete information, contact our nearest representative or write us direct.



ACTUAL SIZE

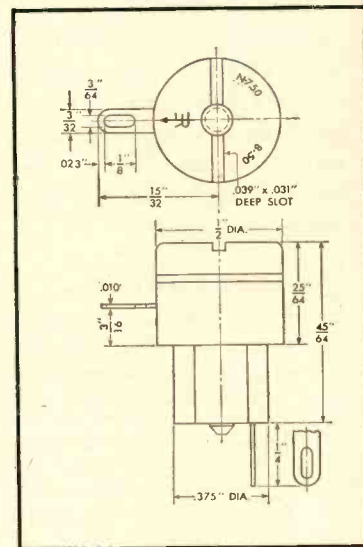

ERIE 554 CERAMICON TRIMMER

Voltage Rating: 350 volts D.C.  
Flash Test: 700 volts D.C. for 15 seconds.  
Initial Q Factor at 1MC: 500 minimum  
Initial Leakage Resistance: 10,000 meg. min.



*Electronics Division*  
**ERIE RESISTOR CORP., ERIE, PA.**

LONDON, ENGLAND

TORONTO, CANADA.





(Continued from page 54A)

- Ihrig, L. C., 18 Lillian Ave., Freeport, L. I., N. Y.
- Jacques, R. B., 1306 Republic Ave., Columbus, Ohio
- James, F. M., 2216 N. Harlam Ave., Elmwood Park 35, Ill.
- Jastram, P. S., 104 Prospect St., Providence, R. I.
- Jenkins, E. F., 1132 Groesbeck Rd., Cincinnati 24, Ohio
- Jenness, R. R., Northwestern Technical Institute, Evanston, Ill.
- Johnson, G. L., 49 Academy Rd., Albany 3, N. Y.
- Karlson, J. E., 8 Raymond Court, Garden City, L. I., N. Y.
- Kibling, C. A., 336 Oakland Beach Ave., Rye, N. Y.
- Laban, J., 55 N. Menard St., Chicago 44, Ill.
- Larson, C. O., 7909 St. Louis Terrace, La Jolla, Calif.
- Matthews, R. P., 2054 Claremont Ave., Montreal 6, P. Q., Canada
- McGinnis, F., 25 Lincoln Ave., New Hyde Park, N. Y.
- Mitchell, O. V., Radio Corporation of America, 30 Rockefeller Pl., New York 20, N. Y.
- Parker, C. B., 1717 Attucks Pl., Dayton 8, Ohio
- Parker, R. H., Riverside Dr., Augusta, Me.
- Plusc, I., 200 Bidwell Pkwy., Buffalo 9, N. Y.
- Rheaume, R. H., 181 Grove St., Stamford, Conn.
- Rowlatt, J. H., 2010 Union Ave., Montreal, P. Q., Canada
- Sauer, W. A., 2128 Pine St., San Diego 3, Calif.
- Stewart, N. H., Box 1312, Houlst Rd., Westinghouse Tube Plant, Fairmont, West Va.
- Thompson, A. C., 111 Garden St., Great Neck, L. I., N. Y.
- Tricamo, V. A., 65 Grand Ave., Freeport, L. I., N. Y.
- Upton, A. P., 3019 Ulysses St., Minneapolis 13, Minn.
- Warnock, E. W., RFD 1, New Carlisle, Ohio
- Youngblood, H. R., Lacey Field, Newburgh, N. Y.

**Admission to Associate**

- Alfie, C. L., 111 Lewis Ave., Box 566, Eatontown, N. J.
- Alsmeyer, R. L., Raytheon Manufacturing Co., G Bldg., Seyon St., Box 31, Waltham 54, Mass.
- Anacker, P. J., 608 W. 192 St., New York 33, N. Y.
- Anderson, F. L., Jr., Pan American-Grace Airways Inc., Limatambo, Lima, Peru
- Anger, H. O., 3742 California Ave., Long Beach 7, Calif.
- Angle, B. C., Astatic Corp., Conneaut, Ohio
- Appa Rao, D., 6, Sambasivam St., Thyagarayanagar, P. O., Madras, South India

(Continued on page 58A)



# New FOLDED UNIPOLE ANTENNA

Another Example of **ANDREW** Ingenuity in Engineering

Concentrating on electrical performance, Andrew engineers have designed a unique Folded Unipole Antenna which—according to comparative tests—easily outperforms other antennas at several times the price.

Used for transmitting and receiving at frequencies from 30 to 40 MC and for powers up to 5,000 watts, this antenna has proved so successful that similar models for higher frequencies are now being designed.

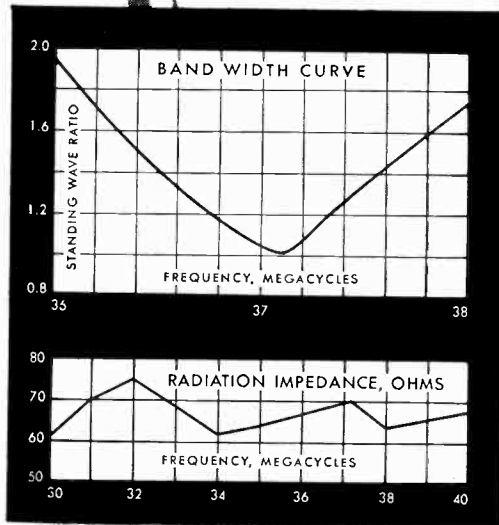

**FEATURES:**

- Light weight — only 15 pounds — simplifies installation.
- Lightning hazard minimized by grounded vertical element.
- "Slide trombone" calibration permits exact adjustment for any frequency between 30 and 40 MC, using only a wrench. Optimum performance for that frequency is guaranteed without "cut and try" methods.
- Proper termination of coaxial transmission line. Unlike other "70-ohm" antennas, the Folded Unipole actually provides a non-reactive impedance with a resistive component varying between 62 and 75 ohms (see lower curve).
- Excellent band width, ideal for FM (see upper curve).

Andrew Co. specializes in the solution of antenna problems. For designing, engineering and building of antenna equipment, consult Andrew Co.

# ANDREW CO.

363 EAST 75th ST., CHICAGO 19, ILL.

WRITE FOR FULL INFORMATION

# TALK IS QUICK!



Pick up a 'phone and talk—to an airplane; a speeding train; an inter-city bus; a boat at sea.

Aireon's radio 'phones make this as simple, sure and easy as using a conventional telephone.

Aireon radio equipment for airlines is used by twenty domestic, four foreign companies; Aireon railroad radio, introduced under war-time restrictions, is *already in use* by four leading railroads. Aireon truck, taxi and bus communications equipment has been proved in service on the trucks of one of the nation's largest fleet operators. It's now in production. Aireon marine equipment will be available soon.

On the crowded highways and skyways of the future, radio 'phone communication will keep traffic moving under quick, efficient control.

**Aireon** MANUFACTURING CORPORATION

**Radio and Electronics • Engineered Power Controls**

NEW YORK • GREENWICH • CHICAGO • KANSAS CITY • OKLAHOMA CITY • BURBANK • SAN FRANCISCO

Proceedings of the I.R.E. January, 1946

57A

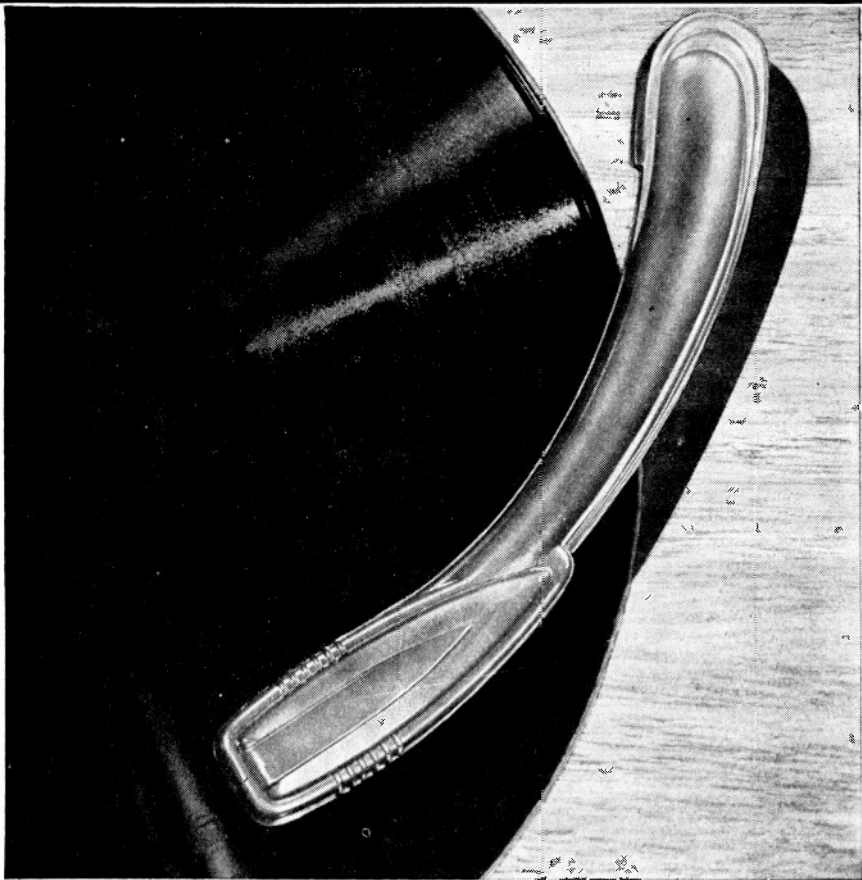

## The SHURE *Glider* Phonograph Pickup is equipped with the SHURE Lever-Type Cartridge

The "Glider" Pickup consists of the light-weight, low-mass Tone Arm and the Lever-Type Cartridge. The Arm is aluminum, uses no springs or counterweights and permits the needle-point to glide along the record smoothly and easily. This means longer needle and record life. The "Glider" is less susceptible to floor vibrations and improves the playing of warped records. The lightness of the Arm permits a needle force of only  $1\frac{1}{8}$  oz. The "Glider" is especially suitable to the playing of the Vinylite records.

The Cartridge employs a radically different means of driving the Crystal Element. The Crystal is driven by a lever which considerably improves the transmission of needle chuck torque into the Crystal. Lower needle point impedance is obtained through this design, as well as greater immunity to shock. The lever arrangement absorbs the full impact of sudden jars to the Cartridge or needle, thus freeing the Crystal from strain or breakage. The output voltage is from 1.6 volts to over 3 volts. The new Cartridge is available in an aluminum case and weighs only .43 oz. (12 grams). The Cartridge is also furnished in steel, weighing .85 oz. (24 grams). The high needle-point compliance of this light-weight Cartridge affords "Faithful Tracking", which results in clearer, fuller tone qualities.

("Glider" Model Number is 93A)

Patented by Shure Brothers. Licensed under the Patents of the Brush Development Company.

# SHURE BROTHERS

Designers and Manufacturers of Microphones and Acoustic Devices

225 West Huron Street, Chicago 10, Illinois  
Cable Address: SHUREMICRO



(Continued from page 56A)

- Applegate, C. C., 737 Blaine Ave., South Bend, Ind.  
 Arnold, M. F., 1804 N. Broad St., Philadelphia, Pa.  
 Bargery, C. J., 8 Torbay Rd., Castle Cary, Somerset, England  
 Bartlett, P. R., Radio Station KFRE, Fresno, Calif.  
 Baulch, E. L., 463 West St., New York, N. Y.  
 Belinski, A. M., 16 Marcella St., Cambridge 41, Mass.  
 Berman, J., 19 Washington St., Dorchester 21, Mass.  
 Bernier, E. J., Box 541, Southridge, Mass.  
 Black, J. G., 1455 Elmdale St., Chicago 26, Ill.  
 Blanchard, H. R., 3410 St. John, Kansas City 1, Mo.  
 Bloch, H., Moerlistr. 63, Zurich, Switzerland  
 Brennan, J. J., USN Supply Corps School, Morris B-12, Soldiers Field, Boston 63, Mass.  
 Brown, R. W., Sperry Gyroscope Co., Manhattan Bridge Pl., Brooklyn 1, N. Y.  
 Bryant, H. L., 7000 Santa Monica Blvd., Hollywood 38, Calif.  
 Burdine, W. G., RFD 2, Waynesville, Ohio  
 Cahill, A. J., 275 Catchart St., London, Ont., Canada  
 Campbell, E. J., 114 Fenner Ave., Clifton, N. J.  
 Campos, S. C., Calle Bascunan Guerrero 43, Santiago, Chile  
 Carney, R., 3433 Gillespie St., Dallas 4, Texas  
 Cartier, A. P., 2 rue Lefort, Geneva, Switzerland  
 Clark, C. G., "The Spinney," Wigan Lane, Chorley, Lancashire, England  
 Clarke, L. G., 77 Martin St., Cambridge 38, Mass.  
 Clelland, F. W., Jr., 36 Gammon Ave. S.E., Atlanta, Ga.  
 Close, R. N., 611 E. Willow Grove Ave., Chestnut Hill, Pa.  
 Coleman, P. D., 6 Colin Kelley Dr., Overlook Homes, Dayton 3, Ohio  
 Cooper, Z. R., 345 Five Oaks Ave., Dayton 5, Ohio  
 Court, G. W. G., T.R.E., Great Malvern, Worcs., England  
 Cox, R. C., 554-9 St., Lorain, Ohio  
 Crawford, B., Radio W9BDO, Seneca, Nebr.  
 Crise, G. M., Radio-Suisse S. A., Prangins, Switzerland  
 Czepinsky, W., 618½ Parkman Ave., Los Angeles 26, Calif.  
 Davis, W. B., 16 Kennedy St., Box 56, Xenia, Ohio  
 Day, J. L., 20 Belshaw Ave., Eatontown, N. J.  
 Dean, A. W., Near East Arab Broadcasting Station, Jaffa, Palestine  
 DeJong, P. G., 4079 Minnesota Ave. N.E., Washington 19, D. C.

(Continued on page 60A)



# TELEVISION

# Sherron Electronics



W2XDK

**We Design - We Develop - We Manufacture**

**Television - FM - Transmitters and Studio Controls, Monitors and television test equipment.**

Our demonstrated experience in designing, developing and fabricating equipment employing video amplifiers, cathode ray tubes, oscilloscope controls and allied circuits to television, establishes our skill and capacity to serve the Television Industry. Our Design section, Engineering department, Development section and Manufacturing department, staffed with expert and experienced personnel, enable us to offer to the television industry for their consideration:

Television Transmitters - Video and Aural  
FM Transmitters  
Studio Control Consoles  
Master Control Boards  
Transmitter Control Consoles  
Audio Control Consoles  
Television Test Equipment

Outstanding evidence of our service to the television industry is the establishment of our Experimental Station W2XDK. Over these facilities, transmitters, monitor controls - plus television test equipment - are subjected to operational inspection. This "proving-ground" assures the purchaser of Sherron Electronics Company Television equipment of tested and accredited broadcasting apparatus.

**See our Television Exhibit  
Booths 34 and 35  
IRE Winter Technical Meeting  
Hotel Astor  
January 23, 24, 25, 26, 1946**

**SHERRON ELECTRONICS CO.**

*Division of Sherron Metallic Corp.*  
Brooklyn 6, N. Y. 1201 Flushing Avenue



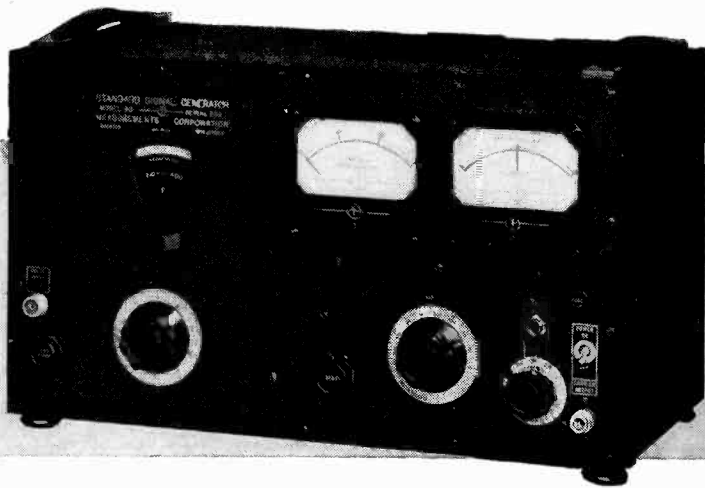

## STANDARD SIGNAL GENERATOR Model 80

### SPECIFICATIONS:

**CARRIER FREQUENCY RANGE:** 2 to 400 megacycles.

**OUTPUT:** 0.1 to 100,000 microvolts. 50 ohms output impedance.

**MODULATION:** A M 0 to 30% at 400 or 1000 cycles internal. Jack for external audio modulation.

Video modulation jack for connection of external pulse generator.

**POWER SUPPLY:** 117 volts, 50-60 cycles.

**DIMENSIONS:** Width 19", Height 10 3/4", Depth 9 1/2".

**WEIGHT:** Approximately 35 lbs.

**PRICE—\$465.00 f.o.b. Boonton.**

Suitable connection cables and matching pads can be supplied on order.

**MEASUREMENTS CORPORATION**  
BOONTON NEW JERSEY



## METAL-TO-GLASS SEALS

**Intricate glass work and tubes  
made to your specification**

The Universal X-Ray plant specializes in the production of metal-to-glass seals. Intricate glass seals are made to customers' specifications for electronic tubes, transformers, resistors, capacitors, condensers, vibrators, switches, relays, instruments, gauges, meters, receivers, transmitters, and other scientific apparatus.

A strong metal-to-glass bond assures unfailing protection against rust, corrosion, and extreme climatic conditions in a vacuum-tight seal. Good deliveries can be made on volume orders. Submit your metal-to-glass seal problems to the Universal engineers for recommendations and estimates.

**UNIVERSAL X-RAY PRODUCTS INC.**

1800-K N, FRANCISCO AVENUE

CHICAGO 47, ILLINOIS



(Continued from page 58A)

- Duggan, J. R., 2323 Davidson Ave., c/o Considine, Bronx 53, N. Y.
- Dvorsky, A. L., c/o The Astatic Corp., Harbor and Sackson St., Conneaut, Ohio
- Eckardt, F., 1691 Jackson Ave., Columbus, Ohio
- Edgar, R. B., Education Department, 11 Phase, Navy Pier, Chicago, Ill.
- Emanuel, F., 1417 Grand Concourse, Bronx 52, N. Y.
- Emery, C. W., 428 1/2 W. 40 Pl., Los Angeles 37, Calif.
- Evans, W. F., 114-63—227 St., St. Albans, L. I., N. Y.
- Fishbein, S. B., 752 Ocean Ave., West End, N. J.
- Fiske, P. E., 2430 Seaside St. San Diego, 7, Calif.
- Folan, A. J. P., 134 N. Circular Rd., Dublin, N.W. 5, Eire
- Forni, P. A., Smith Paper, Inc., Lee, Mass.
- Forrest, R. O., 1742 E. Lombard St., Baltimore 31, Md.
- Foster, G. P., General Electric Co., 14 and Baltimore St., Kansas City, Mo.
- Francoeur, G. R., 110—11 Ave., Belmar, N. J.
- Frey, G., 7 Rue Renault, St. Mande, Seine, France
- Fricke, R. H., RCA Victor Division, Bldg. 53, Section C, Camden, N. J.
- Frost, S. H., 2921 E. Meyer Blvd., Kansas City 5, Mo.
- Goodell, C. E., V.E.H.P., 5 Ave. and Hill St., Ann Arbor, Mich.
- Gray, R. P., 5 Oak St., Marblehead, Mass.
- Green, V. L., 3337 Bellefontaine St., Kansas City 4, Mo.
- Griffith, B. H., Jr., 2119 S. 74 St., West Allis 14, Wis.
- Gryp, E. S., 166—4 St., Elizabeth 1, N.J.
- Guettinger, P., Department HF-VL, Brown Boveri and Co. Ltd., Baden, Switzerland
- Hamby, T. A., 4044—18 St., San Francisco 14, Calif.
- Hawkins, J. E., 89 E. 16 St., Hamilton, Ont., Canada
- Hedlund, K. W., 6967 Eastman St., San Diego, Calif.
- Heenan, P. J., 11 King St. W., Toronto, Ont., Canada
- Heidelberg, R. F., 515—14 Ave., Laurel, Miss.
- Heindl, J. J., Jr., 3935 Frisby St., Baltimore 18, Md.
- Ho, L. C., Hotel Commander, Cambridge, Mass.
- Holley, A. T., Calle Constitucion 097, Santiago, Chile
- Hornaday, G. J., 960-B Suburban Pkwy., Portsmouth, Va.
- Hough, J. B., 117 E. 37 St., New York 16, N. Y.
- Hunn, R. J., E. I. du Pont de Nemours and Co. Inc., Wilmington 98, Del.
- Jerold, W. W., 36 Quaker St., Hillside Heights, L. I., N. Y.

(Continued on page 62A)

Proceedings of the I.R.E. January, 1946

# METAL ASSEMBLIES AND COMPONENTS FOR ELECTRONIC AND MECHANICAL DEVICES

•  
**ENGINEERING**

•  
**DEVELOPING**

•  
**FABRICATING**

•  
**ELECTRO-FORMING**

•  
**PLATING**

•  
**FINISHING**  
•

**B**ERNARD **R**ICE'S **S**ONS

I N C O R P O R A T E D

MANUFACTURERS OF QUALITY METAL PRODUCTS SINCE 1867

OFFICE: 325 FIFTH AVENUE, NEW YORK 16, N. Y.

WORKS: 139-145 NORTH TENTH STREET, BROOKLYN 11, N. Y.



Continued from page 60A)

- Joffe, A. S., 1624 Widener Pl., Philadelphia 41, Pa.
- Johnson, R. A., Radio Research Laboratory, Harvard University, Cambridge, Mass.
- Johnston, C. M., Sperry Gyroscope Co., Stewart Ave. and Clinton Rd., Garden City, L. I., N. Y.
- Joubert, J. G., 63 C.D. Coy, S.S.S., SA Corps of Signals, Box 797, Port Elizabeth, South Africa
- Kane, L., 203 E. 18 St., New York 3, N. Y.
- Kavlak, D. J., 10919 S. Park Ave., Chicago 28, Ill.
- Kennedy, J. F., El Heurah Apts., Dover, Del.
- King, C. W., 1527 W. 15 St., Topeka, Kan.
- Kinney, W. E., 3519 N.W. 13 Ave., Miami 37, Fla.
- Kircher, J. J., 2450 S. 35 St., Milwaukee 7, Wisc.
- Koitto, H. E., 17 W. 91 St., New York 24, N. Y.
- Kolen, N., Jr., 350 E. Armour Blvd., Kansas City 2, Mo.
- Kuck, J. H., 7444 Georgia Ave., Washington 12, D. C.
- Lessem, M., 2527 Ford Ave., Detroit 6, Mich.
- Leff, B., 1930 N. Humboldt Blvd., Chicago, Ill.
- Levin, H. S., 512 Eastern Pkwy., Brooklyn, N. Y.
- Long, R. L., 124 E. Harrison Ave., Maumee, Ohio
- Loudon, R. E., 2436 N. Beachwood Dr., Los Angeles 28, Calif.
- Lyman, J. R., 12 Cass St., Springfield 4, Mass.
- Lynch, P. E., 4325 Waverly St., Kansas City, Kan.
- MacDonald, D. B., Cardigan, Prince Edward Island, Canada
- Manning, C. H., 1548 Hollywood Ave., Salt Lake City 5, Utah
- Markley, H. G., AAF, ATSC, Watson Laboratories, Red Bank, N. J.
- Maxson, J. F., 512-9 Ave., Belmar, N. J.
- McLin, J. T., Box 12, Drew, Miss.
- Melancon, N. J., 140-71 Ash Ave., Flushing, L. I., N. Y.
- Metcalfe, J. D., Staff, Radio Materiel School, Treasure Island, Calif.
- Michelson, L., 129 Wilson Rd., Nahant, Mass.
- Mielke, E. S., Westinghouse Electric Corp., 2519 Wilkens Ave., Baltimore 3, Md.
- Miller, C. E., Jr., 6203 MacDill Ave., Tampa 6, Fla.
- Miller, H. G., Bell Telephone Company of Pennsylvania, 1835 Arch St., Philadelphia 3, Pa.
- Miller, R. E., 1433 S St., S.E., Washington 20, D. C.
- Morrell, G. A., Jr., c/o Astatic Corp., Conneaut, Ohio
- Mudry, J., RCAF, R and C School, Clinton, Ont., Canada
- Mulkey, C. R., Box 2504, Carmel, Calif.

(Continued on page 64A)



*New!*

## A SIMPLIFIED VERTICAL MOUNTING FOR SMALL TRANSFORMERS

Sizes fit Core Stacks with 1/2" to 7/8" center legs

To fully mount the smaller sizes of transformers, Chicago Transformer has developed a new, vertical, shield-type construction possessed of many outstanding characteristics.

- Readily adaptable to various chassis mounting requirements.
- Flexible in application to varying core thicknesses.
- Simple in design: two-unit construction makes for economy.
- Allows grounding of core by direct contact with mounting surface.
- Meets the requirements of the Underwriters' Laboratories.

# CHICAGO TRANSFORMER

DIVISION OF ESSEX WIRE CORPORATION  
3501 WEST ADDISON STREET  
CHICAGO, 18





LABORATORY INSTRUMENTS FOR SPEED AND ACCURACY

# What Happens Inside an -hp- Model 500A Frequency Meter

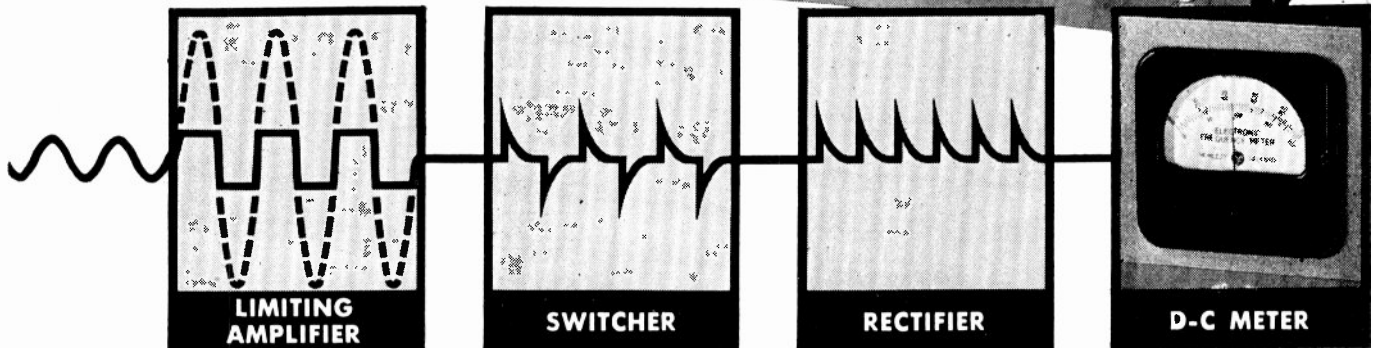
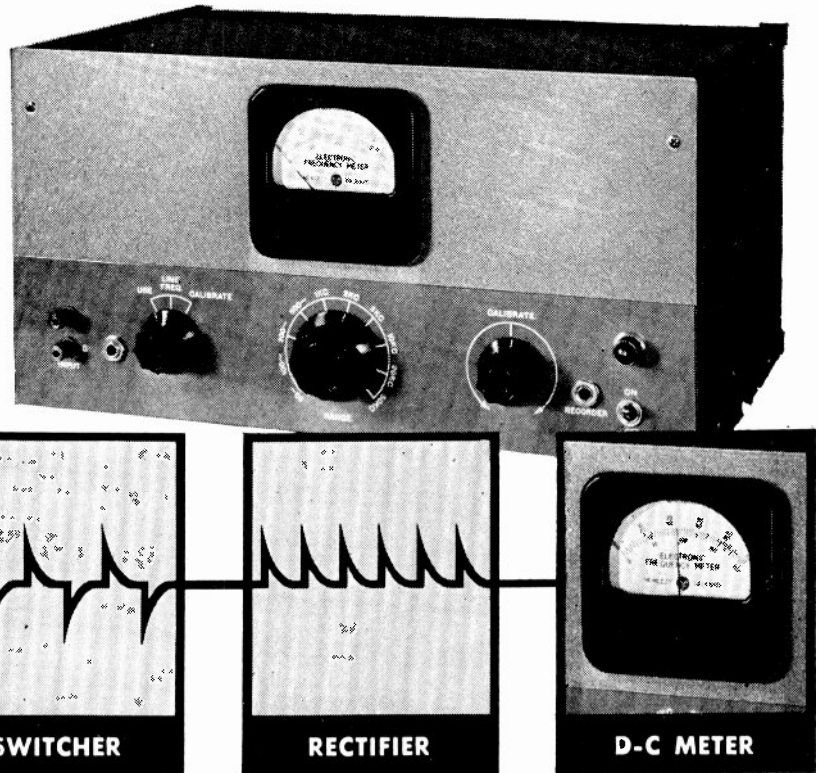

## This Instrument Counts Cycles of an Unknown Frequency

The above diagram shows how the -hp- 500A analyzes an unknown frequency so that cycles per second will accurately register on the specially calibrated d-c meter.

The unknown frequency is introduced to a limiting amplifier which generates a square wave output. The square wave voltages are applied to two switching tubes which become alternately conducting on opposite half cycles. From a constant current supply, the two switching tubes deliver a current to load resistors. Each load resistor causes the charge on a pair of capacitors to vary in accordance with the switched current pulses. Thus a current flows from the combination to the rectifier. The rectified pulses are delivered to the d-c meter. Each pulse is of the same size and independent of other factors. The meter integrates these pulses and gives a deflection which is proportional to the number of

pulses per second. Thus the meter reading is directly related to the unknown frequency.

The instrument is easy to use and requires but a small amount of power. It has good sensitivity and a wide range of usable voltages. The input range is from 0.5 to 200 volts—input impedance is 50,000 ohms. A switch on the panel selects one of ten ranges which are read directly on the meter.

Accuracy of the instrument is  $\pm 2\%$ —independent of line voltages, vacuum tube characteristics and magnitude and wave form of applied voltage—because the meter reading is dependent only upon the constant current supply and the RC combination.

The uses for this meter become readily apparent. Of special interest is its use as a high speed tachometer. (See column at right.) Write for more detailed information today. -hp- engineers are at your service.

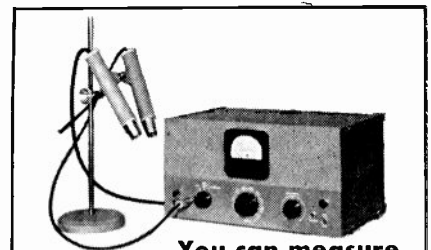

You can measure  
**3,000,000 r.p.m. with this  
-hp- Electronic Tachometer**

Using a photo electric cell pickup in conjunction with an -hp- Model 500A Frequency Meter provides an Electronic Tachometer capable of accurately measuring incredible speeds. This method places no load on the device being clocked.

Two special models of -hp- frequency meters, complete with light source and pickup, are available for this purpose. One model (505A) is calibrated in r.p.m. from 600 to 3,000,000 r.p.m.; the other model (505B) is calibrated in r.p.s. from 50 to 50,000 r.p.s. Speeds as slow as 600 r.p.m. (10 r.p.s.) are conveniently measured directly, while still slower speeds can be measured by a simple expedient. Ask for special technical bulletin on -hp- Models 505A and 505B.

## HEWLETT-PACKARD COMPANY

BOX 1073D, STATION A, PALO ALTO, CALIF.

Audio Frequency Oscillators

Signal Generators

Vacuum Tube Voltmeters

Noise and Distortion Analyzers

Wave Analyzers

Frequency Meters

Square Wave Generators

Frequency Standards

Attenuators

Electronic Tachometers



# EBY # 60 SPEAKER CONNECTORS

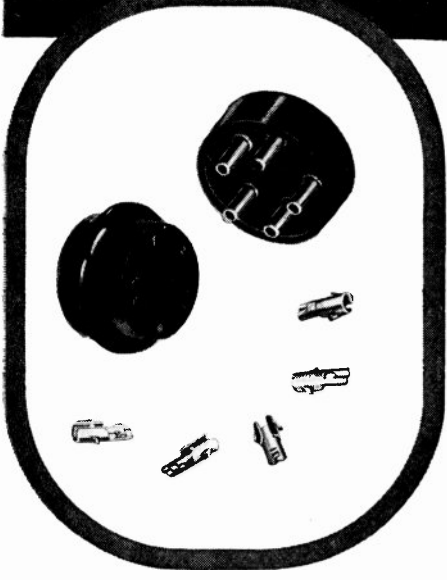

### SAVE APPROXIMATELY 25% IN ASSEMBLY TIME

**Only 2 parts to Female Assembly:**

1. The bakelite casting.
2. Eby patented snap-lock contacts.

Here's assembly speed! It's as simple as this:  
Attach contact to wire and push into cavity.  
Contact automatically locks in place.  
(Casting and contacts supplied unassembled.)

**Male Assembly — nickel-plated brass prongs.**  
Bakelite casting — Standard arrangement for 3, 4, and 5 prongs. Other arrangements to specifications.

**Write today for samples and prices.**  
Eby #60 Male and Female Speaker Connectors  
Are the Standard of the Industry

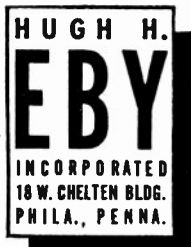

IF IT'S IN A CIRCUIT  
... EBY COMPONENTS  
AND SERVICES WILL  
HELP YOU DO IT BETTER

## Membership

(Continued from page 62A)

- Murray, D. G., Station CHWK, Chilliwack, B. C., Canada
- Myers, A. S., Jr., 7126 Lincoln Dr., Philadelphia 19, Pa.
- Nelson, L. O., 9 Phase, RMS, Navy Pier, Chicago, Ill.
- Newton, I. T., Jr., 1606 Abingdon Dr., Alexandria, Va.
- Nikonow, J. P., 551—5 Ave., New York 17, N. Y.
- Nilson, O. J., 4725 East Side Ave., Dallas 1, Texas
- Norkus, B. S., Box 117, Stratford, Conn.
- O'Dell, D. L., Kansas City Power and Light Co., 14 and Baltimore Ave., Kansas City, Mo.
- Palin, E. L., 98 Donlea Dr., Leaside, Toronto 12, Canada
- Pao, C. S., 282 Massachusetts Ave., Cambridge 39, Mass.
- Phillips, W. S., 4207 Tunis St., Philadelphia 24, Pa.
- Pickering, C. K., 2203 Pickering Ave., East Liverpool, Ohio
- Poll, V. M., 6410 S. Sacramento, Chicago 29, Ill.
- Porter, A. D., 126 Villa St., Waltham 54, Mass.
- Powell, R. M., 5024 H St., S.E., Washington, D.C.
- Prondzinski, R. C., 6325 W. Greenfield Ave., West Allis, Wis.
- Quick, A. E., Jr., 180 Hilton Ave., Hempstead, L. I., N. Y.
- Rabinowitz, I. M., 2137 Wallace Ave., Bronx 60, N. Y.
- Reed, F. C., Jr., Glen Head, L. I., N. Y.
- Riblet, H. J., 26 Concord Ave., Cambridge, Mass.
- Richon, E., 76 Willow St., Brooklyn 2, N. Y.
- Riechers, H., 35-42—73 St., Jackson Heights, L. I., N. Y.
- Rivman, J., 764 McDonald Ave., Brooklyn 18, N. Y.
- Robertson, G. W., 55 Newton Ave., Halifax N. S., Canada
- Ryder, E. M., 1475 Centre St., Roslindale, Mass.
- Sammon, P. J., 828 Sorolla Ave., Coral Gables, Fla.
- Sargent, D. L., 6 Ave. B., Turners Falls, Mass.
- Sather, B. M., 3632—15 Ave. S., Minneapolis 7, Minn.
- Schroeder, G. W., Edison General Electric Appliance Co., Inc., 5600 W. Taylor St., Chicago 44, Ill.
- Scrafford, R. L., c/o Fleet Post Office, New York, N. Y.
- Segal, A. A., 301 Sea Breeze Ave., Brooklyn, N. Y.
- Seitz, H. J., 89-01—73 Ave., Glendale, L. I., N. Y.
- Semmelink, A., Groeneweide, Stellenbosch, South Africa
- Seney, J. S., 1507 Hampton St., Richmond 20, Va.
- Serota, R. M., 3813A N. 52 St., Milwaukee 10, Wisc.
- Shipman, W. A., 99 N. Front St., Columbus 15, Ohio
- Smith, J. W., 28-05 Ditmars Blvd., Long Island City 5, L. I., N. Y.
- Smoller, M., 825 E. 175 St., Bronx 60, N. Y.

(Continued on page 78A)

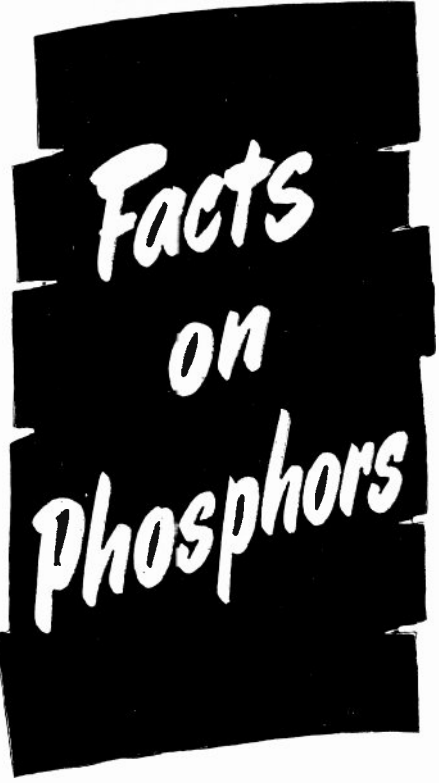

**HIGH GRADE** Patterson phosphors, such as those required in the manufacture of cathode ray tubes and for scientific research, are now available in quantity.

For more than thirty years, the Patterson Screen Division of the Du Pont Company has produced luminescent chemicals for fabrication into x-ray screens. These screens have long been recognized throughout the world as the standard of screen quality. Patterson phosphors are known for their uniformity of emission, color and grain size. They meet exacting needs of a wide variety of specific requirements.

**A BOOKLET—“Patterson Luminescent Chemicals”** describes the general characteristics of various high grade phosphors and outlines their production. It will be mailed upon request. Patterson Screen Division of E. I. du Pont de Nemours & Co. (Inc.), Towanda, Pennsylvania.

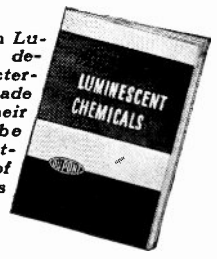

## Patterson Luminescent Chemicals



BETTER THINGS FOR BETTER LIVING  
... THROUGH CHEMISTRY



*A Tube that Stands the GAFF  
built by Federal*

*Engineered*  
Especially for **HEAVY DUTY**  
Industrial Applications

This high power industrial tube built by Federal is the result of the widening use of induction heating for heavy applications...especially designed for the purpose...built to meet the exacting demands of severe operating conditions.

Federal's 9C23 is a tube that can stand the gaff...with extra ruggedness for stamina...heavy duty filament for long life and high power output...

and with the inherent reliability and exceptional qualities that characterize every tube in the extensive Federal line.

Here is another instance where Federal's long experience and leadership in tube design and construction contribute to electronic progress. And it is a good reason to see Federal first for industrial power...rectifier...transmitting tubes.

Remember—"Federal Always Has Made Better Tubes."



Technical Data for Type 9C23	
Maximum Ratings for Maximum Frequency of 20 Mcycles	
D C Plate Voltage . . .	5,000 volts
D C Plate Current . . .	4.0 amperes
Plate Dissipation . . .	25 x lowwatts
Filament Voltage . . .	22 volts
Filament Current . . .	82 amperes
Overall Length . . .	19 1/2 inches
Type of Cooling . . .	water

*Federal Telephone and Radio Corporation*



Newark 1, N.J.



# Permanent Magnets

FOR

## LOUD SPEAKERS

From 1/2 oz. to over 30 lbs. . . . and from start to finish . . . Arnold manufactures better Alnico permanent magnets for loud speakers. They are now available for all civilian applications, and include the proposed Radio Manufacturers Association standard speaker magnets in Alnico V.

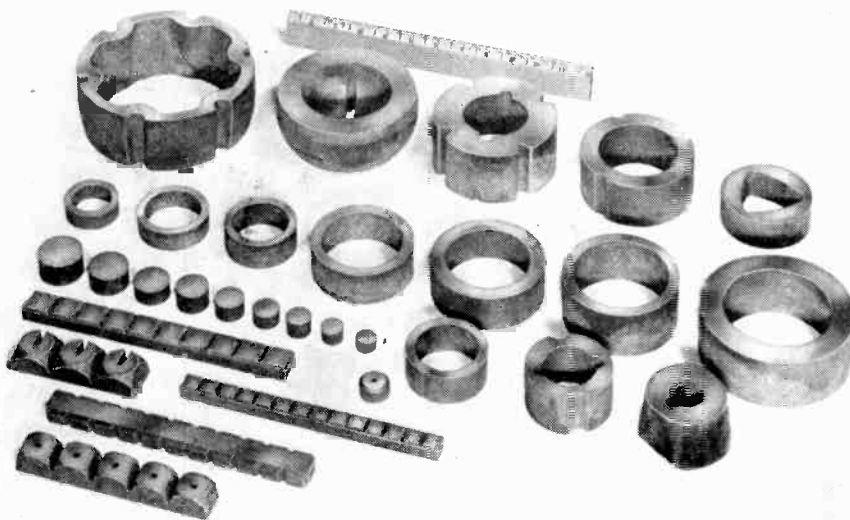

The speaker magnets illustrated above are representative, yet are just one type of permanent magnets described in the new 24-page Arnold bulletin, "Permanent Magnets for Industry."

WRITE TODAY on your company letterhead  
FOR THIS NEW BULLETIN



### THE ARNOLD ENGINEERING COMPANY

147 EAST ONTARIO STREET, CHICAGO 11, ILLINOIS

Specialists in the manufacture of  
ALNICO PERMANENT MAGNETS

## Peacetime Development of New Weapons

No sooner had news of the complete victory in Japan reached this country than the War Department of the United States of America began placing into effect a plan which should bring comfort and confidence to all but future potential enemies.

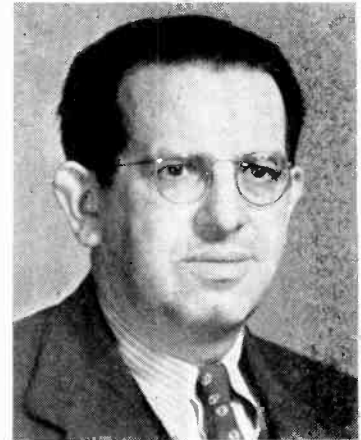

HARRY DIAMOND

Remembering the days of Pearl Harbor, days that caught the Nation unprepared, an unpreparedness that can be measured only in the countless numbers of lives sacrificed in the effort to stem the surge of the aggressor nations; remembering these things, there has been awakened the realization that even the powerful nations might never survive if caught in the storm of another war in the same state of preparedness as the United States faced on December 7, 1941.

Silently but swiftly on V-J Day, machinery was placed in operation under a plan which had been set up as far back as October, 1944, and held in readiness for the war's end, the plan to provide the United States with the best weapons and counterweapons ever conceived, weapons which would exceed the best any potential enemy could devise, weapons such that no other nation would venture to entertain the idea of an attack.



ROBERT O. HUNTOON

Evidence of this plan was revealed in an announcement by the Secretary of War on October 24, 1945, of Army Ordnance plans

(Continued on page 68A)



1/2 ACTUAL SIZE

**RAYTHEON**

**TYPE 1006/CK1006  
A HEAVY DUTY  
FULL-WAVE GAS RECTIFIER**

**TYPE 1006/CK1006 RATINGS  
FULL-WAVE RECTIFIER SERVICE**

	Ionically Heated	Heated Directly
Filament Voltage	1.75 volts	1.75 volts
Filament Current	2.00 amps	2.00 amps
Maximum Peak Anode Voltage (per anode) no load	800 volts	800 volts
Maximum Peak Inverse Voltage	1500 volts	1600 volts
Average D.C. Voltage Drop	30 volts	25 volts
Maximum D.C. Output Current	200 ma.	200 ma.
Minimum D.C. Output Current	20 ma.	0 ma.
Minimum Starting Peak Voltage (half wave or dc)	350 volts	450 volts
Minimum Starting Peak Voltage (full wave)	350 volts	420 volts
Maximum Steady State Peak Anode Current per anode	500 ma.	600 ma.



*Excellence in Electronics*

**RADIO RECEIVING TUBE DIVISION  
NEWTON, MASSACHUSETTS. NEW YORK. CHICAGO**

To supply the requirements of small transmitters or other equipment where rectification efficiency must be maintained at a high level, Raytheon engineers developed type 1006/CK1006.

Utilization of an inert gas enables this tube to perform its functions through a wide range of ambient temperatures. The cathode may be directly heated as shown in the ratings—or where greater efficiency is desired, ionic heating is possible provided the specified minimum load is maintained without rapid intermittent operation. The internal drop is low even during the time rated peak current is flowing.

A very important feature of the 1006/CK1006 is the fact that *no cathode preheating time is required*. Full load can be handled immediately and starting is practically instantaneous.

Obviously, the foregoing electrical characteristics are applicable to many types of mobile equipment. Structurally, too, the 1006/CK1006 fits well into such service because rugged design allows it to withstand considerable shock without change in characteristics.

Many thousands of Raytheon 1006/CK1006 tubes have individually given hundreds of hours of reliable service in equipment subjected to adverse conditions of temperature and vibration. Another convincing "exhibit" of evidence that Raytheon builds *fine* tubes . . . tubes well worth considering for your postwar products!

**BUY  
VICTORY  
BONDS**



A NEW 104 db GAIN

*Portable*

AMPLIFIER—15 WATTS

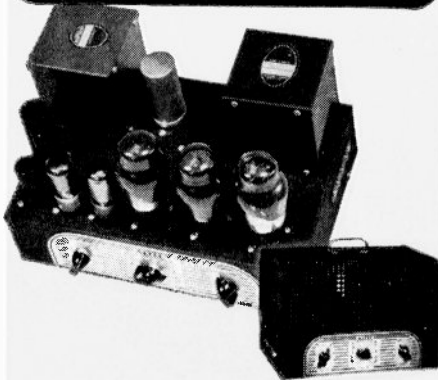

The new Altec Lansing A-323 portable amplifier is specifically engineered to operate adequately from low level phonograph pick-ups, microphones or radio tuners. Up to its rated power, it reproduces high quality sound over the full frequency range without overload or distortion. It is a small, compact, 6-tube portable amplifier especially designed and manufactured to efficiently operate with the Duplex Speaker, public address systems, home radio receiving sets and other applications where high quality, low cost amplification is desired.

**\$118<sup>00</sup>**

WITH INPUT TRANSFORMER

**\$15800**

AT ALL LEADING DEALERS  
OR SEND YOUR ORDER TO

**ALTEC**  
LANSING CORPORATION

1210 TAFT BLDG., HOLLYWOOD 28, CALIF.  
250 WEST 57 STREET, NEW YORK 19, N. Y.  
IN CANADA: NORTHERN ELECTRIC CO.

## Peacetime Development of New Weapons

(Continued from page 66A)

for pressing vigorously new research on the radio proximity fuze, one of the top secret weapons of the war. On October 31, 1944,

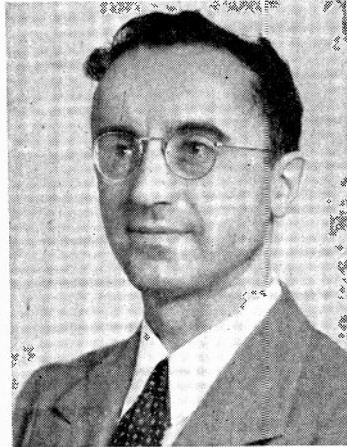

CLEO BRUNETTI

General L. H. Campbell, Chief of Army Ordnance, asked the National Bureau of Standards to set up a postwar establishment for carrying on development work on electronic ordnance under Army sponsorship. In a memorandum to Dr. Lyman J. Briggs, director of the National Bureau of Standards, General Campbell requested the Bureau to undertake a program of development of new and better radio fuzes and other electronic weapons. What these other weapons are is not known, but it suffices that these practical scientists who proved their worth in the radio-fuze development can be depended on to do a job worthy of confidence.

Selection of the National Bureau of Standards as the center of this important work was based on its extensive experience for the past four years, in which the Bureau pioneered in the development of the radio fuze and other devices, the latter in the category of secret weapons as yet unrevealed



C. H. PAGE

to the public. Together with the Johns Hopkins Applied Physics Laboratories, the Bureau served as the focal point for all radio-fuze development in this country and

(Continued on page 70A)

## EASTERN HEAT DISSIPATING UNIT

The Eastern Heat Dissipating Unit is used in connection with television, radar, short wave radio communications, high pressure mercury lamps, X-Ray tubes, induction heating units, and many other applications. It was developed for military requirements in conjunction with radar and electronic tube cooling problems. Units were designed in various sizes and capacities, some with the close heat control range of 2 degrees C. Used successfully for ground, water and airborne service, they combine rugged construction, compactness and light weight.

The model illustrated will dissipate up to 1200 watts with a constant controlled temperature, irrespective of surrounding temperatures, within 2 degrees C. It is complete with Thermostat control, Thermostatic valves and flow switch. Eastern has built airborne units of much smaller sizes and industrial units of much larger sizes and capacities. The specifications for the unit shown are: SIZE: 16" x 7 1/2" x 7 1/2"; METALS: Steel, Bronze, or Aluminium. Other models can be designed to dissipate up to 5000 watts.

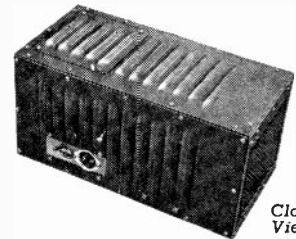

Closed View

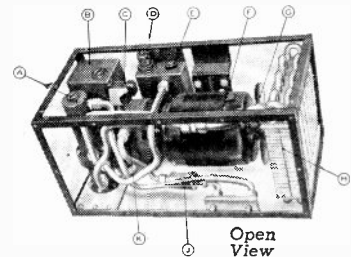

Open View

- |                          |             |
|--------------------------|-------------|
| A. Thermo flow-regulator | F. Motor    |
| B. Reservoir             | G. Fan      |
| C. Flow Switch           | H. Radiator |
| D. Thermostat            | J. Filter   |
| E. Auxiliary Heater      | K. Pump     |

Eastern's experience in solving heat control problems, especially where compactness and light weight are necessary, makes them the logical people with whom to discuss heat control applications. If you are designing or planning to build equipment that calls for heat dissipation or the close control of operating temperatures, Eastern will design and build the entire unit for you to meet your specific requirements.

An inquiry about your heat dissipating needs will not obligate you in the slightest.

A large part of Eastern's business is the designing and building of special pumps, in quantities ranging from 25 to several thousand for the aviation, electronic, chemical, machine and other special fields. Eastern builds over 600 models, both centrifugal and positive pressure, ranging in size from 1/100 H.P. to 3/4 H.P. as standard units.

*Eastern Engineering Co.*

86 FOX STREET, NEW HAVEN 6, CONN.



# CLAIM STAKING

## Hallicrafters and Very High Frequency

Based on the facts in the case, Hallicrafters can stake out a very strong claim to leadership in the very high frequency field. The facts include such things as the Model S-37, FM-AM receiver for very high frequency work. The Model S-37 operates from 130 to 210 Mc.—the highest frequency range of any general coverage commercial type receiver.

Hallicrafters further supports its claim to domination in the high frequency field with the Model S-36A, FM-A M-CW receiver. The 36A operates from 27.8 to 143 Mc., covers both old and new FM bands and is the only commercially built receiver covering this range.

*Further developments in this direction can soon be revealed—adding further support to Hallicrafters claim to continued supremacy in the high frequency field.*

HALCRAFTERS NEW \$600,000 HOME NOW UNDER CONSTRUCTION.



# hallicrafters RADIO



THE HALCRAFTERS CO., MANUFACTURERS OF RADIO AND ELECTRONIC EQUIPMENT • CHICAGO 16, U. S. A.

COPYRIGHT 1945 THE HALCRAFTERS CO.

**DEPENDABLE** performance and durability of a Test Instrument is assured by its design and sturdiness of construction. All B. R. C. instruments are ruggedly built to give exacting and precise direct reading measurements with simplicity of operation.

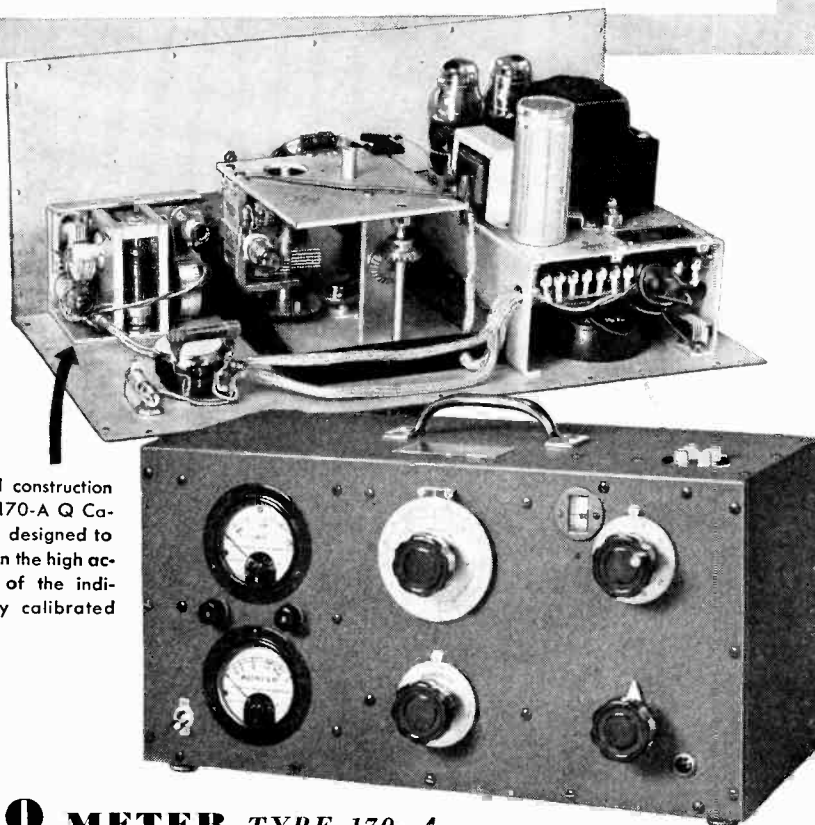

Rugged construction of the 170-A Q Capacitor designed to maintain the high accuracy of the individually calibrated dial.

### **Q METER TYPE 170-A**

This instrument embodies the general operating principles and characteristics of the 160-A Q-Meter but with such design and structural modifications as are required for accurate performance at higher frequencies. Has a frequency range of 30 mc to 200 mc.

**Q METER TYPE 160-A**—A standard for "Q" measurements with a reputation for accurate and dependable service. Has a frequency range of 50 kc to 75 mc which may be extended with external oscillator down to 1 kc.



DESIGNERS AND MANUFACTURERS OF THE "Q" METER . . . QX-CHECKER . . . FREQUENCY MODULATED SIGNAL GENERATOR . . . BEAT FREQUENCY GENERATOR . . . AND OTHER DIRECT READING TEST INSTRUMENTS

## Peacetime Development of New Weapons

(Continued from page 68A)

abroad. It was from the Bureau laboratories that the first successful radio fuze in the world was conceived and built.

Further interest in the selection of the National Bureau of Standards for this work is offered by the fact that *not only will the bureau study the applications of new scientific knowledge to war uses, but it will under-*



A. S. CLARKE

*take the study of peacetime applications of the knowledge gained in the development of new weapons.* So far as this information does not interfere with the safety of the United States and her Allies, the benefit of the new development will be made available to everyone. The National Bureau of Standards maintains widespread contacts with industry on new research and developments, new industrial processes, and new materials. Such contacts present fertile possibilities for translating current industrial advances into the electronic-ordnance art while, at the same time, bringing to industry the fruits of new developments resulting from long-term research on electronic-ordnance devices. Continuity of basic research at the Bureau in the new art of electronic ordnance which has sprung up during the war will lead to the development of new circuits and circuit components which will prove of benefit to industry. Particular examples are new radio tubes, miniature radio components, tiny high-powered electrical generators, mechanical and electronic controls, and new plastics.

To promote the organization of the best of facilities, the Ordnance Department arranged for the construction of a half-million dollar Ordnance Laboratory on the grounds of the National Bureau of Standards. Construction of the building began on May 8, 1945. At the cornerstone-laying ceremonies on July 23, 1945, General Campbell stressed the advantages that peacetime military research could afford not only to national security, but also to the promotion of the industrial economy.

The work at the National Bureau of Standards will be centered in its Ordnance Development Division under the direction of Harry Diamond (A'26-M'30-SM'43-F'43). Several hundred physicists, engineers, and technicians will comprise the staff led by experienced scientists including Robert

(Continued on page 86A)

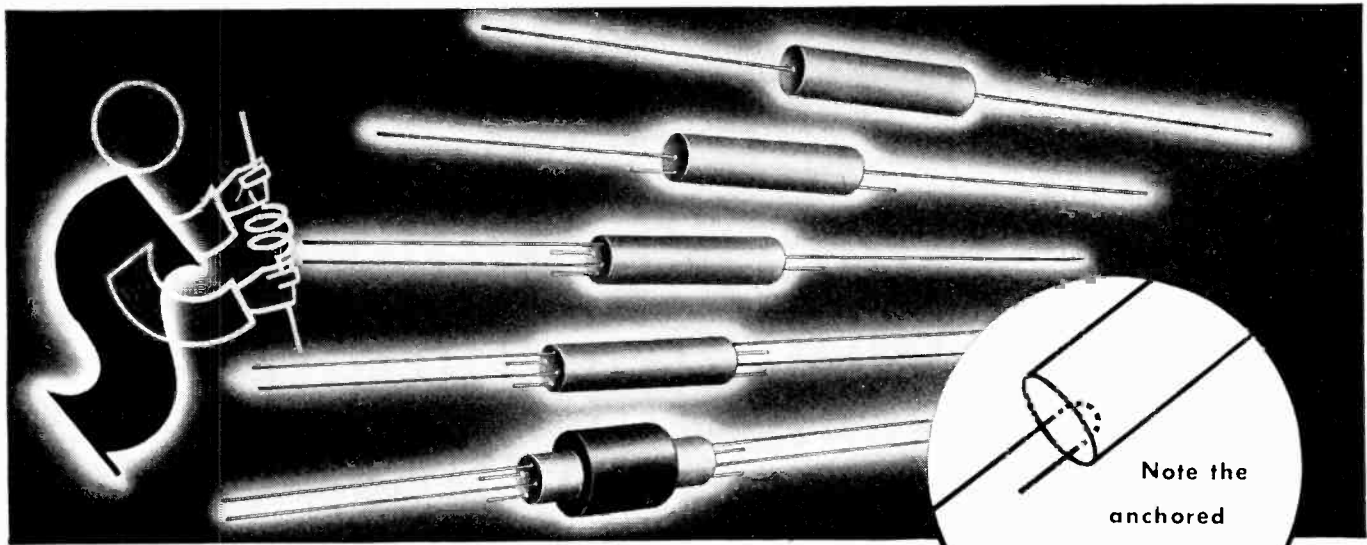

Note the anchored hairpin leads

# MOLDED COIL FORMS

THE MODERN ANSWER TO INEXPENSIVE MECHANICAL SUPPORTS FOR WINDINGS

<p><b>COAXIAL LEADS</b> each end Type DR-1 . . . .750" x .220" Type DR-2 . . . .875" x .280"</p>
<p><b>SINGLE HAIRPIN</b> lead each end Type DR-3 . . . .875" x .280"</p>
<p><b>SINGLE HAIRPIN</b> lead one end <b>DOUBLE HAIRPIN</b> lead other end Type DR-4 . . . .875" x .280"</p>
<p><b>DOUBLE HAIRPIN</b> lead each end Type DR-5 . . . .875" x .280"</p>
<p>Typical use of molded coil form with Stackpole W-1976 iron sleeve core attached</p>

*Reduced space factor . . . simplicity of assembly . . . point-to-point wiring . . . one third fewer soldered connections . . . extreme flexibility of application . . . absolute minimum cost*

These proved advantages mean wide use for Stackpole molded bakelite coil forms in a variety of applications. Hairpin anchored leads mean that the soldered core wires are not disturbed or strained when leads are flexed or moved. The forms being smooth, coils may be wound on separate tubes and slipped over the forms—or windings may be wound directly on the forms. Where required, forms may be provided with Stackpole molded iron sleeve cores, thereby increasing Q materially, decreasing the amount of wire for a given inductance and reducing stray magnetic fields. Write for details or samples to meet your requirements.

**STACKPOLE CARBON CO., ST. MARYS, PA.**  
*Electronic Components Division*

Typical Stackpole Molded Coil Form Applications

UNIVERSAL WINDING

SOLENOID WINDING BENT AT 90

TAPPED UNIVERSAL WINDING

ANTENNA OR COUPLED WINDINGS

IRON CORED UNIVERSAL WINDING

IRON CORED I-F TRANSFORMER OR COUPLED COILS

# STACKPOLE

**FIXED AND VARIABLE RESISTORS • IRON CORES • SWITCHES**





**MEANS MAXIMUM PERFORMANCE  
AT AN ECONOMICAL PRICE . . .**

**T**HERE is more to STANCOR design than theory and paper engineering. Behind-the-scenes operations reveal unremitting *fact-finding*—nothing is taken for granted. For the STANCOR engineer is as persistent as he is practical, demanding—and receiving—high standards of performance.

Engineering design implies more than mere conversion of the customer's electrical requirements to manufacturing specifications. At STANCOR it includes the employment, to the greatest advantage, of selected materials to achieve optimum performance—all with the constant practical thought—more *useful* watts per dollar.

Competent laboratory and sales engineering facilities are available NOW to meet your most exacting transformer specifications.



**STANCOR**  
STANDARD TRANSFORMER CORPORATION  
1500 NORTH HALSTED STREET CHICAGO 22, ILLINOIS

**RESEARCH CORPORATION OFFERS  
\$2,500,000 FOR POSTWAR  
COLLEGIATE RESEARCH**

Scientists who made the atomic bomb, radar, and a host of other vital war weapons will have a chance to return promptly to college laboratories for scientific research and teaching through \$2,500,000 in grants offered to educational institutions by Research Corporation of New York, a non-profit organization devoted to advancing research and technology by use of revenues from inventions assigned to it by public-spirited inventors.

Preference in making these grants will be given, other factors being equal, to smaller institutions and those of more limited financial resources for research.

From 100 to 200 grants of \$2500 to \$5000 each year will be available in order that talented young scientists engaged, for the most part, in war research, in uniform or as civilians, will be able to undertake at universities and colleges research of peacetime importance in pure science, especially chemistry, physics, mathematics, and engineering.

Grants will be made to the institutions at which the scientists will work and teach. The funds allotted will be available for the purchase of needed equipment and for employment of assistants either as Fellows or otherwise. Awards will be based primarily upon the demonstrated ability of the men who will conduct the researches and contribute to the teaching program of the school.

These special postwar grants will round out the plans that are being made for the most effective and most prompt return of the war-engaged scientists to peacetime fundamental and applied research. The Rockefeller Foundation has already announced a comprehensive plan of predoctoral fellowships which will return to college former graduate students who left their studies and researches for war research. Current government legislation and proposed bills being considered by Congress will aid the return to college of students whose scientific and technological education was interrupted by the war. Research Corporation grants will assist colleges in building research-minded staffs which will help train the students returning to colleges from the war, as well as the future contingents of students from our secondary schools in future years.

The grants are made possible by the fact that, during the war years, research programs that normally would be supported by Research Corporation grants have been laid aside in order to free men and facilities for war research.

To scientists of the Office of Scientific Research and Development, Army, Navy, and other war research agencies, the possibilities of these grants are being made known with an invitation to send applications to Dr. Robert R. Williams, Research Corporation, 405 Lexington Avenue, New York 17, New York.

TYPE OF SERVICE

is a full-rate Telegram or Cablegram unless its character is indicated by a suitable symbol above or preceding the address.

# WESTERN UNION

A. N. WILLIAMS  
PRESIDENT

1220

SYMBOLS	
DL	= Day Letter
NL	= Night Letter
LC	= Deferred Cable
NLT	= Cable Night Letter
	Ship Radiogram

Filing time shown in the date line on telegrams and day letters is STANDARD TIME at point of origin. Time of receipt is STANDARD TIME at point of destination

D31CC 179 NL PD BKLY NY JAN 1 1946

ELECTRONIC TUBE USERS EVERYWHERE

OUR STAFF WELCOMES COMPETITIVE NEW YEAR NOW THAT UNCLE SAM'S "ONE MAN" MARKET IS GONE. FIRST CW TUBE WE MADE QUARTER CENTURY AGO IS JOINED BY OUR "E" CITATIONS IN AMPEREX MEMOIR CABINET. TO THE THOUSANDS OF ELECTRONIC TUBE USERS IN SCORES OF INDUSTRIES AND PROCESSES AS "OLD" AS COMMUNICATIONS AND AS NEW AS INDUCTION HEATING WE PLEDGE:

- 1) AMPEREX CREATIVE RESEARCH;
- 2) AMPEREX PRECISION MANUFACTURE;
- 3) AMPEREX HELPFUL SERVICE.

THOSE ARE THE THREE CARDINAL PRINCIPLES ON WHICH WE BUILT AMPEREX DURING THE DECADES PRECEDING THE WAR. THEY KEPT US WITH VASTLY ACCELERATED DEVELOPMENTS AND RESPONSIBILITIES OF WAR YEARS. WE ARE STICKING TO OUR RECOGNIZED SPECIALTY—POWER TUBES AND THEIR APPLICATION IN ALL FIELDS. WE FACE THE BUYERS' MARKET NOW AT HAND WITH CONFIDENCE BASED ON LIFE, PERFORMANCE, RELIABILITY AND ECONOMY SO LONG ASSOCIATED WITH AMPEREX ELECTRONIC TUBES. SEE YOU AT THE ASTOR—HAPPY NEW YEAR.

AMPEREX ELECTRONIC CORPORATION  
79 WASHINGTON ST BKLYN 1, NY

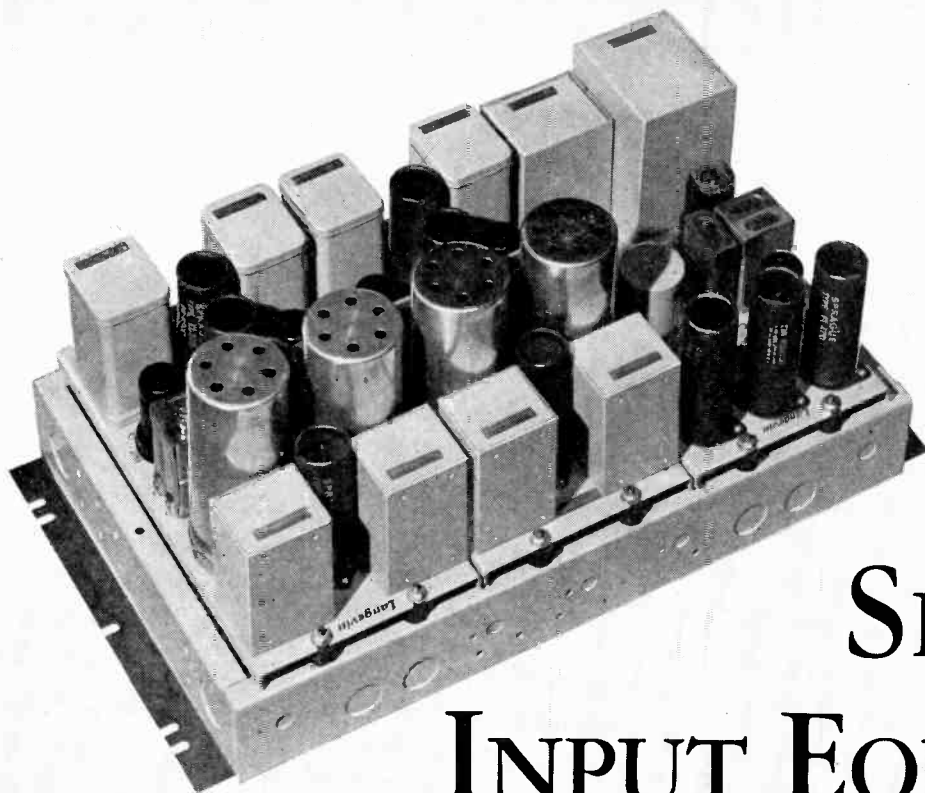

AT LEFT. Two Langevin Type 111-A Dual Pre-Amplifiers and one Langevin 102-A Line-Amplifier mounted on a 3-A Mounting Frame. This unit provides four pre-amplifiers and one line-amplifier, or three pre-amplifiers, one booster-amplifier and one line-amplifier, all in 10½" of rack mounting space. External power supply such as the Langevin 201-B Rectifier, as shown below, is required.

# SPEECH INPUT EQUIPMENT

*Worthy of an Engineer's Careful Consideration*

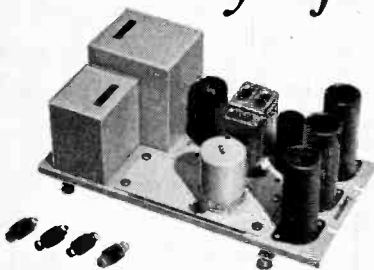

TYPE 102A Amplifier is one of the 102 Series Line Amplifiers of which four different types are available. The "A" is mostly used to drive the line after the master gain control. It is quiet, has excellent frequency characteristic and ample power output with low distortion products.

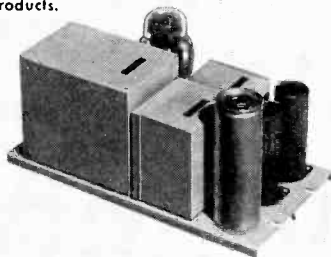

The 201-B Rectifier is one of the 201 Series Rectifiers, of which two types are available, the "B" having additional filtering, thereby giving a slightly lower ripple content than the "A." This unit is capable of supplying power for one 102 Series Line Amplifier and three 111 Pre-Amplifiers (six pre-amplifiers).

Every unit of Langevin speech input equipment is held to a rigid standard of performance. These units may be cascaded in accordance with good engineering practices and still be well within the allowable limits of FM requirements as to frequency response, noise and distortion products.

All Langevin speech input equipment units are mounted on standard 5¼" x 10¼" chassis. Three of these units can be mounted on a Langevin 3-A Mounting Frame, which occupies 10½" of space on any standard rack. Wall mounting steel cabinets for housing these units are also available.

We are proud of the products which bear the name *Langevin*. It will only appear on good apparatus.

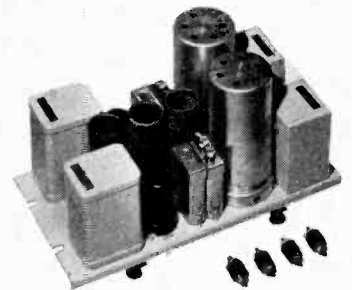

The 111-A Amplifier consists of two individual pre-amplifiers on a single chassis for use in high quality speech input equipment. Its compact unitized construction saves rack space. Input impedances of 30, 250 and 600 ohms; output impedance 600 ohms. It is quiet and has excellent frequency characteristics and ample power output with low distortion products.

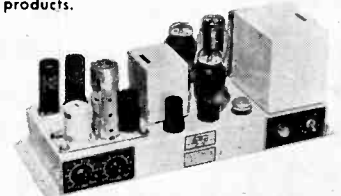

The 108-A Amplifier is one of the 108 Series Monitor Amplifiers, of which four different types are available. The "A" is ordinarily used to drive a monitor system from a 600 ohm or bridging source. Its distortion is low for this type of service. It is quiet and has ample power with excellent frequency characteristics.

## The Langevin Company

INCORPORATED

SOUND REINFORCEMENT AND REPRODUCTION ENGINEERING

NEW YORK  
37 W. 65 St., 23

SAN FRANCISCO  
1050 Howard St., 3

LOS ANGELES  
1000 N. Seward St., 38



# RADIO INTERFERENCE ?

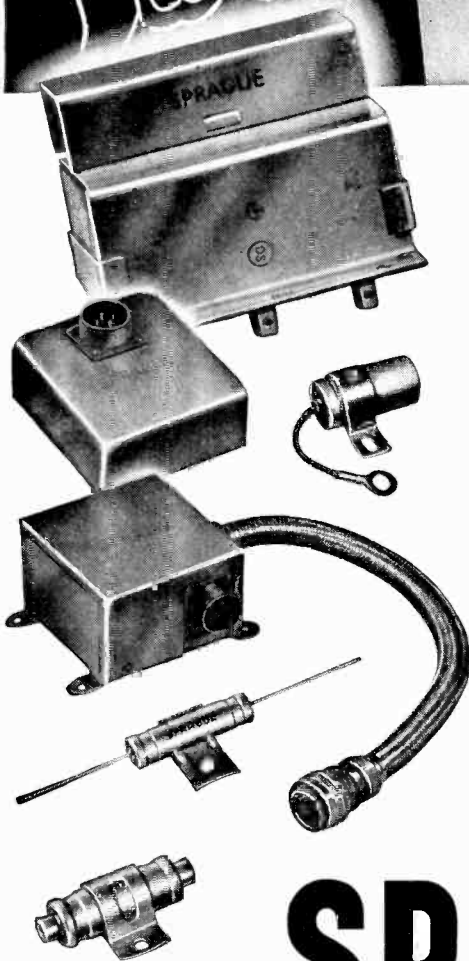
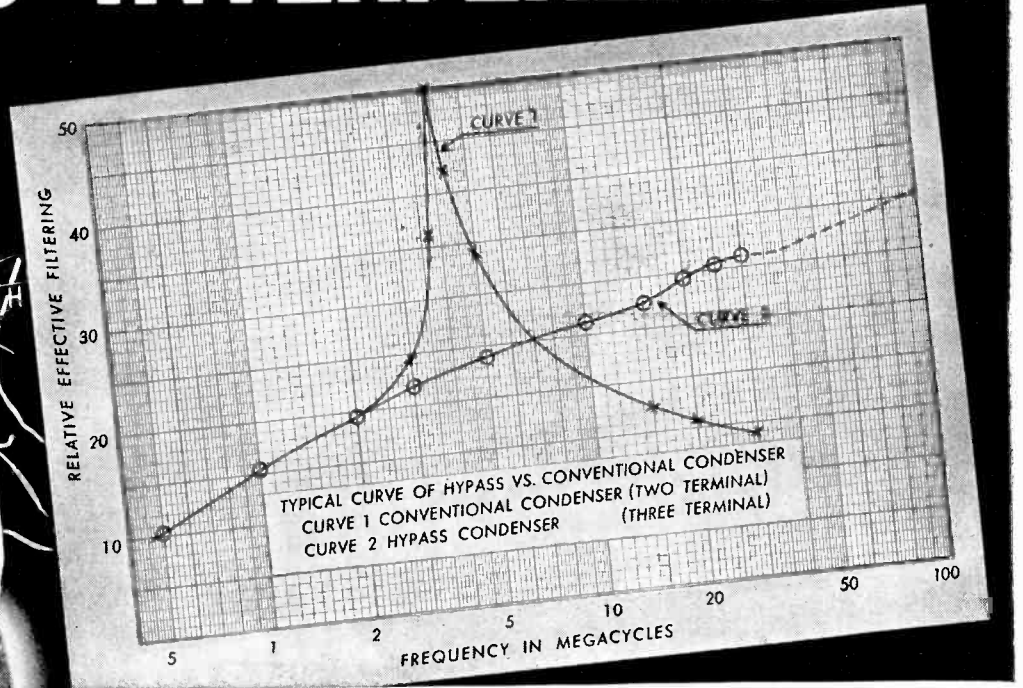

## SPRAGUE HAS *the Answers!*

From inexpensive noise suppression capacitors for automotive use, to heavy-duty designs for service on power equipment, and for current ratings from 5 to 200 amperes capacity, Sprague produces modern filter units for practically any need. An unsurpassed background of engineering experience in dealing with all types of radio noise interference problems, is here at your disposal. Write for Sprague Capacitor Catalog 20.

### ANTI-RESONANT FREQUENCY PROBLEMS SOLVED

Have you a vibrator "hash" problem that a conventional by-pass capacitor shunted by a mica capacitor only partially solves?

If so, write for details on Sprague HYPASS Capacitors, the 3-terminal networks that do the job at 100 megacycles or more!

### SPRAGUE ELECTRIC COMPANY

North Adams, Mass.

# SPRAGUE



5-Times Cited for Distinguished Wartime Service

PIONEERS OF ELECTRIC-ELECTRONIC PROGRESS



**Industrial Condenser  
Corporation's  
NEW HOME**

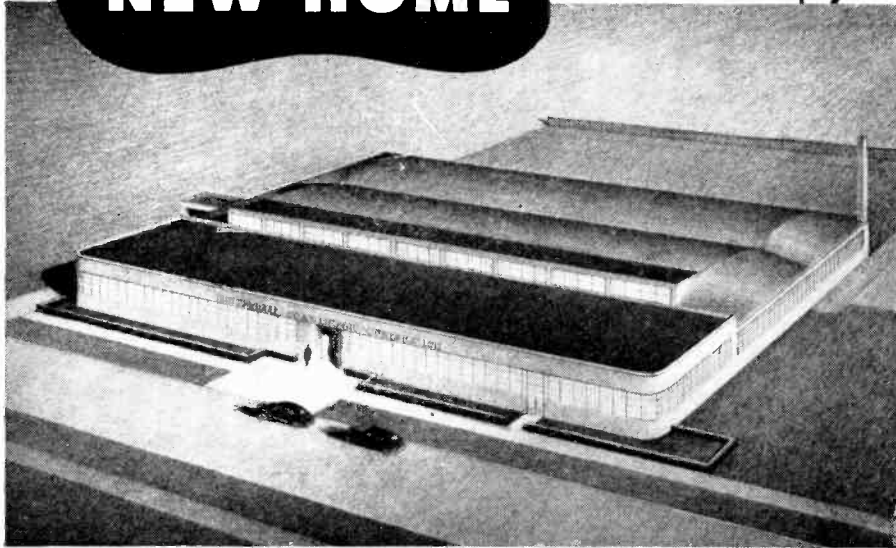

**THE WORLD'S MOST  
MODERN CONDENSER PLANT  
with these outstanding features**

- ★ 1,000,000 VOLT RESEARCH LABORATORY
- ★ VERY LATEST PRODUCTION EQUIPMENT
- ★ SPECIALIZED WAR-LEARNED TECHNIQUES

From this NEW ultra-modern factory come capacitors carefully engineered and accurately produced. Staffed by skilled engineers and backed by 16 years of technical progress, Industrial Condenser Corp. is supplying capacitors for every application. If your specifications call for Electrolytic, Paper, Oil, or Motor capacitors, look to Industrial Condenser Corporation.

**INDUSTRIAL CONDENSER  
CORPORATION**

3243-65 NORTH CALIFORNIA AVENUE, CHICAGO 18, U. S. A.

*District Offices in Principal Cities*

**PAPER, OIL AND ELECTROLYTIC MOTOR CAPACITORS**

**FUTURE OF RADIO COMMUNICATION AND ELECTRONICS**

A vast system of radio relay stations, blanketing the entire country, carrying telephone and telegraph messages, broadcast programs, facsimile, and television simultaneously, was envisaged at Corpus Christi recently by Dr. C. B. Jolliffe, (M'25-F'30), executive vice-president in charge of RCA Laboratories, in an address on "The Radio-Electronic World of Tomorrow," delivered at the Naval Air Technical Training Center on Ward Island.

Pointing out that wartime research has greatly accelerated the normal progress of all branches of communications, Dr. Jolliffe mentioned radar, citizens' radio, electronic heating, and aviation radio as other fields that will become of increasing importance to the public in peacetime.

"Each of these new applications of radio," he said, "can create a new industry which will affect other industries. As the war approaches its conclusion, engineering developments and planning must be speeded up so that the trained men who come out of the armed services are not unemployed or their skills lost because it becomes necessary for them to take employment in other industries."

Discussing television, he said, "It does not take much imagination to see television as a possible five- or ten-billion-dollar enterprise, employing thousands of men and women, directly and indirectly. At the present moment all the instrumentalities are ready." Organization of television into a service, he added, needs the enthusiasm and imagination of creative thinking by young men who will not be stopped because of obstacles.

"It also needs the American spirit of enterprise which means pioneering by capital and industry, and encouragement by Government. Television should have the normal development of a new service, not hampered by unnecessary restrictions or limitations and not retarded by those who may not have the will to pioneer or the inclination to enter a new field now."

Dr. Jolliffe predicted wide application of radar to postwar aviation.

"Radio instruments," he said, "can look ahead, warn the pilot of obstacles and tell him at all times the altitude of his plane. Radio can make flying a safer and more reliable service; therefore it can be an important part of another great industry."

Recalling the many uses of handie-talkies and walkie-talkies by the armed forces, Dr. Jolliffe prophesied counterparts of these applications in peace:

"A farmer's wife can talk to her husband while he is on the tractor; a construction superintendent on a skyscraper give directions to his workers, a doctor can keep in touch with his office; a businessman can talk to his office even though he is in his car on the highway, in his airplane or on a train. The possible uses are as extensive as the human mind can imagine."

Discussing developments in ultra-high frequencies, Dr. Jolliffe pointed out that radio relays could do the job now being accomplished in the telephone and telegraph fields by wires.

"It is not fantastic," he explained, "to imagine long telephone and telegraph lines

*(Continued on page 78A)*

**avoid damage  
from "in-the-package"  
moisture**



**no rust  
no corrosion  
in this container**

**SHIPPERS!** Your product can be seriously damaged by rust, corrosion, or mildew . . . because of "in-the-package" moisture. Avoid such damage. Include Jay Cee Silica Gel, the ideal drying agent, in the packages with your product.

Your container may be sealed "tight as a drum" against outside moisture. Yet, the vapor within can cause untold harm. Particularly, a slight drop in temperature can release dangerous moisture.

Jay Cee Silica Gel keeps the air in the package dry . . . adsorbs the vapor . . . prevents moisture damage. Jay Cee Silica Gel is a crystalline substance resembling rock salt in general appearance . . . chemically inert. Has amazing power to take up moisture without its particles changing in size or shape. Packed in 1, 2, 4, 8 oz. and 1 and 5 lb. bags. Used widely with shipments of metal parts, precision instruments, electronic equipment, dehydrated foods, fabrics, and chemicals.

The illustration shows Mr. Otto Mueller, packaging foreman, inspecting one of his Ampre Sound-On-Film Projectors sealed tightly within a representative moisture vapor-proof barrier, ready to be placed in a shipping carton. Packed within the barrier, with the Projector, are three small bags of Jay Cee Silica Gel . . . which adsorb "in-the-package" moisture and prevent damage from rust or corrosion.  
(Cellophane packaging was used in this illustration as a substitute for the actual wrapping).



**JOLIET CHEMICALS, LTD.**  
116 INDUSTRY AVENUE  
JOLIET, ILLINOIS

**WOLLASTON Process**  
**Wire... So Fine it**  
*can be seen only*  
*under high*  
*Magnification*



We can draw wire as  
 small as

$\frac{1}{100,000}$  of an inch  
 in diameter

... available in **Platinum**  
 and some other Metals

.00001" is less than 1/30 the  
 diameter of the smallest wire  
 die commercially available.  
 Yet our Wollaston Process  
 wire (drawn in a silver jacket)  
 closely meets your specifica-  
 tions for diameter, resistance  
 and other characteristics.

This organization specializes  
 in wire and ribbon of smaller  
 than commercial sizes and  
 closer than commercial toler-  
 ances. Write for List of Products.

**SIGMUND COHN & CO.**



44 GOLD STREET NEW YORK 7

**FUTURE OF RADIO COMMUNICA-  
 TION AND ELECTRONICS**

(Continued from page 76A)

being replaced by lines of towers spaced 25 to 40 miles apart each equipped with small automatic radio transmitters and receivers carrying coast to coast many messages simultaneously over highly directive radio beams. A single line of radio relays can carry telegraph, telephone, and television or radio programs simultaneously with less maintenance or service than wire lines. Radio beams need no supports; maintenance problems are reduced to a minimum."

Another use of radio frequencies which promises great impact on industry," he said, "is in electronic heating." He mentioned the gluing of assemblies, hardening of surfaces, metal welding, and the speeding up of certain production processes such as the drying of penicillin, as established and successful applications of radio heat.

Turning to another phase of postwar technical work, Dr. Jolliffe emphasized that electronic research and development must be directed toward the prevention of another World War.

"In peacetime as well as in war" he stated, "research must be maintained on a wide basis in order to seek solutions of scientific problems from as many angles as possible. Research workers must be permitted to probe all fields freely and not be limited to fields which someone thinks may be useful to war or defense.

"America has a great reservoir of scientific talent—therein lies one of the greatest hope for the future of this country."

**Membership**

(Continued from page 64A)

- Southern, C. D., 1135 Lincoln Bank Tower, Fort Wayne 2, Ind.
- Stephenson, H. L., 582-5 St., Brooklyn 15, N. Y.
- Stewart, E. C., 6023-34 St. N.E., Seattle 5, Wash.
- Stone, R. L., Soundscribe Corp., 82 Audubon St., New Haven, Conn.
- Swarthout, W. M., 789 E. 17 St., Brooklyn 30, N. Y.
- Thomas, E. A., 34, Woodland Grove, Farnborough, Hants., England
- Thompson, L., Mountain View Rd., West Cheshire, Conn.
- Thornley, R. F., 839 Fairfax Rd., Drexel Hill, Pa.
- Tietz, E. C., 2025 Wood St., La Crosse, Wis.
- Timoshenko, G. S., University of Connecticut, Storrs, Conn.
- Vosburgh, M. C., 606 W. 116 St., New York, N. Y.
- Waddell, R. B., 21 Chandler St., Somerville 44, Mass.
- Wladron, R. E., 55 Morgan St., Tuckahoe 7, N. Y.
- Weiss, H. R., 5222-A Von Phul St., St. Louis 7, Mo.
- Weissenberger, E. G., 1096 Cherry St., Winnetka, Ill.
- White, J. P., 806 Maryland Ave. N.E., Washington 2, D. C.
- Woodroffe, D. W., 675 Manukan Rd., Auckland, S.E. 3, New Zealand
- Wrench, O., 726 Illinois St., Lawrence, Kan.
- Yancovitz, M., 779 Shepherd Ave., Brooklyn 8, N. Y.

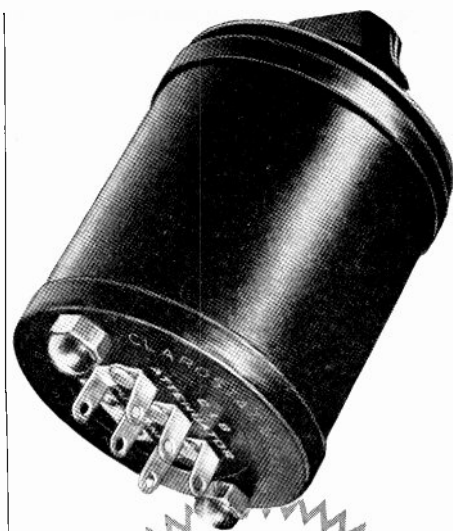

**Sound-  
 System  
 CONTROLS**

★ Clarostat offers an exceptional selection of sound-system controls. For instance, there is the Clarostat Constant - Impedance attenuator, Type CIB, illustrated above. It dissipates 10 watts at any setting. Used as output level control for power amplifiers, or as individual input attenuator for individual speakers. Linear up to 30 db in 10 steps, beginning at absolute zero, then 3 db steps to 24, then 30 db., and infinity.

Clarostat also offers L-pads, T-pads, faders and mixers, in widest range of resistance values, and in both the wire-wound and the composition-element types.

★ **Submit your problem**

If it has to do with sound-system controls or with controls, resistors or resistance devices, send it to us for engineering collaboration. Literature on request.



CLAROSTAT MFG. CO., Inc. - 285-7 N. 6th St., Brooklyn, N. Y.



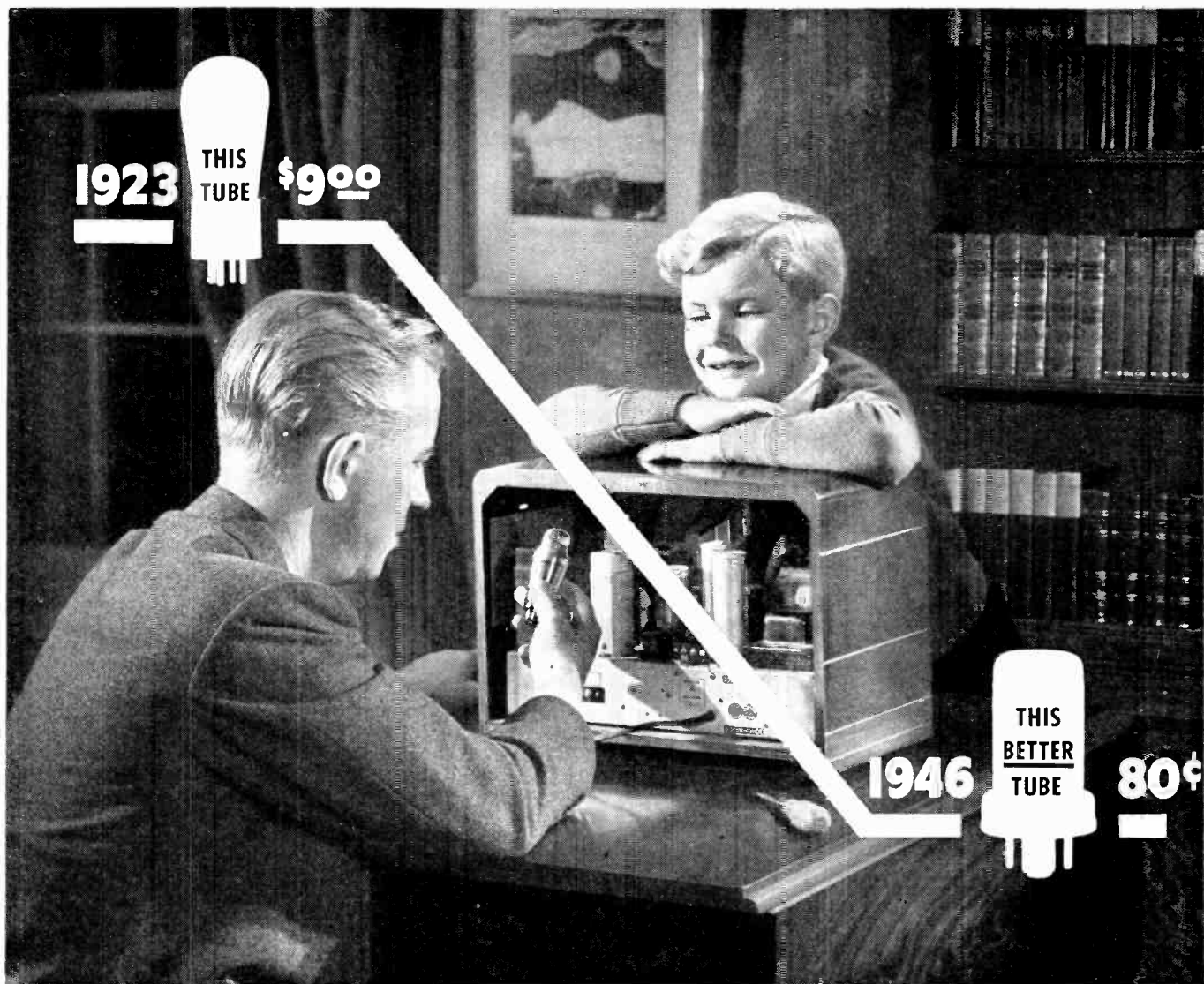

**TODAY - A complete radio set for less than half the cost of the tubes alone in 1923!**

• Today you can buy a six-tube table model radio for about \$25. A little over twenty years ago the six tubes alone cost \$54—*nine dollars apiece*.

Think of it—from \$9 to 80¢. You can buy *eleven* of these more powerful, longer-lasting radio tubes today for what you used to pay for only *one!*

This was brought about through RCA's combination of research, engineering skill, manufacturing efficiency and our American philosophy of making something *better—for less*.

Such progress means far more than simply a saving of \$8.20 on every radio tube. It means that radio has been

brought within the easy reach of practically everyone in this country.

There are now *fifty million* more radios in America than there were twenty years ago. Almost everyone depends upon broadcasting in some measure for entertainment, news, education.

Research and pioneering at RCA Laboratories contributed many of the scientific advances that so greatly improved and extended the services of radio to the American people.

*Radio Corporation of America, RCA Building, Radio City, New York 20, N. Y. . . . Listen to The RCA Victor Show, Sundays, 4:30 P. M., Eastern Time, over the NBC Network.*



The new 1946 RCA Victor Table Model (56X) costing about \$25. With our civilian production increasing, you can again look to RCA for the finest instruments of their kind that science has yet achieved. The principle of making it better—for less—applies to RCA Victor radios, television sets, Victrola radio-phonographs . . . every product bearing the RCA label.



**RADIO CORPORATION of AMERICA**





# Mountings and Antennas



**For All  
Mobile  
Units**

Premax Mountings for mobile installations give the necessary support for both vertical and "whip" type Antennas . . . combined with the proper insulation.

Available in many standard designs, including the popular "Spring" type which relieves the antenna of undue strain over rough roads.

### Standard Equipment for Police Cars, Public Utility Emergency Trucks and Other Mobile Units

Premax Antennas have been adopted by many municipalities and public utilities because of their sturdy construction and ability to bring in the signals at full strength.

Write for complete information on Premax Antennas and Mountings .

**Premax Products**

Division Chisholm-Ryder Co., Inc.

4613 Highland Ave. Niagara Falls, N.Y.

## Binders

for the Proceedings  
Protect your file  
of copies against  
damage and loss

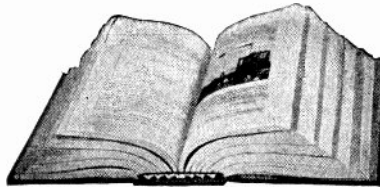

Binders are available for those who desire to protect their copies of the PROCEEDINGS with stiff covers. Each binder will accommodate the twelve monthly issues published during the year. These binders are of blue Spanish grain fabricoid with gold lettering and will serve either as temporary transfers or as permanent binders. They are so constructed that each individual copy of the PROCEEDINGS will lie flat when the pages are turned. Copies can be removed from the binder in a few seconds and are not damaged by their insertion.

Available for both the old, small size PROCEEDINGS or the new, large size (1939 to date).

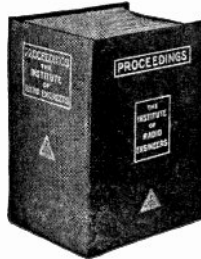

Price: \$1.50

either size (specify which)  
Postpaid to all countries

You may have a volume number or your name stamped in gold for 50 cents additional.

Remittance should accompany  
your order

THE INSTITUTE OF  
RADIO ENGINEERS, INC.  
330 West 42nd Street,  
New York, N.Y.

# ENGINEERED TO THE APPLICATION

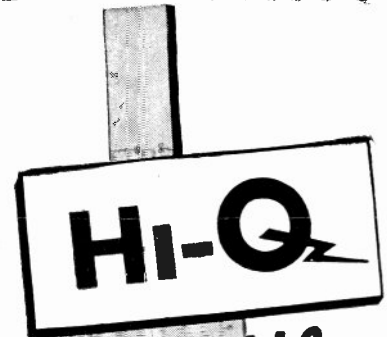

## CERAMIC CAPACITORS

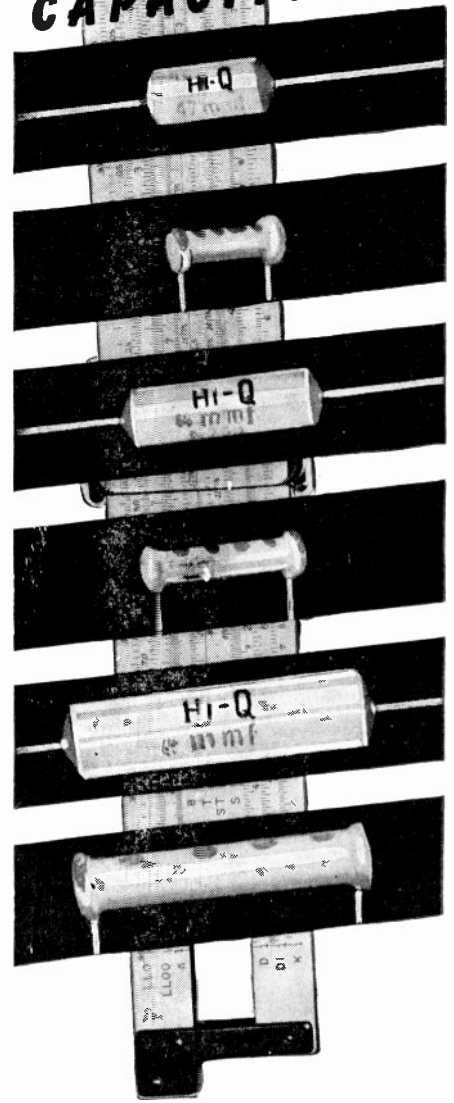

**ELECTRICAL  
REACTANCE  
CORPORATION  
FRANKLINVILLE, N. Y.**

# BEFORE PURCHASING ANY VOLTAGE CONTROL SEE SECO

- VARIABLE VOLTAGE TRANSFORMERS •
- AUTOMATIC VOLTAGE REGULATORS •
- TESTING EQUIPMENT •

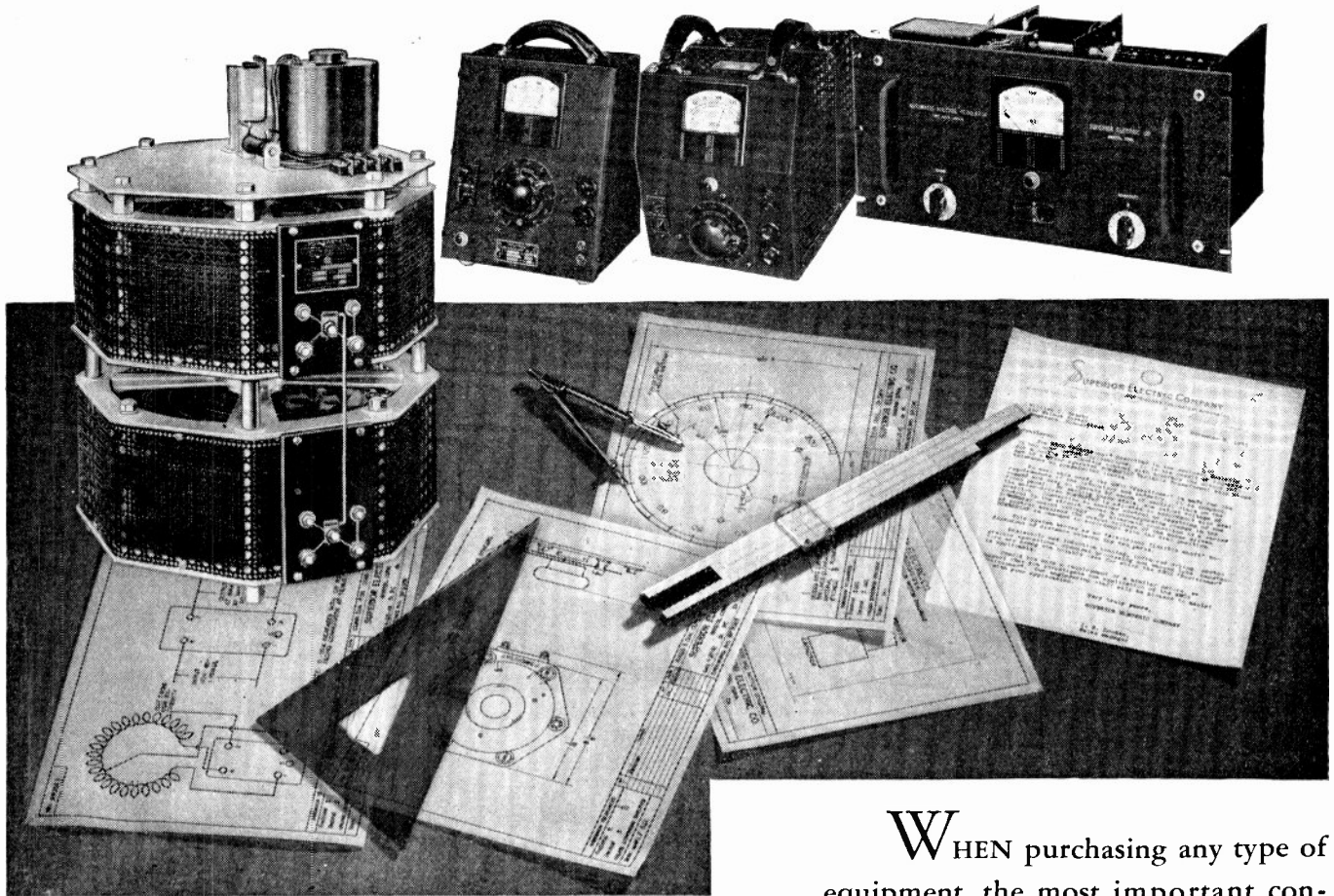

WHEN purchasing any type of equipment, the most important consideration is to obtain the correct apparatus for each application. This is especially true in regard to voltage control equipment. A misapplication or the adaptation of a standard unit to an unusual requirement (where really a special design is necessary) can only produce faulty performance. For this reason, it is our suggestion that a SECO engineer be consulted whenever there is need for an a-c voltage controller. His complete and comprehensive understanding of all phases of voltage control is your assurance of the right equipment for the job.

By simply outlining your particular problem to one of us at SECO results in a prompt recommendation whether it involves a POWERSTAT variable transformer to vary the output voltage from a-c power lines, a SECO Automatic Voltage Regulator to maintain a constant output voltage, or test apparatus such as the VOLTBOX a-c power supply. Call or write and take advantage of the SECO KNOW-HOW.

*Send for Bulletin ER*

## **SUPERIOR ELECTRIC COMPANY**

**781 LAUREL STREET,**

**BRISTOL, CONNECTICUT**

# Specialists in Special Crystals



## 200 - 500 K. C. EXTREMELY STABLE CRYSTALS FOR HIGH OUTPUT AND KEYING

Clamped low frequency plated crystal units with permanent frequency precision,  $\pm 0.1\%$  from  $-30^{\circ}\text{C}$  to  $+60^{\circ}\text{C}$ ! None of the instability typical of old-style spaced units. A crystal that can take it, designed for use in such places as the 30-ton Coast Guard buoy transmitter, lighthouse transmitters, aircraft landing, etc. Each unit subjected to rigid Government specification keying tests. Mounted in aluminum hermetically-sealed holder.

- \* 3 point edge suspension. Top 2 points are spring adjusted, tamper-proof sealed for permanent frequency stability.
- \* Electrical contacts soldered to silver plate at nodal points — no mechanical strain.
- \* Hermetically sealed holder accomplished by spinning aluminum can over gasket under high pressure.
- \* Another Crystalab-engineered development.

See us at the I. R. E. Show  
at booth 144.



Yankee Ingenuity  
makes us

SPECIALISTS IN SPECIAL CRYSTALS



## CRYSTAL RESEARCH LABORATORIES

INCORPORATED  
LABORATORIES AND MAIN OFFICE: 29 ALLYN STREET, HARTFORD 3, CONN.  
New York Office: 15 E. 28th Street, New York 10, N. Y. Phone M.U. 5 2952

• The meeting of extraordinary applications—the designing and developing of new and specialized transformers—these are the day-by-day jobs Electronic Engineering is known for doing well.

**ELECTRONIC**  
Engineering  
**COMPANY**

# Transformers

will meet your most exacting requirements, ordinary or unique—and the finest engineering talent and most complete electronic laboratories available are ready today to consult with and help you.

"SPECIALIZED

Transformer

ENGINEERS"

ELECTRONIC ENGINEERING COMPANY • 3223-9 WEST ARMITAGE AVE. • CHICAGO 47, ILLINOIS



## AVAILABLE I.R.E. STANDARDS

	Price
Standards on Electroacoustics, 1938	\$.50
Definitions of Terms, Letter and Graphical Symbols, Methods of Testing Loudspeakers. (vi + 37 pages, 6 X 9 inches.)	
Standards on Electronics: Definitions of Terms, Symbols, 1938	\$.20
A Reprint (1943) of the like-named section of "Standards on Electronics, 1938." (viii + 8 pages, 8½ X 11 inches.)	
Standards on Electronics: Methods of Testing Vacuum Tubes, 1938	\$.50
Standards on Transmitters and Antennas: Definitions of Terms, 1938	\$.20
A Reprint (1942) of the like-named section of "Standards on Transmitters and Antennas, 1938." (vi + 8 pages, 8½ X 11 inches.)	
Standards on Transmitters and Antennas: Methods of Testing, 1938	\$.50
A Reprint (1942) of the like-named section of "Standards on Transmitters and Antennas, 1938." (vi + 10 pages, 8½ X 11 inches.)	
Standards on Radio Receivers: Definitions of Terms, 1938	\$.20
A Reprint (1942) of the like-named section of "Standards on Radio Receivers, 1938." (vi + 6 pages, 8½ X 11 inches.)	
Standards on Radio Receivers: Methods of Testing Broadcast Radio Receivers, 1938	\$.50
A Reprint (1942) of the like-named section of "Standards on Radio Receivers, 1938." (vi + 20 pages, 8½ X 11 inches.)	
Standards on Radio Wave Propagation: Definitions of Terms, 1942	\$.20
(vi + 8 pages, 8½ X 11 inches.)	
Standards on Radio Wave Propagation: Measuring Methods, 1942	\$.50
Methods of Measuring Radio Field Intensity, Methods of Measuring Power Radiated from an Antenna, Methods of Measuring Noise Field Intensity. (vi + 16 pages, 8½ X 11 inches.)	
Standards on Facsimile: Definitions of Terms, 1942	\$.20
(vi + 16 pages, 8½ X 11 inches.)	
Standards on Facsimile: Temporary Test Standards, 1943	\$.20
(iv + 8 pages, 8½ X 11 inches.)	
ASA STANDARDS (Sponsored by the I.R.E.)	
American Standard: Standard Vacuum-Tube Base and Socket Dimensions	\$.20
(ASA C16.2 — 1939). (8 pages, 7¾ X 10½ inches.)	
American Standard: Manufacturing Standards Applying to Broadcast Receivers	\$.20
(ASA C16.3—1939). (16 pages, 7¾ X 10½ inches.)	
American Standard: Loudspeaker Testing	\$.25
(ASA C16.4—1942). (12 pages, 7¾ X 10½ inches.)	
American Standard: Volume Measurements of Electrical Speech and Program Waves	\$.20
(ASA C16.5—1942). (8 pages, 7¾ X 10½ inches.)	

Prices are net and include postage to any country. Include remittance with order, and address:

THE INSTITUTE OF  
RADIO ENGINEERS, Inc.

330 West 42nd Street, New York 18, N.Y.

Does your oscillograph have single or recurrent sweep frequencies as low as 0.2 cycles per second? *IT CAN...*



with the **DuMONT Type 215**  
**LOW-FREQUENCY LINEAR-**  
**TIME-BASE GENERATOR**

Here's the means for vastly increasing the usefulness of your already useful oscillograph.

This accessory instrument provides a 450 v. d.c. or peak-to-peak undistorted linear-time-base signal voltage of a frequency variable from 0.2 to 125 cycles per second! Special compensating circuit assures linearity.

The single sweep can be initiated either manually or by observed signal. The oscillograph-screen pattern can usually be spread out to three times' full

scale deflection. Return trace blanking signal of either positive or negative phase.

For single sweep, and for low-frequency recurrent-sweep studies, the DuMont Type 215 Low-Frequency Linear-Time-Base Generator used in combination with the DuMont Type 208-B general purpose oscillograph, or equivalent, provides excellent results. Note the typical studies herewith. Definitely "must" equipment.

ALLEN B. DUMONT LABORATORIES, INC.

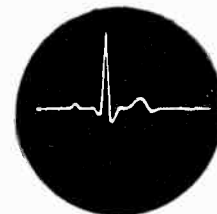

ELECTROCARDIOGRAPHY

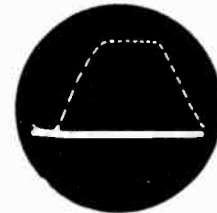

FLASH BULB CHARACTERISTICS

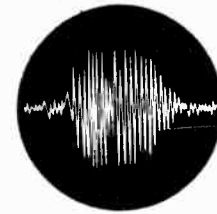

MACHINERY VIBRATION STUDY

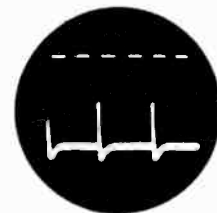

ELECTROENCEPHALOGRAPHY

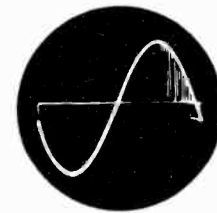

RELAY REBOUNCE STUDY

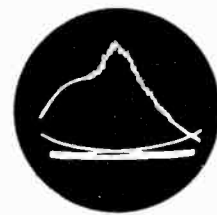

DIESEL ENGINE CYLINDER PRESSURE

Descriptive literature on request.

**DUMONT** Precision Electronics & Television

ALLEN B. DUMONT LABORATORIES, INC., PASSAIC, NEW JERSEY • CABLE ADDRESS: ALBEEDU, PASSAIC, N. J., U. S. A.



SHORT CUT to Model Development  
and Product Assembly ...

## C.T.C. All-Set TERMINAL BOARDS

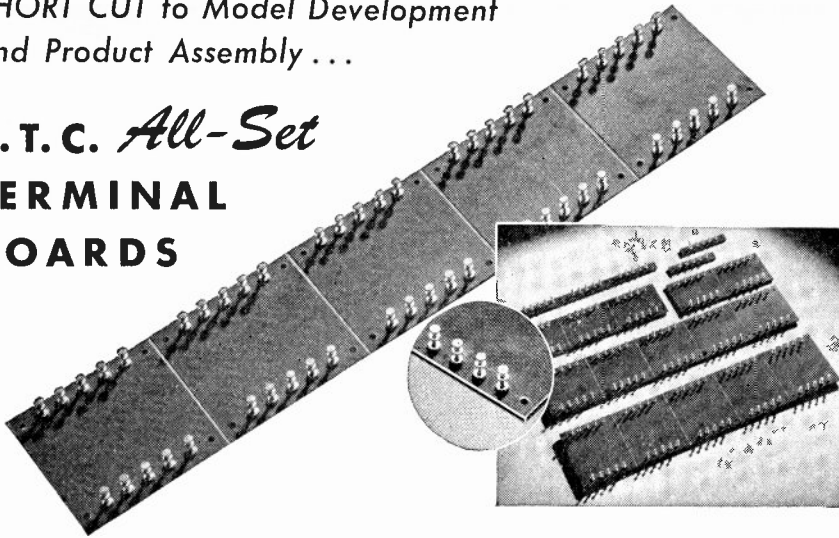

C.T.C. All-Set Terminal Boards save time and money both in the laboratory and on the production line. Available in a variety of sizes covering the entire range of standard resistors and condensers, All-Set Boards come completely assembled, ready to use. No time-wasting board cutting, drilling and lug mounting. Simply select the proper width board and go to work.

C.T.C. All-Set Terminal Boards are made in four widths, 1/2"; (lug row spacing 1 1/2"); 2 1/2" (lug row spacing 2"); 3" (lug row spac-

ing 2 1/2") and are furnished with any size C.T.C. Terminal Lug.

Made of 3/32", 1/8" and 3/16" linen bakelite only, C.T.C. All-Set Terminal Boards come in five sectional boards which may be broken into fifths by bending on a scribed line. Scribing does not weaken the board permitting use of one fifth or more at a time.

All-Set Boards are sold in sets of the four widths or in lots of six or multiples of six in any single width. Extra lugs and stand-offs are included.

Write for C.T.C. Catalog Number 100 for further information on C.T.C. All-Set Terminal Boards and other C.T.C. Components That Click.

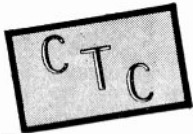

**CAMBRIDGE THERMIONIC CORPORATION**  
456 Concord Avenue Cambridge 38, Mass.

**PLASTICON\*  
CAPACITORS**

*Have You an Application for  
a Capacitor Weighing 1/2 of  
Comparable Paper Capacitors?*

Plasticons are favored by aeronautical engineers because they are lighter and smaller.  
On low voltage capacitors, there is an average saving of 10% in weight. As the voltage rating of capacitors increases, as much as 90% of the weight is saved.  
If weight is a factor, specify PLASTICONS.\*

\* Plasticons-plastic film dielectric capacitors

**CP**

**Condenser Products Company**  
1373 NORTH BRANCH STREET • CHICAGO 22, ILLINOIS

## Attention Associate Members!

Many Associate Members can qualify for higher membership grades and should certainly do so. Members are urged to keep membership grade up in pace with their present development.

An Associate over 24 years of age who is occupied as a radio engineer or scientist, and is in this active practice three years may qualify for Member Grade.

An Associate who has taught college radio or allied subjects for three years may qualify.

Some may possibly qualify for Senior Grade. But transfers can be made only upon your application. For fuller details request transfer application-form in writing or by using the coupon below.



### Coupon

Institute of Radio Engineers  
330 W. 42nd St.  
New York 18, N.Y. 1-46

Please send me the Transfer  
Application Membership-Form.

Name .....

Address .....

Place .....

State .....

Present Grade .....

**KEEP PRODUCTION MOVING with**

**PIERCE**

**SERVICE**

**FAST DELIVERY**  
at  
**REASONABLE PRICES!**

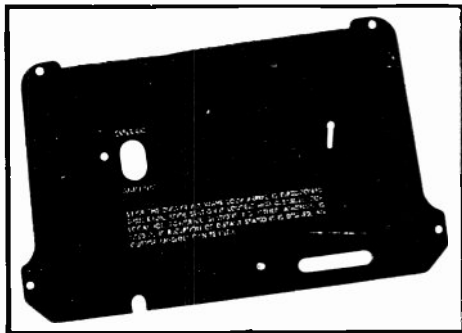
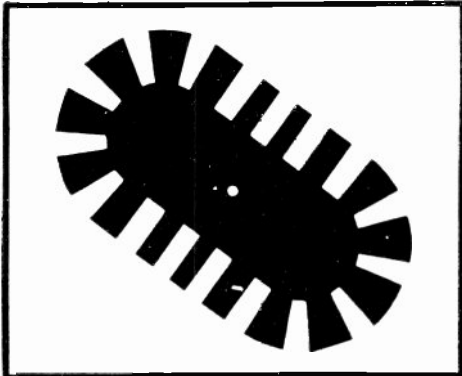
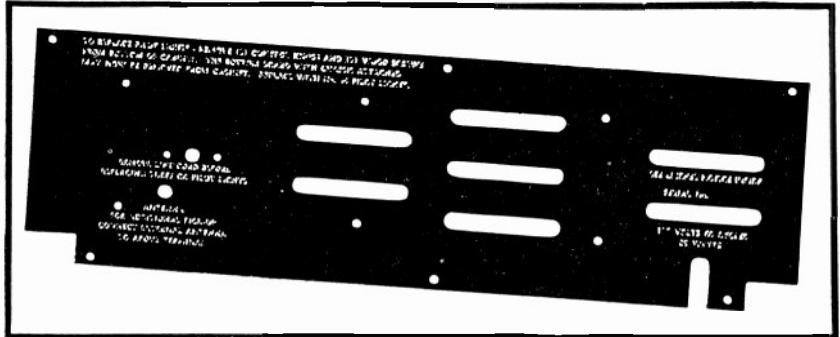

**LOOP ANTENNA FRAMES • CABINET BACKS**  
(complete with envelope protector)

**BAFFLES • LOUD SPEAKER GASKETS**

Die cut and printed complete  
to your specifications from

**NON-METALLIC PULPBOARD, FIBRE BOARD  
BINDERS BOARD, NEWS OR CHIPBOARD**  
paraffine treated or plain.

*Tested for non-conductive properties.*

*Manufacturing processes include lining  
of board for special papers.*

Don't let shortages of the above items bottleneck your production. For ON-TIME-DELIVERY, call on PIERCE. Years of experience, plus accelerated War Production, has given us the "KNOW-HOW" and trained personnel to expedite your job and produce accurate, superior work.

The modern PIERCE factory is amply equipped with up-to-date machinery for Die cutting by Rotary, Platen and Punch Press or Hollow Die Methods. **A complete die-making department and an adequate supply of board insure prompt delivery!**

**SUBMIT SAMPLE OR SPECIFICATIONS FOR  
IMMEDIATE QUOTATIONS—NO OBLIGATION**

**PIERCE**

**PAPER PRODUCTS COMPANY**

**2711 AUBURN STREET    ROCKFORD, ILLINOIS**

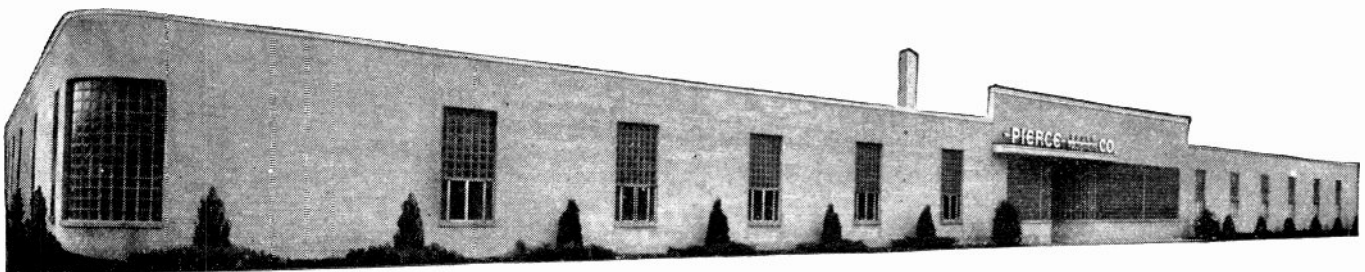

**SUBSIDIARIES**

**Charles H. Luck Envelope Company, Chicago.**

**Capital Envelope Company, St. Paul.**

# ADVERTISER'S INDEX

Section Meetings .....	36A
Membership .....	46A
Positions Open .....	50A
Positions Wanted .....	52A

Aerovox Corporation .....	14A
Aireon Mfg. Corp. ....	4A, 5A, 57A
Alliance Mfg. Co. ....	3A
Altec Lansing Corp. ....	68A
American Lava Corp. ....	13A
Amer. Tel. & Tel. Co. ....	20A
American Transformer Co. ....	35A
Ameperex Electronic Corp. ....	73A
Andrew Co. ....	56A
Arnold Engineering Co. ....	66A
Astatic Corp. ....	36A
Bendix Aviation Corp. (Radio Div.) ..	39A
Bird Electronic Corp. ....	41A
Blaw Knox Co. ....	44A
Boonton Radio Corp. ....	70A
W. J. Brown .....	86A
Brown Engineering Co. ....	52A
Callite Tungsten Corp. ....	11A
Cambridge Thermionic Corp. ....	84A
Centralab .....	10A
Chicago Transformer .....	62A
Cinaudagraph Speakers, Inc. ....	5A
Clarostat Mfg. Co., Inc. ....	78A
Sigmund Cohn & Co. ....	78A
Collins Radio Co. ....	43A
Communication Parts .....	42A
Communication Measurements Laboratory .....	26A
Condenser Products Co. ....	84A
Continental-Diamond Fibre Co. ....	6A
Cornell-Dubilier Elec. Corp. ....	Cover III
Crystal Research Labs, Inc. ....	82A
Allen B. DuMont Laboratories, Inc. 18A, 83A	
E. I. DuPont de Nemours & Co., Inc. ...	64A
Eastern Engineering Co. ....	68A
Hugh H. Eby, Inc. ....	64A
Eicor, Inc. ....	38A
Stanley D. Eilenberger .....	86A
Eitel-McCullough, Inc. ....	87A
Electrical Reactance Corp. ....	80A
Electronic Engr. Co. ....	82A

## Peacetime Development of New Weapons

(Continued from page 70A)

D. Huntoon (A'40), Cleo Brunetti (A'37), C. H. Page (A'41), and A. S. Clarke (A'25). This group will draw on the facilities and experience of the Bureau through consultation with and laboratory assistance of the other regular divisions of the Bureau. The Ordnance Development Division of the National Bureau of Standards henceforth will serve as the central Electronic Ordnance Laboratory (on radio fuzes and other electronic weapons) for the Research and Development Service of the Office of the Chief of Ordnance.

Electronic Mechanics Inc. ....	29A
Electronics Research Pub. Co. ....	54A
Erie Resistor Corp. ....	55A
Fed. Tel. & Radio Corp. ....	27A, 52A, 65A
F. T. Fishers Sons, Ltd. ....	86A
Freed Radio Corp. ....	50A
General Radio Co. ....	Cover IV
Guardian Electric .....	21A
Hallicrafters Co. ....	17A, 69A
Hammarlund Mfg. Co., Inc. ....	24A
Harvey Radio Labs., Inc. ....	33A
Harvey Wells Electronics, Inc. ....	34A
Heintz & Kaufman Ltd. ....	30A
Hewlett-Packard Company .....	63A
Hytron Radio & Electronics Corp. ....	23A
Industrial Condenser Corp. ....	76A
Insulation Mfgs. Corp. ....	45A
Int. Tel. & Tel. ....	27A, 52A, 65A
Joliet Chemicals, Ltd. ....	77A
Kaar Engineering Co. ....	2A
Langevin Company .....	74A
Lewis Electronics .....	4A
Majestic Radio & Television Corp. ....	50A
Frank Massa .....	86A
Measurements Corp. ....	60A
Mycalex Corp. of America .....	31A
National Co., Inc. ....	28A
Newark Electric Co. ....	50A
Ohmite Mfg. Co. ....	47A
M.F.M. Osborne Associates .....	86A
Pierce Paper Products Co. ....	85A
Presto Recording Corp. ....	37A
Albert Preisman .....	86A
Premax Prods. ....	80A
Press Wireless, Inc. ....	25A
Radio Corp. of America. 8A, 9A, 32A, 79A	
Rauland Corp. ....	51A
Raytheon Mfg. Co. ....	67A
Remler Co., Ltd. ....	52A
Bernard Rice's Son's .....	61A
Richardson Co. ....	48A
Revere Copper & Brass Inc. ....	22A
Sherron Electronics Co. ....	59A
Shure Bros. ....	58A
Sonotone .....	50A
Sperry Gyroscope Co., Inc. ....	7A
Sprague Electric Co. ....	75A
Stamford Elec. Products Co., Inc. ....	46A
Stackpole Carbon Co. ....	71A
Standard Transformer Corp. ....	72A
Stoddart Aircraft Radio Co. ....	53A
Stupakoff Ceramic & Mfg. Co. ....	19A
Superior Electric Co. ....	81A
Sylvania Elec. Products Inc. ....	12A
Triplett Electrical Inst. Co. ....	54A
Turner Co. ....	49A
Tung-Sol Lamp Works Inc. ....	16A

United Transformer Corp. ....	Cover II
Universal X-Ray Products Inc. ....	60A
United States Television Mfg. Corp. ...	88A
Westinghouse Elec. Corp. ....	1A
Wilcox Electric Company, Inc. ....	15A
Western Electric Company .....	40A
Paul D. Zottu .....	86A

## Professional Service

**M. F. M. Osborne Associates**  
Consulting Physicists

Fluid Dynamics, Mechanics, Electronic Design, Electromagnetic and Acoustic Wave Propagation, Mathematical Analysis.

703 Albee Bldg., Washington 5, D.C.  
Atlantic 9084

**FRANK MASSA**  
*Electro-Acoustic Consultant*

DEVELOPMENT PRODUCTION DESIGN  
PATENT ADVISOR  
ELECTRO-ACOUSTIC & ELECTRO-MECHANICAL  
VIBRATING SYSTEMS  
SUPERSONIC GENERATORS & RECEIVERS  
3393 Dellwood Rd., Cleveland Heights 18, Ohio

**W. J. BROWN**  
*Electronic & Radio Engineering Consultant*

Electronic Industrial Applications, Commercial and Broadcasting Transmitter and Receiver Design, Test Equipment, etc.

23 years experience in electronic development

2879 Coleridge Rd., Cleveland Hts., Ohio  
Fairmount 0030

**STANLEY D. EILENBERGER**  
*Consulting Engineer*

**INDUSTRIAL ELECTRONICS**

Design—Development—Models  
Complete Laboratory and Shop Facilities  
6309-13—27th Ave.  
Kenosha, Wis. Telephone 2-4213

**ALBERT PREISMAN**  
*Consulting Engineer*

Specializing in Television and Pulse Techniques, Video Amplifiers, Industrial Applications.

616 St. Andrews Lane Silver Spring, Md.

**Paul D. Zottu**  
Consulting Engineer  
Industrial Electronics

High Frequency Dielectric and Induction Heating Applications, Equipment Selection, Equipment and Component Design, Development, Models.

314 Washington St., Newton, Mass. BIG-9240

**F. T. Fisher's Sons Limited**  
Consulting Engineers

Broadcast Transmitters, Antenna Systems, Studio Equipment, Mobile and Fixed Communication Systems.

1425 Dorchester Street W., Montreal

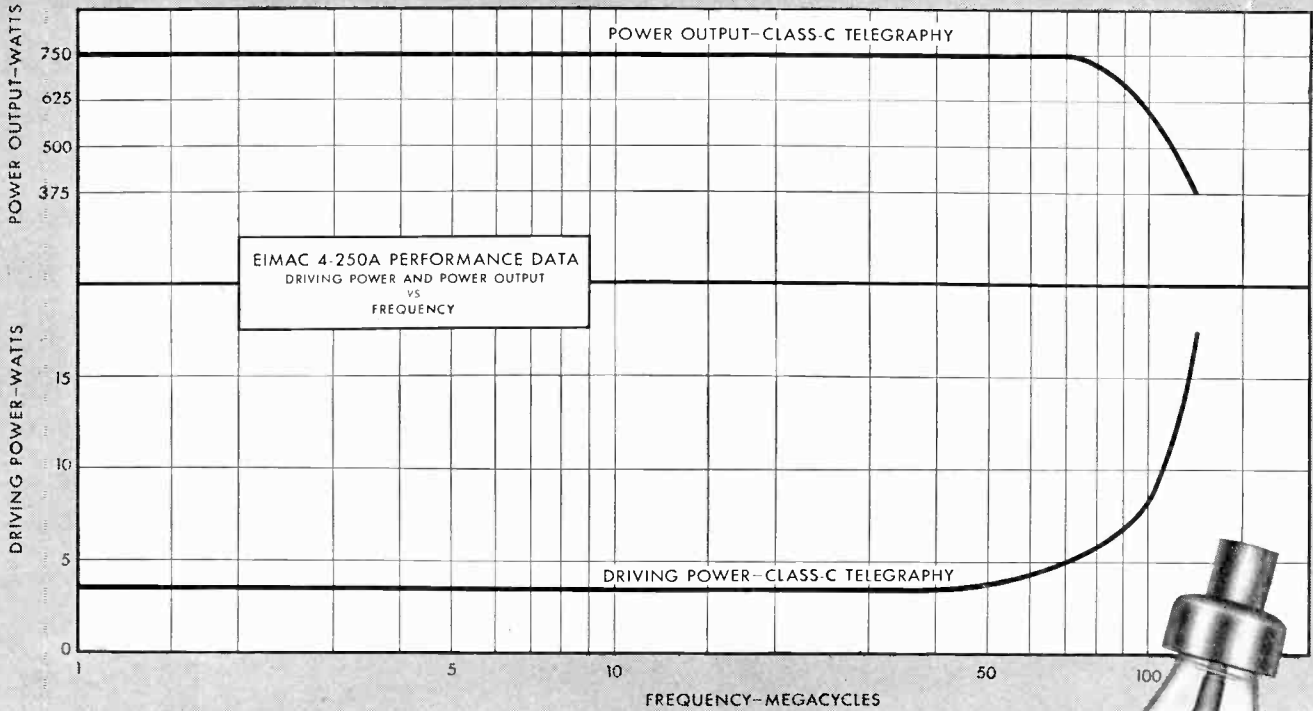

## NEW EIMAC 4-250A TETRODE

Heading a parade of sensational new tubes now in production, the Eimac 4-250A Tetrode—introduced several months ago—is already in great demand. It may pay to check these performance characteristics against your own requirements.

As can be seen by the chart above, the new Eimac 4-250A Tetrode will deliver 750 watts output at frequencies up to 70 Mc. with a driving power of only 5 watts. At frequencies up to 40 Mc. an output of 750 watts may be obtained with a driving power of 3.5 watts.

The grid-plate capacitance of 0.12  $\mu\text{mfd.}$  is extremely low, allowing operation at high frequencies without neutralization. Use of Eimac "X" process control grid reduces both primary and secondary emission which provides utmost stability.

You are invited to supplement the information given here with a technical bulletin on Eimac 4-250A Power Tetrode. It contains an elaboration of the tube's characteristics and constant current curves. Send your name and address and a copy will go to you by return mail.

**The Lid's Coming Off...**

Watch your favorite trade journals for announcements of other new Eimac tubes to be released this year.

**CAUTION!** Check serial numbers on Eimac tubes before you buy. Be sure you're getting newest types. Look for latest serial numbers.

**FOLLOW THE LEADERS TO**



EITEL-McCULLOUGH, INC., 1086 San Mateo Avenue, San Bruno, Calif.  
Plants located at: San Bruno, California and Salt Lake City, Utah  
Export Agents: Frazar & Hansen, 301 Clay St., San Francisco 11, Calif., U. S. A.

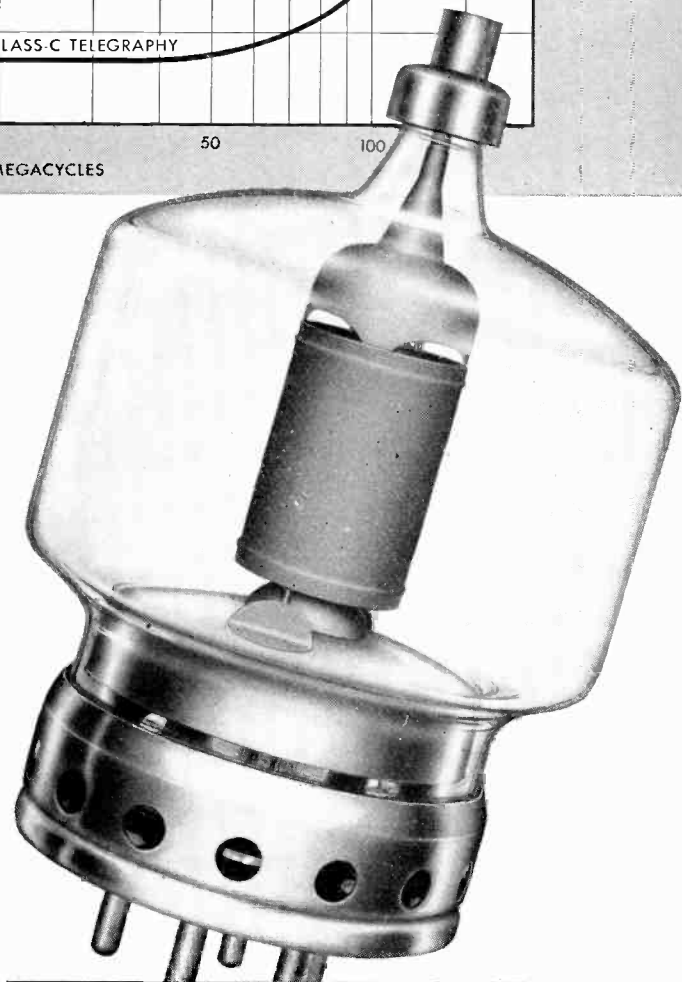

**TYPE 4-250A—POWER TETRODE**  
ELECTRICAL CHARACTERISTICS

Filament: Thoriated Tungsten	
Voltage . . . . .	5.0 volts
Current . . . . .	14.5 amperes
Plate Dissipation (Maximum) . . . . .	250 watts
Direct Interelectrode Capacitances (Average)	
Grid-Plate . . . . .	0.12 $\mu\text{mfd.}$
Input . . . . .	12.7 $\mu\text{mfd.}$
Output . . . . .	4.5 $\mu\text{mfd.}$
Transconductance ( $i_b = 80 \text{ ma.}$ , EB = 3000 v., Ec2 = 500 v.)	4000 $\mu\text{mhos}$



# A NEW AND DIFFERENT SWEEP GENERATOR

Needed in  
TELEVISION, FM, RADAR, HIGH FREQUENCIES

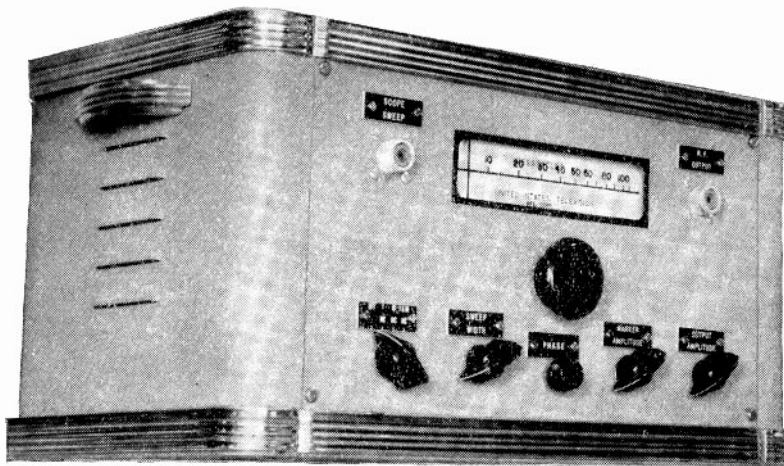

.1 Volt, Max., 500 Kc to 110 Mcs;  
100 Ohms, 10 Mc. Sweep Width

**SAVES TIME**

— In Production and in Testing

**LIGHT**

— Only 16 lbs.

**SMALL**

— 14½" x 8" x 8"

**\$395.00** APPROXIMATE PRICE

For your work in television, FM, radar, high frequencies, etc., you will need one of these newly developed electronic frequency modulated signal generators covering a continuous range between 500 Kc and 110 Mc. Designed primarily for use for field, laboratory, or production alignment of wide band r.f., i.f., or video amplifiers used in radar, direction finders, television, or other wide-band systems.

Sweep range is adjustable from 10 Mc. down to 5,000 cycles at any frequency within the above range for alignment of narrow-band receivers or amplifiers. Self-contained power supply. Input 110 V., 50-60 cycles. A.C. 60 watts. Two internal "markers" are provided, one at intervals of 10 Mc., the other at intervals of 1 Mc. for band-width measurement. The amplitude of these markers is adjustable from the panel. The main dial is



*Also Available Immediately  
In Sample Quantities*

**HIGH VOLTAGE RF POWER SUPPLIES**  
(10 KV, 24 KV, or 30 KV) for 7, 10, 12, or 14 inch direct-viewing Kinescopes and for projection sets

**ICONOSCOPE YOKES**

**CATHODE RAY RECEIVING TUBE YOKES**  
**DEFLECTION TRANSFORMERS**

Write for preliminary technical data. A limited number of orders placed now for the Sweep Generator can be filled immediately.

marked in megacycles/sec. and when set at any frequency the sweep is plus and minus 5 Mc. from this setting.

An attenuator is provided which reduces the output signal of .1 V. to about 30 microvolts, which is well below the gain control region of most receiver or amplifier systems.

**UNITED STATES TELEVISION MFG. CORP.**

106 Seventh Avenue • New York 11, N. Y. • CHelsea 2-1154

**RADIO • TELEVISION • ELECTRONIC PRODUCTS**

stop that **noise!**

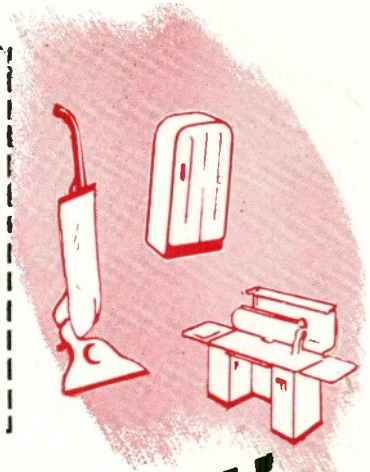

**Capacitor  
Engineering  
That Licked  
Radio Noise**

Vehicular radio equipment manufactured for military use was free from radio noise . . . thanks to the engineering that produced small compact capacitors and filters for generators, inverters, motors and other equipment. Now these can be adapted to a multitude of peace-time products where noise suppression is a "must".

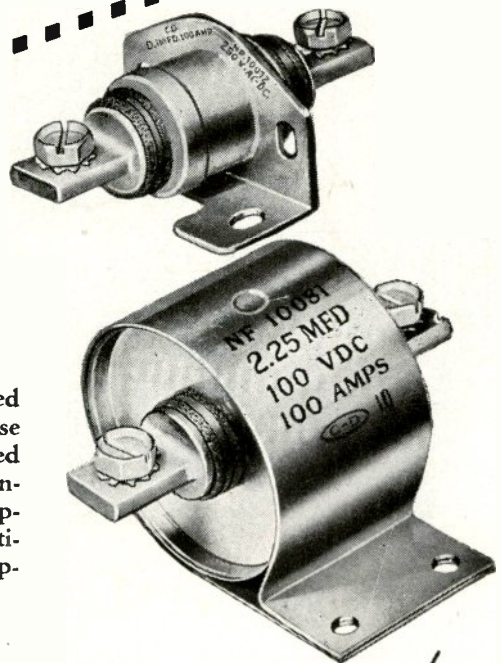

**The NF series of C-D feed-thru capacitors is specially designed and built for this service . . . to reduce radio noise.**

Small and compact, they can be mounted in any position and will operate over a temperature range of plus 85° to minus 55° C. One power line can be fed through the unit, reducing internal inductance and resistance and increasing filtering efficiency. Rated up to 250 V. AC-DC, 100 amps., in sturdy, round metal containers.

Other types of filters and feed thru capacitors are available in a range of sizes and ratings. Write for information. Cornell-Dubilier Electric Corporation, South Plainfield, N. J. Other plants at New Bedford, Brookline, Worcester, Mass., and Providence, R. I.

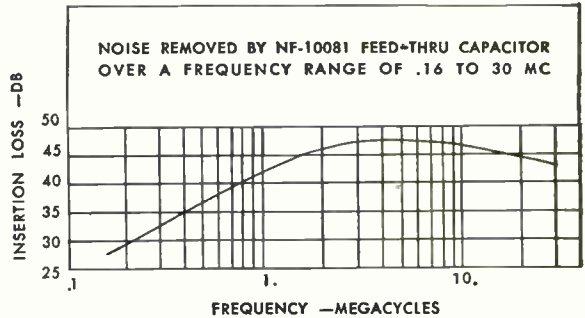

1910  1946

MICA ★ DYKANOL ★ PAPER ★ ELECTROLYTICS

**CORNELL-DUBILIER  
CAPACITORS**



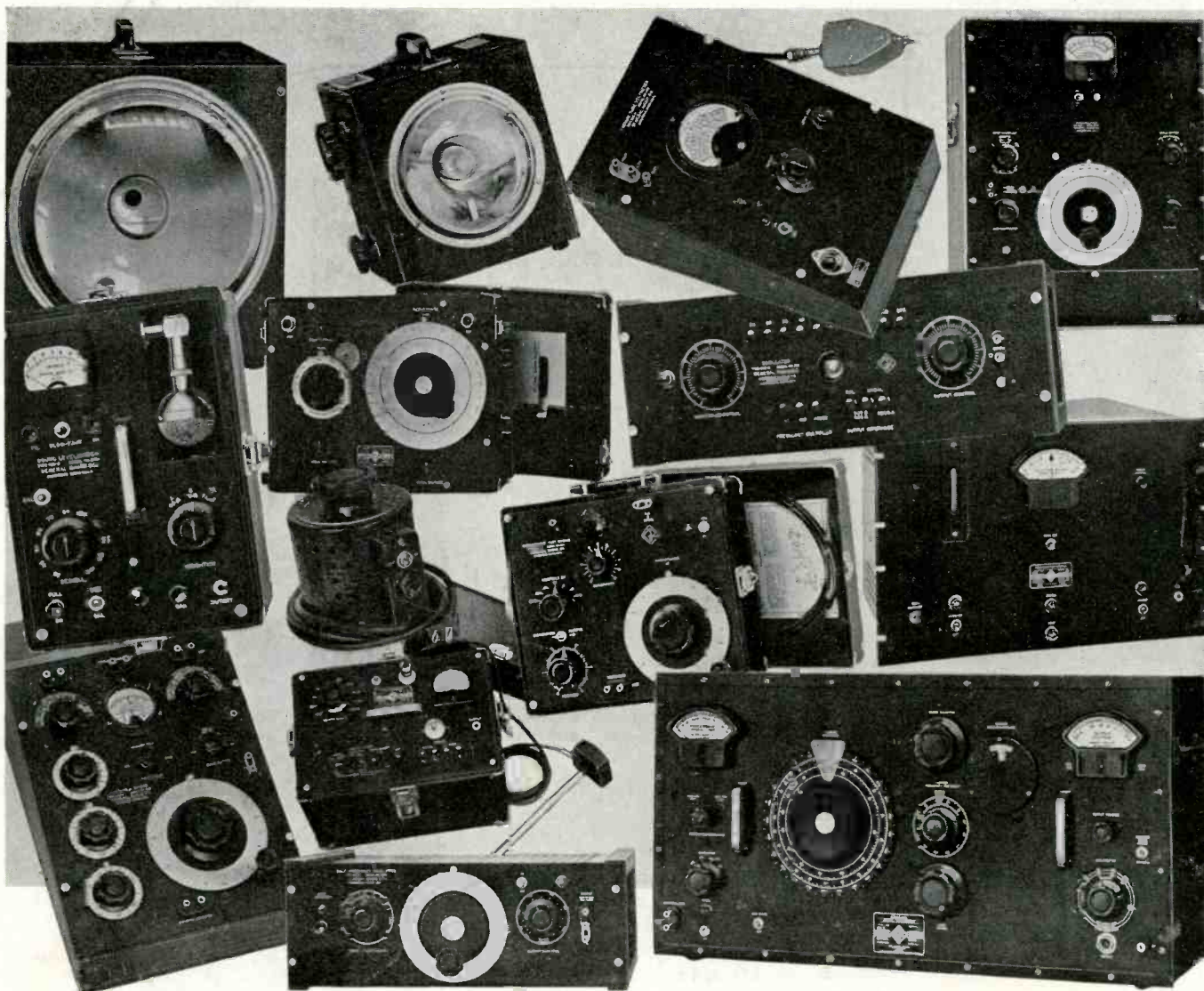

## IN ANY LABORATORY . . .

It is difficult to picture any modern scientific or industrial laboratory that does not have need for some G-R instrument. The considerable impetus given to electronic research during the war has greatly expanded the need for G-R equipment.

Since it was founded in 1915, General Radio has developed, manufactured and supplied industry with an increasingly large number of instruments for audio- and radio-frequency measurements, until at the present time the complete line of G-R equipment and accessories is numbered in the hundreds of models.

General Radio instruments include:

**INDUSTRIAL INSTRUMENTS:** Stroboscopes, Sound and Vibration Meters and Analyzers, D-C Amplifier, Variac Continuously-adjustable Transformers

**WAVEFORM INSTRUMENTS:** Wave Analyzer, Modulation Meter, Distortion Meter, Wave Filters, Oscillograph Recorder

**FREQUENCY MEASURING EQUIPMENT:** Primary and Secondary Standards of Frequency, Interpola-

tion Equipment, Heterodyne Frequency Meters, Frequency Monitors, Wavemeters

**BRIDGES** for measuring: Capacitance, Power Factor, Inductance, Resistance, Vacuum-tube Characteristics

**RESISTANCE:** Standards, Decade Resistors, Resistance Units, Attenuators, Rheostat-potentiometers

**CAPACITANCE** Air and Mica Standards, General-Purpose Fixed and Variable Condensers

**INDUCTANCE:** Standards and Variable Inductors

**STANDARD-SIGNAL GENERATORS**

**OSCILLATORS:** Electronic Audio- and Radio-frequency, Pulse Generator, Tuning Forks

**METERS:** Vacuum-tube and Rectifier-type Voltmeters, Microvolter, Megohmmeters, Oxide Rectifiers

**PARTS AND ACCESSORIES:** Switches, Dials and Knobs, Plugs and Jacks, R-F Chokes

Before you buy any electronic laboratory measuring equipment, it will pay you to investigate the G-R line.



# GENERAL RADIO COMPANY

Cambridge 39,  
Massachusetts

90 West St., New York 6 920 S. Michigan Ave., Chicago 5 1000 N. Seward St., Los Angeles 38