

Proceedings



of the

I · R · E

A JOURNAL of the Theory, Practice, and Applications of Electronics and Electrical Communication

- Radio Communication • Sound Broadcasting • Television • Marine and Aerial Guidance •
- Tubes • Radio-Frequency Measurements • Engineering Education • Electron Optics •
- Sound and Picture Electrical Recording and Reproduction •
- Power and Manufacturing Applications of Radio-and-Electronic Technique •
- Industrial Electronic Control and Processes • Medical Electrical Research and Applications •

EIGHTH CANADIAN VICTORY LOAN

I.R.E. BUILDING FUND
CAMPAIGN

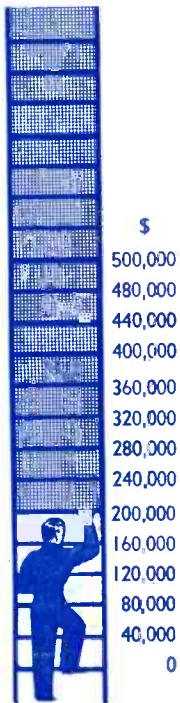

HELP HIM
CLIMB



INVEST IN THE BEST

APRIL, 1945

VOLUME 33 NUMBER 4

Presidential Address

Industrial Electronic
Technique

Electronic-Tube
Developments

Electron-Gun Technique

Recent Transformer
Developments

U-H-F Dielectric
Measurements

Diode Modulation

Cylindrical-Antenna
Impedance

Electronic A-C Power
Regulator

The Institute of Radio Engineers

98% HERMETIC PRODUCTION



The need for maximum dependability in transformer products has swung UTC production into high gear on Hermetic designs. Work at our Varick Street plant, for example, is now 98% Hermetic.



May we cooperate with you on design savings for your applications...war or postwar?

United Transformer Co.

150 VARICK STREET

NEW YORK 13, N. Y.

EXPORT DIVISION: 13 EAST 40th STREET, NEW YORK 16, N. Y., CABLES: "ARLAB"

BOARD OF DIRECTORS

1945

William L. Everitt
President

Hendrik J. van der Bijl
Vice-President

Raymond A. Heising
Treasurer

Haraden Pratt
Secretary

Alfred N. Goldsmith
Editor

Lynde P. Wheeler
Senior Past President

Hubert M. Turner
Junior Past President

1943-1945

Wilmer L. Barrow
F. B. Llewellyn

Harold A. Wheeler

1944-1946

Raymond F. Guy
Lawrence C. F. Horle
William C. White

1945-1947

Stuart L. Bailey
Keith Henney
Benjamin E. Shackelford

1945

E. Finley Carter
Lewis M. Clement
Ralph A. Hackbusch
Donald B. Sinclair
William O. Swinyard

Harold R. Zeamans
General Counsel

BOARD OF EDITORS

Alfred N. Goldsmith
Editor

Ralph R. Batcher
Robert S. Burnap
Walter G. Cady
Philip S. Carter

Lewis M. Clement
William G. Dow

Elmer W. Engstrom
William L. Everitt

William G. H. Finch
George W. Gilman

Peter C. Goldmark
Frederick W. Grover

Lewis B. Headrick
C. M. Jansky, Jr.

Hugh S. Knowles
John D. Kraus

Donald G. Little
Frederick B. Llewellyn

Samuel S. Mackeown
Edward L. Nelson

Harry F. Olson
Harold O. Peterson

Greenleaf W. Pickard
Ralph A. Powers

Haraden Pratt
Conan A. Priest

Herbert J. Reich
Peter C. Sandretto

Vernon W. Sherman
Lynne C. Smeby

E. C. Wente
Harold A. Wheeler

William C. White
Laurens E. Whittemore

Gerald W. Willard
William Wilson
Charles J. Young
Vladimir K. Zworykin

Proceedings

of the I.R.E.

Published Monthly by

The Institute of Radio Engineers, Inc.

VOLUME 33

April, 1945

NUMBER 4

Section Meetings	Next Page
Let's Get Better Acquainted	Edgar Kobak 211
Joseph R. Redman	212
Postwar Engineering Defense Against Aggression	Joseph R. Redman 213
Herbert J. Reich	214
Retiring Presidential Address	H. M. Turner 215
Is Industrial Electronic Technique Different?	W. D. Cockrell 217
Development of Electronic Tubes	I. E. Mouromtseff 223
Some Notes on the Design of Electron Guns	A. L. Samuel 233
Recent Transformer Developments	Reuben Lee 240
A Resonant-Cavity Method for Measuring Dielectric Properties at Ultra-High Frequencies	C. N. Works, T. W. Dakin, and F. W. Boggs 245
A Note on Diode Modulation	A. D. Bailey and G. H. Fett 254
Experimentally Determined Impedance Characteristics of Cylindrical Antennas	George H. Brown and O. M. Woodward, Jr. 257
Electronic Alternating-Current Power Regulator	L. B. Cherry and R. F. Wild 262
Discussion on "Design of Electronic Heaters for Induction Heating"	George H. Brown and J. P. Jordan 267
Institute News and Radio Notes	268
Board of Directors	268
Executive Committee	269
1945 Winter Technical Meeting	269
I.R.E. Building Fund	272
Fellowship Acknowledgments	O. H. Caldwell 274
Institute Committees—1945	275
Technical Committees	276
Institute Representatives in Colleges—1945	277
Institute Representatives on Other Bodies—1945	277
Contributors	278
Section Meetings	34A
Membership	38A
Positions Open	50A

Helen M. Stote, Associate Editor

William C. Copp, Advertising Manager

Responsibility for the contents of papers published in the PROCEEDINGS rests upon the authors. Statements made in papers are not binding on the Institute or its members.



Entered as second-class matter October 26, 1927, at the post office at Menasha, Wisconsin, under the Act of February 28, 1925, embodied in Paragraph 4, Section 538 of the Postal Laws and Regulations. Publication office, 450 Ahnapp Street, Menasha, Wisconsin. Executive, editorial, and advertising offices, 330 West 42nd Street, New York 18, N. Y. Price, \$1.00 a copy. Subscriptions: United States and Canada, \$10.00 a year; foreign countries, \$11.00 a year. Changes of address (with advance notice of fifteen days) and communications regarding subscriptions and payments should be mailed to the Secretary of the Institute, at 330 West 42nd Street, New York 18, N. Y. All rights of republication, including translation into foreign languages, are reserved by the Institute. Abstracts of papers, with mention of their source, may be printed. Requests for republication privileges should be addressed to The Institute of Radio Engineers.

Copyright, 1945, by The Institute of Radio Engineers, Inc.

PAPERS COMMITTEE

Frederick B. Llewellyn
Chairman

Herman A. Affel
Wilmer L. Barrow
Howard A. Chinn
James K. Clapp
Ivan S. Coggeshall
Edward J. Content
Clifford W. Corbett
Murray G. Crosby

Frederick W. Cunningham

Robert B. Dome
Enoch B. Ferrell
Donald G. Fink
Howard S. Frazier
Robert L. Freeman
Stanford Goldman
Frederick W. Grover

O. B. Hanson
Thomas J. Henry
Edward W. Herold
John V. L. Hogan
Frederick V. Hunt

Harley Iams
Loren F. Jones
John G. Kreer, Jr.
Emil Labin

Frederick R. Lack
Hugo C. Leuteritz
Charles V. Litton
Knox McIlwain

Harry R. Mimno
Ilia E. Mouromtseff
G. G. Muller

Albert F. Murray
Dwight O. North
Allen F. Pomeroy
Jack R. Poppele
Simon Ramo

Francis X. Rettenmeyer

Sergei A. Schelkunoff
Donald B. Sinclair
Dayton Ulrey

A. P. Upton
Karl S. Van Dyke
E. K. Van Tassel
John R. Whinnery

Irving Wolff
J. Warren Wright
Harold R. Zeamans

PAPERS

PROCUREMENT COMMITTEE

Dorman D. Israel
General Chairman
Edward T. Dickey
Vice General Chairman

GROUP CHAIRMEN
Arthur B. Bronwell
Nelson P. Case
Madison Cawein

Ivan S. Coggeshall
Murray G. Crosby
Alfred Crossley

Harry Diamond
Arthur E. Harrison
Theodore A. Hunter

James R. Nelson
Harry F. Olson
Donald B. Sinclair
Howard J. Tyzzer

Wilbur L. Webb
William C. White
Karl S. Van Dyke

George W. Bailey
Executive Secretary
William B. Cowilich
Assistant Secretary



THE INSTITUTE OF RADIO ENGINEERS INCORPORATED



SECTIONS MEETINGS

ATLANTA
April 20

CHICAGO
April 20

CLEVELAND
April 26

DETROIT
April 20

LOS ANGELES
April 17

NEW YORK
May 2

PHILADELPHIA
May 3

PITTSBURGH
May 14

PORTLAND
May 14

WASHINGTON
May 14

SECTIONS

ATLANTA—Chairman, R. A. Holbrook; Secretary, J. P. Lenkerd, 1154 Hancock Dr., N.E., Atlanta, Ga.

BALTIMORE—Chairman, W. I. Webb; Secretary, H. L. Spencer, Box 6760, Towson 4, Md.

BOSTON—Chairman, C. C. Harris; Secretary, Corwin Crosby, 16 Chauncy St., Cambridge, Mass.

BUENOS AIRES—Chairman, A. DiMarco; Secretary, H. Krahenbuhl, Trans-radio Internacional, San Martin 379, Buenos Aires, Argentina

BUFFALO-NIAGARA—Chairman, A. J. Dybowski; Secretary, H. G. Korts, 51 Kinsey Ave., Kenmore, N. Y.

CEDAR RAPIDS—Chairman, F. M. Davis; Secretary, J. A. Green, Collins Radio Co., 855-35th St., N.E., Cedar Rapids, Iowa

CHICAGO—Chairman, W. O. Swinyard; Secretary, A. W. Graf, 135 S. LaSalle St., Chicago 3, Ill.

CINCINNATI—Chairman, L. M. Clement; Secretary, J. F. Jordan, The Baldwin Co., 1801 Gilbert Ave., Cincinnati 2, Ohio

CLEVELAND—Chairman, H. B. Okeson; Secretary, A. J. Kres, 16911 Valleyview Ave., Cleveland 11, Ohio

CONNECTICUT VALLEY—Chairman, R. E. Shea; Secretary, L. A. Reilly, 989 Roosevelt Ave., Springfield, Mass.

DALLAS-FORT WORTH—Chairman, J. D. Mathis; Secretary, B. B. Honeycutt, 9025 Roanoak, Dallas 18, Texas

DAYTON—Chairman, G. L. Haller; Secretary, Joseph General, 411 E. Bruce Ave., Dayton 5, Ohio

DETROIT—Chairman, R. A. Powers; Secretary, R. R. Barnes, 1411 Harvard Ave., Berkley, Mich.

EMPORIUM—Chairman, W. A. Dickinson; Secretary, H. E. Ackman, West Creek, R. D. 2, Emporium, Pa.

INDIANAPOLIS—Chairman, H. I. Metz; Secretary, J. D. Colvin, 328 E. 47 St., Indianapolis 5, Ind.

KANSAS CITY—Chairman, A. P. Stuhrman; Secretary, R. N. White, 4800 Jefferson St., Kansas City, Mo.

LONDON—Chairman, G. A. Woonton; Secretary, Robert Wilton, No. 5 Radio School, Royal Canadian Air Force, Clinton, Ont., Canada

LOS ANGELES—Chairman, R. C. Moody; Secretary, R. G. Denechaud, Blue Network Co., 6285 Sunset Blvd., Hollywood 28, Calif.

MONTREAL—Chairman, F. S. Howes; Secretary, J. A. Campbell, Northern Electric Co., Ltd., 1261 Shearer St., Montreal, Que., Canada

NEW YORK—Chairman, G. B. Hoadley; Secretary, J. T. Cimorelli, RCA Manufacturing Co., 415 S. Fifth St., Harrison, N. J.

OTTAWA—Acting Chairman, F. R. Parks; Acting Secretary, L. F. Millett, 33 Regent St., Ottawa, Ont., Canada

PHILADELPHIA—Chairman, T. A. Smith; Secretary, P. M. Craig, Philco Corp., Philadelphia 34, Pa.

PITTSBURGH—Chairman, T. C. Kenny; Secretary, R. K. Crooks, Box 2038, Pittsburgh 30, Pa.

PORTLAND—Chairman, Kenneth Johnson; Secretary, C. W. Lund, Route 4, Box 858, Portland, Ore.

ROCHESTER—Chairman, G. R. Town; Secretary, A. E. Newlon, Research Dept., Stromberg-Carlson Co., Rochester 3, N. Y.

ST. LOUIS—Chairman, N. B. Fowler; Secretary, C. H. Meyer, KFUE, 801 DeMun Ave., St. Louis, Mo.

SAN DIEGO—Chairman, E. B. Robinson; Secretary, Clyde Tirrell, United States Navy Radio and Sound Laboratory, San Diego 52, Calif.

SAN FRANCISCO—Chairman, David Packard; Secretary, William Barclay, Stanford University, Palo Alto, Calif.

SEATTLE—Chairman, G. L. Hoard; Secretary, K. A. Moore, 5102 Findlay St., Seattle 8, Wash.

TORONTO—Chairman, E. O. Swan; Secretary, Alexander Bow, Copper Wire Products, Ltd., 137 Roncesvalles Ave., Toronto, Ont., Canada

TWIN CITIES—Chairman, H. S. McCartney; Secretary, C. W. Engelman, 4648 Chowen Ave. S., Minneapolis 10, Minn.

WASHINGTON—Chairman, H. A. Burroughs; Secretary, L. C. Smeby, 4801 Connecticut Ave., N.W., Washington, D. C.

WILLIAMSPORT—Chairman, L. E. West; Secretary, Frank Burroughs, 2030 Reed St., Williamsport, Pa.

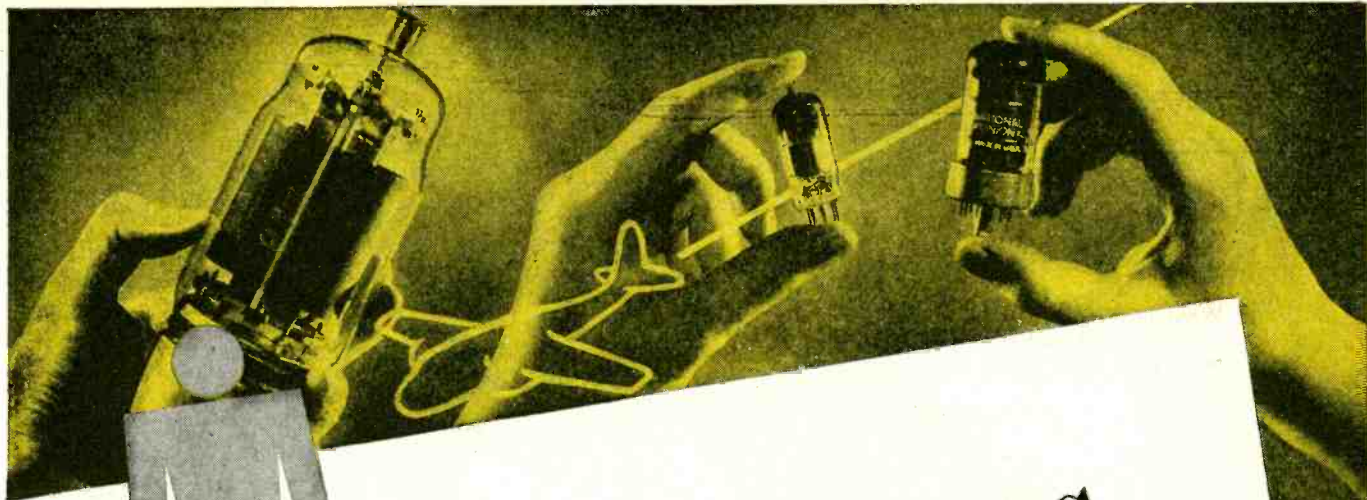

from **MIDGETS** to **GIANTS**

AS A TOP producer of radio and electron tubes, National Union makes hundreds of types—from thumbnail miniatures to giant cathode-ray, transmitting and power tubes.

From National Union Research Laboratories have come an impressive number of entirely new types of tubes with special characteristics to meet new requirements, particularly in the ultra-high frequency regions. N. U. scientists have developed new materials . . . for example, new cathode

coatings for high emission efficiency. They have devised new precision manufacturing methods to produce quality tubes in quantity—fast! They have created new standards for tube performance and useful life under rigorous battlefront conditions.

After the war, you will want tubes like these, which embody advanced scientific techniques . . . more efficient, longer lasting tubes engineered to your new needs. Count on National Union.

NATIONAL UNION
RADIO AND ELECTRON TUBES
NATIONAL UNION RADIO CORPORATION • NEWARK 2, N. J.



What type of microphone is best suited for a particular application?

How can I convert the level of a microphone rated on the basis of milliwatts per bar to a level of volts per bar?

What new types of special purpose microphones have been developed for voice and sound transmission?

These and many other answers may be found in the
NEW and COMPLETE *Electro-Voice* CATALOG



More than an exposition of microphone types, the new Electro-Voice Catalog provides a source of valuable information which should be at the fingertips of every sound man. It contains a simplified Reference Level Conversion Chart which marks the first attempt in the history of the industry to standardize microphone ratings. Several pages are devoted to showing basic operating principles of microphones . . . offering a guide to the proper selection of types for specific applications. And, of course, every microphone in the Electro-Voice line is completely described, from applications to specifications.

*Reserve your copy of the new
Electro-Voice Catalog. Write today.*

BUY AND
HOLD
MORE
WAR
BONDS

***Electro-Voice* MICROPHONES**

ELECTRO-VOICE CORPORATION • 1239 SOUTH BEND AVENUE • SOUTH BEND 24, INDIANA
Export Division: 13 East 40th Street, New York 16, N. Y., U. S. A. Cables: Arlob



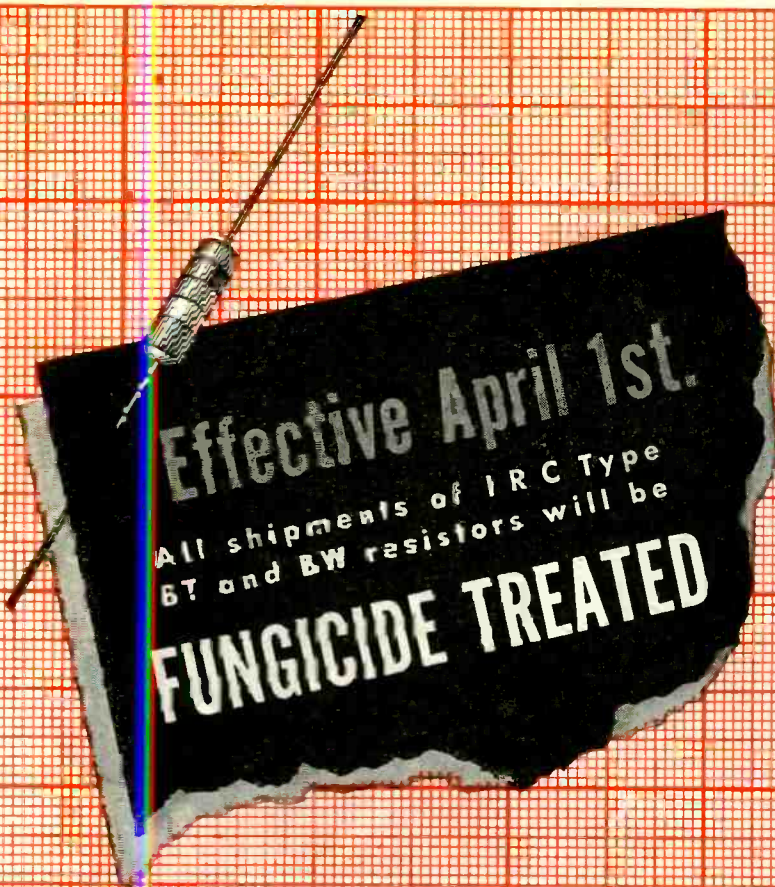

Effective April 1st.

All shipments of IRC Type
BT and BW resistors will be

FUNGICIDE TREATED



INTERNATIONAL RESISTANCE CO.

Dept. 10-D

401, NORTH BROAD STREET, PHILADELPHIA 8, PA.
IRC makes more types of resistance units,
in more shapes, for more applications,
than any other manufacturer in the world.



more efficient
... in miniature



The modern hearing aid is a fine example of greater efficiency ... in miniature. No longer does the awkward ear trumpet or an apologetic "a little louder please" embarrass the hard of hearing. The compact hearing aid of today with its inconspicuous ear button, now admits these people to a world from which partial deafness had formerly isolated them. This has been made possible by smaller tubes.

In countless applications, TUNG-SOL Miniature Tubes do everything the large old style tubes did and in most cases are doing it better.

To manufacturers of radio sets and electronic devices, size and weight reduction is so important that TUNG-SOL is now producing many of the new

miniature types. The development of other miniature types to function where larger tubes are now used is also foreseen.

Designers of electronic equipment are invited to work with TUNG-SOL engineers in the planning of circuits and in the selection of tubes. Consultation work of this character is held in strictest confidence.

TUNG-SOL
vibration-tested
ELECTRONIC TUBES



TUNG-SOL LAMP WORKS INC., NEWARK 4, NEW JERSEY
Also Manufacturers of Miniature Incandescent Lamps, All-Glass Sealed Beam Headlight Lamps and Current Intermittors

SPRAGUE

HYPASS CAPACITORS

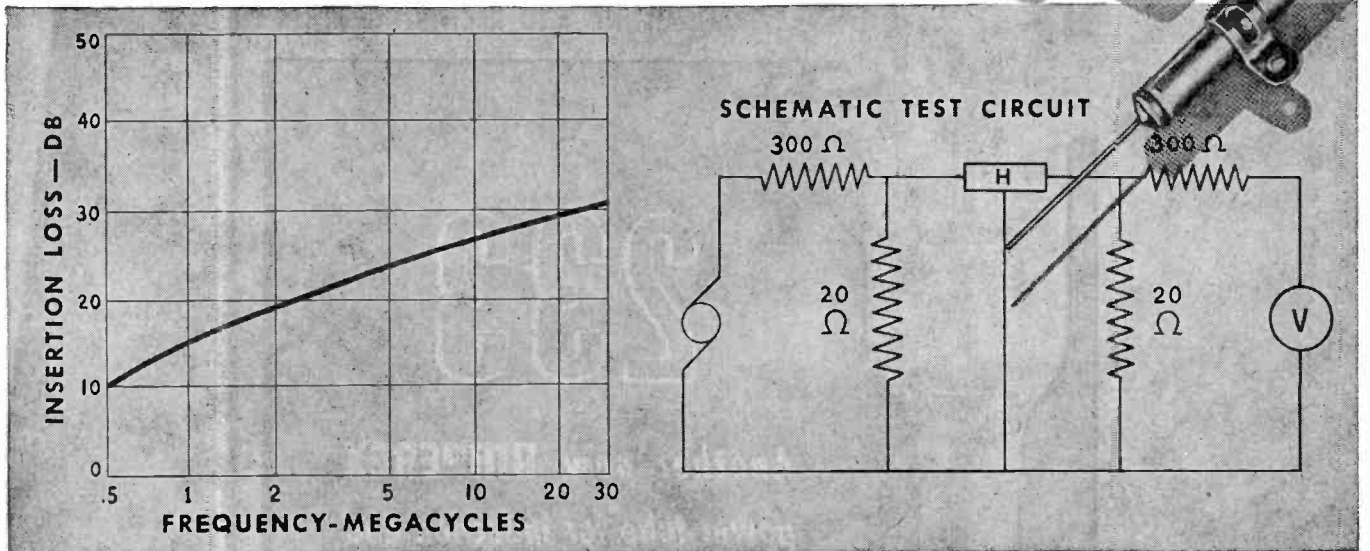
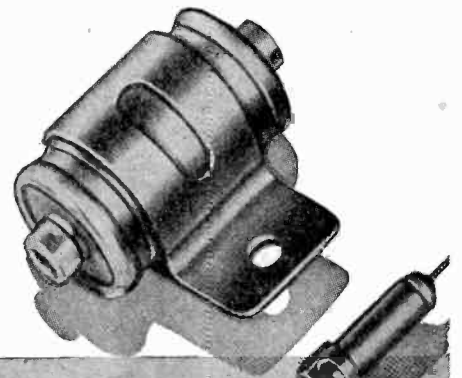

Curve showing insertion loss of a Sprague HYPASS Capacitor.

The Solution to "WHAT TO DO WITH ANTI-RESONANT FREQUENCIES?"

Conventional methods of getting rid of vibrator "hash" usually call for the use of a by-pass capacitor, shunted by a mica capacitor. This system, however, has at least one anti-resonant frequency. Of course the engineer juggles his constants so that this anti-resonant frequency comes where it causes the least trouble—BUT, in today's all-wave devices, there just isn't any such place!

The New Sprague Method is simply to utilize the Sprague HYPASS Capacitor. Technically, this is a 3-terminal network which, at low frequencies, "looks" like a capacitor in respect to its capacity, voltage rating, and size. At high frequencies—well, the above diagram tells the story. Although accurate measurements of their performance at the very high end of the spectrum are difficult to obtain as yet, qualitative indications show that HYPASS units do the job at 100 megacycles and more—so much so that, if you have a "hash" problem, we'd welcome an opportunity to stack them against it.

SPRAGUE ELECTRIC COMPANY, North Adams, Mass.
(Formerly Sprague Specialties Co.)

* T. M. REG. U. S. PAT. OFFICE

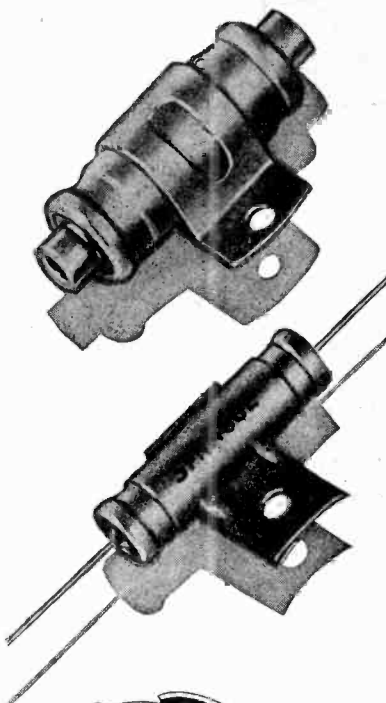

SPRAGUE

CAPACITORS — *KOOLOHM RESISTORS

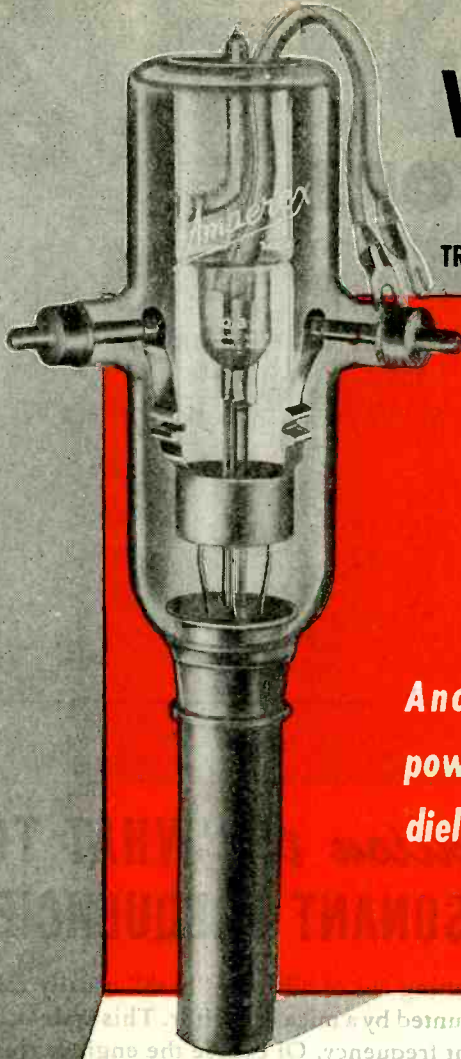

WHY AMPEREX

WATER AND AIR COOLED
TRANSMITTING AND RECTIFYING TUBES

233

Another new **AMPEREX**
power tube for induction and
dielectric heating equipment

The new **Amperex 233** is designed for use as a Class C oscillator or amplifier for generating radio frequency power at frequencies up to 30 megacycles. Two grid arms make neutralization more convenient in the amplifier connection, and also permit cooler operation of the grid when the tube is employed at higher frequencies either in a self-excited oscillator or power amplifier. As do all tubes designed and developed in our laboratory, the 233 incorporates well-known "Amperextras" which make for longer operating efficiency and lower operating costs. **Write for engineering data.**



AMPEREX

... the high performance tube

AMPEREX ELECTRONIC CORPORATION

79 WASHINGTON STREET BROOKLYN 1, N. Y.

Export Division: 13 E. 40th St., New York 16, N. Y., Cables: "Arlab"

GIVE WHAT YOU'VE GOT . . . DONATE A PINT OF BLOOD TO THE RED CROSS



ALLEN H. GARDNER, Pres.
Colonial Radio Corporation



BERNARD WAHLE, Pres.
National Trailways Bus System

Leaders all- These Men in Industry . . . E-L in Current Conversion

These, and many other industrial leaders, anticipate improvements in their postwar equipment which will require current conversion. Vibrator Power Supplies lead the field in current conversion because of their efficiency, versatility, ease of maintenance, and flexibility in size and weight.

Specializing in design and production, Electronic Laboratories, the world's largest manufacturer of Vibrator Power Supplies, has pioneered and perfected many exclusive developments such as multiple input and output, constant output voltage systems, and heavy duty units with capacities up to 1000 watts.

Wherever current must be changed in voltage, frequency or type—especially DC to AC, for which there is an ever increasing demand—consider an E-L Vibrator Power Supply first. Consult with E-L Engineers on *your* current conversion needs.



W. J. HALLIGAN, Pres.
Helicopters Radio



COLONEL JOHN CASEY, Mgr.
Chicago Municipal Airport



W. A. PATTERSON, Pres.
United Air Lines



JOHN E. MCCARTHY, Pres.
Fifth Avenue Coach Company



J. F. MACEULITY, Pres.
Pressed Steel Car Company, Inc.



Electronic

LABORATORIES INC.

INDIANAPOLIS

VIBRATOR POWER SUPPLIES FOR LIGHTING, COMMUNICATIONS AND ELECTRIC MOTOR OPERATION ELECTRIC, ELECTRONIC AND OTHER EQUIPMENT

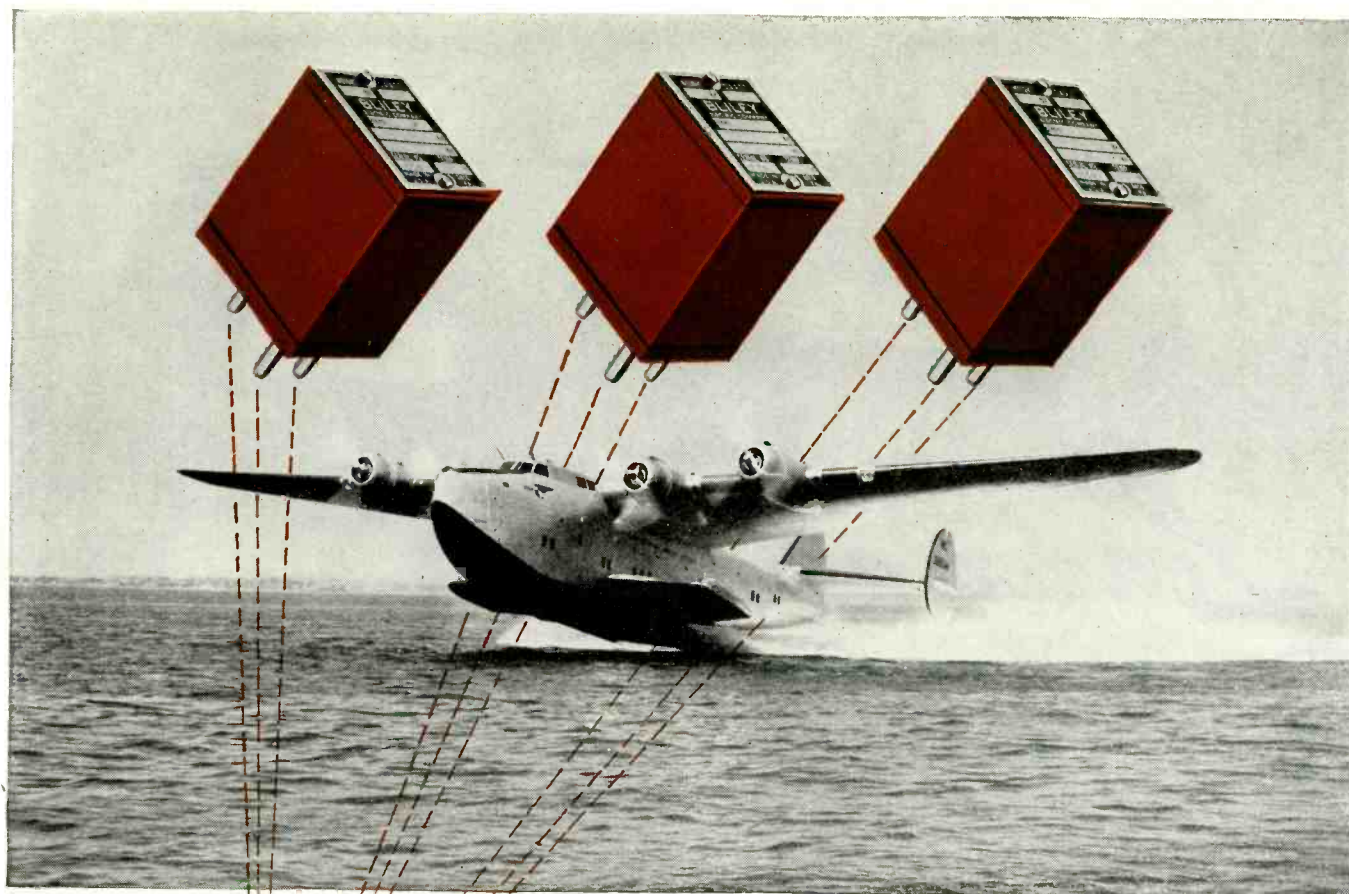

BLILEY CRYSTALS, of course, fly with Pan American

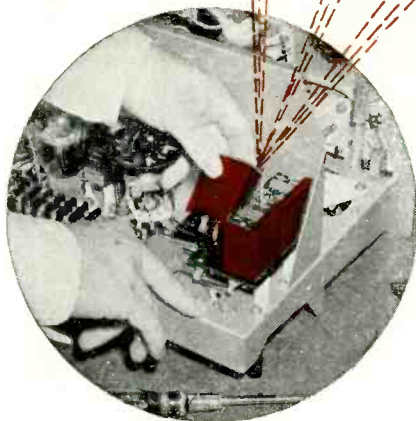

Bliley *acid etched** crystals persistently show up wherever there is an important communications job to be done such as the combination two-way telephone and telegraph and range finder systems of Pan American World Airways. In peace and in war Bliley crystals have flown millions of world-wide miles with their famous Clippers.

Bliley crystals are pre-conditioned for just such rugged assignments. In the Bliley Electric Company plant there is a large section where Bliley

*acid etched** crystals receive their pedigree. Here each crystal gets "the works". Its activity and frequency are *proved* under tough laboratory created service conditions of altitude, humidity, temperature, immersion, shock and vibration.

But licking tough assignments is a tradition with Bliley engineers and craftsmen. This background of research and skill has been responsible for the distinguished record of Bliley Crystals in every field of radio communication. Whatever your crystal problem may be—specify Bliley.

+++

*Acid etching quartz crystals to frequency is a patented Bliley process.
United States Patent No. 2,364,501

Do more than before . . .
buy extra War Bonds

☆ A new star has been added



Bliley CRYSTALS

BLILEY ELECTRIC COMPANY • UNION STATION BUILDING • ERIE • PENNSYLVANIA

WHAT WILL YOU NEED TO PRODUCE BETTER POST-WAR PRODUCTS?

**CORNING
GLASS
GIVES YOU**

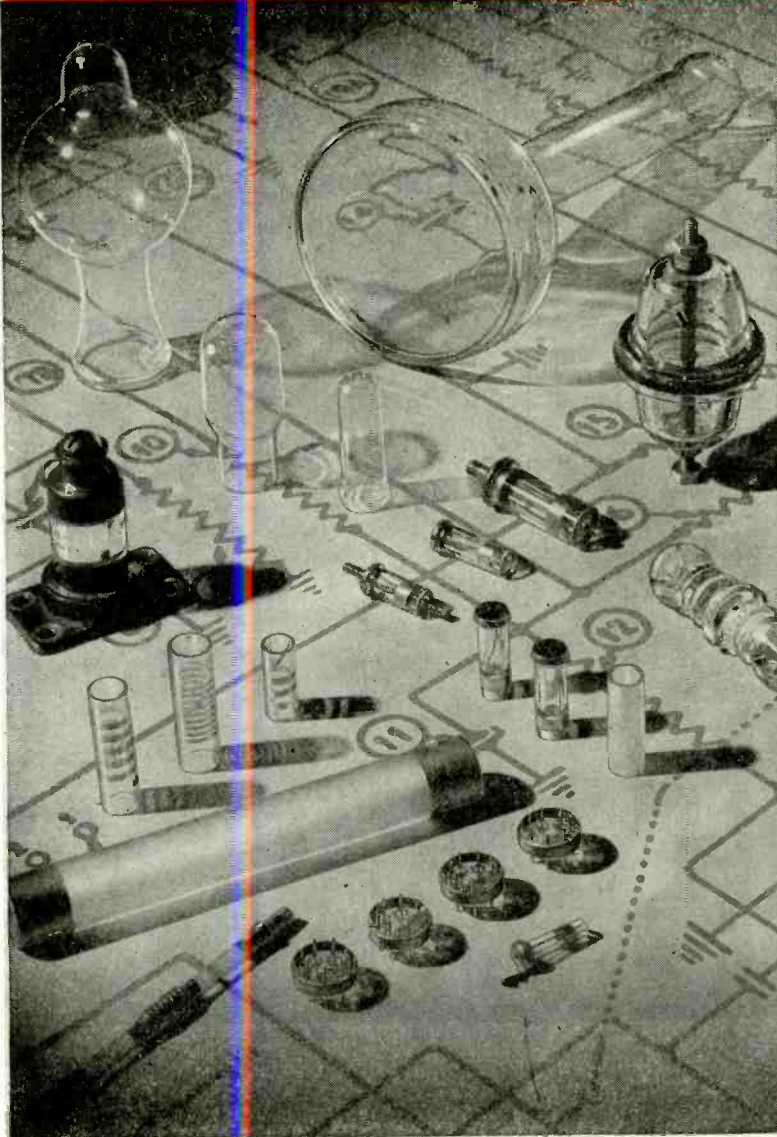

- Special Electrical Qualities
- Thermal Endurance
- Hermetic Sealing
- Mechanical Strength
- Corrosion Resistance
- Precision
- Permanence
- Metallizing
- Dimensional Stability

High dielectric strength—high resistivity—low power factor—wide range of dielectric constants—low losses at all frequencies.

Permanent hermetic seals against gas, oil and water readily made between glass and metal or glass and glass.

Commercial fabrication to the fine tolerances of precision metal working.

Corning's metallizing process produces metal areas of fixed and exact specification, permanently bonded to glass.

AS YOU plan post-war electronic products, give a thought to versatile glass. We really mean glasses, for Corning has, at its fingertips, 25,000 different glass formulae from which to select those especially suited to your electronic applications. Let us show what glass can do for you. We may already have a solution — or Corning Research can find the answer for you. Address Electronic Sales Dept., P-4 Bulb and Tubing Division, Corning Glass Works, Corning, New York.

CORNING
—means—
Research in Glass

Electronic Glassware



"PYREX", "VYCOR" and "CORNING" are registered trade-marks and indicate manufacture by Corning Glass Works, Corning, N. Y.

RESEARCH

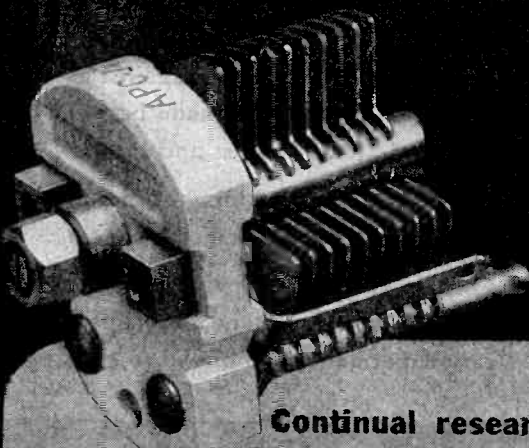

Continual research in chemistry, metallurgy and effects of various atmospheres on different plating finishes assures you that your Hammarlund variable capacitor will stay on the job.

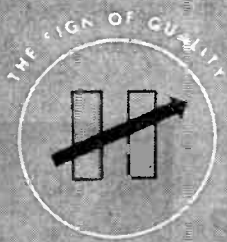

ESTABLISHED 1912

HAMMARLUND

THE HAMMARLUND MFG. CO., INC., 460 W. 34TH ST., N. Y. C.
MANUFACTURERS OF PRECISION COMMUNICATIONS EQUIPMENT

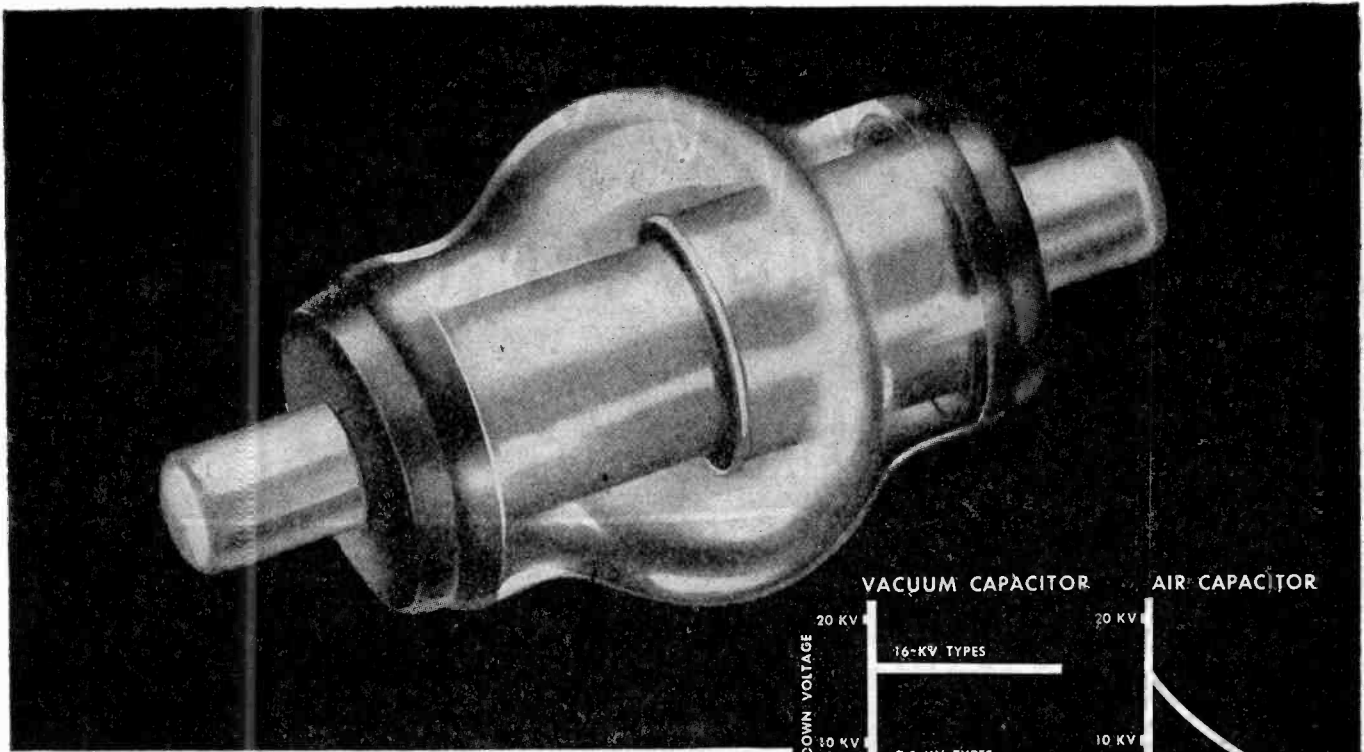

The 16,000-v Type GL-1L22 illustrated above—4 11/16" long, 2" diameter—has only 10 per cent of the volume of an air capacitor with similar rating . . . At the right are two curves showing the breakdown voltages of vacuum capacitors and air capacitors at successive altitudes. Note that air capacitors show a steady drop. However, the figures for G-E vacuum capacitors, sealed against atmospheric changes, remain constant at all times.

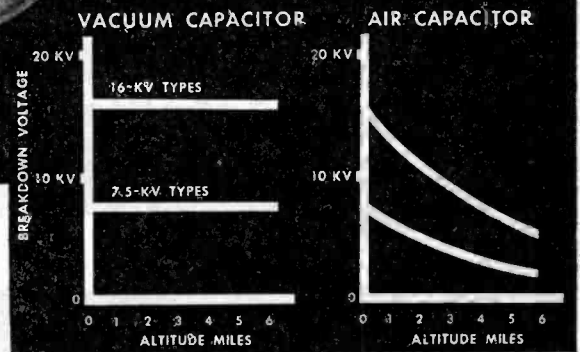

G-E VACUUM CAPACITORS

- are $\frac{1}{10}$ the size of air capacitors
- are unaffected by external conditions

G-E vacuum capacitors are designed for service where voltage peaks run up to 16,000 v, a range that is common in military, aviation, and other radio equipment, and in special applications such as diathermy. They are small in size and compactly built. This fact underscores their usefulness in high-frequency circuit design, where space-saving is important because of short lead-lengths.

● Since vacuum capacitors are completely sealed in, variations in air-density due to changing altitudes or other causes have no effect on voltage breakdown, which remains constant

at all times. Likewise, temperature or humidity changes do not influence performance, nor can dust, insects, or foreign particles in the air affect these capacitors in any way.

● Consult the table at the right to select the right capacitors for your own use. For full details telephone your nearest G-E office or distributor, or write direct to *Electronics Department, General Electric, Schenectady 5, N. Y.*

Hear the G-E radio programs: "The World Today" news, Monday through Friday, 6:45 p. m., EWT, CBS. "The G-E All-Girl Orchestra," Sunday 10 p. m., EWT, NBC. "The G-E House Party," Monday through Friday, 4 p. m., EWT, CBS.

G-E VACUUM CAPACITORS

Type	Peak voltage, volts (a-c, d-c, or r-f)	Capacitance, micromicrofarads	Price
GL-1L32	7,500	6	\$8.50
GL-1L21	7,500	12	8.50
GL-1L36	7,500	25	8.50
GL-1L38	7,500	50	8.50
GL-1L33	7,500	100	10.00
GL-1L31	16,000	6	9.25
GL-1L25	16,000	12	9.25
GL-1L22	16,000	25	9.25
GL-1L23	16,000	50	9.25
GL-1L24	16,000	100	11.00

GENERAL  ELECTRIC

161-D4-8880

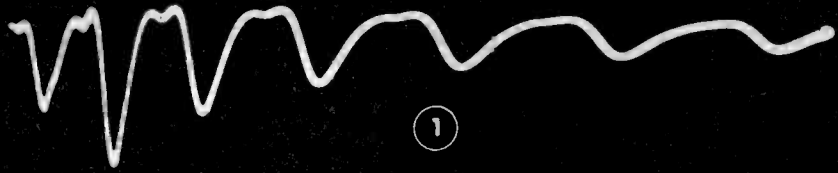

HAVE YOU CO-AX PROBLEMS?

**ATTENUATION
TRANSMISSION TIME
CHARACTERISTIC IMPEDANCE
FAULTS ...**



You can get practical answers with the

TYPE 248

Du MONT OSCILLOGRAPH



► The quickest method for determining co-ax line characteristics is that of applying a pulse to one end and observing reflections that follow. Type 248 Oscillograph, providing high-speed driven sweep and self-contained pulse generator, has proved invaluable for such work in our own laboratories and at the DuMont New York Television Station WABD.

Oscillograms herewith are typical of those obtained when testing a 200- or 300-foot 75-ohm cable, indicating respectively: (1) Reflec-

tions from an open-circuited far end; (2) The absence of reflections following the initial negative pulse, when line is correctly terminated; and (3) Reflections of reversed polarity from a shorted far end. (In each case the pulses are viewed at sending end, which is terminated in a resistance much greater than 75 ohms.)

Transmission time can of course be immediately determined from interval between reflections, using 1 or 10 microsecond markers available from oscillograph's timing cir-

cuit. Reflections illustrated are approximately 1 microsecond apart. Attenuation can be calculated from difference in height of successive peaks.

Proper terminating impedance can be found by varying resistance across receiving end until no reflections are visible. This resistance when measured gives characteristic impedance of cable very accurately. Any discontinuities along line give reflections indicating locations and natures of faults by their spacing and polarities.

► Write for literature ...

© ALLEN B. DUMONT LABORATORIES, INC.

DUMONT

Precision Electronics & Television

ALLEN B. DUMONT LABORATORIES, INC., PASSAIC, NEW JERSEY • CABLE ADDRESS: WESPEXLIN, NEW YORK





FM carrier induction

Adapting the principles of radio to train communication is a simple matter — up to a point. Standard space radio equipment will do in a pinch. But railroads necessarily demand more than adaptations. A coordinated system, for one thing; reliability of performance for another; and the privacy of wire lines. **Alreon** engineers tackled the problem and came up with an FM carrier-current system that makes use of the wayside wires. Communication with trains is established by inductive means. Performance is of telephonic quality. Equipment and operating costs are self liquidating. **The first Alreon FM carrier induction system was installed on the Kansas City Southern Railway, where it is in daily operation. Similar installations have been made on other railroads. All have proved their dependability. Creative engineering of this nature has contributed to the steady growth of Alreon in the electronics field. Behind it is a type of thinking that gets things done. We'll show you what we mean any time you say.**

Alreon

MANUFACTURING CORPORATION

Formerly AIRCRAFT ACCESSORIES CORPORATION

Radio and Electronics • Engineered Power Controls

NEW YORK • CHICAGO • KANSAS CITY • BURBANK

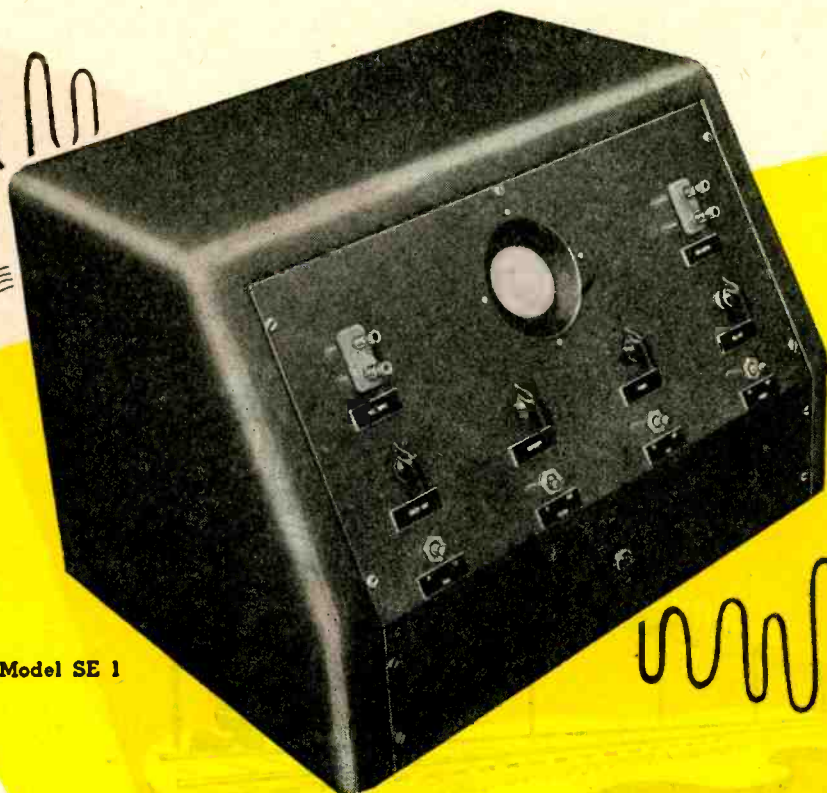
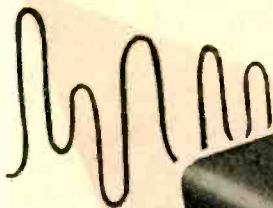

Model SE 1

SHERRON CATHODE RAY NULL DETECTOR

A Laboratory Precision Instrument Built for Production Application

THE SHERRON CATHODE RAY TUBE NULL DETECTOR is a precision laboratory instrument designed for all A.C. Bridge measurements.

- It is both a high impedance detector and an undistorted, filtered and shielded source of 1000 cycles per second.
- It has a gain of 80 db at an input voltage of 100 micro volts.
- Bridge detector impedance is 1 megohm.
- Use of the Cathode Ray Tube permits the separate positive adjustment of both reactance and resistance with their individual indication on the same Cathode Ray Tube.
- Comparison of frequencies can be obtained by means of Lissajous figures.
 - Self protection from overloading is included in this unit. Under any input conditions, the circuit cannot be overloaded or damaged.
 - Since head phones are eliminated, this unit can be used in noisy locations by employing the Cathode Ray Tube for visual indication.
 - Automatic control of the gain precludes the necessity of resetting while adjusting bridge for balance.

Every precision type Bridge requires a Sherron Precision Null Detector

**Sherron
Electronics**

SHERRON ELECTRONICS COMPANY

Division of Sherron Metallic Corporation

1201 FLUSHING AVENUE, BROOKLYN 6, N. Y.

"Where the Ideal is the Standard, Sherron Units are Standard Equipment"

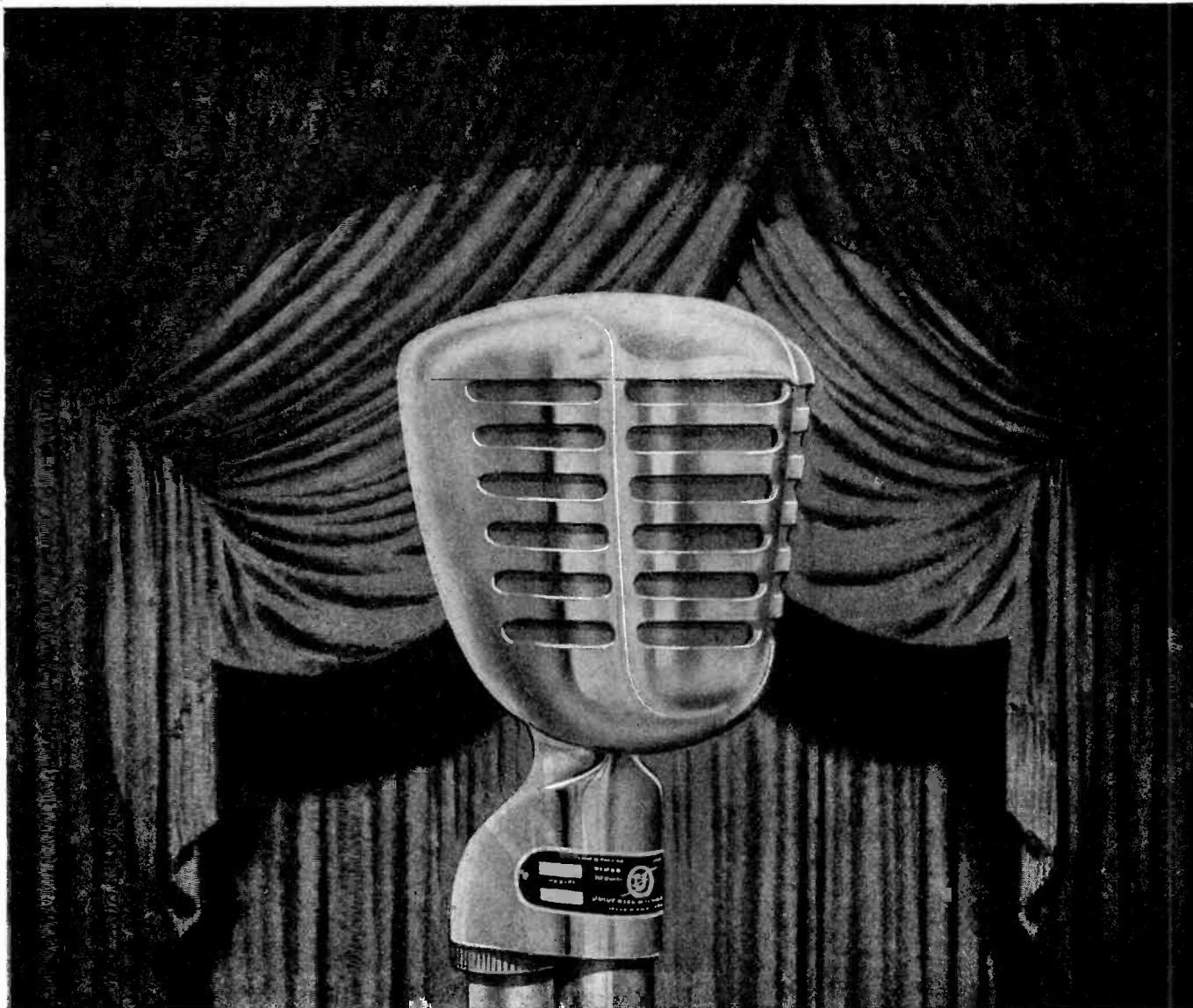

UNIVERSAL'S NEW D-20 MICROPHONE



The stage was set for something new and here it is. Universal's new D-20 Microphone . . . soon on your radio parts jobbers' shelves to fill your essential requirements . . . uses Universal's "Dynoid" construction . . . A dynamic microphone of conventional characteristics built to fill the utility requirements of war time plus advance styling of the many modern things to come. Orders placed now with your Radio Parts Jobbers will assure early delivery when priority regulations are relaxed.

◀ **FREE** — *History of Communications Picture Portfolio. Contains over a dozen 11" x 14" pictures suitable for office, den or hobby room. Write factory for your Portfolio today.*

UNIVERSAL MICROPHONE COMPANY
INGLEWOOD, CALIFORNIA



FOREIGN DIVISION: 301 CLAY STREET, SAN FRANCISCO 11, CALIFORNIA -- CANADIAN DIVISION: 560 KING STREET WEST, TORONTO 1, ONTARIO, CANADA

Proceedings of the I.F.E. April, 1945

15A

MILLIWATTS

Why Western Electric equipment leads the way!

1. Western Electric products are designed by Bell Telephone Laboratories—world's largest organization devoted exclusively to research and development in all phases of electrical communication.
2. Since 1869, Western Electric has been the leading maker of communications apparatus. Today this company is the nation's largest producer of electronic and communications equipment.
3. The outstanding quality of Western Electric equipment is being proved daily on land, at sea, in the air, under every extreme of climate. No other company has supplied so much equipment of so many different kinds for military communications.

Western

From tiny tubes to eight foot water cooled giants—from vest pocket aids for the hard of hearing to super-powered radio transmitters—Western Electric has led the way in electrical communications equipment for many years.

Western Electric vacuum tubes for over 30 years have been noted for their uniformity and long life. Scores of new and radically different

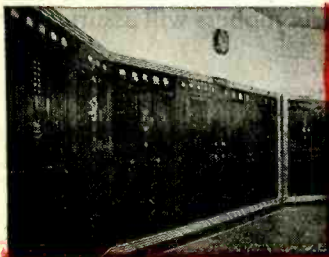

BROADCASTING

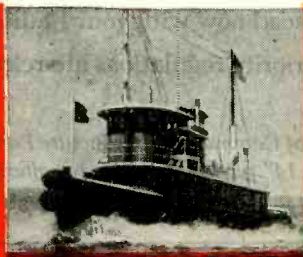

MARINE RADIO

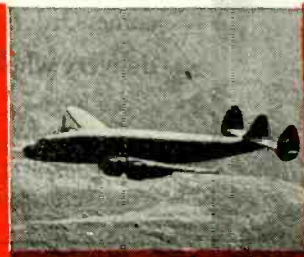

AVIATION RADIO



MOBILE RADIO

Western Electric has specialized

or KILOWATTS

Electric
equipment leads the way!

types of tubes have been introduced by Western Electric and Bell Telephone Laboratories for war services. These new tubes — and the techniques used in developing and manufacturing them — will find many important uses in communications at the war's end.

In all forms of electrical communications, count on Western Electric for continuing leadership.

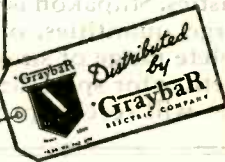

Buy all the War Bonds you can
... and keep all you buy!

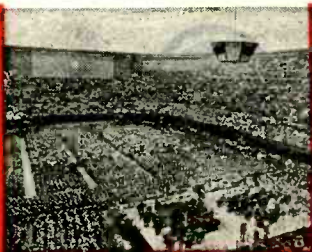

SOUND SYSTEMS



TELEVISION



HEARING AIDS



ACOUSTIC INSTRUMENTS

knowledge in all of these fields

CERAMIC DIELECTRIC TUBES

for
TEMPERATURE COMPENSATING
CAPACITORS

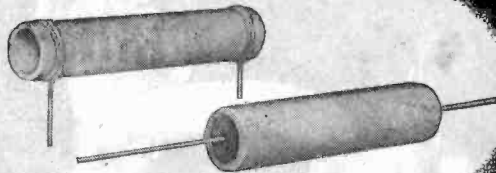

by **STUPAKOFF**

Stupakoff ceramic dielectric tubes have high dielectric strength, good power factor (less than 0.06%) and uniform electrical characteristics. They are available in all temperature coefficients from +120 to -750 parts per million per degree Centigrade. These tubes are employed in temperature compensating capacitors for eliminating frequency drift in RF circuits—also for bypass, lead-through and blocking capacitors.

Stupakoff manufactures a wide variety of ceramic dielectric materials. Inquiries are invited for Stupakoff ceramic dielectric tubes of the 3850 series used to produce capacitors in accordance with J. A. N. specification C-20, and also for those having special electrical characteristics. Stupakoff is prepared to give prompt delivery in large quantities, of ceramic dielectric tubing in a complete range of sizes and coefficients. Your inquiries—whether for specialized or standard ceramic dielectric tubes—will receive prompt attention.

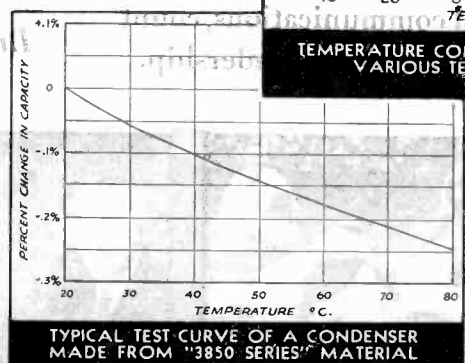
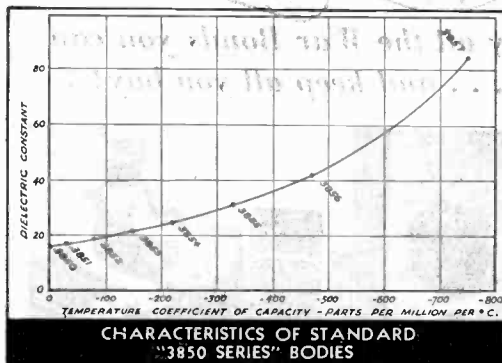
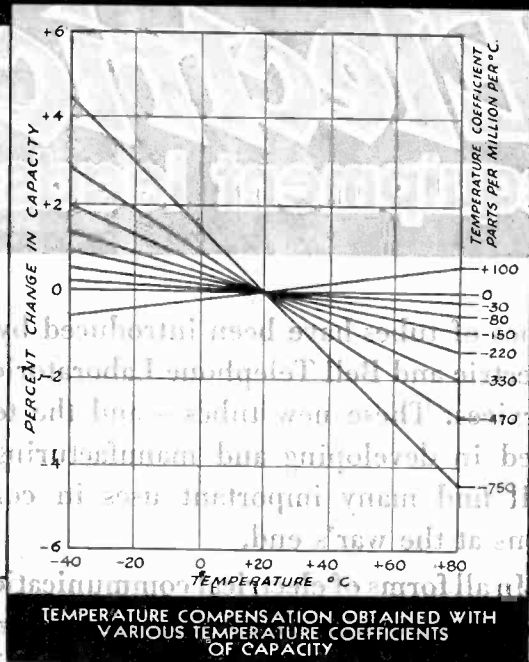

BUY MORE WAR BONDS



STUPAKOFF CERAMIC AND MANUFACTURING CO., LATROBE, PA.
Ceramics for the World of Electronics



The Greeks gave us a word for it . . . now we give it to you

WHEN Sperry first developed its velocity-modulated, ultra-high-frequency tube, the word "KLYSTRON" was registered as the name of the new device.

This name — from the Greek, as coined by scientists of Stanford University — is an apt description of the bunching of electrons between spaced grids within the tube.

"Klystron" is a good name. So good, that it has come into widespread use as the handy way to designate any tube of its general type,

whether a Sperry product or not.

This is perfectly understandable. For the technical description of a Klystron-type tube is unwieldy, whether in written specifications, in conversation, or in instructing members of the Armed Forces in the operation of devices employing such tubes.

These conditions have prompted many requests from standardization agencies—including those of the Army and Navy—for unrestricted use of the name Klystron. In the public interest, Sperry has been glad to

comply with these requests . . .

From now on, the name KLYSTRON belongs to the public, and may be used by anyone as the designation for velocity-modulated tubes of any manufacture.

Sperry will, of course, continue to make the many types of Klystrons it now produces, and to develop new ones.

On request, information about Klystrons will be sent, subject to military restrictions.

SPERRY GYROSCOPE COMPANY, INC. GREAT NECK, N. Y.

Division of the Sperry Corporation

★
LOS ANGELES • SAN FRANCISCO • NEW ORLEANS
HONOLULU • CLEVELAND • SEATTLE

GYROSCOPICS • ELECTRONICS • RADAR • AUTOMATIC COMPUTATION • SERVO-MECHANISMS

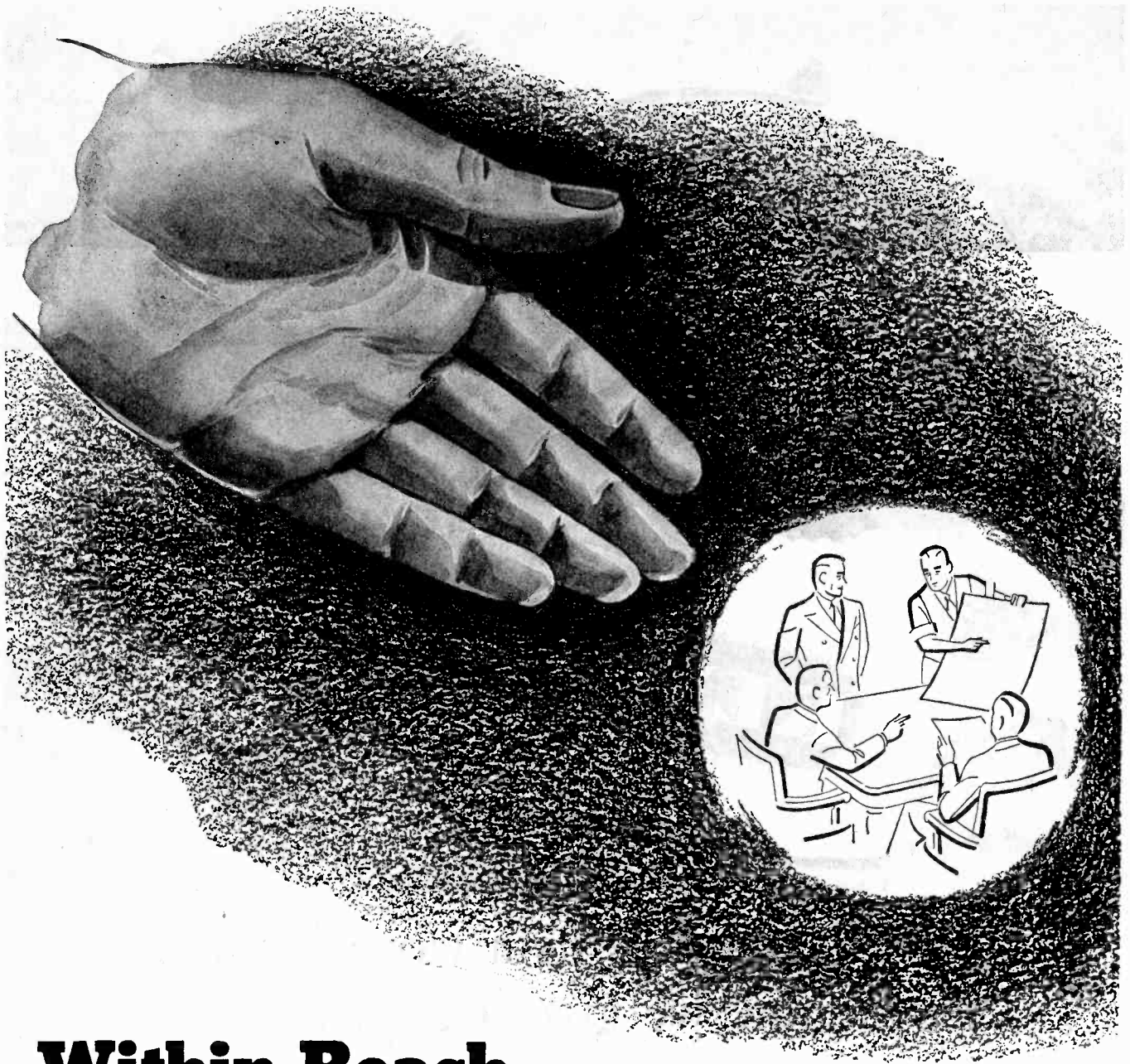

Within Reach

Electronic planning is frequently confronted by seemingly insurmountable obstacles in the form of new tube types, special electronic controls or other devices yet undeveloped. RAULAND engineers have an unusually good record in solving these "tough" problems. For RAULAND is an organization of top-flight electronic specialists...men of long experience, noted for many achievements. Post-war cooperation of this trained staff may bring your objectives within easy reach.

RADIO • RADAR • SOUND •

Rauland

COMMUNICATIONS • TELEVISION

Electroneering is our business

THE RAULAND CORPORATION • CHICAGO 41, ILLINOIS

Buy War Bonds and Stamps! Rauland employees are still investing 10% of their salaries in War Bonds

Here's 31 pounds of long range radio performance

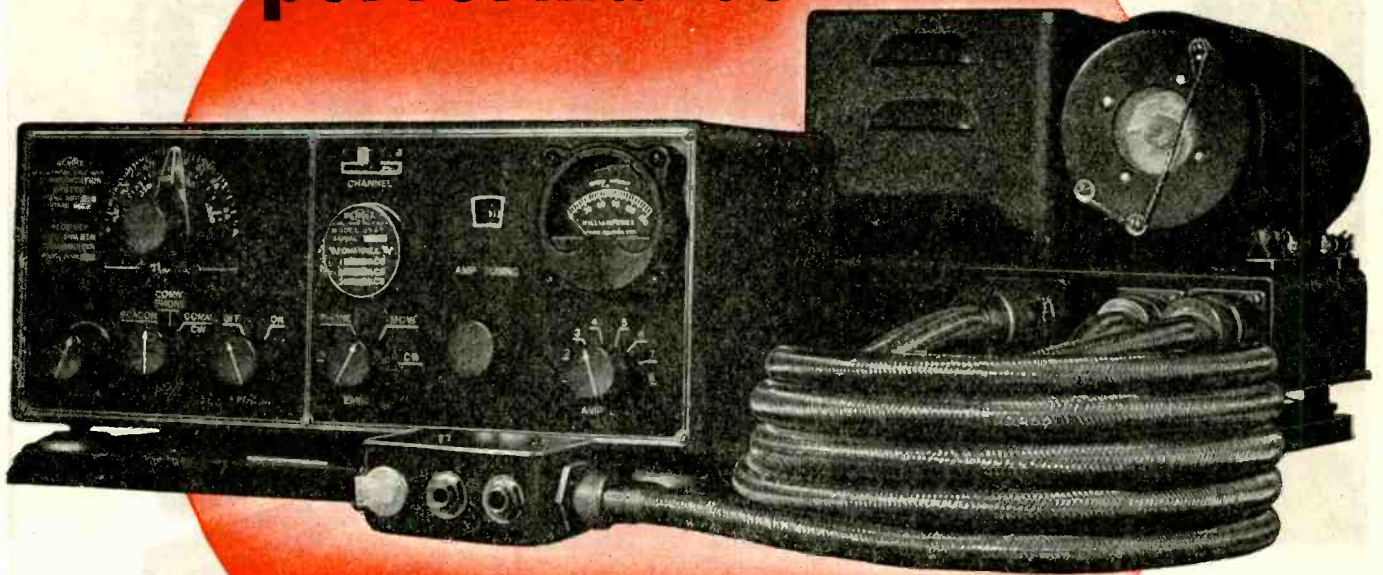

- FOR LIGHT AIRCRAFT
- PORTABLE GROUND STATIONS
- GENERAL MOBILE INSTALLATIONS

ALTAIR MODEL LY-1 COMMUNICATION SYSTEM — designed to give the highest performance with the least size and weight—has demonstrated its outstanding ability for use in light aircraft, in secondary equipment in large aircraft, portable ground stations and general mobile installations. Under the most severe operating conditions, Model LY-1 continues to give reliable communication in both the military and commercial fields.

Besides three crystal controlled transmitter frequencies and two-band reception, the LY-1 provides interphone for two or more stations. For compactness and easy installation only the r-f components are built in with the transmitter-receiver; audio and intermediate frequency amplifiers being housed with the power supply which can be remotely located using only one interconnecting cable. For complete details write Pacific Division, Bendix Aviation Corporation, North Hollywood, California. Sales Engineering offices, New York and St. Louis.

Pacific
Division
BENDIX AVIATION CORPORATION
NORTH HOLLYWOOD, CALIFORNIA



Remler Beauty Has
BRAINS

No MERE AUTOMATONS are the girls who tend machines in Remler factories. They know how to make minor adjustments to keep equipment in top running condition; they learn the operation of several machines and switch from one to the other to lessen fatigue. • The machines are "beauties" too. In many instances they have been designed by Remler engineers to perform multiple tasks which save time and speed up deliveries. • For complete sound transmitting systems; radio, plugs, connectors and special electronic devices manufactured to order, consult—

REMLER COMPANY, LTD. • 2101 Bryant St. • San Francisco, 10, Calif.

REMLER
SINCE 1918
Announcing & Communication Equipment



PLUGS & CONNECTORS

Signal Corps • Navy Specifications

Types:		PL		NAF	
50-A	61	74	114	150	
54	62	76	119	159	
55	63	77	120	180	1136-1
56	64	104	124	291-A	
58	65	108	125	354	No.
59	67	109	127		212938-1
60	68	112	149		

PLP		PLQ		PLS	
56	65	56	65	56	64
59	67	59	67	59	65
60	74	60	74	60	74
61	76	61	76	61	76
62	77	62	77	62	77
63	104	63	104	63	104
64		64			

OTHER DESIGNS TO ORDER

Ideal General Purpose Condensers

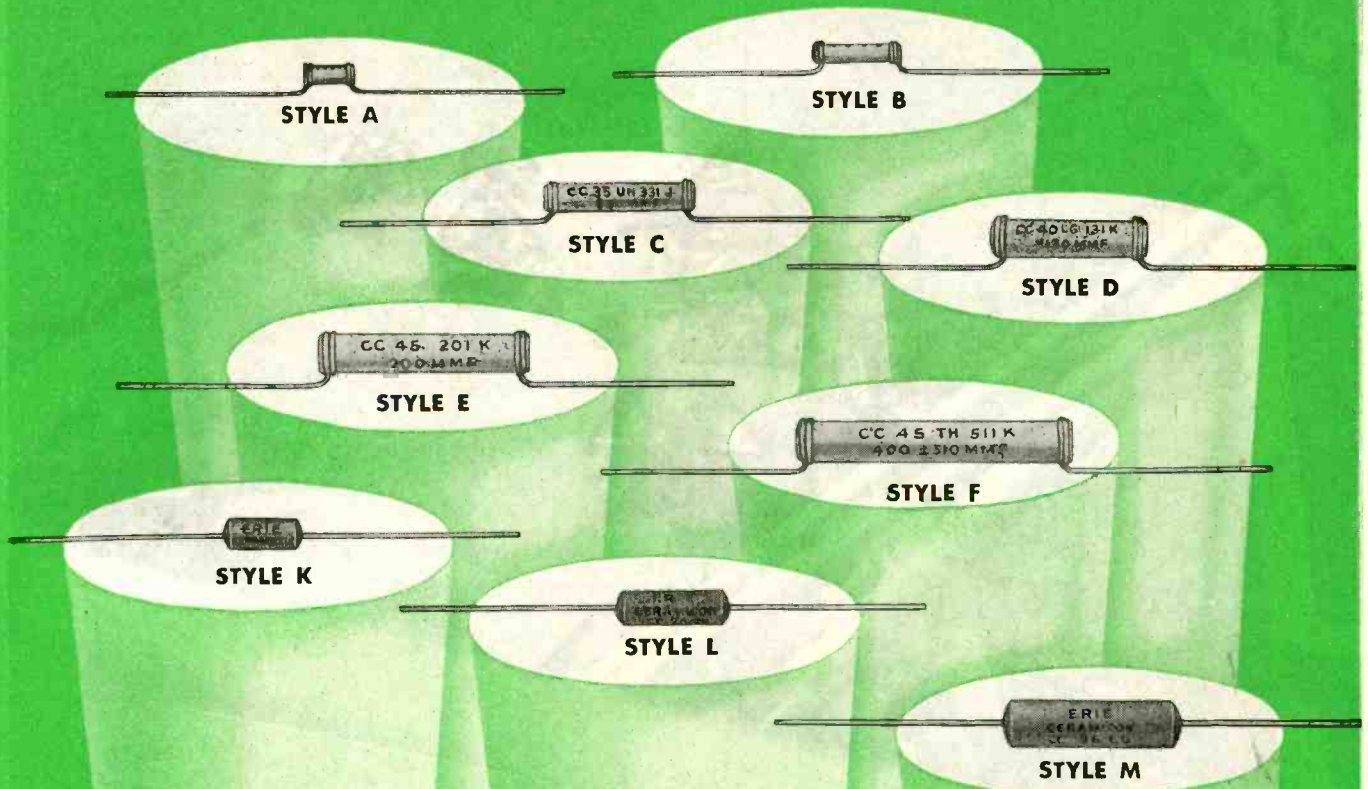

ERIE CERAMICONS*

REG. U. S. PAT. OFF.

When Erie Resistor introduced the first silvered ceramic condensers in this country several years ago, engineers were provided with a simple method of compensating for frequency drift in other components.

Expanded war time demand for condensers has definitely proved that Ceramicons are also superior as general purpose condensers in circuits where some moderate degree of capacity change with temperature is permissible. For example, Ceramicons make excellent coupling condensers, particularly plate-to-grid, where high insulation resistance is of paramount importance.

When specifying Ceramicons under JAN-C-20 for general purpose use, temperature coefficient characteristic "SL" should be given. If Erie designations are used, specify "any temperature coefficient between P100 and N750." The temperature coefficient of these Ceramicons will be between +150 and -870 parts/million/°C, as determined by measurement at 25°C and 85°C. Particularly in the low capacity ranges, this temperature coefficient limit will, in many cases, permit us to ship quickly from stock, since the Ceramicons can be selected from any one of the 10 stand-

ard temperature coefficients between P120 and N750. The capacity range for equivalent physical size is given in the table below.

May we submit samples of Erie Ceramicons to you for your general purpose applications?

CHARACTERISTICS

CAPACITY RANGE IN MMF	JAN-C-20 STYLE	ERIE STYLE	MAXIMUM OVERALL DIMENSIONS
1 to 51	CC20	A	.200 x .400
	CC21	K	.250 x .562
52 to 110	CC25	B	.200 x .656
	CC26	L	.250 x .812
111 to 360	CC35	C	.265 x 1.125
	CC36	M	.340 x 1.328
361 to 510	CC40	D	.375 x 1.110
511 to 820	CC45	E	.375 x 1.960
821 to 1100	CC45	F	.375 x 2.00

* Ceramicon is the registered trade name of silvered ceramic condensers made by Erie Resistor Corporation.

Electronics Division
ERIE RESISTOR CORP., ERIE, PA.
 LONDON, ENGLAND • TORONTO, CANADA



★ ★ ★ Do More Than Before—Buy EXTRA War Bonds ★ ★ ★

NATIONAL RECEIVERS ARE THE EARS OF THE FLEET

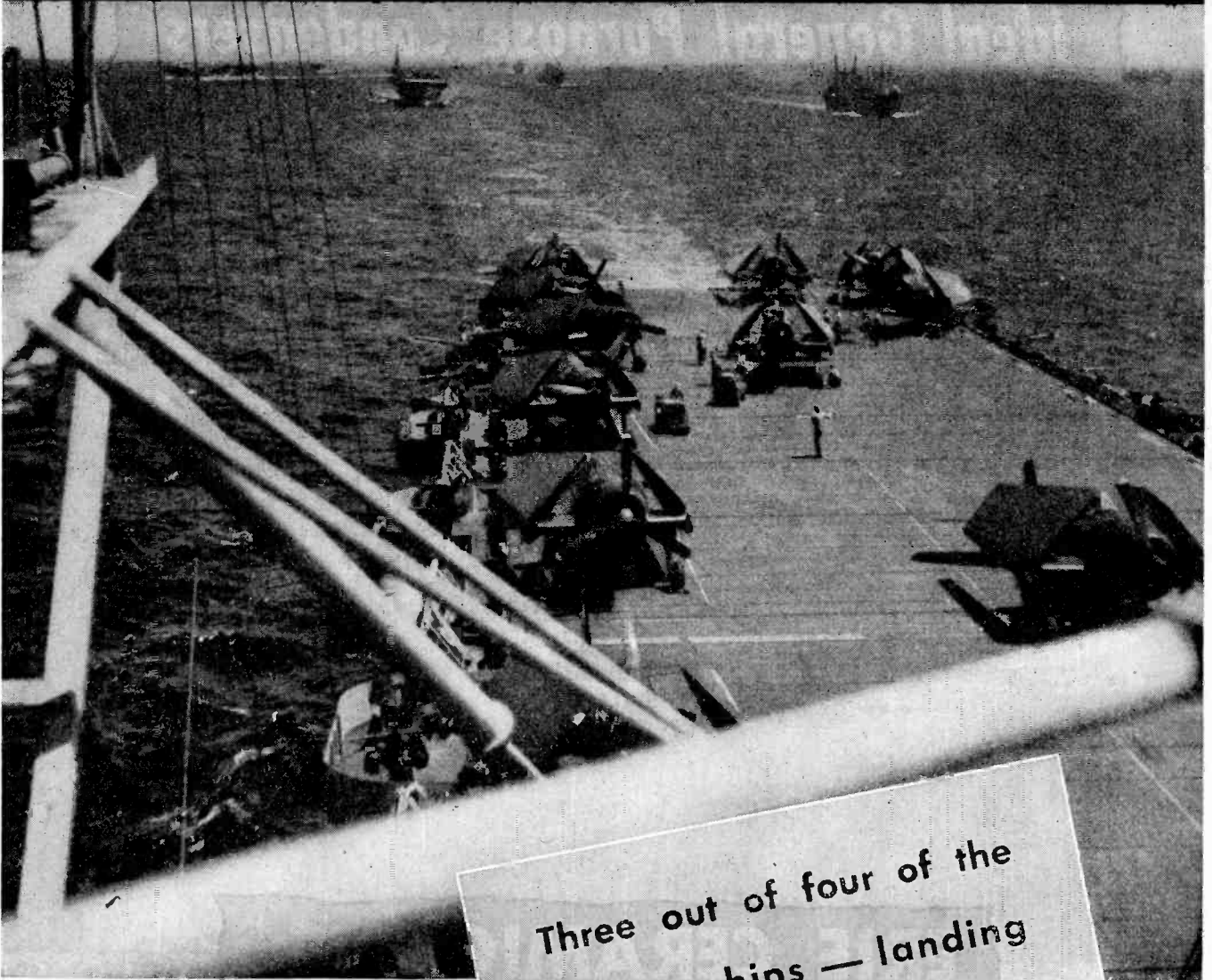

OFFICIAL U. S. NAVY PHOTOGRAPH

Three out of four of the
Navy's ships — landing
craft or larger — are
equipped with receivers
designed by National.

The photograph above was taken from the deck of
the USS Tulagi, participating in the August, 1944,
invasion of France. Modern amphibious operations
require superb radio communications.

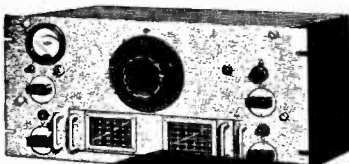

HRO

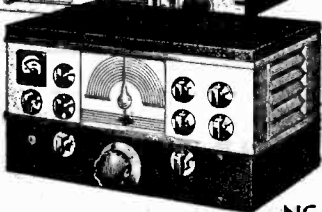

NC-200

NATIONAL COMPANY

MALDEN MASS, U. S. A.



NATIONAL RECEIVERS ARE IN SERVICE THROUGHOUT THE WORLD

Again it's **HYTRON**—Easy on the Battery!

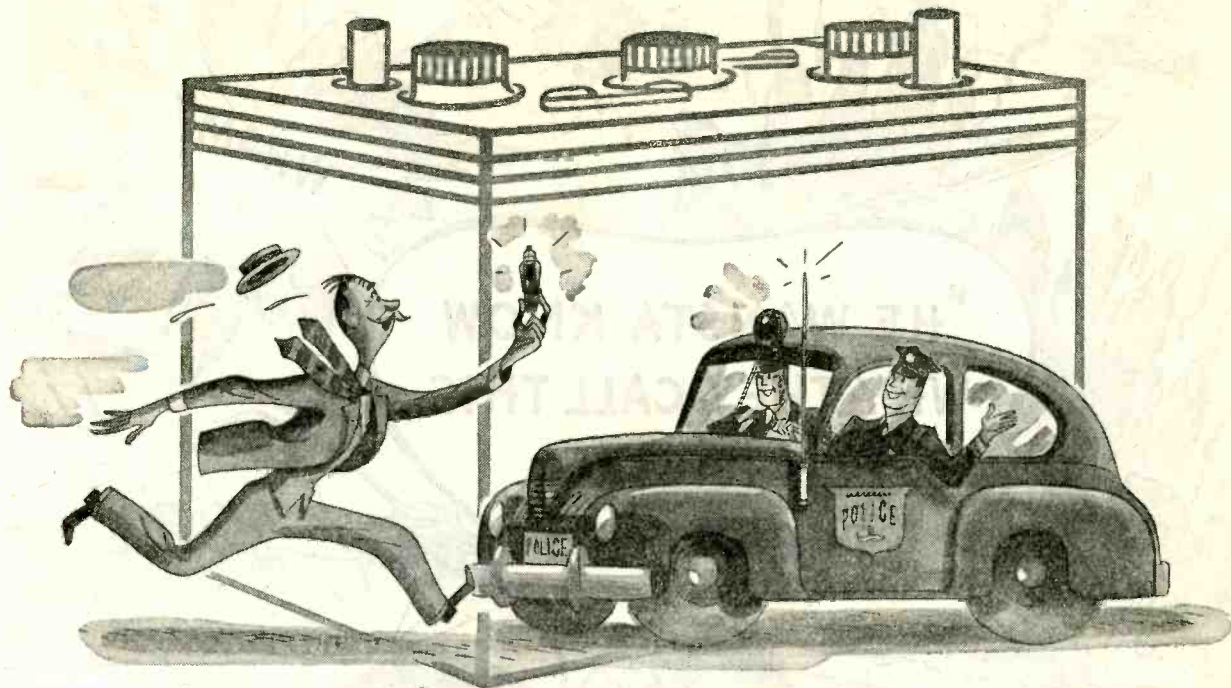

HY1269



HY31Z



HY65



HY69



HY1231Z

In mobile operation, the battery is the kingpin. Two-way police radio takes it out of the battery twenty-four hours a day. Conservation of battery power during stand-by periods is mandatory.

Instant-heating Hytron tubes with thoriated tungsten filaments came to the rescue of police radio. Only when on duty, does police radio equipment draw power when Hytron tubes are used. Filament and plate power go on together.

And that's not all. The Hytron HY31Z, HY65, HY69, HY1231Z, and HY1269 are rugged. HY65 performance in two-way

motorcycle police radio has proved this. Including 12-volt filament tubes for marine applications, Hytron's instant-heating line is versatile. Concentration is on the R. F. beam tetrode — work horse of transmitting tubes — but also included is the HY31Z twin triode for Class B. One type can power a whole transmitter — R. F. and A. F. — thus simplifying the spares problem (e.g., Kaar Engineering transmitters built around the HY69).

Wartime uses are bringing additions to the Hytron instant-heating line. Watch for future announcements.

OLDEST EXCLUSIVE MANUFACTURER OF RADIO RECEIVING TUBES

HYTRON
RADIO AND ELECTRONICS CORP.

MAIN OFFICE: SALEM, MASSACHUSETTS
PLANTS: SALEM, NEWBURYPORT, BEVERLY & LAWRENCE



FORMERLY HYTRON CORPORATION



"HE WAN'STA KNOW
WHY THEY CALL THIS
THA' PACIFIC
THEAYTER"



Fine instruments produced in volume with quality first.... to last.

Triplett



ELECTRICAL INSTRUMENT CO.
BLUFFTON, OHIO

For the widest range
of transmitting and
severe-service
electronic
assemblies

**AEROVOX
RATING-
PLUS
CAPACITORS**

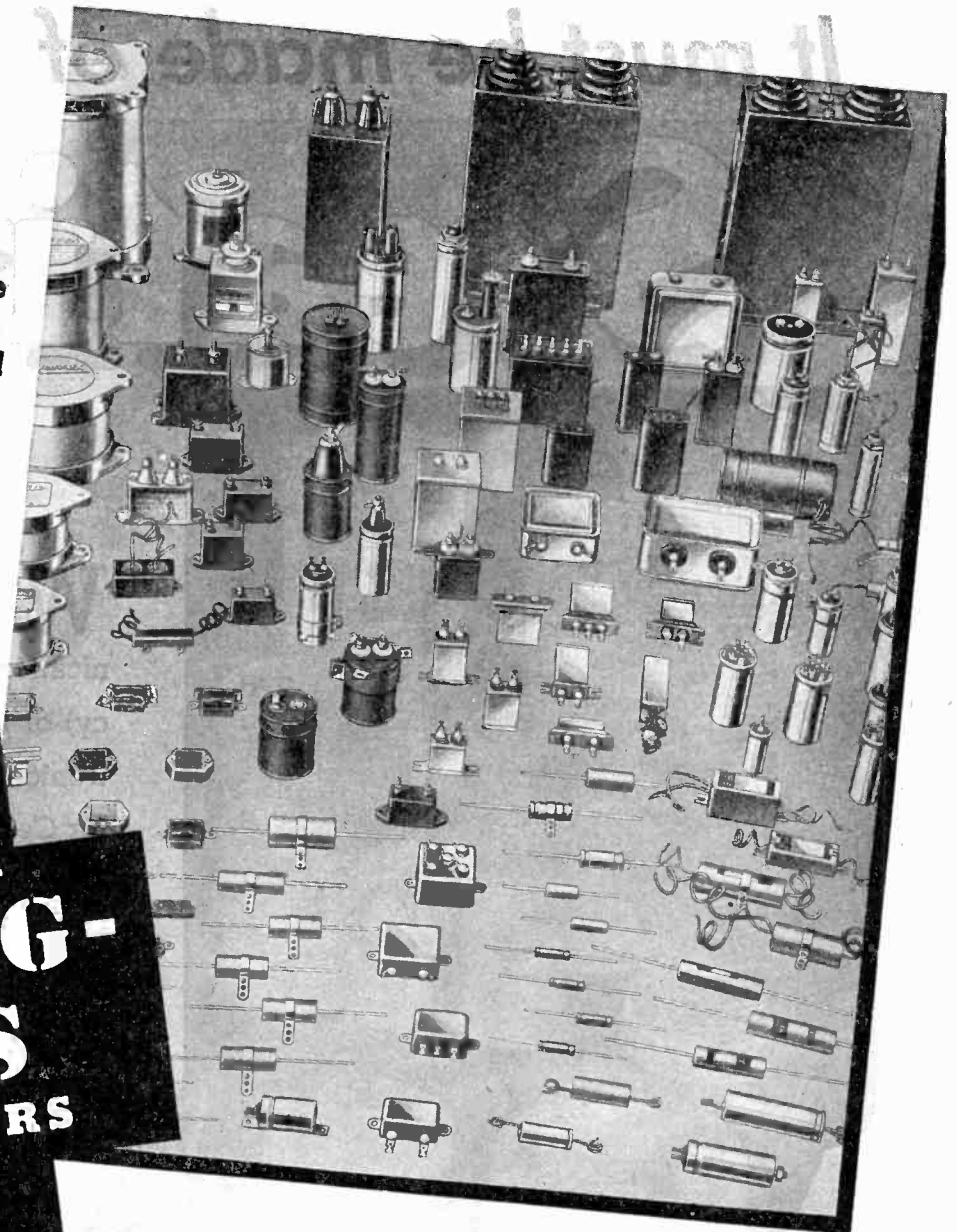

● Critical equipment designers, builders and users are insuring their assemblies with Aerovox rating-plus capacitors. That Aerovox extra safety factor is widely recognized today. Service records speak for themselves.

All Aerovox paper-capacitor voltage ratings are for standard temperature, pressure and humidity conditions,

namely, 20° C., 30 inches of mercury (760 millimeters), and 50% relative humidity.

Where Aerovox capacitors are in hermetically-sealed cases, the only effect caused by changes in standard conditions will be in the external flash-over voltage occurring at lower voltages for conditions involving reduced pressure and increased humidity. The capacitor proper remains unaffected.

The maximum operating temperature for continuous operation at rated voltage is 65° C. ambient. If temperature is greater, operating voltage must be reduced. Derating data will be supplied on request.

Yes indeed, it will pay you to look into this matter of Aerovox rating-plus insurance. Remember, it costs no more but it can save you much expense and trouble.

● Submit your capacitance problems.
Literature on request.



Capacitors

INDIVIDUALLY TESTED

AEROVOX CORPORATION, NEW BEDFORD, MASS., U. S. A.

SALES OFFICES IN ALL PRINCIPAL CITIES

Export: 13 E. 40 ST., NEW YORK 16, N. Y. • Cable: 'ARLAB' • In Canada: AEROVOX CANADA LTD., HAMILTON, ONT.

It must be made of

Steatite

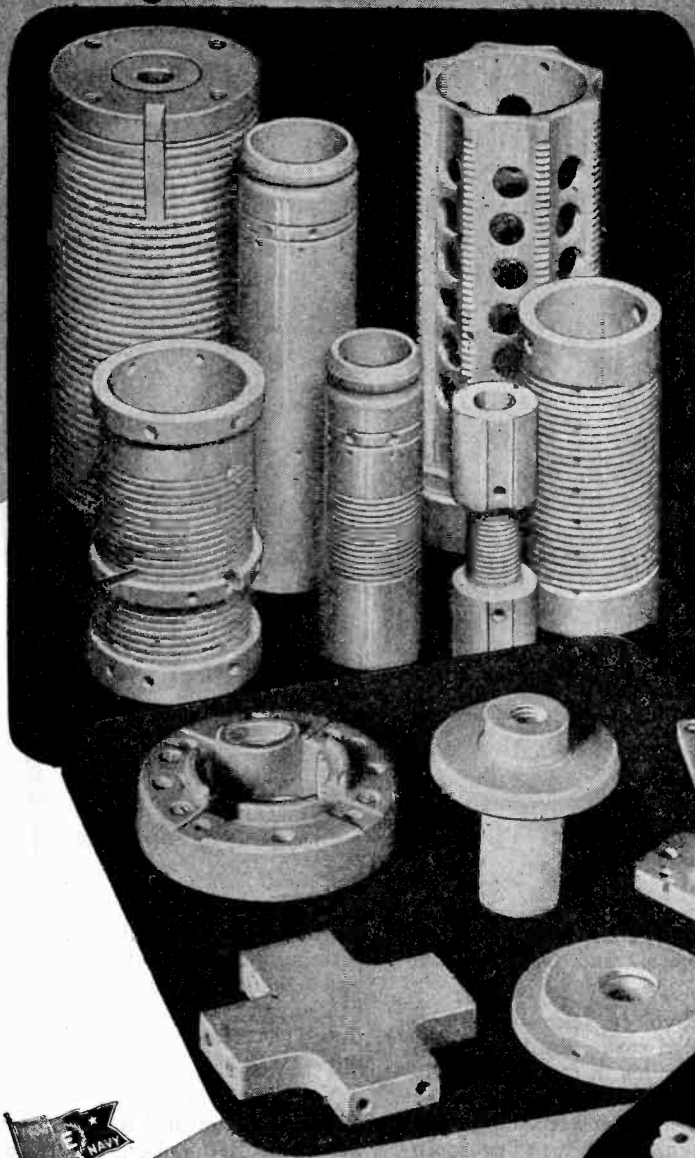

WHETHER in the field of communication (high and ultra-high frequency) or in the various industrial electronic fields, there is no substitute for Centralab Steatite.

There are no other materials that can be made in as many varied forms and shapes as Steatite. Our engineering and laboratory facilities are at your disposal.

Producers of VARIABLE RESISTORS
—SELECTOR SWITCHES—CERAMIC
CAPACITORS, FIXED AND VARIABLE —
STEATITE INSULATORS —
AND BUTTON-TYPE SILVER MICA
CAPACITORS.



Centralab

Division of GLOBE-UNION INC., Milwaukee



THYRATRON WL-678
Grid Controlled Mercury Vapor Rectifier

General Characteristics	55° C Max. Thg	50° C Max. Thg
Filament Voltage.....	5.0 Volts	5.0 Volts
Filament Current.....	7.5 Amperes	7.5 Amperes
Filament Heating Time (Minimum).....	1 Minute	1 Minute
Typical Control Bias at Rated Voltage....	-50 Volts	-75 Volts
Maximum Ratings		
Anode Voltage, Peak Forward.....	10000	15000
Anode Voltage, Peak Inverse.....	10000	15000
Anode Current, Average.....	1.6 Amperes	1.6 Amperes
Anode Current, Peak.....	6 Amperes	6 Amperes
Temperature Range, Condensed Mercury..	25 to 55° C	25 to 50° C

THIS NEW

15,000 VOLT

THYRATRON

**provides split-cycle control of high power
 for R. F. heating units, and radio transmitters**

The WL-678 combines the high voltage characteristics of a Kenotron, the efficiency of a Phanotron, and the controllability of a Thyatron. This latest feat of Westinghouse engineering offers the electronic equipment designer the following outstanding advantages:

- Smooth and instantaneous power control from 0% to 100% load . . .
- Simplified automatic load control . . .
- High speed automatic overload protection . . .
- Low space and weight requirements . . .
- Low control power requirements . . .

For more detailed information—write to your nearest Westinghouse office or to Westinghouse Electric and Manufacturing Company, Lamp Division, Bloomfield, N. J. Westinghouse Electronic Tube distributors are located in principal cities.

Westinghouse
PLANTS IN 25 CITIES OFFICES EVERYWHERE

Quality Controlled Electronic Tubes

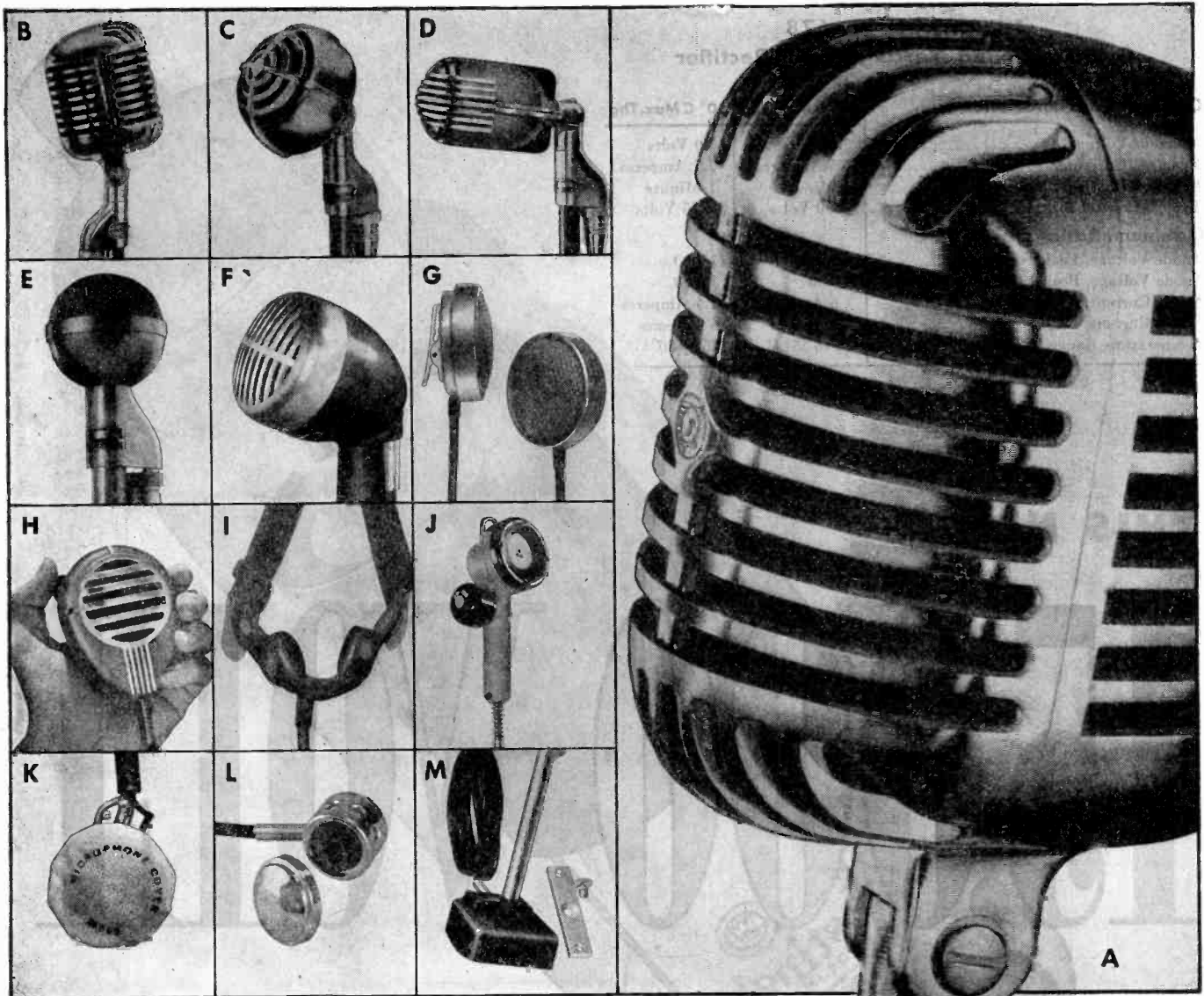

—Your Microphone is here

As outstanding manufacturers of microphones for war —Shure offers a complete microphone line. You will find the proper microphone for every need above. A complete description of any model will be furnished upon request.

- | | |
|-------------------------------------|---------------------------|
| A. Super-Cardioid Broadcast Dynamic | G. Lapel Microphone |
| B. Unidyne Cardioid Dynamic | H. Military Carbon |
| C. Uniplex Cardioid Crystal | I. Throat Microphone |
| D. Stratoliner Dynamic | J. Carbon Hand Microphone |
| E. Laboratory Non-Directional | K. Mask Microphone |
| F. "Economy" Crystal | L. Stethophone |
| | M. Vibration Pick-up |

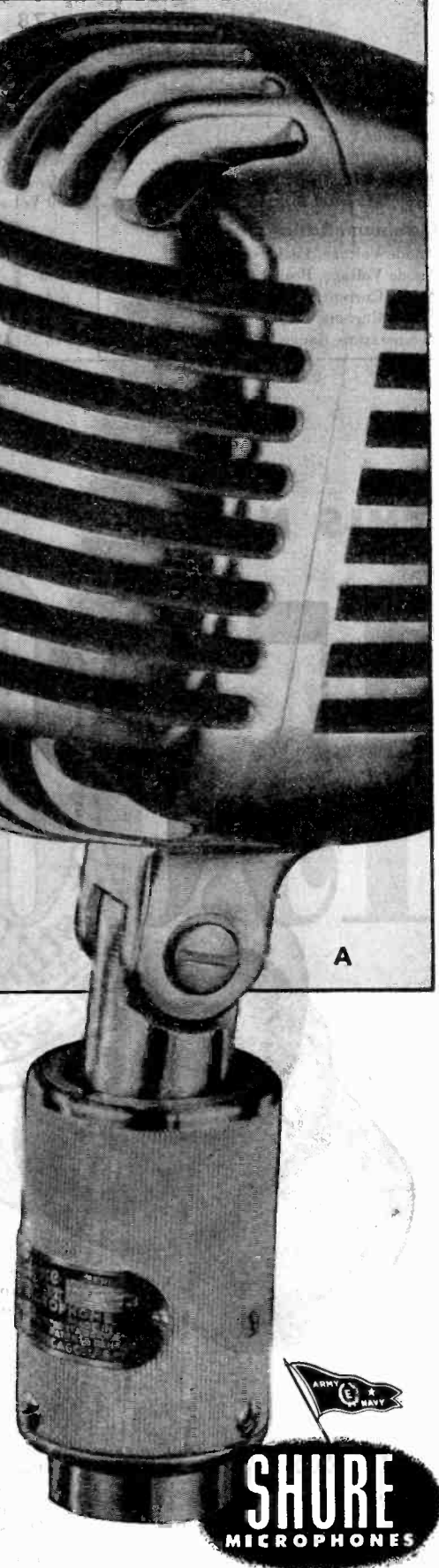

SHURE BROTHERS

Designers and Manufacturers of Microphones and Acoustic Devices

225 West Huron Street

Chicago 10, Illinois

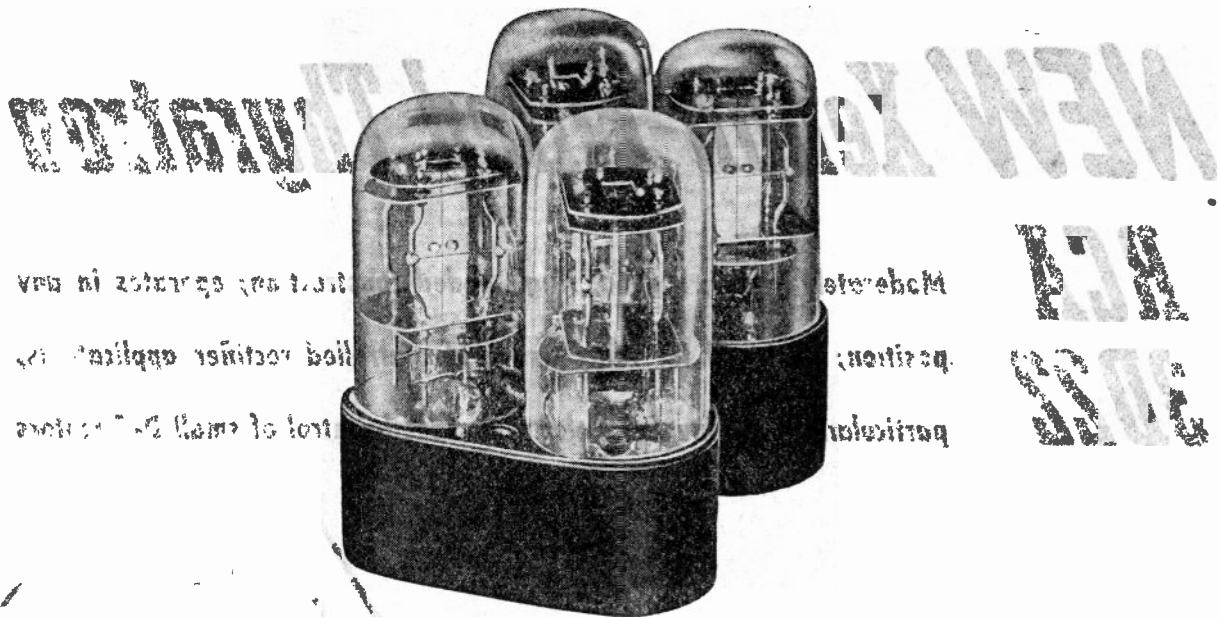

Crystal gateways for your voice

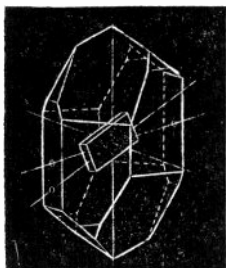
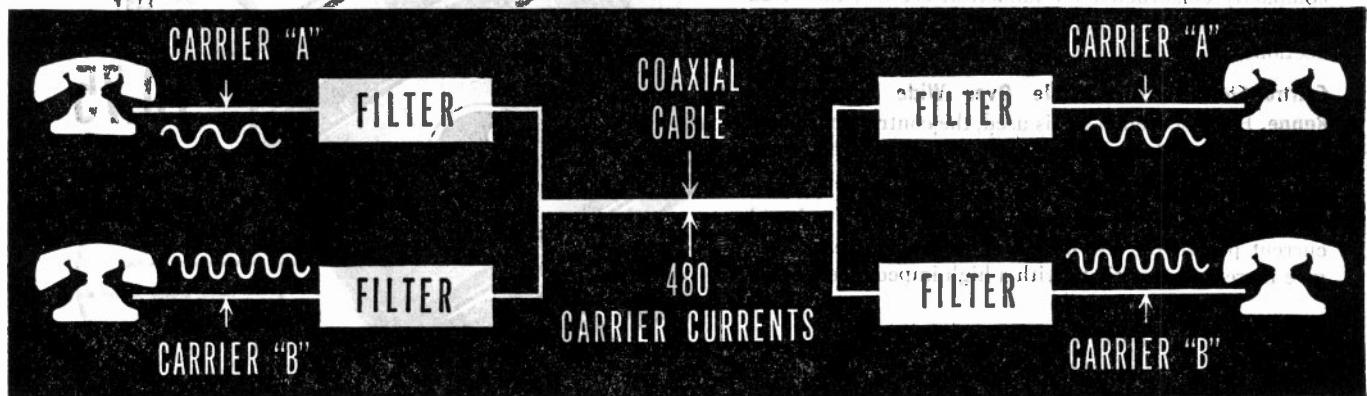

Four hundred and eighty telephone conversations over a coaxial cable was one of the last peacetime achievements of communication research in Bell Telephone Laboratories. In this multi-channel telephone system, each conversation is transported by its own high-frequency carrier current. At each end of the line are crystal gateways; each opens in response to its own particular "carrier" with the message it transports. In telephone terminology, these gateways are filters. The ultra-selective characteristic of these filters is made possible by piezo-electric quartz plates, cut in a special

manner from the mother crystal, and mounted in vacuum. Each set of plates is precisely adjusted so that the filter responds only to the frequency of its assigned channel, rejecting all others. In the coaxial terminal equipment, such crystal gates sort out messages for delivery to their four hundred and eighty individual destinations.

In recent years, Bell Telephone Laboratories research has provided the Armed Forces with many types of electrical equipment in which frequency is controlled by quartz crystals. Notable is the tank radio set which enables a tank crew to communicate over any one of 80 different transmission frequency channels by simply plugging in the appropriate crystal. The future holds rich possibilities for the use of quartz crystals in Bell System telephone service.

BELL TELEPHONE LABORATORIES



Exploring and inventing, devising and perfecting for our Armed Forces at war and for continued improvements and economies in telephone service.

NEW Xenon-Filled Thyatron

RCA 3D22

Moderately priced; rugged, single-ended construction; operates in any position; designed for relay and grid-controlled-rectifier applications, particularly those involving electronic speed-control of small D-C motors

3/4-Ampere Average Continuous Current. The 3D22 is a sensitive, four-electrode thyatron conservatively rated to handle an average output of 0.75 ampere in continuous operation and a peak current of 6 amperes.

Single-ended, Sturdy, Compact Construction. Sturdily and compactly constructed for industrial service, the 3D22 is single-ended and requires no flexible leads for connections.

Control-Characteristic Stable Over Wide Temperature Range. Because Xenon gas is used, the control-characteristic is essentially independent of ambient temperature.

Low Preconduction Current and Low Control-grid Current. The low preconduction current and the low control-grid current permit the use of a high-value grid resistor to give increased sensitivity with a high-impedance circuit.

TECHNICAL DATA

ELECTRICAL

Heater for Unipotential Cathode:	
Voltage (A.C. or D.C.)*	6.3 + 10% Volts
Current	2.6 Amperes
Tube Voltage Drop (Approx.)	10 Volts
Grid. No. 1 Control Ratio (Approx.)†	150

PHYSICAL

Mounting Position	Any
Maximum Overall Length	4 5/8"
Maximum Diameter	2 3/8"
Base	Medium Metal Shell Giant 7-pin, Bayonet

*Heater voltage must be applied at least 30 seconds before start of tube conduction.

†For conditions with 0.1-megohm grid resistor and grid No. 2 volts = 0.

‡Averaged over any 30-second interval.

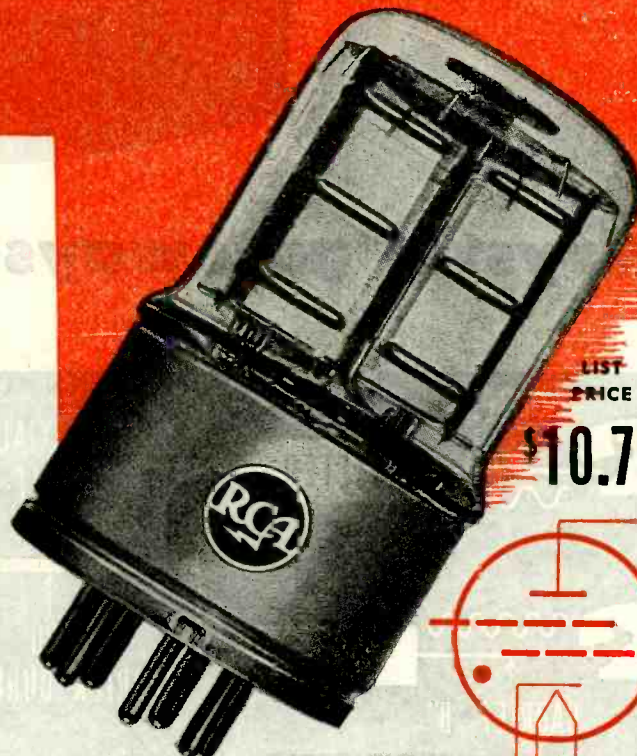

LIST
PRICE

\$10.75

RELAY AND GRID-CONTROLLED RECTIFIER SERVICE

Maximum Ratings, Absolute Values

Peak Forward Anode Voltage	650 max.	Volts
Peak Inverse Anode Voltage	1300 max.	Volts
Peak Cathode Current	6 max.	Amperes
Average Cathode Current‡	0.75 max.	Ampere
Ambient Temperature Range	-75 to +90	°C

WRITE FOR ADDITIONAL DATA

RCA, Commercial Engineering Section
Department 62-29P, Harrison, N. J.

Please send bulletin on RCA-3D22 Thyatron, giving additional information for equipment-design purposes.

Name

Company

Address

City State

THE FOUNTAIN-HEAD OF MODERN TUBE DEVELOPMENT IS RCA

MAIL TODAY!



62-6136-29

RADIO CORPORATION OF AMERICA

RCA VICTOR DIVISION · CAMDEN, N. J.

It has been repeatedly pointed out in the PROCEEDINGS that through close-cooperation and understanding between industrialists and engineers, each group may function more effectively and the public may be the corresponding gainer. Leading industrialists have accordingly been invited to present guest editorials which appear in the PROCEEDINGS in the form in which they are received. There is presented below such an editorial from the pen of the President of the Mutual Broadcasting System, a constructive pioneer in his field of endeavor and a student of engineering functions and needs.

The Editor

Let's Get Better Acquainted

EDGAR KOBAK

There is a story about the phoenix—that it rises in youthful vigor from its own ashes. I am sure the phoenix was an electronics engineer: or vice versa.

Out of this war, which has laid waste a vast section of the earth's surface, will rise a brave new world: we are all convinced of it. Equally, we are sure that this new world will have electronics at its core: because, from a whisper here and there, we of the general public know that the war and its devouring needs have been a challenge to engineers and scientists in electronics and only *they* know, today, how rapid progress has been; and what unheard-of marvels they have in store for us, tomorrow.

When the new day dawns, these inventions and creations in electronics will have to be applied to peacetime living and working needs. That will require another kind of ability and experience—the kind possessed by business leaders and executives. They will have the responsibility of helping to find the practical applications; to shape the devices to the needs; to envision and develop the markets.

The two groups of men, scientists and engineers on the one hand, and the manufacturing executives on the other, are interdependent in the building of this postwar, electronic world. Without scientific development, businessmen have nothing new to sell; and without markets, laboratory developments contribute little to the world.

Personally, I feel this interdependence very keenly. My own start in business was in the testing and servicing of electrical equipment; later as an engineering editor of *Electrical World* and one of the founders of *Electronics* magazine I became intimately acquainted with progress in the electrical and kindred fields, and wrote extensively on the subject. My own appreciation of the engineer's and scientist's role in human progress is very considerable; and I have devoted much time to promoting a similar respect in others.

I believe that this appreciation can be carried further; and that it should be supplemented by a reciprocal feeling on the part of the engineer for the work of the businessman. I can see the need for a closer meeting of their minds—for such meeting is bound to strike sparks from which will come more and more progress.

Therefore, I should like to suggest that as a matter of principle and practice, more scientists and engineers be invited to attend and speak at industry meetings and business conventions; and that more business leaders be given the opportunity to sit in on engineering meetings.

If I am not mistaken, this type of co-operation has been largely responsible for engineering's great contribution to our prosecution of the war; it can and should be the foundation for our future peacetime world. Given both shoulders at the wheel, no man can say what the limits to tomorrow will be—if, indeed, there are any limits.



Joseph R. Redman

Rear Admiral Joseph R. Redman, United States Navy, was born in California in 1891, and has devoted the major portion of more than thirty years to service to his nation in communications activities.

He was graduated from the United States Naval Academy in 1914, and in 1921 completed a special graduate course in electrical engineering at Columbia University.

His professional career has included submarine service; tours of duty as division radio officer on the battleship *New Mexico*; aide and fleet radio officer; engineer officer of the battleship *Colorado*; and shore duty at Washington, D. C., with the bureau of engineering and as chief of technical sections in the naval communications organization.

Admiral Redman has become an expert in dealing with the problems of radio frequency, and in 1932 was named as a technical advisor to the United States delegation to the International Radiotelegraph Conference at Madrid. In 1938 he served as technical advisor to the United States delegation to the Cairo International Telecommunications Conference.

Shortly after Pearl Harbor, Admiral Redman was appointed director of naval communications, a post in which he has served since that time, with the exception of an eight-month tour of duty as cruiser commander in the Pacific war zone.

He is a member of the Joint Communications Board, the Combined Communications Board, and the Board of War Communications.

Following the victory of the Allied Nations, it is to be hoped that the world will be at peace for many years. It is perhaps too much to anticipate an indefinite continuance of world tranquillity. And if war breaks out again, it is essential that the communication and electronic engineers of the nation shall have maintained so advanced a position in their art that aggression can be effectively repelled. Urging such continued peacetime activities for the engineering membership of The Institute of Radio Engineers, the Director of Naval Communications in the Office of the Chief of Naval Operations of the Navy Department of the United States has prepared a guest editorial addressed to the readers of the PROCEEDINGS, which editorial follows in the form in which it was received. It is commended to the thoughtful attention of the membership of the Institute.

The Editor

Postwar Engineering Defense Against Aggression

REAR ADMIRAL JOSEPH R. REDMAN, UNITED STATES NAVY

Wisdom is the application of knowledge gained from the experience of the past to preparation for the future. The current global conflict has presented many new problems, the solution of which is affording us a wealth of experience. After the war it will be wise for us, therefore, in the light of calm analysis to be guided by this experience in safeguarding our future.

Modern warfare has demanded that our scientific skill be matched against that of the enemy. In this competition of skills, the electronic art has proved itself a major weapon of offense and defense. The electronic industry and the radio engineer, faced with heavy responsibility, have proved themselves by responding nobly and in a measure that no layman can fully appreciate. Nothing would give me greater pleasure than to describe to you specific incidents of success which have been results of that response, but the security requirements of war continue to cloak secrecy on many activities. Some day I hope it may be my good fortune to depict the tangible and wonderful contribution of the radio engineer and the radio industry to the winning of this war.

The radio engineer by his very contribution has assumed a responsibility which must remain with him long after this war. It is a modern truism that there are no longer natural defenses to avail us. Oceans are traversed in hours, and the position of the United States has become no different from that of the many other nations who have lived for generations with potential enemies just across their borders. Concepts of reliance on natural protection, and of preparation for war after its declaration have of necessity been abandoned. Henceforth this nation must be prepared for vigorous defense at all times, which will require that our Armed Forces be kept in readiness with the necessary equipment and supplies available for immediate use. Electronic devices, as now demonstrated by experience, will be an increasingly vital part of this equipment of the future.

As complete demobilization cannot again be expected to accompany peace, so, therefore, must every manufacturer, executive, engineer, and workman bear the realization that he must continuously remain an important cog in the total mechanism of preparedness for defense at all times. The future must be characterized by the closest liaison between the Army and Navy, and between the Services and American Industry. Under the aegis of such co-operation new devices, especially in the field of electronics, must be constantly under development and test so that equipment may be kept ever current. Much of that work, too, must be done under the protection of security control so that no potential enemy may avail himself of it.

It behooves The Institute of Radio Engineers and each engineer as an individual, therefore, to live in awareness of the importance of his role and in realization of his responsibility for future years, a role and responsibility which will be discharged with the same high purpose exhibited in this war. It is to be hoped that the closest working relationship may be fostered and maintained at all times between this Institute and the Navy, for our missions cannot be accomplished independently of each other. Our mutual obligations to our Nation must be our first concern, with the skill of the radio engineer in the service of his country one of our first lines of defense. From our united efforts then will come those great achievements which will evidence to the world that unconquerable strength of the United States which stands ever ready to serve the cause of justice and freedom.



Herbert J. Reich

Board of Directors—1944

Herbert J. Reich was born on Staten Island, New York, on October 25, 1900. He received the M.E. degree from Cornell University in 1924, and the Ph.D. degree in physics in 1929. Since that time he has been on the staff of the University of Illinois, where he is professor of electrical engineering. On January 1, 1944, he was granted a leave of absence to join the staff of the radio research laboratory at Harvard University.

He has specialized in the field of electron tubes and electron-tube circuits, and has published approximately forty papers on these and related subjects in technical periodicals. He is author of "Theory and Applications

of Electron Tubes," "Principles of Electron Tubes," and co-author of "Ultra-High-Frequency Techniques."

Professor Reich was elected to Associate membership in 1926, and transferred to Member grade in 1941, and to Senior Member in 1943. He has served on the Board of Editors, and on several committees, and during 1944, he was a member of the Board of Directors.

Professor Reich is a member of the American Institute of Electrical Engineers, the American Physical Society, the American Association for the Advancement of Science, and the Society for the promotion of Engineering Education.

Address of Retiring President*

H. M. TURNER†, FELLOW, I.R.E.

As retiring president, I want to thank Dr. Austin Bailey and his committee for the splendid way they have planned and managed this convention. They have given freely of their time and energy for several months.

I extend to Mr. George Bailey, recently appointed Executive Secretary, a most hearty welcome to our staff.

During the past year the Institute lost by death a former president, Dr. Stuart Ballantine. Dr. Ballantine through his mathematical analysis and imaginative insight, advanced the science of radio and made important contributions to its literature. He will long be remembered as a brilliant mathematical physicist, an outstanding engineer, and a gentleman of winning personality.

In this world torn by strife we long for peace, but until it comes, our thoughts are with those who are serving our country. Members of the Institute are making major contributions to the war effort and for this many will receive high recognition. Some are making the supreme sacrifice as did Mr. B. J. Thompson, a Fellow of the Institute and member of the Board of Directors for eight years. Mr. Thompson was lost in the Mediterranean area, July 4, while on a special mission which was described as of "direct and vital importance to the war." He had served as an expert consultant in the office of the Secretary of War since December, 1943.

For many years I was associated with Mr. Thompson in Institute Affairs, and in view of his outstanding contributions through published papers, committee activities, and as a member of the Board, I desire to pay a tribute to him. He was a rugged individualist, in the best sense of the word. Once convinced of the justice and merit of a cause he was a fearless fighter in its behalf. He could and did present vigorous and convincing arguments in support of the principles to which he adhered. At the same time he was considerate of the opinions of others and always gave them thoughtful and respectful consideration. He was a highly original thinker, a natural analyst. To him a difficult problem was a challenge to which he applied impartial and penetrating logic. As associate research director of the Radio Corporation of America, he had unusual opportunities to apply his talents and creative imagination. He was an effective member of the committee which organized the Radio Technical Planning Board. In 1936 he was awarded the Morris Liebmann Memorial Prize for his development of electron tubes for use at ultra-high frequencies. His work extended the useful oper-

ating range of frequencies far beyond what had previously been possible. Mr. Thompson was recognized internationally as one of the foremost authorities in electronics. He was devoted to the Institute and those who knew him best will miss him most.

During the year the Board of Directors has had under consideration plans whereby our members may be better served.

The Institute has continued its sponsorship of the Radio Technical Planning Board which was very active through the year. Most of its thirteen Panels issued reports and participated as witnesses at a hearing held under the auspices of the Federal Communications Commission during the fall which lasted for several weeks. It is believed that the result of the comprehensive and intensive study which the Radio Technical Planning Board carried forward through the year will be of great help to the Government in making frequency allocations, as well as future considerations which will receive study at the next International Telecommunications Conferences. Not until the frequency assignments are made can industry proceed with the design of new equipment and formulate plans for production which will provide jobs in the postwar period.

A Committee on Education, of which Dr. Everitt is chairman, was appointed a year ago and the subject of postwar education has been discussed by eighteen Sections.

Committees under the chairmanship of Mr. W. C. White in this country and Mr. R. A. Hackbusch in Canada have studied the professional status of radio-and-electronic engineers, and have considered the very difficult problem of collective bargaining. Under our Constitution the Institute cannot function as a bargaining agency. The problem is further complicated by the fact that many of our members would be classified as employers and under present rulings would be disqualified from acting in the matter. Others would be subprofessional for whom professional engineers could not act. The committee has compiled information which is available to Sections.

Of especial interest to younger members is a plan providing opportunities for participation in Institute affairs for those who have not previously been active. A committee, of which Mr. E. Finley Carter is chairman, was appointed for the purpose of discovering the interests and special talents of members who might make effective contributions through serving on committees or in other capacities. A letter has been sent to all Section chairmen suggesting that local committees be formed to supply this information, which will be most helpful to the administrative officers when making appointments. These special qualifications will be utilized

* Decimal classification: R060. Original manuscript received by the Institute, February 1, 1945. Presented Winter Technical Meeting Banquet, New York, N. Y., January 25, 1945.

† Yale University, New Haven, Connecticut.

at the first opportunity. Committee workers provide a potential source of future leadership for the Institute. These Section committees will also assist the Admissions Committee by recommending qualified members from their sections for advancement to higher grades.

Despite travel difficulties and a heavy schedule I was able to visit about a third of our Sections during the past year. I was most favorably impressed with the energy, enthusiasm, and effectiveness with which the Sections are being operated. The work is well organized and is an important part of Institute activities. We discussed problems of mutual interest and I received helpful suggestions from the Section officers and members. One of the most frequent criticisms is the delay in handling applications and transfers. The delay has been due to several things, one of which has been eliminated. The Institute, in common with other societies, has for years published in the PROCEEDINGS, the names of applicants approved by the Admissions Committee before final action by the Board. The procedure has been more of a formality than a benefit as practically no objections were received. In view of this fact, I recommended that we dispense with such publication and this was approved by the Board. Thus, two or three months will be saved in acting on applications and transfers.

With reference to our members outside of the United States, the Board of Directors authorized the formation of a Canadian Council which will deal with problems of national interest within the Dominion. Mr. R. A. Hackbusch has provided the leadership in organizing the Council. It is likely that Councils will be set up in other countries. The Institute has acted as sponsor for the Canadian Radio Technical Planning Board. Mr. Hackbusch has been the guiding spirit.

During the year our Board of Directors has had conferences with distinguished representatives from England and Australia looking towards closer relations, and we have appointed a Liaison Committee of which Dr. Bown is chairman, to formulate plans for co-operation. Last May, I was privileged to have a small part, through a recording, in the celebration of the twenty-fifth anniversary of the Wireless (now Radio) Section of the Institution of Electrical Engineers in London. Opportunity has been afforded me to have informal discussions with engineers from the Buenos Aires Section regarding their activities. Recently word was received from the Paris Société of Radioelectriciens that they are resuming activities after an enforced suspension of over four years, and wish to re-establish co-operative relations with the Institute. This was gratifying news. Greetings on this occasion of renewed activity were sent to them with an expression of our pleasure in their desire for co-operation.

Little progress has been made in standardization, due to lack of time. However, this is a matter that must receive early attention. In recognition of the rapid development in radio and electronics during the war and the important contributions made by our members, we

were invited by the American Standards Association to nominate a director for their Board. Mr. F. R. Lack was named for the post.

The Buenos Aires Section, with our permission, has had IRE standards and papers, which have appeared in the PROCEEDINGS, translated into Spanish so as to be available to more of their members. We are appreciative of this compliment.

Formerly international agreement on standards was highly desirable; now it is a matter of the most urgent necessity. In our co-operative war efforts with Great Britain it is reliably reported that lack of uniformity in a single item increase the war costs \$100,000,000 and what is even more serious, resulted in a delay that could ill be afforded.

With the increasing numbers of radio-and-electronic engineers in various parts of the country, the Board plans regional conventions and conferences, and is studying the problem to see how this can best be accomplished.

When restrictions on the publication of recent developments are removed a flood of papers will be available. The Board has very wisely set aside money for publishing these papers, probably in the form of extra PROCEEDINGS, as soon as they are released. In this way material can be made available to members at the earliest possible date.

We now have over 13,000 members and 33 Sections, six having been added during the year. The new Sections are: Cedar Rapids, Iowa; Dayton, Ohio; San Diego, California; Williamsport, Pennsylvania; and two in Canada—one at London and the other at Ottawa. Mr. Royden, chairman of the Admissions Committee, reports that his committee has acted on four times the usual number of applications. Increased membership gives the Institute greater opportunity for service and increases its prestige. However gratifying growth may be, at this time it presents many problems for the Board of Directors. The present office staff is much too small to handle correspondence and other business promptly. The office space is inadequate for present requirements to say nothing of contemplated expansion of service. Work on the new directory has to be done by our staff outside the secretarial office, as does that of the advertising department. Three months ago the Board room was converted into office space. We trust to luck in obtaining a room in other parts of the building for Board meetings. Next month through the courtesy of the American Physical Society we shall hold our Board meeting in their new headquarters. At present we have no rooms for committee meetings. Plans are now under way to secure space in some other building for the Editorial Department. With three times the membership, our space is only slightly greater than it was ten years ago. In 1943, a special committee was appointed to rent new quarters, but after searching for six months without finding suitable space at reasonable rental, this committee recommended to the Board that we purchase a residence and

adapt it to our requirements, as was done by the American Physical Society. The Board authorized the committee to explore this possibility. Many properties were inspected during 1943 and 1944. Some offered definite promise but so far no commitments have been made. However, the Board is convinced that it will be to the advantage of the Institute to have a permanent home adequate to house the entire staff and has appointed a Building-Fund Committee to secure the necessary funds. Dr. Shackelford is the chairman and Mr. Coggeshall the vice-chairman. It is gratifying to report that many leaders in industry have accepted membership on this Committee and are giving it their enthusiastic support. The Initial Gifts Committee is operating under the chairmanship of Dr. W. R. G. Baker. Through the thoughtfulness of Dr. Shackelford, the Board of Directors were let in on the ground floor of his campaign and you will be interested to know that contributions from Board members averaged \$217. It is a challenging program. Other societies with fewer members have accomplished more. The American Institute of Electrical Engineers had less than 2000 members when it started the project that, with the help of other societies, resulted in

the Engineering Societies Building. I suspect that the total membership of the several groups was less than our present membership. The American Physical Society is much smaller than The Institute of Radio Engineers. The engineers of Dayton, Cincinnati, Detroit, and many other cities have succeeded in acquiring buildings for their activities. We engineers owe much to the Institute and now is our chance to contribute to the building fund. We must plan for the future. With radio and electronics, aviation, and chemical engineering destined to emerge from this war as the "Big Three," industries developed by the war, we should prepare now to grasp the opportunity that will be ours. Recently General Sarnoff of the Radio Corporation of America said, "the future of radio is always greater than its past." A membership of 25,000 is a possibility within a few years. By the end of this year we shall have as many members as AIEE had in 1936, and we are growing more rapidly.

With Dr. Shackelford and Mr. Coggeshall assisted by many others, I look forward with confidence to the success of this campaign and that a year from now Dr. Everitt will confirm this prediction.

Is Industrial Electronic Technique Different?*

W. D. COCKRELL†

Summary—With the reduction in production of military electronic equipment it is logical for radio engineers to consider entering the field of industrial electronics. This junior branch of the industry differs from communication work especially in the emphasis on costs and the type of personnel available for operation and routine servicing. The range of industrial electronics extends from standard communication equipment at one end to the large pumped ignitron and multianode tanks capable of rectifying thousands of kilowatts.

TO DEFINE INDUSTRIAL ELECTRONICS

IN ORDER to give a logical definition of anything we specify the group to which it belongs and then describe the differences between it and the other members of that group. Thus, industrial electronics is definitely a member of the electronic family. Its essential elements are vacuum- or gas-filled tubes through which electrons flow. But the practical technique of operation, the personnel who must install, operate, and service it, and the economics which govern its design and construction will be found to vary somewhat widely from that found in the communication field.

Let us look back a moment at radio or wireless. It had its beginning in ship-to-ship and ship-to-shore com-

munication. A more modern use has been the communication with airplanes. In both of these cases there is no practical substitute. The safety of the cargoes, the ships, and even the lives of the crew depend on adequate communication. Also, to provide better protection, it soon became necessary for some control to be emphasized over the rapidly increasing number of radio stations to prevent interference with each other. Therefore, it was only natural that the requirements for communication radio should be strict; that the government should exercise control over both the stations and operators; that the quality of the equipment should be a much more important consideration than its cost. Thus, each transmitter is licensed by the government only if it meets certain standards. Each operator must have an examination and, for the highest rating, must have had practical experience in station operation.

THE JOB TO BE DONE

Let us next turn to the younger member of this pair, industrial electronics. To the layman this would seem to be the same thing except that the radio tubes were used for industrial purposes. But let us look more closely. Can these industrial jobs be done by other means? The answer is yes, in most cases. Often the alternate means is that of human operators who must do a monotonous task over and over all day long, but this has been done so

* Decimal classification: 621.375.1. Original manuscript received by the Institute, November 8, 1944. Presented, 1945 Winter Technical Meeting, New York, N. Y., January 26, 1945.

† Industrial Engineering Division, General Electric Company, Schenectady, N. Y.

long that it has become generally accepted, even by the ill-paid operators themselves, as necessary in the industry. This included such simple tasks as counting, sorting, inspecting, synchronizing, and regulating (Fig. 1).



Fig. 1—An electronic induction-heating unit.

There is competition in other ways, too. The speed of a motor may be controlled by rotating machinery and electromagnetic control. Some resistance welders may be timed by mechanical means. Alternating current may be rectified to direct current by any of a number of means.

To hold its own in the industrial field the electronic equipment must do one of two things. It must provide a

means for doing a job more economically than can be done in other ways, or it must do a job so much better than can be done by other means that the extra cost will be justified. It will be noted that, unlike radio where reliability is the first essential, in both of the criteria for industrial electronics the word "cost" is evident. Every industrial electronic equipment then must not only do a job but must do it within the required cost. This is perhaps the biggest difference between communication radio and industrial electronics: the large emphasis which must be placed on all costs in the industrial field.

However, do not be led to believe that all industrial electronic equipments are small devices. Just as radio equipment covers the wide range from television stations and 500-kilowatt broadcasters to the crystal receiving set, so does industrial electronic equipment vary from the multimillion-dollar rectifier installations which convert literally hundreds of thousands of kilowatts of power to the small "electric-eye" unit and timing relay.

THE MEN TO DO IT

After having glanced briefly at the equipment, let us now look at the personnel, the men who will install, operate, and service these equipments. Because of the emphasis on reliability in radio the operating personnel as well as the station itself must meet minimum standards and be licensed. Furthermore, it has been found necessary to have an operator on duty at all times when the station is operating.

On the industrial front, we find a far different picture. The industrial user would like to treat his electronic

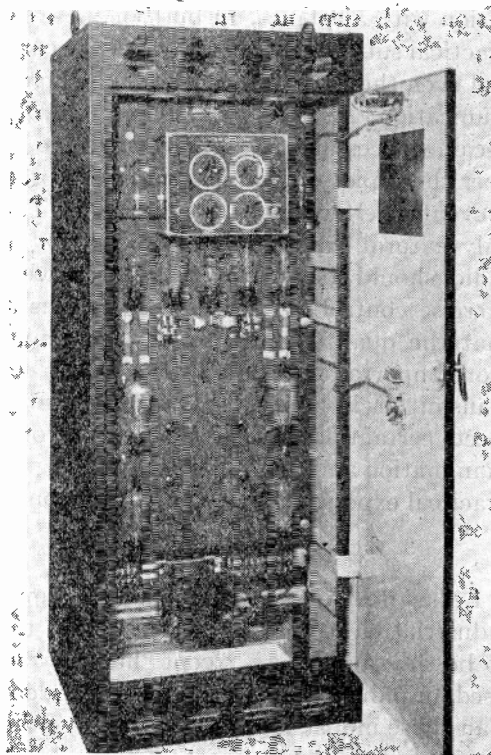

(a)

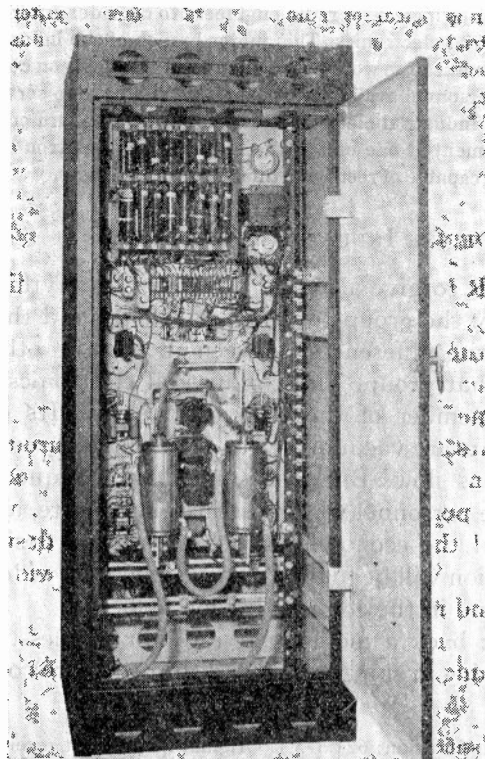

(b)

Fig. 2—Front and back views of an electronic control for resistance welding.

equipment in the same manner as he does his electrical or mechanical equipment. Industrial electronic equipment must be so built that it can be installed by the average electrician as easily as a typical motor or magnetic-control panel. Usually it must be so designed that it can operate satisfactorily in whatever factory atmosphere it must be used. The typical American manufacturing system utilizes two types of personnel on their manufacturing machines. The highly skilled setup man "sets up" or adjusts the machines to perform the desired function so that the unskilled or semiskilled machine operator may perform the simple operation necessary for each cycle of operation (Fig. 2).

Thus, in an industrial plant the average operator at the machine generally knows little or nothing about the operation of the electronic equipment. Not only must the equipment be so designed that no incorrect operation on the operator's part can damage it, but it must also contain safety devices so that the operator cannot be harmed. Other devices such as photoelectric door openers or smoke detectors or precipitators must operate for weeks or months at a time without any supervision.

THE SERVICEMAN

And what about the servicing? Even in the best-designed equipment, tubes do burn out occasionally, vibra-



Fig. 3—One bank of electronic tubes controlling the lighting at Radio City Music Hall.

tion does break leads, and fuses do blow. This is perhaps the most difficult problem which we face today in the acceptance of electronic control. There are, of course, no licensed operators who have passed an examination in the theory of their equipment. There is rarely anyone in the plant from the chief electrician or plant engineer on down who had studied any electronic theory or knew

anything about electronics beyond twisting the dial of his home radio until a year or so ago (Fig. 3).

If someone in his organization has been a radio "ham" the customer is indeed fortunate. Sometimes it is possible to hire the services of a local radio serviceman who

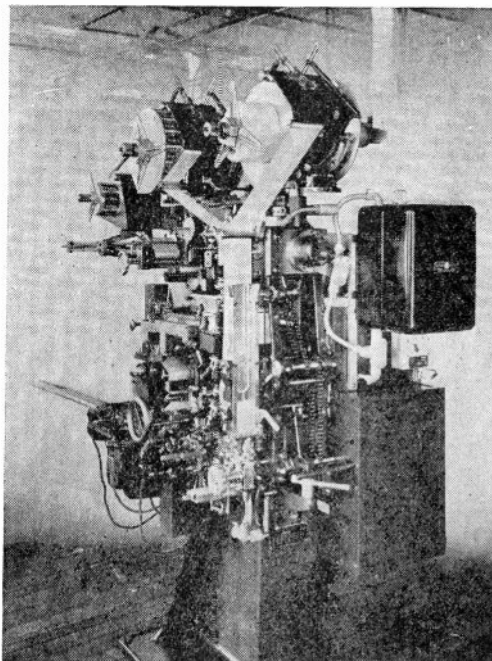

Fig. 4—A photoelectric installation designed into a packaging machine.

has studied and kept himself abreast of the times on industrial electronics. At other times it has been necessary for one or more members of the customer's electrical department to teach themselves how to service the equipment. Even then, he has been handicapped by lack of adequate text material. It is gratifying to note that within the past year much progress has been made in providing better material. The instruction books furnished with electronic equipment have also improved, but it must be remembered that at the present time, industrial electronic devices are not made in large quantities and the preparation of expensive instruction books cannot be justified if the equipment is to be built at a price at which it can be sold.

SOME INDUSTRIAL HISTORY

It will be noted that in almost every case we eventually return to the subject of cost and economics. This, again, emphasizes the extreme importance that cost must play in the industrial field. Industrial electronics had its serious beginning about 1930 and thus was forced to grow up in one of the most difficult times in the history of American business. This was a time of large man-power surpluses, a time when there was little money available for new investments and machinery. The attitude toward untried devices was extremely conservative. Thus, there was little chance of selling

equipment which could not promise a very definite improvement and even then, only in small quantities (Fig. 4).

No manufacturer had much money for development or promotion. Hence, progress was necessarily slow. Each new device or equipment had to prove itself before

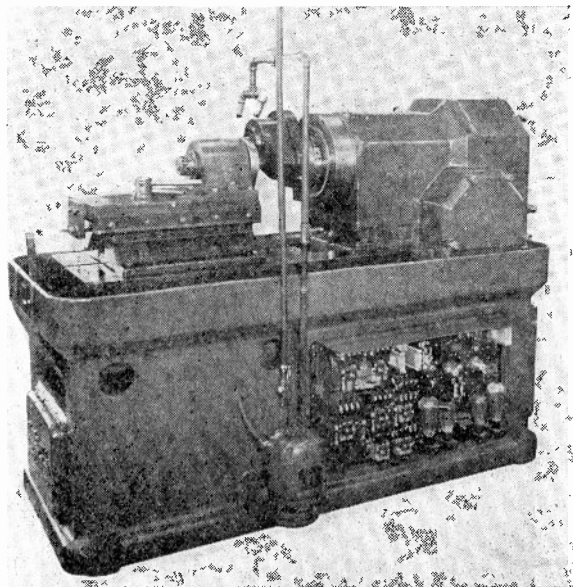

Fig. 5—Electronic motor control on a machine tool.

its use could be expanded. Some manufacturers ventured into this field, saw the long, heartbreaking road which lay ahead, and retired from the field. Other companies small and large, struggled on, plowing back their small profits into better designs and lower costs, and achieved a slow but steady growth in both the volume of their production and the acceptability by industry of their product. Much credit, too, must be given to those pioneer customers who purchased those first equipments. How well they knew the lack of adequate servicing and service instruments in those early days, the necessity for working the "bugs" out of new and untried equipment. It was early found that it was poor policy not to use the best material available, in the equipment in order to minimize the servicing requirements. The appearance on the market of cathode-ray oscillographs was a milestone in electronic servicing.

Just as the war gave an emphasis to radio engineering, it also assisted in industrial electronics. However, the assistance was more indirect than by actual government orders. The demand for planes and other equipment gave an added emphasis to the already rapidly growing field of electronic resistance welding. The demand for the ultimate in operation from machine tools provided an outlet for a rapidly increasing number of electronic motor controls. The use of standard units such as photoelectric relays, timers, and contact amplifiers increased rapidly. It is doubtful if sufficient aluminum and magnesium could have been produced without the assistance of the greatly increased number of power rectifiers (Fig. 5).

Many new manufacturers of electronic equipment for war use have sprung up during this period and many small manufacturers have expanded greatly to supply our war needs. It is expected with the return of peace that many of these factories will turn to industrial electronic equipment, so that it is anticipated that competition will be keen and that the customer will benefit by better equipment and a wider variety of equipment at lower prices.

THE CLASSES OF EQUIPMENT

What is meant by industrial electronics? With what kind of equipment will a man work who wishes to install and service it? Inside of the many factories which form our American industry he will find four classes of devices. The first includes the various forms of electronic communication equipment as useful here as elsewhere. In addition, there are three distinct classes of industrial electronic devices covering a wide range of uses.

TRANSPLANTED COMMUNICATION EQUIPMENT

Electronic-communication equipment used in industry requires only a brief mention. It is radio- and audio-frequency equipment which has been adapted by industry for its own needs. In this classification may be included interphone systems, public-address systems, and carrier-current operation, both for communication and for relaying. This type of electronic equipment is familiar to every broadcast engineer and radio serviceman so that he should be able to install and service it without

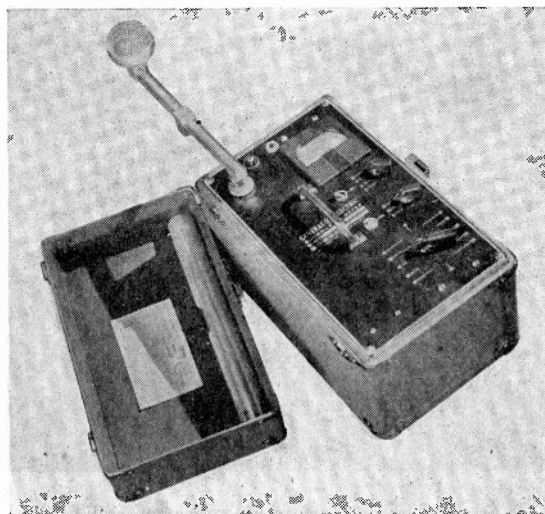

Fig. 6—The sound-level meter.

any more study than that required to work on a new brand of transmitter or receiver (Fig. 6).

The precaution to be used in installing and the defects which need to be corrected and the complaints to be serviced will not be very different from those in any other type of radio or audio equipment.

INDUSTRIAL ELECTRONICS

The Industrial Amplifier

This first class of industrial electronic equipment is somewhat similar. It comprises industrial amplifiers and oscillator units. Although the end use to which these equipments may be put will be new, the principles involved are familiar. The frequencies involved will be within the ranges with which the radioman has worked previously, and the precautions to be observed are also typical (Fig. 7).

However, included with the familiar circuits will be found some new and unfamiliar circuits which must be studied carefully both for themselves and for the unusual effects which they may create in the more familiar circuits. In this field the radio engineer who has kept up to date with the circuits used in television and radar will find himself much better prepared than his less wide-awake friend. Engineers who understand the operation of clipping, discriminating, scanning, and

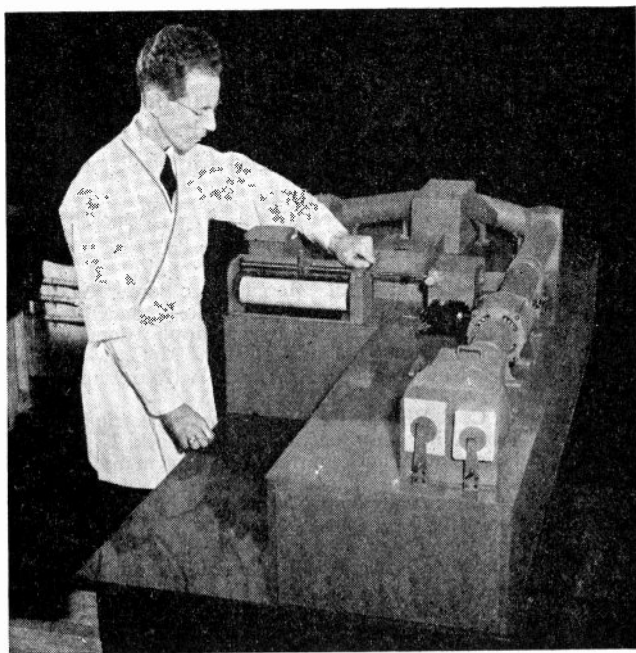

(a)

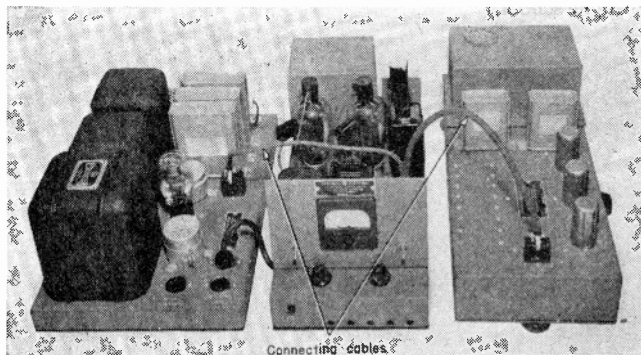

(b)

Fig. 7—The recording color spectrophotometer and its tube units.

pulsing circuits will find themselves much more at home in this class of equipment. In this class we may include such things as oscillators for high-frequency induction and dielectric heating, elevator-leveling equipment, diathermy equipment, metal detection, etc.; amplifiers used for spectrophotometers, biological experiments, frequency and time standards, sound meters, etc.

The Electric Eye and Many Others

Further removed from the communication electronics we find the second class of industrial electronic equip-

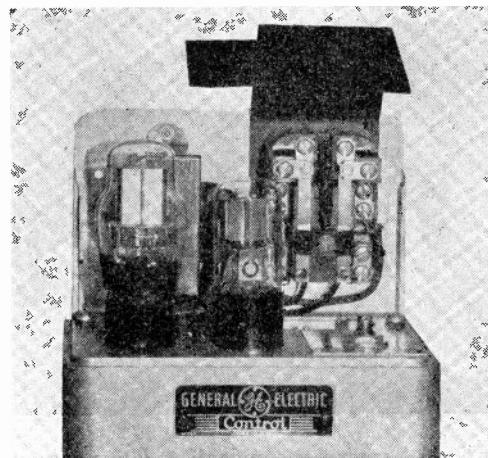

Fig. 8—The chassis of a simple photoelectric relay.

ment consisting mostly of the small control devices. Here we find such commonplace devices as photoelectric relays, timers, and contact amplifiers employing only one or two tubes. These devices usually operate from raw alternating current on the tube plate or anode. Grid rectification is used in new and novel ways. Although the devices are simple, they require a new concept on the part of the high-frequency engineer, who must think in terms of a single cycle rather than in wave trains (Fig. 8).

Here, also, we first meet the grid-controlled gas-filled tubes, the thyratron and the ignitron. Control of these thyratrons by shifting the phase of the grid brings to light a whole host of grid-shifting circuits. Again, amplifiers which must respond to zero frequency or direct current bring a whole new set of problems.

Regulating circuits in which "hunting" of motors may occur require new concepts of oscillation in which mechanical devices form a part of the oscillating circuit.

A comprehensive understanding of the circuits of this class depends not only on a thorough understanding of tube theory, but also on a good working analogy of electrical-circuit fundamentals. To master this class of equipment the radio engineer must first acquire a firm foundation of electrical-engineering principles. This need not involve higher mathematics but it should include a working knowledge of the energy exchange and the fundamental properties of resistance, capacitance and inductance. Also, he must cover the transformer

and the effects of saturation, and the simple principles of the direct-current motor, if he is to service electronic-motor control or electronic-resistance welders.

Power Conversion

With this third class of industrial electronic equipment we become almost completely divorced from radio theory and practice. This is the large power-conversion equipment such as the ignitron and tank-type mercury-arc power rectifiers, inverters, and frequency changers.

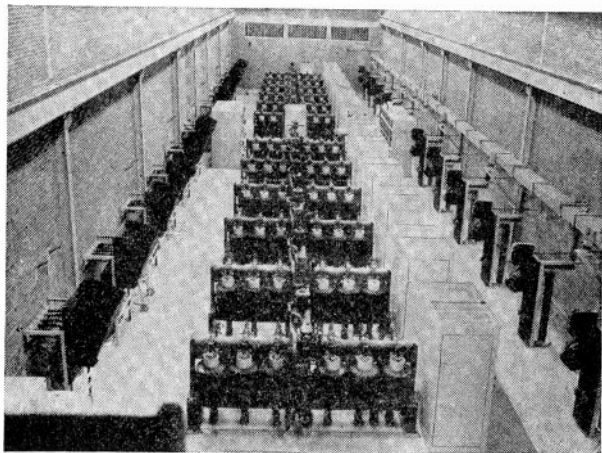

Fig. 9—A large power-rectifier installation, output 60,000 amperes, 600 volts.

The fundamental theory of operation of these devices is usually simple. The rectifier, even the multiphase rectifier, is well known to every radioman. The inverter is simply a low-frequency oscillator using gas-filled tubes. The frequency changer is a combination of the rectifier and inverter. But, because of the sizes of these equipments and the amount of power involved, great emphasis must be placed on such things as maximum tube capacity, efficiency of operation, long life and reliability with minimum maintenance, and the effect of harmonics (Fig. 9).

A very important consideration, also, is the proper circuit-breaker protection for the rectifier, the transformer, and the alternating- and direct-current connected equipment. Since a power rectifier capable of supplying 5000 amperes at 600 volts direct current is a

fairly common piece of equipment it may be seen that the power involved in a short-circuit fault on the direct-current system or failure of a tube to rectify can become tremendous.

The design and installation of this type of equipment would seem to be more in the field of the electrical power engineer than that of the radio or control engineer. Therefore, the radioman interested in this type of equipment would do best to obtain his training through central-station or power-utility sources. On the other hand, the improved design of the largest ignitrons to increase their current-carrying capacity and to reduce the number of possible "arc backs" or failures to rectify, is a challenge to the most expert tube designers.

CONCLUSION

Here is the broad field of industrial electronics, from the communication equipment, familiar to you all, to the power rectifier equipment, much more familiar to the power-house engineer. It is a new field with room for all. Given its first big boost by the needs of the present war it should have a lusty future and repay well the man who will study it seriously and do his part to help build it up. Even a year ago the means for instruction were very meager. Today there is a growing supply of source material for study and a growing need for the services of the men who will take that effort.

Bibliography

- (1) O. K. Marti and H. Winograd, "Mercury Arc Power Rectifiers." McGraw-Hill Book Company, Inc., New York 18, N. Y., 1930. (A basic work on power rectifier design and application.)
- (2) Keith Henney, "Electron Tubes in Industry," McGraw-Hill Book Company, Inc., New York 18, N. Y., 1937. (Many application examples.)
- (3) D. R. Shoults, C. F. Rife, and T. C. Johnson, "Electric Motors in Industry," John Wiley and Sons, Inc., New York, N. Y., 1942. (Covers electric motors and control, including many electronic applications.)
- (4) G. M. Chute, "Electronic Control of Resistance Welding," McGraw-Hill Book Co., Inc., New York 18, N. Y. 1943. (Practical theory and maintenance of electronic welders.)
- (5) "Applied Electronics," Electrical Engineering Staff, Massachusetts Institute of Technology, John Wiley and Sons, Inc., New York, N. Y., 1943. (Broad fundamental theory.)
- (6) W. D. Cockrell, "Industrial Electronic Control," McGraw-Hill Book Co., Inc., New York 18, N. Y., 1944. (Covers basic circuits and applications of industrial electronic control.)
- (7) "Electronics for Radio Men and Electricians," Coyne Electrical School, Chicago, Ill., 1944. (An elementary textbook used by the Coyne school.)

Development of Electronic Tubes*

I. E. MOUROMTSEFF†, ASSOCIATE, I.R.E.

Summary—The main types of modern electronic tubes are briefly surveyed in this paper, together with their general uses. Tubes are classified according to electronic mechanism, and their origin is traced to three independent sources and several independent lines of development.

The earliest group of electron-beam tubes made its appearance as the most direct result of intense scientific study of gas-discharge tubes prompted by William Crookes. These are: the Lenard tube (1894), the X-ray tube (Roentgen, 1895), and the cathode-ray tube (Braun, 1897).

Another direct descendent of the Crookes tube is the mercury-arc rectifier (Cooper Hewitt, 1902) with all its modern derivatives, thyatron, phanotron, ignitron, and excitron. These are industrial tubes par excellence and have become quite indispensable in many branches of industry. Their importance grows rapidly.

High-vacuum tubes, rectifiers, and pliotrons, through de Forest's audion (1908) and Fleming's valve (1904) are connected with the Edison effect observed in incandescent lamps (1884). This vast family includes kenotrons, and all radio and industrial high-frequency tubes. Ultra-high-frequency tubes stand apart in this class, since in their designing electron transit time and associated ultra-high-frequency circuits are two important factors to be considered. Special triodes (or tetrodes), magnetrons and velocity-modulation tubes are the main ultra-high-frequency types.

Finally, independent of all previous groups stands the phototube, unspectacular, but one of the most important tools in modern industry. Its development is rooted in the photoelectric phenomenon observed by Hertz and scientifically studied by Hollwachs (1888), by Elster and Geitel (1912), and others.

THE electronic tube is the heart and soul of every modern electronic application. In spite of the fact that electronics is the youngest branch of electrical engineering and science, the electronic tube is much older than ordinarily surmised. In fact, since Otto von Guericke's invention, 300 years ago, of his primitive vacuum pump and electrostatic friction machine, many a scientist has indulged in admiring the mysterious colorful phenomenon of gas discharge in an evacuated glass vessel. Among these was the great Faraday himself. The actual scientific study of this remarkable phenomenon was begun about 70 years ago by Wilhelm Hittorf, of Münster, Germany (1869)¹ and by a brilliant British chemist, William Crookes.² The latter's inspired lectures and his paper prompted serious study of gaseous discharge throughout the scientific world. In fulfillment of Crookes' vision that "here we shall find the ultimate truth", this study resulted not only in development of

all modern electronics, but brought about a revolutionary electron theory of matter and changed the entire philosophical background of science.

ELECTRON-BEAM TUBES

The first practical result of universal study of Crookes' and Hittorf's "cathode rays"³ in a discharge tube was the discovery of X rays by Wilhelm Roentgen,⁴ Germany, in 1895. Their potential value for surgical, therapeutic, and even industrial purposes was quickly recognized by many. But it took almost 30 years to bring these ideas to full practical realization. An important contribution leading to the wide modern application of *X-ray tubes* in science, medicine, and industry was made in 1913 by W. D. Coolidge in this country; this was substitution of hot tungsten filaments for the original "cold" cathodes.⁵ It coincided with a considerable improvement in vacuum technics which permitted exhausting tubes to the high degree of vacuum necessary for operating tubes at very high voltages.

Most of the modern X-ray tubes are diodes; the anode and anticathode or the target of early tubes are now combined in a single anode. However, the necessity of having tubes suitable for high-quality radiography and of guaranteeing maximum safety of operation makes the tube structure more complicated than that of a simple diode. Tungsten is the commonly used material not only for filaments but also for targets, because of its low vapor pressure, high melting point, high atomic number, and fairly good heat conductivity. For limiting the size of the "focal spot" on which the electrons impinge the small sturdy tungsten filament is mounted within a narrow slot of an electrostatically focusing cup. In order to prevent secondary electrons from bombarding the glass walls, modern tubes are frequently designed with *hooded* anodes.

The problem of cooling the anode is paramount with X-ray tubes as heat generation is confined to the limited area of the focal spot. With low-power tubes the tungsten target is simply supported by a molybdenum rod, and since heat is not readily conducted from the target, the latter heats up to a high temperature as the result of electron bombardment, and heat is radiated into the surrounding space. The other generally used method of cooling the target involves a design in which the target is embedded in the solid-copper anode usually by the process of high-vacuum casting. The heat is then conducted away from the anode by a copper rod

³ This name was inaugurated by a German physicist, H. E. Goldstein, in 1876.

⁴ W. K. Roentgen, "On a new form of radiation," *Electrician*, vol. 36, pp. 415-417; January 24, 1896.

⁵ W. D. Coolidge, "A powerful Roentgen-ray tube with a pure electron discharge," *Phys. Rev.*, vol. 2, pp. 409-430; December, 1913.

* Decimal classification: R330. Original manuscript received by the Institute, November 11, 1944. Presented, National Electronics Conference, Chicago, Ill., October, 1944 (the Chicago Section of The Institute of Radio Engineers was one of the Sponsors of the National Electronics Conference).

† Westinghouse Electric and Manufacturing Company, Bloomfield, New Jersey.

¹ W. Hittorf, "On the conduction of electricity by gases," *Pogg. Ann.*, vol. 136, pp. 1-31; January 27, 1869; pp. 197-235; March 2, 1869.

² W. Crookes, "Repulsion resulting from radiation," *Phil. Trans.* vol. 170, pp. 87-134; November, 1878; "On the illumination lines of molecular pressure and the trajectory of molecules"; pp. 135-164; December, 1878; "Contributions to molecular physics in high vacua"; pp. 641-662; April, 1879.

extending the anode through the tube envelope and is dissipated into the surrounding medium, oil or air, by a "radiator", terminating the rod. With heaviest loads, such as in 220-kilovolt tubes for industrial radiography, circulating oil cooling is applied to a hollow anode. Water is not favored here on account of complications in high-voltage insulation.

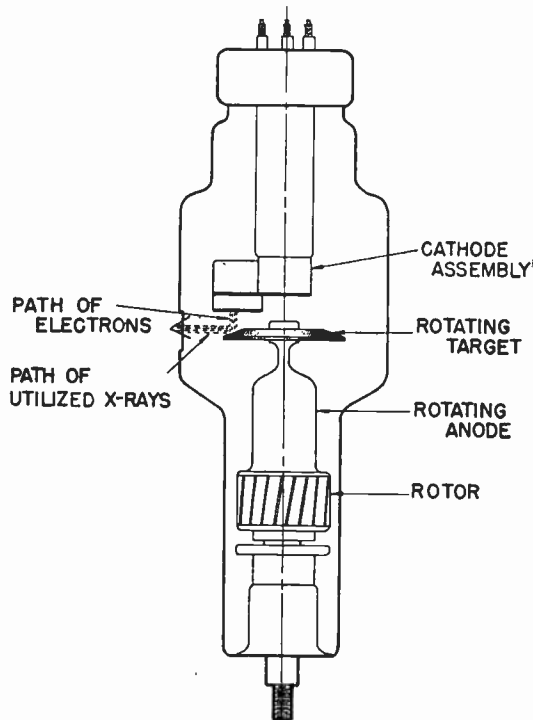

Fig. 1—Rotating anode X-ray tube for radiography requiring high X-ray output.

According to the intended use, X-ray tubes are designed for various operating voltages. For medical diagnostic uses voltage range is between 40 and 100 kilovolts. In medical therapy, tubes are employed up to 1,000,000 volts and even higher; usually they are continually exhausted in operation. For industrial radiography tubes are required from 30 to 220 kilovolts, and a 1,000,000-volt tube was recently employed by the General Electric Company for inspection of seam welds and castings in important apparatus.⁶ These megavolt tubes necessarily have a complicated multisection structure for a more uniform distribution of potential gradient.

In some medical applications it is desirable to make radiographs of very short exposure times requiring high intensities of X-ray radiation, hence, high current density within a small focal spot. The answer to this is the tube with rotating anode, in which the focal spot, though stationary in space, rapidly changes its location on the periphery of the revolving target (Fig. 1). The anode is supported on ball bearings in vacuo; it forms a part of the rotor of an induction motor the stator of which is oil immersed and mounted externally to the tube. The outstanding problem in this type is to provide

⁶ E. E. Charlton and W. F. Westendrop, "A portable million-volt X-ray outfit for industrial laboratories," *Gen. Elec. Rev.*, vol. 44, pp. 652-661; December, 1914.

special lubricant effective at high temperatures in vacuo. This tube was designed in 1930 by the Philips Lamp Company of Holland.⁷

One of the important recent developments in the X-ray field is a cold-cathode tube for high-speed radiography, which permits taking pictures of objects moving with a considerable velocity, such as bullets in the barrel of a gun. The tube permits exposure of less than a microsecond, during which time a current of the order of 2000 amperes flows through the tube. To supply this enormous current an instantaneous metal vapor arc triggered between two cold electrodes is used as cathode. The tube was developed in 1940 by Slack and Ehrke.⁸

As another quite recent development, the Kerst tube, should be mentioned which gives a simple physical means to accelerate electrons up to 30,000,000 electron volts.⁹ Its great value to science and some future practical application are beyond any doubt.

Another early outcome of scientific study of Crookes' discharge tubes was the *Lenard tube*, the typical high-voltage cathode-ray tube, described by Lenard,¹⁰ one year before Roentgen discovered X rays. The Lenard and Roentgen tubes can be viewed as sister tubes as to their general construction, production of electron beam, operating voltages, and even with respect to some of their applications. However, while the purpose of a Roentgen tube is to produce X-ray radiation by electrons impinging upon the target, the Lenard tube is designed to permit the electrons to pass through an extremely thin metal or glass window in the wall of the tube with as little loss of energy as possible and to become available outside the tube for bombardment of various objects. The thin window of the Lenard tube corresponds to the target in an X-ray tube. Thus far, Lenard tubes have been used mainly in biological studies of the effects of electron bombardment on living cells. There are, however, indications that Lenard tubes can compete with, or supplement X-ray treatment of ailing tissues in the human body because of the greater physiological effects of electrons. It may be pointed out that the recently developed Kerst tube can also be designed as a megavolt Lenard tube.

A third important member of the family of the early electron-beam tubes, direct descendants of the Crookes discharge tube, is the *cathode-ray tube*. It can be described as a low-voltage Lenard tube with a large fluorescent screen instead of the thin window at the far-off end of the tube, opposite the cathode. The electron beam impinging upon the screen produces a luminous spot which travels all over the screen as the

⁷ A. Bouwers, "An X-ray tube with rotating anode," *Physica*, vol. 134, pp. 125-134; October, 1930.

⁸ C. M. Slack and L. F. Ehrke, "Radiography at high speed," *Jour. Appl. Phys.*, vol. 12, pp. 165-168; February, 1941.

⁹ D. W. Kerst, "The acceleration of electrons by magnetic induction," *Phys. Rev.*, vol. 60, pp. 47-53; July, 1941; *Phys. Rev.*, vol. 61, p. 93; January, 1942. (A letter to the editor.)

¹⁰ P. Lenard, "On cathode rays in gases at atmospheric pressure and in extreme vacuum," *Ann. der Phys.*, vol. 51, pp. 225-267; January 15, 1894.

beam is deflected. The deflection can be effected by a pair of condenserlike electrodes or by magnet coils arranged in close vicinity to the beam at the place where it emerges from the electron gun. By the deflection and luminous lines produced by the fluorescent spot one can study the character and mutual relation of voltages and currents energizing the deflecting electrodes.

The first tube of this kind was built by Ferdinand Braun in 1897.¹¹ For almost 30 years the Braun tube under the name of *oscilloscope* was used only in laboratories for qualitative study and relative measurements, mainly, in low-frequency technics.

However, as early as the first decade of this century Professor Boris Rosing of St. Petersburg,¹² Russia, and A. A. Campbell-Swinton in England¹³ anticipated the feasibility of the application of the Braun tube in television. Rosing even succeeded in staging some initial experiments in that direction. Twenty-five years later, Zworykin and Farnsworth in this country brought these dreams to realization, Zworykin by designing his ingenious kinescope¹⁴ and iconoscope¹⁵ and Farnsworth by the not less ingenious dissector tube.¹⁶

Since the world-wide experimenting with radio-wave reflection from the Heaviside layer at the end of the 1920's, the cathode-ray tube was employed for measuring extremely short time intervals elapsed between the direct and reflected waves. This possibility permitted one to anticipate a variety of useful future applications in aviation, sea navigation and, perhaps, in highway and street traffic.

The modern cathode-ray tubes are a great improvement in practically every detail over the original Braun tube: the incandescent cathode (usually of the Wehnelt type) instead of the cold cathode; the electron gun for producing a narrow electron pencil, designed according to the rules of modern electron optics; superior qualities of the fluorescent screen replacing the old greenish willemite screen in television, etc. Cathode-ray tubes are now constructed in all sizes from the smallest "magic eye" in radio receiving sets to a tube 20 and even 24 inches in diameter. The variety of their application still increases steadily.

MERCURY-ARC RECTIFIERS

The oldest electronic tube, or industrial tube par excellence, is the *mercury-arc rectifier*. It plays a very im-

portant role in modern industry whenever electric energy generated as alternating-current power is to be converted into direct-current form for operating direct-current railway and other heavy-duty motors with variable load; it is also very useful in industrial electrochemical processes.

The mercury-arc rectifier was invented by Cooper Hewitt¹⁷ on the threshold of this century as a result of his experimenting with mercury-arc lamps, commercial manufacture of which was started by Cooper Hewitt and George Westinghouse in 1900. Production of the rectifiers¹⁸ began in 1902.

It may be noted that for about twenty years before Cooper Hewitt's time, mercury-arc discharge in Crookes' tubes had been studied by several scientists. Thus, in 1882, Jamin and Meneuvrier¹⁹ in France observed unidirectional flow of electric current from an anode to the mercury cathode (this was two years before the "Edison effect" was announced). Later on, similar work was done by a German professor, Arons.²⁰ But all these and similar scientific experiments were limited to laboratory demonstrations with no broad conclusions whatever. A systematic, experimental study of mercury-arc discharge and its practical applications was carried out in this country by Cooper Hewitt in co-operation with the Westinghouse Electric Company, and later on, also, by Weintraub,²¹ Latour, and Steinmetz^{22,23} of the General Electric Company.

The first rectifiers were made of glass and used for charging storage batteries, and also for feeding direct-current street-light arcs from alternating-current mains. But very soon the idea of a mercury steel-tank rectifier for converting power in larger quantity was conceived by Cooper Hewitt²⁴ (1908), and elaborated upon by himself, Frank Conrad and other workers in this field. The pioneer installation of this type of rectifier in this country was known to be made in 1913 at the Westinghouse Shadyside Works;²⁵ another followed it in 1914 for propelling a direct-current electric locomotive from an 11,000-volt single-phase overhead line of the New York, New Haven and Hartford Railroad.²⁶ In the latter project, two rectifier units fed four direct-current 240-horsepower motors at 600 volts.

¹⁷ Cooper Hewitt, U. S. Patents 1,097,320 and 1,097,547; October, 1902–May, 1914, German Patent 157,642; December 19, 1902.

¹⁸ M. von Recklingshausen and P. H. Thomas, "Hewitt mercury lamp," *Trans. A.I.E.E.*, vol. 22, pp. 71–90; June 29, 1903.

¹⁹ M. Jamin and G. Maneuvrier, "On reactive current of an electric arc," *Comptes Rendus*, vol. 94, pp. 1615–1619; June 19, 1882.

²⁰ L. Arons, "On mercury arc," *Ann. der Phys.*, vol. 47, pp. 767–771, November 15, 1892; vol. 58, pp. 73–95; May 1, 1896.

²¹ E. Weintraub, "Investigation of the arc in metallic vapors in exhaust space," *Phil. Mag.*, vol. 7, pp. 95–124; February, 1904.

²² C. P. Steinmetz, "The magnetic arc lamp," *Elec. World*, vol. 43, pp. 974–1175; June 24, 1904.

²³ C. P. Steinmetz, "Constant-current mercury arc rectifier," *Elec. World*, vol. 45, pp. 1174–1175; June 24, 1905.

²⁴ Cooper Hewitt, "Vapor converter," U. S. Patent 1,007,694; 1908–1911.

²⁵ O. K. Marti and H. Winograd, "Mercury Arc Power Rectifiers," McGraw-Hill Book Company, New York, N. Y., 1930, p. 8.

²⁶ W. S. Murray, "Main line electrification," *Trans. A.I.E.E.*, vol. 34, pp. 85–124; January 20, 1915.

¹¹ F. Braun, "On a method of demonstration and study of time curves of variable current," *Ann. der Phys.*, vol. 60, pp. 552–559; March 1, 1897.

¹² V. K. Zworykin, "Television," John Wiley and Sons, Inc., New York, N. Y., 1940, p. 256.

¹³ A. A. Campbell-Swinton, "The possibilities of television," (A letter to the editor), *Nature*, vol. 78; p. 151; June 18, 1908; *Wireless World and Rad. Rev.*, vol. 14, pp. 51–56; April, 1924.

¹⁴ V. K. Zworykin, "Experimental television system and the kinescope," *Proc. I.R.E.*, vol. 21, pp. 1652–1673; December, 1933.

¹⁵ V. K. Zworykin, G. A. Morton, and L. E. Flory, "Theory and performance of the iconoscope," *Proc. I.R.E.*, vol. 25, pp. 1071–1092; August, 1937.

¹⁶ P. T. Farnsworth, "Television by electron image scanning," *Jour. Frank. Inst.*, vol. 218, pp. 411–444; October, 1934.

It is known that a mercury-arc rectifier essentially consists of a glass or steel container having a small pool of mercury for the cathode and one or more carbon anodes (up to 24, in some rectifiers). Each of the anodes is energized by its own phase of the alternating-current power supply which is to be converted into direct-current power. The pool is connected to the load and, through it, to the common return of the alternating-current system. Unlike other thermionic tubes, the electrons necessary for carrying electric current through the mercury rectifier are obtained from a small bright "spot" which rapidly moves on the mercury-pool surface and forms the base of the mercury arc. An almost unlimited supply of electrons can be secured from this cathode without special provision for its heating. Hence, mercury-arc rectifiers are suitable for services requiring very high load current. In order to start the arc, the spot first must be struck, and then maintained during tube operation. This is accomplished by some kind of a "starter" and by one or more *auxiliary anodes* located close to the pool surface.

Glass rectifiers, because of hazards of mechanical breakage and of heat strains in their walls, and because of the involved glass-blowing work in making seals, are limited in permissible output by not over 500 amperes at about 600 volts rectified voltage. At lower current ratings, commonly required by broadcast transmitters, direct voltages of 10,000 volts and even higher can be realized. Modern steel tank rectifiers are built for 10,000 and even up to 16,000 amperes per unit. In this country mercury-pool rectifiers in glass containers are no longer manufactured, except for replacement services, but in Europe they are still in vogue.

A great advantage of the mercury-arc rectifiers over the rotary converters and over the other types of rectifiers is a very low internal-voltage drop, 20 to 30 volts, practically independent of load current. This renders rectifier efficiency very high, up to 98 per cent, and therefore the tube is suitable for applications where the load is highly variable, such as with cranes, streetcars, subways, main railroad lines, etc. Because of the unlimited supply of electrons, these tubes can be greatly overloaded for a short time without fatal effects, hence they are not damaged by short circuits on the line.

However, the internal short circuits caused by backfiring between the anodes and the cathode, or between two anodes always was and still is the main concern of the rectifier designers and for almost 30 years retarded its wide practical use in industry. The situation was aggravated by the reluctance of electrical engineers to part with their well-developed rotary converters in the same type of services. From the start it was known that a single backfiring does not put the rectifier out of commission, but a small amount of gas liberated by an overheated part prepares the way for another freak discharge, until finally the accumulation of spurious gas renders the tube inoperable. On the other hand, air could also diffuse into the tube through imperfect welds and gasket

joints between the component parts of a steel tank.

Decisive steps in the direction of design improvement were originally made (1910) by Bela Schaefer of the Hartman and Braun Company, Frankfurt, Germany;^{27,28} later on of the Brown and Boveri Company of the same country. A tank design was adapted radically departing from the shape of the glass rectifiers which had a side arm for each anode; reliable joints between parts were developed; and rectifiers in operation were kept continually exhausted, so that the uninvited gases could be removed on the spot. This scheme of evacuating the rectifiers in operation was greatly enhanced by the subsequent invention of mercury condensation pumps as mentioned before. The first two steel rectifiers in Europe were installed in a foundry near Frankfurt, Germany, in 1911.

During World War I, work on mercury rectifiers was discontinued everywhere in favor of other urgent problems, except in Germany where acute shortage in copper for building rotating machinery prompted rectifier development. So that, after the war, several prominent European concerns started manufacturing tank rectifiers, and large commercial installations began to emerge. This gave a new impulse to other countries which resumed their work in the same direction. This vast experience accompanied by scientific study of physical phenomena inside the rectifiers by several prominent industrial research workers finally gave a solid basis for designing modern steel-tank rectifiers. However, their application on a wide scale in this country did not start until after 1925. In 1930 the total power supplied by mercury rectifiers throughout the world rose to about 1.5 million kilowatts, while at the present time it has reached several million kilowatts in this country only.

An important item in the more recent development of mercury-arc rectifiers was the introduction of the control grid. It is interesting to note that Cooper Hewitt anticipated the possibility of controlling the rectifier current by a grid located in the path of the current. But grid control of a mercury arc by negative bias was explicitly suggested by a Langmuir patent in 1914.²⁹ However, probably because the patent was written around radio applications of the tube, the idea of grid control had not been seriously considered for mercury-arc rectifiers, until in 1924 Toulon proposed a new method of control by shifting the phase of the alternating voltage applied to the grid with respect to the anode voltage of the same frequency.³⁰ The Toulon method or its modifications permit an easy control of the direct-current rectifier output current and voltage,

²⁷ Bela Schaefer, "A new mercury-arc rectifier of large output," *Elek. Tech. Zeit.*, vol. 32, pp. 2-5; January 5, 1911.

²⁸ Bela Schaefer, "Large power mercury-vapor rectifiers with steel-containing vessels," *Elek. Tech. Zeit.*, vol. 33, pp. 1164-1168; November 7, 1912.

²⁹ I. Langmuir, "Electric discharge controlling device," U. S. Patent 1,289,823; 1914-1918.

³⁰ P. M. Toulon, "Current-regulating arrangement for rectifiers," U. S. Patent 1,654,949; 1923-1928.

without extraneous devices such as on-load tap-changing transformers, or induction regulators. In addition to the advantages of efficient supplying power to a variable load, grid-control renders possible *inverted operation* of a rectifier, that is, inversion of the direct into alternating current without oscillating circuits. This is quite important for the realization in some near future of the dream of power transmission over long distance by means of very high direct voltages. Also, several other problems, can be solved by using grid control, such as feedback of the excess of power in direct-current traction into the alternating-current supply line, effective means of obtaining currents of variable frequency for induction furnaces, changing of the number of phases, or of the frequency of power supply, etc.

All advantages of the ordinary and of the grid-controlled mercury-arc rectifiers are inherent in the newest type of industrial electronic tubes, the *ignitron* (Fig. 2). In addition, this novel tube has some other useful features which contribute to its ever-growing popularity. The ignitron is also a "mercury-pool" tube. But the arc is started in it during each cycle by the *ignitor*. It is a short rod of a highly resistive refractory material with a pointed tip projecting into the mercury pool. When an electric (not electronic) current of a proper density is caused to flow from the ignitor to the pool during only a very short interval (about 100 microseconds) an arc is struck at the ignitor contact surface, and is almost instantaneously transferred to the anode. The electron current flows through the tube until the alternating anode voltage passes through its zero value. Then the arc can again be started by the ignitor, and so on. By means of phase shift in the timing circuit connected to the ignitor one may fire the arc at any desired point within the alternating-current cycle. In this manner it is possible to control both the number of cycles during which the ignitron operates, and the effective current per cycle. From this brief description it is clear that the ignitor performs two or even three duties at once; that of the keep-alive anodes (in starting the main arc during each cycle), of the control grid (in shifting the phase of initiation the anode current), and finally, of the starter in the mercury-pool rectifiers at the beginning of its work.

There are several advantages of single-anode mercury tubes, such as the ignitron. Indeed, it lends itself to large-scale production, since the component parts of a simple cylindrical structure can be readily welded together by modern methods; the necessary insulation between the tube parts can be of the rugged and reliable kovar-to-glass seal type; better joints, better seals, and better outgassing of parts permit making of all-metal tubes of the sealed-off type, even at higher ratings; the individual tubes can be conveniently handled at the factory and in the field; backfiring in the tube can be reduced to its physical minimum because there is no ever present keep-alive arc. Finally, single-anode tubes can be operated in reverse-parallel connec-

tion, realizing a perfectly controlled single-pole double-throw instantaneous switch, the scheme widely used in resistance welding which is perhaps the most important electronically controlled process in modern industry. Resistance welding has been up to the recent time the main application of the ignitron, and many units of welding equipment have been installed during the last 7 or 8 years for numerous consumers all over the coun-

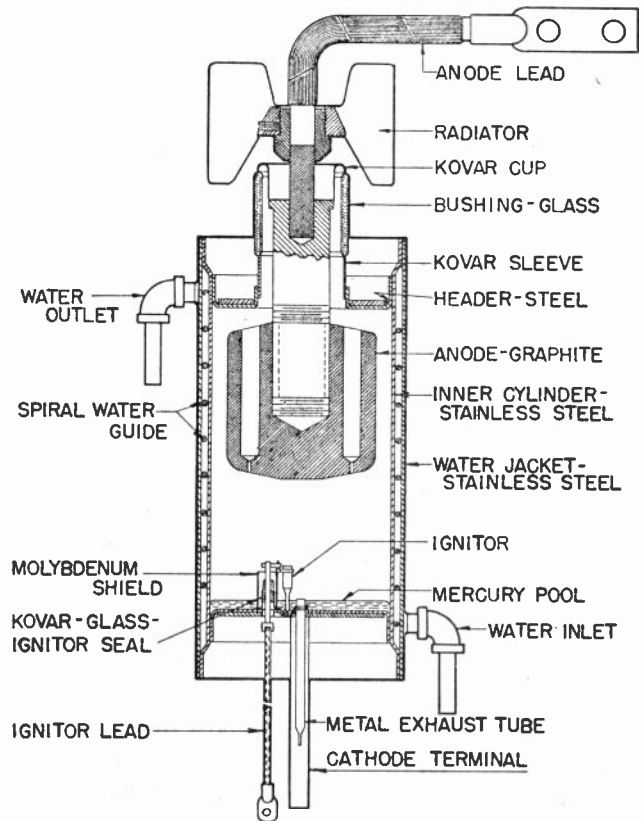

Fig. 2—Size D ignitron for 2400 kilovolt-amperes maximum demand and 14,400 amperes maximum peak current at 250 volts.

try. However, there is no reason not to use the ignitron in other applications. In fact, a number of sets with a total power amounting to about $2\frac{1}{2}$ million kilowatts has been installed since 1940 in the electrochemical industry for production of aluminum, magnesium, and other metals, in which ignitrons serve as precision controlled rectifiers. Ignitrons can also be designed for sufficiently high voltages to be used for supplying power to large transmitting radio sets.

The ignitron was invented by Slepian and Ludwig of the Westinghouse Electric and Manufacturing Company,³¹ and has been used commercially since 1937. Modern ignitrons are almost exclusively of the all-metal type. At the present time there are several standard types in manufacture, ranging from 1700 to 27,000 amperes peak and up to 900 amperes average anode current.

In quite recent times another type of a single-anode

³¹ J. Slepian and L. R. Ludwig, "New method of starting an arc," *Elec. Eng.*, vol. 52, pp. 605-608; September, 1933.

tube was developed by the Allis-Chalmers Company, the so-called *excitron*.³² This is an all-metal mercury-pool tube with a control grid. It possesses all the advantages of a single-anode tube, just outlined. The difference between the excitron and ignitron is in the electronic mechanism of starting and controlling the current dur-

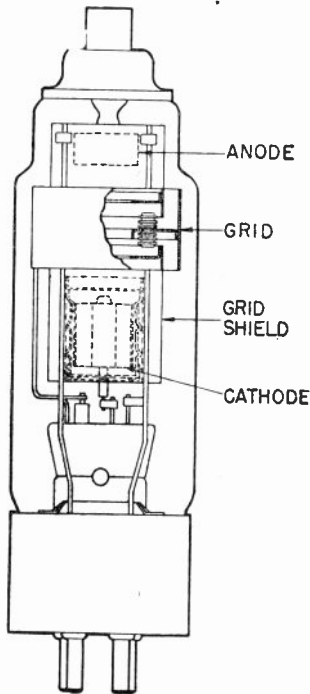

Fig. 3—WL-672 thyatron for 1500 volts, 2.5 average and 30 amperes peak anode current.

ing each cycle, that is, the control-grid versus the ignitor. It seems that the ignitor makes the tube structure simpler as it eliminates the keep-alive anodes and the necessity of having another device for initiating the arc at the beginning of operation. However, the designers claim that the excitron proved to be satisfactory in service.

Another very important member of the family of mercury vapor or gas tubes is the *thyatron* (Fig. 3). In its simplest form it is a gas or mercury-filled triode with a filamentary cathode. Although all early radio receiving triodes fall under this definition, the industrial application of the thyatron in the modern sense of the word was first suggested in 1928–1929 by Hull³³ of the General Electric Company. Actually, the basic principle of its operation was anticipated much earlier.²⁹

The thyatron has a thermionic cathode, a graphite or metal anode, and a control grid surrounding the anode. In modern tubes there usually are two grids: one for controlling the beginning of the discharge, the other for shielding the cathode from the anode electric field. The second grid also performs several other functions tending to improve the effect of the grid control. The thyatrons are usually filled with mercury vapor by placing a

³² H. Winograd, "Development of excitron-type rectifiers," A.I.E.E. Technical Paper No. 44-78; March, 1944.

³³ A. Hull, "Gas-filled thermionic tube," *Trans. A.I.E.E.*, vol. 47, pp. 753–767; July, 1928; "Hot cathode thyatrons," *Gen. Elec. Rev.*, vol. 32, pp. 213–223; April, 1929.

drop of pure mercury inside the tube after its exhaust. Some of the modern thyatrons are filled with one of the heavy monatomic gases, xenon or krypton, rendering the tube operation more nearly independent of the ambient temperature. The cathodes of mercury tubes are of the oxide type, directly or indirectly heated.

There are several standard types of thyatrons assembled in glass envelopes, but attempts are being made to design all-metal tubes along the same lines as the ignitrons are built.

The thyatron is an indispensable tube in modern industry. Similar to the larger mercury tubes (ignitron, excitron) it can be used alone for precise controlling of current and voltage, when power demand is not too high. It is also very useful in regulation service in the circuits designed to keep temperature, motor speed, generator voltage, etc., within the prescribed narrow limits. In circuits designed for counting manufactured goods or other objects, rejecting defective pieces, etc., which utilize sensitive photocells, the thyatron excited by the photocell is a very convenient tool to operate necessary mechanisms. Finally, the thyatron offers a beautiful means for the precise control of firing ignitrons or grid-controlled mercury-pool tubes. The thyatron is a true and simple *electron relay*, the name by which the first radio tubes were sometimes called.

The simplest member of mercury tubes is the *phanotron*. This is a mercury-vapor-filled diode or rectifier. It

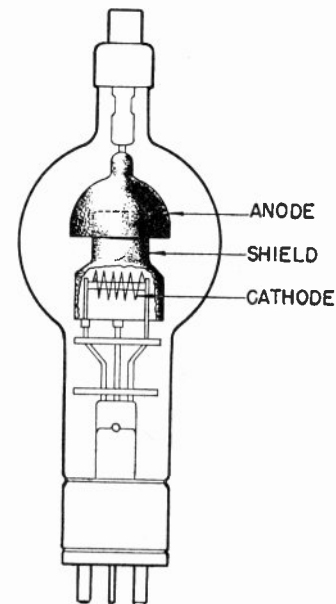

Fig. 4—869-B phanotron for 15,000-volt peak inverse voltage and 5 amperes average current.

consists of a thermionic filamentary (or indirectly heated) cathode and a graphite anode (Fig. 4). Several types of phanotrons, all of the sealed-off variety with glass envelopes, are well known in radio application; in the field of power supply to radio sets they have made the early high-vacuum rectifiers practically obsolete, because of their great efficiency and higher current ratings. The only limitation of the phanotron is the

permissible direct voltage which cannot conveniently exceed 10 or 15 kilovolts without eventually firing back. Since structurally a phanotron is a thyatron with the grid, this type appeared practically simultaneously with the thyatrons, that is, at the end of the 1920's.

The cold-cathode thyatron filled with argon or neon was originally known as "grid-glow tube."³⁴ Its application preceded that of the hot-cathode thyatron by several years. It is still used in services with long stand-by periods, as it does not consume power for heating the cathode.

HIGH-VACUUM RECTIFIERS

In some previous as well as in the following Sections reference is made to an event which has played an outstanding, although indirect, role in the development of all types of electronic tubes. This was a great improvement in vacuum technics as the result of the invention of the molecular³⁵ pump by Gaede (1913) and of the *mercury diffusion* and *condensation pump* by Gaede (1915)³⁶ and Langmuire (1916).^{37,38} With the new pumps it was possible to exhaust tubes to a much greater degree of vacuum than previously. Vacua of at least 10^{-6} millimeter of mercury became easily attainable; this was essential with tubes designed for high-voltage operation as only in high vacuum could pure electron currents unimpeded by the presence of gas ions be established.

The first fruit of the improved vacuum technics was the improved high-vacuum X-ray tube followed shortly by high vacuum rectifiers³⁹ also known as *kenotrons* (1915). The kenotron is a clean-cut diode with a filamentary cathode, usually made of pure tungsten. The first application of high-vacuum rectifiers was supplying rectified direct voltages to X-ray tubes from high-voltage transformers. In this service the kenotron replaced the old mechanical "valves".

With the improvement of radio transmitters the original motor-generator sets used for supplying direct operating voltage to the oscillator tubes were gradually replaced by alternating-current power-supply sets employing kenotrons. This evolution has not required the development of the new types of tubes as practically every triode could be converted into a rectifier simply by omitting the grid. However, the inherent drawbacks of high-vacuum rectifiers soon came to light; frequently they had insufficient maximum emission current and their internal voltage drop was too great. Thus,

toward the end of the 1920's moderately successful attempts were made to adapt mercury-pool rectifiers for radio sets; but very soon in this country kenotrons lost their place to phanotrons for high-duty services. The kenotron still has a very important application in connection with supplying direct-current power, whenever emphasis is placed on high voltages rather than on high currents; such as is the case with X-ray tubes, precipitrons, etc.

HIGH-FREQUENCY TUBES

Up to the most recent time the classification, *industrial* versus *radio* tubes, coincided with the tube division into *gas-filled* versus *high-vacuum tubes*. It was to a certain degree justified, since, by virtue of the physical phenomena in the conventional gas-filled tubes, they could be used only in circuits of low or industrial frequencies (25 or 60 cycles per second); on the other hand, high-frequency radio applications required tubes with as good vacuum as can be established by the modern vacuum technics. However, at the present time, even discounting therapeutic application of high-frequency oscillations, there are industrial installations in which high-frequency or "radio" tubes are employed for induction and dielectric heating of parts and materials in a variety of manufacturing processes.

Nevertheless, up to the present time the development of high-frequency tubes was always intimately connected with the progress of the radio art; this may be modified in the future, as no intricate characteristics are required from industrial tubes but power and efficiency.

The first vacuum tube ever used in high-frequency circuits was built in 1892 by Zehnder⁴⁰ for demonstrating to large audiences Hertzian waves, then recently discovered. The Zehnder tube was a small gas-filled tube in which gas discharge was triggered by high-frequency oscillations. The first tube developed for practical radio applications was the noted Fleming valve (1904),⁴¹ a diode detector based on the phenomenon of unidirectional conduction of electric current, recorded by Edison twenty years earlier,⁴² while experimenting with incandescent lamps. Simultaneously, in Germany another diode detector with a straight *oxide-coated* filament and a cylindrical aluminum anode was produced by Wehnelt,⁴³ the inventor of oxide-coated cathodes. Then, in 1908, the first three-electrode tubes appeared; this was the epoch-making de Forest's *audion*.^{44,45} About the

³⁴ D. D. Knowles and S. P. Sashoff, "Grid controlled glow and arc discharge tube," *Electronics*, vol. 1, pp. 182-185; July, 1930.

³⁵ W. Gaede, "The molecular air pump," *Ann. der Phys.*, vol. 41, pp. 337-380; June, 1913.

³⁶ W. Gaede, "Gas diffusion through mercury vapor at low pressure and a diffusion pump," *Ann. der Phys.*, vol. 46, pp. 357-392; February, 1915.

³⁷ I. Langmuir, "The condensation pump," *Gen. Elec. Rev.*, vol. 19, pp. 1060-1071; December, 1916.

³⁸ I. Langmuir, "The condensation pump," *Jour. Frank. Inst.*, vol. 182, pp. 719-743; December, 1916.

³⁹ S. Dushman, "New device for rectifying high tension alternating-current," *Electrician*, vol. 75, pp. 276-277; May, 1915; *Gen. Elec. Rev.*, vol. 18, pp. 156-167; March, 1915.

⁴⁰ L. Zehnder, "Radiation of electric force" *Ann. der Phys.*, vol. 47, pp. 77-92; September 1, 1892.

⁴¹ J. A. Fleming, "Thermionic valve," British Patent 24,850; November 16, 1904.

⁴² T. A. Edison, "Electrical indicator," U. S. Patent 307,301; October, 1884.

⁴³ A. Wehnelt, "An electric valve," *Ann. der Phys.*, vol. 19, pp. 138-156; January, 1906; *Phys. Zeit.*, vol. 5, pp. 680-681; October 20, 1904 (preliminary information).

⁴⁴ Lee de Forest, "Space telegraphy," U. S. Patent 879,532; January, 1907-February, 1908.

⁴⁵ Lee de Forest, "The audion-detector and amplifier," *Proc. I.R.E.* vol. 2, pp. 15-30; March, 1914.

same time, but later than de Forest, several other inventors in different countries proposed similar tubes. One may note that the effect of the grid on electrostatic field has been known to scientists from the fundamental works of Maxwell and Riemann.

All early radio tubes were "soft" tubes. In fact, at that time there was no means for establishing what we

watts. This progress in tube design, as it is widely known, was directly responsible for the inauguration of the most important branch of engineering art of our time, radio broadcasting (1920). However, soon the output from the individual tubes designed after the pattern of the early receiving tubes enclosed in glass envelopes reached its practical limit of 1 or 2 kilowatts; at higher ratings the tubes would turn out bulky and difficult to manufacture. Then, the invention by Housekeeper of the glass-to-copper seals, in 1922, gave a new impetus to radio-tube development, since water-cooled anodes could be constructed for much higher ratings. At once, the high-frequency output from a single tube rose to 10 and 20 kilowatts, and nothing was in the way of designing much larger modern tubes. In Europe, indeed, prior to this war, all leading manufacturers produced tubes with 350- and even 400-kilowatt output. In this country, however, because of the restriction imposed by the Federal Communications Commission on the output from broadcast transmitters, tubes for more than 100 kilowatts output have not been developed, although for a long time the leading role in development of large tubes belonged to this country. Only recently, a 250-kilowatt tube was announced by the Western Electric Company (Fig. 5).

The emergency of the last few years compelled manufacturers in many branches of industry to turn to "electronic processes". Among these applications induction and dielectric heating of manufactured parts and materials with a variety of purpose became very popular; high frequency or radio tubes were required in large numbers for these services, and proved to be a great success. It is enough to mention that in several (five or

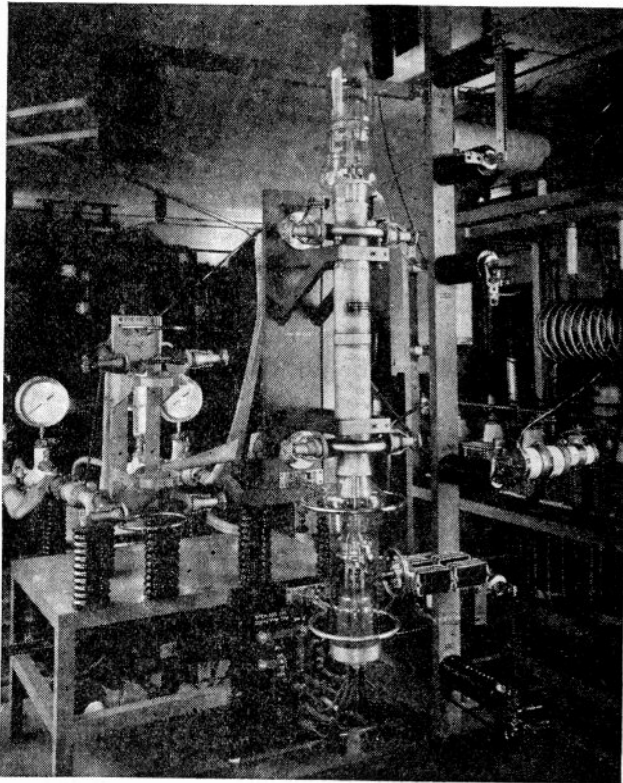

Fig. 5—320-A—Western electric 250-kilowatt tube.

now call high vacuum; on the other hand, for almost ten years, the physical phenomena in vacuum tubes in operation, especially the role of the residual gas, were not quite understood. Gas was even considered as an essential factor in proper tube performance. Moreover, mercury-arc tubes for reception and generation of radio waves were proposed by several inventors. The importance of high vacuum in radio tubes was not realized until theoretical work by Langmuir in this country and Schottky in Europe had been made known.^{46,47} This coincided with a considerable improvement in vacuum technics brought about by Langmuir and Gaede mercury pumps capable of establishing the highest necessary vacua.

A direct result of better vacuum pumps was designing and construction of triodes which could be operated at higher voltages and hence were able to generate or to amplify high-frequency output up to several hundred

⁴⁶ I. Langmuir, "The pure electron discharge," *Phys. Rev.*, vol. 2, pp. 450-486; December, 1913.

⁴⁷ W. Schottky, "The effect of space charge on thermionic currents in high vacua," *Phys. Zeit.*, vol. 15, pp. 526-528; April, 1914; also, pp. 624-630; May, 1914.

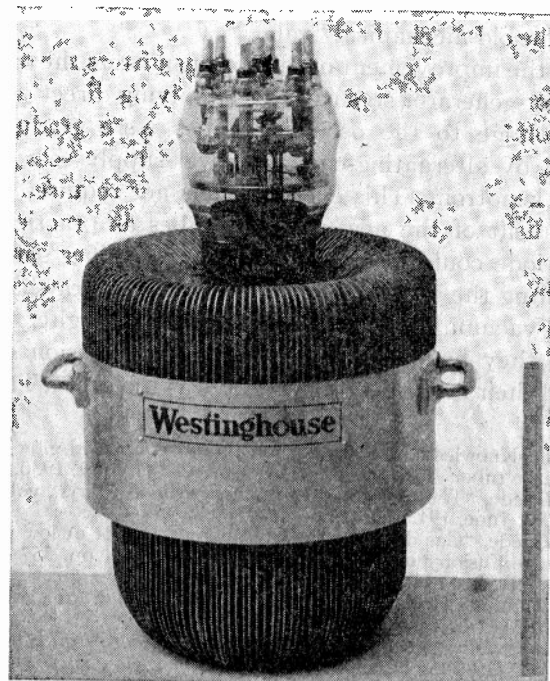

Fig. 6—WL-895-R modern 100-kilowatt maximum rating tube for radio and industrial applications.

six) installations for tin-reflowing, the total high-frequency power utilized is greater than the total nominal power of all broadcast transmitters in this country. The 100-kilowatt tube employed in these projects is of a modern design and was originally intended only for broadcast service; it is shown in Fig. 6. Obviously, if in the future there will be a sufficient demand, tubes of greater ratings can be designed. However, one may anticipate that 500 kilowatts is perhaps the ceiling for practical rating of individual sealed-off tubes; above this figure one may foresee that the cost of tubes will be out of proportion to their advantages because of increased difficulties in design and in manufacturing the tube.

It looks as though in this case industry may turn to the *demountable* tubes; these can be assembled and taken apart for repairs at the place of their use, like engines. The main objection to this type is that they must be continually exhausted in operation, hence they require a better-trained personnel. But the continually pumped mercury-tank rectifiers may serve as a rather encouraging example.

The demountable tubes are not new. Since 1923, the French Navy had in service a number of 10- and 30-kilowatt demountable tubes, designed by Holweck. During the decade preceding this war, because of the invention of the new and improved oil-condensation pump by Burch in England, a few demountable tubes of larger size were in operation throughout Europe in radio; but mainly they became popular in the metallurgical industry for melting alloys. In this country the application of demountable tubes is thus far limited only to a few scientific projects, such as cyclotrons, megavolt X-ray tubes, etc.⁴⁸

While touching upon the types of high-frequency tubes one may note that *forced air-cooling* can be adapted practically to every water-cooled type of tube by soldering or brazing the tube in a specially designed multifinned cooler. Air-cooling represents advantages in those cases when water is not to be wasted; or when one does not wish to go to the expense of building a complicated plumbing system for distilling and recirculating water; or, simply, when the tubes are to be installed in an unheated room, in which ambient temperature may sink below 10 degrees centigrade.

Air-cooling was introduced into practice about eight years ago and since then has become quite popular. Fig. 6 shows the 895 tube in an air-cooler. Made of copper, this cooler weighs about 250 pounds. This, of course, is objectionable from the viewpoint of handling the tube in the factory, in transportation, and in the field. Therefore, one may expect that the time is not remote when aluminum will replace copper in these coolers. For the realization of this, one needs a simple

method of establishing a reliable bond between the aluminum cooler and copper anode.

From the viewpoint of the internal structure and the number of elements for controlling the electron current, large or transmitting tubes are of simpler types than small receiving tubes. Just a glance through an RCA Handbook for receiving tubes persuades one that their design is limited only by the type of service required and by the imagination of the designer, as there are ap-

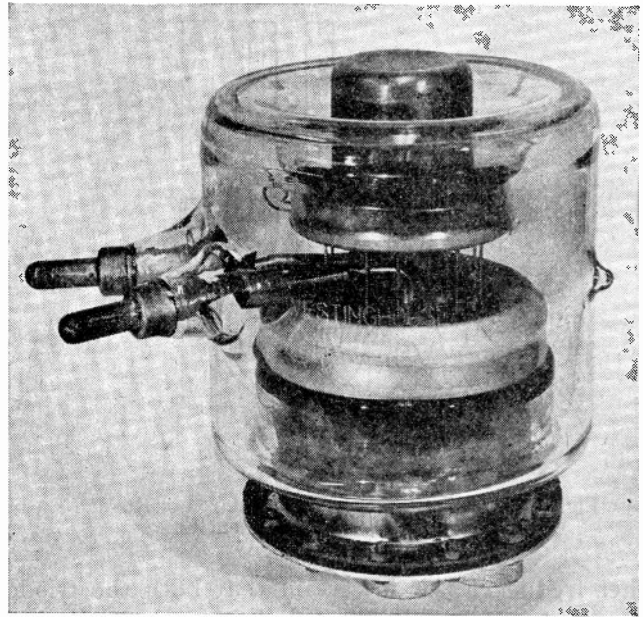

Fig. 7—WL-530 ultra-high-frequency triode for special applications. The first water-cooled tube designed with heavy self-supporting bird-cage thoriated tungsten filament and 100 per cent utilization of the anode surface.

parently no insurmountable manufacturing difficulties in the way of the realization of the most complicated structure. Such designs as that of "octode converters" having 6 grids (7A8), or of the "diode-triode-power-amplifier-pentode" with two cathodes, three anodes, and four grids (1D8-GT) are unthinkable in the larger tubes. Practically, all transmitting tubes with external anodes, up to recent times, were of the triode type. Radiation-cooled types assembled in glass envelopes can be more easily built and are built as screen-grid tubes or tetrodes, while the smaller members of this family are sometimes designed as pentodes.

With the advent of television, frequency modulation, and some other special services, a demand arose within the last ten years for *ultra-high frequency tubes*. In response, several triode amplifiers became available for these services capable of generating power of several kilowatts at required frequencies from 40 to 100 megacycles. Such are the 880, 889, 530 types and several others. These tubes are designed along the same general lines as the conventional triode, but they are of a short squat structure with inverted copper-to-glass seals (Fig. 7), or with kovar skirts brazed to copper anodes in order to reduce the total length of the tube; also, molded-glass

⁴⁸ I. E. Mouromtseff, H. J. Dailey, and L. C. Werner, "Review of demountable versus sealed-off power tubes," *Proc. I.R.E.*, vol. 32, pp. 653-664; November, 1944.

dishes from which all internal parts are supported are characteristic of these tubes. All these features are necessary for the reduction of the tube's internal inductance and interelectrode capacitance which is the main limiting factor in amplifier operation in the designed ultra-high-frequency band. It is quite possible that tetrodes of a good mechanical design will give a more satisfactory performance in these services.

However, with the existing trend to extend television and frequency modulation into the bands of higher and

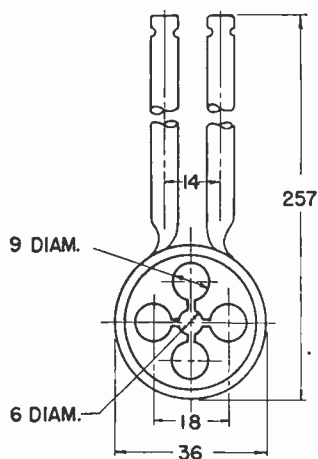

Fig. 8—Multiple water-cooled magnetron of Russian design for very high frequencies.

higher frequencies, it is certain that both the triodes and tetrodes of conventional designs, even if trimmed to the utmost with respect to the interelectrode capacitance and internal tube inductances, will not satisfy the new demands on account of the transit-time limitation. One has to look for a solution with the tubes in which the oscillating circuit and the electronic mechanism of the tube are designed together as integral parts of the same device. Two types of such devices have been known for several years: the magnetron and velocity-variation tube.

The *magnetron* is quite an important member of the vacuum-tube family. It was invented by Hull in 1921 as a power inverter, or power-controlling device. In 1928, two Japanese professors, Yagi and Okabe, found that a magnetron with the anode split into two or more segments is capable of producing oscillations of extremely high frequencies. Since that time vast work has been done by physicists and radio specialists all over the world. In 1940, a novel type of magnetron was described in the Russian technical press and republished in this country.⁴⁹ This tube consists of several individual magnetrons of small diameter (Fig. 8), with their centers arranged in a circle; the whole array is machined in a solid block of copper. The most important innovation is that,

⁴⁹ N. F. Alexeev and D. D. Maliaroff, "Generation of oscillations with a magnetron in the centimeter band," *Proc. I.R.E.*, vol. 32, pp. 136-139; March, 1944.

instead of the usual external circuit, a cylindrical "cavity resonator" is coupled to each magnetron, and all are coupled together through a common central cavity. The authors reported that with this tube they were able to generate 300 watts at a 9-centimeter wavelength. In order to appreciate this improvement one may mention that, when Kilgore of East Pittsburgh reported in 1932 1 watt output from his, then new, magnetron at about the same frequency, it was considered enormous; many interesting feats in transmission of radio beams could be demonstrated with this tube. Previously, even a small fraction of a watt at this frequency was considered satisfactory.⁵⁰

Another "unusual" type of tube of the future is the *klystron* which belongs to the family of electron beam and *velocity-variation* tubes. Attempts to harness a narrow beam of electrons to generate oscillations were made more than 40 years ago by Cooper Hewitt, and then by Vreeland in this country. The latter even succeeded in constructing a practical oscillator with a mercury-arc tube generating 500 cycles per second for laboratory measurements.⁵¹ Then, as early as 1907, an electron-beam tube, in which a magnetically controlled beam swung back and forth between two anodes in high vacuum, was proposed as a radio detector by von Lieben of Vienna.⁵² In more recent times, when radio engineers became ultra-high-frequency-minded, a number of beam oscillators has been proposed, based largely on a rotating or swinging back and forth beam in a cathode-ray tube with multiple anodes.

The first electron beam in which the initially uniform electron beam is converted into a succession of electron clusters by means of velocity variation was described by the Heils, 1935.⁵³ However, not all early beam oscillators were successful in practical applications, because they were forced to deliver power into conventional high-frequency circuits of low impedance, which did not match the inherently very high internal impedance of the beam tubes. It was not until Hansen had studied⁵⁴ and popularized "cavity resonators" that electron-beam tubes could be designed with an acceptable efficiency and output, even at extremely high frequencies. The first, and a very good representative of the velocity-variation beam tubes with cavity resonators for oscillating circuits, was the klystron developed by the Varian brothers,⁵⁵ in 1939. A variety of applications of the klystron may be anticipated in postwar electronics.

⁵⁰ A. G. Clavier, "Production and utilization of micro-waves," *Elec. Commun.*, vol. 12, pp. 3-11; July, 1933.

⁵¹ H. K. Vreeland, "A sine-wave oscillator of the organ pipe type," *Phys. Rev.*, vol. 27, pp. 286-293; October, 1908.

⁵² V. R. von Lieben, German Patent 179,806; 1906.

⁵³ A. Arseniewa Heil and O. Heil, "New method of generating short continuous waves of high intensity," *Zeit. Phys.*, vol. 95, pp. 752-762; July, 1935.

⁵⁴ W. W. Hansen, "On the resonant frequency of closed concentric lines," *Jour. Appl. Phys.*, vol. 10, pp. 38-45; January, 1939.

⁵⁵ R. H. Varian and S. H. Varian, "A high frequency oscillator and amplifier," *Jour. Appl. Phys.*, vol. 10, pp. 321-327; May, 1939.

PHOTOTUBES

Many industrial or nonradio applications of electronic tubes of all kinds are greatly enhanced, or even made possible, by the use of *photocells*. Other tubes, thyratrons or high-vacuum amplifiers, actuated by minute phototube currents and voltages, are used to operate all kinds of mechanisms and electronic circuits.

The phototube is the only modern electronic tube which cannot claim direct descent from the Crookes discharge tube or from the incandescent lamp, although later in its career its design was benefited by the technics and theories developed in connection with other electronic tubes. Photoeffect was first observed in a wet cell and recorded by Becquerel in 1839 with no deductions whatever. Then it was observed under different circumstances by Hertz, during his epoch-making experiments

with electromagnetic waves, in 1888. Immediately, Wilhelm Hallwachs took notice of this and carried out a study of photoelectricity, which was followed by the work of several other scientists, like Righi and the noted physicists, Elster and Geitel. The first photocell useful in scientific measurements consisting of copper oxide on copper was built by Hallwachs, while the first alkali cell almost in its modern form was introduced by Elster and Geitel, in 1912.

The applications of phototubes in modern electronics in a variety of control and regulation devices are too numerous even to attempt to list them. However, one may specifically remember one outstanding application of photosensitive films: this is in television pickup tubes, iconoscope, image dissector, etc., in which the mosaic consists of a multitude of tiny photocells.

Some Notes on the Design of Electron Guns*

A. L. SAMUEL,† SENIOR MEMBER, I.R.E.

Summary—A method is outlined for the design of electron guns based on the simple theory first published by J. R. Pierce. This method assumes that the electrons are moving in a beam according to a known solution of the space-charge equation, and requires that electrodes exterior to the region of space charge be shaped so as to match the boundary conditions at the edge of the beam. An electrolytic tank method is used to obtain solutions for cases which are not amenable to direct calculation. Attention is given to some of the complications ignored by the simple theory and to some of the practical difficulties which are encountered in constructing guns according to these principles. An experimental check on the theory is described, together with some information as to the actual current distribution in a beam produced by a gun based on this design procedure.

INTRODUCTION

THE PROBLEM to be considered in the present paper is the practical design of electron guns to give reasonably high currents and high current densities without the sacrifices in beam current which are normally accepted in cathode-ray-tube guns. The first part of the paper consists of an elaboration of the simple theory as first published by Pierce.¹ Attention will then be given to some of the practical difficulties which are encountered when one attempts to build electron guns according to these principles, and an experimental check on the theory will be described.

FUNDAMENTAL THEORY

Following the method outlined by Pierce,¹ we will start by assuming that the electrons are moving in a

* Decimal classification: R388. Original manuscript received by the Institute, October 5, 1944. Presented, National Electronics Conference, Chicago, Ill., October 6, 1944 (the Chicago Section of The Institute of Radio Engineers was one of the sponsors of the National Electronics Conference).

† Bell Telephone Laboratories, Inc., New York, N. Y.

¹ J. R. Pierce, "Rectilinear electron flow in beams," *Jour. Appl. Phys.*, vol. 2, pp. 548-554; August, 1940.

beam according to known solutions of the space-charge equation. Electrodes exterior to the beam are shaped so that boundary conditions are consistent with the assumed motion. This method results in a simple mathematical description of the fields inside and outside of the beam when the beam is actually present in the electrode system. It completely avoids any separate consideration of the diverging space-charge effect in the beam in the absence of surrounding electrodes, and of the converging effect of the electrode system in the absence of the beam.

The first problem is that of showing that a uniform rectilinear electron flow, according to the known space-charge equations, is theoretically possible in limited regions with abrupt boundaries. For example, consider the flow of electrons from a plane cathode to a parallel plane anode. As long as these planes are infinite in extent, and conditions of complete space charge are assumed, the potential distribution is completely defined and follows the well-known Child equation.² If, however, it is desired to have the condition of space charge flow over a restricted area, then one must satisfy certain boundary conditions at the edge of the beam. Of course, in all practical electronic devices, the electron flow does occur in limited regions, but there usually exists a border region in which the electron flow is neither uniform nor rectilinear. We are now concerned with the problem of abruptly terminating the region of rectilinear flow. A moment's reflection will show that two conditions must be met in the absence of a transition region or of sheets of surface charge. In the first place, the potential must be continuous across the boundary; that is, the

² C. D. Child, "Discharge from hot CaO," *Phys. Rev.*, vol. 32, pp. 492-511; May, 1911.

potential just outside the beam must be everywhere identical with the potential just inside the beam. The potential inside the beam is, of course, specified by Child's equation, or, in the more general case, by a solution of Poisson's equation, while the potential outside the beam must satisfy the Laplace equation. The second condition is that the potential gradient normal to the beam must be zero along the boundary surface;

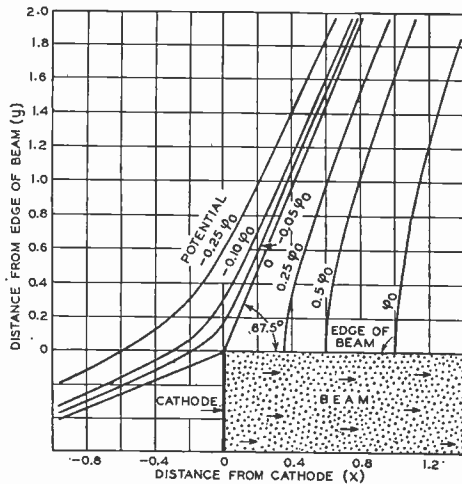

Fig. 1—Equipotential surfaces for parallel rectilinear electron flow with plane boundaries.

otherwise, the electron flow could not remain rectilinear. If a solution for a potential distribution exterior to the beam can be found which satisfies these two conditions along the boundary, then it is possible to have an abrupt boundary to the beam. Pierce has shown that this is indeed theoretically possible, and he has furthermore calculated the required potential distributions outside the beam for several special cases. To achieve these potential distributions, it is necessary only to enclose the region surrounding the beam by metal surfaces which are shaped to conform with the computed equipotential surfaces, and maintain these metal surfaces at the indicated potential.

Suppose, for example, that we consider the case of parallel flow with plane boundaries, in which the electrons entering the region come from a cathode forming one boundary and giving space-charge-limited emission. A plot of the calculated equipotential surfaces is shown in Fig. 1. All of the units are arbitrary, as the shapes of the equipotentials are independent of the absolute magnitude of the potentials involved and of the units in which distance is measured. Potentials are indicated in terms of an arbitrary potential ϕ assigned to one equipotential as measured from the cathode. It will be seen that the zero potential surface is a plane which makes an angle of 67.5 degrees with the normal to the cathode at its edge. Two examples of the way in which these principles might be applied are shown in Fig. 2. As shown on Fig. 2(A), a zero-potential electrode and a positive-potential electrode may be combined to give a parallel beam of electrons if a grid is used to permit the

electrons to pass through the positive electrode. In Fig. 2(B), both negative and positive electrodes are used and the beam passes through a slit in the second electrode. When the width of such a slit is considerably less than the cathode-anode spacing, it has only a small effect on the space-charge conditions in the vicinity of the cathode, but it will have a lens action. If the region to the right of the anode is field free, the beam will diverge as shown.

SOLUTIONS BY THE ELECTROLYTIC-TANK METHOD

In the practical case, we frequently require more complicated configurations which become progressively more difficult to compute. An experimental approach to the problem is required. As is well known, an electrolytic tank can be used to solve problems of potential distribution in the absence of space charge. The only problem is that of simulating the edge of the beam. Pierce has suggested that this be done by means of an insulating strip. As no current can enter this strip from the electrolyte, the potential gradient within the electrolyte must of necessity be zero at its surface. With the condition of zero field normal to the beam boundary so easily disposed of, the problem of finding suitable electrode shapes is merely that of adjusting the shapes and positions of the electrodes in the tank until the potential along the insulating strip varies as the appropriate func-

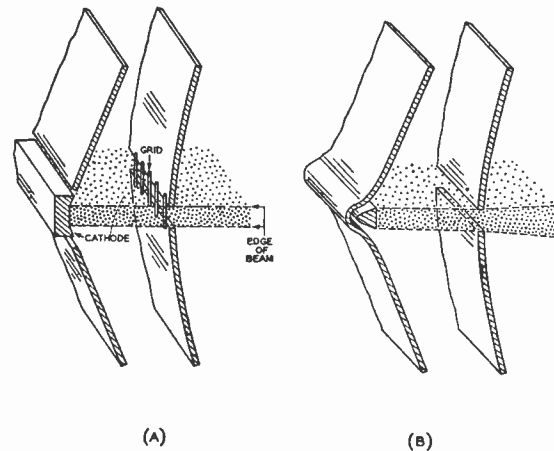

Fig. 2—Illustrations of the way in which bounding surfaces may be constructed to conform with the equipotential surfaces shown in Fig. 1.

tion of distance corresponding to the assumed space-charge conditions in the beam. It should be emphasized that in this method the region represented in the tank is only that portion of space external to the beam. The space-charge region is carefully excluded by the insulating strip.

Let us consider how this method can be applied in the design of electrodes to give parallel electron flow with cylindrical boundaries. Rather than attempting to represent the entire beam, it is convenient to work with only a thin wedge-shaped body of electrolyte formed by planes cutting through the axis of symmetry as

originally suggested by Manifold and Nicoll.³ This procedure is possible in all cases involving axial symmetry. A simple tank construction is shown in Fig. 3. The bottom is a tilted plane of nonconducting material. The thin edge of the wedge of electrolyte is the axis of symmetry corresponding to the axis of the cylindrical beam. Suitable electrodes to establish symmetrical equipotentials would be portions of figures of revolutions about this axis. When the angle of the wedge is small, these can be replaced by singly curved electrodes bent from flat sheets. The edge of the beam is represented by the insulating strip, which in this case is parallel to the thin edge of the wedge and spaced from it a distance corresponding to the radius of the electron beam. A calibrated potentiometer is used to measure the potentials along the insulating strip, and the electrodes are moved

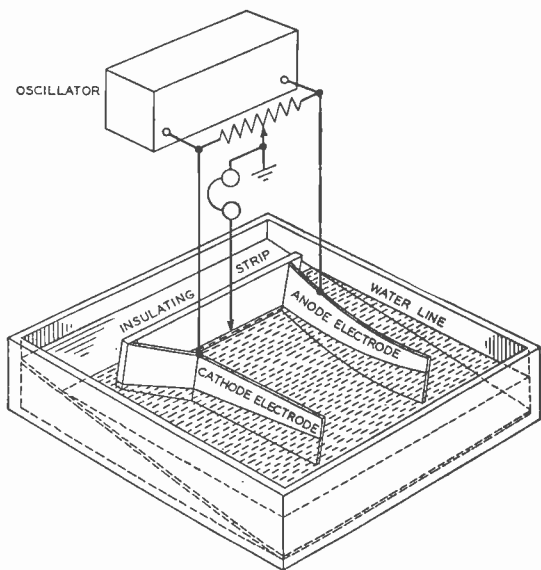

Fig. 3—Electrolytic-tank construction for problems possessing axial symmetry.

about and changed in shape until the desired potential distribution is obtained.

Equipotential surfaces obtained in this way are shown in Fig. 4. As before, the zero potential surface makes an angle of 67.5 degrees with the normal to the cathode. In fact, it can be shown that this is true under all conditions. These surfaces are, of course, only approximately correct. Although there exists but one unique set of equipotential surfaces which exactly match the boundary conditions, it is a fortunate fact that a relatively large number of electrode shapes can be found which produce a good approximation. This allows one to make a certain amount of adjustment of electrode shapes to meet the physical limitations of tube-construction methods.

While only two examples of rectilinear flow between parallel plane electrodes have been considered, it should

³ M. Bowman Manifold and F. H. Nicoll, "Electrolytic field plotting-trough for circular symmetric systems," *Nature*, vol. 142, p. 39; July 2, 1938.

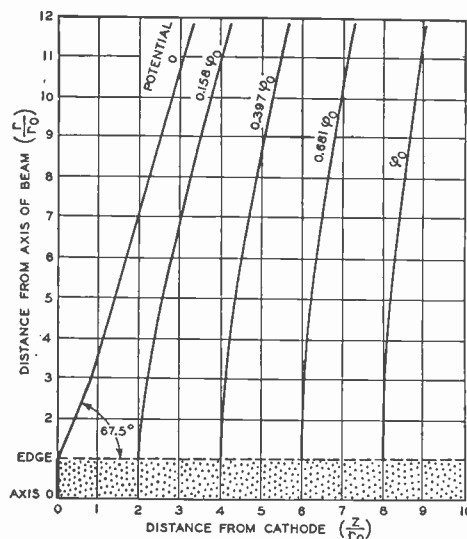

Fig. 4—Equipotential surfaces for parallel rectilinear electron flow with cylindrical boundaries.

be realized that the principles are not restricted to these two examples. Any form of bounding surface can be treated in the same way. The more general conditions of space-charge flow, for which the potential distributions are known,⁴ can be treated in an identical fashion.

The same principles can obviously be applied in the case of radial flow between cylinders and spheres. These

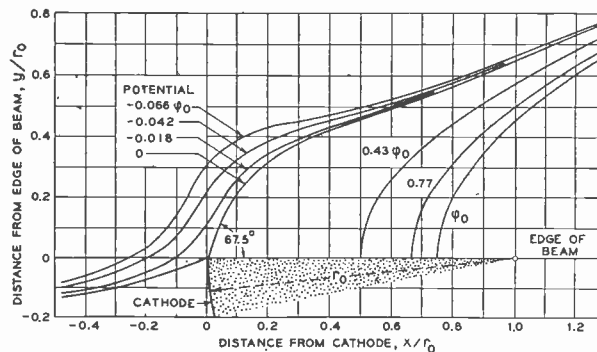

Fig. 5—Equipotential surfaces for radial rectilinear electron flow between segments of cylinders.

cases are of considerable practical interest, as they permit the concentration of the electron emission from a cathode either into parallel beams of high current densities or into converging beams.

The equipotential surfaces for radial rectilinear electron flow between segments of coaxial cylinders can be calculated by an approximate method. These are shown in Fig. 5. Fig. 6 shows a line-focus electron gun based on such equipotentials. Electrons leaving the cathode move along radii until they approach the anode. In passing through the slit in the anode, the beam suffers a diverging action which may be calculated from Davisson's

⁴ C. E. Fay, A. L. Samuel, and W. Shockley, "On the theory of space charge between parallel plane electrodes," *Bell. Sys. Tech. Jour.*, vol. 17, pp. 49-79; January, 1938.

equation⁵ which gives the focal length of such a lens as $f = 2\phi / E_2 - E_1$ where ϕ is the potential at the slit and E_1 and E_2 are the potential gradients which would exist on each side in the absence of the slit. The value of E_1

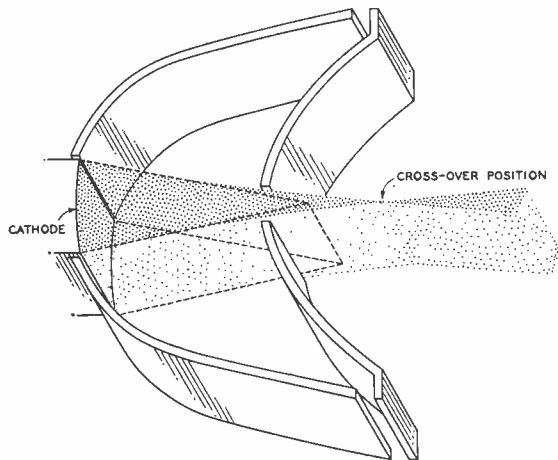

Fig. 6—A gun structure based on radial electron flow between segments of cylinders.

is, of course, that given by the space-charge equation in the gun region. The gradient on the other side of the slit is more difficult to evaluate. For those cases where E_2 can be neglected, the crossover will occur at a distance to the right of the slit as shown in the right hand curve of Fig. 7. It will be observed that for ratio of d/r_0

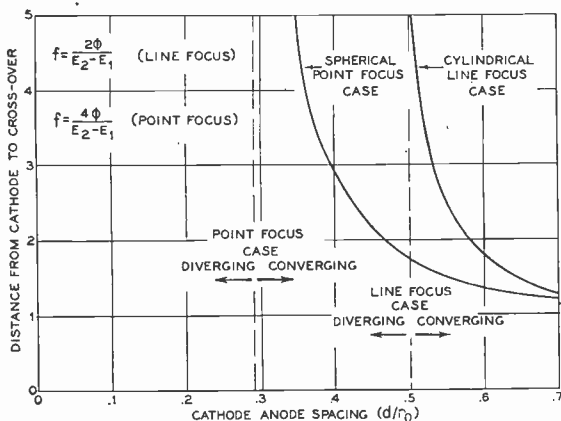

Fig. 7—Position of the crossover for line-focused and point-focused beams.

greater than 0.5 the beam will converge, while for values of d/r_0 of less than 0.5 the beam will diverge. The second curve on Fig. 7 will be considered later.

The analogous sort of spherical symmetrical flow, in which the electrons form a cone-shaped beam between spherical caps, is difficult to treat analytically. There is a different set of equipotentials for each angle of the cone occupied by the flow. The electrolyte tank approach must therefore be used and guns designed to meet specific requirements. The appropriate variations in potential with distance for which the electrodes are to be

adjusted can be obtained from the work of Langmuir and Blodgett.^{6,7} Their data are shown plotted in a form suitable for our use in Fig. 8. For convenience, curves as shown for both the cylindrical and the spherical cases, the abscissa is the ratio of the anode-cathode spacing to the cathode radius, and the ordinate is either their parameter α raised to the 4/3 power or their parameters⁸ $(r\beta^2/r_0)^{2/3}$. When so plotted, the segments of the curves to the left of any specified abscissa value are linear plots to an arbitrary scale of the potential distribution in structures having a value of the ratio of spacing to cathode radius as specified by the abscissa value. For ex-

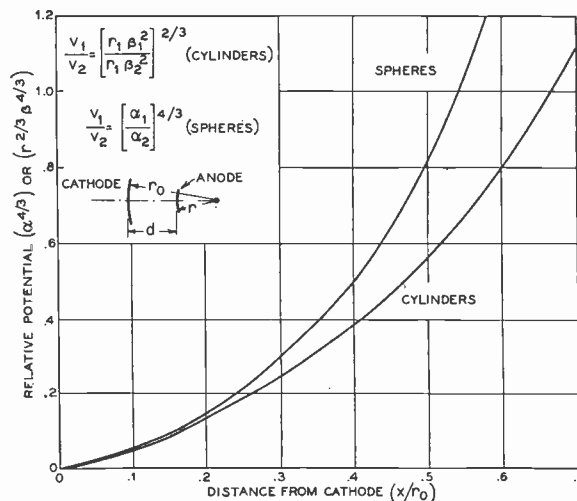

Fig. 8—Potential distribution between coaxial cylinders and concentric spheres with complete space charge. (Authors note. The second expression in the ordinate should read $(r^2/3\beta^4/3/r_0^2/3)$.)

ample, with a value of 0.5 for this ratio, the curve to the left of the abscissa 0.5 is the desired plot. To convert the potential scale into units of the anode potential, one need only divide ordinate values by the ordinate value corresponding to the limiting abscissa value, that is, by 0.83 (for the concentric sphere case), while distances from the cathode are given in terms of the cathode radius directly along the abscissa scale.

DESIGN OF A POINT-FOCUSED GUN

Now let us suppose that we are faced with the job of designing a point-focused gun. Before an intelligent choice can be made of the ratio of spacing to cathode radius, some consideration must be given to the lens action of the hole which must be cut in the anode to transmit the electron beam. As noted earlier, it is possible to compute this from the lens equation of Davisson, provided one knows the field conditions on the far side of the anode. With converging beams these are not known with certainty, so that a certain amount of judgment is involved. By referring again to Fig. 7, which

⁶ I. Langmuir and K. B. Blodgett, "Current limited by space charge between coaxial cylinders," *Phys. Rev.*, vol. 22, pp. 347-356; October, 1923.

⁷ I. Langmuir and K. B. Blodgett, "Current limited by space charge between concentric spheres," *Phys. Rev.*, vol. 24, pp. 49-59; July, 1924.

⁸ For definitions of these parameters see references 6 and 7 above.

⁵ C. J. Davisson and C. J. Calbick, "Electron lenses," *Phys. Rev.*, vol. 42, p. 580; November 15, 1932.

applies to the case in which this field can be neglected, it will be observed that convergence will occur for all values of cathode-anode spacing greater than 0.29. For values less than this, the beam will diverge. In the limit when the ratio of spacing to cathode radius approaches zero, the electrons appear to diverge from a point which is located behind the cathode surface by a distance of twice the cathode-anode spacing.

Having chosen a value of the ratio of anode-cathode spacing to the cathode radius on the basis of the desired beam convergence, we must next decide on the conical angle of the beam. This angle is intimately related to the desired gun perveance, defined as the ratio of the beam current in amperes to the 3/2 power of the voltage. Perveance is used, since it is a constant for any given structure under conditions of complete space charge, subject only to the restriction that only one potential difference is involved, or if more than one potential is involved the ratios between them are maintained constant. The value of this parameter as given by Langmuir and Blodgett when applied to a cone-shaped beam is

$$I/V^{3/2} = 14.68 \times 10^{-6} (1 - \cos \theta)/\alpha^2$$

where θ is the cone angle measured from axis, and α is the same parameter plotted in Fig. 8, where it was seen to depend only upon a ratio of certain dimensions and not upon the absolute scale. From this it is seen that the perveance is independent of the physical size of the gun, being a function of its shape only. In passing, it should be noted that this independence of perveance on size is true in general for all structures in which the 3/2 power law is obeyed. This perveance equation is plotted in Fig. 9. The perveance equation for the cylindrical case is shown in Fig. 10. In using these charts it is convenient to remember that a perveance of 1×10^{-6} corresponds to a current of 1 microampere at 1 volt, 1 milliampere at 100 volts, and 1 ampere at 10,000 volts.

That portion of Fig. 9 to the left of an abscissa value of 0.29 is shaded, to indicate that a diverging beam would result if a circular hole is used in the anode to transmit the beam. For perveances greater than roughly 50×10^{-6} , ways must be found to circumvent this limitation.

Some trouble is to be expected for perveances even lower than this value, however, as a result of the reduced and nonuniform field at the cathode surface caused by field penetration through the hole. To assist in evaluating this effect, two additional geometric curves are shown on Fig. 9. These show the relationship between the cone angle and the cathode-anode spacing when the hole diameter is, respectively, equal to the spacing and equal to $\frac{1}{2}$ the spacing.

An additional design step is required if one wishes to compensate for the anode hole. Consider, for a moment, space-charge flow between complete spherical surfaces. The perveance depends only upon the ratio of cathode-anode spacing to cathode radius. However, for this same structure in the absence of space charge, there will also

exist a unique value for the off-cathode potential gradient. A hole cut into the anode will distort the field at the cathode and modify the off-cathode gradient, as well as altering the space-charge conditions. Compensating changes in the shape of cathode surface opposite the hole which tend to make the no-space-charge off-cathode gradient uniform, will at the same time tend to make the cathode emission uniform under space-charge

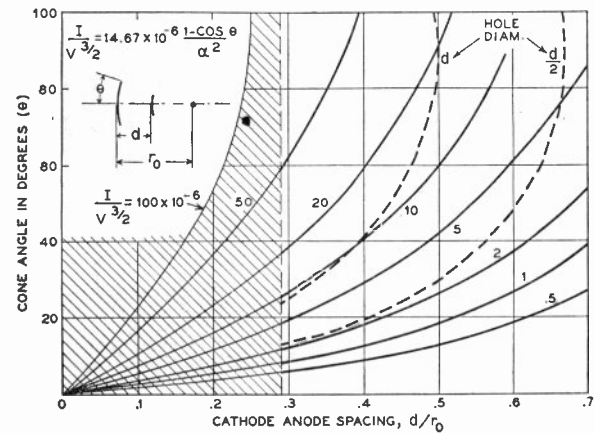

Fig. 9—Beam perveance for spherical caps.

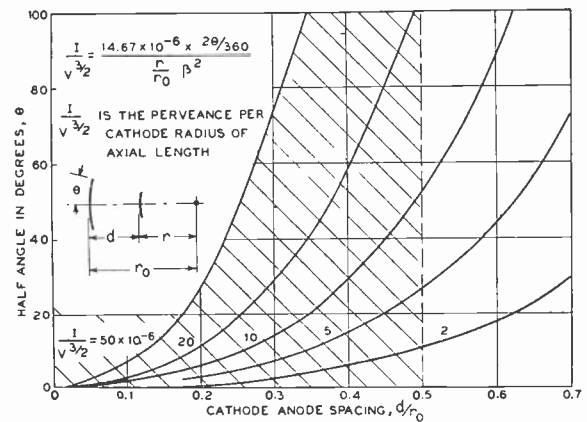

Fig. 10—Beam perveance for cylindrical segments.

conditions, and restore the perveance to its desired value. Only a moderate amount of compensation can be obtained in this way, since altering the shape of the cathode surface will alter the directions of the initial electron accelerations and this will introduce focusing difficulties if carried too far. The electrolytic tank can be used for this problem by setting up electrodes simulating the complete spherical case, introducing the hole in the anode sphere symmetrical with respect to the axis and investigating the off-cathode gradient. As non-spherical surfaces are sure to result from this modification of the design procedure, we have normally omitted it. For cases where some compensation is essential, a number of quite different empirical design approximations have been used from time to time with nearly equal success. None of these methods is sufficiently fundamental to justify detailed description.

With these preliminary considerations out of the way, we can proceed to the electrolytic tank and lay out the

electrode design external to the beam. The design is obviously quite independent of the physical size, although the actual size of any physical gun is fixed by the desired current and by the permissible current density from the cathode.

EXPERIMENTAL CONFIRMATION

As a check on the usefulness of this general method, a gun was designed and constructed to deliver 400 milli-

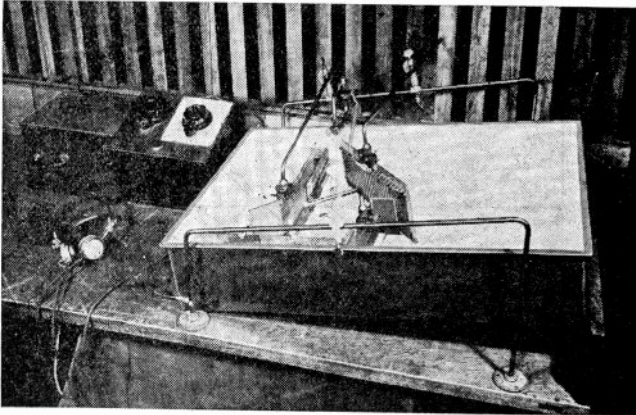

Fig. 11—Electrolytic tank set up for a point-focused gun.

amperes at a computed perveance of 6×10^{-6} . The cone angle was set at 42 degrees and the spacing at 0.47. No effort was made to compensate for the nonuniformity resulting from the anode hole. The electrolytic tank used for this purpose is shown in Fig. 11. This is simply a large developing tray, tipped at an angle. A piece of heavy plate glass with Cartesian co-ordinates etched on it forms the bottom of the wedge-shaped electrolyte. A series of line electrodes are spaced at equal intervals along the insulating sheet which simulates the edge of the beam. In this case this sheet makes an angle of 42 degrees with respect to the axis, as defined by the thin edge of the wedge. The actual electrode shapes which were finally chosen are shown in Fig. 12. This is a single-

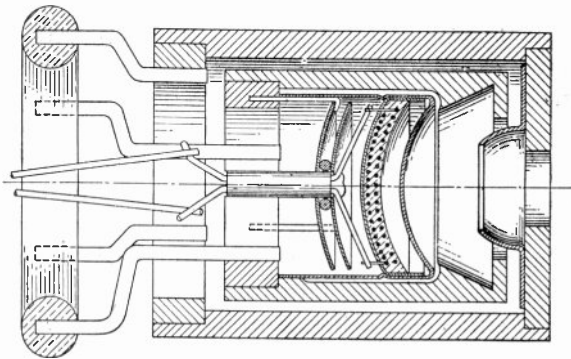

Fig. 12—Section view of a point-focused gun.

potential gun having one electrode at the cathode potential which in this case makes an angle of 67.5 degrees with the normal to the cathode surface at its edge, in accordance with the theoretical requirement. Attention is called to the fact that a double aperture is used in the anode.

The second limits the penetration of any external fields which may be present into the region near the first aperture, and insures that the gun will focus more or less independent of the external conditions. While external fields will produce lens action at the second aperture, this lens is located fairly close to the final crossover position, and so has a fairly small effect. The second aperture also tends to suppress secondary electrons that are knocked out of the edge of the first aperture as a result of imperfectly focused primary electrons from the cathode.

How well this gun performed may be judged by referring to Fig. 13. Three curves are given, one showing the current to a collector placed at some distance from the gun, the second showing the current to a thin disc

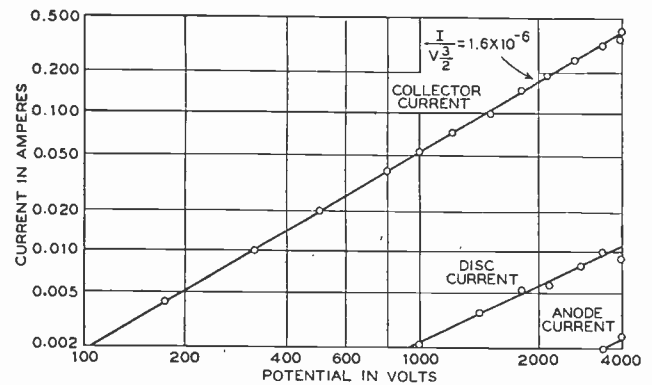

Fig. 13—Experimental point-focused gun data.

containing a 0.100-inch hole placed at the computed crossover point, and the third showing the current to anode of the gun. It will be observed that only a negligible amount of current was deflected to the gun anode, and that something over 96 per cent of the total current passed through the 0.100-inch hole. One disturbing feature was the low perveance, the measured value being 1.6×10^{-6} as compared with the computed value of 6×10^{-6} . This can be explained by the failure to compensate for the hole in the anode.

A series of such guns is shown in Fig. 14. In some of these guns the agreement between calculated and

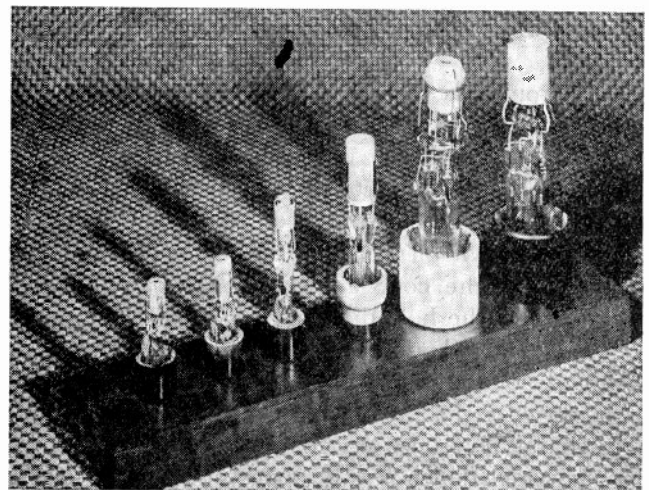

Fig. 14—A series of point-focused guns.

measured perveance is considerably better than for the example quoted. In fact, when proper allowance is made for the effects of the anode hole, the calculated and measured perveances are usually within normal engineering tolerances.

THE CURRENT DISTRIBUTION IN A POINT-FOCUSED BEAM

The current distribution within the beam produced by such a gun is of some interest. While the theoretical basis for the design naively assumes a uniform current distribution throughout the beam, a number of factors are neglected. The nonuniform field at the cathode, imperfection in the matchings of boundary conditions, the removal of edge electrons by the anode, thermal velocities, space-charge effects in the beam after it leaves the anode, to name a few, all tend to destroy this uniformity.^{9,10}

To investigate the actual distribution, a probe tube was constructed as shown in Fig. 15, containing the gun to be tested, a probe electrode containing a 0.010-inch slit which can be moved across the beam at any desired

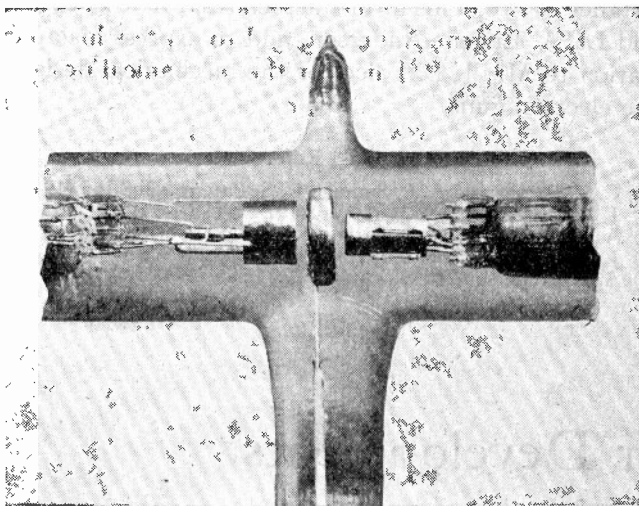

Fig. 15—Probe tube for studying the current distribution in the beam.

distance from the gun, and a suitably shielded collector to measure the current passed by the slit. Ideally, one should measure the current passed by a small hole moved across a diameter of the beam rather than using a slit. The lineup problem makes this an impracticable procedure. However, from the shape of the current distribution observed with a slit, it is possible to obtain a fair idea of the radial distribution. In particular, if the radial distribution is uniform, the integrated distribution curve will be semielliptical, that is, it will have sharp edges. On the other hand, if the radial distribution is Gaussian, an error-function curve will result. These two cases are illustrated in Fig. 16.

⁹ D. B. Langmuir, "Theoretical limitations of cathode-ray tubes," Proc. I.R.E., vol. 25, pp. 977-992; August, 1937.

¹⁰ J. R. Pierce, "Limiting current densities in electron beams," Jour. Appl. Phys., vol. 10, pp. 715-724; October, 1939.

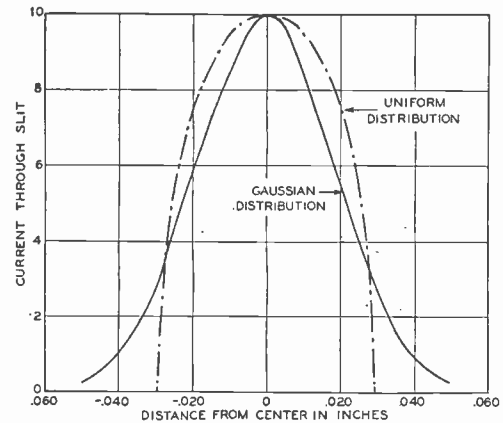

Fig. 16—Calculated probe data for idealized distributions of current density.

Experimental data obtained with the probe tube are shown in Fig. 17 for three different positions of the probe with respect to the gun, and for an accelerating field external to the gun. Very near the gun the distribu-

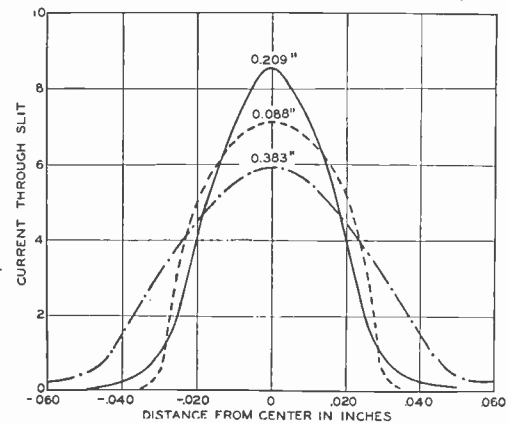

Fig. 17—Probe data at different distances from gun.

tion appears to be quite uniform, except for a slight tail which may be partly due to secondary emission. At greater distances, the distribution becomes more nearly Gaussian with a preliminary increase in current density at the center, and a subsequent decrease as the crossover distance is exceeded. Under the best conditions, the maximum current density appears to be well over one

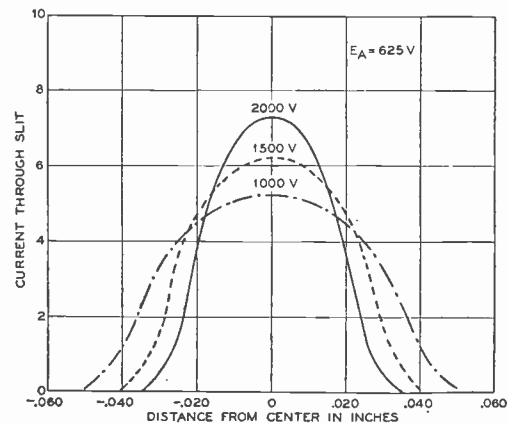

Fig. 18—Effects of accelerating field on beam diameter.

half of the limiting value imposed by thermal velocities. It should be pointed out that the actual shape of the beam cannot be directly inferred from these curves, since the motion of the probe electrode toward or away from the gun changes the field conditions, and so alters the size of the beam. Some idea of the effect of these fields can be obtained from Fig. 18, showing data taken with a fixed probe distance, but different accelerating fields. It will be observed that the accelerating field changes the size of the beam, but it does not have much effect on the essential shape of the current distribution.

HIGHER PERVEANCE GUNS

As mentioned earlier, there appears to be a practical limit to the beam perveance which can be obtained with

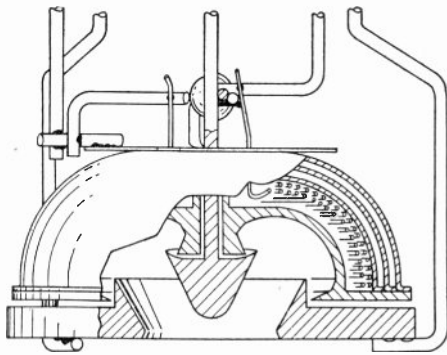

Fig. 19—A toroidal gun producing a point-focused beam.

a point-focused beam of the simple type which has just been discussed. The gun shown in Fig. 19 was constructed in an effort to obtain a still higher perveance.

The cathode surface was made in the form of an axially symmetric section of the surface of a toroid. Since the space-charge relationships between concentric toroids had never before been worked out, an approximation solution was used. The necessary electrode configurations were obtained in the electrolytic tank to produce a hollow conical-shaped beam designed to focus to a point on the axis. The experimental gun had a perveance of 30×10^{-6} as compared with a calculated value of 40×10^{-6} , and appeared to have a very sharply defined crossover.

By using a different portion of the toroidal surfaces, a second gun was designed producing a tubular beam of electrons with a measured beam perveance of 66×10^{-6} . If still higher perveances are required, accelerating grids can be used without invalidating the fundamental correctness of the design method.

ACKNOWLEDGMENTS

Credit has already been given for the valuable contributions to the theory made by Dr. J. R. Pierce. The writer wishes to acknowledge the collaboration and assistance of two of his former associates, Mr. C. V. Parker and Lt. A. Eugene Anderson, and to express his appreciation to Mr. J. P. Laico for the mechanical design of the electron guns.

Additional References

- (1) C. V. Parker and A. L. Samuel, U. S. Patent 2,268,165 (1941).
- (2) J. R. Pierce, U. S. Patent 2,268,197 (1941).
- (3) A. E. Anderson, U. S. Patent 2,308,800 (1943).
- (4) J. R. Pierce, U. S. Patent 2,318,418 (1943).
- (5) A. E. Anderson, U. S. Patent 2,321,886 (1943).

Recent Transformer Developments*

REUBEN LEE†, ASSOCIATE, I.R.E.

Summary—Descriptions of new transformer steel and insulation are given together with new circuits and applications involving transformers. Instances are cited of size reductions and extensions of frequency ranges in which transformers may be used.

Four outstanding and almost parallel developments have made possible a variety of improvements in radio transformers. These developments are: (I) new available core steels, (II) new insulation, (III) new circuits, and (IV) new applications. Stated thus, these developments may not sound very remarkable. The aim of this paper is to show how in some cases these developments make possible drastic size reductions, even to the point of eliminating transformers completely, and how in other cases transformers are used where formerly none were used. A range of instances all the way from complete disappearance of a transformer species to the evolution of a new one should be worth the attention of radio engineers.

* Decimal classification: 621.314.3×R382.1. Original manuscript received by the Institute, September 1, 1944; revised manuscript received, November 22, 1944.

† Westinghouse Electric and Manufacturing Company, Baltimore, Maryland.

I. NEW AVAILABLE STEEL

THE FIRST of these developments, namely, transformer steel, is a revolutionary advance in the art of making electrical sheet steel. Operating flux densities have been increased 30 per cent, losses have been reduced, and permeabilities increased several fold compared to ordinary silicon steel. Outstanding among the new steels is "Hipersil", a steel in which the direction of grain orientation is closely controlled during the manufacturing process. The new material requires that the flux flow in this preferred or grain-oriented direction (see Fig. 1) in order that the full benefit may be realized. For this reason, the cores are no longer stamped out of thin sheets, but are wound from strip and formed on a mandrel. The wound core is then annealed to take out the winding strains, impregnated with a bond, and cut in two to permit assembly with the windings or coils.

Following the cutting operation, the burrs are removed by successive grinding and etching. After the core is assembled with the coil, it is held together by means of a steel band. Because of the similarity of the shape of the two halves of the core to a letter "C", the cores are

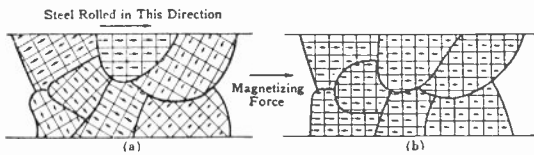

Fig. 1—Grain orientation.

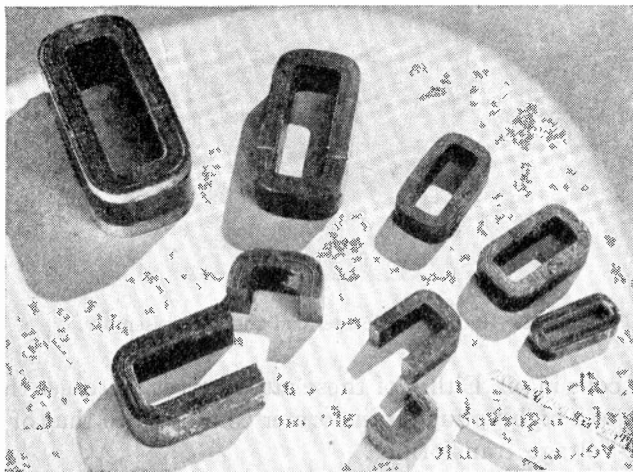

Fig. 2—Hipersil core.

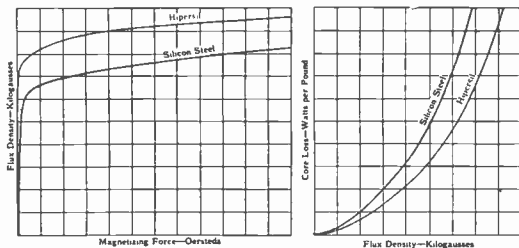

Fig. 3—Saturation curve comparisons, HiperSil versus Si steel.

known as Type C cores. Typical cores made in this manner are shown in Fig. 2, and the improved performance in Figs. 3, 4, 5 and 6. Transformer assemblies are shown in Figs. 7 and 8.

- The material is rolled in three major thicknesses:
- No. 29 gauge (about 13 to 14 mils thick) for frequencies up to 400 cycles
- 5 mils thick for frequencies higher than 400 cycles
- 2 mils thick for frequencies in the low and medium radio-frequency bands.

The superior properties of these steels can be utilized in one of three ways: reduction in size, improved performance, or both. Size reductions of 50 per cent are common at power frequencies using the 13-mil thick material. The 5-mil thickness is most commonly used in

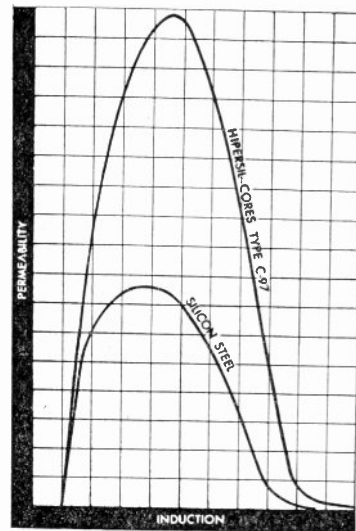

Fig. 4—Permeability of HiperSil and Si steel.

aircraft and portable equipment, where higher frequencies of 400 and 800 cycles are used. The need for high voltages in such equipment has fortunately been met by the advent of this low-loss, high-saturation-point steel. Fig. 9 shows comparative sizes of transformers of the same rating; the two larger units are suitable for 60-cycle operation, and the smallest for 400 cycles. Still more striking size reductions are made possible by the 2-mil thick material within the frequency range for which it is intended. In fact, it can be said that both of the thinner gauge materials make possible in their own fields the building of transformers not formerly practicable.

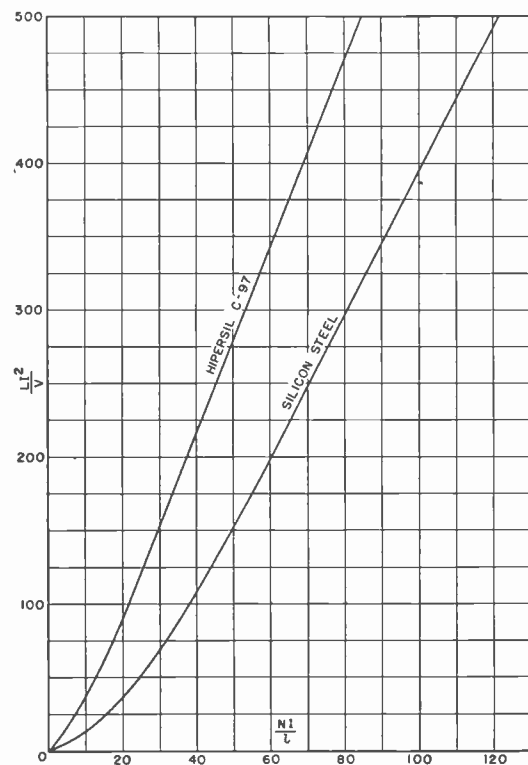

Fig. 5—Choke sizes in HiperSil and Si steel.

A glance at the fundamental transformer equation $e = Nd\phi/dt$ will reveal how the increase in magnetization has effected a reduction in size. If it is possible to increase the total flux, it is also possible to increase the voltage for a given number of turns, or for a fixed voltage

tion of electrical coils have until lately been diluted to some degree, at least, by the use of solvents to lower the viscosity in order to permit full penetration of the windings. When the coils are baked, the varnish dries, but is left with tiny holes through which moisture can penetrate, and in which corona may form. Eventually, this corona destroys the insulation. It is, therefore, necessary to allow large clearances for high voltages or to immerse

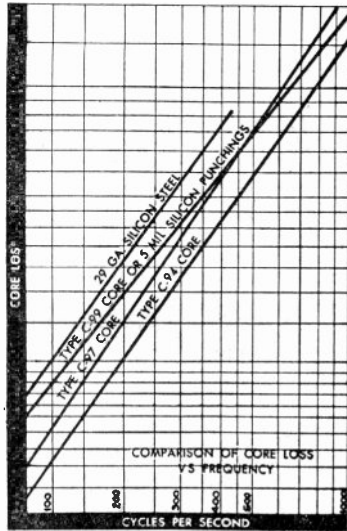

Fig. 6—Comparison of core loss versus frequency.

to reduce the number of turns. This is true at any frequency. But the leakage flux is also proportional to turns, so that if the total turns are reduced, the leakage flux decreases, and therefore better high-frequency performance is made possible.

II. NEW INSULATION

The second development consists in the invention of a radically new varnish. Varnishes used for impregna-

tion of electrical coils in oil. Either of these alternatives increases the size of a high-voltage transformer compared to that of a low-voltage transformer.

A new varnish (marked "Fosterite" after the inventor, Newton C. Foster of the Westinghouse research staff) changes from a liquid to a solid state with only slight change in volume. It is a polymerizing resin of low viscosity, requires no solvent and with care can be made to produce 100 per cent filling of coil interstices. Because of this excellent filling, it is possible to reduce voltage clearances to smaller values than formerly were possible, and therefore to obtain a pronounced reduction in size. Likewise, because of the fact that all air pockets are filled, moisture cannot penetrate the windings, and

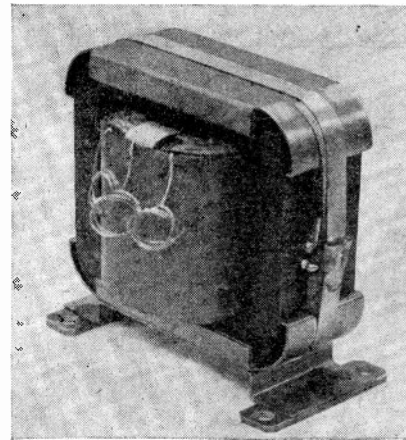

Fig. 8—Radio-transformer coil and core assembly.

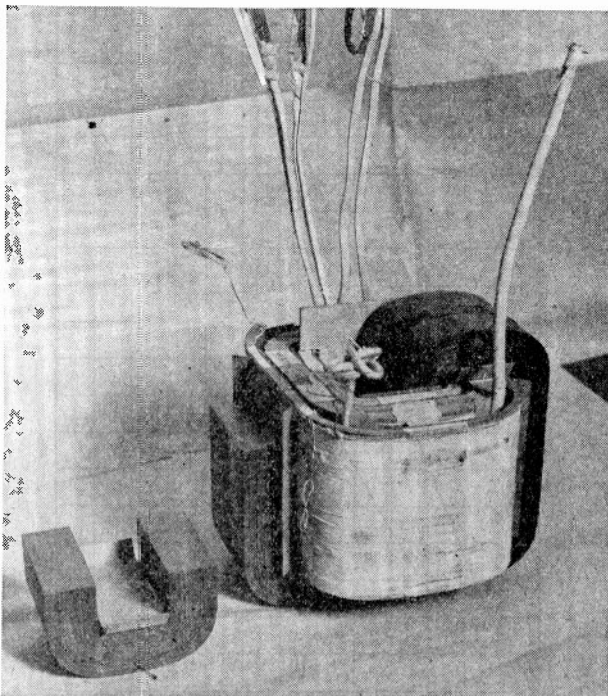

Fig. 7—Partly assembled transformer.

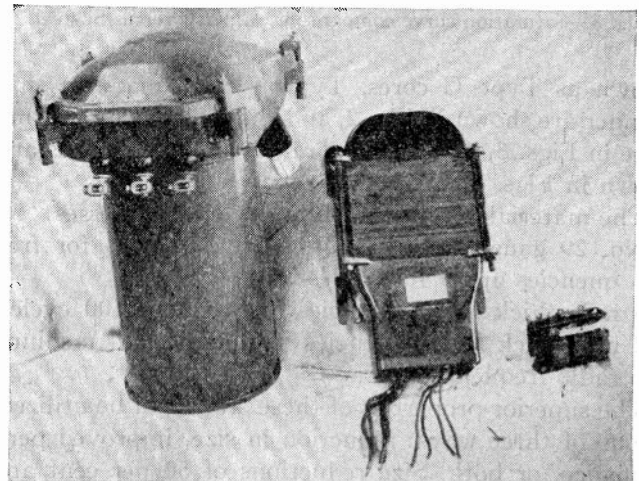

Fig. 9—Comparison picture of oil and dry distribution transformers with dry aircraft transformer.

much apparatus can be sealed effectively by impregnating with Fosterite. This is a great help in the reduction of size of small units. Especially notable are the protection and long life afforded to transformers containing small wire sizes and used in tropical atmospheres. Units with small wire last about one week in the tropics unless they are sealed to prevent moisture from entering the coils. No varnish, wax, gum or other material hitherto has given this protection.

Fosterite has low losses at radio frequencies. Its power factor is approximately 1 per cent at 1 megacycle, compared with 4 per cent for ordinary varnish. Its use, therefore, can be extended to radio-frequency components such as capacitors, chokes, and resistors. But more pertinent to this discussion is the fact that it affords for the first time a low-loss insulating compound for transformers operating at radio frequencies. Thus by the double advantage of decreased voltage clearances and low loss, Fosterite makes size reductions possible which have a wide bearing on radio-frequency performance.

III. NEW CIRCUITS

Typical of the third kind of development is the elimination of transformers in Class B driver stages, particularly the drivers of high-power Class B modulators for broadcast stations. The requirements for driver transformers are unusually difficult. The transformer load is nonlinear, in that grid-current peaks constitute wide departures from sinusoidal shape. The driver tube must deliver these instantaneous peaks although the

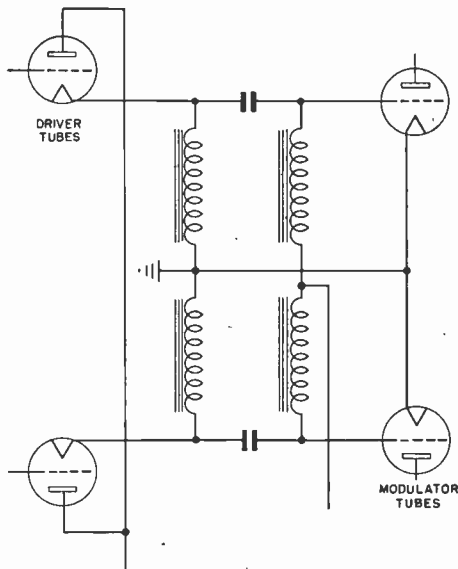

Fig. 10—Cathode-follower circuit.

average load is very low; otherwise distortion will appear in the modulator audio output and therefore in the radio-frequency envelope. The grid-current peaks are the equivalent of higher order harmonic currents, and to insure their appearance in the modulator grid current requires an extension of the driver-transformer fre-

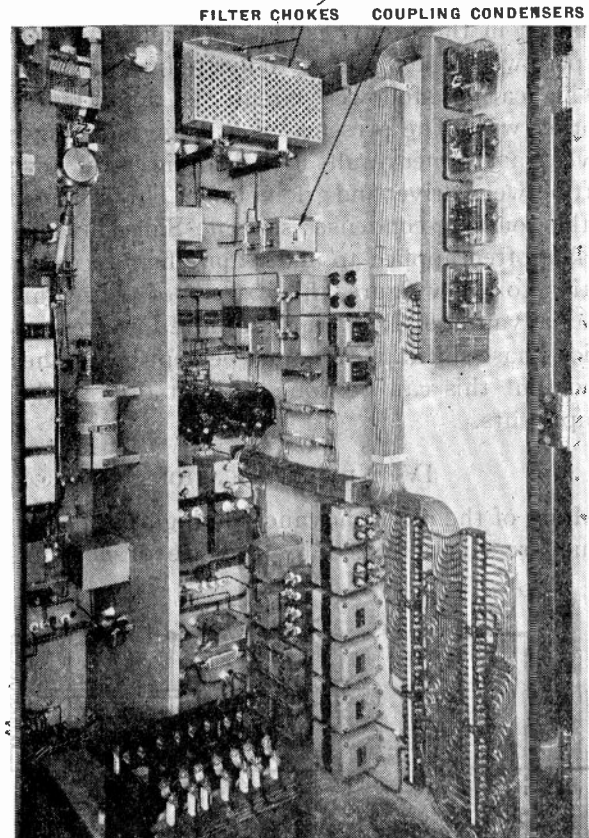

Fig. 11—Rear of exciter cubicle, 50 kilowatt transmitter.

quency range at both ends: on the high-frequency end because of the decreased leakage inductance necessary to allow the higher currents to flow, and on the low-frequency end to prevent transformer-magnetizing current, itself nonlinear, from loading the driver tube to the point where it will not deliver the peak grid power.

These difficult conditions require transformers of exceptionally large size. For example, a $7\frac{1}{2}$ kilovolt-ampere driver transformer weighs two tons; a 60-cycle distribution transformer, of the same rating and voltage class weighs 250 pounds (Fig. 9, left-hand unit). For low (1 to 2 per cent) over-all harmonic distortion, the driver-transformer design becomes impracticable. Hence the occasion arises for dispensing with the driver transformers entirely. This is accomplished by the cathode follower circuit, Fig. 10, which for a push-pull amplifier takes the form of a symmetrical pi filter. The two audio input chokes connect the driver-tube cathodes to ground and carry their plate current. Coupling condensers connect these chokes to the modulator-tube grid chokes, which carry modulator grid current. Sizes of chokes and coupling condensers are chosen to give approximately constant impedance from the lowest audio frequency up to the higher harmonics of the highest audio frequency, and insure that pronounced resonance effects throughout the frequency range are avoided. Leakage inductance is now eliminated, and the chokes are of reasonable dimensions. In Fig. 11, the filter components are

mounted in the exciter cubicle; a transformer for this purpose would be too large to locate internally.

The cathode-follower circuit is advantageous in another way. The presence of leakage inductance in a driver transformer results in high audio-frequency phase shift between driver and grid voltage. This is nonexistent in the coupling-condenser scheme. Since inverse feedback is often applied to audio amplifiers to reduce distortion to a low figure, the absence of phase shift is a great advantage. It is true that the low frequency at which phase shift appears must be kept below the audio band, but this can be done without excessively large components.

IV. NEW APPLICATIONS

Many of the recent advances in high-frequency technique are characterized by the use of nonsinusoidal

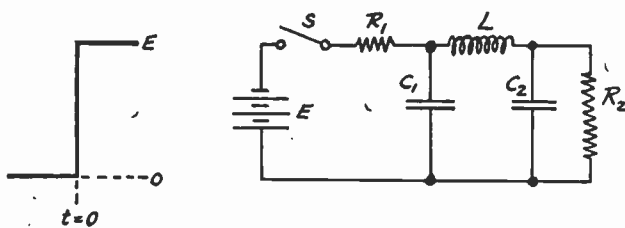

Fig. 12—Equivalent transformer circuit for front of pulse.

wave shapes. Some of these shapes have very steep fronts. They are equivalent to high frequencies of the order of 300 to 3000 kilocycles. To be used at such frequencies, cores must have very low losses, and windings must present as little series impedance or insertion loss as possible. Additionally, the core material must have as high a permeability as can be obtained. An ideal transformer would have infinite inductance on open circuit and zero inductance when short-circuited. It would also

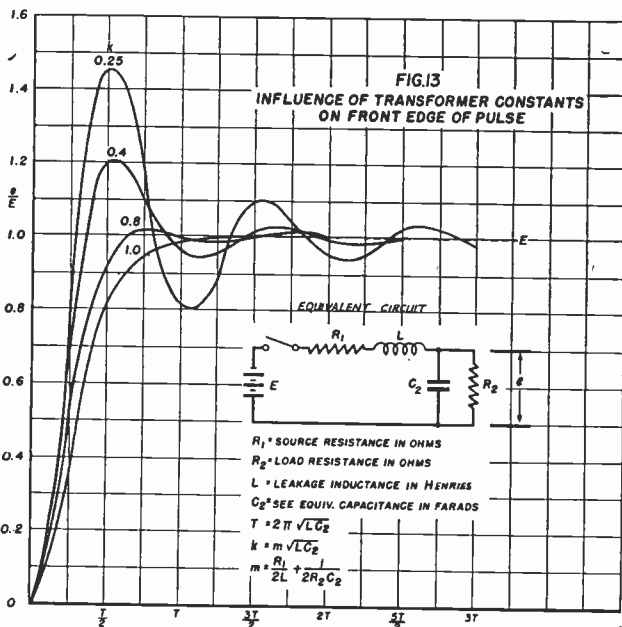

Fig. 13—Performance for front of pulse.

have low distributed capacitance and zero loss. High open-circuit inductance and low losses can be obtained for these applications by the use of thin-gauge Hipersil, which also contributes to the reduction of size, and therefore of leakage inductance and capacitance. In these cases, small size is not merely desirable; it is necessary for obtaining the proper performance. For the steep wave front a good transformer can be considered as an L or pi filter section (Fig. 12) whose wave-front response is shown in Fig. 13.

After the voltage has reached a steady value, often it must be maintained at or near this value for a certain period of time. It is a striking fact that this constancy of voltage is partly achieved through the character of the loads found in these high-frequency applications, which are commonly nonlinear as shown in Fig. 14, so that

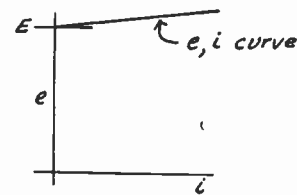

Fig. 14—Nonlinear load characteristic.

large changes of current can be had without much change in voltage. In many such applications, the current change is the more important of the two. By suitably proportioning the leakage inductance and distributed capacitance for a given load, it is possible to obtain the current and voltage wave shapes shown

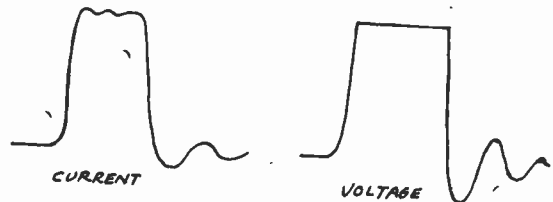

Fig. 15—Oscillograms of voltage and current wave shapes.

in Fig. 15 and thereby give the desired performance. This requires extreme care on the part of the designer, but even this care would avail the designer nothing were

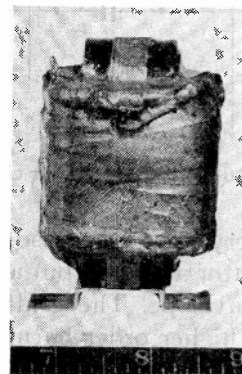

Fig. 16—Pulse transformer.

it not for the availability of materials which make possible the small size essential to obtain the required performance.

An example of the kind just mentioned has a Hipersil core, Fosterite-filled coils and the following characteristics:

Voltage ratio 4000/8000

Voltage rises to 90 per cent of final value in $\frac{1}{4}$ microsecond

Voltage stays constant within plus or minus 5 per cent for 2 microseconds

Maximum flux density in core 8000 gauss

Efficiency 88 per cent

Weight 1 pound 1 ounce

Dimensions $3\frac{1}{2} \times 3 \times 2$ inches (Fig. 16)

Transformers are now used in many such applications where formerly they could not be used, and where great pains had to be taken to eliminate them. Although the developments recounted here preceded the war, their application has been speeded up by it. It is to be hoped the day will soon arrive when more constructive use can be made of such transformers.

A Resonant-Cavity Method for Measuring Dielectric Properties at Ultra-High Frequencies*

C. N. WORKS†, T. W. DAKIN†, AND F. W. BOGGS†

Summary—A re-entrant cylindrical cavity has been adapted to measure the dielectric constant and power factor of small disk samples of insulating materials. The methods of measurement, mechanical details, and electrical coupling and detecting circuits are all described. A single cavity can be utilized only over a frequency range of about 1.5:1 ratio from lowest to highest frequency. Therefore, several different sized cavities would be required to cover a range of frequency from 50 to 1000 megacycles. An accuracy of ± 0.00005 in $\tan \delta$ and ± 1 per cent in dielectric constant may be obtained in routine measurements. Because the cavity has a very high Q (>2000), it is much more sensitive to low power-factor dielectric samples than any conventional coil-and-capacitor resonant circuit.

The chief advantages of this method are that the operation of the apparatus is simple, very rapid, and similar to the susceptance-variation technique now used at lower radio frequencies. Also, the involved computations usually found in other methods operative in this frequency range are eliminated.

I. INTRODUCTION

THE frequency range of 50 to 1000 megacycles has always proved a difficult range in which to measure the dielectric constant and loss of solid materials, because of residual lead and electrode inductance, resistance, and capacitance, and the difficulty of obtaining a solid sample to conform to the shape of the measuring device. Transmission-line methods of measuring a lumped impedance which have been recently treated by Hempel,¹ Kaufman,² Laville,³ Nergaard,⁴

* Decimal classification: R281. Original manuscript received by the Institute, October 25, 1944. Presented, Summer Meeting, American Institute of Electrical Engineers, St. Louis, Missouri, June 29, 1944; Rochester Fall Meeting, Rochester, New York, November 13, 1944. To be published in the *Transactions of the A.I.E.E.*, 1944. Published by permission of the American Institute of Electrical Engineers.

† Westinghouse Electric and Manufacturing Company, East Pittsburgh, Pennsylvania.

¹ W. Hempel, "Centimeter-wave measurements," *Elekt. Nach-Techn.*, vol. 14, pp. 33-43; January, 1937.

² H. Kaufmann, "Impedance measurements in decimeter-wave circuits," *Hochfrequenz- und Elektroakustik*, vol. 53, pp. 61-67; February, 1939.

³ G. Laville, "Recherches experimentales sur la propagation des ondes electromagnetiques le long des fils," *Annal. de Phys.*, vol. 2, pp. 328-404; 1924.

Miller and Salzburg,⁵ and Chipman,⁶ can of course be used to measure a dielectric sample considered as an impedance, but the problem remains here of attaching leads and electrodes to the dielectric so that they will not enter into the measurements, or of correcting for them if they do. Coaxial-transmission-line methods,^{7,8} where a section of (usually resonant) coaxial line is filled with the dielectric, are rigorous and satisfactory, but they require well-machined annular samples of considerable length, especially at the lower frequencies. Another method especially adaptable to high loss materials is that described by Wyman,⁹ where the phase angle and capacitance of a dielectric sample in this frequency range is compared to that of a standard sample with a cathode ray tube. Liquids can be conveniently measured by filling a coaxial line, and liquids surrounding a parallel transmission line have been measured by Drude.^{10,11} Liquids can also be measured readily in small coil and capacitor resonators which are totally immersed.¹²

At somewhat lower frequencies, below 100 megacycles

⁴ L. S. Nergaard, A survey of ultra-high frequency measurements, *RCA Rev.*, vol. 3, pp. 156-195; October, 1938.

⁵ J. M. Miller and B. Salzberg, "Measurements of admittances at ultra-high frequencies," *RCA Rev.*, vol. 3, pp. 486-504; April, 1939.

⁶ R. A. Chipman, "Resonance curve method for absolute measurement of impedance at frequencies of order 300 Mc/sec.," *Jour. Appl. Phys.*, vol. 10, pp. 27-38; January, 1939.

⁷ H. R. L. Lamont, "Theory of resonance in microwave transmission lines with discontinuous dielectric," *Phil. Mag.*, series 7, vol. 29, pp. 521-540; June, 1940.

⁸ C. R. Englund, "Dielectric constants and power factors at centimeter wave lengths," *Bell Sys. Tech. Jour.*, vol. 23, pp. 114-129; January, 1944.

⁹ H. O. Marcy, 3d, and J. Wyman, Jr., "Anomalous dispersion of dipolar ions," *Jour. Amer. Chem. Soc.*, vol. 63, pp. 3388-3397; 1941.

¹⁰ P. P. Drude, "Eine bequeme Methode zur Demonstration des elektrischen Brechungsexponenten von Flüssigkeiten," *Ann. Phys. Chem.*, vol. 55, pp. 633-655; 1895.

¹¹ P. P. Drude, "Zwei Methoden zur Messung der Dielektrizitätskonstanten und der elektrischen absorption beisschnellen Schwingungen," *Zeit. Phys. Chem.*, vol. 23, pp. 267-325; 1897.

¹² J. Wyman, Jr., "Measurement of the dielectric constants of conducting media," *Phys. Rev.*, vol. 35, pp. 623-634; March, 1930.

and down to several hundred kilocycles, the susceptance-variation technique of Hartshorn and Ward¹³ has the advantage of practically eliminating the effect of series lead and electrode inductance and resistance. This method using a coil-and-capacitor arrangement has been applied up to 100 megacycles. At this frequency the dimensions of the usual type of coil and capacitor needed to obtain resonance start to become unusually small. The usual circuits must, therefore, be modified. The coils used also have relatively low Q values so that insertion of low-loss dielectrics into the capacitor lowers the Q values of the circuit only slightly. The sensitivity of the apparatus, therefore, is relatively poor, when measuring low-loss materials. The resonant-cavity method described in this paper obviates most of these difficulties and has many advantages over the older methods.

II. THEORY OF MEASUREMENTS

The transition of the coil and parallel-plate capacitor resonant circuit at higher frequencies to a capacitor with a series of loops in parallel around it and from thence to a doubly (or singly) re-entrant closed cylinder is logical. This re-entrant cylinder is now a closed cavity capable of being resonated. It may also be thought of as a short-circuited quarter-wavelength transmission line with a capacitor at the open end. The capacitor actually makes the physical length of the line less than $\frac{1}{4}$ wavelength. Cross sections of a singly re-entrant cavity and a doubly re-entrant cavity are shown in Fig. 1.

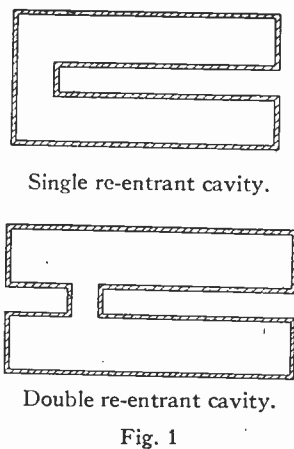

Fig. 1

The dimensions of such cylinders, resonant in the frequency range 50 to 1000 megacycles are quite reasonable, their lengths varying from about 2 feet to 2 inches. This length is governed partly by the average capacitance at the end, and partly by the ratio of the radii of the inner and outer conductors.

Capacitance

The dielectric under consideration is assumed to ex-

¹³ L. Hartshorn and W. H. Ward, "The measurement of the permittivity and power factor of dielectrics at frequencies from 10^4 to 10^8 cycles per second," *Jour. I.E.E.* (London), vol. 79, pp. 597-609; November, 1939.

tend flush to the edges of the electrode posts and fill completely the space between the electrodes. This is not necessary, for the dielectric sample may be smaller than the area of the posts and may even have an air gap in series with it. In such cases, standard equations for a combination of series and parallel dielectrics (air and sample) may be used to obtain the values for the sample, after the overall dielectric properties of the space between the electrodes have been determined.

Let only that part of the apparatus which holds the dielectric be considered. The capacitance between the ends of the re-entrant cylindrical posts when the dielectric is in place is $C_x + C_{e1}$. These and all following symbols are defined below.

DEFINITION OF SYMBOLS

- A = area of electrodes in the cavity in square inches.
- a = outside radius of inner conductor of cavity in centimeters.
- b = inside radius of outer conductor of cavity in centimeters.
- c = velocity of light in centimeters per second.
- C = capacitance between the ends of the re-entrant posts (electrodes) in the cavity at resonance.
- C_x = capacitance of sample being measured.
- C_T = total equivalent capacitance of cavity considered as a resonant coil and condenser.
- C_{a1} = air capacitance, excluding fringing, between parallel electrode faces at the separation existing when the sample is in place in the cavity. Unless there is an air gap between the sample and the electrodes, this is the calculated air capacitance of the sample.
- C_a = air capacitance of the sample. This equals C_{a1} if the sample has the same diameter as the electrodes, and is in contact with them.
- C_{e1} = fringing air capacitance with the electrode separation existing when the sample is in place in the cavity.
- C_{a2} = air capacitance, excluding fringing, between the parallel electrode faces at separation 2, when the sample has been removed and the cavity retuned to resonance by decreasing the electrode separation.
- C_{e2} = fringing capacitance at separation 2, as above.
- $C_1 = C_{a1} + C_{e1}$ = approximately C_{a1}
- $C_2 = C_{a2} + C_{e2}$ = approximately C_{a2}
- C_1', C_1'' = capacitances between the electrodes of the empty cavity, or $(\Delta C_1 = C_1' - C_1'')$ of an identical wavemeter, at f_1' and f_1'' , respectively.
- C_2', C_2'' = capacitances between the electrodes of empty cavity, or $(\Delta C_2 = C_2' - C_2'')$ of an identical wavemeter at f_2' and f_2'' , respectively.
- D_1 = separation of electrodes with the sample in the cavity.
- D_2 = separation of electrodes when the sample has

been removed and the cavity retuned to resonance.

D_1', D_1'' = separation of electrodes in the cavity or the wavemeter identical to the cavity when tuned to frequencies f_1', f_1'' .

D_2', D_2'' = separation of electrodes of the cavity at the half-power points when the cavity is empty.

δ = loss angle.

f = frequency of oscillation, cycles per second.

$(Q_1 = Q_T) = Q$ of cavity with dielectric inserted.

$(Q_2 = Q_0) = Q$ of cavity when dielectric has been removed.

S = length of internal conductor of coaxial part of cavity in centimeters.

ΔS = change in S on retuning cavity to resonance after removing sample. This is the same as the change in separation of the electrodes.

σ = conductivity of metal covering inside of cavity in mhos per centimeter (5.8×10^5 for copper).

ω = angular frequency of oscillations.

Z_0 = characteristic impedance of coaxial part of cavity.

V_0 = voltage of resonance with sample removed from cavity.

V_T = voltage of resonance with sample inserted.

r_0 = radius of electrode in centimeters.

r_s = radius of sample in centimeters.

f_1', f_1'' = frequency at the half-power points with the sample in the cavity.

f_2', f_2'' = frequency at the half-power points with the cavity empty.

$1/Q_x = \tan \delta_x$ = dissipation factor of the dielectric sample $\cong \cos \theta$, the power factor

$\tan \delta_D$ = dissipation factor of dielectric which fills the entire cavity.

$\tan \delta_0$ = dissipation factor of the empty cavity.

ϵ' = dielectric constant.

f_1 = resonant frequency of cavity with sample inserted.

E = electric field strength.

Note: Capacitance is in farads in all equations.

When the dielectric is removed, and the gap between the electrodes (ends of the re-entrant posts) has been closed sufficiently so that the cavity is resonant again at the same frequency, we have capacitance between the electrodes equivalent to what we had before. This capacitance is given by the expression $C_{a2} + C_{e2} - (dC/dS)\Delta S$, where $(dC/dS)\Delta S$ is the correction term for the small change in length of the coaxial line which necessarily takes place when one of the posts is extended inward to diminish the gap.

Now, since the circuit is resonant in each case, the following relation is true:

$$C_x + C_{e1} = C_{a2} + C_{e2} - (dC/dS)\Delta S. \quad (1)$$

The capacitance of the electrode arrangement of two parallel cylinder faces is determined by calibration using

an audio-frequency bridge. This calibration is carried out so that the difference between the total interelectrode capacitance (including the fringing capacitance) at any two spacings of the gap is determined accurately. Thus from this calibration we know $(C_{a2} + C_{e2}) - (C_{a1} + C_{e1})$. Then we have, using (1),

$$C_x = (C_{a2} + C_{e2}) - (C_{a1} + C_{e1}) + C_{a1} - (dC/dS)\Delta S. \quad (2)$$

With the exception of the last term, this is the same expression as is used in the susceptance-variation method to obtain the capacitance of an unknown. It is subject to an approximation, which is valid only if the change in $S, \Delta S$, to retune the cavity to resonance after the sample is removed is small compared to S . We also have made the assumption that C_{e1} , the fringing capacitance with the sample at spacing 1, is the same as without the sample for the same spacing. The correction term for the change in length $(dC/dS)\Delta S$ is usually less than 5 per cent of C_x , so that a small error in $(dC/dS)\Delta S$ has a second-order effect on the value of C_x .

This correction term is derived as follows: The resonant frequency of a short-circuited transmission line with a capacitor at one end is given by

$$Z_0 \tan(2\pi fS/c) = (1/2\pi fC). \quad (3)$$

The frequency characteristic of a re-entrant resonant cavity for the general case where the radius is appreciable compared to a quarter wavelength has been treated in some detail by Hansen.¹⁴ However, if the radius of the resonant cavity is not very large compared to a quarter wavelength, its resonant frequency may be obtained to a good approximation by considering it a short-circuited transmission line with a capacitor at one end. The dimensions of the cavities were so chosen that (3) is very nearly satisfied. In particular, care must be exercised in choosing the radius of the cavity so that it will not be a large fraction of the wavelength. If this is not done the correction term will be less accurate than desired.

By differentiating (3) with respect to the gap distance

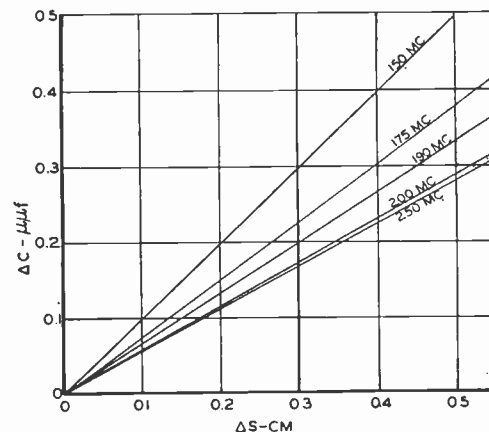

Fig. 2—These curves show the change in capacitance versus change in separation of electrodes at constant frequency. (200-megacycle cavity used in this research.)

¹⁴ W. W. Hansen, "On the resonant frequency of closed concentric lines," *Jour. Appl. Phys.*, vol. 10, pp. 38-45; 1939.

S , the following expression for the correction term is obtained:

$$\frac{dC}{dS} \Delta S = - \frac{(2\pi f)^2 C_2^2}{c} 138 \log_{10} \frac{b}{a} \left(\sec^2 \frac{2\pi f S}{c} \right) \Delta S. \quad (4)$$

It has been found practicable to plot graphs of this function versus ΔS for various values of f and C_2 , from which graphs interpolation can be made to obtain the correction term at any particular measurement. Such a series of curves is shown in Fig. 2.

The assumptions which have been made in this method of measurement are justified experimentally in the results which have been obtained for the dielectric constant. Measurements made on samples of various thicknesses of the same material agree well, which would not be the case if these assumptions were not valid. Measurements made on materials like polystyrene and quartz, which have very little change of dielectric constant over a wide range of frequency, agree well with lower- and higher-frequency measurements by independent methods and those of other experimenters.

Dissipation Factor

It remains now to determine the dissipation factor $\tan \delta_x$ of the dielectric sample. In a resonant circuit, the following relation holds:

$$\tan \delta_{\text{total}} = \tan \delta_0 + \tan \delta_D \quad (5)$$

where $\tan \delta_0$ is the dissipation factor of the empty cavity. Included in $\tan \delta_0$ are all the effects due to coupling elements, measuring elements, and the ohmic resistance of the inside surface of the cavity. $\tan \delta_D$ would be the dissipation factor of the sample being measured if the sample filled the whole cavity, but since the sample does not fill the whole cavity, $\tan \delta_D$ is less than the dissipation factor of the sample by a factor (C_x/C_T) . Then, $\tan \delta_D = \tan \delta_x C_x/C_T$. From (5) and the relation between $\tan \delta_D$ and $\tan \delta_x$ the following expression is obtained:

$$\tan \delta_x = (C_T/C_x) \tan \delta_{\text{total}} - (C_T/C_x) \tan \delta_0. \quad (6)$$

Equation (6) may also be written in its equivalent Q form

$$1/Q_x = (C_T/C_x)(1/Q_T) - (C_T/C_x)(1/Q_0). \quad (6a)$$

$$\text{Now } 1/Q_0 = \Delta C_2/2C_T, \text{ and } 1/Q_T = \Delta C_1/2C_T \quad (6b)$$

$$\text{whence } \tan \delta_x = \Delta C_1/2C_x - (\Delta C_2/2C_x). \quad (6c)$$

Therefore, it is not necessary to know the total equivalent capacitance of our circuit (cavity) if the Q values are measured by changing the capacitance in our cavity by a known amount. ΔC_1 and ΔC_2 are, respectively, the variation in capacitance necessary to detune from one half-power level of resonance to the other, when the cavity is empty (ΔC_2) and when the cavity has dielectric in it (ΔC_1).

In a conventional coil-and-capacitor circuit it is not difficult to detune from resonance to half power by changing the capacitance, for only an additional parallel vernier capacitor is necessary. In a re-entrant cavity it is more difficult, since the only variable capacitance is that between the re-entrant ends. This may be varied

readily when there is no dielectric in place, but complications enter when there is a dielectric sample between the re-entrant ends. Therefore, an indirect measurement of the ΔC value must be made. This can be readily accomplished if a value of dC/df is known. Then the frequency f may be varied to detune the cavity to half power from maximum resonant voltage. From a Δf value, a corresponding ΔC value may be obtained from a calibration chart.

The dissipation factor of the empty cavity is generally but 1/10 of the smallest value obtained with the usual circuit elements. This makes the device much more sensitive for measuring very-low-loss dielectrics than the susceptance-variation circuit used by Hartshorn and Ward.¹³ The theoretical Q of such a cavity will be of the order of magnitude of that of a resonant quarter-wavelength line of the same cross section. The expression for the Q of a coaxial line of this sort is

$$Q = 4\pi\sqrt{\sigma/10} b[(\log_e b/a)/(b/a + 1)]\sqrt{f} \times 10^{-4}. \quad (7)$$

The optimum Q is obtained with a ratio of b/a equal to

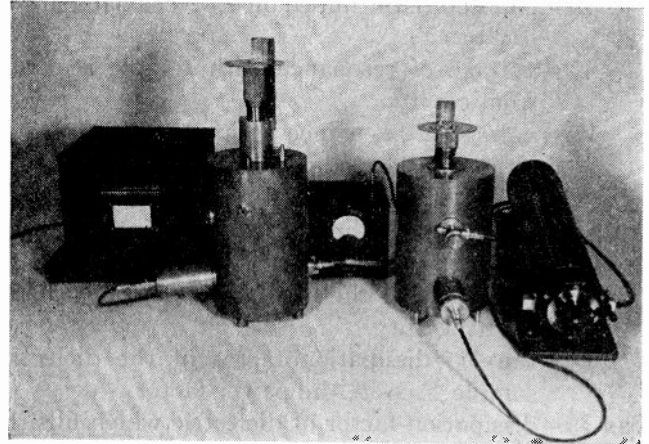

Fig. 3—Measuring apparatus for use at 200 megacycles. Left to right: galvanometer, measuring cavity, microammeter, cavity wave-meter, oscillator.

about 3.6. Because of certain design features in the actual cavity, such as a bellows forming part of the inner conductor, and because of energy absorbed by measuring probes and the effect of the coupling-in loop, the theoretical Q which can be as high as 10,000 is never reached. The authors usually obtained $\frac{1}{4}$ to $\frac{1}{2}$ of the theoretical Q for the empty cavity.

A single resonant cavity of this sort can be operated over a frequency range of 1.0 to 1.5 times the lower frequency, using a practical value of capacitance in the space where the dielectric is placed. Several different-sized cavities are thus necessary to measure dielectrics over the entire frequency range 50 to 1000 megacycles.

III. DESCRIPTION OF APPARATUS

The apparatus in Fig. 3, which operates in the frequency range of 150 to 300 megacycles, has been used by the authors for some time. Another apparatus exactly

like this one except that the cavity and wavemeter are scaled down in size is in use in the frequency range of 400 to 600 megacycles. Equipment to operate at higher and lower frequencies is planned. This equipment is convenient to use and requires little space. An advantage of this method over the coaxial-line method used by other experimenters is the small disk-shaped sample required and the ease of preparing the sample for measurement. The sample required is 1.5 inches or less in diameter and from 0.05 to 0.25 inch thick. Such a piece of material may be readily molded, cast, or machined, in the laboratory. The simple shape of the sample is of particular advantage in the case of ceramics.

Fig. 4 is a schematic circuit diagram of the setup shown in Fig. 3. The power supply which is mounted

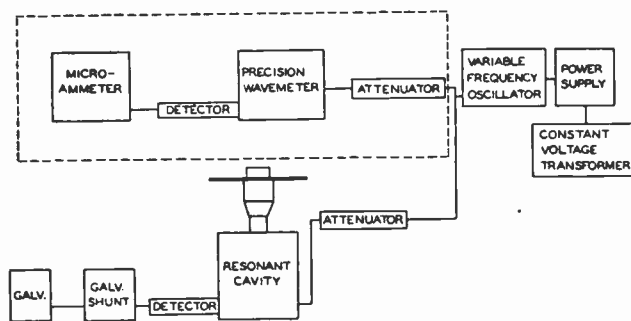

Fig. 4—Arrangement of apparatus for measurement of dielectric properties by the wavemeter method.

elsewhere is not shown in the picture. It is energized from a constant-voltage transformer. The power supply is a conventional voltage-regulated supply delivering a maximum plate current of 80 milliamperes at 450 volts and a filament current of 3.65 amperes alternating current at 2 volts. The oscillator shown is a commercial model made by a well-known radio manufacturer. Its frequency is continuously variable from 150 to 600 megacycles. We have also constructed another oscillator which proved satisfactory. The attenuators shown in the circuit of Fig. 4 are required so that any change taking place in either the cavity or wavemeter will not affect the frequency of the oscillator. From 5 to 10 decibels has proved satisfactory, and since the frequency of the oscillator must be varied in making the measurement, attenuators which are frequency-insensitive are required. Because it is difficult to design and construct attenuators which are frequency-insensitive at this frequency, it was decided to use long lengths of high-loss cable. Such long cables are frequency-insensitive since they always present their characteristic impedance to the oscillator. Coils of this cable were hung on the back of the table and, therefore, did not show in Fig. 3. The re-entrant resonant cavity in which the material to be measured is placed is shown in Figs. 5 and 6.

The exciting loop is made small and placed near the bottom where the current is a maximum. A small loop is used both to keep the Q high and to couple in only a small amount of energy. A strong field across the sample

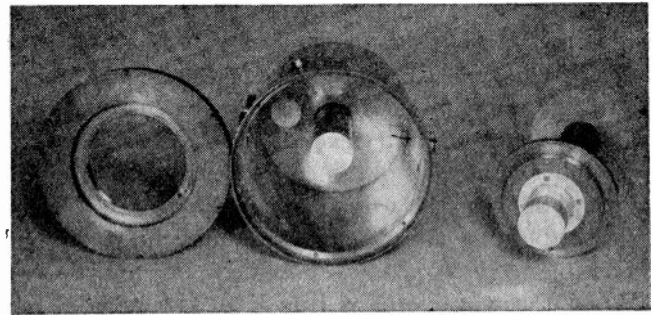

Fig. 5—Interior view of the measuring cavity for use at 200 megacycles. This cavity is 10 inches long and 6 inches in diameter.

is not desired, because it is desired to avoid all heating of the sample. To determine the dielectric constant, the empty cavity must be tuned to the frequency to which the cavity with the sample between the electrodes was tuned. This is accomplished by varying the gap between the electrodes. Therefore, fine adjustment of this gap is required. This adjustment is obtained by means of the differential screw assembly shown in Fig. 7.

To insure a positive contact all slide contacts are eliminated and a Sylphon bellows is used to connect the movable electrode with the top of the cavity. The face of the moving electrode is held rigid and parallel to the fixed electrode by the differential screw assembly (Fig. 7).

The wavemeter is constructed exactly the same as the cavity of Fig. 6, all dimensions being the same, except that the differential screw assembly is shorter since not as great a travel of the top electrode is required.

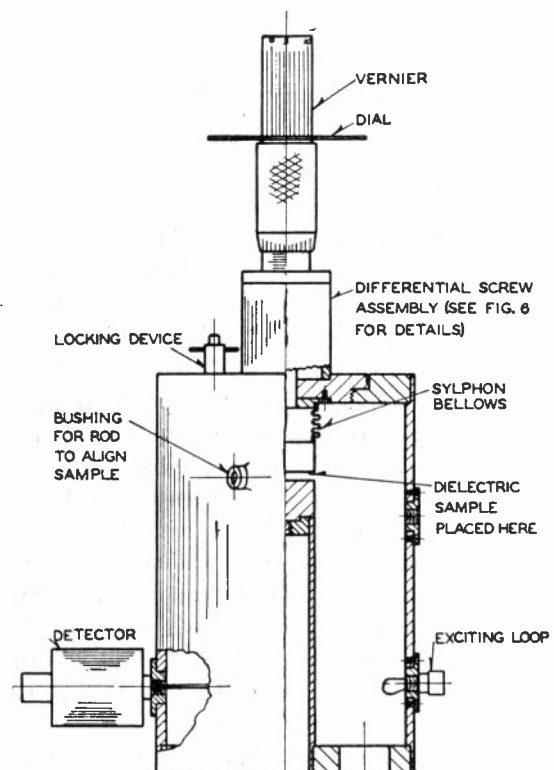

Fig. 6—The re-entrant cavity for measuring dielectric properties of materials.

Although any wavemeter capable of the required precision may be used, a wavemeter exactly the same as the cavity eliminates the need of a calibration curve. A slightly different method of coupling was used. A probe near the top of the cavity excites the cavity. This results in a higher Q than is obtained in the case of the other cavity. The Q of the wavemeter is about 4000. This is desirable because the wavemeter should tune as sharply as possible.

When the wavemeter is tuned to resonance, a very intense field is set up between the two electrodes forming the re-entrant portion of the cavity, therefore, this de-

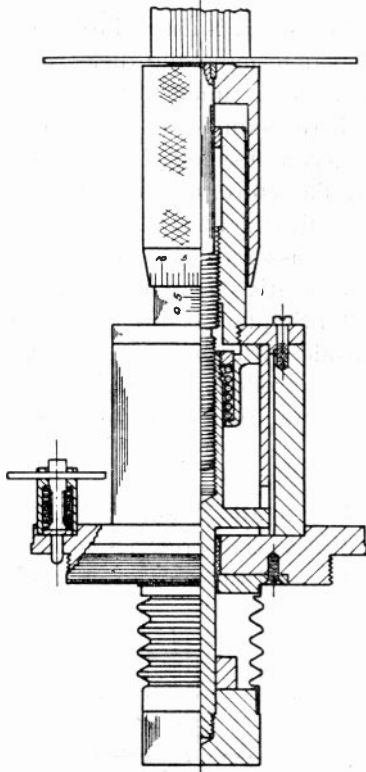

Fig. 7—The differential-screw assembly for the re-entrant cavity.

vice is very sensitive to any change in the position of the electrodes. A movement of less than $1/240,000$ of an inch may be detected. In the case of power factors less than 0.0003 it is necessary to be able to read the position of the electrode to within $1/240,000$ of an inch to obtain an accuracy of 5 per cent. This means a fine-thread screw and a vernier capable of reading a very small part of a turn must be used. Since all backlash should be removed from this screw, it is necessary to load it with a spring and since it is desirable to avoid using a very fine thread, a differential screw was used having screws with 20 threads per inch and 24 threads per inch which is equivalent to a screw of 120 threads per inch. The vernier dial on this assembly reads $1/2000$ of a turn which gives the position of the electrode to $1/240,000$ inch.

The detector units for the wavemeter and cavity consist of two crystals in parallel connected to a probe. These crystals act as a full-wave rectifier. The detector assembly was designed to keep all shunt capacitance very small so that the detector is frequency-insensitive

over a wide range of frequencies. The radio-frequency current is by-passed by large capacitors built into the detector housing. The crystals operate on such a portion of their characteristic curve that the rectified current measured by an indicating instrument connected to the detector reads a current proportional to E^2 in the cavity. The length of the probe which projects into the cavity may be varied without disturbing the electrical circuits of the detector. Other types of detectors, such as a diode, bolometer, or thermocouple may be used. A diode requires a power supply and is less sensitive and less stable than a crystal. It is also more frequency-sensitive and not as compact. The sensitivity of a bolometer or thermocouple is not nearly as good as that of a crystal, and their use requires a bridge circuit of either the balanced or unbalanced type.

The detector in the wavemeter is connected directly to a microammeter, while the detector in the cavity in which the sample is placed is connected to a sensitive galvanometer (Rubicon No. 3402 H.H., sensitivity 0.005 microampere per millimeter) through a shunt. The galvanometer shunt is a ladder network so arranged that the crystal always sees the same impedance regardless of which shunt is in use and the critical damping resistance is always across the galvanometer.

IV. CALIBRATION OF APPARATUS

If the dissipation factor of the cavity without the sample is known for all positions of the electrode, the work of measuring is cut in half. Therefore, it is advisable to obtain a curve of dissipation factor of the cavity without sample versus position of the electrode. Since the method of obtaining the dissipation factor of the empty cavity is the same as that of obtaining the dissipation factor of the cavity with the sample in place, this will be treated under measurements. A further advantage is that once the dissipation factor of the cavity without the sample is known, the entire measurement may be made at the resonant frequency by the "voltage method" (see (13)).

The dissipation factor of the 200-megacycle cavity without a sample was found to be nearly constant for all separations of the electrodes. To obtain the dielectric constant, we must apply two correction factors. For (2) we must obtain the value of $(C_{a2} + C_{e2}) - (C_{a1} + C_{e1})$ and $(dC/dS)\Delta S$. C_{a1} is calculated from the geometry of the electrodes. The value of $(C_{a2} + C_{e2}) - (C_{a1} + C_{e1})$ is obtained from the curve of capacitance versus separation of the electrodes as measured on an audio-frequency bridge. Due to stray capacitance in the circuit which could not be accurately determined, the absolute value of the capacitance between electrodes could not be measured, but the value of capacitance by difference was obtained for various separations of the electrodes, which is expressed by $(C_{a2} + C_{e2}) - (C_{a1} + C_{e1})$. The fringing correction $(C_{e2} - C_{e1})$ has been found to be about 1 per cent or less with $1\frac{1}{2}$ -inch electrodes used in the 200-megacycle cavity shown in Fig. 6.

The value of $(dC/dS)\Delta S$ in (2) is obtained from a

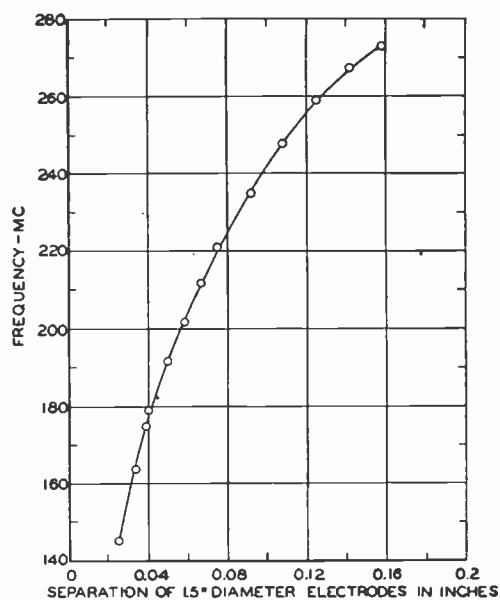

Fig. 8—The relation between resonant frequency and the separation of the electrodes of the cavity. (200-megacycle cavity used in this research.)

curve of ΔC versus ΔS , where $\Delta C = (dC/dS)\Delta S$, and ΔS is the change in S , the length of the inner conductor, when the sample is removed and the cavity is again tuned to resonance at the same frequency. Such a curve is calculated from (4) for each value of f . By choosing values of f at convenient intervals over the frequency band covered by the cavity, a family of curves is obtained as shown in Fig. 2. Interpolating between curves, the value of ΔC corresponding to ΔS may be found for any frequency at which a measurement is made.

The resonant frequency versus electrode separation of the empty 200-megacycle cavity is shown in Fig. 8. Since the wavemeter that was used in these measurements is identical with the measuring cavity, Fig. 8 is also the resonant-frequency-versus-electrode-separation characteristic of the wavemeter. The wavemeter provides the data from which $\tan \delta_x$ is calculated, and also indicates the frequency at which the measurements are made. This curve was obtained by heterodyning the oscillator which excites the cavity with a signal generator or oscillator whose frequency is accurately known and measuring the beat frequency by a suitable device. If the wavemeter were not identical to the measuring cavity, then a curve of wavemeter reading versus electrode separation of the cavity when both were tuned simultaneously to the same frequency would be required.

The crystal response was checked and found to obey the square law for the crystal current magnitude used in the measuring equipment.

V. METHODS OF MEASUREMENT

Wavemeter Method

With the apparatus arranged as shown in Fig. 4, the top of the cavity is removed and a disk of dielectric material is placed between the electrodes. The sample

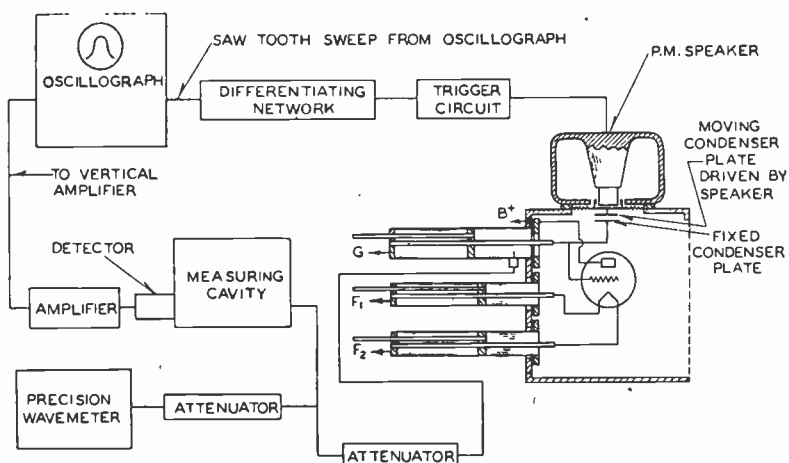

Fig. 9—Arrangement of apparatus for measuring dielectric properties of materials by the frequency-modulation method.

has the same diameter as the electrodes or less. It may be from $1/20$ to $1/4$ inch thick. A locking device assures that the top of the cavity is always replaced in the same position. The sample is centered between the electrodes by means of three rods which extend through equally spaced bushings in the side of the cavity. After the sample has been centered, the rods are withdrawn from the cavity. The top electrode is then brought in contact with the sample or, in the case of samples that are easily compressed, a known air gap is left in series with the sample. D_1 is designated as the separation of the electrodes, when the sample is in place as above.

The frequency of the oscillator is varied until the resonant frequency (maximum response) of the cavity is found, and the wavemeter is tuned to this frequency and its reading noted. Then, the frequency of the oscillator is varied until the response of the cavity is reduced to half; the wavemeter is tuned to this frequency and its reading noted. A corresponding measurement is made on the other side of the resonant frequency. The oscillator is set at the resonant frequency, and the sample is removed from the cavity. The cavity is retuned to resonance and the electrode separation D_2 is noted. Unless a curve of dissipation factor of the cavity versus separation of electrodes has been obtained previously, the procedure of detuning to half power given above for the cavity with the sample in place must be repeated for the cavity with the sample removed.

In the case when the sample fills the entire space between electrodes, the dielectric constant

$$\epsilon' = C_x/C_a \quad (8)$$

where C_x is found from (2) and C_a is the calculated air capacity of the sample. A rough value of ϵ' may be obtained from the relation

$$\epsilon' = D_1/D_2 \quad (9)$$

which is simply the ratio of the electrode separations with and without the sample. This approximate expression usually gives the dielectric constant to within 5 per cent but may be in error by as much as 10 per cent.

The dissipation factor $\tan \delta_x$ is given by (6c). In (6c), we may place

$$\Delta C_1/2C_x \cong (D_1' - D_1'')/2D_2 \quad (10)$$

$$\text{and} \quad \Delta C_2/2C_x \cong (D_2' - D_2'')/2D_2. \quad (11)$$

Then from (6c), (10), and (11),

$$\tan \delta_x \cong \frac{D_1' - D_1''}{2D_2} - \frac{D_2' - D_2''}{2D_2}. \quad (12)$$

Since only the electrode separations are required to solve this equation, it is a very convenient and rapid means of determining the dissipation factor of a sample.

The approximations for ΔC_1 and ΔC_2 in (10) and (11) introduce errors that are usually well within the precision with which D_1' , D_1'' , D_2' , and D_2'' may be read, especially when measuring low-loss material. It should be noted that ΔC_1 and ΔC_2 are the differences of nearly equal quantities. However, when materials having high loss are being measured, and ΔC_1 is large, the terms $C_{e1} - C_{e2}$ and $(dC/dS)\Delta S$ of (2) may be large. Then ΔC_1 should be found in the same way that C_x is found from (2).

Since it is not possible to prepare all samples so that their opposite faces are absolutely parallel or the surfaces perfectly smooth, there is an air gap between the electrodes and sample when the electrodes are brought into contact with the sample. The effect of this unavoidable air gap may be minimized in either of two ways. If it is possible to determine the size of the sample accurately, an air gap of known dimension may be placed in series with it. This method has the serious disadvantage, especially in the case of low-loss materials, of reducing the sensitivity of the measurement so that it may still be impossible to obtain the desired accuracy. The other way of minimizing the effect of irregularities in the sample is to place a thin metal foil of soft material over each face of the sample. This has been done at lower frequencies, and was used in measurements in the 150- to 300-megacycle range. Correction for the losses in the foil is made according to the method of Hartshorn.¹⁵

Heterodyning Method

The construction of a precise wavemeter involves considerable precision machine work, and is, therefore, an expensive operation. Therefore, it may be desirable to eliminate the wavemeter from the apparatus and this eliminates the equipment shown inside the dotted line of Fig. 4. This can be done if the following equipment is available: A calibrated oscillator or signal generator whose frequency or harmonics fall in the required band, a mixer (usually a crystal), and a calibrated receiver or other suitable detector. The frequency of this signal generator must be stable and its frequency known to the precision desired for the value of $\tan \delta_x$.

The frequencies at the half-power points (f_1' , f_1'') and at resonance (f_1) of the measuring cavity with the sample in place are determined by beating the varied frequency of the oscillator feeding the measuring cavity

against the fixed frequency of the second oscillator or signal generator. The two oscillator frequencies are fed through a crystal mixer into a calibrated receiver which measures their beat frequency or difference frequency. The capacitances C_1' and C_1'' (between the electrodes in the cavity) necessary to produce resonance at f_1' and f_1'' are then found after the sample has been removed. The frequencies at the half-power points (f_2' , f_2'') and at resonance (still f_1) with the sample removed are found by the same procedure. These correspond to capacitances C_2' and C_2'' . Calculation of $\tan \delta_x$ then proceeds according to (6c) or (10) to (12).

There are several disadvantages to this method of measuring the frequency which make it more time-consuming than measurement by means of a wavemeter. If there is any instability in one of the elements, it is difficult to determine which one is unstable, making adjustment tedious. At higher frequencies when a signal generator is used, it becomes difficult to locate the beat frequencies and finally, a suitable receiver, if not already at hand, is an expensive instrument.

Frequency Modulation Method of Determining the Dissipation Factor of a Dielectric Sample Using an Oscilloscope

With the equipment arranged as in Fig. 9, the saw-tooth wave from the sweep oscillator in the oscilloscope is applied both to the horizontal deflecting plates and to a trigger circuit. The output of the trigger circuit, which is the derivative of a saw-tooth wave, is fed to a phase-modulation loudspeaker, an integrating device. A speaker with the cone removed was mounted on the frame of a coaxial-line ultra-high-frequency oscillator, similar in construction to one described by Barrow.¹⁶ The movement of the speaker diaphragm rod varies the capacitance in the grid circuit of the oscillator, and therefore, varies the frequency by a small amount. The oscillator delivers a signal which is frequency-modulated in accordance with the saw-tooth sweep applied to the horizontal plates of the oscilloscope. The modulated output of the oscillator is fed to a precision wavemeter and to the cavity containing the dielectric sample. The resonant cavity changes the frequency-modulated signal into an amplitude-modulated signal so that a resonance curve appears on the screen of the oscilloscope.

When the precision wavemeter is tuned to the resonant frequency of the cavity, a pip appears on the resonance curve on the oscilloscope screen due to the absorption of power by the wavemeter. By adjusting the gain controls of the vertical and horizontal amplifiers, the resonance curve of the cavity is made to coincide with the universal resonance curve drawn on the screen of the oscilloscope with its half-power points marked with vertical lines. The bandwidth of the resonance curve can now be measured by running the wavemeter

¹⁵ L. Hartshorn, "Radio-frequency measurements by bridge and resonance methods," John Wiley and Sons, New York, N. Y., 1941; pp. 198-200.

¹⁶ W. L. Barrow, "Oscillator for ultra high frequencies," *Rev. Sci. Instr.*, vol. 9, pp. 170-174; June, 1938.

pip along this curve from one vertical line to the other. By noting the dial reading of the wavemeter when the pip coincides with each vertical line in each case (i.e., sample in place and removed) the same formulas given in a previous section of this paper may be used to obtain the dissipation factor of the dielectric $\tan \delta_x$.

The chief difficulty encountered in using this method is that the bandwidth of the cavity is so narrow and the wavemeter pip of such considerable width in comparison that it is impossible to obtain an accurate measurement of the bandwidth. The same difficulty occurs to a lesser extent in the case of the cavity with the sample in place. However, it is possible to raise the Q of the wavemeter considerably and to lower the Q of the measuring cavity. This should overcome this difficulty. When this equipment is working properly, measurements may be made much faster than when using the first method described (varying the frequency manually to reduce the response to half on each side of resonance). However, it is not as fast or convenient as the voltage method.

Another disadvantage is the fact that introducing a capacitance into the grid circuit of the oscillator lowers its frequency so that it must be designed for a much higher frequency when its signal is modulated in this way. Also, in the case of high-loss material, it is difficult to modulate enough to obtain a sufficient portion of the resonance curve to make measurements.

Voltage Method

In this method the sample is placed in the cavity, the oscillator tuned to resonance, and the galvanometer reading noted. Then the sample is removed from the cavity and the cavity tuned to resonance, the frequency remaining constant, and the galvanometer reading noted. The dielectric constant may be calculated in the usual manner, and the dissipation factor $\tan \delta_x$ is calculated from

$$\tan \delta_x = [(V_0 - V_T)]/V_T (\Delta C_2/2C_x). \quad (13)$$

It should be recalled that $\Delta C_2/2C_x$ is the dissipation factor of the empty cavity and its value is obtained before any measurements are made on samples as explained in the section on Calibration of Apparatus. When the expression $(V_0 - V_T)/V_T$ is less than unity, the absolute accuracy obtained is better than that of the other methods.

Since this method is much faster and more convenient than the others, it is preferred in most cases by the authors. The time required to make a measurement is practically the time required to place the sample in the cavity and then remove it, as the sample need remain only long enough to read the galvanometer deflection. If the apparatus is to be used in the routine testing of samples that have similar dielectric properties, a wavemeter is not needed. However, if the apparatus is to be used in the laboratory to test materials having a wide range of dielectric properties, the use of a wavemeter is recommended.

VI. REPRESENTATIVE MEASUREMENTS OF DIELECTRICS

The results of the measurement of a few typical dielectrics are given in Table I. The power factor of these

TABLE I
TYPICAL RESULTS OF MEASUREMENTS OF DIELECTRIC PROPERTIES AT
ABOUT 200 MEGACYCLES

Material	Thickness of sample inches	Dielectric Constant	Dissipation Factor
Micarta No. 254 (Cresol-formaldehyde) (Resin paper filled)	0.150	3.72	0.047
Columbia Resin CR-39	0.149	2.96	0.027
Pure fused Quartz	0.206	3.79	0.0001
Polystyrene Sample A	0.150	2.55	0.0003
Polystyrene Sample A	0.100	2.565	0.0003
Polystyrene Sample A	0.250	2.56	0.0003
Polystyrene Sample B	0.151	2.56	0.0005
Polyvinyl Carbazole	0.115	3.06	0.0009
Special Styrene Copolymer	0.183	2.64	0.008
High-Tension Porcelain	0.186	5.90	0.010
Zircon Porcelain	0.178	9.5	0.0008
Ultra Steatite	0.215	5.23	0.0007
Steatite	0.247	5.45	0.0034

materials varied from 4.7 to 0.01 per cent. These samples also varied considerably in thickness. The measurements of various thicknesses of Sample A of polystyrene shows that the measurements are independent of the thickness of the sample. Samples were desiccated previous to measurement.

VII. ACCURACY OF METHOD

The accuracy obtainable in this re-entrant cavity method of measurement is about ± 0.00005 in $\tan \delta_x$ and about ± 1 per cent with optimum-size sample, in dielectric constant. The sensitivity or accuracy of the re-entrant cavity as used in this method of measurement is limited largely by the precision and sensitivity of changing, and measuring the change in separation and absolute separation of the electrodes.

The accuracy of the dissipation factor measurement rests upon the assumption that extension of the bellows with a fixed frequency in the cavity does not change the Q of the cavity. This assumption was substantiated by test measurements. The movement of the bellows is never more than $\frac{3}{16}$ inch and usually less than $\frac{1}{8}$ inch. Measurement of the Q of the empty cavity varies only slightly with frequency (obtained by changing the gap separation), almost within the precision of measurement, and within the predicted theoretical change.

The accuracy of all the dielectric-loss measurements described in this report depends upon the assumption that the universal resonance curve holds for our cavity as arranged with the coupling loop and feeding line. In other words, the voltage variations in the cavity are assumed to correspond to frequency changes of the oscillator source according to the resonance curve of the cavity, and are independent of coupling elements. The response of the cavity, has been checked with the universal resonance curve and close agreement obtained.

CONCLUSION

A new method for measuring the dielectric properties of insulating materials in the 100- to 1000-megacycle range has been developed. The theory and several

methods of operation are described. The theory on which this method is based has been justified experimentally. Greater sensitivity and accuracy have been obtained than is possible by other methods operative in this frequency range. This method offers the following advantages:

(1) The samples required are of simple disk shape

which are easily prepared. (2) Both the measurements and the calculations are simple, making possible rapid determinations of both dielectric constant and power factor. (3) These characteristics make the apparatus not only suitable for laboratory use but also for production control where a relatively large number of samples may be involved.

A Note on Diode Modulation*

A. D. BAILEY†, ASSOCIATE, I.R.E., AND G. H. FETT‡

Summary—An analysis of a circuit using the diode as the modulating element is given. The theoretical relations derived for a resistance load are verified experimentally. The effect of using a tuned circuit as a load is discussed and the experimental results are explained in terms of a variable diode resistance.

WHILE the applications of diode modulation are not as numerous as other methods of producing amplitude modulation, there are certain advantages in its use in certain types of carrier telephone equipment and in instruction. This note gives experimental verification for the diode-modulation relations obtained theoretically for a resistance load. The effect of replacing the resistance load by a resonant circuit tuned to the carrier is described and an explanation is given on the basis of a variable diode resistance.

RESISTANCE LOAD

The diode rectifier current-voltage characteristic will be assumed to be ideal; the diode resistance is infinite for negative values of voltage, and zero for positive values of voltage. This diode is connected in series with a resistance load, a direct biasing voltage, and a sinusoidal carrier voltage. Let the magnitude of the biasing voltage be varied. When the bias voltage tends to make the diode plate negative the plate current will flow only a part of the cycle. The fraction of a cycle during which the tube conducts, expressed in radians referred to the carrier voltage, is called the conduction angle. The conduction angle depends upon the ratio of bias voltage to carrier voltage. The magnitude of the conduction angle of the diode will determine the magnitudes of the harmonic components of the carrier voltage appearing across the load, as well as that of the fundamental frequency. The bias voltage may be replaced by the low-frequency modulating signal. Therefore, an analytic relation between conduction angle and amplitude of the fundamental frequency load voltage is important.

Let E_p represent the amplitude of the carrier at the source, E_{bb} the bias voltage, $\cos \alpha = -E_{bb}/E_p$ the cosine

* Decimal classification: R135. Original manuscript received by the Institute, September 29, 1944; revised manuscript received, December 6, 1944.

† Formerly, University of Illinois, Urbana, Illinois; now on active duty, United States Naval Reserve.

‡ University of Illinois, Urbana, Illinois.

of half the conduction angle, and H_1 , H_2 and H_3 represent the amplitudes of the carrier (fundamental), second-, and third-harmonic voltages across the load. Then it may be shown that¹

$$\begin{aligned} \frac{H_1}{E_p} &= \frac{\alpha - \sin \alpha \cos \alpha}{\pi} \\ \frac{H_2}{E_p} &= \frac{1}{\pi} \left[\frac{\sin 3\alpha}{3} + \sin \alpha - \sin 2\alpha \cos \alpha \right] \\ \frac{H_3}{E_p} &= \frac{1}{\pi} \left[\frac{\sin 4\alpha}{4} + \frac{\sin 2\alpha}{2} - \frac{\sin 3\alpha \cos \alpha}{1.5} \right] \end{aligned}$$

In Fig. 1 are plotted the predicted magnitudes of the harmonics to be obtained for an ideal diode. It is seen that the magnitude of the fundamental varies linearly with the ratio of bias to carrier voltage, indicated by the straight line AB in the range of bias values $-E_p/2 < E_{bb} < E_p/2$. (Negative values of E_{bb} are important when the modulating signal is correspondingly negative.) If the direct-current bias is replaced by a modulating signal, then in the range specified linear modulation will take place.

When the theoretical relation experimentally is tested allowance must be made for the finite diode resistance during conduction which reduces the output voltage in the ratio of $R_b/(r_p + R_b)$ where r_p is the alternating-current tube resistance and R_b is the load resistance. Experimentally obtained curves for a 6H6 diode in

¹ For a derivation of the first term see H. J. Reich, "Theory and application of electron tubes," McGraw-Hill Book Company, New York 18, N. Y., 1939, p. 122. The other terms may be derived in exactly the same way. The voltage across the load may be written directly as $e = E_p(\cos \omega_p t - \cos \alpha)$. Expansion of the right-hand side of the equation into a Fourier series

$$e = H_0 + H_1 \cos \omega_p t + H_2 \cos 2\omega_p t + H_3 \cos 3\omega_p t + \dots$$

gives the expressions for the equations for H_2 and H_3 . Thus

$$\begin{aligned} H_2 &= \frac{1}{\pi} \int_0^{2\pi} e \cos 2\omega_p t \, d(\omega_p t) \\ &= \frac{E_p}{\pi} \int_0^{2\pi} (\cos \omega_p t - \cos \alpha) \cos 2\omega_p t \, d(\omega_p t) \end{aligned}$$

and similarly for H_3 ,

$$H_3 = \frac{E_p}{\pi} \int_0^{2\pi} (\cos \omega_p t - \cos \alpha) \cos 3\omega_p t \, d(\omega_p t)$$

series with a 1000-ohm resistive load connected in series with a low-impedance 60-cycle source and a variable direct-current bias are shown in Fig. 2. (The low carrier frequency was chosen because harmonics of the fundamental could then be measured accurately with the wave-analysis equipment available. It also provided a low impedance to the important harmonics in the output.) The similarity between these curves with those of Fig. 1 is striking.

In the curves of Fig. 2 the actual load-voltage frequency components are plotted. The expressions which have been derived assume no internal diode resistance.

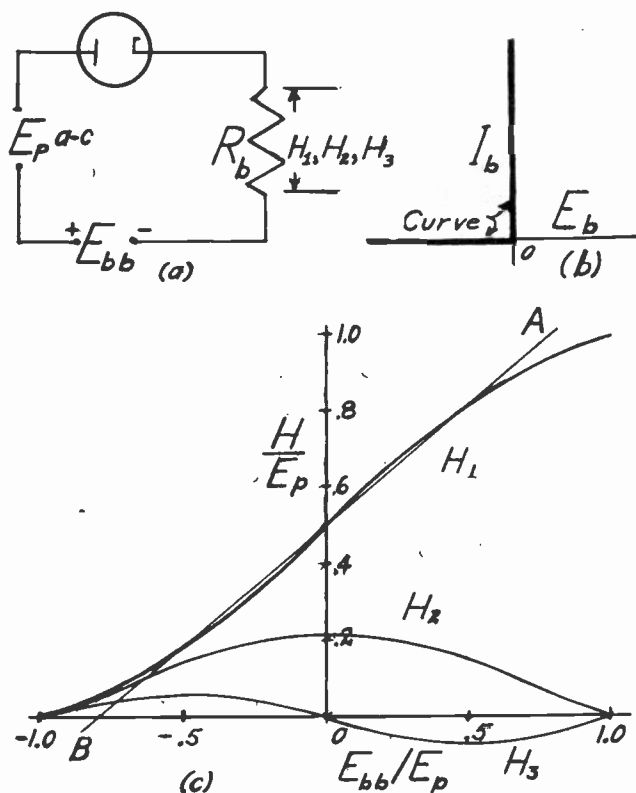

Fig. 1—Ideal diode response. (a) Circuit to be used. (b) Ideal diode characteristic. (c) Harmonic-voltage components across load resistance as function of bias voltage.

If the experimentally obtained curve for H_1 is multiplied by the ratio $(r_p + R_b)/R_b$ it should give a curve identical to that for H_1 in Fig. 1. The comparison is shown in Fig. 2. Since r_p is not constant, the use of an average value will cause some error. The agreement shown in Fig. 2, and similar curves which can be obtained for H_2 and H_3 lead to the conclusion that the derived expressions for an ideal diode with no internal resistance may be modified for the practical problem by multiplication of the expressions for H_1 , H_2 , H_3 by the fraction $R_b/(r_p + R_b)$ to obtain the actual load-voltage components.

TUNED-CIRCUIT LOAD

It might be thought that for a diode modulator terminated with a parallel resonant circuit the response for the fundamental frequency would be the same as

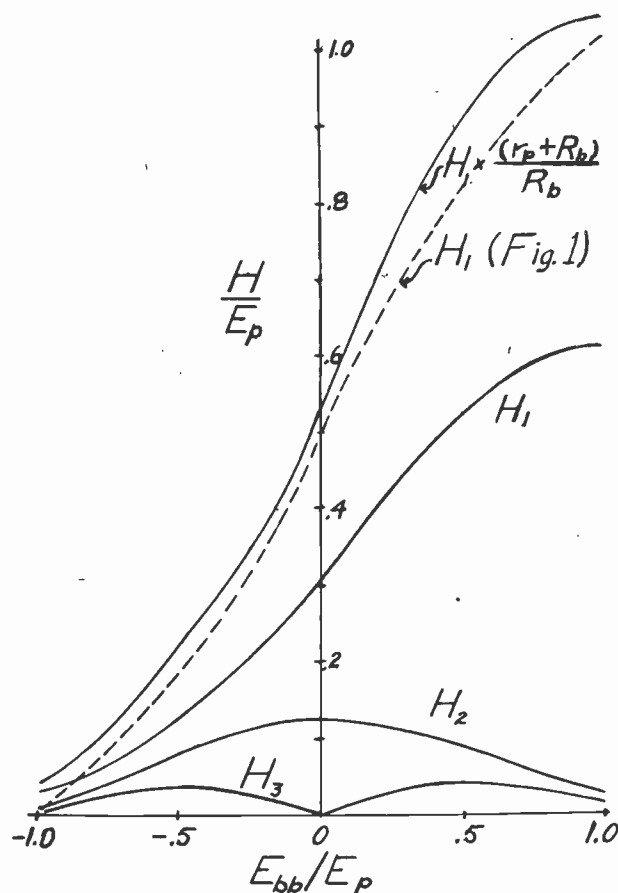

Fig. 2—Experimental diode response for circuit of Fig. 1 (a). Harmonic-voltage components observed, as functions of bias voltage. (Equipment available could not measure phase shift of H_3 .)

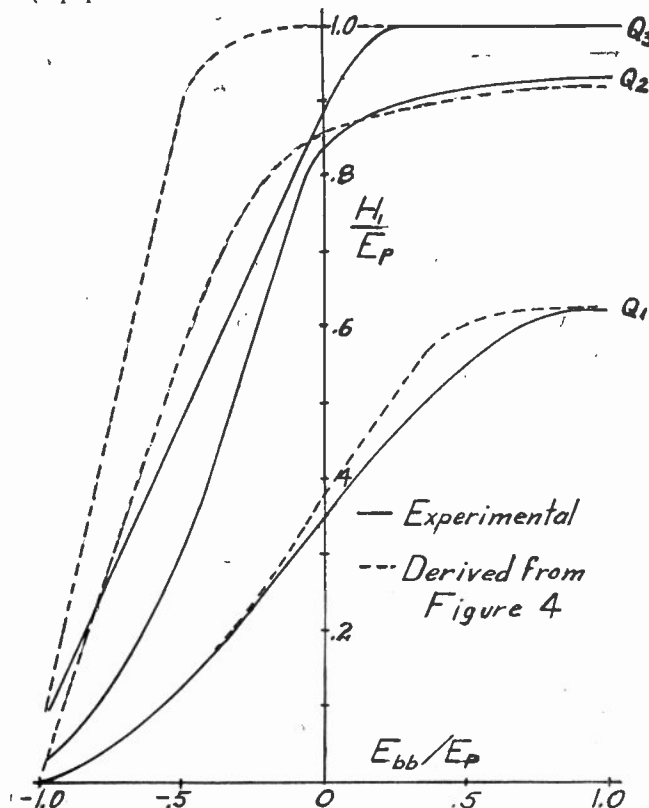

Fig. 3—Experimental diode response for tuned-circuit load. Constants adjusted to $Q_1=9.2$, $Q_2=29.5$, and $Q_3=74.5$ (solid lines). Computed diode response with apparent diode resistance derived from Fig. 4.

that for a resistance load of the same carrier-frequency resistance as the tuned circuit. An experimental analysis shows that this is not so. For example, in Fig. 3 is plotted the fundamental-frequency response for tuned circuits for three different values of Q of the parallel-

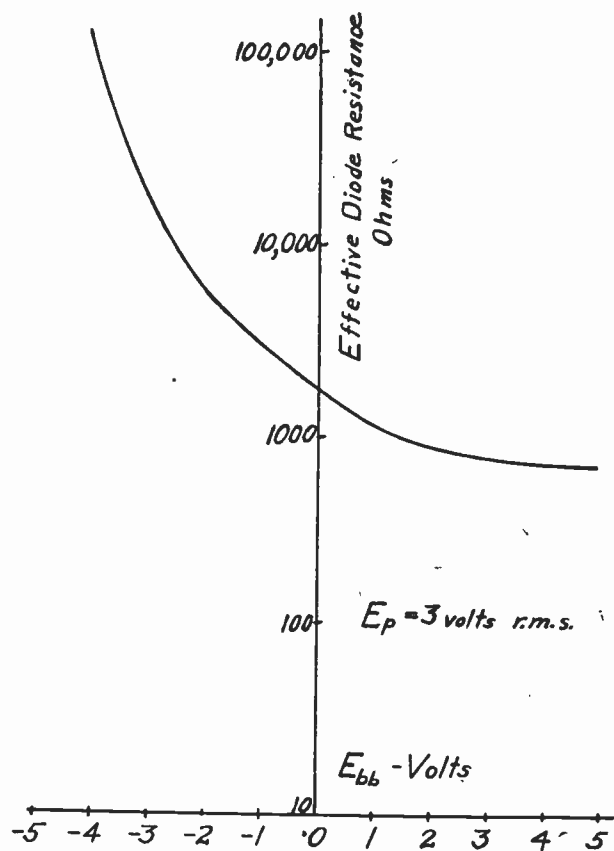

Fig. 4—Apparent effective diode resistance of 6H6 tube with constant-carrier voltage of 3 volts (root-mean-square) as a function of bias voltage.

resonant circuit. It is seen that for circuit 1, with the lowest Q of 9.2 the curve is not too different from what would be predicted for a resistance load. The curves for circuit 2 with a Q of 29.5 and circuit 3 with a Q of 74.5, however, have response curves which differ greatly from those obtained with a similar resistance load.

Since the magnitude of the fundamental does not increase when the bias ratio is positive, (for high values of Q) it is suggested that the diode is actually operating as a variable resistance in series with the load and the source, the magnitude of the resistance dependent upon the value of the negative-bias voltage. Now the apparent effective resistance of the diode may be defined as the ratio of the effective voltage across the diode to the effective current in the diode. The effective value of the diode voltage is the square root of the sum of the squares of the alternating voltage and the direct voltage. An experimental measurement of the apparent effective diode resistance as a function of the biasing voltage is shown in Fig. 4. It is noted that the resistance is nearly constant at the static value of 750 ohms for positive values of bias, and that it rises rapidly to nearly 100,000 ohms for negative values of bias.

If the diode is then considered as a variable resistance, and an analysis of the circuit is made, the curves, shown dotted in Fig. 3, are obtained for the amplitude of the fundamental frequency in terms of the bias. The computed curves and the experimental curves are in fair agreement, when the difficulties of obtaining the apparent effective resistance and the high harmonic content for negative bias are considered.

It is seen from the considerations in this note that the diode-modulation circuit for resistance load may be treated by Fourier analysis in the formal way, and good agreement with practice may be expected. When the load is a parallel resonant circuit, however, the diode must be treated as an apparent effective resistance which varies with the amplitude of the modulating (bias) signal.

ACKNOWLEDGMENT

Acknowledgment is made to Professor H. J. Reich, of the University of Illinois, for suggesting the problem, and to the Graduate School of the University of Illinois for permission to publish the note, which was a part of a thesis submitted for the degree of Master of Science in Electrical Engineering by the first-named author under the direction of the second.

Experimentally Determined Impedance Characteristics of Cylindrical Antennas*

GEORGE H. BROWN†, FELLOW, I.R.E., AND O. M. WOODWARD, JR.†, ASSOCIATE, I.R.E.

Summary—Measurements of resistance and reactance of cylindrical antennas operated against ground have been made, with a wide variation of both antenna length and diameter. These data are displayed by means of a series of graphs.

The maximum values of resistance encountered are displayed. The shortening effect near the quarter-wave resonance point is also shown.

Terminal conditions, such as capacitance of the base of the antenna to ground, are briefly considered, and a series of measurements shows the wide variation in impedance for varying terminal conditions.

Measurements made in the course of the investigation show that the impedance of the antenna is independent of whether the top of the radiator is open or closed. The measured impedance data are also directly applicable to the case of a center-fed dipole.

I. INTRODUCTION

KNOWLEDGE of the base impedance of vertical antennas as a function of antenna length and diameter is very helpful in devising terminating networks for antenna systems. Much has been written concerning the mathematical difficulties of rigorously solving the antenna problem, and several methods of approximation have been proposed. Very little information of an experimental nature has been published. A number of years ago, the writers decided to undertake a systematic investigation of the problem. Other projects of a more pressing nature have seriously impaired our plans. However, the work of measuring the resistance and reactance of simple cylinders has been completed and the data compiled. The purpose of this paper is to present these data in a form that may prove useful.

II. METHOD OF MEASUREMENT

The physical arrangement for making the measurements is shown in Fig. 1. A large circular metallic screen 12 feet in diameter and 15 wires to the inch was placed on the surface of the earth. A concentric transmission line ran below this screen back to a slotted section of measuring line. Here a sensitive probe indicated the ratio of minimum-to-maximum voltage on the line as well as the position of a voltage minimum on the line. These two quantities together with the characteristic impedance of the feed line establish the impedance that exists at the end of the line. The inner diameter of the outer conductor of the feed line was 0.785 inch, while the diameter of the inner conductor was 0.25 inch. The cylinder which formed the antenna was closed at the bottom with a circular metal plate.

* Decimal classification: R241.1×R320. Original manuscript received by the Institute, September 18, 1944; revised manuscript received, November 30, 1944.

† RCA Laboratories, Princeton, New Jersey.

The writers rather like the method of notation which expresses dimensions in electrical degrees. For instance, in Fig. 1, the dimension a which is the physical length from the ground plane to the top of the antenna may be used to compute the length A in electrical degrees.

$$A(\text{degrees}) = 360a/\lambda \quad (1)$$

where λ is the free-space wavelength measured in the same units in which a is measured. The actual diameter d may be used in the same way to express the diameter D in electrical degrees.

Two simple and useful formulas for computing A are

$$A(\text{degrees}) = a_{ft}f_{kc}/2725 \quad (2)$$

and
$$A(\text{degrees}) = a_{inches}f_{mc}/32.7. \quad (3)$$

Measurements were made on wires and cylinders of various diameters, with D ranging from 0.1 degree to 20 degrees. This range was chosen with an eye to practical considerations, for a 3-inch diameter mast at 1 megacycle represents a value of D close to 0.1 degree, while a diameter of 1.3 inches at 500 megacycles is approximately 20 degrees.

The spacing h between the ground plane and the metal plate closing the bottom of the cylinder was chosen so that this electrical spacing H was one degree.

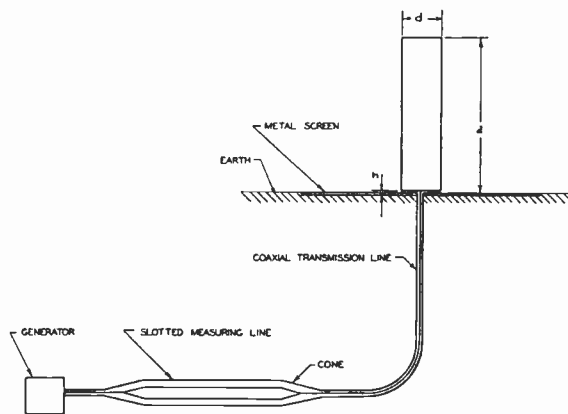

Fig. 1—Physical arrangement used in making impedance measurements.

III. RESISTANCE AND REACTANCE VARIATION, WITH DIAMETER AND FREQUENCY CONSTANT, AND THE ANTENNA LENGTH VARIABLE

A complete series of measurements was made by choosing a cylinder of a certain diameter, maintaining a fixed frequency of 60 megacycles, while the physical length of the antenna was changed. The resulting resistance curves are shown in Fig. 2, while the corresponding reactance values are presented in Fig. 3.

From Fig. 2, we see that the maximum value of

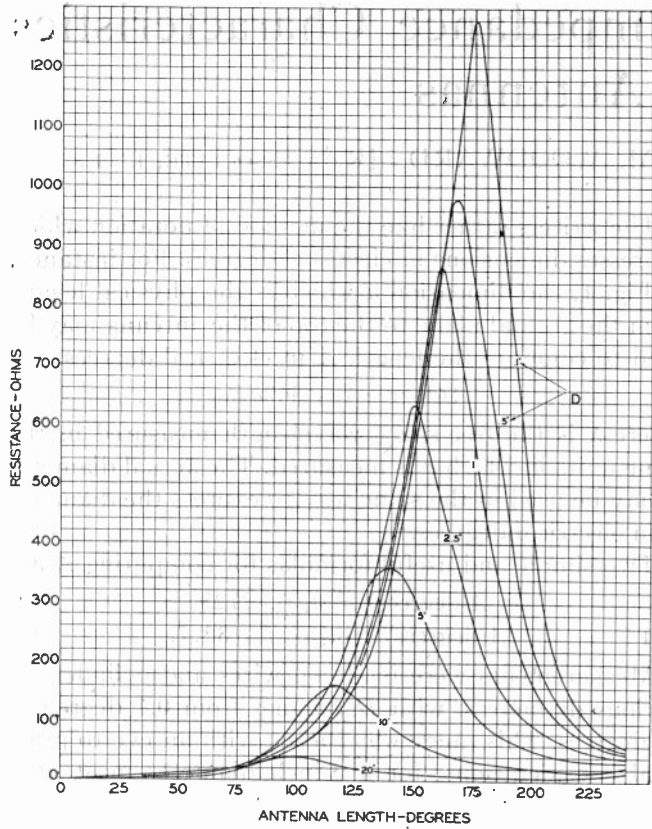

Fig. 2—Measured resistance curves versus antenna length in degrees, for a number of fixed diameters. Here the frequency is held constant and the physical length of the antenna is changed.

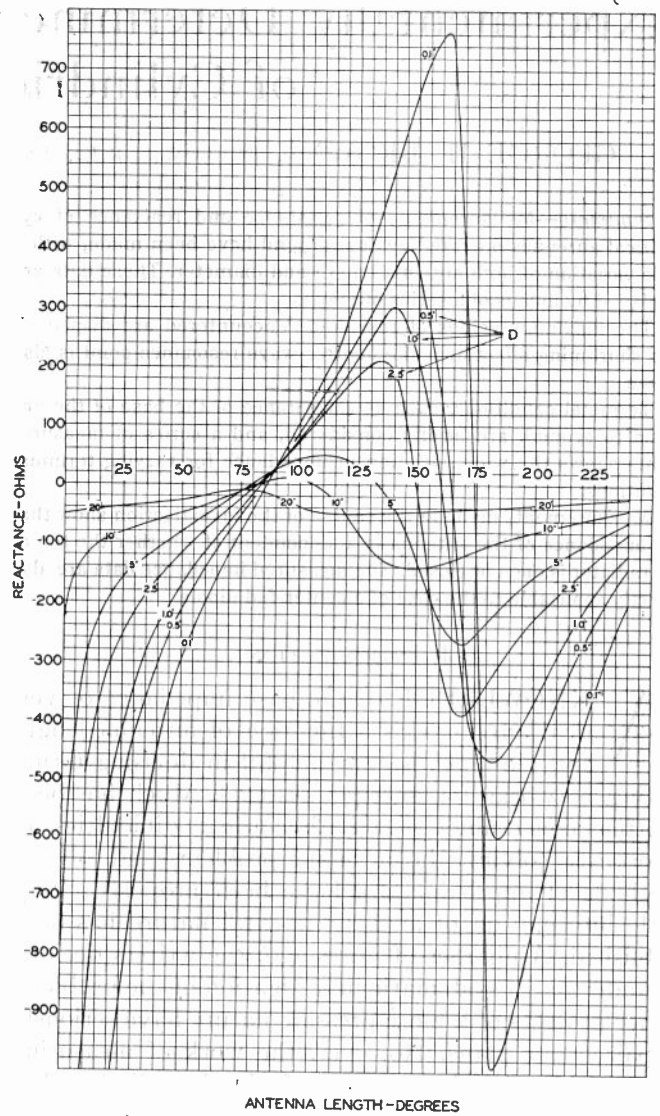

Fig. 3—Measured reactance curves versus antenna length in degrees. Again the frequency is held constant and the physical length of the antenna is changed.

resistance for each diameter becomes greater and occurs closer to $A=180$ degrees as the diameter becomes smaller. This point is illustrated strikingly by Fig. 4. This diagram was constructed from Fig. 2. The top curve in Fig. 4 shows the antenna length A at which maximum resistance occurs for each value of D . The corresponding value of the maximum resistance is shown by the lower curve. The upper curve extrapolates very nicely and shows that as D approaches zero, for maximum resistance, A approaches 180 degrees. The lower curve shows that there is a good chance of the resistance approaching infinity as the diameter approaches zero.

Fig. 3 shows that as the antenna becomes very short, the reactance approaches a definite limiting value. The effect is particularly striking in the case where D is 20 degrees. Actually, in our measurements, the antenna length did not go down to zero degrees, for when the antenna has been trimmed entirely away, the plate which formed the bottom of the cylinder still remained, so that we measured the reactance of this disk hung on the end of the measuring line. It should be realized that all of our measurements shown in Figs. 2 and 3 are the combined impedances of the antenna proper in parallel with the base reactance. Theoreticians may well object that this prevents comparison between theoretical and experimental results. It is entirely possible to imagine a cylinder with the base removed and excited by a number of tiny generators connected between the periphery and the ground plane. Then a knowledge of the relationship

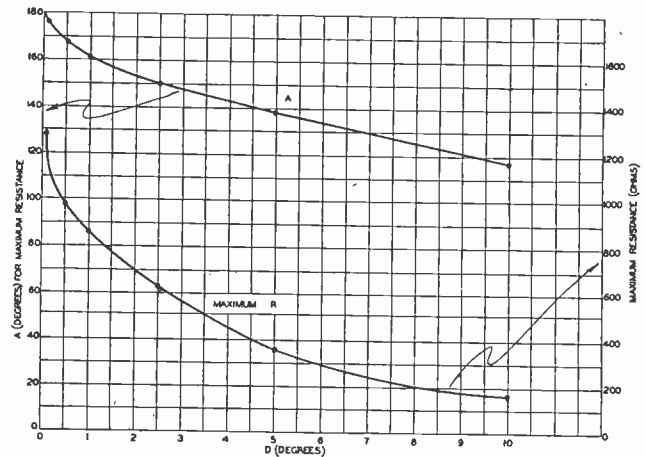

Fig. 4—Maximum resistance versus antenna diameter D and the antenna length A at which the maximum resistance occurs versus antenna diameter.

between the generator voltage and the current delivered by the generators would give an answer closer to the

ideal, since the base charging current would not be present. However, a realistic consideration of the problem soon indicates that these measurements taken under true existing conditions are likely to be of more value from a design standpoint.

It might be added that the effect of this base capacitance only makes itself felt where D is larger than one degree.

It may be observed from Figs. 2 and 3, that the reactance curve crosses through zero close to the point where the resistance is maximum. There is, however, some slight departure from true correspondence. The solid curve in Fig. 5 shows the antenna length for zero reactance as a function of the diameter, D . By calcula-

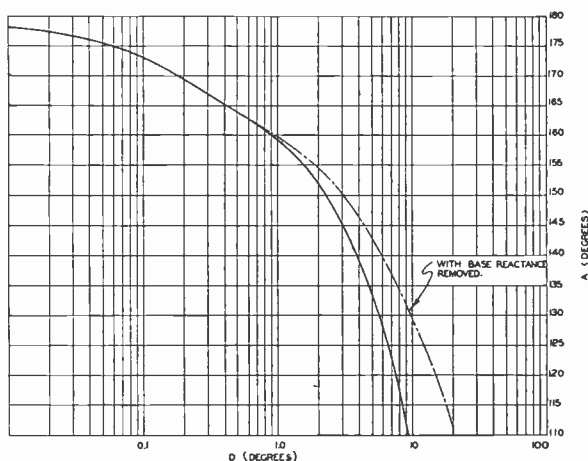

Fig. 5—The solid curve shows the antenna length A for zero reactance (near the maximum resistance point) as a function of the diameter D . This information is taken from measured data. The broken curve shows the same quantities when the base reactance is removed by calculation.

tion from Figs. 2 and 3, the writers determined the zero reactance point when the base reactance was removed. The resulting values of antenna length are shown by the broken curve of Fig. 5.

IV. RESISTANCE AND REACTANCE VARIATION, WITH DIAMETER AND LENGTH CONSTANT, AND WITH VARIABLE FREQUENCY

The curves of Figs. 2 and 3 show the impedance variation when the antenna length is varied. Often, it is of interest to know the action for a fixed antenna as the frequency is varied. By working through the curves of Figs. 2 and 3, and by cross-plotting much of the experimental data, the writers were able to build up Figs. 6 and 7. Here the resistance and reactance variation is shown for a fixed ratio of antenna length to diameter, and the variation of the electrical length of the antenna is secured by varying the frequency.

It may be noted that the reactance curves approach infinite values as the antenna length approaches zero, since the approach to zero antenna length is secured by approaching zero frequency.

Figs. 6 and 7 may prove to be useful in designing antennas to cover a wide frequency range,

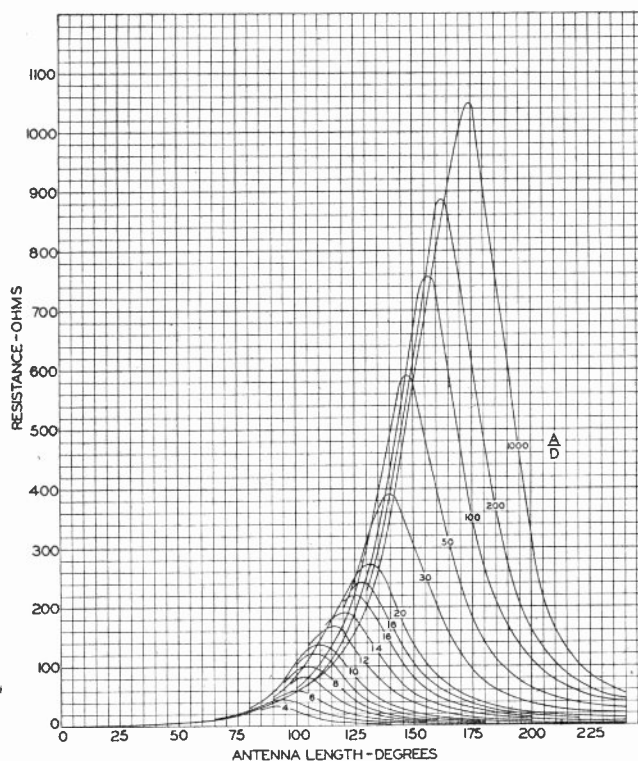

Fig. 6—Antenna resistance versus antenna length A , when a constant ratio of length to diameter A/D is maintained. Here the length and diameter are held constant while the frequency is changed.

Fig. 8 presents the data of Fig. 6 in a somewhat different fashion. Here each curve shows the antenna resistance as a function of the ratio of antenna length to diameter (A/D) for a fixed antenna length. Since the antenna length is fixed for each curve, large values of A/D represent very thin wires, while small values of A/D correspond to fat antennas. It is interesting to note that the resistance of a wire whose length A equals 90 degrees and whose A/D value is greater than 100 is very close to the theoretical value of 36.6 ohms obtained from the assumption of a simple sine-wave distribution of current.

Reactance curves as a function of A/D are given by Fig. 9. Many of these curves would be altered remarkably by removing the shunting reactance at the base, or by altering the terminal conditions.

Reference to Fig. 6 helped in the preparation of Fig. 10, where the maximum resistance as a function of A/D is shown.

Another interesting bit of information may be extracted from the data shown in Fig. 7 and Fig. 9. It is generally known that the first resonance in a vertical antenna occurs close to a length of A equal to 90 degrees, and it is also general knowledge that the antenna should be shortened slightly from the 90-degree length to obtain this resonance or zero-reactance condition. By cross-plotting the data of Figs. 7 and 9, the writers obtained Fig. 11, which shows the shortening (expressed in per cent of 90 degrees or one-quarter wavelength) necessary to secure zero reactance for each value of A/D .

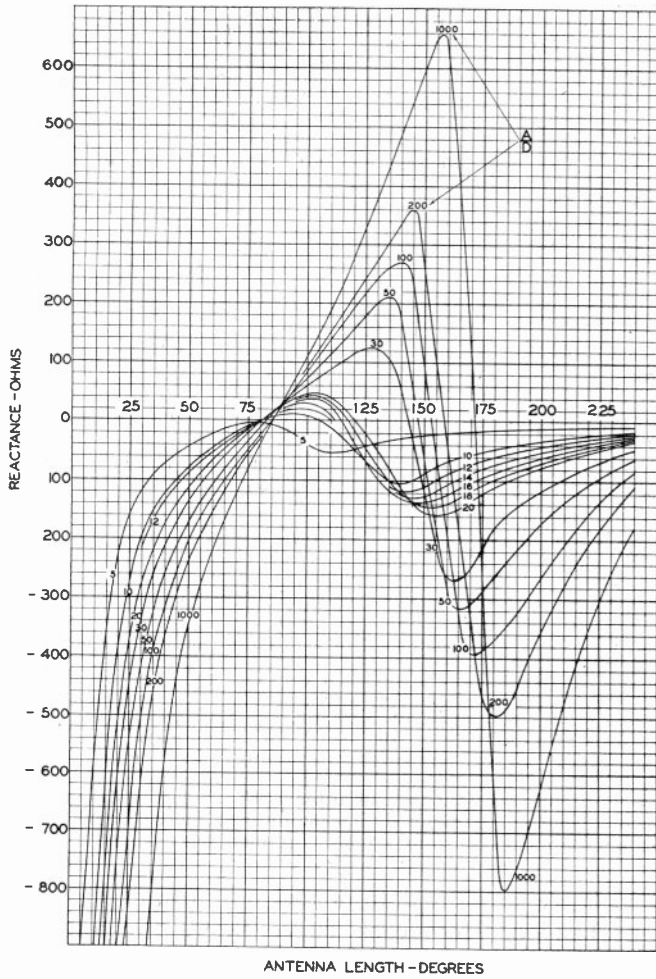

Fig. 7—Reactance curves corresponding to the resistance curves of Fig. 6.

V. REACTANCE OF THE BASE-PLATE

As has been stated, the disk which closes off the bottom of the radiator forms a shunt capacity across the terminals of the radiator. We may estimate the amount of the base shunting reactance by calculating the capacitance of the disk, neglecting fringing at the edges,

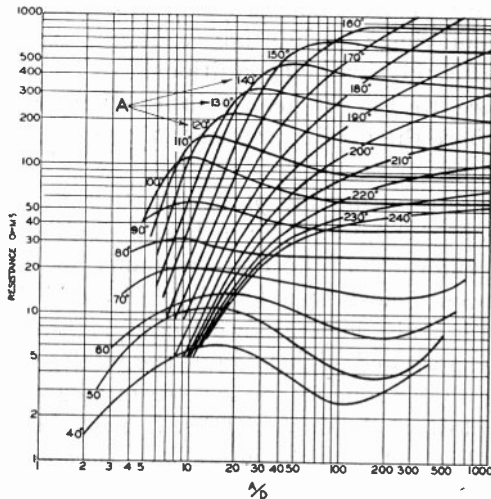

Fig. 8—Resistance versus the ratio A/D with antenna length A as a parameter.

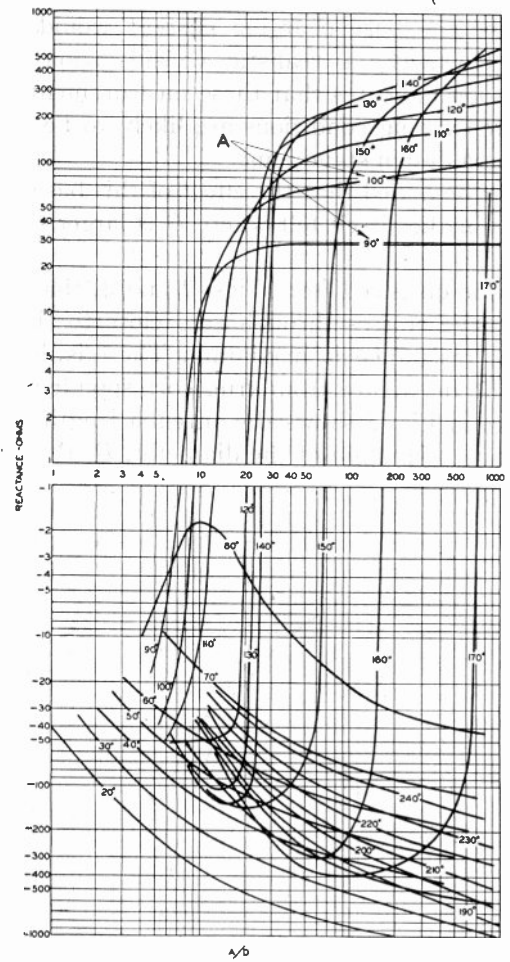

Fig. 9—Antenna reactance versus the ratio A/D for a number of values of antenna length A.

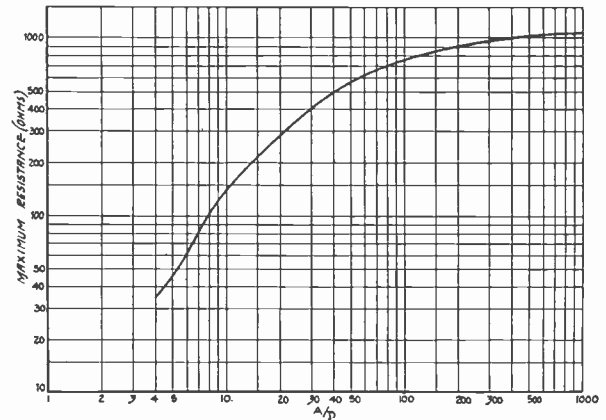

Fig. 10—Maximum resistance as a function of the ratio A/D.

and assuming that all displacement currents flow from the bottom of the disk to the ground plane. Then the shunt reactance is

$$X_s = \frac{\mu c^2 h}{\omega(\pi d^2/4)} \tag{4}$$

where μ = permeability of free space = $4\pi \times 10^{-9}$
 c = velocity of radio waves in freespace = 3×10^{10} centimeters per second
 h = spacing of disk from plane (centimeters)

d = diameter of disk (centimeters)

$\omega = 2\pi f$

f = frequency in cycles per second

Then we may rewrite (4) as

$$X_s = \frac{480(\omega h/c)}{(\omega d/c)^2} \quad (5)$$

However, if we express the spacing in electrical degrees H and the diameter in the same way D , (5) becomes

$$X_s = 27,500H/D^2 \quad (6)$$

In making the measurements shown in Figs. 2 and 3, we kept H equal to 1 degree. Thus, for D equal to 20 degrees, we see that the shunt capacitive reactance is 68.3 ohms, a quantity which is not at all negligible. However, when D is 1 degree, the shunt reactance is 27,500 ohms, a rather high value compared to any value of impedance encountered during the course of measurement.

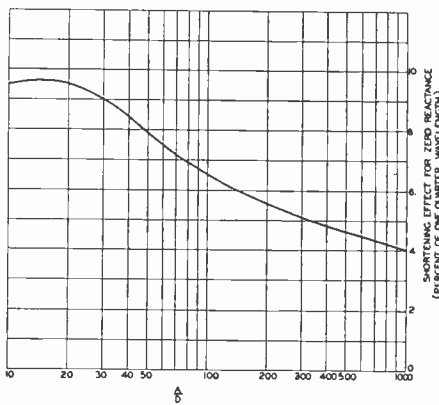

Fig. 11—Shortening effect near the quarter-wave point.

VI. COMPARISON OF IMPEDANCE MEASUREMENTS WITH VARYING TERMINAL CONDITIONS

For the previously disclosed measurements with large diameters, the experimental arrangement looked something like that shown in Fig. 12(a). Another experimental arrangement used for comparison purposes was that shown in Fig. 12(b). Here the inner conductor of the measuring line was the same diameter as the antenna. In fact, the antenna was simply the extension of the inner conductor. The system was so arranged that no insulators were in the measuring line between the point of measurement and the antenna. In these comparative measurements, the antenna diameter was maintained at 20.6 degrees. Three sizes of tubing were chosen for the outer conductor of the transmission line. The diameters of the transmission line as well as the characteristic impedance are given in the captions for Figs. 13 and 14.

Fig. 13 shows the measured resistance values for the arrangements, while Fig. 14 shows the corresponding reactance curves. Curve A in both figures shows the measured values for the arrangement of Fig. 12(a), with a diameter of 20.6 degrees. For this diameter, (6) shows that the shunt capacitive reactance is 65.0 ohms.

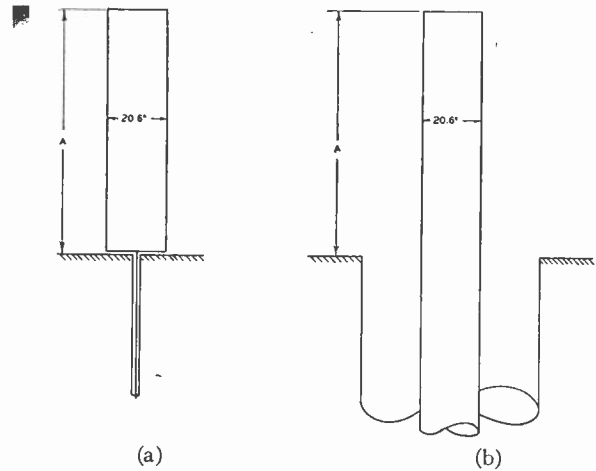

Fig. 12—Experimental arrangement for obtaining curves in Figs. 13 and 14. (a) For curve A . (b) For curves B , C , and D .

To knock out the effect of this shunting reactance, we may imagine an inductive reactance in shunt with the antenna, where this auxiliary reactance has a value of 65.0 ohms. Curve E on Figs. 13 and 14 was computed in exactly this fashion.

For instance, with an antenna length of 100 degrees, curve A shows that R_A is 42.0 ohms and X_A is -39.5 ohms. Then to find the impedance without the shunt capacitance, we calculate the parallel circuit conditions.

$$R_E + jX_E = \frac{j65.0(42.0 - j39.5)}{42.0 + j25.5} = 74.0 + j20.5 \text{ ohms.}$$

Examination of Figs. 13 and 14 shows that curve E fits in with the group formed by curves B , C , and D , particularly with regard to reactance values. This illustrates the point that the excessive base shunting reactance materially effects the measured impedance values. The difference between curves B , C , and D may be attributed again to changing terminal conditions.

The fact that curve E does not conform better to the curves B , C , and D is probably due to the fact that the simple conditions postulated in setting up (6) do not take full account of conditions near the terminals, and

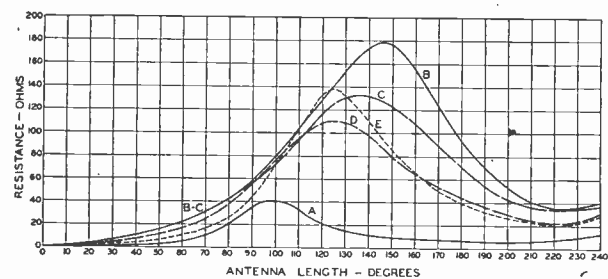

Fig. 13—Resistance as a function of antenna length A . The diameter D is 20.6 degrees.

Curve A —The arrangement shown in Fig. 12(a).

Curve B —The arrangement of Fig. 12(b), with the diameter of the outer conductor equal to 74 degrees. The characteristic impedance of the transmission line is 77.0 ohms.

Curve C —The outer conductor diameter is 49.5 degrees, and the transmission line has a characteristic impedance of 52.5 ohms.

Curve D —The diameter of the outer conductor is 33 degrees. The characteristic impedance is 28.3 ohms.

Curve E —This curve was obtained by tuning out the base reactance with an inductive reactance of 65.0 ohms.

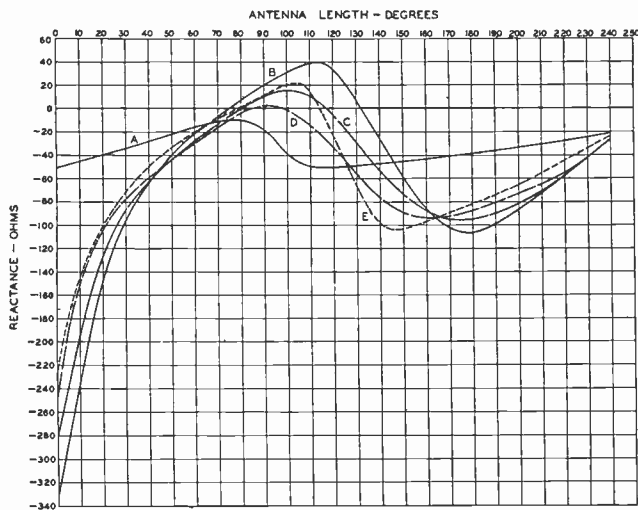

Fig. 14—Reactance curves corresponding to the resistance curves of Fig. 13.

in addition to the fact that curve *A* was measured at 60 megacycles, while curves *B*, *C*, and *D* were obtained at a frequency of 540 megacycles.

VII. COMPARISON OF IMPEDANCE WITH TOP OF RADIATOR CLOSED AND OPEN

Some workers in the field have suggested that results obtained with the radiator closed at the top would be different than when the radiator is open.¹ The writers

¹ L. Brillouin, "The antenna problem," *Quart. Appl. Math.*, vol. I, p. 214; October, 1943.

IX. CONCLUSION

Measured values of resistance and reactance of cylindrical antennas operated against ground have been displayed in a number of ways. It has been demonstrated that the exact conditions at the terminals are extremely important in determining the impedance conditions.

Electronic Alternating-Current Power Regulator*

L. B. CHERRY†, ASSOCIATE, I.R.E., AND R. F. WILD†, ASSOCIATE, I.R.E.

Summary—The object of this paper is to describe an electronic alternating-current power regulator, which is instantaneous and independent of frequency.

The theory and design considerations governing a conventional circuit using gaseous discharge tubes are presented. The effect of the extent of voltage-limiting by the gas tubes on the degree of regulation is discussed.

A bridge-type circuit is described and its theory developed. The effect of the degree of unbalance of the bridge circuit on the degree of regulation is discussed. The application of these circuits for regulation of low power, particularly the use in electronic apparatus, is treated and performance data on both circuits are given.

INTRODUCTION

FOR certain applications there is a need for alternating-current power regulators for low power. One particular application is the supply of constant heater power for vacuum tubes in direct-current

amplifiers, in which varying heater power is one of the main causes of objectionable drift.

The devices used most for stabilizing low-wattage alternating-current power derived from commercial power lines either have a time lag before compensation takes effect, are dependent upon a constant power-line frequency, or are objectionable from the viewpoint of weight and cost.

Since gaseous discharge tubes have been used successfully for regulation of direct voltage, it has been suggested that the voltage-limiting characteristics of these tubes be utilized also for regulation of alternating-current power. The literature shows proposals to use gaseous discharge tubes connected across the primary winding of a power transformer.^{1,2} Such an arrangement yields a degree of regulation which may satisfy certain

* Decimal classification: 621.375.1. Original manuscript received by the Institute, October 4, 1944; revised manuscript received, December 7, 1944.

† Brown Instrument Company, Philadelphia 44, Pennsylvania.

¹ G. F. Lampkin, "A simple A. C. voltage regulator," *Electronics*, vol. 10, pp. 30, 31, 36, 39, 40; August, 1937.

² M. H. Sweet, "A fluorescent lamp voltage stabilizer," *Electronics*, vol. 13, pp. 60-62; August, 1940.

requirements. A higher degree of constancy of alternating-current power, however, is attained by means of a new circuit which is essentially a bridge circuit employing gas-discharge tubes in one arm of the bridge. Both of these circuits yield instantaneous control of the alternating-current power, are independent of power-line frequency, and can be built at relatively low cost.

EQUIVALENT CIRCUIT FOR GASEOUS DISCHARGE TUBES

Before the theory of the control circuits to be described is discussed, the equivalent circuit of a gaseous discharge tube will be briefly analyzed. The equivalent circuit of such a tube is formed by a source of electromotive force E_0 in series relation with a resistor R_T .

In order to obtain the value E_0 of the electromotive force, the regulation characteristic, shown in Fig. 1,

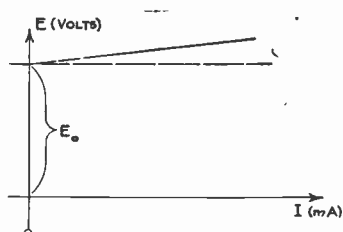

Fig. 1—Gas-tube characteristic.

is extended to the left until it intersects the voltage axis at the desired value E_0 , for which the tube current is zero. The resistance value of resistor R_T is determined by the slope of the regulation characteristic. The characteristic shows that the voltage drop across the tube increases as the tube draws more current. Hence, an analogy can be made between the tube operation and the charging of a storage battery having an electromotive force E_0 and an internal resistance R_T , since the current through a battery on charge increases as the charging voltage is increased. Consequently, this equivalent circuit can be substituted for gas-discharge tubes in the circuit analysis. Obviously, in the case of alternating-current power regulation, the polarity of the electromotive force E_0 is reversed during alternate positive and negative half cycles of the alternating voltage.

CONVENTIONAL ALTERNATING-CURRENT POWER-REGULATOR CIRCUIT

Fig. 2(a) shows a conventional alternating-current power-regulator circuit comprising a resistive load R_L parallel to which two gas-discharge tubes are connected in opposite polarity. The provision of two gas tubes, connected as shown, is believed advisable since most commercially available gas-regulator tubes are designed primarily for unidirectional operation. Connected in series relation with the combination of the gas tubes and load resistor, is a resistor R_1 , provided for the purpose of limiting the maximum current through the gas tubes to its permissible value. The alternating-current power-

line voltage applied to this circuit is assumed to be sinusoidal, as indicated.

Because of the sinusoidal variation of the applied line voltage, it is necessary to consider two conditions of the circuit, namely the condition in which the gas tubes are nonconducting and the condition in which they are conducting. These two circuit conditions are illustrated in Figs. 2(b) and 2(c). Fig. 2(d) shows the voltage drop

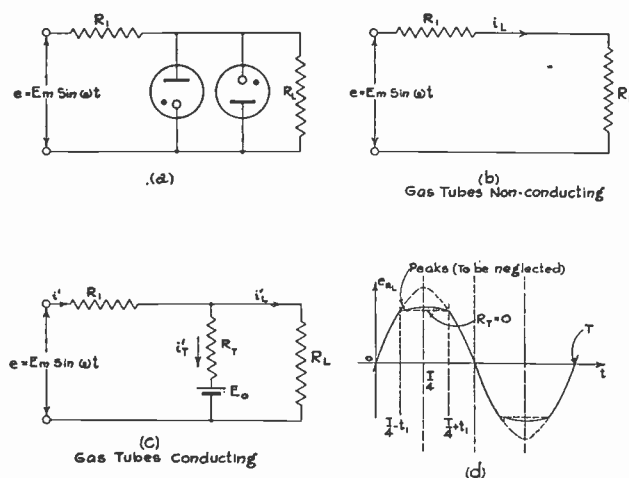

Fig. 2—Equivalent circuits of conventional-type regulator and resultant wave form.

across the load R_L which can be seen to deviate considerably from a sinusoidal wave shape. Since the circuit is to provide constant power, this is of little consequence as long as the effective value of this voltage, or of the corresponding load current, can be controlled to a relatively constant value.

In order to simplify the theoretical circuit analysis, the peaks appearing on the voltage curve, due to the difference between ignition and operating voltages of gas-discharge tubes, as well as the fact that the extinction voltage is lower than the normal operating voltage, will be neglected. It will also be assumed that ignition and extinction of the gas tubes occur at equal intervals before and after the peak values of the voltage applied to the tubes. The curve also shows that the voltage drop across the tubes does not remain perfectly constant during the interval of tube conduction. Finally, the internal impedance of the power source, which in the case of a commercial power line is very low, will also be neglected.

Equations (1), (2), (3), and (4) are derived by simple

$$i_L = \frac{e}{R_1 + R_L} \quad (1)$$

$$e - i'R_1 - i_T'R_T - E_0 = 0 \quad (2)$$

$$E_0 + i_T'R_T - i_L'R_L = 0 \quad (3)$$

$$i' = i_T' + i_L' \quad (4)$$

application of Kirchhoff's laws to the circuits shown in Figs. 2(b) and 2(c). The expression for the instantaneous load current for the condition of nonconducting gas tubes is given directly in (1), whereas the corresponding expression for the instantaneous load current for the

condition of conducting gas tubes is obtained by solving (2), (3), and (4) for i_L . Equation (5) results.

$$i_L' = \frac{e + E_0(R_1/R_T)}{R_1 + R_L(1 + (R_1/R_T))} \quad (5)$$

from this solution. Equations (6) and (7) give expressions for the power supplied to the load during the inter-

$$P_1 = \frac{1}{(T/4) - t_1} R_L \int_0^{(T/4)-t_1} (i_L)^2 dt \quad (6)$$

$$P_2 = \frac{1}{t_1} R_L \int_{(T/4)-t_1}^{T/4} (i_L')^2 dt \quad (7)$$

vals in which the gas tubes are nonconducting and conducting respectively. The total power supplied to the load is given by (8).

$$P = \frac{R_L \int_0^{(T/4)-t_1} (i_L)^2 dt + R_L \int_{(T/4)-t_1}^{T/4} (i_L')^2 dt}{T/4} \quad (8)$$

Inspection of (6), (7), and (8) in connection with Figs. 2(b) and 2(c) readily shows that the power varies with the duration of the interval of conduction, which is determined by the amplitude of the applied line voltage. While the power can be computed by means of (8), as shown later, this equation becomes too complex for a convenient qualitative indication of the degree of regulation.

It was found simpler to make a qualitative analysis in terms of effective load current, which must also approach a constant value for good power regulation. Equation (9) shows the current and voltage relationship in this circuit in the absence of gas tubes. In this equation

$$I_m = E_m / (R_1 + R_L) \quad (9)$$

E_m and I_m designate voltage and current amplitudes, respectively. In order to correlate the conditions of non-conduction and conduction of the gas tubes, it is necessary to assume that the load current immediately before and after ignition and extinction remain the same. No appreciable error is introduced by making this assumption. This particular value of load current may be termed the transitional load current and designated by i_{L_0} . Making this assumption, (10) can be written, since

$$i_{L_0} = E_0 / R_L \quad (10)$$

the voltage drop across the load resistor equals E_0 at the instant immediately preceding ignition of the gas tube. Designating the effective value of load current by I' , a relationship between I' , i_{L_0} and I_m can be found, as set forth in (11), if it is assumed also that a perfect regulator

$$\frac{I'}{i_{L_0}} = \sqrt{2} \left[\frac{1}{\pi} \left[\frac{1}{2} \left(\frac{I_m}{i_{L_0}} \right)^2 - 1 \right] \arcsin \left(\frac{I_m}{i_{L_0}} \right)^{-1} - \frac{1}{2\pi} \left(\frac{I_m}{i_{L_0}} \right) \cos \arcsin \left(\frac{I_m}{i_{L_0}} \right)^{-1} + \frac{1}{2} \right]^{1/2} \quad (11)$$

tube having no internal resistance is used. The transitional load current i_{L_0} in a given circuit depends solely upon the tube characteristics and the load resistor, and is therefore considered as constant. Hence, this equation shows the effective load current I' as a function of the

ratio I_m/i_{L_0} , which again is indicative of the relative duration of the interval of gas-tube conduction. It readily can be seen from (11) that I' approaches the value i_{L_0} for increasing values of I_m/i_{L_0} . The ratio I_m/i_{L_0} is directly proportional to the amplitude E_m of the applied voltage, as set forth in (12). This means that

$$I_m/i_{L_0} = (E_m/E_0)(1/[1 + R_1/R_L]) \quad (12)$$

for an increasing amplitude E_m the wave shape of the load current approaches that of a square wave, for which the effective value equals the amplitude. For this ultimate hypothetical condition the effective load current would be totally independent of fluctuations of the amplitude of the applied line voltage.

Fig. 3 illustrates the relationship between the ratio I'/i_{L_0} and the ratio I_m/i_{L_0} , as set forth in (11).

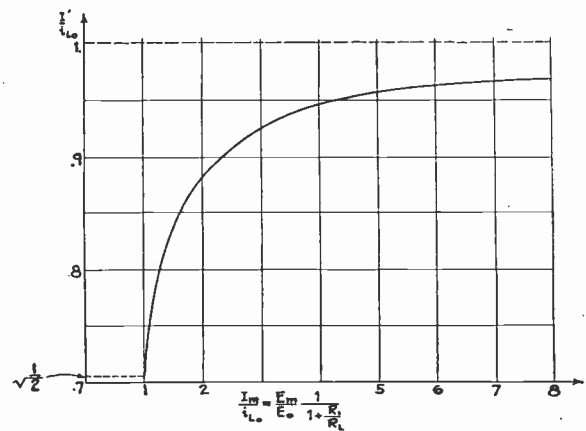

Fig. 3—Plot of (11) indicating the degree of regulation.

To obtain improved regulation, the ratio I_m/i_{L_0} can be increased by increasing the amplitude E_m of the applied line voltage, or by choosing a gas tube which ignites at a lower voltage and thereby effectively decreasing E_0 . The values of the current-limiting resistor R_1 and E_m are interrelated, inasmuch as any substantial increase of R_1 necessitates an increase of E_m in order to ignite the gas tubes. Any increase of E_m , however, also improves the regulation, as mentioned before.

Table I gives experimental and calculated values of power for two different values of applied power line voltage, above and below 110 volts, for the circuit constants shown. Values are shown for the unregulated power as well as experimental and calculated values for

TABLE I

R ₁ = 155 Ω; R _L = 512 Ω; VR-90 Tubes; R _T = 53 Ω (approx.)				
Line Voltage Volts (r-m-s)	Power (Watts)			
	Unregulated	Regulated		
		Experimental	Calculated Using Eq. (8)	Calculated Using Eq. (11)
106	12.95	12.46	10.55	9.66
115	15.43	13.45	11.5	10.07
Change in Line Voltage	Change in Power			
	9	2.48	0.99	0.95

regulated power. It is seen that the values computed by using the more accurate power equation (8) are lower than the experimental values, due to the simplifying assumptions made in the derivation of this equation. The values computed by using (11) deviate still further from the experimental values, because of the additional assumption of perfectly regulating tubes. Table I shows that for a certain change in line voltage an improvement of approximately 2.5 to 1 is obtained experimentally by regulation. It also shows that the calculated values indicate better regulation than that actually obtained, because of the assumptions made.

THE BRIDGE CIRCUIT

Improved regulation is obtained by means of the bridge circuit shown in Fig. 4(a), comprising resistors R_1, R_2, R_3 and the gas-discharge tubes VR connected in

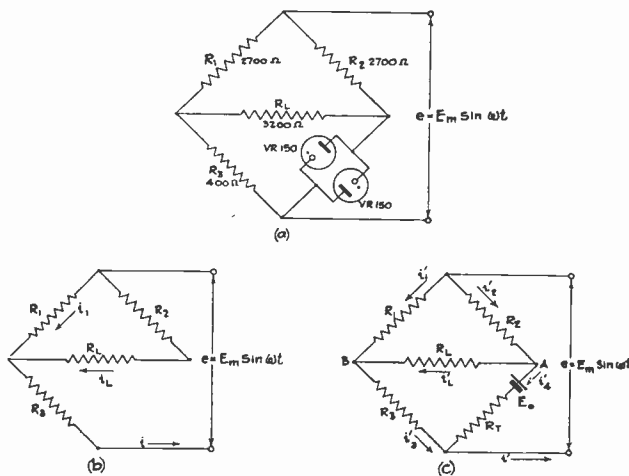

Fig. 4—Circuit of resistance bridge-type regulator together with equivalent circuits for nonconducting gas tube (b) and conducting gas tube (c).

the arms of the bridge, as shown. A resistive load R_L is connected in the diagonal of the bridge between the junction of resistors R_1 and R_3 , and the junction of resistor R_2 and the gas-discharge tubes. Power-line voltage is applied across the other diagonal of the bridge, and is indicated to be of sinusoidal wave shape.

Again two different circuit conditions exist during the conducting and nonconducting intervals of the gas tubes, respectively, which are illustrated in Figs. 4(b) and 4(c). In Fig. 4(c), the gas tubes are replaced by their equivalent circuit.

If this bridge circuit is balanced, a degree of power regulation is obtained comparable to that of the conventional circuit just discussed.³ Considerably better regulation is obtained if the bridge is unbalanced. The instantaneous load current can then be made to decrease for an increase in amplitude of the applied line voltage during intervals of tube conduction, so as to compensate for a corresponding increase in instantaneous load current during intervals of nonconduction. For

this reason, the unbalanced bridge was further investigated.

Equations (13) to (15), and (17) to (22) are derived by application of Kirchhoff's laws to the circuits of Figs. 4(b) and 4(c). From these equations the instantaneous load-current equations (16) and (23), and the power equations (24) and (25) for nonconduction and conduction of the gas tubes respectively, are derived. An expression for total power is given in (26).

$$i = i_1 + i_L \tag{13}$$

$$e - i_L(R_2 + R_L) - iR_3 = 0 \tag{14}$$

$$i_1R_1 - i_L(R_2 + R_L) = 0 \tag{15}$$

$$i_L = \frac{e}{R_3 + (1 + R_3/R_1)(R_2 + R_L)} \tag{16}$$

$$e - i_1'R_1 - i_3'R_3 = 0 \tag{17}$$

$$E_0 - i_L'R_L - i_3'R_3 + i_4'R_T = 0 \tag{18}$$

$$-i_1'R_1 + i_L'R_L + i_2'R_2 = 0. \tag{19}$$

$$i_3' = i_1' + i_L' \tag{20}$$

$$i_2' = i_L' + i_4' \tag{21}$$

$$i' = i_3' + i_4' \tag{22}$$

$$i_L' = \frac{e \left(\frac{R_1}{R_2} - \frac{R_3}{R_T} \right) + E_0 \left(\frac{R_1 + R_3}{R_T} \right)}{R_3 \left(\frac{R_1}{R_2} - \frac{R_3}{R_T} \right) + (R_1 + R_3) \left[\frac{R_L + R_3}{R_T} + \frac{R_2 + R_L}{R_2} \right]} \tag{23}$$

$$P_1 = \frac{1}{(T/4) - t_1} R_L \int_0^{(T/4)-t_1} (i_L)^2 dt \tag{24}$$

$$P_2 = \frac{1}{t_1} R_L \int_{(T/4)-t_1}^{T/4} (i_L')^2 dt \tag{25}$$

$$P = \frac{R_L \int_0^{(T/4)-t_1} (i_L)^2 dt + R_L \int_{(T/4)-t_1}^{T/4} (i_L')^2 dt}{T/4} \tag{26}$$

Inspection of (23) shows that the multiplying factor of the instantaneous applied voltage e can be made negative by properly unbalancing the bridge circuit. Since e is the only variable in this equation the instantaneous load current can then be made to decrease with increasing magnitude of e . Preferably the bridge constants and tubes are so chosen that the second term of the numerator is substantially greater than the first term, so that the amount of decrease of the load current i_L' during tube conduction is just sufficient to compensate for a corresponding increase of the load current i_L over its normal value during nonconduction, caused by a fluctuation of the applied line voltage e . The greater the second term of (23), the greater will be the load current and the power transmitted to the load.

Fig. 5 shows two oscillograms illustrating the decrease in instantaneous load current during gas-tube conduction for increasing amplitude of line voltage, specifically for line voltage values of 175 and 250 volts (root-mean-square).

The phenomenon illustrated by Fig. 5 causes the effective load current to increase slightly to a maximum value and then to decrease again, when the line-voltage amplitude is continuously increased through a

³ T. R. Harrison, United States Patent No. 2,211,114.

predetermined operating range. This can be explained qualitatively by the fact that the gas tubes conduct over a greater part of the cycle for increasing amplitudes of line voltage, so that the decrease in instantaneous load current during the tube-conduction interval overcompensates for the increase in instantaneous load current during the nonconduction interval. By adjusting the values of resistors R_1 , R_2 , and R_3 , the value

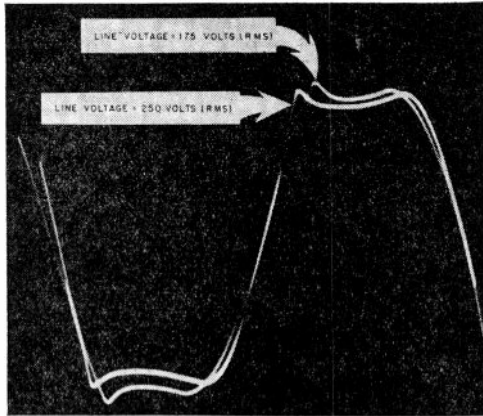

Fig. 5—Wave form of output current of bridge-circuit regulator.

of line-voltage amplitude at which the change of effective load current changes from an increase to a decrease can be varied to suit the operating range. The effect just described is instrumental in rendering better regulation than could be obtained with a balanced bridge, in which the effective load current increases constantly with increasing line-voltage amplitude.

In the design of the unbalanced bridge the factor $[(R_1/R_2) - (R_3/R_T)]$ of the instantaneous line voltage e in (23) for the instantaneous load current i_L' should be in the order of -10 to -20 . R_T was found to be approximately 35 ohms for a VR 150 tube; however, this value varies from tube to tube. The value of resistor R_2 is chosen from the viewpoint of limiting the gas tube current, and should be about 2000 or 3000 ohms.

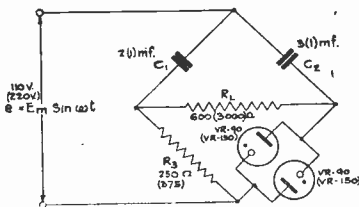

Fig. 6—Circuit of the resistance-capacitance bridge regulator.

Fig. 4(a) shows typical values, which are not critical, for a circuit operating from an applied voltage of 275 to 385 volts (root-mean-square). In this case, a 40 per cent change in applied voltage produces a change in effective load current of about 1 per cent of a nominal current of 27 milliamperes. For this case the efficiency of the circuit is between 4 and 8 per cent, depending upon the applied voltage. This poor efficiency is largely due to power dissipation in the resistors R_1 and R_2 .

In order to improve circuit efficiency a new bridge circuit, shown in Fig. 6, was investigated, in which the resistors R_1 and R_2 are replaced by capacitors C_1 and C_2 . The theory and principle of operation are the same as those developed for the resistance bridge.

APPLICATIONS

For an example of an application of the bridge-circuit power regulator the heater of a type 6P5 vacuum tube and a suitable heater transformer were chosen as the load. Fig. 6 shows circuit constants for typical circuits for operation on 110-volt and 220-volt power lines, respectively. For measurement of the effective load current, the load, comprising the heater and heater transformer, was replaced by an equivalent purely resistive load.

TABLE II

C_1 in microfarads	C_2 in microfarads	R_1 in ohms	R_L in ohms	Voltage-Regulator Tubes Used	Load current in milliamperes and per cent change in load current	Per cent change in 5-milliamperes plate current of 6P5 tube	Per cent change in 5-milliamperes plate current of 6P5 without use of regulator
Line Voltage = 110 ± 10 per cent							
2	3	250 approx.	600	VR-90	73 ± 0.35 per cent	± 0.01 per cent	± 4 per cent
Line Voltage = 220 ± 10 per cent							
1	1	375 approx.	3000	VR-150	32 ± 0.35 per cent	± 0.01 per cent	—

Table II gives the circuit constants and operational data for the circuit shown in Fig. 6. For both 110-volt and 220-volt operation the change in effective load current was ± 0.35 per cent for a change in line voltage of ± 10 per cent of the nominal line voltage, the nominal effective load currents being 73 milliamperes and 32

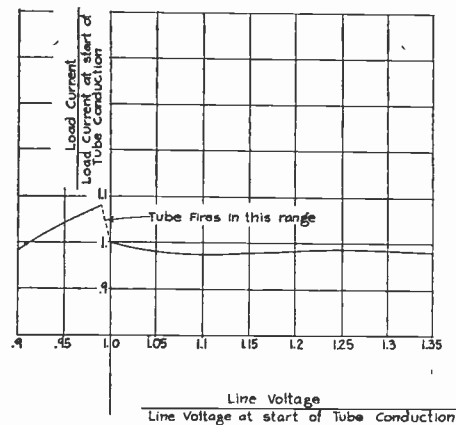

Fig. 7—Experimental curve indicating the degree of regulation given by the resistance-capacitance bridge.

milliamperes, respectively. Without regulation the change in effective load current would have been 10 per cent instead of 0.35 per cent, so that the change in effective load current is about 1/28 of what it would have been without regulation. Finally, the effect of regulation upon the plate current of a 6P5-type vacuum tube was

measured, in order to demonstrate the usefulness of the regulator in connection with direct-current amplifiers. Without regulation a plate-current change of ± 4 per cent about a nominal value of 5 milliamperes is produced by a line-voltage change of ± 10 per cent of the nominal line voltage of 110 volts. However, with the unbalanced-bridge-regulator circuit the plate-current change is reduced from 4 to 0.01 per cent, or one four-hundredth of its original value. Such a reduction in plate-current fluctuation obviously should contribute substantially to a more stable direct-current amplifier.

A typical experimental curve showing the degree of regulation obtainable by the use of the resistance-capacitance bridge is given in Fig. 7. The slight downward tendency of the curve for the highest line voltages

is explained earlier in the discussion of Fig. 5. The efficiency of the resistance-capacitance bridge regulator varies from 30 to 50 per cent depending upon the line-voltage amplitude.

Since the values of capacitance used in this bridge are not critical, this bridge is substantially independent of power-line frequency, as initially claimed, operates without time lag, and is capable of handling any power which the current capacitance of the gas-discharge tubes will permit.

Obviously, the use of this power regulator is not restricted to the specific application discussed above, but may be extended to any other application in which close control of low values of alternating-current power is required.

Discussion on

“Design of Electronic Heaters for Induction Heating”

J. P. JORDAN

George H. Brown:¹ In his paper on electronic heaters, Mr. Jordan states that the rate of heat input is proportional to the square root of the frequency. It is true that his equations (1) and (3) do indicate this point. However, this is on the assumption that his quantity H_t , the tangential component of magnetic flux at the surface of the charge, is independent of frequency. This in turn implies that the current in the exciting coil is independent of frequency. This is, of course, true where the inefficient practice of placing the work coil in series with the tank-circuit inductance is used. However, the writer has found that transformer coupling to the tank circuit pays real dividends in obtaining maximum power from a given vacuum-tube complement. Then at low frequencies, high currents flow in the work coil. Thus the factor H_t for a constant power input varies inversely as the one-fourth power of the frequency.² If this factor is inserted in Mr. Jordan's equation (1), the power dissipated by eddy currents ΔP is seen to be independent of frequency. This effect has been further amplified by the writer in a recent paper which shows that the efficiency of operation is practically constant over a wide range of frequencies.²

A suitable coupling transformer which is useful in many induction-heating applications is shown in Fig. 17 of the writer's paper just referred to. The use of this transformer serves to vitiate another conclusion drawn by Mr. Jordan. He states that a Hartley oscillator is ruled out of the induction-heating picture, because the grid-phase relationship is altered adversely by coupling to the load. However, when the proper transformer is

used, with the primary coil grounded at the proper point so that one end of the primary serves as the grid coil and the other end serves as the plate coil, the effect of loading is to shift both the plate and grid voltages in the same direction, thus preserving the desired 180-degree phase relation. In our laboratory, we use the Hartley circuit in preference to a Colpitts. The Hartley circuit requires a single fixed condenser, while the Colpitts requires a split capacitor, both sides of which must be altered when it is desired to change the grid excitation. This change in grid excitation is quite easily obtained in the Hartley circuit by moving the ground tap on the primary of the transformer. In addition, it has been our observation that we secure greater stability with changing load when using a Hartley circuit which is transformer coupled to the work coil, with at least as good an efficiency as we have secured with a Colpitts circuit.

J. P. Jordan:³ The discussion submitted by Dr. Brown deals with a phase of the subject which was intentionally omitted from the original article. The paper was intended as a discussion of the factors entering into the design of a flexible, general-purpose oscillator, which could be easily applied to a wide range of jobs by any technician. To achieve this end, it has been the writer's experience that the use of multiturn coils connected directly in the tank circuit will cover the majority of all applications with the least difficulty in coil design. Multiturn coils are easy to wind, permit ready adjustment of loading, and are more efficient than any other method of application. Of course, there are jobs requiring the use of single-turn, high-current coils where an output transformer or a shunt capacitor is indicated.

³ General Electric Company, Schenectady 5, New York.

* Proc. I.R.E., vol. 32, pp. 449-452; August, 1944.

¹ RCA Laboratories, Princeton, New Jersey.

² George H. Brown, "The efficiency of induction heating coils," *Electronics*, vol. 17, pp. 124-129; August, 1944.

But, for general-purpose industrial machines, it is far better to design the oscillator for use with multiturn coils in series with the tank, and then adapt the output transformer to the oscillator when an application arises which requires it.

The output transformer has its greatest application under three conditions—first, when it is necessary to use very high rates of power input per unit area; second, when the physical shape of the part necessitates the use of single-turn, high-current coils; and third, when working conditions require the use of the minimum possible operating voltage. Such cases arise when hardening by the self-quenching method, thin surface hardening of restricted areas, and the hardening of grooves or heating of such parts as tees, etc., when a two-piece coil is necessary. However, since the mutual inductance of the usual air-core transformer is relatively low, it cannot be used efficiently over a wide range of coil inductances, thus necessitating a variety of sizes and turn ratios to cover jobs of different sizes. This factor, together with those mentioned above, restricts the application of any oscillator which can be used only with output transformers.

Dr. Brown has pointed out that for all practical pur-

poses the efficiency of operation remains constant over a wide range of frequencies, while high currents are more easily obtained with output transformers at the lower frequencies. However, since the oscillator under discussion was primarily designed for use with multiturn coils, other factors influenced the choice of frequency.

The Hartley circuit which Dr. Brown recommends is an excellent one for some laboratory uses. The writer has used several such oscillators in the past for special applications, and has found them economical to construct, stable, and amenable to ready alteration for laboratory developmental use. However, for the reasons given previously, the Colpitts or coupled-grid circuits appear to the writer to be preferable for an industrial electronic heater which is to be used both with and without output transformers.

George H. Brown:¹ Mr. Jordan's reply to my discussion of his paper indicates that he has drawn a different conclusion from his experience than I have from mine. I am of the opinion that the use of an output transformer takes care of the majority of the applications with the least difficulty.

Institute News and Radio Notes

Board of Directors

February 7 Meeting: At the regular meeting of the Board of Directors, which was held on February 7, 1945, the following were present: W. L. Everitt, president; G. W. Bailey, executive secretary; S. L. Bailey, W. L. Barrow, E. F. Carter, Alfred N. Goldsmith, editor; R. F. Guy, R. A. Heising, treasurer; Keith Henney, Haraden Pratt, secretary; B. E. Shackelford, D. B. Sinclair, W. O. Swinyard, H. M. Turner, H. A. Wheeler, W. C. White, and W. B. Cowilich, assistant secretary.

Executive Committee Actions: The actions of the Executive Committee, taken at its January 9, 1945, meeting, were ratified.

Constitutional Amendments: Consideration was given to amending the Constitution in a manner to provide for district directors, and for the appointment of a special committee to study the situation involving geographical representation, the possible reduction of Board meetings to four a year, and the desirability of increasing the number of members on and duties of the Executive Committee.

The following motion was passed:

"It was moved to appoint a committee to study the management of the Institute by the Board to the end of proposing modifications in methods that will relieve the Board of unnecessary details, having in mind reducing the number of Board meetings and moving toward regional representation."

H. A. Wheeler, chairman; G. W. Bailey, W. L. Barrow, R. A. Heising, Haraden Pratt, and W. O. Swinyard were appointed to the committee mentioned.

President's Visits: President Everitt stated that he plans to visit Institute Sections in Texas and the Middle West and on the Pacific Coast during February and March.

Standing Committees: The appointment of the Committee personnel, which is to be found on page 275 of this issue, was unanimously approved.

Building-Fund Committee: Dr. Shackelford, chairman, reviewed matters relating to the building-fund campaign, and the following actions resulted from the discussion:

Canadian Contributions: Reference was made to the February-3, 1945, letter from Honorable J. L. Ilsley, Canadian Minister of Finance, which was addressed to Mr. Hackbusch of the I.R.E. Canadian Council. This letter indicates the regulations on sending funds to organizations outside Canada.

Following consideration, this motion was unanimously approved:

"It was moved that the Board recommends that the Building-Fund Committee take whatever action is considered suitable to facilitate the obtaining of funds to be contributed in Canada, providing that such funds are transferable after the end of the war without substantial tax liability at the time."

Initial Gifts: A number of substantial donations have already been received.

Honorary Chairman and Vice-Chairman: Powel Crosley, Jr., and L. P. Wheeler have been chosen for the honorary chairmanship and vice-chairmanship, respectively, of the Building Fund; and it was noted with appreciation that they have accepted the corresponding posts.

Education Committee: Unanimous approval was given to the recommendation of the Education Committee that the Institute Sections form educational committees for the purpose of co-operating with the local educational institutions in furthering student guidance, arranging technical courses of study needed by industry, and assisting students and returning war veterans in obtaining jobs.

War Manpower Commission: Secretary Pratt distributed copies of a letter, covering his reappointment as Consultant in the Office of the Chairman, War Manpower Commission, effective January 9, 1945.

B. J. Thompson Memorial: Secretary Pratt, as chairman of the special committee on a memorial for the late Mr. Thompson, reported on the proposal that the income from a fund, to consist of contributions from a group of his close friends and associates (which includes RCA employees and others) be given as a recurrent prize for an outstanding paper, by a young author, recently published by the Institute, and that such fund be administered by the Institute.

Following the discussion, it was moved that the Board would gladly agree to the handling by the Institute of the stated fund,

which would also be administered by the Institute as an annual prize to such an engineer (under 30 years of age) submitting an outstanding paper published by the Institute.

The Institution of Electrical Engineers: Editor Goldsmith explained that in the December 13, 1944, letter from Secretary W. K. Brasher of the Institution of Electrical Engineers, his organization has offered IRE members the privilege of subscribing for its named publications at the listed prices, which are half of the normal annual rates:

"JOURNAL"

"Part I (General) 10s.6d. (\$2)

"Part II (Power Engineering) . . 15s.9d. (\$3)

"Part III (Radio and Communication Engineering) . . . 10s.6d. (\$2)

"or

"all three Parts together . . 31s.6d. (\$6) per annum.

"SCIENCE ABSTRACTS"

"Section A (Physics Abstracts) 17s.6d. (\$3.50)

"Section B (Electrical Engineering Abstracts) 17s.6d. (\$3.50)

"or

"both Sections together 30s.0d. (\$6)"

It was pointed out that a similar reduction (one half) on the Proceedings, in case of the IEE members, would result in the special rate of \$6.00 a year (\$10.00 less 50 per cent discount, plus \$1.00 foreign postage), or the equivalent of annual dues for the Associate grade.

The motion to accept the special-price offer on the IEE publications for the IRE members, to be effective January 1, 1946, and subject to paper limitations, was unanimously approved.

Executive Committee

February 6 Meeting: The Executive Committee meeting, held on February 6, 1945, was attended by W. L. Everitt, president; G. W. Bailey, executive secretary; S. L. Bailey, W. L. Barrow, E. F. Carter, Alfred N. Goldsmith, editor; R. A. Heising, treasurer; Haraden Pratt, secretary; and W. B. Cowlich, assistant secretary.

Membership: The following transfers and applications for membership were unanimously approved: for transfer to Senior Member grade, J. F. Bates, Rinaldo DeCola, D. W. Gellerup, R. A. Henderson, F. P. Herrnfeld, C. B. Jones, A. W. Melloh, Earl Schoenfeld, W. M. Smith, E. K. Stodola, and D. P. Tiedemann; for admission to Senior Member grade, H. G. Booker, W. E. Bradley, Gregory Breit, W. C. Hahn, R. E. Samuelson, N. H. Searby, and Joseph Slepian; for transfer to Member grade, A. E. Anderson, E. F. Brooke, W. R. Clark, N. B. Coil, J. W. Davis, T. A. Elliott, R. C. Fancy,

E. M. Guyer, F. W. Herrmann, W. E. Hudson, W. S. Klein, G. S. Ley, M. A. McLennan, R. J. Nunner, W. H. Ottemiller, Jr., T. B. Perkins, J. M. Pettit, L. D. Prehn, E. O. Ross, F. F. Seifert, H. S. Sheppard, H. L. Spencer, F. G. Suffield, J. E. Tapp, R. A. Whiteman, and C. R. Wischmeyer; for admission to Member grade, G. E. Bowler, P. B. Burley, L. C. Cahan, U. C. S. Dilks, S. B. Dunham, H. C. Florance, K. J. Gardner, B. K. Hawes, Jr., W. P. Jacob, C. E. McClellan, J. T. McNaney, C. H. Millar, A. W. Moody, D. S. Radmacher, E. H. Ross, H. G. Schick, Arnold Shostak, Henry Sturtevant, Frank Virgadamo, H. H. Warrick, L. L. Winter, and H. B. Yarbrough; Associate grade, 192; and Student grade, 81.

1945 Winter Technical Meeting: The Assistant Secretary stated that the registration totaled 3022 (including 1202 registered in advance and 50 women) and that 1180 attended the banquet, 558 the President's Luncheon, and 274 the Luncheon for men in the Armed Services. 395 membership applications were distributed during the four-day meeting, which terminated on January 27, 1945.

1945 Summer Convention: The 1945 Summer Convention scheduled to be held in Montreal during June will be canceled.

"Messrs. A, B, and C." The following Executive Committee appointments were made, and the duties assigned in each case are explained below:

"Mr. A." W. L. Barrow shall be in charge of Standardization and other Technical Committees.

"Mr. B." S. L. Bailey shall be in charge of Advertising, Conventions and Conferences, and Sections.

"Mr. C." E. F. Carter shall be in charge of Admissions, Membership, and Public Relations Committees.

YEARBOOK: It was moved and unanimously approved to send a copy of the Yearbook automatically, without charge, to each member (except in the case of Student members) and to subscribers. The YEARBOOK will be made available to anyone for purchase in limited quantities at \$5.00 a copy.

It was decided to insert suitable brief biographies of all Fellows in the forthcoming YEARBOOK and, at the September meeting of the Executive Committee, to consider extending the biographical data to the members of the Senior-Member grade beginning with a later YEARBOOK following the edition now in preparation.

It was unanimously recommended to the Board that the records for the YEARBOOK be changed to show the year of election to Member grade prior to the adoption of the constitutional amendment creating the grade of Senior Member, as the year of election to the grade of Senior Member in all such cases.

Manual of Procedure for Technical Sessions: President Everitt submitted a proposed draft of the manual, "The Presentation of Technical Developments before Professional Societies," which he had prepared.

It was decided to publish this material in the PROCEEDINGS and to provide 5000 reprints for use by Sections and at national meetings of the Institute.

1945 Winter Technical Meeting

With a total registration of slightly more than 3000, the 1945 Winter Technical Meeting of the Institute, held at the Hotel Commodore, New York, January 24 to 27 inclusive, set a new high mark in attendance and created a commendable record for sustained interest. Despite the wartime difficulties of train travel and a serious shortage of hotel accommodations, engineers from all parts of the country registered for the four-day Meeting. By laying out parallel sessions on a strict schedule and adhering to it, the Papers Committee was able to present 43 papers and one special session. The latter, a symposium on Wave Propagation, occupied the entire afternoon of the final day and produced the high spot of the WTM.

A full house was attracted to the joint session of the IRE and AIEE on the opening night to witness the award of the Edison Medal to Dr. E. F. W. Alexanderson and listen to addresses by the recipient and by Captain J. B. Dow, United States Navy, who discussed the Navy's electronic program. This event, the only one held outside the Hotel Commodore, took place in the auditorium of the Engineering Societies Building.

The annual banquet on Thursday night was attended by over 1200 members and guests. Extra tables were placed in every available space to accommodate the overflow. Prior to the principal address by Francis Colt de Wolf, chief, the telecommunications division, Department of State, Dr. W. L. Everitt, newly elected president of the Institute, awarded the Medal of Honor to Dr. H. H. Beverage; the Morris Liebmann Memorial Prize to Dr. W. W. Hansen; and twelve Fellowships to distinguished engineers in the radio and communications fields. Professor H. M. Turner, retiring president, also spoke.

Colonel V. B. Bagnall, U. S. Army, was the principal speaker at the luncheon on Friday honoring Dr. Everitt as the incoming president. Later in the day, at the conclusion of the afternoon technical session, visiting engineers were guests at a cocktail party made possible through the generosity of nearly forty manufacturers. Here again there was an attendance that far exceeded the estimates of the Arrangements Committee.

The luncheon on Saturday, which was held to honor servicemen, especially those from the Signal Corps stationed at Fort Monmouth, had been expected to close the 1945 WTM but a paper on "Wave Propagation" read on Thursday by K. A. Norton and E. W. Allen, Jr., had started a controversy which increased in interest and intensity during the remainder of the sessions. Recognizing the great importance of the subject, in view of the Federal Communications Commission's preliminary report on allocations, Dr. Everitt and the several committees concerned decided to hold a post-meeting session on Saturday afternoon.

(Continued on page 274)

1945 WINTER



MR. FRANCIS COLT DE WOLF, Chief, Telecommunication Division, Department of State, Guest Speaker at Banquet. Professor Turner in Background.



DR. HAROLD H. BEVERAGE, Recipient, Medal of Honor, 1945,



DR. WILLIAM W. HANSEN Receives Morris Liebmann Memorial Prize for 1944 from DR. WILLIAM L. EVERITT. Lower left, MR. DE WOLF.



DR. EVERITT Presents Certificate of Fellowship to DR. ORESTES H. CALDWELL, who Made the Speech of Acceptance for all Recipients of The Fellow Grade.

TECHNICAL MEETING



CAPTAIN JENNINGS B. DOW, United States Navy, Addresses the Joint I.R.E.-A.I.E.E. Meeting.



GENERAL COMMITTEE; 1945 WINTER TECHNICAL MEETING
Front row: M. B. Long; Frank Gunther; J. E. Shepherd, vice-chairman; Austin Bailey, chairman; Helen M. Stote; Howard S. Frazier, and Martin A. Gilman.
Back row: E. L. Bragdon, Carl E. Scholz, E. W. Herold, G. B. Hoadley, W. B. Lodge, and E. J. Content.



COLONEL V. B. BAGNALL, United States Army, Guest Speaker at President's Luncheon.



MR. H. B. RICHMOND, Banquet Toastmaster, and DR. EVERITT.

I.R.E. Building Fund

Francis Bacon, in "Maxims of the Law," says "I hold every man a debtor to his profession; from the which as men of course do seek to receive countenance and profit, so ought they of duty to endeavor themselves by way of amends to be a help and ornament thereunto."—John Howard Dellinger, National Bureau of Standards.

An Open Letter to the Chairman of the I.R.E. Building Fund

I DO NOT think the Building Fund can be divorced from the whole problem of the future of the Institute, and, therefore, items such as new services which are proposed must be integrated into it, because it all contributes to the broad, over-all plan.

Our society has developed in recent years at an unprecedented rate, both numerically and geographically. We have an opportunity, if we can present a united front, to take the leading part in the development of new services to the members, the profession, the industry, and the commonwealth. To do this we need (1) An aggressive, forward-looking program and (2) A unity of purpose, while at the same time, utilizing the contributions of all the members in determining policy.

To achieve these purposes, we must progress away from the present situation, where the voluntary services of the officers have been depended upon, not only to formulate policies, but also to administer the details of office procedure. During the war and for some time previous, we have been coasting along with an inadequate permanent staff, with the result that communications from and with the members have been neglected and other services have been meager or postponed to the future.

It is my firm conviction that in the development of a unified, aggressive organization, there is nothing more important than a well-trained permanent office staff under capable leadership having a high esprit de corps and an intense loyalty to the organization for which they are working. When this is developed, correspondence between headquarters and the Sections will be prompt and meaningful, the wishes of the Sections can be interpreted into Board matters, and a frequent rotation of officers and Directors, who no longer have to dabble with office detail, is possible and necessary to provide a refreshing flow of new blood between the Institute membership and its management.

To achieve these desired results, the three essential prerequisites are a capable full-time leader at head-

quarters, an adequate staff, and quarters conducive to work of a high caliber.

We have now secured the leadership by appointing Mr. George Bailey as our Executive Secretary. I have heard nothing but good comments upon this choice. He was chosen, among other things, because of his outstanding ability in office management, and his proved capability of organization leadership. We are also moving rapidly to secure a Technical Secretary and a Technical Editor, so that the officers will not be depended upon for the details of management. Thus, we shall have an adequate full-time staff, to co-ordinate our technical committees and editorial functions.

I quite concur with the Building Fund Committee that the need of the proposed new building by the Institute is urgent . . . — Lee de Forest.

The actual decision to embark upon the building-quarters campaign was a result of really hard work for the past two years. Anyone who steps into the crowded Institute headquarters can see that something had to be done and done soon. As a first step, an Office-Quarters Committee was appointed to secure additional space. They started out to look for space to rent and found that it was very scarce, arrangements for future growth were almost impossible, and proposed rentals were extremely high. The Board, after much discussion, then instructed the Quarters Committee to look into the possibility of purchase, not knowing whether we should put the limited Institute capital into down payment on a home which would have to be heavily mortgaged. Many locations were studied and the following condition was found to exist:

1. Any property which is suitably located, comes on the market for a short time and then disappears. Frequently, before we could examine a building, it would be off the market.
2. Prices were constantly going up.
3. The only possible way to purchase a home would be to have the cash on hand and move quickly, when the opportunity arose.

I am very happy to endorse your statement of the needs of the I.R.E. for a new building and endowment and to express my confidence in the Directors and the plan of the Building-Fund Committee.—G. W. Pierce.

The Board discussed thoroughly the matter of financing. Three plans (including some variations) were considered.

1. Part payment with present Institute funds and a mortgage on the balance.
2. A Building-Fund Campaign among the members only, where we might hope to get enough cash to buy the building and then gradually fix it up. This would saddle the Institute with a permanent increase in its fixed charges.
3. A campaign of the proportion now under way which would buy the building, fix it up in an appropriate fashion, and provide sufficient endowment to cover the increase in cost of operation above our present rental.

The Board was inclined in turn to each of these proposals but progressed to the certainty that the latter was the only proper course. By the time the thorough study had been made, it became evident that real-estate prices were going up, and that if we struck "while the iron was hot" we should be able to take advantage of the present favorable tax situation (that is, favorable for the campaign). Accordingly, it was decided to go ahead. I shall not repeat here all the arguments for the plan which have been given in the literature.

With reference to your letter of January 30th, I have no objection to using my name as a sponsor for the Building Fund of The Institute of Radio Engineers. It is a pleasure to assist the Institute as the Signal Corps of the Army has long been in close association with it.—Major General H. C. Ingles.

The Board discussed rather thoroughly the question of the completeness of the proposal which should be submitted in the Building Fund program. There is no vacant land available in a desirable location in New York for a new building, nor is it presently economical to purchase an existing building and demolish it in order to build a new one.

For these reasons, it seemed essential that the Institute have the cash on hand before it would dare buy a building to fit its present needs. It would be impossible to secure an option of sufficient length on a proposed building if the money must be collected later, because all real-estate owners will consider only short-time proposals for options and by the time the money could be collected, a desirable building would be sold.

I feel that it is extremely important for the future of the Institute that we try to get as much utility throughout the organization as possible, while at the same time, moving forward progressively.

W. L. EVERITT, *President*
The Institute of Radio Engineers

War-Loan Bonds

Building-Fund subscribers can receive local war-loan credit by remitting to the Institute war bonds instead of cash or checks, thus discharging a patriotic duty at the same time that they are supporting the Institute's objectives. Series F bonds may be purchased at cost price of \$18.50 upwards, or Series G from \$100 upwards. It is very important that the bond be registered in the name: "The Institute of Radio Engineers, Incorporated," and not in the form in which checks will ordinarily be drawn, to: "I.R.E. Building Fund."

We are just entering the electronic era, and I would like to see the Institute in a position to carry on its functions fully in order to keep the United States in the lead in this field. I believe that one of the functions of the Institute should be that of serving as a liaison between the electronics industry and the Armed Services in order that our country will be better prepared to meet any emergency which may arise.—Joseph R. Redman, Rear Admiral, United States Navy.

For example, a subscriber who had committed himself to a payment of \$25 quarterly might make one or more of his quarterly payments in the form of a check for \$6.50 and a \$25 Series F bond costing him \$18.50. The Institute can make the necessary conversions from Series F to Series G and vice versa so that it may hold a total of \$100,000 of these bonds. Note that Series E bonds, usually sold during drives to individual subscribers for \$18.75 upwards, are not available both on account of limitation on holdings and limitation of registration to individuals.

Canadian subscribers will have their attention drawn to corresponding features in Canada by Mr. R. A. Hackbusch, of the Canadian Council.

The contributions made by the members of the I.R.E. have proved to be the most valuable and revolutionary for civilization, without exception. In a little more than a generation the combined contributions of radio physicists and engineers have become the world's most powerful influence, and the Institute should carefully guard and guide this giant.

In setting up your plans for a permanent home, you might bear in mind space for preserving and showing original developments and contributions to the art,—a small historic museum.—William Dubilier.

(Continued from page 269)

Among those who addressed a packed West Ballroom that day, in addition to Messrs. Norton and Allen, were Major E. H. Armstrong, C. M. Jansky, Jr., John D. Reid, Dale Pollack, and Allen B. DuMont. Sensing the impact of the arguments on many allied phases of radio, newspaper editors assigned reporters to cover the session and as a result, the Institute received wide recognition in the press.

One of the principal points of attraction throughout the WTM were the exhibits of manufacturers where many war-born products were available for inspection. Thirty-nine firms were represented with displays. This feature of the Winter Technical Meeting drew so many favorable comments that additional space for exhibits undoubtedly will be provided at future conventions.

Among the special plans made to entertain the wives of visiting members was a sightseeing trip to the Old Merchants House. Luncheons were held at Wanamakers and The Women Services Club; a special make-up demonstration was given at the Coty Salon, and a fashion show presented at the New York Dress Institute. Fifty women guests participated in these activities.

Music for the annual banquet was supplied by an orchestra donated by the Blue Network. Artists from the National Broadcasting Company entertained the servicemen at the luncheon given them on Saturday.

The General Committee for the 1945 Meeting, headed by Dr. Austin Bailey as chairman, was widely congratulated on the general arrangements, the type and scope of papers presented, and the high standard of entertainment provided for the several social events.

The Institute of Radio Engineers Cancels National Conventions

In view of wartime transportation conditions, as described by the Office of Defense Transportation, The Institute of Radio Engineers has decided to cancel its 1945 Summer Convention.

As a substitute for this National Convention, the Institute urges its many local sections to conduct local conferences on appropriate special subjects, these conferences to be attended by members residing in the immediate vicinity.

The radio industry is devoted one hundred per cent to war work, including the production of radio, radar, electronic, and other equipment of highly essential nature, much of which is at present secret. The Institute therefore deals entirely with information in a war-essential field. It is nevertheless canceling its 1945 Summer Convention in the further interests of the war effort.

Remarks of Dr. O. H. Caldwell, Editor of *Electronic Industries*, in acknowledging IRE Fellow awards, January 25, to

Dr. H. H. Buttner
Dr. O. H. Caldwell
Dr. W. H. Doherty
Dr. A. W. Hull

Dr. A. L. Loomis
Mr. A. V. Loughren
Mr. F. X. Rettenmeyer
Dr. S. A. Schelkunoff

Dr. R. L. Smith-Rose
Dr. K. S. Van Dyke
Captain E. M. Webster
Mr. P. D. Zottu

Mr. President and Directors of the IRE:

The group of distinguished radio engineers on whom you have conferred the great honor of Fellowship in the Institute, have asked me to express their deep appreciation of this recognition. The new status of "Fellow" you have thus placed upon them will certainly further stimulate their efforts and achievements in the ever-expanding radio art. And it will impose on each an even greater responsibility for service to the industry.

As for myself, I feel very humble at having you pin upon me the title of Fellow. And since "fellow" is a word with many shades of meaning, I determined to look a little into the meaning of the term. So, as a faithful editor, I sought out the dictionaries.

"Fellow," I found, comes from a Medieval English word "felawe." Also an earlier Old English form of the word is revealed in "felaghe." And in light of recent World-War events, one especially interesting result of my search showed that the English apparently got their early term "felaghe" from an even older Icelandic word "felagi." The word thus gives a clue to the early voyages of discovery and commerce between Iceland and England. This bit of etymology reveals, too, how, for many hundreds of years, our English mother tongue has been preparing for this very moment tonight,—by bringing this six-letter word "Fellow" first across ancient arctic seas and then down through the centuries, all intact, for your use on this occasion!

Seeking next for definitions of the word "fellow" in its modern form, Webster, I found, gives several definitions of "fellow." Among them is actually this: "fellow, a man of low breeding or of little worth." Now obviously that definition is hardly the one which you IRE directors meant to imply in connection with these engineers of distinction whom you are honoring tonight.

So I looked further and came onto a more appropriate definition also by Webster: "fellow: a sharer, a partner." That definition of "a sharer, a partner" it seems to me sets the sights and the aims not only for IRE Fellows, old and new, but for all the members of the IRE and of the great radio engineering fraternity.

For never, in all history, has a group of trained engineering specialists been handed such a huge responsibility as has been imposed on radio men in the last two or three years.

Think of this; In 1944 over five billion dollars worth of radio equipment and service—five thousand million dollars—was produced based on the technical discoveries and designs created by the members of the IRE and their predecessor engineers. For each of the voting members of the IRE, there is

nearly one and one-half million dollars per man, in 1944. Even more will be produced this year. And all of this five or six billion dollars of actual wealth per year has been created literally out of thin air by radio engineers and radio inventors.

Postwar this huge industry of ours will find new channels and new bases for a useful and expanding existence—of that I have no doubt.

But radio engineers must not be satisfied to be merely employees and staff aids in the huge industries they have created. Radio engineers should themselves take business and industrial leadership. It is time for the radio engineer to be the "big boss" of his own concern and shape its general policies. Instead of avoiding and evading business responsibility in order to keep close to the design room and slide rule, radio engineers should prepare themselves to reach out for the top management positions, for independent proprietorships, for public service in fitting radio into broader usefulness to humanity.

All too often, as you and I have observed, some skillful lawyer or clever salesman or quick-minded accountant is chosen to fill the top place in a radio organization, a post which would have been far better served by a trained radio-minded man having the broad grasp necessary to relate our radio art to general business problems.

Radio engineers are perfectionists, I know. And so they like to keep close to their technical work, improving detail parts into the highest possible efficiency.

But even from this aspect of perfectionism alone, you will admit that fullest perfection in radio cannot come unless the radio engineer has the greatest freedom in which to work. And this means that radio engineers at the top must give sympathetic encouragement to radio engineers throughout the organization.

Radio engineers have created a whole galaxy of great industries—industries tremendous in public service, industries imagination-defying in technical achievement, and industries now astronomic in dollar volume!

But these great industries must be offered by radio men, from top executive posts on down to the design rooms and production departments. This is absolutely necessary, for the good of the radio industries and the public they serve. Let me urge therefore, that radio men accept and even seek out these responsibilities of management and direction. Let us take Webster's tip and make the radio engineer a real "sharer and partner" in the huge industries he is creating.

And let us see that the radio man collects in full, for himself and for his family, his share of the wealth he is producing.

The Institute Adds a Chapter to its Survey of Radio Progress

Remarks by L. E. Whittemore, Chairman, Annual Review Committee, 1944, before Winter Technical Meeting, I.R.E., January 25, 1945.

The 1944 Chapter of the Institute's Survey of Radio Progress will be the 11th installment. The first one related to the year 1934 and dealt with (1) fixed (point-to-point) service, (2) mobile radio service, (3) broadcast transmission, (4) broadcast reception, and (5) fields allied to radio. Each year since then the Institute has published reviews or surveys of progress in several of the specialized technical fields in which its members are interested.

The purpose of these surveys is twofold: first, to present to the specialist in one field a general picture of the important forward steps in the other specialists' fields which he cannot follow day by day and, second, to provide an historical record of the evolutionary progress in radio communication and allied fields in order that radio engineers may be better able to view current developments with a proper perspective. The bibliography, which forms a part of the published reviews, is believed to be a useful and important part of this record.

During recent years, the Annual Review has been a composite of reports prepared by the Institute's several Technical Committees and it has become the custom for the membership of the Annual Review Committee to consist of the Chairmen of these technical Committees and two or three other persons who co-ordinate the material and edit it for publication.

There would be no point in my going into a detailed recital of the work of the Annual Review Committee for 1944. You have just heard the interesting stories presented by the Chairmen of the Technical Committees. The material which they submitted last month for the Annual Survey has been edited and sent to press and you will be able to read it in a forthcoming issue of the PROCEEDINGS. Meanwhile, I am sure we are all making every effort to speed the day when, after the war, these survey chapters can have even greater value to those who are interested in the rapidly expanding fields of radio engineering.

Radio Club Elects Officers

At a recent meeting of The Radio Club of America, announcement was made of the re-election for the 1945 term of the same officers who served during 1944, including three members of The Institute of Radio Engineers. O. James Morelock (A'35) was reappointed vice-president of the Club; M. B. Sleeper (M'42-SM'43) corresponding secretary; and John H. Bose (S'33-A'36), recording secretary.

Institute Committees—1945

ADMISSIONS

G. T. Royden, *Chairman*
F. A. Polkinghorn, *Vice-Chairman*

R. D. Avery	T. T. Goldsmith, Jr.
H. H. Beverage	A. R. Hodges
R. M. Bowie	R. H. Langley
J. L. Callahan	Knox McIlwain
J. D. Cobine	H. J. Reich
E. D. Cook	C. E. Scholz
M. G. Crosby	S. W. Seeley
Lloyd Espenschied	J. E. Shepherd
M. E. Strieby	

AWARDS

W. C. White, *Chairman*
Haraden Pratt, *Vice Chairman*

Austin Bailey	E. W. Engstrom
W. L. Barrow	D. E. Harnett
L. A. du Bridge	Keith Henney
J. V. L. Hogan	

BOARD OF EDITORS

A. N. Goldsmith, *Chairman*

R. R. Batcher	E. L. Nelson
R. S. Burnap	H. F. Olson
W. G. Cady	H. O. Peterson
P. S. Carter	G. W. Pickard
L. M. Clement	R. A. Powers
W. G. Dow	Haraden Pratt
E. W. Engstrom	C. A. Priest
W. L. Everitt	H. J. Reich
W. G. H. Finch	P. C. Sandretto
G. W. Gilman	V. W. Sherman
P. C. Goldmark	L. C. Smeby
F. W. Grover	E. C. Wente
L. B. Headrick	H. A. Wheeler
C. M. Jansky, Jr.	W. C. White
H. S. Knowles	L. E. Whittemore
J. D. Kraus	G. W. Willard
D. G. Little	William Wilson
F. B. Llewellyn	C. J. Young
S. S. Mackeown	V. K. Zworykin

CONSTITUTION AND LAWS

R. F. Guy, *Chairman*

Austin Bailey	R. A. Heising
E. F. Carter	F. E. Terman
I. S. Coggeshall	H. R. Zeamans

EDUCATION

A. B. Bronwell, *Chairman*

R. G. Anthes	G. B. Hoadley
W. E. Arcand	F. H. Kirkpatrick
R. E. Beam	R. C. Manhart
W. H. Campbell	Knox McIlwain
C. C. Chambers	W. H. Radford
Melville Eastham	H. J. Reich
G. H. Fett	J. D. Ryder
A. W. Graf	W. J. Seeley
R. F. Guy	F. R. Stansel
Alan Hazeltine	J. A. Stratton
L. N. Holland	W. O. Swinyard
F. S. Howes	G. R. Town
G. A. Wootton	

EXECUTIVE

W. L. Everitt, *Chairman*
R. A. Heising, *Vice Chairman*
Haraden Pratt, *Secretary*

S. L. Bailey	E. F. Carter
W. L. Barrow	Alfred N. Goldsmith

INVESTMENTS

R. A. Heising, *Chairman*

Fulton Cutting	Haraden Pratt
W. L. Everitt	H. M. Turner
H. R. Zeamans	

MEMBERSHIP

E. D. Cook, *Chairman*

C. R. Barhydt	L. B. Headrick
C. M. Burrill	L. G. Hector
J. M. Clayton	Albert Preisman
R. I. Cole	J. L. Reinartz
J. M. Comer, Jr.	Bernard Salzberg
W. C. Copp	R. B. Shanck
W. H. Doherty	J. C. Stroebel
A. V. Eastman	Sarkes Tarzian
W. G. Eaton	Bertram Trevor
A. J. Ebel	K. S. Van Dyke
W. N. Eldred	H. M. Wagner
D. G. Fink	Ernst Weber
Samuel Gubin	R. H. Williamson

(Section Secretaries *Ex-officio*)

NOMINATIONS

J. V. L. Hogan, *Chairman*
H. M. Turner, *Vice Chairman*

Beverly Dudley	C. M. Jansky, Jr.
O. B. Hanson	R. C. Poulter
W. C. White	

PAPERS

F. B. Llewellyn, *Chairman*

H. A. Affel	Emil Labin
W. L. Barrow	F. R. Lack
H. A. Chinn	H. C. Leuteritz
J. K. Clapp	C. V. Litton
I. S. Coggeshall	Knox McIlwain
E. J. Content	H. R. Mimno
C. W. Corbett	I. E. Mouromtseff
M. G. Crosby	G. G. Muller
F. W. Cunningham	A. F. Murray
R. B. Dome	J. R. Nelson
E. B. Ferrell	D. O. North
D. G. Fink	A. F. Pomeroy
H. S. Frazier	J. R. Poppe
R. L. Freeman	Simon Ramo
Stanford Goldman	F. X. Rettenmeyer
F. W. Grover	S. A. Schelkunoff
O. B. Hanson	D. B. Sinclair
T. J. Henry	Dayton Ulrey
E. W. Herold	A. P. Upton
J. V. L. Hogan	K. S. VanDyke
F. V. Hunt	E. K. Van Tassel
Harley Iams	J. R. Whinnery
L. F. Jones	Irving Wolff
J. G. Kreer, Jr.	J. W. Wright
H. R. Zeamans	

PAPERS PROCUREMENT

Dorman D. Israel
General Chairman

Edward T. Dickey
Vice General Chairman

GROUP CHAIRMEN

A. B. Bronwell	T. A. Hunter
N. P. Case	J. R. Nelson
Madison Cawein	H. F. Olson
I. S. Coggeshall	D. B. Sinclair
M. G. Crosby	H. J. Tyzzer
Alfred Crossley	W. L. Webb
Harry Diamond	W. C. White
A. E. Harrison	K. S. Van Dyke

PUBLIC RELATIONS

I. S. Coggeshall, *Chairman*

G. W. Bailey	(S. L. Bailey, Alter-
O. H. Caldwell	nate)
O. B. Hanson	E. K. Jett
Keith Henney	T. R. Kennedy, Jr.
C. W. Horn	J. R. Poppele
C. M. Jansky, Jr.	A. F. Van Dyck
	L. P. Wheeler

SECTIONS

R. A. Heising, *Chairman*

S. L. Bailey	G. T. Royden
V. M. Graham	B. E. Shackelford
R. V. L. Hartley	W. O. Swinyard
F. A. Polkinghorn	H. P. Westman

(Section Chairmen *Ex-Officio*)

TELLERS

G. B. Hoadley, <i>Chairman</i>	
Edward J. Content, <i>Vice Chairman</i>	
Trevor Clark	Edward DeNike

Technical Committees

MAY 1, 1944, TO MAY 1, 1945

ANNUAL REVIEW

L. E. Whittemore, *Chairman*

Andrew Alford	E. A. Guillemin
R. S. Burnap	R. F. Guy
C. R. Burrows	Keith Henney
W. G. Cady	I. J. Kaar
C. C. Chambers	G. G. Muller
I. S. Coggeshall	H. A. Wheeler
L. F. Curtis	C. J. Young

(Plus Member-at-Large)

ANTENNAS

Andrew Alford, *Chairman*

G. H. Brown	W. E. Jackson
Harry Diamond	R. W. P. King
W. S. Duttera	W. B. Lodge
Sidney Frankel	J. F. Morrison
R. F. Guy	J. C. Schelleng
	D. B. Sinclair

CIRCUITS

E. A. Guillemin, *Chairman*

H. W. Bode	C. A. Nietzert
Cledo Brunnetti	A. F. Pomeroy
F. C. Everett	J. B. Russell, Jr.
W. L. Everitt	Stuart W. Seeley
L. A. Kelley	W. N. Tuttle
J. M. Miller	H. A. Wheeler

ELECTROACOUSTICS

G. G. Muller, *Chairman*

A. J. Begun	Benjamin Olney
F. V. Hunt	H. F. Olson
V. N. James	H. H. Scott
G. M. Nixon	L. J. Sivan

ELECTRONICS

R. S. Burnap, *Chairman*

E. L. Chaffee	E. C. Homer
K. C. Dewalt	D. R. Hull
W. G. Dow	J. H. Hutchings
R. L. Freeman	S. B. Ingram
A. M. Glover	D. E. Marshall
T. T. Goldsmith, Jr.	J. A. Morton
G. W. Greer	I. E. Mouromtseff
L. B. Headrick	L. S. Nergaard

H. W. Parker	A. L. Samuel
H. J. Reich	J. R. Steen
A. C. Rockwood	C. M. Wheeler
J. B. Russell, Jr.	J. R. Wilson
Bernard Salzberg	Irving Wolff
	Jack Yolles

FACSIMILE

C. J. Young, *Chairman*

Maurice Artzt	H. J. Lavery
E. P. Bancroft	B. V. Magee
J. C. Barnes	Pierre Mertz
F. R. Brick, Jr.	L. D. Prehn
W. A. R. Brown	H. C. Ressler
J. J. Callahan	G. D. Robinson
J. L. Callahan	W. L. Roe
A. G. Cooley	L. A. Smith
G. V. Dillenback	W. E. Stewart
J. V. L. Hogan	E. F. Watson
	R. J. Wise

FREQUENCY MODULATION

C. C. Chambers, *Chairman*

J. E. Brown	V. D. Landon
W. F. Cotter	H. B. Marvin
M. G. Crosby	D. E. Noble
W. L. Everitt	B. E. Shackelford
R. F. Guy	D. B. Smith
C. M. Jansky, Jr.	L. P. Wheeler
	W. D. White

RADIO RECEIVERS

L. F. Curtis, *Chairman*

G. L. Beers	A. R. Hodges
W. M. Breazeale	J. K. Johnson
W. F. Cotter	Garrard Mountjoy
Harry Diamond	H. O. Peterson
W. L. Dunn	E. K. Stodola
H. B. Fischer	A. E. Thiessen
H. C. Forbes	H. P. Westman
D. E. Foster	R. M. Wilmotte
C. J. Franks	J. A. Worcester

RADIO WAVE PROPAGATION

C. R. Burrows, *Chairman*

S. L. Bailey	D. H. Menzel]
J. L. Barnes	H. R. Mimno
T. J. Carroll	K. A. Norton
J. H. Dellinger	H. O. Peterson
W. A. Fitch	R. L. Smith-Rose
G. D. Gillett	H. P. Thomas
W. C. Lent	W. D. White

STANDARDS

H. A. Wheeler, *Chairman*

Andrew Alford	E. A. Guillemin
R. S. Burnap	R. F. Guy
C. R. Burrows	I. J. Kaar
W. G. Cady	G. G. Muller
C. C. Chambers	C. J. Young
L. F. Curtis	L. E. Whittemore

SYMBOLS

E. W. Schafer, *Chairman*

R. R. Batcher	J. H. Dellinger
M. R. Briggs	E. T. Dickey
R. S. Burnap	H. S. Knowles
C. R. Burrows	O. T. Laube
H. F. Dart	A. F. Pomeroy

TELEVISION

I. J. Kaar, *Chairman*

Hollis Baird	A. G. Jensen
J. E. Brown	L. M. Leeds
A. B. DuMont	H. M. Lewis
D. E. Foster	A. V. Loughren
G. W. Fyler	H. T. Lyman
P. C. Goldmark	A. F. Murray
T. T. Goldsmith, Jr.	R. E. Shelby
R. N. Harman	D. B. Sinclair
	D. B. Smith

RADIO TRANSMITTERS

R. F. Guy, *Chairman*

Andrew Alford	J. F. Morrison
M. R. Briggs	J. C. Shelleng
Harry Diamond	Robert Serrell
F. A. Gunther	D. B. Sinclair
W. E. Jackson	I. R. Weir
W. B. Lodge	J. E. Young

Institute Representatives in Colleges—1945

Alabama Polytechnic Institute: Woodrow Darling
 Alberta, University of: J. W. Porteous
 Arkansas, University of: P. K. Hudson

British Columbia, University of: H. J. MacLeod
 Brooklyn, Polytechnic Institute of: G. B. Hoadley

California Institute of Technology: S. S. Mackeown
 California, University of: L. J. Black
 Carleton College: C. A. Culver
 Carnegie Institute of Technology: B. R. Teare, Jr.
 Case School of Applied Science: P. L. Hoover
 Cincinnati, University of: W. C. Osterbrock
 Colorado, University of: J. M. Cage
 Columbia University: J. B. Russell
 Connecticut, University of: P. H. Nelson
 Cooper Union: J. B. Sherman
 Cornell University: True McLean

Detroit, University of: A. R. Satullo
 Drexel Institute of Technology: R. T. Zern
 Duke University: W. J. Seeley

Florida, University of: P. H. Craig

Georgia School of Technology: M. A. Honnell

Harvard University: E. L. Chaffee

Idaho, University of: Hubert Hattrup
 Illinois Institute of Technology: C. S. Royce
 Illinois, University of: A. J. Ebel
 Iowa, University of: L. A. Ware

Johns Hopkins University: Ferdinand Hamburger, Jr.

Kansas State College: Karl Martin
 Kansas, University of: G. A. Richardson

Lawrence Institute of Technology: H. L. Byerlay
 Lehigh University: C. G. Brennecke
 Louisiana State University: Taintor Parkinson

Maine, University of: W. J. Creamer, Jr.
 Manhattan College: E. N. Lurch
 Maryland, University of: G. L. Davies
 Massachusetts Institute of Technology: W. H. Radford and
 E. Guillemin
 McGill University: F. S. Howes
 Michigan, University of: L. N. Holland
 Minnesota, University of: O. A. Becklund

Nebraska, University of: F. W. Norris
 Newark College of Engineering: Solomon Fishman
 New York, College of the City of: Harold Wolf
 New York University: Philip Greenstein
 North Carolina State College: W. S. Carley
 North Dakota, University of: E. J. O'Brien
 Northeastern University: G. E. Pihl
 Northwestern University: A. B. Bronwell
 Notre Dame, University of: H. E. Ellithorn

Ohio State University: E. C. Jordan
 Oklahoma Agriculture and Mechanical College: H. T. Fristoe
 Oregon State College: A. L. Albert

Pennsylvania State College: G. H. Crossley
 Pennsylvania, University of: C. C. Chambers
 Pittsburgh, University of: L. E. Williams
 Princeton University: J. G. Barry
 Purdue University: R. P. Siskind

Queen's University: H. H. Stewart

Rensselaer Polytechnic Institute: H. D. Harris
 Rice Institute: C. R. Wischmeyer
 Rose Polytechnic Institute: G. R. Schull
 Rutgers University: J. L. Potter

Southern Methodist University: R. E. Beam
 Stanford University: Victor Carson
 Stevens Institute of Technology: F. C. Stockwell

Texas, University of: E. W. Hamlin
 Toronto, University of: R. G. Anthes
 Tufts College: A. H. Howell

Union College: F. W. Grover
 United States Naval Academy: G. R. Giet
 Utah, University of: O. C. Haycock

Virginia University of: L. R. Quarles
 Virginia: Polytechnic Institute: R. R. Wright

Washington, University of: A. V. Eastman
 Washington University: Stanley Van Wambeck
 Wayne University: G. W. Carter
 Western Ontario, University of: G. A. Wootton
 West Virginia University: R. C. Colwell
 Wisconsin, University of: Glenn Koehler
 Worcester Polytechnic Institute: H. H. Newell

Yale University: H. M. Turner

Institute Representatives on Other Bodies—1945

American Documentation Institute: J. H. Dellinger
 Council of the American Association for the Advancement of Science:
 J. C. Jensen
 Joint Co-ordination Committee on Radio Reception of the E.E.I.,
 N.E.M.A., and R.M.A.: C. E. Brigham
 National Research Council, Division of Engineering and Research:
 F. E. Terman
 Radio Technical Planning Board: Haraden Pratt (W. L. Barrow,
 alternate)
 U. R. S. I. (International Scientific Radio Union) Executive Com-
 mittee: C. M. Jansky, Jr.
 U. S. National Committee, Advisers on Electrical Measuring Instru-
 ments: Melville Eastham and H. L. Olesen
 U. S. National Committee, Advisers on Symbols: L. E. Whittemore
 and J. W. Horton
 U. S. National Committee of the International Electrotechnical Com-
 mission: H. M. Turner
 ASA Standards Council: Alfred N. Goldsmith (H. P. Westman, alter-
 nate)
 ASA Board of Directors: F. R. Lack
 ASA Board of Examination: H. P. Westman
 ASA Electrical Standards Committee: H. M. Turner (H. P. West-
 man, alternate)
 ASA Sectional Committee on Acoustical Measurements and Termi-
 nology: E. D. Cook and H. F. Olson
 ASA Sectional Committee on Definitions of Electrical Terms:
 Haraden Pratt
 ASA Subcommittee on Vacuum Tubes: B. E. Shackelford
 ASA Sectional Committee on Electric and Magnetic Magnitudes
 Units: J. H. Dellinger

ASA Sectional Committee on Electrical Installations on Shipboard:
 I. F. Byrnes
 ASA Sectional Committee on Electrical Measuring Instruments:
 Wilson Aull, Jr.
 ASA Sectional Committee on Graphical Symbols and Abbreviations
 for Use on Drawings: Austin Bailey (H. P. Westman alternate)
 ASA Subcommittee on Communication Symbols: H. M. Turner
 ASA Sectional Committee on Letter Symbols and Abbreviations for
 Science and Engineering: H. M. Turner
 ASA Subcommittee on Letter Symbols for Radio Use: H. M.
 Turner
 ASA Sectional Committee on National Electrical Safety Code, Sub-
 committee on Article 810, Radio Broadcast Reception Equip-
 ment: E. T. Dickey (Virgil M. Graham, alternate)
 ASA Sectional Committee on Preferred Numbers: A. F. Van Dyck
 ASA Sectional Committee on Radio: Alfred N. Goldsmith, chairman;
 Haraden Pratt, and L. E. Whittemore
 ASA Sectional Committee on Radio-Electrical Co-ordination:
 J. V. L. Hogan, C. M. Jansky, Jr., and L. E. Whittemore
 ASA Sectional Committee on Specifications for Dry Cells and Bat-
 teries: H. M. Turner
 ASA Sectional Committee on Standards for Drawings and Drafting
 Room Practices: Austin Bailey (H. P. Westman, alternate)
 ASA Committee on Vacuum Tubes for Industrial Purposes: B. E.
 Shackelford
 ASA War Committee on Radio: Alfred N. Goldsmith*
 ASA War Standards Committee on Methods of Measuring Radio
 Noise: C. J. Franks and Garrard Mountjoy

* Also chairman of its Subcommittee on Insulating Material
 Specifications for the Military Services.

Contributors



A. D. BAILEY

A. D. Bailey (A'43) was born on February 16, 1915, in Waterloo, Iowa. He received the B.A. degree from Iowa State Teachers College, in 1936; the B.S. degree in electrical engineering from Iowa State College, in 1938; and the M.S. degree in electrical engineering, in 1944, from the University of Illinois.

From 1938 to 1941 he was associated with K. R. Brown, consulting engineer, of Des Moines, Iowa, principally engaged in the design and construction supervision of Rural Electrification Administration lines. He joined the staff of the University of Illinois in 1941, as instructor in electrical engineering, and is at present on leave of absence, serving as an Ensign in the United States Naval Reserve. Mr. Bailey is a member of the American Institute of Electrical Engineers, the Society for Promotion of Engineering Education, and Tau Beta Pi.



FITZHUGH W. BOGGS

Fitzhugh W. Boggs was born at Essex Falls, New Jersey, on December 23, 1911. He had most of his schooling in France where he obtained the degree of Bachelier ès Sciences from the Faculté des Sciences de Marseille. In 1938 he received the B.S. degree from Columbia University. In 1934 he took a position as research technician at the College of Physicians and Surgeons, where he worked on neurological problems under the late Professor Joshua Rosett.

From 1939 to 1942 Mr. Boggs was a graduate student and assistant in chemistry at Cornell University. Since October, 1942, he has been a research engineer in the electronics laboratory of the Westinghouse Electric and Manufacturing Company.



LLOYD B. CHERRY

During the summer of 1937, Mr. Cherry was associated with the General Electric Company, in Schenectady, N. Y., and later in the same year joined the commercial engineering department of the Dallas Power and Light Company. From 1938 to 1942 he was instructor of physics and mathematics at Ranger Junior College, Edinburg Junior College, and the University of Texas, where he undertook additional graduate study.

Mr. Cherry joined the research department of the Brown Instrument Company, in 1942, and became engaged in war work directly related to contracts with the Naval Ordnance Laboratory and the Bureau of Ships. He has specialized in the developments of electronic circuits and their mathematical analyses for precision measuring instruments. He is an associate member of Sigma Xi.



GEORGE H. BROWN

George H. Brown (A'30-F'42) was born on October 14, 1908, at North Milwaukee, Wisconsin. He received the B.S. degree at the University of Wisconsin in 1930; the degree of M.S. in 1931; the Ph.D. degree in 1933; and his professional degree of E.E. in 1942. From 1930 until 1933 he was a Research Fellow in the electrical engineering department at the University of Wisconsin, and from 1933 to 1942 he was in the research division of the RCA Manufacturing Company at Camden, New Jersey. Since 1942, he has been at the RCA Laboratories at Princeton, New Jersey. He is a Member of Sigma Xi and the American Institute of Electrical Engineers.

W. D. Cockrell received the B.S. degree in electrical engineering from the University of Florida in 1928. Upon graduation, he became associated with the General Electric



W. D. COCKRELL

Lloyd B. Cherry (A'44) was born in Weatherford, Texas, on March 1, 1915. He received the B.A. degree in physics from the University of Texas, in 1936, and the M.A. degree from the same institution, in 1937.



THOMAS W. DAKIN

Company, and for thirteen years worked with that organization on design of industrial electronic control, producing 29 patents. Since 1941, Mr. Cockrell has been engaged in electronic application work for the industrial engineering division of the General Electric Company. He is a member of the American Institute of Electrical Engineers, and holds a second-class radiotelephone and WERS license. He is registered as a professional engineer in New York State.

Thomas W. Dakin was born on May 5, 1915, in Minneapolis, Minnesota. He received his A.B. degree in physical chemistry from the University of Minnesota in 1935. From 1935 to 1938 he was a graduate assistant in physical and electrochemistry at Michigan State College, from which institution he received his M.S. degree in 1938. From 1938 to 1941 he held a George Chase Christian Fellowship, and later a Lehman Fellowship, at Harvard University where, in 1941, he received his Ph.D. degree in physical chemistry, completing research on the properties of electrolytic solutions. Since becoming associated with the Westinghouse research laboratories in 1941, he has been



REUBEN LEE

for one year a Westinghouse Research Fellow and then a research engineer in the insulation department. His recent research has been on the dielectric properties of plastic materials and the development of high-frequency apparatus for measuring dielectric properties.

G. H. FETT

G. H. Fett was born in Chicago, Illinois, on June 19, 1909. He received the B.S. degree in electrical engineering in 1931 from the University of Illinois; the M.S. degree in 1932, from Iowa State College; and the Ph.D. degree in engineering from the University of Illinois, in 1940.

From 1933 to 1935, Dr. Fett was engaged in research work with Littelfuse Laboratories, Chicago, Illinois. He joined the staff of the University of Illinois, in 1935,



I. E. MOUROMTSEFF

as assistant in the electrical engineering department. He was subsequently appointed instructor, promoted to the rank of associate, and is at present assistant professor, in that department. He is a member of the American Institute of Electrical Engineering, the American Physical Society, the American Welding Society, Sigma Xi, and Tau Beta Pi.

Reuben Lee (A'32) was born on November 8, 1902, at Shirland, Derbyshire, England. He received the B.S. degree in electrical engineering from West Virginia University in 1924. Upon graduation, he became associated with the Westinghouse Electric and Manufacturing Company, first in the student course, followed, in 1925, by the control engineering department, and transferring to the radio engineering department in 1928. Mr. Lee is now a design engineer in the Baltimore plant of that organization. He is a member of Tau Beta Pi.



ARTHUR L. SAMUEL

I. E. Mouromtseff (A'34) was born in December, 1881, at St. Petersburg, Russia. He received the M.E. degree from the Engineering Academy, St. Petersburg, in 1906, and in 1910 was awarded the Diploma-Ingenieur degree in electrical engineering from the Grand Ducal Institute of Technology, Darmstadt, Germany. During the following year he was dean of the Signal Corps School for Army Officers, in Russia. In 1911 Mr. Mouromtseff was a member of the Franco-Russian Radio Committee.

In 1923 he became affiliated with the Westinghouse Electric and Manufacturing Company in the research laboratories at East Pittsburgh. He was transferred to the vacuum-tube department in 1936, and since 1942 has worked in the electronics engineering department, in Bloomfield, N. J.

Arthur L. Samuel (A'24-SM'44) was born at Emporia, Kansas, on December 5, 1901. He received the A.B. degree from the College of Emporia in 1923, the degrees of S.B. and S.M. in electrical engineering from the Massachusetts Institute of Technology in 1926, and has done additional graduate



HUBERT M. TURNER



E. E. SUCKLING

work both at M.I.T. and at Columbia University. He was employed by the General Electric Company intermittently from 1923 to 1927, and was an instructor in the electrical engineering department at the Massachusetts Institute of Technology from 1926 to 1928. Mr. Suckling joined the technical staff of the Bell Telephone Laboratories in 1928, and was engaged in electronic research and development. Since 1931, his principal interest has been in the development of vacuum tubes for use at ultra-high frequencies. He is a member of the American Physical Society and of the American Institute of Electrical Engineers.

E. E. Suckling* was born in Auckland, New Zealand, on August 4, 1915. He received the M.Sc. degree in physics, with a thesis on radio-frequency soil constants. He joined the telecommunication section of the Post and Telegraph Department of the New Zealand government and spent two years in the test laboratory. Mr. Suckling was then

* Paper published in January, 1945, issue of the PROCEEDINGS



O. M. WOODWARD, JR.

transferred to the radio section of the same department, where he has covered a wide variety of projects concerned with radio-station installations. He has also been responsible for a considerable amount of equipment design and development work.



H. M. Turner (A'14-M'20-F'37) was born on July 20, 1882, at Hillsboro, Illinois. He received the B.S. degree in electrical engineering from the University of Illinois in 1910, and remained as assistant instructor for two years while doing graduate study. He received the Master's degree in 1915.

From 1912 to 1918, Professor Turner was instructor at the University of Minnesota, and organized courses in transient phenomena and radio. During the First World War he was placed in charge of technical instruction of the Signal Corps unit of enlisted men at the University of Minnesota, and in 1918 became assistant professor of radio with the Signal Corps School for Officer Candidates at Yale University.

In 1919 he was appointed assistant professor of electrical engineering at Yale, becoming associate professor in 1926, a post which he has held to date.

In 1934 Professor Turner was a delegate from the National Research Council to the U.R.S.I. meeting in London, and delivered a paper on high-frequency measurements. Since 1935 he has been in charge of all the graduate work in electrical engineering at Yale, and has also introduced electrical engineering to Yale juniors.

He is a member of the American Institute of Electrical Engineers, the International Union of Scientific Radio Telegraphy, the American Association for the Advancement of Science, the Franklin Institute, and Sigma Xi. Professor Turner has been active in committee work in The Institute of Radio Engineers on matters relating to standardization, technical papers, instruments and measurements, and communications. He was President of the Institute during 1944.



Rudolf F. Wild (A'37) was born in New York City, on August 27, 1910. He received the M.S. degree in communications engineering from Berlin Institute of Technology in 1935, and became associated with the research group of Farnsworth Television, Inc., at Philadelphia, Pa. In 1939 Farnsworth Television, Inc., was reorganized and transferred to Fort Wayne, Ind., under the new name of Farnsworth Television and Radio Corporation. At that time Mr. Wild became research consultant and patent engineer for the new organization, remaining in that capacity until 1941, when he joined the patent department of Zenith Radio Corporation in Chicago, Ill.

Since 1942 he has been chief electronic research engineer for the Brown Instrument Company of Philadelphia, supervising the design and development of electronic equipment for use with precision measuring instruments.



RUDOLF F. WILD



O. M. Woodward, Jr. (S'38-A'40) was born on January 13, 1915, at Davis, Oklahoma. After receiving the degree of Bachelor of Science in electrical engineering from the University of Oklahoma in 1938, he joined the Seismograph Service Corporation of Tulsa, Oklahoma. During 1941 Mr. Woodward was a research engineer at the RCA Manufacturing Company, Camden, New Jersey. Since January 1, 1942, he has been with RCA Laboratories, Princeton, New Jersey. He is a member of Sigma Xi.



C. N. Works was born at Fairfield, Maine, on July 7, 1910. He received the B.S. degree in electrical engineering from the University of Maine, in 1934. He was employed as a student engineer by Phelps Dodge Copper Products Corporation, Elizabeth, N. J., and later became a research engineer for the Habirshaw cable and wire division of the same company, at Yonkers, New York. Since December, 1942, he has been a research engineer in the insulation department of the research laboratories, Westinghouse Electric and Manufacturing Company, East Pittsburgh, Pennsylvania. Concurrently, with his employment at the Westinghouse Electric and Manufacturing Company, he has been a graduate student at the University of Pittsburgh.



C. N. WORKS

MEMO TO *Purchasing Dept.*

For postwar, recommend we standardize on Solar's hermetically-sealed, patented special twist-prong base Type DY electrolytic. They're properly protected against moisture.

E.M.

ENGINEERING
SPECIFY
Solar
DEPARTMENT

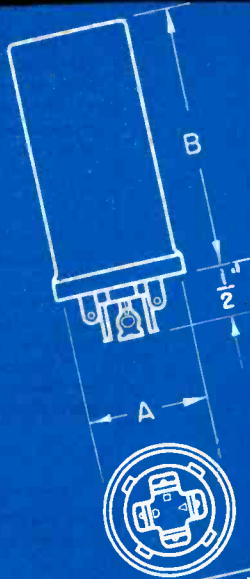

LEADING MANUFACTURERS
EVERYWHERE

PART NO.	SOLAR PART NO.	CAPY MFD.	WKG. VOLTS	DIMENSIONS	
				"A"	"B"
51 B50-1	DY-61	20+20	150	1"	2"
51 B50-2	DY-92	20+20	450	1"	3-3/8"
51 B50-3	DY-94	10+10	450	1"	2-1/2"
51 B50-4	DY-132	15+10+20	350-350-25	1"	2-1/2"
51 B50-5	DY-141	10+10+20	450-450-25	1"	3"

DRAWN *E.O.H.*
TRACED *M.*
APPROVED *J.C.*

DATE *1/4/45*
DWG. No. *51 B50*
ISSUE

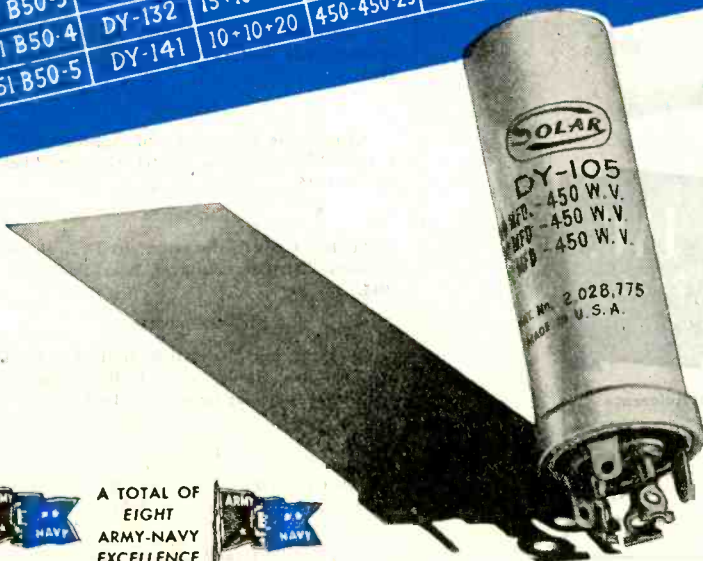

Prominent engineers consistently show their preference for Solar Capacitors. Solar pledges continued production of superior quality capacitors to merit that preference. Solar Manufacturing Corporation, 285 Madison Avenue, New York 17, N. Y.



CAPACITORS &
ELIM-O-STATS



A TOTAL OF
EIGHT
ARMY-NAVY
EXCELLENCE
AWARDS!



COAST-TO-COAST AIR EXPRESS OVERNIGHT DELIVERIES

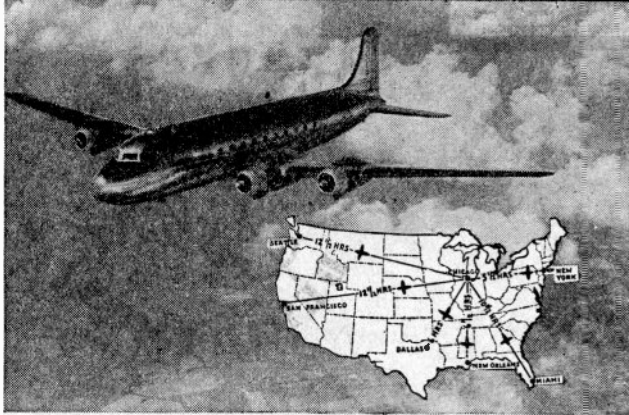

We'll Pay Half the Cost!

WJ Emergency Service scores again! Now, we'll deliver overnight by air express anywhere in the U.S.A.! Just ask for AIR EXPRESS Shipment when you order items of unusual urgency. We'll pay half the express charges on any emergency shipment weighing not over three pounds!

High speed, coast-to-coast overnight deliveries are giving Industry everywhere in entirely new conception of emergency service on Radio and Electronic Supplies. Industries, driving hard on vital research or production, save time and trouble; maintain tight schedules by relying on W-J. Write today for table of air express rates and the new W-J Radio & Electronic Equipment Book that lists many products never cataloged before!



FILL IN AND MAIL
COUPON, TODAY!

WALKER-JIMIESON, INC.

311 South Western Ave., CANAL 2525
CHICAGO 12

GENTLEMEN: Please send me a free copy of your Reference Book & Buyer's Guide.

NAME _____
COMPANY _____
CITY _____ ZONE _____ STATE _____



ATLANTA

"Electronic Heating Methods," by B. J. Dasher, Georgia School of Technology; December 29, 1944.
"Present-Day Television Systems," by W. W. Hibbert, WSB; January 19, 1945.

"Wartime Developments in Electronics," by W. L. Everitt, President, The Institute of Radio Engineers, Inc.; February 14, 1945.

BALTIMORE

"Is the United States Ready for Network Television?" by P. I. Merryman, National Broadcasting Company; January 23, 1945.

BOSTON

"Wide-Range Tuned Circuits for Ultra-High Frequencies," by Edward Karplus, General Radio Company; January 19, 1945.

"Frequency Modulation in Broadcast and Communications Service," by D. E. Noble, Galvin Manufacturing Company; February 16, 1945.

CHICAGO

Third Annual Banquet, W. O. Swinyard, Hazeltine Electronics Corporation, speaker; February 3, 1945.

"Train Communication Systems," by R. A. Clark, Communication Equipment and Engineering Company; February 16, 1945.

"Application of Electronics to Aircraft Control," by Gordon Rosholt, Honeywell Regulator Company; February 16, 1945.

CLEVELAND

"K' Carrier," by Oliver Henderson, The Ohio Bell Telephone Company; January 25, 1945.
Election of Officers; January 25, 1945.

CONNECTICUT VALLEY

"Amplidyne Design and Use," by J. L. Bower, General Electric Company; January 18, 1945.

DALLAS-FORT WORTH

"Wartime Developments of Electronics," by W. L. Everitt, President, The Institute of Radio Engineers, Inc.; February 19, 1945.

DETROIT

"Electronic Dial Calibrator," by H. L. Dawson, International Detrola Corporation; February 21, 1945.

DAYTON

"Amplidyne Principles and Applications," by J. R. Williams, General Electric Company; February 15, 1945.

EMPORIUM

"Pulsed-Cathode Behavior," by D. L. Benedict, Sylvania Electric Products, Inc.; February 27, 1945.

INDIANAPOLIS

"A Frequency-Modulation Method of Calibration for Cutter Heads," by H. E. Roys, Radio Corporation of America; January 26, 1945.

LONDON

"Quartz-Crystal Production," by L. W. Elliott, Canadian Marconi Company; February 1, 1945.

(Continued on page 36A)

LM

An exceptionally sturdy type only $57/64$ " in diameter for low-wattage requirements. Has positive-contact spiral spring to eliminate sliding contact between rotor arm and center terminal. With switch: Type LMD.

LP

A larger type, $1-3/32$ " in diameter for use where voltages do not exceed 350V, and where wattages are .4-watt or less. Can be supplied with sealed cover. Has positive spiral spring contact. With switch: Type LPD.

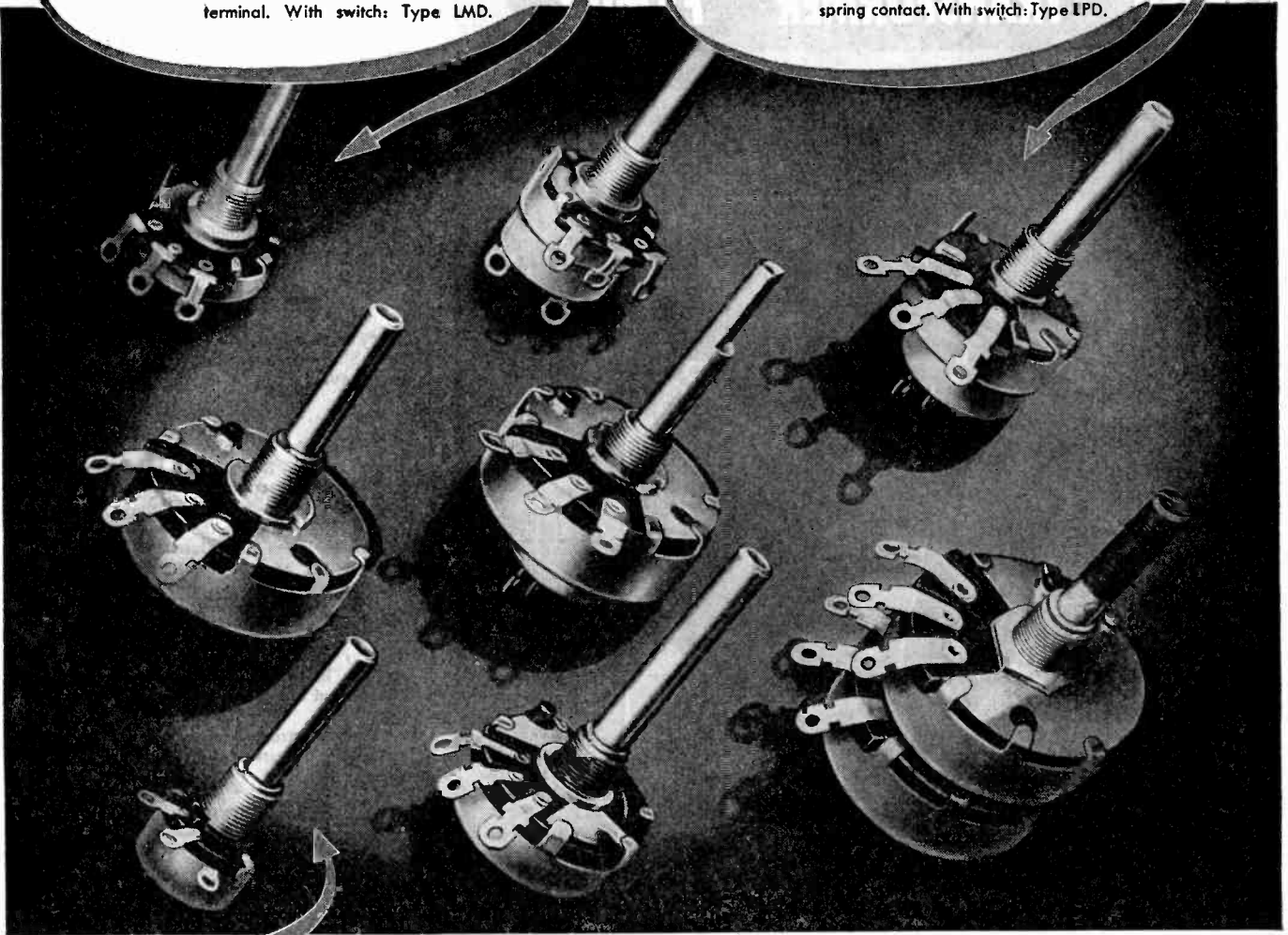
**PSM
MIDGET**

Only $23/32$ " in diameter—unexcelled for low-wattage uses where size and weight are important factors. Widely used in hearing-aid devices and similar equipment.

STACKPOLE VARIABLE RESISTORS

(Volume, Tone Controls, etc.)

WHAT DO YOU NEED IN CARBON?

BRUSHES — CONTACTS

(All carbon, graphite, metal and compositoin types)

IRON CORES RARE METAL CONTACTS

WELDING CARBON PRODUCTS

PACKING, PISTON and SEAL RINGS

RHEOSTAT PLATES and DISCS

BATTERY CARBONS POWER TUBE ANODES

SPECTROGRAPHITE No. 1, etc., etc.

Tested, tried, and proved in all types of equipment calling for units of this sort, Stackpole Variable Resistors offer maximum dependability under all conditions of use. The line is sufficiently broad to meet all requirements up to ratings of 2 watts. Large, medium and midget sizes—with or without switches—high insulation types—standard, sealed, or insulated shafts—standard and water- and dust-proof covers—friction rotor types, and various others.

Write for **ELECTRONIC COMPONENTS CATALOG—RC6**

STACKPOLE CARBON COMPANY, ST. MARYS, PA.

MEET THIS MEMBER OF THE FREED TRANSFORMER FAMILY

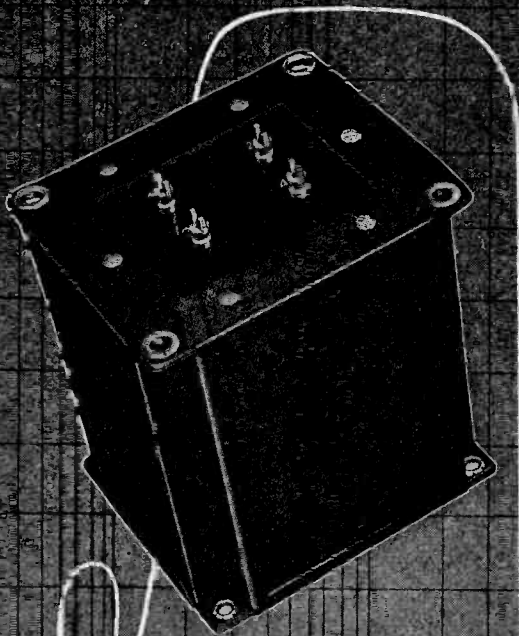

In this BAND PASS FILTER FREED gives you all FIVE

Freed development and research created this Band Pass Filter which is the last word in rugged construction and specialized engineering. A reference to the curve provides an accurate picture of its performance. Five points of superiority are five good reasons why Band Pass Filters for your post war products should be by Freed: 1. They provide maximum performance in a minimum of space; 2. They provide high attenuation in the stop band, with low insertion loss; 3. They are rigidly tested and inspected for uniformity; 4. They are available in a complete range of frequencies to meet your requirements; 5. They are physically constructed for rugged service.

For transformers, reactors, filters for your postwar products, consult Freed Engineering Service now. Descriptive folder on request.

FREED TRANSFORMERS

FREED TRANSFORMER COMPANY

78 SPRING STREET, NEW YORK CITY



(Continued from page 34A)

LOS ANGELES

"Shaking Airplanes with Vacuum Tubes," by R. E. Rawlins, Lockheed Aircraft Corporation; December 19, 1944.

Election of Officers; December 19, 1944.

"Carrier Communication via Power Lines," by R. C. Cheek, Westinghouse Electric and Manufacturing Company; January 11, 1945.

MONTREAL

"The Technical Library in Industry," by Josephine Sheffield, Northern Electric Company; January 31, 1945.

PHILADELPHIA

"Electronics and Electronic-Tube Development," by I. E. Mourmoussieff, Westinghouse Electric and Manufacturing Company; February 7, 1945.

"Some Problems in the Design of Electronic-Power Generators for Industrial-Heating Application," by W. M. Roberds, Radio Corporation of America; March 1, 1945.

PITTSBURGH

"The Ignitron," by J. H. Cox, Westinghouse Electric and Manufacturing Company; January 8, 1945.

"Some Electronic Aspects of the Cyclotron," by A. J. Allen, University of Pittsburgh; February 12, 1945.

PORTLAND

"Kilocycle Cops," by L. North, North Pacific Monitoring Area, Federal Communications Commission; February 15, 1945.

ROCHESTER

"Peacetime Applications of Microwaves," by W. W. Hansen, Sperry Gyroscope Company; February 15, 1945.

ST. LOUIS

"Airway Traffic Control and Radio Navigation," by C. A. Petry, United Airlines; January 17, 1945.

"Antennas for Frequency-Modulation Broadcasting and Relaying," by M. W. Scheldorf, General Electric Company; January 17, 1945.

SAN FRANCISCO

"Survey of Measurements at Ultra-High Frequency," by D. L. Packard, Hewlett-Packard Company; January 3, 1945.

"Survey of Measurements at Ultra-High Frequency," by W. J. Barclay, Stanford University; January 3, 1945.

"Current Outlook From an Engineer's Viewpoint," by F. T. Letchfield, Wells Fargo Bank and Union Trust Company; January 25, 1945.

"The Postwar World of Electronics," by W. C. Eddy, United States Navy Radio Technician Training Program; February 1, 1945.

SEATTLE

"Television and Magnetic-Wire Recording," by W. M. Boland, General Electric Company; February 20, 1945.

WILLIAMSPORT

"Audio Frequency," by Jerry Minter, Measurements Corporation; February 2, 1945.

Proceedings of the I.R.E. April, 1945

POWER

HIGH FREQUENCY HEATING

INTERNATIONAL BROADCAST

FM

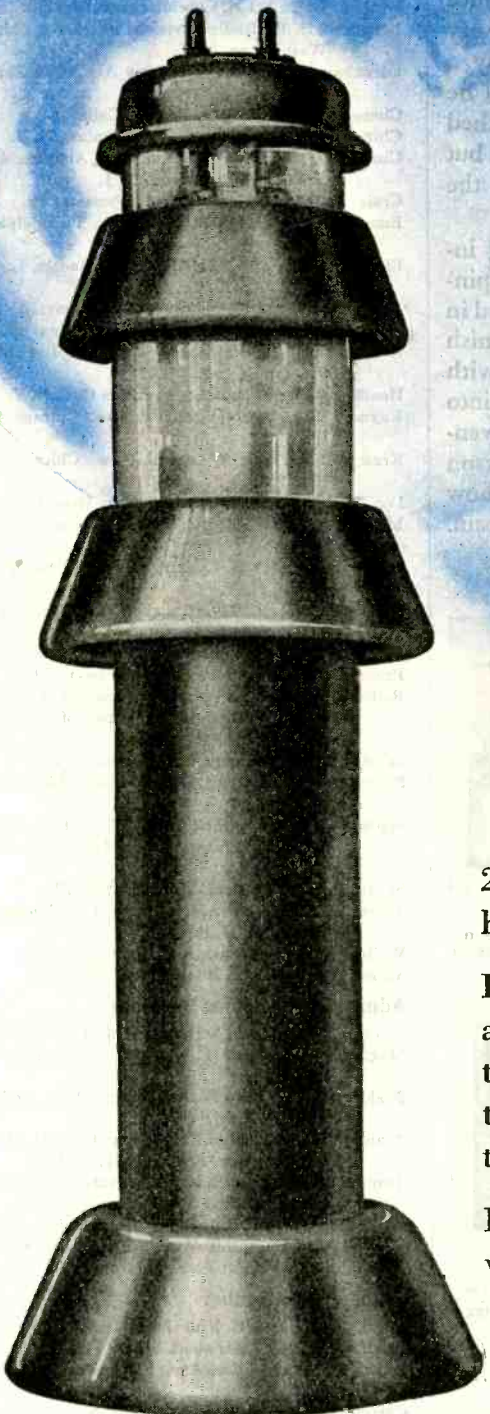

The Most Powerful High-Frequency Tube

200 Kilowatts—developed especially for high-power, high-frequency broadcast and industrial applications.

Into this development has gone all the knowledge and experience of the tube-building art that make the name Federal stand for dependability — a reputation earned by more than 35 years of service in the electronics field.

Federal tubes are built for long life . . . produced with all the care and precision of fine craftsmanship.

Federal always has made better tubes.



Federal Telephone and Radio Corporation



Newark 1, N.J.

How to build up a top-notch Testing Team!

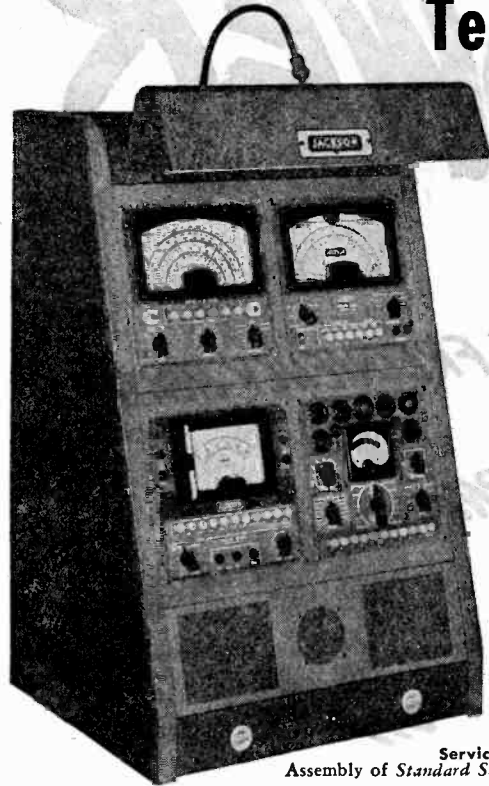

Service Lab
Assembly of Standard Size Jackson Instruments

You don't have to do it all at once—just plan ahead and make every purchase count when you buy a new instrument. Then you'll be building up a perfectly-matched testing team—each a specialist, but each backing up the rest of the team.

That's why Jackson testing instruments are not only built to pinpoint accuracy—but are matched in dimensions, appearance and finish too. You can buy them singly, with assurance that they'll assemble into a combination balancing convenience and appearance with Jackson performance standards. Plan now to own a complete testing team.

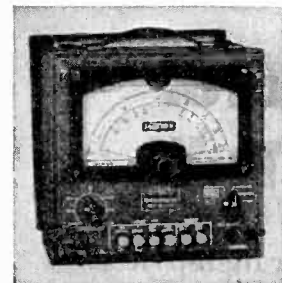

Condenser Tester
Model 650A—Measures Capacity, Power Factor and Leakage

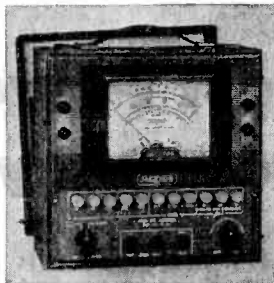

Sensitive Multimeter
Model 642—20,000 ohms per volt—complete ranges



Electronic Multimeter
Model 645—A new Jackson instrument of advanced design

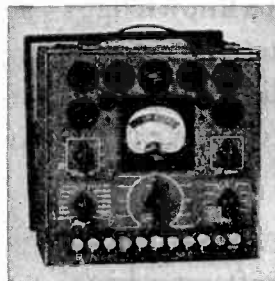

Tube Tester
Model 634—Uses exclusive Jackson "Dynamic" Test Method



Multimeter
Model 643—1000 ohms per volt. Push key range selection

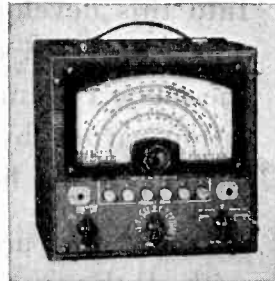

Test Oscillator
Model 640—Accurate to 1/2%, covers full frequency range

BUY WAR BONDS AND STAMPS TODAY



JACKSON

Fine Electrical Testing Instruments

JACKSON ELECTRICAL INSTRUMENT COMPANY, DAYTON, OHIO



The following admissions and transfers were approved on March 7, 1945:

Transfer to Senior Member

- Barco, Allen, 34-18-91 St., Jackson Heights, L. I., N. Y.
- Bennett, G. T., 271 N. Charlotte, Lombard, Ill.
- Bernstein, H. E., Radio Division, Bureau of Ships, Washington, D. C.
- Carnahan, C. W., 425 S. Harvey Ave., Oak Park, Ill.
- Chesney, A. P., Box 215, Encino, Calif.
- Chinn, H. A., 6 Knollwood Rd., Tuckahoe, N. Y.
- Cimorelli, J. T., Radio Corporation of America, 415 S. Fifth St., Harrison, N. J.
- Craig, P. M., 342 Hewitt Road, Wyncote, Pa.
- Emerson, K. H., 3115 Midvale Ave., Philadelphia 29, Pa.
- Findley, L. K., 323 Marcellus Rd., Mineola, L. I., N. Y.
- Haines, D. G., 181 Kenmore Ave., Elmhurst, Ill.
- Hershberger, W. D., RCA Labs., Princeton, N. J.
- Hershman, J. B., Valparaiso Technical Institute, Valparaiso, Ind.
- Hoadley, G. B., 27 Prospect Ave., Sea Cliff, N. Y.
- Kayner, H. J., 9216-Clifton Pk. Ave., Chicago 42, Ill.
- Kramer, Karl, 6601 S. Laramie Ave., Chicago 38, Ill.
- Lee, Reuben, Andover Rd., Linthicum Heights, Md.
- Madsen, C. J., 8945 Eastwood Rd., Wilkinsburg 21, Pa.
- Moles, F. J., 1158 S. Country Club Dr., Schenectady 8, N. Y.
- Mouromtseff, I. E., 219 Montclair Ave., Montclair, N. J.
- Pampel, F. L., 735 Clarence, Oak Park, Ill.
- Prentiss, J. G., 3116 Home Ave., Berwyn, Ill.
- Radford, W. H., Electrical Engineering Department, Massachusetts Institute of Technology, Cambridge 38, Mass.
- Schafer, E. W., 8 Cape Ct., Millburn, N. J.
- Schwalm, W. A., 6001 W. Dickens Ave., Chicago 39, Ill.
- Sepmeyer, L. W., United States Navy Radio and Sound Laboratory, Point Loma, San Diego 52, Calif.
- Smith, P. S., 5110 Altgeld St., Chicago, Ill.
- Teare, B. R., Jr., Carnegie Institute of Technology, Pittsburgh 13, Pa.
- Weibler, C. T., 414 Park Ave., St. Charles, Ill.
- Yoder, R. S., 1219 N. Rossell, Oak Park, Ill.

Admission to Senior Member

- Grierson, C. A. W., 192 Serpentine Rd., Tenafly, N.J.
- Maginnis, W. P., 308 E. Sixth St., Bloomington, Ind.
- Stoddart, R. R., 6644 Santa Monica Blvd., Hollywood 38, Calif.
- Teare, W. H., Research Laboratory, General Electric Company, Schenectady, N. Y.
- Timbie, W. H., Massachusetts Institute of Technology, Cambridge 39, Mass.
- Whitehead, J. R., British Air Commission, 1520 New Hampshire Ave., Washington, D. C.
- Yaeger, H. R., Wright Field, Dayton, Ohio

Transfer to Member

- Aram, N. W., 1527 S. Vine Ave., Park Ridge, Ill.
- Bradford, H. K., Riderwood, Md.
- Brown, W., 1155 Neilson Ave., Far Rockaway, L. I., N. Y.
- Carroll, D. V., Naval W/T Station, Newport Corner, Nova Scotia, Canada
- Clapp, F. D., 978 Grizzly Peak Blvd., Berkeley, Calif.
- Collins, E., 3241 Maple St., Brookfield, Ill.
- Contreras, M. J. A., Office of the President of the Philippines, 1617 Massachusetts Ave., N.W., Washington, D. C.
- Darden, R. R., Jr., 18 Boylston Rd., Newton Highlands, Mass.

(Continued on page 42A)

PLYTUBE

(REG. U. S. PAT. OFFICE)

ANTENNA MASTS for F.M. and TELEVISION

—Can be erected at location by inexperienced personnel from the instructions supplied with mast.

- Portable—Light weight—Telescopic
- Heights up to 100 feet
- Easy to erect and dismantle
- Easy to change sites
- Will raise and support up to 400 pounds at head.
- Designed and tested to withstand wind velocities up to 125 m.p.h.
- Adjustable supports for directional arrays furnished
- Rotating head available for directional arrays.

Also available:

PLYTUBE Masts for horizontal antennas, capable of supporting up to 10,000 pounds head load.

●
PLYTUBE Antennas for Rhombic, "V", Beveridge, Vertical Arrays and other applications.

Submit your specifications for price and delivery

PLYMOLD CORP.
Lawrence, Mass.

Plytube is manufactured under U. S. Pat. No. 2,352,533

55' MAST

with UHF Dipoles
... Easily erected

75' MAST

In place . . . ready for shipment and assembly.

WORLD FAMOUS OSCILLOSCOPES by DUMONT

Use Capacitors by
**INDUSTRIAL CONDENSER
CORP.**

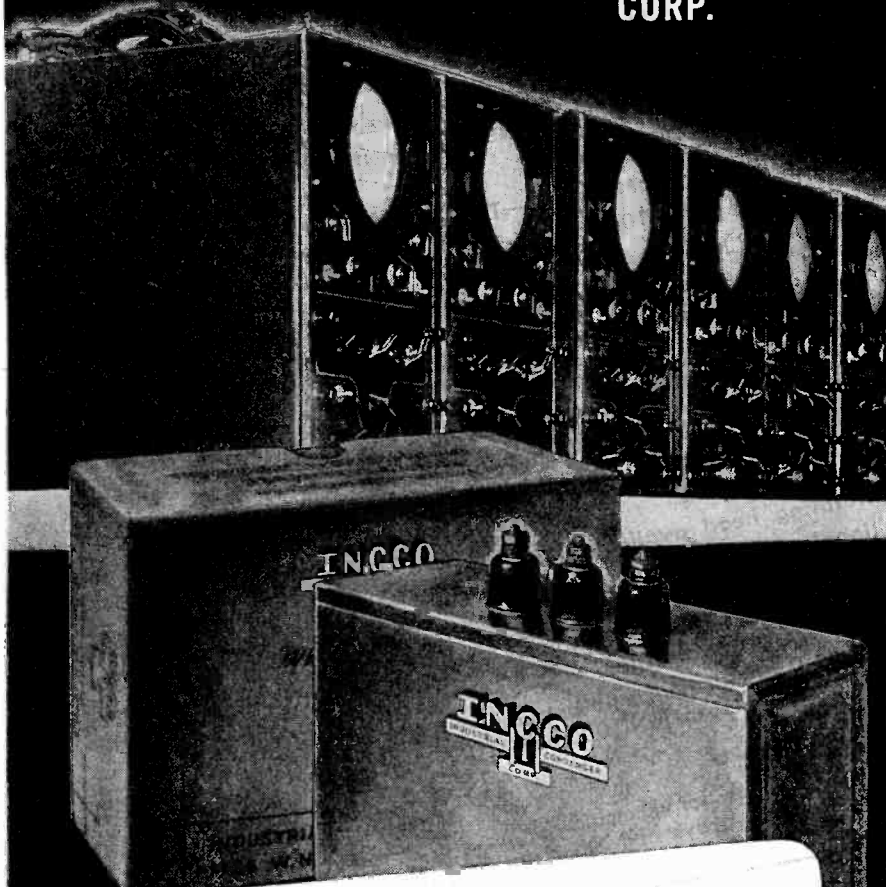

Capacitors used in Dumont's famous oscilloscopes are especially designed, engineered and manufactured for unusual performance under difficult operating conditions.

PAPER, OIL AND ELECTROLYTIC CAPACITORS

INDUSTRIAL CONDENSER CORPORATION

1725 W. NORTH AVE., CHICAGO 22, U. S. A.

DISTRICT OFFICES IN PRINCIPAL CITIES
QUICK DELIVERY FROM DISTRIBUTOR'S STOCKS

Said the
**SIGNAL
CORPS...**



**"Make 'em light...
make 'em strong!"**



SKYDYNE CABINETS for Portable Electronic Equipment

They're as rugged as the combat corpsmen they serve—yet so light, they add only ounces to the delicate radio equipment they protect! And these famous Skydyne cabinets, serving overseas with the U. S. Signal Corps, are now available for your electronic products.

Skydyne

**FORM-MOLDED "SANDWICH"
CONSTRUCTION IS LIGHTER
... STRONGER**

Skydyne combines greater strength with less weight than any other instrument-housing material. Form-molded to exact specifications, Skydyne is laminated on a balsa, cork or light-weight synthetic core



—faced with plywood, metal or other surfacing material. Modern electronic shielding is incorporated in the cabinet itself. Complex shapes and curvatures are possible without complicated design, production or assembly problems. Skydyne assures an attractively streamlined one-piece cabinet that stands up to rough handling, resists heat, vibration, sound. And Skydyne is remarkably inexpensive.

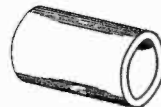

Find out how Skydyne cabinets can improve the appearance and serviceability of your products. Write for literature today.

Skydyne Inc

PORT JERVIS, NEW YORK

ANNOUNCING AN ENTIRELY NEW CERAMIC CAPACITOR DIELECTRIC MYCALEX K

The MYCALEX CORPORATION OF AMERICA has developed and now has in production a new capacitor dielectric which embodies important new advancement in properties. Designated MYCALEX "K," this new ceramic material is unique in that it offers a *selective* range of dielectric constants, from 8 to 15 at one megacycle.

Engineers whose requirements call for a material with a dielectric constant of 10, need only specify MYCALEX K-10. If a dielectric constant of 8 is indicated, MYCALEX K-8 will meet that exact requirement. Other applications might call for use of MYCALEX K-11 or K-12, etc.

MYCALEX K-10 already has been approved by the Army and Navy as Grade H1C5H4 Class H material (JAN-I-12). While other Class H materials are available, to the best of our knowledge these are all steatite or bonded titania or titanate types, obtainable only in relatively small dimensions and subject to wide variations in tolerance. MYCALEX K is available in sheets 14" x 18" in thicknesses of 1/8" to 1"; in thicknesses down to 1/32" in smaller sheets, and in rods 1/4" to 1" in diameter.

Of importance also is the fact that MYCALEX K series can be molded to specifications, with electrodes or metal inserts molded in. It can be fabricated to close tolerances.

So far as we are aware, the MYCALEX CORPORATION OF AMERICA is the exclusive developer and only supplier of this kind of capacitor dielectric.

Write today for further information to Department 15.

MYCALEX K-10

Grade H1C5H4, in accordance with JAN-I-12

Dielectric constant	10.6	} megacycle
Q-Factor	310	
Loss Factor	0.034	
Volume resistivity	6.0×10^{12} ohms-cms.	
Dielectric strength	270 volts/ml (0.10" thickness)	
Modulus of rupture	9000 lbs./sq. in.	
Fractional decrease of capacitance with temperature change	0.0056	
Fractional increase of capacitance with temperature change	0.0076	
Porosity—no dye penetration after six hours at	10,000 lbs./sq. in.	

The above properties were measured in accordance with the procedures of JAN-I-12

Density	0.116 lbs. per cu. in.
Specific gravity	3.22
Softening temperature	400° C.

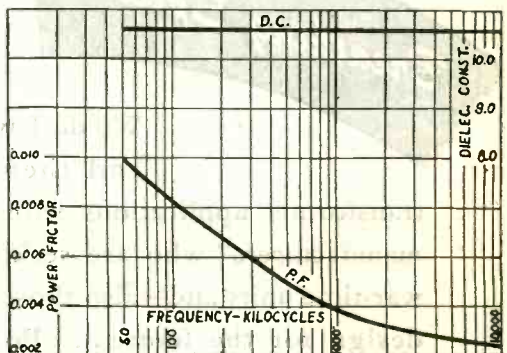
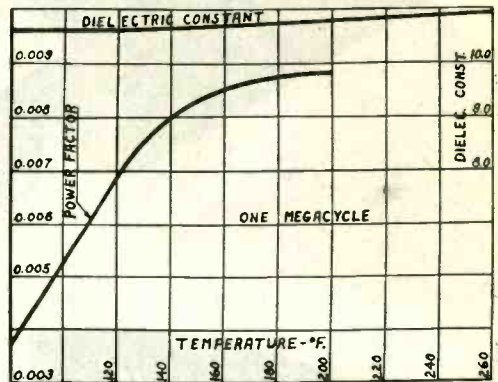

OTHER PRODUCTS OF MYCALEX ARE:

MYCALEX 400—the most highly perfected form of MYCALEX insulation, approved by Army and Navy as Grade L-4 insulation. In sheets, rods and fabricated form.

MOLDED MYCALEX, available to specifications in irregular shapes and into which metal inserts may be incorporated.

MYCALEX
THE INSULATOR

TRADE MARK REG. U. S. PAT. OFF.

MYCALEX CORPORATION OF AMERICA

"OWNERS OF 'MYCALEX' PATENTS"

Plant and General Offices
Clifton, N. J.

Executive Offices
30 Rockefeller Plaza
New York 20, N. Y.

STANCOR

Precision-Built

TRANSFORMERS

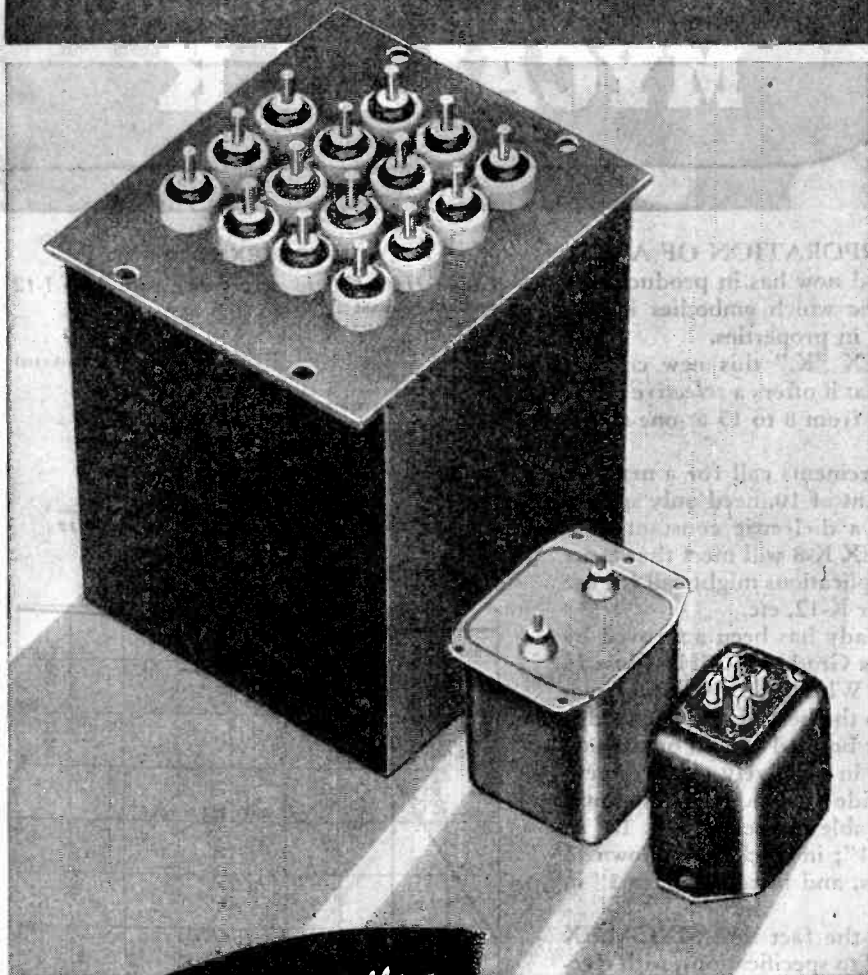

Breathing Spells-

We do have a little time—now and then only—to discuss transformer applications with our fellow “victory manufacturers” who are seeking to improve their war-time units and—also those whose plans include design for the future . . . Possibly time may be found for you. We'll do our best with your inquiry.

STANDARD TRANSFORMER CORPORATION
1500 NORTH HALSTED STREET, CHICAGO 22, ILLINOIS



(Continued from page 38A)

- Engelman, C. W., 4648 Chowen Ave. S., Minneapolis, Minn.
Foin, O. F., Jr., Dudley Hall, 16 Dunster St., Harvard University, Cambridge, Mass.
Fredine, E. L., 511—20 St., N.E., Cedar Rapids, Iowa
Green, J. A., Collins Radio Co., 855—35 St., N.E., Cedar Rapids, Iowa
Gruwell, F. N., 1613 Burwell St., Bremerton, Wash.
Hulst, G. D., Jr., 577 Upper Mountain Ave., Upper Montclair, N. J.
Jensen, K. K., 4012 Denny Ave., North Hollywood, Calif.
Kirkpatrick, G. M., 1134 Glenwood Blvd., Schenectady, N. Y.
Krakora, J. J., Jr., 1006 N. Leamington, Chicago, Ill.
Lindsay, W. R., WMAQ, RFD 1, Elmhurst, Ill.
Ludwig, M. R., 102 E. 19 St., Minneapolis, Minn.
Mautner, R. S., 201 W. 16 St., New York, N. Y.
Mayer, R., Radio Materiel School, Treasure Island, San Francisco, Calif.
Michal, L. V., 3320 M St., Lincoln, Neb.
Morris, C. M., 141 Poplar Ave., Hackensack, N. J.
Mulligan, J. H., Jr., 14 Mitchell Pl., E. Orange, N. J.
Osteflund, S. G., 1342 Cornelia Ave., Chicago, Ill.
Overby, H. S., Norwegian Commission on Industry, 80 Broad St., New York, N. Y.
Pratt, J. H., RCA Victor Co., Ltd., 1001 Lenoir St., Montreal, Canada
Sands, L. G., c/o Curtiss Wright Corp., P.O. Box 30, Bloomfield, N. J.
Smith, E. H., 1620—14 Ave., Seattle, Wash.
Walker, T. H., 31 Bouverie Ave., Swindon, Wiltshire, England
Watson, G. S., RCA Frequency Bureau, 30 Rockefeller Plaza, New York, N. Y.
Wellendorf, J. J., 808 Lincoln Ave., Williamsport, Pa.

Admission to Member

- Babillus, J., 1381 Elmhurst Dr., N.E., Cedar Rapids, Iowa
Biederman, L., Cairo Hotel, Washington, D. C.
Bond, E. G., 512 Pershing Dr., Silver Spring, Md.
Boyers, J. S., Box 271, New London, Conn.
Butler, L. W., 3019 N. 90 St., Milwaukee, Wis.
Christensen, R. J., 1718 San Luis Rey, Coronado, Calif.
Coleman, A. F., 60 Adams Pl., S. Weymouth, Mass.
Craft, L. M., 1364 Elmhurst Dr., N.E., Cedar Rapids, Iowa
Deitz, J., 28 Oakley Village, Baltimore, Md.
Doelz, M. L., 3009 Cottage Grove Ave., Cedar Rapids, Iowa
Frederick, C. L., 31 The Commons, Williamsville, N. Y.
Fromm, K. N., 24 Warfield St., Upper Montclair, N. J.
Harris, L. M., 75 Pasadena Ave., Williamsville, N. Y.
Hocker, J. P., Physical Laboratory, Corning Glass Works, Corning, N. Y.
Hubbard, M. R., 1841 C Ave., N.E., Cedar Rapids, Iowa
Jackson, H. L., Oaklee Village, Baltimore, Md.
James, G. W., Box 294, Syosset, N. Y.
Kahn, R. L., 8 S. Michigan, Chicago, Ill.
L'Allier, L., 1231 St. Catherine St., W., Montreal, P.Q., Canada
Leary, A. R. J., 31 White Birch Rd., Toronto, Ont., Canada
Leighton, J., Bell Telephone Laboratories, Whippary, N. J.
Librizzi, P. N., 179 Grove St., Passaic, N. J.
Lieben, S. B., 318 Ivy Lane, Englewood, N. J.
Liebscher, A., 7618 Fayette St., Philadelphia, Pa.
McKendry, B. A., 80 Lakeshore Rd., Valois, Montreal, Canada
Meahl, H. R., General Electric Co., Bldg. 5, Schenectady, N. Y.

(Continued on page 44A)

VERIQUIL
GRAIT

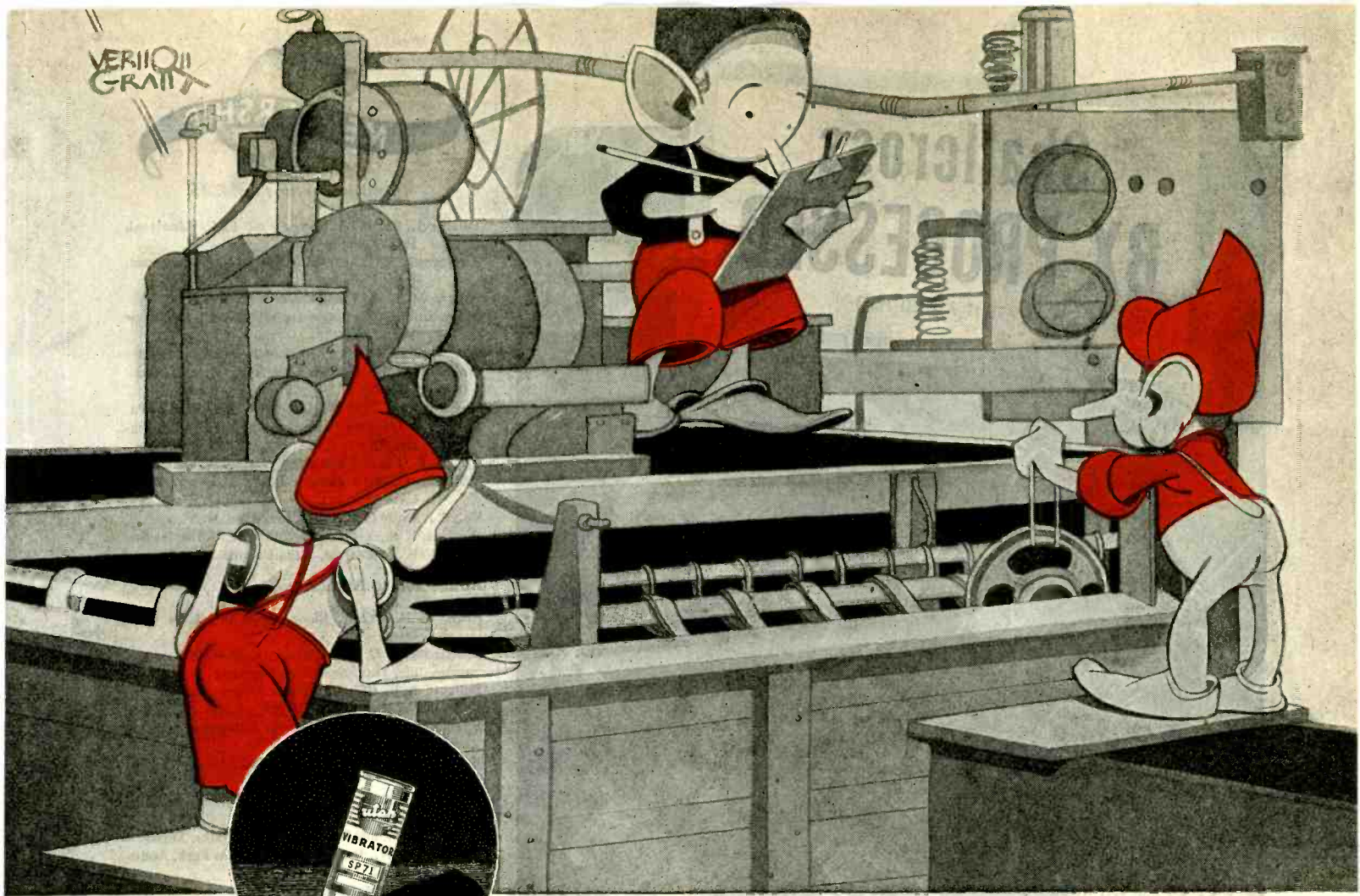

**Every Utah vibrator makes and breaks more than a billion contacts during its lifetime.*

PERFORMANCE—THE PROOF OF UTAH QUALITY



You take for granted the plating process in the manufacture of Utah's radio parts and electronic devices. Just as you would take for granted the Utah loud speakers in manufacturers' sets,

But Utalins* don't. They work on this phase of production as carefully as if they were plating with gold. They know that plating is one of the more important steps in the production of these products of precise manufacture... of proven performance. Products that stand

up under every condition known to man.

Utalins* begin with nothing but raw materials. As each step follows in the process of manufacture... tool making, welding, punch press, electroplating, and all the other steps... it's checked, re-checked, tested, supervised. Finally the finished products, shipped from Utah's self-contained factory, prove the Utah method correct. For they speak by performance.



UTAH RADIO PRODUCTS COMPANY
820 Orleans Street, Chicago 10, Illinois
Utah Electronics (Canada) Ltd., 300
Chambly Rd., Longueuil, Montreal
(23) P.O. - Ucoo Radio, S.A., Misiones
48, Buenos Aires

**Utah's helpers.*

Shallcross BX PROCESSED

(PATENT APPLIED FOR)



(Continued from page 42A)

- Pauch, J. E., RCA Victor Co., Ltd., Montreal, P.Q., Canada
 Raynsford, R. P., 6 Springfield Ave., Westmount, P.Q., Canada
 Saslaw, M. R., 347 Madison Ave., New York, N. Y.
 Shmurak, B., RCA Laboratories, 711 Fifth Ave., New York, N. Y.
 Simpson, J., 14 Clenray Pl., London, Ont., Canada
 Stephen, W. T., 43 Clarendon Ave., Ottawa, Ont., Canada
 Strenger, W. T., 245 W. Haines St., Philadelphia, Pa.
 Swartz, R. O., 4244 Georgia Ave., N.W., Washington, D. C.
 Taylor, P. G., CAA Box 3224, Seattle, Wash.
 Todds, J. G., 5905 Decarie Blvd., Montreal, P. Q., Canada
 Volpe, I. D., 2148 E. 12 St., Brooklyn, N. Y.
 Watters, E. S., Keefer Bldg., 1440 St. Catherine St., W., Montreal, P.Q., Canada

Admission to Associate

- Allen, R. B., 212 E. Bloomington St., Iowa City, Iowa
 Armstrong, J. J., Elm Cottage, Eaglesfield, Lockerbie, Dumfries-Shire, Scotland
 Badgett, A. F., 917 Hurt Bldg., Atlanta, Ga.
 Baer, J., No. Five, (M.E.) A.R.C., R.A.F., M.E.F.
 Baker, G. H., Bell Telephone Laboratories, Inc., Whippany, N. J.
 Barbieri, J. F., 327 Hampden Rd., Upper Darby, Pa.
 Bazy, W., 5008 Washington St., West Roxbury, Mass.
 Benham, J. B., 599 Essex Ave., Gloucester, Mass.
 Bennett, W. W., Jr., 9 Rd. B, Audubon Park, Audubon, N. J.
 Bock, F. J., 1205 N. Lafayette Blvd., S. Bend, Ind.
 Bonnet, E. F., 50 N. Burgess Ave., Columbus, Ohio
 Brook, J. E., 606 Maple Ave., Merchantville, N. J.
 Brooks, J. L., 4944 Cass St., San Diego, Calif.
 Brooks, R. D., Route 9, Fort Wayne, Ind.
 Bryant, R. V., 2638 Perdue Ave., Columbus, Ohio
 Buck, F.W., 87 E. Brown St., West Haven, Conn.
 Burnell, N., 110 Seaman Ave., New York, N. Y.
 Burroughs, L. R., 2415 Central Ave., S. Bend, Ind.
 Buyaki, P. P., RMO Puget Sound Navy Yard, Bremerton, Wash.
 Card, L. C., Cardston, Alberta, Canada
 Chamberlin, N. K., 624 Kingsley St., Phila., Pa.
 Chaphin, W. R., 173 Melrose St., Needham, Mass.
 Chender, J. L., 123 W. 74 St., New York, N. Y.
 Christensen, C. A., American Television Laboratories, 433 E. Erie St., Chicago, Ill.
 Christmas, A. N., "Dorold", Dukes Wood Ave., Gerrards Cross, Bucks., England
 Cohn, H. P., Route 1, Candler, N. C.
 Cole, H. G., 905 W. Jefferson Blvd., S. Bend, Ind.
 Corbin, R.M., 629 S. Carroll St., South Bend, Ind.
 Craig, T. L., 6801 Bay Pkwy., Brooklyn, N. Y.
 Curtis, G. H., Route 3, Box 913G, San Diego, Calif.
 DeBruyn, H. F., 540 Ocean Ave., Brooklyn, N. Y.
 Demuth, J. O., 514 Tenth St., S.E., Cedar Rapids, Iowa
 Denmead, H. R., Jr., 330 W. 42 St., New York
 DeVany, B. V., 415 Westervelt Ave., Staten Island, N. Y.
 Ebaugh, P., 9 Cleveland St., Cambridge, Mass.
 Emond, G. H., 80 LaFontaine, Riviere Du Loup, P.Q., Canada
 Ericson, H. L., 10 Mayflower Rd., Arlington, Mass.
 Fellows, W. N., 4008 Tennyson Rd., University Park, Md.
 Foster, D. V., 1138 W. Jefferson Blvd., S. Bend, Ind.
 Friedman, S. N., 3026 Neil Ave., Columbus, Ohio
 Gardner, A. J., Clyde, Princes Pier, Greenock, Scotland
 Gelnett, V. M., 1121 N. Lawrence St., S. Bend, Ind.
 Gerlach, C. J., 1412 Marietta St., South Bend, Ind.
 Gladmon, E., 1054 Ingraham St., Los Angeles, Calif.
 Gleeson, J., 6 Goldsmith St., Phibsboro, Dublin, Ireland

(Continued on page 48A)

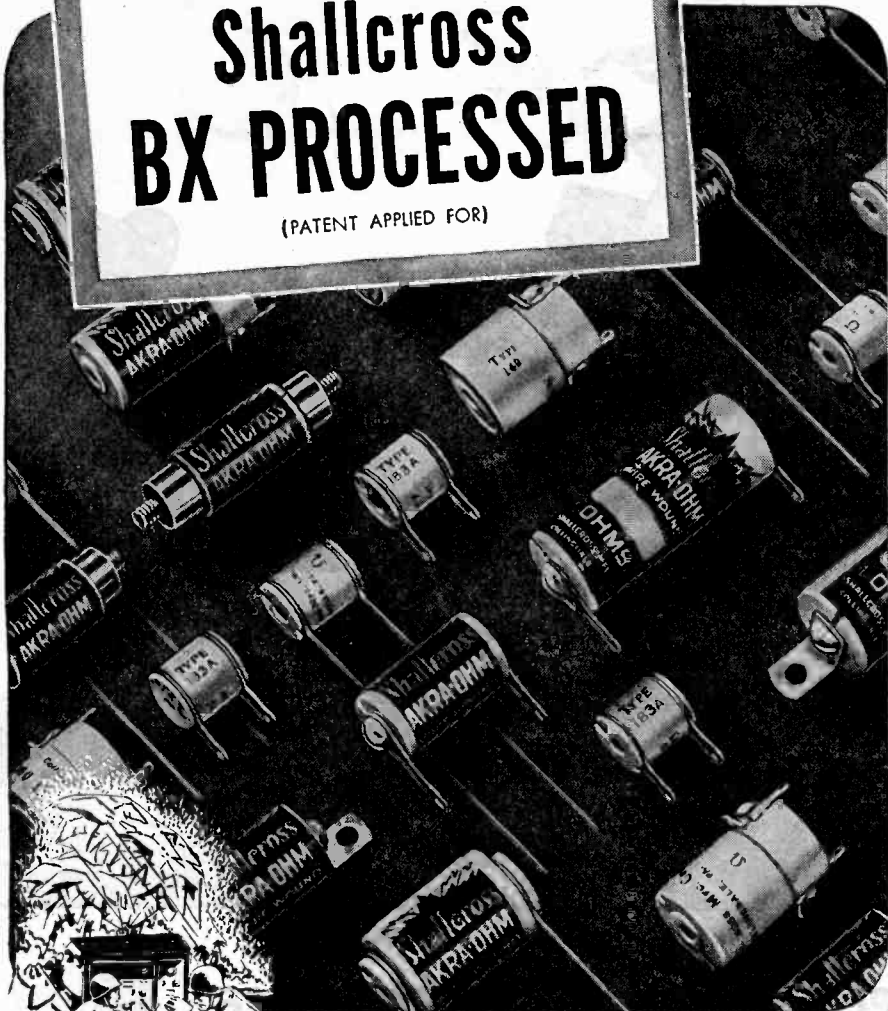

HIGHLY RESISTANT TO MOISTURE AND FUNGUS

Applicable to Any Akra-Ohm Type

BX Processing for Shallcross Akra-Ohm Close Tolerance Wire-Wound Resistors is the culmination of extensive specialized engineering research in close conjunction with the exacting demands of the nation's armed forces.

ANTI-FUNGUS TEST—Exposed in actual outdoor conditions in which the known fungi were numerous and under an average relative humidity of 95%, no fungus or corrosion was apparent after 88 days.

SALT SPRAY—Large users have certified that BX Resistors successfully withstand 200 hours of salt spray containing 20% sodium chloride.

HUMIDITY—Production samples supplied to a leading manufacturer's laboratory successfully withstood 90 days exposure to 90% relative humidity at a temperature of 85° F. Measured while wet, at the end of the test, the resistors were still within a few tenths of one percent of their original value!

TEMPERATURE CYCLING—Five cycles of -55° C. to +85° C. have no effect on the coating or stability of BX Processed Resistors—a fact confirmed by impartial tests in several large industrial laboratories.

Shallcross BX Processed Resistors are identified by the prefix "BX" on the standard type number. Write for details.

SHALLCROSS MFG. CO.

1851 DERT. IR-45, COLLINGDALE, PA.

ENGINEERING • DESIGNING • MANUFACTURING



*These are the reasons
Heintz and Kaufman endorses*

TUBE STANDARDIZATION

STANDARDIZATION IS A WARTIME NECESSITY

Colonel C. C. Irwin, commanding officer of the Signal Corps Standards Agency, recently stated that a majority of Signal Corps contractors are heartily cooperating with the standardization program sponsored by his agency to the end that approved component parts and materials are used wherever possible in equipment supplied to the Signal Corps.

"However, there are some," Colonel Irwin said, "fortunately only a few, who view this program as an attempt to put an unsound theory into practice. Such is, of course, not the case. Standardization is vitally necessary, not only to relieve bottlenecks in production and distribution; to facilitate maintenance by providing interchangeability of parts; but more important, to reduce equipment failures in the field.

"There is no theory in a Gold Star.

"If the reasons behind the laconic phrases 'killed in action,' 'missing,' and 'plane failed to return' could be explained, it is quite probable that equipment failures would bulk large among the reasons.

"It is not expected that the use of approved standard component parts will eliminate equipment failures, but it most certainly will reduce them."

EQUALLY ADVANTAGEOUS IN THE POSTWAR PERIOD

Joint Army and Navy Specifications ("Jan-1A specs") have already established standards of electrical similarity and physical dimensions for vacuum tubes. Heintz and Kaufman will voluntarily continue to apply these engineering standards to post-war Gammatrons as the benefits are so obvious that we believe the designers of communications equipment will insist upon their continuation:

1. Standardization of specifications will facilitate equipment design and production, since it assures

the designer that there will be no physical or electrical changes made in the tube type he has selected. Often such changes have necessitated extensive re-design of equipment.

2. It will assure performance where performance is vital... in air transport and marine communications, in navigation and direction finding.

3. By establishing rigid electrical and physical requirements and tests, tube failures will be materially reduced. Such failures often reflect on the manufacturer of equipment, and must be guarded against just as carefully in peacetime as in war.

STANDARDIZATION DOES NOT LIMIT NEW DESIGN

Standardization of the specifications for current Gammatron tube types will not restrict the development of additional types to meet future needs. (Next month we will list here the Gammatron tubes which will be available indefinitely under our voluntary standardization program.)

*Have you written for
data on the HK-257B
(JAN. 4E27)?*



HEINTZ AND KAUFMAN LTD.

SOUTH SAN FRANCISCO • CALIFORNIA

KEEP BUYING



WAR BONDS

Gammatron Tubes

**INCREDIBLY SMALL . . .
INCREDIBLY EFFICIENT . . .**



These are the reasons
Heintz and Kaufman endorse
TUBE STANDARDIZATION

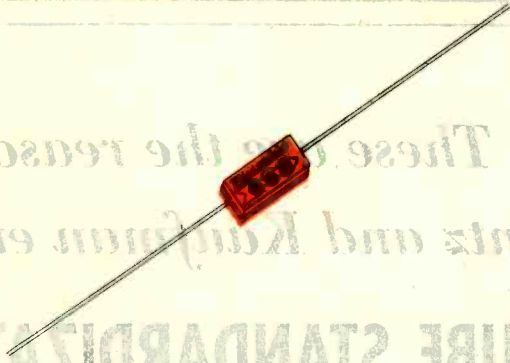

PQ

(Illustrated actual size)

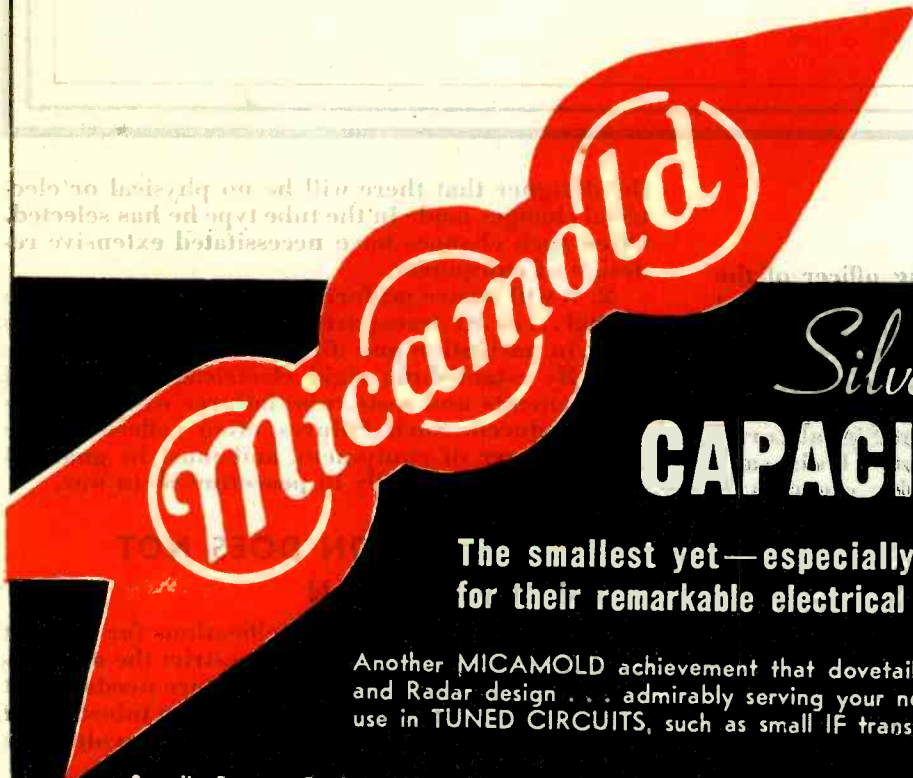

Silvered Mica
CAPACITORS

**The smallest yet—especially notable
for their remarkable electrical qualities**

Another MICAMOLD achievement that dovetails perfectly into advanced Radio and Radar design . . . admirably serving your need for a fine small capacitor to use in TUNED CIRCUITS, such as small IF transformers, tank circuits, etc.

- Capacity Range : 5 mf. to 100 mmf.*
- Voltage Rating : 300 VDC Working 600 VDC Test
- Tolerance : Plus or minus 5% or 1 mmf.—whichever is greater
- Minimum Q : Over 2000
- Temperature Coefficient : Plus or minus 100 parts/million**
- Capacitance Drift : Plus or minus 0.3%**

Molded in Red XM262 (lowloss material)
Tropicalized by application of an
anti-fungus wax

*PQ is so small, it can only be marked with a
3-dot color code indicating capacity in mmfs.

**These figures correspond to characteristic "D"
of specifications JAN - C-5.

Available At Once
SAMPLES OR PRODUCTION QUANTITIES

MICAMOLD Radio Corporation
115 Knickerbocker Ave., Brooklyn 6, N. Y.

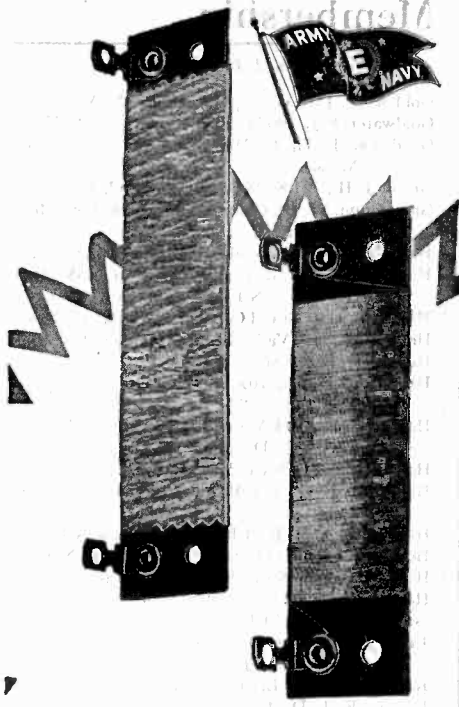

Tight-Tolerance RESISTORS

★ Just turn those tight-tolerance resistor requirements of yours over to CLAROSTAT, just as other instrument-makers have been doing for years past.

Remember, CLAROSTAT specialists offer over two decades of winding experience, outstanding skill, and exclusive winding facilities. They wind all wire sizes even down to .0009" dia. Windings as fine as 600 to 700 turns per inch, on bakelite, ceramic or other material, flat or round. Also string windings in fibre glass, and cord.

Submit your problem . . .

Solving your resistance and control problems is our business. Call on us for engineering collaboration, specifications, quotations.



CLAROSTAT MFG. CO., Inc. - 285-7 N. 6th St., Brooklyn, N. Y.

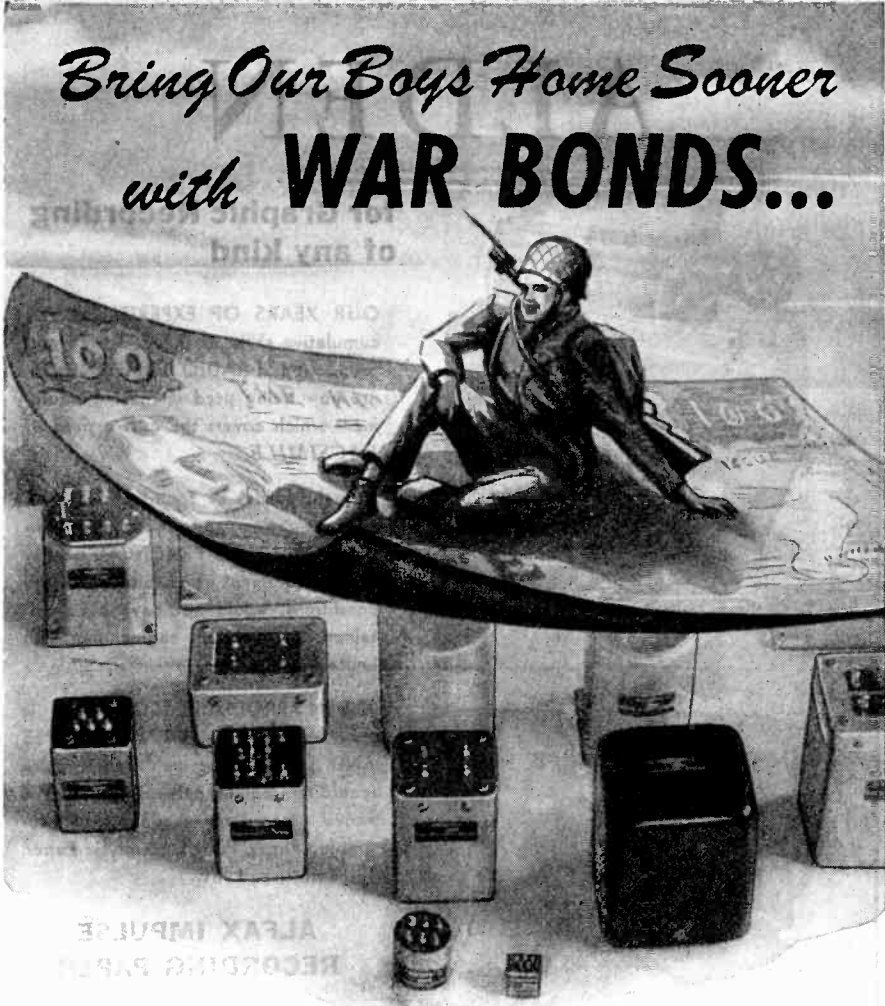

Bring Our Boys Home Sooner
with **WAR BONDS...**

It's squarely up to us at home to finance the weapons of war as well as to build them. This is America's challenge. Here at ADC, we are exerting our energies to produce the finest communication components — and invest in as many War Bonds as possible. Believing that most Americans share our thoughts, we ask you to join us in this pledge — "Let us all continue purchasing War Bonds to the limit and bring our boys home sooner to a peaceful and economically sound country".

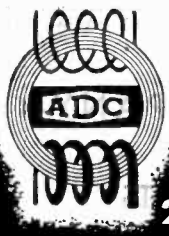

Audio Development Co.

2833 13th Ave. S., Minneapolis 7, Minn.

ALDEN

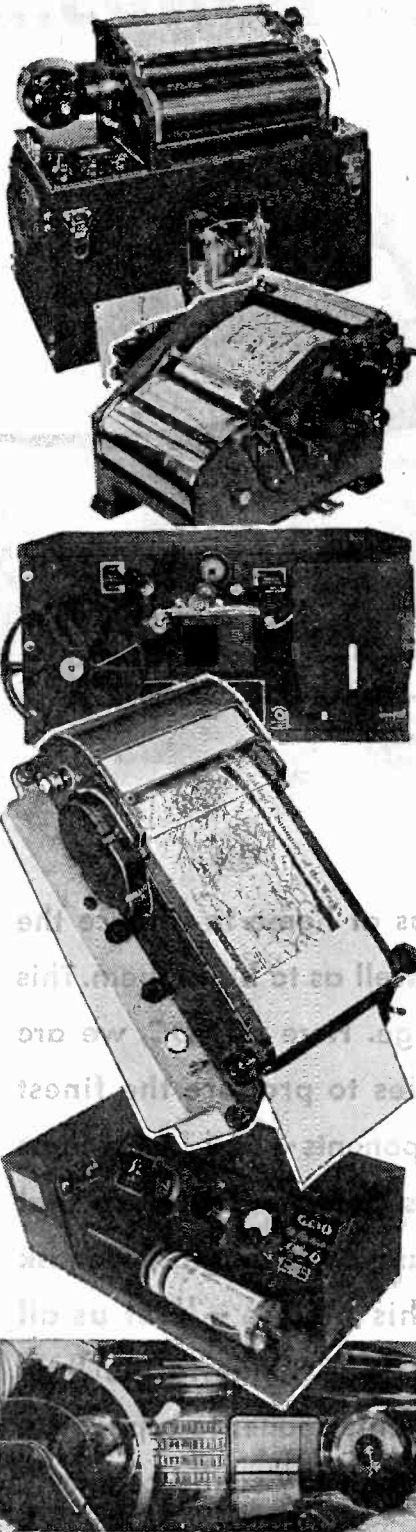

for Graphic Recording of any kind

OUR YEARS OF EXPERIENCE, and cumulative skills, in the designing and production of RADIO COMPONENTS, are now being used in making equipment which covers the *entire field of FACSIMILE.*

Actual service, as found in war and communication work under all conditions, has given a PRACTICAL quality to our equipment which, under ordinary conditions, would not have been obtained in years of engineering with limited application.

ALDEN PRODUCTS COMPANY is manufacturing practically ALL TYPES AND SIZES of facsimile and impulse recording equipment—using all the varied recording mediums: Photographic Paper, Film, Electrolytic Paper, Teledeltos, and Ink.

ALFAX IMPULSE RECORDING PAPER

By "COVERING THE ENTIRE FIELD," we mean . . .

1. Some of our equipment has been used for the transmitting and receiving of photographic pictures of reasonably high-resolution (such as the war pictures now appearing in the news).

2. Continuous Recorders—of the type whose value has been proven on National and International news service circuits—are now on their way to the Orient, to be used for the receiving of the so-called "picture" languages.

3. Also, through the use of ALFAX (the first high-speed black and white permanent recording paper), HIGH-SPEED Signal Analysis Equipment has been made possible for various laboratories and Government Departments. Other equipments have employed Teledeltos Paper for message work and other purposes.

4. The ability of ALFAX Paper and ALDEN Machines to record impulses as they occur, without the inertia problems of many previous methods, has made possible other recorders at various speeds (including slow). They will record a whole day's history of related phenomena, with time indicated, and often—with self-calibrated linear reference marks for ready interpretation.

5. ALDEN Tape Recorders (recording medium, ink)—have been designed to operate with a minimum of trouble and adjustments, and have PROVED MOST SATISFACTORY in day to day service.

ALDEN PRODUCTS COMPANY

117 North Main Street

BROCKTON (64D), MASSACHUSETTS

Membership

(Continued from page 44A)

- Golden, G., 1119 Grant Ave., Bronx, N. Y.
 Goldwater, F. J., 200 W. 20 St., New York, N. Y.
 Goodway, J. T., 64 Waterman Rd., Roslindale, Mass.
 Grant, J. H., 721 S. 28 St., South Bend, Ind.
 Greenbaum, W. H., Country Club Area, Fort Monmouth, N. J.
 Harden, L. R., 225 Broad St., Wethersfield, Conn.
 Haviland, E. F., Graybar Electric Co., 1355 New York Ave., N.E., Washington, D.C.
 Hegel, B., 1750 Grand Concourse, New York, N.Y.
 Held, W. J., 5450 Valley St., Philadelphia, Pa.
 Helminger, S. E., Milford, Ind.
 Hickerson, H. H., 709 S. Fountain St., Wichita, Kan.
 Hoffer, J. F., 3014 A.A.F.B.U., Section C., Unit D, D.A.A.F., Douglas, Ariz.
 Hogan, A. S., 218 Broad Ave., Leonia, N. J.
 Holbrook, J. G., c/o Postmaster, San Francisco, Calif.
 Horstmann, A. F., Jr., 1 Barry Pl., Passaic, N.J.
 Hoskins, C. B., 14 O'Henry Ave., Asheville, N. C.
 Houck, J. W., 25 Normal Terrace, Towson, Md.
 Houts, J. J., R.F.D. 1, Mankato, Minn.
 Iseman, R. L., 1711 Ulster St., Denver, Colo.
 Jordan, C. J., The Daven Co., 191 Central Ave., Newark, N. J.
 Kahn, D. A., 2372 Livingston Ave., Columbus, Ohio
 Keasey, E. T. D., 13 Arthur St., Woodstock, Ont., Canada
 Kenyon, P., 30 Woburn Hill, Green Lane, Stoneycroft, Liverpool, England
 Kehoe, F. P., R.C.A.F., Clinton, Ont., Canada
 Kendall, J. S., 49 Highbrow St., Harborne, Birmingham, England
 Kidd, C. S., Three Company, Three G.H.Q. Signals, M.E.F.
 Klein, A., 212 Rich Ave., Mount Vernon, N.Y.
 Krebs, R. P., 3895 W. 162 St., Cleveland, Ohio
 Kutel, S. S., 2047—27 St., Long Island City, L. I., N. Y.
 Lalanne, R. L., 116 Putnam St., Hartford, Conn.
 Liao, T. W., 307 N. 33 St., Philadelphia, Pa.
 Liguori, A., 302 E. 38 St., New York, N. Y.
 Lowe, G. P., 4543—17 St., N.E., Seattle, Wash.
 Lucas, G., 65 Columbia Pl., Brooklyn, N. Y.
 McElroy, G. E., 192 W. Washington Ave., Pearl River, N.Y.
 Mallalieu, F. R., -68-12 Yellowstone Blvd., Forest Hills, L. I., N. Y.
 Maury, M. A., Sperry Gyroscope Co., Garden City, L. I., N. Y.
 Meades, H. J., R.C.A.F., No. 25 Det., St. George De Malbaie, P.Q., Canada
 Merritt, C. H., Camp Wood, Ariz.
 Meyer, R. E., Civil Aeronautics Administration, Stanley Horner Bldg., 1015—14 St., N.W., Washington, D. C.
 Milam, J. C., 22 Nimitz Dr., Dayton, Ohio
 Miller, J. L., 65 Clarkwood St., Mattapan, Mass.
 Minalga, G. P., 59-C Elizabeth Rd., Hampton, Va.
 Montfort, L. R., 463 West Street, New York, N. Y.
 Moore, W. B., 3347 Grinnell St., San Diego, Calif.
 Morris, H. B., 1707 S. Grant St., South Bend, Ind.
 Morse, D. P., Sperry Gyroscope Co., 55 Johnson St., Brooklyn, N. Y.
 Muckel, C. D., WHTD Transmitter, R.F.D. 1, New Britain, Conn.
 Murakami, T., Swarthmore College, Swarthmore, Pa.
 Nako, G., 310 Westwood Ave., Toronto, Ont., Canada
 Newman, J. M., 1921 Francis Ave., Elkhart, Ind.
 Niederman, B., 1651 W. 63 St., Chicago, Ill.
 Osgood, F. E., 125 Park Ave., W., South Weymouth, Mass.
 Pantchechnikoff, J. I., 9923—99 Ave., Oakland, Calif.
 Porep, J. L., 3335 Harrison St., Oakland, Calif.
 Poeschel, W. R., Special Projects School, Naval Research Laboratory, Washington, D. C.
 Reynolds, R. R., P.O. Box 144, Pico, Calif.
 Riddle, L. G., 3914 Norton Ave., Kansas City, Mo.
 Rodina, J., Jr., 3220—83 St., Jackson Heights, L. I., N. Y.

(Continued on page 60A)

YOU ARE LOOKING AT ANOTHER NEW-*hp*-INSTRUMENT

... a signal generator for use below 100 kc

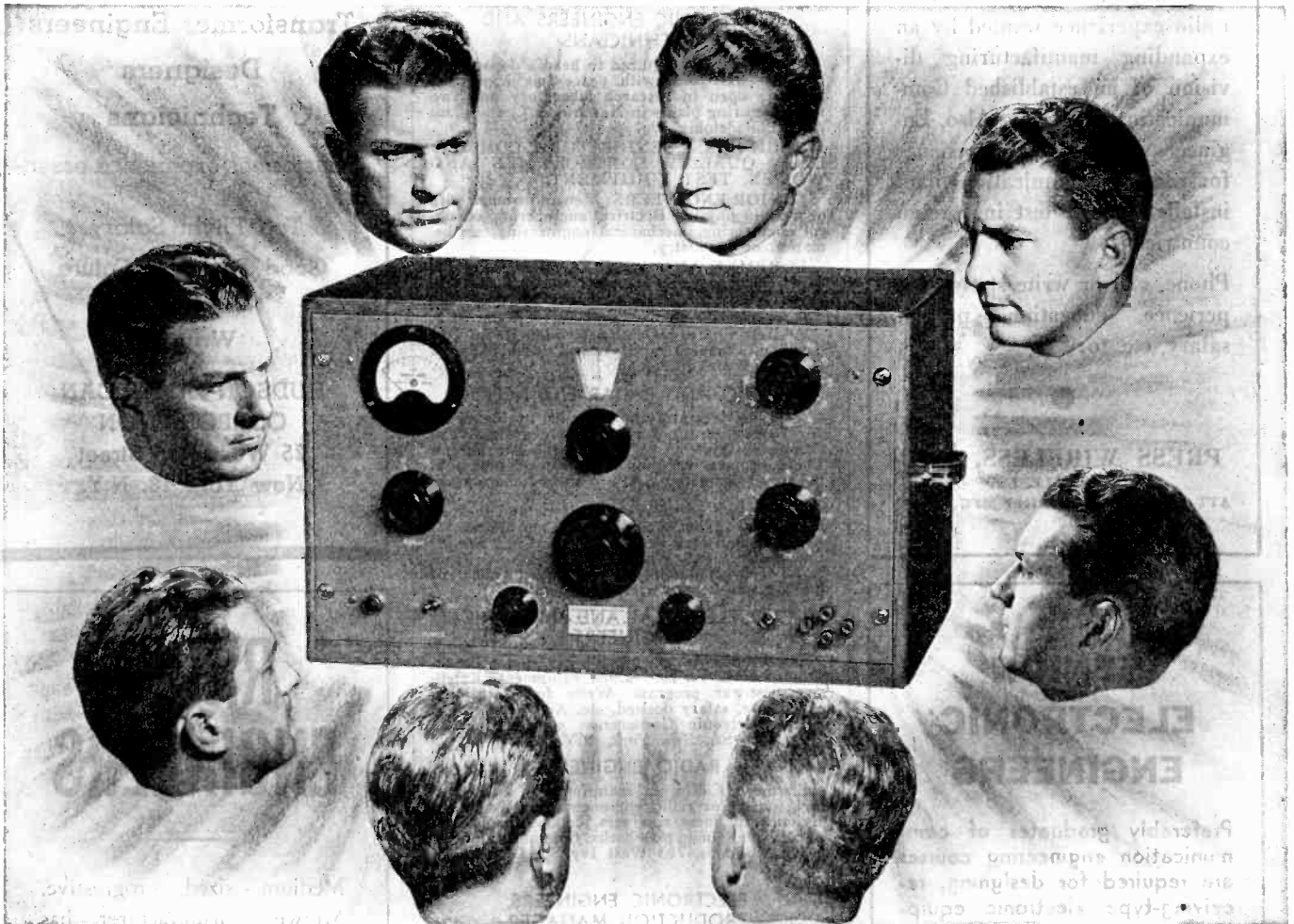

This new *hp*- Audio Signal Generator embodies many new features which are very desirable. Outstanding among these is the new main frequency dial which enables the engineer to make extremely accurate settings. Parallax is completely void and the vernier adjustment is smooth and positive. A spring loaded gear drive, built on a heavy cast frame, maintains accuracy of settings. The Model 205-AH consists of an *hp*-Resistance-Tuned Audio Oscillator, an output meter, an impedance matching system and an attenuator

set. The frequency range is from 1 kc to 100 kc, maximum power output is 5 watts, the hum level is at least 65 db below output voltage and the frequency response is ± 1 db from 10 kc reference. The output attenuator provides 0 to 110 db in 1 db steps, while the output meter is calibrated directly in volts at 500 ohms and in db above 1 milliwatt level.

A limited number of preliminary specification sheets are ready for engineers who write immediately.

HEWLETT-PACKARD COMPANY

BOX 980 D STATION A • PALO ALTO, CALIFORNIA

CANADIAN OFFICE: 560 KING STREET WEST, TORONTO 2



OPPORTUNITIES

Present and Postwar Work

Senior and Junior graduate Engineers with one or more years radio experience wanted by an expanding manufacturing division of an established Communication Company. Also, Engineers with practical experience for radio communication plant installation and test in foreign countries.

Phone, call or write stating experience, education, present salary, etc. to:

PRESS WIRELESS, INC.
HICKSVILLE, L.I.
ATT: S. A. BARONE, CHIEF MFG. ENGR.

SENIOR ELECTRONIC ENGINEERS

Preferably graduates of communication engineering courses are required for designing, receiving-type electronic equipment covering all frequency ranges, and other specialized electronic apparatus. Design experience necessary and knowledge of production is desirable. Excellent post-war opportunities. Salary open. Requirements urgent. Proof of citizenship and certificate of availability are necessary.

Write giving detailed qualifications and if satisfactory, interview will be arranged at our expense.

SUBMARINE SIGNAL CO.
Dept. 420
175 State St. Boston, Mass.

POSITIONS OPEN

The following positions of interest to I.R.E. members have been reported as open. Apply in writing, addressing reply to company mentioned or to Box No.

The Institute reserves the right to refuse any announcement without giving a reason for the refusal.

PROCEEDINGS OF THE I.R.E.

330 West 42nd Street, New York 18, N.Y.

ELECTRONIC ENGINEERS AND TECHNICIANS

An engineer is required to head a department. These war jobs, with peace-time opportunities, are open in research laboratory and two manufacturing plants in Newark, N.J., and plant near Philadelphia, Pa.

ENGINEERS: SENIOR TUBE, COMMERCIAL, QUALITY CONTROL MEN AND WOMEN, TEST EQUIPMENT.

JUNIOR ENGINEERS: Men and women with degrees in physics, electrical engineering, chemical engineering, mechanical engineering, mathematics, or chemistry.

FOREMEN AND ASSISTANT FOREMEN, experienced in radio or radio tube manufacture. **TECHNICIANS, CIRCUIT MEN,** to do wiring and construction.

Address replies to National Union Radio Corporation, Plane St. at Raymond Blvd., Newark 2, N.J. (WMC rules apply.)

RADIO AND RADAR ENGINEERS

Your services are vitally needed by the Army Air Forces for the development of ground communication systems peculiar to the Air Forces. These projects are now under development at the newly activated AAF, Watson Laboratories, Red Bank, N.J.

These are Civil Service positions and the pay scale ranges from \$2600 to \$5600 per annum.

Application may be made to the Civil Service Commission, 641 Washington St., New York, N.Y. or by contacting the Personnel Officer of the Watson Laboratories, Red Bank, N.J.

RADIO, ELECTRICAL AND MECHANICAL ENGINEERS

Opportunity for men with experience in design of receivers and allied equipment. Extensive post-war program. Write fully outlining experience, salary desired, etc. Address Bernard Fein, Electronic Corporation of America, 45 West 18th St., New York, N.Y.

RADIO ENGINEERS

Southern California manufacturer has openings for senior radio engineers with design experience in home receivers, communication receivers, and phono play-backs. Communicate with A. O. Williams, 703 West Ivy St., Glendale 4, Calif.

ELECTRONIC ENGINEERS, PRODUCTION MANAGER

New York corporation is interested in adding Junior and Senior Engineers with design and development experience, and a Production Manager with electronic and mechanical experience.

Salaries, based on experience and capacity, range up to \$100 a week for Junior Engineers, and \$10,000 a year for Senior Engineers and Production Manager. Address reply to Box 368.

ELECTRONIC ENGINEER

of industrial electronics in consulting engineering firm. Must have had experience in this field. Salary as well as a share in the profits. Please write to Box 342 giving detailed information on education and experience.

ENGINEERS FOR INDUSTRIAL ELECTRONICS

Experienced engineers wanted for design and application engineering of electronics to industry in a consulting engineering firm. Position offers unusual opportunity to qualified, reliable and responsible man. Present work will be on war contracts. Write to Box 343.

ACOUSTICAL ENGINEER

Acoustical and electronic engineer for development work on electronic musical instruments.

Also electronic technician and an electronic draftsman. Permanent positions in a research

(Continued on page 32A)

Radars and Electronic Engineers

Experienced in the field of communications and radar.

Top Flight Salary

Good Post-War Future

Transformer Engineers Designers Technicians

Transformer experience essential.

Top Flight Salary.

Good Post-War Future

Write—

HUDSON AMERICAN CORPORATION
25 West 43rd Street
New York 18, N.Y.

RADIO ENGINEERS

Medium - sized, progressive, Midwest manufacturer has openings for one senior and two junior engineers. Desire men for work on military projects now who will be adaptable later to postwar engineering. Prefer men with experience in radio receiver or television laboratory, and with college education in communication engineering.

Our staff knows of this advertisement.

Box No. 355
PROCEEDINGS OF THE I.R.E.
330 West 42nd Street
New York 18, N.Y.

ENGINEERS WANTED

by Large Radio Manufacturer
for Its Midwest Plant

1. R. F. and I. F. Coil Design engineer with knowledge of powdered iron cores for tuning. An important position involving coordination and supervision of other engineers. Man must be engineering graduate or have equivalent experience in permeability tuning systems.

2. Vibrator Power Supply engineer, thoroughly familiar with all types of vibrators, synchronous and non-synchronous, and associated transformer and filter circuits. Engineering graduate or equivalent experience.

Write details on education and background to Dept. 6P, Box 429, Grand Central Station, New York 17, N. Y.

OPPORTUNITY NOW FOR TECHNICAL ENGINEERS

In Expanding Organization
with Post War Future

Progressive company located near San Francisco has splendid openings for Engineers with a degree from a recognized college in physics, electrical or mechanical engineering who have specialized in electronics or allied fields.

Write, stating qualifications, education, draft status and salary requirements. Applicants now employed should submit a detailed resume of their experience together with an evaluation of their present duties.

DALMO VICTOR

1414 El Camino Real
San Carlos, California



(Continued from page 50A)

and development laboratory. Write Supersonics, Inc., 231 East 47th Street, New York 17, N. Y.

SALES ENGINEER

Manufacturers-representatives' company in New England needs a sales engineer, preferably one residing in Connecticut, with good technical background, pleasant personality, and keen judgment in appraising and working out technical details. Past experience in selling not necessary. Work involved includes calling on industrial accounts in New England, and discussing engineering matters and working out solutions of technical problems between customers and manufacturers.

Position represents an immediate opportunity with postwar future and pays well. Send replies to Box 369.

OPPORTUNITIES IN PRESENT AND POST-WAR WORK

Senior and Junior graduate engineers with one or more years radio experience wanted by an expanding manufacturing division of an established communication company.

Present activities include high- and medium-power transmitters, frequency shifters, other communication products for the Navy and designs and models for post-war use.

Engineers with practical experience also required for radio communication plant installation and test in foreign countries.

Phone, call or write stating experience, education, present salary, etc. Press Wireless, Inc., Hicksville, L. I., N. Y.; Attention of S. A. Barone, Chief Mfg. Engr.

TELEVISION TECHNICIANS

The Television Laboratories of the Columbia Broadcasting System, in New York, need television technicians. Men having had definite experience in the television field, transmitters, or receivers, preferred. Excellent opportunity for well qualified applicants. Our staff knows of this advertisement and replies will be kept confidential. Write, giving all details, to CBS Television Engineering Department, 485 Madison Avenue, New York 22, New York.

ENGINEERS

A Midwestern manufacturer of radio transmitters and associated equipment has openings for several junior project engineers qualified to supervise or assist development of transmitters, speech input systems, control apparatus, and similar items. Salary average \$2500 per year. Give full details first letter. Address Box 365.

ELECTRICAL ENGINEER FOR ELECTRONIC RESEARCH

An unusual opportunity for a man who has a knowledge of hot and cold cathode tubes and tube applications in amplifiers, multivibrators, triggers, and switching circuits. Permanent position in laboratory of established manufacturer, doing research and development work, both present and post war. Salary open and commensurate with experience, initiative, and ability. Include complete details of education, experience, and WMC availability with reply to Box 366.

ELECTRONIC ENGINEERS AND DRAFTSMEN

The services are required of several electronic equipment design engineers capable of supervising the system layout of electronic and electro-mechanical devices.

Also, several draftsmen are needed with experience in electronic schematics, circuit layouts, and wiring diagrams, or with considerable experience in other related electrical fields.

Write giving full qualifications to the Personnel Department, Curtiss-Wright Corp., Development Division, 88 Llewellyn Ave., Bloomfield, N. J.

CONSULTING ENGINEERS

For laboratory with adequate facilities to take on the design of R.F. precision measuring instruments on a contract basis. Send reply to Box 359.

ELECTRONICS ENGINEERS

Development engineers on television and ultra-
(Continued on page 54A)

3 RADIO ENGINEERS

One senior engineer and two junior engineers are offered good positions with a sound company. These men will work on military needs now and on a broad program of engineering projects in the postwar future. Men with experience in the design of test equipment and with college education in communication engineering preferred.

Write . . .

COMMUNICATION MEASUREMENTS LABORATORY

120 Greenwich St.
New York 6, N. Y.

OUR MEN NEED ★ BOOKS ★



SEND
ALL YOU CAN SPARE

GIVE A BOOST WITH A BOOK
—Good books, in good condition, are wanted by the 1945 VICTORY BOOK CAMPAIGN for men in all branches of the service. Doubtless some of our soldiers and sailors are interested in modern radio engineering methods and will find your books on that subject helpful to them in their work. Leave yours at the nearest collection center or public library,

Available from Stock

The Cardwell Capacitors illustrated are available from jobber stock, on low priority, while the supply lasts.

Since Cardwell is still engaged 100% in vital war production, this is indeed an exceptional opportunity to obtain immediate delivery on familiar catalog numbers of Cardwell Standard Transmitting Capacitors, as well as more interesting special items.

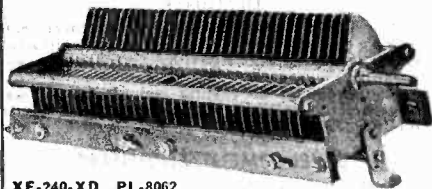

XE-240-XD PL-8062

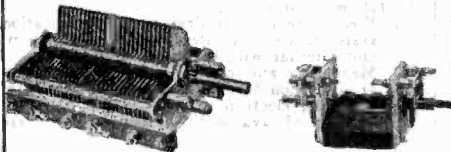

MR-260-BD PL-7013

EOV-2.8-SDJ Midget Dual Neutralizer Condenser PL-6266
Airgap .111"
Max. Cap. Approx. 2.8 per section

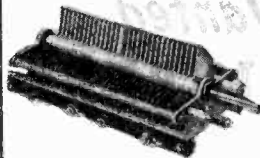

MO-180-BD PL-7031



ER-200-AS Spec., Insulated Shaft Extension PL-6207

Because the specific capacitors shown here are subject to prior sale, and will not be available indefinitely, we advise immediate action. However, a complete listing (periodically revised) of other immediately available Cardwell products of equal merit and versatility will be sent upon request.

CARDWELL CONDENSERS

THE ALLEN D. CARDWELL MANUFACTURING CORPORATION
81 Prospect Street, Brooklyn 1, N. Y.

An ANDREW SOLUTION to an

ANTENNA PROBLEM

Facing with a difficult antenna problem, E. H. Andresen, Chief Engineer of Chicago's Board of Education Station WBEZ, called on ANDREW engineers for a solution. The problem was that of coupling a 70-ohm unbalanced coaxial transmission line to the much smaller balanced impedance of the antenna. Uncertainty of the exact value of the antenna impedance made the problem difficult, and called for some kind of an adjustable coupling device.

ANDREW solved the problem by constructing a quarter wave impedance transforming section with a concentric "bazooka" for the balance conversion. Adjustments were made by varying the average dielectric constant in resonant section. This problem is but one of many that the experienced staff of ANDREW engineers are called upon to solve. As qualified experts in the field of FM, radio and television antenna equipment ANDREW engineers have solved many problems for military and broadcast engineers.

FOR THE SOLUTION OF YOUR ANTENNA PROBLEMS . . . FOR THE DESIGNING, ENGINEERING, AND BUILDING OF ANTENNA EQUIPMENT . . . CONSULT ANDREW

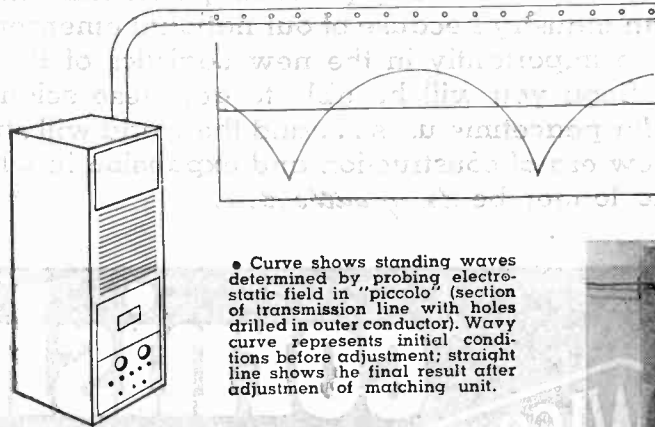

• Curve shows standing waves determined by probing electrostatic field in "piccolo" (section of transmission line with holes drilled in outer conductor). Wavy curve represents initial conditions before adjustment; straight line shows the final result after adjustment of matching unit.

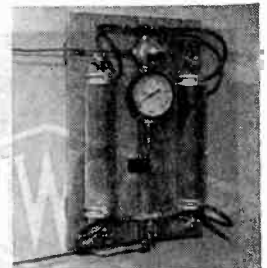

• Twin-barreled dehydrating unit especially designed for WBEZ by ANDREW engineers. Design permits leaving one cartridge in service while the other cartridge is being recharged.

ANDREW CO.



363 East 75th Street, Chicago 19, Illinois

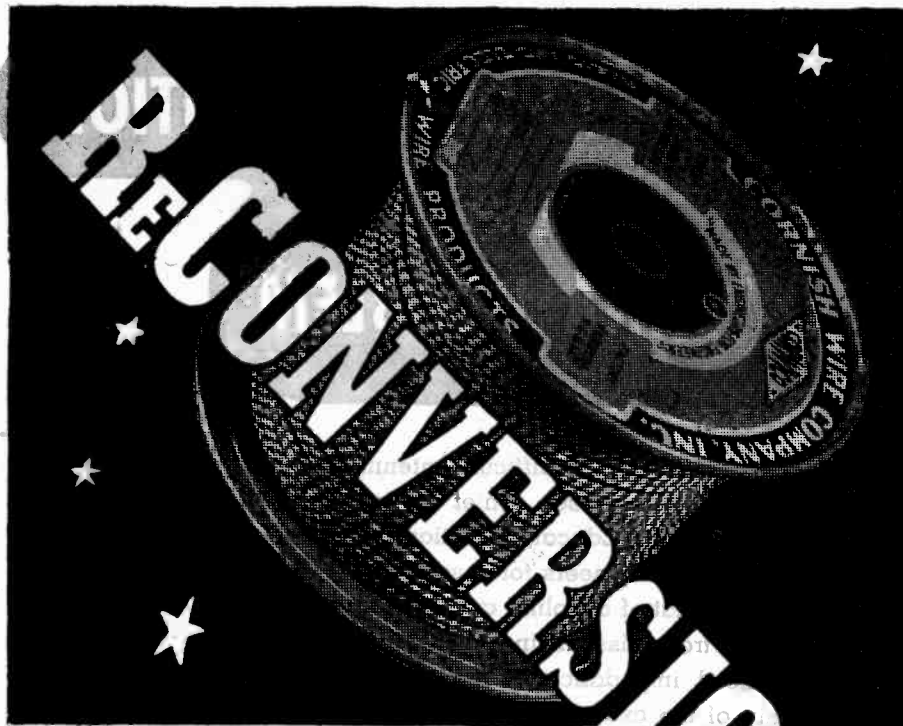

is another phase of

WAR . . .

THEY call it LOGISTICS in war . . . the difficult science of getting supplies to the fronts where they can be used. Post-War Reconversion will involve the same problems . . . just another phase of war itself.

CORWICO Wires, so long practically non-existent for American industry because of our national emergency, will figure importantly in the new Logistics of Reconversion. Soon you will be able to get these scientific strands for peacetime uses . . . and the world will stride into a new era of construction and expansion in which you'll no longer be *doing without* . . .



cornish

WIRE COMPANY, INC.

15 Park Row, New York City, New York

"Made by Engineers for Engineers"

POSITIONS OPEN

(Continued from page 52A)

high-frequency tubes. Technician on tubes. Radio engineers on special applications. Write full details to Box 363.

RADIO ENGINEERS, SUPERVISORS AND TECHNICIANS

Chief Radio Engineers, Transmitter and Studio Supervisors and Technicians between thirty and forty-five years of age are needed at once in important war work in the Pacific to construct and operate radio stations. These positions are with the United States Government, with good salaries and subsistence, and for the duration plus six months. Interested persons with actual broadcast experience should write, giving details of radio work, to Box 356.

RADIO, ELECTRICAL AND MECHANICAL ENGINEERS

In the development and production of all types of radio-receiving and low-power transmitting tubes. Excellent post-war opportunities with an established company in a field of opportunities. Apply in person, or write to Personnel Manager of Raytheon Manufacturing Company, 55 Chapel Street, Newton, Mass.

DESIGNER

A central New England manufacturer employing over 1000 people needs draftsman-designer on telephone and signaling (mechanical) apparatus.

Knowledge of die-casting and plastic applications desirable. WMC regulations prevail. Write to Box 339.

DEVELOPMENT ENGINEERS

Mechanical and electrical. Graduate or equivalent training. Required for development work in the following branches:

1. Electro-mechanical devices, communication systems. Must be interested in development and familiar with magnetic circuits.
2. Measuring and control instruments. Background should be in electrical engineering, including electronics.

Statement of availability required. Address Box 340.

Wanted ENGINEERS

Radio

*Electrical

Electronic

*Mechanical

*Factory Planning

Materials Handling

Manufacturing Planning

Work in connection with the manufacture of a wide variety of new and advanced types of communications equipment and special electronic products.

Apply (or write), giving full qualifications, to:

R.L.D.

EMPLOYMENT DEPT.

Western Electric Co.

100 CENTRAL AVE., KEARNY, N.J.

*Also: C.A.L.

Locust St., Haverhill, Mass.

Applicants must comply with WMC regulations

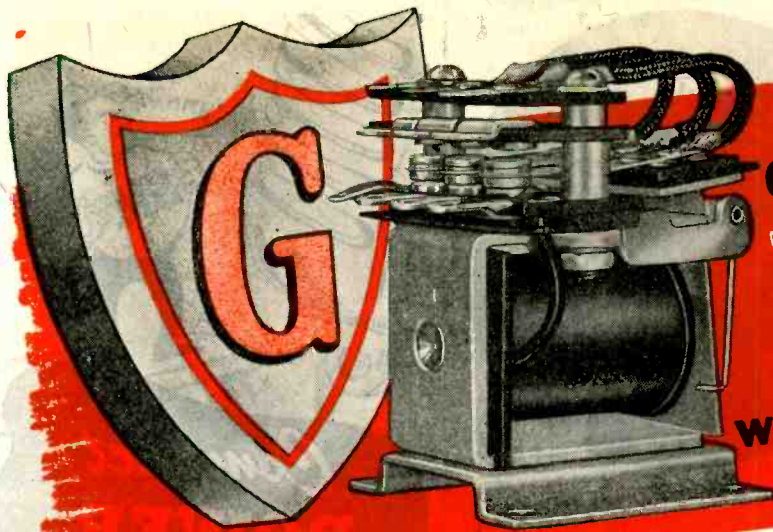

GUARDIAN Series 345 RELAY

a "Basic Design"
with many variations

**meets special applications
saves time . . . saves tooling . . . speeds delivery!**

If your application requires a specially designed relay Guardian engineers can be of great help to you. But, as a result of their wide experience in designing "specials" they have evolved a standard design so flexible that it is now specified in numerous applications that would ordinarily require a specially designed unit. Perhaps you can use it in your "special" application . . . with a saving in money and delivery time. This unusually flexible relay is the SERIES 345. Its chief features are the large coil winding area, numerous contact combinations; the non-binding pin type armature hinge pin, its resistance to shock and vibration, and an ability to operate in extremes of temperature. It is now being used in aircraft, radio, and other exact-

ing applications to insure dependable performance.
STANDARD SERIES 345—The ample coil winding area of the SERIES 345 gives you a wide range of windings for various voltages and currents. Coil winding area is approximately .75 cubic inches. Average power required is 3.56 watts with three pole, double throw contacts of 12½ amp. capacity. Coils are available for either A.C. or D.C. operation.

The maximum switch capacity of the Standard Series 345 is three pole, double throw. Contacts are rated at 12½ amperes at 110 volts, 60 cycles, non-inductive A.C. Moving contacts are attached to but insulated from the armature by a bakelite plate. Terminals are solder lugs. Weight is 6½ ounces.

VARIATIONS OF THE SERIES 345 RELAY



TIME DELAY

WINDING—Multi-wound coils are available for operation on two or more circuits. Or coil may be wound to operate on the discharge of a 3 mfd. condenser.

CONTACTS—Normal switch capacity is three pole, double throw; maximum switch capacity may be up to six pole double throw with 12½ amp. contacts, or any variation of contact combinations within this range, including the operation of contacts in sequence. The flexibility of the contact springs may be increased through the use of coil spring rivets.

TIME DELAY—On D.C. coils a time delay of 0.25 seconds on release or 0.06 second on attract may be achieved through the use of copper slugs which require these time intervals for saturation or de-energizing depending on whether they are used on the heel or head of the coil.

DUST COVER—For applications where this relay may be subject to injury or in atmosphere where dust may be present in sufficient quantity to impede operation, the SERIES 345 may be equipped with a metal dustproof cover.

SCREW TERMINALS—Screw type terminals are optional for applications where terminals must be disconnected occa-

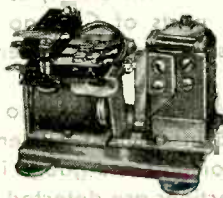

INTERLOCKING UNIT

sionally or where solder lug terminals are not otherwise practical.

INTERLOCKING—Here the series 340 a-c relay is coupled with the d-c coil of a series 405 short telephone type relay in an overload application. Under normal conditions the series 340 contacts are mechanically held in a closed position. Normal current flows through the series 405 coil and then through the series 340 contacts to the circuit for which overload protection is desired. Excessive current, however, energizes the series 405 coil, releasing the locking arrangement and breaking the series 340 contacts. Push button control resets to normal but is ineffective if current is still excessive.



DUST COVER

SERIES 345 RELAY DATA

Normal Volts	Minimum Volts	Normal M.A.	Minimum M.A.	Coil Resist.	Normal Wattage
6	4.8	600	480	10	3.56
12	9.6	300	245	40	3.56
24	18	148	111	162	3.56
32	25.6	112	89	287	3.56
115	92	31	25	3720	3.56

Minimum operating wattage.....2.3

If you will write us about your relay problems our engineers will be glad to make recommendations which may save you time and money. Should you desire a quotation, please mention quantity.

GUARDIAN ELECTRIC

1628-D W. WALNUT STREET

CHICAGO 12, ILLINOIS

A COMPLETE LINE OF RELAYS SERVING AMERICAN WAR INDUSTRY



QUALITY CONTROL The Bushing Tests

The maintenance of uniformity and accuracy in component parts is a recognized prerequisite of quality in a finished transformer, as in any precision product. For this reason, important parts of Chicago Transformers are closely inspected and tested for structural and dimensional accuracy before they reach production.

Ceramic bushings, a vital part of Hermetically-Sealed Chicago Transformers, are subjected to exhaustive tests and inspections. Dimensional accuracy to close tolerances is insured by micrometer and gauge inspection, while internal flaws and structural imperfections are detected by the use of light directed through bushing walls and by air-pressure exerted upon each bushing under water. As a final check the bushings are subjected to a high-voltage breakdown test to determine their insulating properties.

By this type of close control of quality in essential parts, production is facilitated and high standards of quality in the finished transformer are maintained. The result—better service to Chicago Transformer customers.

CHICAGO TRANSFORMER

DIVISION OF ESSEX WIRE CORPORATION

3501 WEST ADDISON STREET

CHICAGO, ILL.



SM Fractional H.P. Motors for blower, band switching, turntable, and other radio applications.

You can get a SM motor engineered and precision-built to your exact job specifications to give you maximum power per ounce of weight and per inch of space, long life and dependable performance. From 1/10th to 1/200th H.P. Speeds from 3,000 to 20,000 R.P.M. Voltage from 6 to 220 AC-DC. SM motors are built of quality materials in a plant with facilities for large volume production. Many thousands have been designed and built for signal corps and military aircraft use. What are your requirements?

Small Motors, Inc.

Dept. 31 - 1308 ELSTON AVE., CHICAGO 22, ILL.

Manufacturers of special small universal, fractional H.P. motors, dynamotors, shaded pole motors, heater motors, generators, Design • Engineering • Production

*A complete, compact test-bench
in a single unit!*

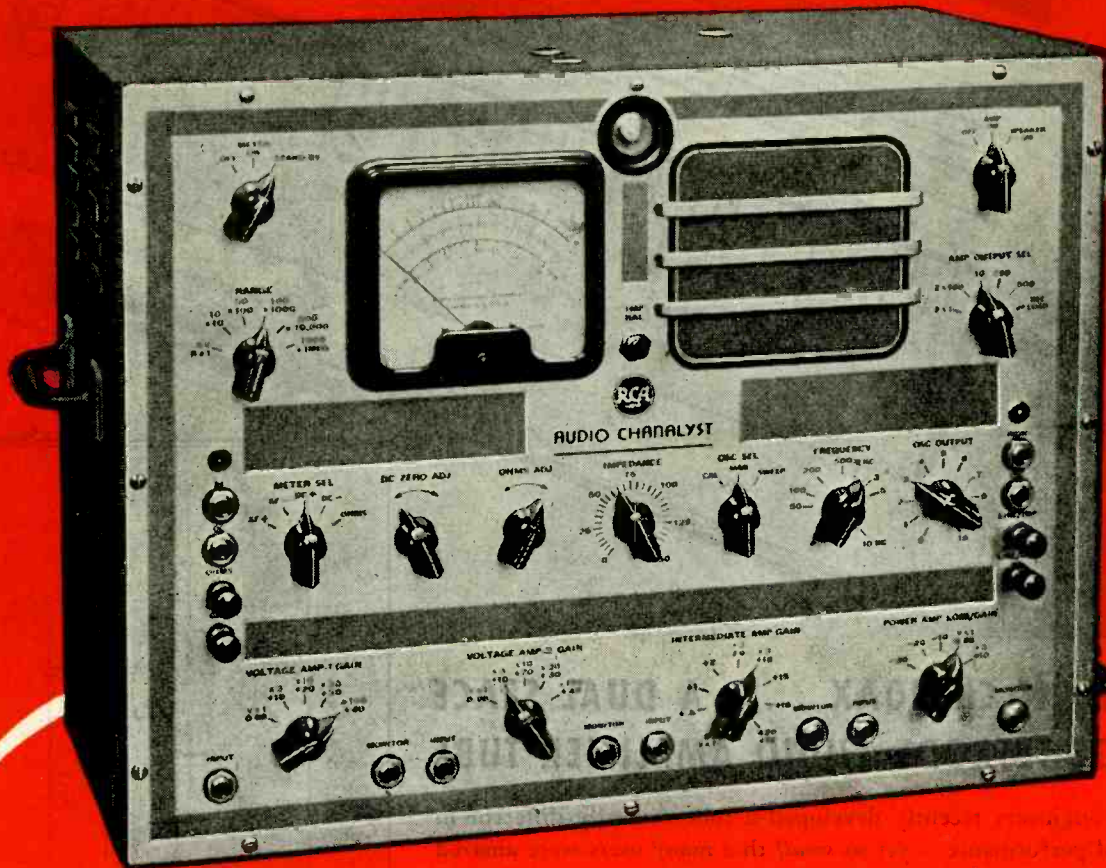

...the new **RCA 170-A AUDIO CHANALYST**
that tests everything—from microphone to multiple speakers

Available on rated orders.

**FOR COMPLETE INFORMATION
Use The Coupon**

Test & Measuring Equipment,
Dept. 110J
Radio Corporation of America,
Camden, New Jersey
Please send me complete information
about the new RCA 170-A
Audio Chanalyst.

Name.....
Company.....
Street.....
City..... State.....
97-6136-110

- With the 170-A you can systematically test any sound system completely for failure to operate, weak output, interrupted operation, and distorted or noisy output.
- You can check the presence, absence, or character of a signal throughout its path—from source to load.

- You can check gains or losses, measure component values, and test the voltages of any item supporting or controlling the signal.
- You can narrow down poor performance to its cause, and locate the defective part in an amazingly short time.

- You can use it to solve signal-interruption problems by multi-channel monitoring.
- In an emergency, you can use the RCA Audio Chanalyst to substitute for defective amplifiers by bridging the signal through it, and thus around the defect.

BUY MORE WAR BONDS



RADIO CORPORATION OF AMERICA

RCA VICTOR DIVISION • CAMDEN, N. J.

In Canada, RCA VICTOR COMPANY LIMITED, Montreal

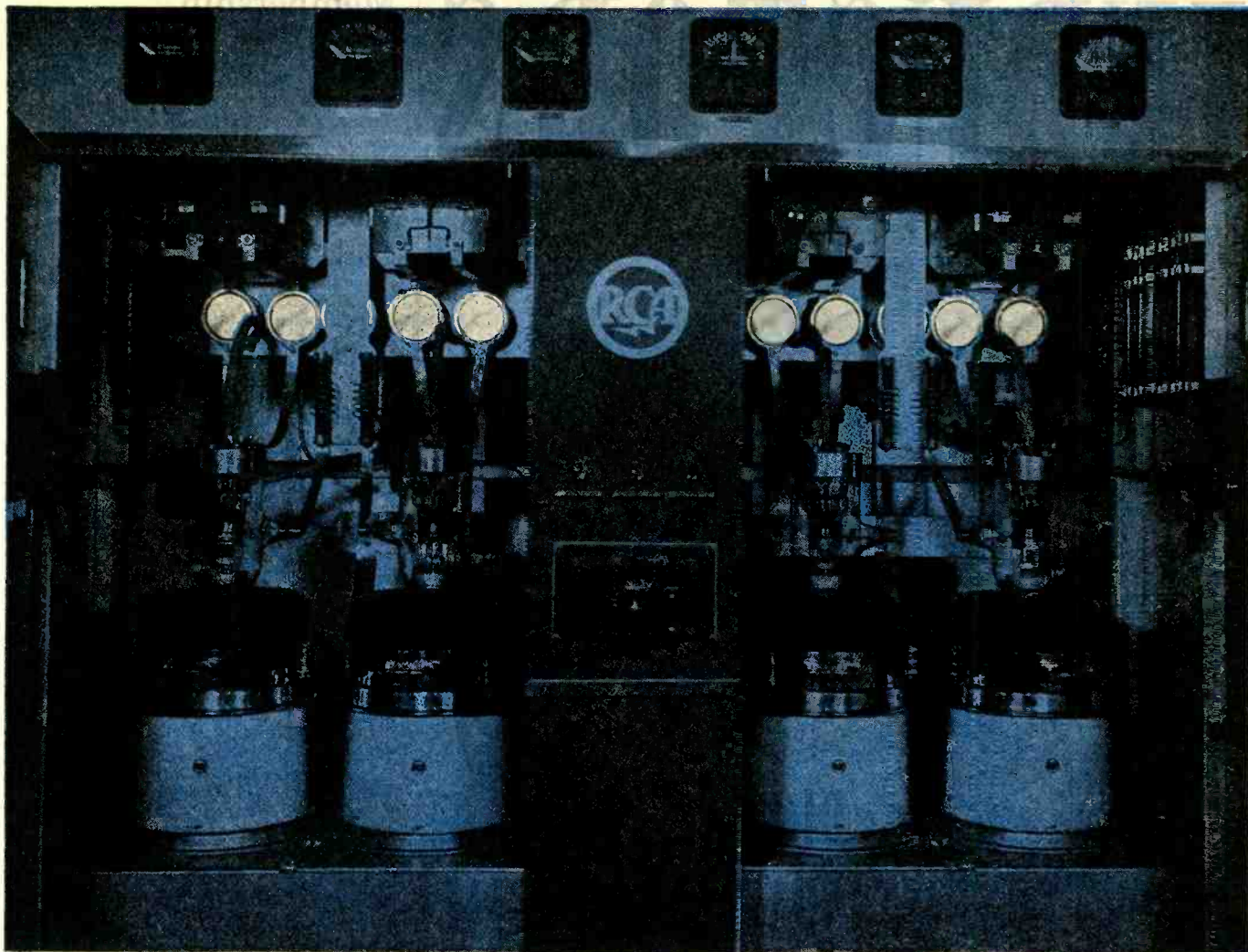

Faradon Capacitors for Broadcast Transmitters

SINCE the earliest days of radio broadcasting, Faradon Capacitors have been used in a large proportion of the transmitters built for leading broadcast stations. They are equally popular with manufacturers of police radio transmitters...aircraft radio transmitters...transmitters for the armed forces...and in many types of industrial electronic machines and appliances.

Why are Faradon Capacitors specified

for this wide range of uses? First... because of their established reputation for dependability. Second... because they include all types and sizes of mica capacitors. No matter why, or for what, you need a mica-type capacitor, there is an RCA Faradon that will "fill the bill."

For complete information on Faradon Capacitors, for any purpose, write to the Engineering Products Department 113 D, RCA Victor Division, Camden, N. J.

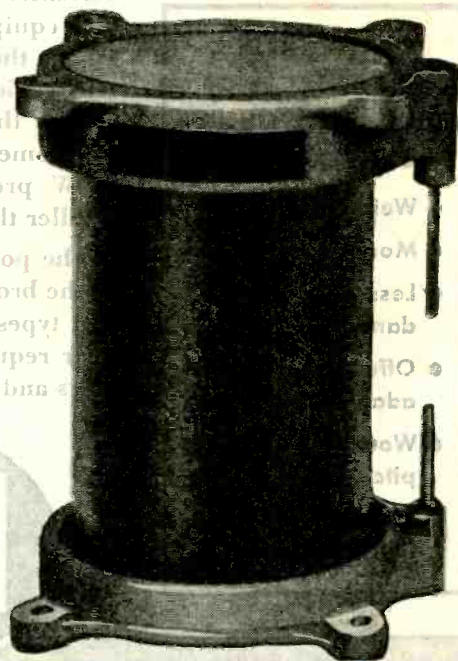

BUY MORE WAR BONDS

RADIO CORPORATION OF AMERICA

RCA VICTOR DIVISION • CAMDEN, N. J.

In Canada, RCA Victor Company Limited, Montréal

INDUCTORS



... BIG or LITTLE ...
STANDARD or SPECIAL

Here you see a large B&W low-frequency variometer-type inductor, tailor-made for a war equipment application, compared in size to the B&W 75-watt "Junior" of amateur radio fame. If a 25-watt "Baby" were put in the picture you'd hardly see it—and some of the new coils just coming off B&W production lines are many times smaller than that!

The point is that B&W offers inductors in the broadest assortment of shapes, sizes, and types on the market today. Whatever your requirement, write for recommendations and suggestions.

**NOTE THESE
ADVANTAGES OF
B&W "AIR WOUND"
CONSTRUCTION**

- Weigh less
- Mount easier
- Less susceptible to damage
- Offer greater design adaptability
- Wound to uniform pitch
- Exceptionally low dielectric loss

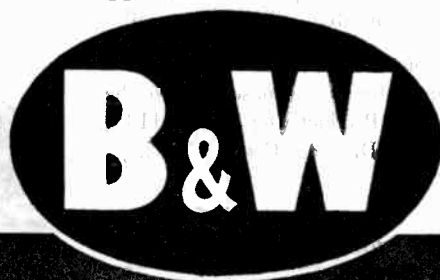

BARKER & WILLIAMSON
235 FAIRFIELD AVENUE UPPER DARBY, PA.

Export: LINDETEVES, INC., 10 Rockefeller Plaza, New York, N. Y., U. S. A.

Membership

(Continued on page 48A)

- Russell, J. H., Asdevlant, F.A.D., N.A.S., Quonset Point, R. I.
- Sachs, A., 850 E. 17 St., Brooklyn, N. Y.
- Safir, R., 40 Argyle Rd., Brooklyn, N. Y.
- Schlinger, W. R., 643 N. Mill St., Santa Paula, Calif.
- Schrader, W., 4117-13 Ave. S., Minneapolis, Minn.
- Schroeder, I. H., 56 Frost St., Cambridge, Mass.
- Shaw, R. G., 1406 N. Benton Way, Los Angeles, Calif.
- Siekman, R. E., 1131 Woodward Ave., S. Bend, Ind.
- Simmonds, R. E., 2 Inskip Dr., Hornchurch, Essex, England
- Smith, Carroll S., 32-B Emerson Ave., Floral Park, L. I., N. Y.
- Smith, H. E., P.O. Box 46, Lakeville, Ind.
- Sowell, L. R., 4324 Amherst St., Dallas, Texas
- Stach, R. W., 2712 L St., Eureka, Calif.
- Stadheim, K., 190 Vernon Ave., Brooklyn, N. Y.
- Stafford, C. M., Jr., 75 Harrison St., Denver, Colo.
- Stalder, L. R., 834 Pleasant Rd., Lancaster, Ohio
- Stallard, R. L., Radiation Laboratory, Massachusetts Institute of Technology, Cambridge, Mass.
- Steinberg, E. E., 69 N. Broadway, Hicksville, L. I., N. Y.
- Stewart, C., 912 Iowa Ave., Iowa City, Iowa
- Strasser, A., 86 South St., Morristown, N. J.
- Strum, P. D., 705 Western Ave., Rocky Mount, N. C.
- Suhs, C. J., 12544 Highland Ave., Blue Island, Ill.
- Taylor, R. E., 227 A St., N.E., Washington, D. C.
- Thompson, J. E., 1440 W. 47th St., Chicago, Ill.
- Thompson, O. I., 105 North Pkwy., Prospect Heights, Ill.
- Thornton, F. Jr., Westinghouse Electric and Manufacturing Co., East Pittsburgh, Pa.
- Tidmarsh, G. P., Consolidated Vultee Aircraft Corp., San Diego, Calif.
- Tooker, H. A., 332 N. Main St., Monroe, N. Y.
- Trimmer, J. P., Communications Bldg. 45, N.A.S., Pensacola, Fla.
- Trusler, C. G., Sergeants' Mess, No. Two Wireless School, Calgary, Alberta, Canada
- Tucker, V. L., 2916 W. Ave. 33, Los Angeles, Calif.
- Turk, K., Jr., 2554 Greenmount Ave., Baltimore, Md.
- Vogel, E. H., 6630 Mardel Ave., St. Louis, Mo.
- Wagner, R. W., 816 Englewood Ave., Buffalo, N. Y.
- Ward, E. P., 402 Michell Ave., Ridley Park, Pa.
- Wasson, J. W., 911 High St., Williamsport, Pa.
- Waterman, H. C., Bendix Aviation Corp., South Bend, Ind.
- Weaver, C. W., 4741 Boyd St., Ashland, Ky.
- Wenk, H. A., Bell Telephone Laboratories, Inc., 180 Varick St., New York, N. Y.
- West, B., P.O. Box 95, 99 Main St., Oceanport, N. J.
- Wetmore, W. L., R.D. 4, Corning, N. Y.
- Williams, E., No. Two Wireless School, Calgary, Alberta, Canada
- Williams, R. S., 2114 S. Leer St., South Bend, Ind.
- Wilson, R. L., 1340 A Ave., N.E., Cedar Rapids, Iowa
- Wilson, W. E. C., 109 Kennedy Ave., Toronto, Ont., Canada
- Zajaczkowski, J. A., 2069 Auburn Ave., Dayton, Ohio
- Corey, V. B., 34-10 Linden Pl., Flushing, L. I., N. Y.
- Malmberg, P., 143-51-38 Ave., Flushing, L. I., N. Y.

**M. F. M. Osborne Associates
Consulting Physicists**

Fluid Dynamics, Mechanics, Electronic Design, Electromagnetic and Acoustic Wave Propagation, Mathematical Analysis.

703 Albee Bldg., Washington 5, D.C.
Atlantic 9084

FRANK MASSA

Electro-Acoustic Consultant

DEVELOPMENT PRODUCTION DESIGN
PATENT ADVISOR

ELECTRO-ACOUSTIC & ELECTRO-MECHANICAL
VIBRATING SYSTEMS

SUPERSONIC GENERATORS & RECEIVERS
3393 Dellwood Rd., Cleveland Heights 18, Ohio

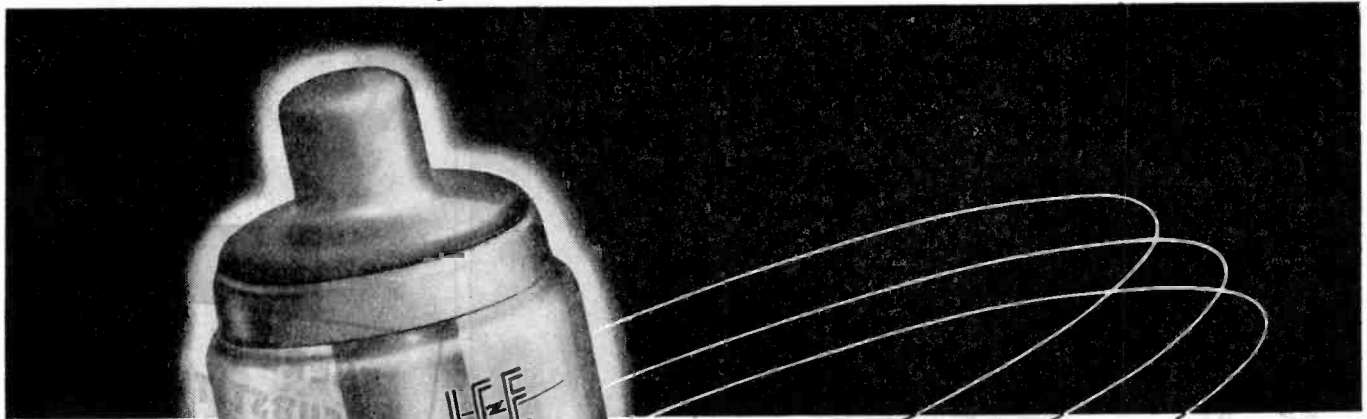

I. C. E.
VC-100 VACUUM
CONDENSOR



HAS THE ANSWER TO YOUR MICROMICROFARAD PROBLEM

You don't have to build equipment to suit the capacity of any particular condenser. I. C. E.'s advanced research now makes available to you reliable vacuum condensers in capacities ranging from 10 to 110 micromicrofarads . . . in steps of one micromicrofarad. I. C. E. precision assures accuracy of one micromicrofarad, plus or minus. Standard condensers available in sizes VC-12 . . . VC-25 . . . VC-50 and VC-100.

Order your requirements today

Send for this Complete Catalog

A new catalog, fully illustrated, describes in detail I. C. E. vacuum condensers as well as other high precision vacuum equipment. Write for your free copy today.

Research on Your Other Problems

The I. C. E. research laboratory is ready to serve you in the development and designing of tubes and other vacuum units required by electronic equipment you are now designing. Write Engineering Department today.



ELECTRONIC TUBES
RESEARCH • DESIGN • PRODUCTION

INDUSTRIAL & COMMERCIAL ELECTRONICS
BELMONT, CALIFORNIA

MOTOR DATA

No. 126

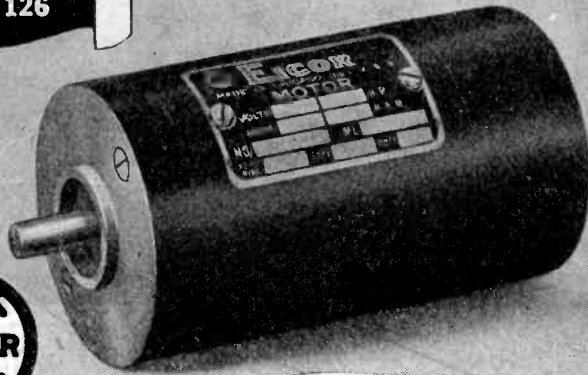

2300 FRAME MOTOR 1/5 HP at 3800 RPM

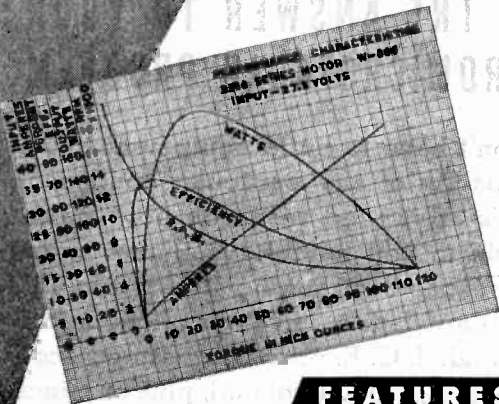

The basic design of the 2300 Frame Motor has been used in scores of individual modifications. Many of these designs are complete and available—others for new equipment can readily be developed.

FEATURES

ELECTRICAL

Series or shunt wound
High starting torque
Low starting current
High efficiency
Low RF interference
Unidirectional or reversible
Armature and field windings varnish impregnated and baked

MECHANICAL

Low weight factor
Unusual compactness
Completely enclosed
Base or flange mounting
Laminated field poles
Precision ball bearings
Segment-built commutator
Permanent end play adjustment

2300 FRAME MOTORS		2318 Series	2310 Shunt
Watts Output, Int.	(max.)	160	50
Torque at 6000 RPM	(in. oz.)	40	10
Torque at 3800 RPM	(in. oz.)	57	—
Lock Torque	(in. oz.)	120	14
Volts Input	(min.)	5	5
Volts Input	(max.)	110	28
Temperature Rise	(int.)	50°C	50°C
Diameter		2 ⁵ / ₁₆ "	2 ⁵ / ₁₆ "
Length less shaft		4 ⁵ / ₃₂ "	2 ³ / ₄ "
Shaft Dia.	(max.)	.312"	.312"
Weight	(lbs.)	2.4	1.5

EICOR INC. 1501 W. Congress St., Chicago, U.S.A.
DYNAMOTORS • D. C. MOTORS • POWER PLANTS • CONVERTERS
Export: Ad Aurema, 89 Broad St., New York, U.S.A. Cable: Aurema, New York

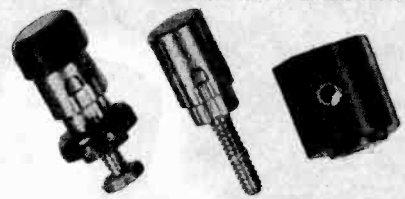

THERE IS NO SUBSTITUTE FOR EBY SPRING BINDING POSTS

From the product designer through to final assembly and use in the field, the Eby Spring Binding Post line offers top service based on dependability.

The spring binding post offers unique advantages that can't be duplicated:

1. No screw cap to tighten or come loose with vibration.
2. Constant, even pressure on the wire at all times in all positions.
3. Easy one-hand feeding of wire into the post.
4. Corrosion-resistant, long-life springs.
5. Complete range of sizes, stem lengths, and accessories for every application.

Replace with Eby Spring Binding Posts — Write today.



HUGH H. EBY
INCORPORATED
18 W. CHELTEN AVE.
PHILADELPHIA, PA.



To assist the equipment designer Federal offers comprehensive data on high frequency cables.

This technical information sheet provides the design-engineer with pertinent electrical and physical characteristics...including impedance, capacitance, attenuation, diameter, materials, and weight... for Federal's wide variety of high-frequency cables.

Single and double braid, armored, dual con-

ductor and dual coaxial, air-spaced, low capacitance lines, and antenna lead-in wire... there's a right type for your job, backed by the built-in superiority that's a tradition with Federal.

Special developments in flexible low-loss cables by Federal have resulted in superior cables for all types of transmission. For a better job, see Federal first.

Write for your cable information sheet today.

Federal Telephone and Radio Corporation

Newark 1, N. J.



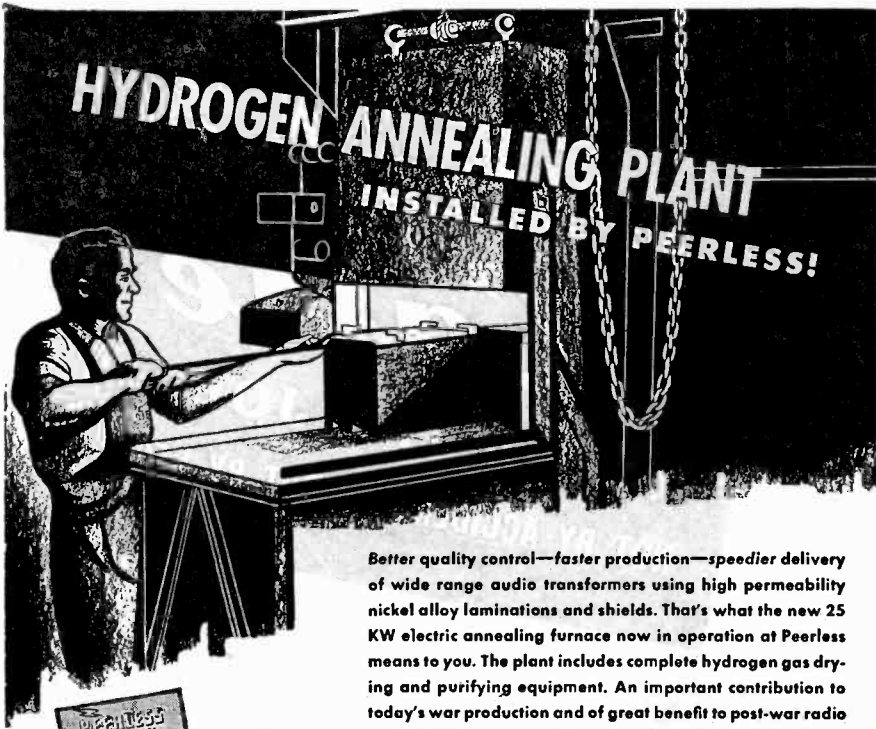

Better quality control—faster production—speedier delivery of wide range audio transformers using high permeability nickel alloy laminations and shields. That's what the new 25 KW electric annealing furnace now in operation at Peerless means to you. The plant includes complete hydrogen gas drying and purifying equipment. An important contribution to today's war production and of great benefit to post-war radio manufacturers of FM, television and geophysical equipment.



Write today for new transformer catalog.



PEERLESS

ELECTRICAL PRODUCTS CO.

6920 MCKINLEY AVENUE • LOS ANGELES 1, CALIFORNIA



Signal Corps Photo

As recently announced, Prentice-Hall is introducing a new series of electrical engineering books, both for college text purposes and professional use, under the editorship of

DR. WILLIAM L. EVERITT

Professor and Head of the Department of Electrical Engineering at the University of Illinois, on leave with the U. S. Army as Director of the Operational Research Staff, Office of the Chief Signal Officer, and President of the Institute of Radio Engineers.

A number of titles are already in preparation. Communications regarding the series may be addressed to Dr. Everitt in care of Prentice-Hall.

PRENTICE-HALL, INC.

70 FIFTH AVENUE
NEW YORK 11

Laboratory Standards

MODEL 62

VACUUM TUBE VOLTMETER

SPECIFICATIONS:
RANGE: Push button selection of five ranges—1, 3, 10, 30 and 100 volts a. c. or d. c.
ACCURACY: 2% of full scale. Useable from 50 cycles to 150 megacycles.
INDICATION: Linear for d. c. and calibrated to indicate r.m.s. values of a sine-wave or 71% of the peak value of a complex wave on a. c.
POWER SUPPLY: 115 volts, 40-60 cycles—no batteries.
DIMENSIONS: 4¾" wide, 6" high, and 8½" deep. **WEIGHT:** Approximately 6 lbs.
PRICE: \$135.00 f.o.b. Boonton, N. J. Immediate Delivery

MEASUREMENTS CORPORATION

BOONTON, NEW JERSEY

FUNGI!

puts the
"finger" on
communications

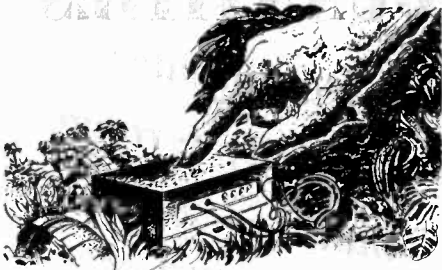

... but **TROPICALIZED**
Q-Max A-27, H. F. Laquer
Offers Sure Protection

From the moment your communication or electrical product arrives on a Pacific beachhead, its "number is up"—unless, of course, it has been *tropicalized!* For Fungi and Mold, those deadly parasitic organisms that thrive in a hot, humid tropical atmosphere, are insidious performance enemies that do not respect the finest workmanship your factory can build into any component part.

The sure, safe and effective antidote is Tropicalized Q-Max A-27, H.F. Lacquer that can easily be applied by brushing or dipping as a post-assembly operation. This dependable, fungicide-and-lacquer combination offers every delicate part double-barreled protection. It offers the protection of the fungicide and that offered by the Q-Max Lacquer, long known for its good electrical characteristics and corrosion resistance. And Q-Max not only fungus-proofs the coated area, but the untreated surfaces adjacent to the treated part as well.

Send for your copy of "Tropicalized Q-Max A-27, H.F. Lacquer," a folder which supplies complete details. Specify this factory-mixed fungicidal lacquer that's non-toxic and meets Government specifications—look for the word Tropicalized on the Q-Max label.

Communication
PRODUCTS COMPANY, INC.
346 BERGEN AVE., JERSEY CITY, N. J.

Q-MAX CHEMICAL DIVISION

Coaxial Transmission Line & Fittings • Sterling Switches • Auto Dryaire • Antenna & Radiating Systems • Tropicalized Q-Max A-27, H.F. Lacquer

Proceedings of the I.R.E. April, 1945

BETTER PERMANENT MAGNETS

for:

RADIO, SOUND and
COMMUNICATIONS
EQUIPMENT

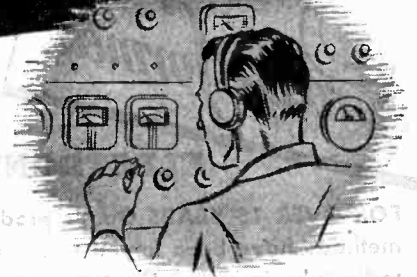

AUTOMOTIVE
and AVIATION
EQUIPMENT

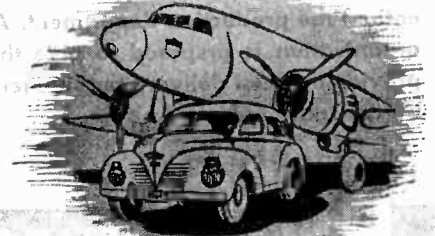

INSTRUMENTS

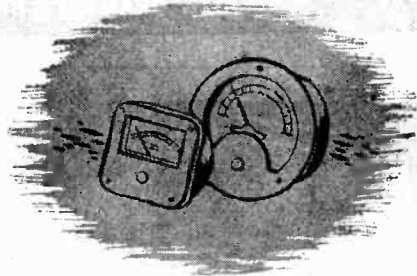

However advanced your own product-development work may be . . . however new or revolutionary the permanent magnets you require . . . Arnold engineers can be of considerable assistance to you in supplying the proper permanent magnets *in volume*. They're precision-built entirely in our own plant, under the closest metallurgical, mechanical and magnetic control to assure peak efficiency at the lowest cost.



NEW! Get your copy of this valuable, up-to-the-minute manual on the design, production and application of modern Alnico permanent magnets. Write us, on your company letterhead, today.

Specialists in the manufacture of
ALNICO PERMANENT MAGNETS

THE ARNOLD ENGINEERING COMPANY

147 EAST ONTARIO STREET, CHICAGO 11, ILLINOIS

SHIPPED ON SCHEDULE

this box contains

GOAT

Precise-formed



ELECTRONIC TUBE PARTS

FOR OVER 15 YEARS Goat's production planning and control methods have been keyed to the exacting requirements of the radio tube industry. Goat parts must be shipped on schedule, because failure to live up to delivery promises may tie up an entire tube production department. At the same time, the Goat organization is prepared to give the extra service needed to provide unusual delivery requirements occasionally demanded by the radio industry.

GOAT

METAL STAMPINGS, INC.

AFFILIATE OF THE FRED GOAT CO., INC. • EST. 1893
314 DEAN ST., BROOKLYN 17, N. Y.

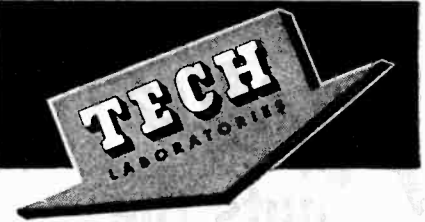

MEASURES QUANTITIES

*with greater
sensitivity & range
than ever before
accomplished*

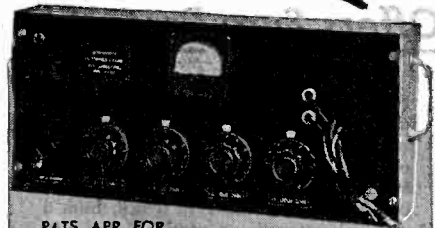

PATS. APP. FOR

TECH LAB MICROHMMETER

... gives direct and instantaneous readings of resistance values down to 5 microhms and up to 1,000,000 megohms. Accuracy in all measurements to better than 2%. Output is sufficient to drive recorder. Entirely AC operated. Furnished in two models. Reasonably prompt deliveries. For complete data regarding other applications write for Bulletin No. 432.



Quality manufacturers of attenuators and other electrical complete instruments. For complete data write for Bulletin No. 431.

TECH

LABORATORIES

7 LINCOLN STREET
JERSEY CITY 7, N. J.



TRANSFORMERS

for TRANSPORTATION APPLICATIONS

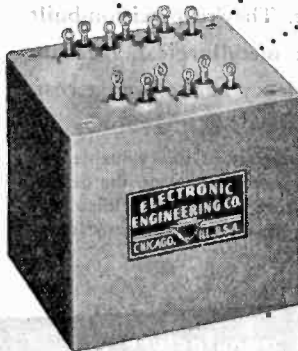

Wherever specialized transformers are required for transportation applications, you will find a high-quality transformer designed and engineered by Electronic Engineering Co., a modern mass production organization . . . For communications equipment in airplanes and trucks, for blind-flying controls and landing apparatus in planes, for signaling and safety equipment in trains, rely on Electronic Engineering Co. for the solution to your problem.

ELECTRONIC ENGINEERING CO.

735 West Ohio Street • Chicago 10, Illinois

Associated Company

Holubow and Rehfeldt Consulting Engineers

Transformer Engineers for Specialized Applications

hallicrafters equipment covers the spectrum

● Hallicrafters equipment covers the radio spectrum. From low to ultra high frequencies there is a Hallicrafters receiver ready to meet your special requirements. Although certain equipment operating in the ultra high frequencies cannot be described at present for security reasons, the characteristics of Hallicrafters' standard line of receivers may be disclosed. This line includes:

Model S-37. FM-AM receiver for very high frequency work. Operates from 130 to 210 Mc. Highest frequency range of any general coverage commercial type receiver.

Model S-36. FM-AM-CW receiver. Operates from 27.8 to 143 Mc. Covers old and proposed new FM bands. Only commercially built receiver covering this range.

Model SX-28A. Operates from 550 kc to 42 Mc continuous in six bands. Combines superb broadcast reception with the highest performance as a versatile communications receiver.

Model S-22R. Completes Hallicrafters coverage in the lower end of the spectrum. Operates from 110 kc to 18 Mc in four bands. A.c./d.c. operation.

BUY A WAR BOND TODAY!



hallicrafters

THE HALLICRAFTERS COMPANY • MANUFACTURERS OF RADIO AND ELECTRONIC EQUIPMENT • CHICAGO 16, U. S. A.

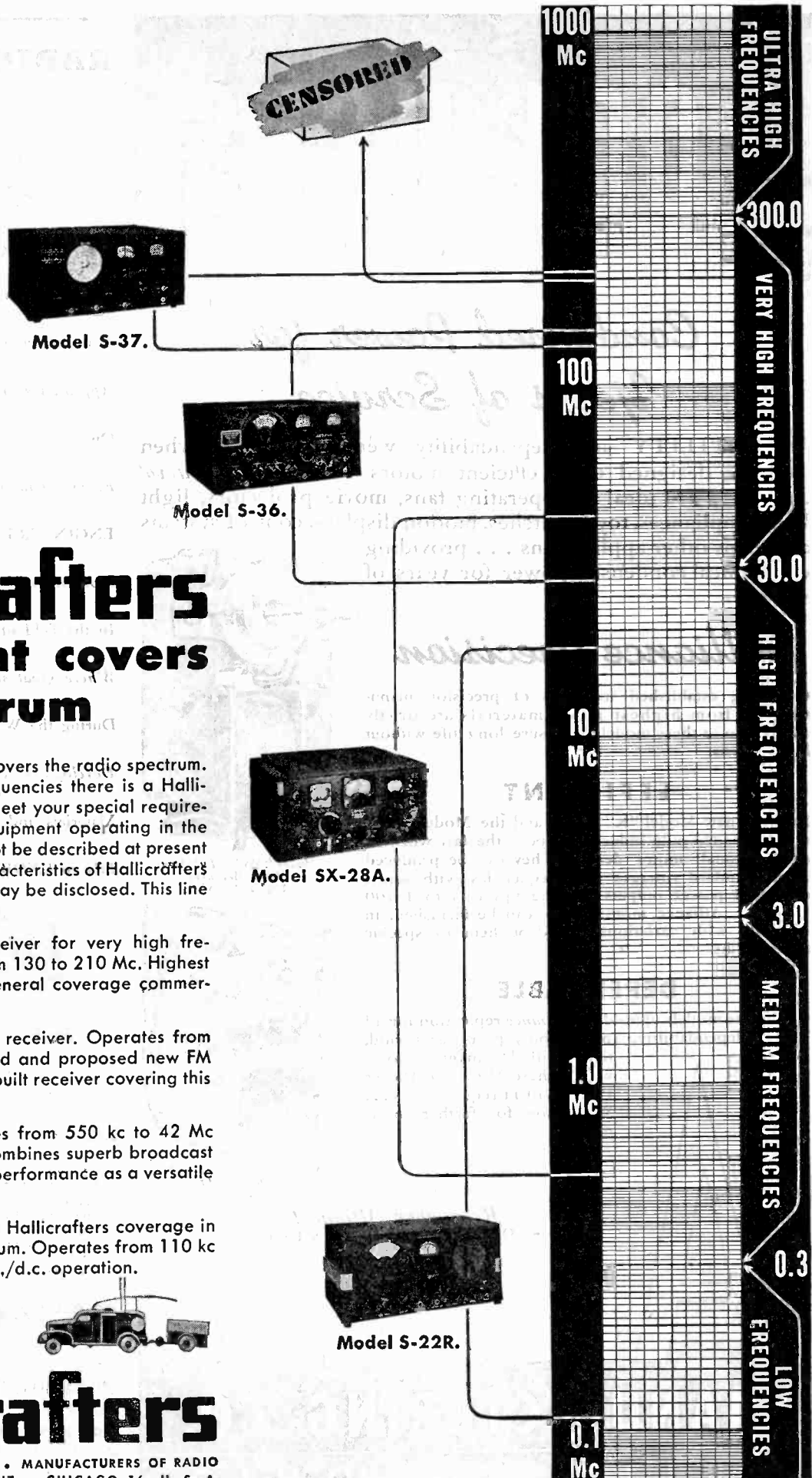

1,001 USES

Condensed Power for Years of Service

VERSATILITY and dependability were paramount when Alliance designed these efficient motors — *Multum in Parvo!* . . . They are ideal for operating fans, movie projectors, light home appliances, toys, switches, motion displays, control systems and many other applications . . . providing economical condensed power for years of service.

Alliance Precision

Our long established standards of precision manufacturing from highest grade materials are strictly adhered to in these models to insure long life without breakdowns.

EFFICIENT

Both the new Model "K" Motor and the Model "MS" are the shaded pole induction type — the last word in efficient small motor design. They can be produced in all standard voltages and frequencies with actual measured power outputs ranging upwards to 1/100 H. P. . . Alliance motors also can be furnished, in quantity, with variations to adapt them to specific applications.

DEPENDABLE

Both these models uphold the Alliance reputation for all round dependability. In the busy post-war period, there will be many "spots" where these Miniature Power Plants will fit requirements . . . Write now for further information.

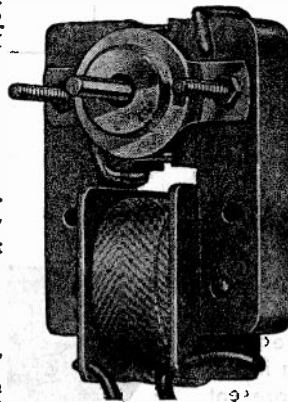

Model "MS" — Full Size Motor Measures 1 3/4" x 2 x 3 1/8"

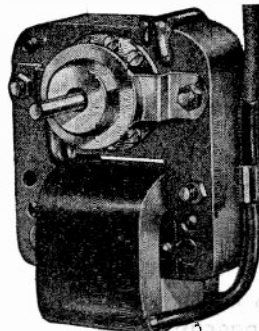

New Model "K" — Full Size Motor Measures 2 1/8" x 2 3/8" x 3 1/8"

Remember Alliance!
—YOUR ALLY IN WAR AS IN PEACE

ALLIANCE

MANUFACTURING CO.

ALLIANCE . OHIO

RADIO PARTS OF "TAYLOR LAMINATED PLASTICS"

WHETHER OR NOT your

Post-war radio has the

Tone, selectivity and quality

Appearance to give it a head start

On competition depends to a large

Extent upon how closely the

ENGINEERS who design it follow

Modern developments, especially

In the field of LAMINATED PLASTICS

Where great strides have been made

During the WAR YEARS in the

Development of new and better

Materials and methods.

Like to KNOW MORE? Write us today.

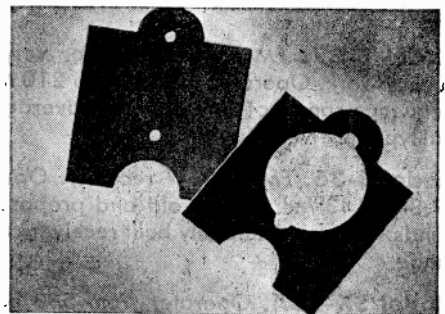

This two-part radio insulator is typical of Taylor's ability to mass-produce accurate parts. Each is stamped in a single operation, one from Vulcanized Fibre and the other from a grade of Phenol Fibre noted for its high dielectric strength. Whatever combination of qualities you may need, it's a good bet that Taylor can give it to you.

TAYLOR FIBRE COMPANY

LAMINATED PLASTICS: PHENOL FIBRE-VULCANIZED FIBRE
Sheets, Rods, Tubes, and Fabricated Parts
NORRISTOWN, PENNSYLVANIA
OFFICES IN PRINCIPAL CITIES

Pacific Coast Headquarters:
544 S. SAN PEDRO STREET, LOS ANGELES

Proceedings of the I.R.E. April, 1945

Still Another DeJUR Achievement

Completely Enclosed ARMY-NAVY Rheostat-Potentiometer

DESIGNED TO CONFORM TO SPECIFICATIONS

JAN. R-22

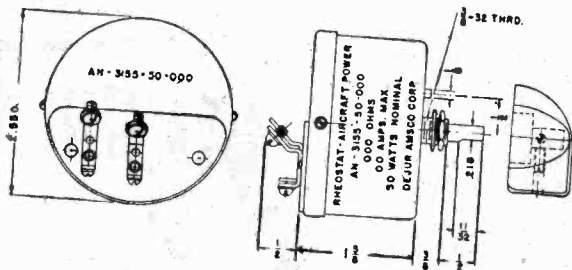
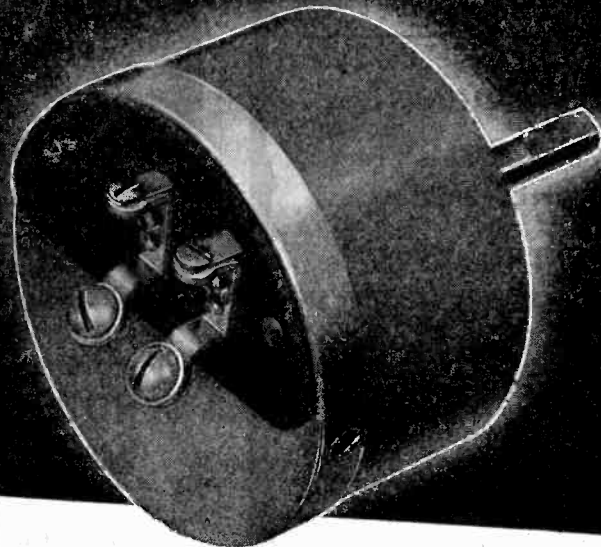

MODEL 231—50 WATTS, Ranges from $\frac{1}{4}$ to 10,000 OHMS

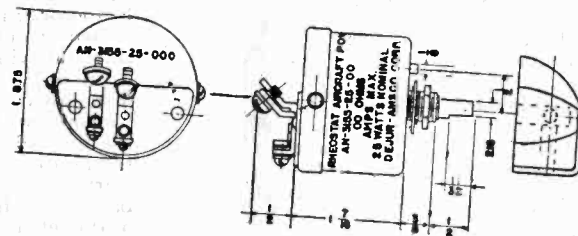

MODEL 235—25 WATTS, Ranges from 2 to 5000 OHMS

These two new DeJur rheostat-potentiometers are completely enclosed in permanently sealed, corrosion-proof metal cases. Terminals are brought through a sealed terminal board. Thus, no dust can penetrate, no varying degrees of heat, cold or humidity can affect their high operating efficiency. Rigid requirements, including the salt spray corrosion test, are met.

Supporting these advantages is the excellence of DeJur precision construction. You can subject these instruments to great shock or vibration . . . take them up miles into the air . . . and their close tolerances remain unaffected. Write for additional details, or consult with a DeJur engineer. Special features built to order—length of shaft (round, slotted or flatted) can be provided to individual specifications.

DeJUR-AMSCO CORPORATION

GENERAL OFFICE: NORTHERN BLVD. AT 45th STREET, LONG ISLAND CITY 1, N. Y.
IN CANADA . . . ATLAS RADIO CORP. LTD., 560 KING ST. WEST, TORONTO, CANADA



BUY
AND
HOLD
MORE
WAR
BONDS

TECHNICAL NOTES

Excerpts from *New Home Study Lessons Being Prepared under the Direction of the CREI Director of Engineering Texts*

Engineers!

Send for This Free Article on the

DELTA-WYE TRANSFORMATION

Each month CREI presents a specially prepared, practical technical article in its popular magazine, *CREI NEWS*. The final article on Circuit Equivalents appears in the April issue and discusses the Delta-Wye Transformation with illustrative examples—a Bridged-Tee Variable Attenuation Pad and an I.F. Trap circuit employed in a television receiver.

We believe that the readers of *I.R.E. Proceedings* will find this article of practical interest and possibly of assistance in their daily work.

The CREI NEWS is issued free of charge. Merely write a card or letter and request your copy of the April issue. Your name will be added to the mailing list and you will receive each forthcoming issue together with the interesting series of articles that are planned for the future. We will also be glad to send all past articles on "Circuit Equivalents," if available. *Write today*—You will incur no obligation in doing so, and you will undoubtedly appreciate its contents.

The subject of "Circuit Equivalents" is but one of many that are being constantly revised and added to CREI lessons by A. Preisman, Director of Engineering Texts, under the personal supervision of CREI President, E. H. Rietzke. CREI home study courses are of college calibre for the professional engineer and technician who recognizes CREI training as a proved program for personal advancement in the field of Radio-Electronics. Complete details of the home study courses sent on request. . . .

Write for 36-page booklet.

CAPITOL RADIO Engineering Institute

E. H. RIETZKE, President

Home Study Courses in Practical Radio-Electronics Engineering for Professional Self-Improvement

Dept. PR-4, 3224—16th St., N.W.
WASHINGTON 10, D.C.

Contractors to the U. S. Navy—U. S. Coast Guard—Canadian Broadcasting Corp. Producers of Well-trained Technical Radiomen for Industry.

70A

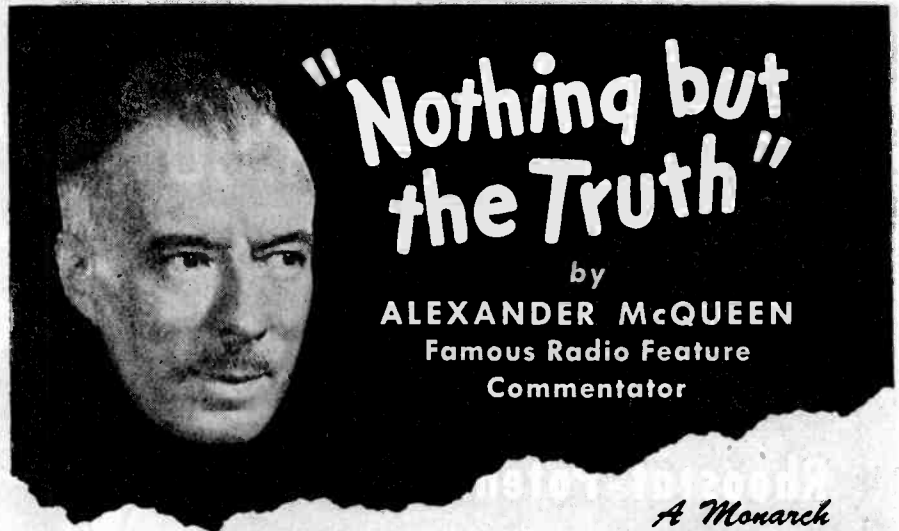

"Nothing but the Truth"

by
ALEXANDER McQUEEN
Famous Radio Feature
Commentator

*A Monarch
Fact Story!*

HOW THE FIRST "FOOT" MEASUREMENT WAS STARTED!

Just four hundred years ago, Charles V of Austria, Holy Roman Emperor, in seeking a standard of measurement for his domain, adopted the following procedure: To the doors of the church one morning he dispatched a trustworthy member of his court with instructions to detain the first 16 men who emerged from the house of worship. These 16 stalwarts were directed to stand just back of each other so that the toes of the left foot of every second man touched the heel of his neighbor in front. The total measurement of the 16 feet thus lined up was then divided by 16 and the result was declared to be "one foot"



... and that's "NOTHING BUT THE TRUTH"
... BUT TODAY

For the exacting measurements and calibrations which are desirable in every phase of radio and electronic work, engineers and production experts insist upon

MONARCH

TESTING • MEASURING • CALIBRATING EQUIPMENT

... and that's "nothing but the truth"



2014 N. MAJOR AVE. • CHICAGO 39, ILL.

YOU NEED THIS
for
POST-WAR PLANNING



In your plans to manufacture radios and similar electronic equipment you must include Mica Trimmers of every type. Therefore, this Trimmer Catalog will be of considerable help to you. In it we have listed and clearly illustrated all the standard types. Complete specifications are given for each type including Capacity curves and outline drawings showing every essential dimension.

Every Design Engineer and Purchasing Agent should have a copy of our Trimmer Catalog handy for ready reference.

When Civilian Production is again permissible we are prepared to resume our position as the world's largest Mica Trimmer manufacturer and to continue to serve your needs with R. F. and I. F. Coils and Transformers.



AUTOMATIC
MANUFACTURING
CORPORATION

COMPLETE ELECTRONIC ASSEMBLIES & COMPONENT PARTS

900 PASSAIC AVE.

EAST NEWARK, N. J.

Formerly AUTOMATIC WINDING CO., INC.

TRIMMERS



TRANSFORMERS

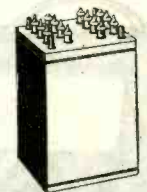

CHOKE COILS



R. F. COILS

WIRE, RIBBON and Other Metal Products

★ Smaller than Commercial Sizes; closer than Commercial Tolerances

An organization devoted to the research, development and production of wire and ribbon and similar products of Platinum and other Precious Metals, as well as Rare and Base Metals . . . This metallurgical plant is completely equipped with alloying, melting and working facilities for precision production. Equipment and staff permit specialization in smaller than commercial sizes and closer than commercial tolerances for the most exacting technical requirements.

SIGMUND COHN & CO.

44 Gold Street • New York 7, N. Y.



Immediate Delivery! WIDE RANGE VACUUM TUBE VOLTMETERS

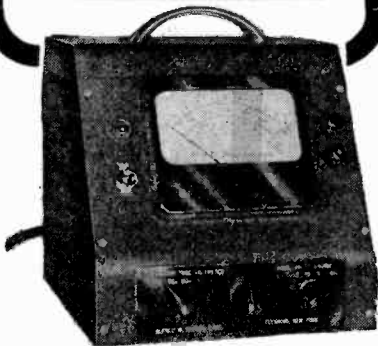

- High input impedance for both AC and DC measurements.
- Convenient, low capacity "Probe" especially adapted to high frequency radio use—100 megacycles and over.
- Self-regulating operation from power line; no batteries.
- Multiple voltage ranges — accurate and stable.

BULLETIN ON REQUEST

**ALFRED W. BARBER
LABORATORIES**

34-04 Francis Lewis Blvd. Flushing, N.Y.

INDEX

Section Meetings	34A
Membership	38A
Positions Open	50A

DISPLAY ADVERTISERS

Aerovox Corporation	27A
Aireon Manufacturing Corp.	13A
Alden Products Company	48A
Alliance Manufacturing Company	68A
American Telephone & Telegraph Co.	31A
Amperex Electronic Corporation	8A
Andrew Company	53A
Arnold Engineering Company	65A
Audio Development Company	47A
Automatic Manufacturing Corp.	71A
Alfred W. Barber Laboratories	72A
Barker & Williamson	60A
Bendix Aviation Corp.	21A
Bliley Electric Company	Facing 9A
Browning Laboratories, Inc.	51A
Capitol Radio Engineering Institute	70A
Allen D. Cardwell Mfg. Corp.	53A
Centralab	28A
Chicago Transformer Corp.	56A
Clarostat Manufacturing Co., Inc.	47A
Sigmund Cohn & Company	72A
Communication Measurements Laboratory	52A, 72A
Communication Products Company	65A
Cornell-Dubilier Electric Corp.	Cover III
Coming Glass Works	9A
Cornish Wire Co., Inc.	54A
Dalmo Victor	52A
DeJur-Amco Corp.	69A
Allen B. DuMont Labs., Inc.	12A
Hugh H. Eby, Inc.	62A
Eicor, Inc.	62A
Eitel-McCullough, Inc.	74A
Electronic Engineering Co.	64A
Electronic Laboratories, Inc.	Facing 8A
Electro-Voice Corporation	4A
Erie Resistor Corporation	23A
Federal Telephone & Radio Corp.	37A, 63A
Freed Transformer Company	36A
General Electric Co.	11A
General Radio Co.	Cover IV
Goat Metal Stampings, Inc.	66A
Guardian Electric Mfg. Co.	55A
Hallicrafters Company	67A
Hammarlund Mfg. Co., Inc.	10A
Heintz & Kaufman, Ltd.	45A
Hewlett-Packard Company	49A
Hudson American Corp.	50A
Hytron Corporation	25A
Industrial & Commercial Electronics	61A
Industrial Condenser Corp.	40A
International Resistance Co.	5A
International Telephone & Telegraph Corp.	37A, 63A
Jackson Electrical Instrument Co.	38A
Kaar Engineering Co.	73A
Frank Massa	60A
Measurements Corp.	64A
Micamold Radio Corp.	46A
Monarch Manufacturing Co.	70A
Mycalex Corp. of America	41A
National Company	24A
National Union Radio Corp.	3A
National Vulcanized Fibre Co.	72A
M.F.M. Osborne Associates	60A
Peerless Electrical Products Co.	64A
Plymold Corporation	39A
Prentice-Hall, Inc.	64A
Press Wireless, Inc.	50A
Radio Corp. of America, RCA Victor Div.	32A, 58A, 59A
Rauland Corporation	20A
Raytheon Manufacturing Co.	57A
Remler Co., Ltd.	22A
Shallcross Mfg. Company	44A
Sherron Electronics Co.	14A
Shure Brothers	30A
Skydyne, Inc.	40A
Small Motors, Inc.	56A
Solar Manufacturing Corp.	33A
Sperry Gyroscope Co., Inc.	19A
Sprague Electric Company	7A
Stackpole Carbon Company	35A
Standard Transformer Corp.	42A
Stupakoff Ceramic and Mfg. Co.	18A
Submarine Signal Company	50A
Taylor Fibre Company	68A
Tech Laboratories	66A
Triplett Electrical Instrument Co.	26A
Tung-Sol Lamp Works, Inc.	6A
United Transformer Company	Cover II
Universal Microphone Co.	15A
Utah Radio Products Company	43A
Walker-Jimieson, Inc.	34A
Western Electric Company	16A, 17A, 54A
Westinghouse Electric & Mfg. Co.	29A

CML SERVES THE ELECTRONIC INDUSTRY

Designed to meet the most rigorous specifications for precision, every CML unit is equipment of accredited performance.

1

ROTOBRIDGE . . . This automatic inspector checks for proper wiring, correct resistance, capacity and inductance values in all types of electronic equipment.

2

MODEL 1100, MODEL 1110 . . . Voltage regulated power supply units; with extremely low noise level and excellent regulation.

3

MODEL 1420 GENERATOR . . . Furnishes test power over a wide frequency range; may also be employed in 3-phase circuits.

4

MODEL 1200 STROBOSCOPE . . . Stops motion within range of 600 to 800,000 R.P.M.

WRITE FOR DESCRIPTIVE BULLETINS

COMMUNICATION MEASUREMENTS LABORATORY

120 GREENWICH ST., NEW YORK 6, N. Y.

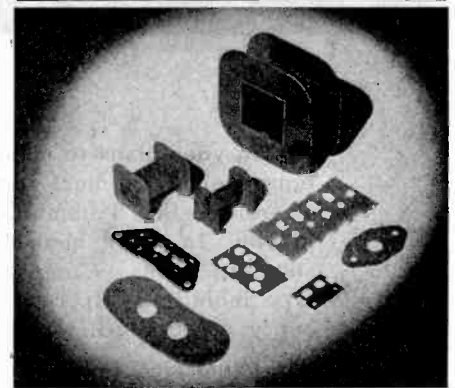

In Everything of Uncle Sam's that "flies, floats or shoots"

NATIONAL VULCANIZED FIBRE

PHENOLITE
Laminated BAKELITE

—because of their lightness in weight, high dielectric strength, ready machinability, exceptional wearing and other qualities—are playing a vital part.

"BACK THE ATTACK" with WAR BONDS

NATIONAL VULCANIZED FIBRE CO.

Offices in Principal Cities
WILMINGTON, DELAWARE



TYPE 648—Heavy duty dual power pack with parallel output. 300 volts at 200 ma. from 6 volt battery

TYPE 650—Standard: 200 volts at 50 ma. Optional: 200 volts at 75 ma. This type available for 6, 12, or 32 volt operation. Has built-in filter. Notice simplicity of construction.

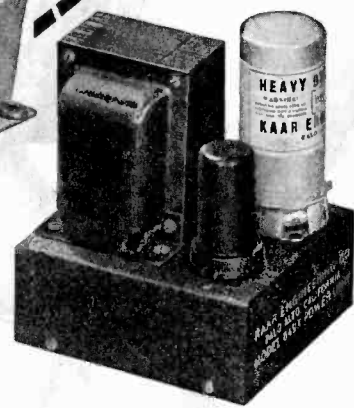
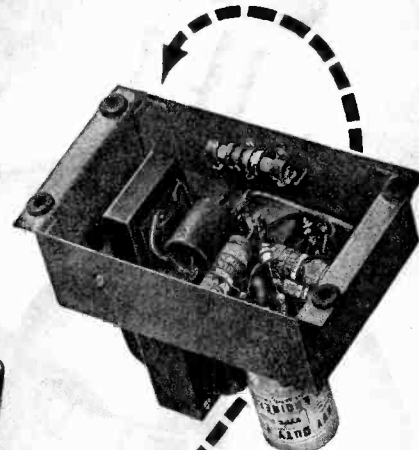

TYPE 649—Provides 240 volts at 50 ma. Available at other standard ratings, and for operation from 6 or 12 volt batteries. Type 647, not illustrated, provides 240 volts at 75 ma.

KAAR POWER PACKS

Engineered for
 ✓ SIMPLICITY
 ✓ EFFICIENCY
 ✓ DEPENDABILITY

Use this West Coast source for vibrator power packs

Kaar Engineering Company offers prompt delivery of standard and special types of vibrator power packs for operation from 6, 12, or 32 volt sources. In addition, laboratory facilities are available for a variety of power

packs designed to your own specifications.

Take advantage of this convenient West Coast source of exceptionally efficient low-drain packs, designed for simplicity and dependability.

KAAR

ENGINEERING CO.

PALO ALTO, CALIFORNIA



Export Agents: FRAZAR & HANSEN
 301 Clay Street • San Francisco 11, Calif.

MOBILE RECEIVERS—Crystal controlled superheterodynes for medium and high frequencies. Easy to service.

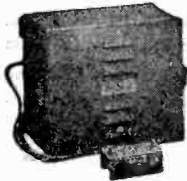

CRYSTALS—Low-drift quartz plates. Fundamental and harmonic types available in various holders.



TRANSMITTERS—Mobile, marine, and central station transmitters for medium and high frequencies. Instant heating, quickly serviced.

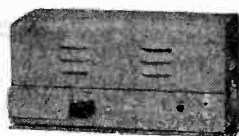

MICROPHONES—Type 4-C single button carbon. Superb voice quality, high output, moisture proof.



CONDENSERS—Many types of small variable air condensers available for tank circuit and antenna tuning.

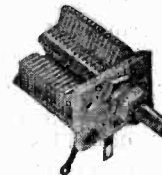

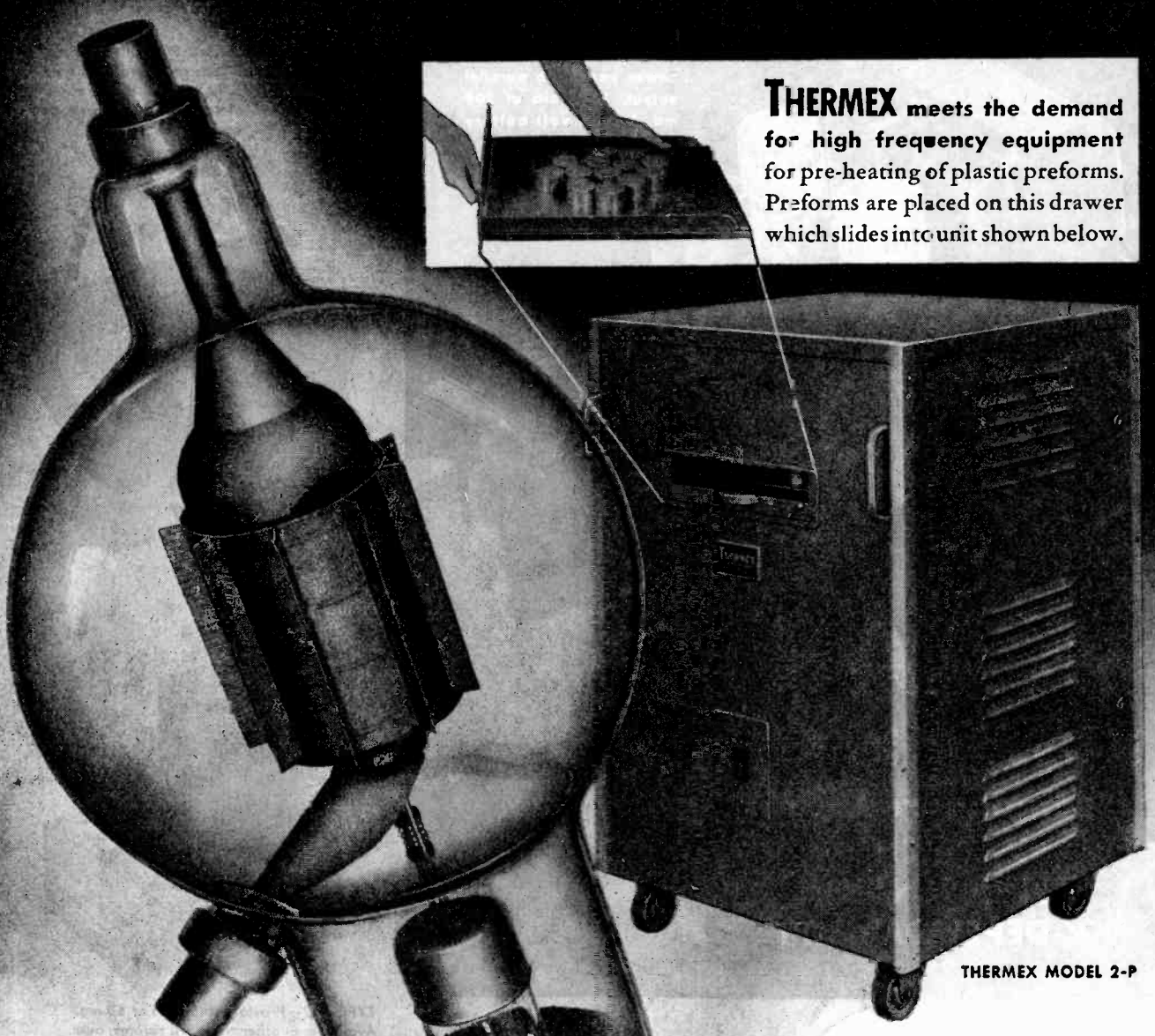

THERMEX meets the demand for high frequency equipment for pre-heating of plastic preforms. Preforms are placed on this drawer which slides into unit shown below.

THERMEX MODEL 2-P

Of course it uses Eimac tubes

This compact Thermex unit measures 28 inches by 28 inches, stands 47 inches high, and weighs only 614 pounds. It is a practical and flexible piece of equipment with built-in heating cabinet and removable 12 inch by 15 inch drawer-electrode.

Being completely automatic, there is nothing to do but plug this Thermex in and load and unload the preform drawer. No dials, no tuning, not even a button to push. Closing the preform drawer all the way in, turns on the high frequency power and timer. At the end of the prescribed time, which may be anywhere from 5 to 10 seconds up to 2 minutes, the red indicating light goes out, the operator removes the tray and unloads the preforms into the mold cavities.

The Thermex Model No. 2-P, which is illustrated, operates at a frequency of 25 to 30 megacycles using 230 volt 60 cycle single phase current. It has an output in excess of 3400 BTUs per hour, and it uses a pair of Eimac 450-TH tubes. The use of electronic heating has increased production for many plastic manufacturers who

have been leaders in utilizing the science of electronics.

The Thermex Division of the Girdler Corporation of Louisville, Ky., is a leader in supplying equipment for this and other industrial applications. It's natural that Eimac tubes are used, since these tubes are first choice of leading electronic engineers throughout the world.

Follow the leaders to

Eimac
REG. U. S. PAT. OFF.
TUBES

EITEL-McCULLOUGH, Inc.

985 San Mateo Avenue, San Bruno, California

Plants located at: San Bruno, California and Salt Lake City, Utah
Export Agents: Faazer & Hansen, 301 Clay St., San Francisco 11, California, U. S. A.

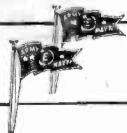

Eimac has received 7 ARMY-NAVY "E" AWARDS for production efficiency • San Bruno 5, Salt Lake City 2

it's attention to details . . .

Human skill can't be scientifically tested. That's why it is always the unknown quality in manufacturing. But experience is a reliable guide to measuring the true value of skill. In building C-D Capacitors, precision work is backed by the accumulated experience of conscientious men and women, some of whom have been with Cornell-Dubilier for nearly the whole of our 34 years of existence; others for five, ten and twenty years of loyal service.

To the human element in making C-D Capacitors are added the finest facilities—the careful selection of flawless materials. These, together with the expert workmanship of trained minds and skilled hands, have given Cornell-Dubilier a reputation for quality, for minute attention to every detail, and dependability since 1910. Cornell-Dubilier Electric Corporation, South Plainfield, N.J.

ALSO AT NEW BEDFORD,
BROOKLINE, WORCESTER,
MASS., PROVIDENCE, R. I.

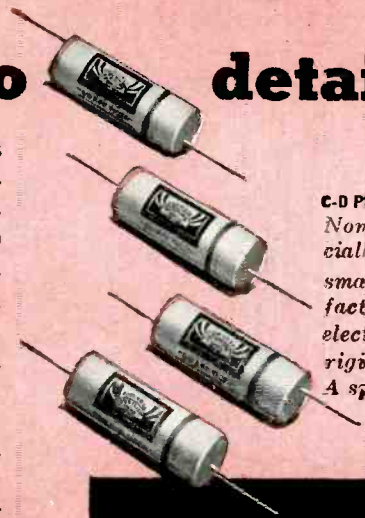

C-D PAPER TUBULAR CAPACITOR TYPE DT
Non-inductively wound, specially sealed and impregnated, small in size, with high safety factor. Type DT is uniform in electrical properties and has rigidly anchored wire leads. A specially-treated tube keeps out moisture.

CORNELL - DUBILIER CAPACITORS



MCA - DYKANOL - PAPER -
WET AND DRY ELECTROLYT CS



A NEW VARIAC FOR 400 TO 2600 CYCLES

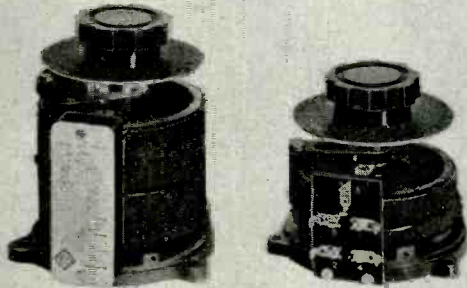

200-CU NEW 60-AU
60 ~ 400-2600 ~
SAME POWER RATING

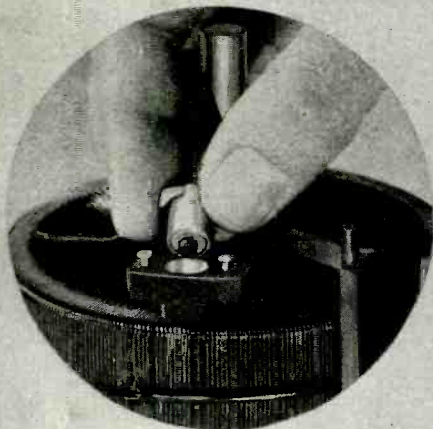

UNIT BRUSH — REPLACED IN
A FEW SECONDS

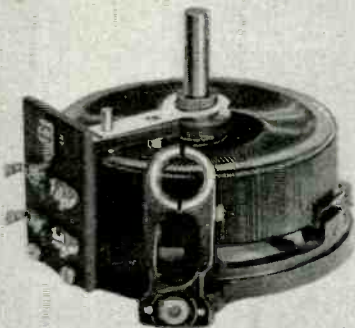

POSITIVE ROTOR CONTACT
WITH NO PIGTAILS

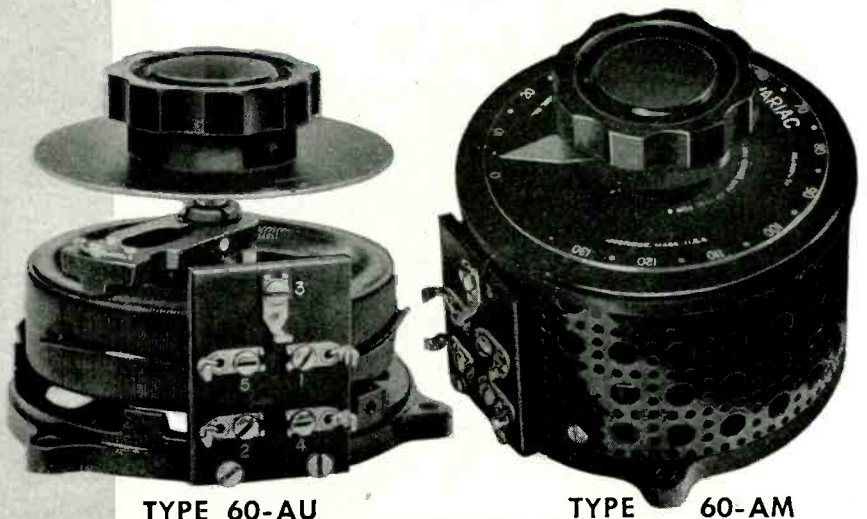

TYPE 60-AU

TYPE 60-AM

DESIGNED for an increasing number of applications requiring the control of power at frequencies higher than 60 cycles, this new VARIAC meets the need for a unit for frequencies between 400 and 2600 cycles. It is a companion to the widely used Type 200-A having substantially the same power rating . . . 860 va; with a load current of 5 amperes, rated, and a maximum current of 7.5 amperes near zero and line voltages.

A number of new mechanical features are incorporated in the Type 60-A VARIAC. Included are:

- New unit brush construction requiring no tools for brush replacement and designed to prevent contact between brush holder and winding when the brush wears away
- Positive rotor contact with NO pigtail
- Combination screws and solder terminals
- Fully insulated hollow steel shaft
- Improved bearings, suitable for motor drive

As seen in the photograph, the Type 60-A VARIAC is considerably smaller than its 60-cycle counterpart. The Type 60-AU is priced at \$13.00 and the 60-AM at \$15.00.

Because all VARIAC production is scheduled months in advance on high priority war orders for 60-cycle models, these new VARIACS are now available only in sample quantities.

● **WRITE FOR BULLETIN 921**

VARIAC



MADE ONLY BY

GENERAL RADIO COMPANY

Cambridge 39, Mass.

NEW YORK
CHICAGO
LOS ANGELES